



# Plant Applications 8.2

Client



**Proprietary Notice**

The information contained in this publication is believed to be accurate and reliable. However, General Electric Company assumes no responsibilities for any errors, omissions or inaccuracies. Information contained in the publication is subject to change without notice.

No part of this publication may be reproduced in any form, or stored in a database or retrieval system, or transmitted or distributed in any form by any means, electronic, mechanical photocopying, recording or otherwise, without the prior written permission of General Electric Company. Information contained herein is subject to change without notice.

© 2021, General Electric Company. All rights reserved.

**Trademark Notices**

GE, the GE Monogram, and Predix are either registered trademarks or trademarks of General Electric Company.

Microsoft® is a registered trademark of Microsoft Corporation, in the United States and/or other countries.

All other trademarks are the property of their respective owners.

We want to hear from you. If you have any comments, questions, or suggestions about our documentation, send them to the following email address:

[doc@ge.com](mailto:doc@ge.com)

# Table of Contents

Using the Plant Applications Client .....	9
Logging In and Switching Users .....	9
Manually Timing Out from a Client Session.....	11
Protect Data .....	12
Accessing Web Reports.....	12
Viewing Hyperlinks.....	12
Using the Shortcut Bar.....	12
Creating Shortcuts.....	13
Create a Shortcut to an External Application.....	13
Editing Shortcuts .....	13
Rename Items on the Shortcut Bar .....	13
Edit a Link on the Shortcut Bar .....	14
Organizing Your Shortcuts .....	14
Create a Shortcut Group.....	14
Rename a Shortcut Group.....	14
Add a Shortcut to a Group .....	14
Delete a Group from the Shortcut Bar .....	15
Delete Items from the Shortcut Bar .....	15
Creating a Shortcut to a Report.....	15
Displays.....	15
Opening a Display .....	15
Identifying the Display Type .....	15
Entering Locations and Reasons in a Display.....	16
Arranging Displays .....	16
Closing a Display .....	17
Views.....	17
Creating a View .....	17
Opening a View .....	17
Saving Views .....	18
Closing a View.....	18
Server Tasks .....	18
Adding a New Server.....	18

Deleting a Server .....	19
Editing the Current Server Information .....	19
Connecting to a Different Server .....	19
Disconnecting from the Current Server .....	19
Changing your Plant Applications Password.....	19
Viewing Reports .....	20
Adding a Report to the Report Menu.....	20
Creating a Shortcut to a Report.....	20
Opening the Report Menu .....	20
Anatomy of an Alarm View Display.....	21
Editing Alarm Details .....	21
Filter and Sort Alarms.....	22
Search For Historical Alarms.....	22
Anatomy of an Autolog Display .....	23
Event-based Autolog Displays .....	23
Time-based Autolog Displays.....	23
Entering Data in an Autolog Display .....	23
Adding Comments to an Autolog Display .....	24
Viewing Product Specifications in an Autolog Display .....	24
Making Product Changes on an Autolog Display.....	24
Searching for Events in an Autolog Display.....	25
Search Shortcuts.....	25
Viewing Production Event Details in an Autolog Display .....	26
Showing Event Status in an Autolog Display .....	26
Adding a Status Column.....	26
Changing a Production Event Status in an Autolog Display .....	27
Change the Status of a Production Event .....	27
Adding a User-Defined Event .....	27
Changing the Status of a User-Defined Event.....	28
Anatomy of a Downtime Display .....	29
Changing Visible Columns in a Downtime Display .....	29
Change the Default Columns .....	30
Adding New Downtime Events.....	30

Adding Comments to a Downtime Event .....	31
Inserting Downtime Events .....	31
Editing Downtime Events .....	32
Changing Date and Time Formats in Downtime Display .....	32
Anatomy of a Downtime+ Display .....	33
Navigating the Downtime+ Display .....	34
Using Touchscreen Mode (Downtime+) .....	35
Editing Start and End Times (Downtime+).....	36
Editing Downtime Durations.....	37
Filtering Downtime+ Events .....	38
Saving a Filter .....	41
Step 1: Modify LocalSettings.xml to Capture the Filter Information .....	41
Step 2: Capture the Filter Information from the Display .....	42
Step 3: Copy the Filter Information.....	42
Step 4: Save the Filter Information in the Persistence String Display Option .....	42
Adding a Downtime Event.....	43
Finding Downtime Events .....	44
Entering Comments to a Downtime+ Display .....	46
Copying Faults and Reasons (Downtime+) .....	47
Anatomy of a Genealogy View Display .....	49
Parts of the Display .....	49
Terms.....	50
Uses.....	50
Key Data .....	50
Functions in the Genealogy View .....	51
Displaying the Inventory List.....	51
Configuring the Inventory List.....	51
Manually Moving an Event from Inventory .....	52
Staging an Event by Scanning a Barcode.....	52
Manually Completing a Running Event .....	52
Manually Unloading a Running Event .....	52
Manually Moving a Staged Event to the Running Position .....	52
Manually Unloading a Staged Event .....	53

Changing the Status of an Event.....	53
Viewing the Input History for an Input .....	53
Viewing the Event Details for an Event .....	53
Viewing the Family Tree for an Event .....	54
Viewing Production Event Data for an Event .....	54
Viewing Event Information from the Family Tree for an Event.....	54
Viewing the Production Schedule.....	55
Viewing the Pattern Details for the Producing Unit .....	55
Viewing Comments for an Event .....	55
Printing a Label for an Event .....	55
Changing Display Options for All Events.....	56
Using the Zoom Feature.....	56
Changing Unit Details Data .....	56
Changing Unit Time Frame .....	56
Saving Locations of the Input Positions .....	57
Anatomy of a Non-Productive Time (NPT) View Display.....	58
Non-Productive Time View Tool Bar .....	59
Calendar Time Scale.....	60
Change the Time Scale .....	60
Scheduling Non-Productive Time from 14:50 to 15:20 .....	60
Scheduling Non-Productive Time .....	61
Schedule Non-Productive Time.....	61
Editing Non-Productive Time .....	61
Edit Non-Productive Time.....	61
Copying Non-Productive Time (NPT) .....	62
Copy a Scheduled Non-Productive Time .....	62
Deleting Non-Productive Time .....	62
Delete Non-Productive Time .....	62
Troubleshooting .....	62
Meaning of the Gray and Green Calendar Box.....	62
Anatomy of a Production Overview Display.....	63
Anatomy of a Production Run Analyst (Operator) Display.....	64
Inserting Historical Run Summaries.....	64

## Plant Applications Client

Insert the Last Production Run Summary .....	64
Insert the Last Three Production Run Summaries .....	65
Search and Select a Run Summary from All Production Runs .....	65
Inserting Product Specifications in a Production Run Analyst Display .....	65
Insert Product Specifications .....	65
Viewing Historical Statistics in a Production Run Analyst Display .....	66
View Historical Statistics .....	66
Anatomy of a Relative View Display .....	67
Anatomy of a Schedule View Display .....	68
Sort Order .....	68
Setup Patterns .....	68
Uses of a Schedule View .....	68
Key Data .....	68
Adding a New Process Order .....	68
Add a New Process Order Manually .....	69
Adding Comments to a Process Order .....	69
Add Comments to a Process Order .....	69
Activating a Process Order .....	69
Activate a Pending Process Order .....	70
Advancing a Process Order .....	70
Advance and Edit a Process Order .....	70
Binding a Process Order to a Path .....	72
Bind a Process Order to a Path .....	72
Changing a Process Order Status .....	72
Change Any Process Order Status .....	72
Changing the Visible Columns or Rows .....	72
Select Columns Visible in the Production Schedule .....	72
Select Rows Visible in the Materials Tab (Details View) .....	73
Completing an Active Process Order .....	73
Complete an Active Process Order .....	73
Creating a Child Process Order .....	73
Create a Child Process Order .....	73
Deleting Process Order Comments .....	74

Delete the Comments for a Process Order Manually.....	74
Editing a Process Order .....	74
Edit a Process Order .....	74
Editing Process Order Run Times .....	74
Edit Process Order Run Times for a Process Order .....	75
Editing Process Order Comments .....	75
Edit the Comments for a Process Order .....	75
Moving a Process Order Backward .....	75
Move a Process Order Backward.....	75
Moving a Process Order Forward .....	76
Move a Process Order Forward .....	76
Pausing a Process Order .....	76
Pause a Process Order Manually.....	76
Reworking a Process Order .....	76
Rework a Process Order .....	76
Returning Child Process Order to Parent .....	76
Return to Parent Process Order from a Child Process Order .....	77
Unbinding a Process Order from a Path .....	77
Unbind a Process Order from a Path .....	77
Viewing a Specific Time in the Schedule .....	77
View a Specific Time in the Schedule .....	77
Viewing Child Process Orders .....	77
View Child Process Orders for a Process Order.....	77
Viewing Parent Process Orders .....	77
View Parent Process Orders for a Child Process Order .....	78
Viewing the Process Order History .....	78
View Historical Changes for a Process Order .....	78
Viewing Process Order Comments.....	78
View Comments for a Process Order .....	78
Anatomy of a Sequence of Events (SOE) Display.....	79
Adding User-Defined Events.....	79
Add a User-Defined Event.....	79
Modifying Event Details in an SOE Display .....	80



Anatomy of a Trend Display .....	81
Viewing Trend Details .....	81
Changing the Time Range .....	81
Anatomy of a Waste Display .....	82
Adding Waste Events to a Waste Display.....	82
Add a Waste Event.....	82
Changing Visible Columns in a Waste Display .....	83
Display or Hide Columns .....	83
Commenting Waste Events in a Waste Display.....	83
Comment Waste Events.....	84
Anatomy of a Waste+ Display .....	85
Navigating the Waste+ Display .....	86
Using Touchscreen Mode (Waste+) .....	86
Enter the Touch Screen Mode .....	87
Editing Event Timestamp (Waste+) .....	87
Edit an Event Timestamp .....	88
Filtering Waste+ Events .....	88
Use the Advanced Filter .....	89
Filter by Waste Amounts .....	91
Show or Hide Confirmed Waste Events .....	91
Saving a Filter .....	92
Step 1: Modify LocalSettings.xml to Capture the Filter Information .....	92
Step 2: Capture the Filter Information from the Display .....	92
Step 3: Copy the Filter Information.....	92
Step 4: Save the Filter Information in the Persistence String Display Option .....	93
Adding a Waste+ Event .....	93
Manually Enter a Waste Event .....	93
Finding Waste Events .....	94
Search for a Waste Event.....	95
Entering Comments for a Waste+ Display.....	96
Add Comments to a Waste+ Event .....	96
Copying Faults and Reasons (Waste+) .....	98
Copy Faults and Reasons .....	98

SQL Connection Error ..... 99

Data Outside Visible Time Range ..... 99

Display Does Not Open ..... 99

Display Has Been Deleted ..... 99

Grid Population Fails ..... 100

Unknown or Unhandled Error Condition ..... 101

Validating a Downtime+ or Waste+ Result Set ..... 101

## Using the Plant Applications Client

The Plant Applications Client provides a customizable environment for using Plant Applications views and displays to access your plant data. Access to views and displays is determined by your user name and password. A merged, Manufacturing Database (MDB) is available with Plant Applications, version 6.0. If Plant Applications has been merged with S95 in Proficy SOA, the Plant Applications Client displays will reflect the merged data.

---

**TIP:** If you are using Windows Authentication and logging into a domain other than the default domain, you will need to include the fully qualified domain name (FQDN). Contact your site administrator if you need assistance.

---

The Plant Applications Client has these functions:

- Contains all Plant Applications controls and displays
- Allows for user customizable environment
- Contains built-in cross-application automation
- Allows for direct access to content on Plant Applications Web Server

---

**NOTE:** If you do not have access to a particular **display**, which is part of a **view**, you will still be able to open the **view**, but you will see a message informing you that you do not have permission to open the particular **display**.

---

Different Plant Applications modules enable different types of displays in the Plant Applications Client. Each display is also exposed as an ActiveX control, and may be used outside of the Plant Applications Client in any ActiveX container, such as Intellution's iFIX Workspace.

Plant Applications Client sessions can be configured by an administrator to automatically time out and enter a protected state. When you log back in, displays to which you have access are reopened. Also refer to Manually Timing Out from a Client Session.

A number of Plant Applications displays are available for viewing through the Proficy Client, which is installed as part of Proficy Workflow. Thus, Proficy Client users have available a way to consolidate displays into a single client for viewing. Plant Applications licensing is required to view Plant Applications displays in the Proficy Client. Refer to Using Plant Applications Displays in the Proficy Client to set up the Proficy Client to view Plant Applications displays.

## Logging In and Switching Users

---

This information applies to the Plant Applications Client program.

---

You may be required to provide credentials to log into the Client. While working in the Plant Applications Client, another user can log in without having to close and then re-open the Plant Applications Client.

To log in:

When you start the Plant Applications Client, you are challenged for authentication if your current credentials (user name and password) do not match requirements. For example, if Windows authentication is not enabled, you must use Plant Applications (Proficy) credentials. When challenged for credentials by the Plant Applications Server Login dialog, follow these steps:

1. Select **Proficy Authentication** to submit a user name and password defined in Plant Applications. Optionally, select **Windows Authentication** to submit credentials that are your Windows authentication credentials.

2. If choosing **Windows Authentication**, choose the domain name from the drop-down selection. If your domain is not listed, enter the fully qualified domain name (FQDN).

To switch users:

1. From the **File** menu, select **Switch User**. The Plant Applications Server Login dialog box appears.
2. The new user should do the following:
  - a. In the **UserName** box, type your Plant Applications user name.
  - b. In the **Password** box, type your Plant Applications password.
  - c. Click **OK**.

## Manually Timing Out from a Client Session

An option is available in the Plant Applications Client to manually initiate a session timeout, thus requiring a user to log back in. To initiate a manual session timeout, do one of following:

- Select **Session Timeout** from the File menu.
- Mouse-over and click the **Session Timeout** button  from the Client toolbar.

# Common Tasks

## Protect Data

---

[This information applies to the Plant Applications Client program.](#)

---

The **Unauthenticate** feature is a security feature that helps ensure the integrity of your data. If you activate this feature, verification will be required for any changes made.

To help prevent unauthorized changes, you can activate the **Unauthenticate** feature to ensure that any changes will require user verification. This helps prevent unauthorized changes, in the event you leave your workstation unattended.

After a change has been approved, the **Unauthenticate** feature becomes available. After you activate the feature, it is not available unless a change has been made.

If Data Security User sign-off or Data Security Approver sign-off has been given, any changes will reset the sign-off status to **<Unapproved>**.

---

*The **Unauthenticate** feature will be available only if electronic signature authorization is required for some element of the display, such as variables or products.*

---

To activate the Unauthenticate feature:

- Do one of the following:
  - From the **File** menu, select **Unauthenticate**.
  - On the toolbar, click the **Unauthenticate** button .

## Accessing Web Reports

---

[This information applies to the Plant Applications Client program.](#)

---

You can gain access to reports that have been published to the Plant Applications Web Report server, without having to log out of the Plant Applications Client. Keep in mind that the Web content that is available to you is determined by your Plant Applications user name and password.

To gain access to Plant Applications web reports:

1. From the **File** menu, click **Open Report Menu**.
2. Type your Plant Applications user name and password and click **Logon**.

## Viewing Hyperlinks

If enabled, the HyperLinks Menu is displayed in the default location with the default size, or if the Hyperlinks Menu was previously resized or repositioned during the current Schedule View session, it is displayed according to these settings.

To display the HyperLinks menu:

- Select Display HyperLinks from the View Menu, or click the Display HyperLinks tool icon.

## Using the Shortcut Bar

The Shortcut Bar is an additional menu bar within the Plant Applications Client. There are basically two types of shortcuts you can add to the Shortcut Bar: shortcuts to Displays and shortcuts to external applications. You can create shortcuts to Displays on different servers and shortcuts to external applications, such as Excel.

To help you organize your shortcuts, you can create Groups on the Shortcut Bar. You can either create your Groups first and then add the shortcuts to a Group, or you can add your shortcuts, create your Groups and then add the shortcuts to the Groups.

To open the Shortcut Bar do one of the following:

- From the **Window** menu, select **Shortcut Bar**.
- Press **Ctrl + B**.

## Creating Shortcuts

---

[This information applies to the Plant Applications Client program.](#)

---

Adding shortcuts to your Shortcut Bar allows you quick access to a displays and external applications or documents by clicking the shortcut.

You can create shortcuts to displays on the current server or even on other servers. You can also create a shortcut to an external application, such as Excel.

To create a shortcut to a display:

1. Open the Shortcut Bar.
2. If your Shortcut Bar is organized by [Groups](#), select the desired group.
3. Open a display.
4. Right-click on the Shortcut Bar and click **Add Shortcut to Current Display**.

---

*If you have more than one display open, the active display will be added to the Shortcut Bar.*

---

### Create a Shortcut to an External Application

1. Open the Shortcut Bar.
2. If your Shortcut Bar is organized by [Groups](#), select the desired group.
3. Right-click on the Shortcut Bar and click **Add Link to External Application**. The **Select Executable to Link** dialog box appears.
4. Navigate to the application (\*.EXE) you want to link to and click **Open**.

---

*The new link is added as **New ListItem**.*

---

5. To rename the short cut, right-click on the shortcut and click **Rename Item**. The name field becomes editable. Type the new name and press **ENTER**.

## Editing Shortcuts

---

[This information applies to the Plant Applications Client program.](#)

---

You can change the name of a shortcut, if the shortcut is to a Display. If the shortcut is to an external application (a link), such as Excel, you can rename it, determine whether to allow opening more than one session of the application, and have it open a specific file or web page.

### Rename Items on the Shortcut Bar

1. Right-click on the shortcut and click **Rename Item**.

2. Type the new name of the shortcut and press **ENTER**.

### Edit a Link on the Shortcut Bar

1. Right-click on the link on the Shortcut Bar and click **Edit Link**. The **Edit Shortcut Details** dialog box appears.
2. Do one or more of the following:
  - a. To change the name of the shortcut, type the new name in the **Shortcut Name** box.
  - b. In the Parameters box, you can type the path to a specific file to be opened by the linked-to application. For example, if you created a link to Microsoft Word, you can type the path to a specific .DOC file and that file will open when you click the link. Additionally, if you created a link to Internet Explorer, you can type the URL of the page you want to open when you click the link.

---

*If the path has spaces in it, you must enclose the complete path in double quotation marks (" ").*

---

*If your path is a URL, you do not have to include the "http:\\".*

---

- c. In the **Allow Multiple Links** box, do one of the following:
  - o Select **True** if you want to allow opening multiple sessions of the application.

---

*To open multiple sessions, right-click on the link and select **Open in New Window** from the pop-up menu.*

---

- o Select **False** if you want to allow opening only one session of the program.

## Organizing Your Shortcuts

[This information applies to the Plant Applications Client program.](#)

By default, the Shortcut Bar has a **Main** Group. To help you organize your shortcuts, you can create additional groups on the Shortcut Bar. You can either create your groups first and then add the shortcuts to a group, or you can add your shortcuts, create your groups and then add the shortcuts to the groups.

### Create a Shortcut Group

1. Open the Shortcut Bar. [How?](#)
2. Right-click on the Shortcut Bar and click **Add New Group**.

---

*The group is added as **New Group**.*

---

### Rename a Shortcut Group

1. Select the group you want to rename.
2. Right-click on the group and click **Rename Group**. The group name becomes editable.
3. Type the new group name and press **ENTER**.

### Add a Shortcut to a Group

Do one of the following:

- To add an existing shortcut to a group, click and drag the shortcut to the desired group.
- To add a new shortcut to a group, see [Creating Shortcuts](#).



### Delete a Group from the Shortcut Bar

1. Select the group you want to delete.
2. Right-click on the group and click **Delete Group**.

### Delete Items from the Shortcut Bar

Right-click on the shortcut and click **Delete Item**.

## Creating a Shortcut to a Report

---

[This information applies to the Plant Applications Client program.](#)

---

To create a shortcut to a Plant Applications report:

1. Open the Shortcut Bar. [How?](#)
2. Open the desired report.
3. If your Shortcut Bar is organized into groups, select the desired Shortcut group. See [Organizing Your Shortcuts](#) for more information about Shortcut groups.
4. Right-click on the Shortcut Bar and click **Add Shortcut to Current Display**.

## Displays

---

[This information applies to the Plant Applications Client program.](#)

---

After logging in to the Plant Applications Client, you will need to open either a View or Display. Keep in mind that the user name and password you used to log in to the Plant Applications Client will determine the Views and Displays you have access to.

---

*If you are running a Manufacturing Database (MDB), entities are aspected from Proficy SOA to Plant Applications and vice versa to form a merged database. Data in displays will reflect the combined data. Refer to the Proficy Client Help for a description of the MDB created through the MESCore Service Provider.*

---

### Opening a Display

1. From the **File** menu, select **Open Display**. The **Open Display** dialog box appears.
2. Do the following:
  - a. **optional:** Under **Server**, select a different server from the drop-down list, or click **Browse**  to select a new server.
  - b. Under **Available Displays** locate the desired Display.

---

*Each display type is identified by an icon. Click [here](#) for more information.*
  - c. Click **OK**.
3. If you are prompted to load a new toolbar, click **Yes**.

### Identifying the Display Type













---

[This information applies to the Plant Applications Client program.](#)

---

Each display has an icon associated with it to help you quickly and easily identify it.

Icon	Display Type
------	--------------

	Alarm View
	AutoLog
	Down Time
	Genealogy View
	Non-Productive Time View
	Production Overview
	Production Run Analyst
	Relative View
	Schedule View
	Sequence of Events View
	Trend View (Normal)
	Trend View (SPC)
	Waste View

## Entering Locations and Reasons in a Display

This information applies to the Plant Applications Client program.

If you have configured your reason trees, you can associate locations and reasons to specific events within a display.

1. In the display, scroll to the Location column.
2. Select a location from the drop-down list. Locations must be selected before reasons. To delete a reason, click **Delete**.

Start Date	Start Time	End Time	Duration	Product	Location	Fault	C.S.
26-Jul	05:49	07:08	79.0 Min	BSTK65	TM1 Dry End	Web Break	
26-Jul	03:48	05:18	93.0 Min	BSTK65	TM1 Dry End	Web Break	
25-Jul	11:57	13:43	106.3 Min	BSTK45	TM1 Dry End	Web Break	
	11:57:24	12:28:41	31.3	BSTK45	TM1 Dry End	Web Break	
	12:28:41	13:06:12	37.5	BSTK45	TM1 Wet End	Unknown	
	13:06:12	13:43:42	37.5	BSTK45	TM1 Dry End	Missed TU	
25-Jul	11:24	11:27	3.0 Min	BSTK45	DM1 Wet End	Web Break	
25-Jul	08:48	08:53	5.1 Min	BSTK45	TM1 Address	Web Break	
					TM1 Inventory		

3. The first reason level must be selected first, the second reason level second, and so on, up to the fourth reason level.

Start Date	Start Time	End Time	Fault	Category	Reason
26-Jul	05:49	07:08	Web Break		
26-Jul	03:48	05:18	Web Break		
25-Jul	11:57	13:43	Web Break		
	11:57:24	12:28:41	Web Break		
	12:28:41	13:06:12	Unknown	Unsched Mech	015 BELT
	13:06:12	13:43:42	Missed TU		011 FAN
					012 FANER
					016 BELT
25-Jul	11:24	11:27	Web Break		024 BELT
25-Jul	08:48	08:53	Web Break		030 FAN
25-Jul	06:49	08:10	Web Break		023 BELT
25-Jul	04:49	06:19	Web Break		

## Arranging Displays

This information applies to the Plant Applications Client program.

Displays can be either **docked** or **tabbed**.

To change the layout of displays:

1. From the Window menu, select Dock Current Display.

By default, the current display will be docked at the bottom of the screen.

2. To move a docked window, place the mouse pointer over the display's frame and click and drag the display to the desired position.

## Closing a Display

---

This information applies to the Plant Applications Client program.

---

To close a display, do one of the following:

- From the **File** menu, select **Close Display**.

---

*If you have a **View** open, selecting **Close Display** will close the topmost display in the view. In other words, the active display will be the one that is closed.*

---

- Click the **Close**  button on the Display.

## Views

---

This information applies to the Plant Applications Client program.

---

Views are a collection of displays and shortcuts. The only way to create a view is within the Plant Applications Client. You cannot use the Plant Applications Administrator to create a view.

### Creating a View

1. Open and position displays as desired.
2. Add any desired shortcuts to the Shortcut Bar, and add any reports to the Report Menu.
3. Format open displays as desired, such as Time Formatting, Column Visibility, Column Widths, and Comment Visibility.
4. From the **File** menu, click **Save View As**. The **Save View As** dialog box dialog box appears.
5. Do the following:
  - a. **optional:** Select a different server from the **Server** drop-down list, or click **Browse**  to select a different server.
  - b. In the **View Name** box, type the name of your View.
  - c. Click **OK**.

### Opening a View

---

This information applies to the Plant Applications Client program.

---

After logging in to the Plant Applications Client, you will need to open either a view or display. Keep in mind that the user name and password you used to log into the Plant Applications Client will determine the views and displays you have access to.

To open a view:

1. From the **File** menu, select **Open View**. The **Open View** dialog box appears.
2. Do the following:
  - a. **optional:** Under **Server**, select a different server from the drop-down list, or click **Browse**  to select a new server.
  - b. Under **Available Views**, locate the desired view.
  - c. Click **OK**.
3. If you are prompted to load a new toolbar, click **Yes**.

## Saving Views

---

This information applies to the Plant Applications Client program.

---

Views are a collection of Displays and Shortcuts. Within the Plant Applications Client, you can open the Displays, arrange them in the order you want to view them on your screen, and then save them as a View. The positions of the Displays within the View are permanently saved, so that the data displayed and the look and feel remains consistent regardless of who opens the View.

To save changes to a view:

1. Open the View and make the desired changes.

---

*Before you can save any changes, you will need to click on every display in the view.*

---

2. From the **File** menu, click **Save View**.

## Closing a View

---

This information applies to the Plant Applications Client program.

---

To close a View:

From the **File** menu, click **Close View**.

## Server Tasks

Regardless of the Display or View you have open, you can perform several server-related tasks.

[Add a new server](#)

[Delete a server](#)

[Edit the current server](#)

[Connect to a different server](#)

[Disconnect from the current server](#)

[Change your password](#)

## Adding a New Server

---

This information applies to the Plant Applications Client program.

---

1. From the **File** menu, click **Server**. The **Connect Server** dialog box appears.
2. Right-click inside the dialog box and click **New**. The **Server** dialog box appears.
3. Do the following:
  - a. In the **Server Name** box, type the name of the server you want to add.
  - b. In the **User** box, type your Plant Applications user name.
  - c. In the **Password** box, type your Plant Applications password.
  - d. Click **Advanced** to set this server as the default server or to automatically connect to this server when you log on to the Plant Applications Client.

---

*If you select the **Default Server** option, the **Connect at Startup** option is automatically selected.*

---

- e. Click **OK**.

4. Click **Close**.

## Deleting a Server

---

[This information applies to the Plant Applications Client program.](#)

---

1. From the **File** menu, select **Server**. The **Connect Server** dialog box appears
2. Right-click on the server you want to delete and click **Delete**.
3. Click **Yes** to confirm the deletion.

## Editing the Current Server Information

---

[This information applies to the Plant Applications Client program.](#)

---

1. From the **File** menu, select **Server**. The **Connect Server** dialog box appears
2. Right-click on the server you want to edit and click **Edit**. The **Server** dialog box appears.
3. Make any necessary changes and click **OK**.
4. Click **Close** to close the **Connect Server** dialog box.

## Connecting to a Different Server

---

[This information applies to the Plant Applications Client program.](#)

---

You must have a site user name and password on the server you want to connect to.

Before you can connect to a different server, you'll need to first add it. Click [here](#) for information on adding a server.

1. From the **File** menu, select **Server**. The **Connect Server** dialog box appears.
2. Right-click on the server you want to connect to and click **Connect**.
3. When prompted, enter your user name and password and click **OK**.

## Disconnecting from the Current Server

---

[This information applies to the Plant Applications Client program.](#)

---

1. From the **File** menu, select **Server**. The **Connect Server** dialog box appears.
2. Right-click on the server you want to disconnect from and click **Disconnect**.
3. Click **Close**.

## Changing your Plant Applications Password

---

[This information applies to the Plant Applications Client program.](#)

---

When you change your password, you are changing it only for the selected server. You must use the new password for everything you have access to on the selected server.

1. From the **File** menu, select **Server**. The **Connect Server** dialog box appears.
2. Right-click on the desired server and click **Change Password**. The **Plant Applications Server Change Password** dialog box appears.
3. Do the following:
  - a. In the **Old Password** box, type your current password.

- b. In the **New Password** box, type your new password.
  - c. In the **Retype Password** box, retype your new password.
  - d. Click **OK**.
4. Click **Close**.

## Viewing Reports

---

This information applies to the Plant Applications Client program.

---

The Report menu is a way to quickly access often-used reports.

### Adding a Report to the Report Menu

1. Open the Shortcut Bar. [How?](#)
2. While viewing the report you want to add, right-click on the Shortcut Bar and click **Add Current Report to Reports Menu**.
3. From the **Tools** menu, click **Reports**. The list of reports currently attached to the Report menu will be displayed.
4. Selecting the report in the Report menu will browse to the report directly without the Web Client menu.

### Creating a Shortcut to a Report

---

This information applies to the Plant Applications Client program.

---

To create a shortcut to a Plant Applications report:

1. Open the Shortcut Bar. [How?](#)
2. Open the desired report.
3. If your Shortcut Bar is organized into groups, select the desired Shortcut group. See [Organizing Your Shortcuts](#) for more information about Shortcut groups.
4. Right-click on the Shortcut Bar and click **Add Shortcut to Current Display**.

### Opening the Report Menu

---

This information applies to the Plant Applications Client program.

---

Opening the Report menu provides you access to all the Web reports that have been created and are available to you based on your user name and password.

To open the Report menu:

1. From the **File** menu, select **Open Report Menu**.
2. The report window will open your default Plant Applications Web Server. You may be required to type your Plant Applications user name and password if the system cannot automatically authenticate you.

---

*After using the Web Server, click the **Logout** button  to prevent unauthorized access to your Web reports.*

---

# Alarm View Display

## Anatomy of an Alarm View Display

---

This information applies to the Plant Applications Client program.

---

The Alarm View Display is a real-time application designed to show active and historical alarms on key variables. Alarms conditions are based on alarm rules that compare data to product-based specification limits in real time. In order to use the Alarm View Display, you must first configure alarms. Refer to How to Configure Alarms. Key elements of the display include the following:

- Acknowledgement column showing Yes or No
- Comments shown below each Alarm
- Time Range of Alarm shown
- Cause Reasons shown
- Actions taken shown

### Key Uses

- Alarm critical variables and require acknowledgement
- Expose operating procedures on alarm conditions
- Enter Reasons and Comments for alarm conditions

### Key Data

- Alarm start times and end times
- Alarm condition
- Alarm Cause Reasons and corrective actions
- Alarm comments

## Editing Alarm Details

To edit alarm details:

---

This information applies to the Plant Applications Client program.

---

1. In the Alarm View display, double-click an alarm or right-click an alarm and select **Edit Alarm**. The **Edit Alarm** dialog box appears.
2. On the **General** tab, select or clear **Ack Status**. Selecting Ack Status will acknowledge the alarm. Clearing Ack Status will set the alarm status to Not Acknowledged.
3. On the **Cause** tab, select a cause for the user-defined event.
4. On the **Actions** tab, select an action for the user-defined event.
5. On the **Research** tab, do the following:
  - a. From the **User** list, select a user who is responsible for researching the user-defined event.
  - b. From the **Research Status** list, choose either **Open** or **Closed**.
  - c. Click **Open Date** to identify the date the case was opened.

- d. Click **Close Date** to identify the date the case was closed.
6. Click the **History** tab to view a history of the event.
7. Click **OK** when finished.

## Filter and Sort Alarms

---

[This information applies to the Plant Applications Client program.](#)

---

1. Right-click within the Alarm window.
2. Select Filter Options.
3. Select Alarm Priorities and Acknowledgement.
4. Select OK when finished.

## Search For Historical Alarms

---

[This information applies to the Plant Applications Client program.](#)

---

1. Select an Alarm to research history for.
2. Right-click within the Alarm window.
3. Select Quick Search.
4. Quick Search will find recent Alarms for the selected Variable.
5. For A Complex Query, right-click and select Query Wizard.
6. Identify Alarm Variables to search.
7. Identify Alarm Variables to search for.
8. Select other Search Criteria such as Priority and Reasons.
9. Select Search to return results to the Alarm Window.



# Autolog Display

## Anatomy of an Autolog Display

Autolog displays are identified by the Autolog icon . The information in this topic applies to the Plant Applications Client program.

Production Event and User-Defined Event (UDE) data may be locked based on the event status to prevent changes. Only transitions to other locked statuses are allowed for statuses that have been locked. In Autolog displays, related data-entry fields are locked.

Data can be entered, filtered, and summarized by time or event. Comments, product specifications, and operating procedures can be applied and reviewed.

Based upon the quality of the data, disposition decisions can be made.

You can view more information about a cell, including its status, by right-clicking on the cell and selecting **Cell Information**.

### Event-based Autolog Displays

- Variables on the left side of Display
- Values are color coded by alarm limit
- Comments are indicated with an underline
- Event information at the top of each column
- Test scheduling indicated by cell background color
- Product specification for each cell shown along the bottom

### Time-based Autolog Displays

- Time interval at the top of each column
- Manually entered values in cells
- Automatic process data from historian shown in cells
- Comment window at the bottom

## Entering Data in an Autolog Display

This information applies to the Plant Applications Client program.

---

**NOTE:** The “unavailable” status of an Autolog cell means there is no data available to populate the cell. For example, test data is collected less frequently than the Autolog display is updated. Unavailable cells may be locked so that only an administrator can enter a value.

---

To enter data:

1. Select the cell where you want to enter the data.
2. Press the spacebar to activate the cell.
3. Do one of the following:

- If the variable is a custom data type (defines what data can be entered in the variable cell), select a value from the drop-down list.
- Type the value into the cell.

## Adding Comments to an Autolog Display

---

This information applies to the Plant Applications Client program.

---

Adding comments is a great way to provide additional information. Comments can be either text that you type or you can paste a link to an external document, such as a Microsoft Word document.

Keep in mind that if you paste a link to a document, the document cannot be moved to a different folder or directory; otherwise, the link will be broken and the document will not be found.

To add comments to data in a cell:

1. Select the cell.
2. Right-click and choose **View Comments**. The **Comment** dialog box appears.
3. In the Comment box, type your comments or paste a link to an external file.
4. Click the **Save Comment** button . The value in the cell will be underlined.

To add comments to column or row headings:

1. Click the column or row heading you want to comment. The **Comment** dialog box appears.
2. In the Comment box, type your comments or paste a link to an external file.
3. Click the **Save Comment** button . The value in the cell will be underlined.

## Viewing Product Specifications in an Autolog Display

---

This information applies to the Plant Applications Client program.

---

You can view a variety of product specifications for each variable in your Autolog Display. When you add a specification, a column for each value is added to the Autolog Display.

---

*Adding too many specifications will prevent you from scrolling to the data columns.*

---

To view Product Specifications:

- While viewing an Autolog Display, select the **View** menu and then do one or more of the following:
  - Click **Reject Limit Columns** to view the upper and lower reject limits for all variables
  - Click **Target Column** to view the target specification for all variables
  - Click **User Limit Columns** to view the upper and lower user limits for all variables
  - Click **Warning Limit Columns** to view the upper and lower warning limits for all variables
  - Click **Test Frequency Column** to view the test frequency for all variables

## Making Product Changes on an Autolog Display

---

This information applies to the Plant Applications Client program.

---

You can either add a product to change or you can update a product change.

To Make Product Changes:

1. While viewing your Autolog Display, select the **Actions** menu, and then click **Change Product**.
2. In the **Change Product** dialog box, under **Product Changes On Sheet**, click the production unit.
3. Under **Products**, select the product you want to change to and then click **Add**.
4. **optional:** Under **Start Time** change the date and time you want the product change to occur.
5. Click **OK**.

To Update a Product Change:

1. While viewing your Autolog Display, select the **Actions** menu, and then click **Change Product**.
2. In the **Change Product** dialog box, under **Product Changes On Sheet**, click the product change you want to update.
3. Do one or more of the following:
  - To change the start time, under **Start Time**, change the start date and time.
  - To change the product, under **Products**, click a different product.
4. Click **Update**.
5. Click **OK**.

## Searching for Events in an Autolog Display

---

[This information applies to the Plant Applications Client program.](#)

---

To search for events:

1. From the **Tools** menu, click **Goto Event**. The **Search Production Event <event name>** dialog box appears.
2. Do one of the following:
  - To search for search for a specific event, in the **<event name> Search** box, type the event number, or any portion of the event number, and click **Search**.
  - To search for all events, click **Search**.
3. In the list of events, select the event you want to go to and click **OK**.

## Search Shortcuts

In an Autolog display, you can quickly locate and put focus on a specific cell using either your keyboard or a scanner. If you are using a keyboard, there is no visual indication that anything is happening.

---

**NOTE:** *You can enter the timestamp first and then the variable ID or enter the variable ID first and then the timestamp.*

---

To locate a variable:

1. Type or scan the tilde character (~).
2. Type or scan the variable ID.

3. Press **ENTER** or scan a carriage return.
4. Type or scan the tilde character (~).
5. Type or scan the timestamp of the variable using the format: YYMMDDHHMMSS
6. Press **ENTER** or scan a carriage return.

**EXAMPLE:** Using the keyboard to locate the value for a variable with the ID of 2 and with a timestamp of 29-Nov-06 09:30:25, you would type:

1. ~
2. 2
3. Press **ENTER**.
4. ~
5. 061129093025
6. Press **ENTER**.

## Viewing Production Event Details in an Autolog Display

---

This information applies to the Plant Applications Client program.

---

To view Production Event details:

1. Open the desired Autolog Display.
2. Scroll to the column of the Event to edit and select a cell in the Event's column.
3. From the **Action** menu, click **Edit <event name>**.
4. In the **<event name> Information** dialog box, make any necessary changes.
5. Click **OK**.

## Showing Event Status in an Autolog Display

---

This information applies to the Plant Applications Client program.

---

If you do not see **Status** as a column heading in your Autolog display, you can edit the display options to temporarily view it. If you want to permanently add **Status** as a column heading, you will need to save the display as a view ([How?](#)).

Production and User-Defined Event data may be locked based on the event status to prevent changes. Only transitions to other locked statuses are allowed for statuses that have been locked. In an Autolog display, related data-entry fields are locked. Refer to Locking Production Statuses.

### Adding a Status Column

Permanently adding a Status column heading to show Production and User-Defined Event status can be done by changing the display option in the Administrator. Refer to Autolog Display Options Settings.

To temporarily add "Status" as a column heading:

1. Open the desired Autolog display.
2. From the **View** menu, click **Display Options**.

3. In the **Display Options** dialog box, on the **Display** tab, select the **Status** option.
4. Click **OK**.

## Changing a Production Event Status in an Autolog Display

---

This information applies to the Plant Applications Client program.

---

Depending on how the Autolog Display has been configured, there are two methods for changing the status of a Production Event. If the display option, **UseExtendedEdit**, is set to **True** you can use the first method. If the option is set to **False**, you will need to use the second method in order to change the Production Event status.

**UseExtendedEdit** is a display option that can be changed only through the Plant Applications Administrator.

---

*Keep in mind that this only applies if the display is an **event-based Autolog Display**.*

---

Production Event data may be locked based on the event status to prevent changes. Only transitions to other locked statuses are allowed for statuses that have been locked. In an Autolog display, related data-entry fields are locked.

### Change the Status of a Production Event

Method 1:

1. Scroll to the column of the event to edit.
2. From the **Actions** menu, click **Edit <event name>**.
3. In the **<event name> Information** dialog box, on the **General** tab, select the desired status from the **Status** drop-down list.
4. Click **Apply**.
5. Click the **Close** button to close the dialog box.

Method 2:

---

*In order to use this method, **Status** must be displayed as a column heading. Click [here](#) for more information.*

---

1. In the Autolog Display, scroll to the event whose status you want to change.
2. Click the event's status.
3. From the pop-up menu, click the status you want to change to.

## Adding a User-Defined Event

You must configure a User-Defined Event (UDE) before you can add one in an Autolog or Sequence of Events (SOE) display. For more information, see [Configuring User-Defined Events on a Production Unit](#).

To add a user-defined event:

1. Do one of the following:

- Add a new column in an Autolog UDE display.
  - Right-click an SOE event to add a UDE around it (in terms of time).
2. Select **Add User Defined Event**. The Add User-Defined Events dialog box appears.
  3. On the **General** tab, do the following:
    - a. Select the UDE from the **Event Type** list.
    - b. In the **Description** box, type a brief description of the User-Defined Event. The description will be displayed in the list of events. This step is optional.
    - c. In the Status field, select a status. The default status that was selected when creating a UDE (refer to Creating a User-Defined Event) is initially displayed.
- TIP:** If the Status field is locked and does not allow an entry, it means that a default status was not selected when creating a UDE.
- d. The **Timestamp** box is automatically filled with the timestamp of the event that you clicked in step 1. To insert the UDE at the current time, click **Now**.
  4. On the **Cause** tab, select a default cause for the user-defined event.
  5. On the **Actions** tab, select a default action for the user-defined event.
  6. On the **Research** tab, do the following:
    - a. From the **User** list, select a user who is responsible for researching the user-defined event.
    - b. From the **Research Status** list, choose either **Open** or **Closed**.
    - c. Click **Open Date** to identify the date the case was opened.
    - d. Click **Close Date** to identify the date the case was closed.
  7. Click the **History** tab to view a history of the event.
  8. Select **OK** to save the new user-defined event.

## Changing the Status of a User-Defined Event

Follow these steps to change the status of a User-Defined Event in an Autolog display:

---

*In order to use this method, **Status** must be displayed as a column heading. Click [here](#) for more information.*

---

1. In the Autolog Display, scroll to the event whose status you want to change.
2. Click the status of the event.
3. From the pop-up menu, click the status you want to change to.

User-Defined Event data may be locked based on the event status to prevent changes. Only transitions to other locked statuses are allowed for statuses that have been locked. In an Autolog display, related data-entry fields are locked.

# Downtime Display

## Anatomy of a Downtime Display

---

This information applies to the classic Downtime Display.

---

Downtime displays are identified with the Downtime icon . A downtime display interacts with real-time downtime information. It can show downtime for a single production unit (Unit mode), or it can show downtime for each unit within a production line (Line mode).

Downtime events and reasons can be manually entered or automatically detected. You can also attach comments or documents to each event.

Key elements of the display include the following:

- Red rows indicate missing reasons.
- Blue rows indicate the event has been split.
- Green rows indicate the event is in progress.
- Black rows indicate the event is complete and all the required information has been provided.
- Downtime summaries are light yellow.
- Downtime details are white and can be displayed by double-clicking on a summary row.
- Downtime comments are shown in the Comment Window at the bottom of the display and are indicated by a pencil icon .

### Key Uses

- Review automatically detected downtime events
- Manually enter downtime details
- Manually change downtime reasons
- Add comments and attach documents to downtime events

### Key Information

- Downtime start and end times
- Downtime duration
- Downtime cause location
- Downtime fault
- Downtime cause reasons
- Downtime actions reasons
- Downtime comments

## Changing Visible Columns in a Downtime Display

---

This information applies to the classic Downtime Display.



---

You can temporarily control the data that is displayed in a Downtime display by displaying or hiding columns. To specify which columns are displayed by default, you must open the Plant Applications Administrator and edit the column display options for the downtime display.



To temporarily view or hide columns:

1. From the **View** menu, click **Column Visibility**.
2. In the **Change Column Visibility** dialog box, do one or more of the following:
  - To display additional columns, under **Hidden Columns**, select the column(s) you want to display and click the **Move Selected**  button.



---

  - To display all columns, click the **Move All**  button.*
  - To hide columns, under **Visible Columns**, select the column(s) you want to hide and click the **Remove Selected**  button.

---

  - To hide all columns, click the **Remove All**  button.*
3. Click the **Close**  button to close the dialog box.

## Change the Default Columns

1. Open the Plant Applications Administrator.
2. Expand Client Management.
3. Expand Displays.
4. Double-click the Downtime display. The Edit Display dialog box appears.
5. Click the Display Options tab.
6. Under Display Columns, for each of the columns you want to appear in your downtime display, click the  **Edit** button. The Assign Property Value dialog box appears.
7. Select **True** from the Value drop-down list.
8. Click **Ok**.
9. Click the  **Save** button.
10. Click **Ok** to reload the services.
11. If your downtime display is open in the Plant Applications Client, you must close the display and re-open it to see your changes.

## Adding New Downtime Events

This information applies to the classic Downtime Display.

For information about inserting detail downtime events or splitting existing detail downtime events, see [Inserting Detail Downtime Events](#).

To add a new Downtime event:

1. While viewing the Downtime display, do one of the following:
  - From the **Actions** menu, click **Open New Event**.
  - On the toolbar, click the **Open New Event**  button.
  - Right-click on a row and select **Open New Event** from the pop-up menu.
2. Click **Yes** to add the new downtime event.
3. Enter the appropriate information for the downtime event.



---

*Most information, such as Locations, Reasons, and Categories, can be selected from a drop-down list.*

---

## Adding Comments to a Downtime Event

---

[This information applies to the classic Downtime Display.](#)

---

Adding comments is a great way to provide additional information. Comments can be either text that you type or a link to an external document, such as a Microsoft Word document.

Keep in mind that if you paste a link to a document, the document cannot be moved to a different folder or directory; otherwise, the link will be broken and the document will not be found.

To add comments to a downtime event

1. Select the detail row.

---

**NOTE:** *If you can not see any detail rows, click the **Expand All Events**  button.*

---

2. Right-click and click **Add Comment** from the pop-up menu.
3. In the Comment window, type your comments or paste a link to an external file.
4. Click the **Save Comment** button .

---

**INFORMATION:** *The pencil icon  on a row indicates that the event has a comment added.*

**INFORMATION:** *To view comments, click the desired detail row and then click the pencil button  on the toolbar.*

---

## Inserting Downtime Events

---

[This information applies to the classic Downtime Display.](#)

---

You can either insert a Downtime event or you can split single Downtime events into smaller time periods. The results are the same.

To split Downtime event times:

1. In the **Downtime** display, click the detail row where you want to insert a new detail event.

---

*If you do not see any detail rows, click the **Expand All Events**  button.*

---

2. Do one of the following:
  - In the **Downtime** column, type the number of minutes in the first portion of the detail split. For example, to split a 17-minute downtime event into two events, the first one lasting 10 minutes and the second one lasting seven minutes, type **10** into the Downtime column.
  - In the **Start Time** column, type the start time of the second downtime event. For example, if the start time of a **17-minute** downtime event is **06:24**, and you type **06:27**, you'll split the 17-minute downtime event into two events. The first event will start at **06:24** and will be a **three-minute** downtime event. The second event will start at **06:27** and will be a **14-minute** downtime event.
  - In the **End Time** column, type the end time of the second downtime event. For example, if the end time of the **17-minute** downtime event is **06:41**, and you type **06:30**, you'll split the **17-minute** downtime event into two events: **one six-minute**

event and **one 11-minute** event. The first event will start and **06:24** and end at **06:30**. The second event will start at **06:30** and end at **06:41**.

---

*If you do not see these columns, see [Changing Visible Columns](#).*

---

- Click the **Insert New Event**  button.

## Editing Downtime Events

---

*This information applies to the classic Downtime Display.*

---

You can change any of the information in a Downtime event. Be careful, though, when changing dates or times to avoid accidentally merging or splitting downtime events.

To edit a Downtime event:

1. While viewing a Downtime Display, select the desired detail row.
2. Click the cell with the information you want to change.
  - If the information is a date, a start or end time, or the downtime minutes, type the new information.
  - Most other information can be changed by selecting a different option from a drop-down list.

## Changing Date and Time Formats in Downtime Display

---

*This information applies to the classic Downtime Display.*

---

To change date or time formats:

1. From the **View** menu, click **Time Formats**. The **Select Time Format** dialog box appears.
2. Select the desired options.
3. Click **OK**.

# Downtime+ Display

## Anatomy of a Downtime+ Display

**NOTE:** Plant Applications 5.0 SIM 77, September 2012, introduced a new duration format in the Downtime+ display. To enable the format, you must add the DurationFormat node in the LocalSettings.xml file as follows:

```
<!-- Two duration formats can be used in the Downtime + display: 0.0 (default) and hh:mm:ss. The second is manually added. -->
```

```
<DurationFormat>hh:mm:ss</DurationFormat>
```

The Downtime+ display enables plant floor operators to view and edit downtime events, using either a touch screen or keyboard for navigating the display. The Downtime+ display in touch screen mode highlights information as follows:

- **Red** text indicates missing reasons.
- **Bold red** text indicates the event has been split or that the event is grouped and that one or more detail record is not complete. Events are grouped when they share adjacent start and end times.
- **Bold blue** text indicates the event has been split or that the event is grouped and that all detail records are complete.
- **Green** text indicates the event is in progress.
- Black text indicates the event is complete and all the required information has been provided.

A Downtime+ screen includes these areas:

	Start Time	End Time	Duration	Reason	
	1/10/2008 7:25:00 AM	1/10/2008 7:45:00 AM	20.00	Plant is closed	
	1/10/2008 4:20:00 AM	1/10/2008 4:40:00 AM	20.00	Operator Assist	Machine Jan
	1/10/2008 1:45:00 AM	1/10/2008 2:30:00 AM	45.00	Plant is closed	
▶ 3	1/10/2008 1:15:00 AM	1/10/2008 1:25:00 AM	10.00	Operator Assist	Machine Jan
	1/10/2008 12:50:00 AM	1/10/2008 1:00:00 AM	10.00	Operator Assist	Machine Jan
	1/9/2008 7:55:00 PM	1/9/2008 8:05:00 PM	10.00	Maintenance Assist	Adjustment n
	1/9/2008 7:10:00 PM	1/9/2008 7:15:00 PM	5.00	Major Maintenance	Engineering

**1** Click or tap **Grid Actions** to:

- Manually create a downtime event, click or tap **Insert Record**.
- Locate a downtime event within a time period, click or tap **Go to Date**. The **Date/Time Entry** panel appears.
- Hide (or view, if hidden) confirmed downtime events, click or tap **Hide Confirmed**.
- Filter on selected columns, click or tap **Build Advanced Filter**.
- Filter downtime events by length of downtime (duration), click or tap **Duration Filter** and use the slider.

**2** Click or tap **Row Actions** to:

---

*You must select a row to view or use **Row Actions**.*

---

- Expand or collapse grouped downtime events, click or tap **Expand Group**. Downtime events are grouped when there is no gap between the end-time of one event and the start-time of the next event.
- Split the selected downtime event into two separate events, click or tap **Split Record**. The **Split Value** pane appears.
- Delete the selected downtime event, click or tap **Delete**.
- Copy and paste reasons, click or tap **Copy Fault/Reasons**. To copy and paste reasons, you must first view the downtime event details, then copy and paste the reasons.

**3** Click or tap a cell in the downtime event row to edit reasons, duration, and statuses. Based on the selected cell, the appropriate panel (**4**) appears.

**4** When you click or tap a row or a cell in a row, a panel appears with the appropriate data entry tools or selections.

**5** Click or tap **Change Size Mode** to change to or from touch screen mode. This button is visible only if the display option, Allow Mode Toggle, has been set to True by the Plant Applications Administrator. For information about the display options, see Configuring a Downtime+ Display.

**6** When you change to touch screen mode, the on-screen keyboard button appears. Click this button to use the on-screen keyboard.

**7** Select values easily by dragging the sliders.

**8** The time range of the downtime events is displayed at the top of the display.

**9** Use the scroll buttons to page through the events in increments that are equal to one-fourth the time specified by the Initial Windows Setting.

## Navigating the Downtime+ Display

---

*This information applies to the Downtime+ Display.*

---

To make selections in the Downtime+ display, you can click with a mouse or tap (using your finger or stylus). You can also use the arrow keys on your keyboard to make selections and move around the display.

1. Click or tap a cell in the display or click or tap a row and use the arrow keys to select a cell. The appropriate panel is displayed.
2. Press ENTER or tap the panel. The panel becomes active.

3. Tap the buttons or press the arrow keys to choose a button or select a box and use the keypad to enter a new value.

## Using Touchscreen Mode (Downtime+)

This information applies to the Downtime+ Display.

The Downtime+ display enables the use of a touch screen. To facilitate the use of a stylus or other tapping device, you can change the size of the text and buttons. You can also use an on-screen keyboard to enter text. The Change Size Mode button is visible only if the display option, Allow Mode Toggle, has been set to True by the Plant Applications Administrator. For information about the display options, see Configuring a Downtime+ Display.

To enter touch screen mode:

1. Click or tap the **Grid Actions** tab.

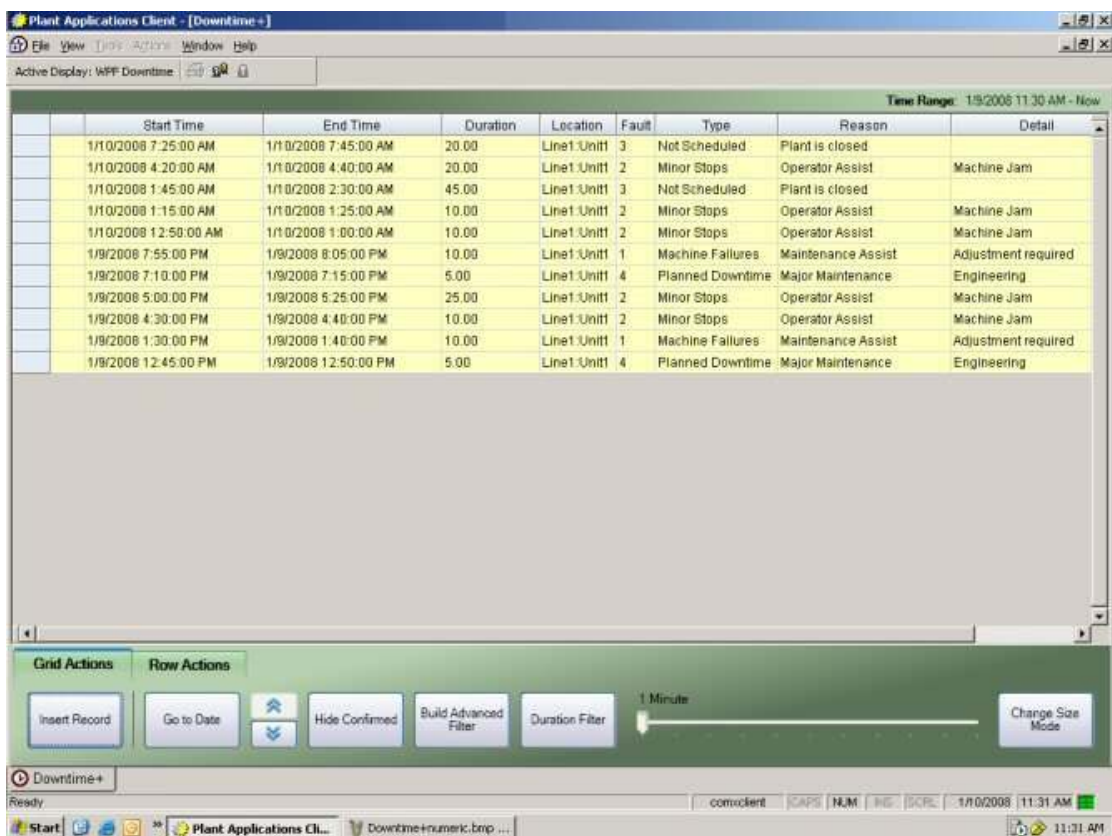

2. Click **Change Size Mode**. The text and buttons become larger and the **On-screen Keyboard** button appears.



3. Click the **On-screen Keyboard** button to open an on-screen keyboard. By default, Microsoft's On-Screen Keyboard is used.



4. Click **Change Size Mode** to exit touch screen mode.

## Editing Start and End Times (Downtime+)

This information applies to the Downtime+ Display.

Click or tap a cell in the Start Time or End Time column to display the Date/Time Entry tab where you can edit the selected time.

To edit start and end times:

1. Click or tap a cell in the **Start Time** or **End Time** column to display the **Date/Time Entry** panel.

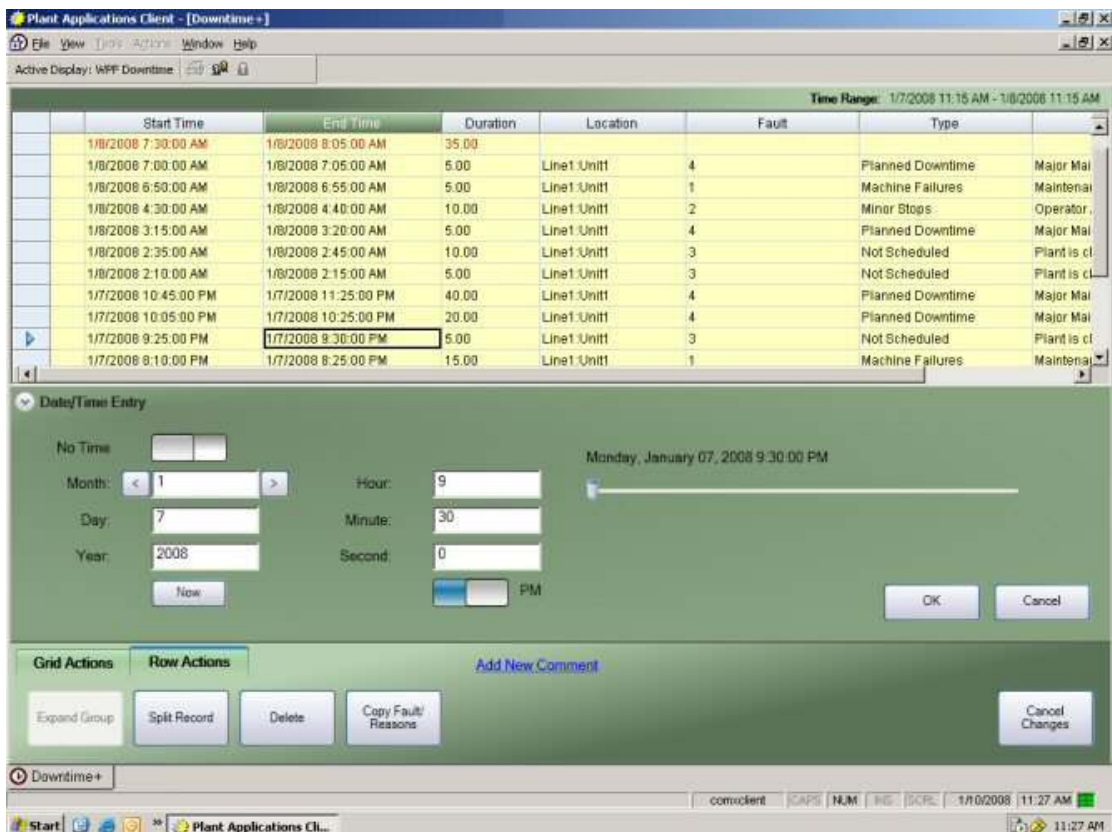

**NOTE:** You must click or tap the cell of a detail record and not a summary record.

2. Click or tap one of the entry fields to adjust the value. Click or tap the arrows to change the value.

3. When an End Time cell is selected, the **No Time** toggle appears. To create an event with no end time (open record), slide the toggle to the right and then click OK.
4. Slide the toggle to switch between AM and PM.
5. Click or tap an entry field and then use the arrow buttons or slider to select a value. The scale of the slider changes automatically based on the selected entry field.
6. Click or tap **OK** to save your changes or click or tap **Cancel** to cancel your changes.
7. After you click or tap **OK**, you can click or tap **Cancel Changes** to cancel the changes that you have made.

## Editing Downtime Durations

This information applies to the Downtime+ Display.

There are two ways to edit the duration of a downtime event.

- [Edit the start time or end time](#)
- [Edit the duration](#)

Editing the duration of the downtime event will adjust the end time of the event. Clicking or tapping a cell in the **Duration** column will display the **Numeric Entry** expander window where you can edit the duration.

To edit the duration of a downtime event:

1. Click or tap a cell in the **Duration** column. The **Numeric Entry panel** appears.



*You must click or tap the cell of a detail record and not a summary record.*

2. Click or tap in the **Value** box and use the keypad to enter a new duration value.

3. Click **OK**.

## Filtering Downtime+ Events

This information applies to the Downtime+ Display.

In the Downtime+ display, you can filter events by one or more of the values in a column. You can also filter confirmed events and filter events by duration (length of the downtime event).

Filtering uses AND logic to determine the results that are returned. This means that the records that are returned must meet **all** the criteria you select. Consider the following records:

Column 1	Column 2	Column 3
A	Red	Square
A	Yellow	Oval
A	Yellow	Oval
B	Red	Round

If you selected **A** and **B** from Column 1 and **Red** from Column 2 and **Oval** from Column 3, no records would be returned because no single row matched all criteria. However, if you selected **A** and **B** from Column 1 and **Red** and **Yellow** from Column 2 and **Square** and **Oval** from Column 3, three records would be returned.

*NOTE: When you apply filtering, summary records are not displayed; however, the detail records belonging to the summary records will be displayed.*

To use the Advanced Filter:

1. Click or tap **Grid Actions**.

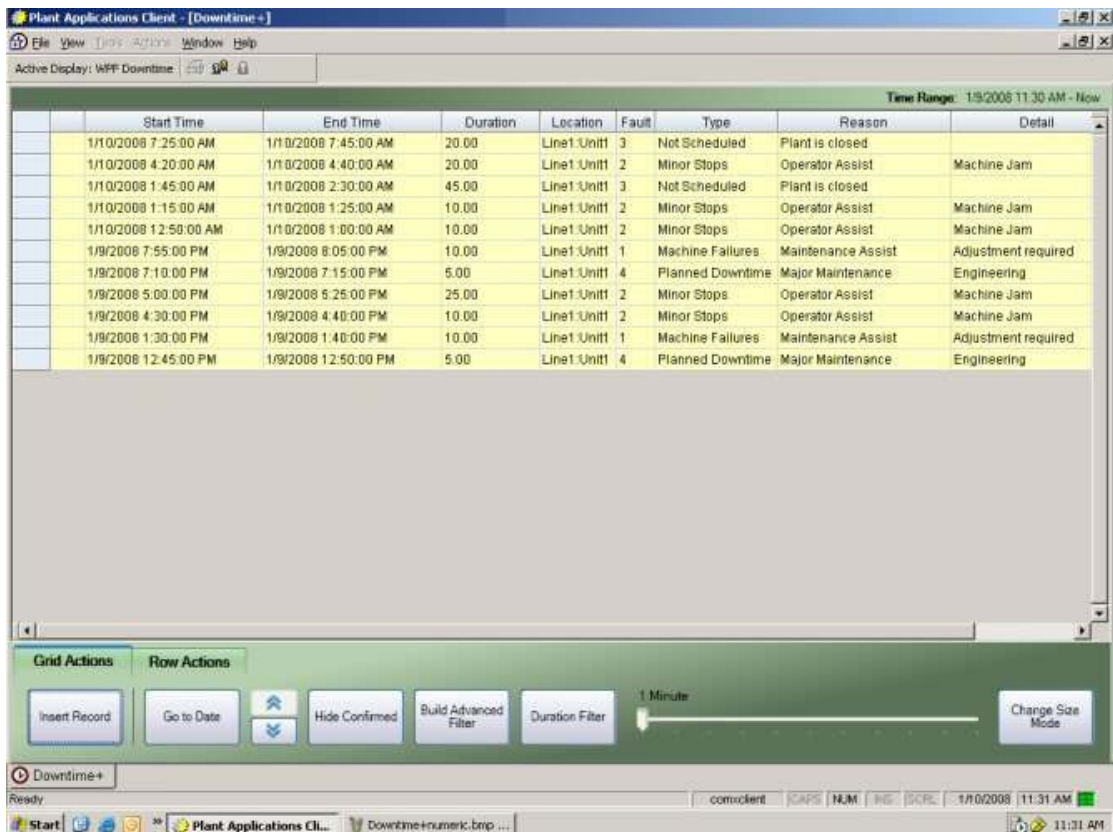



- Click or tap **Build Advanced Filter**. A **message box** appears.

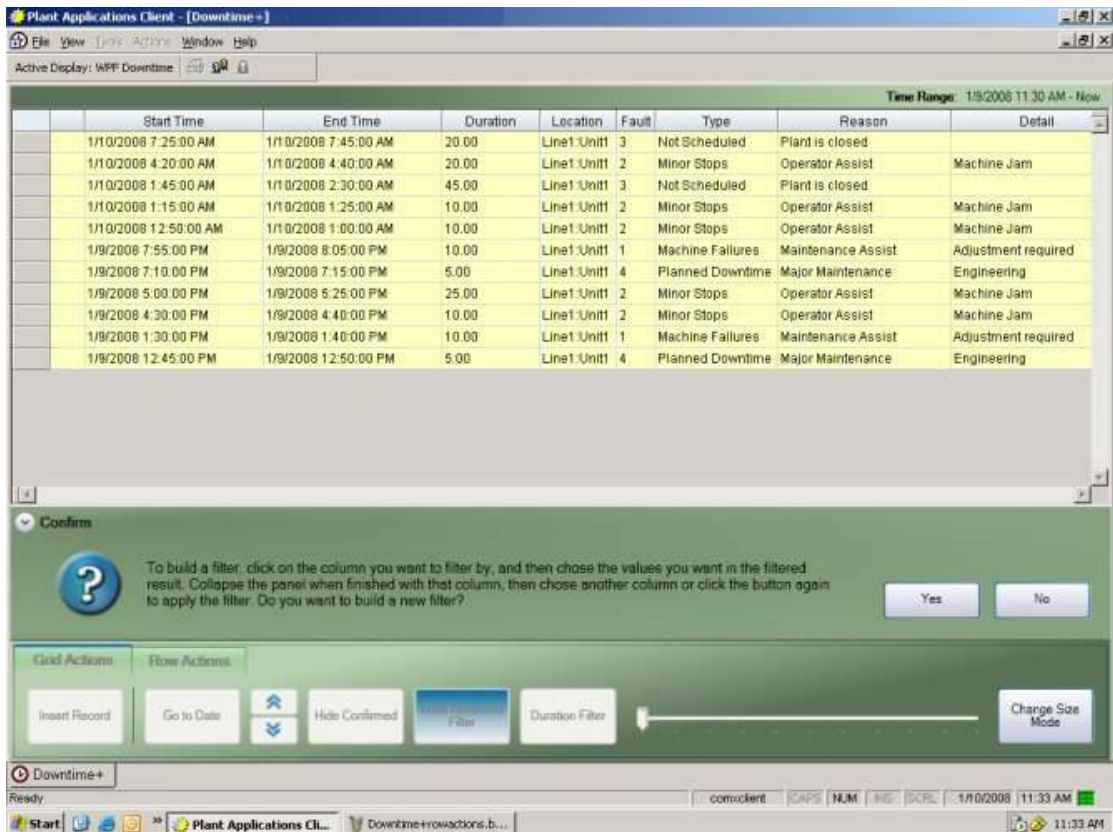

- Click or tap **Yes** to start selecting what you want to filter on. The **Build Advanced Filter** becomes the **Apply Advanced Filter** button.
- Click or tap a value in a cell. A **panel** appears with the available choices.

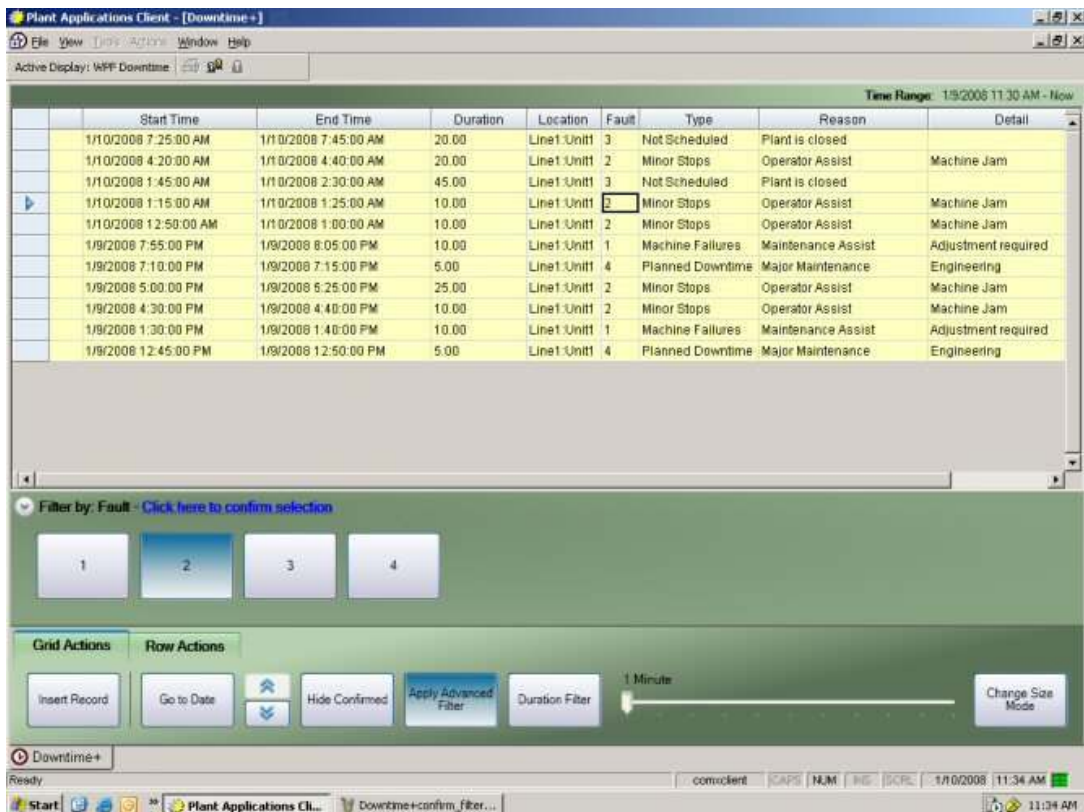

5. Click or tap one or more of the choices and click the text "Click here to confirm selection."
6. To filter by additional columns, click or tap another cell in a different column and select one or more of the available choices. Although you can make more than one selection per column, you can only select a column once.
7. After you have selected all the values you want to filter on, click or tap **Apply Advanced Filter**. The downtime records are filtered and the **Apply Advanced Filter** button becomes the **Clear Advanced Filter** button.
8. To clear the filter and display all of the downtime records, click or tap **Clear Advanced Filter**.

To filter by downtime duration:

1. Click or tap **Grid Actions**.

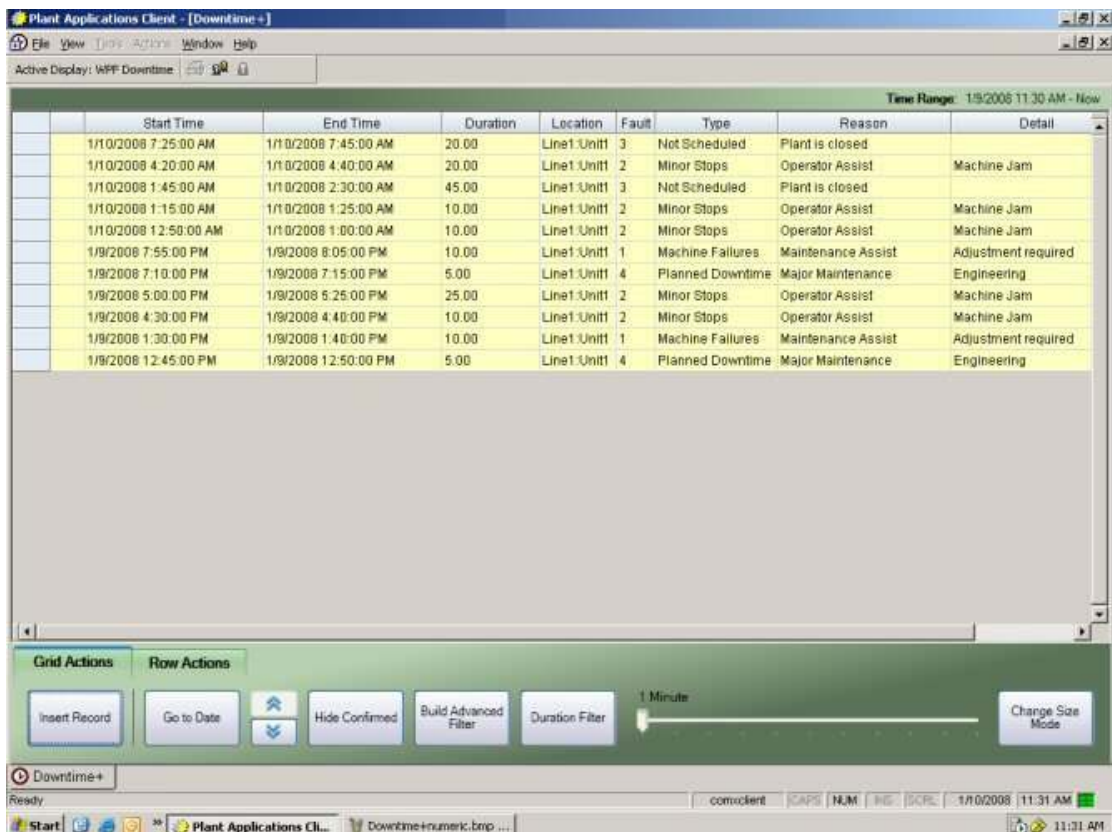

2. Click or tap **Duration Filter** and drag the slider to the desired duration. Downtime events with a duration equal to or greater than the selected duration are displayed.
3. Click or tap **Duration Filter** to display all downtime events.

Show or hide confirmed downtime events:

1. Click or tap **Grid Actions**.

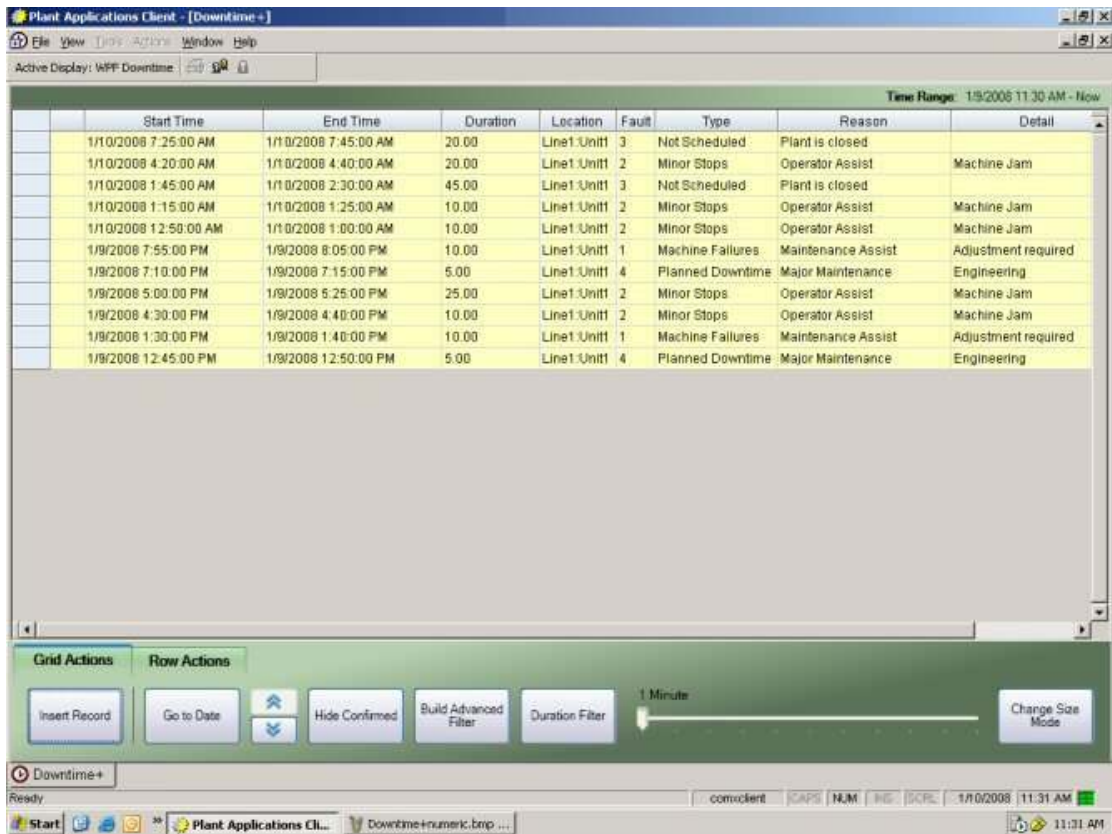

2. Click or tap **Hide Confirmed**. Downtime events that have incomplete information (for example, no faults or reasons) are displayed.

Confirmed events are those events that have a reason tree attached and all reason levels within the reason tree have been entered.

3. Click or tap **Hide Confirmed** to display all downtime events within the specified window.

## Saving a Filter

This information applies to the Downtime+ and Waste+ displays.

You can save a filter in a Downtime+ or Waste+ display so that when the display is opened, by anyone, the saved filter is automatically applied. Additionally, if a new filter is applied to the display, the saved filter will be applied when the display is re-opened.

The procedure to save a filter should be performed by an administrator or someone with advanced knowledge of Plant Applications. Furthermore, this procedure must be followed for each display for which you want to save a filter.

### Step 1: Modify LocalSettings.xml to Capture the Filter Information

1. Locate LocalSettings.xml, which is located in the ..\Plant Applications\Client folder.
2. Open LocalSettings.xml in Notepad or another text editor.
3. Search for the element, PermitPersistenceStringLoad and change the value from **false** to **true**.
4. Save and close LocalSettings.xml.

## Step 2: Capture the Filter Information from the Display

1. Open Plant Applications Client and open a Downtime+ or Waste+ display.
2. Filter the information in the display. For information about applying filters, see the topic [Filtering downtime events](#) or [Filtering waste events](#).
3. With the filter applied, close the display and close Plant Applications Client.

## Step 3: Copy the Filter Information

1. Locate LocalSettings.xml and open it in Notepad or another text editor.
2. Search for the element, LastPersistenceData.
3. Confirm that the value for DisplayType and SheetName match the display you just closed.
4. Copy all tags and data, starting with <LastPersistenceData and including </LastPersistenceData>. **Example:**

```
<LastPersistenceData DisplayType="Downtime+" SheetName="DT">
  <data>
    <filters>
      <filter type="advanced">
        <values column="Reason_Level1">
          <value>Not Scheduled</value>
        </values>
      </filter>
    </filters>
  </data>
</LastPersistenceData>
```

5. Open a new document in your text editor and paste the copied information.
6. Remove all line breaks and tab characters so that the text is all on one line. **Example:**

```
<LastPersistenceData DisplayType="Downtime+"
SheetName="DT"><data><filters><filter type="advanced"><values
column="Reason_Level1"><value>Not
Scheduled</value></values></filter></filters></data></LastPersistence
Data>
```

7. Copy the single line.

## Step 4: Save the Filter Information in the Persistence String Display Option

1. Open Plant Applications Administrator.
2. Expand Client Management and expand Displays.
3. Right-click the appropriate Downtime+ or Waste+ display and click **Edit** <display name>. The Edit Display dialog box appears.
4. Click the **Display Options** tab.
5. Under the Sheet Persistence heading, edit the Persistence String display option:
  - a. Click the  **Edit** button. The Assign Property Value dialog box appears.
  - b. In the Value box, paste the single line you copied previously in Step 3: Copy the filter information.
  - c. Click **OK**.

6. Save and close the Edit Display dialog box.

**NOTES:**

To temporarily clear the saved filter, click the **Clear Advanced Filter** button in the display.  
 To change the saved filter, repeat all of the preceding steps.  
 To remove the saved filter, remove the string from the Persistence String display option.

## Adding a Downtime Event

This information applies to the Downtime+ Display.

Downtime events can be manually added using the downtime display.

To manually enter a downtime event:

1. Click or tap **Grid Actions**.

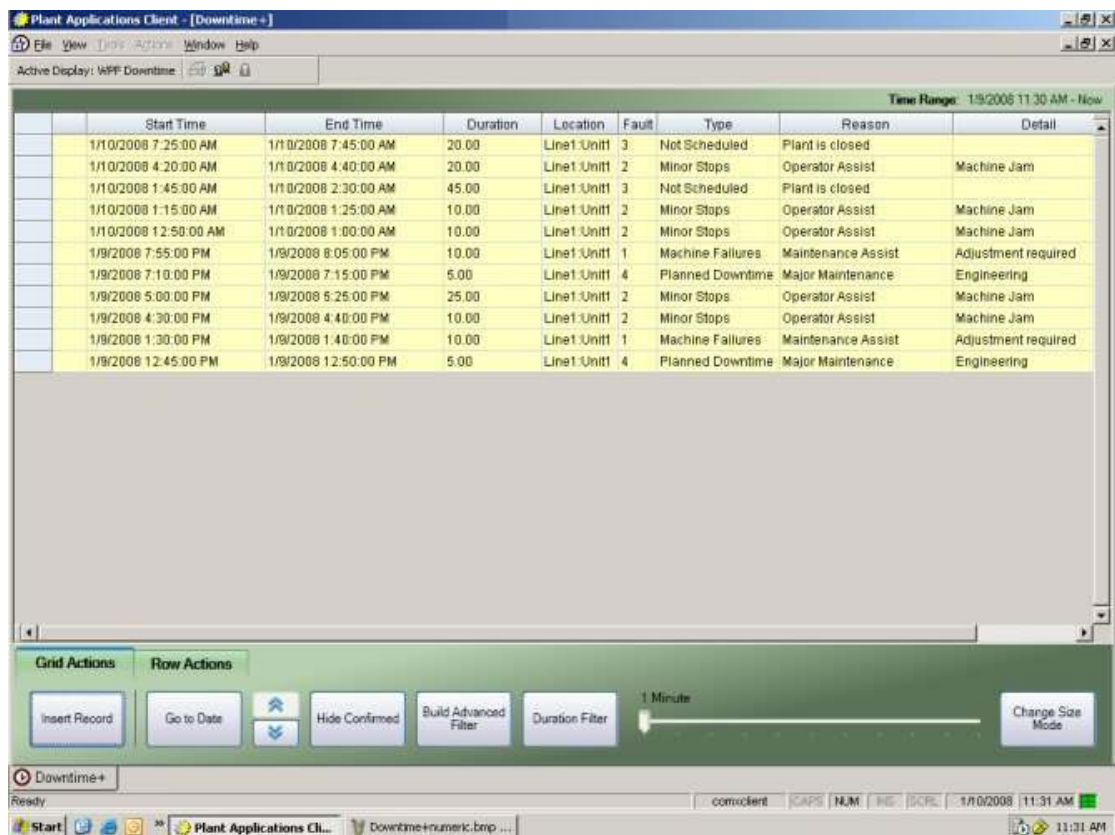

2. Click or tap **Insert Record**. An empty row (the working row) is added to the top of the rows of downtime events and the **Data/Time Entry** panel appears.

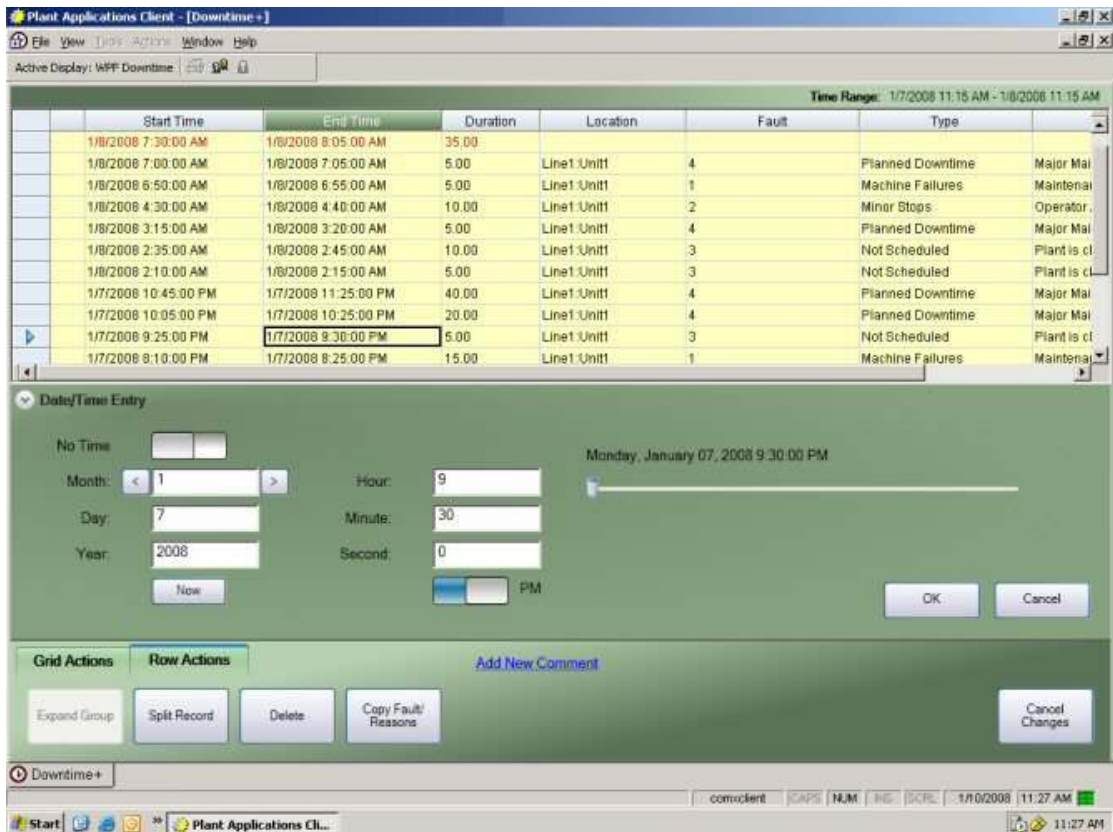

3. Enter the start date and time of the downtime event and click or tap **OK**. The start time is entered and the end time cell becomes active.
4. Enter the end date and time of the downtime event. The cell to the right becomes active and the appropriate panel appears.
5. Continue entering the downtime information.

## Finding Downtime Events

This information applies to the Downtime+ Display.

You can find downtime events within a specific time frame, which is defined by the Initial Windows Setting. The displayed downtime records are calculated as follows:

(Start Time – Initial Windows Setting) to End Time.

For example, if the Initial Windows Setting is 24 hours (the default) and the date entered on the Date/Time Entry expander window is Wednesday, November 28, 2007 3:30pm, all downtime records between Tuesday, November 27, 2007 3:30 PM and Wednesday, November 28, 2007 3:30 PM are displayed. If either end time falls within a downtime event, the downtime event is not included in the downtime events that are displayed. In this example, a downtime event that occurred on Tuesday, November 27, 2007 with a start time of 3:20 PM and an end time of 3:40 PM would not be displayed.

To find downtime events:

1. In the Downtime+ display, click or tap **Grid Actions** and click or tap **Go to Date**. The **Date/Time Entry** panel appears.

# Plant Applications Client

The screenshot shows the 'Plant Applications Client - [Downtime+]' window. The active display is 'WFF Downtime'. The time range is set to '1/7/2008 11:15 AM - 1/8/2008 11:15 AM'. Below the title bar is a table of downtime records:

Start Time	End Time	Duration	Location	Fault	Type
1/8/2008 7:30:00 AM	1/8/2008 8:05:00 AM	35.00			
1/8/2008 7:00:00 AM	1/8/2008 7:05:00 AM	5.00	Line1_Unit1	4	Planned Downtime Major Mai
1/8/2008 6:50:00 AM	1/8/2008 6:55:00 AM	5.00	Line1_Unit1	1	Machine Failures Maintena
1/8/2008 4:30:00 AM	1/8/2008 4:40:00 AM	10.00	Line1_Unit1	2	Minor Stops Operator,
1/8/2008 3:15:00 AM	1/8/2008 3:20:00 AM	5.00	Line1_Unit1	4	Planned Downtime Major Mai
1/8/2008 2:35:00 AM	1/8/2008 2:45:00 AM	10.00	Line1_Unit1	3	Not Scheduled Plant is cl
1/8/2008 2:10:00 AM	1/8/2008 2:15:00 AM	5.00	Line1_Unit1	3	Not Scheduled Plant is cl
1/7/2008 10:45:00 PM	1/7/2008 11:25:00 PM	40.00	Line1_Unit1	4	Planned Downtime Major Mai
1/7/2008 10:05:00 PM	1/7/2008 10:25:00 PM	20.00	Line1_Unit1	4	Planned Downtime Major Mai
1/7/2008 9:25:00 PM	1/7/2008 9:30:00 PM	5.00	Line1_Unit1	3	Not Scheduled Plant is cl
1/7/2008 8:10:00 PM	1/7/2008 8:25:00 PM	15.00	Line1_Unit1	1	Machine Failures Maintena

Below the table is a 'Date/Time Entry' dialog box. It contains fields for 'Month' (1), 'Day' (7), and 'Year' (2008). The 'Hour' is set to 9 and 'Minute' to 30. The time is 'Monday, January 07, 2008 9:30:00 PM'. There are 'Now', 'OK', and 'Cancel' buttons.

At the bottom of the window, there are 'Grid Actions' and 'Row Actions' buttons. The 'Row Actions' include 'Expand Group', 'Split Record', 'Delete', 'Copy Fault/Reasons', and 'Cancel Changes'. There is also an 'Add New Comment' link.

The second screenshot shows the same window with the time range changed to '1/9/2008 11:30 AM - Now'. The table now displays records from January 9, 2008:

Start Time	End Time	Duration	Location	Fault	Type	Reason	Detail
1/10/2008 7:25:00 AM	1/10/2008 7:45:00 AM	20.00	Line1_Unit1	3	Not Scheduled	Plant is closed	
1/10/2008 4:20:00 AM	1/10/2008 4:40:00 AM	20.00	Line1_Unit1	2	Minor Stops	Operator Assist	Machine Jam
1/10/2008 1:45:00 AM	1/10/2008 2:30:00 AM	45.00	Line1_Unit1	3	Not Scheduled	Plant is closed	
1/10/2008 1:15:00 AM	1/10/2008 1:25:00 AM	10.00	Line1_Unit1	2	Minor Stops	Operator Assist	Machine Jam
1/10/2008 12:50:00 AM	1/10/2008 1:00:00 AM	10.00	Line1_Unit1	2	Minor Stops	Operator Assist	Machine Jam
1/9/2008 7:55:00 PM	1/9/2008 8:05:00 PM	10.00	Line1_Unit1	1	Machine Failures	Maintenance Assist	Adjustment required
1/9/2008 7:15:00 PM	1/9/2008 7:15:00 PM	5.00	Line1_Unit1	4	Planned Downtime	Major Maintenance	Engineering
1/9/2008 5:00:00 PM	1/9/2008 5:25:00 PM	25.00	Line1_Unit1	2	Minor Stops	Operator Assist	Machine Jam
1/9/2008 4:30:00 PM	1/9/2008 4:40:00 PM	10.00	Line1_Unit1	2	Minor Stops	Operator Assist	Machine Jam
1/9/2008 1:30:00 PM	1/9/2008 1:40:00 PM	10.00	Line1_Unit1	1	Machine Failures	Maintenance Assist	Adjustment required
1/9/2008 12:45:00 PM	1/9/2008 12:50:00 PM	5.00	Line1_Unit1	4	Planned Downtime	Major Maintenance	Engineering

The 'Date/Time Entry' dialog box is no longer visible. The 'Row Actions' now include 'Insert Record', 'Go to Date', 'Hide Confirmed', 'Build Advanced Filter', 'Duration Filter', and 'Change Size Mode'.

2. Enter the date and time and click **OK**. The downtime records within the defined window are displayed.

- Use the  scroll buttons to page up or down in increments that are equal to one-fourth the time specified by the Initial Windows Setting, until the time range specified by the MAX display setting is reached, then it begins moving the start time and end time down in increments one-fourth the MAX time specified.

## Entering Comments to a Downtime+ Display

Adding comments to a Downtime+ display is a useful way to provide additional information. Comments can be either text that you type or a link to an external document, such as a Microsoft Word document.

Keep in mind that if you paste a link to a document, the document cannot be moved to a different folder or directory; otherwise, the link will be broken and the document will not be found.

**NOTE:** Comments are categorized as either Reason, Action, or Research comments. All Reason comments are listed first in the Comments window.

To add comments to a DT+ event:

- Select a row in the DT+ display, and select the **Row Actions** tab.

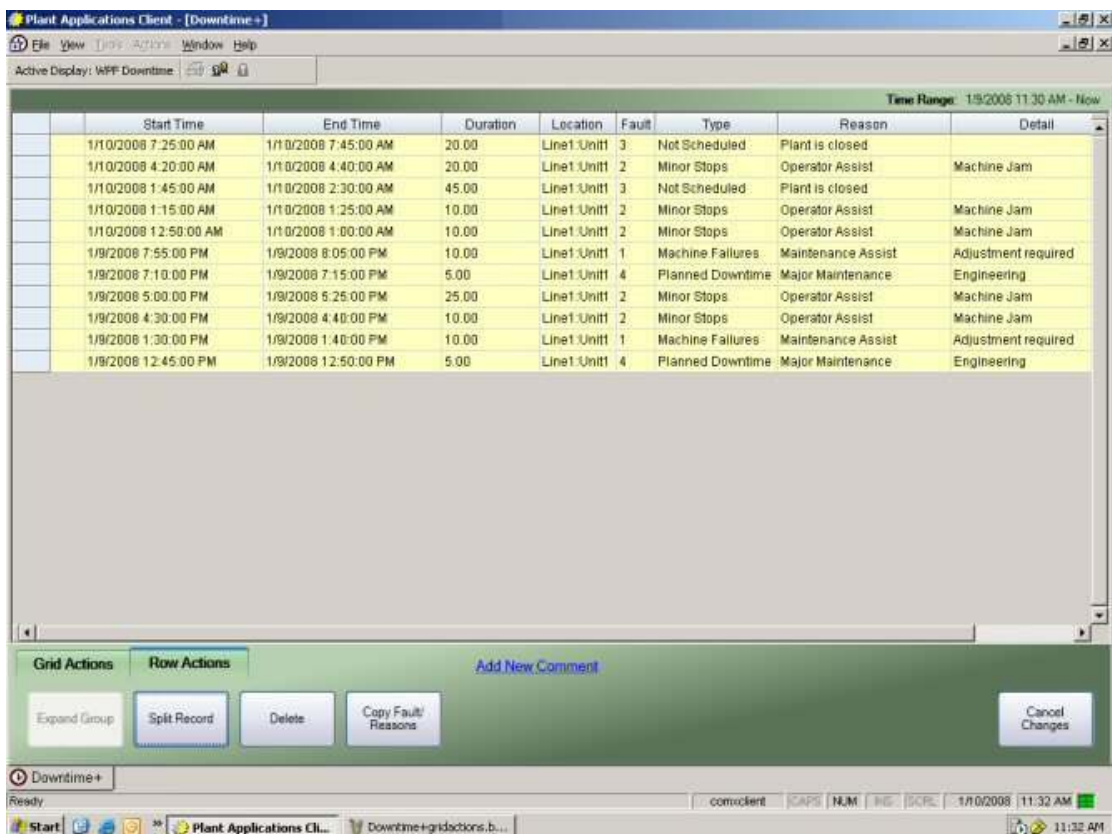

- Click the **New Comment** button or the **Manage Comments** button.
- In the Comments dialog that is displayed, select **Reason**, **Action**, or **Research** from the drop-down menu. Type your comment in the **box**, which supports simple text with no formatting. You can also type URLs to documents and web sites.



	Start Time	End Time	Duration	Location	Fault	Type	Reason	Detail
	1/10/2008 11:45:00 AM	1/10/2008 7:45:00 AM	20.00	Line1\Unit1 4	Planned Downtime	Major Maintenance	Engineering	Engineering
	1/10/2008 7:25:00 AM	1/10/2008 7:45:00 AM	20.00	Line1\Unit1 3	Not Scheduled	Plant is closed		
	1/10/2008 4:20:00 AM	1/10/2008 4:40:00 AM	20.00	Line1\Unit1 2	Minor Stops	Operator Assist		Machine Jam
	1/10/2008 1:45:00 AM	1/10/2008 2:30:00 AM	45.00	Line1\Unit1 3	Not Scheduled	Plant is closed		
	1/10/2008 1:15:00 AM	1/10/2008 1:25:00 AM	10.00	Line1\Unit1 2	Minor Stops	Operator Assist		Machine Jam
	1/10/2008 12:50:00 AM	1/10/2008 1:00:00 AM	10.00	Line1\Unit1 2	Minor Stops	Operator Assist		Machine Jam
	1/9/2008 7:55:00 PM	1/9/2008 8:05:00 PM	10.00	Line1\Unit1 1	Machine Failures	Maintenance Assist		Adjustment required
	1/9/2008 7:10:00 PM	1/9/2008 7:15:00 PM	5.00	Line1\Unit1 4	Planned Downtime	Major Maintenance	Engineering	Engineering
	1/9/2008 5:00:00 PM	1/9/2008 5:25:00 PM	25.00	Line1\Unit1 2	Minor Stops	Operator Assist		Machine Jam
	1/9/2008 4:30:00 PM	1/9/2008 4:40:00 PM	10.00	Line1\Unit1 2	Minor Stops	Operator Assist		Machine Jam
	1/9/2008 1:30:00 PM	1/9/2008 1:40:00 PM	10.00	Line1\Unit1 1	Machine Failures	Maintenance Assist		Adjustment required
	1/9/2008 12:45:00 PM	1/9/2008 12:50:00 PM	5.00	Line1\Unit1 4	Planned Downtime	Major Maintenance	Engineering	Engineering

- Click or tap the **Save** button to save your comments. Downtime events with comments are indicated with the  icon, which is displayed beside the row item.

## Copying Faults and Reasons (Downtime+)

This information applies to the Downtime+ Display.

You can quickly enter or change faults and reasons for a downtime record.

To copy faults and reasons:

- Select a downtime event. You can click or tap anywhere in the row.
- On the **Row Actions** tab, click or tap **Copy Fault/Reasons**.

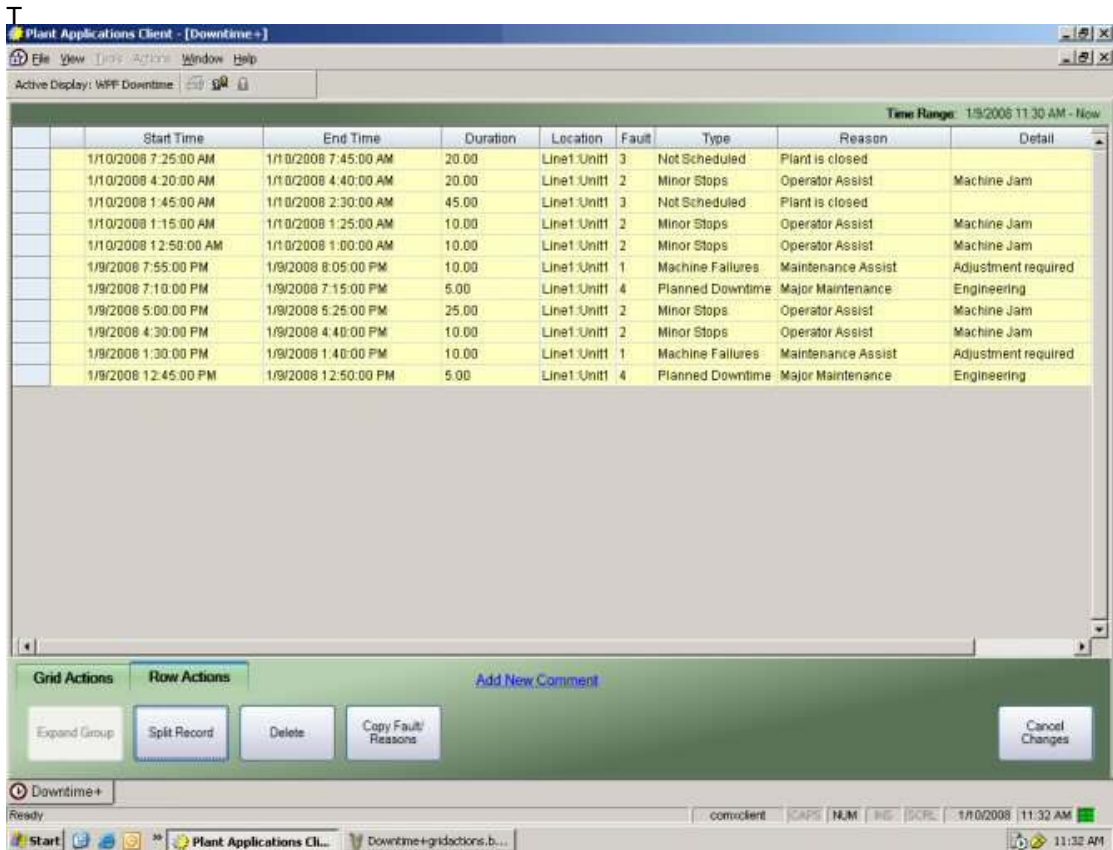

3. Select the downtime event where you want to paste the faults and reasons. You can click or tap anywhere in the row.

To select multiple rows, click the row header for the first row and drag to select additional rows.

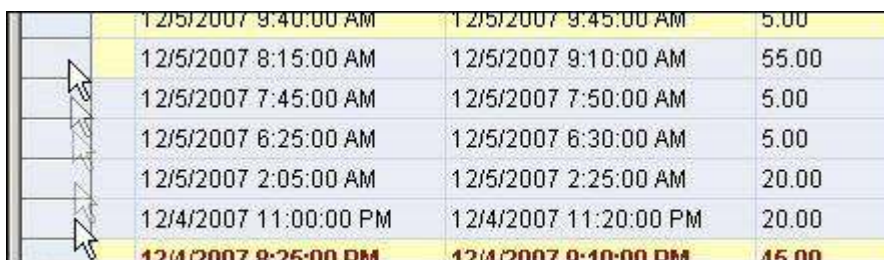

4. On the **Row Actions** tab, click or tap **Paste Fault/Reasons**. The fault and reasons are changed.

# Genealogy View Display

## Anatomy of a Genealogy View Display

This information applies to the Plant Applications Client program.

The Genealogy View display is a real-time application used to load product from an input production unit or from multiple input production units on to an output or producing production unit. Raw Material Events are put into Staged and Running positions and are consumed to make new products. Relationships are created for the parent and children events.

With the display, production event statuses can be updated manually by moving input events to the staged and running positions on an output or producing unit, completing an input event, creating a new production event on the output of the producing unit and unloading an incorrect staged event or incorrect running event.

With the use of historian tag values as triggers, the automatic staging, running, completing, and consuming of events can occur.

The display can filter for only valid input events based on specific production statuses and only valid input events based on the product being created on the producing unit. This filter can also use a Bill Of Material specification as well.

The display allows for the review of: production event details (such as dimensions) for current, staged or historical events on the production unit, the status of an output or producing unit, the family tree identifying parent and child events for a production event, input history for a selected input position, current event running on an output or producing unit and the staged or next production events to be run. If an Autolog display is associated with a production unit, it can be viewed within the Genealogy display for the selected event.

Labels can be printed manually for a selected event or automatically if configured.

Product based routing is achieved through a combination of the plant model, the execution path, and specifications.

### Parts of the Display

The screenshot displays the Genealogy View interface. On the left, a production unit diagram shows a central 'Unit:Line1' with various input and output positions. Six blue callout numbers (1-6) highlight specific components: 1 points to a production event in the log; 2 and 3 point to input positions; 4 points to the central unit; 5 points to a status indicator; and 6 points to a lot box. On the right, a table lists production events with columns for Event, Status, Product, Time, Age, Count, and Location. The table shows a sequence of 'Inventory' events for product '<None>' occurring on 'Unit2:Line1' from 07:26:12 to 07:40:41 on 24-Mar-2010.

Event	Status	Product	Time	Age	Count	Location
2455278.09171	Inventory	<None>	24-Mar-2010 07:26:12	3183		Unit2:Line1
2455278.09175	Inventory	<None>	24-Mar-2010 07:32:13	3177		Unit2:Line1
2455278.09176	Inventory	<None>	24-Mar-2010 07:34:15	3175		Unit2:Line1
2455278.0919	Inventory	<None>	24-Mar-2010 07:35:08	3174		Unit2:Line1
2455278.09198	Inventory	<None>	24-Mar-2010 07:35:23	3174		Unit2:Line1
2455278.09207	Inventory	<None>	24-Mar-2010 07:35:39	3174		Unit2:Line1
2455278.09214	Inventory	<None>	24-Mar-2010 07:35:54	3174		Unit2:Line1
2455278.09221	Inventory	<None>	24-Mar-2010 07:36:09	3173		Unit2:Line1
2455278.09236	Inventory	<None>	24-Mar-2010 07:36:39	3173		Unit2:Line1
2455278.09244	Inventory	<None>	24-Mar-2010 07:36:54	3173		Unit2:Line1
2455278.09251	Inventory	<None>	24-Mar-2010 07:37:09	3172		Unit2:Line1
2455278.09258	Inventory	<None>	24-Mar-2010 07:37:24	3172		Unit2:Line1
2455278.09256	Inventory	<None>	24-Mar-2010 07:37:39	3172		Unit2:Line1
2455278.09274	Inventory	<None>	24-Mar-2010 07:37:55	3172		Unit2:Line1
2455278.09284	Inventory	<None>	24-Mar-2010 07:38:10	3171		Unit2:Line1
2455278.09291	Inventory	<None>	24-Mar-2010 07:38:25	3171		Unit2:Line1
2455278.09299	Inventory	<None>	24-Mar-2010 07:38:40	3171		Unit2:Line1
2455278.09306	Inventory	<None>	24-Mar-2010 07:38:55	3171		Unit2:Line1
2455278.09314	Inventory	<None>	24-Mar-2010 07:39:10	3170		Unit2:Line1
2455278.09322	Inventory	<None>	24-Mar-2010 07:39:26	3170		Unit2:Line1
2455278.0933	Inventory	<None>	24-Mar-2010 07:39:41	3170		Unit2:Line1
2455278.09337	Inventory	<None>	24-Mar-2010 07:39:56	3170		Unit2:Line1
2455278.09345	Inventory	<None>	24-Mar-2010 07:40:11	3169		Unit2:Line1
2455278.09352	Inventory	<None>	24-Mar-2010 07:40:26	3169		Unit2:Line1
2455278.0936	Inventory	<None>	24-Mar-2010 07:40:41	3169		Unit2:Line1

1. Listing of available production events that can be manually or automatically moved to the Staged (2) or Running (3) positions.
2. The staged position.
3. The running position.
4. The first box on the left (the red one), indicates the number of High alarms. The second box from the left indicates the number of Medium alarms. The third box from the left indicates the number of Low alarms. The box on the right (the green one) indicates if the unit is running or is down, as defined by the downtime configuration, and also will display the number of downtime events on the unit for the current production day.
5. The unit view represents the producing unit and displays the current production, the number of downtime minutes and production for the day, as defined by the Data Range display option.
6. The events that were created. Use the scroll bar to move through the list of events.
7. Use the drop-down list to select a different unit.

## Terms

**Running:** Running generally means that an item is being consumed on the unit. It does not necessarily mean that it is only this unit on which an item is being, or has been, consumed. Unloading from the running stage generally means that an item has been partially consumed.

**Staged:** An item in the staged position means that it is ready to be run. Unloading from the staged position generally means that an item has not been consumed and is being returned to inventory.

## Uses

- Move Input Events to the Staged and Running positions on an Output or Producing Unit.
- Manually Complete an Input Event.
- Manually create a new Production Event on the output of the Producing Unit.
- Manually Unload an incorrect Staged Event or incorrect Running Event.
- Automatic Staging, Running, Completing, and Consuming of Events based on Historian Tag values.
- Filter to display only valid Input Events based on specific Production Statuses.
- Filter to display only valid Input Events based on Product being created on the Producing Unit.
- Modify or View Current Event Running on an Output or Producing Unit.
- Review Production Event Details such as dimensions.
- Provide an Overview of the Status of an Output or Producing Unit.
- View the Family Tree for a Production Event.
- Update the Production Status of a Production Event.
- View the Input History for a selected Input position.
- Print Labels for the selected Event.
- Set up automatic label printing.

## Key Data

- Display a filtered inventory listing of all Events that are available to run on the Producing Unit.

- View Autolog display data associated with the Event.
- Time, Product, and Status/Routing Of Production Events.
- Current Running Event on an Output or Producing Unit.
- View Staged or Next Production Events to be Run.
- View Production Event Details for Current Running Event, for the Staged Production Event, and for Historical Production Events on that Production Unit.
- Family Tree displays all Parent and Child Events for a selected Event.
- Key performance statistics can be viewed for the Producing Unit such as: Downtime, Efficiency, Waste, Alarms, and Process Orders.

## Functions in the Genealogy View

Most, if not all, of the functions in Genealogy View are available by right-clicking on an object, which will display a menu with various options specific to the selected object. Many of the functions that you will use most often can also be accessed by clicking an icon on the toolbar.

### Displaying the Inventory List

The Genealogy View inventory list displays the current list of events that are available to be loaded into the input positions on a producing unit.

To display the inventory list:

1. On the input for which you want to display the available inputs, do one of the following:
  - Click to select an empty staged or running position, right-click the selected input position, and select **Load Inventory**.
  - OR--
  - Click to select either a staged or running position and click the  **Load Inventory** icon from the toolbar.

The inventory list for selected input will be displayed. If you have multiple inputs, the inventory list automatically refreshes and lists the available events for the selected input.

---

**NOTE:** You can sort the Inventory List by clicking the column heading for the column you wish to sort the list by.

---

### Configuring the Inventory List

You can sort the inventory list and determine which columns to display.

To configure the inventory list:

1. Display the inventory list.
2. Right-click anywhere in the inventory list and select **Manage Columns**. The **Display Options** dialog box appears.
3. To display columns, select the column from the Hidden list and move it to the Visible list. To hide a column, select the column and move it to the Hidden list.
4. To sort columns, use the drop-down lists in the Sort Order section to control how the columns are sorted. To temporarily sort the inventory list, you can click on a specific column heading
5. Click the **Close [X]** button to save your changes and close the dialog box.

## Manually Moving an Event from Inventory

The inventory list displays the current list of events available to be staged or run on the producing unit. You can manually move an event from the inventory list to either the running position or the staged position.

To manually move an event from inventory:

1. Display the inventory list.
2. Drag the selected event to either the desired staged or running position.

## Staging an Event by Scanning a Barcode

The inventory list shows the current list of events available to be staged or run on the producing unit. A barcode label can be read if it corresponds to an event number in the inventory list.

To stage an event by scanning a barcode:

1. Display the inventory list.
2. Scan the barcode. The Event Number is displayed in the selected position. An Event can be placed directly into the Running Position if there is not an event currently in that position.

## Manually Completing a Running Event

A running event is the current event being made on the producing unit.

To manually complete a running event:

1. Select the running input position. The running box is highlighted.
2. Right-click and select **Complete [Event Number]**. The event is then completed and the status is changed, depending on how the Status for Completed running events display option has been configured (the default is "consumed"). An event in the staged position is automatically moved into the running position.

## Manually Unloading a Running Event

A running event is the current event being made on the producing unit. If this is the incorrect event, it must be unloaded from the running position, which will move it back into inventory.

To manually unload a running event:

1. Click the event in the running position that you want to unload.
2. Right-click and select **Unload [Event Number]**. The event is then removed from the running position and placed back into inventory.

## Manually Moving a Staged Event to the Running Position

A staged event is automatically moved to the running position when an event in the running position is completed. However, if there is no running event, then an event can be moved from staged to running.

To manually move a staged event to the running position:

1. Select the Staged input position. The staged box will be highlighted.
2. Right-click and select **Move [Event Number] to Running**. The staged event is then moved into the running position.

## Manually Unloading a Staged Event

If the incorrect event is in the staged position, it must be unloaded and moved back into inventory.

To unload a staged event:

1. Click on the event in the staged position.
2. Right-click and select **Unload [Event Number]**. The event is then removed from the staged position and placed back into inventory.

## Changing the Status of an Event

The status of an event indicates the current state of a production event. If you have configured the **Allow status changes on inputs** and **Allow status changes on outputs** display options to allow status changes, you can manually change the status of an event.

To change an event status:

1. Select the staged, running, or output event. The selected box will be highlighted.
2. Right-click and select **[Production event] Status**.
3. Select the appropriate event status from the list of available status events.

## Viewing the Input History for an Input

The input history displays the events that have been loaded or unloaded from the staged or running position on a particular input.

To view the input history for a single input:

1. Select the staged or running events position inside the selected raw material input. The selected box will be highlighted.
2. Right-click, point to **Actions**, and select **View Input History**. The Input History dialog box appears, listing the history for the specific raw material input for the previous 24 hours.

To view the input history for all inputs:

- Right-click any empty portion of the Genealogy View, point to **Actions**, and select **View Input History**. The Input History dialog box appears, listing the input history for all raw material inputs.

## Viewing the Event Details for an Event

The event details displays detailed information for the selected event. Depending on which of the two methods used to view the details, you may be able to edit the:

- Event number
- Event status
- Start time and end time
- Comments

To view the event details for an event:

Do one of the following:

1. In an empty area of the display, right-click, point to **Actions**, and select **View Details**. There will be a check mark next to View Details.

2. Click an inventory, staged, running, or output event. The Event Details box appears.  
--OR--
1. Click an inventory, staged, running, or output event.
2. Right-click and select **Edit [Event Type] Properties**. A dialog box appears with five tabs. On the General tab, you can edit the:
  - Event number
  - Event status
  - Start time and end time
  - Comments

Additionally, you can view genealogy, related events, and event history information for the selected event.

---

*NOTE: To turn off viewing details, in an empty area of the display, right-click, point to **Actions**, and select **View Details**. The check mark is removed.*

---

## Viewing the Family Tree for an Event

The View Family Tree option displays the parent and child events for the selected event.

To view the family tree for an event:

1. Select the staged, running, or output event position. The selected box will be highlighted.
2. Right-click and select **View Family Tree**. The view changes to Tree View.
3. To view the Family Tree for any specific Production Event, double click on that event.
4. To return to the Genealogy Unit View click on the white space, right click and select **View Genealogy Unit**.

## Viewing Production Event Data for an Event

The View Events option allows production event data to be displayed for the selected event. An Autolog is displayed in the right hand window pane. For this option to work, you must either:

- Assign the Production Event Autolog display to the Genealogy View on the Genealogy Data tab when configuring the Genealogy View in the Plant Applications Administrator. For more information, see the topic Creating and Configuring the Genealogy View Display.
- Select the Default Genealogy Display option on the General tab of the Autolog display.

To view the production even data for an event:

1. Right-click on a blank area, point to **Actions** and select **View Events**. A checkmark is displayed next to the View Events option.
2. Click an event in the staged, running, or output position or in the inventory list. An Autolog is opened in the lower right-hand corner displayed the selected event data.
3. To close detailed data window, right-click on a blank area, point to **Actions** and select **View Events**. The checkmark next to the View Events option is removed.

## Viewing Event Information from the Family Tree for an Event

The View Event Details option allows production event information to be displayed for the selected event in the Tree View.

To view the event details for an event:



1. Select the staged, running, or output events position. The box selected will be highlighted.
2. Right click and choose **View Family Tree** from the menu.
3. Right click and select **Show (Event Type) Detail Window** from the menu.
4. An Event Details will open up in the upper left portion of the display.
5. To close the Event Details window, right click and select **Hide (Event Type) Data** from the menu.

## Viewing the Production Schedule

The production schedule is used to display the current production schedule and the status of the current active process order. The currently active process order is used to track the actual quantity produced against a process order and its planned quantity, planned start time and planned end time. The production schedule allows process orders to be reordered and edited.

To view the production schedule:

1. Right-click on a blank area of the Genealogy View, point to **Actions** and select **View Production Schedule**. A Schedule View display will open if it is available for the current production unit. For more information on the Schedule View display, see the topic Creating and Configuring the Schedule View Display.
2. To close the Schedule View window, click on the x in the upper right hand corner.

## Viewing the Pattern Details for the Producing Unit

If activated, process orders can contain setup patterns that are specific to an individual process order. Setup patterns detail the dimensions a product is to be manufactured to for a specific order. The View Pattern Details option displays the current pattern details in the output event positions for the unit, if it exists.

To view the pattern details for the producing unit:

- Right click on a blank area of the Genealogy View, point to **Actions**, and select **View Pattern Details**. The current pattern details are displayed in the output event.

## Viewing Comments for an Event

The Add Comments option displays any comments associated with the selected event. If an event has a comment attached, there will be a black triangle located in the upper left hand corner of the event box.

To view comments for an event:

1. Right-click on a blank area of the Genealogy View, point to **Actions** and then click **View Comments**. The comments window will open at the bottom of the display
2. Select the desired event.
3. If comments exist for the event they will be displayed. New comments can be added in the comment window by clicking in the comment window and typing in your comment.

## Printing a Label for an Event

The Print Label option allows a label to be printed for the selected event, if that option is available and configured. The label printing executable program called is defined by the Filename For Auto Labeling display option. For more information, see the topic Genealogy View Display Options.

To Print A Label for An Event:

1. Select an event from the staged, running, or output positions.
2. Right-click and choose **Print Label for [EventNumber]**.

## Changing Display Options for All Events

The Display Options allows toggling the one additional piece of data that is shown in an Event Box in addition to the Event Number.

To Change Display Options for All Events:

1. Right click on a blank area of the Genealogy View to display a menu.
2. Choose **Display Options**.
3. Select from the following:
  - Process Order
  - Customer Order
  - Diameter
  - Weight
  - Length
  - Width

## Using the Zoom Feature

The Zoom feature allows enlarging or shrinking of the Genealogy View display components.

To use the Zoom feature:

- Right click on a blank area of the Genealogy View, point to **Zoom** and select one of the following:
  - Zoom In
  - Zoom Out
  - Clear Zoom

## Changing Unit Details Data

The Change Unit Details option allows changes to what is shown in the middle of the Producing Units data box. This allows current production and efficiency numbers to be shown.

To Change Unit Details:

1. Right-click anywhere in and select **Unit Display Options**. The Display Options dialog box appears.
2. From the **Display Options** window move the **Hidden** data options and the **Visible** options using the > < buttons.

The following options are available: View Unit Production Rate, View Unit Production Rate Percent, View Unit Production Good Items, View Process Order, View Alarm Counts, View Product Code, View Production Amount, View Production Total Items, View Downtime Minutes, View DownTime Percent, View Waste Minutes, View Waste Percent, View Waste Amount, View Efficiency Percent, View Inventory Total Items, View Unit Production Rate Percent.

## Changing Unit Time Frame

The Time Frame option determines when the event count in the production unit box will be reset. The default is determined by the Date Range option, which is specified when configuring the Genealogy View display in the Plant Applications Administrator. For more information, see the topic, Genealogy View Display Options.

The three options are:

- **Day To Date:** Selecting Day To Date will reset the event count at the start of your production day, which is defined by the EndOfDayHour and EndOfDayMinute site parameters. For information on these two site parameters, see the topics, Editing EndOfDayHour Site Parameter and Editing EndOfDayMinute Site Parameter.
- **Rolling 24 Hour:** Selecting Rolling 24 Hour will show the event count for the past 24 hours.
- **Shift To Date:** Selecting Shift To Date will reset the event count each time there is a shift change. For more information about shifts and crew schedules, see the topic, Administering Crew Schedules.

To change the unit time frame:

- Right click on a blank area of the Genealogy View, point to Time Frame and select one of the following:
  - Day To Date
  - Shift To Date
  - Rolling 24 Hour

## Saving Locations of the Input Positions

You can save your view configurations by using the Save Positions command in the Genealogy View display. For example, you can click and drag the raw material input boxes, open the Inventory window or an Autolog display, save the position and when you re-open the Genealogy View, everything will be the same as when you closed it.

To save locations of the input positions:

- Right click on a blank area of the Genealogy View and select **Save Positions**.

---

*NOTE: You must click the  Load Inventory icon to refresh the Inventory window.*

---

# Non-Productive Time Management (Client)

## Anatomy of a Non-Productive Time (NPT) View Display

The Non-Productive Time View accessed as a client display is used to manage Non-Productive Time (NPT).

**NOTE:** If no security has been assigned to this display, all users will have Manager access to the display. If a security group has been assigned, a user must have a minimum of Read/Write access to the security group to perform all of the tasks in the display. For more information, see *Display Security*.

In the Non-Productive Time View accessed as a client display, you can:

- [Schedule Non-Productive Time](#)
- [Edit Non-Productive Time](#)
- [Copy Scheduled Non-Productive Time](#)
- [Delete Scheduled Non-Productive Time](#)

The display offers the following features:















**TIP:** The Data Window Display under the tool bar is removed from Plant Applications 6.1, 6.2, and later versions. It is replaced with a Search feature to go to the desired starting time and date. Thirty days of data before and after the starting date is loaded and is refreshed as you move through the calendar.

The screenshot shows the 'Plant Applications Client - [NPT]' window. The interface includes a menu bar (File, View, Tools, Actions, Window, Help), a toolbar with icons for scheduling and editing, and a main calendar view. The calendar displays NPT events for units L1:Unit 1, L1:Unit 2, L2:Unit 1, and L2:Unit 2 across the dates Monday, May 15, to Friday, May 19, 2006. The left pane shows a list of Production Units with checkboxes. The status bar at the bottom indicates 'Ready' and 'NPT'.

- ① Non-Productive Time View tool bar
- ② Production Unit list. If there is only one production unit on the display, the Production Unit list is not displayed.
- ③ Non-Productive Time calendar
- ④ Comment box



## Non-Productive Time View Tool Bar





	Click the <b>Show All</b> button to show all production units in the list.
	Click the <b>Show Selected</b> button to show only the selected production units.
	Click the <b>Go</b> button to retrieve non-productive time data for the selected production units. In the Plant Applications 6.2, August 2014 SIM, data is resynchronized automatically when you go forward or backward a week or a month.
	Click the <b>Select All</b> button to select all production units in the list.
	Click the <b>Deselect All</b> button to clear all the selections in the production list.
	Click the <b>Show/Hide</b> button to show or hide the production unit list.
	Click the <b>Comments</b> button to show or hide comments.
	Click the <b>Set Time</b> button to determine the starting point to display 30 days of data before or after the starting point.
	Click the <b>Day</b> button to change the calendar to Day view.
	Click the <b>Work Week</b> button to change the calendar to Work Week view.
	Click the <b>Week</b> button to change the calendar to Week view.
	Click the <b>Month</b> button to change the calendar to Month view.
	Click the <b>Current Time</b> button to go to the current day, week, or month.
	Click the <b>Go To First</b> button to go to the first non-productive time entry.

	Click the <b>Go To Last</b> button to go to the last non-productive time entry.
---	---

## Calendar Time Scale

When you switch the Non-productive Time View to a  single day or  five-day work week view, a time scale becomes visible. This time scale determines the default duration for entries in the calendar. By default, the time scale is set to 30-minute increments.

### Change the Time Scale

1. If necessary, change the calendar view to  single day or  five-day work week view.
2. Right-click the time scale and select the time increments for the calendar.

When you schedule non-productive time, the time scale also determines how the non-productive time is displayed. For example, if the time increment is 15 minutes, then the non-productive time will span the nearest 15 minute intervals in the calendar grid. A non-productive time of 14:50 to 15:20 would span 14:45 to 15:30. However, the time displayed in the cell will be accurate.

### Scheduling Non-Productive Time from 14:50 to 15:20

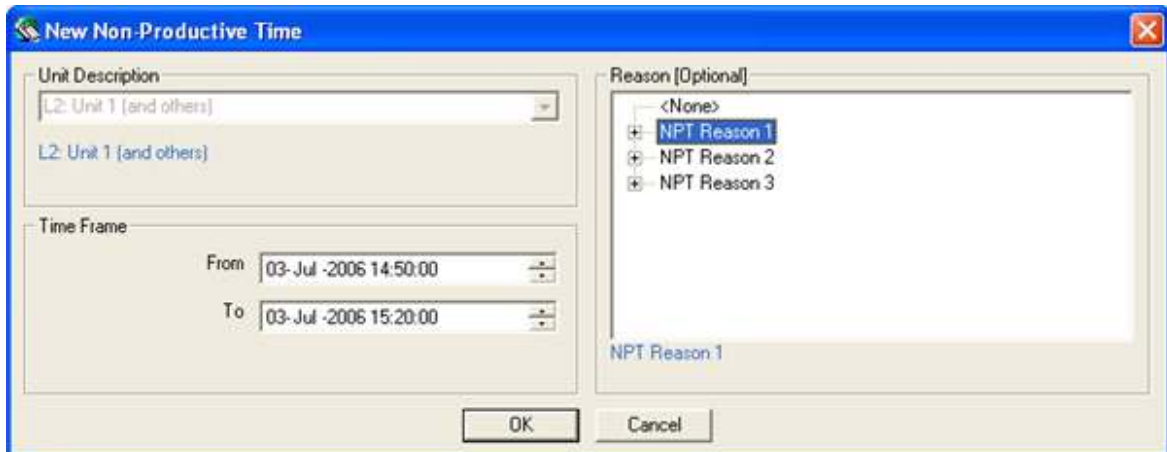

### Result

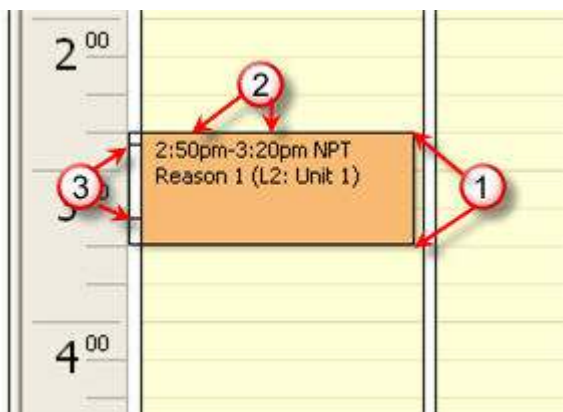

-  Cell is to nearest 15 minute increments. In this example, 2:45 - 3:30

- ② Actual time is displayed in the cell.
- ③ Lines indicate actual time span.

## Scheduling Non-Productive Time

This task applies to the Non-Productive Time View (client) display. To manage non-productive time through the Plant Applications Administrator program, see Non-Productive Time (Administrator).

Non-Productive Time client displays are identified with .

### Schedule Non-Productive Time

1. In the Plant Applications Client program, open the Non-Productive Time View display.
2. If necessary, select the production unit on which you want to schedule non-productive time from the Production Unit list. If only one production unit has been configured for this display, the Production Unit list will not be visible.

---

**NOTE:** If there are no production units in the list, click  **Show All**.

---

3. In the calendar, double-click the day and time you want to schedule as non-productive time, or right-click a cell and select **New**, to display the [New Non-Productive Time dialog](#).
4. Configure non-productive time by selecting a unit, time frame, and reason. When finished, click **OK**.

## Editing Non-Productive Time

This task applies to the Non-Productive Time View (client) display. To manage non-productive time through the Plant Applications Administrator program, see Non-Productive Time (NPT).

There are three ways to edit non-productive time.

- If you want to change the date of the non-productive time, drag the non-productive time to the new date on the calendar.
- If you want to adjust the time frame, drag a start or end time to resize the non-productive time cell.

---

**NOTE:** Starting with the Plant Applications 6.2 August 2014 SIM, you can drag NPT boundaries to change time ranges. Adjacent or overlapping NPT events are automatically adjusted or removed. NPT events can now be adjoining (the end time of one event can be the same as the start time for a second event).

---

- If you want to change reasons, you must edit the non-productive time.

### Edit Non-Productive Time

1. In the Plant Applications Client program, open the [Non-Productive Time View](#) display.
2. To view the scheduled non-productive time for a production unit, select the production unit in the Production Unit list. By default, all production units are selected.
3. Double-click the non-productive time in the calendar you want to edit, or right-click the non-productive time to open the Edit Non-Productive Time dialog for making changes. You can also drag the start or end time of an event to make a change.

## Copying Non-Productive Time (NPT)

This task applies to the Non-Productive Time View (client) display. To manage non-productive time through the Plant Applications Administrator program, see Non-Productive Time.

Once you have scheduled Non-Productive Time (NPT) on a particular day, you can copy the existing NPT and paste it onto another day.

### Copy a Scheduled Non-Productive Time

1. In the Plant Applications Client program, open the [Non-Productive Time View](#) display.
2. In the NPT View, right-click on the scheduled non-productive time, and choose **Copy**.
3. Right-click the day you want to schedule NPT, and choose **Paste**. The new NPT will be scheduled for the new day but within the time frame of the NPT you copied.
4. Repeat step 3 on each day you want to schedule NPT.

## Deleting Non-Productive Time

This task applies to the Non-Productive Time View (client) display. To manage non-productive time through the Plant Applications Administrator program, see Non-Productive Time.

### Delete Non-Productive Time

1. In the Plant Applications Client program, open the [Non-Productive Time View](#) display.
2. In the Non-Productive Time View, right-click the scheduled non-productive time and choose **Delete** (or click the non-productive time and press the **Delete** key). A message appears asking you to confirm the deletion.
3. Click **Yes** to delete the non-productive time.

## Troubleshooting

### Meaning of the Gray and Green Calendar Box

When you move a non-productive time to another time or day, the original position will turn gray and the new position will turn green to indicate that a request is pending. After the request has been processed, the new position will turn white.

On occasion, it may appear that the Router service is not processing the request. This may be an issue with caching. To clear the cache, click the  **Go** button.



# Production Overview Display

## Anatomy of a Production Overview Display

The Production Overview display is a real-time application used to show data specific to the performance of each Production Unit on a Line. There are four different views available for the Production Overview.

- Production Execution Path View
- Units View
- Alarms View
- Icons View

### Uses

Provide data for each Production Unit in a Production Line. The following data is available for display: the Product, Production Amount, Alarm Count, Downtime Minutes, Waste Amount, Process Order, Production Rate, Downtime Efficiency, Waste Efficiency, and the Overall Efficiency for the current production day. Double-Clicking a value will also display the detail data for that value. High, Medium, and Low Alarm Counts are shown in the small boxes above the data and the 4<sup>th</sup> small box indicates if the Unit is Running or Not as defined by the Downtime configuration. The Number of Downtime Events is displayed in this box for the current production day. The number of events in Inventory between Units is shown in the Inventory Box.

### Key Data

The following data is available for display:

- Alarm Counts
- Product Code
- Process Order
- Production Rate
- Production Amount
- Production Quality
- Downtime Minutes
- Waste Amount
- Overall Efficiency
- Detail data for each value is accessible

# Production Run Analyst Display

## Anatomy of a Production Run Analyst (Operator) Display

Production Run Analyst Displays are identified with the Production Run Analyst icon . The Production Run Analyst Display, formerly known as the Operator Display, is designed for reviewing current process and quality conditions versus standard (recipe) conditions and historical conditions. It provides historical statistics for quality and process data.

The display provides a convenient method for comparing current conditions to current or other recipe targets. Historical production run averages and control statistics can be reviewed by right-clicking on a cell for a particular variable and product combination. Product specifications are displayed, and operating procedures can be attached.

- Variables are underlined if comments are attached.
- Targets for the current product are displayed in a column.
- Current real-time values are displayed in the Current column
- Ad ho Summary columns are added to the right of the Current column.
- Summary statistics are shown by right-clicking a cell.
- Specifications for the selected cell are displayed at the bottom of the Display.

### Key Uses

- Compare current conditions to current recipe targets
- Compare current conditions to other recipe targets
- Review historical production run averages
- Review historical production run control statistics
- Compare current conditions to previously captured data sets
- Review product, product specifications, and operating procedures

### Key Data

- Summarize quality and process data
- Results of calculations
- Product specifications / recipes
- Historical statistics for quality and process data

## Inserting Historical Run Summaries

In the Production Run Analyst display, you have three options for inserting historical run summaries.

- Insert the last production run
- Insert the last three production runs
- Search and select from all production runs

### Insert the Last Production Run Summary

- From the **Actions** menu, select **Insert Last Production Run**.

## Insert the Last Three Production Run Summaries

- From the **Actions** menu, select **Insert Last 3 Production Runs**.

## Search and Select a Run Summary from All Production Runs

1. From the Actions menu, click Query For Production Runs.
2. The Plant Applications Run Summary Query wizard will start. In the first page, do one of the following:
  - a. To search for an existing query, in the **Search Queries Named** box, type the name, or partial name, of the query you want to run and click **Search**. If you don't know the name, leave the box empty and click **Search** to retrieve a list of all saved queries. Then, click **Next**.
  - b. If you have no saved queries, click **Next**.
3. On the second page of the wizard, select the product or products you want to include as part of the query.
4. On the third page of the wizard, define one or more criteria you want to use for the query. As you define criteria, click **Add**.

---

*You must add at least one criteria if you want to save the query for future use.*
5. On the fourth page of the wizard, you can review a summary of the criteria you've defined for the query. Click **Execute Query**. When the **Query Status** displays "Query Complete," click **Next**.
6. On the fifth page, select the run summaries you want to include on your display by clicking the box next to **No**. Then, click **Next**.
7. On the sixth page, do the following:
  - a. To save the query, type the name of the query in the **Save Query Name As** box and click **Save**.
  - b. Click **Finish** to add the run summaries to your display.

## Inserting Product Specifications in a Production Run Analyst Display

Inserting production specifications, or targets, allows you to compare current real-time values to specifications.

### Insert Product Specifications

1. From the Actions menu, click Insert New Product Specifications.
2. In the Insert Product Specifications dialog box, do the following:
  - a. Select a product group from the **Product Group** drop-down list.
  - b. Under **Products**, select a product.
3. Click **OK**.

## Viewing Historical Statistics in a Production Run Analyst Display

### View Historical Statistics

Do one or more of the following:

- To see production run statistics, right-click a **Summary** column heading.
- To see summary, scroll to a particular cell and right-click to see summary statistics for a variable and production run.

# Relative View Display

## Anatomy of a Relative View Display

---

*This display is available only if you have purchased an Efficiency or Quality license. Refer to Contact Information.*

---

The Relative View display is a real-time application designed to compare a series of variables to product-based specification or recipe limits. Values are plotted according to the relative distance between the current value and its specification limits. If specification limits are not available, values are plotted against historical statistics for the current product. The display offers these features:

- Current value relative to product specifications shown with a colored bar
- Previous values shown with non-colored bars around current value
- Plus or minus trend indicator
  - (+) = Getting better
  - (-) = Getting worse
- Target line is shown in the middle
- Warning limits and reject limits are shown above and below the targets
- Variable descriptions are shown at the bottom.

### Key Uses

- Compare current values of several variables against specifications
- Access historical trends by drilling down into a specific variable

### Key Data

- Summarized quality and process data
- Product specifications / recipe limits

# Schedule View Display

## Anatomy of a Schedule View Display

Use a Schedule View display to view and execute the current production schedule. Active process orders track actual production and quantities against process orders, and display remaining quantities, planned quantities, planned start times, and planned end times. You can reorder, change the status of, and edit process orders, and the production schedule provides normal, warning, and alarm indicators to aid in tracking progress. Refer to Schedule Display Process Order Grid for additional information.

### Sort Order

By default, process orders are sorted by schedule status, then implied sequence (descending), and then forecast start date. You can control the sort order when you configure the production execution path. For more information, see Defining Execution Paths.

### Setup Patterns

Process orders may contain *setup patterns*, which are details of the dimensions to which products are manufactured for specific process orders. Setup patterns display status (which can be changed), planned and actual quantities for all patterns within a process order, as well as normal, warning, and alarm indicators. Setup patterns can be reordered and edited.

In a Schedule View display, you can view customer orders and the item details associated with them.

### Uses of a Schedule View

- See an overview of the active process order
- Create, schedule, and reorder process orders
- Associate bills of materials to process orders
- Edit process orders
- Change the status of process orders
- Bind and unbind a process order from a specific path
- Select the currently active process order against which production is counted
- Track progress of process orders by quantity or time
- Provide setup patterns to aid in the manufacturing of dimensional products
- View customizable normal, warning, and alarm indicators.

### Key Data

- Planned, actual, and remaining quantities for each order
- Planned start and planned end times for each order
- Normal, warning, and alarm indicators
- Process orders are listed in order of execution

## Adding a New Process Order

The Process Order appears in the Production Schedule View when a time frame containing the specified Process Order's projected Start Time is set. All information specified when adding the Process Order is preserved throughout the Schedule View.

## Add a New Process Order Manually

1. Select **Add New Process Order** from the **Actions** menu, or click the **Add New Process Order** tool icon, or in the Process Order Actions hyperlink category, click the **Add New Process Order** hyperlink, or right-click on a Process Order in any column except the Path or Status column and select **Add New Process Order**.
2. From the Add Process Order window the following are required entries:
  - A new unique Process Order Number is required for each Order.
  - Select a Control Type of Quantity, Duration, or Time.
  - Select a Product for the Process Order.
  - Enter a Start Time or select the drop down arrow to initiate a calendar.
  - Check whether an end time will be used to complete the running of the order at the specified time.
  - Enter a Planned Quantity for the Process Order.
3. Select the Advanced tab and specify any desired information. Parameters for additional user-defined data relevant to a site are defined in the Advanced tab:
  - User General 1 – describes additional, user-specific data about a Process Order.
  - User General 2 – describes additional, user-specific data about a Process Order.
  - User General 3 – describes additional, user-specific data about a Process Order.
  - Info – describes extended, user-specific information about a Process Order.
  - Block Number – defines an identifier that signifies a collection of as many as 10 Process Orders.
  - Production Rate – describes a target Production Rate for the specified product that is manufactured according to the Process Order.
4. Click the **Save** button.

---

*When you associate a bill of materials formulation with a process order, only the formulations associated with the selected product will be available for selection.*

---

## Adding Comments to a Process Order

In the Schedule View, comments can be added to a specific Process Order if security allows it.

### Add Comments to a Process Order

1. Select **View (Process Order) Comment** from the **View** menu, or click the View Process Order Comment tool icon, or in the **Process Order Actions** hyperlink category on the right, click the **View Process Order Comment** hyperlink, or right-click on a Process Order in any column except the Path or Status column and select **View Process Order Comment**. In the Comment For Process Order window, click the New Comment button. In the text area, type the desired comment. Click the Save Comment button.
2. The **Comment For Process Order: (Process Order)** window is displayed. In the text area, type the desired comment.
3. Click [x] to close the **Comment For Process Order: (Process Order)** window when completed.

## Activating a Process Order

In the Schedule View, the Active Process Order is indicated by a Status of Active. The currently Active Process Order is used to track the Actual Quantity produced against a Process Order and its Planned Quantity. Activating a Process Order makes it the current running Process Order that product quantities, Process Order run times, and Process Order statistics are applied to.

## Activate a Pending Process Order

1. Select the Status hyperlink **Change (Process Order) To Next** from the Process Order Status hyperlink category, or right-click on a Process Order in the Status column and select the Status of **Next**.
2. If the current Status is Pending, then select **Next**.
3. Select **Yes** to Change Process Order [Process Order] From Pending to Next.
4. If the current Status Next, then select **Active**.
5. Select Yes to Change Process Order [Process Order] From Next to Active.

## Advancing a Process Order

Within the Schedule View display, you can manually move an active process order to any production unit that is part of the production execution path. Keep in mind that the process order must have a status of Active before it can be advanced to another production unit.

Before you can manually advance a process order, the **Schedule Control Type** needs to be set to **Schedule Flows Independently** on the **General** tab of the **Execution Path Configuration** dialog box in the Plant Applications Administrator.

## Advance and Edit a Process Order

1. In the Schedule View display, select a process order with a status of **Active** and do one of the following:
  - Right-click and click Edit Starts for *<process order name>*.
  - In the [HyperLinks menu](#), under Process Order Actions, click Edit Starts for *<process order name>*.
  - Click the Edit Starts for Process Order icon  on the toolbar.
  - On the Actions menu, click Edit Starts for *<process order name>*.
2. In the **Edit Starts for Schedule** dialog box, click the **Advance** button.
3. In the **Edit Starts for Schedule Unit Selection** dialog box, select the production unit you want to advance the process order to and click the **OK** button.
4. To close the process order on a production unit, right-click the production unit and click **Close**. This will enter an end time for the production run on the selected production unit.
5. To open a process order on a production unit, right-click the production unit and click **Open**. This will enter a start time for the production run on the selected production unit.
6. To delete a process order on a production unit, right-click the production unit and click **Delete**, then click **Yes** to confirm the deletion.
7. To edit the run times on a production unit, right-click the production unit, click **Edit** and then do the following:
  - a. In the **Advance Schedule Edit Run Times** dialog box, enter the new start time. You cannot move the start time beyond the start time of the scheduling unit.



- b. To edit the end time, select the **End Time** check box and enter the new end time. You cannot move the end time beyond either the end time of the scheduling unit or the current time.
- c. Click the **Save** button.

Please note the following limitations when editing run times:

- The end time cannot exceed the current process order's actual end time or the actual start time of the next process order.
- The start time cannot go beyond the start time on the scheduling unit.
- If you stop and then re-start a process order on a unit, and the start time of the second record is before the end time of the first record, the start time of the second record becomes the end time of the first record.

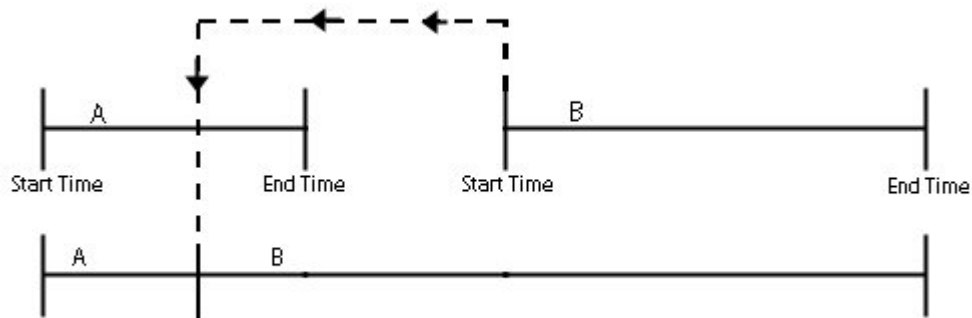

- If you stop and then re-start a process order on a unit and then change the end time of the first record to go beyond the end time of the second record, the two records will be merged.

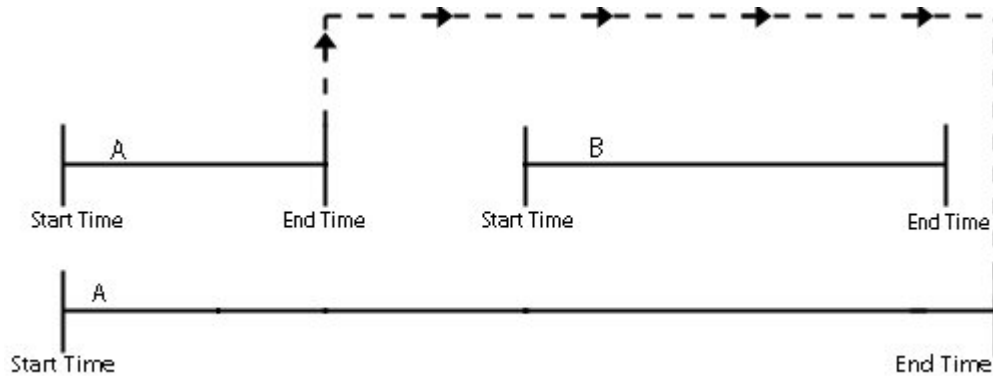

- If you stop and then re-start a process order on a unit and then change the end time of the first record to go between the start time and end time of the second record, the end time of the first record becomes the start time of the second record.

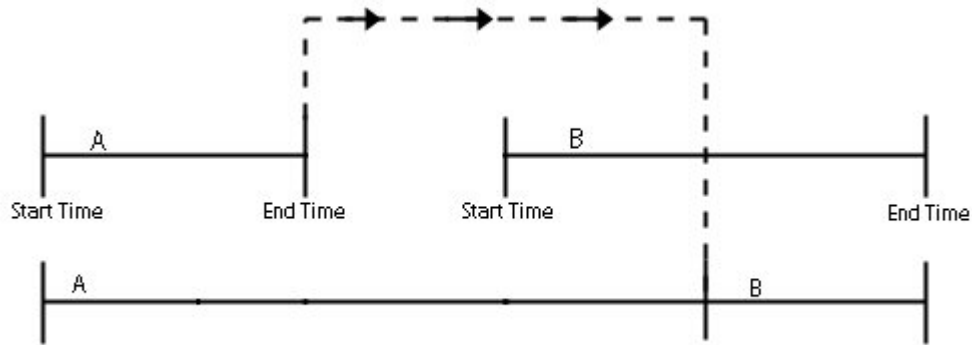

## Binding a Process Order to a Path

In the Schedule View, the selected Process Order is Bound to a Path. If the Display Unbound Process Orders display option is set to True (this value is set in the Display Options from the Administrator), the unbound Process Orders are displayed below all Path-bound process orders, with no information displayed in the Path column.

### Bind a Process Order to a Path

1. Select the **Bind (Process Order) to (Path)** hyperlink from the **Process Order Actions** hyperlink category.
2. Click **Yes** to confirm.

## Changing a Process Order Status

In the Schedule View display, only Valid Transitions appear in the hyperlink and right-click menus for the selected Process Order. If the limit of Process Orders on one of the Statuses to which the Process Order can be transitioned has been reached, the Transition to this Status is not displayed.

### Change Any Process Order Status

1. Select the desired Status hyperlink from the Process Order Status hyperlink category, or right-click on a Process Order in the Status column and select the desired Status.
2. Dialog windows will ask the change to be confirmed. Click **Yes** to accept the Status change or **No** to reject it.

## Changing the Visible Columns or Rows

Only the selected columns for Process Orders are displayed in the Schedule View. These configurable settings remain after switching to and back from the Process Order Detail View. The initial columns shown are configured in the Administrator.

### Select Columns Visible in the Production Schedule

1. Open the Change Column Visibility dialog box by one of the following methods:
  - From the View menu in the Schedule view, choose Select Process Order Columns
  - Click the Select Process Order Columns tool icon
  - Double-click any Process Order column header

- Right-click on a Process Order in any column except the Path or Status column and choose Select Process Order Columns.
2. In the Change Column Visibility dialog box, double-click the items in the Hidden Columns and Visible Columns lists, or use the arrow buttons to move column names from one list to the other.

### Select Rows Visible in the Materials Tab (Details View)

1. Double-click any row heading to open the Change Visibility dialog box.
2. In the Change Visibility dialog box, double-click the items in the Hidden and Visible lists, or use the arrow buttons to move names from one list to the other.

## Completing an Active Process Order

In the Schedule View display, the Active Process Order is indicated by a Status of Active. The currently Active Process Order is used to track the Actual Quantity produced against a Process Order and its Planned Quantity. Completing an Active Process Order allows a different Process Order to be activated. If another Process Order has a Status of Next it will automatically become the Active Process Order when the current Active Process Order is Moved To Complete.

### Complete an Active Process Order

1. Select the **Change (Process Order) To Complete** Status hyperlink from the Process Order Status hyperlink category, or right-click on a Process Order in the Status column and select the Status of **Complete** from the menu that is displayed.
2. Choose **Yes** to Change Process Order [ProcessOrder] From Active to Complete. If Auto Promote From Next to Active is configured and another Process Order has a Status of Next, then that Order will automatically become the new Active Process Order.

## Creating a Child Process Order

In the Schedule View display, a new Child Process Order is created with the specified name and properties. This allows parts of an order to be made on other Execution Paths. The Links column of this Process Order contains the name of the Parent Process Order. The maximum product quantity available to be given to other Child Process Orders is reduced by the number given to the new Child Process Order. The quantity accumulated on a Child Process Order gets applied to the Parent as well.

### Create a Child Process Order

1. If the Process Order is already Bound to a Path, then it is required to Unbind it prior to creating a Child Process Order.
2. To Unbind the Process Order, select the **UnBind (Process Order)** hyperlink from the **Process Order Actions** hyperlink category. Click **Yes** to confirm.
3. Select **Create Child For (Process Order)** from the **Actions** menu, or click the **Create Child For (Process Order)** tool icon, or in the **Process Order Actions** hyperlink category, click the **Create Child For (Process Order)** hyperlink, or right-click on a Process Order in any column except the Path or Status column and select **Create Child For (Process Order)**.
4. In the Create **Child Process Order** window, specify the Child Process Order's Name, Path, and Quantity.

5. To specify a desired Start and End time, click the Planned Start Time drop down and specify the desired times using the calendar.
6. To insert the Child before or after a certain Process Order, click the Before/After Process Order drop down. Select the desired insertion position (using the Before and After bullets) and select a Process Order from the Process Order combo box.
7. When finished, click the **Save** button.

## Deleting Process Order Comments

In the Schedule View display, comments made to a specific Process Order can be deleted for each Process Order if security allows access.

### Delete the Comments for a Process Order Manually

1. Select **View (Process Order) Comment** from the **View** menu, or click the View Process Order Comment tool icon, or in the **Process Order Actions** hyperlink category on the right, click the **View Process Order Comment** hyperlink, or right-click on a Process Order in any column except the Path or Status column and select **View Process Order Comment**. In the Comment For Process Order window, click the New Comment button. In the text area, type the desired comment. Click the Save Comment button.
2. The **Comment For Process Order: (Process Order)** window is displayed. In the text area, click the **Delete Comment** icon.
3. Click the **Save Icon** to save the changes.
4. Click [X] to close the **Comment For Process Order: (Process Order)** window when completed.

## Editing a Process Order

The process order appears in the Schedule View when a time frame containing the specified process order's projected start time is set. All information specified when editing the process order is preserved throughout the Schedule View.

### Edit a Process Order

1. Open the Edit Process Order dialog box by one of the following methods:
  - Choose Edit [Process Order] Properties from the Actions menu
  - Click the Edit [Process Order] Properties toolbar icon
  - In the Process Order Actions hyperlink category, click Edit [Process Order] Properties
  - Double-click a process order in any column other than Path or Status
  - Right-click in any column other than Path or Status and then choose Edit [Process Order] Properties
2. In the **Edit Process Order** dialog box, change order parameters as required. Refer to [Adding a New Process Order](#).
3. When you have finished editing the process order, click **Save**.

---

*When you associate a bill of materials formulation with a process order, only the formulations associated with the selected product will be available for selection.*

---

## Editing Process Order Run Times

In the Schedule View display, Edit Process Order Run Times calls up the selected Process Order in an editing window that allows the Start and End Times to be moved for each time frame the Order was run.

## Edit Process Order Run Times for a Process Order

1. Select **Edit (Process Order) Run Times** from the **Actions** menu, or click the **Edit (Process Order) Run Times** tool icon, or in the **Process Order Actions** hyperlink category, click the **Edit (Process Order) Run Times** hyperlink, or right-click on a Process Order in any column except the Path or Status column and select **Edit (Process Order) Run Times**.
2. The **Edit Production Schedule Run Times** dialog box is displayed.
3. The **Search** functions on the hyperlink menu are **Goto Specific Time**, **Goto Previous Transition**, or **Goto Next Transition** for this Process Order.
4. The **View** functions on the hyperlink menu on the right allow the **Widen Time Frame**, **Scroll Forward**, or **Scroll Backward**.
5. The **Actions** functions on the hyperlink menu allow the Start and End Times for the Process Order to be shifted forward or backward.

## Editing Process Order Comments

In the Schedule View display, comments made to a specific Process Order can be edited for each Process Order if security allows the user access.

### Edit the Comments for a Process Order

1. Select **View (Process Order) Comment** from the **View** menu, or click the View Process Order Comment tool icon, or in the **Process Order Actions** hyperlink category on the right, click the **View Process Order Comment** hyperlink, or right-click on a Process Order in any column except the Path or Status column and select **View Process Order Comment**. In the Comment For Process Order window, click the New Comment button. In the text area, type the desired comment. Click the Save Comment button.
2. The **Comment For Process Order: (Process Order)** window is displayed. In the text area, type the desired comment.
3. Click the **Save Icon** to save the changes.
4. Click [x] to close the **Comment For Process Order: (Process Order)** window when completed.

## Moving a Process Order Backward

In the Schedule View display, the selected process order can be moved up one row on the path it is bound to (switching places with the process order above it). The status the process order is in must have the **Enable <status name> PO Ordering** feature enabled in the Administrator. Typically, you can only move within the same status unless Sort With was enabled when you configured the production execution path.

### Move a Process Order Backward

- Select **Move Process Order Backward** from the **Actions** menu, or click the **Move Process Order Backward** tool icon, or in the **Process Order Actions** hyperlink category, click the **Move Process Order Backward** hyperlink, or right-click on a Process Order in any column except the Path or Status column and select **Move Process Order Backward**.

## Moving a Process Order Forward

In the Schedule View display, the selected Process Order is moved down one row on the Path it is Bound to (switching places with the Process Order above it). The Status the Process Order is in must have the Movable feature enabled in the Administrator. Typically, you can only move within the same status unless the Sort With feature is enabled in the Administrator.

### Move a Process Order Forward

- Select **Move Process Order Forward** from the **Actions** menu, or click the **Move Process Order Forward** tool icon, or in the **Process Order Actions** hyperlink category, click the **Move Process Order Forward** hyperlink, or right-click on a Process Order in any column except the Path or Status column and select **Move Process Order Forward**.

## Pausing a Process Order

In the Schedule View display, the Active Process Order is indicated by a Status of Active. The currently Active Process Order is used to track the Actual Quantity produced against a Process Order and its Planned Quantity. Pausing a Process Order allows it to be set to Pending to be completed at a later time.

### Pause a Process Order Manually

1. Select the Status hyperlink **Change (Process Order) To Pending** from the Process Order Status hyperlink category, or right-click on a Process Order in the Status column and select the Status of **Pending**.
2. Select **Yes** to Change Process Order [Process Order] From Active to Next.

## Reworking a Process Order

In the Schedule View display, the Re Work option allows a new Process Order to be created with the specified name and properties, and is added to the proper path. The Process Order's type is labeled with red text as Re-run in the Status column.

### Rework a Process Order

1. Select **Re Work (Process Order)** from the **Actions** menu, or click the **Re Work Process Order** tool icon, or in the **Process Order Actions** hyperlink category, click the **Re Work (Process Order)** hyperlink, or right-click on a Process Order in any column except the Path or Status column and select **Re Work (Process Order)**.
2. Specify the new Process Order name, Source Process Order, Start Time, and Quantity to be Re Worked.
3. Click the **Save** button.

## Returning Child Process Order to Parent

In the Schedule View display, child Process Orders allow parts of an order to be made on other Execution Paths. The quantity accumulated on a Child Process Order also gets applied to the Parent Process Order.

## Return to Parent Process Order from a Child Process Order

- Select **Return (Process Order) To Parent** from the **Actions** menu, or right-click on a Process Order in any column except the Path or Status column and select **Return (Process Order) To Parent**.

## Unbinding a Process Order from a Path

In the Schedule View display, the selected Process Order is removed from the Path to which it was previously bound. If the Display Unbound Process Orders display option is set to True (this value is set in the Display Options from the Administrator), the unbound Process Order is displayed below all Path-bound process orders, with no information displayed in the Path column.

### Unbind a Process Order from a Path

1. Select the **UnBind (Process Order)** hyperlink from the **Process Order Actions** hyperlink category.
2. Click **Yes** to confirm.

## Viewing a Specific Time in the Schedule

In the Schedule View display, the viewing window is adjusted to display only the Process Orders whose forecasted duration is partially or completely contained by the new time frame of the Schedule View, and those that are linked to such Process Orders.

### View a Specific Time in the Schedule

1. Select **Go To Time** tool icon, or in the **Search** hyperlink category on the right, click the **Go To Time** hyperlink, or right-click on a Process Order in any column other than the Status or Path column and select **Go To Time**.
2. From the Select Date window, make changes by typing over the current date/time or using the arrow keys to scroll one piece of the date/time at a time.

## Viewing Child Process Orders

In the Schedule View display, child Process Orders allow parts of an order to be made on other Execution Paths. The quantity accumulated on a Child Process Order also gets applied to the Parent Process Order.

### View Child Process Orders for a Process Order

- Select **View Children For (Process Order)** from the **Actions** menu, or click the **View Children For (Process Order)** tool icon, or right-click on a Process Order in any column except the Path or Status column and select **View Children For (Process Order)**.

## Viewing Parent Process Orders

In the Schedule View display, child Process Orders allow parts of an order to be made on other Execution Paths. The quantity accumulated on a Child Process Order also gets applied to the Parent Process Order.

## View Parent Process Orders for a Child Process Order

- Select **View Parent For (Process Order)** from the **Actions** menu, or click the **View Parent For (Process Order)** tool icon, or right-click on a Process Order in any column except the Path or Status column and select **View Parent For (Process Order)**.

## Viewing the Process Order History

In the Schedule View display, the history of changes made to a specific Process Order can be viewed for each Process Order.

### View Historical Changes for a Process Order

1. Select **View Process Order History** from the **Tools** menu, or click the **View (Process Order) History** tool icon, or in the Process Order Actions hyperlink category on the right, click the **View (Process Order) History** hyperlink, or right-click on a Process Order in any column other than the Status or Path column and select **View (Process Order) History**.
2. A **History** window of all changes made to the Process Order is shown.
3. Click [x] to close the **History** window when completed.

## Viewing Process Order Comments

Comments made to a specific Process Order can be viewed for each Process Order.

### View Comments for a Process Order

1. Select **View (Process Order) Comment** from the **View** menu, or click the View Process Order Comment tool icon, or in the **Process Order Actions** hyperlink category on the right, click the **View Process Order Comment** hyperlink, or right-click on a Process Order in any column except the Path or Status column and select **View Process Order Comment**. In the Comment For Process Order window, click the New Comment button. In the text area, type the desired comment. Click the Save Comment button.
2. The **Comment For Process Order: (Process Order)** window is displayed.
3. Click [x] to close the **Comment For Process Order: (Process Order)** window when completed.



# Sequence of Events (SOE) Display

## Anatomy of a Sequence of Events (SOE) Display

Sequence of Event Displays are identified with the Sequence of Event icon . These displays interact with all event types, which can be sorted by time. Detailed information is provided for production, product change, and downtime, waste, and user-defined events. Key features of the screen are as follows:

- The chronology of all events can be viewed in the left-hand window pane.
- Sub-events can be viewed by clicking the event.
- Detail for currently selected event in lower-right window. The display option, **DisplayDetailPanel** must be set to *True* to view the detail panel in the SOE display.

### Key Uses

- Review Downtime and Waste Events
- Review Other Types of Events In Sequence with Downtime and Waste
- Interact with Research Fields for Downtime and Waste
- Enter User-defined Events

### Key Data

- All Data from Downtime and Waste
- Research Fields for Downtime, Waste, User-defined Events
- User-defined Event Times
- User-defined Event Reasons
- User-defined Event Comments

## Adding User-Defined Events

You must configure a User-Defined Event (UDE) before you can add one in an Autolog or Sequence of Events (SOE) display. For more information, see [Configuring User-Defined Events on a Production Unit](#).

### Add a User-Defined Event

1. Do one of the following:
  - Add a new column in an Autolog UDE display.
  - Right-click an SOE event to add a UDE around it (in terms of time).
2. Select **Add User Defined Event**. The Add User-Defined Events dialog box appears.
3. On the **General** tab, do the following:
  - a. Select the UDE from the **Event Type** list.
  - b. In the **Description** box, type a brief description of the User-Defined Event. The description will be displayed in the list of events. This step is optional.
  - c. In the Status field, select a status. The default status that was selected when creating a UDE (refer to [Creating a User-Defined Event](#)) is initially displayed.

**TIP:** If the Status field is locked and does not allow an entry, it means that a default status was not selected when creating a UDE.

- d. The **Timestamp** box is automatically filled with the timestamp of the event that you clicked in step 1. To insert the UDE at the current time, click **Now**.
4. On the **Cause** tab, select a default cause for the user-defined event.
5. On the **Actions** tab, select a default action for the user-defined event.
6. On the **Research** tab, do the following:
  - a. From the **User** list, select a user who is responsible for researching the user-defined event.
  - b. From the **Research Status** list, choose either **Open** or **Closed**.
  - c. Click **Open Date** to identify the date the case was opened.
  - d. Click **Close Date** to identify the date the case was closed.
7. Click the **History** tab to view a history of the event.
8. Select **OK** to save the new user-defined event.

## Modifying Event Details in an SOE Display

Follow these steps to modify event details in an SOE display:

1. Select an Event to view details for.
2. Right-click and select Show Details.

# Trend Display

## Anatomy of a Trend Display

Trend Displays are identified with the Trend Display icon . A Trend Display is a real-time display designed for trending variables against product-based specifications or recipe limits. Trends summarize quality and process data by time or event. Historical trends and product specifications (recipe limits) can be reviewed. Trends can include the following information:

- Overall display information at the bottom of the Trend Display
- Variable trends in each rectangle
- Variable alarm state highlighted with a colored border around a rectangle

---

**NOTE:** Starting with Plant Applications 6.2.2, control limits can be automatically calculated as an option based on a configurable sample size. When available, calculated sigma values are reflected by control limits in trend charts.

---

### Key Uses

- Trend Summarized Event or Time-Based Data
- Compare Trends to Specification Limits
- Review Historical Trends

### Key Data

- Summarized Quality and Process Data
- Product Specifications / Recipe Limits
- Data Point Comments (Annotations)

## Viewing Trend Details

Follow these steps to view Trend Details:

1. Double-click an individual Trend to resize it to full screen.
2. Hover the mouse pointer over individual data points to see details and comments
3. Double-click on the Trend to return to normal size.

## Changing the Time Range

Change the time range in a Trend Display as follows:

1. Select the Get Trend Time icon in the toolbar.
2. Enter the Start and End Times for the trend using the Data and Time selection fields.

# Waste Display

## Anatomy of a Waste Display

---

This information applies to the classic Waste Display.

---

Waste Displays are identified with the Waste icon . The classic Waste Display is used to interact with Waste detail data. Waste events and reasons can be automatically detected or manually entered via an Autolog Display. You can also attach comments or documents to each event. Key features are as follows:

- Red indicates missing Reasons.
- Production event without details is shaded in yellow.
- Time-based Waste is shaded in light green.
- Total Waste for an event is in the Amount column.

### Key Uses

- Review automatically detected waste events
- Manually enter waste details on time basis
- Manually enter waste details on "production event" basis
- Manually change downtime reasons
- Add comment and attach documents to waste events

### Key Data

- Waste timestamp
- Waste "production event" (Batch, etc.)
- Waste cause location
- Waste type
- Waste amount
- Waste unit of measure
- Waste cause reasons
- Waste action reasons
- Waste comments

## Adding Waste Events to a Waste Display

---

This information applies to the classic Waste Display.

---

### Add a Waste Event

1. Do one of the following:
  - Right-click on the row where you want to add an event and click **Insert New Event** from the pop-up menu.
  - From the **Actions** menu, click **Insert New Menu**.

2. In the **Insert Waste** dialog box, enter the following information:
  - **optional:** In the **Date** box, edit the default date. By default, the date is the date of the event you have selected.
  - **optional:** In the **Time** box, edit the default time. By default, the time is the time of the event you have selected.
  - In the **Location** box, type the cause location of the waste event.

---

*Based on the location you enter, you may be required to identify the production event associated with the waste event.*

---

- **optional:** In the **<event name>** box, select a different production event from the drop-down list. By default, the production event is the production event you have selected.
  - In the **Amount** box, type the amount of waste.
  - In the **Units** box, select the units of measurement from the drop-down list.
  - **optional:** In the **Fault** box, select a Fault from the drop-down list.
  - **optional:** In the **Category** box, select a Category from the drop-down list.
  - **optional:** In the **Reason** box, select a Reason from the drop-down list.
3. Do one of the following:
    - To insert the event and create additional events, click **Apply**.
    - To insert this event and close the dialog box, click **OK**.

---

*If you click **Apply** and then **OK**, you'll insert the event twice.*

---

## Changing Visible Columns in a Waste Display

---

[This information applies to the classic Waste Display.](#)

---

You can control the data that is displayed in a Waste display by displaying or hiding columns.

### Display or Hide Columns

1. From the **View** menu, click **Column Visibility**.
2. In the **Change Column Visibility** dialog box, do one or more of the following:
  - To display additional columns, under **Hidden Columns**, select the column(s) you want to display and click the **Move Selected**  button.

---

*To display all columns, click the **Move All**  button.*

---
  - To hide columns, under **Visible Columns**, select the column(s) you want to hide and click the **Remove Selected**  button.

---

*To hide all columns, click the **Remove All**  button.*

---
3. Click the **Close**  button to close the dialog box.

## Commenting Waste Events in a Waste Display

---



[This information applies to the classic Waste Display.](#)

---

Adding comments is a great way to provide additional information. Comments can be either text that you type, or you can paste a link to an external document, such as a Microsoft Word document.

Keep in mind that if you paste a link to a document, the document cannot be moved to a different folder or directory; otherwise, the link will be broken and the document will not be found.

## Comment Waste Events

1. If you cannot see the detail rows, do one of the following:
  - To expand only one Summary row, select the Summary row you want to expand and click the **Expand Event** button .
  - To expand all Summary rows, click the **Expand All Events** button .
2. Right-click the Detail row you want to comment, and click **Add Comment**.
3. In the Comment window at the bottom of the screen, type the comment or paste a document and click the **Save** button .

---

*The **Pencil**  icon indicates Detail rows that have comments added.*

---

# Waste+ Display

## Anatomy of a Waste+ Display

This information applies to the Waste+ Display.

The Waste+ display enables plant floor operators to view and edit waste events, using either a touch screen or keyboard for navigating the display. The following image shows the Waste+ display in touch screen mode. A classic [Waste Display](#) is also available to interact with Waste detail data.

The Waste+ display in touch screen mode highlights information as follows:

- Red text indicates missing reasons.
- Rows that are shaded yellow indicate production events without details.
- Rows that are shaded light green indicate time-based waste.
- Black text indicates the event is complete and all the required information has been provided.

A Waste+ screen includes these areas:

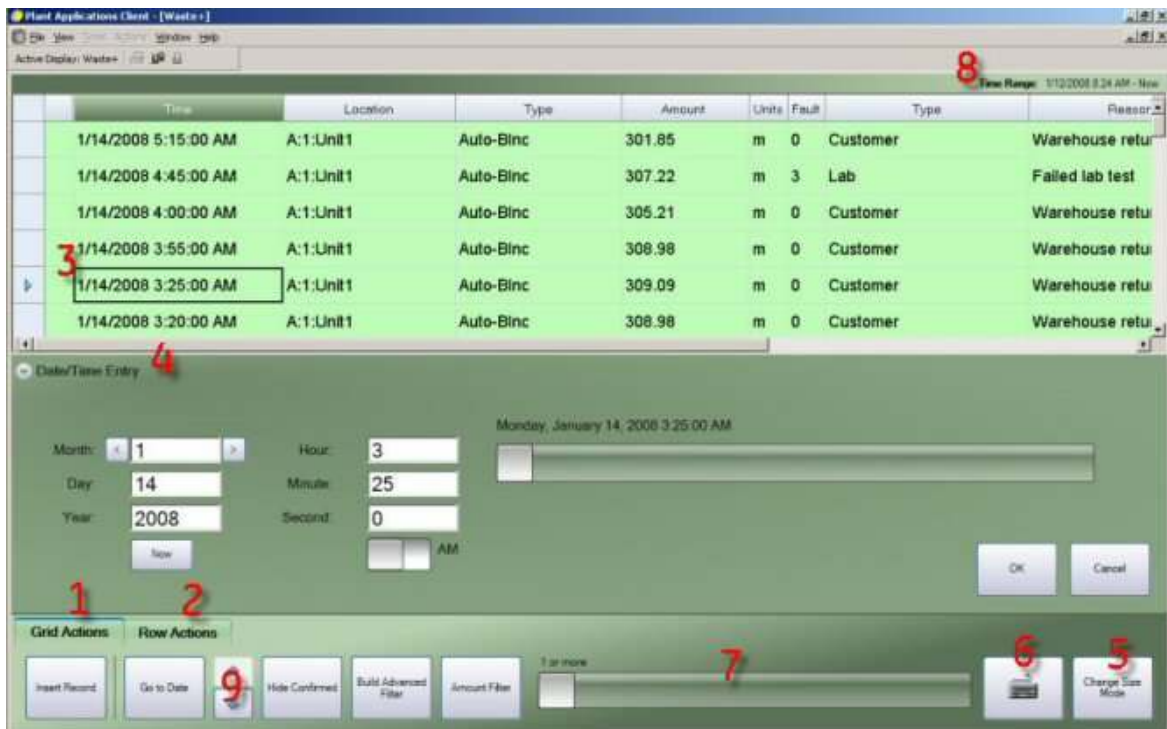

1 Click or tap **Grid Actions** to:

- Manually create a waste event, click or tap **Insert Record**.
- Locate a waste event within a specific time period, click or tap **Go to Date**. The **Date/Time Entry** panel appears.
- Hide confirmed waste events, click or tap **Hide Confirmed**.
- Filter on selected columns, click or tap **Build Advanced Filter**.
- Filter waste events by amount, click or tap **Amount Filter** and use the slider.

**2** Click or tap **Row Actions** to:

---

**NOTE:** You must select a row to view or use **Row Actions**.

---

- Expand grouped waste events, click or tap **Expand Group**.
- Delete the selected waste event, click or tap **Delete**.
- Copy and paste reasons, click or tap **Copy Fault/Reasons**. To copy and paste reasons, you must first view the waste event details, then copy and paste the reasons.

**3** Click or tap a cell in the waste event row to edit reasons, amounts, and other information. Based on the selected cell, the appropriate panel (**4**) appears.

**4** When you click or tap a row or a cell in a row, a panel appears with the appropriate data entry tools or selections.

**5** Click or tap **Change Size Mode** to change to or from touch screen mode. This button is visible only if the display option, Allow Mode Toggle, has been set to True by the Plant Applications Administrator. For information about the display options, see Configuring a Waste+ Display.

**6** When you change to touch screen mode, the on-screen keyboard button appears. Click this button to use the on-screen keyboard.

**7** Select values easily by dragging the sliders.

**8** The time range of the waste events is displayed at the top of the display.

**9** Use the scroll buttons to page through the events in increments that are equal to one-fourth the time specified by the Initial Windows Setting.

## Navigating the Waste+ Display

---

This information applies to the Waste+ Display.

---

To make selections in the Waste+ display, you can click with a mouse or tap (using your finger or stylus). You can also use the arrow keys on your keyboard to make selections and move around the display.

1. Click or tap a cell in the display or click or tap a row and use the arrow keys to select a cell. The appropriate panel is displayed.
2. Press ENTER or tap the panel. The panel becomes active.
3. Tap the buttons or press the arrow keys to choose a button or select a box and use the keypad to enter a new value.

## Using Touchscreen Mode (Waste+)

---

This information applies to the Waste+ Display.

---

The Waste+ display enables the use of a touch screen. To facilitate the use of a stylus or other tapping device, you can change the size of the text and buttons. You can also use an on-screen



## Plant Applications Client

keyboard to enter text. The Change Size Mode button is visible only if the display option, Allow Mode Toggle, has been set to True by the Plant Applications Administrator. For information about the display options, see [Configuring a Waste+ Display](#).

### Enter the Touch Screen Mode

1. Click or tap the **Grid Actions** tab.

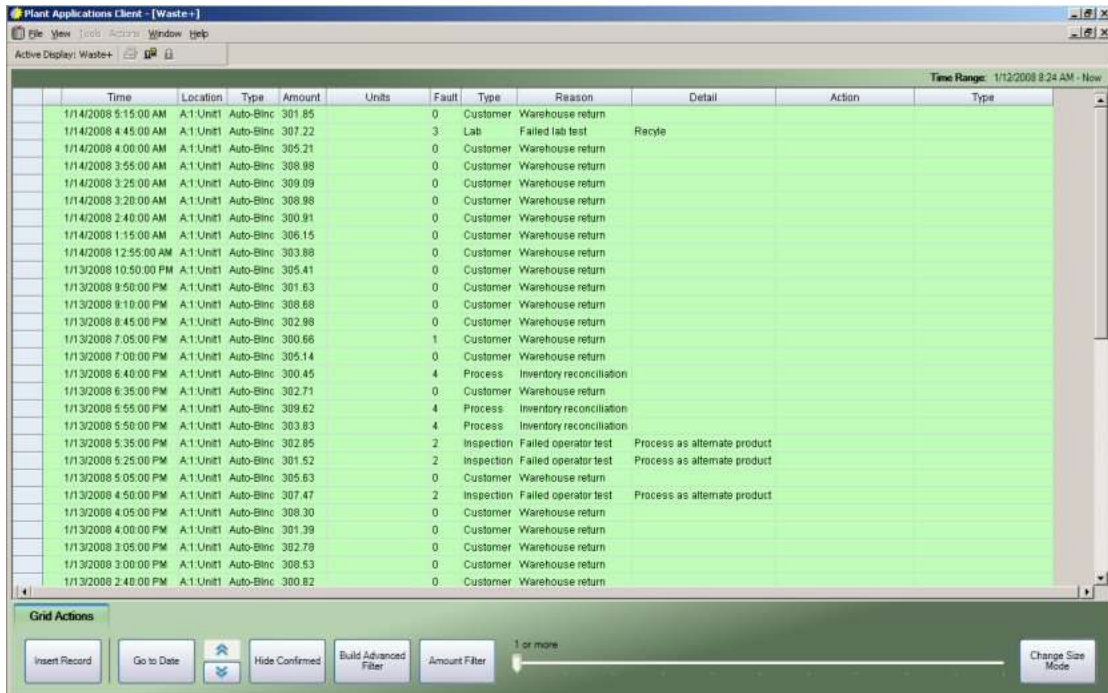

2. Click **Change Size Mode**. The text and buttons become larger and the **On-screen Keyboard** button appears.



3. Click the **On-screen Keyboard** button to open the on-screen keyboard. By default, [Microsoft's On-Screen Keyboard](#) is used.



4. Click **Change Size Mode** to exit touch screen mode.

## Editing Event Timestamp (Waste+)

This information applies to the Waste+ Display.

Click or tap a cell in the Time column to display the Date/Time Entry tab where you can edit the selected time.

## Edit an Event Timestamp

1. Click or tap a cell in the **Time** column to display the **Date/Time Entry** panel.



**NOTE:** You must click or tap the cell of a detail record and not a summary record.

2. Click or tap one of the entry fields to adjust the value. Click or tap the arrows to change the value.
3. Slide the toggle to switch between AM and PM.
4. Click or tap an entry field and then use the arrow buttons or slider to select a value. The scale of the slider changes automatically based on the selected entry field.
5. Click or tap **OK** to save your changes or click **Cancel** to cancel your changes.
6. After you click or tap **OK**, you can click or tap **Cancel Changes** to cancel the changes that you have made.

## Filtering Waste+ Events

This information applies to the Waste+ Display.

In the Waste+ display, you can filter events by one or more of the values in a column. You can also filter confirmed events and filter events by amount.

Filtering uses AND logic to determine the results that are returned. This means that the records that are returned must meet **all** the criteria you select. Consider the following records:

Column 1	Column 2	Column 3
A	Red	Square

## Plant Applications Client

A	Yellow	Oval
A	Yellow	Oval
B	Red	Round

If you selected **A** and **B** from Column 1 and **Red** from Column 2 and **Oval** from Column 3, no records would be returned because no single row matched all criteria. However, if you selected **A** and **B** from Column 1 and **Red** and **Yellow** from Column 2 and **Square** and **Oval** from Column 3, three records would be returned.

***NOTE:** When filtering is applied, summary records are not displayed; however, the detail records belonging to the summary records will be displayed, if they meet the filter criteria.*

## Use the Advanced Filter

1. Click or tap **Grid Actions**.

The screenshot displays the 'Plant Applications Client' window. The main area is a data grid with the following columns: Time, Location, Type, Amount, Units, Fault, Type, Reason, Detail, Action, and Type. The data rows show various transactions, including 'Warehouse return' and 'Inventory reconciliation'. Below the grid is a 'Grid Actions' panel with several buttons: 'Insert Record', 'Go to Date', 'Hide Confirmed', 'Build Advanced Filter', 'Amount Filter', and 'Change Size Mode'. The 'Build Advanced Filter' button is highlighted, indicating it is the next step in the process.

2. Click or tap **Build Advanced Filter**. A **message box** appears.

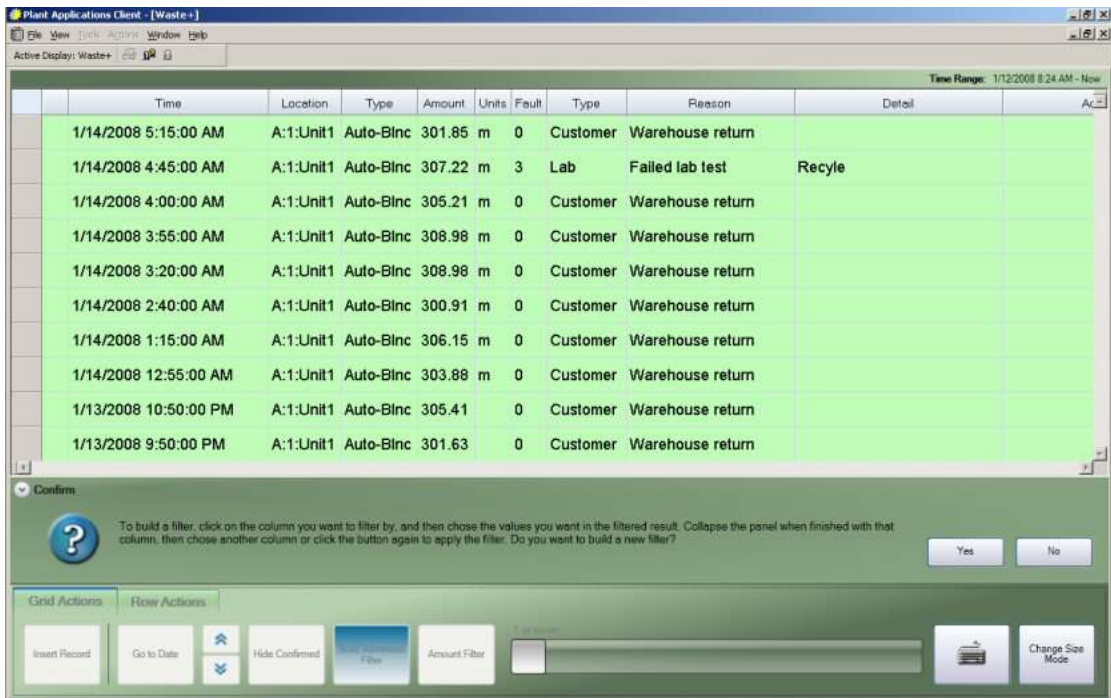

3. Click or tap Yes to start selecting what you want to filter on. The **Build Advanced Filter** becomes the **Apply Advanced Filter** button.
4. Click or tap a value in a cell. A **panel** appears with the available choices.

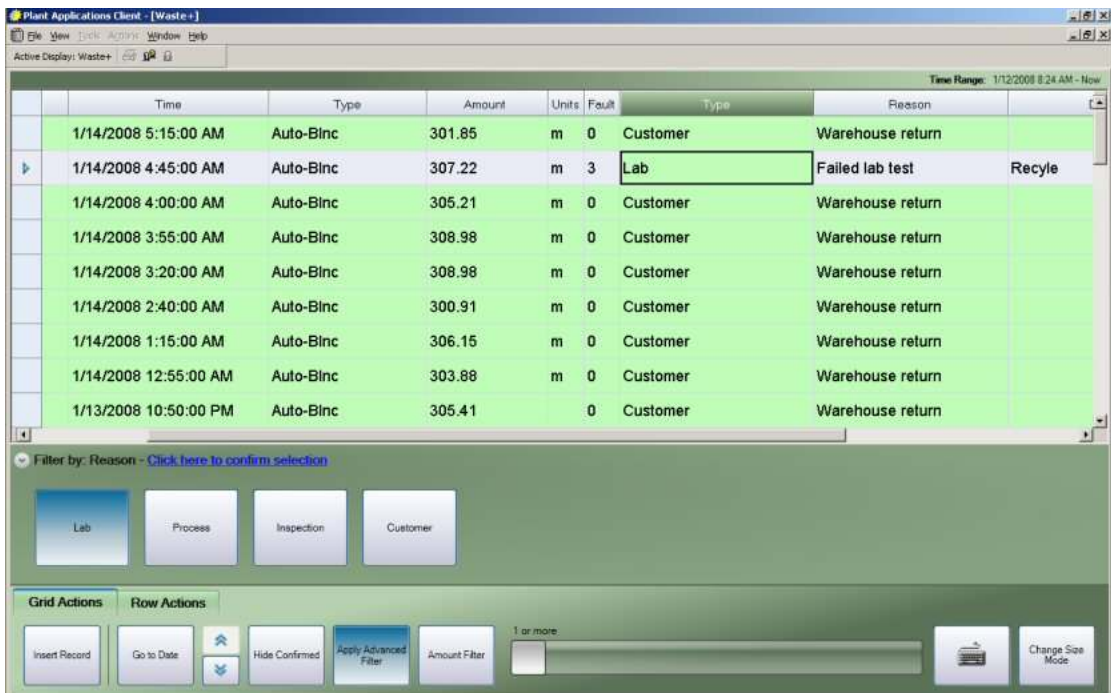

5. Click or tap one or more of the choices and click the text "Click here to confirm selection."
6. To filter by additional columns, click or tap another cell in a different column and select one or more of the available choices. Although you can make more than one selection per column, you can only select a column once.
7. After you have selected all the values you want to filter on, click or tap **Apply Advanced Filter**. The waste records are filtered, and the **Apply Advanced Filter** button becomes the **Clear Advanced Filter** button.

## Plant Applications Client

8. To clear the filter and display all of the waste records, click or tap **Clear Advanced Filter**.

## Filter by Waste Amounts

1. Click or tap **Grid Actions**.

Time	Location	Type	Amount	Units	Fault	Type	Reason	Detail	Action	Type
1/14/2008 5:15:00 AM	A:1:Unit1	Auto-Binc	301.85		0	Customer	Warehouse return			
1/14/2008 4:45:00 AM	A:1:Unit1	Auto-Binc	307.22		3	Lab	Failed lab test	Recycle		
1/14/2008 4:00:00 AM	A:1:Unit1	Auto-Binc	305.21		0	Customer	Warehouse return			
1/14/2008 3:55:00 AM	A:1:Unit1	Auto-Binc	308.98		0	Customer	Warehouse return			
1/14/2008 3:25:00 AM	A:1:Unit1	Auto-Binc	309.09		0	Customer	Warehouse return			
1/14/2008 3:20:00 AM	A:1:Unit1	Auto-Binc	308.98		0	Customer	Warehouse return			
1/14/2008 2:40:00 AM	A:1:Unit1	Auto-Binc	300.91		0	Customer	Warehouse return			
1/14/2008 1:15:00 AM	A:1:Unit1	Auto-Binc	306.15		0	Customer	Warehouse return			
1/14/2008 12:55:00 AM	A:1:Unit1	Auto-Binc	303.88		0	Customer	Warehouse return			
1/13/2008 10:50:00 PM	A:1:Unit1	Auto-Binc	305.41		0	Customer	Warehouse return			
1/13/2008 9:50:00 PM	A:1:Unit1	Auto-Binc	301.83		0	Customer	Warehouse return			
1/13/2008 9:10:00 PM	A:1:Unit1	Auto-Binc	308.88		0	Customer	Warehouse return			
1/13/2008 8:45:00 PM	A:1:Unit1	Auto-Binc	302.98		0	Customer	Warehouse return			
1/13/2008 7:05:00 PM	A:1:Unit1	Auto-Binc	300.66		1	Customer	Warehouse return			
1/13/2008 7:00:00 PM	A:1:Unit1	Auto-Binc	305.14		0	Customer	Warehouse return			
1/13/2008 6:40:00 PM	A:1:Unit1	Auto-Binc	300.45		4	Process	Inventory reconciliation			
1/13/2008 6:35:00 PM	A:1:Unit1	Auto-Binc	302.71		0	Customer	Warehouse return			
1/13/2008 5:55:00 PM	A:1:Unit1	Auto-Binc	309.62		4	Process	Inventory reconciliation			
1/13/2008 5:50:00 PM	A:1:Unit1	Auto-Binc	303.83		4	Process	Inventory reconciliation			
1/13/2008 5:35:00 PM	A:1:Unit1	Auto-Binc	302.95		2	Inspection	Failed operator test	Process as alternate product		
1/13/2008 5:25:00 PM	A:1:Unit1	Auto-Binc	301.52		2	Inspection	Failed operator test	Process as alternate product		
1/13/2008 5:05:00 PM	A:1:Unit1	Auto-Binc	305.63		0	Customer	Warehouse return			
1/13/2008 4:50:00 PM	A:1:Unit1	Auto-Binc	307.47		2	Inspection	Failed operator test	Process as alternate product		
1/13/2008 4:05:00 PM	A:1:Unit1	Auto-Binc	308.30		0	Customer	Warehouse return			
1/13/2008 4:00:00 PM	A:1:Unit1	Auto-Binc	301.39		0	Customer	Warehouse return			
1/13/2008 3:05:00 PM	A:1:Unit1	Auto-Binc	302.78		0	Customer	Warehouse return			
1/13/2008 3:00:00 PM	A:1:Unit1	Auto-Binc	308.53		0	Customer	Warehouse return			
1/13/2008 2:40:00 PM	A:1:Unit1	Auto-Binc	300.82		0	Customer	Warehouse return			

2. Click or tap **Amount Filter** and drag the slider to the desired amount. Waste events with an amount equal to or greater than the selected amount are displayed.
3. Click or tap **Amount Filter** to display all waste events.

## Show or Hide Confirmed Waste Events

1. Click or tap **Grid Actions**.

Time	Location	Type	Amount	Units	Fault	Type	Reason	Detail	Action	Type
1/14/2008 5:15:00 AM	A:1:Unit1	Auto-Binc	301.85		0	Customer	Warehouse return			
1/14/2008 4:45:00 AM	A:1:Unit1	Auto-Binc	307.22		3	Lab	Failed lab test	Recycle		
1/14/2008 4:00:00 AM	A:1:Unit1	Auto-Binc	305.21		0	Customer	Warehouse return			
1/14/2008 3:55:00 AM	A:1:Unit1	Auto-Binc	308.98		0	Customer	Warehouse return			
1/14/2008 3:25:00 AM	A:1:Unit1	Auto-Binc	309.09		0	Customer	Warehouse return			
1/14/2008 3:20:00 AM	A:1:Unit1	Auto-Binc	308.98		0	Customer	Warehouse return			
1/14/2008 2:40:00 AM	A:1:Unit1	Auto-Binc	300.91		0	Customer	Warehouse return			
1/14/2008 1:15:00 AM	A:1:Unit1	Auto-Binc	306.15		0	Customer	Warehouse return			
1/14/2008 12:55:00 AM	A:1:Unit1	Auto-Binc	303.88		0	Customer	Warehouse return			
1/13/2008 10:50:00 PM	A:1:Unit1	Auto-Binc	305.41		0	Customer	Warehouse return			
1/13/2008 9:50:00 PM	A:1:Unit1	Auto-Binc	301.83		0	Customer	Warehouse return			
1/13/2008 9:10:00 PM	A:1:Unit1	Auto-Binc	308.88		0	Customer	Warehouse return			
1/13/2008 8:45:00 PM	A:1:Unit1	Auto-Binc	302.98		0	Customer	Warehouse return			
1/13/2008 7:05:00 PM	A:1:Unit1	Auto-Binc	300.66		1	Customer	Warehouse return			
1/13/2008 7:00:00 PM	A:1:Unit1	Auto-Binc	305.14		0	Customer	Warehouse return			
1/13/2008 6:40:00 PM	A:1:Unit1	Auto-Binc	300.45		4	Process	Inventory reconciliation			
1/13/2008 6:35:00 PM	A:1:Unit1	Auto-Binc	302.71		0	Customer	Warehouse return			
1/13/2008 5:55:00 PM	A:1:Unit1	Auto-Binc	309.62		4	Process	Inventory reconciliation			
1/13/2008 5:50:00 PM	A:1:Unit1	Auto-Binc	303.83		4	Process	Inventory reconciliation			
1/13/2008 5:35:00 PM	A:1:Unit1	Auto-Binc	302.95		2	Inspection	Failed operator test	Process as alternate product		
1/13/2008 5:25:00 PM	A:1:Unit1	Auto-Binc	301.52		2	Inspection	Failed operator test	Process as alternate product		
1/13/2008 5:05:00 PM	A:1:Unit1	Auto-Binc	305.63		0	Customer	Warehouse return			
1/13/2008 4:50:00 PM	A:1:Unit1	Auto-Binc	307.47		2	Inspection	Failed operator test	Process as alternate product		
1/13/2008 4:05:00 PM	A:1:Unit1	Auto-Binc	308.30		0	Customer	Warehouse return			
1/13/2008 4:00:00 PM	A:1:Unit1	Auto-Binc	301.39		0	Customer	Warehouse return			
1/13/2008 3:05:00 PM	A:1:Unit1	Auto-Binc	302.78		0	Customer	Warehouse return			
1/13/2008 3:00:00 PM	A:1:Unit1	Auto-Binc	308.53		0	Customer	Warehouse return			
1/13/2008 2:40:00 PM	A:1:Unit1	Auto-Binc	300.82		0	Customer	Warehouse return			

2. Click or tap **Hide Confirmed**. Waste events that have incomplete information (for example, no faults or reasons) are displayed.

Confirmed events are those events that have a reason tree attached and all reason levels within the reason tree have been entered.

3. Click or tap **Hide Confirmed** to display all waste events within the specified window.

## Saving a Filter

This information applies to the Downtime+ and Waste+ displays.

You can save a filter in a Downtime+ or Waste+ display so that when the display is opened, by anyone, the saved filter is automatically applied. Additionally, if a new filter is applied to the display, the saved filter will be applied when the display is re-opened.

The procedure to save a filter should be performed by an administrator or someone with advanced knowledge of Plant Applications. Furthermore, this procedure must be followed for each display for which you want to save a filter.

### Step 1: Modify LocalSettings.xml to Capture the Filter Information

1. Locate LocalSettings.xml, which is located in the .\Plant Applications\Client folder.
2. Open LocalSettings.xml in Notepad or another text editor.
3. Search for the element, PermitPersistenceStringLoad and change the value from **false** to **true**.
4. Save and close LocalSettings.xml.

### Step 2: Capture the Filter Information from the Display

1. Open Plant Applications Client and open a Downtime+ or Waste+ display.
2. Filter the information in the display. For information about applying filters, see the topic [Filtering downtime events](#) or [Filtering waste events](#).
3. With the filter applied, close the display and close Plant Applications Client.

### Step 3: Copy the Filter Information

1. Locate LocalSettings.xml and open it in Notepad or another text editor.
2. Search for the element, LastPersistenceData.
3. Confirm that the value for DisplayType and SheetName match the display you just closed.
4. Copy all tags and data, starting with <LastPersistenceData and including </LastPersistenceData>. **Example:**

```
<LastPersistenceData DisplayType="Downtime+" SheetName="DT">
  <data>
    <filters>
      <filter type="advanced">
        <values column="Reason_Level1">
          <value>Not Scheduled</value>
        </values>
      </filter>
```

```
</filters>
</data>
</LastPersistenceData>
```

5. Open a new document in your text editor and paste the copied information.
6. Remove all line breaks and tab characters so that the text is all on one line. **Example:**

```
<LastPersistenceData DisplayType="Downtime+"
SheetName="DT"><data><filters><filter type="advanced"><values
column="Reason_Level1"><value>Not
Scheduled</value></values></filter></filters></data></LastPersistence
Data>
```

7. Copy the single line.

## Step 4: Save the Filter Information in the Persistence String Display Option

1. Open Plant Applications Administrator.
2. Expand Client Management and expand Displays.
3. Right-click the appropriate Downtime+ or Waste+ display and click **Edit <display name>**. The Edit Display dialog box appears.
4. Click the **Display Options** tab.
5. Under the Sheet Persistence heading, edit the Persistence String display option:
  - a. Click the  **Edit** button. The Assign Property Value dialog box appears.
  - b. In the Value box, paste the single line you copied previously in Step 3: Copy the filter information.
  - c. Click **OK**.
6. Save and close the Edit Display dialog box.

---

### NOTES:

*To temporarily clear the saved filter, click the **Clear Advanced Filter** button in the display.*

*To change the saved filter, repeat all of the preceding steps.*

*To remove the saved filter, remove the string from the Persistence String display option.*

---

## Adding a Waste+ Event

---

This information applies to the Waste+ Display.

---

Waste events can be manually added using the waste display.

### Manually Enter a Waste Event

1. Click or tap **Grid Actions**.

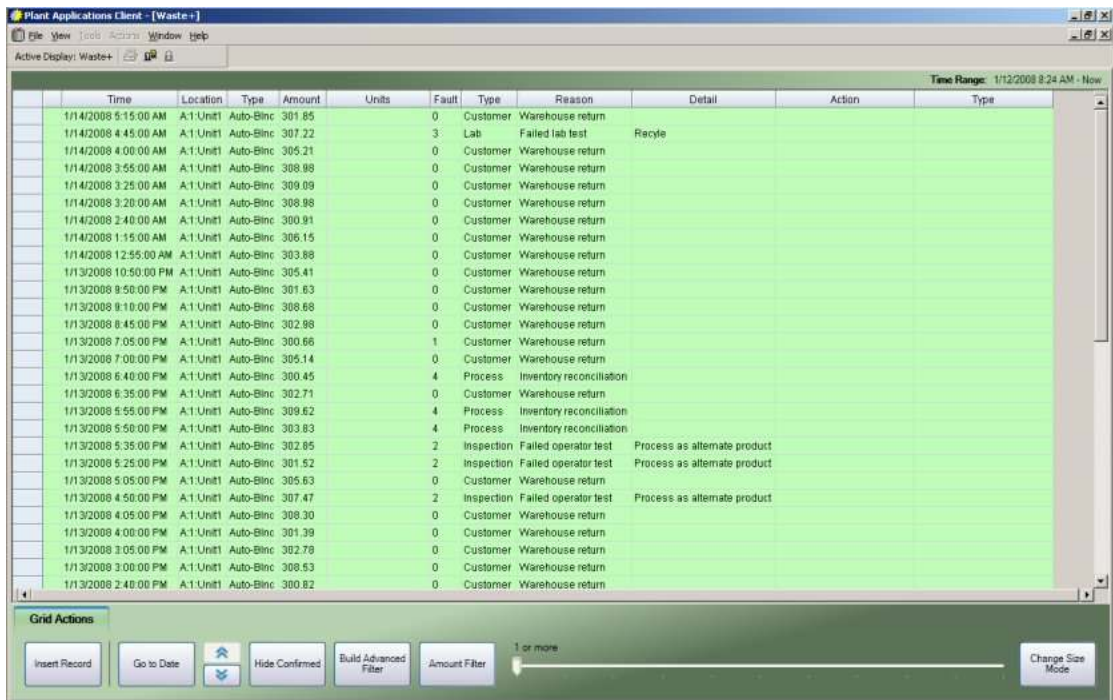

- Click or tap **Insert Record**. An empty row (the working row) is added to the top of the rows of waste events and the **Data/Time Entry** panel appears.



- Enter the time of the waste event and click or tap **OK**. After you enter the time, the cell to the right becomes active and the appropriate panel appears.
- Continue entering the waste information.

## Finding Waste Events

This information applies to the Waste+ Display.



You can search for a waste event within a specific time frame, which is defined by the Initial Windows Setting. The displayed waste records are calculated as follows:

(Start Time – Initial Windows Setting) to End Time.

For example, if the Initial Windows Setting is 24 hours (the default) and the date entered on the Date/Time Entry expander window is Wednesday, November 28, 2007 3:30pm, all waste records between Tuesday, November 27, 2007 3:30 PM and Wednesday, November 28, 2007 3:30 PM are displayed. If either end time falls within a waste event, the waste event is not included in the waste events that are displayed. In this example, a waste event that occurred on Tuesday, November 27, 2007 with a start time of 3:20 PM and an end time of 3:40 PM would not be displayed.

## Search for a Waste Event

1. In the Waste+ display, click or tap **Grid Actions** and click or tap **Go to Date**. The **Date/Time Entry panel** appears.

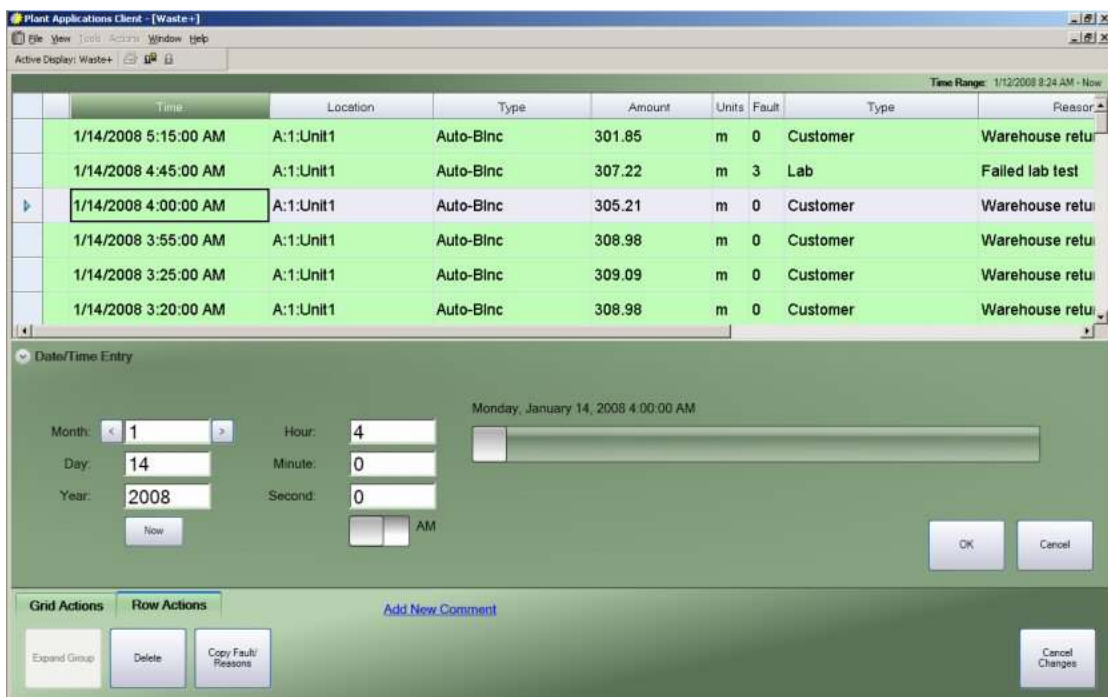

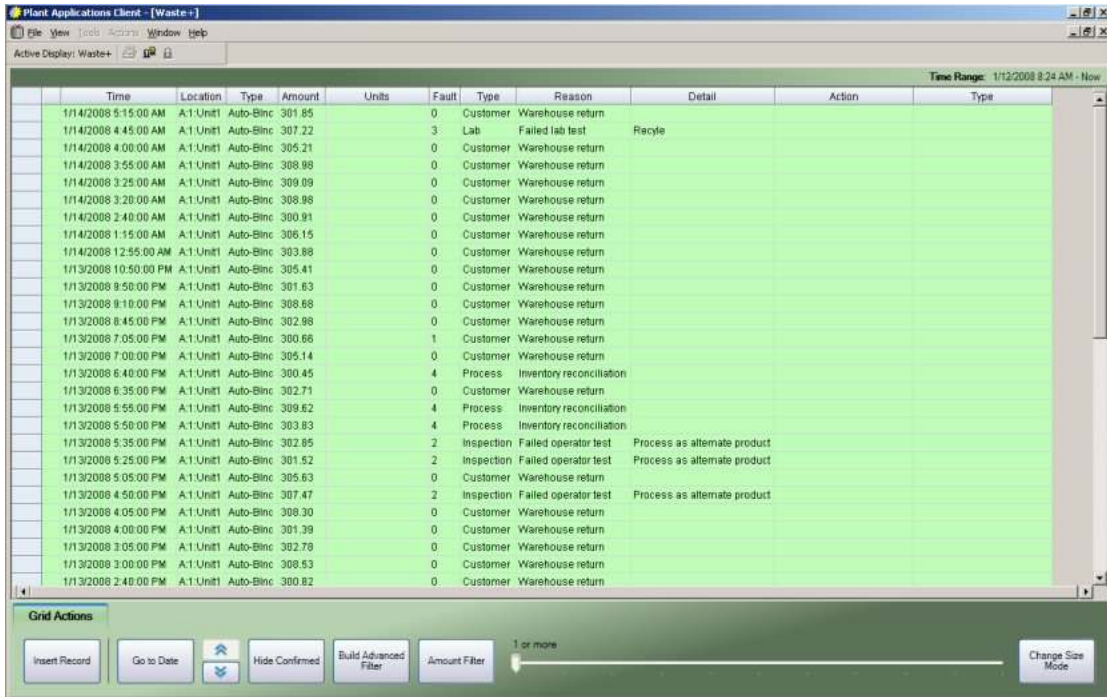

2. Enter the date and time and click **OK**. The waste records within the defined window are displayed.



3. Use the scroll buttons to page up or down in increments that are equal to one-fourth the time specified by the Initial Windows Setting, until the time range specified by the MAX display setting is reached, then it begins moving the start time and end time down in increments one-fourth the MAX time specified.

## Entering Comments for a Waste+ Display

Adding comments to a Waste+ display is a useful way to provide additional information. Comments can be either text that you type or a link to an external document, such as a Microsoft Word document.

Keep in mind that if you paste a link to a document, the document cannot be moved to a different folder or directory; otherwise, the link will be broken, and the document will not be found.

---

**NOTE:** Comments are categorized as either **Reason**, **Action**, or **Research** comments. All Reason comments are listed first in the Comments window.

---

### Add Comments to a Waste+ Event

1. Select a row in the Waste+ display, and select the **Row Actions** tab.

## Plant Applications Client

Time Range: 1/9/2008 11:30 AM - Now

Start Time	End Time	Duration	Location	Fault	Type	Reason	Detail
1/10/2008 7:25:00 AM	1/10/2008 7:45:00 AM	20.00	Line1\Unit1	3	Not Scheduled	Plant is closed	
1/10/2008 4:20:00 AM	1/10/2008 4:40:00 AM	20.00	Line1\Unit1	2	Minor Stops	Operator Assist	Machine Jam
1/10/2008 1:45:00 AM	1/10/2008 2:30:00 AM	45.00	Line1\Unit1	3	Not Scheduled	Plant is closed	
1/10/2008 1:15:00 AM	1/10/2008 1:25:00 AM	10.00	Line1\Unit1	2	Minor Stops	Operator Assist	Machine Jam
1/10/2008 12:50:00 AM	1/10/2008 1:00:00 AM	10.00	Line1\Unit1	2	Minor Stops	Operator Assist	Machine Jam
1/9/2008 7:55:00 PM	1/9/2008 8:05:00 PM	10.00	Line1\Unit1	1	Machine Failures	Maintenance Assist	Adjustment required
1/9/2008 7:10:00 PM	1/9/2008 7:15:00 PM	5.00	Line1\Unit1	4	Planned Downtime	Major Maintenance	Engineering
1/9/2008 5:00:00 PM	1/9/2008 5:25:00 PM	25.00	Line1\Unit1	2	Minor Stops	Operator Assist	Machine Jam
1/9/2008 4:30:00 PM	1/9/2008 4:40:00 PM	10.00	Line1\Unit1	2	Minor Stops	Operator Assist	Machine Jam
1/9/2008 1:30:00 PM	1/9/2008 1:40:00 PM	10.00	Line1\Unit1	1	Machine Failures	Maintenance Assist	Adjustment required
1/9/2008 12:45:00 PM	1/9/2008 12:50:00 PM	5.00	Line1\Unit1	4	Planned Downtime	Major Maintenance	Engineering

Grid Actions Row Actions Add New Comment

Expand Group Split Record Delete Copy Fault/Reasons Cancel Changes

Downtime+ Ready comclient CAPS NUM ENG SCPL 1/10/2008 11:32 AM

2. Click the **New Comment** button or the **Manage Comments** button.
3. In the Comments dialog box that appears, select **Reason**, **Action**, or **Research** from the drop-down menu. Type your comment in the **box**, which supports simple text with no formatting. You can also type URLs to documents and web sites.

Time Range: 1/9/2008 11:30 AM - Now

Start Time	End Time	Duration	Location	Fault	Type	Reason	Detail
1/10/2008 11:45:00 AM	1/10/2008 7:45:00 AM	20.00	Line1\Unit1	4	Planned Downtime	Major Maintenance	Engineering
1/10/2008 7:25:00 AM	1/10/2008 7:45:00 AM	20.00	Line1\Unit1	3	Not Scheduled	Plant is closed	
1/10/2008 4:20:00 AM	1/10/2008 4:40:00 AM	20.00	Line1\Unit1	2	Minor Stops	Operator Assist	Machine Jam
1/10/2008 1:45:00 AM	1/10/2008 2:30:00 AM	45.00	Line1\Unit1	3	Not Scheduled	Plant is closed	
1/10/2008 1:15:00 AM	1/10/2008 1:25:00 AM	10.00	Line1\Unit1	2	Minor Stops	Operator Assist	Machine Jam
1/10/2008 12:50:00 AM	1/10/2008 1:00:00 AM	10.00	Line1\Unit1	2	Minor Stops	Operator Assist	Machine Jam
1/9/2008 7:55:00 PM	1/9/2008 8:05:00 PM	10.00	Line1\Unit1	1	Machine Failures	Maintenance Assist	Adjustment required
1/9/2008 7:10:00 PM	1/9/2008 7:15:00 PM	5.00	Line1\Unit1	4	Planned Downtime	Major Maintenance	Engineering
1/9/2008 5:00:00 PM	1/9/2008 5:25:00 PM	25.00	Line1\Unit1	2	Minor Stops	Operator Assist	Machine Jam
1/9/2008 4:30:00 PM	1/9/2008 4:40:00 PM	10.00	Line1\Unit1	2	Minor Stops	Operator Assist	Machine Jam
1/9/2008 1:30:00 PM	1/9/2008 1:40:00 PM	10.00	Line1\Unit1	1	Machine Failures	Maintenance Assist	Adjustment required
1/9/2008 12:45:00 PM	1/9/2008 12:50:00 PM	5.00	Line1\Unit1	4	Planned Downtime	Major Maintenance	Engineering

Grid Actions Row Actions Reason Action

Expand Group Split Record Delete Copy Fault/Reasons

Downtime+ Ready comclient CAPS NUM ENG SCPL 1/10/2008 11:46 AM

- Click or tap the **Save** button to save your comments. Waste events with comments are indicated with the  icon, which is displayed beside the row item.

## Copying Faults and Reasons (Waste+)

This information applies to the Waste+ Display.

You can quickly enter or change faults and reasons for a waste record.

### Copy Faults and Reasons

- Select a waste event. You can click or tap anywhere in the row.
- On the **Row Actions** tab, click or tap **Copy Fault/Reasons**.

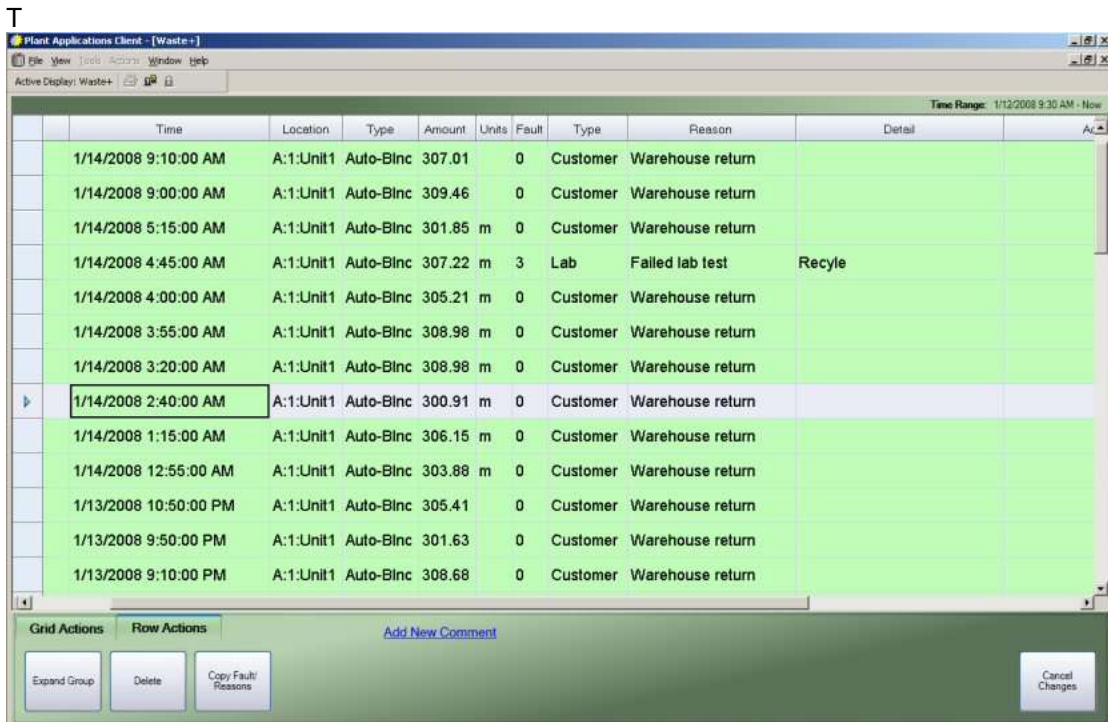

- Select the waste event where you want to paste the faults and reasons. You can click or tap anywhere in the row.

To select multiple rows, click the row header for the first row and drag to select additional rows.

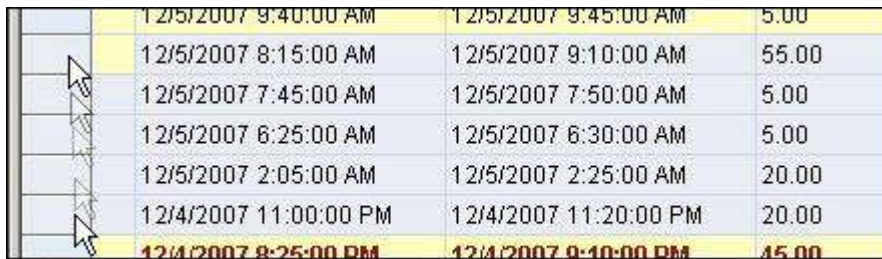

- On the **Row Actions** tab, click or tap **Paste Fault/Reasons**. The fault and reasons are changed.

# Troubleshooting

## SQL Connection Error

A **Reconnecting** message will appear when the Client attempts to execute a database command and the SQL Server connection has been interrupted. This could be because SQL Server shutdown, restarted, lost its network connection, a computer stopped responding, or cluster failover. This does not include the Client losing its network connection.

If the connection to SQL Server cannot be restored, the **SQL Connection Error** dialog box will appear. By default, reconnection will be attempted in 10 seconds. However, you can force the reconnection by clicking **Retry** or you can stop the attempt to reconnect by clicking **Abort**.

---

**NOTE:** *If you click **Abort**, all open displays will be closed, all buffered data will be lost, and the Client will be closed.*

---

The amount of time to attempt a reconnection is controlled by the DatabaseReconnectionRetryTime site parameter.

## Data Outside Visible Time Range

The client computer system data and time cannot be significantly different from the Proficy server. If it is, you may see the following error message:

***The data you are trying to insert is outside the visible time range, and cannot be posted. Please navigate to the time period you want to update, or change your input time.***

If you receive this error message, you must ensure that all computers connecting to the Proficy server have synchronized the system clock. Plant Applications does not support cross-time zone use. Timestamps are determined by the Proficy server and not by the client computer.

## Display Does Not Open

---

**This information applies to the Downtime+ and Waste+ displays.**

---

A message will appear in the Plant Applications Client message log indicating the error in instantiating the control.

This can occur if the Plant Applications Client installation does not complete or if errors occurring during installation that prevent the necessary **.dlls** from being installed.

- Ensure that Microsoft .NET Framework 3.0 or higher is installed.
- Ensure that the following **.dlls** are registered.
  - Microsoft.InteropFormTools.dll
  - PlantApps.WPFDisplays.DisplayWrapper.dll
  - PlantAppsWPFControls.ocx
- Ensure that the Plant Applications ISI is installed.

## Display Has Been Deleted

---

[This information applies to the Downtime+ and Waste+ displays.](#)

---

Error message: This Sheet has been deleted. Unable to continue.

Under normal circumstances, the Client container window should trap this error and report it. If the display reports this error in a message box, it is likely that the display was deleted after the Client invokes the display and before the display begins reading its settings from the database.

This may also occur as a result of server or network failure.

Another possibility is that a non-ASCII character was used in the naming of the display and as a result, the Sheet Display Options cannot be loaded by name. Check the name of the display in the Plant Applications Administrator.

## Grid Population Fails

---

[This information applies to the Downtime+ and Waste+ displays](#)

---

Error: Grid population failed at: \_\_\_\_\_

For example, "Grid population failed at: LocalSettings"

A known condition has occurred during start-up which prevents the display from loading. Known conditions are trapped during the following procedures, indicating where the problem is. Normally this suggests corrupt data in the configuration tables or support files.

- **LocalSettings:** The XML configuration file "LocalSettings.xml" in the Client install directory on the local machine is corrupt, the XML is invalid, or one of the values contains an illegal or unparseable character. Open the .xml file in Internet Explorer to determine where the error is. Replace the LocalSettings.xml file with a back-up, or the standard deployed version.
- **DisplayOptions:** The database connection was lost during display option loading, or one of the display options saved for this display is invalid or corrupt. Display option values for a display are stored in the Sheet\_Display\_Options table. Ensure that there are valid values of the correct datatype for each display option. If necessary, you can delete all display option values for the corresponding display and re-set them in the Plant Applications Administrator. Because most display options are available as drop-down lists, the NumberFormat option could be most easily corrupted.
- **ColorScheme:** The database connection was lost during color scheme loading, or one of the color scheme values saved for this sheet is invalid or corrupt. Color Scheme values are stored in the Color\_Scheme\_Data table. Ensure that the values stored are valid.
- **SecurityConfig:** The database connection was lost during security config loading, or one of the security display options saved for this sheet is invalid or corrupt. Display option values for a sheet are stored in the Sheet\_Display\_Options table. Ensure that there are valid values of the correct datatype for each display option.
- **ApplyNLS:** The database connection was lost during language prompt loading, or one of the language strings was corrupt.
- **ApplySecurity:** One of the security display options, while a valid value, could not be parsed as Boolean (meaning True/False) against the current user level. This suggests an unknown user level or a corrupt display option value.
- **Subscribe:** The display was unable to subscribe to events on one of the display's production units. Ensure that all production units on the display have the correct event configuration. Ensure that the production units on the display still exist. Ensure that the ISI is installed properly and functioning normally. Ensure that the Proficy Server services are running.

## Unknown or Unhandled Error Condition

---

[This information applies to the Downtime+ and Waste+ displays](#)

---

Error: The display was unable to open because an exception was thrown during start-up. Check the error log for more information. The exception thrown was: \_\_\_\_

– or –

An incorrect result is displayed on the grid after an otherwise successful initial load.

If an error message appears, the .NET exception message will be listed below. Check that the display's initial result-set is valid and contains no corruption or duplicate (non-unique) records. See [Validating a Downtime+ or Waste+ Result Set](#) for instructions on how to inspect the result set. Retain the .xml result for inspection by Technical Support, if necessary.

If the error still cannot be isolated, enable logging on the display, re-open, and inspect the log file to find the exact error. Logging is extremely detailed, and module-specific. It is recommended that you use the application Chainsaw to read the logging results. A document on enabling logging is forthcoming and will be sent at a later date.

If Technical Support is unable to troubleshoot the problem using the log file, capture the original error message for additional troubleshooting.

## Validating a Downtime+ or Waste+ Result Set

---

[This information applies to the Downtime+ and Waste+ displays](#)

---

To inspect the resultset of a given display:

1. Stop the Plant Applications Client, if running
2. Open the file "LocalSettings.xml" in the Client install directory on the client computer.
3. Edit the node <DebugMode> and set the value to **True**.
4. Save the LocalSettings.xml file.
5. On the root of the C: drive on the client computer, delete any file called DebugWPFWaste-DataSet.xml or DebugWPFDownTime-Dataset.xml.
6. Start the Plant Applications Client and open the display that caused the error. The display will look different. This is normal when debug mode is enabled.
7. On the root of the C: drive, find the file DebugWPFWaste-DataSet.xml for a waste display or DebugWPFDownTime-DataSet.xml for a downtime display.
8. Open the file in Internet Explorer to look for errors. The following common errors might be immediately visible.
  - The file is completely empty: An error has occurred in the retrieval of data, such that no result-set (not even an empty one) is returned. Ensure that at least one production unit on the display has a collection model configured for the display type. Ensure that there is at least one production unit assigned to the display in Admin.
  - Internet Explorer returns an error when opening the file: The dataset is corrupt because it contains an invalid character that cannot be parsed by the display. Inspect the database for corrupt data.
  - A repeating node is found: Each data point in the result set **must** have a unique ID. If a data point contains a non-unique ID, an error has occurred in the stored procedure which retrieves the data. This may suggest a configuration problem or a bug in the stored procedure.

9. When finished troubleshooting, re-open the LocalSettings.xml file and set the <DebugMode> node back to **False**.
10. Save the LocalSettings.xml file.
11. Close and re-open the Plant Applications Client.