



Proficiency Plant Applications 2022

Client Management



Proprietary Notice

The information contained in this publication is believed to be accurate and reliable. However, General Electric Company assumes no responsibilities for any errors, omissions or inaccuracies. Information contained in the publication is subject to change without notice.

No part of this publication may be reproduced in any form, or stored in a database or retrieval system, or transmitted or distributed in any form by any means, electronic, mechanical photocopying, recording or otherwise, without the prior written permission of General Electric Company. Information contained herein is subject to change without notice.

© 2022, General Electric Company. All rights reserved.

Trademark Notices

GE, the GE Monogram, and Predix are either registered trademarks or trademarks of General Electric Company.

Microsoft® is a registered trademark of Microsoft Corporation, in the United States and/or other countries.

All other trademarks are the property of their respective owners.

We want to hear from you. If you have any comments, questions, or suggestions about our documentation, send them to the following email address:

doc@ge.com

Table of Contents

Client Management	4
Configuring the Client Session Timeout.....	4
Displaying Plant Applications Data	4
Creating a Display Group	4
Displays and Licensing.....	5
Editing Display Group Membership.....	5
Exporting Display Configuration	6
Importing Display Configuration	6
Linking to an On-Screen Keyboard	7
Using Plant Applications Displays in the Proficy Client.....	7
Alarm View Display	8
Configuring an Alarm View Display	8
Autolog Display	9
Creating Time-Based Displays	10
Creating Production Event Displays.....	10
Setting Up Production Status for User-Defined Events.....	11
Autolog Display Options Settings	12
Downtime Displays.....	13
Configuring a Downtime Display	13
Configuring a Downtime+ Display	13
Genealogy View Display	15
Creating and Configuring the Genealogy View Display	15
Genealogy View Display Options	17
Production Overview Display	18
Creating and Configuring the Production Overview Display	19
Production Run Analyst Display.....	19
Non-Productive Time View Display.....	19
Setting Up a Non-Productive Time Client Display.....	20
Relative View Display.....	20
Schedule View Display.....	20
Creating and Configuring a Schedule View Display.....	21
Sequence of Events Display	21

Trend View Display	21
Waste Displays	21
Configuring a Waste Display	22
Configuring a Waste+ Display	22
Configuring Security Rights for a Web UI Display	24
User Views	24
Creating a View	24
About Plant Applications ActiveX Controls	26
Proficy.ALC_Autolog Control	26
Proficy_DWN.Downtime	26
Proficy_ALM.AlarmView	26
Proficy_GVW.Genealogy	26
Proficy_SOE.SOEView	26
Proficy_SVW.ScheduleView	26
Proficy_WST.Waste	26
Autolog ActiveX Control	26
Proficy.ALC_Autolog Control	26
Events: Proficy.ALC_Autolog Control	27
Methods: Proficy.ALC_Autolog Control	27
Properties: Proficy.ALC_Autolog Control	29
Alarm View ActiveX Control	33
Proficy_ALM.AlarmView Control	33
Events: Proficy_ALM.AlarmView Control	34
Methods: Proficy_ALM.AlarmView Control	35
Properties: Proficy_ALM.AlarmView Control	37
Downtime ActiveX Control	41
Proficy_DWN.Downtime Control	41
Events: Proficy_DWN.Downtime Control	42
Methods: Proficy_DWN.Downtime Control	43
Properties: Proficy_DWN.Downtime Control	46
Genealogy View ActiveX Control	59
Proficy_GVW.Genealogy Control	59
Events: Proficy_GVW.Genealogy Control	59

Client Management

Methods: Proficy_GVW.Genealogy Control	60
Properties: Proficy_GVW.Genealogy Control	62
Sequence of Events ActiveX Control	64
Proficy_SOE.SOEView Control	64
Events: Proficy_SOE.SOEView Control	65
Methods: Proficy_SOE.SOEView Control	66
Properties: Proficy_SOE.SOEView Control	67
Schedule View ActiveX Control	69
Proficy_SVW.ScheduleView Control	69
Events: Proficy_SVW.ScheduleView Control	70
Methods: Proficy_SVW.ScheduleView Control	71
Properties: Proficy_SVW.ScheduleView Control	74
Waste ActiveX Control	89
Proficy_WST.Waste Control	89
Events: Proficy_WST.Waste Control	90
Methods: Proficy_WST.Waste Control	91
Properties: Proficy_WST.Waste Control	94

Client Management



 **Client Management** is where you create and manage displays, which are graphical interface for displaying and manipulating data. Displays are configured from the Plant Applications Administrator and viewed from the Plant Applications Client.

- From **Displays**, you create display groups and displays.
- From **User Views**, you create new view groups and see a list of views that have been created. Views are a group of displays and are created within the Plant Applications Client.

Plant Applications Client sessions can be configured to time out and enter a protected state, thus requiring a user to log back in. When logged back in, displays to which a user has access are reopened.

Selected Plant Applications displays can be viewed through the Proficy Client installed by Proficy Workflow. Plant Applications licensing is required. Refer to Using Plant Applications Displays in the Proficy Client.

Configuring the Client Session Timeout

When set up by a system administrator, Plant Applications Client sessions time out based on inactivity and require a user to log back in. Inactivity means there is no mouse movement or keyboard input over the configured timeout duration. An option is available in the Client to manually initiate a Client session timeout. When restarted, a user has access to the Client displays that were previously open given they have viewing permission.

Displaying Plant Applications Data

The Plant Applications Client is comprised of ActiveX controls (displays) for presenting and manipulating Plant Applications data in many different formats. Displays are configured from the Plant Applications Administrator and viewed in the Proficy Client. WebUI displays can be viewed through Proficy Vision or a browser-based application.

Selected Plant Applications displays can be viewed through the Proficy Client installed by Proficy Workflow. Plant Applications licensing is required. Refer to Using Plant Applications Displays in the Proficy Client.

Creating a Display Group

Display groups are a convenient way to organize the various displays. For example, you can create display groups based on security needs or based on job function.

By default, a display group, **No Display Group Assigned**, already exists. You can choose to rename this group or create a new display group.

Note: Even if you rename the default display group, you cannot delete this display group or edit the display group membership.

To create a new display group:

Client Management

1. In the Plant Applications Administrator server tree, expand  **Client Management**.
2. Right-click **Displays** and click **Add New Display Group**. A blank new entry position displays in the **Displays** list.
3. Type the name of the display group and press **ENTER**.

Note: *Display group names must be unique on each Proficy server.*

To rename a display group:

1. In the Plant Applications Administrator server tree, expand  **Client Management**.
2. Expand **Displays**.
3. Right-click on the display group you want to rename and click **Rename <display group name>**. The display group name will become editable.
4. Type the new display group name and press **ENTER**.



Displays and Licensing

Display	Efficiency License	Quality License	Production License
Alarm View		yes	
Autolog Downtime	yes		
Autolog Genealogy			yes
Autolog Process Order			yes
Autolog Process Order/Time			yes
Autolog Product Change		yes	
Autolog Product Time	yes	yes	
Autolog Production Event		yes	
Autolog Time Based	yes	yes	
Autolog Uptime	yes		
Autolog User Defined Event	yes		
Autolog Waste	yes		
Downtime Line View	yes		
Downtime Unit View	yes		
Downtime+ View	yes		
Genealogy View			yes
Non-Productive Time	yes	yes	yes
Production Overview			yes
Production Run-Analyst		yes	
Relative View	yes	yes	
Schedule View			yes
Sequence of Events View	yes		
Trend View (Normal)	yes	yes	
Trend View (SPC)	yes	yes	
Waste View	yes		
Waste+ View	yes		

Editing Display Group Membership

By default, Plant Applications includes a default display group. This default display group can not be deleted, although it can be renamed. If you delete a display group that contains displays, the displays

are automatically added to the default display group. Only displays in the default display group can be moved to other display groups. If you remove a display from a display group, it is moved back into the default display group.

1. In the Plant Applications Administrator tree, expand  **Client Management**.
2. Expand the **Displays** folder.
3. Right-click on a display group and click **Edit Display Group Membership**. The **Edit Sheet Group Membership** dialog box appears.
4. Select one or more displays and click the  **Move Selected** button (or double-click individual displays). Click the  **Move All** button to move all of the displays to this display group.
5. Click  **Close**.

Exporting Display Configuration

You can export display configuration for all displays, for displays within a display group, or a single display. You can export:

- **Displays:** The exported worksheet contains configuration information from the **General**, **Header**, and **Display Properties** tabs of the Edit Display dialog box.
- **Display Variables:** The exported worksheet contains configuration information from the Units and Variables tabs of the Edit Display dialog box.
- **Display Options:** The exported worksheet contains configuration information from the **Display Options** tab of the Edit Display dialog box.
- **Display Plots:** The exported worksheet contains configuration information from the **Plots** tab of the Edit Display dialog box.

To export display configuration:

1. In the Plant Applications Administrator, expand  **Client Management**.
2. Do one of the following.
 - To export configurations for all displays, right-click **Displays** and select **Export Displays**. The **Configuration Export** dialog box appears.
 - To export configurations for displays within a display group, right-click the display group and select **Export <display group name>**. The **Configuration Export** dialog box appears.
 - To export a single display, right-click the display and select **Export <display name>**. The **Configuration Export** dialog box appears.
3. Select one or more of the options and click OK. Excel automatically creates a worksheet for each of the selected options.

Importing Display Configuration

The display configurations on the Displays worksheet can be imported onto a new Proficy server or onto an existing Proficy Server. If you are importing display configuration onto an existing Proficy Server, you must change the name of the display; otherwise, the import will fail. However, the configuration information on the other worksheets (DisplayVariables, DisplayPlots, and DisplayOptions) can be changed and the changes will be applied to the existing display.

To import display configuration:

Client Management

1. Ensure the workbook containing your display configuration is open.
2. In the Plant Applications Administrator, expand  **Client Management**.
3. Do one of the following.
 - Right-click Displays and select Import Configuration.
 - Right-click a display group and select Import Configuration.

Linking to an On-Screen Keyboard

The Downtime+ and Waste+ displays can be used with an on-screen keyboard. By default, Microsoft's On-Screen Keyboard is used. If you use a different on-screen keyboard, you must link it to the displays by editing the LocalSettings.xml file on each client computer. This file is located at ..\Plant Applications\Client. The LocalSettings.xml file can be edited in any text editor.

To edit the LocalSettings.xml file:

1. On the client computer, locate the LocalSettings.xml file and open it with a text editor.
2. Look for the following line of code and change the path to the location of your on-screen keyboard.

```
<OnScreenKeyboardPath>C:\windows\system32\osk.exe</OnScreenKeyboardPath>
```

3. Save and close the LocalSettings.xml file.

Using Plant Applications Displays in the Proficy Client

Selected Plant Applications displays can be viewed through the Proficy Client installed by Proficy Workflow. Plant Applications licensing is required. The following displays are available for viewing in the Proficy Client:

- Non-Productive Time
- Downtime+ and Waste+
- Alarms, Schedule, and Genealogy
- Autolog displays for Downtime, Genealogy, Process Order, and Time, Product Change, Product-Time, Production Event, Time-based Autolog, Uptime, User-Defined Event, and Waste

To set up a display in the Proficy Client:

1. In the Plant Applications Administrator, define the display in the Displays folder under **Client Management**.
2. In the Proficy Client under **Global Displays** in the Models pane, add a display for viewing in the Proficy Client. Give it the same name as used to define the display in the Plant Applications Administrator.

TIP: You can duplicate an existing Plant Applications display that has already been set up. Click the **Duplicate** button, and change the display name. Once the new display has been created, select it from the list, and then edit the class to match the new display type.

3. Open the display in the **Display Editor** under **Displays**.
4. At the Overview tab, select the **Use existing** option.
5. For the **.NET or Silverlight Assembly**, click the **Set** button at the right side.

6. Browse to the path relative to your workflow installation folder, for example, \Program\Applications\PAContainer. Next, select the PAContainer.dll file, and click **Open**.
7. Assign the type of display in the **Class Name** field. For example, use PAContainer.Alarms for an Alarms view, or use PAContainer.Autolog for all of the Autolog derived displays.
8. Click the **Save** button in the Display Editor toolbar.

To view a display in the Proficy Client:

1. In the Proficy Client under **Global Displays** in the Models pane, select a display.
2. Under **Displays**, select **Global Viewer**.

Alarm View Display

Note: This display is available only if you have purchased a Quality license. To contact us, please see the Contact Information topic.

The Alarm View Display is a real-time application designed to show active and historical alarms on key variables. Alarms conditions are based on alarm rules that compare data to product-based specification limits in real time.

In order to use the Alarm View Display, you must first configure your Alarms.

Key Uses

- Alarm critical variables and require acknowledgement.
- Expose operating procedures on alarm conditions.
- Enter Reasons and Comments for alarm conditions.

Key Data

- Alarm start times and end times.
- Alarm condition.
- Alarm Cause Reasons and corrective actions.
- Alarm comments.

Configuring an Alarm View Display

Note: This display is available only if you have purchased a Quality license. To contact us, please see the Contact Information topic.

1. In the Plant Applications Administrator Tree, expand the applicable server, and then expand **Client Management**.
2. Expand the **Displays** folder.
3. Right-click the appropriate Display Group, point to **Add New Display**, and then click **Alarm View**.
4. Type the name of the new Alarm View display and press **ENTER**.
5. Double-click the newly created Alarm View display. The **Edit Display** dialog box appears.
6. Click the **Units** tab.
7. Under **Available Units**, navigate to the desired Production Unit.

Client Management

8. Select the Production Unit and click the **Add** button to move the Production Unit to the **Selected Units** list.
9. Click the **Variables** tab.
10. To add the variables, you want to monitor alarms on, click the **Add** button.
11. In the **Search Variable** dialog box, search for the desired variables, and click **OK**.
12. To change any of the default display options, click the **Display Options** tab.
13. Click the **Save** button to save your changes.
14. Click the **Close** button to close the **Edit Display** dialog box.
15. Click **Yes** to activate the display.

Autolog Display

An Autolog Display is used to interact with quality and process data in a format similar to a spreadsheet. Autolog Displays can be time-based or event-based. In a time-based Autolog Display, each column represents a specified time period. In an event-based Autolog Display, each column represents an event such as a production event or a product-change event.

Autolog displays are real-time applications used to interact with quality and process data in spreadsheet format. An Autolog display can be configured so that new columns are automatically added in one of two ways:

- Based on time, in which case each column represents a time slice
- Based on an event, in which case each column represents an event such as a production event or a product change event

Display options for an Autolog are set up in the Plant Applications Administrator by right-clicking on an Autolog display listed under **Displays** in the Client Management section and choosing to edit the display. Work through the selections in each tab to set up an Autolog display. Refer to [Autolog Display Options Settings](#) for a description of the Display Options tab.

Production or User-Defined Event data can be locked based on the event status to prevent changes. This action permanently locks data for all Production or User-Defined Events with this status on all units. Only transitions to other locked statuses are allowed for statuses that have been locked. In Autolog, related data-entry fields are locked. Refer to Locking Production Statuses.

Key Uses

- Manually enter data.
- View filtered and summarized process data by time or event.
- Review product, product specifications, and operating procedures.
- Review and make disposition decisions.
- Add comments and attach documents to production events or specific data points.

Key Data

- Summarized quality and process data
- Results of calculations
- Product specifications and recipes
- Specification alarms
- Time, product, and status and routing of production event

- Production event comments, variable comments, data comment

Creating Time-Based Displays



Note: This display is available only if you have purchased an Efficiency license. To contact us, please see the Contact Information topic.

1. In the Plant Applications Administrator tree, expand  **Client Management**.
2. Expand the **Displays** folder.
3. Right-click a display group, point to **New Display** and click **Autolog Time-Based**. An active entry field will be added under the display group.
4. Type the name of the new display and press **ENTER**.

Note: Display names must be unique on a given Proficy server.

5. Double-click the new production event display. The **Edit Display - <display name>** dialog box appears.
6. On the **General** tab, do the following:
 - a. Under **Windows Settings (Hrs)**, specify the default time window of the display by editing the **Initial** and **Max** window hours.
 - b. Under **Time Information**, select a time interval from the **Interval** list and in the **Offset** box enter the amount of time after midnight that you want the first column to be inserted. For example, if you select an interval of **10 minutes** and an offset of **00:05**, the first column will be inserted at **00:05**, and then every **10 minutes** afterwards.

Note: If you select <none> as the time interval, no columns will be inserted, and no records will be written to the Tests table until both a column and value are manually entered in the display.

7. Click the **Headers** tab and select desired display options. Select the **Display Specification Window** option to display product specifications at the bottom of the display. Select the **Display Comment Window** option to have the comment window open in the display.
8. Click the **Display Properties** tab and select the columns and rows to make visible in the display. The **Event** option is the identifier for the production event. Selecting the **Dynamic Rows** option causes only the variables with specification to display; other variables will be hidden. Selecting the **Wrap Product Code** option will wrap the product code to the size of the column.
9. Click the **Variables** tab and click **Add**. The **Search Variables** dialog box appears. Select the variables you want to include in this display.
10. After selecting the variables, you can change the order of selected variables by clicking **Up** or **Down**. Titles may be added to the display by clicking **Add Title** and typing in the appropriate text. Titles will be added directly above the selected variable.
11. Click the **Display Options** tab to edit the various display options. Click  to edit the default value of a selected display option.
12. Click  **Save** in the toolbar.
13. Click  **Close**.
14. Click **Yes** to activate the display.

Creating Production Event Displays



Note: This display is available only if you have purchased a Quality license. To contact us, please see the Contact Information topic.

1. In the Plant Applications Administrator tree, expand  **Client Management**.
2. Expand the **Displays** folder.
3. Right-click a display group, point to **New Display** and click **Autolog Production Event**. An active entry field will be added under the display group.
4. Type the name of the new display and press **ENTER**.

Note: *Display names must be unique on a given Proficy server.*

5. Double-click the new production event display. The **Edit Display - <display name>** dialog box appears.
6. On the **General** tab, do the following:
 - a. Specify the default time window of the display by editing the **Initial** and **Max** window hours.
 - b. Identify the master production unit by selecting a production unit from the **Master Unit** list.
 - c. Identify the **Event Prompt**. This will be used in titles in the display to identify a production event.
7. Click the **Headers** tab and select desired display options. Select the **Display Specification Window** option to display product specifications at the bottom of the display. Select the **Display Comment Window** option to have the comment window open in the display.
8. Click the **Display Properties** tab and select the columns and rows to make visible in the display. The **Event** option is the identifier for the production event. Selecting the **Dynamic Rows** option causes only the variables with specification to display; other variables will be hidden. Selecting the **Wrap Product Code** option will wrap the product code to the size of the column.
9. Click the **Variables** tab and click **Add**. The **Search Variables** dialog box appears. Select the variables you want to include in this display.

Note: *If you want to limit your variable search to only the master production unit, ensure the **Variables from master unit only** option (located at the bottom of the Variables tab) is selected. If you want to search all variables, clear the option.*

10. After selecting the variables, you can change the order of selected variables by clicking **Up** or **Down**. Titles may be added to the display by clicking **Add Title** and typing in the appropriate text. Titles will be added directly above the selected variable.
11. Click the **Display Options** tab to edit the various display options. Click  to edit the default value of a selected display option.
12. Click  **Save** in the toolbar.
13. Click  **Close**.
14. Click **Yes** to activate the display.

Setting Up Production Status for User-Defined Events

User-Defined Events can be displayed with Production Status information in an Autolog display. Setup involves these steps:

1. Use the Production Status editor to add any statuses you want to see displayed. Select the Lock Event Data option for a status to lock the status so that no related data can be changed. (In Autolog, only transitions from one locked status to another are allowed.) Refer to Production Statuses and Events.

2. Select a status in the Default Production Status field in the User-Defined Event Configuration screen. This action is necessary to enable Production Statuses for User-Defined Events. Refer to Creating a User-Defined Event.
3. Select *True* for the DisplayStatus option under Column Headers in the Display Options tab when setting up an Autolog display. Refer to Autolog Display Options Settings.

Autolog Display Options Settings

Display Options for Autolog displays are set in the Display Options tab of the Edit Display screen for an Autolog display, which is accessed by right-clicking a display under **Client Management** in the Plant Applications Administrator. Click in the Edit column to change a value.

Usage notes for each category are given below.

Client Setting – Use Drilldown URL selections to add a custom menu item to the right-click menu for a cell.

Color Scheme – Use to select a color scheme.

Column Header – For time-based displays, set a minimum column width between 10 and 30 to ensure accommodation of data. The default is -1, which auto-sizes the columns. For event-based displays, users can configure a Conformance model that calculates the conformance and percent-complete based on a selected number of variables. Conformance (Target, Warning, or Reject) relates to whether any of the values for the selected variables have exceeded any specification limits. Percent-complete is the percentage of the selected variables that have been tested. DisplayStatus refers to the status or classification of the Production or User-Defined Event. A user can select the status from a list of defined statuses. If the event data has been locked, only transitions to another locked status are allowed. Refer to Locking Production Statuses.

Data Security – For time-based displays, use options to add a row for approval by a user (must also be assigned to a security group) or administrator. For event-based displays, use options to lock columns after approval and show the Data Security user and approver.

Display Enhancements – Use options to customize the display. Web-based applications offer additional features as described in other help topics. Event-based displays have an additional option for the number of days to display quality analysis data.

Display Setting – Use to set the position of the cursor in a display cell when a new column is added:

0 (default) – moves the cursor to the new column in the row where positioned before the new column was added.

-1 – leaves the cursor where it is when a new column is added.

Integer value greater than 0 – moves the cursor to the row number as specified by the integer value when a new column is added. For example, if a user has the cursor positioned in row 1 and ColumnFocusSetting is set to 10, the cursor is moved to row 10 in the new column when the new column is added.

Also, use to display the hyperlink menu for convenient access to features.

Electronic Signature – Use to set e-signature options including default reason IDs.

Event Edits – For event-based displays, select to use the Event Edit dialog, which offers more features than Common Dialogs.

Labels – For event-based displays, display the production status used to trigger event label generation.

Security – Use to lock cells when no data is available ("unavailable" cell) so that only an administrator can enter a value. You might use this option to lock cells so that no data can be manually entered when data is not scheduled for collection. For example, an Autolog display has hourly columns, but data for a variable is collected only every two hours. For event-based displays, configure additional security settings.

Downtime Displays

Note: Downtime displays are available with the Efficiency Management license. For assistance, refer to Contact Information.

A downtime display interacts with real-time downtime information. It can show downtime for a single production unit (Unit mode), or it can show downtime for each unit within a production line (Line mode). Downtime events and reasons can be manually entered or automatically detected. You can also attach comments or documents to each event.

For customers who use touch screens, the Downtime+ display is available.

For more information, refer to Anatomy of a Downtime Display or Anatomy of a Downtime+ Display.

Configuring a Downtime Display

Note: Downtime displays are available with the Efficiency Management license. To contact us, please see the Contact Information topic.

1. In the Plant Applications Administrator tree, expand  **Client Management**.
2. Expand the **Displays** folder.
3. Right-click a display group, point to **New Display** and click **Downtime**. An active entry field is added under the display group.
4. Type the name of the new display and press **ENTER**.
5. Right-click the new display and click **Edit Display**.
6. Select the default time window of the Display by updating the "Initial" and "Max" window hours.
7. Select the Master Unit of the Display by selecting the "Master Unit" drop-down and selecting a Unit from the list.
8. Select the "Save" icon to save the Display settings.
9. Update the security of the Display. Select the Display; right-click and select "Security."
10. Select the appropriate User Group and close the Object Security window.
11. Activate the Display. Select the Display; right-click and select "Activate."

Configuring a Downtime+ Display

Note: Downtime displays are available with the Efficiency Management license. To contact us, please see the Contact Information topic.

The Downtime+ display can be used with a touch screen or keyboard and shows downtime events in real time.

Prerequisites:

Before you configure the Downtime+ display, you must:

- Install .NET Framework 3.0. For download information, go to the Microsoft web site: <http://www.microsoft.com/downloads/details.aspx?FamilyID=10CC340B-F857-4A14-83F5-25634C3BF043&displaylang=en>
- Have the Efficiency Management module license
- Create your plant model
- Configure downtime event detection on the production unit

To configure a Downtime+ display:

1. In the Plant Applications Administrator, expand  Client Management and expand Displays.
2. Right-click a display group, point to **Add New Display**, and select **Downtime+**. An active entry field is added under the display group.
3. Type the name of the display and press **ENTER**.
4. Double-click the new display or right-click and select **Edit <display name>**. The **Edit Display - <display name>** dialog box appears.
5. On the **General** tab, under **Window Settings (Hrs)**, do the following:
 - In the **Initial** box, type the number of hours of data to load when the display is opened. The default value is 24 hours. The time the display is opened is the starting point. For example, if the Initial value is 24 and the Downtime+ display is opened at 8:00 AM on July 15, 2008, then all downtime events that occurred from 8:00 AM July 15, 2008 to 8:00 AM July 14, 2008 will be displayed.
 - In the **Max** box, type the number of hours of data to view in the display. This value should be greater than or equal to the **Initial** value. The default value is 24 hours.
 - In the **Max Edit** box, type the number of hours that data can be edited in the display. The default value, 0, means that all data can be edited. For example, if you type 2 in the box, only the past 2 hours of data can be edited.
6. Click the **Units** tab to select the production units on which you want to detect downtime events. Only the units that have been configured to detect downtime events will be available for selection.

Note: *The number of units selected will affect performance. In general, the greater number of units selected, the slower the performance.*

7. Click the **Display Options** tab to customize the downtime display. To change any of the display option, click the **Edit**  button. The **Assign Property Value** dialog box appears.

The following option groups are available:

- **Color schemes:** The default scheme is the same as the classic downtime display. For information about creating a new color scheme, see Color Schemes.
 - **Red** text indicates missing reasons.
 - **Bold red** text indicates the event has been split or that the event is grouped and that one or more detail records is not complete. Events are grouped when they share adjacent start and end times.
 - **Bold blue** text indicates the event has been split or that the event is grouped and that all detail records are complete.
 - **Green** text indicates the event is in progress.
 - Black text indicates the event is complete and all the required information has been provided.
- **Display Columns:** You can choose to display or hide the columns that are selectable.
- **Display Enhancements:**

- Actions Confirmed – If **True**, causes and reasons must be selected in the display to determine if a record is considered confirmed.
 - Allows Mode Toggle –If **True**, the Change Size Mode button is displayed on the Grid Actions tab of the Downtime+ Display. The Change Size Mode button enables you to change the size of text and buttons to accommodate using a touch screen. In addition, the On-screen Keyboard button is displayed, which enables the user of the display to open an on-screen keyboard. By default, Microsoft's On-Screen Keyboard is used, but any on-screen keyboard can be used. For more information, see [Linking to an On-screen Keyboard](#).
 - Location Column – If **True**, the Location column is visible.
 - Number Format – This is a .NET string format. For more information, go to the MSDN web site: [http://msdn2.microsoft.com/en-us/library/0c899ak8\(VS.85\).aspx](http://msdn2.microsoft.com/en-us/library/0c899ak8(VS.85).aspx).
 - Touchscreen mode – If set to **True**, the display starts up in touchscreen mode, which makes it easier to use a stylus or other tapping device by increasing the size of the text in the display.
- **Security:** To understand the different security levels, see Access Levels and Privileges for Client Displays.
8. Save the display and click **Yes** to activate it.

Genealogy View Display

Note: This display is available only if you have purchased a Production license. For assistance, refer to Contact Information.

The Genealogy View display is a real-time application used to load product from an input production unit or from multiple input production units on to an output or producing production unit. Raw Material events are put into Staged and Running positions and are consumed to make new products. Relationships are created for the parent and children events.

Creating and Configuring the Genealogy View Display

Note: This display is available only if you have purchased a Production license. To contact us, please see the Contact Information topic.

The Genealogy View display is a real-time application used to load product from an input production unit or from multiple input production units on to an output or producing production unit. Raw material events are put into **Staged** and **Running** positions and are consumed to make new products. Relationships are created for the parent and children events.

1. Listing of available production events that can be manually or automatically moved to the Staged (2) or Running (3) positions.
2. Current staged event.
3. Current running event.
4. The first box on the left (the red one), indicates the number of High alarms. The second box from the left indicates the number of Medium alarms. The third box from the left indicates the number of Low alarms. The box on the right (the green one) indicates if the unit is running or is down, as defined by the downtime configuration, and also will display the number of downtime events on the unit for the current production day.
5. The unit view displays the current production, the number of downtime minutes and production for the day, as defined by the Data Range display option.
6. The events that were created. Use the scroll bar to move through the list of events.
7. Use the drop-down list to select a different unit.

To Create Genealogy View Displays:

1. In the Plant Applications Administrator, expand **Client Management**.
2. Expand the **Displays** folder
3. Right-click on the display group and point to **Add New Display** and click **Genealogy View**. An editable text field will appear under the display group.
4. Type the name of the new display and press **ENTER**.

Note: Display names must be unique.

5. Right-click on the new display and click **Edit <display name>**. The **Display Edit - Genealogy View** dialog box appears.
6. Select the default time window of the display by updating the Initial and Max window hours.
7. Choose a Maximum Edit (Max Edit) time to constrain how far back the user can edit Genealogy View data.
8. Choose a Maximum Inventory (Max Inv:) to constrain how far back to pull in Production Events that have an inventory status.
9. Select the Master Unit of the Display by clicking on the Master Unit drop down box and picking a Production Unit from the list.

10. Select the **Display Options** tab. The various Display Options can be used to enhance the functionality of the Genealogy display. For more information on display options, see the topic [Genealogy View Display Options](#).
11. The **Genealogy Data** tab is used to assign the Autolog display that is associated with each production unit that will be used on this Genealogy View display to show detailed event data. This is the link to the Autolog display that is displayed for the selected event when View Events is selected.
12. Click the  **Save** icon.
13. Click **Yes** to activate the display.
14. Click the **Close** button to exit and close the **Display Edit - Genealogy View** dialog box.

Genealogy View Display Options

Create Event On Scan: If this option is set to **True**, a scanned event number will be created on a temporary unit when the event number is not found.

Date Range: This option determines when the event count in the production unit box is reset. The three options are:

- **Day To Date:** Selecting Day To Date will reset the event count at the start of your production day, which is defined by the EndOfDayHour and EndOfDayMinute site parameters. For information on these two site parameters, see the topics, Editing EndOfDayHour Site Parameter and Editing EndOfDayMinute Site Parameter.
- **Rolling 24 Hour:** Selecting Rolling 24 Hour will show the event count for the past 24 hours.
- **Shift To Date:** Selecting Shift To Date will reset the event count each time there is a shift change. For more information about shifts and crew schedules, see the topic, Administering Crew Schedules.

Maximum levels displayed: This option determines how many levels of the tree are displayed when switching to Tree View. The default is five.

Use Input Scroll: This option determines if a scroll bar and drop-down box is used on the raw material input box to move to different raw material inputs. By default, this is set to False, so no scroll bar and drop-down box is displayed. For example, if you have two raw material inputs and the option is set to False, your Genealogy View display will show two input boxes. If the option is set to True, the display will show only one input box, but the input box will have a scroll bar and drop-down box to select the other input box.

Use Input Scroll option set to True

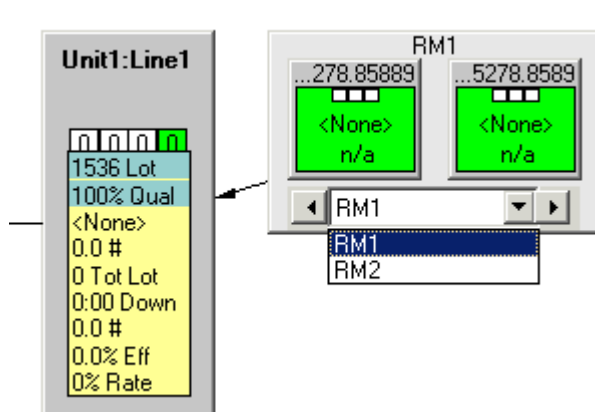

Use Input Scroll option set to False

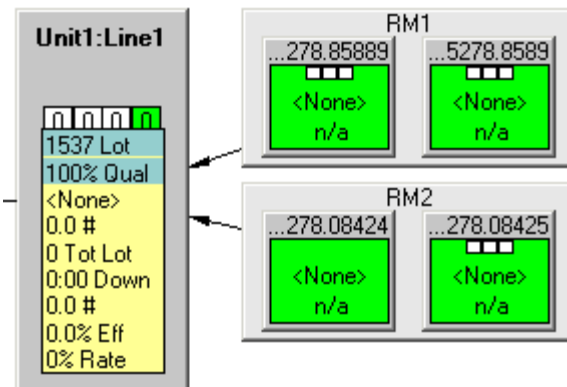

Allow reprocessing of events: If set to True, the option adds a Reprocess Events option on the right-click menu, which you can see by right-clicking on an event component link when in Tree View. When you reprocess an event, the event is put back into pending tasks and the services perform all required tasks on the event.

Auto Update Inventory List: If set to True, this option will update the inventory list when an input is selected. For example, if you have Raw Material Input 1, which uses Unit1 as its input source, and Raw Material Input 2, which uses Unit 2 as its input source, the inventory list will display events on Unit 1 when you click on Raw Material Input 1 and events on Unit 2 when you click on Raw Material Input 1. The default is False.

DisplayTreeViewAlarms: If set to True, alarms will be displayed on all parent and child events. If set to False, alarms will be displayed only on the event that has focus.

Large Font: This option determines the default font for the display.

Large Font Size: This option determines the size of the default font for the display.

MaxEventsPerLevel: This option determines the maximum number of events, per level, that are displayed when in Tree View.

Maximum Inventory List Results: This option determines the maximum number of events listed in the inventory list. The default is 0 (zero), which means that all events will be displayed.

Small Font: This option determines the font used when zooming out.

Small Font Size: This option determines the size of the font when zooming out.

UseWebBasedApplications: This option specifies that web-based reports will be used when opening a report from within the display.

Default Number of Patterns: This option specifies the default number of patterns.

DisplayHyperlinks: This option determines whether the hyperlink panel will be open when the display is opened. The default is False, which means that the hyperlink panel will not be open when the display is open.

Allow status changes on inputs: Setting this option to True allows you to change the status of input events. An extra option, <production event> Status, is added to the menu that is opened when you right-click on an event in an input box. For more information on production event statuses, see the topic Production Statuses for Events.

Allow status changes on output: Setting this option to True allows you to change the status of output events. An extra option, <production event> Status, is added to the menu that is opened when you right-click on an event in an output box. For more information on production event statuses, see the topic Production Statuses for Events.

Auto Label Status: Select the production status that will trigger the generation of event labels.

Filename For Auto Labeling: Select the executable file (.EXE) that will be used to create the labels.

Start display in family tree mode: Selecting True will start the Genealogy View display in Tree View mode.

Status for Completed running events: Select the status that will be applied to completed events. The default status is Consumed.

Production Overview Display

Client Management

The Production Overview display is a real-time application used to show data specific to the performance of each Production Unit on a Line. Four different views are available:

- Production Execution Path View
- Units View
- Alarms View
- Icons View

Creating and Configuring the Production Overview Display

The Production Overview display is a real-time application used to show data specific to the performance of each production unit on a product line. There are four different views available for the Production Overview. They are Production Execution Path View, Units View, Alarms View, and Icons View.

To Create Production Overview Displays:

1. In the Plant Applications Server Manager tree, expand **Client Management**.
2. Expand the **Displays** folder
3. Right-click on the display group and point to **Add New Display** and click **Production Overview**. An editable text field will appear under the display group.
4. Type the name of the new display and press **ENTER**.
5. Display names must be unique.
6. Right-click on the new display and click **Edit <display name>**. The **Display Edit - Production Overview** dialog box appears.
7. Select the default time window of the display by updating the Initial and Max window hours.
8. Select the Production Line to be displayed using the **Line Information** pick list.
9. Select the **Units** tab.
10. Select each Production Unit from the Available Units window that will be used on this Production Overview Display and click **Add**.
11. Select the **Display Options** tab.
12. The various Display Options can be used to enhance the functionality of the Genealogy display.
13. Click the  **Save** icon.
14. Click **Yes** to activate the display.
15. Click the **Close** button to exit and close the **Display Edit - Production Overview** dialog box.

Production Run Analyst Display

Note: *This display is available only if you have purchased a Production license. For assistance, see Contact Information.*

Real-time application designed for operators to review current process and quality conditions versus standard (recipe) conditions and historical conditions. This display is set up in the Administrator. Refer to Anatomy of a Anatomy of a Production Run Analysis (Operator) Display.

Non-Productive Time View Display

Note: This display is available only if you have purchased an Efficiency, Quality, or Production license. See Contact Information.



The Non-Productive Time View is used in a client display to manage non-productive time. Refer to Anatomy of a Anatomy of a Non-Productive Time View Display.

Setting Up a Non-Productive Time Client Display

This display is available only if you have purchased an Efficiency, Quality, or Production license.

The Non-Productive Time View accessed as a client display is used to manage non-productive time. Changes made in the Non-Productive Time View update the NonProductive_Detail table in the Plant Applications database.

To configure a Non-Productive Time View:

1. In the Plant Applications Server Manager tree, expand  **Client Management**.
2. Right-click on a display group, point to Add New Display, and click **Non-Productive Time**. A blank new entry field opens under the display group list.
3. Type the name of the display, and press **Enter**.
4. Double-click the new display. The **Edit Display** dialog box appears.
5. Do one of the following:
 - To select all units on a single line, click the **General** tab and select the line from the **Line** list.
 - To select specific units, click the **Units** tab and select the individual units you want to include on the display.
6. Click  **Save**.
7. Click **Yes** to activate the display.
8. Close the **Edit Display** dialog box.

Relative View Display

Note: This display is available only if you have purchased an Efficiency or Quality license. For assistance, refer to Contact Information.

The Relative View display is a real-time application designed to compare a series of variables to product-based specification or recipe limits. Refer to Anatomy of a Relative View Display.

Schedule View Display

Note: This display is available only if you have purchased a Production license. For assistance, refer to Contact Information.

Use a Schedule View display to view and execute the current production schedule. Refer to Anatomy of a Schedule View Display.



Schedule View Display Options are set up in the Display Options tab of the Edit Display _Schedule View screen. Access the display options by right-clicking a display under **Client Management** in the Plant Applications Administrator.

Creating and Configuring a Schedule View Display

Note: *This display is available only if you have purchased a Production license. To contact us, please see the Contact Information topic.*

Topics on using a Schedule View display are located in online Help for the Proficy Client, which is available on computers with the Client application installed.

To Create a Schedule View Display:

1. In the Plant Applications Server Manager tree, expand **Client Management** and then the **Displays** folder.
2. Select a display group, then right-click on it and choose **Add New Display > Schedule View**.
3. Enter the name of the new display. Display names must be unique.
4. Select the new display, and then right-click on it and choose **Edit (Display Name)**. Alternatively, double-click the display icon.
5. In the Edit Display dialog box that appears, set the default time window of the display by updating the Initial and Max window hours.
6. Enter a Max Edit time to limit the age of data that users may edit in this display.
7. Click the **Paths** tab.
8. Select each execution path from the list in Available Paths that will be used for this display, and then click **Add**.
9. Click the **Display Options** tab. The various Schedule View Display Options can be used to enhance the functionality of the display.
10. Click  Save. Activate the display when prompted to do so.
11. Click the **Close**  button to close the Edit Display dialog box. The display is now available in the Plant Applications Client.

Sequence of Events Display

Note: *This display is available only if you have purchased an Efficiency license. For assistance, refer to Contact Information.*

A Sequence of Events Display is used for interacting with all types of events, sorted by time. Detailed information is provided for Production, Product Change, Downtime, Waste and User-defined events. Refer to Anatomy of a Sequence of Events Display.

Trend View Display

The Trend View Displays (Normal or SPC) are available only if you have purchased an Efficiency or Quality license. To obtain licensing, refer to Contact Information.

The Trend Display is a real-time display designed for trending variables against product-based specifications or recipe limits. Trends summarize quality and process data by time or event. Historical trends and product specifications (recipe limits) can be reviewed. Refer to Anatomy of a Trend Display.

Waste Displays

Note: *The Waste Displays are available only if you have purchased an Efficiency license. For assistance, refer to Contact Information.*

The Waste Displays are used to interact, in real time, with waste detail information. Refer to Anatomy of a Waste Display or Anatomy of a Waste+ Display.

Configuring a Waste Display

Note: *The Waste displays are available only if you have purchased an Efficiency license. For assistance, refer to Contact Information.*

Follow these steps to configure a classic Waste Display:

1. In the Plant Applications Server Manager tree, expand **Client Management**.
2. Expand the **Displays** folder
3. Right-click on the display group and point to **Add New Display** and click **Waste View**. An editable text field will appear under the display group.
4. Type the name of the new display and press **ENTER**. Display names must be unique.
5. Right-click on the new display and click **Edit <display name>**. The **Display Edit - Waste View** dialog box appears.
6. Select the default time window of the display by updating the "Initial" and "Max" window hours.
7. Select the Master Unit of the display by selecting the "Master Unit" drop down and selecting a unit from the list.
8. Select the  **Save** icon to save the display settings.
9. Click **Yes** to activate the display.

Configuring a Waste+ Display

Note: *The Waste displays are available only if you have purchased an Efficiency license. For assistance, refer to Contact Information.*

The Waste+ display can be used with a touch screen or keyboard and shows waste events in real time.

Prerequisites:

Before you configure the Waste+ display, you must:

- Ensure .NET Framework 3.0 or higher is installed from the Microsoft web site.
- Have or obtain an Efficiency Management module license.
- Create a plant model.
- Configure waste event detection on the production unit.

To configure a Waste+ display:

1. In the **Plant Applications Administrator**, expand  **Client Management** and expand **Displays**.
2. Right-click a display group, point to **Add New Display**, and select **Waste+**. An active entry field is added under the display group.
3. Type the name of the display and press **ENTER**.

4. Double-click the new display or right-click and select **Edit <display name>**. The **Edit Display - <display name>** dialog box appears.
5. On the **General** tab, under **Window Settings (Hrs)**, do the following:
 - In the **Initial** box, type the number of hours of data to load when the display is opened. The default value is 24 hours. The time the display is opened is the starting point. For example, if the Initial value is 24 and the Waste+ display is opened at 8:00 AM on July 15, 2008, then all waste events that occurred from 8:00 AM July 15, 2008 to 8:00 AM July 14, 2008 will be displayed.
 - In the **Max** box, type the number of hours of data to view in the display. This value should be greater than or equal to the **Initial** value. The default value is 24 hours.
 - In the **Max Edit** box, type the number of hours that data can be edited in the display. The default value, 0, means that all data can be edited. If you type 2 in the box, only the past 2 hours of data can be edited.
6. Click the **Units** tab to select the production units on which you want to detect waste events. Only the units that have been configured to detect waste events will be available for selection.

Note: *the number of units selected will affect performance. In general, the greater number of units selected, the slower the performance.*

7. Click the **Display Options** tab to customize the waste display. To change any of the display option, click the **Edit** button. The **Assign Property Value** dialog box appears.

The following option groups are available.

- **Color schemes:** The default scheme is the same as the classic waste display. For information about creating a new color scheme, see Color Schemes.
 - **Red** text indicates missing reasons.
 - Rows shaded **yellow** indicate production events without details.
 - Rows shaded **green** indicate time-based waste events.
 - Black text indicates the event is complete and all the required information has been provided.
 - **Display Columns:** You can choose to display or hide the columns that are selectable.
 - **Display Enhancements:**
 - **Actions Confirmed** – If **True**, causes and reasons must be selected in the display to determine if a record is considered confirmed.
 - **Allows Mode Toggle** – If **True**, the Change Size Mode button is displayed on the Grid Actions tab of the Waste+ Display. The Change Size Mode button enables the user to change the size of text and buttons to accommodate using a touch screen. In addition, the On-screen Keyboard button is displayed, which enables the user of the display to open an on-screen keyboard. By default, Microsoft's On-Screen Keyboard is used, but any on-screen keyboard can be used. For more information, see [Linking to an On-screen Keyboard](#).
 - **Location Column** – If **True**, the Location column is visible.
 - **Location Column** – If **True**, the Location column is visible.
 - **Number Format** – This is a .NET string format. For more information, go to the MSDN web site: [http://msdn2.microsoft.com/en-us/library/0c899ak8\(VS.85\).aspx](http://msdn2.microsoft.com/en-us/library/0c899ak8(VS.85).aspx).
 - **Touchscreen mode** – If set to **True**, the display starts up in touchscreen mode, which makes it easier to use a stylus or other tapping device by increasing the size of the text in the display.
 - **Security:** To understand the different security levels, see Access Levels and Privileges for Client Displays.
8. Save the display and click **Yes** to activate it.



Configuring Security Rights for a Web UI Display

Web Client Displays are no longer supported as of Plant Applications 6.3.

Web Client Displays provide access to Plant Applications event information through a browser-based application or Proficy Vision. Setup is described in the *Getting Started Guide*.

For a downtime event, granular security enables permissions to be set to change information in the Event Details view based on users assigned to security (user) groups in Plant Applications. Once security groups are defined, follow the steps below to set up security.

To configure security rights for a Web UI display:

1. In the Plant Applications Administrator, expand  Client Management and expand Displays.
2. Right-click a display group, point to **Add New Display**, and select **WebUI**. An active entry field is added under the display group.
3. Type the name of the display and press the **Enter** key.
4. Double-click the new display or right-click and select **Edit <display name>**. The **Edit Display - <display name>** dialog box appears.
5. On the **General** tab, under **Line Information**, open the drop-down box to select a production line. Next, pick a unit from the dialog that opens.
6. On the **Units** tab, add any additional units to include in downtime reporting.
7. Click the **Display Options** tab to customize the security options for the downtime display.
8. To change a value for a security option, click the **Edit**  button. Select a Security Group for the **Value** field in the Assign Property Value dialog box. Security controls for the Downtime+ and WebUI Displays are set in the Display Options tab of the Edit Display screen (sheet). For a particular control, select the lowest level Security Group that you want to have rights.
9. Save the display, and close it.
10. Right-click on the display, and select **Activate**.

User Views

User views are a combination of displays and shortcut bars that have been arranged in a logical pattern in the Plant Applications Client. Views can be created only from the Plant Applications Client. The displays you group can be on different servers; however, the View will be saved to the default Proficy Server.

Within the Plant Applications Administrator, you can group the views and control the user security at the view level or the view group level.

Plant Applications includes a view group called "Default View Group." You can rename this default view group, but you cannot delete it or edit the membership of the group.

Creating a View

This information applies to the Plant Applications Client program.

Views are a collection of displays and shortcuts. The only way to create a view is within the Plant Applications Client. You cannot use the Plant Applications Administrator to create a view.

Client Management

To create a View:

1. In the Plant Applications Client program, open and position displays as desired.
2. Add any desired shortcuts to the Shortcut Bar, and add any reports to the Report Menu.
3. Format open displays as desired, such as Time Formatting, Column Visibility, Column Widths, and Comment Visibility.
4. From the **File** menu, click **Save View As**. The **Save View As** dialog box dialog box appears.
5. Do the following:
 - a. **optional:** Select a different server from the **Server** drop-down list, or click **Browse**  to select a different server.
 - b. In the **View Name** box, type the name of your View.
 - c. Click **OK**.

ActiveX Controls

About Plant Applications ActiveX Controls

Proficy ActiveX controls provide an efficient way to view, manage and edit different stages of the production process.

The ActiveX controls can be dropped into an iFix and other ActiveX control containers.

Frequently used Proficy ActiveX controls include:

<u>Proficy.ALC_Autolog Control</u>
<u>Proficy_DWN.Downtime</u>
<u>Proficy_ALM.AlarmView</u>
<u>Proficy_GVW.Genealogy</u>
<u>Proficy_SOE.SOEView</u>
<u>Proficy_SVW.ScheduleView</u>
<u>Proficy_WST.Waste</u>

Other Proficy ActiveX controls are:



- Proficy_OPR.OPControl
- Proficy_OVW.OverView
- Proficy_RVW.RelativeView
- Proficy_TRD.ViewChart

Autolog ActiveX Control

Proficy.ALC_Autolog Control

The Proficy.ALC_Autolog control provides a way to view or insert quality and efficiency data based on time or a specified event type.

Topics:

	Events: Proficy.ALC_Autolog control
	Methods: Proficy.ALC_Autolog control
	Properties: Proficy.ALC_Autolog control

Client Management

List:

	CellInfo		ProductUpdated
	CommandDescription		RowInfo
	DisplayOption		ScrollTo
	DisplayOptionDescription		SecondUserId
	ExtendedInfo		SetActiveTime
	ExecuteCommand		SheetName
	GetCurrentCell		Shutdown
	GetTimeRange		StartTime
	HyperLinkMenuVisible		Startup
	LastError		TimeRangeChanged
	MaxColumns		UpdateValue
	MaxRows		ValueUpdated
	MySheetTimeFormat		

Events: Proficy.ALC_Autolog Control

ProductUpdated

	Purpose	Fired when the event value has changed.
	Syntax	Event ProductUpdated (<i>Product As String, StartTime As String, EndTime As String, UnitName As String</i>)

TimeRangeChanged

	Purpose	The absolute values of the display's time range have changed.
	Syntax	Event TimeRangeChanged (<i>StartTime As String, EndTime As String</i>)

ValueUpdated

	Purpose	Alerts control users that a value has been updated. As a result users can react, for example, change the color of the screen or set an alarm.
	Syntax	Event ValueUpdated (<i>Row As Long, Column As Long</i>)

Methods: Proficy.ALC_Autolog Control

ExecuteCommand

	Purpose	Send a command name as a string, including one or more of the following parameters.
	Syntax	Function ExecuteCommand (<i>CommandName As String, ParamArray Parameters() As Variant</i>) As Boolean

	<i>Parameters</i>	Parameter	Description
		AddTrend	Trend the variable data for the current cell.
		AlignColumn	Set the leftmost column to be the active column.
		DeleteColumn	Delete the currently selected column.
		EditEvent	Open the Edit Event dialog
		InsertColumn	Insert a column after the currently selected column.
		FindEventDialog	Open a Find Event dialog box.
		FindTimeDialog	Open a Find Time dialog box.
		GotoLastRunDialog	Go to the last product run.
		Print	Print the Autolog display.
		PrintLabel	Print a label for the selected event.
		ShowHelp	Open Plant Applications help.
		ViewArrayData	Display array data (<i>if array data exists</i>) for the currently selected cell.
		ViewCalculation	Show the calculation for the current cell
		ViewCellInformation	Show information for the currently selected cell.
		ViewDisplayOptions	Open the Display Options dialog box.
		ViewHeaderOptions	Open a dialog box to specify what should be in the header.
		ViewProductChange	Display Product Change dialog box.
		ViewTestHistory	Open a dialog box that contains the current cell's history. Note: The history includes any value that was previously entered in the cell.

GetCurrentCell

	Purpose	Select the current cell
	Syntax	Sub GetCurrentCell (<i>Row As Long, Column As Long</i>)

GetTimeRange

	Purpose	Select the time range for the current display.
	Syntax	Sub GetTimeRange (<i>sTime As String, eTime As String</i>)

ScrollTo

	Purpose	Go to a target time date; the exact time is True or False. If there is no production event at the exact time, it is false. Scrollto will find the closest date and go there.
	Syntax	Function ScrollTo (<i>TargetTime As Date, ExactTime As Boolean</i>) As Boolean

SetActiveTime

Client Management

	Purpose	Put the column with the time you provide as the far right hand column. The column that matches provided time is on the far right-hand side
	Syntax	Sub SetActiveTime (<i>ResultOn As Date</i>)

Shutdown

	Purpose	ALWAYS USE shutdown when you have finished using the control.
	Syntax	Sub shutdown ()

Startup

	Purpose	Start the control. Note: The parameters are optional. If they are not defined the control looks for the information in the following order. <ol style="list-style-type: none"> 1. In the registry for the current user. 2. If the user is not found the control will prompt you to connect.
	Syntax	Function startup (<i>[ServerName As String], [UserName As String], [Password As String]</i>) As Boolean

UpdateValue

	Purpose	Set the value in a specified row/column.
	Syntax	Function updateValue (<i>Row As Long, Column As Long, Value</i>) As Boolean

Properties: Proficy.ALC_Autolog Control

CellInfo

	Purpose	Returns data from the current cell.	
		<i>Read-only</i>	
	Syntax	Property CellInfo (<i>[Row], [Column], [Flags]</i>) As alcCellInfo	
		Cell Data	Cell Data Description
		CellArrayData	Array data.
		CellArrayStatus	Array status.
		CellComment	Comments.
		CellEntryTime	Entry time.
		CellLowerReject	Lower rejection limit.
		CellLowerWarning	Lower warning limit.
		CellProduct	Product.
		CellTarget	Target.
		CellUpperReject	Upper rejection limit.
		CellUpperWarning	Upper warning limit.

	CellValue	Value.
	ColumnComment	Comment for the cell's column.
	ColumnEventNumber	Event number for the cell's column.
	ColumnResultTime	Result time for for the cell's column.

CommandDescription

	Purpose	Returns a string that tells what a specified command has done.
		<i>Read-only</i>
	Syntax	Property CommandDescription(<i>CommandName</i>) As String

DisplayOption

	Purpose	Set any of the following display options.	
		<i>Read/Write</i>	
	Syntax	Property DisplayOption (<i>OptionName As String, [DontDraw As Boolean]</i>)	
		<p>Where [DontDraw As True] = Do not refresh the screen until all of the options that should be set are set. [DontDraw As False] = Refresh the screen after each option is set.</p>	
		Display Option	Description
		AutoPrint	Print a log report upon completion of the automatic logging.
		ColumnNumbering	Display/do not display column numbers.
		CommentsVisible	Display/do not display the comments.
		DisplayDataSecurityApprover	Display/do not display the approver signature.
		DisplayConformance	Turn on/off conformance tracking for events based displays.
		DisplayDataSource	Display/do not display the name of the data source.
		DisplayDataTypeId	Display/do not display the data type ID.
		DisplayDate	Display/do not display the date.
		DisplayEngineeringUnits	Display/do not display the engineering units.
		DisplayESignatureLevel	Display/do not display the electronic signature level.
		DisplayEvent	Turn on/off the event number row in the header.
		DisplayHyperLinks	Show/hide the hyperlink menu at startup.
		DisplayPercentComplete	Display/do not display the logging's percent complete.
		DisplayProduct	Turn on/off the product code row in the header.
		DisplayProductionLine	Turn on/off the Production Line column in the header.

Client Management

		DisplayProductionUnit	Turn on/off the Production Unit column in the header.
		DisplayGrid	Display/do not display the grid border around cells.
		DisplaySpecification	Turn on/off the Specification column in the header.
		DisplayStatus	Display/do not display the Status row in the header.
		DisplayTime	Display/do not display the time.
		DisplayDataSecurityUser	Display/do not display the user signature.
		DisplayVariableDescription	Display/do not display a description of the variable.
		DisplayVariableId	Display/do not display the variable ID.
		DisplayVariableOrder	Display/do not display the variable order.
		DynamicRows	Turn on/off dynamic row functionality
		DataSecurityLockApprovedColumns	Display ESignature Lock Approved columns.
		HyperlinkSplitterWidth	Set the width of the Hyperlink menu to the right of the control (pixels).
		RejectColumnVisible	Show/hide the Reject column.
		RowNumbering	Display/do not display row numbers.
		ShowColumnHeaders	Show/hide the column headers.
		ShowRowHeaders	Show/hide the row headers.
		SpecWindowVisible	Turn on/off the Specification window at the bottom of the display.
		TargetColumnVisible	Show/hide the Target column.
		TestFrequencyColumnVisible	Show/hide the Test Frequency column.
		TimeFormat	Set the time format in either of the following: HH:mm HH:mm:ss
		ToggleLimitColumns	Display/do not display the limit columns.
		UserColumnVisible	Show/hide the User column.
		WarningColumnVisible	Show/hide the Warning column.

DisplayOptionDescription

	Purpose	Returns a description of each display option by name.
		<i>Read-only</i>
	Syntax	Property DisplayOptionDescription (<i>CommandName</i>) As String

ExtendedInfo

	<i>Purpose</i>	Returns additional data from the current or specified cell	
		<i>Read-only</i>	
	<i>Syntax</i>	Property ExtendedInfo ([Row], [Column]) As alcExtendedInfo	
		Cell Data	Cell Data Description
		Product	Product
		ProductEndTime	Pproduct end time
		ProductExternalLink	Product external link.
		ProductionLineDesc	Production line description
		ProductionUnitDesc	Production unit description.
		ProductStartTime	Start time.
		SpecificationDesc	Specification description.

HyperLinkMenuVisible

	<i>Purpose</i>	Shows/hides the Hyperlink menu to the right of the control.	
	<i>Value</i>	<i>Show</i>	True
		<i>Hide</i>	False
		<i>Read/Write</i>	
	<i>Syntax</i>	Property HyperLinkMenuVisible As Boolean	

LastError

	<i>Purpose</i>	Displays an error message describing the last error.	
		<i>Read-only</i>	
	<i>Syntax</i>	Property LastError As String	

MaxColumns

	<i>Purpose</i>	Returns the number of the last column on the control.	
		<i>Read-only</i>	
	<i>Syntax</i>	Property MaxColumns As Long	

MaxRows

	<i>Purpose</i>	Returns the number of the last row on the control.	
		<i>Read-only</i>	
	<i>Syntax</i>	Property MaxRows As Long	

MySheetTimeFormat

	<i>Purpose</i>	Returns the time format that the control uses.	
		<i>Read-only</i>	
	<i>Syntax</i>	Property MySheetTimeFormat As String	

RowInfo

	Purpose	Provides information about the row.	
	Syntax	Property RowInfo ([Row]) As alcRowInfo	
		Row Data	Row Data Description
		VariableComment	Variable comments.
		VariableDesc	Variable descriptions.
		VariableEngUnits	Variable engineering units.
		VariableExternalLink	Variable external links.
		VariableInputTag	Variable input tags.
		VariableOutputTag	Variable output tags.

SecondUserId

	Purpose	Set the User_Id of an eSignature second approver.	
		<i>Read/Write</i>	
	Syntax	Property SecondUserId As Long	

SheetName

	Purpose	Set the name of the display that the control will display.	
		<i>Read/Write</i>	
	Syntax	Property SheetName As String	

StartTime



	Purpose	Shows when the control started for the current session.	
		<i>Read-only</i>	
	Syntax	Property StartTime As Date	

Alarm View ActiveX Control





Proficy_ALM.AlarmView Control

























The Proficy.AL.M.AlarmView control provides a way to display and edit alarm conditions.

Topics:

	Events: Proficy_ALM.AlarmView control.
	Methods: Proficy_ALM.AlarmView control.
	Properties: Proficy_ALM.AlarmView control.

List:

	AckFromDialog		LastError
	CloseDisplay		MaxYReached
	CommandDescription		Navigate

	ContextChanged		PopUpTrendAlarmPriority
	ControlError		Progress
	ControlMessage		RaiseTrendFromDialog
	DisplayOption		SheetName
	DisplayOptionDescription		Shutdown
	EndTime		StartTime
	ExecuteCommand		Startup
	FilterSpecial		StatusBarVisible
	HyperLinkMenuVisible		TimeRangeChanged
	ItemAdded		TrendSPCVariable
	ItemDeleted		TrendVariable
	ItemUpdated		WebTrendVariable

Events: Proficy_ALM.AlarmView Control

CloseDisplay

	Purpose	The user has no access to the display or the license is lost.
	Syntax	Event <code>CloseDisplay()</code>

ContextChanged

	Purpose	The cursor is moved around indicating that the menu or some other attribute about the display may have changed. Note: <code>ContextChanged</code> is used primarily inside the Plant Applications client.
	Syntax	Event <code>ContextChanged()</code>

ControlError

	Purpose	There is an internal error in the control.
	Syntax	Event <code>ControlError(ErrorMessage As String)</code>

ControlMessage

	Purpose	Contains string information messages about the context of the last action; Note: <code>ControlMessage</code> is primarily used to display data in the Plant Applications client status bar.
	Syntax	Event <code>ControlMessage(Message As String)</code>

ItemAdded

	Purpose	A new row is inserted into the AlarmView display.
	Syntax	Event <code>ItemAdded(Row As Long, Col As Long, AlarmMsg As PRAlarmMsg)</code>

ItemDeleted

	Purpose	A row is deleted in the AlarmView display.
---	----------------	--

Client Management

	Syntax	Event ItemDeleted (AlarmMsg As PRAlarmMsg)
--	---------------	---

ItemUpdated

	Purpose	A row is updated in the AlarmView display.
	Syntax	Event ItemUpdated (Row As Long, Col As Long, AlarmMsg As PRAlarmMsg)

MaxYReached

	Purpose	Internal use only.
---	----------------	--------------------

Navigate

	Purpose	Internal use by the Proficy Plant Applications client.
	Syntax	Event Navigate (DestinationURL As String)

Progress

	Purpose	Internal use only.
---	----------------	--------------------

TimeRangeChanged

	Purpose	The absolute values of the display's time range have changed.
	Syntax	Event TimeRangeChanged (StartTime As String, EndTime As String)

TrendSPCVariable

	Purpose	Internal use by the Proficy Plant Applications Client
---	----------------	---

TrendVariable

	Purpose	Internal use by the Proficy Plant Applications client.
---	----------------	--

WebTrendVariable

	Purpose	Internal use by the Proficy Plant Applications client.
---	----------------	--

Methods: Proficy_ALM.AlarmView Control

AckFromDialog

	Purpose	Send an acknowledgment message for the specified alarm ID.
	Syntax	Sub AckFromDialog (AlarmId As Long)

ExecuteCommand

	Purpose	Send a command name as a string, including one or more of the following parameters.	
	Syntax	Function ExecuteCommand (CommandName As String, ParamArray Parameters() As Variant) As Boolean	
	Parameters	Parameter	Description
		Acknowledge	Acknowledge a currently selected alarm.

		AddTrend	Open a trend of the currently selected variable.
		AlarmAnalysis	Open an Analysis window for the currently selected variable.
		ClearControl	Shut down the Alarm display.
		CommentWindowCommand	Open the Comment window.
		DisplayActionCommentSubtext	Display Action comment subtext.
		DisplayCauseCommentSubtext	Display Cause comment subtext.
		DisplayHyperLinksCommand	Display hyperlinks.
		DisplayResearchCommentSubtext	Display Research comment subtext.
		DisplayTemplateCommentSubtext	Display Template comment subtext.
		DisplayVariableCommentSubtext	Display Variable comment subtext.
		DoNotDisplaySubtext	Turn off comments subtext.
		FilterOnly	<ul style="list-style-type: none"> • Open a Filter dialog box to enter filter criteria. • Change the display to Filter Only mode. • Display only alarms allowed by the criteria.
		FindTimeDialog	Open a Find Time dialog box.
		Print	Print the AlarmView display.
		QueryWizard	<ul style="list-style-type: none"> • Change the display to Query mode. • Open a Search dialog to enter alarm search criteria. • Display alarms that fulfill the criteria.
		QuickSearchSimilarAlarms	Display a quick on screen query to find and display alarms that are similar to alarms for the currently selected row.
		ReturnToRealTimeMode	Change back from Query mode to Real time mode.
		SortByPriority	Sort alarm rows by priority
		SortByAcknowledgement	Sort alarm rows by acknowledgement.
		SortByTime	Sort alarm rows by time.
		ViewDisplayOptions	Open a Display Options dialog box.
		ViewTimeline	Open a Timeline Web report.

FilterSpecial

	Purpose	Display an ad hoc view of alarms based on the specified parameters. For example:
---	----------------	---

Client Management

		<i>If:</i>	<ul style="list-style-type: none"> All of the parameters are used. <i>IsUnit</i> is True <i>ID</i>, <i>ST</i> (start time) and <i>ET</i> (End time) are specified,
		<i>Then:</i>	The filter looks for alarms triggered for the Unit ID within the specified start to end times. Only the alarms that fit the criteria display. If no alarms fit the criteria, the display is blank.
	Syntax	Sub FilterSpecial (<i>Id As Long</i> , <i>IsUnit As Boolean</i> , <i>ST As Date</i> , <i>ET As Date</i>)	

RaiseTrendFromDialog

	Purpose	Internal use by the Proficy Plant Applications Client.
	Syntax	Sub RaiseTrendFromDialog (<i>StartTime</i> , <i>EndTime</i> , <i>VarId As Long</i> , <i>VarTag As String</i> , <i>AlarmTypeId As Long</i>)

Shutdown

	Purpose	ALWAYS USE shutdown when you have finished using the control.
	Syntax	Sub Shutdown ()

Startup

	Purpose	<p>Start the control.</p> <p>Note: The parameters are optional. If they are not defined the control looks for the information in the following order.</p> <ol style="list-style-type: none"> In the registry for the current user. If the user is not found the control will prompt you to connect.
	Syntax	Function Startup (<i>[ServerName As String]</i> , <i>[UserName As String]</i> , <i>[Password As String]</i>) As Boolean

Properties: Proficy_ALM.AlarmView Control

CommandDescription

	Purpose	Returns a string that tells what a specified command has done.
		<i>Read-only</i>
	Syntax	Property CommandDescription (<i>CommandName</i>) As String

DisplayOption

	Purpose	Set any of the following display options.		
		<i>Read/Write</i>		
	Syntax	Property DisplayOption (<i>OptionName As String</i> , <i>[DontDraw As Boolean]</i>)		
		<p>Where</p> <p><i>[DontDraw As True]</i> = Do not refresh the screen until all of the options that should be set are set.</p> <p><i>[DontDraw As False]</i> = Refresh the screen after each option is set.</p>		
		<table border="1"> <thead> <tr> <th>Display Option</th> <th>Description</th> </tr> </thead> <tbody> </tbody> </table>	Display Option	Description
Display Option	Description			

		AckByVisible	Display an acknowledged value of Yes/No.
		ActionCommentVisible	Display/do not display the Action Column Indicator icon.
		ActionVisible	Display/do not display the Action Reason value.
		AckVisible	Display/do not display the name of the user who acknowledged the alarm.
		AlarmTimeOut	Create an audible alarm for one minute after a specified time out value (<i>minutes</i>) is reached.
		AudibleAlarm	Sound a tone for each alarm if the sound binary ID's are set.
		CauseCommentVisible	Display/do not display the Comment Indicator icon.
		CauseVisible	Display/do not display the Cause Reason value.
		CommentSplitterRatio	Set the Comment window size as a percentage of the Display window.
		CommentSubText	Select a comment type that will be previewed in an alarm's Row 2. Types are: <ul style="list-style-type: none"> • Action • Cause • None • Research • Template • Variable
		CommentWindow	Open the Comment window.
		DescriptionVisible	Display the Description Value-variable template, trigger, and/or custom text descriptions as defined by the template.
		DisplayHyperLinks	Show/hide the Hyperlink menu at startup.
		DurationVisible	Display/do not display the length of time (duration) that the value was in alarm state.
		EndVisible	Show/hide the alarm End Time.
		HighMsgBox	Display/do not display a Message box for each high priority alarm.
		HighPrioritySoundBinaryId	Set the high priority sound tone.
		HyperlinkSplitterWidth	Display/do not display the Hyperlink menu to the right of the contro (pixels).
		IncludeAck	Display/do not display acknowledged alarms.
		IncludeHighPriority	Display/do not display high priority alarms.
		IncludeLowPriority	Display/do not display low priority alarms.
		IncludeMediumPriority	Display/do not display medium priority alarms.
		IncludeUnAck	Display/do not display unacknowledged alarms.

Client Management

		LowMsgBox	Display/do not display a Message box for each low priority alarm.
		LowPrioritySoundBinaryId	Set the low priority sound tone.
		MediumMsgBox	Display/do not display a Message box for each medium priority alarm.
		MediumPrioritySoundBinaryId	Set the medium priority sound tone.
		MsgBoxBackColor1Id	Select the Message Box background color number 1. Choices are: <ul style="list-style-type: none"> • Black • Blue • Green • Grey • LtBlue • LtGreen • LtGrey • LtOrange • LtRed • LtYellow • Orange • Red • White • Yellow
		MsgBoxBackColor2Id	Select the Message Box background color number 2. Choices are the same as for MsgBoxBackColor1Id .
		OnlyOpenAlarms	Display only alarms that are open.
		OpenColorId	Color for an open alarm.
		PopUpTrendAlarmPriority	Automatically opens an ad-hoc Trend for SPC alarms greater than or equal to a selected priority value.
		PriorityVisible	Display the alarm priority value.
		QuickSearchRowCount	<i>(When using Quick Search)</i> limit the number of alarms of the same variable that are retrieved.
		RequiredReasonsColorId	Set the color for alarms that are required to have cause and action reasons selected.
		SortingOrder	Select the field to sort alarms by. Choices are: <ul style="list-style-type: none"> • Priority • Time

			<ul style="list-style-type: none"> Unacked
		StartVisible	Display/do not display the alarm start time.
		ValueVisible	Display/do not display the alarm start value.
		VarTempCommentVisible	Display/do not display the Variable Template comment value.

DisplayOptionDescription

	<i>Purpose</i>	Returns a description of each display option by name.
		<i>Read-only</i>
	<i>Syntax</i>	Property DisplayOptionDescription (<i>CommandName</i>) As String

EndTime

	<i>Purpose</i>	Returns the end time of the current row.
		<i>Read-only</i>
	<i>Syntax</i>	Property EndTime (As Date)

HyperLinkMenuVisible

	<i>Purpose</i>	Show/hide the Hyperlink menu to the right of the control.				
	<i>Value</i>	<table border="1"> <tr> <td><i>Show</i></td> <td>True</td> </tr> <tr> <td><i>Hide</i></td> <td>False</td> </tr> </table>	<i>Show</i>	True	<i>Hide</i>	False
<i>Show</i>	True					
<i>Hide</i>	False					
		<i>Read/Write</i>				
	<i>Syntax</i>	Property HyperLinkMenuVisible As Boolean				

LastError

	<i>Purpose</i>	Displays an Error message that describes the last error.
		<i>Read-only</i>
	<i>Syntax</i>	Property LastError As String

PopUpTrendAlarmPriority

	<i>Purpose</i>	Internal use only.
		<i>Read-only</i>
	<i>Syntax</i>	Property PopUpTrendAlarmPriority As Long

SheetName

	<i>Purpose</i>	Set the name of the display that the control will display.
		<i>Read/Write</i>
	<i>Syntax</i>	Property SheetName As String

StartTime

	<i>Purpose</i>	Show when the control started for the current session.
		<i>Read/Write</i>
	<i>Syntax</i>	Property StartTime As Date

StatusBarVisible



	<i>Purpose</i>	Show/hide the Status Bar.	
	<i>Value</i>	<i>Show</i>	True
		<i>Hide</i>	False
		<i>Read/Write</i>	
	<i>Syntax</i>	Property StatusBarVisible As Boolean	

Downtime ActiveX Control





Proficy_DWN.Downtime Control





















































The Proficy_DWN.Downtime control provides a way to display and edit downtime events.

Topics:

	Events: Proficy_DWN.Downtime control.
	Methods: Proficy_DWN.Downtime control.
	Properties: Proficy_DWN.Downtime control.

List:

	Action1ColumnVisible		EndDateColumnVisible
	Action2ColumnVisible		EndTime
	Action3ColumnVisible		EndTimeColumnVisible
	Action4ColumnVisible		EventFilterDuration
	CellMove		ExecuteCommand
	CloseDisplay		FaultColumnVisible
	CloseItem		FilterEventsByDuration
	ColumnName		FrozenColumns
	CommandDescription		GridFontSize
	CommentColumnVisible		HyperLinkMenuVisible
	ContextChanged		InsertComment
	CopyReasons		InsertItem
	ControlError		ItemAdded
	ControlMessage		ItemUpdated
	CurrentAction1		LastError
	CurrentAction1List		LocationColumnVisible
	CurrentAction2		Navigate
	CurrentAction2List		NonConfirmedOnly
	CurrentAction3		OpenItem
	CurrentAction3List		Password
	CurrentAction4		PasteComment

	CurrentAction4List		PasteReasons
	CurrentComment		PrintOut
	CurrentDuration		ProductColumnVisible
	CurrentFault		ProductUpdated
	CurrentFaultList		Reason1ColumnVisible
	CurrentItemRow		Reason2ColumnVisible
	CurrentItemTime		Reason3ColumnVisible
	CurrentLocation		Reason4ColumnVisible
	CurrentLocationList		RowMove
	CurrentReason1		ServerName
	CurrentReason1List		SheetName
	CurrentReason2		ShowFindTimeDialog
	CurrentReason2List		ShowFindTimeFormatDialog
	CurrentReason3		StartDateColumnVisible
	CurrentReason3List		ShowVisibilityDialog
	CurrentReason4		Shutdown
	CurrentReason4List		StartTime
	CurrentStatus		StartTimeColumnVisible
	CurrentStatusList		Startup
	DateTimeFormat		StatusColumnVisible
	DeleteItem		SummaryTimeFormat
	DetailDateFormat		TimeRangeChanged
	DetailsOnly		TreeVisibility
	DisplayOption		UptimeColumnVisible
	DisplayOptionDescription		UserName
	DurationColumnVisible		VisibleColumns

Events: Proficy_DWN.Downtime Control

CellMove

	Purpose	The selected cell has changed.
	Syntax	Event CellMove (Row As Long, Column As Long)

CloseDisplay

	Purpose	The user has no access to the display or the license is lost.
	Syntax	Event CloseDisplay ()

ContextChanged

Client Management

	Purpose	The cursor is moved around indicating that the menu or some other attribute about the display may have changed. Note: <code>ContextChanged</code> is used primarily inside the Plant Applications client.
	Syntax	Event <code>ContextChanged()</code>

ControlError

	Purpose	There is an internal error in the control.
	Syntax	Event <code>ControlError(ErrorMessage As String)</code>

ControlMessage

	Purpose	Contains string information messages about the context of the last action; Note: <code>ControlMessage</code> is primarily used to display data in the Plant Applications client status bar.
	Syntax	Event <code>ControlMessage(Message As String)</code>

ItemAdded

	Purpose	A new row is inserted into the Downtime display.
	Syntax	Event <code>ItemAdded(Row As Long)</code>

ItemUpdated

	Purpose	A row is updated in the Downtime display.
	Syntax	Event <code>ItemUpdated(Row As Long, Column As Long)</code>

Navigate

	Purpose	Internal use by the Proficy Plant Applications client.
	Syntax	Event <code>Navigate(DestinationURL As String)</code>

ProductUpdated

	Purpose	A product change has occurred.
	Syntax	Event <code>ProductUpdated(Product As String, StartTime As String, EndTime As String, UnitName As String)</code>

RowMove

	Purpose	The cursor is moved up or down from one row to another.
	Syntax	Event <code>RowMove(Row As Long)</code>

TimeRangeChanged

	Purpose	The absolute values of the display's time range have changed.
	Syntax	Event <code>TimeRangeChanged(StartTime As String, EndTime As String)</code>

Methods: Proficy_DWN.Downtime Control

CloseItem

	Purpose	Close (<i>set the end time of</i>) a Downtime event.
	Syntax	Function CloseItem ([EndTime]) As Boolean

ColumnName

	Purpose	Return the name of the column when given a column number
	Syntax	Function ColumnName (Column As Long) As String

CopyReasons

	Purpose	Copy the reasons from the currently selected row.
	Syntax	Sub CopyReasons ()

DeleteItem

	Purpose	Delete the currently selected row.
	Syntax	Sub DeleteItem ()

ExecuteCommand

	Purpose	Send a command name as a string, including one or more of the following parameters.	
	Syntax	Function ExecuteCommand (CommandName As String, ParamArray Parameters() As Variant) As Boolean	
	Parameters	Parameter	Description
		AddComment	Add a comment to the current active Downtime row; opens a Comment box for a comment to be entered.
		AppendComment	Add a new comment to the Downtime event; opens an active Comment window for the comment to be entered.
		CloseItem	Close (<i>set the end time of</i>) a Downtime event.
		ColumnVisibilityDialog	Open a Column Visibility dialog box.
		CommentsVisibleCommand	Open a Comment dialog box.
		CopyReasons	Copy the reasons from the currently selected row.
		DeleteRow	Delete the currently selected row.
		DisplayHyperLinksCommand	Display hyperlinks.
		ExpandAllCommand	Expand/compress all rows in the display.
		ExpandedCommand	Expand/compress the current row.
		FilterEventsByDurationCommand	Enable the property EventFilterDuration .

Client Management

		FindTime	Go to a specified time. Note: An example of the syntax is as follows. ExecuteCommand ("FindTime", 01/01/05 13:30)
		FindTimeDialog	Open a Find Time dialog box.
		InsertRow	Insert a row after the currently selected row.
		NonConfirmedOnlyCommand	Display only unconfirmed downtime.
		OpenItem	Insert a row after the last downtime event of the display; opens a new downtime event that has no end time. Note: OpenItem only works if: <ul style="list-style-type: none"> • The display is scrolled up to the current time. • No there are no existing downtime events.
		PasteReasons	Paste the reasons into a selected row.
		Print	Print the Downtime display.
		TimeFormatDialog	Open a Time Format dialog box.
		TreeVisibleCommand	Show the tree display. Note: TreeVisibility is used only when a Downtime line displays.
		ViewEventAnalysis	Open an Event Analysis Web report.
		ViewEventHistory	Open an Event History Web report.
		ViewTimeline	Open a Timeline Web report.

InsertComment

	Purpose	Add a comment to the current active Downtime row; opens a Comment box for a comment to be entered.
	Syntax	Sub InsertComment ()

InsertItem

	Purpose	Insert a row after the currently selected row.
	Syntax	Sub InsertItem ()

OpenItem

	Purpose	Insert a row after the last downtime event of the display; opens a new downtime event that has no end time. Note: OpenItem only works if: <ul style="list-style-type: none"> • The display is scrolled up to the current time. • No there are no existing downtime events.
---	----------------	---

	Syntax	Function OpenItem ([<i>StartTime</i>]) As Boolean
--	---------------	--

PasteComment

	Purpose	Add a new comment to the Downtime event after opening an active Comment window for the comment to be entered.
	Syntax	Sub PasteComment ()

PasteReasons

	Purpose	Paste reasons into a selected row. Note: See CopyReasons() .
	Syntax	Sub PasteReasons ()

PrintOut

	Purpose	Print the Downtime display.
	Syntax	Sub PrintOut ()

ShowFindTimeDialog

	Purpose	Open a Find Time dialog box.
	Syntax	Sub ShowFindTimeDialog ()

ShowFindTimeFormatDialog

	Purpose	Open a Find Time Format dialog box.
	Syntax	Sub ShowFindTimeformatDialog ()

ShowVisibilityDialog

	Purpose	Open a Visibility dialog box.
	Syntax	Sub ShowVisibilityDialog ()

Shutdown

	Purpose	ALWAYS USE shutdown when you have finished using the control.
	Syntax	Sub ShowVisibilityDialog ()

Startup

	Purpose	Start the control. Note: The parameters are optional. If they are not defined the control looks for the information in the following order. <ol style="list-style-type: none"> 1. In the registry for the current user. 2. If the user is not found the control will prompt you to connect.
	Syntax	Function Startup ([<i>ServerName As String</i>], [<i>UserName As String</i>], [<i>Password As String</i>]) As Boolean

Properties: Proficy_DWN.Downtime Control

Client Management

Action1ColumnVisible

	<i>Purpose</i>	Show/hide the Action 1 column.	
	<i>Value</i>	<i>Show</i>	True
		<i>Hide</i>	False
		<i>Read/Write</i>	
	<i>Syntax</i>	Property Action1ColumnVisible As Boolean	

Action2ColumnVisible

	<i>Purpose</i>	Show/hide the Action 2 column.	
	<i>Value</i>	<i>Show</i>	True
		<i>Hide</i>	False
		<i>Read/Write</i>	
	<i>Syntax</i>	Property Action2ColumnVisible As Boolean	

Action3ColumnVisible

	<i>Purpose</i>	Show/hide the Action 3 column.	
	<i>Value</i>	<i>Show</i>	True
		<i>Hide</i>	False
		<i>Read/Write</i>	
	<i>Syntax</i>	Property Action3ColumnVisible As Boolean	

Action4ColumnVisible

	<i>Purpose</i>	Show/hide the Action 4 column.	
	<i>Value</i>	<i>Show</i>	True
		<i>Hide</i>	False
		<i>Read/Write</i>	
	<i>Syntax</i>	Property Action4ColumnVisible As Boolean	

CommandDescription

	<i>Purpose</i>	Return a string that tells what a specified command has done.	
		<i>Read-only</i>	
	<i>Syntax</i>	Property CommandDescription (<i>CommandName</i>) As String	

CommentColumnVisible

	<i>Purpose</i>	Show/hide the Comment column.	
	<i>Value</i>	<i>Show</i>	True
		<i>Hide</i>	False
		<i>Read/Write</i>	
	<i>Syntax</i>	Property CommentColumnVisible As Boolean	

CurrentAction1

	<i>Purpose</i>	Set or retrieve the first action for the selected Downtime detail row. <ul style="list-style-type: none">The selected action must be chosen from the Current Action1 list.	
---	----------------	--	--

		<ul style="list-style-type: none"> Action 1 becomes the first action in a tree. Once the Current Action 1 is set other actions that were included in the Current Action 1 list are now included in a Current Action 2 list.
		<i>Read/Write</i>
	<i>Syntax</i>	Property CurrentAction1 As String

CurrentAction1List

	<i>Purpose</i>	Returns a list of available actions from which one can be selected and set as Current Action 1.
		<i>Read-only</i>
	<i>Syntax</i>	Property CurrentAction1List As Variant

CurrentAction2

	<i>Purpose</i>	Set or retrieve the second action for the selected Downtime detail row. <ul style="list-style-type: none"> Action 1 must be set before an Action 2 can be selected. The selected action must be chosen from the Current Action 2 list. Action 2 becomes the second action in a tree. Once the Current Action 2 is set other actions that were included in the Current Action 2 list are now included in a Current Action 3 list.
		<i>Read/Write</i>
	<i>Syntax</i>	Property CurrentAction2 As String

CurrentAction2List

	<i>Purpose</i>	Returns a list of available actions from which one can be selected and set as Current Action 2.
		<i>Read-only</i>
	<i>Syntax</i>	Property CurrentAction2List As Variant

CurrentAction3

	<i>Purpose</i>	Set or retrieve the third action for the selected Downtime detail row. <ul style="list-style-type: none"> Action 2 must be set before an Action 3 can be selected. The selected action must be chosen from the Current Action 3 list. Action 3 becomes the third action in a tree. Once the Current Action 3 is set other actions that were included in the Current Action 3 list are now included in a Current Action 4 list.
		<i>Read/Write</i>
	<i>Syntax</i>	Property CurrentAction3 As String

CurrentAction3List

	<i>Purpose</i>	Returns a list of available actions from which one can be selected and set as Current Action 3.
		<i>Read-only</i>
	<i>Syntax</i>	Property CurrentAction3List As Variant

Client Management

CurrentAction4

	<i>Purpose</i>	Set or retrieve the fourth action for the selected Downtime detail row. <ul style="list-style-type: none">Action 3 must be set before an Action 4 can be selected.The selected action must be chosen from the Current Action 4 list.Action 4 becomes the fourth action in a tree.
		<i>Read/Write</i>
	<i>Syntax</i>	Property CurrentAction4 As String

CurrentAction4List

	<i>Purpose</i>	Returns a list of available actions from which one can be selected and set as Current Action 4.
		<i>Read-only</i>
	<i>Syntax</i>	Property CurrentAction4List As Variant

CurrentComment

	<i>Purpose</i>	Returns a comment for the current row.
		<i>Read-only</i>
	<i>Syntax</i>	Property CurrentComment As String

CurrentDuration

	<i>Purpose</i>	Set the duration of the current row.
		<i>Read/Write</i>
	<i>Syntax</i>	Property CurrentDuration As Single

CurrentFault

	<i>Purpose</i>	Set the fault in a current row.
		<i>Read/Write</i>
	<i>Syntax</i>	Property CurrentFault As String

CurrentFaultList

	<i>Purpose</i>	Returns a list of valid fault values
		<i>Read-only</i>
	<i>Syntax</i>	Property CurrentFaultList As Variant

CurrentItemRow

	<i>Purpose</i>	Set the row number of current item.
		<i>Read/Write</i>
	<i>Syntax</i>	Property CurrentItemRow As Long

CurrentItemTime

	<i>Purpose</i>	Returns the start time of the current downtime row.
		<i>Read-only</i>

	Syntax	Property CurrentItemTime As Date
--	---------------	---

CurrentLocation

	Purpose	Set the location of the current row; the location must be selected from the Current Location list.
		<i>Read/Write</i>
	Syntax	Property CurrentLocation As String

CurrentLocationList

	Purpose	Returns a list of available locations from which one can be selected and set as the Current Location.
		<i>Read-only</i>
	Syntax	Property CurrentLocationList As Variant

CurrentReason1

	Purpose	Set or retrieve the first reason for the selected Downtime detail row. <ul style="list-style-type: none"> The selected reason must be chosen from the Current Reason 1 list. Reason 1 becomes the first reason in a tree. Once the Current Reason 1 is set other reasons that were included in the Current Reason 1 list are now included in a Current Reason 2 list.
		<i>Read/Write</i>
	Syntax	Property CurrentReason1 As String

CurrentReason1List

	Purpose	Returns a list of available reasons from which one can be selected and set as Current Reason 1.
		<i>Read-only</i>
	Syntax	Property CurrentReason1List As Variant

CurrentReason2

	Purpose	Set or retrieve the second reason for the selected Downtime detail row. <ul style="list-style-type: none"> Reason 1 must be set before a Reason 2 can be selected. The selected reason must be chosen from the Current Reason 2 list. Reason 2 becomes the second reason in a tree. Once the Current Reason 2 is set other reasons that were included in the Current Reason 2 list are now included in a Current Reason 3 list.
		<i>Read/Write</i>
	Syntax	Property CurrentReason2 As String

CurrentReason2List

	Purpose	Returns a list of available reasons from which one can be selected and set as Current Reason 2.
		<i>Read-only</i>

	<i>Syntax</i>	Property CurrentReason2List As Variant
--	---------------	---

CurrentReason3

	<i>Purpose</i>	Set or retrieve the third reason for the selected Downtime detail row. <ul style="list-style-type: none"> Reason 2 must be set before a Reason 3 can be selected. The selected reason must be chosen from the Current Reason 3 list. Reason 3 becomes the third reason in a tree. Once the Current Reason 3 is set other reasons that were included in the Current Reason 3 list are now included in a Current Reason 4 list.
		<i>Read/Write</i>
	<i>Syntax</i>	Property CurrentReason3 As String

CurrentReason3List

	<i>Purpose</i>	Returns a list of available reasons from which one can be selected and set as Current Reason 3.
		<i>Read-only</i>
	<i>Syntax</i>	Property CurrentReason3List As Variant

CurrentReason4

	<i>Purpose</i>	Set or retrieve the fourth reason for the selected Downtime detail row. <ul style="list-style-type: none"> Reason 3 must be set before a Reason 4 can be selected. The selected reason must be chosen from the Current Reason 4 list. Reason 4 becomes the fourth reason in a tree.
		<i>Read/Write</i>
	<i>Syntax</i>	Property CurrentReason4 As String

CurrentReason4List

	<i>Purpose</i>	Returns a list of available reasons from which one can be selected and set as Current Reason 4.
		<i>Read-only</i>
	<i>Syntax</i>	Property CurrentReason4List As Variant

CurrentStatus

	<i>Purpose</i>	Set the status of the current row; the status must be selected from the Current Status list.
		<i>Read/Write</i>
	<i>Syntax</i>	Property CurrentStatus As String

CurrentStatusList

	<i>Purpose</i>	Returns a list of available statuses from which one can be selected and set as the Current Status.
		<i>Read-only</i>

	Syntax	Property CurrentStatusList As Variant
--	---------------	--

DateTimeFormat

	Purpose	Set the format for the date and time.
		<i>Read/Write</i>
	Syntax	Property DateTimeFormat (<i>FType</i> As Byte) As String

DetailDateFormat

	Purpose	Set the format for the date.
		<i>Read/Write</i>
	Syntax	Property DetailDateFormat As String

DetailsOnly

	Purpose	Expand all of the summary rows to show all the detail data at once for the display's current time range.
		<i>Read/Write</i>
	Syntax	Property DetailsOnly As Boolean

DisplayOption

	Purpose	Set any of the following display options. Note: Widths are in pixels.	
		<i>Read/Write</i>	
	Syntax	Property DisplayOption (<i>OptionName</i> As String, [<i>DontDraw</i> As Boolean])	
		Where [<i>DontDraw</i> As True] = Do not refresh the screen until all of the options that should be set are set. [<i>DontDraw</i> As False] = Refresh the screen after each option is set.	
		Display Option	Description
		Action1Visible	Show/hide the Action 1 column.
		Action2Visible	Show/hide the Action 2 column.
		Action3Visible	Show/hide the Action 3 column.
		Action4Visible	Show/hide the Action 4 column.
		Action1Width	Set the Action 1 column width.
		Action2Width	Set the Action 2 column width.
		Action3Width	Set the Action 3 column width.
		Action4Width	Set the Action 4 column width.
		CommentSplitterRatio	The Comment window size as a percentage of the Display window.
		CommentsVisible	Display/do not display the displays' comments.
		CommentVisible	Display/do not display the Comment column.

Client Management

		CommentWidth	Set the Comment column width..
		DetailDate	Set the format for the date.
		DetailsOnly	Display event details only, no summary.
		DetailTime	Set the format for the time.
		DisplayHyperLinks	Show/hide the Hyperlinks menu at startup.
		DurationVisible	Show/hide the Duration column.
		DurationWidth	Set the Duration column width..
		EndDateVisible	Display/do not display the EndDate column
		EndTimeVisible	Display/do not display the EndTime column
		EndDateWidth	Set the EndDate column width.
		EndTimeWidth	Set the EndTime column width.
		EventFilterDuration	Filter a downtime event by duration in minutes, e.g. to show only downtime events that are less than or equal to 10 minutes, set the value to 10 . Important: To enable EventFilterDuration , FilterEventsByDuration must be set to True.
		Expanded	Expand/compress the current row.
		ExpandAll	Expand/compress all rows in the display.
		FaultVisible	Display/do not display the Fault column.
		FaultWidth	Set the Fault column width.
		FilterEventsByDuration	Enable/disable EventFilterDuration
		FontSize	Set the size of the fonts used in the display.
		FrozenColumns	Number of columns to fix in place when scrolling the cursor to the right.
		LocationVisible	Display/do not display the Location column.
		LocationWidth	Set the Location column width.
		NonConfirmedOnly	Display only event details that still require reasons to be selected.
		ProductVisible	Show/hide the Product column.
		ProductWidth	Set the Product column width.
		Reason1Visible	Show/hide the Reason 1 column.
		Reason2Visible	Show/hide the Reason 2 column.
		Reason3Visible	Show/hide the Reason 3 column.
		Reason4Visible	Show/hide the Reason4 column.
		Reason1Width	Set the Reason 1 column width.

		Reason2Width	Set the Reason 2 column width.
		Reason3Width	Set the Reason 3 column width.
		Reason4Width	Set the Reason 4 column width.
		StartDateVisible	Show/hide the Start Date column.
		StartTimeVisible	Show/hide the Start Time column.
		StartDateWidth	Set the Start Date column width.
		StartTimeWidth	Set the Start Time column width.
		StatusVisible	Show/hide the Status column.
		StatusWidth	Set the Status column width.
		SummaryDate	Set the format of the summary date, e.g. mm/dd/yy.
		SummaryTime	Set the format for the summary time, e.g. hh:mm:ss.
		TreeSplitterWidth	<i>(If the Tree is displayed)</i> width of the frame that holds the tree.
		TreeStatistic	Set which statistic should be displayed for the tree when the display is in Line Downtime mode. The statistic can be any of the following. <ul style="list-style-type: none"> • Action1 • Action2 • Action3 • Action4 • Reason1 • Reason2 • Reason3 • Reason4
		TreeVisible	Show/hide the Tree display.
		UptimeVisible	Show/hide the Uptime column.
		UptimeWidth	Set the Uptime column width.

DisplayOptionDescription

	Purpose	Description of each display option by name.	
		<i>Read-only</i>	
	Syntax	Property DisplayOptionDescription (<i>CommandName</i>) As String	

DurationColumnVisible

	Purpose	Show/hide the Duration column.	
	Value	<i>Show</i>	True
		<i>Hide</i>	False

Client Management

		<i>Read/Write</i>
	<i>Syntax</i>	Property <code>DurationColumnVisible</code> As Boolean

EndDateColumnVisible

	<i>Purpose</i>	Show/hide the End Date column.	
	<i>Value</i>	<i>Show</i>	True
		<i>Hide</i>	False
		<i>Read/Write</i>	
	<i>Syntax</i>	Property <code>EndDateColumnVisible</code> As Boolean	

EndTime

	<i>Purpose</i>	Returns the end time of the current row.	
		<i>Read-only</i>	
	<i>Syntax</i>	Property <code>EndTime</code> As Date	

EndTimeColumnVisible

	<i>Purpose</i>	Show/hide the End Time column.	
	<i>Value</i>	<i>Show</i>	True
		<i>Hide</i>	False
		<i>Read/Write</i>	
	<i>Syntax</i>	Property <code>EndTimeColumnVisible</code> As Boolean	

EventFilterDuration

	<i>Purpose</i>	Filter a downtime event by duration in minutes, e.g. to show only downtime events that are less than or equal to 10 minutes, set the value to 10 . Important: To enable <code>EventFilterDuration</code> , the property <code>FilterEventsByDuration</code> must be set to True.	
		<i>Read/Write</i>	
	<i>Syntax</i>	Property <code>EventFilterDuration</code> As Single	

FaultColumnVisible

	<i>Purpose</i>	Show/hide the Fault column.	
	<i>Value</i>	<i>Show</i>	True
		<i>Hide</i>	False
		<i>Read/Write</i>	
	<i>Syntax</i>	Property <code>FaultColumnVisible</code> As Boolean	

FilterEventsByDuration

	<i>Purpose</i>	Enable/disable the property <code>EventFilterDuration</code> .	
	<i>Value</i>	<i>Enable</i>	True
		<i>Disable</i>	False
		<i>Read/Write</i>	
	<i>Syntax</i>	Property <code>FilterEventsByDuration</code> As Boolean	

FrozenColumns

	<i>Purpose</i>	Keep selected columns "frozen" to the left side.
		<i>Read/Write</i>
	<i>Syntax</i>	Property FrozenColumns As Integer

GridFontSize

	<i>Purpose</i>	Set the size of the fonts used in the display.
		<i>Read/Write</i>
	<i>Syntax</i>	Property GridFontSize As Integer

HyperLinkMenuVisible

	<i>Purpose</i>	Show/hide the Hyperlink menu to the right of the control.
	<i>Value</i>	<i>Show</i> True
		<i>Hide</i> False
		<i>Read/Write</i>
	<i>Syntax</i>	Property HyperLinkMenuVisible As Boolean

LastError

	<i>Purpose</i>	Display an error message describing the last error.
		<i>Read/Write</i>
	<i>Syntax</i>	Property LastError As String

LocationColumnVisible

	<i>Purpose</i>	Show/hide the Location column.
	<i>Value</i>	<i>Show</i> True
		<i>Hide</i> False
		<i>Read/Write</i>
	<i>Syntax</i>	Property LocationColumnVisible As Boolean

NonConfirmedOnly

	<i>Purpose</i>	Display only unconfirmed downtime.
	<i>Value</i>	<i>Display unconfirmed</i> True
		<i>Display all</i> False
		<i>Read/Write</i>
	<i>Syntax</i>	Property NonConfirmedOnly As Boolean

Password

	<i>Purpose</i>	Set the password used to startup the control.
		<i>Read/Write</i>
	<i>Syntax</i>	Property Password As String

ProductColumnVisible

	<i>Purpose</i>	Show/hide the Product column.
	<i>Value</i>	<i>Show</i> True

Client Management

		<i>Hide</i>	False
		<i>Read/Write</i>	
	<i>Syntax</i>	Property ProductColumnVisible As Boolean	

Reason1ColumnVisible

	<i>Purpose</i>	Show/hide the Reason 1 column.	
	<i>Value</i>	<i>Show</i>	True
		<i>Hide</i>	False
		<i>Read/Write</i>	
	<i>Syntax</i>	Property Reason1ColumnVisible As Boolean	

Reason2ColumnVisible

	<i>Purpose</i>	Show/hide the Reason 2 column.	
	<i>Value</i>	<i>Show</i>	True
		<i>Hide</i>	False
		<i>Read/Write</i>	
	<i>Syntax</i>	Property Reason2ColumnVisible As Boolean	

Reason3ColumnVisible

	<i>Purpose</i>	Show/hide the Reason 3 column.	
	<i>Value</i>	<i>Show</i>	True
		<i>Hide</i>	False
		<i>Read/Write</i>	
	<i>Syntax</i>	Property Reason3ColumnVisible As Boolean	

Reason4ColumnVisible

	<i>Purpose</i>	Show/hide the Reason 4 column.	
	<i>Value</i>	<i>Show</i>	True
		<i>Hide</i>	False
		<i>Read/Write</i>	
	<i>Syntax</i>	Property Reason4ColumnVisible As Boolean	

ServerName

	<i>Purpose</i>	Set the Server name.	
		<i>Read/Write</i>	
	<i>Syntax</i>	Property ServerName As String	

SheetName

	<i>Purpose</i>	Set the name of the display that the control will display.	
		<i>Read/Write</i>	
	<i>Syntax</i>	Property SheetName As String	

StartDateColumnVisible

	<i>Purpose</i>	Show/hide the Start Date column.	
---	----------------	----------------------------------	--

	<i>Value</i>	<i>Show</i>	True
		<i>Hide</i>	False
		<i>Read/Write</i>	
	<i>Syntax</i>	Property StartDateColumnVisible As Boolean	

StartTime

	<i>Purpose</i>	Shows when the control started for the current session.	
		<i>Read-only</i>	
	<i>Syntax</i>	Property StartTime As Date	

StartTimeColumnVisible

	<i>Purpose</i>	Show/hide the Start Time column.	
	<i>Value</i>	<i>Show</i>	True
		<i>Hide</i>	False
		<i>Read/Write</i>	
	<i>Syntax</i>	Property StartTimeColumnVisible As Boolean	

StatusColumnVisible

	<i>Purpose</i>	Show/hide the Status column.	
	<i>Value</i>	<i>Show</i>	True
		<i>Hide</i>	False
		<i>Read/Write</i>	
	<i>Syntax</i>	Property StatusColumnVisible As Boolean	

SummaryTimeFormat

	<i>Purpose</i>	Set the format for the time.	
		<i>Read/Write</i>	
	<i>Syntax</i>	Property SummaryTimeFormat As String	

TreeVisibility

	<i>Purpose</i>	Show/hide the tree display. Note: TreeVisibility is used only when a Downtime line displays.	
	<i>Value</i>	<i>Show</i>	True
		<i>Hide</i>	False
		<i>Read/Write</i>	
	<i>Syntax</i>	Property TreeVisibility As Boolean	

UptimeColumnVisible

	<i>Purpose</i>	Show/hide the Uptime column.	
	<i>Value</i>	<i>Show</i>	True
		<i>Hide</i>	False
		<i>Read/Write</i>	
	<i>Syntax</i>	Property UptimeColumnVisible As Boolean	

UserName

	<i>Purpose</i>	Set the user name to startup the control.
		<i>Read/Write</i>
	<i>Syntax</i>	Property UserName As String

VisibleColumns



	<i>Purpose</i>	OBSOLETE Use specific column visibility properties.
		<i>Read/Write</i>
	<i>Syntax</i>	Property VisibleColumns As Long

Genealogy View ActiveX Control





















Proficy_GVW.Genealogy Control

The Proficy_GVW.Genealogy control provides a way to view and manage production and production event genealogy.

Topics:

	Events: Proficy_GVW.Genealogy control.
	Methods: Proficy_GVW.Genealogy control.
	Properties: Proficy_GVW.Genealogy control.

List:

	AddEventToInput		ExecuteCommand
	AlarmClick		HyperLinkMenuVisible
	CloseDisplay		LastError
	CommandDescription		Navigate
	ContextChanged		SheetName
	ControlError		Shutdown
	ControlMessage		Startup
	DisplayOption		TrendSPCVariable
	DisplayOptionDescription		TrendVariable
	EventIdentify		WebTrendVariable

Events: Proficy_GVW.Genealogy Control

AlarmClick

	<i>Purpose</i>	An alarm was clicked.
	<i>Syntax</i>	Event AlarmClick (<i>AlarmMsg</i> As Object)

CloseDisplay

	<i>Purpose</i>	The user has no access to the display or the license is lost.
---	----------------	---

	Syntax	Event <code>CloseDisplay()</code>
--	---------------	-----------------------------------

ContextChanged

	Purpose	The cursor is moved around indicating that the menu or some other attribute about the display may have changed. Note: <code>ContextChanged</code> is used primarily inside the Plant Applications client.
	Syntax	Event <code>ContextChanged()</code>

ControlError

	Purpose	There is an internal error in the control.
	Syntax	Event <code>ControlError(ErrorMessage As String)</code>

ControlMessage

	Purpose	Contains string information messages about the context of the last action; Note: <code>ControlMessage</code> is primarily used to display data in the Plant Applications client status bar.
	Syntax	Event <code>ControlMessage(Message As String)</code>

EventIdentify

	Purpose	Obsolete.
--	----------------	-----------

Navigate

	Purpose	Internal use by the Proficy Plant Applications client.
	Syntax	Event <code>Navigate(URL As String)</code>

TrendSPCVariable

	Purpose	Internal use by the Proficy Plant Applications client.
	Syntax	Event <code>TrendSPCVariable(StartTime As String, EndTime As String, VariableID As Long)</code>

TrendVariable

	Purpose	Internal use by the Proficy Plant Applications client.
	Syntax	Event <code>TrendVariable(Row As Long, StartTime As String, EndTime As String, VariableID As Long, VariableTag As String)</code>

WebTrendVariable

	Purpose	Internal use by the Proficy Plant Applications client.
	Syntax	Event <code>WebTrendVariable(StartTime As String, EndTime As String, VariableID As Long)</code>

Methods: Proficy_GVW.Genealogy Control**AddEventToInput**

Client Management

	Purpose	Add an event number and production unit ID; add a production event to the input for this production unit.
	Syntax	Sub AddEventToInput (<i>EventNum As String, PU_Id As Long</i>)

ExecuteCommand

	Purpose	Send a command name as a string, including one or more of the following parameters.	
	Syntax	Function ExecuteCommand (<i>CommandName As String, ParamArray Parameters() As Variant</i>) As Boolean	
	Parameters	Parameter	Description
		AddComment	Add a comment to the current active Downtime row; open a Comment box for a comment to be entered.
		Comments	Open the Comments dialog box.
		Complete	Equivalent to selecting Complete from the display's Popup menu or for a selected event.
		DeleteEvent	Delete a selected event.
		EventDetails	Display details for a selected event.
		FamilyTree	Change the display to the Family Tree mode.
		GoToEvent	<i>(Family tree mode)</i> highlight the selected event. <i>(Unit View mode)</i> open the Find Event dialog box.
		InputHistory	Open an Input History dialog box.
		InsertEvent	Create a new production event
		InsertEventCurrent	Insert a new production event before the current event.
		LinkChildEvent	<i>(Family tree mode only)</i> Open a dialog box to select child event to link to current event
		LinkParentEvent	<i>(Family tree mode only)</i> Open a dialog box to select parent event to link to current event
		LoadInventory	Open a dialog box of available production events from which one event can be selected for the current unit.
		mnuTopic	Internal use only.
		MoveUp	<i>(Family tree only)</i> scroll up in the family tree.
		MoveDown	<i>(Family tree only)</i> scroll down in the family tree.
		ProductionControl	Change the display to Production Control mode.
		MoveForward	<i>(Family tree only)</i> scroll right in the family tree.
		MoveBack	<i>(Family tree only)</i> scroll left in the family tree.
		MoveRunning	Change the current event from staged to running.
		PatternDetails	Show the production execution path.
		PrintLabel	Print a label for the selected event.

		ProdSched	Open the Schedule View in context of the current event.
		RefreshTree	Refresh the family tree.
		SavePositions	Save the positions of the objects on the screen.
		SetFocus	Make the node with the focus, the center of the Family Tree view.
		ShowEventDetailWindow	Open a window to show event details for a selected event.
		UnitDisplayOptions	Open the Display Options dialog box.
		UnitView	Change back to Unit View from Family Tree view.
		Unload	Move a selected production event from a selected input
		ViewAlarms	Open an Alarms Web report.
		ViewEventNameData	Open an <Event Name> Data Web report.
		ViewGenealogyData	Open a <Genealogy Data> Web report.
		ZoomIn	Increase the display content size.
		ZoomOut	Decrease the display content size.
		ZoomOff	Go back to the default display content size (100%)..

Shutdown

	Purpose	ALWAYS USE Shutdown when you have finished using the control.
	Syntax	Sub Shutdown ()

Startup

	Purpose	Start the control. Note: The parameters are optional. If they are not defined the control looks for the information in the following order. <ol style="list-style-type: none"> 1. In the registry for the current user. 2. If the user is not found the control will prompt you to connect.
	Syntax	Function Startup ([ServerName As String], [UserName As String], [Password As String]) As Boolean

Properties: Proficy_GVW.Genealogy Control

CommandDescription

	Purpose	Returns a string that tells what a specified command has done.
		<i>Read-only</i>
	Syntax	Property CommandDescription (CommandName) As String

DisplayOption

	Purpose	Set any of the following display options.
---	----------------	---

		<i>Read/Write</i>	
	Syntax	Property DisplayOption (<i>OptionName As String</i>)	
		Display Option	Description
		DisplayHyperLinks	Show the Hyperlink menu at startup.
		HyperLinkSplitterWidth	Set the width of the Hyperlink menu to the right of the control.
		RealTimeUpdates	Refresh the tree in real time
		RefreshTree	Show the genealogy of the current tree.
		ShowDefects	Obsolete
		StartUpPositions	Internal use by Proficy Plant Applications Client.
		StartUpView	What mode the display starts in. Modes are: <ul style="list-style-type: none"> • Family Tree • Production Control • Unit View
		StartUpViewVas	Display/do not display the available inventory grid
			1 Display
			0 Do not display
		StartUpZoom	Percent zoom the display window should be in at startup.
		VasColumnsHidden	Internal use by the Proficy Plant Applications Client.
		ViewAlarmCounts	(<i>Unit mode</i>) display/do not display alarm counts.
		ViewDowntimeMinutes	(<i>Unit mode</i>) display/do not display downtime minutes.
		ViewOverallEfficiency	(<i>Unit mode</i>) display/do not display overall efficiency.
		ViewProcessOrder	(<i>Unit mode</i>) display/do not display the Process Order.
		ViewProductCode	(<i>Unit mode</i>) display/do not display the product code.
		ViewProductionAmount	(<i>Unit mode</i>) display/do not display the production amount.
		ViewProductionQuality	(<i>Unit mode</i>) display/do not display the production quality.
		ViewProductionRate	(<i>Unit mode</i>) display/do not display the production rate.
		ViewProductionUnits	(<i>Unit mode</i>) display/do not display production units.
		ViewWasteAmount	(<i>Unit mode</i>) display/do not display the waste amount.

DisplayOptionDescription

	Purpose	Shows a description of each display option by name.
---	----------------	---

		<i>Read-only</i>
	<i>Syntax</i>	Property DisplayOptionDescription (<i>CommandName</i>) As String

HyperLinkMenuVisible

	<i>Purpose</i>	Show/hide the Hyperlink menu to the right of the control.	
	<i>Value</i>	<i>Show</i>	True
		<i>Hide</i>	False
		<i>Read/Write</i>	
	<i>Syntax</i>	Property HyperLinkMenuVisible As Boolean	

LastError

	<i>Purpose</i>	Displays an error message describing the last error.	
		<i>Read-only</i>	
	<i>Syntax</i>	Property LastError As String	

SheetName



	<i>Purpose</i>	Set the name of the display that the control will display.	
		<i>Read/Write</i>	
	<i>Syntax</i>	Property SheetName As String	

Sequence of Events ActiveX Control









Proficy_SOE.SOEView Control

The Proficy_SOE.SOEView control provides a way to display and edit a group of selected events in context of each other.











Topics:

	Events: Proficy_SOE.SOEView control.
	Methods: Proficy_SOE.SOEView control.
	Properties: Proficy_SOE.SOEView control.

List:

	CloseDisplay
	ContextChanged
	ControlError
	ControlMessage
	DisplayOption
	ExecuteCommand
	FocusChange
	HideTreeColumns
	LastError

Client Management

	MaxYReached
	Navigate
	ParentClosing
	Progress
	SetSheetName
	SheetName
	Shutdown
	Startup
	TimeIntervalChanged
	Version

Events: Proficy_SOE.SOEView Control

CloseDisplay

	Purpose	The user has no access to the display or the license is lost.
	Syntax	Event <code>CloseDisplay()</code>

ContextChanged

	Purpose	The cursor is moved around indicating that the menu or some other attribute about the display may have changed. Note: <code>ContextChanged</code> is used primarily inside the Plant Applications client.
	Syntax	Event <code>ContextChanged()</code>

ControlError

	Purpose	There is an internal error in the control.
	Syntax	Event <code>ControlError(ErrorMessage As String)</code>

ControlMessage

	Purpose	Contains string information messages about the context of the last action; Note: <code>ControlMessage</code> is primarily used to display data in the Plant Applications client status bar.
	Syntax	Event <code>ControlMessage(Message As String)</code>

FocusChange

	Purpose	Obsolete
	Syntax	Event <code>FocusChange(AlarmId As Long)</code>

MaxYReached

	Purpose	Internal use only
---	----------------	-------------------

Navigate

	Purpose	Internal use by the Proficy Plant Applications client.
---	----------------	--

	Syntax	Event Navigate (<i>DestinationURL As String</i>)
--	---------------	---

Progress

	Purpose	Internal use only
---	----------------	-------------------

TimeIntervalChanged

	Purpose	The length of the display's time interval has changed.
	Syntax	Event TimeIntervalChanged (<i>StartTime As Date, EndTime As Date</i>)

Methods: Proficy_SOE.SOEView Control**ExecuteCommand**

	Purpose	Send a command name as a string, including one or more of the following parameters.	
	Syntax	Function ExecuteCommand (<i>CommandName As String, ParamArray Parameters() As Variant</i>) As Boolean	
	Parameters	Parameter	Description
		Acknowledge	Acknowledge the current selected alarm.
		DisplayHyperlinksCommand	Show/hide hyperlinks.
		DetailPanelVisibleCommand	Show/hide the Detail panel.
		ExpandedTreeOnloadCommand	Expand/do not expand tree when load sheet.
		FindEventDialog	Open a Find Event dialog box.
		FindTimeDialog	Open a Find Time dialog box.
		Print	Print the SOEView display.
		ReturntoRealtimeMode	Change back from Search mode to Real time mode.
		RestartSOE	Restart the Proficy_SOE.SOEView display.
		SetSelectedAsRoot	Set the currently selected event type in the tree as the root of tree.
		SearchforAlarms	Open a Search dialog box.
		SearchforDowntimeEvents	Open a Search dialog box.
		SearchforProductChanges	Open a Search dialog box.
		SearchforProductionEvents	Open a Search dialog box.
		SearchforUserDefinedEvents	Open a Search dialog box.
		SearchforWasteEvents	Open a Search dialog box.
		ShowAddUDEScreen	Open a User Defined Event form.
		ShowPopupFilter	Open a Filter dialog box.

Client Management

		SummaryPanelVisibleCommand	Show/hide a Summary panel.
		ViewDisplayOptions	Open a Display Options dialog box.
		ViewTimeline	Open a Timeline Web report.

HideTreeColumns

	Purpose	Show/hide Tree columns.	
	Syntax	Sub HideTreeColumns (<i>LocalArray()</i> As String)	

ParentClosing

	Purpose	Internal use only.	
	Syntax	Function ParentClosing () As Boolean	

SetSheetName

	Purpose	Internal use only.	
	Syntax	Sub SetSheetName (<i>s</i> As String, [<i>flgLoadTree</i> As Boolean = True])	

Shutdown

	Purpose	ALWAYS USE shutdown when you have finished using the control.	
	Syntax	Sub Shutdown ()	

Startup

	Purpose	Start the control. Note: The parameters are optional. If they are not defined the control looks for the information in the following order. <ol style="list-style-type: none"> 1. In the registry for the current user. 2. If the user is not found the control will prompt you to connect. 	
	Syntax	Function Startup ([<i>ServerName</i> As String], [<i>UserName</i> As String], [<i>Password</i> As String]) As Boolean	

Properties: Proficy_SOE.SOEView Control

DisplayOption

	Purpose	Set any of the following display options. Note: Widths are in pixels.	
		<i>Read/Write</i>	
	Syntax	Property DisplayOption (<i>OptionName</i> As String)	
		Display Option	Description
		DetailPanelVisible	Show/hide the Detail Panel.
		DisplayHyperlinks	Show the Hyperlink menu at startup.
		ExpandedTreeOnload	Expand/do not expand tree when the control is loaded.

		HyperlinkSplitterWidth	Set the width of the Hyperlinks menu to the right of the control.
		SummaryDetailHeightSplitterRatio	Specify the Summary Panel as a percent of the height of the screen.
		SummaryDetailSplitterRatio	Specify the Summary Panel size as a percent of the screen, e.g. 25 = 25% of screen.
		SummaryPanelVisible	Show/hide the Summary Panel.
		TreeCommentVisible	(<i>Tree View</i>) Show/hide the Comments column
		TreeCommentWidth	Set the Comments column width.
		TreeDurationVisible	(<i>Tree View</i>) Show/hide the Duration column.
		TreeDurationWidth	Set the Duration column width.
		TreeEndtimeVisible	(<i>Tree View</i>) Show/hide the Endtime column.
		TreeEndtimeWidth	Set the Endtime column width.
		TreeEventsVisible	(<i>Tree View</i>) Show/hide the Events column.
		TreeEventsWidth	Set the Events column width.
		TreeSplitterWidth	Set the Splitter pane width.
		TreeStarttimeVisible	(<i>Tree View</i>) Show/hide the Starttime column.
		TreeStarttimeWidth	Set the Starttime column width.
		TreeTimestampVisible	(<i>Tree View</i>) Show/hide show/hide the Timestamp column.
		TreeTimestampWidth	Set the Timestamp column width.
		TreeUnitVisible	(<i>Tree View</i>) Show/hide the Unit Column.
		TreeUnitWidth	Set the Unit column width.

LastError

	<i>Purpose</i>	Display an error message describing the last error.
		<i>Read-only</i>
	<i>Syntax</i>	Property LastError As String

SheetName

	<i>Purpose</i>	Set the name of the display that the control will display.
		<i>Read/Write</i>
	<i>Syntax</i>	Property SheetName As String

Version

	<i>Purpose</i>	Returns the control version.
		<i>Read-only</i>



<i>Syntax</i>	Property Version As String
---------------	-----------------------------------

Schedule View ActiveX Control







































Proficy_SVW.ScheduleView Control

The Proficy_SVW.ScheduleView control provides a way to display managed process orders.

Topics:

	Events: Proficy_SVW.ScheduleView control.
	Methods: Proficy_SVW.ScheduleView control.
	Properties: Proficy_SVW.ScheduleView control.

List:

	AckFromDialog		PatternDimYColumnVisible
	ActiveOrder		PatternDimZColumnVisible
	ActiveProductCode		PatternElementColumnVisible
	BillOfMaterialsActualQuantityRowVisible		PatternItemsColumnVisible
	BillOfMaterialsEngineeringUnitsRowVisible		PatternOrderColumnVisible
	BillOfMaterialsItemOrderRowVisible		PatternProductColumnVisible
	BillOfMaterialsLocationRowVisible		PatternStatusColumnVisible
	BillOfMaterialsLotNumberRowVisible		ProcessOrderAlarmsColumnVisible
	BillOfMaterialsLowerRejectRowVisible		ProcessOrderCommentColumnVisible
	BillOfMaterialsProductCodeRowVisible		ProcessOrderEndTimeColumnVisible
	BillOfMaterialsProductDescriptionRowVisible		ProcessOrderLinksColumnVisible
	BillOfMaterialsQuantityPerRowVisible		ProcessOrderPathColumnVisible
	BillOfMaterialsRequiredQuantityRowVisible		ProcessOrderProcessOrderColumnVisible
	BillOfMaterialsScrapFactorRowVisible		ProcessOrderProductionEfficiencyColumnVisible
	BillOfMaterialsSubstitutionsRowVisible		ProcessOrderQuantityColumnVisible
	BillOfMaterialsUpperRejectRowVisible		ProcessOrderStartTimeColumnVisible
	CloseDisplay		ProcessOrderStatusColumnVisible
	ColumnName		ProcessOrderTimeEfficiencyColumnVisible
	CommandDescription		RowName

	ContextChanged		SequenceCodeColumnVisible
	ControlDataChanged		SequenceCommentColumnVisible
	ControlMessage		SequenceDimAColumnVisible
	CurrentPathId		SequenceDimXColumnVisible
	CurrentPPIId		SequenceDimYColumnVisible
	CurrentProcessOrder		SequenceDimZColumnVisible
	CurrentProcessOrderRow		SequenceQuantityColumnVisible
	DisplayOption		SequenceRepetitionsColumnVisible
	DisplayOptionDescription		SequenceStatusColumnVisible
	ExecuteCommand		ServerName
	ItemAdded		SheetName
	ItemDeleted		Shutdown
	ItemUpdated		StartTime
	EndTime		Startup
	LastError		TimeRangeChanged
	Navigate		UserName
	Password		VisibleBillofMaterialsRows
	PatternCommentColumnVisible		VisiblePatternColumns
	PatternDimAColumnVisible		VisibleProcessOrderColumns
	PatternDimXColumnVisible		VisibleSequenceColumns

Events: Proficy_SVW.ScheduleView Control

CloseDisplay

	Purpose	The user has no access to the display, or the license is lost.
	Syntax	Event <code>CloseDisplay()</code>

ContextChanged

	Purpose	The cursor is moved around indicating that the menu or some other attribute about the display may have changed. Note: <code>ContextChanged</code> is used primarily inside the Plant Applications client.
	Syntax	Event <code>ContextChanged()</code>

ControlDataChanged

	Purpose	The process order or the product code is changed.
	Syntax	Event <code>ControlDataChanged(Msg As Object)</code>

ControlMessage

	Purpose	Contains string information messages about the context of the last action;
--	----------------	--

Client Management

		Note: <code>ControlMessage</code> is primarily used to display data in the Plant Applications client status bar.
	Syntax	Event <code>ControlMessage</code> (<i>Message As String</i>)

ItemAdded

	Purpose	A new row is inserted into the ScheduleView display.
	Syntax	Event <code>ItemAdded</code> (<i>Row As Long, Col As Long, AlarmMsg As PRAlarmMsg</i>)

ItemDeleted

	Purpose	A row is deleted from the ScheduleView display.
	Syntax	Event <code>ItemDeleted</code> (<i>AlarmMsg As PRAlarmMsg</i>)

ItemUpdated

	Purpose	A row is updated in the ScheduleView display.
	Syntax	Event <code>ItemUpdated</code> (<i>Row As Long, Col As Long, AlarmMsg As PRAlarmMsg</i>)

Navigate

	Purpose	Note: Only used in the Plant Applications client.
	Syntax	Event <code>Navigate</code> (<i>DestinationURL As String</i>)

TimeRangeChanged

	Purpose	The absolute values of the display's time range have changed.
	Syntax	Event <code>TimeRangeChanged</code> (<i>StartTime As String, EndTime As String</i>)

Methods: Proficy_SVW.ScheduleView Control

AckFromDialog

	Purpose	Send an acknowledgment message for a specified alarm ID.
	Syntax	Sub <code>AckFromDialog</code> (<i>AlarmId As Long</i>)

ColumnName

	Purpose	Return the name of the column when given a column number.
	Syntax	Function <code>ColumnName</code> (<i>Grid As Object, Column As Long</i>) As String

ExecuteCommand

	Purpose	Send a command name as a string, including one or more of the following parameters.	
	Syntax	Function <code>ExecuteCommand</code> (<i>CommandName As String, ParamArray Parameters() As Variant</i>) As Boolean	
	Parameters	Parameter	Description
		Acknowledge	Acknowledge the currently selected alarm.

	DisplayHyperLinksCommand	Show/hide hyperlinks
	DockToProcessOrderSummaryView	Internal use by Plant Applications Client.
	EditProperty	Edit a selected user defined property.
	EventAnalysis	Open an Event Analysis Web Report
	FindSpecificProcessOrder	Open a Find Process order dialog box.
	FindTimeDialog	Open a Find Time dialog box.
	PatternAdd	Open an Edit Pattern dialog box for a new pattern.
	PatternColumnVisibilityDialog	Open the Pattern Column Visibility dialog box.
	PatternEdit	Open an Edit Pattern dialog box for a selected pattern.
	PatternMoveBack	<i>(Visible only when Pattern is turned on)</i> move a selected pattern back.
	PatternMoveFwd	Move a selected pattern forward.
	PatternViewComments	Open a Pattern Comments dialog box.
	PatternViewHistory	Open a Pattern History dialog box.
	Print	Print the ScheduleView display.
	ProcessOrderAdd	Add a new Process order to the Schedule event.
	ProcessOrderColumnVisibilityDialog	Open the Process Order Column Visibility dialog box.
	ProcessOrderCreateChild	Create a child order of the current order.
	ProcessOrderDetail	Open the Process Order Detail Web report.
	ProcessOrderDetailView	Display the process order detail.
	ProcessOrderEdit	Open a Process Order Edit dialog box for the current process order.
	ProcessOrderMoveBack	Move a selected process order back.
	ProcessOrderMoveFwd	Move a selected process order forward.
	ProcessOrderReturnToParent	Internal use only.
	ProcessOrderReWork	Schedule a process order for rework.
	ProcessOrderViewChildren	Turn child only filter on for the selected process order ID. A parent must be selected to work.
	ProcessOrderViewComments	Open a Comments dialog box for a selected process order

Client Management

		ProcessOrderViewHistory	Open a History dialog box for a selected process order
		ProcessOrderViewParent	Turn parent only filter on for the selected process order ID. A child must be selected to work.
		ProductionScheduleEditRunTimes	Edit the selected process order manually.
		ProductionScheduleUnitControl	<i>(If the manual order flow extended edit option is True)</i> open the unit control dialog box to advance an order or set the runtime.
		ProductionScheduleView	Display the production schedule for a selected process order.
		SequenceAdd	Add a new sequence to the scheduled event. Note: A sequence is used normally if there are no process orders. A sequence runs batches in order; no process order numbers are involved.
		SequenceColumnVisibilityDialog	Open the Sequence Column Visibility dialog box.
		SequenceEdit	Open a Sequence Edit dialog box for the current sequence.
		SequenceMoveBack	Move the selected sequence back.
		SequenceMoveFwd	Move the selected sequence forward.
		SequenceViewComments	Open a Comments dialog box for a selected sequence.
		SequenceViewHistory	Open a History dialog box for a selected sequence.
		ViewTimeline	Open a Timeline Web report.

RowName

	Purpose	Return the name of the row when given a row number
	Syntax	Function RowName (<i>Grid As Object, Row As Long</i>) As String

Shutdown

	Purpose	ALWAYS USE shutdown when you have finished using the control.
	Syntax	Sub shutdown ()

Startup

	Purpose	Start the control. Note: The parameters are optional. If they are not defined the control looks for the information in the following order. <ol style="list-style-type: none"> 1. In the registry for the current user. 2. If the user is not found the control will prompt you to connect.
---	----------------	---

Syntax	Function Startup ([ServerName As String], [UserName As String], [Password As String]) As Boolean
---------------	---

Properties: Proficy_SVW.ScheduleView Control

ActiveOrder

 Purpose	Returns the active order.		
	<i>Read-only</i>		
Syntax	Property ActiveOrder As String		
	Data	Description	
	ProcessOrder	Process order value.	
	ProductCode	Product code value.	

ActiveProductCode

 Purpose	Returns the active product code.		
	<i>Read-only</i>		
Syntax	Property ActiveProductCode As String		

BillOfMaterialsActualQuantityRowVisible

 Purpose	Show/hide the Bill of Materials Actual Quantity row.		
Value	<i>Show</i>	True	
	<i>Hide</i>	False	
	<i>Read/Write</i>		
Syntax	Property BillOfMaterialsActualQuantityRowVisible As Boolean		

BillOfMaterialsEngineeringUnitsRowVisible

 Purpose	Show/hide the Bill of Materials Engineering Units row.		
Value	<i>Show</i>	True	
	<i>Hide</i>	False	
	<i>Read/Write</i>		
Syntax	Property BillOfMaterialsEngineeringUnitsRowVisible As Boolean		

BillOfMaterialsItemOrderRowVisible

 Purpose	Show/hide the Bill of Materials Item Order row.		
Value	<i>Show</i>	True	
	<i>Hide</i>	False	
	<i>Read/Write</i>		
Syntax	Property BillOfMaterialsItemOrderRowVisible As Boolean		

BillOfMaterialsLocationRowVisible

 Purpose	Show/hide the Bill of Materials Location row.		
Value	<i>Show</i>	True	
	<i>Hide</i>	False	

Client Management

		<i>Read/Write</i>
	<i>Syntax</i>	Property BillOfMaterialsLocationRowVisible As Boolean

BillOfMaterialsLotNumberRowVisible

	<i>Purpose</i>	Show/hide the Bill of Materials Lot Number row.	
	<i>Value</i>	<i>Show</i>	True
		<i>Hide</i>	False
		<i>Read/Write</i>	
	<i>Syntax</i>	Property BillOfMaterialsLotNumberRowVisible As Boolean	

BillOfMaterialsLowerRejectRowVisible

	<i>Purpose</i>	Show/hide the Bill of Materials Lower Reject row.	
	<i>Value</i>	<i>Show</i>	True
		<i>Hide</i>	False
		<i>Read/Write</i>	
	<i>Syntax</i>	Property BillOfMaterialsLowerRejectRowVisible As Boolean	

BillOfMaterialsProductCodeRowVisible

	<i>Purpose</i>	Show/hide the Bill of Materials Product Code row.	
	<i>Value</i>	<i>Show</i>	True
		<i>Hide</i>	False
		<i>Read/Write</i>	
	<i>Syntax</i>	Property BillOfMaterialsProductCodeRowVisible As Boolean	

BillOfMaterialsProductDescriptionRowVisible

	<i>Purpose</i>	Show/hide the Bill of Materials Product Description row.	
	<i>Value</i>	<i>Show</i>	True
		<i>Hide</i>	False
		<i>Read/Write</i>	
	<i>Syntax</i>	Property BillOfMaterialsProductDescriptionRowVisible As Boolean	

BillOfMaterialsQuantityPerRowVisible

	<i>Purpose</i>	Show/hide the Bill of Materials Quantity Per row.	
	<i>Value</i>	<i>Show</i>	True
		<i>Hide</i>	False
		<i>Read/Write</i>	
	<i>Syntax</i>	Property BillOfMaterialsQuantityPerRowVisible As Boolean	

BillOfMaterialsRequiredQuantityRowVisible

	<i>Purpose</i>	Show/hide the Bill of Materials Required Quantity row.	
	<i>Value</i>	<i>Show</i>	True
		<i>Hide</i>	False
		<i>Read/Write</i>	
	<i>Syntax</i>	Property BillOfMaterialsRequiredQuantityRowVisible As Boolean	

BillOfMaterialsScrapFactorRowVisible

	<i>Purpose</i>	Show/hide the Bill of Materials Scrap Factor row.	
	<i>Value</i>	<i>Show</i>	True
		<i>Hide</i>	False
		<i>Read/Write</i>	
	<i>Syntax</i>	Property BillOfMaterialsScrapFactorRowVisible As Boolean	

BillOfMaterialsSubstitutionsRowVisible

	<i>Purpose</i>	Show/hide the Bill of Materials Substitutions row.	
	<i>Value</i>	<i>Show</i>	True
		<i>Hide</i>	False
		<i>Read/Write</i>	
	<i>Syntax</i>	Property BillOfMaterialsSubstitutionsRowVisible As Boolean	

BillOfMaterialsUpperRejectRowVisible

	<i>Purpose</i>	Show/hide the Bill of Materials Upper Reject row.	
	<i>Value</i>	<i>Show</i>	True
		<i>Hide</i>	False
		<i>Read/Write</i>	
	<i>Syntax</i>	Property BillOfMaterialsUpperRejectRowVisible As Boolean	

CommandDescription

	<i>Purpose</i>	Returns a string that tells what a specified command has done.	
		<i>Read-only</i>	
	<i>Syntax</i>	Property CommandDescription (<i>CommandName</i>) As String	

CurrentPathId

	<i>Purpose</i>	Returns the path ID of the selected process order.	
		<i>Read/Write</i>	
	<i>Syntax</i>	Property CurrentPathId As Long	

CurrentPPId

	<i>Purpose</i>	Returns the PP ID of the selected process order.	
		<i>Read/Write</i>	
	<i>Syntax</i>	Property CurrentPPId As Long	

CurrentProcessOrder

	<i>Purpose</i>	Returns the current process order.	
		<i>Read-only</i>	
	<i>Syntax</i>	Property CurrentProcessOrder As String	

CurrentProcessOrderRow

	<i>Purpose</i>	Returns the current process order row.	
---	----------------	--	--

Client Management

		<i>Read-only</i>
	<i>Syntax</i>	Property CurrentProcessOrderRow As Long

DisplayOption

	<i>Purpose</i>	Set any of the following display options. Note: Widths are in pixels.	
		<i>Read/Write</i>	
	<i>Syntax</i>	Property DisplayOption (<i>OptionName As String, [DontDraw As Boolean]</i>)	
		Where [DontDraw As True] = Do not refresh the screen until all of the options that should be set are set. [DontDraw As False] = Refresh the screen after each option is set.	
		Display Option	Description
		AddSecurity	Allow an override to the standard security of Inserting (e.g. <i>AutoLog=Columns, Downtime=Rows</i>)
		ArrangeSecurity	Allow an override to the standard security of ordering process orders, patterns and pattern details.
		Bill Of Materials Actual Quantity Visible	Show/hide the Bill of Materials Actual Quantity row.
		Bill Of Materials Engineering Units Visible	Show/hide the Bill of Materials Engineering Units row.
		Bill Of Materials Item Order Visible	Show/hide the Bill of Materials Item Order row.
		Bill Of Materials Location Visible	Show/hide the Bill of Materials Location row.
		Bill Of Materials Lot Number Visible	Show/hide the Bill of Materials Lot Number row.
		Bill Of Materials Product Code Visible	Show/hide the Bill of Materials Product Code row.
		Bill Of Materials Product Description Visible	Show/hide the Bill of Materials Product Description row.
		Bill Of Materials Quantity Per Visible	Show/hide the Bill of Materials Quantity Per row.
		Bill Of Materials Remaining Quantity Visible	Show/hide the Bill of Materials Remaining Quantity row.

		Bill Of Materials Required Quantity Visible	Show/hide the Bill of Materials Required Quantity row.
		Bill Of Materials Scrap Factor Visible	Show/hide the Bill of Materials Scrap Factor row.
		Bill Of Materials Substitutions Visible	Show/hide the Bill of Materials Substitutions Visible row.
		Bill Of Materials Upper Reject Visible	Show/hide the Bill of Materials Upper Reject row.
		DeleteSecurity	Allow an override to the standard security of deleting (e.g. <i>AutoLog=Columns, DownTime=Rows</i>)
		DisplayHyperLinks	Show/hide the hyperlink menu at startup.
		Display Unbound Process Orders	Display unbound process orders.
		EditSecurity	Allow an override to the standard security for editing process orders, patterns, and pattern details.
		HyperlinkSplitterWidth	Set the width of the Hyperlink menu on the right side of the control
		Pattern Comment Visible	Show/hide the Pattern Comment column.
		Pattern Dimension A Visible	Show/hide the Pattern Dim A column.
		Pattern Dimension X Visible	Show/hide the Pattern Dim X column.
		Pattern Dimension Y Visible	Show/hide the Pattern Dim Y column.
		Pattern Dimension Z Visible	Show/hide the Pattern Dim Z column.
		Pattern Element Visible	Show/hide the Pattern Element column.
		Pattern Order Visible	Show/hide the Pattern Order column.
		Pattern PatternMaxTotalDimZ	Maximum mention Z value.

Client Management

			Note: Used to prevent entering a value that is larger than Dimension Z.
		Pattern Product Visible	Show/hide the Pattern Product column.
		Pattern Status Visible	Show/hide the Pattern Status column.
		Pattern UserGeneralPrompt1	Label for the Pattern User General Prompt #1, e.g. User General 1.
		Pattern UserGeneralPrompt2	Label for the Pattern User General Prompt #1, e.g. User General 2.
		Pattern UserGeneralPrompt3	Label for the Pattern User General Prompt #1, e.g. User General 3.
		PatternCommentWidth	Set the Pattern Comment column width.
		PatternDimensionAWidth	Set the Pattern Dim A column width.
		PatternDimensionXWidth	Set the Pattern Dim X column width.
		PatternDimensionYWidth	Set the Pattern Dim Y column width.
		PatternDimensionZWidth	Set the Pattern Dim Z column width.
		PatternElementWidth	Set the Pattern Element column width.
		PatternOrderWidth	Set the Pattern Element column width.
		PatternProductWidth	Set the Pattern Product column width.
		PatternStatusWidth	Set the Pattern Status column width.
		Process Order Alarms Visible	Show/hide the Process Order Alarms column.
		Process Order Comment Visible	Show/hide the Process Order Comment column.
		Process Order End Visible	Show/hide the Process Order End Time column.

		Process Order Line Populated	Determine if the Process Order Line column should be displayed.
		Process Order Links Visible	Show/hide the Process Order Links column.
		Process Order Path Visible	Show/hide the Process Order Path column.
		Process Order Production Efficiency Visible	Show/hide the Process Order Production Efficiency column.
		Process Order Process Order Visible	Show the Process Order Process Order column.
		Process Order Product Populated	Determine if Process Order Product column should be displayed.
		Process Order Quantity Visible	Show/hide the Process Order Quantity column.
		Process Order Status Visible	Show/hide the Process Order Status column.
		Process Order Start Visible	Show/hide the Process Order Start column.
		Process Order Time Efficiency Visible	Show/hide the Process Order Time Efficiency column.
		Process Order Unit Populated	Determine if Process Order Unit column should be displayed.
		Process Order UserGeneralPrompt1	Specify the label for the Process Order user general prompt #1, e.g. User Process Order 1
		Process Order UserGeneralPrompt2	Specify the label for the Process Order user general prompt #1, e.g. User Process Order 2
		Process Order UserGeneralPrompt3	Specify the label for the Process Order user general prompt #1, e.g. User Process Order 3
		ProcessOrderAlarmsWidth	Set the Process Order Alarms column width.

Client Management

		ProcessOrderCommentWidth	Set the Process Order Comment column width.
		ProcessOrderEndTimeWidth	Set the Process Order End Time column width.
		ProcessOrderLinksWidth	Set the Process Order Links column width.
		ProcessOrderPathWidth	Set the Process Order Path column width.
		ProcessOrderProcessOrderWidth	Set the Process Order Process Order column width.
		ProcessOrderProductionEfficiencyWidth	Set the Process Order Production Efficiency column width.
		ProcessOrderQuantityWidth	Set the Process Order Quantity column width.
		ProcessOrderStartTimeWidth	Set the process Order Start Time column width.
		ProcessOrderStatusWidth	Set the Process Order Status column width.
		ProcessOrderTimeEfficiencyWidth	Set the Process Order Time Efficiency column width.
		ProductionScheduleSortByPath	Sort/Do not sort the production schedule by path.
		Sequence Code Visible	Show/hide the Sequence Code column.
		Sequence Comment Visible	Show/hide the Sequence Comment column.
		Sequence Dimension A Visible	Show/hide the Sequence Dim A column.
		Sequence Dimension X Visible	Show/hide the Sequence Dim X column.
		Sequence Dimension Y Visible	Show/hide the Sequence Dim Y column.
		Sequence Dimension Z Visible	Show/hide the Sequence Dim Z column.
		Sequence Quantity Visible	Show/hide the Sequence Quantity column.

		Sequence Repetitions Visible	Show/hide the Sequence Repetitions column.
		Sequence Status Visible	Show/hide the Sequence Status column.
		Sequence UserGeneralPrompt1	Specify the label for the Sequence user general prompt #1, e.g. Sequence user #1
		Sequence UserGeneralPrompt2	Specify the label for the Sequence user general prompt #1, e.g. Sequence user #2
		Sequence UserGeneralPrompt3	Specify the label for the Sequence user general prompt #3, e.g. Sequence user #1
		SequenceCodeWidth	Set the Sequence Code column width.
		SequenceCommentWidth	Set the Sequence Comment column width.
		SequenceDimensionAWidth	Set the Sequence Dim A column width.
		SequenceDimensionXWidth	Set the Sequence Dim X column width.
		SequenceDimensionYWidth	Set the Sequence Dim Y column width.
		SequenceDimensionZWidth	Set the Sequence Dim Z column width.
		SequenceQuantityWidth	Set the Sequence Quantity column width.
		SequenceRepetitionsWidth	Set the Sequence Repititions column width.
		SequenceStatusWidth	Set the Sequence Status column width.
		StartUp Production Schedule Filter	Filter the Startup Production schedule. Filters are: <ul style="list-style-type: none"> • <ALL> • <STATUS> - Active • <STATUS> - Complete • <STATUS> - Next

			<ul style="list-style-type: none"> • <STATUS> - Overproduced • <STATUS> - Pending • <STATUS> - Planning • <STATUS> - Underproduced
--	--	--	--

DisplayOptionDescription

	<i>Purpose</i>	Returns a description of each display option by name.
		<i>Read-only</i>
	<i>Syntax</i>	Property DisplayOptionDescription (<i>CommandName</i>) As String

EndTime

	<i>Purpose</i>	Returns the end time of the current row.
		<i>Read-only</i>
	<i>Syntax</i>	Property EndTime As Date

LastError

	<i>Purpose</i>	Displays an error message describing the last error.
		<i>Read-only</i>
	<i>Syntax</i>	Property LastError As String

Password

	<i>Purpose</i>	Set the password used to startup the control.
		<i>Read/Write</i>
	<i>Syntax</i>	Property Password As String

PatternCommentColumnVisible

	<i>Purpose</i>	Show/hide the Pattern Comment column.
	<i>Value</i>	<i>Show</i> True
		<i>Hide</i> False
		<i>Read/Write</i>
	<i>Syntax</i>	Property PatternCommentColumnVisible As Boolean

PatternDimAColumnVisible

	<i>Purpose</i>	Show/hide the Pattern Dim A column.
	<i>Value</i>	<i>Show</i> True
		<i>Hide</i> False
		<i>Read/Write</i>
	<i>Syntax</i>	Property PatternDimAColumnVisible As Boolean

PatternDimXColumnVisible

	<i>Purpose</i>	Show/hide the Pattern Dim X column.	
	<i>Value</i>	<i>Show</i>	True
		<i>Hide</i>	False
		<i>Read/Write</i>	
	<i>Syntax</i>	Property PatternDimXColumnVisible As Boolean	

PatternDimYColumnVisible

	<i>Purpose</i>	Show/hide the Pattern Dim Y column.	
	<i>Value</i>	<i>Show</i>	True
		<i>Hide</i>	False
		<i>Read/Write</i>	
	<i>Syntax</i>	Property PatternDimYColumnVisible As Boolean	

PatternDimZColumnVisible

	<i>Purpose</i>	Show/hide the Pattern Dim Z column.	
	<i>Value</i>	<i>Show</i>	True
		<i>Hide</i>	False
		<i>Read/Write</i>	
	<i>Syntax</i>	Property PatternDimZColumnVisible As Boolean	

PatternElementColumnVisible

	<i>Purpose</i>	Show/hide the Pattern Element column.	
	<i>Value</i>	<i>Show</i>	True
		<i>Hide</i>	False
		<i>Read/Write</i>	
	<i>Syntax</i>	Property PatternElementColumnVisible As Boolean	

PatternItemsColumnVisible

	<i>Purpose</i>	Show/hide the Pattern Items column.	
	<i>Value</i>	<i>Show</i>	True
		<i>Hide</i>	False
		<i>Read/Write</i>	
	<i>Syntax</i>	Property PatternItemsColumnVisible As Boolean	

PatternOrderColumnVisible

	<i>Purpose</i>	Show/hide the Pattern Order column.	
	<i>Value</i>	<i>Show</i>	True
		<i>Hide</i>	False
		<i>Read/Write</i>	
	<i>Syntax</i>	Property PatternOrderColumnVisible As Boolean	

PatternProductColumnVisible

	<i>Purpose</i>	Show/hide the Pattern Product column.	
	<i>Value</i>	<i>Show</i>	True
		<i>Hide</i>	False

		<i>Read/Write</i>
	<i>Syntax</i>	Property PatternProductColumnVisible As Boolean

PatternStatusColumnVisible

	<i>Purpose</i>	Show/hide the Pattern Status column.	
	<i>Value</i>	<i>Show</i>	True
		<i>Hide</i>	False
		<i>Read/Write</i>	
	<i>Syntax</i>	Property PatternStatusColumnVisible As Boolean	

ProcessOrderAlarmsColumnVisible

	<i>Purpose</i>	Show/hide the Process Order Alarms column.	
	<i>Value</i>	<i>Show</i>	True
		<i>Hide</i>	False
		<i>Read/Write</i>	
	<i>Syntax</i>	Property ProcessOrderAlarmsColumnVisible As Boolean	

ProcessOrderCommentColumnVisible

	<i>Purpose</i>	Show/hide the Process Order Comment column.	
	<i>Value</i>	<i>Show</i>	True
		<i>Hide</i>	False
		<i>Read/Write</i>	
	<i>Syntax</i>	Property ProcessOrderCommentColumnVisible As Boolean	

ProcessOrderEndTimeColumnVisible

	<i>Purpose</i>	Show/hide the Process Order End Time column.	
	<i>Value</i>	<i>Show</i>	True
		<i>Hide</i>	False
		<i>Read/Write</i>	
	<i>Syntax</i>	Property ProcessOrderEndTimeColumnVisible As Boolean	

ProcessOrderLinksColumnVisible

	<i>Purpose</i>	Show/hide the Process Order Links column.	
	<i>Value</i>	<i>Show</i>	True
		<i>Hide</i>	False
		<i>Read/Write</i>	
	<i>Syntax</i>	Property ProcessOrderLinksColumnVisible As Boolean	

ProcessOrderPathColumnVisible

	<i>Purpose</i>	Show/hide the Process Order Path column.	
	<i>Value</i>	<i>Show</i>	True
		<i>Hide</i>	False
		<i>Read/Write</i>	
	<i>Syntax</i>	Property ProcessOrderPathColumnVisible As Boolean	

ProcessOrderProcessOrderColumnVisible

	<i>Purpose</i>	Show/hide the Process Order Process Order column.	
	<i>Value</i>	<i>Show</i>	True
		<i>Hide</i>	False
		<i>Read/Write</i>	
	<i>Syntax</i>	Property ProcessOrderProcessOrderColumnVisible As Boolean	

ProcessOrderProductionEfficiencyColumnVisible

	<i>Purpose</i>	Show/hide the Process Order Production Efficiency column.	
	<i>Value</i>	<i>Show</i>	True
		<i>Hide</i>	False
		<i>Read/Write</i>	
	<i>Syntax</i>	Property ProcessOrderProductionEfficiencyColumnVisible As Boolean	

ProcessOrderQuantityColumnVisible

	<i>Purpose</i>	Show/hide the Process Order Quantity column.	
	<i>Value</i>	<i>Show</i>	True
		<i>Hide</i>	False
		<i>Read/Write</i>	
	<i>Syntax</i>	Property ProcessOrderQuantityColumnVisible As Boolean	

ProcessOrderStartTimeColumnVisible

	<i>Purpose</i>	Show/hide the Process Order Start Time column.	
	<i>Value</i>	<i>Show</i>	True
		<i>Hide</i>	False
		<i>Read/Write</i>	
	<i>Syntax</i>	Property ProcessOrderStartTimeColumnVisible As Boolean	

ProcessOrderStatusColumnVisible

	<i>Purpose</i>	Show/hide the Process Order Status column.	
	<i>Value</i>	<i>Show</i>	True
		<i>Hide</i>	False
		<i>Read/Write</i>	
	<i>Syntax</i>	Property ProcessOrderStatusColumnVisible As Boolean	

ProcessOrderTimeEfficiencyColumnVisible

	<i>Purpose</i>	Show/hide the Process Order Time Efficiency column.	
	<i>Value</i>	<i>Show</i>	True
		<i>Hide</i>	False
		<i>Read/Write</i>	
	<i>Syntax</i>	Property ProcessOrderTimeEfficiencyColumnVisible As Boolean	

SequenceCodeColumnVisible

	<i>Purpose</i>	Show/hide the Sequence Code column.	
---	----------------	-------------------------------------	--

Client Management

	<i>Value</i>	<i>Show</i>	True
		<i>Hide</i>	False
		<i>Read/Write</i>	
	<i>Syntax</i>	Property SequenceCodeColumnVisible As Boolean	

SequenceCommentColumnVisible

	<i>Purpose</i>	Show/hide the Sequence Comment column.	
	<i>Value</i>	<i>Show</i>	True
		<i>Hide</i>	False
		<i>Read/Write</i>	
	<i>Syntax</i>	Property SequenceCommentColumnVisible As Boolean	

SequenceDimAColumnVisible

	<i>Purpose</i>	Show/hide the Sequence Pattern Dim A column.	
	<i>Value</i>	<i>Show</i>	True
		<i>Hide</i>	False
		<i>Read/Write</i>	
	<i>Syntax</i>	Property SequenceDimAColumnVisible As Boolean	

SequenceDimXColumnVisible

	<i>Purpose</i>	Show/hide the Sequence Pattern Dim X column.	
	<i>Value</i>	<i>Show</i>	True
		<i>Hide</i>	False
		<i>Read/Write</i>	
	<i>Syntax</i>	Property SequenceDimXColumnVisible As Boolean	

SequenceDimYColumnVisible

	<i>Purpose</i>	Show/hide the Sequence Pattern Dim Y column.	
	<i>Value</i>	<i>Show</i>	True
		<i>Hide</i>	False
		<i>Read/Write</i>	
	<i>Syntax</i>	Property SequenceDimYColumnVisible As Boolean	

SequenceDimZColumnVisible

	<i>Purpose</i>	Show/hide the Sequence Pattern Dim Z column.	
	<i>Value</i>	<i>Show</i>	True
		<i>Hide</i>	False
		<i>Read/Write</i>	
	<i>Syntax</i>	Property SequenceDimZColumnVisible As Boolean	

SequenceQuantityColumnVisible

	<i>Purpose</i>	Show/hide the Sequence Quantity column.	
	<i>Value</i>	<i>Show</i>	True
		<i>Hide</i>	False
		<i>Read/Write</i>	

	Syntax	Property SequenceQuantityColumnVisible As Boolean
--	---------------	--

SequenceRepetitionsColumnVisible

	Purpose	Show/hide the Sequence Repetitions column.	
	Value	Show	True
		Hide	False
		<i>Read/Write</i>	
	Syntax	Property SequenceRepetitionsColumnVisible As Boolean	

SequenceStatusColumnVisible

	Purpose	Show/hide the Sequence Status column.	
	Value	Show	True
		Hide	False
		<i>Read/Write</i>	
	Syntax	Property SequenceStatusColumnVisible As Boolean	

ServerName

	Purpose	Set the Server name.	
		<i>Read/Write</i>	
	Syntax	Property ServerName As String	

SheetName

	Purpose	Set the name of the display that the control will display.	
		<i>Read/Write</i>	
	Syntax	Property SheetName As String	

StartTime

	Purpose	Shows when the control started for the current session.	
		<i>Read-only</i>	
	Syntax	Property StartTime As Date	

UserName

	Purpose	Set the user name to startup the contro	
		<i>Read-only</i>	
	Syntax	Property UserName As String	

VisibleBillOfMaterialsRows

	Purpose	Set the number of Bill of Materials rows that can be visible.	
		<i>Read/write</i>	
	Syntax	Property VisibleBillOfMaterialsRows As Long	

VisiblePatternColumns

	Purpose	Set the number of Pattern columns that can be visible.	
---	----------------	--	--

Client Management

		<i>Read/write</i>
	<i>Syntax</i>	Property VisiblePatternColumns As Long

VisibleProcessOrderColumns

	<i>Purpose</i>	Set the number of Process Order columns that can be visible.
		<i>Read/write</i>
	<i>Syntax</i>	Property VisibleProcessOrderColumns As Long

VisibleSequenceColumns



	<i>Purpose</i>	Set the number of Sequence columns that can be visible.
		<i>Read/write</i>
	<i>Syntax</i>	Property VisibleSequenceColumns As Long

Waste ActiveX Control





























Proficy_WST.Waste Control



















































The Proficy_WST.Waste control provides a way to display and edit waste.

Topics:

	Events: Proficy_WST.Waste Control control.
	Methods: Proficy_WST.Waste Control control.
	Properties: Proficy_WST.Waste Control control.

List:

	Action1ColumnVisible		DetailsOnly
	Action2ColumnVisible		DisplayOption
	Action3ColumnVisible		DisplayOptionDescription
	Action4ColumnVisible		EndTime
	AmountColumnVisible		EventColumnVisible
	CellMove		EventFilterAmount
	CloseDisplay		ExecuteCommand
	ColumnName		FaultColumnVisible
	CommandDescription		FilterEventsByAmount
	CommentColumnVisible		FrozenColumns
	ContetxtChanged		GridFontSize
	CopyReasons		HyperLinkMenuVisible
	ControlError		InsertComment
	ControlMessage		InsertItem
	CurrentAction1		ItemAdded

	CurrentAction1List		ItemUpdated
	CurrentAction2		LastError
	CurrentAction2List		LocationColumnVisible
	CurrentAction3		Navigate
	CurrentAction3List		NonConfirmedOnly
	CurrentAction4		PasteComment
	CurrentAction4List		PasteReasons
	CurrentAmount		PrintOut
	CurrentComment		ProductColumnVisible
	CurrentFault		ProductUpdated
	CurrentFaultList		Reason1ColumnVisible
	CurrentItemRow		Reason2ColumnVisible
	CurrentItemTime		Reason3ColumnVisible
	CurrentLocation		Reason4ColumnVisible
	CurrentLocationList		ServerName
	CurrentReason1		SheetName
	CurrentReason1List		ShowFindTimeDialog
	CurrentReason2		ShowFindTimeFormatDialog
	CurrentReason2List		ShowVisibilityDialog
	CurrentReason3		Shutdown
	CurrentReason3List		StartTime
	CurrentReason4		Startup
	CurrentReason4List		TimeColumnVisible
	CurrentType		TimeRangeChanged
	CurrentTypeList		TypeColumnVisible
	DateTimeFormat		UnitsColumnVisible
	DeleteItem		VisibleColumns

Events: Proficy_WST.Waste Control

CellMove

	Purpose	The selected cell has changed.
	Syntax	Event CellMove (<i>Row As Long, Column As Long</i>)

CloseDisplay

	Purpose	The user has no access to the display or the license is lost.
	Syntax	Event CloseDisplay ()

ContextChanged

Client Management

	Purpose	The cursor is moved around indicating that the menu or some other attribute about the display may have changed. Note: <code>ContextChanged</code> is used primarily inside the Plant Applications client.
	Syntax	Event <code>ContextChanged()</code>

ControlError

	Purpose	There is an internal error in the control.
	Syntax	Event <code>ControlError(ErrorMessage As String)</code>

ControlMessage

	Purpose	Contains string information messages about the context of the last action; Note: <code>ControlMessage</code> is primarily used to display data in the Plant Applications client status bar.
	Syntax	Event <code>ControlMessage(Message As String)</code>

ItemAdded

	Purpose	A new row is inserted into the Waste display.
	Syntax	Event <code>ItemAdded(Row As Long)</code>

ItemUpdated

	Purpose	A row is updated in the Waste display.
	Syntax	Event <code>ItemUpdated(Row As Long, Column As Long)</code>

Navigate

	Purpose	Note: Only used in the Plant Applications client.
	Syntax	Event <code>Navigate(DestinationURL As String)</code>

ProductUpdated

	Purpose	A product change has occurred.
	Syntax	Event <code>ProductUpdated(Product As String, StartTime As String, EndTime As String, UnitName As String)</code>

TimeRangeChanged

	Purpose	The absolute values of the display's time range have changed.
	Syntax	Event <code>TimeRangeChanged(StartTime As String, EndTime As String)</code>

Methods: Proficy_WST.Waste Control

ColumnName

	Purpose	Return the name of the column when given a column number
	Syntax	Function <code>ColumnName(Column As Long) As String</code>

CopyReasons

	Purpose	Copy the reasons from the currently selected row.
	Syntax	Sub CopyReasons ()

DeleteItem

	Purpose	Delete the currently selected row.
	Syntax	Sub DeleteItem ()

ExecuteCommand

	Purpose	Send a command name as a string, including one or more of the following parameters.	
	Syntax	Function ExecuteCommand (<i>CommandName As String, ParamArray Parameters() As Variant</i>) As Boolean	
	Parameters	Parameter	Description
		AddComment	Add a new comment to the Waste event; opens a Comment dialog box for the comment to be entered.
		AppendComment	Add a comment to the current active Waste row; opens a Comment box for a comment to be entered.
		ColumnVisibilityDialog	Open a Column Visibility dialog box.
		CommentsVisibleCommand	Open a Comment dialog box.
		CopyReasons	Copy the reasons from the currently selected row.
		DeleteRow	Delete the currently selected row.
		DisplayHyperLinksCommand	Show/hide hyperlinks.
		ExpandAllCommand	Expand/compress all rows in the display.
		ExpandedCommand	Expand/compress the current row.
		FilterEventsByAmountCommand	Enable/disable the property EventFilterAmount .
		FindTime	Go to a specified time. Note: An example of the syntax is as follows. ExecuteCommand ("FindTime", 01/01/05 13:30)
		FindTimeDialog	Open a Find Time dialog box.
		Insertrow	Insert a row after the currently selected row.
		NonConfirmedOnlyCommand	Display only unconfirmed Waste.
		PasteReasons	Paste the reasons into a selected row.
		Print	Print the Waste display.
		TimeFormatDialog	Open a Time Format dialog box.
		ViewEventAnalysis	Open an Event Analysis Web report.

Client Management

		ViewEventHistory	Open an Event History Web report.
		ViewTimeline	Open a Timeline Web report.

InsertComment

	<i>Purpose</i>	Add a comment to the current active Waste row; opens a Comment box for a comment to be entered.
	<i>Syntax</i>	Sub <code>InsertComment()</code>

InsertItem

	<i>Purpose</i>	Insert a row after the currently selected row.
	<i>Syntax</i>	Sub <code>InsertItem()</code>

PasteComment

	<i>Purpose</i>	Add a new comment to the Waste event; opens an active Comment window for the comment to be entered.
	<i>Syntax</i>	Sub <code>PasteComment()</code>

PasteReasons

	<i>Purpose</i>	Paste the reasons into a selected row. Note: See CopyReasons() .
	<i>Syntax</i>	Sub <code>PasteReasons()</code>

PrintOut

	<i>Purpose</i>	Print the Waste display.
	<i>Syntax</i>	Sub <code>PrintOut()</code>

ShowFindTimeDialog

	<i>Purpose</i>	Open a Find Time dialog box.
	<i>Syntax</i>	Sub <code>ShowFindTimeDialog()</code>

ShowTimeFormatDialog

	<i>Purpose</i>	Open a Time Format dialog box.
	<i>Syntax</i>	Sub <code>ShowTimeFormatDialog()</code>

ShowVisibilityDialog

	<i>Purpose</i>	Open a Show Visibility dialog box.
	<i>Syntax</i>	Sub <code>ShowVisibilityDialog()</code>

Shutdown

	<i>Purpose</i>	ALWAYS USE <code>shutdown</code> when you have finished using the control.
	<i>Syntax</i>	Sub <code>Shutdown()</code>

Startup

	Purpose	Start the control. Note: The parameters are optional. If they are not defined the control looks for the information in the following order. 1. In the registry for the current user. 2. If the user is not found the control will prompt you to connect.
	Syntax	Function Startup ([<i>ServerName As String</i>], [<i>UserName As String</i>], [<i>Password As String</i>]) As Boolean

Properties: Proficy_WST.Waste Control**Action1ColumnVisible**

	Purpose	Show/hide the Action 1 column.	
	Value	<i>Show</i>	True
		<i>Hide</i>	False
		<i>Read/Write</i>	
	Syntax	Property Action1ColumnVisible As Boolean	

Action2ColumnVisible

	Purpose	Show/hide the Action 2 column.	
	Value	<i>Show</i>	True
		<i>Hide</i>	False
		<i>Read/Write</i>	
	Syntax	Property Action2ColumnVisible As Boolean	

Action3ColumnVisible

	Purpose	Show/hide the Action 3 column.	
	Value	<i>Show</i>	True
		<i>Hide</i>	False
		<i>Read/Write</i>	
	Syntax	Property Action3ColumnVisible As Boolean	

Action4ColumnVisible

	Purpose	Show/hide the Action 4 column.	
	Value	<i>Show</i>	True
		<i>Hide</i>	False
		<i>Read/Write</i>	
	Syntax	Property Action4ColumnVisible As Boolean	

AmountColumnVisible

	Purpose	Show/hide the Amount column.	
	Value	<i>Show</i>	True
		<i>Hide</i>	False
		<i>Read/Write</i>	

Client Management

	Syntax	Property AmountColumnVisible As Boolean
--	---------------	--

CommandDescription

	Purpose	Returns a string that tells what a specified command has done.
		<i>Read-only</i>
	Syntax	Property CommandDescription (<i>CommandName</i>) As String

CommentColumnVisible

	Purpose	Show/hide the Comment column
	Value	<i>Show</i> True
		<i>Hide</i> False
		<i>Read/Write</i>
	Syntax	Property CommentColumnVisible As Boolean

CommentVisibility

	Purpose	Open a Comment dialog box.
		<i>Read/Write</i>
	Syntax	Property CommentVisibility As Boolean

CurrentAction1

	Purpose	Set or retrieve the first action for the selected Waste detail row. <ul style="list-style-type: none"> The selected action must be chosen from the Current Action1 list. Action 1 becomes the first action in a tree. Once the Current Action 1 is set other actions that were included in the Current Action 1 list are now included in a Current Action 2 list.
		<i>Read/Write</i>
	Syntax	Property CurrentAction1 As String

CurrentAction1List

	Purpose	Returns a list of available actions from which one can be selected and set as Current Action 1.
		<i>Read-only</i>
	Syntax	Property CurrentAction1List As Variant

CurrentAction2

	Purpose	Set or retrieve the second action for the selected Waste detail row. <ul style="list-style-type: none"> Action 1 must be set before an Action 2 can be selected. The selected action must be chosen from the Current Action 2 list. Action 2 becomes the second action in a tree. Once the Current Action 2 is set other actions that were included in the Current Action 2 list are now included in a Current Action 3 list.
		<i>Read/Write</i>

	<i>Syntax</i>	Property CurrentAction2 As String
--	---------------	--

CurrentAction2List

	<i>Purpose</i>	Returns a list of available actions from which one can be selected and set as Current Action 2.
		<i>Read-only</i>
	<i>Syntax</i>	Property CurrentAction2List As Variant

CurrentAction3

	<i>Purpose</i>	Set or retrieve the third action for the selected Waste detail row. <ul style="list-style-type: none"> Action 2 must be set before an Action 3 can be selected. The selected action must be chosen from the Current Action 3 list. Action 3 becomes the third action in a tree. Once the Current Action 3 is set other actions that were included in the Current Action 3 list are now included in a Current Action 4 list.
		<i>Read/Write</i>
	<i>Syntax</i>	Property CurrentAction3 As String

CurrentAction3List

	<i>Purpose</i>	Returns a list of available actions from which one can be selected and set as Current Action 3.
		<i>Read-only</i>
	<i>Syntax</i>	Property CurrentAction3List As Variant

CurrentAction4

	<i>Purpose</i>	Set or retrieve the fourth action for the selected Waste detail row. <ul style="list-style-type: none"> Action 3 must be set before an Action 4 can be selected. The selected action must be chosen from the Current Action 4 list. Action 4 becomes the fourth action in a tree.
		<i>Read/Write</i>
	<i>Syntax</i>	Property CurrentAction4 As String

CurrentAction4List

	<i>Purpose</i>	Returns a list of available actions from which one can be selected and set as Current Action 4.
		<i>Read-only</i>
	<i>Syntax</i>	Property CurrentAction4List As Variant

CurrentAmount

	<i>Purpose</i>	Set the waste amount value for currently selected row.
		<i>Read/Write</i>
	<i>Syntax</i>	Property CurrentAmount As Single

Client Management

CurrentComment

	<i>Purpose</i>	Returns a list of all comments associated with the current row.
		<i>Read-only</i>
	<i>Syntax</i>	Property CurrentComment As String

CurrentFault

	<i>Purpose</i>	Set the fault in a current row.
		<i>Read/Write</i>
	<i>Syntax</i>	Property CurrentFault As String

CurrentFaultList

	<i>Purpose</i>	Returns a list of valid fault values
		<i>Read-only</i>
	<i>Syntax</i>	Property CurrentFaultList As Variant

CurrentItemRow

	<i>Purpose</i>	Set the row number of current item.
		<i>Read/Write</i>
	<i>Syntax</i>	Property CurrentItemRow As Long

CurrentItemTime

	<i>Purpose</i>	Returns the start time of the current Waste row.
		<i>Read-only</i>
	<i>Syntax</i>	Property CurrentItemTime As Date

CurrentLocation

	<i>Purpose</i>	Set the location of the current row; the location must be selected from the Current Location list.
		<i>Read/Write</i>
	<i>Syntax</i>	Property CurrentLocation As String

CurrentLocationList

	<i>Purpose</i>	Returns a list of available locations from which one can be selected and set as the Current Location.
		<i>Read-only</i>
	<i>Syntax</i>	Property CurrentLocationList As Variant

CurrentReason1

	<i>Purpose</i>	Set or retrieve the first reason for the selected Waste detail row. <ul style="list-style-type: none">• The selected reason must be chosen from the Current Reason 1 list.• Reason 1 becomes the first reason in a tree. Once the Current Reason 1 is set other reasons that were included in the Current Reason 1 list are now included in a Current Reason 2 list.
---	----------------	---

		<i>Read/Write</i>
	<i>Syntax</i>	Property CurrentReason1 As String

CurrentReason1List

	<i>Purpose</i>	Returns a list of available reasons from which one can be selected and set as Current Reason 1.
		<i>Read-only</i>
	<i>Syntax</i>	Property CurrentReason1List As Variant

CurrentReason2

	<i>Purpose</i>	Set or retrieve the second reason for the selected Waste detail row. <ul style="list-style-type: none"> Reason 1 must be set before a Reason 2 can be selected. The selected reason must be chosen from the Current Reason 2 list. Reason 2 becomes the second reason in a tree. Once the Current Reason 2 is set other reasons that were included in the Current Reason 2 list are now included in a Current Reason 3 list.
		<i>Read/Write</i>
	<i>Syntax</i>	Property CurrentReason2 As String

CurrentReason2List

	<i>Purpose</i>	Returns a list of available reasons from which one can be selected and set as Current Reason 2.
		<i>Read-only</i>
	<i>Syntax</i>	Property CurrentReason2List As Variant

CurrentReason3

	<i>Purpose</i>	Set or retrieve the third reason for the selected Waste detail row. <ul style="list-style-type: none"> Reason 2 must be set before a Reason 3 can be selected. The selected reason must be chosen from the Current Reason 3 list. Reason 3 becomes the third reason in a tree. Once the Current Reason 3 is set other reasons that were included in the Current Reason 3 list are now included in a Current Reason 4 list.
		<i>Read/Write</i>
	<i>Syntax</i>	Property CurrentReason3 As String

CurrentReason3List

	<i>Purpose</i>	Returns a string that tells what a specified command has done.
		<i>Read-only</i>
	<i>Syntax</i>	Property CurrentReason3List As Variant

CurrentReason4

	<i>Purpose</i>	Set or retrieve the fourth reason for the selected Waste detail row.
---	----------------	--

Client Management

		<ul style="list-style-type: none"> Reason 3 must be set before a Reason 4 can be selected. The selected reason must be chosen from the Current Reason 4 list. Reason 4 becomes the fourth reason in a tree.
		<i>Read/Write</i>
	<i>Syntax</i>	Property CurrentReason4 As String

CurrentReason4List

	<i>Purpose</i>	Returns a list of available reasons from which one can be selected and set as Current Reason 4.
		<i>Read-only</i>
	<i>Syntax</i>	Property CurrentReason4List As Variant

CurrentType

	<i>Purpose</i>	Set the Waste type value for the currently selected row.
		<i>Read/Write</i>
	<i>Syntax</i>	Property CurrentType As String

CurrentTypeList

	<i>Purpose</i>	Returns a list of available types from which one can be selected and set as the Current Type.
		<i>Read-only</i>
	<i>Syntax</i>	Property CurrentTypeList As Variant

DateTimeFormat

	<i>Purpose</i>	Set the format for the date and time.
		<i>Read/Write</i>
	<i>Syntax</i>	Property DateTimeFormat (FType As Byte) As String

DetailsOnly

	<i>Purpose</i>	Expand all of the summary rows to show all the detail data at once for the display's current time range.
		<i>Read/Write</i>
	<i>Syntax</i>	Property DetailsOnly As Boolean

DisplayOption

	<i>Purpose</i>	Set any of the following display options. Note: Widths are in pixels.
		<i>Read/Write</i>
	<i>Syntax</i>	Property DisplayOption (OptionName As String, [DontDraw As Boolean])
		<p><i>Where</i></p> <p>[DontDraw As True] = Do not refresh the screen until all of the options that should be set are set.</p> <p>[DontDraw As False] = Refresh the screen after each option is set.</p>

		Display Option	Description
		Action1Visible	Show/hide the Action 1 column.
		Action2Visible	Show/hide the Action 2 column.
		Action3Visible	Show/hide the Action 3 column.
		Action4Visible	Show/hide the Action 4 column
		Action1Width	Set the Action 1 column width.
		Action2Width	Set the Action 2 column width.
		Action3Width	Set the Action 3 column width.
		Action4Width	Set the Action 4 column width.
		AmountVisible	Show/hide the Amount column.
		CommentSplitterRatio	Set the Comment window size as a percentage of the Display window.
		CommentsVisible	Display/do not display the displays' comments.
		CommentVisible	Display/do not display the Comment column.
		DetailsOnly	Display event details only, no summary.
		EventFilterAmount	Filter a downtime event by amount, e.g. to show only downtime events that are more or equal to 10, set the value to 10. Important: To enable EventFilterAmount , FilterEventsByAmount must be set to True.
		EventVisible	Display/do not display the Event column.
		ExpandAll	Expand/compress all rows in the display
		Expanded	Expand/compress the current row.
		FaultVisible	Display/do not display the Fault column.
		FilterEventsByAmount	Enable/disable EventFilterAmount .
		FontSize	Set the size of the fonts used in the display.
		FrozenColumns	Set the number of columns to fix in place when scrolling the cursor to the right.
		HyperlinkSplitterWidth	Set the width of the Hyperlink menu to the right of the control.
		LocationVisible	Show/hide the Location column.
		LocationWidth	Set the Location column width.
		MeasurementVisible	Show/hide the Measurement column/
		MeasurementWidth	Set the Measurement column width.
		NonConfirmedOnly	Display only event details that still require reasons to be selected.

Client Management

		ProductVisible	Show/hide the Product column.
		Reason1Visible	Show/hide the Reason 1 column.
		Reason2Visible	Show/hide the Reason 2 column.
		Reason3Visible	Show/hide the Reason 3 column.
		Reason4Visible	Show/hide the Reason 4 column.
		Reason1Width	Set the Reason 1 column width.
		Reason2Width	Set the Reason 2 column width.
		Reason3Width	Set the Reason 3 column width.
		Reason4Width	Set the Reason 4 column width.
		StartDateVisible	Show/hide the Start Date column.
		SummaryDate	Set the format of the summary date, e.g. mm/dd/yy.
		SummaryTime	Set the format for the summary time, e.g. hh:mm:ss.
		TypeVisible	Show/hide the Type column.
		TypeWidth	Set the Type column width.

DisplayOptionDescription

	<i>Purpose</i>	Description of each display option by name.
		<i>Read-only</i>
	<i>Syntax</i>	Property DisplayOptionDescription (<i>CommandName</i>) As String

EndTime

	<i>Purpose</i>	End time of the current row.
		<i>Read-only</i>
	<i>Syntax</i>	Property EndTime As Date

EventColumnVisible

	<i>Purpose</i>	Show/hide the Event column
	<i>Value</i>	<i>Show</i> True
		<i>Hide</i> False
		<i>Read/Write</i>
	<i>Syntax</i>	Property EventColumnVisible As Boolean

EventFilterAmount

	<i>Purpose</i>	Filter a downtime event by amount, e.g. to show only Waste events that are more than or equal to 10, set the value to 10 . Note: The unit of measurement is determined by what unit the Waste is being tracked in. Important: To enable EventFilterAmount , the property FilterEventsByAmount must be set to True.
---	----------------	---

		<i>Read/Write</i>
	<i>Syntax</i>	Property EventFilterAmount As Single

FaultColumnVisible

	<i>Purpose</i>	Show/hide the Fault column	
	<i>Value</i>	<i>Show</i>	True
		<i>Hide</i>	False
		<i>Read/Write</i>	
	<i>Syntax</i>	Property FaultColumnVisible As Boolean	

FilterEventsByAmount

	<i>Purpose</i>	Enable/disable the property EventFilterAmount .	
	<i>Value</i>	<i>Enable</i>	True
		<i>Disable</i>	False
		<i>Read/Write</i>	
	<i>Syntax</i>	Property FilterEventsByAmount As Boolean	

FrozenColumns

	<i>Purpose</i>	Keep selected columns "frozen" to the left side.	
		<i>Read/Write</i>	
	<i>Syntax</i>	Property FrozenColumns As Integer	

GridFontSize

	<i>Purpose</i>	Set the size of the fonts used in the display.	
		<i>Read/Write</i>	
	<i>Syntax</i>	Property GridFontSize As Integer	

HyperLinkMenuVisible

	<i>Purpose</i>	Show/hide the Hyperlink menu.	
	<i>Value</i>	<i>Show</i>	True
		<i>Hide</i>	False
		<i>Read/Write</i>	
	<i>Syntax</i>	Property HyperLinkMenuVisible As Boolean	

LastError

	<i>Purpose</i>	Display an error message describing the last error.	
		<i>Read-only</i>	
	<i>Syntax</i>	Property LastError As String	

LocationColumnVisible

	<i>Purpose</i>	Show/hide the Location column	
	<i>Value</i>	<i>Show</i>	True
		<i>Hide</i>	False
		<i>Read/Write</i>	

Client Management

	Syntax	Property LocationColumnVisible As Boolean
--	---------------	--

NonConfirmedOnly

	Purpose	Display only unconfirmed Waste.	
	Value	<i>Display unconfirmed only</i>	True
		<i>Display all waste</i>	False
		<i>Read/Write</i>	
	Syntax	Property NonConfirmedOnly As Boolean	

ProductColumnVisible

	Purpose	Show/hide the Product column.	
	Value	<i>Show</i>	True
		<i>Hide</i>	False
		<i>Read/Write</i>	
	Syntax	Property ProductColumnVisible As Boolean	

Reason1ColumnVisible

	Purpose	Show/hide the Reason 1 column.	
	Value	<i>Show</i>	True
		<i>Hide</i>	False
		<i>Read/Write</i>	
	Syntax	Property Reason1ColumnVisible As Boolean	

Reason2ColumnVisible

	Purpose	Show/hide the Reason 2 column.	
	Value	<i>Show</i>	True
		<i>Hide</i>	False
		<i>Read/Write</i>	
	Syntax	Property Reason2ColumnVisible As Boolean	

Reason3ColumnVisible

	Purpose	Show/hide the Reason 3 column.	
	Value	<i>Show</i>	True
		<i>Hide</i>	False
		<i>Read/Write</i>	
	Syntax	Property Reason3ColumnVisible As Boolean	

Reason4ColumnVisible

	Purpose	Show/hide the Reason 4 column.	
	Value	<i>Show</i>	True
		<i>Hide</i>	False
		<i>Read/Write</i>	
	Syntax	Property Reason4ColumnVisible As Boolean	

ServerName

	<i>Purpose</i>	Set the Server name.
		<i>Read-only</i>
	<i>Syntax</i>	Property ServerName As String

SheetName

	<i>Purpose</i>	Set the name of the display that the control will display.
		<i>Read/Write</i>
	<i>Syntax</i>	Property SheetName As String

StartTime

	<i>Purpose</i>	Shows when the control started for the current session.
		<i>Read-only</i>
	<i>Syntax</i>	Property StartTime As Date

TimeColumnVisible

	<i>Purpose</i>	Show/hide the Time column.
	<i>Value</i>	<i>Show</i> True
		<i>Hide</i> False
		<i>Read/Write</i>
	<i>Syntax</i>	Property TimeColumnVisible As Boolean

TypeColumnVisible

	<i>Purpose</i>	Show/hide the Type column.
	<i>Value</i>	<i>Show</i> True
		<i>Hide</i> False
		<i>Read/Write</i>
	<i>Syntax</i>	Property TypeColumnVisible As Boolean

UnitsColumnVisible

	<i>Purpose</i>	Show/hide the Units column.
	<i>Value</i>	<i>Show</i> True
		<i>Hide</i> False
		<i>Read/Write</i>
	<i>Syntax</i>	Property UnitsColumnVisible As Boolean

VisibleColumns

	<i>Purpose</i>	OBSOLETE Use specific column visibility properties.
		<i>Read/Write</i>
	<i>Syntax</i>	Property VisibleColumns As Long