



# 360 View



# Contents

<b>Chapter 1: Overview</b>	<b>1</b>
Overview of the 360 View Module	2
Access the 360 View Page	2
Filter Assets	2
Search for an Asset	3
Access More Options for an Asset	3
Add an Asset to Favorites	3
Remove an Asset from Favorites	3
<b>Chapter 2: Asset Groups</b>	<b>4</b>
Create an Asset Group	5
Create a Static Asset Group	5
Modify an Asset Group	6
Change the Assets in an Asset Group	6
Delete an Asset Group	7
Add an Asset Group to Favorites	7
Remove an Asset Group from Favorites	7
Filter Asset Groups	8
<b>Chapter 3: Admin</b>	<b>9</b>
About Configuring 360 View Definitions	10
About Default 360 View Definitions	10
Access the 360 View Admin Page	10
Add a 360 View	11
Modify a 360 View	11
Delete a 360 View	11
Modify the 360 View Tab Configuration	12
<b>Chapter 4: Deployment and Upgrade</b>	<b>13</b>
Deployment	14

Upgrade	14
<b>Chapter 5: Reference</b>	<b>15</b>
General Reference	16
Data Models	17
Catalog Items	18

# Copyright Digital, part of GE Vernova

© 2024 GE Vernova and/or its affiliates. All rights reserved.

GE, the GE Monogram, and Predix are trademarks of General Electric Company used under trademark license.

This document may contain Confidential/Proprietary information of GE Vernova and/or its affiliates. Distribution or reproduction is prohibited without permission.

THIS DOCUMENT AND ITS CONTENTS ARE PROVIDED "AS IS," WITH NO REPRESENTATION OR WARRANTIES OF ANY KIND, WHETHER EXPRESS OR IMPLIED, INCLUDING BUT NOT LIMITED TO WARRANTIES OF DESIGN, MERCHANTABILITY, OR FITNESS FOR A PARTICULAR PURPOSE. ALL OTHER LIABILITY ARISING FROM RELIANCE UPON ANY INFORMATION CONTAINED HEREIN IS EXPRESSLY DISCLAIMED.

Access to and use of the software described in this document is conditioned on acceptance of the End User License Agreement and compliance with its terms.

# Chapter 1

---

## Overview

### Topics:

- [Overview of the 360 View Module](#)
- [Access the 360 View Page](#)
- [Filter Assets](#)
- [Search for an Asset](#)
- [Access More Options for an Asset](#)
- [Add an Asset to Favorites](#)
- [Remove an Asset from Favorites](#)

## Overview of the 360 View Module

360 View provides a configurable overview of the status of the assets and asset groups in your APM system. When you select an asset or a group in 360 View, a set of dashboards is displayed according to the following factors:

- The family of the asset record, or the type of asset group that you have selected in the hierarchy
- The site of the selected asset record
- Your assigned security roles

You can initiate actions or access related records for assets using the [More Options](#) menu.

The content of 360 View is configured by a 360 View Administrator, but you can personalize the view to better support your APM workflow requirements. For example, you can:

- Select your preferred 360 View from a list if more than one 360 View is available for the asset or group. Your selection is stored as a user preference.
- Save a selected asset or group as a favorite.

**Note:** The asset or group that you select in the 360 View page is remembered as a user preference. Next time when you access 360 View, the most recently accessed asset or group is displayed by default. Note, however, that when you select an Asset or Group in the 360 View, it does not update the global asset context for other applications, and the global asset context does not override your saved 360 View preferences.

**Tip:** You can select  at the top of the **360 View** page to refresh the content of all dashboards in the current view.

## Access the 360 View Page

### Procedure

In the **Applications** menu, navigate to the **ASSET HEALTH** section, and then select **360 View**. The **360 View** page appears.

## Filter Assets

### Procedure

1. [Access the 360 View page](#).
2. In the left pane, in the **Hierarchy** section, select . The **Filter** menu appears.
3. Enter values as described in the following table.

Field	Description
CATEGORY	Select a taxonomy category.
CLASS	Select a taxonomy class.
TYPE	Select a taxonomy type.

4. Select **Apply**.  
The hierarchy is filtered according to your selection.

## Search for an Asset

### Before You Begin

If you want to search for an asset in a filtered assets list, [apply the filter](#) before you search for an asset.

### Procedure

1. [Access the 360 View page](#).
2. In the left pane, select **Hierarchy**, select , and then enter at least two characters in the text box.  
The search results appear in the left pane.

## Access More Options for an Asset

### About This Task

The 360 View More Options menu provides options to open the asset in Record Manager, [save the asset as a favorite](#), and other actions defined by the Associated Pages configured for the asset family.

### Procedure

1. [Access the 360 View page](#).
2. Select the Asset for which you want to access the More Options menu.
3. In the left pane, select , and then select the action that you want to perform.  
The selected action is performed for the Asset.

## Add an Asset to Favorites

### Procedure

1. [Access the 360 View page](#).
2. Select the Asset that you want to add to favorites.
3. In the left pane, select , and then select **Add to Favorites**.  
The selected Asset is added to favorites.

## Remove an Asset from Favorites

### Procedure

1. [Access the 360 View page](#).
2. Select the Asset that you want to remove from favorites.
3. In the left pane, select , and then select **Remove from Favorites**.  
The selected Asset is removed from favorites.

# Chapter 2

---

## Asset Groups

### Topics:

- [Create an Asset Group](#)
- [Create a Static Asset Group](#)
- [Modify an Asset Group](#)
- [Change the Assets in an Asset Group](#)
- [Delete an Asset Group](#)
- [Add an Asset Group to Favorites](#)
- [Remove an Asset Group from Favorites](#)
- [Filter Asset Groups](#)



## Create an Asset Group

### Procedure

1. Access the [360 View](#) page.
2. In the drop-down list box in the left pane, select **Group**, and then select . The **New Asset Group** workspace appears.
3. Enter values as described in the following table.

Field	Description
<b>Group Name</b>	Enter a name for the Asset Group.
<b>Group Description</b>	Enter a description for the Asset Group.

4. If you want to add a parent to the Asset Group:
  - a) In the **Select a Parent** box, select . The **Asset Finder** window appears.
  - b) Select the asset with which you want to associate the Asset Group, and then select **Done**.  
**Note:** Only child Assets of the selected parent can be added to the Asset Group.  
The number of Assets that you have selected for the Asset Group appears.
5. If you do not want other users to access the Asset Group, select the **Personal Group** check box.  
**Note:**
  - You can mark asset groups that you create in Asset Hierarchy or 360 View as personal groups.
  - Unless you are a super user, you cannot view other users' personal groups.
6. Select **Save**.  
The Asset Group is created and appears in the **Asset Group** section.
7. Select **Done** to return to the **360 View** page.  
**Note:** Relationships are determined while creating an Asset Group during an associated module workflow.

## Create a Static Asset Group

### Before You Begin

Create an Asset Group based on a query.

### About This Task

This topic describes how to create a static Asset Group from an Asset Group based on a query.

### Procedure

1. Access the [360 View](#) page.
2. In the drop-down list box in the left pane, select **Group**, and then select the Asset Group that you want to copy.  
The properties of the selected Asset Group appear in the workspace.

3. Select **Save As a Static Group**.  
The **Save Asset Group** window appears.
4. Select **OK**.  
The Asset Group copy appears, and Assets are added to the Asset Group based on the current results of the base query.  
  
**Note:** Depending on the number of Assets in the Asset Group and the number of pending static Asset Group creation requests in the queue, it may take some time for the Asset Group copy to appear.
5. Select **Done** to return to the **360 View** page.  
The newly created Asset Group appears in the left pane.

#### Next Steps

- Add Assets to the Asset Group.
- [Modify the Asset Group](#).

## Modify an Asset Group

#### Procedure



1. [Access the 360 View page](#).
2. In the drop-down list box in the left pane, select **Group**, and then select the group that you want to modify.
3. In the left pane, select , and then select **Edit**.  
The properties of the selected Asset Group appear in the workspace.
4. Modify the properties, and then select **Save**.  
The changes are saved.
5. Select **Done** to return to the **360 View** page.
6. Select **Save**.  
The Asset Group is created and appears in the **Asset Group** section.

## Change the Assets in an Asset Group

#### About This Task

This topic describes how to add or remove assets from an Asset Group.

#### Procedure

1. [Access the 360 View page](#).
2. In the drop-down list box in the left pane, select **Group**, and then select the group to which you want to add or remove assets.
3. In the left pane, select , and then select **Edit**.  
The properties of the selected Asset Group appear in the workspace.
4. In the assets list, select .  
The **Choose Assets to add to the group** window appears.
5. Select or clear the check boxes for the assets that you want to add or remove from the group.

#### Tip:

- You can use the **Search** and the taxonomy-based **Filter** boxes to find assets. If you want to use both the search and filter options together, apply the filter first, and then search.
  - You can view the currently-selected assets in a list view instead of a hierarchical view by selecting **Show Selected Only**.
  - You can view all the child assets of an asset by switching the **Select children** toggle and then selecting an asset.
6. Select **Done**.  
The number of assets that you want to add or remove appears.
  7. Select **Save**.  
The selected assets are added or removed from the Asset Group.

## Delete an Asset Group

### Procedure

1. [Access the 360 View page](#).
2. In the drop-down list box in the left pane, select **Group**, and then select the group that you want to delete.
3. In the left pane, select , and then select **Edit**.
4. Select **Delete**.

If the Asset Group is linked to an analysis, a message appears, displaying the list of linked analyses. You must unlink the Asset Group from all the analyses before deleting it.

If the Asset Group is not linked to an analysis, a message appears, asking you to confirm that you want to delete the Asset Group.

5. Select **OK**.  
The Asset Group is deleted.

## Add an Asset Group to Favorites

### Procedure

1. [Access the 360 View page](#).
2. In the drop-down list box in the left pane, select **Group**, and then select the Asset Group that you want to add to favorites.
3. In the left pane, select , and then select **Add to Favorites**.  
The selected Asset Group is added to favorites.

## Remove an Asset Group from Favorites

### Procedure

1. [Access the 360 View page](#).
2. In the drop-down list box in the left pane, select **Group**, and then select the Asset Group that you want to remove from favorites.
3. In the left pane, select , and then select **Remove from Favorites**.

The selected Asset Group is removed from favorites.

## Filter Asset Groups

### About This Task

You can filter the 360 View groups list to display only the groups that are of interest to you by selecting one or more filter options, which include the type of group, the parent asset that the group is linked to, and the group ownership parameters.

When you first access the 360 View, the groups list is filtered using the default filter settings that have been defined in the 360 View application settings. When you modify the filter settings, the new settings are saved as a user preference.

### Procedure

1. [Access the 360 View page.](#)
2. In the drop-down list box in the left pane, select **Group**.
3. In the left pane, select  .  
The Group Filter window is displayed.
4. Modify the filter options, and then select **Apply**.  
The filter options are applied and saved as your user preference.

**Note:** You can revert to the default filter settings by selecting **Reset** in the Group Filter window.

# Chapter 3

---

## Admin

### Topics:

- [About Configuring 360 View Definitions](#)
- [About Default 360 View Definitions](#)
- [Access the 360 View Admin Page](#)
- [Add a 360 View](#)
- [Modify a 360 View](#)
- [Delete a 360 View](#)
- [Modify the 360 View Tab Configuration](#)

## About Configuring 360 View Definitions

360 View allows you to configure an unlimited number of views to display the required visualizations for any combination of asset or asset group type, site, and user role.

Each 360 View definition consists of one 360 View record linked to one or more 360 View Tab Config records. The 360 View record must have a unique name, and it must be associated with a site, which can be the Global site, a Role or an Asset Type. You can designate whether the view is active. Inactive 360 Views are not displayed to end users.

Each 360 View Tab Config record defines one visualization tab to be included in the 360 View. You can select a General Dashboard, Graph or Query from the catalog, or you can enter the URL for an Advanced Visualization dashboard.

If you select a General Dashboard, it must contain a Filter Query, which returns the asset or group entity key, and optionally, it can include additional filter parameters. You can use the following query as an example: `Public\360 View Content\Queries\Asset or Group Filter Query`.

If you select a Query, you can specify whether to display the query results in a tabular format, or as a Map, provided the query that you specify must conform to the requirements of the Maps module.

## About Default 360 View Definitions

Even if you do not configure any 360 Views, users can access default asset and group views, which apply for any asset or group type, site, or user role. Each default view displays a single dashboard as follows:

View Name	Dashboard
Default Asset View	Public\360 View Content\Asset Overview Dashboard
Default Group View	Public\360 View Content\Group Overview Dashboard

The default dashboards display information on recommendations, work history, and asset criticality. You can modify the dashboards to show relevant content for APM users.

## Access the 360 View Admin Page

### About This Task

You can use the **360 View Admin** page to configure the records that define 360 Views.



**Note:** You can access the **360 View Admin** page only if you are a member of the Asset 360 View Admin security group or role.

### Procedure

In the **Applications** menu, navigate to **ADMIN > Application Settings > 360 View**. The **360 View Admin** page appears, displaying the **360 Views** workspace.

## Add a 360 View

### Procedure

1. Access the [360 View Admin](#) page.
2. Select .  
A new row appears in the grid.
3. Enter values for the following fields:
  - Site
  - Name (must be unique)
  - Role
  - Asset Type
4. Select the **Is Active** check box to enable users to access the view.
5. Select .  
The 360 View is added.

## Modify a 360 View

### Procedure

1. Access the [360 View Admin](#) page.
2. As needed, modify values in the grid. You can modify multiple rows at the same time.
3. Select .  
The 360 Views are modified.

## Delete a 360 View

### About This Task



When you delete a 360 View, any 360 View Tab Config records linked to the 360 View are also deleted.

### Procedure

1. Access the [360 View Admin](#) page.
2. Select the check boxes corresponding to the 360 Views that you want to delete.
3. Select **Delete**.  
A message appears, asking you to confirm that you want to delete the 360 Views.
4. Select **OK**.  
The 360 Views are deleted, along with any linked 360 View Tab Config records.

# Modify the 360 View Tab Configuration

## Procedure

1. Access the [360 View Admin](#) page.
2. Select the check box corresponding to the 360 View that you want to configure.
3. Select **Edit**.  
The **Editing <name>** workspace appears.
4. Select .  
A new row is added to the grid.
5. Enter values for the following fields:
  - Site
  - Name  
Ensure that the name for each tab is unique.
6. In the **Content Path** box, select .  
The **Content Path** window appears.
7. Select the content item that you want to display.
  - For General Dashboards, Queries, or Graphs, select the item from the catalog viewer.
  - For Advanced Visualizations, select **Advanced Visualization**, and then enter the URL path for the visualization.
8. Select **OK**.
9. In the Query Type field, select Map if you want to display the query results in Maps visualization.  
**Note:** The query that you specify in this case must conform to the requirements of the Maps module.
10. Repeat steps 4-9 for each 360 View tab that you want to configure.
11. Select one of the tabs as the default one.
12. If you want to specify a tab order other than alphabetical, enter a numeric value in the **Order** box for each tab.
13. Select .  
The tab definitions are saved. You can select **Done** to return to the **360 Views** workspace.



# Chapter 4

---

## Deployment and Upgrade

### Topics:

- [Deployment](#)
- [Upgrade](#)

## **Deployment**

### **Deployment**

Refer to the deployment information here [Deploy 360 View for the First Time](#).

## **Upgrade**

### **Upgrade**

Refer to the upgrade information here: Upgrade 360 View.

# Chapter 5

---

## Reference

### Topics:

- [General Reference](#)
- [Data Models](#)
- [Catalog Items](#)

## General Reference

### 360 View Security Groups

The following table lists the baseline Security Groups available for users within this module, as well as the baseline Roles to which those Security Groups are assigned.

**Important:** Assigning a Security User to a Role grants that user the privileges associated with all of the Security Groups that are assigned to that Role. To avoid granting a Security User unintended privileges, before assigning a Security User to a Role, be sure to review all of the privileges associated with the Security Groups assigned to that Role. Also, be aware that additional Roles, as well as Security Groups assigned to existing Roles, can be added via Security Manager.

This module is a Foundation module that is accessible to the Everyone group.

Security Group	Roles
MI 360 View Admin	Asset 360 View Admin

The baseline family-level privileges that exist for these Security Groups are summarized in the following table.

Family	Asset 360 View Admin	Everyone
Entity Families		
360 View	View, Update, Insert, Delete	View
360 View Tab	View, Update, Insert, Delete	View
Relationship Families		
360 View Has 360 View Tab	View, Update, Insert, Delete	View

### 360 View URLs

There are two URL routes associated with 360 View: 360view/hierarchy and 360view/group. The following table describes the various paths that build on the routes, and the values that you can specify for each element in the path.

Element	Description	Accepted Value(s)	Notes
#360view/hierarchy/<EntityKey>: Opens the <b>360 View</b> page on the hierarchy view for an asset.			
EntityKey	Specifies the Entity Key of the record that you want to open in the 360 View hierarchy page.	Any Entity Key that corresponds to an existing record in the asset hierarchy.	N/A
#360view/group/<EntityKey>: Opens the <b>360 View</b> page on the group view for an asset group.			
EntityKey	Specifies the Entity Key of the record that you want to open in the 360 View group page.	Any Entity Key that corresponds to an existing asset group.	N/A

**Table 1: Example URLs**

Example URL	Destination
#360view/hierarchy/9876543	Opens the 360View page on the hierarchy view, displaying the asset record with the Entity Key 9876543.
#360view/hierarchy/-1	Opens the 360View page on the hierarchy view, displaying the Home location in the hierarchy.
#360view/groups/123456	Opens the 360View page on the groups view, displaying the asset group with the Entity Key 123456.

## 360 View Site Filtering

The hierarchy section of the 360 View page displays only the assets that are assigned to Sites to which you have access.

Asset Group records are not site filtered, but site filtering affects what is displayed in the groups section of the **360 View** page as follows:

- When you select a parent asset record to link to a group, you can select only assets associated with Sites to which you have access.
- If an Asset Group is linked to a parent asset, you can only view the group in the **360 View** page if you have access to the Site to which the parent asset is assigned.
- If an Asset Group that is not linked to a parent asset contains assets associated with Sites to which you do not have access, you cannot view those assets in the edit group workspace and data for those assets is not included in the 360 View dashboard.

## Data Models

### 360 View Data Model

The following diagram shows how the families used in 360 View are related to one another.

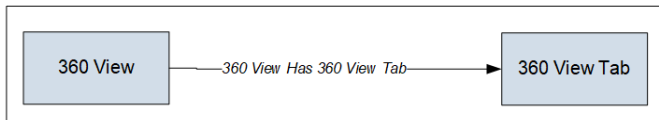

**Note:** In the diagram, boxes represent entity families and arrows represent relationship families that are configured in the baseline database. You can determine the direction of the each relationship definition from the direction of the arrow head: the box from which the arrow originates is the predecessor, and the box to which the arrow head points is the successor.

### Asset Groups Data Model

The following diagram shows how the families used in Asset Groups created in the **Asset Groups** page in 360 View are related to one another.

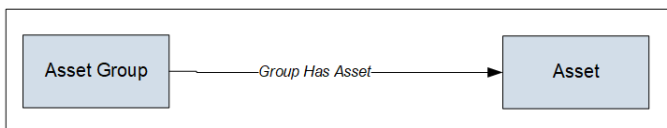

**Note:** In the diagram, boxes represent entity families and arrows represent relationship families that are configured in the baseline database. You can determine the direction of the each relationship definition from the direction of the arrow head: the box from which the arrow originates is the predecessor, and the box to which the arrow head points is the successor.

Asset includes families such as Equipment and Functional Locations.

In addition, Asset Groups created by certain analysis workflows use relationships other than Group Has Asset, as shown in the following image.

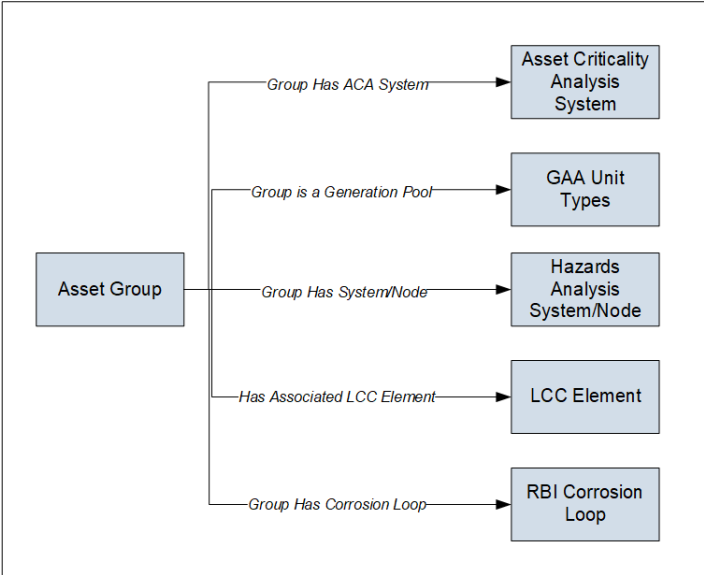

## Catalog Items

### Content Folder

#### 360 View Content Folder

The Catalog folder \\Public\360 View Content contains the following items used by the 360 View module.

Item	Item Type	Behavior and Usage
Asset Overview Dashboard	Dashboard	Default dashboard displayed by the Default Equipment View and the Default Functional Location View.  You can modify this dashboard to display the information you want to view for assets in the default 360 View. This will change the view for all users.
Group Overview Dashboard	Dashboard	Default dashboard displayed by the Default Group View (Relationship-based) and the Default Group View (Query-based).  You can modify this dashboard to display the information you want to view for groups in the default 360 View. This will change the view for all users.

## Queries Folder

### 360 View Queries Folder

The Catalog folder \\Public\360 View Content\Queries contains the following items used by the 360 View module.

Item	Item Type	Behavior and Usage
Asset or Group Filter Query	Query	Filter query used by the Default Asset Dashboard and the Default Group Dashboard.
Performance Recommendations	Query	Query used by the Default Asset Dashboard and the Default Group Dashboard.
Work History	Query	Query used by the Default Asset Dashboard and the Default Group Dashboard.