



Risk Based Inspection (RBI) 580



Contents

Chapter 1: Overview	1
Overview of the Risk Based Inspection (RBI) Module	2
Overview of the RBI 580 Methodology	2
About RBI Methodologies	2
Access the Risk Based Inspection Overview Page	3
Access the Unit Summary Workspace	4
Access the Asset Summary Workspace	5
Access the Asset Summary Workspace for a New Asset	5
Suggest and Link PDMs to RBI Component associated with an Asset	5
About Asset Info Summary	7
Access the Asset Info Summary	7
RBI Workflow	8
Chapter 2: Workflows	9
Define Component	10
Perform an RBI Analysis	12
RBI Recommendation Management	16
RBI Recommendation Implementation	18
Chapter 3: RBI Tree	21
Overview of the RBI Tree	22
About RBI Tree Navigation	22
About RBI Tree Elements	23
About Searching and Filtering Records in the RBI Tree	23
Actions Available in the RBI Tree	24
Chapter 4: Corrosion Loops	27
About Corrosion Loops	28
Access an RBI Corrosion Loop	29
Create an RBI Corrosion Loop	29

Link RBI Corrosion Loops to a Process Unit	29
Unlink an RBI Corrosion Loop from a Unit	30
Link Potential Degradation Mechanisms (PDMs) to an RBI Corrosion Loop	30
Unlink a Potential Degradation Mechanism (PDM)	31
Suggest and Link PDMs to RBI Components associated with a Corrosion Loop	31
Delete an RBI Corrosion Loop	32

Chapter 5: RBI Components 33

About RBI Components	34
About Integration with Thickness Monitoring (TM)	36
About Using TM Analysis Values at the Asset Level	36
About Using TM Analysis Values at the Thickness Monitoring Location (TML) Group Level	36
Access an RBI Component	36
Create an RBI Component	36
Link RBI Components to an RBI Corrosion Loop	37
Unlink an RBI Component from an RBI Corrosion Loop	38
Link Potential Degradation Mechanisms (PDMs) to an RBI Component	38
Suggest and Link PDMs to an RBI Component	39
Unlink a Potential Degradation Mechanism (PDM) from an RBI Component	40
Link an RBI Component to a TML Group	40
Apply an RBI Component	41
View RBI Component in the Unit Summary Workspace	41
View RBI Component in the Asset Summary Workspace	42
Inactivate an RBI Component	42
Delete an RBI Component	43

Chapter 6: RBI Analyses 44

About RBI Analysis	46
About Active Analysis	47
About What-If Analysis	47
About Inspection History	49
About Assigning Inspections to a Degradation Mechanism Evaluation (DME)	49
About Inspection Priority on PRD Analyses	50
Access an RBI Criticality Analysis	51
Create an RBI Analysis	52

Add a What-If Analysis	53
Calculate an RBI Criticality Analysis	54
Calculate all RBI Criticality Analyses Associated with a Process Unit	54
Calculate all RBI Criticality Analyses Associated with a Single Asset or Corrosion Loop	55
Calculate all RBI Criticality Analyses Associated with Multiple Assets	56
Generate a Report for an Asset	57
Access the Risk Matrix for an RBI Criticality Analysis	59
Duplicate an RBI Criticality Analysis	59
Apply an RBI Criticality Analysis	60
Finalize Risk of an RBI Criticality Analysis	61
Finalize Risk of Multiple RBI Criticality Analyses	62
Delete an RBI Criticality Analysis	62

Chapter 7: Inspection Groups 64

About Inspection Groups	65
About Inspection Grouping Criteria	68
About Representative and Represented Asset Selection Criteria	68
About Modifying an Inspection Group	68
About Activating a Group	69
About Representative Inspections	69
About Represented Inspections	69
About Inspection Grouping Recommendations	70
Create Inspection Groups	70
Access Inspection Groups	71
Modify an Inspection Group	72
Activate an Inspection Group.	73
Access an Inspection Plan	74
Approve an Inspection Plan	74
Implement an RBI Recommendation to an Inspection Task	75
Generate a Report for the Inspection Event	76
Specify Inspection Task as Complete	77
Access Represented Inspections	78

Chapter 8: RBI Analysis Export 79

About RBI Analysis Export	80
---------------------------	----

Access the RBI Analysis Export Workspace	83
Export Analyses	83
Chapter 9: RBI Bulk Evergreening	85
About RBI Bulk Evergreening	86
Access Analyses that are Pending Evergreening	86
Duplicate Analysis for Evergreening	87
Delete Analyses Created for Evergreening	87
Export Evergreened Analyses	88
Calculate Evergreened Analyses	88
Finalize Risk for Evergreened Analyses	89
Access Active Analyses	90
Generate Recommendations for Active Evergreened Analyses	90
Chapter 10: RBI Bulk What-If Analyses	92
About RBI Bulk What-If Analyses Creation	93
Access Analyses Pending What-If Creation	93
Create Bulk What-If Analyses	93
Add Additional Fields to be Copied to What-If Analyses	94
Delete Bulk What-If Analyses	94
Export Bulk What-If Analyses	95
Calculate Bulk What-If Analyses	95
Finalize Risk for What-If Analyses	96
Access Active What-If Analyses	97
Generate Recommendations for Active What-If Analyses	97
Chapter 11: Degradation Mechanisms	99
About Degradation Mechanisms (DMs)	100
About Associating Potential Degradation Mechanisms (PDMs)	101
About Degradation Mechanism Evaluations (DMEs)	102
Add Degradation Mechanisms (DMs)	102
Evaluate a Degradation Mechanism (DM)	103
Assess the Unmitigated Risk of a Degradation Mechanism (DM)	103
Access the Inspection History of a Degradation Mechanism (DM)	104

Assign Inspections to a Degradation Mechanism Evaluation (DME)	105
Link an Inspection Consequence Evaluation to an RBI Degradation Mechanism Evaluation (DME)	105
Delete Degradation Mechanisms (DMs)	106
Chapter 12: Recommendations	107
About RBI Recommendations	108
Policies Used to Generate Recommendations	109
About Recommendation Generation for Inspection Group	117
About Inspection Strategies for Generating RBI Recommendations	122
About Consolidating RBI Recommendations	122
Access the Recommended Actions Pane	124
View RBI Recommendations Linked to an Inspection Plan	124
Create an RBI Recommendation Manually	124
Generate Recommendations for a Single RBI Criticality Analysis	125
Generate RBI Recommendations for Multiple RBI Criticality Analyses	126
Generate Recommendations for all Analyses in an Asset Hierarchy Level	127
Chapter 13: Inspection Plans	129
RBI Inspection Plans	130
Inspection Plan Management	140
Managing Recommended Actions in Inspection Plan	144
Implement Recommended Actions to Inspection Tasks	146
Inspection Plan Revision History	148
Chapter 14: ASM Integration	150
About Asset Strategy Management (ASM) Integration	151
Asset Strategy Management (ASM) Integration Workflow	154
About Unmitigated Risk	154
About Mitigated Risk	155
Access Asset Strategy Manager (ASM) from an Inspection Plan	155
Approve the Inspection Plan of an Asset	156
Chapter 15: Flexible RBI Methodology	157

Overview	158
Configure Analysis Validation	160
Configure Consequence Evaluation Validation and Calculation	165
Configure Degradation Mechanism Evaluation Validation and Calculation	175
Configure Degradation Mechanism Roll-up	185
Configure Analysis Roll-up	190
Chapter 16: Pipeline	195
Pipeline Components	196
Pipeline Analyses	199
Pipeline Degradation Mechanisms	212
Pipeline Recommendations	217
Pipeline ASM Integration	225
Chapter 17: Pressure Relief Devices	230
PRD Components	231
PRD Analyses	238
PRD Degradation Mechanisms	247
PRD Recommendations	252
PRD ASM Integration	259
Chapter 18: Admin	265
Access the Global Preferences Workspace	266
About Global Preferences	266
Configure RBI Overview Preferences	269
About Configuring Multiple Degradation Mechanisms (DMs) for a Single RBI Criticality Analysis	270
Enable Inspection Grouping	271
Access RBI 580 Flexible Calculation Preferences	271
Create a Flexible Calculation Configuration	271
Create a Flexible Calculation Validation	272
Create a Flexible Calculation Output Preference	273
Update the Non-Intrusive Requirement Met Query	274
Use the Upgrade APM Version 3 Active Analyses Utility	274
Configure the Asset Info Summary	275

Chapter 19: Data Loaders	277
RBI 580 Data Loader	278
Corrosion Loop	331
RBI Components to TML Groups Relationship Data Loader	338
Chapter 20: Deployment and Upgrade	343
Deployment	344
Upgrade	344
Chapter 21: Reference	345
General Reference	346
Data Models	378
Family Field Descriptions	379
Catalog Items	472
Calculations	486
Family Search Configuration	494
Policies	495
Mappings	508
Reports	523

Copyright GE Digital

© 2023 General Electric Company.

GE, the GE Monogram, and Predix are either registered trademarks or trademarks of All other trademarks are the property of their respective owners.

This document may contain Confidential/Proprietary information of and/or its suppliers or vendors. Distribution or reproduction is prohibited without permission.

THIS DOCUMENT AND ITS CONTENTS ARE PROVIDED "AS IS," WITH NO REPRESENTATION OR WARRANTIES OF ANY KIND, WHETHER EXPRESS OR IMPLIED, INCLUDING BUT NOT LIMITED TO WARRANTIES OF DESIGN, MERCHANTABILITY, OR FITNESS FOR A PARTICULAR PURPOSE. ALL OTHER LIABILITY ARISING FROM RELIANCE UPON ANY INFORMATION CONTAINED HEREIN IS EXPRESSLY DISCLAIMED.

Access to and use of the software described in this document is conditioned on acceptance of the End User License Agreement and compliance with its terms.

Chapter 1

Overview

Topics:

- [Overview of the Risk Based Inspection \(RBI\) Module](#)
- [Overview of the RBI 580 Methodology](#)
- [About RBI Methodologies](#)
- [Access the Risk Based Inspection Overview Page](#)
- [Access the Unit Summary Workspace](#)
- [Access the Asset Summary Workspace](#)
- [Access the Asset Summary Workspace for a New Asset](#)
- [Suggest and Link PDMs to RBI Component associated with an Asset](#)
- [About Asset Info Summary](#)
- [Access the Asset Info Summary](#)
- [RBI Workflow](#)

Overview of the Risk Based Inspection (RBI) Module

Risk Based Inspection (RBI) allows you to analyze the risk of the components of a piece of asset failing due to specific degradation mechanisms through defining both the consequence and probability of failure and then to define an Inspection Strategy for each mechanism.

Using RBI, you can set up corrosion loops to organize the components that you want to analyze. For each component in a corrosion loop, you can create one of the following types of analyses:

- **RBI Criticality Analysis:** To create an RBI Criticality Analysis, you must use the RBI 580 methodology. You can also create an RBI PRD Criticality Analysis or an RBI Pipeline Analysis.
- **RBI 581 Risk Analysis:** To create an RBI 581 Risk Analysis, you must use the RBI 581 methodology.

Overview of the RBI 580 Methodology

You can create an RBI Criticality Analysis using the RBI 580 methodology. If the risk values are unacceptable, you can analyze various data scenarios using a What If Analysis. For example, you might create a What If Analysis to see what the risk level would be if you changed the operating pressure or what the risk level might be in five years.

Based on the analysis results, you can create RBI Recommendation records to suggest actions that might mitigate the risk associated with an RBI Component. You can then create Tasks from those RBI Recommendation records to track the work.

About RBI Methodologies

Risk Based Inspection supports the following methodologies.

- **RBI 580:** This methodology is included in the Risk Based Inspection module.
- **RBI 581:** This methodology is implemented with the RBI 581 module.

The RBI 581 Methodology

After you conduct a RBI 581 Risk Analysis, if it is possible to mitigate risk at the component, RBI 581 will recommend inspection tasks that will, for a specified period, keep the projected risk below the thresholds. These thresholds are called Risk Targets. They are determined by your organization. If risk cannot be mitigated (i.e., inspections would not bring risk below the Risk Target values), the Risk Summary of the analysis provides a synopsis which will help determine the next course of action.

Based on the analysis results, if risk is mitigated, you can generate recommendations. This is to capture recommended actions and create non-recurring inspection tasks that must be completed in order to mitigate risk over the plan period.

The RBI 580 Methodology

After you conduct an RBI Criticality Analysis, if the risk values are unacceptable, you can analyze hypothetical scenarios using What If Analyses and Future Risk Analyses to see how additional actions or factors might affect the risk. For example, you might create a What If Analysis to see what the risk level would be if you changed the operating pressure. Or, you might create a Future Risk Analysis to see what the risk level might be in five years.

Based on the analysis results, you can create RBI Recommendations to capture recommended actions that might mitigate the risk associated with a component. You can then create Tasks or SAP Notifications

from the RBI Recommendations to track the progress and ensure that the recommended actions are implemented.

After the recommended actions are implemented, you can conduct another RBI Criticality Analysis to determine if the new operating procedures or environment have actually reduced the risk.

Access the Risk Based Inspection Overview Page

Procedure

In the **Applications** menu, navigate to the **INTEGRITY** section, and then select **Risk Based Inspection**.

Note: You can also access the **Risk Based Inspection Overview** page for a process unit (i.e., functional location marked as a unit). To do so:

- a. In the main navigation bar, select .
The Asset Hierarchy appears.
- b. In the pane, navigate to and select the functional location for which you want to access the **Risk Based Inspection Overview** page, and then, in the workspace, select **Integrity**.
The **Integrity** section appears, displaying a list of analyses performed on the selected functional location.
- c. In the row containing **Risk Based Inspection**, select the link.

The **Risk Based Inspection Overview** page appears, displaying the following information:

- The **Assets** section: Contains a list of assets in the selected process unit.
- The **Process Units** section: Contains a list of process units under the selected functional location, a description for each process unit, the number of assets in each process unit, and the number of Corrosion Loops in each process unit.
- The **Pending Reassessment** section: Contains a list of assets that are ready to be duplicated for evergreening.
- The **No Recommendations** section: Contains a list of assets in the process unit that have at least one component with a Risk Completed analysis with no recommendations.
- The **Inspection/TM Updates** section: Contains two sections, the **Inspection Updates** and **TM Updates** sections. The **Inspection Updates** section contains a list of recent Inspections performed on assets which have an active analysis in the process unit. This list contains Inspections that have a Completion Date after the analysis Calculation Date. The **TM Updates** section contains a list of Corrosion Analyses performed on assets which have an active analysis in the process unit if the Corrosion Analyses have been calculated after the RBI Analysis.
- The **Current Risk Overview** graph: Plots the number of assets in the process unit by their current risk values in a pie chart.
- The **Current Risk** section: Contains a list of assets plotted in the Current Risk Overview pie chart.
- The **The RBI Risk Matrix** graph: Plots the total number of RBI Components based on their consequence of failure and probability of failure values. Only if a component is linked to an active RBI Criticality Analysis, RBI PRD Criticality Analysis, or RBI Pipeline Analysis, it is considered while plotting the graph. This graph appears only if the Risk Based Inspection license is active.
- The **Past Risk Overview** graph: Plots the number of assets in the process unit by their past risk values in a pie chart.
- The **Past Risk** section: Contains a list of assets plotted in the Past Risk Overview pie chart.

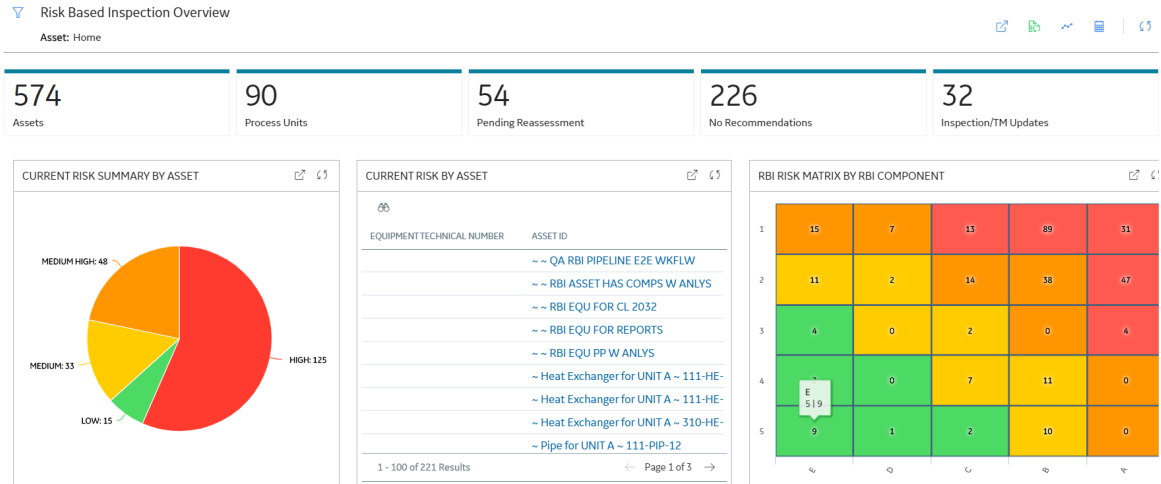

Tip: To return to the **Risk Based Inspection Overview** page after selecting a tab, select the tab again.

Note: The **Risk Based Inspection Overview** page is not updated automatically when you return to the previously opened tab. You can select Refresh (🔄) button to update the page.

Access the Unit Summary Workspace

Before You Begin

To mark a Functional Location as a Process Unit, access the Functional Location via Record Manager, and then select the **Is a Unit?** check box.

Procedure

1. Access the **Risk Based Inspection Overview** page.
2. In the workspace, select the **Process Units** tab.
The **Process Units** section appears, displaying a list of process units.
3. In the row containing the process unit that you want to access, select the link.

The **Unit Summary** workspace appears, displaying the following information:

- The **Process Unit Overview** section:
 - If at least one corrosion loop is linked to the unit, a list of all Corrosion Loops linked to the process units are displayed.
 - OR-
 - A list of RBI Assets linked to the process unit with one or more RBI Components, and rolled up values from the RBI Assets related Inspection Plans are displayed.
- The **Process Unit Details** section: Contains the datasheet of the Functional Location that represents the process unit.
- The **Process Unit Tree** section:
 - If at least one corrosion loop is linked to the unit, a list of all Corrosion Loops linked to the process unit is displayed.
 - OR-
 - A list of RBI Assets with one or more RBI Components linked to the process unit is displayed.

Note: You can view all assets linked to the unit, regardless of whether an RBI Component is linked, by selecting the **Show All Assets** filter option.

Access the Asset Summary Workspace

Procedure

1. Access the **Risk Based Inspection Overview** page.
2. In the workspace, select the **Assets** tab.
The **Assets** section appears, displaying a list of assets.

Note: The **Assets** section displays the Equipment or Functional Locations that have at least one component.

3. In the row containing the asset that you want to access, in the **Asset ID** column, select the link.
The **Asset Summary** workspace appears, displaying the following information:
 - The **Asset Overview** section: Contains the list of RBI Components related to the asset. If you select a component hyperlink, the **Component Overview** section appears in the workspace.
 - The **Asset Details** section: Contains the datasheet of the Equipment or the Functional Location that represents the asset.

Access the Asset Summary Workspace for a New Asset

Procedure

1. In the Asset Summary workspace, select the **Assets** using the **Asset Hierarchy**.
2. In the **Applications** menu, navigate to the **INTEGRITY** section, and then select **Risk Based Inspection**.

For Equipment Records, the **Asset Summary** workspace appears.

or

For Functional Location Records, the **Risk Based Inspection Overview** page appears.

3. For Functional Location Records, select .
The **Asset Summary** workspace appears.

Note: The Asset Summary workspace displays the following information:

- The **Asset Overview** section: Contains the list of RBI Components related to the asset. If you select a component hyperlink, the **Component Overview** section appears in the workspace.
- The **Asset Details** section: Contains the datasheet of the Equipment or the Functional Location that represents the asset.

Suggest and Link PDMs to RBI Component associated with an Asset

Before You Begin

Ensure that you have entered all the field values that are used as a criteria for suggestion in the RBI Components associated with the Asset.

Note: The **Enable Suggestion of Potential Degradation Mechanism** must be selected in the [Global Preferences Workspace](#).

About This Task

The GE Digital APM provides an option to automatically suggest Potential Degradation Mechanisms (PDMs) to all the RBI Components associated with the Asset. You can decide whether to link the suggested PDMs to the RBI Component. The suggestions are generated using the RBI Degradation Mechanism Screening Policy. Screening criteria for each PDM is referred from API 581 and API 571. Both the documents are recommended practices and provides guidelines on how to screen components for individual degradation mechanism.

Additional guidelines or good engineering practices defined within these documents are not made mandatory for suggestion purposes. Also, customers might be defining screening criteria based on historical data. Customers requiring these additional guidelines to be included for suggesting PDMs can make suitable changes to the policy. For more information, refer [Policies Used to Suggest PDMs](#) topic.

The baseline policy suggests the following Thinning and Lining Damage Mechanisms for the components based on the criteria.

- 581-Atmospheric Tank Bottom Corrosion
- 581-Cooling Water Corrosion
- 581-Soil Side Corrosion
- 581-Internal Component Lining Damage
- 581-High Temperature Oxidation
- 581-High Temperature Sulfidic and Naphthenic Acid
- 581-Sulfuric Acid Corrosion
- 581-Hydrofluoric Acid Corrosion
- 581-Hydrochloric Acid Corrosion

Note:

You can add sub-policies for each degradation mechanism type that you want to automatically suggest in the RBI Degradation Mechanism Screening Policy.

This topic describes how to use the suggested PDMs to link to an RBI Component associated with the Asset.

Procedure

1. [Access the asset](#) to which you want to suggest PDMs for associated RBI Components.
2. In the upper-right corner of the workspace, select , and then select **Suggest PDMs for Components**.

The list of suggested PDMs appears for each RBI Components, displaying the reasons for the suggestions.

Note:

- By default, all suggested PDMs for each RBI Components will be selected to link to the RBI Component.
 - You can deselect the PDMs which you do not want to link to the RBI Component.
 - You cannot deselect the PDMs that are already linked to the RBI Component.
 - Suggestion basis is set from the return nodes in RBI 581 DM Screening - Thinning and Lining Policy and the numerical values will be in imperial UOM.
 - The list is grouped by the Component ID field which is unique for each RBI Component.
3. Select **Link**.

The suggested PDMs are linked to the RBI components.

Note: The GE Digital APM supports the suggested PDMs for a maximum of 25 RBI Components per Asset with the baseline configuration.

About Asset Info Summary

The Asset info summary in RBI **Asset View** page, provides the ability to see a high-level view of the critical information of the Asset. This information will be critical for analysis during critical workflow steps like finalizing risk and review or approval of inspection plan. This information appears in the Asset info summary when you select  next to the Asset, RBI Component, or Analysis ID in the RBI workspace.

The Asset info summary displays the following information:

Fields	Description
HEATH INDICATORS	A count of health indicators per alert level is displayed. Note: This field is displayed only when the Asset Health Manager module is licensed, and at least one Health Indicator related to the asset is available.
RBI RISK	The highest risk level of the active analyses linked to the related components which are stored in the Inspection Plan of the Assets section. Note: When using the alternative inspection plan workflow, this field is displayed only when the Inspection Plan is created and will be updated only when the Inspection Plan is modified.
REMAINING LIFE	The most conservative remaining life from the related Asset Corrosion Analysis records.
OPEN RECS	A count of Inspection recommendations related to the asset that have a status of Created.
WORK HISTORY	A count of work history records related to the asset.
RELATED LINKS	Hyperlinks to navigate to the Thickness Monitoring and Inspection Management modules for the current asset.

Note:

- From [Asset Info Configuration](#) you can configure RBI RISKS, REMAINING LIFE, OPEN RECS, and WORK HISTORY fields.
- A maximum of six fields can appear at a time.
- If a field does not appear in the Asset info summary, it indicates that the field does not contain a value or the family that is needed to access the field value is not licensed.
- The Thickness Monitoring and Inspection Management hyperlinks does not appear if the module is not licensed.

Access the Asset Info Summary

Procedure

1. [Access the Asset Summary workspace](#) for the asset that you want to view in the Asset information summary.

Note: You can also view the Asset info summary for the parent asset of an RBI Component or RBI Analysis from their respective workspaces.

2. Select  next to the Asset ID.
The Asset info summary appears.

Next Steps

[Configure the Asset Info Summary.](#)

RBI Workflow

This workflow provides the basic, high-level steps for using this module. The steps and links in this workflow do not necessarily reference every possible procedure. For more procedures, see the links in the Related Information section.

1. Define a Process Unit record that corresponds to the functional location on which you want to perform an RBI analysis. To do so, in the Functional Location record, ensure that the **Is a Unit?** check box is selected.
2. [Create a Corrosion Loop](#). Groups of components that are subject to similar degradation mechanisms can be part of a single corrosion loop. If you do not need to create a Corrosion Loop skip to step 4.
3. [Link Potential Degradation Mechanisms \(PDMs\) to the Corrosion Loop](#).
4. [Create an RBI Component](#) to store the details of the operating conditions, design conditions, process fluids, and so on. Each component is a part of an asset that is modeled for the purpose of performing an RBI Risk Assessment.
5. If you have created a Corrosion Loop, then [link it to the RBI Component](#). PDMs linked to the Corrosion Loop are inherited by the RBI Component. If you have not created a Corrosion Loop, then [link PDMs directly to the RBI Component](#).
6. [Create an RBI Analysis](#) to store details of the risk assessments, probability of failure, and consequence of failure. For each DM that is linked to the RBI Component, the corresponding Degradation Mechanism (DM) is linked to the RBI Analysis.
7. [Add additional Degradation Mechanisms to the RBI Analysis](#) if needed.
8. [Evaluate the DMs in the analysis](#).
9. [Calculate the analysis](#).
10. Evaluate the consequences and probability of failure, and [finalize the risk](#). The state of the analysis changes to Risk Completed.
11. [Generate Recommendations](#). You can also create Recommendations manually.
12. [Promote the asset to Asset Strategy Management \(ASM\)](#). All the analyses associated with the asset are promoted to ASM.

Chapter 2

Workflows

Topics:

- [Define Component](#)
- [Perform an RBI Analysis](#)
- [RBI Recommendation Management](#)
- [RBI Recommendation Implementation](#)

Define Component

RBI: Define Components

This workflow describes the process of identifying and creating records for the following elements of a process unit:

- Corrosion loops
- Components
- Potential degradation mechanisms for each component

In the following workflow diagram, the blue text in a shape indicates that the corresponding description has been provided in the sections that follow the diagram. For more information, refer to the [Interpreting the Workflow Diagrams](#) topic in the [APM Product Workflows](#) documentation.

Note: For information on the personas associated with a GE Digital APM module, refer to the [APM Product Workflows](#) documentation.

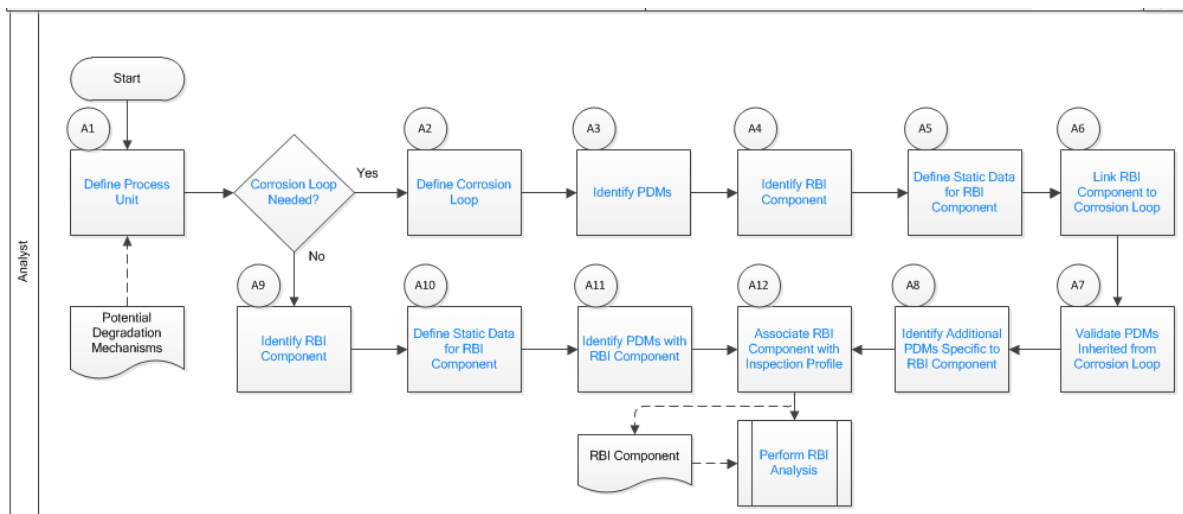

1. [Define Process Unit](#) on page 11
2. [Corrosion Loop Needed?](#) on page 11
3. [Define Corrosion Loop](#) on page 11
4. [Identify Potential Degradation Mechanisms \(PDMs\)](#) on page 11
5. [Identify RBI Component](#) on page 11
6. [Define Static Data for RBI Component](#) on page 11
7. [Link RBI Component to Corrosion Loop](#) on page 12
8. [Validate PDMs Inherited from Corrosion Loop](#) on page 12
9. [Identify Additional PDMs Specific to RBI Component](#) on page 12
10. [Perform RBI Analysis](#) on page 18
11. [Associate RBI Component with Inspection Profile](#) on page 12
12. [Identify PDMs with RBI Component](#) on page 12
13. [Define Static Data for RBI Component](#) on page 11
14. [Identify RBI Component](#) on page 11

Define Process Unit

Persona: Analyst

Define the Process Unit record that corresponds to the unit on which you want to perform an RBI analysis. A Functional Location record for which the **Is Unit** check box is selected is the Process Unit record.

Corrosion Loop Needed?

Persona: Analyst

Identify whether the process unit can be divided into corrosion loops in the process unit. Although this is not always required, defining corrosion loops allows components in the loop to inherit Potential Degradation Mechanisms (PDMs) from the loop. Defining a corrosion loop is not applicable in the case of a storage tank.

Define Corrosion Loop

Persona: Analyst

Create a Corrosion Loop record for each corrosion loop that you have identified in the process unit. Groups of assets or components that are subject to similar degradation mechanisms can be part of a single corrosion loop.

Identify Potential Degradation Mechanisms (PDMs)

Persona: Analyst

PDMs are processes that induce deleterious micro and macro material changes over time that are harmful to material condition or mechanical properties. Damage mechanisms are usually incremental, cumulative, and, in some instances, unrecoverable. Common damage mechanisms include corrosion, chemical attack, creep, erosion, fatigue, fracture, and thermal aging.

GE Digital APM provides a library of PDMs that you can link to a corrosion loop. The available PDMs differ between RBI 580 and RBI 581. They store the details of the damage mechanisms to which the assets or components in the corrosion loop are vulnerable. PDMs also provide details on how the damage mechanisms will be evaluated while performing an RBI analysis.

Identify RBI Component

Persona: Analyst

Identify RBI Components, each of which is a part of an asset that is modeled for the purpose of performing an RBI Risk Assessment. Create a Criticality Calculator RBI Component record for each component that you have identified.

These RBI Components may be comprised of one or more subcomponents. For example, a Column top RBI Component might consist of the head, nozzle, and shell asset subcomponents.

Define Static Data for RBI Component

Persona: Analyst

Provide process and design data of the component such as operating pressure, operating temperature, and so on in the Criticality Calculator RBI Component record that you have created. This information is used to calculate an RBI analysis. If you want to perform an RBI 581 Risk Analysis, then you should also provide details in the **RBI 581** section of the RBI Component datasheet.

Link RBI Component to Corrosion Loop

Persona: Analyst

Link the RBI Components that have been created to the corresponding Corrosion Loop. PDMs created in a corrosion loop are inherited by the RBI Components in that loop. These PDMs serve as a starting point when you perform an RBI analysis on the component.

Validate PDMs Inherited from Corrosion Loop

Persona: Analyst

For each RBI Component, validate the PDMs that have been inherited from the corrosion loop. This will help you decide whether additional PDMs need to be linked to the RBI Component, or if existing PDMs can be removed.

Identify Additional PDMs Specific to RBI Component

Persona: Analyst

Identify additional PDMs that may need to be added to the RBI Component based on its specific conditions, design, or process. Link the RBI Component to the appropriate PDM by selecting from the library of PDMs available. The available PDMs differ between RBI 580 and RBI 581.

Associate RBI Component with Inspection Profile

Persona: Analyst

To utilize data from the Inspection History and Corrosion History records of an RBI Component, associate the related RBI Component with the Inspection Profile. This information can be used to perform an RBI analysis on the component.

Perform RBI Analysis

Persona: Analyst

Go to the [Perform RBI Analysis workflow](#).

Identify PDMs with RBI Component

Persona: Analyst

If you have not defined a corrosion loop in the process unit, PDMs will not be inherited by the RBI Components. Therefore, you have to link the RBI Component to applicable PDMs. The PDMs used in RBI 580 differ from those used in RBI 581.

Perform an RBI Analysis

RBI: Perform RBI Analysis

This workflow describes the process of performing an RBI Criticality Analysis or an RBI 581 Risk Analysis on the components that you have created. Specifically, this workflow describes how to evaluate consequences and probability of failure and assess the unmitigated risk rank for each damage mechanism in an analysis.

In the following workflow diagram, the blue text in a shape indicates that the corresponding description has been provided in the sections that follow the diagram. For more information, refer to the [Interpreting the Workflow Diagrams](#) topic in the [APM Product Workflows](#) documentation.

Note: For information on the personas associated with a GE Digital APM module, refer to the [APM Product Workflows](#) documentation.

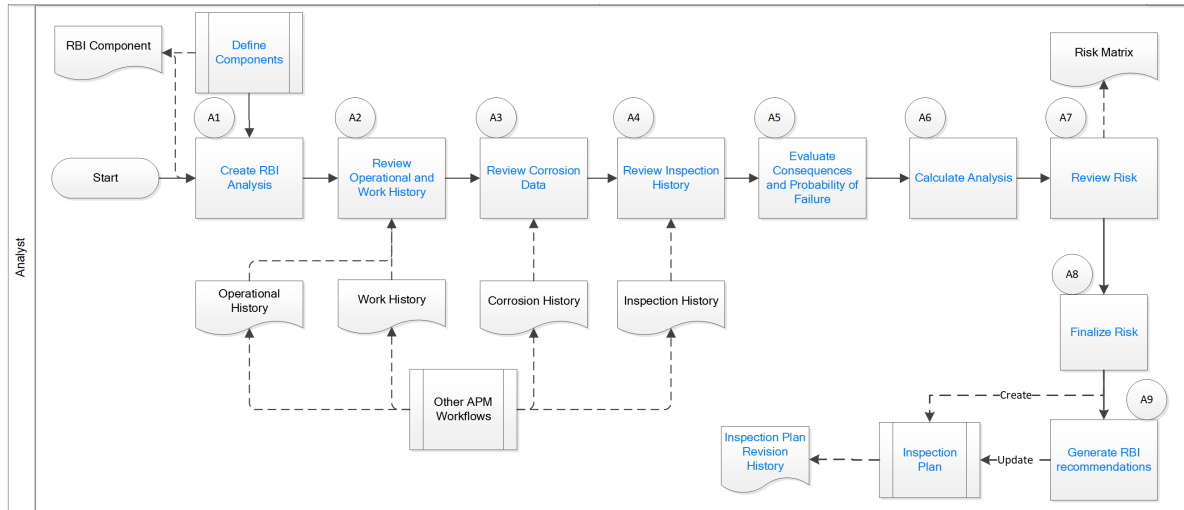

Define Components

Persona: Analyst

Go to the [Define Components workflow](#).

Create RBI Analysis

Persona: Analyst

For each RBI Component that you have defined:

- If you want to perform an RBI 580 analysis, create an RBI Criticality Analysis record.
- If you want to perform an RBI 581 analysis, create an RBI 581 Risk Analysis record.

Note: For an RBI Component, you can create multiple RBI analyses. However, only one analysis is active per component.

When you create an RBI Analysis, information related to the operating conditions and design data of the component is inherited by the analysis. You can, however, modify these values. The RBI Analysis also stores details of the risk assessments, probability of failure, and other details.

Review Operational and Work History

Persona: Analyst

Review and understand the relevant history of the RBI Component from the following records:

- **Operational History:** This will provide details on the extent of degradation that may have already taken place with regard to each PDM. This information is available in the Asset Health Manager module.
- **Work History:** This will provide details of the repair, replacement, or refurbishment activities that may have been performed on the component. This information is available in the APM Foundation module.

Review Corrosion Data

Persona: Analyst

Review and understand the corrosion data of the component. This information is available in the TM Corrosion Analysis performed on the asset in the Thickness Monitoring module.

After you integrate the RBI and Thickness Monitoring modules, the controlling corrosion data defined in the TM Corrosion Analysis is used to populate the corresponding field in the component.

Review Inspection History

Persona: Analyst

Review the most recent evaluation of the condition of the component.

You can access a list of Inspections performed on a specific Degradation Mechanism by accessing the Inspection History of the Degradation Mechanism. After an Inspection is assigned to a Degradation Mechanism, the inspection is accounted for mitigating risk during inspection planning.

Evaluate Consequences and Probability of Failure

Persona: Analyst

If you are performing an RBI 581 Risk Analysis, then assess the outcome of a failure event or situation for the component by evaluating the Safety, Health, and Environmental (SHE) Consequences, and Financial Consequences.

If you are performing an RBI Criticality Analysis, then assess the outcome of a failure event or situation for that particular component by evaluating Flammable, Toxic, Product loss, Environmental, and Production loss consequence categories in addition to evaluating the damage mechanism.

Evaluate the probability of failure for each DM.

Calculate Analysis

Persona: Analyst

Calculate the analysis to view the final damage factor, driving risk, and risk summary. The risk summary indicates whether risk is mitigated by plan date with help of inspection planning.

Review Risk

Persona: Analyst

If you have performed an RBI 580 analysis, assess the unmitigated risk for each damage mechanism (that is, the Probability of Failure determined for the individual DMs combined with the Consequence). This unmitigated risk is represented on a RBI 5x5 risk matrix and forms the basis for prioritizing Inspection Activities.

If you have performed an RBI 581 analysis, assess the mitigated and unmitigated risk for each damage mechanism (i.e., the Probability of Failure determined for the individual DMs combined with the Consequence). The unmitigated and mitigated risks are represented on a RBI 581 ISO risk graph.

Finalize Risk

Persona: Analyst

After the RBI analysis is calculated, the analyst needs to review the risk and approve the calculations. When the risk is finalized, an inspection plan is created or updated for that asset.

If you have performed an RBI 580 analysis, finalize the unmitigated risk assessment by:

- Reviewing the cumulative risk rank for RBI 580 analysis.
- Changing the state of the analysis to Risk Completed.

If you have performed an RBI 581 analysis, finalize the mitigated and unmitigated risk assessments by:

- Reviewing the Safety, Health, and Environmental (SHE) Risk and the Probability of Failure (POF) values for an RBI 581 analysis.
- Changing the state of the analysis to Risk Completed.

Generate Recommendations

Persona: Analyst

After you finalize the unmitigated risk assessment, you can have GE Digital APM generate Recommendations for the analysis.

Recommendations are generated based on the unmitigated risk that you have assessed and the acceptable risk threshold values. These recommendations, when implemented, can mitigate the risk associated with the individual damage mechanisms. Inspection Strategies outline the recommended inspection scope, method, and interval or target completion date to be applied based on the result of the RBI Analysis. After the recommendations are generated, they can be reviewed and approved within the Inspection Plan.

If you have performed an RBI 580 analysis:

- Each damage mechanism in the analysis is designated an Inspection priority value based on the unmitigated risk. This value is used to generate recommendations. Implementing these recommendations will mitigate the risk. As a general rule, an increased scope, a more effective inspection method, and more frequent inspections will be recommended for higher risk assets.
- Inspection Strategies provide recommendations for inspection activities to mitigate risks assessed for the individual damage mechanisms. After you complete the analysis, each damage mechanism is assigned an Inspection Priority value based on the unmitigated risk. This value, along with a few others, is used to generate Recommendations.
- Recommendations are generated only for quantitative damage mechanisms.
- The recommendations are recurring.

If you have performed an RBI 581 analysis:

- Recommendations are generated for all the damage mechanisms that contain a value in the Recommended Inspection Effectiveness field.
- The recommendations are non-recurring.

Recommendation Management

Persona: Analyst

Go to the [Recommendation Management workflow](#).

RBI Recommendation Management

RBI: Recommendation Management

This workflow describes the process of reviewing the recommendations that are generated by GE Digital APM. You can also create recommendations manually, supersede recommendations, or consolidate recommendations. After the Inspection Plan is approved, you can implement the RBI Recommendation as an Inspection Task in the **Inspection Plan** page or implement the resulting Action as a task in Asset Strategy Management (ASM).

In the following workflow diagram, the blue text in a shape indicates that the corresponding description has been provided in the sections that follow the diagram. For more information, refer to the [Interpreting the Workflow Diagrams](#) topic in the [APM Product Workflows](#) documentation.

Note: For information on the personas associated with a GE Digital APM module, refer to the [APM Product Workflows](#) documentation.

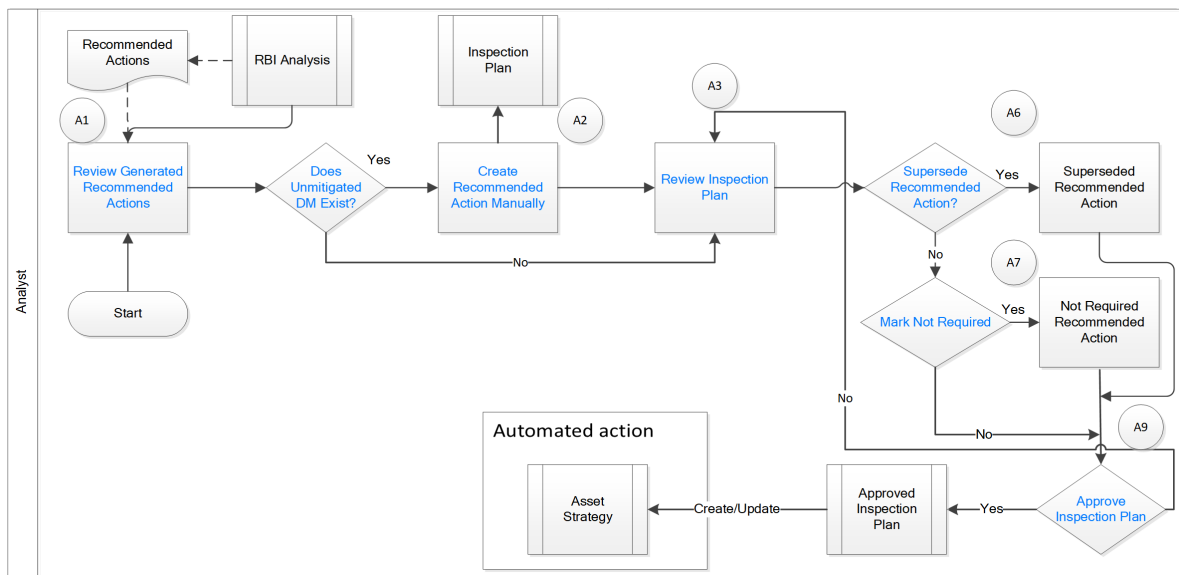

Review Generated Recommended Actions

Persona: Analyst

Review the generated Recommended Actions for applicability, effectiveness, and practicality. If you disagree with the Recommended Actions, you must update them in the associated damage mechanism to mitigate the risk.

Update Recommendation to Mitigate Risk

Persona: Analyst

If you think that implementing the generated recommendation will not mitigate the risk, update the recommendation with details on how to improvise it so that the risk is mitigated to below the risk threshold values.

Does Unmitigated DM Exist?

Persona: Analyst

Verify if there is a damage mechanism for which the risk is not mitigated to below the risk threshold values. This can happen when the damage mechanism does not have an agreed-upon inspection strategy defined. In such cases, the damage mechanism is identified as unmitigated.

Assess Mitigated Risk

Persona: Analyst

Assess the mitigated risk of the damage mechanisms for which the risk is not mitigated to below the risk threshold values.

Create Recommended Actions Manually

Persona: Analyst

For DMs whose recommendations are not created by the Inspection Strategies, if further risk mitigation is needed, then manually create appropriate Recommended Actions. The risk mitigation can be based on several factors that include (but are not limited to):

- Collective experience of the team
- Statutory compliance
- Industry standards

Review Inspection Plan

Persona: Analyst

The Recommendations created from an RBI analysis will be available for review within the Inspection Plan for the asset. You can review all the Recommendations for each damage mechanism.

Supersede Recommended Action?

Persona: Analyst

If a recommendation becomes invalid or redundant because of implementing another recommendation, you must supersede it. For example, if a recommendation suggests that you perform an annual external inspection of a piece of asset, and if another recommendation suggests that you perform a quarterly external inspection of the same piece of asset, then you can choose to supersede the former.

Mark Not Required

Persona: Analyst

If a recommendation becomes invalid or redundant due to the implementation of another recommendation, you can mark it as Not Required. For example, if there is a time based and risk based recommendation for the same damage mechanism with the same task type, you can choose to mark either of the recommendation as Not Required.

Approve Inspection Plan

Persona: Analyst

As a result of the reconciliation process, recommendations that are superseded, consolidated, and not required remain in the system for auditing purposes. After the Inspection Plan is approved, the recommendations that are in the Approved state can be implemented as Inspection Tasks in the **Asset Strategy Management** page or in the **Inspection Plan** page.

Asset Strategy Management

Persona: Analyst

Go to the Asset Strategy Management Workflow.

Risks and Actions

Persona: Analyst

After you approve an Inspection Plan, the recommendations linked to the asset are converted into actions. The damage mechanisms are converted into risks.

Recommendation Implementation

Persona: Analyst

Go to the [Recommendation Implementation workflow](#).

Perform RBI Analysis

Persona: Analyst

Go to the [Perform RBI Analysis workflow](#).

RBI Recommendation Implementation

RBI: Recommendation Implementation

This workflow describes the process of:

- Reviewing the recommendations linked to an asset.
- Deciding if you want to implement the approved RBI Recommended Actions through Inspection Plan or Asset Strategy Management.
- Reviewing the inspection tasks linked to an asset.
- Modifying or creating tasks.

In the following workflow diagram, the blue text in a shape indicates that the corresponding description has been provided in the sections that follow the diagram. For more information, refer to the [Interpreting the Workflow Diagrams](#) topic in the [APM Product Workflows](#) documentation.

Note: For information on the personas associated with a GE Digital APM module, refer to the [APM Product Workflows](#) documentation.

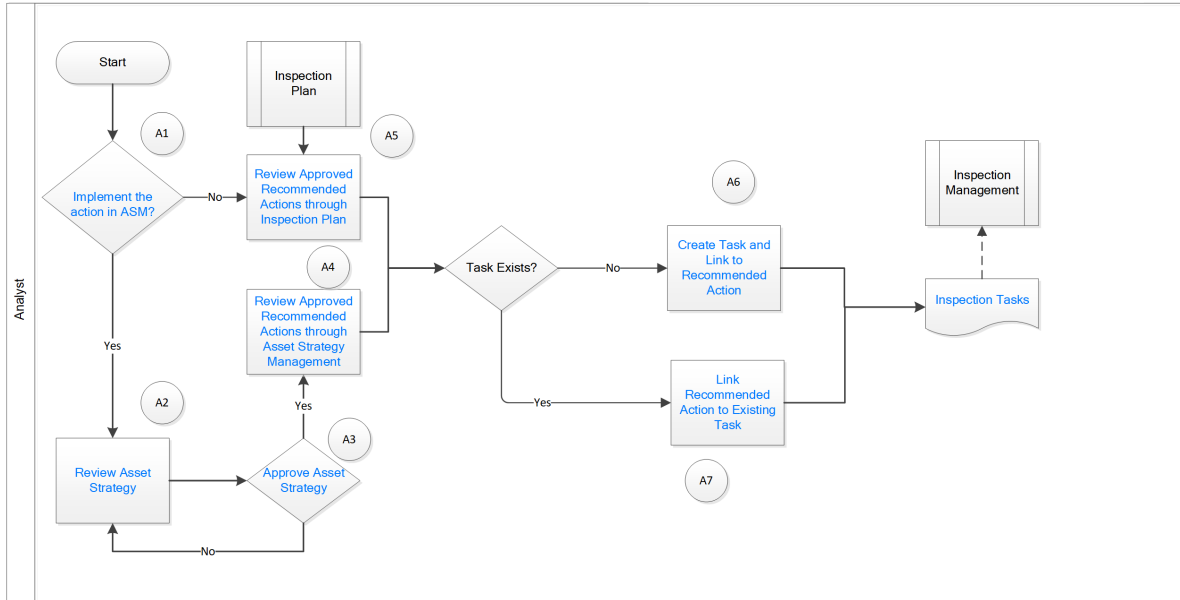

Recommendation Management

Persona: Analyst

Go to the [Recommendation Management workflow](#).

Implement the action in ASM?

Persona: Analyst

After you approve an Inspection Plan, you can choose to implement the RBI Recommended Actions through Inspection Plan or Asset Strategy Management. This decision needs to be made by the owner operator depending on the corporate philosophy of implementing RBI Recommendations.

Review Asset Strategy

Persona: Analyst

After you approve an Inspection Plan, an Asset Strategy is created or updated for the asset. The RBI recommendations linked to the asset are converted into actions and the damage mechanisms are converted into risks.

You can review the risks and Actions created in Asset Strategy Management to verify that implementing the suggested actions will mitigate the risk (to values below the risk threshold). You cannot modify the unmitigated risk assessment for the risk and the mitigated risk assessment for the Action inherited from an RBI Analysis. You can, however, add an ad hoc Action to mitigate the risk.

If the suggested Actions does not mitigate the risk (to values below the risk threshold), create an ad hoc Action in the Asset Strategy that was created after approving the Inspection Plan for the asset.

Approve Asset Strategy

Persona: Analyst

After you review the risk and its associated Actions, when the Actions are ready for implementation, you must approve the Asset Strategy so that its state changes to Active.

Review Approved Recommended Actions through Inspection Plan

Persona: Analyst

Review the approved RBI Recommended Actions through Inspection Plan, if you want to implement the Actions through Inspection Plan and not Asset Strategy Management.

Review Approved Recommended Actions through Asset Strategy Management

Persona: Analyst

Review the approved RBI Recommended Actions through Asset Strategy Management to evaluate the implementation options, if you want to implement the Actions through Asset Strategy Management.

Link Recommended Action to Existing Task

Persona: Analyst

If an existing Inspection Task provides the same instructions as a Recommended Action, link the Recommended Action to the task. You can modify the task if needed. You can link only one Inspection Task to a Recommended Action. If you have performed an RBI 580 analysis, these tasks must be recurring. If you have performed an RBI 581 analysis, these tasks must not be recurring. Similarly, you can link an RBI sourced Action to an existing task if you choose to implement from Asset Strategy Management.

Create Task and Link to Recommended Action

Persona: Analyst

If an appropriate Task does not exist, create a task to implement a Recommended Action. Link the Task to the Recommended Action. The new Task is populated with appropriate information from the Recommended Action. If you have performed an RBI 580 analysis, then these tasks must be recurring. If you have performed an RBI 581 analysis, then these tasks must not be recurring. Similarly, you can create a new Task from Asset Strategy Management to implement the RBI sourced action, and the new Task will be populated with appropriate information from the RBI sourced action.

Inspection Tasks

Persona: Analyst

The asset strategy may be implemented as Tasks that have been defined directly from Recommended Actions through Inspection Plan or Asset Strategy Management. These Tasks can be managed from the Inspection Management or Thickness Monitoring module.

Inspection Planning

Persona: Analyst

Go to the Inspection Planning Workflow.

Chapter 3

RBI Tree

Topics:

- [Overview of the RBI Tree](#)
- [About RBI Tree Navigation](#)
- [About RBI Tree Elements](#)
- [About Searching and Filtering Records in the RBI Tree](#)
- [Actions Available in the RBI Tree](#)

Overview of the RBI Tree

The RBI Tree provides a way to interact with and access the RBI **Process Units** or the RBI **Assets** and their records in the Risk Based Inspection module.

The RBI Tree displays records in the database and how they are related to one another. It provides a dynamic view of the **Process Units**, RBI **Assets**, RBI Components, and the corresponding RBI Analyses.

About the RBI Tree

The RBI Tree is available on the left side of the RBI Asset workspace or the RBI Process Unit workspace. The RBI Tree is designed to streamline navigation and display relevant information for each level that is selected in the tree.

About RBI Tree Navigation

The RBI Tree allows you to browse RBI records in the Unit view or Asset view. You can select the RBI Process Unit, or the RBI Asset as needed.

RBI Unit View

In the RBI Unit view, if the Process Unit contains one or more linked Corrosion Loops, then the RBI tree displays the records as follows:

- Process Unit
 - Corrosion Loop
 - RBI Component
 - RBI Analysis (RBI 580 or RBI 581)
 - PRD Component
 - Protected RBI Component
 - Protected Asset
 - PRD Analysis

If the Process Unit does not contain any linked Corrosion Loops, then the RBI tree displays the records as follows:

- Process Unit
 - RBI Asset
 - RBI Component
 - RBI Analysis (RBI 580 or RBI 581)
 - PRD Component
 - Protected RBI Component
 - Protected Asset
 - PRD Analysis

Note: The Asset view of the Process Unit Tree displays only the RBI Assets that contain one or more linked RBI Components by default. To view all assets, select the **Show All Assets** filter option.

RBI Asset View

In the RBI Asset view, the RBI tree displays the records as follows.

- RBI Asset
 - RBI Component
 - RBI Analysis (RBI 580 or RBI 581)
 - PRD Component
 - Protected RBI Component
 - Protected Asset
 - PRD Analysis

Note: If the Component is linked to both an Asset and a Process Unit, you can switch between the RBI Unit view and the RBI Asset view.









Note: If the RBI Corrosion Loop or RBI Asset has related PRD (Pressure Relief Device) Components, then the RBI tree also displays the related Protected RBI Component, Protected Asset, and PRD Analysis.

Collapsible

To avail more screen space, you can select  and collapse the tree.

About RBI Tree Elements

The RBI objects in the RBI tree are represented by the following icons.

RBI Object	Icon
Asset	
Process Unit	
Corrosion Loop	
Active Component	
Inactive Component	
Protected Component	
Protected Asset	
Archived Analysis	
Inactive Analysis	

About Searching and Filtering Records in the RBI Tree

You can search and apply a filter to the records displayed in the RBI tree. When you apply a search or a filter, the tree is automatically updated to reflect the records that match the search or filter criteria.

Note: The new search or filter criteria does not change the display of the current record selected and all the related parents in the RBI tree.

Search for Records in the RBI Tree

When you search the records in the RBI Tree, the results include only records with an Entity ID that matches the search term. The search results display both the parent nodes and associated child nodes, if any.

Filter Records in the RBI Tree

The filter options in the RBI Tree are not selected by default.



Filter Options	Description
Include Archived	Analyses in the Archived state are included in the tree.
Latest Created	Only the latest analysis in the Created state are included beneath each Component.
Include What-If	What-If analyses are included in the tree.
Show All Assets	The tree reloads with all assets linked to a Process Unit, regardless of whether the Asset contain any linked RBI Components. Note: The filter option is only available on the Corrosion Loop View of the Process Unit Tree.

Actions Available in the RBI Tree







The RBI Tree provides a set of actions that you can perform based on your selection in the tree.

The action buttons that are displayed is based on the type of record currently selected, state of the record, and the user permissions.

The following actions are available when a user selects a record in the RBI Tree.

Current Selection in RBI Tree	Actions Available	Comments
All	Collapse Navigation Tree 	Always Available.
Asset	Create New Component 	None.
	Delete 	Always disabled. Note: You cannot delete Assets through the RBI Workflow.

Current Selection in RBI Tree	Actions Available	Comments
Component	Create an RBI 580 or RBI 581 Analysis	The selection appears based on the RBI license. Note: PRD Components and Pipeline Segments have RBI 580 as the only option.
	Apply an RBI Component on page 41	The selection enables you to apply an RBI component.
	Unlink	This option is available only on the tree for the Process Units.
	Inactivate	This option is available only on the tree in the Asset Summary workspace. Note: You cannot reactivate a component.
	Delete	None.
	Open in Corrosion Loop View /Open in Asset View	This option is available only if the Component is linked to both an Asset and a Corrosion Loop.
PRD Component	Link Protected Assets	This option is available only if the PRD Component has no related protected RBI Components.
	Link Protected Components	This option is available only if the PRD Component has no related Protected Assets.
RBI Analysis	Duplicate Analysis	None.
	Apply Analysis	None.
	Create What-If Analysis	None.
	Delete	None.
Process Unit	Create New Corrosion Loop	None.
	Link Existing Corrosion Loop	None.
	Delete	Always disabled. Note: You cannot delete Process Units through the RBI Workflow.
Corrosion Loop	Create New Component	None.
	Link Existing Component	None.
	Unlink	None.
	Delete	None.

Current Selection in RBI Tree	Actions Available	Comments
Protected Component	Unlink 	None.
	Delete 	Always disabled. Note: To Delete a Component that is protected by a Pressure Relief Device, load the Asset or Process Unit it is directly linked to.
	Open in Corrosion Loop View /Open in Asset View 	This option is available only if the Component is linked to both an Asset and a Corrosion Loop.
Protected Asset	Unlink 	None.
	Delete 	Always disabled. Note: You cannot delete Assets through the RBI Workflow.
Protected Analysis	Delete 	Always disabled. Note: To Delete an Analysis of a component that is protected by a Pressure Relief Device, load the Component in the Asset it is directly linked to.

Chapter 4

Corrosion Loops

Topics:

- [About Corrosion Loops](#)
- [Access an RBI Corrosion Loop](#)
- [Create an RBI Corrosion Loop](#)
- [Link RBI Corrosion Loops to a Process Unit](#)
- [Unlink an RBI Corrosion Loop from a Unit](#)
- [Link Potential Degradation Mechanisms \(PDMs\) to an RBI Corrosion Loop](#)
- [Unlink a Potential Degradation Mechanism \(PDM\)](#)
- [Suggest and Link PDMs to RBI Components associated with a Corrosion Loop](#)
- [Delete an RBI Corrosion Loop](#)

About Corrosion Loops

A Corrosion Loop is a collection of components grouped together for the purpose of conducting an RBI Criticality Analysis.

InGE Digital APM, Corrosion Loops are used to store relevant identifying and grouping information of the loop. Each Corrosion Loop is linked to other records to further define the Corrosion Loop. For example, Corrosion Loops are linked to Potential Degradation Mechanisms (PDMs), which define the ways in which the components in the Corrosion Loop can fail.

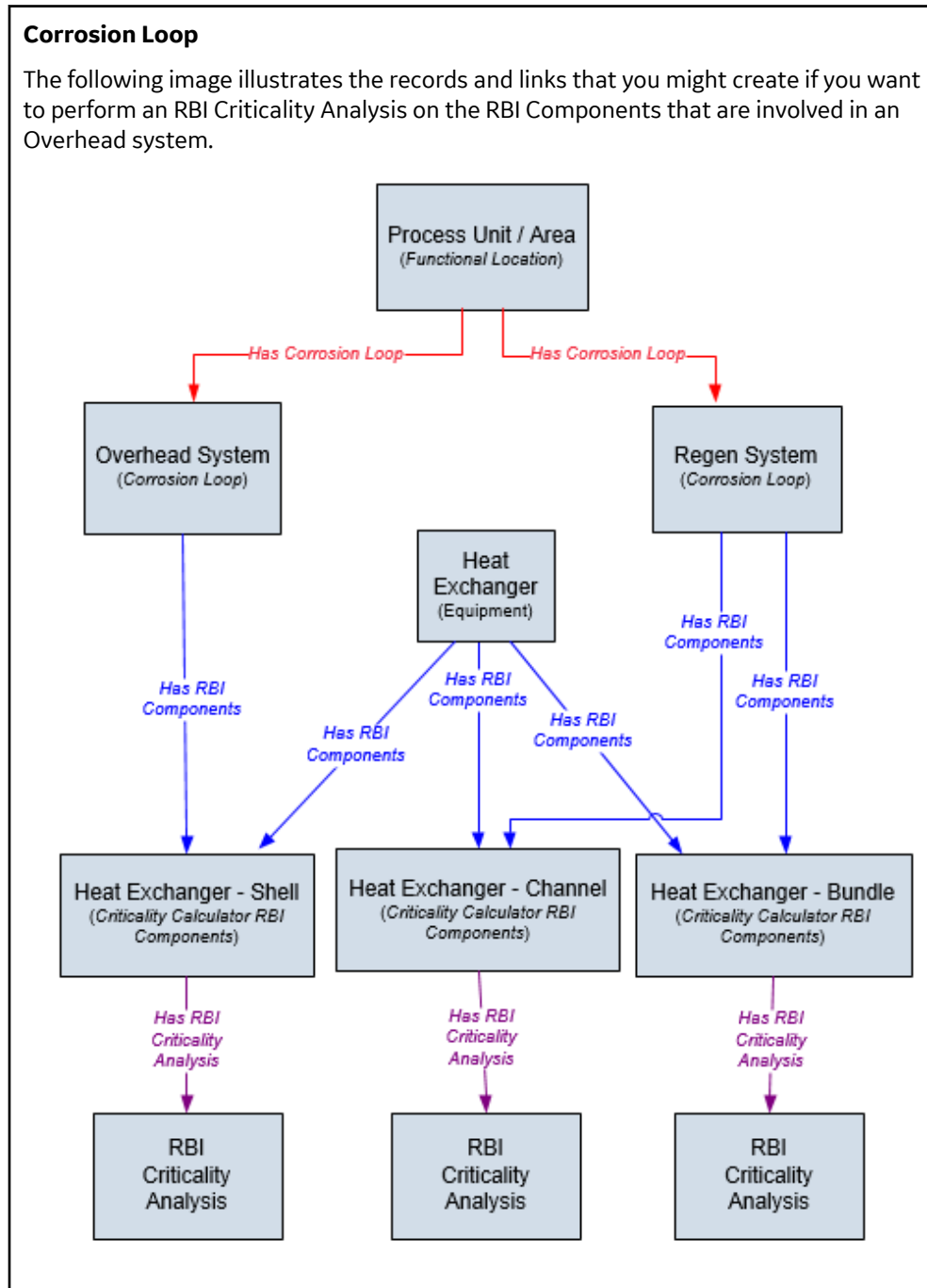

Access an RBI Corrosion Loop

Procedure



1. Access the [Unit Summary workspace](#) of the process unit that is linked to the Corrosion Loop you want to access.
2. In the left pane, select the Corrosion Loop that you want to access.
The **Corrosion Loop: <name>** workspace appears, displaying the following information:
 - The **Corrosion Loop Details** section: Contains the Corrosion Loop datasheet.
 - The **Potential Degradation Mechanisms** section: Contains a list of Potential Degradation Mechanisms (PDMs) that are linked to the Corrosion Loop.
 - The **Corrosion Loop Overview** section: Contains a list of RBI Components related to the corrosion loop.

Create an RBI Corrosion Loop

About This Task

This topic describes how to create a Corrosion Loop and link it to a Process Unit. You can also [link an existing Corrosion Loop to a Process Unit](#).

Procedure

1. Access the [Process Unit](#) for which you want to create a Corrosion Loop.
2. In the left pane, select , and then select **Create New Corrosion Loop**.
The **Corrosion Loops Details** section appears, displaying a blank datasheet for the Corrosion Loop. The value in the RBI Corrosion Loop ID field is populated automatically.
3. As needed, enter values in the [available fields](#).
4. In the upper-right corner of the section, select .
The RBI Corrosion Loop is created and linked to the selected Process Unit.

Next Steps

- [Link Potential Degradation Mechanisms \(PDMs\) to an RBI Corrosion Loop](#)

Link RBI Corrosion Loops to a Process Unit

About This Task

This topic describes how to link an existing Corrosion Loop to a Process Unit. You can also [create a new Corrosion Loop and link it to a Process Unit](#).

Procedure

1. Access the [Process Unit](#) to which you want to link Corrosion Loops.
2. In the left pane, select , and then select Link Existing Corrosion Loop.

The **Select Corrosion Loops** window appears, displaying a list of Corrosion Loops that are not yet linked to a process unit.

3. In the row containing each Corrosion Loop that you want to link to the unit, select the check box, and then select **Done**.
The selected Corrosion Loops are linked to the unit.

Next Steps

- [Link Potential Degradation Mechanisms \(PDMs\) to an RBI Corrosion Loop.](#)

Unlink an RBI Corrosion Loop from a Unit

Procedure

1. [Access the Process Unit](#) from which you want to unlink a Corrosion Loop.
2. In the left pane, select the Corrosion Loop that you want to unlink, and then select .
A message appears, asking you to confirm if you want to unlink the selected Corrosion Loop.
3. Select **Yes**.
The selected RBI Corrosion Loop is unlinked from the unit.

Link Potential Degradation Mechanisms (PDMs) to an RBI Corrosion Loop

About This Task

When you link PDMs to an RBI Corrosion Loop, the PDMs are applied to all the RBI Components contained in that RBI Corrosion Loop.

This topic describes how to link one or more PDMs to a Corrosion Loop. You cannot create PDMs; you can only link them. Therefore, a PDM must already exist to be linked to a Corrosion Loop.

Procedure

1. [Access the Corrosion Loop](#) to which you want to link PDMs.
2. In the workspace, select the **Corrosion Loop Details** tab.
The **CORROSION LOOP DETAILS** and the **POTENTIAL DEGRADATION MECHANISMS** sub-sections appear.
3. In the **POTENTIAL DEGRADATION MECHANISMS** sub-section, select .
A list of PDMs appears, displaying the methodology type of each PDM.
Tip: If you select the link that corresponds to a PDM, the PDM record appears in Record Explorer on a new page.
4. In the row containing each PDM that you want to link to the Corrosion Loop, select the check box, and then select **OK**.
The selected PDMs are linked to the Corrosion Loop.

Next Steps

- [Create an RBI Component.](#)

- [Link RBI Components to an RBI Corrosion Loop.](#)

Unlink a Potential Degradation Mechanism (PDM)

Procedure

1. [Access the Corrosion Loop](#) from which you want to unlink a PDM.
2. In the workspace, select the **Corrosion Loop Details** tab.
The **CORROSION LOOP DETAILS**, and the **POTENTIAL DEGRADATION MECHANISMS** sub-sections appear. The **POTENTIAL DEGRADATION MECHANISMS** sub-section displays a list of associated PDMs.
3. In the **POTENTIAL DEGRADATION MECHANISMS** sub-section, select the row that contains the PDM that you want to unlink from the RBI Corrosion Loop, and then select .
A message appears, asking you to confirm that you want to unlink the selected PDM.
4. Select **Yes**.
The PDM is unlinked from the selected RBI Corrosion Loop.

Suggest and Link PDMs to RBI Components associated with a Corrosion Loop

Before You Begin

Ensure that you have entered all field values that are used as a criteria for suggestions in the RBI Components associated with the Corrosion Loop.

Note: The **Enable Suggestion of Potential Degradation Mechanism** must be selected in the [Global Preferences Workspace](#).

About This Task

The GE Digital APM provides an option to automatically suggest Potential Degradation Mechanisms (PDMs) for all the RBI Components associated with a Corrosion Loop. You can decide whether to link the suggested PDMs to the RBI Component. The suggestions are generated using the RBI Degradation Mechanism Screening Policy. Screening criteria for each PDM is referred from API 581 and API 571. Both the documents are recommended practices and provides guidelines on how to screen components for individual degradation mechanism.

Additional guidelines or good engineering practices defined within these documents are not made mandatory for suggestion purposes. Also, customers might be defining screening criteria based on historical data. Customers requiring these additional guidelines to be included for suggesting PDMs can make suitable changes to the policy. For more information, refer [Policies Used to Suggest PDMs](#) topic.

The baseline policy suggests the following Thinning and Lining Damage Mechanisms for the components based on the criteria.

- 581-Atmospheric Tank Bottom Corrosion
- 581-Cooling Water Corrosion
- 581-Soil Side Corrosion
- 581-Internal Component Lining Damage
- 581-High Temperature Oxidation

- 581-High Temperature Sulfidic and Naphthenic Acid
- 581-Sulfuric Acid Corrosion
- 581-Hydrofluoric Acid Corrosion
- 581-Hydrochloric Acid Corrosion

Note:

You can add sub-policies for each degradation mechanism type that you want to automatically suggest in the RBI Degradation Mechanism Screening Policy.

This topic describes how to use the suggested PDMs to link to an RBI Component associated with the Asset.

Procedure

1. [Access an RBI Corrosion Loop](#) on page 29 to which you want to suggest PDMs for associated RBI Components.
2. In the upper-right corner of the workspace, select , and then select **Suggest PDMs for Components**.
The list of suggested PDMs appears for each RBI Components, displaying the reasons for the suggestions.

Note:

- By default, all suggested PDMs for each RBI Components will be selected to link to the RBI Component.
 - You can deselect the PDMs which you do not want to link to the RBI Component.
 - You cannot deselect the PDMs that are already linked to the RBI Component.
 - Suggestion basis is set from the return nodes in RBI 581 DM Screening - Thinning and Lining Policy and the numerical values will be in imperial UOM.
 - The list is grouped by the Component ID field which is unique for each RBI Component.
3. Select **Link**.
The suggested PDMs are linked to the RBI components.

Note: The GE Digital APM supports the suggested PDMs for a maximum of 25 RBI Components per Corrosion Loop with the baseline configuration.

Delete an RBI Corrosion Loop

Before You Begin

If the Corrosion Loop that you want to delete is linked to a Potential Degradation Mechanisms record (PDM), [unlink the PDM](#) before deleting the Corrosion Loop.

Procedure

1. [Access the Corrosion Loop](#) that you want to delete.
 2. In the left pane, select .
- A message appears, asking you to confirm that you want to delete the selected Corrosion Loop.
3. Select **Yes**.
The Corrosion Loop is deleted.

Chapter

5

RBI Components

Topics:

- [About RBI Components](#)
- [About Integration with Thickness Monitoring \(TM\)](#)
- [About Using TM Analysis Values at the Asset Level](#)
- [About Using TM Analysis Values at the Thickness Monitoring Location \(TML\) Group Level](#)
- [Access an RBI Component](#)
- [Create an RBI Component](#)
- [Link RBI Components to an RBI Corrosion Loop](#)
- [Unlink an RBI Component from an RBI Corrosion Loop](#)
- [Link Potential Degradation Mechanisms \(PDMs\) to an RBI Component](#)
- [Suggest and Link PDMs to an RBI Component](#)
- [Unlink a Potential Degradation Mechanism \(PDM\) from an RBI Component](#)
- [Link an RBI Component to a TML Group](#)
- [Apply an RBI Component](#)
- [View RBI Component in the Unit Summary Workspace](#)
- [View RBI Component in the Asset Summary Workspace](#)
- [Inactivate an RBI Component](#)
- [Delete an RBI Component](#)

About RBI Components

In Risk Based Inspection, you can divide an asset into components whose risk you want to analyze using an RBI Criticality Analysis. You can divide a piece of asset into components based on shared degradation mechanisms. Each sub-part of the asset that shares the same degradation mechanisms will belong to the same RBI Component.

In GE Digital APM, the information related to an RBI component is stored in the following Criticality Calculator RBI Component records:

- Criticality RBI Component - Cylindrical Shell
- Criticality RBI Component - Exchanger Bundle
- Criticality RBI Component - Exchanger Header
- Criticality RBI Component - Exchanger Tube
- Criticality RBI Component - Piping
- Criticality RBI Component - Pump Compressor Casing
- Criticality RBI Component - Tank Bottom
- Criticality RBI Pipeline Segment (only if the Pipeline Management license is active)

The information related to a PRD component is stored in the following Criticality Calculator PRD Components:

- Criticality PRD Component - Relief Valve
- Criticality PRD Component - Rupture Disk

Heat Exchanger

Consider a Heat Exchanger, which is a piece of asset that contains the following components:

- A Cylindrical Shell that makes up the Heat Exchanger Shell section.
- A Cylindrical Shell that makes up the Heat Exchanger Channel section.
- Any number of small tubes that make up the Heat Exchanger Bundle section.

Each of the components can contain items such as Nozzles, Flanges, or Piping.

In RBI, to analyze the ways in which the exchanger can fail, you must divide the components into logical groups that represent common failure characteristics. Each group of components is a separate component and is represented by a single RBI Component record. Keep in mind that some of these groups are involved in the overhead system, and others are involved in the cooling water system.

For example, you might group the asset's components as follows:

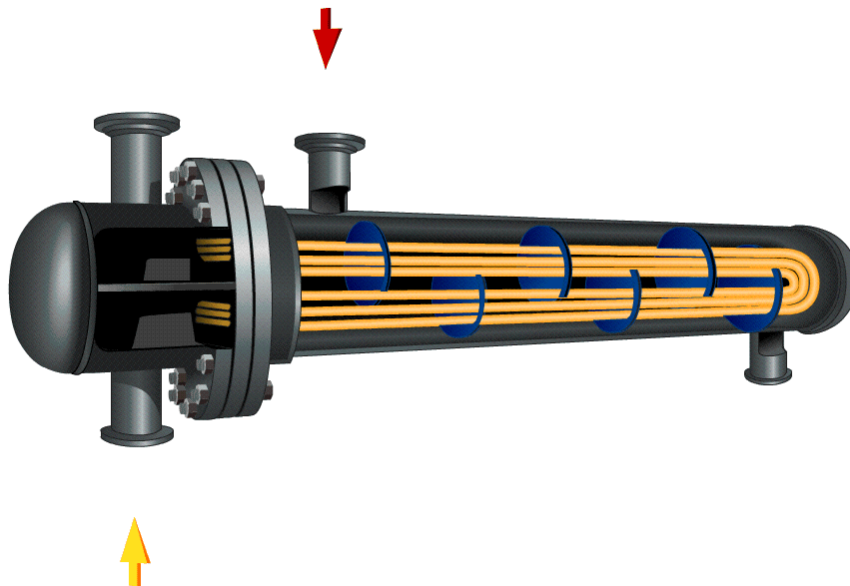

- Heat Exchanger Shell: Includes a cylindrical shell, an inlet nozzle, an outlet nozzle, and a head, often referred to as a shell cover. The Shell is part of the Cooling Water System (blue) because the purpose of the shell is to allow water to flow over the tubes and cool the process fluid running through the channel and bundle section of the exchanger.
- Heat Exchanger Channel: Includes a cylindrical shell, an inlet nozzle an outlet nozzle and a flat head, often referred to as a dollar plate. The Channel is part of the OVHD System (yellow) because the purpose of the Channel is to funnel the process fluid in to the tubes and allow cooling of the process fluid running through the channel and bundle section of the exchanger.
- Heat Exchanger Bundle: Includes tubes, baffles, and a tubesheet. The Bundle is part of the OVHD System (yellow) because the purpose of the bundle is to provide as much surface area as possible for the process fluid in to the tubes and allow cooling of the process fluid running through the bundle section of the exchanger.

If you create an [RBI Criticality Analysis](#) using this example, your database contains the following records:

- Unit / Area (Functional Location record)
- Overhead System (Corrosion Loop record)
- Cooling Water System (Corrosion Loop record)
- Heat Exchanger (Asset record)
- Heat Exchanger Shell (Criticality Calculator RBI Components record)
- Heat Exchanger Channel (Criticality Calculator RBI Components record)
- Heat Exchanger Bundle (Criticality Calculator RBI Components record)

Note: If you have already created Functional Location records to represent the OVHD System and Cooling Water System using the recommended asset hierarchy, you must create additional Corrosion Loop records to represent these same systems. The existing Functional Location records need not be linked to the Corrosion Loop records.

About Integration with Thickness Monitoring (TM)

This topic has been intentionally excluded from the GE Digital APM product documentation website. This topic is available to you via the product documentation that is provided within the GE Digital APM system.

About Using TM Analysis Values at the Asset Level

This topic has been intentionally excluded from the GE Digital APM product documentation website. This topic is available to you via the product documentation that is provided within the GE Digital APM system.

About Using TM Analysis Values at the Thickness Monitoring Location (TML) Group Level

This topic has been intentionally excluded from the GE Digital APM product documentation website. This topic is available to you via the product documentation that is provided within the GE Digital APM system.

Access an RBI Component

Procedure

1. [Access the Asset Summary workspace](#) for the asset that contains the RBI Component that you want to access.

-or-

[Access the Corrosion Loop](#) that contains the RBI Component that you want to access.

2. Select the link to the component that you want to access.

-or-

In the left pane, select the component that you want to access.

The **Component:<name>** workspace for the selected component appears, displaying the **COMPONENT OVERVIEW**, **POTENTIAL DEGRADATION MECHANISMS**, and **COMPONENT DETAILS** sub-sections.

3. To access the datasheet for the RBI Component, expand the **COMPONENT DETAILS** sub-section. The datasheet for the selected RBI Component appears.

Note: If needed, modify values in the available fields, and then select  to save your changes.

Create an RBI Component

About This Task

This topic describes how to create a new RBI Component and link it to an Asset or a Corrosion Loop. You can also [link an existing RBI Component to an Asset or a Corrosion Loop](#).

Procedure

1. Access the [Asset Summary workspace](#) of the asset in which you want to create an RBI Component.

-or-

[Access the Corrosion Loop](#) in which you want to create an RBI Component.

2. In the left pane, select , and then select **Create New Component**. The **Create New RBI Component** window appears.
3. Enter values in the following fields:
 - Asset: This field is automatically populated with the asset for which you are creating an RBI Component.
 - Component Family: Select the component family for the Component that you want to create.
 - Component Type: Select the component type for the RBI Component that you want to create.

Note: The Component Types in the **Component Type** drop-down list box are populated based on the Component Family selected in the **Component Family** drop-down list box. For more information on the baseline Component Families and the Component Types that are supported for each Component Family, refer to the [MI RBI COMPONENT FAMILIES System Code Table](#) on page 355 topic.
4. Select **Create**.
A new RBI Component is created, and is automatically linked to the selected Asset and the Corrosion Loop. The **COMPONENT** workspace appears displaying the **COMPONENT OVERVIEW**, **POTENTIAL DEGRADATION MECHANISMS**, and **COMPONENT DETAILS** sections.
5. In the **COMPONENT DETAILS** section, enter values in the [available fields](#).
6. In the upper-right corner of the datasheet, select .
The changes made to the RBI Component are saved.

Results

- The RBI Component inherits linked [Potential Degradation Mechanisms](#) from the RBI Corrosion Loop.

Next Steps

- [Link Potential Degradation Mechanisms \(PDMs\) to an RBI Component](#).

Link RBI Components to an RBI Corrosion Loop

About This Task

This topic describes how to link existing RBI Components to an Asset or Corrosion Loop. You can also [create a new RBI Component](#).

Procedure

1. [Access the Corrosion Loop](#) that you want to link to an RBI Component.
2. In the left pane, select , and then select **Link Existing Component**.
The **Select RBI Components** window appears, displaying a list of components in the same site that are not linked to a Corrosion Loop.
3. Select the check boxes that correspond to the components that you want to link, and then select **Done**.

The selected RBI Components are linked to the Corrosion Loop.

Results

- The PDMs that are linked to the Corrosion Loop are linked to the RBI Components, in addition to the ones that are directly linked to the component.

Next Steps

- [Link Potential Degradation Mechanisms \(PDMs\) to an RBI Component.](#)

Unlink an RBI Component from an RBI Corrosion Loop

Procedure

1. [Access the Corrosion Loop](#) from which you want to unlink the RBI Component.
2. In the left pane, select the RBI Component that you want to unlink from the Corrosion Loop, and then select .

-or-

Select the check box next to the RBI Component you want to unlink from the Corrosion Loop, and then select .

A message appears, asking you to confirm that you want to unlink the selected RBI Component.

3. Select **Yes**.

The RBI Component is unlinked from the selected Corrosion Loop.

Link Potential Degradation Mechanisms (PDMs) to an RBI Component

About This Task

If the RBI Component is linked to a Corrosion Loop, then all the PDMs linked to the Corrosion Loop are also linked to the Component. You can, however, link additional PDMs to the Component.

This topic describes how to link one or more PDMs to an RBI Component. You cannot create PDMs; you can only link them. Therefore, a PDM must already exist to be linked to an RBI Component.

Procedure

1. [Access the RBI Component](#) to which you want to link PDMs.
2. Expand the **POTENTIAL DEGRADATION MECHANISMS** section.
The list of PDMs linked to the RBI Component appears.

3. Select .

A list of PDMs appears, displaying the methodology type of each PDM.

Tip: If you select the link that corresponds to a PDM, the PDM record appears in Record Explorer on a new page.

4. Next to each PDM that you want to link to the RBI Component, select the check box, and then select **OK**.

The selected PDMs are linked to the RBI Component.

Note: PDMs that can be used with an RBI 581 Risk Analysis contain a 581 prefix (e.g., 581-Amine Cracking).

Suggest and Link PDMs to an RBI Component

Before You Begin

Ensure **Enable Suggestion of Potential Degradation Mechanism** is selected in the [Global Preferences Workspace](#).

About This Task

The GE Digital APM provides an option to automatically suggest Potential Degradation Mechanisms (PDMs) based on criteria provided in the RBI Component fields. User can then decide whether to link the suggested PDMs to the RBI Component. The suggestions are generated using the RBI Degradation Mechanism Screening Policy. Screening criteria for each PDM is referred from API 581 and API 571. Both the documents are recommended practices and provides guidelines on how to screen components for individual degradation mechanism.

Additional guidelines or good engineering practices defined within these documents are not made mandatory for suggestion purposes. Also, customers might be defining screening criteria based on historical data. Customers requiring these additional guidelines to be included for suggesting PDMs can make suitable changes to the policy. For more information, refer [Policies Used to Suggest PDMs](#) topic.

The baseline policy suggests the following Thinning and Lining Damage Mechanisms for the components based on the criteria.

- 581-Atmospheric Tank Bottom Corrosion
- 581-Cooling Water Corrosion
- 581-Soil Side Corrosion
- 581-Internal Component Lining Damage
- 581-High Temperature Oxidation
- 581-High Temperature Sulfidic and Naphthenic Acid
- 581-Sulfuric Acid Corrosion
- 581-Hydrofluoric Acid Corrosion
- 581-Hydrochloric Acid Corrosion

Note:

You can add sub-policies for each degradation mechanism type that you want to automatically suggest in the RBI Degradation Mechanism Screening Policy.

This topic describes how to use the suggested PDMs to link to an RBI Component.

Procedure

1. [Access the RBI Component](#) to which you want to suggest PDMs.
2. Expand the **POTENTIAL DEGRADATION MECHANISMS** section.
The list of PDMs linked to the RBI Component appears.
3. Select **Suggest PDMs**.

Note: Before performing this step, you must provide all field values that are used as a criteria for suggestion in the associated RBI Component datasheet.

The list of suggested PDMs appears, displaying the reasons for the suggestions.

Note:

- By default, all suggested PDMs will be selected to link to the RBI Component.
 - You can deselect the PDMs which you do not want to link to the RBI Component.
 - You cannot deselect the PDMs that are already linked to the RBI Component.
 - Suggestion basis is set from the return nodes in RBI 581 DM Screening - Thinning and Lining Policy and the numerical values will be in imperial UOM.
4. Select **Link**.
The suggested PDMs are linked to the RBI Component.

Next Steps

- Create an RBI 581 Risk Analysis.

Unlink a Potential Degradation Mechanism (PDM) from an RBI Component

Procedure

1. [Access the RBI Component](#) from which you want to unlink a PDM.
2. Expand the **POTENTIAL DEGRADATION MECHANISMS** section.
The list of PDMs linked to the RBI Component appears.
3. Select the row that contains the PDM you want to unlink from the RBI Component, and then select .
A message appears, asking you to confirm that you want to unlink the selected PDM.
4. Select **Yes**.
The PDM is unlinked from the RBI Component.

Link an RBI Component to a TML Group

Before You Begin

- The value in the Source of Calculated Corrosion Rates field in the RBI Component must be Component.
- The parent Asset of the RBI Component must not be a Thickness Monitoring Piping Asset.
- You must have an active license for the Thickness Monitoring module.

Procedure

1. [Access the RBI Component](#) to which you want to link a TML Group.
2. Select .
3. Next to each TML Group that you want to link to the RBI Component, select the check box, and then select **OK**.
The selected TML Groups are linked to the RBI Component.

Note:

- If you do not have a Thickness Monitoring license, the **Manage TML Group** button () will be disabled.
- If an asset is identified for rotation in Thickness Monitoring module, you need to select the **Source of Corrosion Rates** as Manual or Asset.
- If the Source of Calculated Corrosion rate is set to Asset or Component on the related component and the related TML asset has more than 1000 TMLs where the related TML Corrosion Analysis has not been calculated, you must calculate the asset in the Thickness Monitoring module before continuing.

Results

- An RBI Component linked to a TML Group inherits the TM corrosion rate values from the TML Group. If the component contains a Criticality Calculator Internal Corrosion Damage Mechanism Evaluation, the resulting damage factor value will be based on the corrosion rate determined by the value in the [Selected Corrosion Rate field](#).

Apply an RBI Component

About This Task

When you apply an RBI Component, you make a copy of the original record. The applied RBI Component is not automatically linked to the original RBI Component's Corrosion Loop. Instead, the applied RBI Component can be linked to the same or a different asset and then to a Corrosion Loop.

Procedure

1. [Access the RBI Component](#) that you want to apply.
2. In the upper-left pane of the page, select .

The **Hierarchy Finder** window appears.
3. Navigate through the **Hierarchy Finder** to select the asset to which you want to apply the RBI Component.
4. Select **OK**.

The RBI Component is applied to the selected asset.

Next Steps

- [Link RBI Components to an RBI Corrosion Loop](#)

View RBI Component in the Unit Summary Workspace

Before You Begin

To view the RBI Component in the Unit Summary Workspace, the RBI Component you have selected must be linked to an RBI Corrosion Loop.

Procedure

1. [Access the Asset Summary workspace](#) of the asset that is linked to the RBI Component that you want to view in the Unit Summary.

2. In the left pane, select the RBI Component that you want to view in the Unit Summary.
3. Select .
The RBI Component is displayed within the Unit Summary workspace. The left pane will be reloaded to show the components' parent corrosion loop and the related Process Unit.

View RBI Component in the Asset Summary Workspace



Procedure

1. Access the Corrosion Loop that is linked to the RBI Component that you want to view in the Asset Summary.
2. In the left pane, select the RBI Component that you want to view in the Asset Summary.
3. Select .
The RBI Component is displayed within the Asset Summary workspace. The left pane will be reloaded to show the components' parent RBI asset.

Inactivate an RBI Component

About This Task

You can now inactivate an RBI Component. When you do so, the following changes occur:

- The  icon for the RBI Component changes to  in the RBI Tree.
- The value in the Component Status field is set to Inactive.
- The state of the RBI Analyses in the RBI Component are set to Archived (only if there is a valid operation from the current state of the analyses to Archived).
- The RBI Recommendations linked to the archived analyses are set to Archived. If, however, an RBI Recommendation is in the Consolidated or Superseded state, it is not set to Archived - only the master Recommendation is archived in this case.
- If the Asset associated with the RBI Component contains an Inspection Plan in the Approved state, it is changed to the Modified state. If, however, the **Use Alternative Inspection Plan Process** feature is enabled, the Inspection Plan will not be changed to the Modified state; you must update the Inspection Plan to regenerate the Inspection Plan details.
- Risks linked to the Asset Strategy of the associated Asset are deleted.

Important:

- You cannot reactivate an RBI Component.
- You cannot inactivate an RBI Component if the associated Asset contains an Asset Strategy in the Pending Review state.

Procedure

1. Access the **Asset Summary workspace** of the Asset associated with the RBI Component that you want to inactivate.
2. In the left pane, select the RBI Component that you want to inactivate.
3. Select .
A message appears, asking you to confirm that you want to inactivate the RBI Component.
4. Select **Yes**.

The RBI Component is inactivated. In the RBI Tree, the  icon appears for the RBI Component, indicating that it is now inactive.

Note: If the inactivated RBI Component is linked to an inventory group, all the RBI 581 Risk Analyses related to the RBI Components linked to the same inventory group will be marked for recalculation (that is, the  button turns orange).

Delete an RBI Component

Before You Begin

- [Unlink all the Potential Degradation Mechanisms \(PDMs\) linked to the RBI Component.](#)
- [Delete all the RBI Analyses linked to the RBI Component.](#)

Procedure

1. [Access the Asset Summary workspace](#) of the asset that is linked to the RBI Component that you want to delete.

-or-

[Access the Corrosion Loop](#) that is linked to the RBI Component that you want to delete.

2. In the left pane, select the RBI Component that you want to delete.
3. In the left pane, select .

A message appears, asking you to confirm that you want to delete the selected RBI Component.

4. Select **Yes**.

The RBI Component is deleted, and all links to existing related entities are removed.

Chapter 6

RBI Analyses

Topics:

- [About RBI Analysis](#)
- [About Active Analysis](#)
- [About What-If Analysis](#)
- [About Inspection History](#)
- [About Assigning Inspections to a Degradation Mechanism Evaluation \(DME\)](#)
- [About Inspection Priority on PRD Analyses](#)
- [Access an RBI Criticality Analysis](#)
- [Create an RBI Analysis](#)
- [Add a What-If Analysis](#)
- [Calculate an RBI Criticality Analysis](#)
- [Calculate all RBI Criticality Analyses Associated with a Process Unit](#)
- [Calculate all RBI Criticality Analyses Associated with a Single Asset or Corrosion Loop](#)
- [Calculate all RBI Criticality Analyses Associated with Multiple Assets](#)
- [Generate a Report for an Asset](#)
- [Access the Risk Matrix for an RBI Criticality Analysis](#)
- [Duplicate an RBI Criticality Analysis](#)
- [Apply an RBI Criticality Analysis](#)
- [Finalize Risk of an RBI Criticality Analysis](#)
- [Finalize Risk of Multiple RBI Criticality Analyses](#)

- [Delete an RBI Criticality Analysis](#)



About RBI Analysis

An RBI Analysis is a combination of linked RBI Analysis records and their successor records. These records contain risk information about the RBI Component for which the analysis was created. There are two kinds of RBI Analyses: RBI 581 and RBI 580.

- The details of an RBI 580 analysis are stored in an RBI Criticality Analysis record. It is based on the API 580 specification for Risk Based Inspection requirements and methodologies, and is the type of analysis provided in baseline RBI.
- The details of an RBI 581 analysis are stored in an RBI 581 Risk Analysis. It is based on the API 581 specification, and is provided by the RBI 581 module.

Depending on the requirements of the organization, generally you will use one of the two types of analyses, but not both.

Note: Unless otherwise specified, RBI Analysis procedures are the same for both RBI 581 and RBI 580 analyses. Generally, RBI 581 Risk Analysis and RBI Criticality Analysis records will be referred to collectively as RBI Analyses.

Details

There are two types of RBI Analyses:

- **Main RBI Analysis:** An RBI Analysis that represents current information about the RBI Component and the operating environment. You can use the information in a main RBI Analysis as the starting point for a child What If Analysis.
- **What-If Analysis:** A child analysis of a main RBI Analysis. What If Analyses allow you to calculate the risk associated with an RBI Component under hypothetical circumstances or at some future date. For example, you might want to see what the risk would be if you changed the operating pressure or what the risk could be in a few years.

Note: While the RBI Analysis is linked to child What-If Analyses (through the Has RBI Analysis family), those child RBI Analysis records are not considered part of the main RBI Analysis. Instead, they are considered part of their own RBI Analysis.

RBI Analysis

The following example shows the records that you would see after creating a What-If Analysis from a main RBI Analysis. Yellow boxes represent records in the main RBI Analysis, and orange boxes represent records in the What-If Analysis. These two root RBI Analysis records are linked to each other.

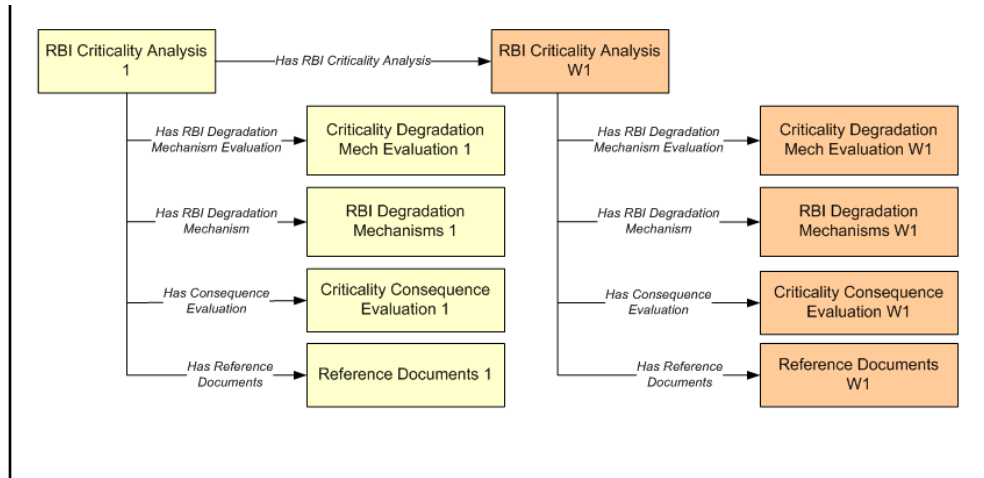

About Active Analysis

An RBI Criticality Analysis or a What If Analysis can be active or inactive. An active analysis is the one on which recommendations and tasks for a particular RBI Analysis will be based. For an RBI Component, you can have only one active analysis. There is no limit, however, to the number of inactive analyses that can exist for an RBI Component.

When you create an analysis, it is in the Created state. If the analysis is active, you can then set the analysis to one of the following states in that order:

- Risk Completed
- Accepted by ASM

If the analysis is inactive, however, the state of the analysis will automatically be set to Archived. If you change the state of an analysis to Risk Completed, all the other analyses are marked inactive (i.e., their state is set to Archived).

About What-If Analysis

A What-If Analysis is a child analysis of a main RBI Analysis (or another What-If Analysis) in an active state that allows you to calculate the risk associated with an RBI Component under hypothetical circumstances. What-If Analyses allow you to analyze hypothetical situations to determine how operational and procedural changes would impact the risk associated with a component's failure on a certain date.

When you create a What-If Analysis:

- A record of the RBI Criticality Analysis or RBI Pipeline Analysis is created. For the What-If Analysis, however, the value in the Event Type field is populated with the value W.

Note: For a normal RBI Analysis, the value in the Event Type field is blank.

- The What-If Analysis is linked to the main analysis through the Has Child RBI Criticality Analysis relationship.
- The Consequence Evaluation, Degradation Mechanisms (DMs), and Degradation Mechanism Evaluations (DMEs) linked to the main analysis are copied and linked to the What-If Analysis.
- The Analysis ID of the What-If Analysis is in the following format: W <Analysis ID of the main analysis> <Number>, where <Number> is the sequential number of the What-If Analysis.
- You can duplicate the What-If Analysis. You cannot, however, apply the What-If Analysis.

- You can [change the state of the What-If Analysis](#). The [state assignments and operations that are applicable to an RBI Analysis](#) are also applicable to a What-If Analysis.
- GE Digital APM copies the values from the fields in the main analysis to the What-If Analysis. However, values in the following fields are not copied:
 - Fields in RBI Criticality Analysis:
 - Consequence Category Rolled Up
 - Driving Risk
 - Eff Date for Risk Analysis
 - Inspection Priority Rolled Up
 - Probability of Failure Rolled up
 - Risk Category
 - Risk Completed
 - Risk Completed Date
 - Fields in Criticality Consequence Evaluation:
 - Average Leak Rate
 - Cleanup Cost
 - Deinventory Time
 - Distance to End Effect
 - Estimated Leak Quantity
 - Estimated Release Rate
 - Final Phase
 - Flammable Affected Area
 - Initial Leak Rate
 - Leak Size
 - Pool Area
 - Probability of Ignition
 - Release Duration
 - Toxic Mix Release Rate
 - Toxicity Area
 - Fields in RBI Degradation Mechanisms
 - Combined Consequence
 - Inspection Priority
 - Probability of Failure
 - Fields in Criticality Env. Crack. Deg. Mech. Eval
 - Adjusted Years Last Inspection
 - DF
 - Likelihood Category
 - Updated Potential
 - Years in Service
 - Years Last Inspection
 - Fields in Criticality Int. Corr. Deg. Mech. Eval
 - DF
 - Estimated
 - Estimated Wall Loss
 - Fractional Wall Loss
 - Likelihood Category

- Pressure at Minimum Thickness
- Structural Minimum Thickness
- Wall Ratio
- Years in Service
- Fields in Criticality Ext. Corr. Deg. Mech. Eval
 - Age
 - Area Humidity Factor
 - Calculated Corrosion Rate
 - Coating Factor
 - DF
 - Estimated Minimum Thickness
 - Estimated Wall Loss
 - Fractional Wall Loss
 - Insulation Condition Factor
 - Insulation Type Factor
 - Likelihood Category
 - Wall Ratio
 - Years in Service

About Inspection History

When you [calculate an RBI PRD Criticality Analysis](#), Degradation Mechanism Evaluations (DMEs) are used as an input to calculate the Probability of Failure. A key factor in calculating the Probability of Failure for the analysis is the assessment of previous inspections, which are contained in the Inspection History.

Details

As part of each analysis, you can choose the inspection for each DME. This selection assists in reducing uncertainty posed by the particular Degradation Mechanism (DM) and in determining its rate of deterioration. Each Inspection is quantitatively assessed to determine its effectiveness in achieving this goal.

You can select the Inspections used to calculate the following:

- Duration between current and last inspection
- Inspection Confidence Factor
- Updated Characteristic Life

The resulting quantitative value, or Inspection History, indicates how effective prior inspections were at identifying the DM and the rate of degradation.

About Assigning Inspections to a Degradation Mechanism Evaluation (DME)

You can use Inspection Management to record inspection results for a piece of asset. In each Inspection, you can specify the DM for which you were looking during the inspection.

In RBI, you use [RBI Components](#) to divide a piece of an asset into parts. You then define DMs for those components, and then conduct analyses for each RBI Component.

Assigning Inspections to DMEs in RBI

If an RBI Component represents parts of a piece of an asset that you have inspected in the past, and have recorded results in Inspection records, you can assign those inspections to the appropriate DMEs for that component. By doing so, you identify the inspections that were used to detect DMs for that component.

The type of analysis used will determine what happens when you assign an inspection to a DM. For any RBI 580 DME, the listed inspections fall within a specified 20-year window. When you are working with an RBI Analysis, GE Digital APM uses the values in the Inspection Confidence field of the Inspection records to automatically populate the following fields in the Criticality Degradation Mech Evaluation representing that degradation mechanism:

- Inspection Confidence: Indicates how effective the last inspection was at detecting the DM and identifying the rate of degradation.
- Equivalent Number of Inspections: Indicates the number of inspections that will be used when calculating the analysis.

Assigning PRD Inspections to DMEs

You can also assign inspections that are associated with pressure relief devices (PRDs) when you are working with an RBI PRD Criticality Analysis. When you do so, the Inspection records that you select will belong to the PRD Pop Test Checklist family, and values that are stored in the PRD Pop Test Checklist records that you select will be used as inputs to RBI PRD Criticality Analysis calculations. Specifically, values in the following fields in the PRD Pop Test Checklist records are used in RBI PRD Criticality Analysis calculations:

- Completion Date
- Inspection Confidence
- Leak Test Results
- Over Pressure Test Results

For any PRD DME, the listed inspections fall within a specified 20-year window. The Date in Service field must contain a date prior to the date in the Completion Date field. The Completion Date and Inspection Confidence fields in the PRD Pop Test Checklist must contain values in order to assign a PRD Pop Test Checklist to a DM that is associated with an RBI PRD Criticality Analysis.

The Leak Test Results and Over Pressure Test Results fields, however, do not have to contain values in order to assign an Inspection record of this type to a DME. Instead, in this case, the following default values will be used in the RBI PRD criticality Analysis calculations:

- Leak: This value is used as an input by default when the Leak Test Results field does not contain a value in the PRD Pop Test Checklist that you assign to a DME.
- Fail: This value is used as an input by default when the Over Pressure Test Results field does not a value in the PRD Pop Test Checklist that you assign to a DME.

When you are working with an RBI 581 Risk Analysis or an RBI Criticality Analysis, (i.e., not an RBI PRD Criticality Analysis), if you want to specify manual values, you can choose to override the automatic Inspection Confidence and Equivalent Number of Inspections. In most cases; however, you will want GE Digital APM to populate the fields automatically to avoid subjective interpretations of the values.

About Inspection Priority on PRD Analyses

When you calculate an RBI PRD Criticality Analysis, in each RBI Degradation Mechanism Evaluation linked to the PRD Analysis a probability of failure and consequence of failure are calculated. Together, the values are used to determine the Inspection Priority, which is stored in the Inspection Priority (Unmitigated Risk) field in the related RBI Degradation Mechanism. The fields used to determine the inspection priority are:

- Leak Degradation Mechanism Evaluations
 - Probability of Leak – RBI Interval
 - Leak Consequence Category

Note: This field is stored on the related PRD Consequence Evaluation.
- Over Pressure Degradation Mechanism Evaluation
 - Probability of Loss of Containment – RBI Interval
 - Consequence of Failure at Over Pressure

The probability of failure, consequence of failure and resulting inspection priority as described above can be viewed for each degradation mechanism linked to the RBI PRD Analysis on the Degradation Mechanisms tab of the RBI Analysis workspace.

The Degradation Mechanism Evaluation on an RBI PRD Criticality Analysis with the most conservative inspection priority becomes the driving risk. The driving risk values are stored on the RBI PRD Criticality Analysis.

The Inspection Priority is used to determine the driving RBI Component when a single pressure relief device protects more than one RBI Component. The RBI Component that belongs to the RBI Analysis whose Inspection Priority has the most conservative value (the lowest number) becomes the driving RBI Component. Recommendation are generated based on the Inspection Priority under the Analysis Outputs RBI Interval column.

Inspection Priority for Current Interval

When you calculate an RBI PRD Criticality Analysis, in each RBI Degradation Mechanism Evaluation linked to the RBI Analysis a probability of failure and consequence of failure are calculated for the current interval. The current interval is defined as the difference of the calculation date and the value of the Next Inspection Date field stored on the RBI PRD Criticality Analysis. Together, the values are used to determine an Inspection Priority. The fields used to determine the inspection priority are:

- Leak Degradation Mechanism Evaluations
 - Probability of Leak – Current Interval
 - Leak Consequence Category

Note: This field is stored on the related PRD Consequence Evaluation.
- Over Pressure Degradation Mechanism Evaluation
 - Probability of Loss of Containment – Current Interval
 - Consequence of Failure at Over Pressure

The Degradation Mechanism Evaluation on a PRD Criticality Analysis with the most conservative inspection priority for the current interval becomes the driving risk for the current interval. The driving risk values are stored on the PRD Criticality Analysis under the Analysis Outputs Current Interval column.

Inspection Priority and Risk Matrices

Specifically, to determine the Inspection Priority, the Probably of Failure and Combined Consequence are plotted on a matrix available by selecting the area in the page header that contains Inspection Priority, Risk Category, and APM Risk data.

Access an RBI Criticality Analysis

About This Task

Procedure

In the left pane, select the RBI Analysis that you want to access.

-or-

[Access the component](#) that contains the RBI Analysis that you want to access. Then, below the graph in the **Component Overview** section, select the RBI Analysis that you want to access.

The **Analysis** workspace appears, displaying the **Analysis Details**, **Degradation Mechanism**, and **Consequence Evaluations** sections.

Note: If needed, you can modify Analysis Details values in the [available fields](#), review the [required fields](#), and then select  to save your changes.

Create an RBI Analysis

About This Task

You can create an RBI Criticality Analysis for an RBI Component.

Procedure

1. [Access the RBI Component](#) for which you want to create an RBI Criticality Analysis.
2. In the left pane, select , and then select **Semi-Quantitative (580)**.
A new analysis is created, and the **Analysis** workspace appears.

Note:

- When an analysis is created, the Consequence Evaluations and [Degradation Mechanisms](#) corresponding to the [Potential Degradation Mechanisms](#) linked to the selected component are also created.
 - If the Source of Calculated Corrosion rate is set to Asset or Component on the related component and the related TML asset has more than 1000 TMLs where the related TML Corrosion Analysis has not been calculated, you need to calculate the asset in the Thickness Monitoring module before continuing.
3. Enter Analysis Details values in the [available fields](#).
 4. [Review the required fields](#).
 5. In the upper-right corner of the section, select .
The RBI analysis is created.

Results

- For each Potential Degradation Mechanism (PDM) linked to the Component, a Degradation Mechanism (DM) is added to the Analysis.

Next Steps

- [Add Degradation Mechanisms \(DMs\)](#).

Add a What-If Analysis

About This Task

You can add a What-If Analysis to the following types of analyses:

- RBI Criticality Analysis
- RBI Pipeline Analysis

When you create a What-If Analysis, a copy of the main RBI Analysis is created. In the What-If Analysis, however, the value in the Event Type field is populated with the value W.

You cannot add a What-If Analysis to an RBI PRD Criticality Analysis.

Procedure

1. Perform one of the following sets of steps:

- a) [Access the analysis](#).
- b) In the navigation pane, select , and then select **Create What If Analysis**.

-or-

- a) [Access the component](#) that is linked to the analysis to which you want to add a What-If Analysis.
- b) Expand the **COMPONENT OVERVIEW** section.
Below the graph, a list of analyses linked to the component appears in a grid.
- c) Select the check box that corresponds to the analysis to which you want to add a What-If Analysis.
- d) In the upper-right corner of the grid, select .

The **Create What If Analysis** window appears.

2. In the **Create What If Analysis** window:

- In the **Scenario ID** box, enter an ID to identify the scenario.
- In the **Scenario Reference Date** box, select a date.

3. Select **Done**.

The What-If Analysis is created and linked to the main analysis. The **Analysis** workspace appears.

Note:

- If needed, modify Analysis Details values in the [available fields](#), and then select  to save your changes.
- If the Source of Calculated Corrosion rate is set to Asset or Component on the related component and the related TML asset has more than 1000 TMLs where the related TML Corrosion Analysis has not been calculated, you need to calculate the asset in the Thickness Monitoring module before continuing.

Results

- The Analysis ID of the What-If Analysis is in the following format: W <Analysis ID of the main analysis> <Number>, where <Number> is the sequential number of the What-If Analysis.
- All the fields (with a few [exceptions](#)) in the What-If Analysis are populated with values in the main analysis fields.
- The Consequence Evaluation, Degradation Mechanisms (DMs), and Degradation Mechanism Evaluations (DMEs) linked to the main analysis are copied and linked to the What-If Analysis.

Calculate an RBI Criticality Analysis

Before You Begin

- Make sure that you have entered values in all the [required fields](#). Otherwise, the calculation fails.
- Make sure that a DM is linked to the RBI Criticality Analysis. Otherwise, the calculation fails.

About This Task

This topic describes how to calculate a single RBI Analysis. In addition to an individual analysis, you can also calculate:

- [All analyses associated with a Process Unit.](#)
- [All analyses associated with a single asset or Corrosion Loop.](#)
- [All analyses associated with multiple assets.](#)

Tip: This procedure also applies to calculating a What-If Analysis.

Procedure

1. [Access the RBI Criticality Analysis](#) that you want to calculate.
2. Select .

Note: The  button is enabled only for [RBI Analyses in the Created state](#).

The **Analysis Calculation** window appears, displaying the calculation progress and a log detailing any errors. If the calculation fails, a list of the required fields appear in an error report at the bottom of the **Analysis Calculation** window.

3. After the calculation is complete:
 - To view log details, select **View Complete Log**.
 - To close the window, select **Close**.

The RBI Criticality Analysis is calculated.

Calculate all RBI Criticality Analyses Associated with a Process Unit

Before You Begin

- Ensure that you have entered values in all the [required fields](#). Otherwise, the calculation fails.
- Make sure that a DM is linked to each of the RBI Criticality Analyses. Otherwise, the calculation fails.

About This Task

This topic describes how to calculate all RBI Analyses associated with a single Process Unit. You can also calculate:

- [A single analysis](#)
- [All analyses associated with a single asset or Corrosion Loop.](#)
- [All analyses associated with multiple assets.](#)

Procedure

1. Access the [Unit Summary workspace](#).

2. On the upper-right corner of the page, select .

This begins the calculation of any RBI 580, RBI 581, PRD, or Pipeline analyses associated with the process unit.

The **Analysis Calculation** window appears, displaying the calculation progress and a log detailing any errors. If a calculation fails, a list of the required fields appear in an error report at the bottom of the **Analysis Calculation** window.

3. After the calculation is complete:

- To view the log details for all calculated analyses, select **View Complete Log**.
- To view the log details for a single analysis, in the list, select that analysis.
- To close the window, select **Close**.

The RBI Criticality Analyses for the selected Process Unit are calculated.

4. Optionally, if you want to view the status of all bulk analyze operations, on the upper-right corner of the **Risk Based Inspection Overview** page, select .

The **Schedule Logs** page appears, displaying a list of all the operations in GE Digital APM that are in progress, along with the percentage of completion. You can also access a list of operations that have been successful or have failed.

Tip: For more information on Schedule Logs, refer to the Schedule Logs section of the documentation.

Calculate all RBI Criticality Analyses Associated with a Single Asset or Corrosion Loop

Before You Begin

- Ensure that you have entered values in all the [required fields](#). Otherwise, the calculation fails.
- Make sure that a DM is linked to each of the RBI Criticality Analyses. Otherwise, the calculation fails.

About This Task

This topic describes how to calculate all RBI Analyses associated with a single Asset or Corrosion Loop. You can also calculate:

- [A single analysis](#)
- [All analyses associated with a Process Unit](#).
- [All analyses associated with multiple assets](#).

Procedure

1. Access the [Asset Summary workspace](#) of the Asset that is associated with the analyses you want to calculate.

-or-

[Access the Corrosion Loop](#) that is associated with the analyses that you want to calculate.

2. In the upper-right corner of the section, select .

This begins the calculation of any RBI 580, RBI 581, PRD, or Pipeline analyses associated with the process unit.

The **Analysis Calculation** window appears, displaying the calculation progress and a log detailing any errors. If the calculation fails, a list of the required fields appear in an error report at the bottom of the **Analysis Calculation** window.

3. After the calculation is complete:
 - To view the log details for all calculated analyses, select **View Complete Log**.
 - To view the log details for a single analysis, in the list, select that analysis.
 - To close the window, select **Close**.

The RBI Criticality Analysis is calculated.

4. Optionally, if you want to view the status of all bulk analyze operations, on the upper-right corner of the **Risk Based Inspection Overview** page, select .

The **Schedule Logs** page appears, displaying a list of all the operations in GE Digital APM that are in progress, along with the percentage of completion. You can also access a list of operations that have been successful or have failed.

Tip: For more information on Schedule Logs, refer to the Schedule Logs section of the documentation.

Calculate all RBI Criticality Analyses Associated with Multiple Assets

Before You Begin

- Ensure that you have entered values in all the [required fields](#). Otherwise, the calculation fails.
- Make sure that a DM is linked to each of the RBI Criticality Analyses. Otherwise, the calculation fails.

About This Task

This topic describes how to calculate all the RBI Analyses associated with multiple assets. You can also calculate:

- [A single analysis](#)
- [All analyses associated with a Process Unit](#).
- [All analyses associated with a single asset or Corrosion Loop](#).

Procedure

1. [Access the Risk Based Inspection Overview page](#) for the Functional Location that contains the assets for which you want to calculate all analyses.
2. If you want to calculate analyses associated with all the assets in the functional location, then proceed to step 5. You cannot, however, calculate all analyses if you have selected Home on the **Asset Hierarchy** page.

-or-

If you want to calculate analyses associated with selected assets, then in the workspace heading, select the **Assets** tab.

The **Assets** section appears.

3. Select the check boxes that correspond to the assets for which you want to calculate all analyses.
4. Select .

Note: If you have selected Home on the **Asset Hierarchy** page, and have not selected any assets, then the  button is disabled.

A message appears, specifying the number of assets that you have selected, and asking you if you want to continue.

5. Select **Yes**.

This begins the calculation of any RBI 580, RBI 581, PRD, or Pipeline analyses associated with the process unit.

The **Analysis Calculation** window appears, displaying a list of analyses that are sent for calculation, the asset and the component that each analysis is associated with, and the status of each calculation. If the calculation fails, a list of the required fields appear in an error report at the bottom of the **Calculate Analysis** window.

6. After the calculation is complete:

- To view the log details for all calculated analyses, select **View Complete Log**.
- To view the log details for a single analysis, in the list, select that analysis.
- To close the window, select **Close**.

The RBI Criticality Analysis is calculated.

7. Optionally, if you want to view the status of all bulk analyze operations, on the upper-right corner of the **Risk Based Inspection Overview** page, select .

The **Schedule Logs** page appears, displaying a list of all the operations in GE Digital APM that are in progress, along with the percentage of completion. You can also access a list of operations that have been successful or have failed.

Tip: For more information on Schedule Logs, refer to the Schedule Logs section of the documentation.

Generate a Report for an Asset

Before You Begin

- [Configure GE Digital APM to use Reporting Server](#).

About This Task

This topic describes how to generate the following types of reports:

- [Asset Summary report](#)
- [Asset Risk report](#)

Procedure

1. Access the **Asset Summary workspace** for the asset for which you want to generate the report.
2. Select , and then:
 - If you want to generate an Asset Summary report, select **RBI 580 Asset Summary Report**. The Asset Summary report appears.



RBI 580 Asset Summary Report

RBI Analysis Summary

Asset	Component	Component Type	Inspection Priority	Driving Risk
~ ~ QA RBI ACTIONS AND TASKS FOR REOCCURRING AND NONREOCCURRING RECOMMS	RBICOMP- ~ ~ QA RBI ACTIONS AND TASKS FOR REOCCURRING AND NONREOCCURRING RECOMMS-CS-1970	Heat Exchanger-Shell	8	MEDIUM HIGH

Inspection Management Summary

Task ID	Equipment ID	Task Type	Last Date	Task State
REOCCURRING TASK1	QA RBI ACTIONS AND TASKS FOR REOCCURRING AND NONREOCCURRING RECOMMS	FLOOR SCAN	8/5/2016 8:00:00 AM	SCHEDULED WITHOUT CHANGE
REOCCURRING TASK2	QA RBI ACTIONS AND TASKS FOR REOCCURRING AND NONREOCCURRING RECOMMS	FFS	8/5/2016 8:00:00 AM	SCHEDULED WITHOUT CHANGE

Thickness Monitoring Summary

TML Group ID	Remaining Life	Controlling Corrosion Rate
TMLGRP-64253061431	119.9984	10.0001
TMLGRP-64253061431	-24	18.0025
TMLGRP-64253061923		
TMLGRP-64253061923	55.1193	19.8326

-or-

- If you want to generate an Asset Risk report, select **RBI 580 Asset Risk Report**. The Asset Risk report appears.



RBI 580 Asset Risk Report

Equipment	Description					
RBI EQU PP W ANLYS						
Component	RBICOMP- ~ ~ RBI EQU PP W ANLYS-PP-1493					
Damage Mechanism	Criticality Calculator External Corrosion					
Risk Assessment Ref	RBI-64253029728			Date of Analysis	6/5/2014 1:47:44 PM	
Corrosion Rate	0.004			Estimated Half Life		
Risk Assessment	FLAM-COF	TOX-COF	PL-COF	POF	Priority	Risk Category
	E	E	A	4	10	HIGH
Inspection Technique	CUI					
Periodicity	0			Required Effectiveness		
Recommendation ID	REC-1909					
Recommendation Scope	Profile RT may be used for piping 10" or less in diameter, otherwise strip and visually examine a minimum of 50% of: - barrier penetrations - termination of insulation, - damaged insulation, - insulation support rings, - the number of vertical changes of direction identified as damaged for piping only					

Access the Risk Matrix for an RBI Criticality Analysis

Procedure

1. [Access the analysis](#) containing the Risk Matrix that you want to access.
2. In the workspace, in the page heading, select the area in the header that contains the Inspection Priority, Risk Category, and APM Risk data.
The **Risk Summary** section appears, displaying the **RBI Risk Matrix** subsection.

Tip: Refer to the Risk Matrix section of the documentation for details about working with the Risk Matrix.

Duplicate an RBI Criticality Analysis

About This Task

When you duplicate an RBI Criticality Analysis, you make an exact copy of the original RBI Analysis. The duplicated RBI Criticality Analysis is linked to the same RBI Component as the original RBI Criticality Analysis. To copy an RBI Criticality Analysis, and link it to a different RBI Component, you can [apply an RBI Analysis](#).

Procedure

1. Perform one of the following sets of steps:
 - a) [Access the component](#) that contains the RBI Criticality Analysis that you want to duplicate.
 - b) Expand the **COMPONENT OVERVIEW** section.
 - c) Below the graph, select the check box next to the RBI Criticality Analysis that you want to duplicate, and then select .

-or-

- a) [Access the analysis that you want to duplicate.](#)
- b) In the navigation pane, select .

The **Select Degradation Mechanisms** window appears.

Only [Degradation Mechanisms \(DMs\)](#) that can be applied to the duplicated analysis appear in the window. By default, the check boxes next to all the Degradation Mechanisms are selected.

2. If you do not want a particular DM to be applied, clear the check box that corresponds to the DM.
3. If you want the Recommendations to be copied, select the **Copy Recommendations for Degradation Mechanisms** check box. You can select this check box only if the **Enable Recommendation To be Generated at Created State** check box in the [Global Preferences](#) workspace is selected.
4. Select **Done**.

The RBI Criticality Analysis is duplicated.

Note:

- Similarly, you can duplicate a What-If Analysis regardless of its state. The duplicated What-If Analysis is a copy of the main RBI Analysis.
- If the Source of Calculated Corrosion rate is set to Asset or Component on the related component and the related TML asset has more than 1000 TMLs where the related TML Corrosion Analysis has not been calculated, you must calculate the asset in the Thickness Monitoring module before continuing.

Results

- All the DMs that you have selected are copied and linked to the duplicated analysis.
- If you have selected the **Copy Recommendations for Degradation Mechanisms** check box, then Recommendations are also copied.

Apply an RBI Criticality Analysis

About This Task

When you apply an RBI Criticality Analysis, you make a copy of the original RBI Criticality Analysis. The applied RBI Criticality Analysis is not automatically linked to the original RBI Component. Instead, the applied RBI Criticality Analysis can be linked to any RBI Component of the same type as the source component. To copy an RBI Criticality Analysis and link it to the same RBI Component, you can [duplicate an RBI Criticality Analysis](#).

Procedure

1. Perform one of the following sets of steps:
 - a) [Access the component](#) that contains the RBI Criticality Analysis that you want to apply.
 - b) Expand the **COMPONENT OVERVIEW** section.
 - c) Below the graph, select the check box next to the RBI Criticality Analysis that you want to apply, and then select .

-or-

- a) [Access the analysis that you want to apply.](#)

- b) In the navigation pane, select .

The **Select Degradation Mechanisms** window appears.

Only **Degradation Mechanisms (DMs)** that can be applied to the duplicated analysis appear in the window. By default, the check boxes next to all the Degradation Mechanisms are selected.

2. In the **Hierarchy** section, navigate to and select the asset that contains the RBI Component to which you want to apply the analysis.

A list of available RBI Components in the selected asset appears in the **Available RBI Components** section.

3. Select the RBI Components to which you want to apply the analysis.

The selected RBI Components appear in the **Selected RBI Components** column.

4. Select **Next**.

A list of Degradation Mechanisms (DMs) linked to the analysis appears.

5. In each row containing the DMs that you want to link to the new analysis, ensure that the check box is selected.

6. Select **Done**.

The RBI Criticality Analysis is applied.

Finalize Risk of an RBI Criticality Analysis

You can modify the state of an RBI Criticality Analysis based on the available operation. For more information on State Assignments and Operations, refer to [About RBI Criticality Analysis State Assignments and Operations](#).

Procedure

1. [Access the analysis](#) whose state you want to modify.
2. Select the button that indicates the current state of the analysis (that is, Created).

A menu appears, displaying a list of operations that you can perform on the analysis to modify its state.

3. Select **Finalize Risk**, and then select **Done**.

Note: You can modify the state of an analysis to Risk Completed only if you have calculated the analysis.

The state of the RBI Criticality Analysis is modified, and an Inspection Plan is created and linked to the parent asset of the analysis.

Note:

- If you want to access the Inspection Plan, select the **Inspection Plan** link.
- When an RBI Criticality Analysis is not in the Created state, you cannot modify the analysis and the related Consequence Evaluations, Degradation Mechanisms, and Degradation Mechanism Evaluations through the Risk Based Inspection (RBI) module. You can, however, modify the fields that are not disabled when the record is accessed through Record Manager.

Next Steps



- [Generate Recommendations for a Single RBI Criticality Analysis](#) on page 125.

Finalize Risk of Multiple RBI Criticality Analyses

About This Task

This topic describes how to finalize risk of the analyses that are linked to multiple assets or Corrosion Loops. You can finalize risk of only the analyses that are calculated and are in the Created state. You cannot finalize risk of multiple analyses that belong to the same component. In such cases, the status of the analyses that belong to the same component are not changed, however, the status of the remaining analyses are updated to Risk Completed.

Procedure

1. Access the [Risk Based Inspection Overview page](#), and then select the **Assets** tab.
or
Access the [Unit Summary workspace](#) of the Process Unit that is linked to the Corrosion Loops.
2. In the **Assets** section, select the check boxes that correspond to the assets that contain the analyses for which you want to finalize risk.
or
Select the check box for each Corrosion Loop containing analyses for which you want to finalize risk.
The  button is enabled.
3. Select .
- The **Finalize Risk** window appears, displaying any RBI 580, RBI 581, PRD, or Pipeline analyses that are calculated, and are in the Created state.
4. Select the check box for each analysis for which you want to finalize risk.
The **Finalize Risk** button is enabled.
5. Select **Finalize Risk**.
The selected analyses are moved to the Risk Completed state.
Note: If an Inspection Plan does not exist for the parent asset of the analyses, an Inspection Plan is created and linked to the asset.
6. Select **Close**.

Next Steps

- [Generate RBI Recommendations for Multiple RBI Criticality Analyses](#) on page 126.

Delete an RBI Criticality Analysis

Before You Begin

You cannot delete an RBI Criticality Analysis if it is Active, has a child analysis, or has Recommendations.

- If an RBI Criticality Analysis has a child analysis, delete the child analysis.
- If an RBI Criticality Analysis has Recommendations, delete the recommendations.

Procedure

1. [Access the component](#) containing the RBI Criticality Analysis that you want to delete.
2. Below the graph, in the row containing the Analysis ID that you want to delete, select the check box, and then select .

A message appears, asking you to confirm that you want to delete the RBI Criticality Analysis.

3. Select **Yes**.

The RBI Criticality Analysis is deleted.

Chapter 7

Inspection Groups

Topics:

- [About Inspection Groups](#)
- [About Inspection Grouping Criteria](#)
- [About Representative and Represented Asset Selection Criteria](#)
- [About Modifying an Inspection Group](#)
- [About Activating a Group](#)
- [About Representative Inspections](#)
- [About Represented Inspections](#)
- [About Inspection Grouping Recommendations](#)
- [Create Inspection Groups](#)
- [Access Inspection Groups](#)
- [Modify an Inspection Group](#)
- [Activate an Inspection Group.](#)
- [Access an Inspection Plan](#)
- [Approve an Inspection Plan](#)
- [Implement an RBI Recommendation to an Inspection Task](#)
- [Generate a Report for the Inspection Event](#)
- [Specify Inspection Task as Complete](#)
- [Access Represented Inspections](#)

About Inspection Groups

API specifications state that, asset that require inspections can be grouped based on pre-defined criteria, and inspections can be performed on a subset of the group. The Assets within this subset are called Representative Assets. The inspections performed on this subset can represent actual inspections for certain Assets that are not a part of the subset. Assets that are represented by this subset are called Represented Assets. The RBI module facilitates this workflow by allowing you to create and manage Inspection Groups.

An Inspection Group represents a collection of assets within a process unit, that are related to similar RBI Components. These RBI components are grouped in such a way that inspections performed on the asset associated with one RBI Component will satisfy the inspection requirements for the pieces of asset associated with other RBI Components within the same group.

Note: Inspection Grouping can only be performed on asset within a process unit that have active [RBI 580 Risk Analysis](#). You cannot create Inspection Groups for RBI Components that are linked to RBI PRD Criticality Analysis, Pipeline Analysis, or RBI 581 Analysis records.

In GE Digital APM, an Inspection Group is represented by an Inspection Group record and its related Grouping Element records.

- **Inspection Group:** An Inspection Group record stores information about the attributes that are shared by all RBI Components included in the Inspection Group.
- **Grouping Element:** Grouping Element records store information about the RBI Components included in the Inspection Group.

Each Grouping Element identifies one of the following types of assets related to RBI Components in the Inspection Group:

- **Representative Assets:** Representative Assets are equipment for which you must perform an inspection in order to meet the inspection requirements defined by API specifications. Each Grouping Element record that is classified as a Representative Asset meets the following criteria:
 - The Selected for Inspection field in the record contains the value True.
 - The record is linked to at least one other Grouping Element record and is the predecessor in the Represents Inspections relationship definition.
- **Represented Assets:** Represented Assets are equipment for which the inspection requirements will be satisfied by the Representative Assets. Each Grouping Element record that is classified as a Represented Asset meets the following criteria:
 - The Selected for Inspection field in the Grouping Element record contains the value False.
 - The record is linked to another Grouping Element record and is the successor in the Represents Inspections relationship definition.

An Inspection Group can contain Grouping Element records where the Selected for Inspection field is set to True, but for which there are no Represented Assets. This means there is no relationship between these Grouping Element records and other Grouping Element records. In this case, inspections are required on the associated pieces of asset, but those inspections cannot satisfy the inspection requirements of other pieces of asset in the Inspection Group.

This concept is illustrated in the following image that shows a part of the RBI data model.

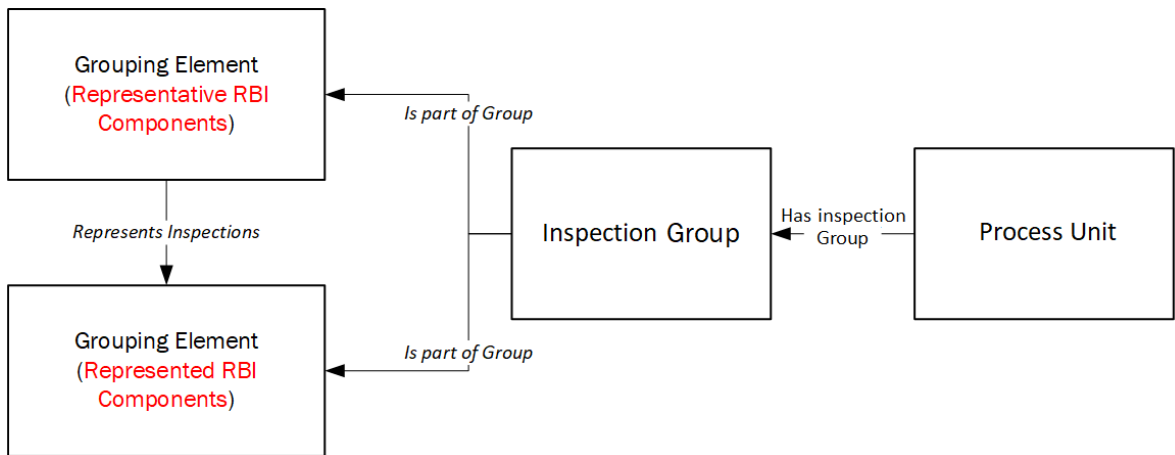

GE Digital APM allows grouping to be performed for all asset belonging to a process unit. The associated RBI Components are categorized based on the following criteria:

- Equipment Type
- Corrosion Type
- Risk Category

Equipment Type

The Equipment Type of an RBI Component identifies the type of equipment associated with that RBI Component, and corresponds with the value in the Component Type field in the associated Criticality Calculator RBI Components record.

Not every value in the Component Type field in Criticality Calculator RBI Components records is associated with an Equipment Type for which an Inspection Group can be created. The following table lists the Equipment Types for which you can create Inspection Groups and the Component Type values that correspond to each Equipment Type.

Equipment Type	Corresponding Component Type values
Piping	Any value that includes the word PIP.
Vessels	Any of the following values: <ul style="list-style-type: none"> • Air Cooled Exchanger-Header • Column-Bottom • Column-Middle • Column-Top • Filter • Heat Exchanger-Channel • Heat Exchanger-Shell • Pressure Vessel • Reactor
Tanks	Storage Tank

The Equipment Type is stored in the Grouping Equipment Type field in the Inspection Group record for an Inspection Group.

Corrosion Type

The following table lists the Corrosion Types for which you can create Inspection Groups and the RBI Degradation Mechanisms records and additional criteria that correspond to each Corrosion Type.

Corrosion Type	RBI Degradation Mechanisms record	Additional Criteria
Corrosion Under Insulation (CUI)	The RBI Criticality Analysis must have one related Criticality Calculator External Corrosion.	The Insulated? field in the associated Criticality Calculator RBI Components record contains the value True. The Susceptible to CUI field in the associated RBI Criticality Analysis record contains the value Yes.
Internal Corrosion (ICPC)	The RBI Criticality Analysis must have one related Criticality Calculator Internal Corrosion.	The Thinning Type field in the associated RBI Degradation Mechanism Evaluation (DME) record contains the value General. For piping components, the value in the Injection Point Circuit field should be set to False in the Criticality RBI Component - Piping record.

The Corrosion Type associated with an Inspection Group is stored in the Corrosion Type field of the Inspection Group record.

The following steps provide the general workflow for using the Inspection Grouping functionality:

- Create Inspection Groups.
- Modify Inspection Groups.
- Generate RBI Recommendation records to be linked to the Inspection Group.
- Specify Inspection Task as complete to generate represented inspections.

Risk Category

The Risk Category for an RBI Component is determined based on the value stored in the Inspection Priority (Unmitigated Risk) field in the RBI Degradation Mechanisms record linked to the associated RBI Criticality Analysis of the Criticality Calculator RBI Components record.

The RBI Components are assigned one of the following Risk Categories based on the defined Inspection Priority Ranges:

Risk Category	Inspection Priority Range
High	1-5
Medium High	6-12
Medium	13-19
Low	20-25

The Risk Category associated with an Inspection Group is stored in the Risk Category field in the Inspection Group record for that Inspection Group. When Inspection Groups are created, for Components belonging to the same Asset but assigned to different Risk Categories, the Components assigned to the higher risk category will be selected for inspection.

About Inspection Grouping Criteria

This topic has been intentionally excluded from the GE Digital APM product documentation website. This topic is available to you via the product documentation that is provided within the GE Digital APM system.

About Representative and Represented Asset Selection Criteria

This topic has been intentionally excluded from the GE Digital APM product documentation website. This topic is available to you via the product documentation that is provided within the GE Digital APM system.

About Modifying an Inspection Group

You might want to make changes to Inspection Groups on the basis of information that is not captured in GE Digital APM. For example, your organization might have policies that mandate a certain inspection schedule for some pieces of asset for which, unique circumstances exist. In this case, you can modify values in certain fields for an Asset belonging to an Inspection Group that is not activated or archived. The values in the Selected for Inspection and Excluded from Group fields can be modified to ensure consistency with the policies of your organization on inspection practices.

Inspection Groups that are in the Proposed state can be modified by:

- Excluding an Asset from an Inspection Group
- Selecting an additional Asset that requires inspection in an Inspection Group

Exclude an Asset from an Inspection Group

Assets can be excluded from an Inspection Group. After excluding an Asset from an Inspection Group that has been classified as a Representative Asset, you must refresh the Inspection Group. This allows the system to re-evaluate the Representative and Represented Asset classifications in the Inspection Group to determine whether changes need to be made to the Inspection Group.

This is necessary because the number of Representative Assets that are selected for an Inspection Group is based on a percentage of the total number of Assets that are included in the Inspection Group. Refreshing the Inspection Group ensures that the number of Representative Assets remains consistent as per the grouping criteria for the Corrosion Type, Equipment Type, and Risk Category.

Select Additional Assets for Inspection

When you evaluate the Representative and Represented Assets in an Inspection Group, you might decide that certain Assets that were not selected as Representative Assets by the system require an inspection.

When you select additional Assets for inspection, these Assets will not be considered as Representative Assets by GE Digital APM. Inspections will be generated for such Assets, but their inspections will not satisfy the inspection requirements for any other pieces of asset.

You cannot select an additional Asset for inspection in an Inspection Group whose Corrosion Type is CUI and Risk Category is Low.

About Activating a Group

When an Inspection Group is created, its state is set to Proposed. An Inspection Group in a Proposed state can be activated. You can activate an Inspection Group by changing the state of the group from Proposed to Implemented or Not Implemented. After activating an Inspection Group, no additional modifications are possible for the group.

After you have reviewed an Inspection Group, and are satisfied with the Representative and Represented Asset classifications for the group, you can implement the group. After you implement the Inspection Group, RBI Recommendation records are generated based on these classifications.

To implement an Inspection Group, the following conditions must be satisfied:

- The **Recommendation Creation Enabled** check box must be selected in the **Global Preferences** workspace.
- The **Enable Inspection Group** check box must be selected in the **Global Preferences** workspace.
- The Policy and Inspection Strategy records necessary to create the RBI Recommendation records for the Inspection Groups must exist.

If you have reviewed an Inspection Group and do not want to have RBI Recommendation records generated for the Inspection Group, you can choose not to implement the group. In this case, you must activate the Inspection Group to the Not Implemented state. When you activate an Inspection Group record to either the Implemented or Not Implemented state, any existing activated Inspection Group within the Process Unit with the same Equipment Type, Corrosion Type, and Risk Category will be archived.

About Representative Inspections

Representative Inspections are inspections performed on Representative Assets in an Inspection group. An inspection report can be generated for an Inspection Task created from an RBI Recommendation for a Representative asset. These inspections have the value in the Is Representative Inspection field set to True.

These inspections can be viewed in the **Inspection Management Overview** page. In the **Inspection Overview** workspace, these inspections are indicated by Representative Inspection | <Inspection Group Name>. However, this indication appears only when the **Enable Inspection Grouping** check box is selected in the **Global Preferences** workspace. You can choose to generate represented inspections for all Assets represented by the representative inspections by selecting the **Inspection Task Complete** check box in the inspection report.

About Represented Inspections

You can choose to generate represented inspections when the representative inspections are completed on the Representative Assets belonging to an Inspection group. The represented inspections have the value in the Is Represented Inspection field set to True.

These inspections belong to the General Inspection family, and can be viewed in the **Inspection Management Overview** page. In the **Inspection Overview** workspace, these inspections are indicated by Represented Inspection | <Inspection Group Name>. However, this indication appears only when the **Enable Inspection Grouping** check box is selected in the **Global Preferences** workspace.

Note: Represented inspections will have a lower inspection confidence than the associated representative inspection because actual inspection is performed on the Representative Asset.

About Inspection Grouping Recommendations

RBI Recommendation records for Inspection Grouping are generated for Representative and Represented Assets when you implement a group. These records are created at different points in the RBI workflow than the records that are created based on the results of an RBI Analysis. However, these two sets of RBI Recommendation records are similar, that is, they allow you to create Inspection Task records from the Inspection Plan page or from Asset Strategy Management. In addition, the Policy and Inspection Strategy records are used to generate RBI Recommendation records.

For RBI Recommendation records that are generated from Inspection Groups, certain Inspection Strategy records with values mapped to the RBI Recommendations indicate that no action must be taken on behalf of the associated Asset. The following types of RBI Recommendation records are generated from Inspection Groups:

- **Perform Inspection:** These RBI Recommendation records indicate that you must perform inspection on the piece of an asset associated with the record. This type of RBI Recommendation records are generated for Grouping Element records that contain the value True in the Selected for Inspection field.
- **Do Not Perform Inspection:** These RBI Recommendation records indicate that no inspection is required to be performed for the piece of an asset associated with the record. Such RBI Recommendation records are generated for Grouping Element records categorized as Represented Assets. The inspection performed on the associated Representative Asset fulfills the inspection requirement for these Assets. The Recommended Inspection Scope field contains the following value. No Inspection recommended. Inspection performed on ~ <Representative Asset>
The value in the Recommended Interval field is set to 0. Inspection tasks cannot be created for a Do Not Perform recommendation.

Note: RBI Recommendation records are not generated for Inspection Groups whose Risk Category is Low and Corrosion Type is Corrosion Under Insulation because such groups cannot be implemented.

Create Inspection Groups

This topic describes how to create Inspection Groups for a Process Unit.

Before You Begin

- Ensure that you have [enabled Inspection Grouping from the Global Preferences workspace](#).
- Ensure that you have [calculated all RBI 580 Criticality Analyses associated with the Process Unit](#).
- Make sure that the Process Unit has Asset with active analysis.

Procedure

1. [Access the Risk Based Inspection Overview page](#).
2. In the workspace, select the **Process Units** tab.
The **Process Units** section appears, displaying a list process units.
3. Select the row corresponding to the process unit for which you want to create Inspection Groups.
The **Open Inspection Group** button is enabled.
4. Select **Open Inspection Group**.
The **Inspection Group Assets** section appears.

- In the left pane, select  .
The **Create New Inspection Group** window appears.
- Based on the categories that you want to include in the Inspection Groups, select values in the **Corrosion Type**, **Grouping Equipment Type**, and **Risk Category** drop-down list boxes.
Note: You must select at least one value in each drop-down list box.
Tip: In a drop-down list box, to select or clear all values, hover over the box, and then select or clear the check box.
- Select **Create**.
The job status appears in the page heading, displaying the progress of the job.

Results

If the job is successful, the Inspection Groups are created, and appear in the left pane.

Note: All the Inspection Groups that are created will be in the Proposed state. If you create Inspection Groups when Inspection Groups already exist for the Process Unit, all pre-existing Inspection Groups with the same Equipment Type, Risk Category, and Corrosion Type in the Proposed state are deleted, and are replaced with new groups.

Next Steps

[Modify Inspection Groups.](#)

Access Inspection Groups

Before You Begin

Make sure that you have [created Inspection Groups for the process unit.](#)



About This Task

This topic describes how to access Inspection Groups for a process unit.

Procedure

- Access the [Risk Based Inspection Overview](#) page.
- In the workspace, select the **Process Units** tab.
The **Process Units** section appears, displaying a list process units.
- Select the row containing the process unit for which you want to access Inspection Groups, and then select **Open Inspection Group**.
The page containing all the Inspection Groups for the selected process unit appears.

Tip: You can perform the following actions in the **Inspection Group Assets** section:

- Set column preferences:** Select  to access the **Table Settings** window, where you can set column preferences for the table.
- Apply filter criteria:** Select  to access the **Filter Columns** window, where you can apply filter criteria for the table.

To filter Inspection Groups in the left pane, perform the following actions:

- Select , and then select or clear the **Archived Groups** check box to show or hide Inspection Groups that are in the archived state.

- Select , and then select or clear the **Active Groups** check box to show or hide activated Inspection Groups.
- Select **Apply** to apply the filters. To clear all the applied filters, select **Clear**.

You can access the datasheet for the Inspection Group record in the **Inspection Group Details** section.

Modify an Inspection Group

You can modify an Inspection Group that is in the Proposed state.

Before You Begin



Make sure that you have created Inspection Groups for the selected process unit.

About This Task

This topic describes how to modify Inspection Groups.

Procedure

1. [Access the Inspection Groups](#) for the process unit.
2. In the left pane, select the Inspection Group that you want to modify.

Note: Only the Inspection Groups that are in the Proposed state can be modified.
3. To exclude an Asset from an Inspection Group, perform the following steps:
 - a) For the row corresponding to each grouping element that you want to exclude from the Inspection Group, select the check box under the **EXCLUDED FROM GROUP** column.
A message appears suggesting that the selections for inspections need updating.
 - b) Select .
The Inspection Group is refreshed, and new grouping element records are categorized as Representative Assets to satisfy the minimum Asset selection percentage criterion.
 - c) Select .

The selected Assets are excluded from the Inspection Group.

Note: If you select  after selecting the check box under the **EXCLUDED FROM GROUP** column without refreshing the group, the minimum Asset selection percentage criterion is not satisfied. This can lead to data inconsistency.

4. To select an additional Asset for inspection in an Inspection Group, perform the following steps:
 - a) For the row corresponding to the Asset that requires inspection, select the check box under the **SELECTED FOR INSPECTION** column.

Note: You cannot clear this check box for Assets that are selected for inspection by the system.
 - b) If you want to refresh the Inspection Group to optimize the number of Assets that are selected for inspection, select . If you want to save the changes without optimizing the number of Assets, proceed to the next step.

Note: When the Inspection Group is refreshed, certain Representative Assets are categorized as Represented Assets, while the minimum Asset selection percentage criterion is still satisfied.
 - c) Select .

For the Grouping Element records, the value in the Selected for Inspection field is to set to True, and the value User Defined appears in the **SELECTION BASIS** column.

Note: The value in the **SELECTION BASIS** column and the current selection percentage is updated only after you select .

Results

The selected Inspection Group is modified.

Tip: To reset the changes and revert all the check boxes under the **SELECTED FOR INSPECTION** and **EXCLUDED FROM GROUP** columns to their original states, select .

Note: You cannot modify an Inspection Group whose Corrosion Type is CUI and Risk Category is Low.

Next Steps

[Activate an Inspection Group.](#)

Activate an Inspection Group.

Before You Begin

Make sure that you have reviewed the Assets that are selected for inspection for the Inspection Group.

About This Task

This topic describes how to change the state of an Inspection Group from Proposed to Implemented or Not Implemented.

Procedure

1. [Access the Inspection Groups](#) for the process unit.
2. In the left pane, select the Inspection Group that you want to activate.
3. To change the state of the group from Proposed to Implemented, in the **Proposed** box, select **Implement**, and then select **Done**.
The **Activate Inspection Group** window appears asking you to confirm if you want to perform the Implement operation.
4. To change the state of the group from Proposed to Not Implemented, in the **Proposed** box, select **Do not Implement**, and then select **Done**.
The **Activate Inspection Group** window appears asking you to confirm if you want to perform the Do not Implement operation.
5. Select **Yes**.

Results

- The selected Inspection Group is activated, and based on the action that you have performed, the state of the selected group is changed to Implemented or Not Implemented, and the  icon appears next to the group name in the left pane.
- After the Inspection Group is activated, no further changes can be made to the Grouping Element records.
- After an Inspection Group record is activated (to either the Implemented or Not Implemented state), any existing activated Inspection Group within the Process Unit with the same Equipment Type, Risk

Category, and Corrosion Type are archived. When an Inspection Group is archived, Inspection Tasks are unlinked from the RBI Recommendation.

- The RBI Recommendations that are generated when you activate an Inspection Group will recommend an action based on the defined inspection strategies and policy records. When the Inspection Group is implemented, the following types of RBI Recommendations are generated:
 - For Assets that are selected for inspection, the Perform Inspection recommendations are generated.
 - For Represented Assets, the Do Not Perform Inspection recommendations are generated.

Note: You cannot implement an Inspection Group and generate RBI Recommendation records if the **Recommendation Creation Enabled** check box is cleared in the **Global Preferences** section of the **RBI Admin Preferences** page. In addition, you cannot implement an Inspection Group whose Corrosion Type is CUI and Risk Category is Low.

Access an Inspection Plan

You can access the Inspection Plan for an Asset to view the RBI Recommendation records associated with the Asset.

Procedure

1. [Access the Inspection Groups](#) for the process unit.
2. In the left pane, select the Inspection Group containing the grouping element for which you want to access the Inspection Plan.
A table of RBI Components in the Inspection Group appears in the **Inspection Group Assets** section.
3. Select the row corresponding to the grouping element for the related Asset for which you want to access the Inspection Plan, select **Open**, and then select **Inspection Plan**.
The **Inspection Plan** page containing the RBI Recommendation records for the selected grouping element appears.

Approve an Inspection Plan

Any user with the MI Inspection Plan Approver Security Role can move an Inspection Plan to the Approved state. RBI Recommendations within an approved Inspection Plan can be implemented as Inspection Tasks.

About This Task

Procedure

1. [Access the Inspection Plan that you want to approve](#).
2. In the **Proposed** box, select **Approve**, and then select **Done**.
The job status appears in the page heading, displaying the progress of the job. When the Inspection Plan is approved, a message appears, stating that the Inspection Plan has been approved.

Note:

- After you approve an Inspection Plan, you cannot delete, supersede, or designate recommendations as Not Required. You must first move them to the Modified state.
- While the Inspection Plan is being modified, you cannot delete, supersede, or designate recommendations as Not Required.

Next Steps

[Implement RBI Recommendations to Inspection Tasks.](#)

Implement an RBI Recommendation to an Inspection Task

You can create a new Inspection Task or link existing Inspection Tasks to an RBI Recommendation that is in the Approved state in an Inspection Plan.

Before You Begin

- Make sure that the **Implement Recommended Actions to Tasks in ASM** setting is set to False in the **Global Preferences** section of the **RBI Admin Preferences** page.
- You must have an Inspection Plan that is in the Approved state.

Procedure

1. [Access the Inspection Plan](#) that contains the RBI Recommendations that you want to implement as tasks.
2. Next to each RBI Recommendation that you want to implement, select the check box.
3. Select **Implement**.

Note: RBI Recommendations for represented Assets cannot be implemented as tasks. In addition, the Do Not Perform Inspection Grouping Recommendations cannot be implemented as tasks.

The **Implement as Inspection Task** window appears.

4. Select one of the following:

Action	Description
Create New	Creates a new task that is linked to the RBI Recommendation. The new task is assigned a Task ID, and the Task ID appears in the Task ID column for the respective RBI Recommendation.
Link Existing	Allows you to select an existing Inspection Task to link to the RBI Recommendation. The task uses the existing Task ID. Note: You cannot link non-reoccurring tasks to reoccurring recommendations.

5. Select **Implement**.
The Inspection Task is linked to the RBI Recommendation and appears in the **Existing Tasks** section of the **Inspection Plan** page.

The Inspection Task fields are populated with the following values:

Field	Value
Desired Interval	The least value among the following: <ul style="list-style-type: none"> The value in the Interval field The value in the RBI Half-Life field in the associated Degradation Mechanism Evaluation The value in the TM Half-Life field in the associated Asset Corrosion Analysis Time-Based Inspection Settings Note: If you are linking to an existing Inspection Task, this field is populated only if the value in the Override Interval field is False and the value in the Reoccurring field is True.
Desired Interval Basis	The value of the Interval Basis that corresponds to the Interval field Note: If you are linking to an existing Inspection Task, this field is populated only if the value in the Override Interval field is False and the value in the Reoccurring field is True.
Last Date	The value in the Creation Date field
Next Date	The value in the Target Completion Date field Note: This field is populated only when the RBI Recommendation field, NonRecurring? is true.
Task ID	The value in the Degradation Mechanism field concatenated with the value in the Task Type field Note: If you are linking to an existing Inspection Task, this field is not populated.
Task Type	The value in the Task Type field

Generate a Report for the Inspection Event

You can generate an inspection report for an inspection task. To generate an inspection report, the Inspection Management license must be active.

Before You Begin

You must have one or more inspection tasks linked to the RBI Recommendations in the inspection plan.

Procedure

1. [Access the Inspection Plan](#) containing the inspection task for which you want to generate a report.
2. In the **Existing Tasks** section of the **Inspection Plan** page, select the link corresponding to the inspection task for which you want to generate a report.
The page containing the Inspection Task datasheet for the selected inspection task appears.

3. Select **Generate Report**.
The **Create Inspection** window appears.

Note: If inspection events already exist for the inspection task, a message appears asking you to confirm if you want to create a new event.

4. Select the inspection report that you want to generate from the **Inspection Event** drop-down list box, and then select **Create**.
The **Inspection Overview** workspace for the inspection appears, displaying the **Inspection Data** section.

Note: The page heading of the report indicates the inspection type (that is, representative or represented inspection) and contains a link to return to the associated Inspection Group. The link to return to the associated Inspection Group is not available in the following scenarios:

- The associated Inspection Group is archived.
- The inspection task is not linked to an RBI Recommendation.

The inspection type is not indicated and is displayed as N/A in the following scenarios:

- The grouping element selected for inspection does not represent any Asset.
- The grouping element has the Selection Basis set to User Selected.
- The grouping element has the Selection Basis set to Temperature or Pressure Criteria in an Internal Corrosion (ICPC) Inspection Group.

Specify Inspection Task as Complete

After performing inspection on a Representative Asset, you can specify the corresponding inspection task as complete and choose to generate inspections for the associated Represented Assets. To generate represented inspections for Representative Assets, the Inspection Management license must be active.

Before You Begin

You must have generated an inspection report and performed inspection on the Representative Asset.

Procedure

1. [Access the Inspection Groups](#) for the process unit.
2. In the left pane, select the Inspection Group containing the Asset for which you want to access the inspection.
A table of RBI Components in the Inspection Group appears in the **Inspection Group Assets** section.
3. Select the row corresponding to the Representative Asset for which you want to access the inspection, select **Open**, and then select **Asset Inspection Overview**.
The **Inspection Management Overview** page for the selected Asset appears.
4. Select the **Inspections** tab.
A list of inspections for the selected Representative Asset appears.

Note: The check box under the **IS REPRESENTATIVE INSPECTION** column is selected for inspections created against the tasks generated from Inspection Group recommendations. This column appears only when Inspection Grouping is enabled from the **Global Preferences** workspace.

5. In the row containing the inspection whose data you want to access, select the link.
The **Inspection Overview** workspace for the selected inspection appears, displaying the **Inspection Data** section.
6. Select the **Inspection Task Complete** check box.
7. Select **Save**.
The inspection report is saved, and the **Generate Represented Inspections** window appears, asking you to confirm if you want to generate represented inspections for the selected inspection.
8. Perform one of the following actions:
 - a) To generate represented inspections for the selected representative inspection, select **Yes**.
The represented inspections for the Assets represented by the selected representative inspection are generated.
 - b) To return to the saved inspection report without generating represented inspections, select **No**.

Next Steps

[Access represented inspections.](#)

Access Represented Inspections

About This Task

This topic describes how to access represented inspections that are generated after you have specified the Inspection Task for the corresponding Representative Asset as complete.

Before You Begin

[Specify the Inspection Task for the Representative Asset as complete.](#)

Procedure

1. [Access the Inspection Groups](#) for the process unit.
2. In the left pane, select the Inspection Group containing the grouping element for the related Represented Asset for which you want to access the represented inspections.
A table of RBI Components in the Inspection Group appears in the **Inspection Group Assets** section.
3. Select the row corresponding to the Represented Asset for which you want to access the represented inspections, select **Open**, and then select **Asset Inspection Overview**.
The **Inspection Management Overview** page for the selected Asset appears.
4. Select the **Inspections** tab.
A list of inspections for the selected Represented Asset appears.

Note: For represented inspections, the check box under the **IS A REPRESENTED INSPECTION** column is selected. This column appears only when Inspection Grouping is enabled from the **Global Preferences** workspace.

5. In the row containing the represented inspection whose data you want to access, select the link.
The **Inspection Overview** workspace for the selected inspection appears, displaying the **Inspection Data** section.

Note: The page heading indicates the inspection type (that is, representative or represented inspection) and contains a link to return to the associated Inspection Group. The link to return to the associated Inspection Group is not available in the following scenarios:

- The associated Inspection Group is archived.
- The Inspection task is not linked to an RBI Recommendation.

Chapter 8

RBI Analysis Export

Topics:

- [About RBI Analysis Export](#)
- [Access the RBI Analysis Export Workspace](#)
- [Export Analyses](#)

About RBI Analysis Export

RBI Analysis Export workspace allows you to review analyses that you can select for the export with the related component data. You can also export the Analysis and Component data in the RBI data loader template format for easy data modification and re-importing.

Note: When exporting the existing analyses and component data in the **RBI Analysis Export** section, the (Picklist) sheet in the RBI data loader template is excluded. To reference the valid values for picklist fields, you can download the RBI data loader template in the **Data Loaders** workspace.

When to Export

- Export is useful when you want to evergreen or re-assess existing analyses based on triggers such as time, process variations, inspection, or thickness updates. These changes can include the implementation of risk mitigation strategies or maintenance based on your inspection plan.
- Export is also useful for providing a quick solution to bulk edit current analyses in the Created state and their related components. After exporting the records which need to be modified, you can update the records in the resulting excel file. After updating, you can re-import using the [RBI Data loader](#) process.

What to Export

The data displayed in the RBI Analysis Export workspace is based on the catalog query `\\Public\Meridium\Modules\Risk Based Inspection\Queries\Data Export Analyses - 580`. By default, this query returns the analyses in the Created state that are linked to RBI Components on Assets, which fall within the selected level of the asset hierarchy. This query has the following parameters:

- **Asset:** The query returns the analyses of the assets that are available after the selected value in the asset hierarchy. By default, this parameter displays the current asset hierarchy context of the RBI Overview page when you navigate to the RBI Analysis Export workspace.
- **Analysis State:** The query returns analyses for only those assets which are in the selected state, Created or Active. The default value of this parameter is Created.

The export tool takes the Component Entity Key, Asset Entity Key, and Analysis Entity Key from the selected query results to determine what data to export. The following families are considered on each exported worksheet:

- **Asset:** Equipment and Functional location
- **RBI Component:**
 - Criticality RBI Component – Cylindrical Shell
 - Criticality RBI Component – Exchanger Bundle
 - Criticality RBI Component – Exchanger Header
 - Criticality RBI Component – Exchanger Tube
 - Criticality RBI Component – Piping
 - Criticality RBI Component – Tank Bottom
- **RBI_Criticality_Analysis:** RBI Criticality Analysis
- **Consequence_Evaluation:** Criticality Consequence Evaluation and any child families of Criticality Consequence Evaluation configured through the Flexible Calculation Configurations for Consequence Evaluation Calculations
- **DME_Environmental_Cracking:** Criticality Env. Crack. Deg. Mech. Eval
- **DME_External_Corrosion:** Criticality Ext. Corr. Deg. Mech. Eval
- **DME_Internal_Corrosion:** Criticality Int. Corr. Deg. Mech. Eval

- **DME_Other:** Criticality Other Damage Mech. Eval
- **Degradation_Mechanism:** RBI Degradation Mechanisms
- **DME_Custom:** All action families configured through the Flexible Calculation Configurations for Degradation Mechanism Evaluation Calculations.

RBI Analysis Export Data

The RBI Analysis Export allows you to bulk review the analyses and related data, and subsequently import it to GE Digital APM. You can export the data in the RBI 580 Data Loader format to enable importing and updating data.

To match the RBI 580 Data Loader format, the following lookup fields are included in each sheet:

- **Asset:** Equipment ID, CMMS System, Equipment Technical Number
- **RBI_Component:** Asset Lookup Fields, Component, Component Type, Component Family
- **RBI_Criticality_Analysis:** Component Lookup Fields, Analysis Unique ID
- **Consequence_Evaluation:** Analysis Lookup Fields, Consequence
- **All DME Sheets:** Analysis Lookup Fields, Damage Mechanism
- **DME_Custom:** Analysis Lookup Fields, Damage Mechanism
- **Degradation_Mechanism:** Analysis Lookup Fields, Damage Mechanism

Following the lookup fields, datasheet fields for each family associated with the template sheet are exported with the following exceptions:

- **System Fields:** You cannot edit these fields. These fields are maintained by GE Digital APM
- **Output Fields:** These fields are calculative. You cannot set these fields. Output fields are fields, which are not copied when an analysis is duplicated. This includes fields which have been configured as output fields in the Flexible Output Preferences.

The default datasheet in the Family Management determines the fields to be exported for each family. If there is no datasheet marked as Default in Family Management for a family, then the fields from the first available datasheet is used.

System Fields Excluded from Export

These fields are usually disabled in the datasheet.

Table 1: Component System Fields

Field ID	Field Caption
MI_CCRBICOM_CALC_INV_N	Calculated Inventory
MI_CCRBICOM_EQUIP_FAMIL_C	Asset Family
MI_RBICOMPO_COMPO_STATUS_C	Component Status
MI_RBICOMPO_EQUIP_C	Asset
MI_RBICOMPO_EQUIP_TYPE_C	Asset Type
MI_RBICOMPO_FUNCT_LOCAT_C	Functional Location

Table 2: Analysis System Fields

Field ID	Field Caption
MI_AN_ANALY_ID_CHR	Analysis ID
MI_AN_ANALY_START_DATE_DT	Analysis Start Date
MI_AN_ANALY_TYPE_CHR	Analysis Type
MI_CRITANAL_COMP_C	Component
MI_CRITANAL_COMP_TP_C	Component Type
MI_CRITANAL_EQ_ID_C	Asset ID
MI_CRITANAL_EQ_ITEM_TYPE_C	Criticality Item Type
MI_CRITANAL_EQ_LOCATION_C	Location ID
MI_MRBIANAL_GEN_FAIL_FREQ_N	Generic Failure Frequency

Table 3: Degradation Mechanism Evaluation System Fields

Field ID	Field Caption
MI_CRDEMEEV_FAIL_FREQ_N	Failure Frequency
MI_RBDEMEEV_DEG_MEC_DESC_C	Degradation Mechanism Description
MI_RBDEMEEV_DF_N	DF

RBI Analysis Export Best Practices

- The RBI Analysis Export workspace displays the Analyses in the Created state by default. Using the RBI 580 Data Loader template, you can review the data for the analyses and re-import them into GE Digital APM. When you re-import the data, any modifications that are made to the RBI Analyses and RBI Component data in GE Digital APM, are updated. The RBI Analysis, CE, and DME updated are looked up based on the defined lookup fields and the Analysis Unique ID (MI_ANALYSIS_ID).
- To export an active analysis with a state other than Created and re-import it as a new analysis in a Created state, consider the following steps:
 1. Select 'Active' for the Analysis State query parameter to return the active analysis and export.
 2. Update the **MI_ANALYSIS_ID** column on the analysis, consequence evaluation and degradation mechanism evaluation sheets to a unique value before importing the file into GE Digital APM.

This creates a new Analysis with ID matching the value provided in the data loader template.

Note:

- Data will be exported using your login and culture settings.

Important: Only users with the same unit of measure and culture settings can re-import through the Risk Based Inspection (RBI) 580 Data loader.

Access the RBI Analysis Export Workspace

About This Task

Analyses displayed for export are linked to assets related to the given functional location or process unit.

Note:

- The analyses that are displayed for export are either 580 or 581 analyses. You can choose which analyses should be displayed by default by setting the value of the **RBI Analysis Type Preference** dropdown in the **RBI Overview Preferences** page.
- RBI PRD Criticality analyses and RBI Pipeline analyses are not supported for export.

Procedure

1. Access the **Risk Based Inspection Overview** page.
2. Select the **Actions** button.
3. Select **Export Analyses**.

Results

The **RBI Analysis Export** workspace appears, displaying analyses to export. By default, the analyses will be filtered based on the asset hierarchy using the key passed from the Risk Based Inspection Overview and in Created state.

Note:

- You can use the filter to change the default analyses displayed. When you select the filter button, a query prompt will be displayed where you can change the Asset Hierarchy Asset or the Analysis State.
- When both RBI 580 and RBI 581 are licensed, you can override the default preference for the type of analyses displayed for export by setting the value of the **Analysis Type** dropdown in the **RBI Analysis Export** workspace.

Export Analyses

About This Task

The RBI Export functionality allows you to export one or more analyses and its related data from the **RBI Analysis Export** page. The export allows you to bulk review analyses and its related data and subsequently import it back to GE Digital APM. To facilitate this functionality, the data is exported to a file which is in the RBI 580 Data Loader format to allow for importing and updating the data.

Note: The RBI 580 Data Loader file that is exported will contain relevant Asset, Component, Consequence Evaluation, and Degradation Mechanism Evaluation data related to the Analyses selected for export.

Procedure

1. Access the **RBI Analysis Export Workspace** page.
2. Select the check box next to each of the analysis that you want to export.
3. Select 

A message appears, asking you to confirm that you want to export one or more selected analyses.

4. Select **Yes**.

The selected analyses are exported to an excel file which is downloaded to the browser.

Note:

- The RBI 580 Data loader excel worksheets which is exported from the Evergreening page will include all fields present on the respective family's default datasheet. All fields that are considered calculated, system populated, or informational fields will not be exported.
- Exported excel worksheet field values will be updated with the logged in users culture settings and unit of measure conversion set.
- You can click the **Open Data Loaders** button to launch the **APM Data Loaders** workspace and re-import the exported data.

Chapter 9

RBI Bulk Evergreening

Topics:

- [About RBI Bulk Evergreening](#)
- [Access Analyses that are Pending Evergreening](#)
- [Duplicate Analysis for Evergreening](#)
- [Delete Analyses Created for Evergreening](#)
- [Export Evergreened Analyses](#)
- [Calculate Evergreened Analyses](#)
- [Finalize Risk for Evergreened Analyses](#)
- [Access Active Analyses](#)
- [Generate Recommendations for Active Evergreened Analyses](#)

About RBI Bulk Evergreening

RBI Bulk Evergreening is the process of duplicating active analyses in bulk based on the associated process unit or functional location. The evergreened analyses use the latest Risk Completed data available to create more up-to-date analyses for the process unit or functional location.

When to Evergreen

When an analysis is initially created, its record contains details that are observed at the time of the assessment. Evergreening is useful when a functional location or process unit has undergone changes. These changes can include the implementation of risk mitigation strategies or maintenance. Additionally, evergreening is useful after a set amount of time has passed since the previous analysis.

Batches

During the duplication process, you select or create an Evergreening Batch ID to group your evergreened analyses. You can filter analyses based on the batch in the RBI Bulk Evergreening workspace. The Evergreen Batch ID that you select will be copied to the Scenario ID field in the duplicated analysis.

Access Analyses that are Pending Evergreening

About This Task

Analyses that are ready for evergreening or pending reassessment are analyses which are active on components that are linked to assets related to the given functional location or process unit.

Note: The analyses that are ready for evergreening are either 580 or 581 analyses. You can choose which analyses you want to evergreen in the RBI Overview Preferences page in Application Settings by setting the Analysis Type Preference. Also, RBI PRD Criticality analyses and RBI Pipeline analyses are not supported for evergreening.

Procedure

- Access Analyses that are Pending Evergreening from the **RBI Bulk Evergreening** workspace:
 1. Select the **Actions** button.
 2. Select the **RBI Bulk Evergreening** option.

The **RBI Bulk Evergreening** workspace appears, displaying a list of analyses that are ready for evergreening under the **Pending Evergreening** tab.
- Access Analyses that are Pending Evergreening from the Risk Based Inspection Overview page:
 1. Select the **Pending Reassessment** tab.

The **Pending Reassessment** section appears, displaying a list of analyses that are ready for evergreening. The analyses listed have a Date Criticality Calculated that is five or more years prior to the current date.
- Access Analyses that are Pending Evergreening from a Process Unit:
 1. Access the **Risk Based Inspection Overview** page.
 2. Select the Process Units tab.

The Process Units section appears.

3. Select the process unit that you want to evergreen.

4. Select .

The RBI Bulk Evergreening workspace appears, displaying a list of analyses that are ready for evergreening. The analyses listed belong to the selected process unit.

Duplicate Analysis for Evergreening

Procedure

1. Access the [RBI Bulk Evergreening workspace from a process unit or any workspace](#).
2. In the **Ready for Evergreening** section, select the analyses that you want to duplicate.

3. Select .

The **Duplicate Active Analyses** window appears.

4. In the **Evergreen Batch ID** box:
 - Select an existing Evergreen Batch ID.
 - or-
 - Select **add caption** and enter a new scenario.

Note: The Evergreen Batch ID you select is copied to the Scenario ID field. Also, the batch you select is saved as a user preference in your browser.

5. In the **Scenario Date** box, enter a date.
6. Select **Done**.

Note: If you select an existing Evergreen Batch ID and then select **Done**, a window appears, stating the batch already exists and asking if you want to continue.

The **Created** section appears, displaying a list of analyses that have been created. A progress indicator for the duplication process appears in the **Created** section. If the analyses duplicated successfully, a green check mark appears. If there were errors in the duplication process, a red warning icon appears.

7. Optionally, if you want to view the status of all bulk analyze operations, in the **Risk Based Inspection**

Overview page, select .

The **Schedule Logs** page appears, displaying a list of all the operations in GE Digital APM that are in progress, along with the percentages of completion. You can also access a list of operations that have been successful or have failed.

Delete Analyses Created for Evergreening

Procedure

1. Access the [RBI Bulk Evergreening workspace from a process unit or any workspace](#).
2. Select the **Created** tab.

The **Created** section appears.

3. Next to each analysis that you want to delete, select the check box.

Tip: For optimal performance, GE Digital APM recommends deleting 10 or fewer analyses at a time.

4. Select .

A message appears, asking you to confirm that you want to delete one or more selected analyses.

5. Select **Yes**.

The selected analyses are deleted.

Export Evergreened Analyses

About This Task

The RBI Export functionality gives users the ability to export one or more Analyses and its related data from the Evergreening page. The export allows the user to bulk review analyses and its related data and subsequently allows to import it back to GE Digital APM. To facilitate this functionality, the data is exported to a file which is in the RBI 580 Data Loader format to allow for importing and updating the data.

Note: The RBI 580 Data Loader file that is exported will contain relevant Asset, Component, Consequence Evaluation, and Degradation Mechanism Evaluation data related to the Analyses selected for export.

Procedure

1. Access the **RBI Bulk Evergreening** workspace from a process unit or any workspace.

2. Select the **Created** tab.
The **Created** section appears.

Tip: The analyses that appear in this section are filtered by Evergreen Batch ID. The Evergreen Batch ID that appears by default is the one you selected while creating analyses; the batch that appears is also a default user preference in your browser. You can select a batch using the **Evergreen Batch** box in the **RBI Bulk Evergreening** workspace. To access all analyses, select the blank value in the box.

3. Next to each analysis that you want to export, select the check box.

4. Select .

A message appears, asking you to confirm that you want to export one or more selected analyses.

5. Select **Yes**.

The selected analyses are exported to an excel file which is downloaded to the browser.

Note:

- The RBI 580 Data loader excel worksheets which is exported from the Evergreening page will include all fields present on the respective family's Default datasheet. All fields that are considered calculated, system populated, or informational fields will not be exported.
- Exported excel worksheet field values will take into account the logged in users culture settings and unit of measure conversion set.

Calculate Evergreened Analyses

Procedure

1. Access the **RBI Bulk Evergreening** workspace from a process unit or any workspace.

2. Select the **Created** tab.

The **Created** section appears.

Tip: The analyses that appear in this section are filtered by Evergreen Batch ID. The Evergreen Batch ID that appears by default is the one you selected while creating analyses; the batch that appears is also a default user preference in your browser. You can select a batch using the **Evergreen Batch** box in the **RBI Bulk Evergreening** workspace. To access all analyses, select the blank value in the box.

3. Next to each analysis that you want to calculate, select the check box.

4. Select .

The **Analysis Calculation** window appears, displaying the calculation progress and a log detailing any errors.

5. After the calculation is complete:

- To view the log details for all calculated analyses, select **View Complete Log**.
- To view the log details for a single analysis, in the list, select that analysis.
- To close the window, select **Close**.

The evergreened analysis is calculated.

6. Optionally, if you want to view the status of all bulk analyze operations, in the **Risk Based Inspection**

Overview page, select .

The **Schedule Logs** page appears, displaying a list of all the operations in GE Digital APM that are in progress, along with the percentages of completion. You can also access a list of operations that have been successful or have failed.

Finalize Risk for Evergreened Analyses

Before You Begin

You must [calculate risk on an evergreened analysis](#) before finalizing risk.

Procedure

1. [Access the RBI Bulk Evergreening workspace from a process unit or any workspace.](#)

2. Select the **Created** tab.

The **Created** section appears.

Tip: The analyses that appear in this section are filtered by Evergreen Batch ID. The Evergreen Batch ID that appears by default is the one you selected while creating analyses; the batch that appears is also a default user preference in your browser. You can select a batch using the **Evergreen Batch** box in the **RBI Bulk Evergreening** workspace. To access all analyses, select the blank value in the box.

3. Next to each analysis for which you want to finalize risk, select the check box.

4. Select .

A window appears, confirming that you want to finalize risk for the selected analyses.

5. Select **Yes**.

The selected analyses are moved to the Risk Completed state.

Note: If an Inspection Plan does not exist on the parent asset of the analyses, a new Inspection Plan will be created and linked to the asset after the analysis has been successfully moved to the Risk Completed state.

The **Active** section appears, displaying a list of active evergreened analyses for the selected batch.

Access Active Analyses

About This Task

Active evergreened analyses are RBI Criticality Analyses for RBI Components linked to RBI Assets. These analyses were created during the bulk evergreening process, and they are not in the Created or Archived state.

Procedure

1. Access the **RBI Bulk Evergreening** workspace from a process unit or any workspace.
2. In the **RBI Bulk Evergreening** workspace, select the **Active** tab.

The **Active** section appears, displaying a list of active evergreen analyses and a count of their associated RBI Recommendations records.

Tip: The analyses that appear in this section are filtered by Evergreen Batch ID. The Evergreen Batch ID that appears by default is the one you selected while creating analyses; the batch that appears is also a default user preference in your browser. You can select a batch using the **Evergreen Batch** box in the **RBI Bulk Evergreening** workspace. To access all analyses, select the blank value in the box.

Generate Recommendations for Active Evergreened Analyses

Procedure

1. Access the **RBI Bulk Evergreening** workspace from a process unit or any workspace.
2. Select the **Active** tab.

The **Active** section appears.

Tip: The analyses that appear in this section are filtered by Evergreen Batch ID. The Evergreen Batch ID that appears by default is the one you selected while creating analyses; the batch that appears is also a default user preference in your browser. You can select a batch using the **Evergreen Batch** box in the **RBI Bulk Evergreening** workspace. To access all analyses, select the blank value in the box.

3. Next to each analysis for which you want to generate recommendations, select the check box.

Tip:

- You can generate recommendations for all listed analyses in the selected batch in the **Active** section by selecting  when all check boxes in the first column of the table are cleared. If you select the check box in the first row of the table, recommendations are generated for the analyses that appear in the current page in the **Active** section (up to 100 analyses can be displayed in a page).
- The **Recommendations** column contains a count of recommendations that are directly linked to the analysis. Consolidated recommendations (CREC) are excluded from this count.

4. Select .

The **Confirm Bulk Generate Recommendations** window appears, asking if you want to generate recommendations and generate duplicate recommendations if recommendations have already been generated.

5. Select **Yes**.

The **Generate Recommendations** window appears, asking if you want to consolidate recommendations for each Degradation Mechanism and Task Type.

Tip: If you choose to consolidate recommendations, the recommendations generated during this process will be consolidated with existing recommendations. For more information on consolidating recommendations, consult recommendation consolidation in RBI 580 and RBI 581.

6. Select **Yes**.

The Recommendations are generated. The **Recommendation Generation** window appears, displaying the progress and number of Recommendations generated and consolidated for each asset.

Note: You can close the **Recommendation Generation** window before it is complete. You can view progress using the Schedule Logs.

7. Select **Close**.

8. Optionally, if you want to view the status of all bulk operations, select .

The **Schedule Logs** page appears, displaying a list of all the operations in GE Digital APM that are in progress, along with the percentage of completion. You can also access a list of operations that have been successful or have failed.

Results

Generated recommendations are linked to the Inspection Plan of the related RBI asset.

Note:

- You can use the **Inspection Plan Summary** page to approve the Inspection Plan and implement recommendations.
- In the RBI Global Preference settings, if the **Enable Recommendation To be Generated at Created State** check box is selected, recommendations will not be linked to the Inspection Plan until the related analysis is moved to the Risk Complete state and the Inspection Plan is generated.

Chapter 10

RBI Bulk What-If Analyses

Topics:

- [About RBI Bulk What-If Analyses Creation](#)
- [Access Analyses Pending What-If Creation](#)
- [Create Bulk What-If Analyses](#)
- [Add Additional Fields to be Copied to What-If Analyses](#)
- [Delete Bulk What-If Analyses](#)
- [Export Bulk What-If Analyses](#)
- [Calculate Bulk What-If Analyses](#)
- [Finalize Risk for What-If Analyses](#)
- [Access Active What-If Analyses](#)
- [Generate Recommendations for Active What-If Analyses](#)

About RBI Bulk What-If Analyses Creation

RBI bulk What-If Analyses creation is the process of creating What-If Analyses in bulk. These analyses are created on an analysis that is not archived. It is based on the associated process unit or Functional Location. The What-If Analyses allow you to duplicate a current analysis while changing certain input values to determine the risk of possible scenarios.

When to Create What-If Analyses in Bulk

What-If Analyses allow you to analyze hypothetical situations to determine how operational and procedural changes would impact the risk associated with a component's failure on a certain date. Bulk What-If Analysis creation is useful when you want to quantify the impact of a change to a Functional Location or process unit. These changes can include the implementation of risk mitigation strategies or maintenance.

Batches

While creating What-If Analyses, you select or create an Batch ID to group your analyses. You can filter analyses based on the batch in the **RBI Bulk What-If** workspace. The Batch ID that you select will be copied to the Scenario ID field of the What-If Analyses.

Access Analyses Pending What-If Creation

About This Task

Analyses that are available for What-If creation and are linked to active components that are on assets related to the given Functional Location or process unit.

Note: The Analyses for What-If creation are either RBI Criticality Analyses or RBI 581 Risk Analyses. You can choose the type of the analysis in the **RBI Overview Preferences** page under Application Settings by setting the **Analysis Type Preference**.

RBI PRD Criticality Analyses and RBI Pipeline Analyses are not supported.

Procedure

1. Access the **Risk Based Inspection Overview** page.
2. Select **Actions > Bulk Create What-If Analyses**.
The **Bulk Create What-If Analyses** workspace appears, displaying the **Pending What-If Analysis Creation** section with a list of analyses available for What-If creation.

Create Bulk What-If Analyses

Procedure

1. [Access Analyses Pending What-If Creation](#) on page 93.
2. In the **Pending What-If Analysis Creation** section, select the analyses for which you want to create What-If Analyses.
3. Select .
The **Bulk Create What-If Analyses** window appears.
4. In the **Batch ID** box:

- If you want to use an existing batch, select an existing Batch ID.
- If you want to create a new batch, select **add caption**, and enter a new scenario.

Note: The Batch ID you select is copied to the Scenario ID field. Also, the batch you select is saved as a user preference in your browser.

5. In the **Plan Date** box, enter a date.
6. Set any additional values you would like to copy to the what-if analysis in the **Common Fields** section.

Note: Any fields in the **Common Fields** section that are set to null will not be copied. If a default value is set in any of the **Common Fields**, it will be copied to the created what-if analysis.

7. Select **Done**.

Note: If you have selected an existing Batch ID, after you select **Done**, a window appears, stating that the batch already exists, asking if you want to continue.

The **Created** section appears, displaying a list of analyses that have been created. A <green check mark> appears, indicating that the analyses are created. In case of errors, <red warning icon> appears.

8. If you want to view the status of all the bulk What-If Analyses creation, in the **Risk Based Inspection**

Overview page, select .

The **Schedule Logs** page appears, displaying a list of all the operations in GE Digital APM that are in progress, along with the percentages of completion. You can also access a list of operations that have been successful or failed.

Add Additional Fields to be Copied to What-If Analyses

Procedure

1. Access the **Datasheet Builder** page for the RBI Criticality Analysis Family.
2. Add fields to What If Analysis Datasheet , by following the steps: [Add Fields to a Datasheet](#).

Note:

- When what-if analyses are created, the additional fields will be processed in order of their location on the datasheet from top to bottom and left to right. If you have any fields which have dependencies on other fields, the dependencies will need to come before the field on the datasheet.
- Datasheet will be displayed when Creating Bulk What-if Analyses.

Delete Bulk What-If Analyses

Procedure

1. [Access Analyses Pending What-If Creation](#) on page 93.
2. Select **Created**.
The **Created** section appears.
3. Next to each analysis that you want to delete, select the check box.
Tip: For optimal performance, we recommend that you want to delete one or more selected analyses.
4. Select **Yes**.
The selected analyses are deleted.

Export Bulk What-If Analyses

About This Task

Using the RBI Export functionality, you can export one or more analyses and related data from the **Bulk What-If** workspace. You can then review the analyses and related data in bulk, and then import it back into GE Digital APM.

To facilitate this functionality, data is exported to a file in the RBI 580 Data Loader format to allow for importing and updating the data.

Note: The RBI 580 Data Loader file that is exported will contain the Asset, Component, Consequence Evaluation, and Degradation Mechanism Evaluation data related to the analyses you select to export.

To facilitate this functionality, data is exported to a file in the RBI 581 Data Loader format to allow for importing and updating the data.

Note: The RBI 581 Data Loader file that is exported will contain the Asset, Component, Consequence Evaluation, and Degradation Mechanism Evaluation data related to the analyses you select to export.

Procedure

1. [Access Analyses Pending What-If Creation](#) on page 93.
2. Select **Created**.
The **Created** section appears.

Tip: The analyses that appear in the **Created** section are filtered by Batch ID. The Batch ID that appears by default is the one you selected while creating analyses. This ID is also set as the default user preference in your browser. You can select a batch using the **Batch ID** box in the **Create What-If Analyses** workspace. To access all analyses, select the blank value in the **Batch ID** box.

3. Next to each analysis that you want to export, select the check box.
4. Select .
A message appears, asking you to confirm that you want to export one or more analyses.
5. Select **Yes**.
The selected analyses are exported to an Excel spreadsheet.

Note:

- The RBI 580 Data Loader Excel worksheet that is exported includes all the fields available in the respective family's default datasheet, except the fields that are considered calculated, system populated, or informational fields.
- The RBI 581 Data Loader Excel worksheet that is exported includes all the fields available in the respective family's default datasheet, except the fields that are considered calculated, system populated, or informational fields.
- The fields values in the Excel worksheet considers the culture settings and unit of measure conversion set of the logged-in user.

Calculate Bulk What-If Analyses

Procedure

1. [Access Analyses Pending What-If Creation](#) on page 93.

2. Select **Created**.

The **Created** section appears.

Tip: The analyses that appear in the **Created** section are filtered by Batch ID. The Batch ID that appears by default is the one you selected while creating analyses. This ID is also set as the default user preference in your browser. You can select a batch using the **Batch ID** box in the **Create What-If Analyses** workspace. To access all analyses, select the blank value in the **Batch ID** box.

3. Next to each analysis that you want to export, select the check box.

4. Select .

The **Analysis Calculation** window appears, displaying the calculation progress and a log with error details.

Tip: After the calculation is complete:

- To view the log details of all the calculated analyses, select **View Complete Log**.
- To view the log details for a single analysis, select the analysis in the list.

5. If you want to view the status of all the bulk What-If Analyses creation, in the **Risk Based Inspection**

Overview page, select .

The **Schedule Logs** page appears, displaying a list of all the operations in GE Digital APM that are in progress, along with the percentages of completion. You can also access a list of operations that have been successful or failed.

Finalize Risk for What-If Analyses

Before You Begin

Calculate the What-If Analyses for which you want to finalize the risk.

Procedure

1. [Access Analyses Pending What-If Creation](#) on page 93.

2. Select **Created**.

The **Created** section appears.

Tip: The analyses that appear in the **Created** section are filtered by Batch ID. The Batch ID that appears by default is the one you selected while creating analyses. This ID is also set as the default user preference in your browser. You can select a batch using the **Batch ID** box in the **Create What-If Analyses** workspace. To access all analyses, select the blank value in the **Batch ID** box.

3. Next to each analysis for which you want to finalize risk, select the check box.

4. Select <finalize-risk-icon>.

A message appears, asking you to confirm that you want to finalize risk for the selected analyses.

5. Select **Yes**.

Risk is finalized for the selected analyses and they are moved to the Risk Completed state.

Note: If an Inspection Plan does not exist on the parent asset of the analyses and the **Use Alternative Inspection Plan** option is set to false, a new Inspection Plan is created and linked to the asset after the analysis is moved to the Risk Completed state.

The **Active** section appears, displaying a list of active What-If Analyses for the selected batch.

Access Active What-If Analyses

About This Task

Active What-If Analyses are RBI Analyses for RBI Components linked to RBI Assets. These analyses were created during the bulk What-If process, and they are not in the Created or Archived state.

Procedure

1. [Access Analyses Pending What-If Creation](#) on page 93.
2. Select **Active**.
The **Active** section appears, displaying a list of active analyses and a count of associated RBI Recommendations.

Generate Recommendations for Active What-If Analyses

Procedure

1. [Access Analyses Pending What-If Creation](#) on page 93.
2. Select **Active**.
The **Active** section appears.
3. Next to each analysis for which you want to generate Recommendations, select the check box.

Tip:

- You can generate recommendations for all the listed analyses in the selected batch by selecting  when all check boxes in the first column of the table are cleared. If you select the check box in the first row of the table, recommendations are generated for the analyses that appear in the current page in the **Active** section (up to 100 analyses can be displayed in a page).
- The **Recommendations** column contains a count of recommendations that are directly linked to the analysis. Consolidated recommendations (CREC) are excluded from this count.

4. Select +.
The **Confirm Bulk Generate Recommendations** window appears, asking if you want to generate recommendations (and duplicate recommendations if recommendations have already been generated).

5. Select **Yes**.
The **Generate Recommendations** window appears, asking if you want to consolidate recommendations for each Degradation Mechanism and Task Type.

Tip: If you choose to consolidate recommendations, the recommendations generated during this process will be consolidated with the existing recommendations. For more information, refer to [About Consolidating RBI Recommendations](#) on page 255.

6. Select **Yes**.
The recommendations are generated. The **Recommendation Generation** window appears, displaying the progress and number of Recommendations generated and consolidated of each asset.

Note: You can close the **Recommendation Generation** window before the operation is complete. You can view the progress using Schedule Logs.

7. Select **Close**.

8. If you want to view the status of bulk What-If Analyses creation, in the **Risk Based Inspection**

Overview page, select .

The **Schedule Logs** page appears, displaying a list of all the operations in GE Digital APM that are in progress, along with the percentages of completion. You can also access a list of operations that have been successful or failed.

Results

Generated recommendations are linked to the Inspection Plan of the related RBI Asset.

Note:

- You can use the **Inspection Plan Summary** page to approve the Inspection Plan and implement recommendations.
- In the RBI Global Preference settings, if the **Enable Recommendation To be Generated at Created State** check box is selected, recommendations will not be linked to the Inspection Plan until the related analysis is moved to the Risk Complete state and the Inspection Plan is generated.

Chapter 11

Degradation Mechanisms

Topics:

- [About Degradation Mechanisms \(DMs\)](#)
- [About Associating Potential Degradation Mechanisms \(PDMs\)](#)
- [About Degradation Mechanism Evaluations \(DMEs\)](#)
- [Add Degradation Mechanisms \(DMs\)](#)
- [Evaluate a Degradation Mechanism \(DM\)](#)
- [Assess the Unmitigated Risk of a Degradation Mechanism \(DM\)](#)
- [Access the Inspection History of a Degradation Mechanism \(DM\)](#)
- [Assign Inspections to a Degradation Mechanism Evaluation \(DME\)](#)
- [Link an Inspection Consequence Evaluation to an RBI Degradation Mechanism Evaluation \(DME\)](#)
- [Delete Degradation Mechanisms \(DMs\)](#)

About Degradation Mechanisms (DMs)

A Degradation Mechanism is a defined method that affects failure as explained in an RBI Analysis. When an RBI Analysis is performed, DMs are assigned to capture the failure that should apply to an RBI Analysis to calculate its risk.

Example: Degradation Mechanisms

The following table provides a list of DMs that can be linked to each component type. This list is not comprehensive.

Component	Degradation Mechanism
Pump	Amine Cracking
	Blocked Discharge
	Brittle Fracture
Vessel	Carburization
	Caustic Cracking
	Chloride Stress Corrosion Cracking (CI SCC)
Heat Exchanger	Amine Cracking
	Caustic Cracking
	Criticality Calculator External Corrosion

When you associate degradation mechanisms with a Corrosion Loop, you have two options:

- You can link only the DMs that are common across all underlying RBI Components. If you choose this option, you will need to link additional degradation mechanisms with each RBI Component as needed.
- or-
- You can associate all possible DMs for all underlying RBI Components, even if those DMs apply only to one or a few of the components. If you choose this option, you will need to unlink DMs from each component as needed.

Unmitigated Risk for RBI Degradation Mechanisms

When you [calculate an RBI Criticality Analysis](#), the unmitigated risk and unmitigated financial risk for each DM is calculated automatically and stored in the related RBI Degradation Mechanisms record. If you have created a custom calculator, unmitigated risk will be calculated by your custom calculator and displayed on the following datasheets:

- Risk Matrix
- Degradation Mechanism with Risk Mitigation
- Degradation Mechanism without Risk Mitigation

After the unmitigated risk and unmitigated financial risk are calculated for the DMs, depending on how the administrative settings are configured, you can:

- Accept the calculated unmitigated values.
- or-
- Override the calculated unmitigated values.

About Associating Potential Degradation Mechanisms (PDMs)

Each RBI Corrosion Loop contains multiple RBI Components. Each of these components can fail in multiple ways. To indicate the ways in which components can fail, you can link Potential Degradation Mechanisms (PDMs) to the RBI Corrosion Loops.

Each PDM that is linked to the RBI Corrosion Loop represents a degradation mechanism (a way in which the components in that Corrosion Loop might fail). Once the RBI Corrosion Loop has been associated with a PDM, all components added to that RBI Corrosion Loop will inherit the PDM.

For each component, you can define the specific ways in which the RBI Component that it represents can fail.

Note: PDMs can be standardized and inherited from RBI Corrosion Loops. When a new RBI Component is generated from and linked to a specific RBI Corrosion Loop, the PDMs associated with that RBI Corrosion Loop will be inherited by the new RBI Component.

Example: Overhead (OVHD) System

Suppose you have created an RBI Corrosion Loop to represent an OVHD system. You may have determined that components in this corrosion loop can fail in the following ways:

- Exchanger Failure: The tubes in the exchanger could foul and cause the exchanger to produce too much or too little cooling.
- Column Failure: The column may be susceptible.

In this case, the RBI Corrosion Loop would be linked to two PDMs to represent each type of degradation mechanism in the preceding list. After the PDMs are linked to the RBI Corrosion Loop as a whole, and you have determined the components in the corrosion loop, you will need to validate the degradation mechanisms for each component.

Assuming that the OVHD system contains the Exchanger and the Column, the RBI Corrosion Loop representing the OVHD system would be linked to the following RBI Component records:

- Column Top (belongs to the Column)
- Outlet Nozzle (belongs to the Column)
- Exchanger Shell (belongs to the Water Heater)

Each of these RBI Components would be linked automatically to all the PDMs that are linked to the Corrosion Loop. You would need to determine, however, which degradation mechanisms make sense for each component. To do so, you might decide that the RBI Component should be linked to the PDMs as described in the following table.

RBI Component	PDM
Column Top	Environmental Cracking
Outlet Nozzle	External Corrosion
Exchanger Shell	Environmental Cracking

So, while the RBI Corrosion Loop is linked to two PDMs, each RBI Component is linked to only one PDM in this case.

About Degradation Mechanism Evaluations (DMEs)

For each Degradation Mechanism (DM) that belongs to an RBI Criticality Analysis, a corresponding Criticality Degradation Mech Evaluation record also belongs to that RBI Criticality Analysis. In each Criticality Degradation Mech Evaluation that is associated with a qualitative degradation mechanism (i.e., the corresponding RBI Degradation Mechanisms record was created from a Potential Degradation Mechanism with the value Qualitative in the Methodology Type field), you can specify the probability that the corresponding component will fail due to that degradation mechanism.

For example, if an RBI Criticality Analysis contains an Erosion DM, it will also contain a corresponding Erosion Criticality Degradation Mech Evaluation. In this DME, you can specify a value in the Probability Category field to indicate the probability that the RBI Component will fail due to erosion.

After you select a value in the Probability Category field and calculate the RBI Criticality Analysis, the Probability Category Description field will be populated automatically based on the values in an existing Degradation Mechanisms Evaluation Factors record.

Degradation Mechanisms

Suppose a Degradation Mechanisms Evaluation Factors record contains the following values in the following fields:

- Degradation Mechanism: Erosion
- Ranking: 1
- Ranking Description: Erosion - Impact Resistant Material. Good Inspection History with no evidence of Damage.

If an RBI Analysis is linked to an Erosion Criticality Degradation Mech Evaluation, and you select 1 in the Probability Category field, the value in the Probability Category Description field will be populated with the value in the Ranking Description field in the Degradation Mechanisms Evaluation Factors record containing the values Erosion and 1. In this example, the Probability Category Description field would be populated with the value Erosion - Impact Resistant Material. Good Inspection History with no evidence of Damage.

Add Degradation Mechanisms (DMs)

About This Task

For each Potential Degradation Mechanism (PDM) linked to the Component, a DM is added to the Analysis. You can, however, add additional DMs to the analysis.

Note: You cannot add a DM if the [state of the analysis](#) is Risk Completed.

Procedure

1. [Access the analysis](#) to which you want to add DMs.
2. In the **Degradation Mechanisms** section, select . A window appears, displaying a list of the DMs that can be applied to the RBI Criticality Analysis, displaying the methodology type of each DM.

Tip: If you select the link that corresponds to a DM, the associated PDM record appears in Record Explorer on a new page.

3. In the row containing each DM that you want to add, select the check box, and then select **Add**.
The selected DMs are added to the RBI Criticality Analysis.

Results

- A Consequence Evaluation is created and linked to the RBI Criticality Analysis.

Next Steps

- [Evaluate a Degradation Mechanisms Record \(DM\)](#).

Evaluate a Degradation Mechanism (DM)

Procedure

1. [Access the analysis](#) containing the DM that you want to evaluate.
2. In the **Degradation Mechanisms** section, in the row containing the DM that you want to modify, select the link.

A window appears, displaying a blank datasheet of the corresponding Degradation Mechanism Evaluation (DME).

3. Enter values in the [available fields](#).
4. Select .

The DM is evaluated.

Assess the Unmitigated Risk of a Degradation Mechanism (DM)

Before You Begin

- [Generate Recommendations for the analysis](#).
- [Change the state of the analysis to Risk Completed](#).

Procedure

1. [Access the analysis](#) containing the DM for which you want to assess the unmitigated risk.
2. In the **Degradation Mechanisms** section, select the row containing the DM that you want to assess, and then select .

The **Risk Matrix** window appears.

RBI RISK MATRIX BY RBI COMPONENT

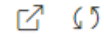

1	14	1	7	14	4
2	9	0	4	9	2
3	2	0	2	0	0
4	1	0	7	9	0
5	5	1	2	9	0
	E	O	C	S	F

3. Select the cell that represents the risk rank for each category, and then select **Done**. These categories depend on the risk matrix that is defined by your organization. By default, these categories are Safety, Environment, Operations, and Financial.

The unmitigated risk and unmitigated financial risk values for the DM are saved.

Access the Inspection History of a Degradation Mechanism (DM)

Procedure

1. [Access the analysis](#) whose inspection history you want to access.
2. Below the graph, in the row containing the analysis whose Inspection History you want to access, select the link.
The **Analysis** workspace appears.
3. In the **Degradation Mechanisms** section, select the row containing the DM whose inspection history you want to view, and then select .

A window appears, displaying the inspection history for the selected DM.

Tip: If you want to access the Inspection in Inspection Management, select the link in the Inspection Report column. The **Inspection Data** section appears, displaying the Inspection datasheet.

Assign Inspections to a Degradation Mechanism Evaluation (DME)

Before You Begin

- You can assign up to six Inspections.

Important: For RBI 580 Qualitative DMs, you can access the inspection history; however, you cannot take credit for an Inspection to calculate the Damage Factor.

Procedure

1. [Access the inspection history](#) for the analysis containing the DME to which you want to assign Inspections.

Note: The listed inspections fall within a specified 20-year window.

2. In the row containing each Inspection that you want to assign, select the check box, and then select **OK**.

The selected Inspections are assigned to the DME.

Tip: To view the Inspection in Inspection Management, select the link in the **Inspection Reports** column.

Link an Inspection Consequence Evaluation to an RBI Degradation Mechanism Evaluation (DME)

About This Task

Important: To link an Inspection Confidence Evaluation to an RBI DME, the Risk Based Inspection or the RBI 581 license must be active.

Procedure

1. Access the analysis containing the RBI DME to which you want to link an Inspection Confidence Evaluation.

Note: To link an Inspection Confidence Evaluation to an RBI DME, the associated RBI Analysis must be in the Active state. Only Active RBI Analyses will display current Inspection Reports in their corresponding Inspection History section.

2. In the **Degradation Mechanism** section, select the row containing the DME that you want to link to the Inspection Confidence Evaluation, and then select .

Note: The RBI DME that you select must also be the DME in the corresponding Inspection Confidence Evaluation.

A window appears, displaying a list of corresponding Inspection Reports.

3. Next to the Inspection Report containing the Inspection Confidence Evaluation that you want to link to the RBI DME, select the check box.
4. In the lower-right corner of the section, select **OK**.

The Inspection Confidence Evaluation is linked to the RBI DME.

Delete Degradation Mechanisms (DMs)

Before You Begin

- When you delete a DM, the associated RBI Degradation Mechanism Evaluation (DME) and RBI Consequence Evaluation records are also deleted.
- You cannot delete a DM if the associated analysis is in Risk Completed state.

Procedure

1. [Access the analysis](#) that contains the DMs that you want to delete.
2. In the **Degradation Mechanisms** section, select the row containing the DM that you want to delete, and then select .

A message appears, asking you to confirm that you want to delete the selected DM.

3. Select **Yes**.

The DMs, along with the associated DMEs and RBI Consequence Evaluations, are deleted.

Chapter 12

Recommendations

Topics:

- [About RBI Recommendations](#)
- [Policies Used to Generate Recommendations](#)
- [About Recommendation Generation for Inspection Group](#)
- [About Inspection Strategies for Generating RBI Recommendations](#)
- [About Consolidating RBI Recommendations](#)
- [Access the Recommended Actions Pane](#)
- [View RBI Recommendations Linked to an Inspection Plan](#)
- [Create an RBI Recommendation Manually](#)
- [Generate Recommendations for a Single RBI Criticality Analysis](#)
- [Generate RBI Recommendations for Multiple RBI Criticality Analyses](#)
- [Generate Recommendations for all Analyses in an Asset Hierarchy Level](#)

About RBI Recommendations

An RBI Recommendation stores information about actions that should be performed to help mitigate the risk associated with a degradation mechanism (DM). Each RBI Recommendation is linked to:

- A Degradation Mechanisms record, which defines the type of failure that the recommended action can help mitigate.
- An Asset record, which defines the piece of asset to which the recommendation applies.
- An Inspection Plan, which is linked to the associated asset.
- An RBI Criticality Analysis record.

Generating Recommendations

GE Digital APM generates RBI Recommendations for:

- [All DMs in a single RBI criticality Analysis](#)
- [Multiple RBI Criticality Analyses linked to a single Asset](#)
- [All assets in an Asset Hierarchy level](#)
- [Active evergreened analyses](#)

These recommendations are recurring.

[Recommendations that are linked to approved Inspection Plans can be implemented as Inspection Tasks directly or from Asset Strategy Management \(ASM\) through the Action created during the Inspection Plan approval.](#)

Note: You can also create recommendations for a single DM.

Content needed for generating recommendations

- Policies
- RBI Strategy Mapping Configuration and RBI Strategy Mapping details
- Inspection Strategies

Policies in RBI 580

The following policies are used for generating recommendations in RBI 580:

- Appendix_B is used for internal corrosion strategy rules for vessels, exchangers, and tanks.
- Appendix_D is used for internal corrosion strategy rule sets for Air Cooled Heat Exchangers.
- Appendix_E is used for internal corrosion strategy rule sets for piping.
- Appendix_F is used for external and CUI strategy rule sets for vessels, exchangers, tanks, and piping.
- Appendix_G is used for environmental cracking strategy rule sets for vessels, exchangers, tanks, and piping.
- Appendix_H is used for corrosion and cracking strategy rule sets for exchanger bundles and tubes.
- Appendix_I is used for plate corrosion and weld cracking strategy rule sets for storage tank bottoms.

Example: Appendix B

A Pressure Vessel called F0065-097 that has a Criticality Calculator Internal Corrosion DM needs to have recommendations generated. Appendix_B applies, since F0065-097 has a Criticality Item Type, DM, and Policy Input data that fit the criteria of the policy.

The following inputs are needed to satisfy the Appendix_B policy:

- Criticality item type in the RBI Criticality Analysis
- Inspection Priority (Unmitigated Risk) field in the associated RBI Degradation Mechanism
- Non-Intrusive Requirement Met field in the associated Criticality Int. Corr. Deg. Mech. Eval. record
- Estimated Half Life field in the associated Criticality Int. Corr. Deg. Mech. Eval. record
- General Corrosion field in the associated Criticality Int. Corr. Deg. Mech. Eval. record

Suppose asset F0065-097 has the following values:

Field	Value
Criticality item type	Pressure Vessel
Inspection Priority	10
Non-Intrusive Requirement Met	No
Half-Life	44.9651 years
General Corrosion	Yes

Given the data for F0065-97, Logic Case Nodes LC112 and LC11 are recommended.

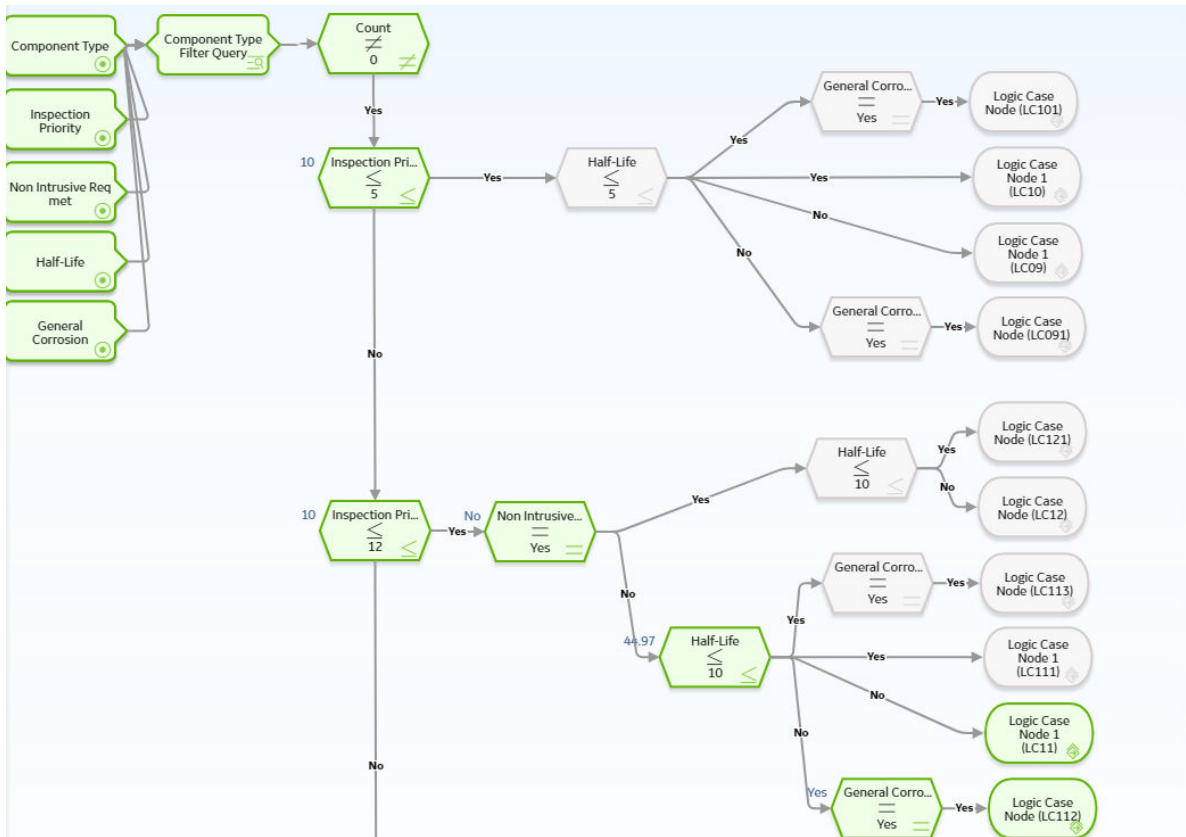

Policies Used to Generate Recommendations

This topic provides a list of policies used by RBI Strategy Mapping groups to generate RBI Recommendations.

If you want to modify the design of a policy, you must be a member of the following Security Groups:

- MI Policy Designer
- and-
- MI RBI Recommendation Policy Designer

If you want to view a policy, you must be a member of the following Security Groups:

- MI Policy Viewer
- and-
- MI RBI Recommendation Policy Viewer

Criteria Used to Generate RBI Recommendations from RBI Analyses

The following table lists the criteria used by RBI Strategy Mapping Groups to determine the Policy that GE Digital APM uses to select the Inspection Strategy. The selected Inspection Strategy is then used to populate the RBI Recommendation.

Note: The GE Digital APM RBI Best Practice assumes that you will use the RBI Strategy Mapping Configurations, RBI Strategy Mapping Details, and policy queries that GE Digital provides, and that you will not modify them.

The following table provides a list of Policies that are used to generate RBI Recommendations.

Policy Name	Degradation Mechanisms	Policy Inputs	Criticality Item Type	Applicable Logic Case Nodes
Appendix_B	Criticality Calculator Internal Corrosion	<ul style="list-style-type: none"> • Estimated Half Life field in the associated Criticality Int. Corr. Deg. Mech. Eval. record • General Corrosion field in the associated Criticality Int. Corr. Deg. Mech. Eval. record • Non-Intrusive Requirement Met field in the associated Criticality Int. Corr. Deg. Mech. Eval. record • Inspection Priority (Unmitigated Risk) field in the associated RBI Degradation Mechanism • Criticality item type in the associated policy 	<p>Any value except:</p> <ul style="list-style-type: none"> • Air Cooled Exchanger-Header • Air Cooled Exchanger-Tbs • Storage Tank Bottom • Heat Exchanger-Bundle • Any value associated with a pipe • Any value associated with a pressure relief device <p>Note: Values associated with pressure relief devices are not excluded by the associated policy query. Instead, these criticality item types are not valid for an RBI Analysis whose degradation mechanism is Criticality Calculator Internal Corrosion.</p>	<ul style="list-style-type: none"> • LC09 • LC10 • LC11 • LC12 • LC13 • LC14 • LC15 • LC16 • LC091 • LC101 • LC111 • LC112 • LC113 • LC121 • LC131 • LC132 • LC133 • LC141 • LC151 • LC152 • LC153 • LC161

Policy Name	Degradation Mechanisms	Policy Inputs	Criticality Item Type	Applicable Logic Case Nodes
Appendix_D	Criticality Calculator Internal Corrosion	<ul style="list-style-type: none"> Estimated Half Life field in the associated Criticality Int. Corr. Deg. Mech. Eval. record General Corrosion field in the associated Criticality Int. Corr. Deg. Mech. Eval. record Non-Intrusive Requirement Met field in the associated Criticality Int. Corr. Deg. Mech. Eval. record Inspection Priority (Unmitigated Risk) field in the associated RBI Degradation Mechanism Criticality item type in the associated policy 	Any of the following values: <ul style="list-style-type: none"> Air Cooled Exchanger-Header Air Cooled Exchanger-Tbs 	<ul style="list-style-type: none"> LC17 LC18 LC19 LC20 LC21 LC22 LC23 LC171 LC172 LC173 LC181 LC182 LC183 LC191 LC201 LC202 LC203 LC211 LC221 LC222 LC223 LC231
Appendix_E	Criticality Calculator Internal Corrosion	<ul style="list-style-type: none"> Estimated Half Life field in the associated Criticality Int. Corr. Deg. Mech. Eval. record General Corrosion field in the associated Criticality Int. Corr. Deg. Mech. Eval. record Inspection Priority (Unmitigated Risk) field in the associated RBI Degradation Mechanisms Criticality item type in the associated policy 	<ul style="list-style-type: none"> Piping <p>Note: Values associated with pressure relief devices are not excluded by the associated policy query. Instead, these criticality item types are not valid for an RBI Analysis whose degradation mechanism is Criticality Calculator External Corrosion.</p>	<ul style="list-style-type: none"> LC24 LC25 LC26 LC27 LC28 LC29 LC30 LC31 LC241 LC251 LC261 LC271 LC281 LC291 LC301 LC311

Policy Name	Degradation Mechanisms	Policy Inputs	Criticality Item Type	Applicable Logic Case Nodes
Appendix_F	Criticality Calculator External Corrosion	<ul style="list-style-type: none"> • Insulated field in the associated RBI Analysis • Insulation Damage field in the associated Criticality Ext. Corr. Deg. Mech. Eval. record • Estimated Half Life field in the associated Criticality Int. Corr. Deg. Mech. Eval. record • Inspection Priority(Unmitigated Risk) field in the associated RBI Degradation Mechanisms • Component Type • Criticality item type in the associated policy 	<p>Any value except:</p> <ul style="list-style-type: none"> • Storage Tank Bottom • Heat Exchanger-Bundle • Any value associated with a pressure relief device <p>Note: Values associated with pressure relief devices are not excluded by the associated policy query. Instead, these criticality item types are not valid for an RBI Analysis whose degradation mechanism is Criticality Calculator Internal Corrosion.</p>	<ul style="list-style-type: none"> • LC32 • LC33 • LC34 • LC35 • LC36 • LC37 • LC38 • LC39 • LC40 • LC41 • LC42 • LC321 • LC331 • LC341 • LC351 • LC361 • LC371 • LC381 • LC391 • LC401 • LC411 • LC421

Policy Name	Degradation Mechanisms	Policy Inputs	Criticality Item Type	Applicable Logic Case Nodes
Appendix_G	<p>Any of the following values:</p> <ul style="list-style-type: none"> • Amine Cracking (ASCC) • Carbonate Cracking • Caustic Cracking • Chloride Stress Corrosion Cracking (CI SCC) • Hydrogen Stress Cracking (HSC)- Hydrofluoric Acid • Polythionic Acid SCC (PTA) • Sulfide Stress Cracking (SSC) • Wet H2S Damage (Blistering, SOHIC, SCC) 	<ul style="list-style-type: none"> • Estimated Half Life field in the associated Criticality Int. Corr. Deg. Mech. Eval. record • Damage Mechanism field in the associated Criticality Env. Crack. Deg. Mech. Eval. record • Damaged At Last Inspection field in the associated Criticality Env. Crack. Deg. Mech. Eval. record • Is Entry Possible field in the associated Criticality Env. Crack. Deg. Mech. Eval. record • PT or MT Access field in the associated Criticality Env. Crack. Deg. Mech. Eval. record • Inspection Priority (Unmitigated Risk) field in the associated RBI Degradation Mechanism. • Estimated Half Life field in the associated Criticality Int. Corr. Deg. Mech. Eval. record • Criticality item type in the associated policy 	<p>Any value except:</p> <ul style="list-style-type: none"> • Air Cooled Exchanger-Header • Air Cooled Exchanger-Tbs • Heat Exchanger-Bundle 	<ul style="list-style-type: none"> • LC44 • LC45 • LC46 • LC49 • LC50 • LC51 • LC54 • LC55 • LC56 • LC59 • LC60 • LC61 • LC62 • LC441 • LC451 • LC461 • LC491 • LC501 • LC511 • LC541 • LC551 • LC561 • LC601 • LC611 • LC621

Policy Name	Degradation Mechanisms	Policy Inputs	Criticality Item Type	Applicable Logic Case Nodes
Appendix_H	<p>Any of the following values:</p> <ul style="list-style-type: none"> Amine Cracking (ASCC) Carbonate Cracking Caustic Cracking Chloride Stress Corrosion Cracking (CI SCC) Hydrogen Stress Cracking (HSC)- Hydrofluoric Acid Hydrofluoric Acid Polythionic Acid SCC (PTA) Sulfide Stress Cracking (SSC) Wet H2S (Blistering, SOHIC, SCC) Criticality Calculator Internal Corrosion Criticality Calculator External Corrosion 	<ul style="list-style-type: none"> Estimated Half Life field in the associated Criticality Int. Corr. Deg. Mech. Eval. record Inspection Priority (Unmitigated Risk) field in the associated RBI Degradation Mechanism Criticality item type in the associated policy <p>Note: The input value of Inner Pipe displayed in the Appendix_H policy is not considered for generating a recommendation.</p>	Heat Exchanger-Bundle	<ul style="list-style-type: none"> LC65 LC66 LC67 LC68 LC69 LC70 LC71 LC72 LC651 LC661 LC671 LC681 LC691 LC701 LC711 LC721
Appendix_I	<p>Any of the following values:</p> <ul style="list-style-type: none"> Amine Cracking (ASCC) Carbonate Cracking Caustic Cracking Chloride Stress Corrosion Cracking (CI SCC) Hydrogen Stress Cracking (HSC)- Hydrofluoric Acid Hydrofluoric Acid Polythionic Acid SCC (PTA) Sulfide Stress Cracking (SSC) Amine Cracking Criticality Calculator Internal Corrosion Criticality Calculator External Corrosion 	<ul style="list-style-type: none"> Estimated Half Life field in the associated Criticality Int. Corr. Deg. Mech. Eval. record Inspection Priority (Unmitigated Risk) field in the associated RBI Degradation Mechanism Criticality item type in the associated policy 	Storage Tank Bottom	<ul style="list-style-type: none"> LC73 LC74 LC75 LC76 LC731 LC741 LC751

Policy Name	Degradation Mechanisms	Policy Inputs	Criticality Item Type	Applicable Logic Case Nodes
PRD_Strategies	<p>Any of the following values:</p> <ul style="list-style-type: none"> Blocked Discharge Blocked Discharge - Admin Control Control Valve Failure (Fail Opposite) Control Valve Failure (Fail Safe) Electrical Power Failure Exchanger Tube Rupture Fire Liquid Overfill Liquid Overfill - Admin Control Loss of Cooling Runaway Reaction Thermal Relief Thermal Relief - Admin Control Tower Pump Failures Leak 	<ul style="list-style-type: none"> Inspection Priority (Unmitigated Risk) field in the associated RBI Degradation Mechanism Criticality item type in the associated policy 	Any value associated with a pressure relief device.	<ul style="list-style-type: none"> PSV01 PSV02 PSV03 RD01 RD02
Pipeline Inspection Strategy	<p>Any of the following values:</p> <ul style="list-style-type: none"> Criticality Calculator External Corrosion Criticality Calculator Internal Corrosion 	<ul style="list-style-type: none"> Is CP System field in the associated RBI Analysis Is Pigging Possible field in the associated RBI Analysis Wall Thickness Loss field in the Criticality Int. Corr. Deg. Mech. Eval. record Wall Thickness Loss field in the Criticality Ext. Corr. Deg. Mech. Eval. record 	Pipeline	<ul style="list-style-type: none"> PLC111 PLC121 PLC122 PLC131 PLC132 PLC141 PLC142 PLC211 PLC221 PLC222 PLC231 PLC323 PLC241 PLC242

Policy Name	Degradation Mechanisms	Policy Inputs	Criticality Item Type	Applicable Logic Case Nodes
Pipeline Cracking Inspection Strategy	Any of the following values: <ul style="list-style-type: none"> Amine Cracking (ASCC) Carbonate Cracking Caustic Cracking Chloride Stress Corrosion Cracking (CI SCC) Hydrogen Stress Cracking (HSC)- Hydrofluoric Acid Polythionic Acid SCC (PTA) Sulfide Stress Cracking (SSC) Wet H2S (Blistering, SOHIC, SCC) 	<ul style="list-style-type: none"> Inspection Priority (Unmitigated Risk) field in the associated RBI Degradation Mechanism Is Pigging Possible field in the associated RBI Analysis 	Pipeline	<ul style="list-style-type: none"> PL001 PL002 PL004 PL006 PL008
TPD Inspection Strategy	Third Party Damage	<ul style="list-style-type: none"> Previous Damage Points field on the associated Third Party Degradation Mechanism Evaluation Inspection Priority field in the associated RBI Degradation Mechanism 	Pipeline	<ul style="list-style-type: none"> ILC-P1 ILC-P2 ILC-P3 ILC-P4 ILC-P11 ILC-P21 ILC-P31

About Recommendation Generation for Inspection Group

An RBI Recommendation stores information about actions that should be performed to help mitigate the risk associated with a Degradation Mechanism (DM). You can generate RBI Recommendations for an Inspection Group when the Inspection Group is transitioned to an Implemented state.

An RBI Recommendation generated from an Inspection Group is linked to the following records:

- An Inspection Group record
- An Asset record, which defines the piece of an asset to which the recommendation applies
- An Inspection Plan, which is linked to the associated asset
- A Degradation Mechanism record, which defines the type of failure that the recommended action can help mitigate
- An RBI Criticality Analysis, which is used to create the grouping element

RBI Recommendations are recurring and can be linked to Inspection Tasks directly or from Asset Strategy Management (ASM) through Actions. These recommendations can be viewed in Inspection plan page for

the Asset, and the RBI Asset Summary page for the Asset and RBI Analysis. These recommendations can be consolidated, superseded with other RBI Recommendations or Compliance Recommendations.

When an Inspection group is transitioned to an Implemented state, RBI recommendations are generated for all Representative and Represented Assets in an Inspection group. For RBI Recommendations to be generated, following conditions should be met for a grouping element belonging to the Inspection Group:

- Selected for Inspection is checked, or, Selected for Inspection is unchecked, and it is a represented Asset
- Exclude from Group is unchecked

There are two types of RBI Recommendations generated for an Inspection group.

- A Do not perform recommendation is generated for all Represented Assets. This RBI Recommendation has the field Is Do Not Perform Recommendations set to true.
- A Perform recommendation is generated for all Representative Assets. This RBI Recommendation has the field Is Do Not Perform Recommendations set to false.

Following two policies are used for generating recommendations for Inspection Groups. These policies can be viewed from the Policy Designer Overview page in the Module Workflow Policies section.

- **CUI Insp Grouping Policy:** This policy is used by an Inspection Group where the Corrosion Type is CUI.
- **Internal Corrosion Insp Grouping Policy:** This policy is used by an Inspection Group where the Corrosion Type is Internal Corrosion.

CUI Insp Grouping Policy

CUI Insp Grouping Policy generates recommendations for Criticality Calculator External Corrosion.

The following inputs are needed for the CUI Insp Grouping policy:

- **Inspection Group:** Inspection Group record being set to Implemented state
- **Generate Recommendations:** Boolean flag used to determine the type of recommendations being generated for the Inspection Group

The CUI Inspection Grouping Policy outputs following nodes. The return value from the “Logic Case Node” nodes in the policy are used as record identifier for the Inspection Strategy records used to generate the RBI Recommendations.

Note: The UseExternalHalfLife node is always true for External Degradation Mechanism

Policy Name	Degradation Mechanisms	Policy Inputs	Applicable Logic Case Nodes
CUI Insp Grouping Policy	Criticality Calculator External Corrosion	<ul style="list-style-type: none"> • Inspection Group – A record belonging to the Inspection Group Family. • Generate Inspection – A flag indicating if recommendation should be generated or not. 	<ul style="list-style-type: none"> • LC331 • LC361 • LC391 • LC431 • LC_NOGUI

CUI Insp Grouping Policy

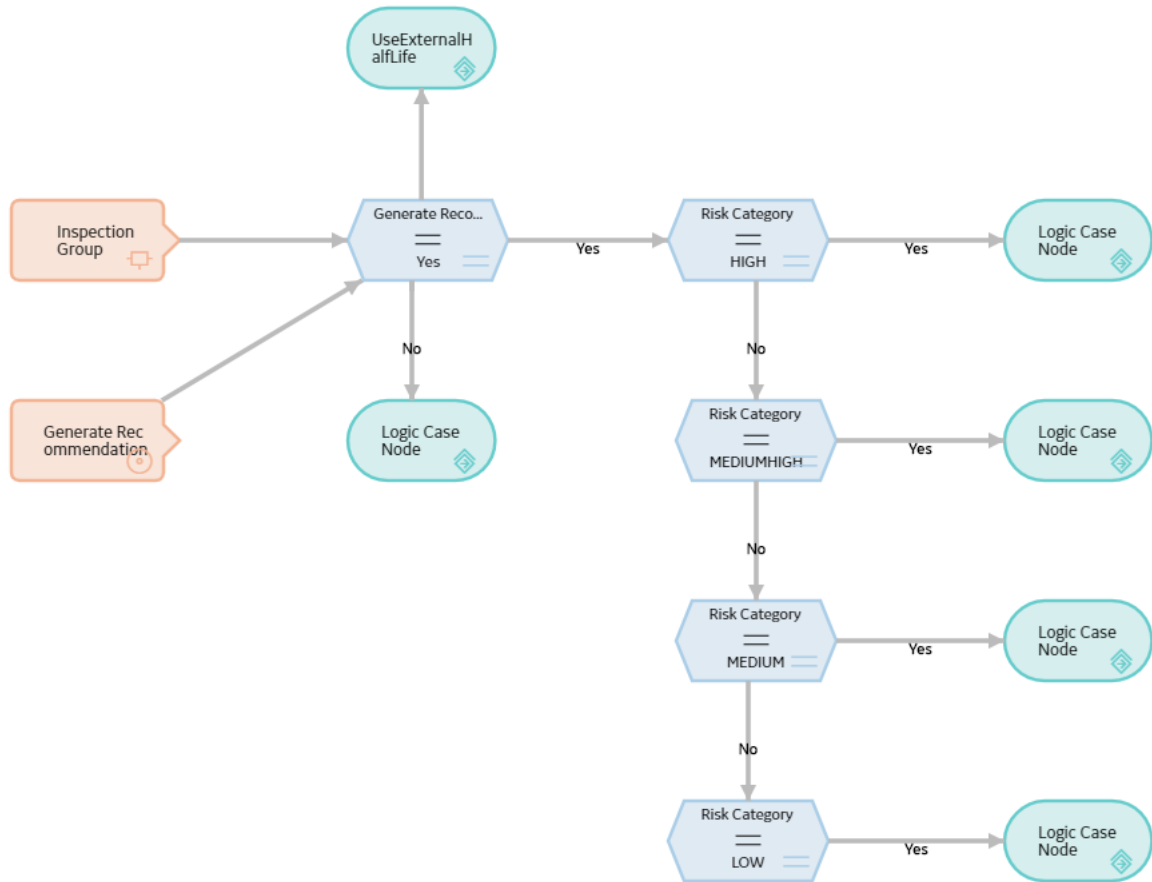

Internal Corrosion Insp Grouping Policy

Internal Corrosion Insp Grouping Policy generates recommendations for Criticality Calculator Internal Corrosion.

The following inputs are needed for the Internal Corrosion Insp Grouping policy:

- **Inspection Group:** Inspection Group record being set to Implemented state
- **Generate Recommendations:** Boolean flag used to determine the type of recommendations being generated for the Inspection Group

The Internal Corrosion Grouping Policy returns Logic Case Node as its output. The return value from the “Logic Case Node” nodes in the policy are used as record identifier for the Inspection Strategy records used to generate the RBI Recommendations as per the risk category and Equipment Type.

Policy Name	Degradation Mechanisms	Policy Inputs	Applicable Logic Case Nodes
CUI Insp Grouping Policy	Criticality Calculator External Corrosion	<ul style="list-style-type: none"> Inspection Group – A record belonging to the Inspection Group Family. Generate Inspection – A flag indicating if recommendation should be generated or not. 	<ul style="list-style-type: none"> LC_NOICPC LC10 LC25 LC11 LC27 LC13 LC29 LC15 LC31

Logic Case Node	Risk	Equipment Type
LC_NOICPC	N/A	N/A
LC10	High	Vessels, Tanks
LC25	High	Piping
LC11	Medium High	Vessels, Tanks
LC27	Medium High	Piping
LC13	Medium	Vessels, Tanks
LC29	Medium	Piping
LC15	Low	Vessels, Tanks
LC31	Low	Piping

Internal Corrosion Insp Grouping Policy

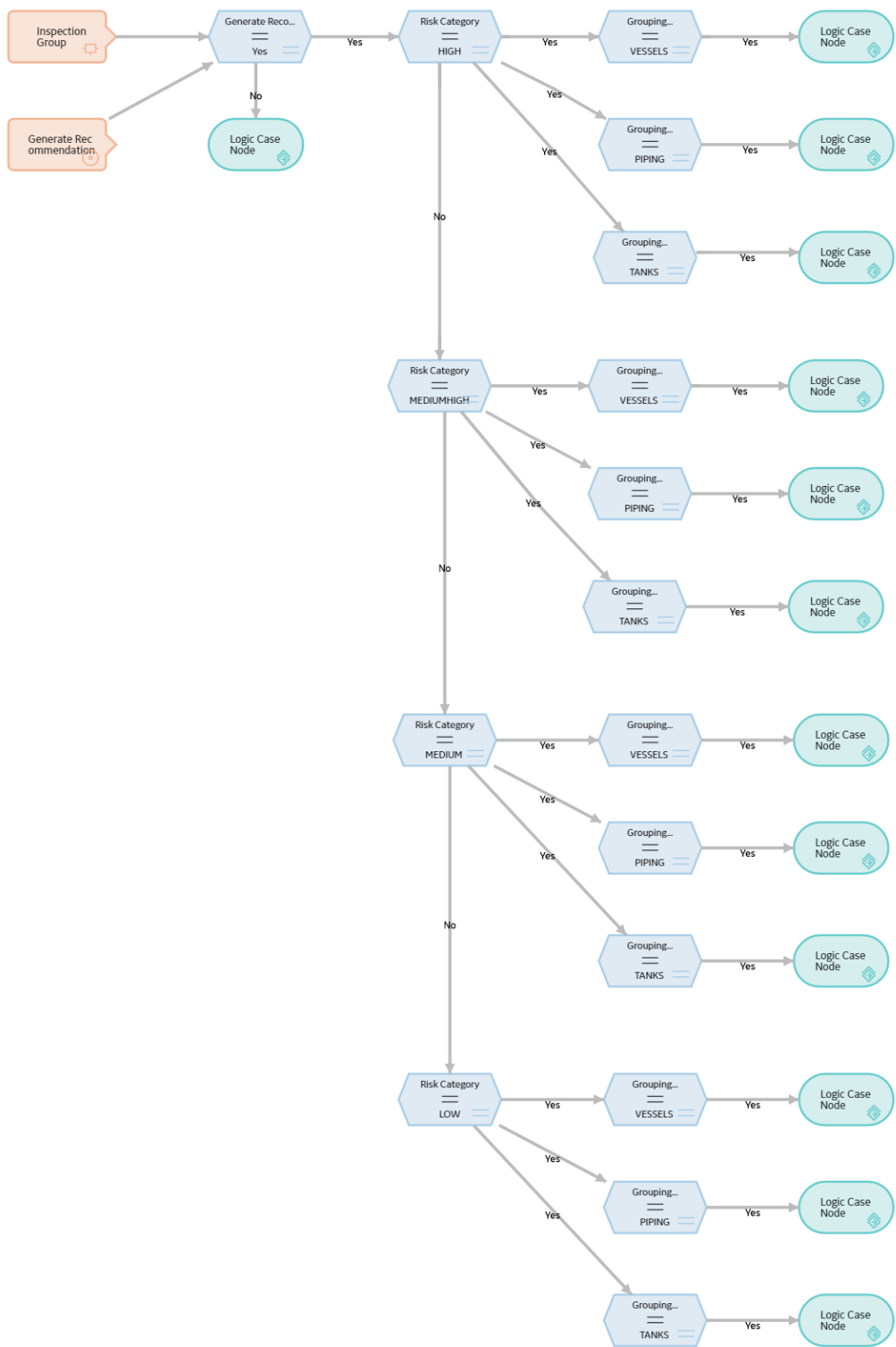

About Inspection Strategies for Generating RBI Recommendations

GE Digital APM provides a set of baseline Inspection Strategies that are used to generate RBI Recommendations. In other words, RBI Recommendations that you create are populated automatically with values that are stored in the Inspection Strategies.

Before you can generate RBI Recommendations using Inspection Strategies, you must ensure that the **Recommendation Creation Enabled** check box is selected on the [Global Preferences](#) page.

GE Digital APM uses an RBI Strategy Mapping Configuration record to determine which policy should be used to find the Inspection Strategy. Specifically, an RBI Strategy Mapping Configuration identifies the Policy to use based on:

- The value in the Criticality Item Type field in the source RBI Criticality Analysis.
- The RBI Criticality Analysis Family ID. This value identifies the Analysis family for which the Policy and Degradation Mechanism (DM) are valid.

Recommendation Generation

Scenario A: An associated RBI Criticality Analysis:

- Whose Criticality Item Type field contains the value Heat Exchanger-Bundle.
- That is linked to an RBI Degradation Mechanism whose Degradation Mechanism field contains the value Criticality Calculator Internal Corrosion.

Scenario B: An associated RBI Criticality Analysis:

- Whose Criticality Item Type field contains the value Storage Tank Bottom.
- That is linked to an RBI Degradation Mechanism whose Degradation Mechanism field contains the value Criticality Calculator Internal Corrosion.

The policy that will be selected in Scenario A is different from the Policy that will be selected in Scenario B.

The RBI Strategy Mapping Groups also define additional logic that determines the Inspection Strategy that should be used to populate the RBI Recommendation. This logic relies on the following items:

- Values stored in the source records that make up the RBI Criticality Analysis.
- Input nodes that exist in the selected Policy.

About Consolidating RBI Recommendations

If two or more RBI Recommendations that are associated with a single RBI Asset contain similar information, you can consolidate them into a single RBI Recommendation. The single RBI Recommendation that is created is called the master RBI Recommendation. The two or more RBI Recommendations that you have selected to consolidate are called source RBI Recommendations.

When you consolidate:

- The state of the master RBI Recommendation is set to Proposed.
- The state of the source RBI Recommendations is changed to Consolidated.
- The source RBI Recommendations are linked to the master RBI Recommendation.

The system consolidates RBI Recommendations that are associated with a single RBI Asset if they contain the same values in the following fields:

- Damage Mechanism
- Task Type

These values come from the Inspection Strategy that is linked to the RBI Criticality Analysis associated with the RBI Recommendation.

The values in the Damage Mechanism and Task Type fields, in addition to any other fields containing matching values, in the source RBI Recommendations will be used to populate the corresponding fields in the master RBI Recommendation. Additionally, the most conservative (i.e., lowest) value in the Recommended Interval Scope field among the source RBI Recommendations will match the value in the Recommended Interval Scope field in the master RBI Recommendation.

Example: Recommendation Consolidation

Suppose you want to generate RBI Recommendations for RBI Analysis A, RBI Analysis B, and RBI Analysis C, which have the following details:

Field Name	RBI Analysis A	RBI Analysis B	RBI Analysis C
Degradation Mechanism	Criticality Calculator Internal Corrosion	Criticality Calculator Internal Corrosion	Criticality Calculator External Corrosion
Inspection Task Type	RBI - MED - EXCH TUBES	RBI - MED - EXCH TUBES	RBI - EXTERNAL - VERY HIGH
Recommended Inspection Interval	90	120	180

In this case, four RBI Recommendations will be created. Since RBI Analysis A and RBI Analysis B are linked to an RBI Degradation Mechanism whose Degradation Mechanism value is Criticality Calculator Internal Corrosion, and the associated Inspection Strategies contain the same Inspection Task Type value, the RBI Recommendations generated from these records would be consolidated automatically into a single master RBI Recommendation. The state of the consolidated records is set to Consolidated, and the state of the master record is set to Proposed.

The following table lists the four RBI Recommendations that will be created as a result of the automatic RBI Recommendation generation process.

State	Damage Mechanism	Task Type	Recommended Interval Scope
Consolidated	Criticality Calculator Internal Corrosion	RBI - MED - EXCH TUBES	90
Consolidated	Criticality Calculator Internal Corrosion	RBI - MED - EXCH TUBES	120
Proposed	Criticality Calculator Internal Corrosion	RBI - MED - EXCH TUBES	90
Proposed	Criticality Calculator External Corrosion	RBI - EXTERNAL - VERY HIGH	180

Notice that two RBI Recommendations are set to Proposed. The recommendation with task type RBI - MED - EXCH TUBES is the master RBI Recommendation described in this topic, and the other is the RBI Recommendation that was created from the Inspection Strategy that was used for RBI Analysis C.

In the master RBI Recommendation, the value in the Recommended Interval Scope field is set to 90 because this is the most conservative (i.e., lowest) value that exists in the Recommended Inspection Interval field in the source RBI Recommendations.

Access the Recommended Actions Pane

Procedure

1. [Access an RBI Criticality Analysis.](#)

2. In the workspace, select 

The **Recommended Actions** pane appears, displaying any recommendations associated with the analysis.

Results

- For a Recommendation that is promoted to Asset Strategy Management (ASM), you can access the associated Asset Strategy by selecting the link in the **Strategy ID** column.
- You can use the functionalities of the **Recommended Actions** pane.

Tip: For information about additional options available when working with the Recommendation records, refer to the Action Management section of the documentation.

View RBI Recommendations Linked to an Inspection Plan

Procedure

[Access an Inspection Plan.](#)

The **Inspection Plan** workspace appears, displaying any Recommendations that are linked to the Inspection Plan.

Results

- For Recommendations associated with approved Inspection Plans, you can access the associated Asset Strategy in Asset Strategy Manager (ASM) by selecting the **Open Strategy** link.
- In the **Recommended Actions** table, you can perform the following actions:
 - Modify the state of Recommendations to Supersede.
 - Modify the state of Recommendations to Not Required.
 - Delete Recommendations.
 - Implement Recommendations as Inspection Tasks.

Create an RBI Recommendation Manually

Before You Begin

- [Modify the state of the analysis to Risk Completed.](#)

About This Task

This topic describes how to create an RBI Recommendation manually for a Degradation Mechanism (DM). You can also:

- [Generate RBI Recommendations for all DMs in a single RBI Analysis.](#)
- [Generate RBI Recommendations for all RBI Analyses linked to a single asset.](#)

Procedure

1. [Access the analysis](#) that contains the DM for which you want to create a recommendation.
2. In the **Degradation Mechanisms** section, select the row containing the DM to which you want to add a recommendation, and then select .

The **Degradation Mechanisms** section appears, displaying a list of DMs associated with the analysis.

A message appears, confirming that you have created a recommendation for the DM.

Results

The recommendation is linked to the Inspection Plan of the related RBI Asset.

Note:

- You can use the functionalities of the **Recommended Actions** pane.
- If, in the RBI Global Preference settings, the **Enable Recommendation To be Generated at Created State** check box is selected, recommendations will not be linked to the Inspection Plan until the related analysis is moved to the Risk Complete state and the Inspection Plan is generated.

Tip: For information about additional options available when working with the Recommendation records, refer to the Action Management section of the documentation.

Generate Recommendations for a Single RBI Criticality Analysis

Before You Begin

- [Modify the state of the analysis to Risk Completed.](#)

About This Task

This topic describes how to create RBI Recommendations for all Degradation Mechanisms (DMs) contained in an analysis. You can also:

- Create an RBI Recommendation manually.
- Generate RBI Recommendations for all RBI Analyses linked to a single asset.

Procedure

1. [Access the analysis](#) for which you want to generate recommendations.
2. Select , and then select **Generate Recommendations**.

The **Create Recommendations** window appears, asking you to confirm that you want to generate recommendations for the analysis.

3. Select **Yes**.

A message appears, confirming that you have generated recommendations for all the DMs contained in the analysis.

Results

The recommendations are linked to the Inspection Plan of the related RBI Asset.

Note:

- You can use the functionalities of the **Recommended Actions** pane.
- If, in the RBI Global Preference settings, the **Enable Recommendation To be Generated at Created State** check box is selected, recommendations will not be linked to the Inspection Plan until the related analysis is moved to the Risk Complete state and the Inspection Plan is generated.

Tip: For information about additional options available when working with the Recommendation records, refer to the Action Management section of the documentation.

Generate RBI Recommendations for Multiple RBI Criticality Analyses

About This Task

This topic describes how to generate recommendations for all RBI Criticality Analyses linked to components within a single asset.

You can also:

- [Create an RBI Recommendation manually.](#)
- [Generate Recommendations for a single RBI Analysis.](#) This will generate Recommendations for all the Degradation Mechanisms (DMs) in the RBI Analysis.

Procedure

1. [Access the Asset Summary workspace](#) for the asset for which you want to generate recommendations.
2. Select , and then select **Generate Recommendations**.

The **Create Recommendations** window appears, asking you to confirm that you want to generate recommendations for the asset.

3. Select **Yes**.

A message appears, confirming that you have generated recommendations for all the RBI Criticality Analyses linked to all the components in the asset.

Results

The recommendations are linked to the Inspection Plan of the related RBI Asset.

Note:

- You can use the functionalities of the **Recommended Actions** pane.
- If, in the RBI Global Preference settings, the **Enable Recommendation To be Generated at Created State** check box is selected, recommendations will not be linked to the Inspection Plan until the related analysis is moved to the Risk Complete state and the Inspection Plan is generated.

Tip: For information about additional options available when working with the Recommendation records, refer to the Action Management section of the documentation.

Generate Recommendations for all Analyses in an Asset Hierarchy Level

About This Task

This topic describes how to generate RBI Recommendations for assets linked to a Functional Location in the Asset Hierarchy. You can also:

- [Create an RBI Recommendation manually.](#)
- [Generate Recommendations for a single RBI Analysis.](#)
- [Generate Recommendations for all RBI Analyses linked to a single asset.](#)

Note: The consolidation of recommendations is supported only from the asset view when the **Enable Recommendation To be Generated at Created State** preference is set to True.

Procedure

1. Access the **Risk Based Inspection Overview** page for the Asset Hierarchy level for which you want to generate recommendations.
2. Select the **No Recommendations** tab.
The **No Recommendations** section appears, displaying assets that have at least one component with a Risk Completed analysis with no recommendations.
3. Select the check boxes next to the assets for which you want to generate recommendations.

Tip: You can generate recommendations for all listed assets in the **No Recommendations** section by selecting  when all check boxes in the first column of the table are cleared. If you select the check box in the first row of the table, recommendations are generated for the analyses that appear in the current page in the **No Recommendations** section (up to 100 analyses can be displayed in a page). You cannot, however, generate RBI Recommendations for all analyses if the Asset Hierarchy level is set to Home. Generating recommendations will only apply to components that do not have recommendations.

4. Select .
- The **Generate Recommendations** window appears, asking if you want to consolidate recommendations for each Degradation Mechanism and Task Type.

Tip: If you choose to consolidate recommendations, the recommendations generated during this process will be consolidated with existing recommendations. For more information on consolidating recommendations, consult recommendation consolidation in RBI 580 and RBI 581.

5. Select **Yes**.
The recommendations are generated. The **Recommendation Generation** window appears, displaying the progress and number of recommendations generated and consolidated for each asset.

Note: You can close the **Recommendation Generation** window before it is complete. You can view progress using the Schedule Logs.

6. Select **Close**.
7. Optionally, if you want to view the status of all bulk analyze operations, in the **Risk Based Inspection Overview** page, select 
The **Schedule Logs** page appears, displaying a list of all the operations in GE Digital APM that are in progress, along with the percentages of completion. You can also access a list of operations that have been successful or have failed.

Results

The recommendations are linked to the Inspection Plan of the related RBI Asset.

Note:

- You can use the functionalities of the **Recommended Actions** pane.
- If, in the RBI Global Preference settings, the **Enable Recommendation To be Generated at Created State** check box is selected, recommendations will not be linked to the Inspection Plan until the related analysis is moved to the Risk Complete state and the Inspection Plan is generated.

Chapter 13

Inspection Plans

Topics:

- [RBI Inspection Plans](#)
- [Inspection Plan Management](#)
- [Managing Recommended Actions in Inspection Plan](#)
- [Implement Recommended Actions to Inspection Tasks](#)
- [Inspection Plan Revision History](#)

RBI Inspection Plans

About Inspection Plans

An Inspection Plan allows you to view, manage, approve, and implement all RBI Recommended Actions related to an Asset. Inspection Plans are created for RBI Assets when one of the related components has an analysis that is moved to the Risk Completed state. When a user generates recommendations for RBI Analyses, the RBI Recommended Actions are added to Inspection Plans. An RBI Analyst can perform actions like supersede, mark as not required, or delete RBI Recommended Actions before approving the inspection plan.

After an Inspection Plan is approved, organizations can decide if they want to implement the approved RBI Recommended Actions through Inspection Plan or Asset Strategy Management. If an organization decides to implement the approved Recommended Actions through Inspection Plan, RBI Analysts can create a new inspection task or link an existing task to a Recommended Action. The Inspection Plan also displays the existing inspection tasks for an asset.

States of an Inspection Plan

Proposed

When an Inspection Plan is created, it will be in the Proposed state. An Inspection Plan is created for an RBI Asset when one of the related components has an analysis that is moved to the Risk Completed state. For Assets with multiple RBI Components, Inspection Plans are created when you finalize risk of an analysis for a single component.

Approved

After an analyst has reviewed all the Recommended Actions in an Inspection Plan, they can approve the Inspection Plan by transitioning it to the Approved state. This will also create or update the asset strategy for the Asset automatically, by creating or updating any Risks and Actions sourced from RBI. After an Inspection Plan is approved, all the related RBI Recommended Actions will move to the Approved state. An analyst can approve the Inspection Plan if all the RBI Components related to the asset have at least one active RBI Analysis.

Modified

An Inspection Plan is modified whenever reassessment or evergreening of RBI is done for the Asset. If the Inspection Plan is in the Approved state, and an analyst finalizes the risk for an analysis of an RBI Component, the Inspection Plan state is changed to Modified. When the state of an Inspection Plan is changed from Approved to Modified, GE Digital APM creates an Inspection Plan history record containing a snapshot of the Recommended Actions associated with the approved plan along with its implementation history.

About Inspection Plan Approval

An MI Inspection Plan Approver can approve Inspection Plans. Approving an Inspection Plan also integrates the related asset with Asset Strategy Manager (ASM). When an Inspection Plan is approved:

- Degradation Mechanisms (DMs) are used to create Risks in ASM.
- Recommendations are used to create Actions.

For more information on ASM Integration, see [About Asset Strategy Management \(ASM\) Integration](#).

When an Inspection Plan is in the Approved state, users can create or link Inspection Tasks to the related RBI Recommendations.

If the MI RBI Analyst transitions another RBI Criticality Analysis for an RBI Component linked to the asset related to the Inspection Plan to the Risk Completed state, the Inspection Plan will be moved to the Modified state.

An MI Inspection Plan Approver or MI Compliance Analyst can then delete, mark as not required, or supersede Compliance Recommendations.

Each time the Inspection Plan is changed from the Approved to Modified state, an Inspection Plan Revision record is created and linked to the existing Inspection Plan. For each existing RBI Recommendation record, a Recommendation Revision record is created and linked to the Inspection Plan Revision.

Additionally, the MI Inspection Plan Approver must change the state of the Inspection Plan to Approved before linking more Inspection Tasks to the plan.

About Modifying an Inspection Plan

An MI RBI Analyst can modify an Inspection Plan associated with an Asset by changing the state of an RBI Criticality Analysis for an RBI Component that is linked to the Asset to the Risk Completed state. This will archive the previous Risk Completed Analysis and its related RBI Recommendations. The archived RBI Recommendations will be unlinked from the Inspection Plan.

When an analyst modifies an Inspection Plan by finalizing the risk of an analysis for an RBI Component:

- Any existing RBI Recommendations on the active analysis of the component are unlinked from the Inspection Plan and moved to the Archived state.

Note: If the parent asset has multiple components, the RBI Recommendations linked to the other components are unaffected and remain in the Approved state.

- The Inspection Tasks previously linked to the recommendations are unlinked from the recommendations. However, the tasks remain linked to the asset.
- If RBI Recommendations are created or generated, the resulting recommendations populate the Inspection Plan.
- If the Inspection Plan is in the Approved State:
 - The plan is moved from the Approved to Modified state.
 - An Inspection Plan Revision record is created and linked to the existing Inspection Plan.
 - For each existing recommendation record linked to the Inspection Plan, a Recommendation Revision record is created and linked to the Inspection Plan Revision.

Note: The alternative inspection plan can be modified manually. For more information, refer to [Modify an Alternative Inspection Plan](#).

Access an Inspection Plan

You can access an Inspection Plan for an asset, component, and RBI Criticality Analysis.

Procedure

1. [Access the Asset Summary workspace](#) for the asset for which you want to access the Inspection Plan.
The **Asset Summary** workspace appears.

Note: You can also access the related Inspection Plan from a component and Criticality Analysis.

2. Select the **Inspection Plan** link.

The **Inspection Plan** workspace appears.

Note: If an Inspection Plan does not exist, a message stating so appears. Inspection Plans are created and linked to an asset when an analysis for at least one associated component is moved to the Risk Completed state. When using the alternative Inspection plan, the Inspection Plan is created by selecting the **Create Inspection Plan** option.

Delete an Inspection Plan

You can delete Inspection Plans that are obsolete or unnecessary.

Before You Begin

You must have one of the following Security Roles:

- MI Inspection Plan Approver
- MI Compliance Analyst

Procedure

1. [Access the Inspection Plan](#) that you want to delete.
2. In the **Inspection Plan** page, select .
The **Confirm Delete** window appears, asking you to confirm that you want to delete the Inspection Plan.
3. Select **Yes**.
The Inspection Plan is deleted.

Note: An Inspection Plan cannot be deleted if it has recommendations. If the field Use Alternative Inspection Plan preference is set to true, the recommendations must be removed through record manager.

Approve an Inspection Plan

Any user with the MI Inspection Plan Approver Security Role can move an Inspection Plan to the Approved state. After the Inspection Plan is approved, recommendations can be implemented as tasks.

About This Task

When an Inspection Plan is in the Approved state, you can create new Inspection Tasks or link existing Inspection Tasks to the related recommendations. The Inspection Tasks are transferred to the Inspection Management module.

Note:

Approving an Alternative Inspection Plan will automatically implement tasks. For more information, refer to [Approve an Alternative Inspection Plan](#).

Procedure

1. [Access the Inspection Plan](#) that you want to approve.
2. In the **Proposed** box, select **Approve**, and then select **Done**.
A message appears, stating that the Inspection Plan has been approved.

Note:

- After you approve an Inspection Plan, you cannot delete, supersede, or designate recommendations as Not Required. You must first move them to the Modified state.

- While the Inspection Plan is being modified, you cannot delete, supersede, or designate recommendations as Not Required.

About Alternative Inspection Plans

The GE Digital APM provides an Alternative Inspection Plan functionality to enhance usability and flexibility of the existing Inspection Plan. An Alternative Inspection Plan is created manually, when an RBI Analyst analyzes and finalizes the risk for each component linked to the RBI Asset.

The Inspection Plan consists of the following sections:

- **Inspection Plan**- Contains the information about the Inspection Plan.
- **Inspection Plan Details**- Contains the inspection strategies, which are needed to mitigate the damage mechanism that is identified during the RBI analysis.

The inspection strategies are generated automatically for all damage mechanisms in the analyses, based on the following policy content configured in RBI Strategy Mapping Configuration and Detail mappings:

- Appendix_B
- Appendix_D
- Appendix_E
- Appendix_F
- Appendix_G
- Appendix_H
- Appendix_I

The policy content returns inspection strategy records which are mapped to Inspection Plan Detail Records.

Inspection Plan Detail Field	Inspection Strategy Field	Behavior and Usage												
Task Type	Inspection Task Type	The picklist will be populated with all Inspection Task Types that are valid for the given Degradation Mechanism based on the Degradation Mechanism Strategy family.												
Highest Level of Inspection	Inspection Confidence	<p>The Inspection Confidence is converted to a Level of Inspection Category (A - E) as follows:</p> <table border="1"> <thead> <tr> <th>Highest Level of Inspection</th> <th>Confidence</th> </tr> </thead> <tbody> <tr> <td>A</td> <td> <ul style="list-style-type: none"> • Very High • Highly Effective </td> </tr> <tr> <td>B</td> <td> <ul style="list-style-type: none"> • High • Usually Effective </td> </tr> <tr> <td>C</td> <td> <ul style="list-style-type: none"> • Medium • Fairly Effective </td> </tr> <tr> <td>D</td> <td> <ul style="list-style-type: none"> • Low • Poorly Effective </td> </tr> <tr> <td>E</td> <td> <ul style="list-style-type: none"> • Ineffective </td> </tr> </tbody> </table>	Highest Level of Inspection	Confidence	A	<ul style="list-style-type: none"> • Very High • Highly Effective 	B	<ul style="list-style-type: none"> • High • Usually Effective 	C	<ul style="list-style-type: none"> • Medium • Fairly Effective 	D	<ul style="list-style-type: none"> • Low • Poorly Effective 	E	<ul style="list-style-type: none"> • Ineffective
Highest Level of Inspection	Confidence													
A	<ul style="list-style-type: none"> • Very High • Highly Effective 													
B	<ul style="list-style-type: none"> • High • Usually Effective 													
C	<ul style="list-style-type: none"> • Medium • Fairly Effective 													
D	<ul style="list-style-type: none"> • Low • Poorly Effective 													
E	<ul style="list-style-type: none"> • Ineffective 													
Extent	Inspection Extent	The picklist will be populated with all the Extents that are valid for the selected Task Type and given Degradation Mechanism based on the Degradation Mechanism Strategy family.												

Inspection Scope	Recommended Inspection Scope	The picklist will be populated with the Recommended Inspection Scope for the selected Task Type, Extent, Inspection Confidence, and given Degradation Mechanism based on the Degradation Mechanism Strategy family.
Interval Scope	Recommended Inspection Interval	The picklist will be populated with the Recommended Inspection Interval for the selected Task Type, Extent, Inspection Confidence, and given Degradation Mechanism based on the Degradation Mechanism Strategy family.

To view the Inspection Strategies that are valid for a Degradation Mechanism you can run the following query and select the Degradation Mechanism:

```
SELECT [MI_DEGMECH_STRAT].[MI_DEGMECH_STRAT_DM_C] "Degradation
Mechanism"
, [MI_DEGMECH_STRAT].[MI_DEGMECH_STRAT_ID_C] "Inspection Strategy ID"
, [MI_INSP_STRAT].[MI_INSP_STRAT_TASK_TYPE_C] "Inspection Task Type"
, [MI_INSP_STRAT].[MI_INSP_STRAT_CONF_C] "Inspection Confidence"
, [MI_INSP_STRAT].[MI_INSP_STRAT_EXTENT_C] "Inspection Extent"
, [MI_INSP_STRAT].[MI_INSP_STRAT_REC_SCOPE_T] "Recommended Inspection
Scope"
, [MI_INSP_STRAT].[MI_INSP_STRAT_REC_INT_N] "Recommended Interval"
FROM [MI_DEGMECH_STRAT] JOIN [MI_INSP_STRAT]
ON [MI_DEGMECH_STRAT].[MI_DEGMECH_STRAT_ID_C] = [MI_INSP_STRAT].[
MI_INSP_STRAT_ID_C]
WHERE [MI_DEGMECH_STRAT].[MI_DEGMECH_STRAT_DM_C] =
(? :s :id=DM :table='MI_DEGRADATION_MECHANISM_TYPES')
```

In the Alternative Inspection Plan, you can manually add the strategies to mitigate any additional risk for damage mechanisms.

After adding strategies to the Inspection Plan, RBI Analysts can review the implementation strategies such as target inspection date, interval, and interval scope. The Inspection Plan Details display the proposed next date for all the inspection strategies to help with the implementation cycle. An RBI Analyst can select the implementation methods like creating a new task versus linking to an existing task. After an Inspection Plan is reviewed and approved, implementation strategies can be executed based on the selections made by the RBI Analysts.

You can also perform actions such as Edit an Approved Plan, Update the Plan, and Capture the Revision History, including asset information to ensure a flexible, easy-to-use, and seamless inspection planning process.

Note: The Alternative Inspection Plan does not support the following workflows:

- Compliance Management
 - When you use the Alternative Inspection Plan process, the compliance recommendations have the following behavior:
 - If the parent asset has no RBI components linked, you can continue to use the current inspection plan workflow which supports compliance recommendation.
 - If the parent asset has at least one RBI component linked, you will be forced to use the Alternative Inspection Plan and will not be able to view the compliance recommendations.
- RBI Inspection Grouping
- Promotion to Asset Strategy Management

Create an Alternative Inspection Plan

When the alternative Inspection Plan preference is set to True, an MI RBI Analyst can create an Inspection Plan from the RBI Asset page.

About This Task

The Inspection Plan should be created once the analyst has analyzed and finalized risk for each component linked to the RBI Asset.

Procedure

1. Access the [Asset Summary workspace](#) for the asset for which you want to create an Inspection Plan. The **Asset Summary** workspace appears.

Note: You can also access the related Inspection Plan for a component and Criticality Analysis.

2. Select **+Create Inspection Plan**.

The Inspection Plan is created. Inspection Plan Details are generated automatically for the Damage Mechanisms on Risk Completed analyses related to the RBI Asset where there is an associated Inspection Strategy derived from policy content.

Note:

- All RBI Components linked to the Asset must have an active analysis to create the Inspection Plan.
- If an Inspection Plan has already been created, the Inspection Plan link appears with the **Update** button.
- The Inspection Plan Details are not generated for Other Degradation Mechanism Evaluation records.

Update an Alternative Inspection Plan

An MI RBI Analyst can update an Inspection Plan from either the RBI Asset page or the Inspection Plan page. This removes the current Inspection Plan Detail records and regenerate new Inspection Plan Details based on the current risk complete analyses.

About This Task

When an analyst modifies an Alternative Inspection Plan:

- Any existing Inspection Plan Details are removed.
- The Inspection tasks previously linked to the Inspection Plan details are unlinked from the details. However, the tasks remain linked to the asset.
- New Inspection Plan Details are generated based on the Degradation Mechanisms on the Risk Complete analyses related to the Asset.
- If the Inspection Plan is in the Approved State:
 - The plan is moved from the Approved to Modified state.
 - An Inspection Plan Revision record is created and linked to the existing Inspection Plan.
 - For each existing Inspection Plan detail record linked to the Inspection Plan, an Inspection Plan detail revision record is created and linked to the Inspection Plan Revision.

Procedure

1. Access the [Asset Summary workspace](#) for the asset for which you want to create an Inspection Plan. The **Asset Summary** workspace appears.

-or-

[Access the Inspection Plan](#) that you want to modify.

2. Select .

A confirmation message appears to update the Inspection Plan.

Note: If the button is an orange , then there are active analyses on the RBI Components linked to the Asset which were not available when the Inspection Plan was generated. This indicates that the Inspection Plan must be updated.

3. Select **Yes**.

The Inspection Plan is updated.

Note:

If you do not want to delete and re-create Inspection Plan details, instead you want to modify the existing records, you can [edit an approved alternative Inspection Plan](#).

Edit an Approved Alternative Inspection Plan

An MI RBI Analyst can edit an approved alternative Inspection Plan from the Inspection Plan page. This will enable the current Inspection Plan record and related Inspection Plan Details for modification.

About This Task

When an analyst edits an approved alternative Inspection Plan:

- The plan is moved from the approved to modified state.
- An Inspection Plan Revision record is created and linked to the existing Inspection Plan.
- For each existing Inspection Plan detail record linked to the Inspection Plan, an Inspection Plan Detail Revision record is created and linked to the Inspection Plan Revision.

Procedure

1. [Access the Inspection Plan](#) that you want to edit.
 2. Select .
 3. Select **Yes**.
- The Inspection Plan is enabled for editing.

Add an Inspection Plan Detail record to an Alternative Inspection Plan

To add an Inspection Plan Detail Record, the Alternative Inspection Plan must be in either Proposed or Modified state.

About This Task

Use the **Inspection Plan** page, to add an Inspection Plan Detail which was not generated automatically during Inspection plan creation.

Procedure

1. [Access the Inspection Plan](#) for which you want to add an Inspection Plan Detail.
2. In the Inspection Plan Details section, enter the new Inspection Plan Detail record values in the last row of the Bulk Data Form.

Note:

- The Degradation Mechanism field is required for the Task Type and Extent field picklists to populate.
 - Once the Component field is set, the Degradation Mechanism field will be filtered to the Degradation Mechanisms linked to the specified Component.
 - After saving the changes, the Asset Key field is set automatically on the Inspection Plan Detail record. The Inspection Plan Detail record will also be linked automatically to the Inspection Plan record.
 - The Recurring flag will be selected by default.
3. Select .
- The Inspection Plan Details are saved successfully.

Mark an Inspection Plan Detail to be Implemented to an Inspection Task

About This Task

The Inspection Plan details are implemented as Inspection Tasks when the related Inspection Plan is moved to Approved state and when the **Task** field is set in the Inspection Plan detail record. You can either select **Create New**, or a pre-existing Task linked to the Asset in the **Task** drop-down list before approving the Inspection Plan.

Procedure

1. [Access the Inspection Plan](#) for which you want to implement Inspection Tasks.
2. In the Inspection Plan Details section, in the **Task** drop-down list, select a pre-existing Inspection Task that is linked to the parent RBI Asset or select **Create New**.

Note: If the Inspection Plan Detail is non-recurring, you cannot link an existing task. You can only create new tasks.

3. Select .
- The Inspection Plan Detail is marked for implementation. The Inspection Tasks does not get created and linked until the [Inspection Plan is moved to Approved State](#).

Note:

- You can unlink an Inspection Task from an Inspection Plan Detail by resetting the **Task** drop-down list to blank.
- The Task gets unlinked, after approving the Inspection Plan.

Approve an Alternative Inspection Plan

Any user with the MI Inspection Plan Approver Security Role can move an Inspection Plan to the Approved state. When the Inspection Plan is approved, Inspection Plan Details are implemented as Tasks.

About This Task

Inspection Plan details are implemented as tasks when the Task field is set on the Inspection Plan detail record. The user can select either Create New, or a pre-existing Task linked to the Asset in the Task field before approving the Inspection Plan. Once approved, the Inspection Task will be created and/or linked to the Inspection Plan detail.

Procedure

1. [Access the Inspection Plan](#) that you want to approve.
2. In the **Proposed** box, select **Approve**, and then select **Done**.

A message appears, stating that the Inspection Plan has been approved.

Note:

- After you approve an Inspection plan, you cannot delete, edit, or add an Inspection plan details. You must first move the Inspection plan to the modified state.
- After Approval, the Task field will be updated to the new Inspection Task ID if Create New was selected.
- Alternative Inspection Plans are not promoted to the Asset Strategy Management module.

Implement Inspection Plan Detail to a New Inspection Task

When implementing Inspection Plan Detail to a new Inspection Task, the Inspection Task fields are populated with the following values:

Field	Value	Source
Desired Interval	The value of the Interval Scope field.	Inspection Plan Detail
Desired Interval Basis	RBI 580 or RBI 581 Note: <ul style="list-style-type: none"> • The field is undefined for non-recurring tasks. • If the Methodology field is not defined or the Override Interval field is True, then the field is set to User Defined. 	Inspection Plan Detail
Last Date	The value of the Last Date field.	Inspection Plan Detail
Next Date	The value will be calculated and populated based on the Last Date and Desired Interval.	Inspection Plan Detail
Override Interval	False	Inspection Plan Detail
Reason	The value in the Methodology field.	Inspection Plan Detail
Reoccurring	The value in the Reoccurring field.	Inspection Plan Detail
Task Details	The value in the Inspection Scope field concatenated with the value in the Basis field.	Inspection Plan Detail
Task ID	The value in the Degradation Mechanism field concatenated with the value in the Task Type field.	Inspection Plan Detail
Task Type	The value in the Task Type field.	Inspection Plan Detail

Note: To add custom mapping from Inspection Plan Detail to Inspection Task, refer to [KBA 000039697](#).

Implement Inspection Plan Detail to an Existing Inspection Task

When implementing Inspection Plan Detail to an existing Inspection Task, the Inspection Task fields are populated with the following values:

Field	Value	Source
Desired Interval	<p>The least value of Interval Scope among the related Inspection Plan Details.</p> <p>Note:</p> <ul style="list-style-type: none"> The field is populated only if the value in the Override Interval field is False and the value in the Reoccurring field is True. Next Date is calculated and populated based on Desired Interval and Last Date. Last Date is not mapped while linking to an existing Inspection Task. If the Inspection Plan Detail is already linked to an Inspection Task, the Interval Scope of the Inspection Task will be updated with the Interval Scope on the detail, when the Inspection Plan is approved. 	Inspection Plan Detail
Desired Interval Basis	<p>RBI 580 or RBI 581</p> <p>Note:</p> <ul style="list-style-type: none"> The field is populated only if the value in the Override Interval field is False and the value in the Reoccurring field is True. The field is undefined for non-recurring tasks. If the Methodology field is not defined or the Override Interval field is True, then the field is set to User Defined. 	Inspection Plan Detail
Reason	The value in the Methodology field.	Inspection Plan Detail
Reoccurring	<p>The value in the Reoccurring field.</p> <p>Note: If the Inspection Plan Detail is already linked to an Inspection Task, the Reoccurring field of the Inspection Task will be updated with the Reoccurring field on the detail, when the Inspection Plan is approved.</p>	Inspection Plan Detail

Field	Value	Source
Task Details	<p>The value in the Inspection Scope field concatenated with the value in the Basis field.</p> <p>Note:</p> <ul style="list-style-type: none"> The value is appended to the top of the previous Task Details value. If the Inspection Plan Detail is already linked to an Inspection Task, the Task Details of the Inspection Task will be updated with the Inspection Scope and Basis on the detail, when the Inspection Plan is approved. 	Inspection Plan Detail
Task Type	<p>The value in the Task Type field.</p> <p>Note: If the Inspection Plan Detail is already linked to an Inspection Task, the Task Type of the Inspection Task will be updated with the Task Type on the detail, when the Inspection Plan is approved.</p>	Inspection Plan Detail

Note: Task ID, Override Interval, and Last Date are not mapped while implementing an Inspection Plan Detail to an existing task.

Inspection Plan Management

Overview

The **Inspection Plan Management** page allows you to review multiple inspection plans and active recommended actions for any level in the Asset Hierarchy. In addition, you can approve or implement multiple Inspection Plans in bulk.

Note: Inspection plans can be created in either Risk Based Inspection or in Compliance Management.

Access Inspection Plan Management

Procedure

1. In the **Risk Based Inspection Overview** page, select the **Actions** button.
2. Select the **Inspection Plan Management** option.
The **Inspection Plan Management** page appears, displaying the **Inspection Plans** section.

The screenshot shows the 'Inspection Plan Management' page. At the top, there are browser tabs for 'Inspect...verview', 'Complia...verview', and 'Inspect...agement'. The page title is 'Inspection Plan Management' with a sub-header 'Asset: Home'. Below this, there are two main sections: 'Inspection Plans' and 'Active Recommended Actions'. The 'Inspection Plans' section contains a table with 16 rows, each with a checkbox and a description. The 'Active Recommended Actions' section contains a table with 16 rows, each with a status (e.g., Approved, Modified, Proposed). At the bottom, there is a pagination control showing '1 - 100 of 145 Results' and a 'Rows per page' dropdown set to 100.

Inspection Plans	Active Recommended Actions
<input type="checkbox"/> INSPECTION PLAN	STATE ↑
<input type="checkbox"/> ~ ~ QA COMPLIANCE EQUIP1-Piping	Approved
<input type="checkbox"/> ~ ~ QA COMPLIANCE EQUIP2-Piping	Approved
<input type="checkbox"/> ~ ~ QA EQUIP COMP BULK CREATE NEW 01	Approved
<input type="checkbox"/> ~ ~ QA EQUIP COMP BULK CREATE NEW 02	Approved
<input type="checkbox"/> ~ ~ QA EQUIP COMP BULK CREATE NEW 03	Approved
<input type="checkbox"/> ~ ~ QA COMPLIANCE EQUIP4-Piping	Modified
<input type="checkbox"/> ~ ~ QA EQUIP COMP BULK CREATE NEW 04	Modified
<input type="checkbox"/> ~ ~ RBI EQU COMP ALL DATA	Proposed
<input type="checkbox"/> ~ ~ Arch An, Crted An, Arch W-If, PAppr An	Proposed
<input type="checkbox"/> ~ ~ Arch Anlys, Rsk Cmpl Anlys, Crted Anlys, No W-If	Proposed
<input type="checkbox"/> ~ ~ Arch Anlys, Rsk Cmpl W-If	Proposed
<input type="checkbox"/> ~ ~ Comp Anlyzd Every 5 Yrs	Proposed
<input type="checkbox"/> ~ ~ Comp Has 10 Anlys	Proposed
<input type="checkbox"/> ~ ~ COMP W ARCH, RC, and CR ANLYS	Proposed
<input type="checkbox"/> ~ ~ COMP W W-IF ANLYS	Proposed
<input type="checkbox"/> ~ ~ Crted Anlys, Rsk Cmpl W-If	Proposed

Next Steps

You can access Inspection Plans and Active Recommended Actions. You can also implement Inspection Plans that are in the Approved state in bulk.

Approve Inspection Plans in Bulk

Before You Begin

You must have one or more Inspection Plans that are in the Modified or Proposed state.

Procedure

1. Access the [Inspection Plan Management](#) page.

The **Inspection Plan Management** page appears, displaying the **Inspection Plans** section.

2. Select the check box next to each Inspection Plan in the **Inspection Plans** section.
3. Select **Approve**.
4. The **Confirm Approval** window appears, asking you to confirm if you want to approve the selected Inspection Plans.
5. Select **Yes**.

The job status appears in the page heading, displaying the progress of the Inspection Plan approval for the selected plans. To review the progress, you can select  to access the **Schedule Logs** page and

search for Type Mechanical Integrity and Description Inspection Plan Approval to check the progress of the approval.

Note: The Recommended Actions linked to the Approved Inspection Plans can be accessed in the Active Recommended Actions section.

User can choose to implement the Recommended Actions to Tasks in Asset Strategy Management or in Inspection Plan Management page.

Implement Inspection Plans in Bulk by Creating New Inspection Tasks

Before You Begin

You must have one or more Inspection Plans that are in the Approved state.

Note: This option is only available when the following selection in the Inspection Configuration section of the IM Admin Preferences available in the Applications settings of the Inspection Management is set to false. Implement Recommended Actions to Tasks in ASM should be unchecked.

Note: This feature is not supported when using Alternative Inspection Plans. Implementation of Tasks occur during the Approval process when the Use Alternative Inspection Plan preference is true.

Procedure

1. Access the [Inspection Plan Management](#) page.
The **Inspection Plan Management** page appears, displaying the **Inspection Plans** section.
2. In the **Inspection Plans** section, next to each Approved Inspection Plan that you want to implement, select the check box.
3. Select **Implement**, and then select **Create New**.
The **Create New** window appears, displaying the **Select Recommended Actions** section. This section displays all the Recommendations linked to the Inspection Plan that have not been implemented to Tasks.
4. Select each Recommended Action for which you want to create new Inspection Tasks.
5. Select **Next**.
The **Edit Details** section appears.
6. You can edit Last Date in bulk using the Bulk Edit Last Date or edit Last Date for individual records in edit details section for recurring recommendations only.

Note: For all non-recurring recommendations, one cannot edit the Last Date column in the Edit Details sections. Last Date is blank for non-recurring recommendations and is not updated when user edits the date in Bulk Edit Last Date field.

7. Modify the details for the Recommended Actions that you selected.
8. Select **Finish**.
The job status appears in the page heading, displaying the progress of the Inspection Task creation.
When the process is complete, you can select  to access the **Schedule Logs** page.

Results

The newly created Inspection Tasks are linked to the selected Recommended Actions and linked to the Asset related to the Inspection Plan.

Implement Inspection Plans in Bulk by Linking Existing Inspection Tasks

Before You Begin

You must have one or more Inspection Plans that are in the Approved state.

Note: This option is only available when the Implement Recommended Actions to Tasks in ASM preference in the Inspection Configuration section of the IM Admin Preferences available in the Applications settings of the Inspection Management is unchecked.

Note: This feature is not supported when using Alternative Inspection Plans. Implementation of Tasks occur during the Approval process when the Use Alternative Inspection Plan preference is true.

Procedure

1. Access the [Inspection Plan Management](#) page.
The **Inspection Plan Management** page appears, displaying the **Inspection Plans** section.
2. In the **Inspection Plans** section, next to each Approved Inspection Plan that you want to implement, select the check box.
3. Select **Implement**, and then select **Link Existing**.
The **Link Existing Inspection Tasks** window appears, displaying the **Select Recommended Actions** section. This section displays all the Recommendations linked to the Inspection Plan that has not been implemented to Tasks.
4. Select each Recommended Action that you want to link to Inspection Tasks.
Note: For optimal performance, no more than 100 recommended actions should be selected at one time.
5. Select **Next**.
The **Edit Details** section appears with the Recommended Actions and the existing task which will be linked. The task to link is matched, based on the task type and related asset.
Note: If no task with a matching task type or related asset is found or if the recommended action is recurring and the matching task is nonrecurring, an error will be displayed.
6. Select **Finish**.
The job status appears in the page heading, displaying the progress of the Inspection Task creation.
When the process is complete, you can select  to access the **Schedule Logs** page.

Results

The Inspection Tasks are linked to the selected Recommended Actions.

Review Active Recommended Actions

The Active Recommended Actions section displays all the recommended actions that have Inspection Plans in an Approved state.

Inspection Plans					Active Recommended Actions	
RECOMMENDATION ID	STATE ↑	INSPECTION PLAN	SOURCE	RECOMMENDATION HEADLINE	DAMAGE MECHANISM	
REC-10123	Approved	-- QA EQUIP COMP BULK CREATE NEW 03	API 570		Criticality Calculator External Corrosion	
REC-10125	Approved	-- QA EQUIP COMP BULK CREATE NEW 02	API 570		Criticality Calculator External Corrosion	
REC-10127	Approved	-- QA EQUIP COMP BULK CREATE NEW 01	API 570		Criticality Calculator External Corrosion	
REC-10128	Approved	-- QA EQUIP COMP BULK CREATE NEW 03	API 570		Criticality Calculator Internal Corrosion	
REC-10130	Approved	-- QA EQUIP COMP BULK CREATE NEW 02	API 570		Criticality Calculator Internal Corrosion	
REC-10132	Approved	-- QA EQUIP COMP BULK CREATE NEW 01	API 570		Criticality Calculator Internal Corrosion	
REC-10225	Approved	-- QA Compliance Bulk Approval Process 05	API 570		Criticality Calculator External Corrosion	
REC-10228	Approved	-- QA Compliance Bulk Approval Process 05	API 570		Criticality Calculator Internal Corrosion	
REC-10303	Approved	testfunction4 -- QA COMPLIANCE APPROVED BUTTON	API 570		Criticality Calculator External Corrosion	
REC-10304	Approved	testfunction4 -- QA COMPLIANCE APPROVED BUTTON	API 570		Criticality Calculator Internal Corrosion	
REC-10344	Approved	testaction5 -- QA COMPLIANCE IMPLEMENT ACTION	RBI 580	RBI-RBICOMP-testaction5 -- QA COMPLIANCE IMPLEMENT ACTION-EB-2624-Creep	Creep	
REC-10345	Approved	testaction4 -- QA COMPLIANCE UNLINK ACTION	RBI 580	RBI-RBICOMP-testaction4 -- QA COMPLIANCE UNLINK ACTION-EB-2622-Creep	Creep	
REC-10363	Approved	bulkAction1 -- QA COMPLIANCE BULK CREATE RBI	API 570		Criticality Calculator External Corrosion	
REC-10364	Approved	bulkAction1 -- QA COMPLIANCE BULK CREATE RBI	API 570		Criticality Calculator Internal Corrosion	
REC-10383	Approved	bulkAction1 -- QA COMPLIANCE BULK CREATE RBI	RBI 581	RBI-bulkAction1-EB -- bulkAction1 -- QA COMPLIANCE BULK CREATE RBI-581-Thinning Damage	581-Thinning Damage	
REC-10443	Approved	bulkAction1 -- QA COMPLIANCE BULK CREATE RBI	RBI 580	RBI-RBICOMP-bulkAction1 -- QA COMPLIANCE BULK CREATE RBI-HD-2628-Creep	Creep	
REC-10249	Implemented	testaction4 -- QA COMPLIANCE UNLINK ACTION	API 570		Criticality Calculator External Corrosion	
REC-10250	Implemented	testaction4 -- QA COMPLIANCE UNLINK ACTION	API 570		Criticality Calculator Internal Corrosion	
REC-10305	Implemented	testaction5 -- QA COMPLIANCE IMPLEMENT ACTION	API 570		Criticality Calculator External Corrosion	
REC-10306	Implemented	testaction5 -- QA COMPLIANCE IMPLEMENT ACTION	API 570		Criticality Calculator Internal Corrosion	
REC-9985	Implemented	-- QA COMPLIANCE EQUIP2-Piping	API 570		Criticality Calculator Internal Corrosion	
REC-9983	Not Required	-- QA COMPLIANCE EQUIP2-Piping	API 570		Criticality Calculator External Corrosion	

Managing Recommended Actions in Inspection Plan

Modify an RBI Recommendation





RBI Recommendations can be marked not required, superseded, or deleted from the **Inspection Plan** workspace.

Before You Begin

You must either belong to the MI RBI Analyst Security Group or have MI Inspection Plan Approver Security Role to modify an RBI Recommendation.

Procedure

1. [Access the Inspection Plan](#) that contains the RBI Recommendations that you want to modify.
2. Modify the RBI Recommendation in one of the following ways:

State	Action
Supersede ()	<p>Changes the state of the RBI Recommendation to Superseded. To supersede recommendations:</p> <ol style="list-style-type: none"> Next to two or more Recommendations, select the check boxes. Select  . The Supersede Recommended Actions window appears. Select the recommendation that you want to designate as the master recommendation. Select Supersede. The master recommendation supersedes the other recommendations and appears in the grid. Note: You can view the superseded recommendations by selecting the number in the Linked Actions column.
Not Required ()	<p>Changes the state of the RBI Recommendation to Not Required.</p> <ol style="list-style-type: none"> Next to each Recommendation that you want to mark Not Required, select the check box. Select  . A window appears, asking you to confirm that you want to mark the recommendation as Not Required. Select Yes. The Reason for Not Required window appears, asking you to state a reason for marking the recommendation as Not Required. Enter a reason for marking the recommendation as Not Required, and then select Done. The RBI Recommendation is moved to the Not Required state.
Unlink Superseded Recommendations	<p>Changes the state of the recommendations from Superseded to Proposed. This unlinks superseded recommendations from the master recommendation.</p> <ol style="list-style-type: none"> In the row containing the recommendation that you want to modify, in the Linked Actions column, select the number. The Linked Recommended Actions window appears, displaying the linked superseded and consolidated recommendations. Next to each superseded recommendation that you want to unlink, select the check box. Note: You can only unlink superseded recommendations from the Inspection Plan. To unlink consolidated recommendations, you must use the Recommended Actions pane from the Asset Summary workspace for the related asset. Select Unlink. The selected RBI Recommendations are unlinked from the master recommendation and appear in the grid. The RBI recommendations are moved to the Proposed state.

Note: To consolidate RBI Recommendations, you must use the **Recommended Actions** pane from the **Asset Summary** workspace for the related asset.

Delete an RBI Recommendation

Procedure

1. [Access the Inspection Plan](#) that contains the RBI recommendation that you want to delete.
2. Next to each recommendation that you want to delete, select the check box.
3. Select  .
A window appears, asking if you want to delete the selected records.
4. Select **Yes**.
The RBI Recommendations are deleted.

Implement Recommended Actions to Inspection Tasks

Implement an RBI Recommendation to an Inspection Task

You can create new Inspection Tasks or link existing Inspection Tasks to an RBI Recommendation that is in the Approved state in an Inspection Plan.

Before You Begin

- Ensure that the **Implement Recommended Actions to Tasks in ASM** setting is set to False in the **Global Preferences** section of the **RBI Admin Preferences** page.
- You must have an Inspection Plan that is in the Approved state.

Procedure

1. [Access the Inspection Plan](#) that contains the RBI Recommendations that you want to implement.
2. Next to the RBI Recommendation that you want to implement, select the check box.
3. Select **Implement**.
The **Implement as Inspection Task** window appears.
4. Select one of the following:

Action	Description
Create New	Creates a new task that is linked to the RBI Recommendation. The new task is assigned a Task ID, and the Task ID appears in the Task ID column for the respective RBI Recommendation.
Link Existing	Allows you to select an existing Inspection Task to link to the RBI Recommendation. The task uses the existing Task ID. Note: You cannot link non-reoccurring tasks to reoccurring recommendations.

5. Select **Implement**.
The Inspection Task is linked to the RBI Recommendation and appears in the **Existing Tasks** section of the **Inspection Plan** page.

The Inspection Task fields are populated with the following values from the RBI Recommendation:

Field	Value	Source
Desired Interval	<p>The least value among the following:</p> <ul style="list-style-type: none"> The value in the Interval field The value in the RBI Half-Life field in the associated Degradation Mechanism Evaluation The value in the TM Half-Life field in the associated Asset Corrosion Analysis Time-Based Inspection Settings <p>Note: If you are linking to an existing Inspection Task, this field is populated only if the value in the Override Interval field is False and the value in the Reoccurring field is True.</p>	RBI Recommendation
Desired Interval Basis	<p>The value of the Interval Basis that corresponds to the Interval field</p> <p>Note: If you are linking to an existing Inspection Task, this field is populated only if the value in the Override Interval field is False and the value in the Reoccurring field is True.</p>	RBI Recommendation
Next Date	<p>The value in the Target Completion Date field</p> <p>Note: This field is populated only when the RBI Recommendation field, NonRecurring? is true.</p>	RBI Recommendation
Next Date Basis	<p>RBI Recommendation or RBI 581 Recommendation</p> <p>Note: This field is populated only when the RBI Recommendation field, NonRecurring? is true.</p>	None
Override Interval	<p>False</p> <p>Note: If you are linking to an existing Inspection Task, this field is not populated.</p>	None
Reason	RBI Recommendation or RBI 581 Recommendation	None
Reoccurring	The negated value of the NonRecurring? field	RBI Recommendation
Task Details	The value in the Recommended Inspection Scope field concatenated with the value in the Recommendation Basis field	RBI Recommendation
Task ID	<p>The value in the Degradation Mechanism field concatenated with the value in the Task Type field</p> <p>Note: If you are linking to an existing Inspection Task, this field is not populated.</p>	RBI Recommendation
Task Type	The value in the Task Type field	RBI Recommendation

Unlink an Inspection Task from an RBI Recommendation

You can unlink Inspection Tasks from Compliance Recommendations to remove them from the Linked Actions.

Procedure

1. [Access the Inspection Plan](#) that contains the RBI Recommendations from which you want to unlink tasks.
2. Next to the RBI Recommendation that contains the Inspection Task that you want to unlink, select the check box.
3. Select .
4. Select **Yes**.
The Inspection Task is unlinked from the RBI Recommendation.

Note: The Inspection Task will remain linked to the parent asset. The Desired Interval and Desired Interval Basis fields in the Inspection Task will remain populated based on the previously linked recommendation.

Inspection Plan Revision History

About Inspection Plan Revision History

An Inspection Plan Revision History record is created when the state of an Inspection Plan is changed from Approved to Modified.

You can modify an Inspection Plan in any of the following scenarios:

- For Compliance Management: When an MI Inspection Plan Approver or an MI Compliance Analyst updates the Compliance Recommendations.
- For Risk Based Inspection (RBI): When an RBI Risk Analysis is moved to the Risk Completed state.

[The Inspection Plan Revision History record can be accessed through the Inspection Plan](#). Using this record, you can track the progress of an Inspection Plan and view the following details:

- The name of the user who modified or approved the Inspection Plan.
- The date of revision.
- The reason for revision.

Access Inspection Plan Revision History

You can access the revision history of an Inspection Plan that has been updated.

Procedure

1. [Access the Inspection Plan](#) for which you want to access the revision history.
2. In the **Inspection Plan** page, select .
3. In the **Revision Date** column, select the link in the row that contains the Inspection Plan Revision History record that you want to access.

The Inspection Plan Revision History record appears.

Chapter

14

ASM Integration

Topics:

- [About Asset Strategy Management \(ASM\) Integration](#)
- [Asset Strategy Management \(ASM\) Integration Workflow](#)
- [About Unmitigated Risk](#)
- [About Mitigated Risk](#)
- [Access Asset Strategy Manager \(ASM\) from an Inspection Plan](#)
- [Approve the Inspection Plan of an Asset](#)

About Asset Strategy Management (ASM) Integration

You can approve the Inspection Plan of an asset if all the RBI Components in the asset have an active RBI Criticality Analysis. When you approve the Inspection Plan, the asset is promoted to ASM. When an asset is promoted:

- Degradation Mechanisms (DMs) are used to create Risks in ASM.
- Recommendations are used to create Actions, which can be implemented as Inspection Tasks. These tasks are listed in Inspection Management.

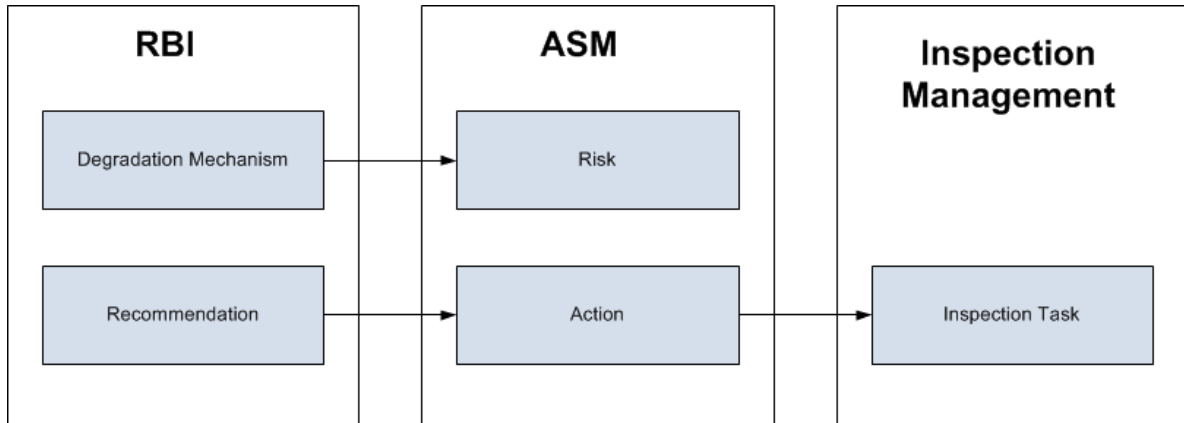

Note: The way in which you manage the unmitigated and mitigated risk values depends on how administrative settings are configured.

Details

You can decide how you want to track recommended actions based on the risk information in the DMs. You can choose either of the following options:

- You can create or generate RBI Recommendations to record the mitigated risk values and then approve the Inspection Plan of the asset. Approving the Inspection Plan will transfer the Degradation Mechanism and RBI Recommendations, along with unmitigated and mitigated risk values, to ASM. Risks are created for the Degradation Mechanism and Actions are created for the recommendation. You can implement either RBI Recommendations from an approved Inspection plan or Actions from an active Asset Strategy as an Inspection Task.
- You will not create RBI Recommendations. Instead, you will recommend a future action and manage mitigated risk values using Actions in ASM.

To transfer RBI Recommendations to Asset Strategies in ASM, you must approve the Inspection Plan of the corresponding asset.

Note: A single asset can have multiple RBI Components, and each RBI Component can have only one active RBI Criticality Analysis.

After you approve the Inspection Plan of the asset:

- All the RBI Criticality Analyses and RBI Recommendations linked to the RBI Components in the asset are set to the Accepted by ASM state. You cannot modify them.
- If you create another RBI Criticality Analysis for an RBI Component linked to the asset and modify the state of the new analysis to Risk Completed, the Inspection Plan will be moved to the Modified state. You can re-approve the Inspection Plan to promote the asset to ASM again.

Example: ASM Integration

In the following image, Asset A is linked to two RBI Components, Component 1 and Component 2, which are each linked to a Risk Completed RBI Criticality Analysis, Analysis 1 and Analysis 2, respectively. If you approve the Inspection Plan on Asset A, the asset is promoted to ASM, and both Analysis 1 and Analysis 2 are set to the Accepted by ASM state.

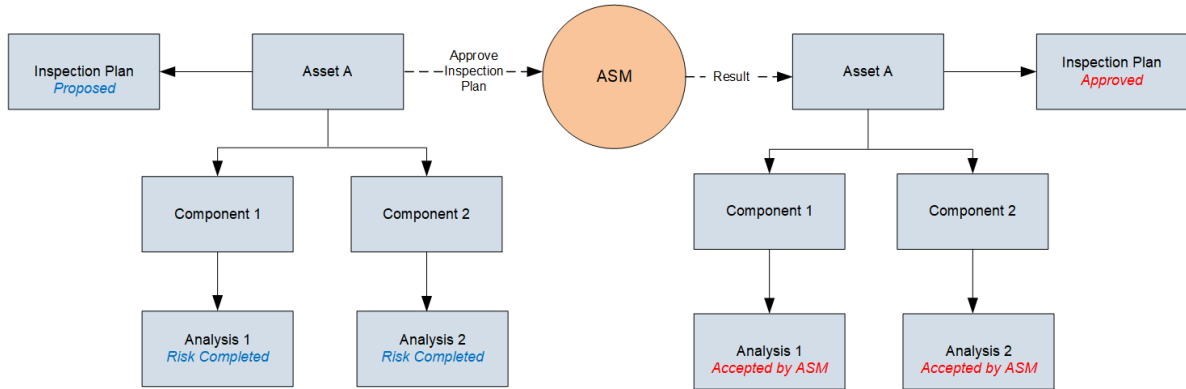

Managing Asset Strategies That Were Created from RBI

After an Asset Strategy has been created from RBI, you can manage the Asset Strategy using ASM. Some restrictions will apply to the Asset Strategy depending on how the administrative settings are configured.

The following table provides information about which Actions are always allowed and which ones are always restricted.

Always Allowed	Always Restricted
<ul style="list-style-type: none"> • Creating Risks. • Assigning new Actions to Risks that did not originate in RBI. • Managing Asset Strategy states. • In the Risk Analysis, clearing the Selected Actions check box for any Action that did not originate in RBI. • Assigning new Actions to any Risk that originated in RBI. • Assigning existing Actions that did not originate in RBI to any Risk that did originate in RBI. • Assigning new Risks to any Action that originated in RBI. • Assigning existing Risks that did not originate in RBI to any Action that did originate in RBI. • Accessing the Risk Matrix to view the unmitigated risk rank for any Risk that was created from RBI. • Accessing the Risk Matrix to view the mitigated risk rank for any Action that was created from RBI. • Copying a Risk that was created from RBI. • Copying a Risk that was created from RBI. 	<ul style="list-style-type: none"> • Risk Records • Undoing a Risk that was created from RBI. • Removing a Risk that was created from RBI. • Assigning Actions that originated in RBI to a Risk that originated in RBI. • For any Risk that was created from RBI, modifying values in the following fields in the Risk datasheet (listed in the order in which they appear on the datasheet, from top to bottom): <ul style="list-style-type: none"> ◦ Name ◦ Description ◦ Risk Basis ◦ Failure Mode ◦ Maintainable Item ◦ Failure Cause • Modifying the unmitigated risk rank or unmitigated financial risk rank for any Risk that was created from RBI. • Action Records <ul style="list-style-type: none"> ◦ Removing an Action that was created from RBI. ◦ Assigning Risks that originated in RBI to an Action that originated in RBI. ◦ For any Action that was created from RBI, modifying values in the following fields on the Action datasheet (listed in the order in which they appear in the datasheet, from top to bottom): <ul style="list-style-type: none"> ◦ Action Basis ◦ Name ◦ Action Type ◦ Interval ◦ Interval Units ◦ Nonrecurring ◦ Cost ◦ Shutdown Required ◦ Cost Basis ◦ Target Completion Date ◦ Modifying the mitigated risk rank for any Action that was created from RBI. ◦ In the Risk Analysis, clearing the Selected Actions check box for an Action that was created from RBI. • General <ul style="list-style-type: none"> ◦ Applying an Asset Strategy Template as a master template to the Asset Strategy

The following table describes Actions that are allowed for Asset Strategies that were created from RBI and the corresponding administrative setting that allows it.

Action	Corresponding Administration Action
Implement Actions as Tasks in ASM	<p>This action is allowed if the Implement Recommended Actions to Tasks in ASM check box is selected.</p> <p>If the Implement Recommended Actions to Tasks in ASM check box is cleared, recommendations can be implemented only as Inspection Tasks through the Inspection Plan of the related asset.</p>

Asset Strategy Management (ASM) Integration Workflow

1. [Create an RBI Component](#) for each piece of an asset.
2. [Create an RBI Criticality Analysis](#) for the component.
3. [Assess the unmitigated risk](#) of the Degradation Mechanisms (DMs) that are linked to the RBI Criticality Analyses.
4. [Modify the state of all the RBI Criticality Analyses to Risk Completed.](#)
An Inspection Plan will be created and linked to the parent asset if one does not exist. If the Inspection Plan does exist and is approved, the state of the Inspection Plan will be updated to Modified.
5. [Generate Recommendations](#) for all the analyses within the asset and assess the mitigated risk. Recommendations will be linked to the Inspection Plan of the asset.
6. [Access an Inspection Plan](#) for the asset.
7. [Approve the Inspection Plan.](#)
This will transition the Inspection Plan to the Approved state and promote all the RBI Recommendations and DMs associated with the asset to ASM.

Approving an Inspection Plan on an asset includes steps to analyze the risk associated with each component, recommend a future action based on the risks, and transfer the analysis data to ASM. You can recommend a future action in one of the following ways:

- Using RBI Recommendations in RBI: In this workflow, you will identify the mitigated risk of DMs in RBI.
- Using Actions in ASM: In this workflow, you will identify the mitigated risk of DMs in ASM.

In most cases, you will complete the steps in either workflow on a regular basis as you refine the operating conditions and environment. RBI Analyses are dynamic tools that help you refine your strategy for maintaining RBI Components.

About Unmitigated Risk

When you [calculate an RBI Criticality Analysis](#), the unmitigated SHE risk and unmitigated financial risk for each Degradation Mechanisms record (DM) are calculated automatically and stored in the DM. The calculation is performed using Risk Mapping Policies.

Unmitigated Risk

The unmitigated risk rank is plotted on a Risk Matrix. This value is the intersection of the consequence and probability that are calculated when you calculate an RBI Criticality Analysis.

Tip: For more information, refer to the Risk Matrix section of the documentation.

- Consequence of Failure: The consequence of failure is the highest among the values in the following fields in the associated Criticality Consequence Evaluation:
 - Safety Risk Category

- Flammable Consequence Category
- Toxic Consequence Category
- Operations Risk Category
- Product Leak Category

Note: The Product Leak Consequence field will contain a value only if the RBI Component contains the value Heat Exchanger -Bundle in the Component Type field.

- Environmental Risk Category
- Environmental Consequence Category

Note: The Environmental Consequence Category field will contain a value only if the RBI Component contains the value Storage Tank - Bottom in the Component Type field.

- Probability of Failure: This value is calculated and stored in the DM.

Unmitigated Financial Risk

The unmitigated financial risk rank is set on a Risk Matrix. This value is the product of the consequence and probability that are calculated when you calculate an RBI Criticality Analysis.

Tip: For more information, refer to the Risk Matrix section of the documentation.

- Financial Consequence: The financial consequence is the highest among the values in the following field in the associated Criticality Consequence Evaluation:
 - Lost Production Category
- Probability of Failure: This value is calculated and stored in the DM.

About Mitigated Risk

When you calculate an RBI Criticality Analysis, the [unmitigated risk](#) and [unmitigated financial risk](#) for each DM is calculated automatically and stored in the related Degradation Mechanisms record (DM).

By default, the mitigated risk values are set to the same values as the unmitigated risk values. You can modify the mitigated risk values manually using the risk matrix to indicate how the risk could be lowered if certain actions are taken.

Access Asset Strategy Manager (ASM) from an Inspection Plan

Procedure

1. [Access an Inspection Plan](#) for the asset which you want to access the Asset Strategy in Asset Strategy Manager (ASM).
2. In the workspace, select the **Open Strategy** link. The **Risks and Actions** workspace appears for the Asset Strategy in the Asset Strategy Manager (ASM). For more information, refer to the Asset Strategy Management documentation.

Note: The **Open Strategy** link will be available only if the Inspection Plan is in the Approved or Modified state and an Asset Strategy exists for the asset. The state of the asset strategy also appears next to the **Open Strategy** link.

Approve the Inspection Plan of an Asset

Before You Begin

- All the RBI Components linked to the asset must contain an active RBI Criticality Analysis (that is, analysis in the Risk Completed, Pending Approval, Approved, or Implemented state).

Procedure

1. Access the [Inspection Plan workspace](#) for the Inspection Plan that you want to approve.
2. Select the button that indicates the current state of the Inspection Plan (that is, Proposed or Modified).

A menu appears, displaying a list of operations that you can perform on the Inspection Plan to modify its state.

3. Select **Approve**, and then select **Done**.

The Inspection Plan is approved.

If the selected asset is not currently linked to an Asset Strategy, an Asset Strategy is created and linked to the asset.

Results

The selected asset, along with all the DMs and Recommendations linked to the asset, are [promoted to Asset Strategy Manager \(ASM\)](#).

Next Steps

Access [ASM](#).

Chapter 15

Flexible RBI Methodology

Topics:

- [Overview](#)
- [Configure Analysis Validation](#)
- [Configure Consequence Evaluation Validation and Calculation](#)
- [Configure Degradation Mechanism Evaluation Validation and Calculation](#)
- [Configure Degradation Mechanism Roll-up](#)
- [Configure Analysis Roll-up](#)

Overview

About the Flexible RBI Methodology

GE Digital APM enables you to perform the RBI assessment through the following baseline methods:

- Semi-quantitatively (RBI 580) – Based on API Recommended Practice 580.
- Quantitatively (RBI 581) – Based on API Recommended Practice 581.

However, because of the broad diversity in organizations' size, culture, federal and/or local regulatory requirements, some organizations may want to use their own RBI methodology. To meet such requirements, the API RP 580 is designed to provide a framework that clarifies the expected attributes of a quality risk assessment without imposing any undue constraints on users. GE Digital APM follows the same approach to offer you the flexibility to configure the RBI 580 methodology within the context of existing corporate risk management practices. The configured RBI 580 methodology is referred to as the flexible RBI methodology.

The following diagram illustrates the continuum of the RBI methodologies.

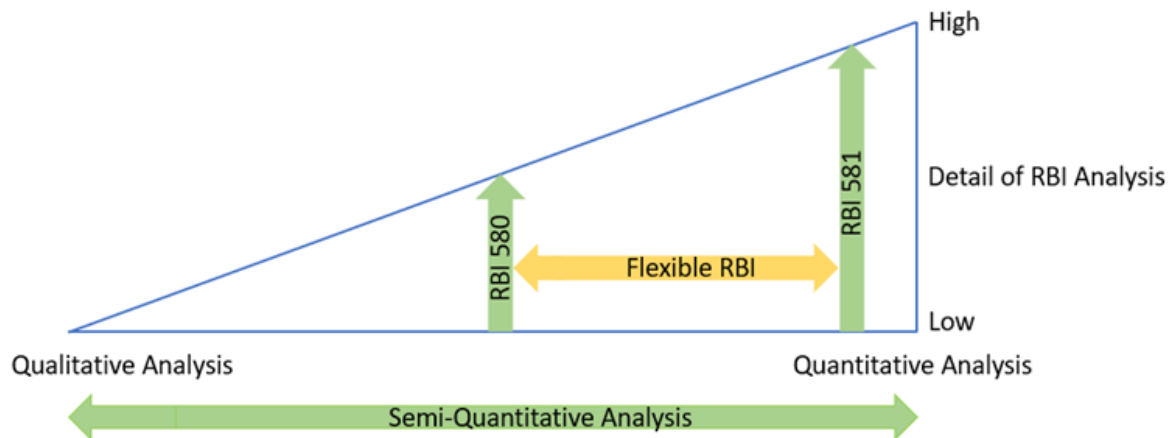

Each approach provides a systematic way to screen for risk, identify areas of potential concern, and develop a prioritized list for an in-depth inspection or analysis. You can choose any of the approaches for your analysis. However, consistency of the approach is vital to compare results from one assessment to the next.

Advantages of Flexible RBI

Following are some of the advantages of the flexible RBI methodology:

- You can configure the existing RBI 580 methodology based on your requirements.
- You can modify the calculations without editing the rules.
- You can implement the flexible RBI methodology in a short time.
- You can use the flexible configuration at any step during the analysis calculation.
- You can use a combination of baseline and flexible configuration during the analysis calculation.

Flexible RBI Framework

By default, when you calculate the analysis, the analysis goes through the following validation steps:

- Analysis validation: Verifies if all the required fields in the analysis have valid values.

- CE Validation: Verifies if all the required fields in the consequence evaluation records have valid values.
- DME Validation: Verifies if all the required fields in the degradation mechanism evaluation records have valid values.

Note: The PRD workflow is not supported in the Flexi RBI Methodology; this means that if the Protected RBI Component has a custom DME mapped to it, you cannot run the PRD analysis. As a workaround, add a protected asset instead of a protected component to the PRD.

If there are any validation errors, the appropriate error messages appear on the **Analysis Calculation** window and the calculation fails. If there are no validation errors, it goes through the following calculation steps:

- CE Calculation: Calculates the consequence evaluation (CoF) values.
- DME Calculation: Calculates the degradation mechanism evaluation (PoF) values.
- DM Roll-up: Rolls up the CoF values to the degradation mechanism records.
- Analysis Roll-up: Rolls up the worst-case risk values from RBI degradation mechanism to analysis.

Based on the calculation, the CoF and PoF values are updated in the analysis and the risk value is determined.

The following diagram illustrates the sequence of events that occur when you calculate an analysis:

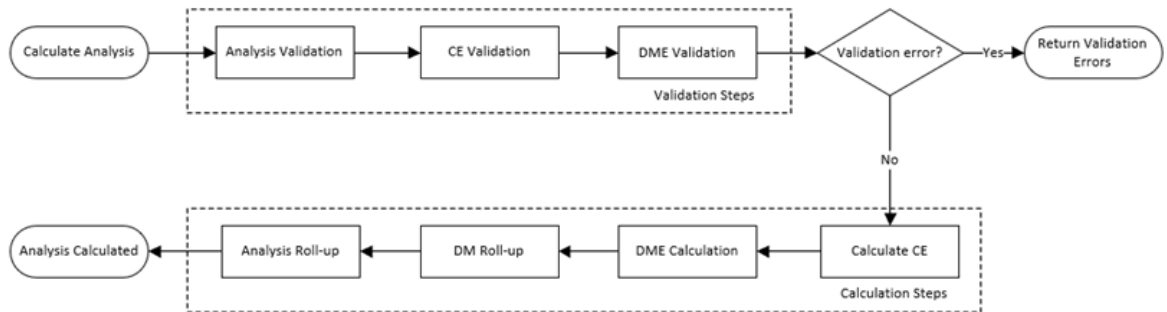

As part of the flexible RBI implementation, all the validation and calculation steps are configured to check for a configured record at the beginning of each step. If a configured record is available for a step, it overrides the baseline validation or calculation for that step and perform the validation or calculation defined in the configured record. The following workflow illustrates the flexible RBI framework:

Note: The operations highlighted in orange color are part of flexible RBI configuration.

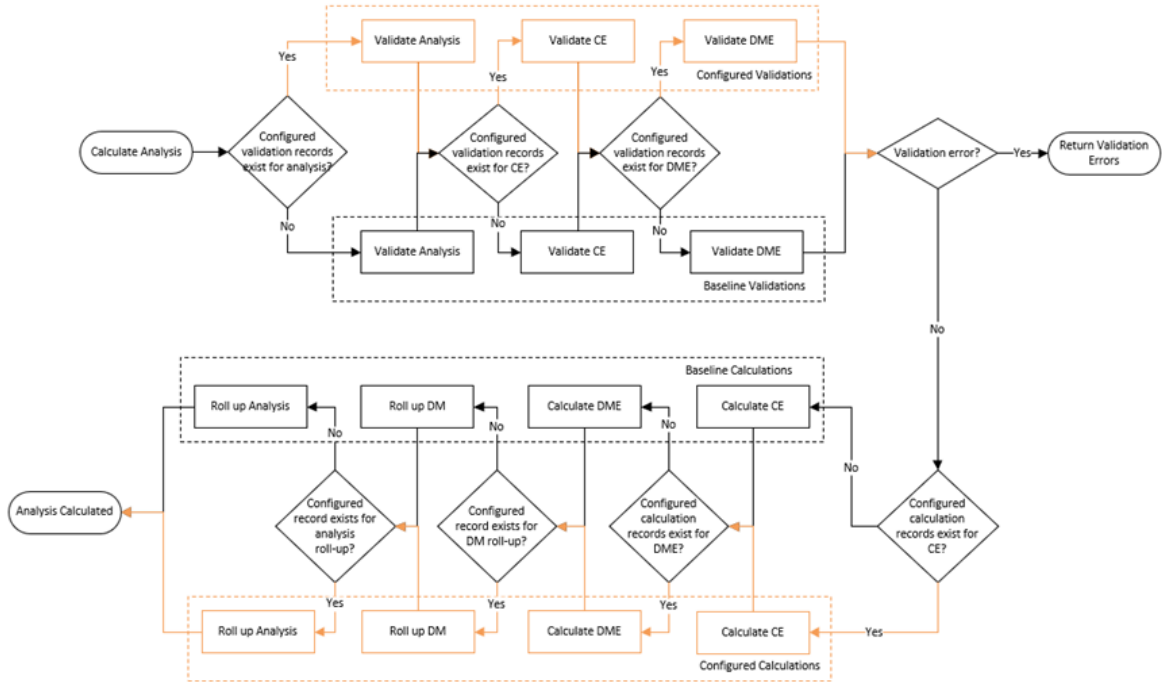

It is not required to configure all the validation and calculation steps to use the flexible configuration. Depending on your requirement, you can configure only the steps in which you want to achieve the flexibility. For example, if you want to configure only the DME validation and DME calculation, you can configure only these two steps. For other steps, the baseline validations and calculations will be performed.

The following sections in this chapter defines how to configure the flexible RBI framework. Each section contains an example that defines the steps that you need to perform to create a sample configuration.

- [Configure Analysis Validation](#)
- [Configure Consequence Evaluation Validation and Calculation](#)
- [Configure DME Validation and Calculation](#)
- [Configure Degradation Mechanism Roll-up](#)
- [Configure Analysis Roll-up](#)

Configure Analysis Validation

About the Analysis Validation

When you calculate an RBI Criticality Analysis, it validates the fields in the analysis and verifies if all the fields required for calculation contain valid values. If any of the fields required for calculation are blank or contain invalid values, the calculation fails, and appropriate error messages appear in the **Analysis Calculation** window. You can now configure these validations based on your requirements. If you use the flexible validations, it overrides the baseline validations. The following image illustrates the flexible analysis validation framework:

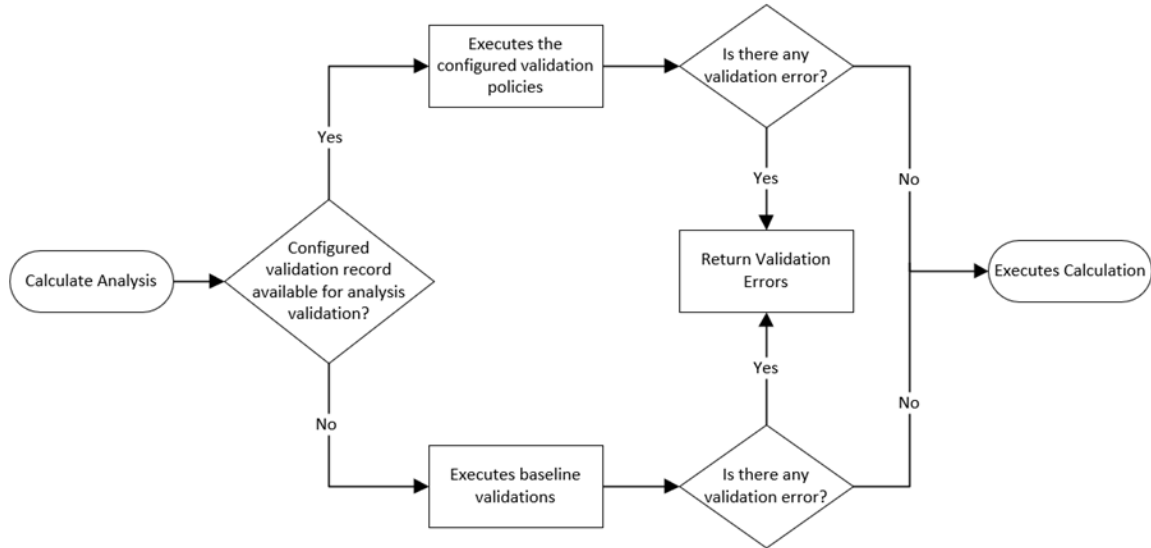

Workflow

This topic describes the sequence of the tasks that you must perform to configure the flexible analysis validation. Based on the complexity of the configuration, you may need to perform certain tasks outside of the Risk Based Inspection module. When performing such tasks, we recommend that you follow the documentation of the respective modules.

The following image illustrates the workflow to configure the flexible analysis validation:

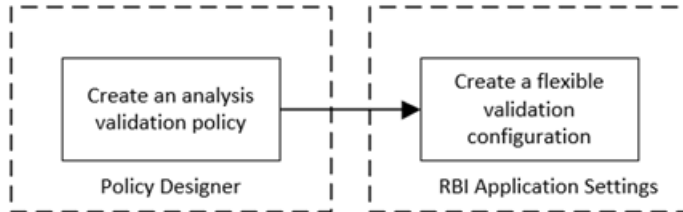

Note: If you want to use additional fields for validations which are not part of baseline, you can add the additional fields to the RBI Criticality Analysis family. You must configure the family before creating the analysis validation policy. For more information on creating family fields, refer to the [Family Management documentation](#).

Create an Analysis Validation Policy

About This Task

As part of the flexible validation configuration, to configure new validations, you must create a policy to define the validation rules. After you create the analysis validation policy, you must configure the policy in the **Flexible Calculation Validation** section in RBI 580 Flexible Calculation Preferences. If you use the analysis validation policy, all the baseline analysis validations are overridden.

This topic describes the basic steps on creating an analysis validation policy. For more information on creating, managing, and activating policies, refer to the [Policy Designer documentation](#).

Procedure

1. [Create a policy](#).
2. Access the Design workspace of the policy.
3. Add an Entity node that represents the RBI Criticality Analysis family. For information on Entity nodes, refer to the [Entity Nodes in Policy Designer](#) topic.
4. As needed, add other nodes required for validation. For information on the different types of nodes, refer to the [Condition, Logic, and Calculation Nodes in Policies](#) section in the Policy Designer documentation.
5. For each validation, add a Return Value node that has the error message that you want to display to the user when validating the policy. For information on Return Value node, refer to the [Return Value Nodes in Policy Designer](#) topic.

Note: Each Return Value node must have a unique name and the error messages must not contain more than 255 characters.

6. Save the policy.
The analysis validation policy is created.

Create Flexible Analysis Validation Configuration

If you want to override the baseline analysis validation logic, you must create a flexible analysis validation record in the RBI 580 Flexible Calculation Preferences section. For more information on creating a flexible analysis validation record, refer to the [Create a Flexible Calculation Configuration](#) on page 271 topic.

Before You Begin

Before creating a flexible analysis validation configuration, make sure that a policy is created for the flexible validations.

Procedure

Create a flexible validation record with the following configuration:

Master section:

- Analysis Family: RBI Criticality Analysis
- Action: Analysis Validation
- Action Family: Select the family that you want to use for the flexible analysis validation.
- Policy Name: Select the policy that must be used for the validation.
- Sequence: 1

Detail section:

- Input Entity Family: Select the family defined in Input Entity of the analysis validation policy.
- Policy Node Name: Enter the name of the input Entity node defined in the analysis validation policy.

The flexible analysis validation configuration record is created.

Configure Analysis Validation - Example

About This Task

Suppose you want to create a new analysis validation to validate the following fields:

- Design Pressure: This is a required field and the value must not be less than 0.
- Design Temperature: This is a required field and the value must not be less than 0.

Procedure

1. Create a validation policy to perform the validations on fields. For detailed steps on creating the validation policy, refer to the [Create Sample Validation Policy](#) topic.
2. Create an analysis validation record in the RBI Application Settings with the following settings:
 - **Analysis Family:** RBI Criticality Analysis
 - **Action:** Analysis Validation
 - **Action Family:** RBI Criticality Analysis
 - **Policy Name:** Select the validation policy created in step 1.

For more information on validation configuration, refer to the [Create Flexible Analysis Validation Configuration](#) on page 162 topic.

The flexible analysis validation record is now configured. Now, when you calculate an RBI Criticality Analysis, the following events will occur:

- The baseline analysis validations will be overridden.
- The validation policy will be triggered. If the input fields contain null values or invalid values, the calculation will fail, displaying an appropriate validation error message.
- If there is no validation error, the calculation will be executed.

Create a Sample Analysis Validation Policy

About This Task

This task explains the basic steps that you need to perform to configure validations as part of the example. For detailed information on creating and configuring a policy, refer to the [Policy Designer](#) documentation.

Procedure

1. Create a Policy with the name Configured Analysis Validation Policy.
2. Configure an Entity node to represent the RBI Criticality Analysis family.
3. Configure an Is Null node and map the value in the Design Pressure field of the RBI Criticality Analysis family.
4. Set the output value of the Is Null node to -1.

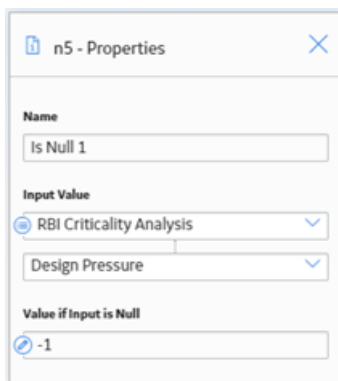

The screenshot shows a configuration window titled "n5 - Properties" with a close button (X) in the top right corner. The window contains the following fields:

- Name:** A text input field containing "Is Null 1".
- Input Value:** A dropdown menu with "RBI Criticality Analysis" selected.
- Design Pressure:** A dropdown menu with "Design Pressure" selected.
- Value if Input is Null:** A text input field containing "-1".

5. Map the output of the Is Null node to the input of the Equal node.
6. Configure the Equal node such that:
 - If the value in the Design Pressure field is null, a Return Value node is triggered to display an error message indicating that Design Pressure is a required field.

n7 - Properties

Name
Return Value

Return Value
 Design Pressure is a required Field

- If the value in the Design Pressure field is not null, the output is mapped to the Less Than node.

n2 - Properties

Name
Equal

Production Loss is Null

Answer

Display Node

=

-1

7. Configure the Less Than node such that if the value in the Design Pressure field is less than zero, a Return Value node displays an error message indicating that the value must not be less than zero.

n8 - Properties

Name
Less Than

RBI Criticality Analysis

Design Pressure

Display Field

<

0

8. Repeat steps 3 through 7 for the Design Temperature field.
9. Save the policy.
The validation policy is created.

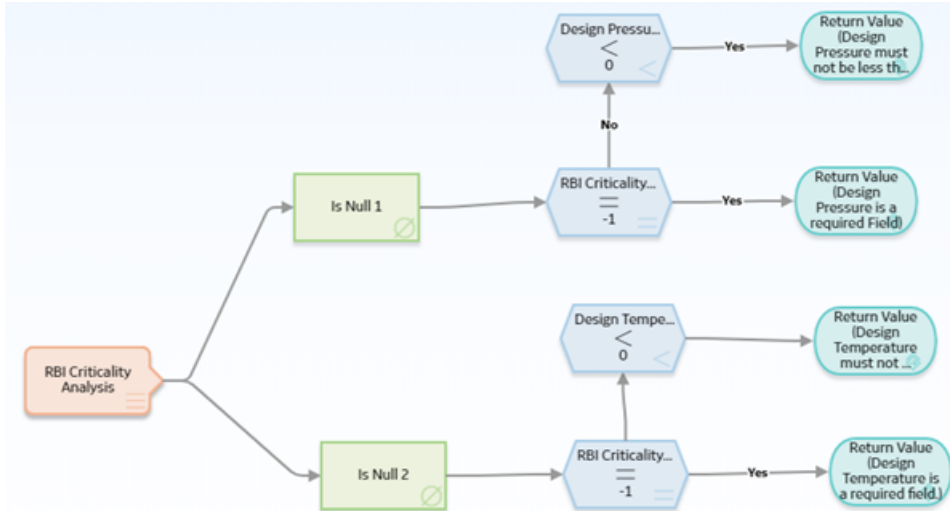

Configure Consequence Evaluation Validation and Calculation

About Consequence Evaluation Validation and Calculation

When you calculate an RBI Criticality Analysis, it gives you the Consequence of Failure (CoF) value based on the values in the consequence evaluation fields. You can now configure this calculation based on your requirements. These calculations override the baseline calculations. The following image illustrates the flexible CE calculation framework:

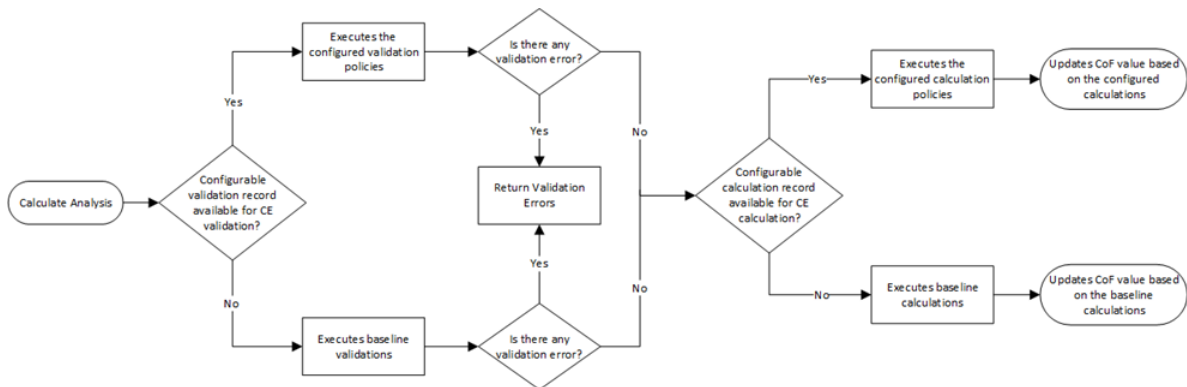

Workflow

This topic describes the overview of the tasks that you need to perform to configure the flexible CE validation and calculation. Based on the complexity of the configuration, you may need to perform certain tasks outside of the Risk Based Inspection module. When performing such tasks, we recommend that you follow the documentation of the respective modules.

The following image illustrates the typical workflow of the flexible Consequence Evaluation calculation configuration:

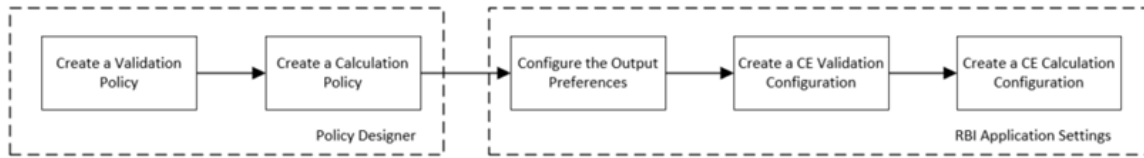

Note: To configure flexible CE calculation, it is not mandatory to perform all the tasks mentioned in the workflow. You can perform only the tasks that are specific to your configuration. For example, if you want to configure only the CE Calculation using the baseline CE family, you can perform only the following tasks:

- Configure CE calculation policy.
- Create Calculation Configuration in RBI Application Settings.

If you do not want to use the baseline CE family and want to use a new CE family for the flexible configuration, you must complete the following tasks before configuring the validation and calculation.

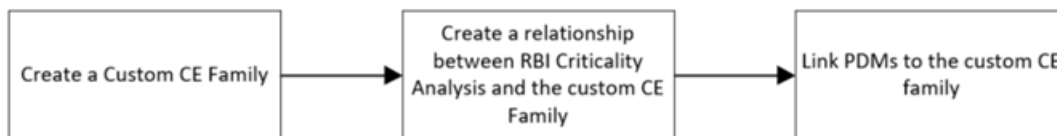

Create a Consequence Evaluation Family and Datasheet

About This Task

If you want to use a new family to configure the flexible CE calculation, you can create a child family under the Criticality Consequence Evaluation family. This is not a mandatory step to configure the flexible CE calculation. However, if you want to use new fields for the calculation that are not part of the baseline family, we recommend that you create a new family and do the configuration. This will make sure that the baseline family is not modified, and you can use the baseline family whenever required.

For more information on creating and configuring a family, refer to the [Family Management documentation](#).

Create Relationship between RBI Criticality Analysis and CE Family

About This Task

If you have created a family as part of the flexible CE calculation, you must create a relationship definition between the RBI Criticality Analysis family and the new family.

This topic describes the basic steps to create a relationship definition between the RBI Criticality Analysis and the Consequence Evaluation family. For detailed documentation on creating relationship definitions, refer to the Family Management documentation.

Procedure

1. Access the Has Consequence Evaluation Relationship Definition. For information on accessing a relationship family, refer to the [Access the Relationship Definition Section](#) topic.
2. Create a One-to-Many Relationship Definition between the RBI Criticality Analysis family (Predecessor family) and the new CE family (successor family). For information on creating a relationship definition, refer to the [Create a Relationship Definition](#) topic.

Link Potential Degradation Mechanism to Consequence Evaluation Family

About This Task

If you have created a family as part of the flexible CE calculation, you must link the family to the applicable Potential Degradation Mechanism (PDM) records. This topic describes the steps that you need to perform to link the family to a Potential Degradation Mechanism. For more information on Potential Degradation Mechanisms, refer to the [About Potential Degradation Mechanisms \(PDM\)](#) on page 359 topic.

Procedure

1. In the record manager, select the datasheet of the Potential Degradation Mechanism that you want link to the family.
The Potential Degradation Mechanism datasheet appears, displaying the **General** section.
2. Select **Consequences**.
3. In the Consequence 1 row:
 - Select a failure mode in the **Value(s)** box.
 - Select the new CE family in the **Consequence Eval Used** box.
4. Select .

The potential degradation mechanism is linked to the configured Consequence Evaluation family.

Create CE Validation Policy

About This Task

As part of the flexible CE calculation, if you do not want to use the baseline validations and want to use new validations, you can create a new validation policy. If you use a configured validation policy, it overrides all the baseline validations. After you create the validation policy, you must configure the policy in the **Flexible Calculation Validation** section in **RBI 580 Flexible Calculation Preferences** page.

This topic describes the basic steps on creating a validation policy. For more information on creating, managing, and activating policies, refer to the [Policy Designer documentation](#).

Procedure

1. [Create a policy](#).
2. Access the Design workspace of the policy.
3. Add an Entity node that represents the family that you want to validate. For more information on Entity nodes, refer to the [Entity Nodes in Policy Designer](#) topic.
4. As needed, add other nodes required for the validations. For more information on the different types of nodes, refer to the [Condition, Logic, and Calculation Nodes in Policies](#) section in the Policy Designer documentation.
5. For each validation, add a Return Value node that has the error message that you want to display to the user when validating the policy. For more information on Return Value node, refer to the [Return Value Nodes in Policy Designer](#) topic.

Note: Each Return Value node must have a unique name and the error messages must not contain more than 255 characters.

6. Save the policy.
The analysis validation policy is created.

Create CE Calculation Policy

About This Task

As part of the flexible CE calculation configuration, you must create a new calculation policy to perform the calculations. These calculations are used to derive the CoF value.

This task explains the basic steps on creating a calculation policy. For more information on creating, managing, and activating policies, refer to the [Policy Designer documentation](#).

Procedure

1. [Create a policy](#).
2. Access the Design workspace of the policy.
3. Add an Entity node that represents the family that you want to calculate. For more information on Entity nodes, refer to the [Entity Nodes in Policy Designer](#) topic.
4. Add any other nodes to perform the required calculations. For more information on the different types of nodes, refer to the [Condition, Logic, and Calculation Nodes in Policies](#) section in the Policy Designer documentation.
5. For each calculation, add an Edit Entity node that contains the details of the output field and its value. For more information on Edit Entity nodes, refer to the [Edit Entity Nodes in Policy Designer](#) topic.
6. Save the policy.
The calculation policy is created.

Configure CE Output Preferences

About This Task

You can configure the output fields for the family where you have configured the flexible calculation. The output fields are not copied to new records when the parent RBI Criticality Analysis is copied, and the values are reset when the analysis is calculated. For more information on configuring the output fields, refer to the [Create a Flexible Calculation Output Preference on page 273](#) topic.

Create Flexible CE Validation Configuration

If you want to override the baseline validations, you must create a flexible validation record in the RBI 580 Flexible Calculation Preferences section. For more information on creating a flexible validation record, refer to the [Create a Flexible Calculation Validation on page 272](#) topic.

Before You Begin

Make sure that a policy is created for the validations that you want to perform.

Procedure

Create a flexible validation record with the following configuration:

Master section:

- **Analysis Family:** RBI Criticality Analysis
- **Action:** Consequence Evaluation Validation
- **Action Family:** Select the family that you want to use for the flexible CE validation.
- **Policy Name:** Select the policy that must be used for the validation.
- **Sequence:** 1

Detail section:

- **Input Entity Family:** Select the family defined in Input Entity of the CE validation policy.
- **Policy Node Name:** Enter the name of the input Entity node defined in the validation policy.

The flexible CE validation record is created.

Create Flexible CE Calculation Configuration

If you want to override the baseline calculations, you must create a flexible calculation record in the RBI 580 Flexible Calculation Preferences section. For more information on creating a flexible calculation record, refer to the [Create a Flexible Calculation Configuration](#) on page 271 topic.

Before You Begin

Make sure that a policy is created for the calculations that you want to perform.

Procedure

Create a flexible calculation record with the following configuration:

Master section:

- **Analysis Family:** RBI Criticality Analysis
- **Action:** Consequence Evaluation Calculation
- **Action Family:** Select the family that you want to use for the flexible CE calculation.
- **Policy Name:** Select the policy that must be used for the calculation.
- **Sequence:** 1

Detail section:

- **Input Entity Family:** Select the family defined in Input Entity of the CE calculation policy.
- **Policy Node Name:** Enter the name of the input Entity node defined in the calculation policy.

The flexible CE calculation configuration record is created.

Configure Consequence Evaluation Calculation - Example

About This Task

Suppose you want to configure a Consequence Evaluation calculation such that based on the value in the Production Loss field, an output field, Lost Production Category is updated with a value. The Production Loss field must have the following properties:

- It is a required field. If the field is blank, the validation must fail with a message indicating that it is a required field.
- The field value cannot be less than zero. If the field value is less than zero, the validation must fail with a message indicating that the value in the field is invalid.
- The field is mapped to the Loss Production Category field as described in the following table.

Value in Production Loss Field	Value in Lost Production Category Field
0 - 1000000	E
1000001 - 10000000	D
10000001 - 100000000	C

Value in Production Loss Field	Value in Lost Production Category Field
1000000001 - 10000000000	B
10000000001 – Any higher value	A

Procedure

1. Create a new Consequence Evaluation family (Criticality Configured Consequence Evaluation). For information on creating a family, refer to the [Create a Family](#) topic.
 - a) Create the following fields:
 - Production Loss
 - Lost Production Category

For information on creating family fields, refer to the [Create a New Family Field](#) topic.
 - b) Create a datasheet in the family. For information on creating a datasheet, refer to the [Create a Datasheet](#) topic.
 - c) Add the newly created fields to the datasheet. For information on adding fields to a datasheet, refer to the [Add Fields to a Datasheet](#) topic.
 - d) Create a One-to-Many relationship definition between the RBI Criticality Analysis family (Predecessor family) and the Criticality Configured Consequence Evaluation family (successor family). For more information on creating a relationship definition, refer to the [Create a Relationship Definition](#) topic.
2. Link a Potential Degradation Mechanism to the Criticality Configured Consequence Evaluation family. For example, link the Creep PDM to the newly configured family. For more information on linking PDM to a family, refer to the [Link Potential Degradation Mechanism to Consequence Evaluation Family](#) on page 167 topic.
3. Create a validation policy to perform the validations in the Production Loss field. For information on creating the validation policy, refer to the [Create a Sample Validation Policy](#) on page 182 topic.
4. Create a calculation policy to update the value in the Lost Production Category field based on the value in the Production Loss field. For information on creating the calculation policy, refer to the [Create a Sample Calculation Policy](#) on page 173 topic.
5. Configure the output preferences in the RBI Application Settings page and mark the Lost Production Category field as an output field. For more information on configuring output preferences, refer to the [Configure CE Output Preferences](#) on page 168 topic.
6. Create the flexible validation record in the RBI Application Settings page with the following configuration:
 - Analysis Family: RBI Criticality Analysis
 - Action: Consequence Evaluation Validation
 - Action Family: Criticality Configured Consequence Evaluation
 - Policy Name: Select the validation policy created in step 3.

For more information on validation configuration, refer to the [Create a Flexible Calculation Validation](#) on page 272 topic.
7. Configure the Calculation Configuration in the RBI Application Settings page with the following settings:
 - Analysis Family: RBI Criticality Analysis
 - Action: Consequence Evaluation Calculation
 - Action Family: Criticality Configured Consequence Evaluation
 - Policy Name: Select the calculation policy created in step 4.

For more information on calculation configuration, refer to the [Create a Flexible Calculation Configuration](#) on page 271 topic.

Results

The flexible Consequence Evaluation calculation is now configured. Now, when you calculate an RBI Criticality Analysis, the following events will occur:

- The baseline calculations will be overridden.
- The validation policy will be triggered. If the value in the Production Loss field is invalid, the calculation will fail with an appropriate validation error.
- If there is no validation error, the calculation policy will be triggered.
- As defined in the calculation policy, the value in the Lost Production Category will be updated as per the value in the Production Loss field.

Create a Sample Validation Policy

About This Task

This topic describes the basic steps that you need to perform to configure validations as part of the example. For detailed information on creating and configuring a policy, refer to the Policy Designer documentation.

Procedure

1. Create a Policy with the name Configured CE Validation Policy.
2. Configure an Entity node to represent the Configured Consequence Evaluation family.
3. Configure an Is Null node and map the value in the Production Loss field of the Configured Consequence Evaluation family.
4. Set the output value of the Is Null node to -1.

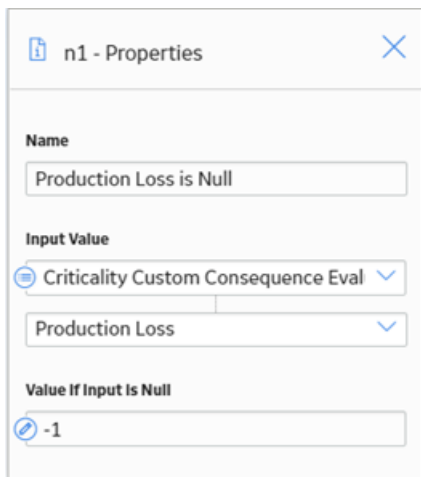

5. Map the output of the Is Null node to the input of the Equal node.
6. Configure the Equal node such that:
 - If the value in the Production Loss field is null, a Return Value node is triggered to display an error message indicating that Production Loss is a required field.

n3 - Properties

Name
Return Validation Message

Return Value
Production Loss is required.

- If the value in the Production Loss field is not null, the output is mapped to the Less Than node.

n2 - Properties

Name
Equal

Production Loss is Null

Answer

Display
Node

=

-1

7. Configure the Less Than node such that if the value in the Production Loss field is less than zero, a Return Value node displays an error message indicating that the value must not be less than zero.

n4 - Properties

Name
Less Than

Criticality Custom Consequence Eval

Production Loss

Display
Field

<

0

8. Save the policy.
The validation policy is created.

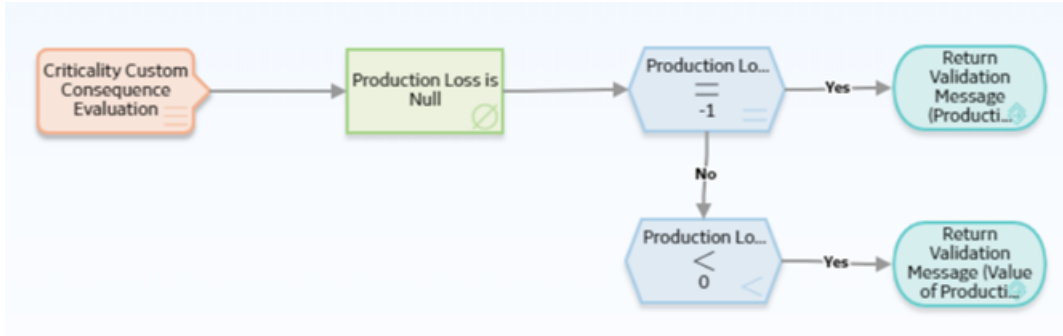

Create a Sample Calculation Policy

About This Task

This topic describes the basic steps that you need to perform to configure a policy with the calculations as part of the example. For detailed information on creating and configuring a policy, refer to the Policy Designer documentation.

Procedure

1. Create a Policy with the name Configured CE Calculation Policy.
2. Configure an Entity node to represent the Configured Consequence Evaluation family.
3. Map the value in the Production Loss field to the input field of a Less Than or Equal node.
4. Configure the Less Than or Equal node such that if the value in the Production Loss field is less than 1000000, an Edit Entity node is triggered.

5. Configure the Edit Entity node to update the value in the Lost Production as E.

n3 - Properties

Name
Update Production Loss Category

Family ID
Criticality Custom Consequ

Entity Key(s)
Criticality Custom Conseq
Entity Key

Auto-map field values?
 Yes No

Field values collection

Field
Lost Production Category

Value
E

6. Similarly, configure the other Less Than or Equal nodes to trigger the respective Edit Entity nodes to update the value in the Lost Production Category field.
 7. Save the policy.
- The calculation policy is created.

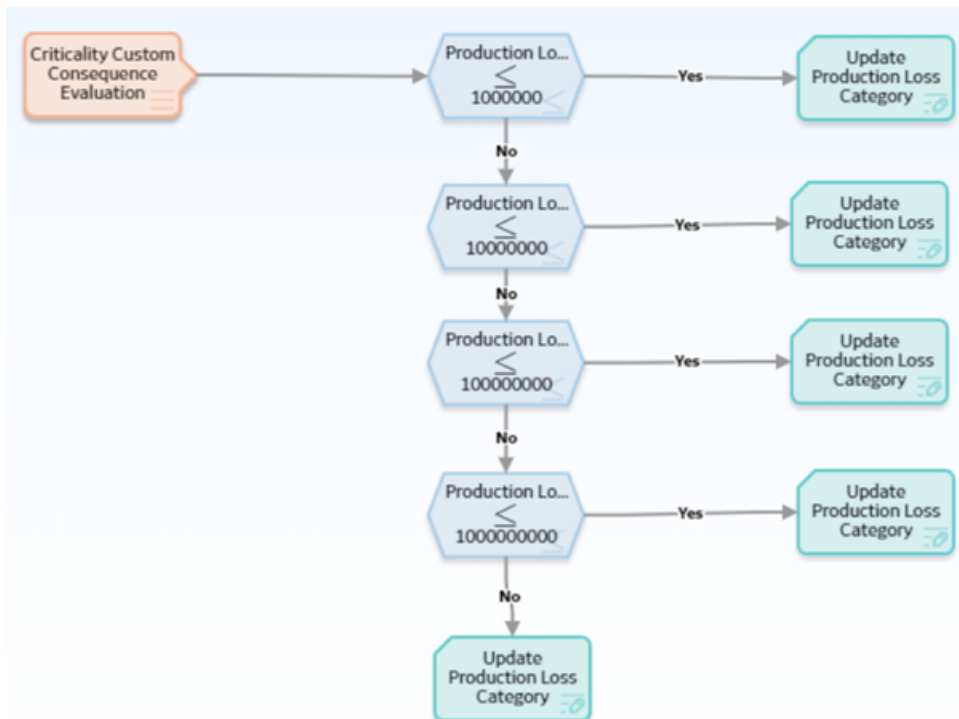

Configure Degradation Mechanism Evaluation Validation and Calculation

About DME Validation and Calculation

When you calculate an RBI Criticality Analysis, you can now configure the Probability of Failure (PoF) calculation based on your requirements. These calculations override the baseline calculations.

Using the flexible DME calculation, you can:

- Add calculations for configured Degradation Mechanism Evaluations (DMEs) or a baseline DME without having to edit rules.
- Reduce implementation time.
- Achieve results through Policies.
- Avoid the need to write rules to perform flexible calculations.
- Expedite the database upgrade process.
- Use a combination of configured DMEs and add existing Criticality Calculator DMEs to calculate RBI Analyses.

The following image illustrates the flexible DME calculation framework.

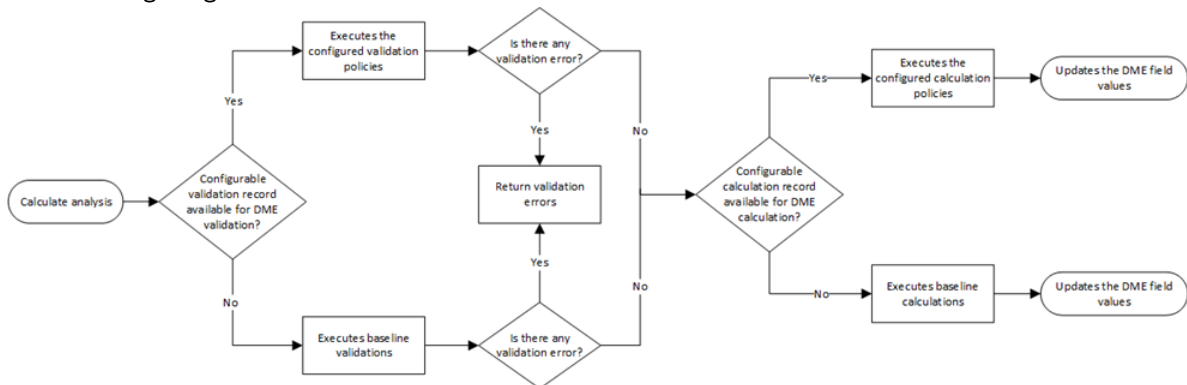

Workflow

This topic describes the sequence of the tasks that you need to perform to configure the flexible DME validation and calculation. Based on the complexity of the configuration, you may need to perform certain tasks outside of the Risk Based Inspection module. When performing such tasks, we recommend that you follow the documentation of the respective modules.

The following image illustrates the workflow of the flexible DME calculation configuration:

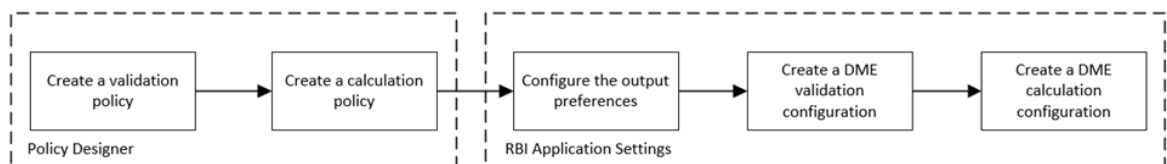

Note: To configure flexible DME calculations, it is not mandatory to perform all the tasks mentioned in the workflow. You can perform only the tasks that are specific to your configuration. For example, if you want to configure only the DME Calculation using the baseline DME family, you can perform only the following tasks:

- Create a flexible calculation policy.
- Create the calculation configuration in the RBI Application Settings.

If you do not want to use the baseline DME family and want to use a new DME family for the flexible configuration, you must complete the following tasks before configuring the validation and calculation.



Create DME Family and Datasheet

About This Task

If you want to use a new family to configure the flexible DME calculation, you can create a child family under the Criticality Degradation Mech Evaluation family. This is not a mandatory step to configure the flexible DME calculation. However, if you want to use new fields for the calculation that are not part of the baseline family, we recommend that you create a new family and do the configuration. This will make sure that the baseline family is not modified, and you can use the baseline family whenever required.

For more information on creating and configuring a family, refer to the [Family Management documentation](#).

Create Relationship Between RBI Criticality Analysis and DME Family

About This Task

If you have created a family as part of the flexible DME configuration, you must create a relationship definition between the RBI Criticality Analysis family and the new family.

This topic describes the basic steps to create a relationship definition between the RBI Criticality Analysis and the configured DME family. For the detailed documentation on creating relationship definitions, refer to the Family Management documentation.

Procedure

1. Access the Has RBI Degradation Mechanism Evaluation relationship definition. For information on accessing a relationship family, refer to the [Access the Relationship Definition Section](#) topic.
2. Create a One-to-Many relationship definition between the RBI Criticality Analysis family (Predecessor family) and the new DME family (successor family). For information on creating a relationship definition, refer to the [Create a Relationship Definition](#) section.

Create Degradation Mechanisms

About This Task

A Degradation Mechanism is a defined method that affects failure as explained in an RBI Analysis. As part of the flexible DME calculation, you can create your own Degradation Mechanism and use it for DME calculation. For more information on Degradation Mechanisms, refer to the [Degradation Mechanisms](#) section.

Procedure

1. [Access the System Codes and Tables Page](#).

2. Access the MI_DEGRADATION_MECHANISM_TYPES System Code Table.
The workspace for the MI DEGRADATION MECHANISMS TYPES (Degradation Mechanism Types) System Code Table appears.
3. [Add the required Degradation Mechanism to the System Code Table.](#)
The Degradation Mechanism is created.

Next Steps

Log out of GE Digital APM and log back in to make the newly created degradation mechanisms available in the **Degradation Mechanisms** section.



Create a Potential Degradation Mechanism

About This Task

Potential Degradation Mechanisms (PDM) records are used to represent ways in which a component may fail. If you want to link the new Degradation Mechanism to an RBI Component, you must create a new PDM. For more information on PDMs, refer to the [About Potential Degradation Mechanisms \(PDM\)](#) on page 359 topic.

Important: You cannot link configured PDMs to PRD components.

Procedure

1. Select , and then navigate to and select **Potential Degradation Mechanisms**.
The Record Manager page appears, displaying a new PDM record.
2. In the **General** section of the Potential Degradation Mechanism datasheet, enter the following values:
 - In the **Degradation Mechanism** box, select the configured Degradation Mechanism.
 - In the **Degradation Mechanism Description** box, select the configured Degradation Mechanism.
 - In the **DM Methodology** box, select the configured DME family.
 - In the **Methodology Type** box, select Quantitative.
3. Select the **Consequences** tab.
 - In the **Value(s)** box, select a failure mode.
 - In the **Consequence Eval Used** box, select the newly configured DME.
4. Select .
The Potential Degradation Mechanism is created.

Next Steps

Log out of GE Digital APM and log back in to make the newly created potential degradation mechanisms available in the **Potential Degradation Mechanisms** section.

Configure Data Mapping

About This Task

For each component that will use a configured Degradation Mechanism Evaluation, you must create a new Data Mapping Group record to map the fields from Component to the configured DME family. For information on creating Data Mapping Groups, refer to the [Create Data Mapping Group](#) on page 522 topic.

Create DME Validation Policy

About This Task

As part of the flexible DME calculation, if you do not want to use the baseline validations and want to use new validations, you can create a new validation policy. If you use a configured validation policy, it overrides all the baseline validations. After you create the validation policy, you must configure the policy in the **Flexible Calculation Validation** section in **RBI 580 Flexible Calculation Preferences** page.

This topic describes the basic steps on creating a validation policy. For more information on creating, managing, and activating policies, refer to the [Policy Designer documentation](#).

Procedure

1. [Create a policy](#).
2. Access the Design workspace of the policy.
3. Add an Entity node that represents the family that you want to validate. For information on Entity nodes, refer to the [Entity Nodes in Policy Designer](#) topic.
4. As needed, add other nodes required for the validations. For information on the different types of nodes, refer to the [Condition, Logic, and Calculation Nodes in Policies](#) section in the Policy Designer documentation.
5. For each validation, add a Return Value node that has the error message that you want to display to the user when validating the policy. For information on Return Value nodes, refer to the [Return Value Nodes in Policy Designer](#) topic.

Note: Each Return Value node must have a unique name, and the error messages must not contain more than 255 characters.

6. Save the policy.
The validation policy is created.

Create DME Calculation Policy

About This Task

As part of the flexible DME calculation configuration, you must create a new calculation policy to perform the calculations. These calculations are used to derive the PoF values. If you use configured calculations, all the baseline calculations are overridden.

This topic describes the basic steps on creating a calculation policy. For more information on creating, managing, and activating policies, refer to the Policy Designer documentation.

Note: As a best practice, save the PoF value to the Degradation Mechanism record as part of the Degradation Mechanism Evaluation calculation.

Procedure

1. [Create a policy](#).
2. Access the Design workspace of the policy.
3. Add an Entity node that represents the family that you want to use in calculations. For information on Entity nodes, refer to the [Entity Nodes in Policy Designer](#) topic.

Note: As a best Practice for the DME Calculation, there should be minimum of two input nodes, one for the DME family and one for the DM family.

4. As needed, add other nodes required for calculations. For information on the different types of nodes, refer to the [Condition, Logic, and Calculation Nodes in Policies](#) section in the Policy Designer documentation.
5. For each calculation, add an Edit Entity node that contains the details of the output field and its value. For information on Edit Entity nodes, refer to the [Edit Entity Nodes in Policy Designer](#) topic.
6. Save the policy.
The calculation policy is created.

Configure DME Output Preferences

About This Task

You can configure the output fields for the family where you have configured the flexible calculation. The output fields are not copied to new records when the parent RBI Criticality Analysis is copied, and the values are reset when the analysis is calculated. For more information on configuring the output fields, refer to the [Create a Flexible Calculation Output Preference](#) on page 273 topic.

Create Flexible DME Validation Configuration

If you want to override the baseline validations, you must create a flexible validation record in the RBI 580 Flexible Calculation Preferences section. For more information on creating a flexible validation record, refer to the [Create a Flexible Calculation Validation](#) on page 272 topic.

Before You Begin

Make sure that a policy is created for the validations that you want to perform.

Procedure

Create a flexible validation record with the following configuration:

Master section:

- **Analysis Family:** RBI Criticality Analysis
- **Action:** Degradation Mechanism Evaluation Validation
- **Action Family:** Select the family that you want to use for the flexible DME validation.
- **Policy Name:** Select the policy that must be used for the validation.
- **Sequence:** 1

Detail section:

- **Input Entity Family:** Select the family defined in Input Entity of the DME validation policy.
- **Policy Node Name:** Enter the name of the input Entity node defined in the validation policy.

Results

The flexible DME validation record is created.

Create Flexible DME Calculation Configuration

If you want to override the baseline DME calculations, you must create a flexible calculation record in the RBI 580 Flexible Calculation Preferences section. For more information on creating a flexible calculation record, refer to the [Create a Flexible Calculation Configuration](#) on page 271 topic.

Before You Begin

Make sure that a policy is created for the calculations that you want to perform.

Procedure

Create a flexible calculation record with the following configuration:

Master section:

- **Analysis Family:** RBI Criticality Analysis
- **Action:** Degradation Mechanism Evaluation Calculation
- **Action Family:** Select the family that you want to use for the flexible DME calculation.
- **Policy Name:** Select the policy that must be used for the calculation.
- **Sequence:** 1

Detail section:

- **Input Entity Family:** Select the family defined in Input Entity of the DME calculation policy.
- **Policy Node Name:** Enter the name of the input Entity node defined in the calculation policy.

Configure DME Calculation - Example

About This Task

Suppose you want to create a new DME calculation configuration such that:

- A new degradation mechanism, Creep, is used for calculation.
- The output is calculated based on the value in the following input fields:
 - Date in Service: This is a required date field and the date must be greater than 1900-01-01.
- Based on the values in the input fields, following output field values are updated:
 - Age: The value in this field is calculated based on value in the Date in Service field.
 - Likelihood Category: The value in this field is calculated based on the value in the Age field as described in the following table.

Age	Likelihood Category
Less than or equal to 1 Year	5
More than 1 and less than or equal to 3 Years	3
More than 3 and less than or equal to 7 Years	2
More than 7 Years	1

Procedure

1. Create the following DME family (Criticality Configured Creep DME). For information on creating a family, refer to the [Create a Family](#) topic.
 - a) Create the following fields:
 - Date in Service
 - Age
 - Likelihood Category

For information on creating family fields, refer to the [Create a New Family Field](#) topic.
 - b) Create a datasheet in the family. For information on creating a datasheet, refer to the [Create a Datasheet](#) topic.
 - c) Add the newly created fields to the datasheet in their respective sections as described in the following table.

Input Fields	Output Fields
Date in Service	Age
	Likelihood Category

- For information on adding fields to a datasheet, refer to the [Add Fields to a Datasheet](#) topic.
2. Create a One-to-Many relationship definition between the RBI Criticality Analysis family (Predecessor family) and the Criticality Configured Creep DME family (successor family). For more information on creating a relationship definition, refer to the [Create a Relationship Definition](#) topic.
 3. Create a new Degradation Mechanism (Creep). For information on creating Degradation Mechanisms, refer to the [Create Degradation Mechanisms](#) on page 176 topic.
 4. [Create a Potential Degradation Mechanism](#) on page 177.
 5. Create a validation policy to perform the validations on the input field. For detailed steps on creating the validation policy, refer to the [Create a Sample Validation Policy](#) on page 182 topic.
 6. Create a calculation policy to update the output fields based on the value in the input field. For detailed steps on creating the calculation policy, refer to the [Create a Sample Calculation Policy](#) on page 184 topic.
 7. Configure the output fields in the **Output Preferences** section in RBI Application settings. For more information on configuring output preferences, refer to the [Configure DME Output Preferences](#) on page 179.
 8. Create a flexible validation record in the RBI Application Settings with the following settings:
 - Analysis Family: RBI Criticality Analysis
 - Action: Degradation Mechanism Evaluation Validation
 - Action Family: Criticality Configured Creep DME
 - Policy Name: Select the validation policy created in step 4.

For more information on validation configuration, refer to the [Create a Flexible Calculation Validation](#) on page 272 topic.

9. Create a flexible calculation configuration in the RBI Application Settings with the following settings:
 - Analysis Family: RBI Criticality Analysis
 - Action: Degradation Mechanism Evaluation Calculation
 - Action Family: Criticality Configured Creep DME
 - Policy Name: Select the calculation policy created in step 5.

For more information on calculation configuration, refer to the [Create a Flexible Calculation Configuration](#) on page 271 topic.

Results

The flexible DME calculation is now configured. Now, when you calculate an RBI Criticality Analysis, the following events will occur:

- The baseline calculations will be overridden.
- The validation policy will be triggered. If the input field contains null values or invalid values, the calculation will fail, displaying an appropriate validation error message.
- If there is no validation error, the calculation policy will be triggered.
- As defined in the calculation policy, the value in the output fields are populated based on the values in the input field.

Create a Sample Validation Policy

About This Task

This topic describes the basic steps that you need to perform to configure validations as part of the example. For detailed information on creating and configuring a policy, refer to the Policy Designer documentation.

Procedure

1. Create a Policy with the name Configured CE Validation Policy.
2. Configure an Entity node to represent the Configured Consequence Evaluation family.
3. Configure an Is Null node and map the value in the Production Loss field of the Configured Consequence Evaluation family.
4. Set the output value of the Is Null node to -1.

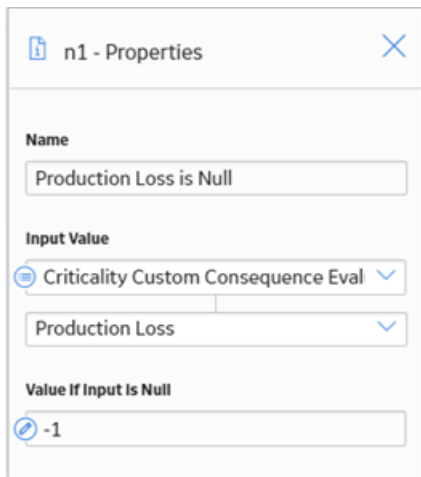

The screenshot shows a dialog box titled "n1 - Properties" with a close button (X) in the top right corner. It contains three sections: "Name" with a text input field containing "Production Loss is Null"; "Input Value" with a dropdown menu set to "Criticality Custom Consequence Eval" and a sub-dropdown set to "Production Loss"; and "Value If Input Is Null" with a text input field containing "-1".

5. Map the output of the Is Null node to the input of the Equal node.
6. Configure the Equal node such that:
 - If the value in the Production Loss field is null, a Return Value node is triggered to display an error message indicating that Production Loss is a required field.

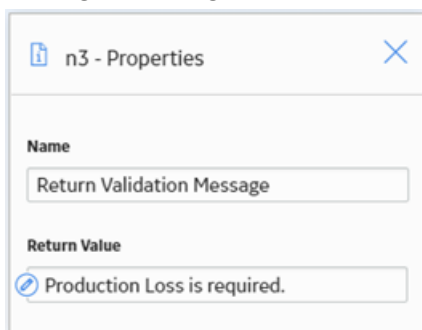

The screenshot shows a dialog box titled "n3 - Properties" with a close button (X) in the top right corner. It contains two sections: "Name" with a text input field containing "Return Validation Message"; and "Return Value" with a text input field containing "Production Loss is required.".

- If the value in the Production Loss field is not null, the output is mapped to the Less Than node.

n2 - Properties

Name

Production Loss is Null

Display

=

-1

- Configure the Less Than node such that if the value in the Production Loss field is less than zero, a Return Value node displays an error message indicating that the value must not be less than zero.

n4 - Properties

Name

Criticality Custom Consequence Eval

Display

<

0

- Save the policy.
 The validation policy is created.

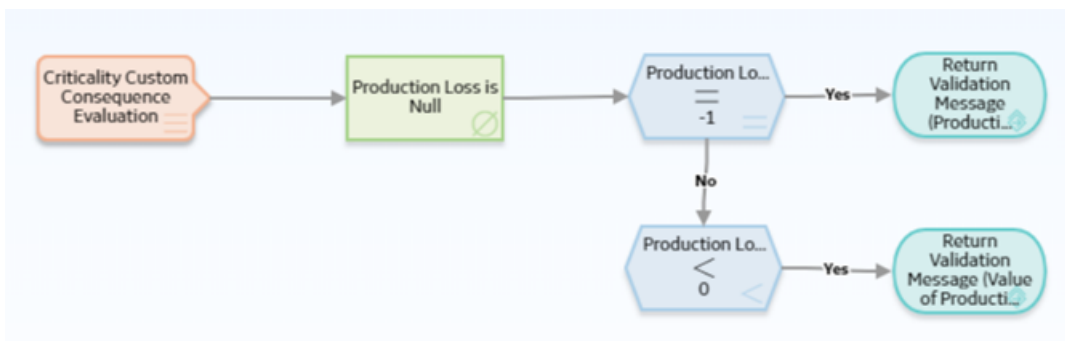

Create a Sample Calculation Policy

This topic describes the general steps that you need to perform to configure the calculations as part of the scenario. For detailed information on creating and configuring a policy, refer to the Policy Designer documentation.

Before You Begin

Create a query to derive the value in the Calculated Age field based on the value in the Date in Service field.

```
SELECT ABS((DATEDIFF('DD', [MI_MRBIANAL].[MI_CRITANAL_DATE_CRIT_CALC_D], [CRIT_CUST_CREEP_DME].[MI_RBDEMEEV_DATE_IN_SERV_DT]) / 365.4)) "Age"  
FROM [MI_MRBIANAL]  
JOIN_SUCC [CRIT_CUST_CREEP_DME] ON {MIR_HSRBIDME}  
WHERE [MI_MRBIANAL].ENTY_KEY = (? :s :caption='Analysis Key')
```

For information on creating queries, refer to the [About Creating Queries](#) topic.

Procedure

1. Create a Policy with the name Configured DME Calculation Policy.
2. Configure an Entity node (DME) to represent the Criticality Configured Creep DME family.
3. Add a Query node and map the DME Entity node to the Query node.
4. Configure the Query node to the query created for Age calculation.

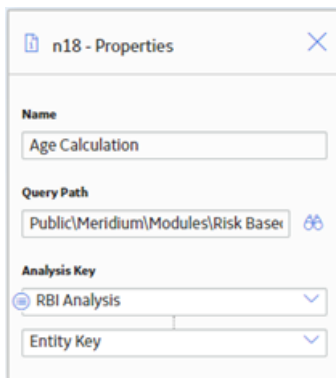

5. Add a Less Than or Equal node and configure it such that if the value in the Age field is less than or equal to 1, it triggers an Edit Entity node. Configure the Edit Entity node to update the value in the Likelihood Category as 5.

n27 - Properties

Name: POF-5

Family ID: Criticality Creep Deg. Mech

Entity Key(s): DME

Age

Auto-map field values? Yes No

Field values collection:

Entity Key Column:

Field: Age

Value: Age Calculation

Calculated Age

Likelihood Category: 5

- Similarly, configure the other calculations by adding Less Than or Equal nodes and the corresponding Edit Entity nodes.
- Save the policy.
The calculation policy is created.

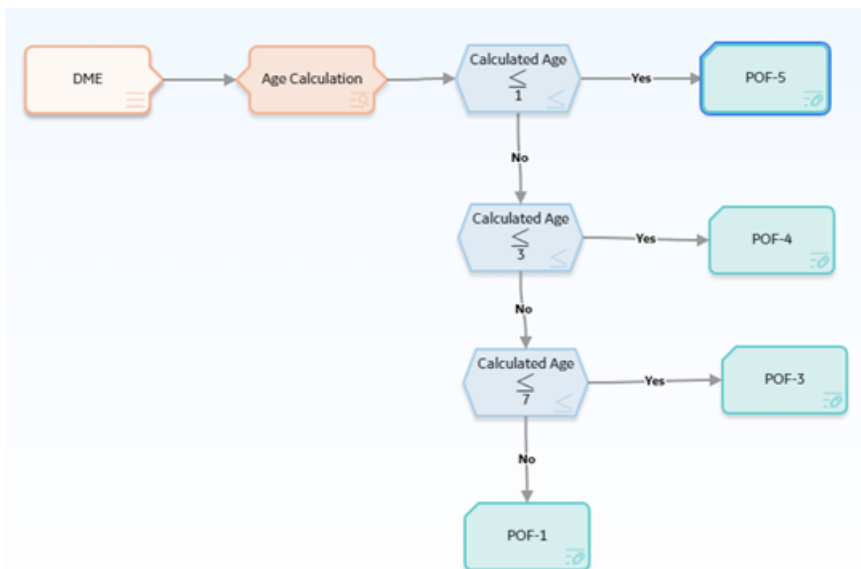

Configure Degradation Mechanism Roll-up

About Degradation Mechanism Roll-up

After the Consequence of Failure (CoF) values are calculated, these values are rolled up to the Degradation Mechanism records. The rolled-up values are used during the analysis roll-up to determine the risk value of the component. By default, the values are rolled up based on the logic defined in the

baseline rules. However, you can create a policy for the roll-up logic and configure it to be executed during the analysis calculation. When you use the policy for DM roll-up, it overrides the baseline rules.

The following image illustrates the flexible DM roll-up framework:

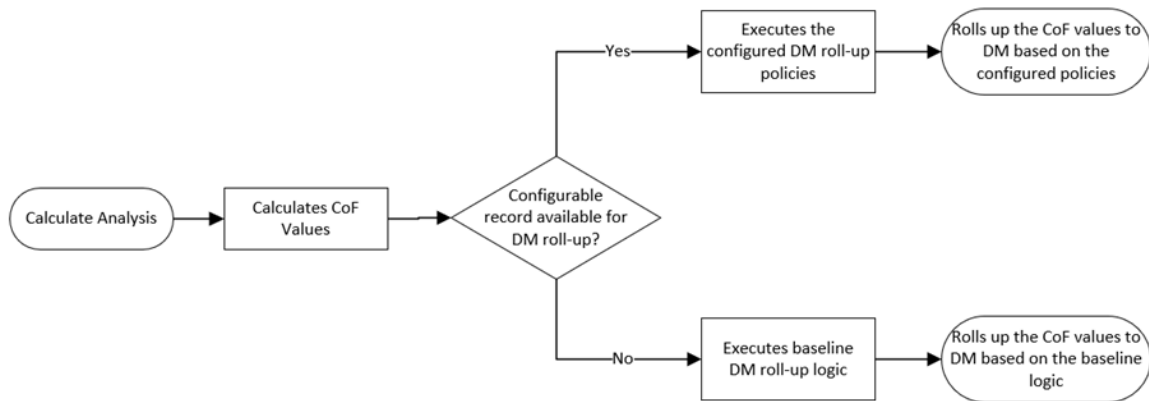

Workflow

This topic describes the sequence of the tasks that you must perform to configure the DM roll-up calculation. Based on the complexity of the configuration, you may need to perform certain tasks outside of the Risk Based Inspection module. When performing such tasks, we recommend that you follow the documentation of the respective modules.

The following image illustrates the workflow of the flexible DM roll-up configuration:

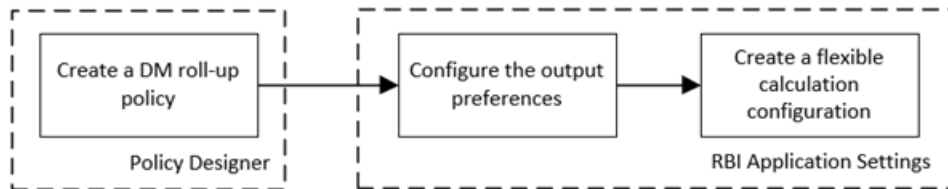

Note: If you are rolling up multiple consequence values, you can add additional fields to the RBI Degradation Mechanisms family. You must configure the family before creating the DM roll-up policy. For more information on creating family fields, refer to the Family Management documentation.

Create a DM Roll-up Policy

About This Task

As part of the flexible DM roll-up configuration, you must create a policy to define the roll-up logic. After you create the DM roll-up policy, you must configure the policy in the Flexible Calculation Configuration section in RBI 580 Flexible Calculation Preferences page. If you use a DM roll-up policy, it overrides the baseline degradation mechanism rollup logic.

This topic describes the basic steps on creating a DM roll-up policy. For more information on creating, managing, and activating policies, refer to the [Policy Designer documentation](#).

Procedure

1. [Create a policy](#).
2. Access the Design workspace of the policy.
3. Add an Entity node that represents the Degradation Mechanism family. For information on Entity nodes, refer to the [Entity Nodes in Policy Designer](#) topic.

Note: You can map only one entity to each node. If you have multiple consequence evaluations, instead of using multiple Input Entity nodes, you can use a Query node to access the data. For information on using Query nodes, refer to the [Query Nodes in Policy Designer](#) topic.

4. As needed, add other nodes required for calculations. For information on the different types of nodes, refer to the [Condition, Logic, and Calculation Nodes in Policies](#) section in the Policy Designer documentation.
5. For each calculation, add an Edit Entity node that contains the details of the output field and its value. For information on Edit Entity nodes, refer to the [Edit Entity Nodes in Policy Designer](#) topic.
6. Save the policy.
The DM roll-up policy is created.

Configure DM Roll-up Output Preferences

About This Task

You can configure the output fields for the family where you have configured the flexible calculation. The output fields are not copied to new records when the parent RBI Criticality Analysis is copied, and the values are reset when the analysis is calculated. For more information on configuring the output fields, refer to the [Create a Flexible Calculation Output Preference on page 273](#) topic.

Create Flexible DM Roll-up Configuration

If you want to override the baseline DM roll-up logic, you must create a flexible DM roll-up record in the RBI 580 Flexible Calculation Preferences section. For more information on creating a flexible roll-up configuration record, refer to the [Create a Flexible Calculation Configuration on page 271](#) topic.

Before You Begin

Make sure that a policy is created for the logic that you want to perform to roll up the CoF values to DM records.

Procedure

Create a flexible calculation record with the following configuration:

Master section:

- **Analysis Family:** RBI Criticality Analysis
- **Action:** Degradation Mechanism Roll-Up
- **Action Family:** Select the family that you want to use for the flexible DM roll-up.
- **Policy Name:** Select the policy that must be used for the roll-up.
- **Sequence:** 1

Detail section:

- **Input Entity Family:** Select the family defined in Input Entity of the DM roll-up policy.
- **Policy Node Name:** Enter the name of the input Entity node defined in the DM roll-up policy.

Results

The flexible DM roll-up configuration record is created.

Configure DM Roll-up - Example

About This Task

Suppose you want to roll up the CoF values to the following fields in the Degradation Mechanism records:

Field in Degradation Mechanism	Roll-up logic based on CE values
SHE CoF	Highest consequence value among Flammable, Toxic, and Environmental.
Financial CoF	Highest consequence value between Product Leak and Lost Production Category.

Procedure

1. Since the fields are not baseline fields, create the fields in the RBI Degradation Mechanism family. For information on creating new fields, refer to the [Create a New Family Field](#) topic.
2. Create a DM roll-up policy to update the values in the fields based on the CoF values. For information on creating the DM roll-up policy, refer to the [Create Sample DM Roll-up Policy](#) on page 188 topic.
3. Configure the output fields in the Output Preferences section in RBI Application Settings. For more information on configuring output preferences, refer to the [Configure DM Roll-up Output Preferences](#) on page 187 topic.
4. Create the calculation configuration in RBI Application Settings with the following settings:
 - Analysis Family: RBI Criticality Analysis
 - Action: Degradation Mechanism Roll-Up
 - Action Family: RBI Degradation Mechanisms
 - Policy Name: Select the calculation policy created in step 2.

For more information on calculation configuration, refer to the [Create Flexible DM Roll-up Configuration](#) on page 187 topic.

Results

The flexible DM roll-up is now configured. Now, when you calculate an RBI Criticality Analysis, the following events will occur:

- The baseline degradation mechanism roll-up will be overridden.
- The configured DM roll-up policy is triggered. As defined in the policy, the CoF values are rolled up to the Degradation Mechanism records.

Create Sample DM Roll-up Policy

This topic describes the general steps that you must perform to configure the DM roll-up policy as part of this scenario. For the detailed information on creating and configuring a policy, refer to the [Policy Designer documentation](#).

Before You Begin

Create the following queries:

- Consequence Evaluation SHE COF Roll Up Query: To roll up the highest consequence value among Flammable, Toxic, and Environmental.
- Consequence Evaluation FIN COF Roll Up Query: To get the highest consequence between Product Leak and Lost Production Category.

The following query is an example for the Consequence Evaluation SHE COF Roll Up Query.

```
SELECT Min(SHECOF."SHE-COF") "SHECOF"
FROM (SELECT [MI_CRCOEVAL].[MI_CRCOEVAL_ENV_CONS_CAT_C] "SHE-COF"
FROM [MI_PTDEMECH]
JOIN [MI_RBDEMECH]
JOIN_PRED [MI_MRBIANAL])
```

```

JOIN_SUCC [MI_CRCOEVAL] ON {MIR_HSCONEVA} ON {MIR_HSDEGMEC} ON
[MI_PTDEMECH].[MI_PTDEMECH_DEG_MECH_C] = [MI_RBDEMECH].
[MI_DEGR_MECH_DEG_MECH_C]
WHERE ([MI_CRCOEVAL].[MI_RCONEVAL_CONS_C] IN ([MI_PTDEMECH].
[MI_PTDEMECH_CONSE_1_C], [MI_PTDEMECH].[MI_PTDEMECH_CONSE_2_C],
[MI_PTDEMECH].[MI_PTDEMECH_CONSE_3_C], [MI_PTDEMECH].
[MI_PTDEMECH_CONSE_4_C], [MI_PTDEMECH].[MI_PTDEMECH_CONSE_5_C],
[MI_PTDEMECH].[MI_PTDEMECH_CONSE_6_C]) AND [MI_RBDEMECH].ENTY_KEY =
(? :n :caption='DM Entity':id=DMEntity))
UNION
SELECT [MI_CRCOEVAL].[MI_CRCOEVAL_FLAM_CONS_CAT_C] "SHE-COF"
FROM [MI_PTDEMECH]
JOIN [MI_RBDEMECH]
JOIN_PRED [MI_MRBIANAL]
JOIN_SUCC [MI_CRCOEVAL] ON {MIR_HSCONEVA} ON {MIR_HSDEGMEC} ON
[MI_PTDEMECH].[MI_PTDEMECH_DEG_MECH_C] = [MI_RBDEMECH].
[MI_DEGR_MECH_DEG_MECH_C]
WHERE ([MI_CRCOEVAL].[MI_RCONEVAL_CONS_C] IN ([MI_PTDEMECH].
[MI_PTDEMECH_CONSE_1_C], [MI_PTDEMECH].[MI_PTDEMECH_CONSE_2_C],
[MI_PTDEMECH].[MI_PTDEMECH_CONSE_3_C], [MI_PTDEMECH].
[MI_PTDEMECH_CONSE_4_C], [MI_PTDEMECH].[MI_PTDEMECH_CONSE_5_C],
[MI_PTDEMECH].[MI_PTDEMECH_CONSE_6_C]) AND [MI_RBDEMECH].ENTY_KEY =
(? :n :caption='DM Entity':id=DMEntity))
UNION
SELECT [MI_CRCOEVAL].[MI_CRCOEVAL_TOX_CONS_CAT_C] "SHE-COF"
FROM [MI_PTDEMECH]
JOIN [MI_RBDEMECH]
JOIN_PRED [MI_MRBIANAL]
JOIN_SUCC [MI_CRCOEVAL] ON {MIR_HSCONEVA} ON {MIR_HSDEGMEC} ON
[MI_PTDEMECH].[MI_PTDEMECH_DEG_MECH_C] = [MI_RBDEMECH].
[MI_DEGR_MECH_DEG_MECH_C]
WHERE ([MI_CRCOEVAL].[MI_RCONEVAL_CONS_C] IN ([MI_PTDEMECH].
[MI_PTDEMECH_CONSE_1_C], [MI_PTDEMECH].[MI_PTDEMECH_CONSE_2_C],
[MI_PTDEMECH].[MI_PTDEMECH_CONSE_3_C], [MI_PTDEMECH].
[MI_PTDEMECH_CONSE_4_C], [MI_PTDEMECH].[MI_PTDEMECH_CONSE_5_C],
[MI_PTDEMECH].[MI_PTDEMECH_CONSE_6_C]) AND [MI_RBDEMECH].ENTY_KEY =
(? :n :caption='DM Entity':id=DMEntity))) SHECOF

```

Procedure

1. Create a Policy with the name Configured DM Roll-up Policy
2. Configure an Entity node (RBI Degradation Mechanism) to represent the RBI Degradation Mechanisms family.
3. Add a Query node and map the RBI Degradation Mechanism Entity node to the Query node.
4. Configure the Query node to the query created for the SHE CoF Roll-up.

n1 - Properties

Name
Get SHE COF Roll Up

Query Path
Public\Meridium\Modules\Risk Base

DM Entity
RBI Degradation Mechanism

Entity Key

5. Repeat steps 3 and 4 to add the query for the Financial CoF Roll-up.
6. Add an Edit Entity node to update the values in the fields.

n13 - Properties

Select...

Field	Value
SHE COF	Get SHE COF Roll U
Financial COF	Get FIN COF Roll U

SHECOF

FINCOF

The DM Roll-up policy is created.



Configure Analysis Roll-up

About Analysis Roll-up

After the CoF and PoF values are updated in the Degradation Mechanism records, these values are rolled up to the Analysis. By default, the values are rolled up based on the logic defined in the baseline rules. However, you can create a policy for the roll-up logic and configure it to be executed during the analysis calculation. When you use the policy for analysis roll-up, it overrides the baseline rules.

Following image illustrates the flexible analysis roll-up framework:

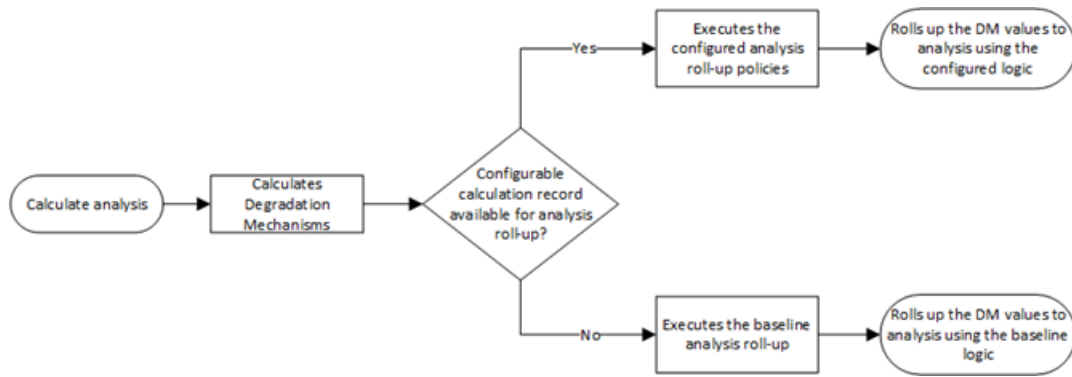

Note: If you configure the flexible analysis roll-up, the Risk Category value is required on the analysis to be able to move the analysis to Risk Completed state.

Workflow

This topic describes the sequence of the tasks that you need to perform to configure the analysis roll-up. Based on the complexity of the configuration, you may need to perform certain tasks outside of the Risk Based Inspection module. When performing such tasks, we recommend that you follow the documentation of the respective modules.

The following image illustrates the workflow of the flexible analysis roll-up configuration:

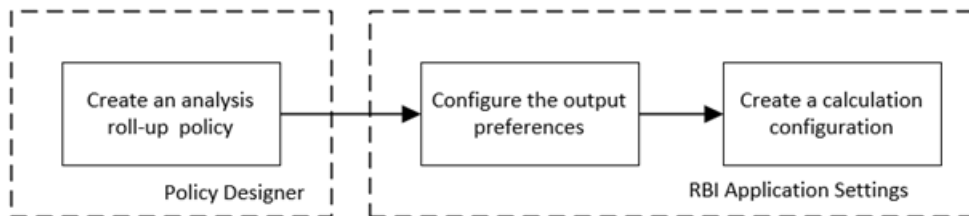

Note: If you are rolling up multiple risk values, you can add additional fields to the RBI Criticality Analysis family. You must configure the family before creating the Analysis roll-up policy. For more information on creating family fields, refer to the Family Management documentation.

Create an Analysis Roll-up Policy

About This Task

As part of the flexible analysis roll-up configuration, you must create a policy to define the roll-up logic. After you create the analysis roll-up policy, you must configure the policy in the Flexible Calculation Configuration section in RBI 580 Flexible Calculation Preferences page. If you use the analysis roll-up policy, all the baseline logics for analysis roll-up are overridden.

This topic describes the basic steps on creating an analysis roll-up policy. For more information on creating, managing, and activating policies, refer to the [Policy Designer documentation](#).

Procedure

1. [Create a policy](#).
2. Access the Design workspace of the policy.
3. Add an Entity node that represents the RBI Criticality Analysis family. For information on Entity nodes, refer to the [Entity Nodes in Policy Designer](#) topic.

Note: You can map only one entity to each node. If you have multiple degradation mechanisms, you must use a Query node to access the data. For information on using Query nodes, refer to the [Query Nodes in Policy Designer](#) topic.

4. As needed, add other nodes required for calculations. For information on the different types of nodes, refer to the [Condition, Logic, and Calculation Nodes in Policies](#) section in the Policy Designer documentation.
5. For each calculation, add an Edit Entity node that contains the details of the output field and its value. For information on Edit Entity nodes, refer to the [Edit Entity Nodes in Policy Designer](#) topic.
6. Save the policy.
The analysis roll-up policy is created.

Configure Analysis Roll-up Output Preferences

About This Task

You can configure the output fields for the family where you have configured the flexible calculation. The output fields are not copied to new records when the parent RBI Criticality Analysis is copied, and the values are reset when the analysis is calculated. For more information on configuring the output fields, refer to the [Create a Flexible Calculation Output Preference](#) on page 273.

Create Flexible Analysis Roll-up Configuration

If you want to override the baseline analysis roll-up logic, you must create a flexible analysis roll-up record in the RBI 580 Flexible Calculation Preferences section. For more information on creating a flexible analysis roll-up configuration record, refer to the [Create a Flexible Calculation Configuration](#) on page 271 topic.

Before You Begin

Make sure that a policy is created for the logic that you want to perform to roll up the CoF values to analysis records.

Procedure

Create a flexible calculation record with the following configuration:

Master section:

- **Analysis Family:** RBI Criticality Analysis
- **Action:** Analysis Roll-Up
- **Action Family:** Select the family that you want to use for the flexible analysis roll-up.
- **Policy Name:** Select the policy that must be used for the roll-up.
- **Sequence:** 1

Detail section:

- **Input Entity Family:** Select the family defined in Input Entity of the analysis roll-up policy.
- **Policy Node Name:** Enter the name of the input Entity node defined in the analysis roll-up policy.

Results

The flexible analysis roll-up configuration record is created.

Configure Analysis Roll-up - Example

About This Task

Suppose there are multiple DMs with calculated SHE Risk and Financial Risk values. If you want to roll up the minimum DM values, you must create the following fields in the analysis records:

Field in RBI Criticality Analysis	Roll-up logic based on DM values
SHE Risk	Minimum SHE Risk value from the DMs
Financial Risk	Minimum Financial Risk value from the DMs

Procedure

1. Since the fields are not baseline fields, create the fields in the RBI Criticality Analysis family. For information on creating new fields, refer to the [Create a New Family Field](#) topic.
2. Create an analysis roll-up policy to update the values in the fields based on the DM values. For information on creating the analysis roll-up policy, refer to the [Create Sample Analysis Roll-up Policy](#) on page 193 topic.
3. Configure the output fields in the Output Preferences section in RBI Application settings. For more information on configuring output preferences, refer to the [Configure Analysis Roll-up Output Preferences](#) on page 192 topic.
4. Create the Calculation Configuration in the RBI Application Settings with the following settings:
 - Analysis Family: RBI Criticality Analysis
 - Action: Analysis Roll-Up
 - Action Family: RBI Criticality Analysis
 - Policy Name: Select the roll-up policy created in step 2.

For more information on calculation configuration, refer to the [Create Flexible Analysis Roll-up Configuration](#) on page 192 topic.

Results

The flexible analysis roll-up is now configured. Now, when you calculate an RBI Criticality Analysis, the following events will occur:

- The baseline logics for analysis roll-up will be overridden.
- The configured analysis roll-up policy is triggered. As defined in the policy, the DM values are rolled up and updated in the analysis.

Create Sample Analysis Roll-up Policy

This topic describes the general steps that you must perform to configure the analysis roll-up policy as part of this scenario. For the detailed information on creating and configuring a policy, refer to the [Policy Designer documentation](#).

Before You Begin

Create the following query

- Configured Analysis Roll Up Query: To roll up the minimum SHE Risk and minimum Financial Risk values from DMs. The following query is a sample query for this requirement.

```
SELECT Min ([MI_RBDEMECH].[MI_RBDEMECH_SHE_RISK_NBR]) "SHE Risk"  
      , Min ([MI_RBDEMECH].[MI_RBDEMECH_FINA_RISK_NBR]) "Financial Risk"
```

```

FROM [MI_MRBIANAL]
JOIN_SUCC [MI_RBDEMECH] ON {MIR_HSDEGMEC}
WHERE [MI_MRBIANAL].ENTY_KEY = (? :s :caption='Analysis
Entity' :id=AnalysisEntity)

```

Procedure

1. Create a Policy with the name Configured Analysis Roll-up Policy.
2. Configure an Entity node (RBI Criticality Analysis) to represent the RBI Criticality Analysis family.
3. Add a Query node and map the RBI Criticality Analysis Entity node to the Query node.

4. Add an Edit Entity node to update the values in the SHE Risk and Financial Risk fields.

The analysis roll-up policy is created.



Chapter 16

Pipeline

Topics:

- Pipeline Components
- Pipeline Analyses
- Pipeline Degradation Mechanisms
- Pipeline Recommendations
- Pipeline ASM Integration

Pipeline Components

About Integration with Thickness Monitoring (TM)

This topic has been intentionally excluded from the GE Digital APM product documentation website. This topic is available to you via the product documentation that is provided within the GE Digital APM system.

About Using TM Analysis Values at the Asset Level

This topic has been intentionally excluded from the GE Digital APM product documentation website. This topic is available to you via the product documentation that is provided within the GE Digital APM system.

About Using TM Analysis Values at the Thickness Monitoring Location (TML) Group Level

This topic has been intentionally excluded from the GE Digital APM product documentation website. This topic is available to you via the product documentation that is provided within the GE Digital APM system.

Access a Pipeline Component

About This Task

Important: A Pipeline Component functions the same way as an RBI Component. It is visible only if the Pipeline Management license is active.

Procedure

1. [Access the Asset Summary workspace](#) for the asset that contains the Pipeline Component that you want to access.

-or-

[Access the Corrosion Loop](#) that contains the Pipeline Component that you want to access.

2. Below the graph, select the link corresponding to the component that you want to access.

-or-

In the left pane, select the component that you want to access.

The workspace for the selected component appears, displaying the **Component Overview** section.

3. Select the **Component Details** tab.

The **Component Details** section appears, displaying the datasheet of the Component.

Note: If needed, modify values in the [available fields](#), and then select  to save your changes.



Create a Pipeline Component

About This Task

This topic describes how to create a new Pipeline Component and link it to an Asset or a Corrosion Loop. You can also [link an existing Pipeline Component to an Asset or a Corrosion Loop](#).

Important: A Pipeline Component functions the same way as an RBI Component. It is visible only if the Pipeline Management license is active.

Procedure

1. Access the [Asset Summary workspace](#) of the asset in which you want to create a Pipeline Component.
- or-
2. Access the [Corrosion Loop](#) in which you want to create a Pipeline Component.
3. In the left pane, select , and then select **Create New Component**.
The **Create New RBI Component** window appears.
4. Enter values in the following fields:
 - **Asset:** This field is automatically populated with the asset for which you are creating a Pipeline Component.
 - **Component Family:** Select Criticality RBI Pipeline Segment.
 - **Component Type:** Select the component type for the Pipeline Component that you want to create.
5. Select **Create**.
A new Pipeline Component is created, and is automatically linked to the selected Asset and the Corrosion Loop. The **Component Details** section appears, displaying the component datasheet.
6. Enter values in the [available fields](#).
7. In the upper-right corner of the datasheet, select .
The changes made to the Pipeline Component are saved.

Results

- The Pipeline Component inherits linked [Potential Degradation Mechanisms](#) from the RBI Corrosion Loop.

Next Steps

- [Link Potential Degradation Mechanisms \(PDMs\) to a Pipeline Component](#).

Link Potential Degradation Mechanisms (PDMs) to a Pipeline Component

About This Task

If the Pipeline Component is linked to a Corrosion Loop, then all the PDMs linked to the Corrosion Loop are also linked to the Component. You can, however, link additional PDMs to the Component.

This topic describes how to link one or more PDMs to a Pipeline Component. You cannot create PDMs; you can only link them. Therefore, a PDM must already exist to be linked to a Pipeline Component.

Important: A Pipeline Component functions the same way as an RBI Component. It is visible only if the Pipeline Management license is active.

Procedure

1. Access the [Pipeline Component](#) to which you want to link PDMs.
2. Select the **Potential Degradation Mechanisms** tab.
The **Potential Degradation Mechanisms** section appears, displaying a list of PDMs linked to the Pipeline Component.

3. Select **Add PDM**.
A list of PDMs appears, displaying the methodology type of each PDM.
Tip: If you select the link that corresponds to a PDM, the PDM record appears in Record Explorer on a new page.
4. Next to each PDM that you want to link to the Pipeline Component, select the check box, and then select **OK**.
The selected PDMs are linked to the Pipeline Component.

Next Steps

- [Create an RBI Pipeline Analysis](#).

Unlink a Potential Degradation Mechanism (PDM) from a Pipeline Component

About This Task

Important: A Pipeline Component functions the same way as an RBI Component. It is visible only if the Pipeline Management license is active.

Procedure

1. [Access the Pipeline Component](#) from which you want to unlink a PDM.
2. Select the **Potential Degradation Mechanisms** tab.
The **Potential Degradation Mechanisms** section appears, displaying a list of PDMs linked to the Pipeline Component.
3. In the row that contains the PDM you want to unlink from the Pipeline Component, select .
A message appears, asking you to confirm that you want to unlink the selected PDM.
4. Select **Yes**.
The PDM is unlinked from the Pipeline Component.

Apply a Pipeline Component

About This Task

When you apply a Pipeline Component, you make a copy of the original record. The applied Pipeline Component is not automatically linked to the original RBI Component's Corrosion Loop. Instead, the applied RBI Component can be linked to the same or a different asset and then to a Corrosion Loop.

Important: A Pipeline Component functions the same way as an RBI Component. It is visible only if the Pipeline Management license is active.

Procedure

1. [Access the Pipeline Component](#) that you want to apply.
2. In the upper-right corner of the page, select .
The **Hierarchy Finder** window appears.
3. Navigate through the **Hierarchy Finder** to select the asset to which you want to apply the Pipeline Component.

4. Select **OK**.

The Pipeline Component is applied to the selected asset.

Next Steps

- [Link Pipeline Components to an RBI Corrosion Loop](#)

Delete a Pipeline Component

Before You Begin

- [Unlink all the Potential Degradation Mechanisms \(PDMs\) linked to the Pipeline Component.](#)
- [Delete all the RBI Analyses linked to the Pipeline Component.](#)

About This Task

Important: A Pipeline Component functions the same way as an RBI Component. It is visible only if the Pipeline Management license is active.

Procedure

1. [Access the Asset Summary workspace](#) of the asset that is linked to the Pipeline Component that you want to delete.

-or-

[Access the Corrosion Loop](#) that is linked to the Pipeline Component that you want to delete.

2. Next to the Component what you want to delete, select the check box next, and then select .

A message appears, asking you to confirm that you want to delete the selected Pipeline Component.

3. Select **Yes**.

The Pipeline Component is deleted, and all links to existing related entities are removed.

Pipeline Analyses

About Pipeline Analysis

A Pipeline Analysis is an analysis of the records that contain risk information specific to pipelines. These details are stored in an RBI Pipeline Analysis record. To access this record, you need the Pipeline Management license.

A Pipeline Analysis can be created once you have identified at least one piece of an asset or RBI Component. Pipeline Analyses function the same way as an [RBI Analysis](#).

About Active Analysis

An RBI Criticality Analysis or a What If Analysis can be active or inactive. An active analysis is the one on which recommendations and tasks for a particular RBI Analysis will be based. For an RBI Component, you can have only one active analysis. There is no limit, however, to the number of inactive analyses that can exist for an RBI Component.

When you create an analysis, it is in the Created state. If the analysis is active, you can then set the analysis to one of the following states in that order:

- Risk Completed
- Accepted by ASM

If the analysis is inactive, however, the state of the analysis will automatically be set to Archived. If you change the state of an analysis to Risk Completed, all the other analyses are marked inactive (i.e., their state is set to Archived).

About What-If Analysis

A What-If Analysis is a child analysis of a main RBI Analysis (or another What-If Analysis) in an active state that allows you to calculate the risk associated with an RBI Component under hypothetical circumstances. What-If Analyses allow you to analyze hypothetical situations to determine how operational and procedural changes would impact the risk associated with a component's failure on a certain date.

When you create a What-If Analysis:

- A record of the RBI Criticality Analysis or RBI Pipeline Analysis is created. For the What-If Analysis, however, the value in the Event Type field is populated with the value W.
- **Note:** For a normal RBI Analysis, the value in the Event Type field is blank.
- The What-If Analysis is linked to the main analysis through the Has Child RBI Criticality Analysis relationship.
- The Consequence Evaluation, Degradation Mechanisms (DMs), and Degradation Mechanism Evaluations (DMEs) linked to the main analysis are copied and linked to the What-If Analysis.
- The Analysis ID of the What-If Analysis is in the following format: W <Analysis ID of the main analysis> <Number>, where <Number> is the sequential number of the What-If Analysis.
- You can duplicate the What-If Analysis. You cannot, however, apply the What-If Analysis.
- You can [change the state of the What-If Analysis](#). The [state assignments and operations that are applicable to an RBI Analysis](#) are also applicable to a What-If Analysis.
- GE Digital APM copies the values from the fields in the main analysis to the What-If Analysis. However, values in the following fields are not copied:
 - Fields in RBI Criticality Analysis:
 - Consequence Category Rolled Up
 - Driving Risk
 - Eff Date for Risk Analysis
 - Inspection Priority Rolled Up
 - Probability of Failure Rolled up
 - Risk Category
 - Risk Completed
 - Risk Completed Date
 - Fields in Criticality Consequence Evaluation:
 - Average Leak Rate
 - Cleanup Cost
 - Deinventory Time
 - Distance to End Effect
 - Estimated Leak Quantity
 - Estimated Release Rate
 - Final Phase
 - Flammable Affected Area
 - Initial Leak Rate
 - Leak Size

- Pool Area
- Probability of Ignition
- Release Duration
- Toxic Mix Release Rate
- Toxicity Area
- Fields in RBI Degradation Mechanisms
 - Combined Consequence
 - Inspection Priority
 - Probability of Failure
- Fields in Criticality Env. Crack. Deg. Mech. Eval
 - Adjusted Years Last Inspection
 - DF
 - Likelihood Category
 - Updated Potential
 - Years in Service
 - Years Last Inspection
- Fields in Criticality Int. Corr. Deg. Mech. Eval
 - DF
 - Estimated
 - Estimated Wall Loss
 - Fractional Wall Loss
 - Likelihood Category
 - Pressure at Minimum Thickness
 - Structural Minimum Thickness
 - Wall Ratio
 - Years in Service
- Fields in Criticality Ext. Corr. Deg. Mech. Eval
 - Age
 - Area Humidity Factor
 - Calculated Corrosion Rate
 - Coating Factor
 - DF
 - Estimated Minimum Thickness
 - Estimated Wall Loss
 - Fractional Wall Loss
 - Insulation Condition Factor
 - Insulation Type Factor
 - Likelihood Category
 - Wall Ratio
 - Years in Service

About Inspection History

When you [calculate an RBI PRD Criticality Analysis](#), Degradation Mechanism Evaluations (DMEs) are used as an input to calculate the Probability of Failure. A key factor in calculating the Probability of Failure for the analysis is the assessment of previous inspections, which are contained in the Inspection History.

Details

As part of each analysis, you can choose the inspection for each DME. This selection assists in reducing uncertainty posed by the particular Degradation Mechanism (DM) and in determining its rate of deterioration. Each Inspection is quantitatively assessed to determine its effectiveness in achieving this goal.

You can select the Inspections used to calculate the following:

- Duration between current and last inspection
- Inspection Confidence Factor
- Updated Characteristic Life

The resulting quantitative value, or Inspection History, indicates how effective prior inspections were at identifying the DM and the rate of degradation.

About Assigning Inspections to a Degradation Mechanism Evaluation (DME)

You can use Inspection Management to record inspection results for a piece of asset. In each Inspection, you can specify the DM for which you were looking during the inspection.

In RBI, you use [RBI Components](#) to divide a piece of an asset into parts. You then define DMs for those components, and then conduct analyses for each RBI Component.

Assigning Inspections to DMEs in RBI

If an RBI Component represents parts of a piece of an asset that you have inspected in the past, and have recorded results in Inspection records, you can assign those inspections to the appropriate DMEs for that component. By doing so, you identify the inspections that were used to detect DMs for that component.

The type of analysis used will determine what happens when you assign an inspection to a DM. For any RBI 580 DME, the listed inspections fall within a specified 20-year window. When you are working with an RBI Analysis, GE Digital APM uses the values in the Inspection Confidence field of the Inspection records to automatically populate the following fields in the Criticality Degradation Mech Evaluation representing that degradation mechanism:

- Inspection Confidence: Indicates how effective the last inspection was at detecting the DM and identifying the rate of degradation.
- Equivalent Number of Inspections: Indicates the number of inspections that will be used when calculating the analysis.

Assigning PRD Inspections to DMEs

You can also assign inspections that are associated with pressure relief devices (PRDs) when you are working with an RBI PRD Criticality Analysis. When you do so, the Inspection records that you select will belong to the PRD Pop Test Checklist family, and values that are stored in the PRD Pop Test Checklist records that you select will be used as inputs to RBI PRD Criticality Analysis calculations. Specifically, values in the following fields in the PRD Pop Test Checklist records are used in RBI PRD Criticality Analysis calculations:

- Completion Date
- Inspection Confidence
- Leak Test Results
- Over Pressure Test Results

For any PRD DME, the listed inspections fall within a specified 20-year window. The Date in Service field must contain a date prior to the date in the Completion Date field. The Completion Date and Inspection

Confidence fields in the PRD Pop Test Checklist must contain values in order to assign a PRD Pop Test Checklist to a DM that is associated with an RBI PRD Criticality Analysis.

The Leak Test Results and Over Pressure Test Results fields, however, do not have to contain values in order to assign an Inspection record of this type to a DME. Instead, in this case, the following default values will be used in the RBI PRD criticality Analysis calculations:

- Leak: This value is used as an input by default when the Leak Test Results field does not contain a value in the PRD Pop Test Checklist that you assign to a DME.
- Fail: This value is used as an input by default when the Over Pressure Test Results field does not a value in the PRD Pop Test Checklist that you assign to a DME.

When you are working with an RBI 581 Risk Analysis or an RBI Criticality Analysis, (i.e., not an RBI PRD Criticality Analysis), if you want to specify manual values, you can choose to override the automatic Inspection Confidence and Equivalent Number of Inspections. In most cases; however, you will want GE Digital APM to populate the fields automatically to avoid subjective interpretations of the values.

About Inspection Priority on PRD Analyses

When you calculate an RBI PRD Criticality Analysis, in each RBI Degradation Mechanism Evaluation linked to the PRD Analysis a probability of failure and consequence of failure are calculated. Together, the values are used to determine the Inspection Priority, which is stored in the Inspection Priority (Unmitigated Risk) field in the related RBI Degradation Mechanism. The fields used to determine the inspection priority are:

- Leak Degradation Mechanism Evaluations
 - Probability of Leak – RBI Interval
 - Leak Consequence Category

Note: This field is stored on the related PRD Consequence Evaluation.
- Over Pressure Degradation Mechanism Evaluation
 - Probability of Loss of Containment – RBI Interval
 - Consequence of Failure at Over Pressure

The probability of failure, consequence of failure and resulting inspection priority as described above can be viewed for each degradation mechanism linked to the RBI PRD Analysis on the Degradation Mechanisms tab of the RBI Analysis workspace.

The Degradation Mechanism Evaluation on an RBI PRD Criticality Analysis with the most conservative inspection priority becomes the driving risk. The driving risk values are stored on the RBI PRD Criticality Analysis.

The Inspection Priority is used to determine the driving RBI Component when a single pressure relief device protects more than one RBI Component. The RBI Component that belongs to the RBI Analysis whose Inspection Priority has the most conservative value (the lowest number) becomes the driving RBI Component. Recommendation are generated based on the Inspection Priority under the Analysis Outputs RBI Interval column.

Inspection Priority for Current Interval

When you calculate an RBI PRD Criticality Analysis, in each RBI Degradation Mechanism Evaluation linked to the RBI Analysis a probability of failure and consequence of failure are calculated for the current interval. The current interval is defined as the difference of the calculation date and the value of the Next Inspection Date field stored on the RBI PRD Criticality Analysis. Together, the values are used to determine an Inspection Priority. The fields used to determine the inspection priority are:

- Leak Degradation Mechanism Evaluations
 - Probability of Leak – Current Interval

- Leak Consequence Category
 - Note:** This field is stored on the related PRD Consequence Evaluation.
- Over Pressure Degradation Mechanism Evaluation
 - Probability of Loss of Containment – Current Interval
 - Consequence of Failure at Over Pressure

The Degradation Mechanism Evaluation on a PRD Criticality Analysis with the most conservative inspection priority for the current interval becomes the driving risk for the current interval. The driving risk values are stored on the PRD Criticality Analysis under the Analysis Outputs Current Interval column.

Inspection Priority and Risk Matrices

Specifically, to determine the Inspection Priority, the Probably of Failure and Combined Consequence are plotted on a matrix available by selecting the area in the page header that contains Inspection Priority, Risk Category, and APM Risk data.

Access an RBI Pipeline Analysis

Procedure

1. [Access the component](#) that contains the RBI Analysis that you want to access.
2. Below the graph, select the RBI Analysis that you want to access.
The **Analysis** workspace appears, displaying the **Analysis Details**, **Degradation Mechanisms**, and **Consequence Evaluations** sections.

Note: If needed, you can modify values in the [available fields](#), review the [required fields](#), and then select  to save your changes.

Create an RBI Analysis

About This Task

You can create an RBI Pipeline Analysis for an RBI Component.

Procedure

1. [Access the RBI Component](#) for which you want to create an RBI Pipeline Analysis.
2. In the left pane, select , and then select **Semi-Quantitative (580)**.
A new analysis is created, and the **Analysis** workspace appears.

Note: When an analysis is created, the Consequence Evaluations and [Degradation Mechanisms](#) corresponding to the Potential Degradation Mechanisms linked to the selected component are also created.

3. Enter Analysis Details values in the [available fields](#).
4. [Review the required fields](#).
5. In the upper-right corner of the section, select .
The RBI analysis is created.

Results

- For each Potential Degradation Mechanism (PDM) linked to the Component, a Degradation Mechanism (DM) is added to the Analysis.

Next Steps

- [Add Degradation Mechanisms \(DMs\)](#).

Add a What-If Analysis

About This Task



You can add a What-If Analysis to the following types of analyses:

- RBI Criticality Analysis
- RBI Pipeline Analysis

When you create a What-If Analysis, a copy of the main Pipeline Analysis is created. In the What-If Analysis, however, the value in the Event Type field is populated with the value W.

You cannot add a What-If Analysis to an RBI PRD Criticality Analysis.

Procedure

1. Perform one of the following sets of steps:
 - a. [Access the analysis](#) to which you want to add a What-If Analysis.
 - b. In the upper-right corner of the workspace, select , and then select **Create What If Analysis**.-or-
 - a. [Access the component](#) that is linked to the analysis to which you want to add a What-If Analysis.
Below the graph, a list of analyses linked to the component appears in a grid.
 - b. Select the check box that corresponds to the analysis to which you want to add a What-If Analysis.
 - c. In the upper-right corner of the grid, select .The **Create What If Analysis** window appears.
2. In the **Create What If Analysis** window:
 - In the **Scenario ID** box, enter an ID to identify the scenario.
 - In the **Scenario Reference Date** box, select a date.
3. Select **Done**.

The What-If Analysis is created and linked to the main analysis. The **Analysis** workspace appears.

Note: If needed, modify Analysis Details values in the [available fields](#), and then select  to save your changes.

Results

- The Analysis ID of the What-If Analysis is in the following format: W <Analysis ID of the main analysis> <Number>, where <Number> is the sequential number of the What-If Analysis.
- All the fields (with a few [exceptions](#)) in the What-If Analysis are populated with values in the main analysis fields.
- The Consequence Evaluation, Degradation Mechanisms (DMs), and Degradation Mechanism Evaluations (DMEs) linked to the main analysis are copied and linked to the What-If Analysis.

Calculate an RBI Pipeline Analysis

Before You Begin

- Make sure that you have entered values in all the [required fields](#). Otherwise, the calculation fails.
- Make sure that a DM is linked to the RBI Pipeline Analysis. Otherwise, the calculation fails.

About This Task

This topic describes how to calculate a single RBI Analysis. In addition to an individual analysis, you can also calculate:

- [All analyses associated with a Process Unit.](#)
- [All analyses associated with a single asset or Corrosion Loop.](#)
- [All analyses associated with multiple assets.](#)

Tip: This procedure also applies to calculating a What-If Analysis.

Procedure

1. [Access the RBI Pipeline Analysis](#) that you want to calculate.
2. In the upper-right corner of the workspace, select .

Note: The  button is enabled only for [RBI Analyses in the Created state](#).

The **Analysis Calculation** window appears, displaying the calculation progress and a log detailing any errors. If the calculation fails, a list of the required fields appear in an error report at the bottom of the **Analysis Calculation** window.

3. After the calculation is complete:
 - To view log details, select **View Complete Log**.
 - To close the window, select **Close**.

The RBI Pipeline Analysis is calculated.

Calculate all RBI Pipeline Analyses Associated with a Process Unit

Before You Begin

- Ensure that you have entered values in all the [required fields](#). Otherwise, the calculation fails.
- Make sure that a DM is linked to each of the RBI Pipeline Analyses. Otherwise, the calculation fails.

About This Task

This topic describes how to calculate all RBI Analyses associated with a single Process Unit. You can also calculate:

- [A single analysis.](#)
- [All analyses associated with a single asset or Corrosion Loop.](#)
- [All analyses associated with multiple assets.](#)

Tip: This procedure also applies to calculating a What-If Analysis.

Procedure

1. Access the [Unit Summary workspace](#).

2. On the upper-right corner of the page, select .

The **Analysis Calculation** window appears, displaying the calculation progress and a log detailing any errors. If a calculation fails, a list of the required fields appear in an error report at the bottom of the **Analysis Calculation** window.

3. After the calculation is complete:

- To view the log details for all calculated analyses, select **View Complete Log**.
- To view the log details for a single analysis, in the list, select that analysis.
- To close the window, select **Close**.

The RBI Pipeline Analyses for the selected Process Unit are calculated.

4. Optionally, if you want to view the status of all bulk analyze operations, on the upper-right corner of the **Risk Based Inspection Overview** page, select .

The **Schedule Logs** page appears, displaying a list of all the operations in GE Digital APM that are in progress, along with the percentage of completion. You can also access a list of operations that have been successful or have failed.

Tip: For more information on Schedule Logs, refer to the Schedule Logs section of the documentation.

Calculate all RBI Pipeline Analyses Associated with a Single Asset or Corrosion Loop

Before You Begin

- Ensure that you have entered values in all the [required fields](#). Otherwise, the calculation fails.
- Make sure that a DM is linked to each of the RBI Pipeline Analyses. Otherwise, the calculation fails.

About This Task

This topic describes how to calculate multiple RBI Analyses associated with a *single* Asset or Corrosion Loop. You can also calculate:

- [A single analysis](#).
- [All analyses associated with a Process Unit](#).
- [All analyses associated with multiple assets](#).

Procedure

1. Access the [Asset Summary workspace](#) of the Asset that is associated with the analyses you want to calculate.

-or-

[Access the Corrosion Loop](#) that is associated with the analyses that you want to calculate.

2. In the upper-right corner of the page, select .

The **Analysis Calculation** window appears, displaying the calculation progress and a log detailing any errors. If the calculation fails, a list of the required fields appear in an error report at the bottom of the **Analysis Calculation** window.

3. After the calculation is complete:

- To view the log details for all calculated analyses, select **View Complete Log**.
- To view the log details for a single analysis, in the list, select that analysis.
- To close the window, select **Close**.

The RBI Pipeline Analysis is calculated.

4. Optionally, if you want to view the status of all bulk analyze operations, on the upper-right corner of the **Risk Based Inspection Overview** page, select .

The **Schedule Logs** page appears, displaying a list of all the operations in GE Digital APM that are in progress, along with the percentage of completion. You can also access a list of operations that have been successful or have failed.

Tip: For more information on Schedule Logs, refer to the Schedule Logs section of the documentation.

Calculate all RBI Pipeline Analyses Associated with Multiple Assets

Before You Begin

- Ensure that you have entered values in all the [required fields](#). Otherwise, the calculation fails.
- Make sure that a DM is linked to each of the RBI Pipeline Analyses. Otherwise, the calculation fails.

About This Task

This topic describes how to calculate all the RBI Analyses associated with *multiple* assets. You can also calculate:

- [A single analysis](#).
- [All analyses associated with a Process Unit](#).
- [All analyses associated with a single asset or Corrosion Loop](#).

Procedure

1. Access the **Risk Based Inspection Overview** page for the Functional Location that contains the assets for which you want to calculate all analyses.
2. If you want to calculate analyses associated with all the assets in the functional location, then proceed to step 5. You cannot, however, calculate all analyses if you have selected Home on the **Asset Hierarchy** page.

-or-

If you want to calculate analyses associated with selected assets, then in the workspace heading, select the **Assets** tab.

The **Assets** section appears.

3. Select the check boxes that correspond to the assets for which you want to calculate all analyses.
4. In the upper-right corner of the page, select .

Note: If you have selected Home on the **Asset Hierarchy** page, and have not selected any assets, then the  button is disabled.

A message appears, specifying the number of assets that you have selected, and asking you if you want to continue.

5. Select **Yes**.

The **Analysis Calculation** window appears, displaying a list of analyses that are sent for calculation, the asset and the component that each analysis is associated with, and the status of each calculation.

If the calculation fails, a list of the required fields appear in an error report at the bottom of the **Calculate Analysis** window.

6. After the calculation is complete:
 - To view the log details for all calculated analyses, select **View Complete Log**.
 - To view the log details for a single analysis, in the list, select that analysis.
 - To close the window, select **Close**.

The RBI Pipeline Analysis is calculated.

7. Optionally, if you want to view the status of all bulk analyze operations, on the upper-right corner of the **Risk Based Inspection Overview** page, select .

The **Schedule Logs** page appears, displaying a list of all the operations in GE Digital APM that are in progress, along with the percentage of completion. You can also access a list of operations that have been successful or have failed.

Tip: For more information on Schedule Logs, refer to the Schedule Logs section of the documentation.

Access the Risk Matrix for an RBI Pipeline Analysis

Procedure

1. [Access the analysis](#) containing the Risk Matrix that you want to access.
2. In the workspace, select the area in the header that contains Inspection Priority, Risk Category, and APM Risk data.

The **Risk Summary** window appears, displaying the **RBI Risk Matrix** subsection.

Note: Refer to the Risk Matrix section of the documentation for details about working with the Risk Matrix.

Duplicate an RBI Pipeline Analysis

About This Task

When you duplicate an RBI Pipeline Analysis, you make an exact copy of the original RBI Analysis. The duplicated RBI Pipeline Analysis is linked to the same Pipeline Component as the original RBI Pipeline Analysis. To copy an RBI Pipeline Analysis, and link it to a different Pipeline Component, you can [apply an RBI Analysis](#).

Procedure

1. [Access the component](#) that contains the RBI Pipeline Analysis that you want to duplicate.
2. Below the graph, select the check box next to the RBI Pipeline Analysis that you want to duplicate, and then select .

The **Select Degradation Mechanisms** window appears.

Only [Degradation Mechanisms \(DMs\)](#) that can be applied to the duplicated analysis appear in the window. By default, the check boxes next to all the Degradation Mechanisms are selected.

3. If you do not want a particular DM to be applied, clear the check box that corresponds to the DM.
4. If you want the Recommendations to be copied, select the **Copy Recommendations for Degradation Mechanisms** check box. You can select this check box only if the **Enable Recommendation To be Generated at Created State** check box in the [Global Preferences](#) workspace is selected.
5. Select **Done**.

The RBI Pipeline Analysis is duplicated.

Results

- All the DMs that you have selected are copied and linked to the duplicated analysis.
- If you have selected the **Copy Recommendations for Degradation Mechanisms** check box, then Recommendations are also copied.

Apply an RBI Pipeline Analysis

About This Task

When you apply an RBI Pipeline Analysis, you make a copy of the original RBI Pipeline Analysis. The applied RBI Pipeline Analysis is not automatically linked to the original Pipeline Component. Instead, the applied RBI Pipeline Analysis can be linked to any Pipeline Component of the same type as the source component. To copy an RBI Pipeline Analysis and link it to the same Pipeline Component, you can [duplicate an RBI Pipeline Analysis](#).

Procedure

1. [Access the component](#) that contains the RBI Pipeline Analysis that you want to apply.
2. Below the graph, select the check box next to the RBI Pipeline Analysis that you want to apply, and then select .
The **Select RBI Components to Apply Analysis** window appears.
3. In the **Hierarchy** section, navigate to and select the asset that contains the Pipeline Component to which you want to apply the analysis.
A list of available Pipeline Components in the selected asset appears in the **Available RBI Components** section.
4. Select the Pipeline Components to which you want to apply the analysis.
The selected Pipeline Components appear in the **Selected RBI Components** column.
5. Select **Next**.
A list of Degradation Mechanisms (DMs) linked to the analysis appears.
6. In each row containing the DMs that you want to link to the new analysis, ensure that the check box is selected.
7. Select **Done**.
The RBI Pipeline Analysis is applied.

Change the State of an RBI Pipeline Analysis

Procedure

1. [Access the Analysis](#) whose state you want to change.
The current state of the analysis appears in the upper-right corner of the page.
2. In the upper-right corner of the page, select the button that indicates the current state of the analysis. For example, if the current state of the analysis is Created, then select the **Created** button.
A menu appears, displaying a list of operations that you can perform on the analysis to change its state.
3. Select the necessary operation that will change the state of the analysis, and then select **Done**. For example, if you want to change the state of the analysis from Created to Risk Completed, select **Finalize Risk**.

Note: You can change the state of an analysis to Risk Completed only if you have calculated the analysis.

Tip: You can view the states assigned to various users or view the history by selecting **Manage State Assignments**. If not already done, you can assign the next state of the event to the appropriate user, and then select **Done**.

The state of the RBI Pipeline Analysis is changed and none of the fields in the analysis are editable.

Note: When an RBI Pipeline Analysis is not in the Created state, the analysis and the related Consequence Evaluations, Degradation Mechanisms, and Degradation Mechanism Evaluations are not editable through the RBI module. However, the fields that are not disabled are editable when the record is accessed through record manager.

Next Steps

- [Promote to Asset Strategy Management \(ASM\)](#).

Finalize Risk of Multiple RBI Pipeline Analyses

About This Task

This topic describes how to finalize risk of multiple analyses that are linked to multiple Assets or Corrosion Loops. You can finalize risk of only the analyses that are calculated and are in the Created state. You cannot finalize risk of multiple analyses that belong to the same component. In such cases, the status of the analyses that belong to the same component are not changed, however, the status of the remaining analyses are updated to Risk Completed.

Procedure

1. Access the [Risk Based Inspection Overview page](#), and then select the **Assets** tab.

-or-

Access the [Unit Summary workspace](#) of the Process Unit that is linked to the Corrosion Loops.

2. In the **Assets** section, select the check boxes that correspond to the assets that contain the analyses to which you want to assign a new state.

-or-

Select the check box for each Corrosion Loop containing analyses for which you want to finalize risk.

The  button is enabled.

3. Select .
The **Finalize Risk** window appears, displaying only the analyses that are calculated and are in the Created state.
4. Select the check box for each analysis for which you want to finalize risk.
The **Finalize Risk** button is enabled.
5. Select **Finalize Risk**.
The selected analyses are moved to the Risk Completed state.
6. Select **Close**.

Next Steps

- [Promote to Asset Strategy Management \(ASM\)](#).

Delete an RBI Pipeline Analysis

Before You Begin

You cannot delete an RBI Pipeline Analysis if it is Active, has a child analysis, or has Recommendations.

- If an RBI Pipeline Analysis has a child analysis, delete the child analysis.
- If an RBI Pipeline Analysis has Recommendations, delete the recommendations.

Procedure

1. [Access the component](#) containing the RBI Pipeline Analysis that you want to delete.
2. Below the graph, in the row containing the Analysis ID that you want to delete, select the check box, and then select .

A message appears, asking you to confirm that you want to delete the RBI Pipeline Analysis.

3. Select **Yes**.

The RBI Pipeline Analysis is deleted.

Pipeline Degradation Mechanisms

About Degradation Mechanisms (DMs)

A Degradation Mechanism is a defined method that affects failure as explained in an RBI Analysis. When an RBI Analysis is performed, DMs are assigned to capture the failure that should apply to an RBI Analysis to calculate its risk.

Example: Degradation Mechanisms

The following table provides a list of DMs that can be linked to each component type. This list is not comprehensive.

Component	Degradation Mechanism
Pump	Amine Cracking
	Blocked Discharge
	Brittle Fracture
Vessel	Carburization
	Caustic Cracking
	Chloride Stress Corrosion Cracking (CI SCC)
Heat Exchanger	Amine Cracking
	Caustic Cracking
	Criticality Calculator External Corrosion

When you associate degradation mechanisms with a Corrosion Loop, you have two options:

- You can link only the DMs that are common across all underlying RBI Components. If you choose this option, you will need to link additional degradation mechanisms with each RBI Component as needed.

-or-

- You can associate all possible DMs for all underlying RBI Components, even if those DMs apply only to one or a few of the components. If you choose this option, you will need to unlink DMs from each component as needed.

Unmitigated Risk for RBI Degradation Mechanisms

When you [calculate an RBI Criticality Analysis](#), the unmitigated risk and unmitigated financial risk for each DM is calculated automatically and stored in the related RBI Degradation Mechanisms record. If you have created a custom calculator, unmitigated risk will be calculated by your custom calculator and displayed on the following datasheets:

- Risk Matrix
- Degradation Mechanism with Risk Mitigation
- Degradation Mechanism without Risk Mitigation

After the unmitigated risk and unmitigated financial risk are calculated for the DMs, depending on how the administrative settings are configured, you can:

- Accept the calculated unmitigated values.

-or-

- Override the calculated unmitigated values.

About Associating Potential Degradation Mechanisms (PDMs)

Each RBI Corrosion Loop contains multiple RBI Components. Each of these components can fail in multiple ways. To indicate the ways in which components can fail, you can link Potential Degradation Mechanisms (PDMs) to the RBI Corrosion Loops.

Each PDM that is linked to the RBI Corrosion Loop represents a degradation mechanism (a way in which the components in that Corrosion Loop might fail). Once the RBI Corrosion Loop has been associated with a PDM, all components added to that RBI Corrosion Loop will inherit the PDM.

For each component, you can define the specific ways in which the RBI Component that it represents can fail.

Note: PDMs can be standardized and inherited from RBI Corrosion Loops. When a new RBI Component is generated from and linked to a specific RBI Corrosion Loop, the PDMs associated with that RBI Corrosion Loop will be inherited by the new RBI Component.

Example: Overhead (OVHD) System

Suppose you have created an RBI Corrosion Loop to represent an OVHD system. You may have determined that components in this corrosion loop can fail in the following ways:

- Exchanger Failure: The tubes in the exchanger could foul and cause the exchanger to produce too much or too little cooling.
- Column Failure: The column may be susceptible.

In this case, the RBI Corrosion Loop would be linked to two PDMs to represent each type of degradation mechanism in the preceding list. After the PDMs are linked to the RBI Corrosion Loop as a whole, and you have determined the components in the corrosion loop, you will need to validate the degradation mechanisms for each component.

Assuming that the OVHD system contains the Exchanger and the Column, the RBI Corrosion Loop representing the OVHD system would be linked to the following RBI Component records:

- Column Top (belongs to the Column)

- Outlet Nozzle (belongs to the Column)
- Exchanger Shell (belongs to the Water Heater)

Each of these RBI Components would be linked automatically to all the PDMs that are linked to the Corrosion Loop. You would need to determine, however, which degradation mechanisms make sense for each component. To do so, you might decide that the RBI Component should be linked to the PDMs as described in the following table.

RBI Component	PDM
Column Top	Environmental Cracking
Outlet Nozzle	External Corrosion
Exchanger Shell	Environmental Cracking

So, while the RBI Corrosion Loop is linked to two PDMs, each RBI Component is linked to only one PDM in this case.

About Degradation Mechanism Evaluations (DMEs)

For each Degradation Mechanism (DM) that belongs to an RBI Criticality Analysis, a corresponding Criticality Degradation Mech Evaluation record also belongs to that RBI Criticality Analysis. In each Criticality Degradation Mech Evaluation that is associated with a qualitative degradation mechanism (i.e., the corresponding RBI Degradation Mechanisms record was created from a Potential Degradation Mechanism with the value Qualitative in the Methodology Type field), you can specify the probability that the corresponding component will fail due to that degradation mechanism.

For example, if an RBI Criticality Analysis contains an Erosion DM, it will also contain a corresponding Erosion Criticality Degradation Mech Evaluation. In this DME, you can specify a value in the Probability Category field to indicate the probability that the RBI Component will fail due to erosion.

After you select a value in the Probability Category field and calculate the RBI Criticality Analysis, the Probability Category Description field will be populated automatically based on the values in an existing Degradation Mechanisms Evaluation Factors record.

Degradation Mechanisms

Suppose a Degradation Mechanisms Evaluation Factors record contains the following values in the following fields:

- Degradation Mechanism: Erosion
- Ranking: 1
- Ranking Description: Erosion - Impact Resistant Material. Good Inspection History with no evidence of Damage.

If an RBI Analysis is linked to an Erosion Criticality Degradation Mech Evaluation, and you select 1 in the Probability Category field, the value in the Probability Category Description field will be populated with the value in the Ranking Description field in the Degradation Mechanisms Evaluation Factors record containing the values Erosion and 1. In this example, the Probability Category Description field would be populated with the value Erosion - Impact Resistant Material. Good Inspection History with no evidence of Damage.

Add Degradation Mechanisms (DMs)

About This Task

For each Potential Degradation Mechanism (PDM) linked to the Component, a DM is added to the Analysis. You can, however, add additional DMs to the analysis.

Note: You cannot add a DM if the [state of the analysis](#) is Risk Completed.

Procedure

1. [Access the analysis](#) to which you want to add DMs.
2. In the workspace, select the **Degradation Mechanisms** tab.
The **Degradation Mechanisms** section appears, displaying a list of DMs associated with the analysis.
3. In the upper-left corner of the section, select .
A list of the DMs that can be applied to the RBI Pipeline Analysis appears, displaying the methodology type of each DM.

Tip: If you select the link that corresponds to a DM, the associated PDM record appears in Record Explorer on a new page.

4. In the row containing each DM that you want to add, select the check box, and then select **Add**.
The selected DMs are added to the RBI Pipeline Analysis.

Results

- A Consequence Evaluation is created and linked to the RBI Pipeline Analysis.

Next Steps

- [Evaluate a Degradation Mechanisms Record \(DM\)](#).

Evaluate a Degradation Mechanism (DM)

Procedure

1. [Access the analysis](#) containing the DM that you want to evaluate.
2. In the workspace heading, select the **Degradation Mechanisms** tab.
The **Degradation Mechanisms** section appears, displaying a list of DMs associated with the analysis.
3. In the row containing the DM that you want to modify, select the link.
A blank datasheet of the corresponding Degradation Mechanism Evaluation (DME) appears.
4. Enter values in the [available fields](#).
5. Select .
The DM is evaluated.

Assess the Unmitigated Risk of a Degradation Mechanism (DM)

Before You Begin

- [Generate Recommendations for the analysis](#).
- [Change the state of the analysis to Risk Completed](#).

Procedure

1. [Access the analysis](#) containing the DM for which you want to assess the unmitigated risk.
2. In the workspace heading, select the **Degradation Mechanisms** tab.
The **Degradation Mechanisms** section appears, displaying a list of DMs associated with the analysis.
3. Select the row containing the DM that you want to assess, and then in the upper-right corner of the section, select .
The **Risk Matrix** window appears.

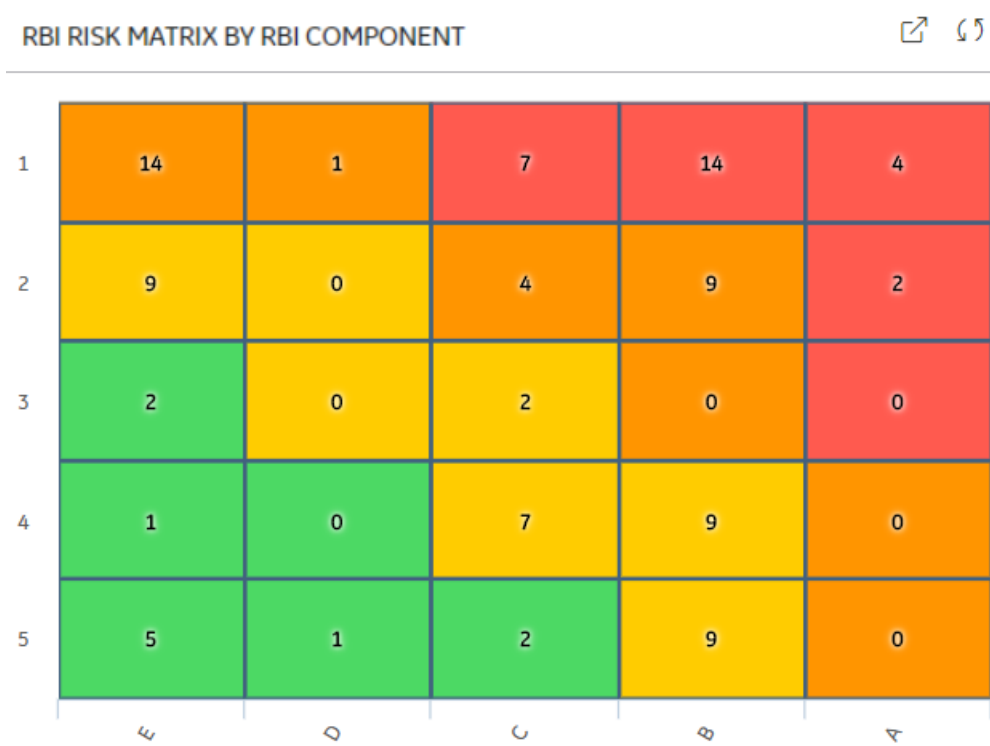

4. Select the cell that represents the risk rank for each category, and then select **Done**. These categories depend on the risk matrix that is defined by your organization. By default, these categories are Safety, Environment, Operations, and Financial.

The unmitigated risk and unmitigated financial risk values for the DM are saved.

Access the Inspection History of a Degradation Mechanism (DM)

Procedure

1. [Access the analysis](#) whose inspection history you want to access.
2. Below the graph, in the row containing the analysis whose Inspection History you want to access, select the link.
The **Analysis Details** section appears, displaying the analysis datasheet.
3. In the workspace, select the **Degradation Mechanisms** tab.
The **Degradation Mechanisms** section appears, displaying a list of DMs associated with the analysis.
4. Select the row containing the DM whose inspection history you want to view, and then select .
The inspection history for the selected DM appears.

Tip: If you want to access the Inspection in Inspection Management, select the link in the **Inspection Report** column. The **Inspection Data** section appears, displaying the Inspection datasheet. For more

information about Inspection Reports, refer to the Inspection Management section of the documentation.

Assign Inspections to a Degradation Mechanism Evaluation (DME)

Before You Begin

- You can assign up to six Inspections.

About This Task

Important: For RBI 580 Qualitative DMs, you can access the inspection history; however, you cannot take credit for an Inspection to calculate the Damage Factor.

Procedure

1. [Access the inspection history](#) for the analysis containing the DME to which you want to assign Inspections.

Note: The listed inspections fall within a specified 20-year window.

2. In the row containing each Inspection that you want to assign, select the check box, and then select **OK**.

The selected Inspections are assigned to the DME.

Tip: To view the Inspection in Inspection Management, select the link in the **Inspection Reports** column. For more information on Inspection Reports, refer to the Inspection Management section of the documentation.

Delete Degradation Mechanisms (DMs)

Before You Begin

- When you delete a DM, the associated RBI Degradation Mechanism Evaluation (DME) and RBI Consequence Evaluation records are also deleted.
- You cannot delete a DM if the associated analysis is in Risk Completed state.

Procedure

1. [Access the analysis](#) that contains the DMs that you want to delete.
2. In the workspace heading, select the **Degradation Mechanisms** tab.
The **Degradation Mechanisms** section appears, displaying a list of DMs associated with the analysis.
3. Select the row containing the DM that you want to delete, and then, in the upper-right corner of the section, select .
A message appears, asking you to confirm that you want to delete the selected DM.
4. Select **Yes**.
The DMs, along with the associated DMEs and RBI Consequence Evaluations, are deleted.

Pipeline Recommendations

About RBI Recommendations

An RBI Recommendation stores information about actions that should be performed to help mitigate the risk associated with a degradation mechanism (DM). Each RBI Recommendation is linked to:

- A Degradation Mechanisms record, which defines the type of failure that the recommended action can help mitigate.
- An Asset record, which defines the piece of asset to which the recommendation applies.
- An Inspection Plan, which is linked to the associated asset.
- An RBI Criticality Analysis record.

Generating Recommendations

GE Digital APM generates RBI Recommendations for:

- [All DMs in a single RBI criticality Analysis](#)
- [Multiple RBI Criticality Analyses linked to a single Asset](#)
- [All assets in an Asset Hierarchy level](#)
- [Active evergreened analyses](#)

These recommendations are recurring.

[Recommendations that are linked to approved Inspection Plans can be implemented as Inspection Tasks directly or from Asset Strategy Management \(ASM\) through the Action created during the Inspection Plan approval.](#)

Note: You can also create recommendations for a single DM.

Content needed for generating recommendations

- Policies
- RBI Strategy Mapping Configuration and RBI Strategy Mapping details
- Inspection Strategies

Policies in RBI 580

The following policies are used for generating recommendations in RBI 580:

- Appendix_B is used for internal corrosion strategy rules for vessels, exchangers, and tanks.
- Appendix_D is used for internal corrosion strategy rule sets for Air Cooled Heat Exchangers.
- Appendix_E is used for internal corrosion strategy rule sets for piping.
- Appendix_F is used for external and CUI strategy rule sets for vessels, exchangers, tanks, and piping.
- Appendix_G is used for environmental cracking strategy rule sets for vessels, exchangers, tanks, and piping.
- Appendix_H is used for corrosion and cracking strategy rule sets for exchanger bundles and tubes.
- Appendix_I is used for plate corrosion and weld cracking strategy rule sets for storage tank bottoms.

Example: Appendix B

A Pressure Vessel called F0065-097 that has a Criticality Calculator Internal Corrosion DM needs to have recommendations generated. Appendix_B applies, since F0065-097 has a Criticality Item Type, DM, and Policy Input data that fit the criteria of the policy.

The following inputs are needed to satisfy the Appendix_B policy:

- Criticality item type in the RBI Criticality Analysis
- Inspection Priority (Unmitigated Risk) field in the associated RBI Degradation Mechanism
- Non-Intrusive Requirement Met field in the associated Criticality Int. Corr. Deg. Mech. Eval. record
- Estimated Half Life field in the associated Criticality Int. Corr. Deg. Mech. Eval. record
- General Corrosion field in the associated Criticality Int. Corr. Deg. Mech. Eval. record

Suppose asset F0065-097 has the following values:

Field	Value
Criticality item type	Pressure Vessel
Inspection Priority	10
Non-Intrusive Requirement Met	No
Half-Life	44.9651 years
General Corrosion	Yes

Given the data for F0065-97, Logic Case Nodes LC112 and LC11 are recommended.

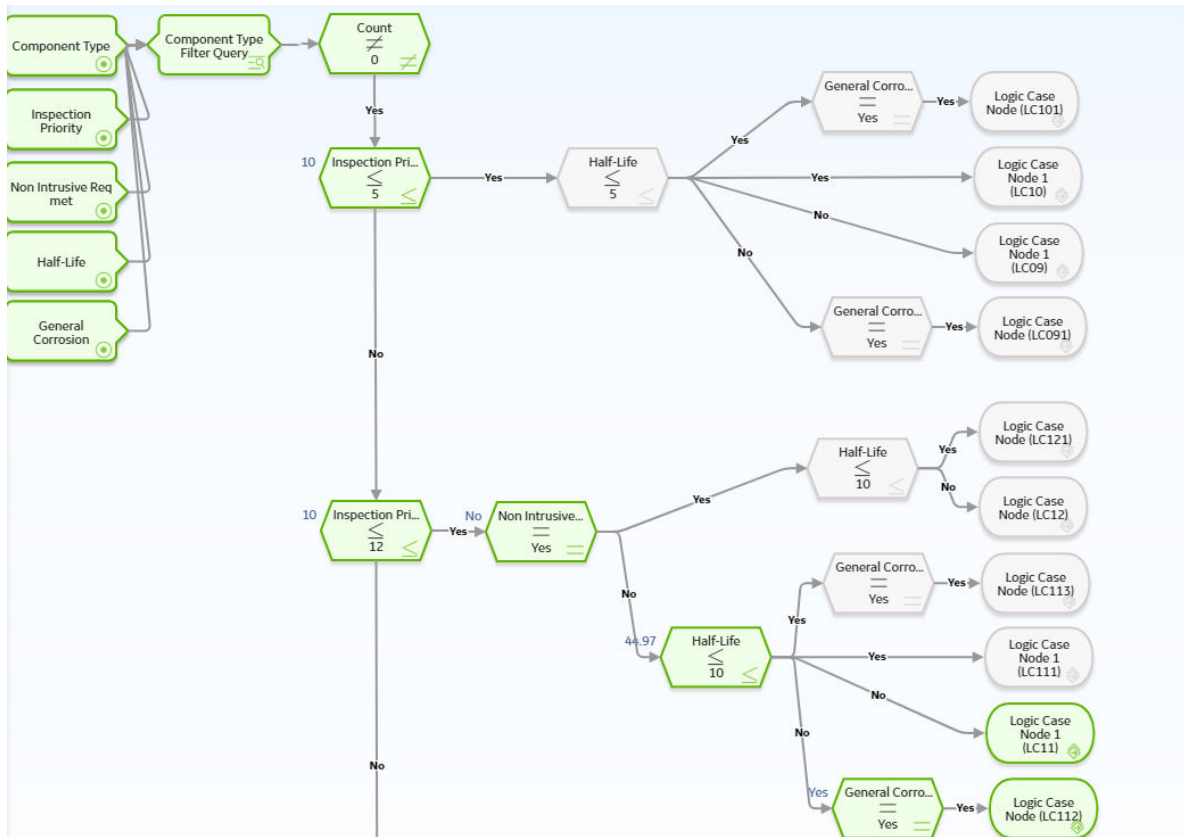

About Inspection Strategies for Generating RBI Recommendations

GE Digital APM provides a set of baseline Inspection Strategies that are used to generate RBI Recommendations. In other words, RBI Recommendations that you create are populated automatically with values that are stored in the Inspection Strategies.

Before you can generate RBI Recommendations using Inspection Strategies, you must ensure that the **Recommendation Creation Enabled** check box is selected on the [Global Preferences](#) page.

GE Digital APM uses an RBI Strategy Mapping Configuration record to determine which policy should be used to find the Inspection Strategy. Specifically, an RBI Strategy Mapping Configuration identifies the Policy to use based on:

- The value in the Criticality Item Type field in the source RBI Criticality Analysis.

- The RBI Criticality Analysis Family ID. This value identifies the Analysis family for which the Policy and Degradation Mechanism (DM) are valid.

Recommendation Generation

Scenario A: An associated RBI Criticality Analysis:

- Whose Criticality Item Type field contains the value Heat Exchanger-Bundle.
- That is linked to an RBI Degradation Mechanism whose Degradation Mechanism field contains the value Criticality Calculator Internal Corrosion.

Scenario B: An associated RBI Criticality Analysis:

- Whose Criticality Item Type field contains the value Storage Tank Bottom.
- That is linked to an RBI Degradation Mechanism whose Degradation Mechanism field contains the value Criticality Calculator Internal Corrosion.

The policy that will be selected in Scenario A is different from the Policy that will be selected in Scenario B.

The RBI Strategy Mapping Groups also define additional logic that determines the Inspection Strategy that should be used to populate the RBI Recommendation. This logic relies on the following items:

- Values stored in the source records that make up the RBI Criticality Analysis.
- Input nodes that exist in the selected Policy.

About Consolidating RBI Recommendations

If two or more RBI Recommendations that are associated with a single RBI Asset contain similar information, you can consolidate them into a single RBI Recommendation. The single RBI Recommendation that is created is called the master RBI Recommendation. The two or more RBI Recommendations that you have selected to consolidate are called source RBI Recommendations.

When you consolidate:

- The state of the master RBI Recommendation is set to Proposed.
- The state of the source RBI Recommendations is changed to Consolidated.
- The source RBI Recommendations are linked to the master RBI Recommendation.

The system consolidates RBI Recommendations that are associated with a single RBI Asset if they contain the same values in the following fields:

- Damage Mechanism
- Task Type

These values come from the Inspection Strategy that is linked to the RBI Criticality Analysis associated with the RBI Recommendation.

The values in the Damage Mechanism and Task Type fields, in addition to any other fields containing matching values, in the source RBI Recommendations will be used to populate the corresponding fields in the master RBI Recommendation. Additionally, the most conservative (i.e., lowest) value in the Recommended Interval Scope field among the source RBI Recommendations will match the value in the Recommended Interval Scope field in the master RBI Recommendation.

Example: Recommendation Consolidation

Suppose you want to generate RBI Recommendations for RBI Analysis A, RBI Analysis B, and RBI Analysis C, which have the following details:

Field Name	RBI Analysis A	RBI Analysis B	RBI Analysis C
Degradation Mechanism	Criticality Calculator Internal Corrosion	Criticality Calculator Internal Corrosion	Criticality Calculator External Corrosion
Inspection Task Type	RBI - MED - EXCH TUBES	RBI - MED - EXCH TUBES	RBI - EXTERNAL - VERY HIGH
Recommended Inspection Interval	90	120	180

In this case, four RBI Recommendations will be created. Since RBI Analysis A and RBI Analysis B are linked to an RBI Degradation Mechanism whose Degradation Mechanism value is Criticality Calculator Internal Corrosion, and the associated Inspection Strategies contain the same Inspection Task Type value, the RBI Recommendations generated from these records would be consolidated automatically into a single master RBI Recommendation. The state of the consolidated records is set to Consolidated, and the state of the master record is set to Proposed.

The following table lists the four RBI Recommendations that will be created as a result of the automatic RBI Recommendation generation process.

State	Damage Mechanism	Task Type	Recommended Interval Scope
Consolidated	Criticality Calculator Internal Corrosion	RBI - MED - EXCH TUBES	90
Consolidated	Criticality Calculator Internal Corrosion	RBI - MED - EXCH TUBES	120
Proposed	Criticality Calculator Internal Corrosion	RBI - MED - EXCH TUBES	90
Proposed	Criticality Calculator External Corrosion	RBI - EXTERNAL - VERY HIGH	180

Notice that two RBI Recommendations are set to Proposed. The recommendation with task type RBI - MED - EXCH TUBES is the master RBI Recommendation described in this topic, and the other is the RBI Recommendation that was created from the Inspection Strategy that was used for RBI Analysis C.

In the master RBI Recommendation, the value in the Recommended Interval Scope field is set to 90 because this is the most conservative (i.e., lowest) value that exists in the Recommended Inspection Interval field in the source RBI Recommendations.

Access the Recommended Actions Pane

Procedure

1. [Access an RBI Pipeline Analysis.](#)
2. In the workspace, select . The **Recommended Actions** pane appears, displaying any recommendations associated with the analysis.

Results

- For a Recommendation that is promoted to Asset Strategy Management (ASM), you can access the associated Asset Strategy by selecting the link in the **Strategy ID** column.

- You can now utilize the functionality of the **Recommended Actions** pane.

Tip: For information about additional options available when working with the Recommendation records, refer to the Action Management section of the documentation.

Create an RBI Recommendation Manually

Before You Begin

- [Change the state of the Analysis to Risk Completed.](#)

About This Task

This topic describes how to create a Recommendation manually for a Degradation Mechanism (DM).

You can also:

- [Generate RBI Recommendations for all DMs in a single RBI Analysis.](#)
- [Generate RBI Recommendations for all RBI Analyses linked to a single Asset.](#)

Procedure

1. [Access the analysis](#) that contains the DM for which you want to generate recommendation.
2. In the workspace heading, select the **Degradation Mechanisms** tab.
The **Degradation Mechanisms** section appears, displaying a list of DMs associated with the analysis.
3. Select the row containing the DM to which you want to add a recommendation.
4. In the upper-left corner of the section, select .

A message appears, confirming that you have successfully generated a recommendation for the DM.

Results

- You can now utilize the functionality of the **Recommendations** pane .

Tip: For information about additional options available when working with the Recommendation records, refer to the Action Management section of the documentation.

Generate Recommendations for a Single RBI Pipeline Analysis

Before You Begin

- [Change the state of the Analysis to Risk Completed.](#)

About This Task

This topic describes how to generate Recommendations for all Degradation Mechanisms (DMs) contained in an analysis.

You can also:

- [Create an RBI Recommendation manually.](#)
- [Generate RBI Recommendations for all RBI Analyses linked to a single Asset.](#)

Procedure

1. [Access the analysis](#) for which you want to generate recommendations.
2. In the upper-right corner of the page, select  , and then select **Generate Recommendations**.

The **Create Recommendations** dialog box appears, asking you to confirm that you want to generate recommendations for the analysis.

3. Select **Yes**.

A message appears, confirming that you have generated recommendations for all the DMs contained in the analysis.

Results

- You can now utilize the functionality of the **Recommended Actions** pane .

Tip: For information about additional options available when working with the Recommendation records, refer to the Action Management section of the documentation.

Generate RBI Recommendations for Multiple RBI Pipeline Analyses

About This Task

This topic explains how to generate recommendations for all RBI Pipeline Analyses linked to components within a single asset.

You can also:

- [Create an RBI Recommendation manually](#).
- [Generate Recommendations for a single RBI Analysis](#). This will generate Recommendations for all the Degradation Mechanisms (DMs) in the RBI Analysis.

Procedure

1. [Access the Asset Summary workspace](#) for the asset for which you want to generate Recommendations.

2. In the upper-right corner of the page, select  , and then select **Generate Recommendations**.

The **Create Recommendations** dialog box appears, asking you to confirm that you want to generate recommendations for the asset.

3. Select **Yes**.

A message appears, confirming that you have generated recommendations for all the RBI Pipeline Analyses linked to all the components in the asset.

Results

- You can now utilize the functionality of the **Recommended Actions** pane .

Tip: For information about additional options available when working with the Recommendation records, refer to the Action Management section of the documentation.

Generate Recommendations for all Analyses in an Asset Hierarchy Level

About This Task

This topic describes how to generate RBI Recommendations for assets linked to a Functional Location in the Asset Hierarchy. You can also:

- [Create an RBI Recommendation manually](#).
- [Generate Recommendations for a single RBI Analysis](#).
- [Generate Recommendations for all RBI Analyses linked to a single asset](#).

Note: The consolidation of recommendations is supported only from the asset view when the **Enable Recommendation To be Generated at Created State** preference is set to True.

Procedure

1. Access the **Risk Based Inspection Overview** page for the Asset Hierarchy level for which you want to generate recommendations.
2. Select the **No Recommendations** tab.
The **No Recommendations** section appears, displaying assets that have at least one component with a Risk Completed analysis with no recommendations.
3. Select the check boxes next to the assets for which you want to generate recommendations.

Tip: You can generate recommendations for all listed assets in the **No Recommendations** section by selecting  when all check boxes in the first column of the table are cleared. If you select the check box in the first row of the table, recommendations are generated for the analyses that appear in the current page in the **No Recommendations** section (up to 100 analyses can be displayed in a page). You cannot, however, generate RBI Recommendations for all analyses if the Asset Hierarchy level is set to Home. Generating recommendations will only apply to components that do not have recommendations.

4. Select .
- The **Generate Recommendations** window appears, asking if you want to consolidate recommendations for each Degradation Mechanism and Task Type.

Tip: If you choose to consolidate recommendations, the recommendations generated during this process will be consolidated with existing recommendations. For more information on consolidating recommendations, consult recommendation consolidation in RBI 580 and RBI 581.

5. Select **Yes**.
The recommendations are generated. The **Recommendation Generation** window appears, displaying the progress and number of recommendations generated and consolidated for each asset.

Note: You can close the **Recommendation Generation** window before it is complete. You can view progress using the Schedule Logs.

6. Select **Close**.
7. Optionally, if you want to view the status of all bulk analyze operations, in the **Risk Based Inspection**

Overview page, select .

The **Schedule Logs** page appears, displaying a list of all the operations in GE Digital APM that are in progress, along with the percentages of completion. You can also access a list of operations that have been successful or have failed.

Results

The recommendations are linked to the Inspection Plan of the related RBI Asset.

Note:

- You can use the functionalities of the **Recommended Actions** pane.
- If, in the RBI Global Preference settings, the **Enable Recommendation To be Generated at Created State** check box is selected, recommendations will not be linked to the Inspection Plan until the related analysis is moved to the Risk Complete state and the Inspection Plan is generated.

Pipeline ASM Integration

About Asset Strategy Management (ASM) Integration

You can approve the Inspection Plan of an asset if all the RBI Components in the asset have an active RBI Criticality Analysis. When you approve the Inspection Plan, the asset is promoted to ASM. When an asset is promoted:

- Degradation Mechanisms (DMs) are used to create Risks in ASM.
- Recommendations are used to create Actions, which can be implemented as Inspection Tasks. These tasks are listed in Inspection Management.

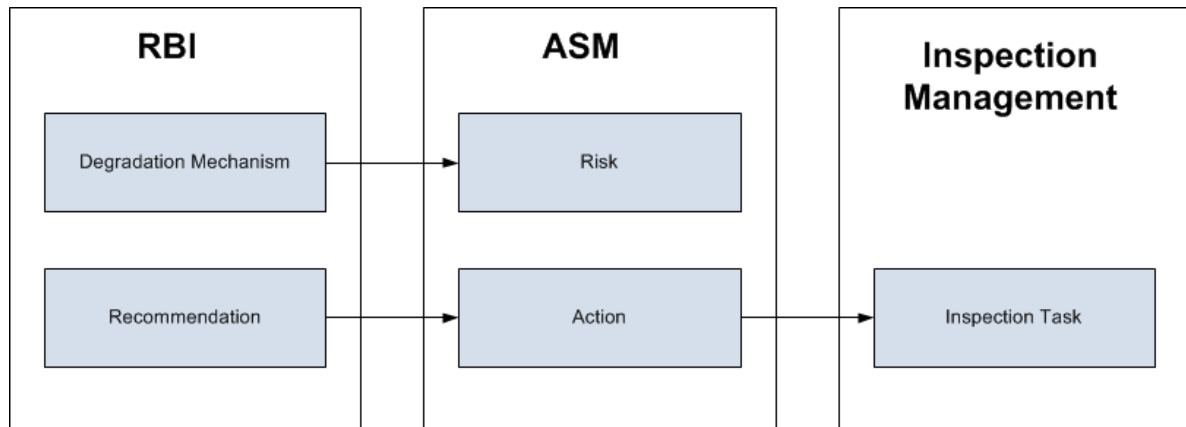

Note: The way in which you manage the unmitigated and mitigated risk values depends on how administrative settings are configured.

Details

You can decide how you want to track recommended actions based on the risk information in the DMs. You can choose either of the following options:

- You can create or generate RBI Recommendations to record the mitigated risk values and then approve the Inspection Plan of the asset. Approving the Inspection Plan will transfer the Degradation Mechanism and RBI Recommendations, along with unmitigated and mitigated risk values, to ASM. Risks are created for the Degradation Mechanism and Actions are created for the recommendation. You can implement either RBI Recommendations from an approved Inspection plan or Actions from an active Asset Strategy as an Inspection Task.
- You will not create RBI Recommendations. Instead, you will recommend a future action and manage mitigated risk values using Actions in ASM.

To transfer RBI Recommendations to Asset Strategies in ASM, you must approve the Inspection Plan of the corresponding asset.

Note: A single asset can have multiple RBI Components, and each RBI Component can have only one active RBI Criticality Analysis.

After you approve the Inspection Plan of the asset:

- All the RBI Criticality Analyses and RBI Recommendations linked to the RBI Components in the asset are set to the Accepted by ASM state. You cannot modify them.

- If you create another RBI Criticality Analysis for an RBI Component linked to the asset and modify the state of the new analysis to Risk Completed, the Inspection Plan will be moved to the Modified state. You can re-approve the Inspection Plan to promote the asset to ASM again.

Example: ASM Integration

In the following image, Asset A is linked to two RBI Components, Component 1 and Component 2, which are each linked to a Risk Completed RBI Criticality Analysis, Analysis 1 and Analysis 2, respectively. If you approve the Inspection Plan on Asset A, the asset is promoted to ASM, and both Analysis 1 and Analysis 2 are set to the Accepted by ASM state.

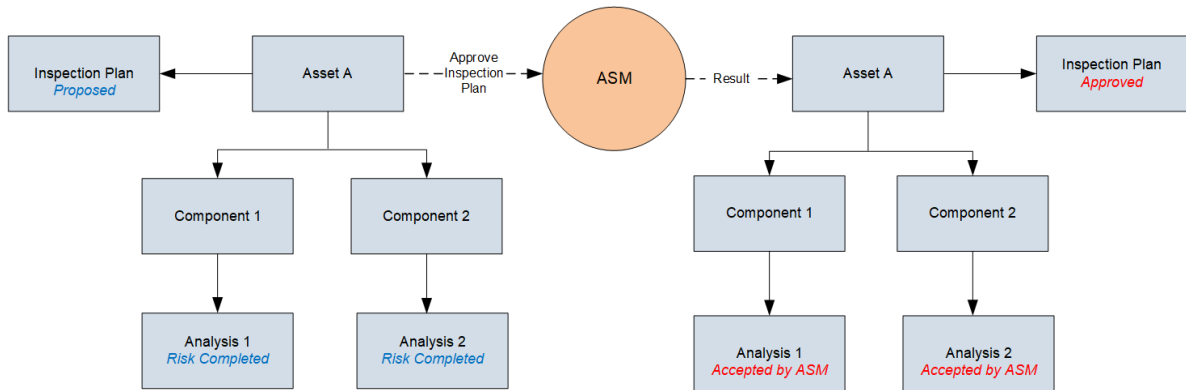

Managing Asset Strategies That Were Created from RBI

After an Asset Strategy has been created from RBI, you can manage the Asset Strategy using ASM. Some restrictions will apply to the Asset Strategy depending on how the administrative settings are configured.

The following table provides information about which Actions are always allowed and which ones are always restricted.

Always Allowed	Always Restricted
<ul style="list-style-type: none"> • Creating Risks. • Assigning new Actions to Risks that did not originate in RBI. • Managing Asset Strategy states. • In the Risk Analysis, clearing the Selected Actions check box for any Action that did not originate in RBI. • Assigning new Actions to any Risk that originated in RBI. • Assigning existing Actions that did not originate in RBI to any Risk that did originate in RBI. • Assigning new Risks to any Action that originated in RBI. • Assigning existing Risks that did not originate in RBI to any Action that did originate in RBI. • Accessing the Risk Matrix to view the unmitigated risk rank for any Risk that was created from RBI. • Accessing the Risk Matrix to view the mitigated risk rank for any Action that was created from RBI. • Copying a Risk that was created from RBI. • Copying a Risk that was created from RBI. 	<ul style="list-style-type: none"> • Risk Records • Undoing a Risk that was created from RBI. • Removing a Risk that was created from RBI. • Assigning Actions that originated in RBI to a Risk that originated in RBI. • For any Risk that was created from RBI, modifying values in the following fields in the Risk datasheet (listed in the order in which they appear on the datasheet, from top to bottom): <ul style="list-style-type: none"> ◦ Name ◦ Description ◦ Risk Basis ◦ Failure Mode ◦ Maintainable Item ◦ Failure Cause • Modifying the unmitigated risk rank or unmitigated financial risk rank for any Risk that was created from RBI. • Action Records <ul style="list-style-type: none"> ◦ Removing an Action that was created from RBI. ◦ Assigning Risks that originated in RBI to an Action that originated in RBI. ◦ For any Action that was created from RBI, modifying values in the following fields on the Action datasheet (listed in the order in which they appear in the datasheet, from top to bottom): <ul style="list-style-type: none"> ◦ Action Basis ◦ Name ◦ Action Type ◦ Interval ◦ Interval Units ◦ Nonrecurring ◦ Cost ◦ Shutdown Required ◦ Cost Basis ◦ Target Completion Date ◦ Modifying the mitigated risk rank for any Action that was created from RBI. ◦ In the Risk Analysis, clearing the Selected Actions check box for an Action that was created from RBI. • General <ul style="list-style-type: none"> ◦ Applying an Asset Strategy Template as a master template to the Asset Strategy

The following table describes Actions that are allowed for Asset Strategies that were created from RBI and the corresponding administrative setting that allows it.

Action	Corresponding Administration Action
Implement Actions as Tasks in ASM	<p>This action is allowed if the Implement Recommended Actions to Tasks in ASM check box is selected.</p> <p>If the Implement Recommended Actions to Tasks in ASM check box is cleared, recommendations can be implemented only as Inspection Tasks through the Inspection Plan of the related asset.</p>

Asset Strategy Management (ASM) Integration Workflow

This workflow provides the basic, high-level steps for promoting an Asset to ASM.

1. [Create a Pipeline Component](#) for each piece of an asset.
2. [Create an RBI Pipeline Analysis](#) for the component.
3. [Assess the unmitigated risk](#) of the Degradation Mechanisms (DMs) that are linked to the RBI Pipeline Analyses.
4. [Change the state of all the RBI Pipeline Analyses to Risk Completed](#).
5. [Generate Recommendations](#) for all the analyses within the asset, and assess the mitigated risk.
6. [Promote the Asset to ASM](#).

This will promote all the RBI Recommendations and DMs associated with the Asset to ASM.

Promoting an Asset to ASM includes steps to analyze the risk associated with each component, recommend future action based on the risks, and transfer the analysis data to ASM. You can recommend future action in one of the following ways:

- **Using RBI Recommendations in RBI:** In this workflow, you will identify the mitigated risk of DMs in RBI.
- **Using Actions in ASM:** In this workflow, you will identify the mitigated risk of DMs in ASM.

In most cases, you will complete the steps in either workflow on a regular basis as you refine the operating conditions and environment. RBI Analyses are dynamic tools that help you refine your strategy for maintaining RBI Components.

About Unmitigated Risk

When you [calculate an RBI Criticality Analysis](#), the unmitigated SHE risk and unmitigated financial risk for each Degradation Mechanisms record (DM) are calculated automatically and stored in the DM. The calculation is performed using Risk Mapping Policies.

Unmitigated Risk

The unmitigated risk rank is plotted on a Risk Matrix. This value is the intersection of the consequence and probability that are calculated when you calculate an RBI Criticality Analysis.

Tip: For more information, refer to the Risk Matrix section of the documentation.

- **Consequence of Failure:** The consequence of failure is the highest among the values in the following fields in the associated Criticality Consequence Evaluation:
 - Safety Risk Category
 - Flammable Consequence Category
 - Toxic Consequence Category
 - Operations Risk Category
 - Product Leak Category

Note: The Product Leak Consequence field will contain a value only if the RBI Component contains the value Heat Exchanger -Bundle in the Component Type field.

- Environmental Risk Category
 - Environmental Consequence Category

Note: The Environmental Consequence Category field will contain a value only if the RBI Component contains the value Storage Tank - Bottom in the Component Type field.

- Probability of Failure: This value is calculated and stored in the DM.

Unmitigated Financial Risk

The unmitigated financial risk rank is set on a Risk Matrix. This value is the product of the consequence and probability that are calculated when you calculate an RBI Criticality Analysis.

Tip: For more information, refer to the Risk Matrix section of the documentation.

- Financial Consequence: The financial consequence is the highest among the values in the following field in the associated Criticality Consequence Evaluation:
 - Lost Production Category
- Probability of Failure: This value is calculated and stored in the DM.

About Mitigated Risk

When you calculate an RBI Criticality Analysis, the [unmitigated risk and unmitigated financial risk](#) for each DM is calculated automatically and stored in the related Degradation Mechanisms record (DM).

By default, the mitigated risk values are set to the same values as the unmitigated risk values. You can modify the mitigated risk values manually using the risk matrix to indicate how the risk could be lowered if certain actions are taken.

Promote an Asset to Asset Strategy Management (ASM)

Before You Begin

- All the Pipeline Components linked to the Asset must contain an active RBI Pipeline Analysis, that is, analysis in Risk Completed, Pending Approval, Approved, or Implemented state.

Procedure

1. Access the [Asset Summary workspace](#) for the asset that you want to promote to ASM.
2. In the workspace heading, select  , and then select **Promote to ASM**.

The selected asset is [promoted to ASM](#).

Results

- If the selected asset is not currently linked to an Asset Strategy, a new Asset Strategy is created and linked to the asset.
- All the Degradation Mechanisms (DMs) and Recommendations linked to the Asset are promoted to ASM.

Chapter 17

Pressure Relief Devices

Topics:

- [PRD Components](#)
- [PRD Analyses](#)
- [PRD Degradation Mechanisms](#)
- [PRD Recommendations](#)
- [PRD ASM Integration](#)

PRD Components

About Pressure Relief Devices (PRD)

A pressure relief device (PRD) is a device that protects asset or RBI Components from pressure buildup. In RBI, you will store information about PRDs in records belonging to subfamilies of the PRD Components family.

Specifically, RBI supports the use of the following types of PRDs:

- Pressure relief valves (stored in Criticality Calculator PRD Component - Relief Valve records)
- Rupture disks (stored in Criticality Calculator PRD Component - Rupture Disk records)

Note: Throughout this documentation, where the distinction between the two subfamilies is irrelevant to the discussion, you will see the term PRD Components to refer to a record in either subfamily.

About Identifying Protected Asset or RBI Components

After you have created a PRD Component to identify a pressure relief device (PRD), you can identify the asset or RBI Components that the PRD protects.

- A PRD can protect either an asset or RBI Components, but not both.
 - If a PRD protects an asset, it can protect one or many pieces of an asset.
 - If a PRD protects RBI Components, it can protect one or many RBI Components.
- A single piece of an asset can be protected by multiple PRDs.
- A single RBI Component can be protected by multiple PRDs.
- If you identify a new protected asset or RBI Component for a PRD for which an RBI PRD Analysis already exists, the existing RBI PRD Analysis will become invalid. You will need to create a new RBI PRD Analysis to account for the new protected asset or RBI Component.

About Integration with Thickness Monitoring (TM)

This topic has been intentionally excluded from the GE Digital APM product documentation website. This topic is available to you via the product documentation that is provided within the GE Digital APM system.

About Using TM Analysis Values at the Asset Level

This topic has been intentionally excluded from the GE Digital APM product documentation website. This topic is available to you via the product documentation that is provided within the GE Digital APM system.

About Using TM Analysis Values at the Thickness Monitoring Location (TML) Group Level

This topic has been intentionally excluded from the GE Digital APM product documentation website. This topic is available to you via the product documentation that is provided within the GE Digital APM system.

Access a PRD Component

About This Task

Important: To distinguish PRD Components from RBI Components in a Corrosion Loop, PRD Components have the icon  before the Component ID. All PRD Components function the same way as RBI Components.

Procedure

1. Access the **Asset Summary workspace** for the asset that contains the PRD Component that you want to access.

-or-

Access the **Corrosion Loop** that contains the PRD Component that you want to access.

2. Below the graph, select the link corresponding to the component that you want to access.

-or-

In the left pane, select the component that you want to access.

The workspace for the selected component appears, displaying the **Component Overview** section.

3. Select the **Component Details** tab.

The **Component Details** section appears, displaying the datasheet of the Component.

Note: If needed, modify values in the **available fields**, and then select  to save your changes.

Create a PRD Component

About This Task

This topic describes how to create a new PRD Component and link it to an Asset or a Corrosion Loop. You can also [link an existing PRD Component to an Asset or a Corrosion Loop](#).

Important: To distinguish PRD Components from RBI Components in a Corrosion Loop, PRD Components have the icon  before the Component ID. All PRD Components function the same way as RBI Components.

Procedure

1. Access the **Asset Summary workspace** of the asset in which you want to create a PRD Component.

-or-

Access the **Corrosion Loop** in which you want to create a PRD Component.

2. In the left pane, select , and then select **Create New Component**.

The **Create New RBI Component** window appears.

3. Enter values in the following fields:

- **Asset:** This field is automatically populated with the asset for which you are creating a PRD Component.
- **Component Family:** Select the component family for the Component that you want to create.
- **Component Type:** Select the component type for the PRD Component that you want to create.

4. Select **Create**.

A new PRD Component is created, and is automatically linked to the selected Asset and the Corrosion Loop. The **Component Details** section appears, displaying the component datasheet.

5. Enter values in the [available fields](#).
6. In the upper-right corner of the datasheet, select .

The changes made to the PRD Component are saved.

Results

- The PRD Component inherits linked [Potential Degradation Mechanisms](#) from the RBI Corrosion Loop.

Next Steps

- [Link a Protected RBI Component to a PRD Component](#).

Link PRD Components to an RBI Corrosion Loop

About This Task

This topic describes how to link existing PRD Components to an Asset or Corrosion Loop. You can also [create a new PRD Component](#).

Important: To distinguish PRD Components from RBI Components in a Corrosion Loop, PRD Components have the icon  before the Component ID. All PRD Components function the same way as RBI Components.

Procedure

1. [Access the Corrosion Loop](#) that you want to link to a PRD Component.
2. In the left pane, select , and then select **Link Existing Component**. The **Select RBI Components** window appears, displaying a list of components in the same site that are not linked to a Corrosion Loop.
3. Select the check boxes that correspond to the components that you want to link, and then select **Done**.

The selected PRD Components are linked to the Corrosion Loop.

Results

- The PDMs that are linked to the Corrosion Loop are linked to the PRD Components, in addition to the ones that are directly linked to the component.

Next Steps

- [Link a Protected RBI Component to a PRD Component](#).

Unlink a PRD Component from an RBI Corrosion Loop

About This Task

Important: To distinguish PRD Components from RBI Components in a Corrosion Loop, PRD Components have the icon  before the Component ID. All PRD Components function the same way as RBI Components.

Procedure

1. [Access the Corrosion Loop](#) from which you want to unlink the PRD Component.
2. In the left pane, select the PRD Component that you want to unlink from the Corrosion Loop, and then select .

-or-

Below the graph, next to the PRD Component that you want to unlink from the Corrosion Loop, select the check box, and then select .

A message appears, asking you to confirm that you want to unlink the selected PRD Component.

3. Select **Yes**.

The PRD Component is unlinked from the selected Corrosion Loop.

Link a Protected RBI Component to a PRD Component

Procedure

1. [Access the PRD Component](#) to which you want to link a Protected RBI Component.

Tip: This documentation assumes that you will link a Protected RBI Component to a PRD Component. The same operations apply if you link a Protected Asset to a PRD Asset.

Note: The PRD workflow is not supported in the Flexi RBI Methodology; this means that if the Protected RBI Component has a custom DME mapped to it, you cannot run the PRD analysis. As a workaround, add a protected asset instead of a protected component to the PRD.

2. In the navigation pane, select , and then select **Link Protected Components**. The **Select Protected Components** window appears.
3. In the **Hierarchy** section, navigate to and select the asset that contains the RBI Component that you want to link.
A list of available RBI Components in the selected asset appear in the **Available RBI Components** section.
4. In the **Available RBI Components** section, select the RBI Component that you want to link.
The selected component appears in the **Selected RBI Components** section.
5. Select **Done**.

The selected RBI Component is now linked to the PRD Component.

Next Steps

- [Link Potential Degradation Mechanisms \(PDMs\) to a PRD Component](#).

Unlink a Protected RBI Component from a PRD Component

Procedure

1. [Access the PRD Component](#) to which you want to link or unlink a Protected RBI Component.

Tip: This documentation assumes that you will you will unlink a Protected RBI Component from the PRD Component. The same operations apply if you unlink a Protected Asset from a PRD Asset.

2. In the left pane, select the protected RBI Component that you want to unlink from the PRD Component.
3. In the left pane, select .

A message appears, asking you to confirm that you want to unlink the selected Protected RBI Component.

4. Select **Yes**.

A message appears, specifying that after you link or unlink protected assets or components, you must calculate the RBI PRD Analysis again to view updated results.

5. Select **Yes**.

The Protected RBI Component is unlinked from the PRD Component.

Link Potential Degradation Mechanisms (PDMs) to a PRD Component

About This Task

If the PRD Component is linked to a Corrosion Loop, then all the PDMs linked to the Corrosion Loop are also linked to the Component. You can, however, link additional PDMs to the Component.

This topic describes how to link one or more PDMs to a PRD Component. You cannot create PDMs; you can only link them. Therefore, a PDM must already exist to be linked to a PRD Component.

Important: To distinguish PRD Components from RBI Components in a Corrosion Loop, PRD Components have the icon  before the Component ID. All PRD Components function the same way as RBI Components.

Procedure

1. [Access the PRD Component](#) to which you want to link PDMs.
2. Select the **Potential Degradation Mechanisms** tab.
The **Potential Degradation Mechanisms** section appears, displaying a list of PDMs linked to the PRD Component.
3. Select **Add PDM**.
A list of PDMs appears, displaying the methodology type of each PDM.

Tip: If you select the link that corresponds to a PDM, the PDM record appears in Record Explorer on a new page.

4. Next to each PDM that you want to link to the PRD Component, select the check box, and then select **OK**.

Note: PDMs that can be used with an RBI 581 Risk Analysis contain a 581 prefix (e.g., 581-Amine Cracking).

The selected PDMs are linked to the PRD Component.

Next Steps

- [Create an RBI PRD Criticality Analysis](#).

Unlink a Potential Degradation Mechanism (PDM) from a PRD Component

About This Task

Important: To distinguish PRD Components from RBI Components in a Corrosion Loop, PRD Components have the icon  before the Component ID. All PRD Components function the same way as RBI Components.

Procedure

1. [Access the PRD Component](#) from which you want to unlink a PDM.
2. Select the **Potential Degradation Mechanisms** tab.

The **Potential Degradation Mechanisms** section appears, displaying a list of PDMs linked to the PRD Component.

3. In the row that contains the PDM you want to unlink from the PRD Component, select .
4. Select **Yes**.

The PDM is unlinked from the PRD Component.

Apply a PRD Component

About This Task

When you apply a PRD Component, you make a copy of the original record. The applied PRD Component is not automatically linked to the original RBI Component's Corrosion Loop. Instead, the applied RBI Component can be linked to the same or a different asset and then to a Corrosion Loop.

Important: To distinguish PRD Components from RBI Components in a Corrosion Loop, PRD Components have the icon  before the Component ID. All PRD Components function the same way as RBI Components.

Procedure

1. [Access the PRD Component](#) that you want to apply.
2. In the upper-right corner of the page, select .
The **Hierarchy Finder** window appears.
3. Navigate through the **Hierarchy Finder** to select the asset to which you want to apply the PRD Component.
4. Select **OK**.
The PRD Component is applied to the selected asset.

Next Steps

- [Link PRD Components to an RBI Corrosion Loop](#)

Duplicate an RBI PRD Criticality Analysis

About This Task

When you duplicate an RBI PRD Criticality Analysis, you create copy of the original RBI Analysis. The duplicated RBI PRD Criticality Analysis is linked to the same RBI Component as the original RBI PRD Criticality Analysis.

Procedure

1. [Access the component](#) that contains the RBI PRD Criticality Analysis that you want to duplicate.
2. Below the graph, select the check box next to the RBI PRD Criticality Analysis that you want to duplicate, and then select .

The **Select Degradation Mechanisms** window appears.

Only [Degradation Mechanisms \(DMs\)](#) that can be applied to the duplicated analysis appear in the window. By default, the check boxes next to all the Degradation Mechanisms are selected. If you do not want a particular DM to be applied, clear the check box that corresponds to the DM.

3. If you want the Recommendations to be copied, select the **Copy Recommendations for Degradation Mechanisms** check box.

Note:

You can only select this check box if the **Enable Recommendation To be Generated at Created State** check box in the [Global Preferences](#) workspace is selected.

4. Select **Done**.

Results

- A new RBI PRD Criticality Analysis is created with all input fields from the original analysis.
Note: If the input field **Next Inspection Date** is before the current date when copying then the field will not be copied.
- A copy of the DMs that you have selected are created and linked to the duplicated analysis.
- If you have selected the **Copy Recommendations for Degradation Mechanisms** check box:
 - Related Recommendations are copied and linked to the duplicated analysis.
 - Output fields, in addition to input fields from the original analysis are copied.

Delete a PRD Component

Before You Begin

- [Unlink all the Potential Degradation Mechanisms \(PDMs\) linked to the PRD Component.](#)
- [Delete all the RBI Analyses linked to the PRD Component.](#)

About This Task

Important: To distinguish PRD Components from RBI Components in a Corrosion Loop, PRD Components have the icon  before the Component ID. All PRD Components function the same way as RBI Components.

Procedure

1. [Access the Asset Summary workspace](#) of the asset that is linked to the PRD Component that you want to delete.

-or-

[Access the Corrosion Loop](#) that is linked to the PRD Component that you want to delete.

2. In the left pane, select the RBI Component that you want to delete.

3. Select .

A message appears, asking you to confirm if you want to delete the selected PRD Component.

4. Select **Yes**.

The PRD Component is deleted, and all links to existing related entities are removed.

PRD Analyses

About PRD Analysis

A PRD Analysis is an analysis that contains data specific to pressure relief devices.

Details

A PRD Analysis for a pressure relief device can be created once you have identified at least one piece of an asset or RBI Component that it protects. PRD Analyses function the same way as [RBI Analyses](#).

However, the following features that are available for RBI Analyses are not available for RBI PRD Analyses:

- Creating What If Analyses from RBI PRD Analyses
- Specifying that TM Analysis values at the TML Group level be used to calculate RBI corrosion rate values

When you create a Criticality Calculator PRD Component:

- When prompted to select an Asset, you should select the Asset that represents the pressure relief device itself.
- When prompted for the Component family, you should select one of the following options:
 - Criticality Calculator PRD Component - Relief Valve
 - Criticality Calculator PRD Component - Rupture Disk
- When prompted for the Component Type, you should select one of the following options:
 - Balanced Bellows PRD
 - Conventional PRD
 - Pilot-Operated PRD
 - PRD with Rupture Disk
 - Rupture Disk Only
- An Asset that represents a Pressure Relief Device cannot be linked to both RBI Components and PRD Components.

About Active Analysis

An RBI Criticality Analysis or a What If Analysis can be active or inactive. An active analysis is the one on which recommendations and tasks for a particular RBI Analysis will be based. For an RBI Component, you can have only one active analysis. There is no limit, however, to the number of inactive analyses that can exist for an RBI Component.

When you create an analysis, it is in the Created state. If the analysis is active, you can then set the analysis to one of the following states in that order:

- Risk Completed
- Accepted by ASM

If the analysis is inactive, however, the state of the analysis will automatically be set to Archived. If you change the state of an analysis to Risk Completed, all the other analyses are marked inactive (i.e., their state is set to Archived).

About Inspection History

When you [calculate an RBI PRD Criticality Analysis](#), Degradation Mechanism Evaluations (DMEs) are used as an input to calculate the Probability of Failure. A key factor in calculating the Probability of Failure for the analysis is the assessment of previous inspections, which are contained in the Inspection History.

Details

As part of each analysis, you can choose the inspection for each DME. This selection assists in reducing uncertainty posed by the particular Degradation Mechanism (DM) and in determining its rate of deterioration. Each Inspection is quantitatively assessed to determine its effectiveness in achieving this goal.

You can select the Inspections used to calculate the following:

- Duration between current and last inspection
- Inspection Confidence Factor
- Updated Characteristic Life

The resulting quantitative value, or Inspection History, indicates how effective prior inspections were at identifying the DM and the rate of degradation.

About Assigning Inspections to a Degradation Mechanism Evaluation (DME)

You can use Inspection Management to record inspection results for a piece of asset. In each Inspection, you can specify the DM for which you were looking during the inspection.

In RBI, you use [RBI Components](#) to divide a piece of an asset into parts. You then define DMs for those components, and then conduct analyses for each RBI Component.

Assigning Inspections to DMEs in RBI

If an RBI Component represents parts of a piece of an asset that you have inspected in the past, and have recorded results in Inspection records, you can assign those inspections to the appropriate DMEs for that component. By doing so, you identify the inspections that were used to detect DMs for that component.

The type of analysis used will determine what happens when you assign an inspection to a DM. For any RBI 580 DME, the listed inspections fall within a specified 20-year window. When you are working with an RBI Analysis, GE Digital APM uses the values in the Inspection Confidence field of the Inspection records to automatically populate the following fields in the Criticality Degradation Mech Evaluation representing that degradation mechanism:

- Inspection Confidence: Indicates how effective the last inspection was at detecting the DM and identifying the rate of degradation.
- Equivalent Number of Inspections: Indicates the number of inspections that will be used when calculating the analysis.

Assigning PRD Inspections to DMEs

You can also assign inspections that are associated with pressure relief devices (PRDs) when you are working with an RBI PRD Criticality Analysis. When you do so, the Inspection records that you select will belong to the PRD Pop Test Checklist family, and values that are stored in the PRD Pop Test Checklist records that you select will be used as inputs to RBI PRD Criticality Analysis calculations. Specifically, values in the following fields in the PRD Pop Test Checklist records are used in RBI PRD Criticality Analysis calculations:

- Completion Date
- Inspection Confidence
- Leak Test Results
- Over Pressure Test Results

For any PRD DME, the listed inspections fall within a specified 20-year window. The Date in Service field must contain a date prior to the date in the Completion Date field. The Completion Date and Inspection Confidence fields in the PRD Pop Test Checklist must contain values in order to assign a PRD Pop Test Checklist to a DM that is associated with an RBI PRD Criticality Analysis.

The Leak Test Results and Over Pressure Test Results fields, however, do not have to contain values in order to assign an Inspection record of this type to a DME. Instead, in this case, the following default values will be used in the RBI PRD criticality Analysis calculations:

- Leak: This value is used as an input by default when the Leak Test Results field does not contain a value in the PRD Pop Test Checklist that you assign to a DME.
- Fail: This value is used as an input by default when the Over Pressure Test Results field does not a value in the PRD Pop Test Checklist that you assign to a DME.

When you are working with an RBI 581 Risk Analysis or an RBI Criticality Analysis, (i.e., not an RBI PRD Criticality Analysis), if you want to specify manual values, you can choose to override the automatic Inspection Confidence and Equivalent Number of Inspections. In most cases; however, you will want GE Digital APM to populate the fields automatically to avoid subjective interpretations of the values.

About Inspection Priority on PRD Analyses

When you calculate an RBI PRD Criticality Analysis, in each RBI Degradation Mechanism Evaluation linked to the PRD Analysis a probability of failure and consequence of failure are calculated. Together, the values are used to determine the Inspection Priority, which is stored in the Inspection Priority (Unmitigated Risk) field in the related RBI Degradation Mechanism. The fields used to determine the inspection priority are:

- Leak Degradation Mechanism Evaluations
 - Probability of Leak – RBI Interval
 - Leak Consequence Category

Note: This field is stored on the related PRD Consequence Evaluation.
- Over Pressure Degradation Mechanism Evaluation
 - Probability of Loss of Containment – RBI Interval
 - Consequence of Failure at Over Pressure

The probability of failure, consequence of failure and resulting inspection priority as described above can be viewed for each degradation mechanism linked to the RBI PRD Analysis on the Degradation Mechanisms tab of the RBI Analysis workspace.

The Degradation Mechanism Evaluation on an RBI PRD Criticality Analysis with the most conservative inspection priority becomes the driving risk. The driving risk values are stored on the RBI PRD Criticality Analysis.

The Inspection Priority is used to determine the driving RBI Component when a single pressure relief device protects more than one RBI Component. The RBI Component that belongs to the RBI Analysis whose Inspection Priority has the most conservative value (the lowest number) becomes the driving RBI Component. Recommendation are generated based on the Inspection Priority under the Analysis Outputs RBI Interval column.

Inspection Priority for Current Interval

When you calculate an RBI PRD Criticality Analysis, in each RBI Degradation Mechanism Evaluation linked to the RBI Analysis a probability of failure and consequence of failure are calculated for the current interval. The current interval is defined as the difference of the calculation date and the value of the Next Inspection Date field stored on the RBI PRD Criticality Analysis. Together, the values are used to determine an Inspection Priority. The fields used to determine the inspection priority are:

- Leak Degradation Mechanism Evaluations
 - Probability of Leak – Current Interval
 - Leak Consequence Category

Note: This field is stored on the related PRD Consequence Evaluation.
- Over Pressure Degradation Mechanism Evaluation
 - Probability of Loss of Containment – Current Interval
 - Consequence of Failure at Over Pressure

The Degradation Mechanism Evaluation on a PRD Criticality Analysis with the most conservative inspection priority for the current interval becomes the driving risk for the current interval. The driving risk values are stored on the PRD Criticality Analysis under the Analysis Outputs Current Interval column.

Inspection Priority and Risk Matrices

Specifically, to determine the Inspection Priority, the Probably of Failure and Combined Consequence are plotted on a matrix available by selecting the area in the page header that contains Inspection Priority, Risk Category, and APM Risk data.

Access an RBI PRD Criticality Analysis

About This Task

Procedure

1. [Access the component](#) that contains the RBI Analysis that you want to access.
2. Below the graph, select the RBI Analysis that you want to access.
The **Analysis Details** section appears, displaying the analysis datasheet.

Note: If needed, you can modify values in the [available fields](#), review the [required fields](#), and then select  to save your changes.

Create an RBI Analysis

About This Task

You can create an RBI PRD Criticality Analysis for an RBI Component.

Procedure

1. [Access the RBI Component](#) for which you want to create an RBI PRD Criticality Analysis.
2. In the left pane, select , and then select **Semi-Quantitative (580)**.
A new analysis is created, and the **Analysis** workspace appears.

Note: When an analysis is created, the Consequence Evaluations and [Degradation Mechanisms](#) corresponding to the [Potential Degradation Mechanisms](#) linked to the selected component are also created.

3. Enter Analysis Details values in the [available fields](#).
4. [Review the required fields](#).
5. In the upper-right corner of the section, select .
The RBI analysis is created.

Results

- For each Potential Degradation Mechanism (PDM) linked to the Component, a Degradation Mechanism (DM) is added to the Analysis.

Next Steps

- [Add Degradation Mechanisms \(DMs\)](#).

Calculate an RBI PRD Criticality Analysis

Before You Begin

- Make sure that you have entered values in all the [required fields](#). Otherwise, the calculation fails.
- Make sure that an Over Pressure DME is linked to the RBI PRD Criticality Analysis. Otherwise, the calculation fails.

About This Task

This topic describes how to calculate a single analysis. In addition to an individual analysis, you can also calculate:

- [All analyses associated with a Process Unit](#).
- [All analyses associated with a single asset or Corrosion Loop](#).

Procedure

1. [Access the RBI PRD Criticality Analysis](#) that you want to calculate.
2. In the upper-right corner of the workspace, select .

Note: The  button is enabled only for [RBI Analyses in the Created state](#).

The **Analysis Calculation** window appears, displaying the calculation progress and a log detailing any errors. If the calculation fails, a list of the required fields appear in an error report at the bottom of the **Analysis Calculation** window.

3. After the calculation is complete:
 - To view log details, select **View Complete Log**.
 - To close the window, select **Close**.

The RBI PRD Criticality Analysis is calculated.

Calculate all RBI PRD Criticality Analyses Associated with a Process Unit

Before You Begin

- Ensure that you have entered values in all the [required fields](#). Otherwise, the calculation fails.

- Make sure that an Over Pressure DME is linked to each of the RBI PRD Criticality Analysis. Otherwise, the calculation fails.

About This Task

This topic describes how to calculate all analyses associated with a single Process Unit. You can also calculate:

- [A single analysis.](#)
- [All analyses associated with a single asset or Corrosion Loop.](#)

Procedure

1. Access the **Unit Summary** workspace.

2. On the upper-right corner of the page, select .

The **Analysis Calculation** window appears, displaying the calculation progress and a log detailing any errors. If a calculation fails, a list of the required fields appear in an error report at the bottom of the **Analysis Calculation** window.

3. After the calculation is complete:

- To view the log details for all calculated analyses, select **View Complete Log**.
- To view the log details for a single analysis, in the list, select that analysis.
- To close the window, select **Close**.

The RBI PRD Criticality Analyses for the selected Process Unit are calculated.

4. Optionally, if you want to view the status of all bulk analyze operations, on the upper-right corner of the **Risk Based Inspection Overview** page, select .

The **Schedule Logs** page appears, displaying a list of all the operations in GE Digital APM that are in progress, along with the percentage of completion. You can also access a list of operations that have been successful or have failed.

Tip: For more information on Schedule Logs, refer to the Schedule Logs section of the documentation.

Calculate all RBI PRD Criticality Analyses Associated with a Single Asset or Corrosion Loop

Before You Begin

- Ensure that you have entered values in all the [required fields](#). Otherwise, the calculation fails.
- Make sure that an Over Pressure DME is linked to each of the RBI PRD Criticality Analysis. Otherwise, the calculation fails.

About This Task

This topic describes how to calculate multiple analyses associated with a single Asset or Corrosion Loop. You can also calculate:

- [A single analysis.](#)
- [All analyses associated with a Process Unit.](#)

Procedure

1. Access the **Asset Summary** workspace of the Asset that is associated with the analyses you want to calculate.

-or-

[Access the Corrosion Loop](#) that is associated with the analyses that you want to calculate.

2. In the upper-right corner of the page, select .

The **Analysis Calculation** window appears, displaying the calculation progress and a log detailing any errors. If the calculation fails, a list of the required fields appear in an error report at the bottom of the **Analysis Calculation** window.

3. After the calculation is complete:
 - To view the log details for all calculated analyses, select **View Complete Log**.
 - To view the log details for a single analysis, in the list, select that analysis.
 - To close the window, select **Close**.

The RBI PRD Criticality Analysis is calculated.

4. Optionally, if you want to view the status of all bulk analyze operations, on the upper-right corner of the **Risk Based Inspection Overview** page, select .

The **Schedule Logs** page appears, displaying a list of all the operations in GE Digital APM that are in progress, along with the percentage of completion. You can also access a list of operations that have been successful or have failed.

Tip: For more information on Schedule Logs, refer to the Schedule Logs section of the documentation.

Access the Risk Matrix for an RBI PRD Criticality Analysis

About This Task

Procedure

1. [Access the analysis](#) containing the Risk Matrix that you want to access.
2. In the workspace, select the **Risk Matrix** tab.
The **Risk Matrix** section appears, displaying the **RBI Risk Matrix** subsection.

Tip: Refer to the Risk Matrix section of the documentation for details about working with the Risk Matrix.

Change the State of an RBI PRD Criticality Analysis

Procedure

1. [Access the Analysis](#) whose state you want to change.
The current state of the analysis appears in the upper-right corner of the page.
2. In the upper-right corner of the page, select the button that indicates the current state of the analysis. For example, if the current state of the analysis is Created, then select the **Created** button.

A menu appears, displaying a list of operations that you can perform on the analysis to change its state.

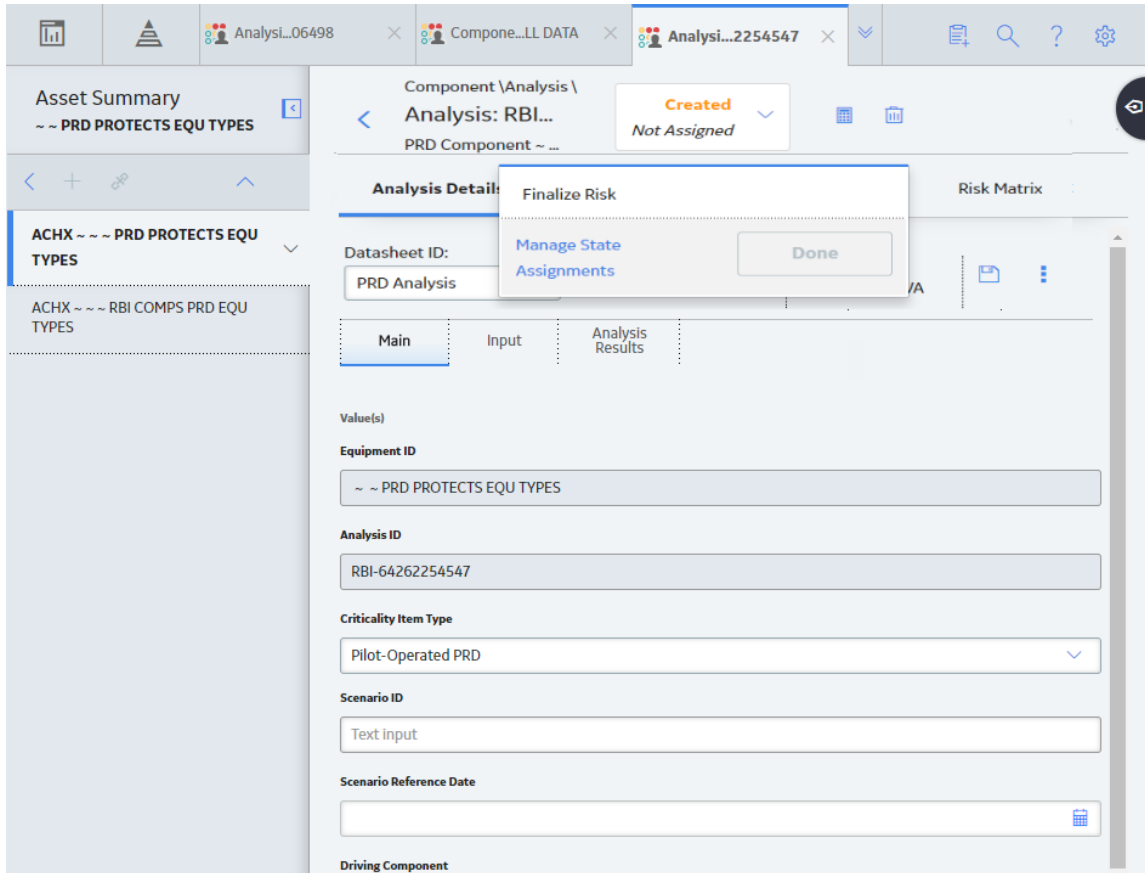

3. Select the necessary operation that will change the state of the analysis, and then select **Done**. For example, if you want to change the state of the analysis from Created to Risk Completed, select **Finalize Risk**.

Note: You can change the state of an analysis to Risk Completed only if you have calculated the analysis.

Tip: You can view the states assigned to various users or view the history by selecting **Manage State Assignments**. If not already done, you can assign the next state of the event to the appropriate user, and then select **Done**.

The state of the RBI PRD Criticality Analysis is changed and none of the fields in the analysis are editable.

Note: When an RBI PRD Criticality Analysis is not in the Created state, the analysis and the related Consequence Evaluations, Degradation Mechanisms, and Degradation Mechanism Evaluations are not editable through the RBI module. However, the fields that are not disabled are editable when the record is accessed through record manager.

Next Steps

- [Promote to Asset Strategy Management \(ASM\)](#).

Finalize Risk of Multiple RBI PRD Criticality Analyses

About This Task

This topic describes how to finalize risk of multiple analyses that are linked to multiple Assets or Corrosion Loops. You can finalize risk of only the analyses that are calculated and are in the Created state. You cannot finalize risk of multiple analyses that belong to the same component. In such cases, the status of the analyses that belong to the same component are not changed, however, the status of the remaining analyses are updated to Risk Completed.

Procedure

1. Access the [Risk Based Inspection Overview](#) page , and then select the **Assets** tab.

-or-

Access the [Unit Summary](#) workspace of the Process Unit that is linked to the Corrosion Loops.

2. In the **Assets** section, select the check boxes that correspond to the assets that contain the analyses to which you want to assign a new state.

-or-

Select the check box for each Corrosion Loop containing analyses for which you want to finalize risk.

The  button is enabled.

3. Select .
- The **Finalize Risk** window appears, displaying only the analyses that are calculated and are in the Created state.
4. Select the check box for each analysis for which you want to finalize risk.
The **Finalize Risk** button is enabled.
5. Select **Finalize Risk**.
The selected analyses are moved to the Risk Completed state.
6. Select **Close**.

Next Steps

- [Promote to Asset Strategy Management \(ASM\)](#).

Delete an RBI PRD Criticality Analysis

Before You Begin

You cannot delete an RBI PRD Criticality Analysis if it is Active, has a child analysis, or has Recommendations.

- If an RBI PRD Criticality Analysis has a child analysis, delete the child analysis.
- If an RBI PRD Criticality Analysis has Recommendations, delete the recommendations.

Procedure

1. Access the [component](#) containing the RBI PRD Criticality Analysis that you want to delete.
2. Below the graph, in the row containing the Analysis ID that you want to delete, select the check box, and then select .

A message appears, asking you to confirm that you want to delete the RBI PRD Criticality Analysis.

3. Select **Yes**.

The RBI PRD Criticality Analysis is deleted.

PRD Degradation Mechanisms

About Degradation Mechanisms (DMs)

A Degradation Mechanism is a defined method that affects failure as explained in an RBI Analysis. When an RBI Analysis is performed, DMs are assigned to capture the failure that should apply to an RBI Analysis to calculate its risk.

Example: Degradation Mechanisms

The following table provides a list of DMs that can be linked to each component type. This list is not comprehensive.

Component	Degradation Mechanism
Pump	Amine Cracking
	Blocked Discharge
	Brittle Fracture
Vessel	Carburization
	Caustic Cracking
	Chloride Stress Corrosion Cracking (CI SCC)
Heat Exchanger	Amine Cracking
	Caustic Cracking
	Criticality Calculator External Corrosion

When you associate degradation mechanisms with a Corrosion Loop, you have two options:

- You can link only the DMs that are common across all underlying RBI Components. If you choose this option, you will need to link additional degradation mechanisms with each RBI Component as needed.
- or-
- You can associate all possible DMs for all underlying RBI Components, even if those DMs apply only to one or a few of the components. If you choose this option, you will need to unlink DMs from each component as needed.

Unmitigated Risk for RBI Degradation Mechanisms

When you [calculate an RBI Criticality Analysis](#), the unmitigated risk and unmitigated financial risk for each DM is calculated automatically and stored in the related RBI Degradation Mechanisms record. If you have created a custom calculator, unmitigated risk will be calculated by your custom calculator and displayed on the following datasheets:

- Risk Matrix
- Degradation Mechanism with Risk Mitigation
- Degradation Mechanism without Risk Mitigation

After the unmitigated risk and unmitigated financial risk are calculated for the DMs, depending on how the administrative settings are configured, you can:

- Accept the calculated unmitigated values.
- or-
- Override the calculated unmitigated values.

About Associating Potential Degradation Mechanisms (PDMs)

Each RBI Corrosion Loop contains multiple RBI Components. Each of these components can fail in multiple ways. To indicate the ways in which components can fail, you can link Potential Degradation Mechanisms (PDMs) to the RBI Corrosion Loops.

Each PDM that is linked to the RBI Corrosion Loop represents a degradation mechanism (a way in which the components in that Corrosion Loop might fail). Once the RBI Corrosion Loop has been associated with a PDM, all components added to that RBI Corrosion Loop will inherit the PDM.

For each component, you can define the specific ways in which the RBI Component that it represents can fail.

Note: PDMs can be standardized and inherited from RBI Corrosion Loops. When a new RBI Component is generated from and linked to a specific RBI Corrosion Loop, the PDMs associated with that RBI Corrosion Loop will be inherited by the new RBI Component.

Example: Overhead (OVHD) System

Suppose you have created an RBI Corrosion Loop to represent an OVHD system. You may have determined that components in this corrosion loop can fail in the following ways:

- Exchanger Failure: The tubes in the exchanger could foul and cause the exchanger to produce too much or too little cooling.
- Column Failure: The column may be susceptible.

In this case, the RBI Corrosion Loop would be linked to two PDMs to represent each type of degradation mechanism in the preceding list. After the PDMs are linked to the RBI Corrosion Loop as a whole, and you have determined the components in the corrosion loop, you will need to validate the degradation mechanisms for each component.

Assuming that the OVHD system contains the Exchanger and the Column, the RBI Corrosion Loop representing the OVHD system would be linked to the following RBI Component records:

- Column Top (belongs to the Column)
- Outlet Nozzle (belongs to the Column)
- Exchanger Shell (belongs to the Water Heater)

Each of these RBI Components would be linked automatically to all the PDMs that are linked to the Corrosion Loop. You would need to determine, however, which degradation mechanisms make sense for each component. To do so, you might decide that the RBI Component should be linked to the PDMs as described in the following table.

RBI Component	PDM
Column Top	Environmental Cracking
Outlet Nozzle	External Corrosion
Exchanger Shell	Environmental Cracking

So, while the RBI Corrosion Loop is linked to two PDMs, each RBI Component is linked to only one PDM in this case.

About Degradation Mechanism Evaluations (DMEs)

For each Degradation Mechanism (DM) that belongs to an RBI Criticality Analysis, a corresponding Criticality Degradation Mech Evaluation record also belongs to that RBI Criticality Analysis. In each Criticality Degradation Mech Evaluation that is associated with a qualitative degradation mechanism (i.e., the corresponding RBI Degradation Mechanisms record was created from a Potential Degradation Mechanism with the value Qualitative in the Methodology Type field), you can specify the probability that the corresponding component will fail due to that degradation mechanism.

For example, if an RBI Criticality Analysis contains an Erosion DM, it will also contain a corresponding Erosion Criticality Degradation Mech Evaluation. In this DME, you can specify a value in the Probability Category field to indicate the probability that the RBI Component will fail due to erosion.

After you select a value in the Probability Category field and calculate the RBI Criticality Analysis, the Probability Category Description field will be populated automatically based on the values in an existing Degradation Mechanisms Evaluation Factors record.

Degradation Mechanisms

Suppose a Degradation Mechanisms Evaluation Factors record contains the following values in the following fields:

- Degradation Mechanism: Erosion
- Ranking: 1
- Ranking Description: Erosion - Impact Resistant Material. Good Inspection History with no evidence of Damage.

If an RBI Analysis is linked to an Erosion Criticality Degradation Mech Evaluation, and you select 1 in the Probability Category field, the value in the Probability Category Description field will be populated with the value in the Ranking Description field in the Degradation Mechanisms Evaluation Factors record containing the values Erosion and 1. In this example, the Probability Category Description field would be populated with the value Erosion - Impact Resistant Material. Good Inspection History with no evidence of Damage.

Add Degradation Mechanisms (DMs)

About This Task

For each Potential Degradation Mechanism (PDM) linked to the Component, a DM is added to the Analysis. You can, however, add additional DMs to the analysis.

Note: You cannot add a DM if the [state of the analysis](#) is Risk Completed.

Procedure

1. [Access the analysis](#) to which you want to add DMs.
2. In the **Degradation Mechanisms** section, select  .
A window appears, displaying a list of the DMs that can be applied to the RBI PRD Criticality Analysis appears, displaying the methodology type of each DM.

Tip: If you select the link that corresponds to a DM, the associated PDM record appears in Record Explorer on a new page.

3. In the row containing each DM that you want to add, select the check box, and then select **Add**.
The selected DMs are added to the RBI PRD Criticality Analysis.

Results

- A Consequence Evaluation is created and linked to the RBI PRD Criticality Analysis.

Next Steps

- [Evaluate a Degradation Mechanisms Record \(DM\)](#).

Evaluate a Degradation Mechanism (DM)

Procedure

1. [Access the analysis](#) containing the DM that you want to evaluate.
2. In the **Degradation Mechanisms** section, in the row containing the DM that you want to modify, select the link.
A window appears, displaying a blank datasheet of the corresponding Degradation Mechanism Evaluation (DME) appears.
3. Enter values in the [available fields](#).
4. Select .
The DM is evaluated.

Assess the Unmitigated Risk of a Degradation Mechanism (DM)

Before You Begin

- [Generate Recommendations for the analysis](#).
- [Change the state of the analysis to Risk Completed](#).

Procedure

1. [Access the analysis](#) containing the DM for which you want to assess the unmitigated risk.
2. In the **Degradation Mechanisms** section, select the row containing the DM that you want to assess, and then select .
The **Risk Matrix** window appears.

RBI RISK MATRIX BY RBI COMPONENT

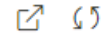

1	14	1	7	14	4
2	9	0	4	9	2
3	2	0	2	0	0
4	1	0	7	9	0
5	5	1	2	9	0
	E	O	C	S	F

3. Select the cell that represents the risk rank for each category, and then select **Done**. These categories depend on the risk matrix that is defined by your organization. By default, these categories are Safety, Environment, Operations, and Financial. The unmitigated risk and unmitigated financial risk values for the DM are saved.

Access the Inspection History of a Degradation Mechanism (DM)

Procedure

1. [Access the analysis](#) whose inspection history you want to access.
2. Below the graph, in the row containing the analysis whose Inspection History you want to access, select the link. The **Analysis** workspace appears.
3. In the **Degradation Mechanisms** section, select the row containing the DM whose inspection history you want to view, and then select . A window appears, displaying the inspection history for the selected DM.

Tip: If you want to access the Inspection in Inspection Management, select the link in the **Inspection Report** column. The **Inspection Data** section appears, displaying the Inspection datasheet.

Assign Inspections to a Degradation Mechanism Evaluation (DME)

Before You Begin

- You can assign up to six Inspections.

About This Task

Important: For RBI 580 Qualitative DMs, you can access the inspection history; however, you cannot take credit for an Inspection to calculate the Damage Factor.

Procedure

1. [Access the inspection history](#) for the analysis containing the DME to which you want to assign Inspections.
Note: The listed inspections fall within a specified 20-year window.
2. In the row containing each Inspection that you want to assign, select the check box, and then select **OK**.
The selected Inspections are assigned to the DME.
Tip: To view the Inspection in Inspection Management, select the link in the **Inspection Reports** column.

Delete Degradation Mechanisms (DMs)

Before You Begin

- When you delete a DM, the associated RBI Degradation Mechanism Evaluation (DME) and RBI Consequence Evaluation records are also deleted.
- You cannot delete a DM if the associated analysis is in Risk Completed state.

Procedure

1. [Access the analysis](#) that contains the DMs that you want to delete.
2. In the **Degradation Mechanisms** section, select the row containing the DM that you want to delete, and then select .
A message appears, asking you to confirm that you want to delete the selected DM.
3. Select **Yes**.
The DMs, along with the associated DMEs and RBI Consequence Evaluations, are deleted.

PRD Recommendations

About RBI Recommendations

An RBI Recommendation stores information about actions that should be performed to help mitigate the risk associated with a degradation mechanism (DM). Each RBI Recommendation is linked to:

- A Degradation Mechanisms record, which defines the type of failure that the recommended action can help mitigate.
- An Asset record, which defines the piece of asset to which the recommendation applies.
- An Inspection Plan, which is linked to the associated asset.
- An RBI Criticality Analysis record.

Generating Recommendations

GE Digital APM generates RBI Recommendations for:

- [All DMs in a single RBI criticality Analysis](#)
- [Multiple RBI Criticality Analyses linked to a single Asset](#)

- All assets in an Asset Hierarchy level
- Active evergreened analyses

These recommendations are recurring.

Recommendations that are linked to approved Inspection Plans can be implemented as Inspection Tasks directly or from Asset Strategy Management (ASM) through the Action created during the Inspection Plan approval.

Note: You can also create recommendations for a single DM.

Content needed for generating recommendations

- Policies
- RBI Strategy Mapping Configuration and RBI Strategy Mapping details
- Inspection Strategies

Policies in RBI 580

The following policies are used for generating recommendations in RBI 580:

- Appendix_B is used for internal corrosion strategy rules for vessels, exchangers, and tanks.
- Appendix_D is used for internal corrosion strategy rule sets for Air Cooled Heat Exchangers.
- Appendix_E is used for internal corrosion strategy rule sets for piping.
- Appendix_F is used for external and CUI strategy rule sets for vessels, exchangers, tanks, and piping.
- Appendix_G is used for environmental cracking strategy rule sets for vessels, exchangers, tanks, and piping.
- Appendix_H is used for corrosion and cracking strategy rule sets for exchanger bundles and tubes.
- Appendix_I is used for plate corrosion and weld cracking strategy rule sets for storage tank bottoms.

Example: Appendix B

A Pressure Vessel called F0065-097 that has a Criticality Calculator Internal Corrosion DM needs to have recommendations generated. Appendix_B applies, since F0065-097 has a Criticality Item Type, DM, and Policy Input data that fit the criteria of the policy.

The following inputs are needed to satisfy the Appendix_B policy:

- Criticality item type in the RBI Criticality Analysis
- Inspection Priority (Unmitigated Risk) field in the associated RBI Degradation Mechanism
- Non-Intrusive Requirement Met field in the associated Criticality Int. Corr. Deg. Mech. Eval. record
- Estimated Half Life field in the associated Criticality Int. Corr. Deg. Mech. Eval. record
- General Corrosion field in the associated Criticality Int. Corr. Deg. Mech. Eval. record

Suppose asset F0065-097 has the following values:

Field	Value
Criticality item type	Pressure Vessel
Inspection Priority	10
Non-Intrusive Requirement Met	No
Half-Life	44.9651 years
General Corrosion	Yes

Given the data for F0065-97, Logic Case Nodes LC112 and LC11 are recommended.

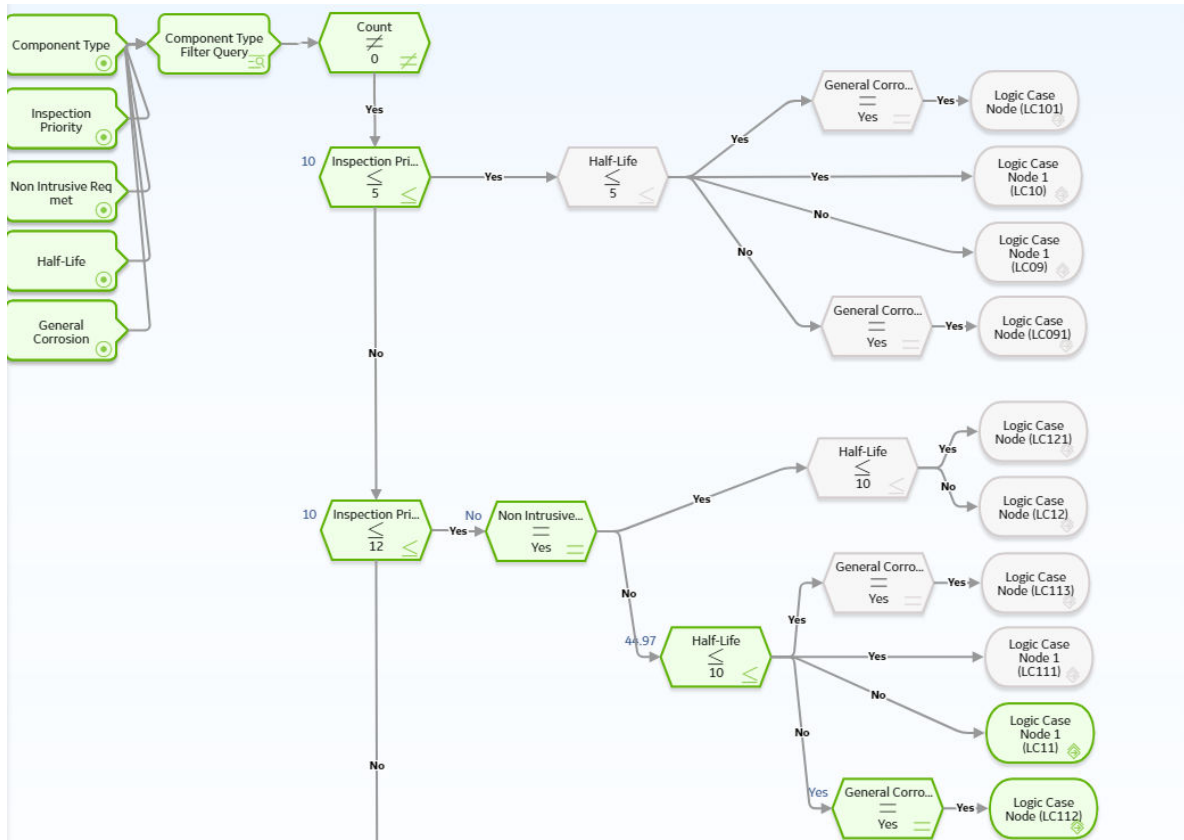

About Inspection Strategies for Generating RBI Recommendations

GE Digital APM provides a set of baseline Inspection Strategies that are used to generate RBI Recommendations. In other words, RBI Recommendations that you create are populated automatically with values that are stored in the Inspection Strategies.

Before you can generate RBI Recommendations using Inspection Strategies, you must ensure that the **Recommendation Creation Enabled** check box is selected on the [Global Preferences](#) page.

GE Digital APM uses an RBI Strategy Mapping Configuration record to determine which policy should be used to find the Inspection Strategy. Specifically, an RBI Strategy Mapping Configuration identifies the Policy to use based on:

- The value in the Criticality Item Type field in the source RBI Criticality Analysis.
- The RBI Criticality Analysis Family ID. This value identifies the Analysis family for which the Policy and Degradation Mechanism (DM) are valid.

Recommendation Generation

Scenario A: An associated RBI Criticality Analysis:

- Whose Criticality Item Type field contains the value Heat Exchanger-Bundle.
- That is linked to an RBI Degradation Mechanism whose Degradation Mechanism field contains the value Criticality Calculator Internal Corrosion.

Scenario B: An associated RBI Criticality Analysis:

- Whose Criticality Item Type field contains the value Storage Tank Bottom.

- That is linked to an RBI Degradation Mechanism whose Degradation Mechanism field contains the value Criticality Calculator Internal Corrosion.

The policy that will be selected in Scenario A is different from the Policy that will be selected in Scenario B.

The RBI Strategy Mapping Groups also define additional logic that determines the Inspection Strategy that should be used to populate the RBI Recommendation. This logic relies on the following items:

- Values stored in the source records that make up the RBI Criticality Analysis.
- Input nodes that exist in the selected Policy.

About Consolidating RBI Recommendations

If two or more RBI Recommendations that are associated with a single RBI Asset contain similar information, you can consolidate them into a single RBI Recommendation. The single RBI Recommendation that is created is called the master RBI Recommendation. The two or more RBI Recommendations that you have selected to consolidate are called source RBI Recommendations.

When you consolidate:

- The state of the master RBI Recommendation is set to Proposed.
- The state of the source RBI Recommendations is changed to Consolidated.
- The source RBI Recommendations are linked to the master RBI Recommendation.

The system consolidates RBI Recommendations that are associated with a single RBI Asset if they contain the same values in the following fields:

- Damage Mechanism
- Task Type

These values come from the Inspection Strategy that is linked to the RBI Criticality Analysis associated with the RBI Recommendation.

The values in the Damage Mechanism and Task Type fields, in addition to any other fields containing matching values, in the source RBI Recommendations will be used to populate the corresponding fields in the master RBI Recommendation. Additionally, the most conservative (i.e., lowest) value in the Recommended Interval Scope field among the source RBI Recommendations will match the value in the Recommended Interval Scope field in the master RBI Recommendation.

Example: Recommendation Consolidation

Suppose you want to generate RBI Recommendations for RBI Analysis A, RBI Analysis B, and RBI Analysis C, which have the following details:

Field Name	RBI Analysis A	RBI Analysis B	RBI Analysis C
Degradation Mechanism	Criticality Calculator Internal Corrosion	Criticality Calculator Internal Corrosion	Criticality Calculator External Corrosion
Inspection Task Type	RBI - MED - EXCH TUBES	RBI - MED - EXCH TUBES	RBI - EXTERNAL - VERY HIGH
Recommended Inspection Interval	90	120	180

In this case, four RBI Recommendations will be created. Since RBI Analysis A and RBI Analysis B are linked to an RBI Degradation Mechanism whose Degradation Mechanism value is Criticality Calculator Internal Corrosion, and the associated Inspection Strategies contain the same Inspection Task Type value, the RBI

Recommendations generated from these records would be consolidated automatically into a single master RBI Recommendation. The state of the consolidated records is set to Consolidated, and the state of the master record is set to Proposed.

The following table lists the four RBI Recommendations that will be created as a result of the automatic RBI Recommendation generation process.

State	Damage Mechanism	Task Type	Recommended Interval Scope
Consolidated	Criticality Calculator Internal Corrosion	RBI - MED - EXCH TUBES	90
Consolidated	Criticality Calculator Internal Corrosion	RBI - MED - EXCH TUBES	120
Proposed	Criticality Calculator Internal Corrosion	RBI - MED - EXCH TUBES	90
Proposed	Criticality Calculator External Corrosion	RBI - EXTERNAL - VERY HIGH	180

Notice that two RBI Recommendations are set to Proposed. The recommendation with task type RBI - MED - EXCH TUBES is the master RBI Recommendation described in this topic, and the other is the RBI Recommendation that was created from the Inspection Strategy that was used for RBI Analysis C.

In the master RBI Recommendation, the value in the Recommended Interval Scope field is set to 90 because this is the most conservative (i.e., lowest) value that exists in the Recommended Inspection Interval field in the source RBI Recommendations.

Access the Recommended Actions Pane

Procedure

1. [Access an RBI PRD Criticality Analysis.](#)

2. In the workspace, select . The **Recommended Actions** pane appears, displaying any recommendations associated with the analysis.

Results

- For a Recommendation that is promoted to Asset Strategy Management (ASM), you can access the associated Asset Strategy by selecting the link in the **Strategy ID** column.
- You can now utilize the functionality of the **Recommended Actions** pane.

Tip: For information about additional options available when working with the Recommendation records, refer to the Action Management section of the documentation.

Create an RBI Recommendation Manually

Before You Begin

- [Change the state of the Analysis to Risk Completed.](#)

About This Task

This topic describes how to create a Recommendation manually for a Degradation Mechanism (DM).

You can also:

- [Generate RBI Recommendations for all DMs in a single RBI Analysis.](#)
- [Generate RBI Recommendations for all RBI Analyses linked to a single Asset.](#)

Procedure

1. [Access the analysis](#) that contains the DM for which you want to generate recommendation.
2. In the **Degradation Mechanisms** section, select the row containing the DM to which you want to add a recommendation, and then select .

A message appears, confirming that you have successfully generated a recommendation for the DM.

Results

- You can now utilize the functionality of the **Recommendations** pane .

Tip: For information about additional options available when working with the Recommendation records, refer to the Action Management section of the documentation.

Generate Recommendations for a Single RBI PRD Criticality Analysis

Before You Begin

- [Change the state of the Analysis to Risk Completed.](#)

About This Task

This topic describes how to create a Recommendation for all Degradation Mechanisms (DMs) contained in an analysis.

You can also:

- [Create an RBI Recommendation manually.](#)
- [Generate RBI Recommendations for all RBI Analyses linked to a single Asset.](#)

Procedure

1. [Access the analysis](#) for which you want to generate recommendations.
2. In the upper-right corner of the page, select  , and then select **Generate Recommendations**. The **Create Recommendations** dialog box appears, asking you to confirm that you want to generate recommendations for the analysis.
3. Select **Yes**.
A message appears, confirming that you have generated recommendations for all the DMs contained in the analysis.

Results

- You can now utilize the functionality of the **Recommendations** pane .

Tip: For information about additional options available when working with the Recommendation records, refer to the Action Management section of the documentation.

Generate RBI Recommendations for Multiple RBI PRD Criticality Analyses

About This Task

This topic explains how to generate recommendations for all RBI PRD Criticality Analyses linked to components within a single asset.

You can also:

- [Create an RBI Recommendation manually.](#)
- [Generate Recommendations for a single RBI Analysis.](#) This will generate Recommendations for all the Degradation Mechanisms (DMs) in the RBI Analysis.

Procedure

1. Access the **Asset Summary** workspace for the asset for which you want to generate Recommendations.
2. In the upper-right corner of the page, select , and then select **Generate Recommendations**.
The **Create Recommendations** dialog box appears, asking you to confirm that you want to generate recommendations for the asset.
3. Select **Yes**.
A message appears, confirming that you have generated recommendations for all the RBI PRD Criticality Analyses linked to all the components in the asset.

Results

- You can now utilize the functionality of the **Recommended Actions** pane .

Tip: For information about additional options available when working with the Recommendation records, refer to the Action Management section of the documentation.

Generate Recommendations for all Analyses in an Asset Hierarchy Level

About This Task

This topic describes how to generate RBI Recommendations for assets linked to a Functional Location in the Asset Hierarchy. You can also:

- [Create an RBI Recommendation manually.](#)
- [Generate Recommendations for a single RBI Analysis.](#)
- [Generate Recommendations for all RBI Analyses linked to a single asset.](#)

Note: The consolidation of recommendations is supported only from the asset view when the **Enable Recommendation To be Generated at Created State** preference is set to True.

Procedure

1. Access the **Risk Based Inspection Overview** page for the Asset Hierarchy level for which you want to generate recommendations.
2. Select the **No Recommendations** tab.
The **No Recommendations** section appears, displaying assets that have at least one component with a Risk Completed analysis with no recommendations.
3. Select the check boxes next to the assets for which you want to generate recommendations.

Tip: You can generate recommendations for all listed assets in the **No Recommendations** section by selecting  when all check boxes in the first column of the table are cleared. If you select the check box in the first row of the table, recommendations are generated for the analyses that appear in the current page in the **No Recommendations** section (up to 100 analyses can be displayed in a page). You cannot, however, generate RBI Recommendations for all analyses if the Asset Hierarchy level is set to Home. Generating recommendations will only apply to components that do not have recommendations.

4. Select .

The **Generate Recommendations** window appears, asking if you want to consolidate recommendations for each Degradation Mechanism and Task Type.

Tip: If you choose to consolidate recommendations, the recommendations generated during this process will be consolidated with existing recommendations. For more information on consolidating recommendations, consult recommendation consolidation in RBI 580 and RBI 581.

5. Select **Yes**.

The recommendations are generated. The **Recommendation Generation** window appears, displaying the progress and number of recommendations generated and consolidated for each asset.

Note: You can close the **Recommendation Generation** window before it is complete. You can view progress using the Schedule Logs.

6. Select **Close**.

7. Optionally, if you want to view the status of all bulk analyze operations, in the **Risk Based Inspection**

Overview page, select .

The **Schedule Logs** page appears, displaying a list of all the operations in GE Digital APM that are in progress, along with the percentages of completion. You can also access a list of operations that have been successful or have failed.

Results

The recommendations are linked to the Inspection Plan of the related RBI Asset.

Note:

- You can use the functionalities of the **Recommended Actions** pane.
- If, in the RBI Global Preference settings, the **Enable Recommendation To be Generated at Created State** check box is selected, recommendations will not be linked to the Inspection Plan until the related analysis is moved to the Risk Complete state and the Inspection Plan is generated.

PRD ASM Integration

About Asset Strategy Management (ASM) Integration

You can approve the Inspection Plan of an asset if all the RBI Components in the asset have an active RBI Criticality Analysis. When you approve the Inspection Plan, the asset is promoted to ASM. When an asset is promoted:

- Degradation Mechanisms (DMs) are used to create Risks in ASM.
- Recommendations are used to create Actions, which can be implemented as Inspection Tasks. These tasks are listed in Inspection Management.

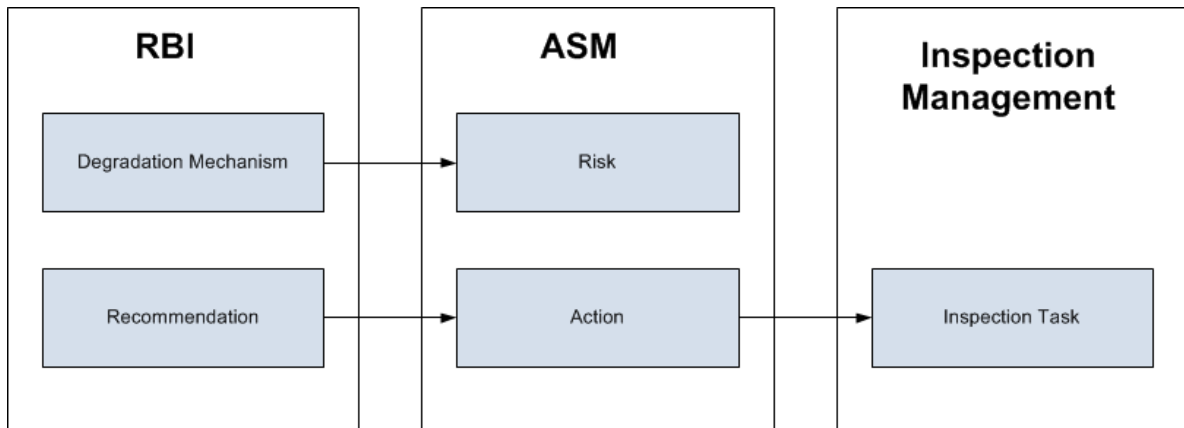

Note: The way in which you manage the unmitigated and mitigated risk values depends on how administrative settings are configured.

Details

You can decide how you want to track recommended actions based on the risk information in the DMs. You can choose either of the following options:

- You can create or generate RBI Recommendations to record the mitigated risk values and then approve the Inspection Plan of the asset. Approving the Inspection Plan will transfer the Degradation Mechanism and RBI Recommendations, along with unmitigated and mitigated risk values, to ASM. Risks are created for the Degradation Mechanism and Actions are created for the recommendation. You can implement either RBI Recommendations from an approved Inspection plan or Actions from an active Asset Strategy as an Inspection Task.
- You will not create RBI Recommendations. Instead, you will recommend a future action and manage mitigated risk values using Actions in ASM.

To transfer RBI Recommendations to Asset Strategies in ASM, you must approve the Inspection Plan of the corresponding asset.

Note: A single asset can have multiple RBI Components, and each RBI Component can have only one active RBI Criticality Analysis.

After you approve the Inspection Plan of the asset:

- All the RBI Criticality Analyses and RBI Recommendations linked to the RBI Components in the asset are set to the Accepted by ASM state. You cannot modify them.
- If you create another RBI Criticality Analysis for an RBI Component linked to the asset and modify the state of the new analysis to Risk Completed, the Inspection Plan will be moved to the Modified state. You can re-approve the Inspection Plan to promote the asset to ASM again.

Example: ASM Integration

In the following image, Asset A is linked to two RBI Components, Component 1 and Component 2, which are each linked to a Risk Completed RBI Criticality Analysis, Analysis 1 and Analysis 2, respectively. If you approve the Inspection Plan on Asset A, the asset is promoted to ASM, and both Analysis 1 and Analysis 2 are set to the Accepted by ASM state.

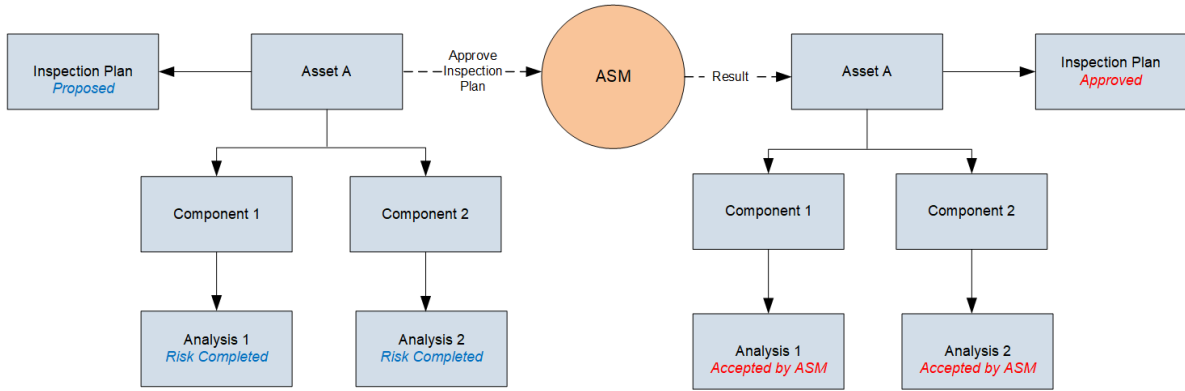

Managing Asset Strategies That Were Created from RBI

After an Asset Strategy has been created from RBI, you can manage the Asset Strategy using ASM. Some restrictions will apply to the Asset Strategy depending on how the administrative settings are configured.

The following table provides information about which Actions are always allowed and which ones are always restricted.

Always Allowed	Always Restricted
<ul style="list-style-type: none"> • Creating Risks. • Assigning new Actions to Risks that did not originate in RBI. • Managing Asset Strategy states. • In the Risk Analysis, clearing the Selected Actions check box for any Action that did not originate in RBI. • Assigning new Actions to any Risk that originated in RBI. • Assigning existing Actions that did not originate in RBI to any Risk that did originate in RBI. • Assigning new Risks to any Action that originated in RBI. • Assigning existing Risks that did not originate in RBI to any Action that did originate in RBI. • Accessing the Risk Matrix to view the unmitigated risk rank for any Risk that was created from RBI. • Accessing the Risk Matrix to view the mitigated risk rank for any Action that was created from RBI. • Copying a Risk that was created from RBI. • Copying a Risk that was created from RBI. 	<ul style="list-style-type: none"> • Risk Records • Undoing a Risk that was created from RBI. • Removing a Risk that was created from RBI. • Assigning Actions that originated in RBI to a Risk that originated in RBI. • For any Risk that was created from RBI, modifying values in the following fields in the Risk datasheet (listed in the order in which they appear on the datasheet, from top to bottom): <ul style="list-style-type: none"> ◦ Name ◦ Description ◦ Risk Basis ◦ Failure Mode ◦ Maintainable Item ◦ Failure Cause • Modifying the unmitigated risk rank or unmitigated financial risk rank for any Risk that was created from RBI. • Action Records <ul style="list-style-type: none"> ◦ Removing an Action that was created from RBI. ◦ Assigning Risks that originated in RBI to an Action that originated in RBI. ◦ For any Action that was created from RBI, modifying values in the following fields on the Action datasheet (listed in the order in which they appear in the datasheet, from top to bottom): <ul style="list-style-type: none"> ◦ Action Basis ◦ Name ◦ Action Type ◦ Interval ◦ Interval Units ◦ Nonrecurring ◦ Cost ◦ Shutdown Required ◦ Cost Basis ◦ Target Completion Date ◦ Modifying the mitigated risk rank for any Action that was created from RBI. ◦ In the Risk Analysis, clearing the Selected Actions check box for an Action that was created from RBI. • General <ul style="list-style-type: none"> ◦ Applying an Asset Strategy Template as a master template to the Asset Strategy

The following table describes Actions that are allowed for Asset Strategies that were created from RBI and the corresponding administrative setting that allows it.

Action	Corresponding Administration Action
Implement Actions as Tasks in ASM	<p>This action is allowed if the Implement Recommended Actions to Tasks in ASM check box is selected.</p> <p>If the Implement Recommended Actions to Tasks in ASM check box is cleared, recommendations can be implemented only as Inspection Tasks through the Inspection Plan of the related asset.</p>

Asset Strategy Management (ASM) Integration Workflow

This workflow provides the basic, high-level steps for promoting an Asset to ASM.

1. [Create a PRD Component](#) for each piece of an asset.
2. [Create an RBI PRD Criticality Analysis](#) for the component.
3. [Assess the unmitigated risk](#) of the Degradation Mechanisms (DMs) that are linked to the RBI PRD Criticality Analyses.
4. [Change the state of all the RBI PRD Criticality Analyses to Risk Completed.](#)
5. [Generate Recommendations](#) for all the analyses within the asset, and assess the mitigated risk.
6. [Promote the Asset to ASM.](#)

This will promote all the RBI Recommendations and DMs associated with the Asset to ASM.

Promoting an Asset to ASM includes steps to analyze the risk associated with each component, recommend future action based on the risks, and transfer the analysis data to ASM. You can recommend future action in one of the following ways:

- **Using RBI Recommendations in RBI:** In this workflow, you will identify the mitigated risk of DMs in RBI.
- **Using Actions in ASM:** In this workflow, you will identify the mitigated risk of DMs in ASM.

In most cases, you will complete the steps in either workflow on a regular basis as you refine the operating conditions and environment. RBI Analyses are dynamic tools that help you refine your strategy for maintaining RBI Components.

About Unmitigated Risk

When you [calculate an RBI Criticality Analysis](#), the unmitigated SHE risk and unmitigated financial risk for each Degradation Mechanisms record (DM) are calculated automatically and stored in the DM. The calculation is performed using Risk Mapping Policies.

Unmitigated Risk

The unmitigated risk rank is plotted on a Risk Matrix. This value is the intersection of the consequence and probability that are calculated when you calculate an RBI Criticality Analysis.

Tip: For more information, refer to the Risk Matrix section of the documentation.

- **Consequence of Failure:** The consequence of failure is the highest among the values in the following fields in the associated Criticality Consequence Evaluation:
 - Safety Risk Category
 - Flammable Consequence Category
 - Toxic Consequence Category
 - Operations Risk Category
 - Product Leak Category

Note: The Product Leak Consequence field will contain a value only if the RBI Component contains the value Heat Exchanger -Bundle in the Component Type field.

- Environmental Risk Category
 - Environmental Consequence Category

Note: The Environmental Consequence Category field will contain a value only if the RBI Component contains the value Storage Tank - Bottom in the Component Type field.

- Probability of Failure: This value is calculated and stored in the DM.

Unmitigated Financial Risk

The unmitigated financial risk rank is set on a Risk Matrix. This value is the product of the consequence and probability that are calculated when you calculate an RBI Criticality Analysis.

Tip: For more information, refer to the Risk Matrix section of the documentation.

- Financial Consequence: The financial consequence is the highest among the values in the following field in the associated Criticality Consequence Evaluation:
 - Lost Production Category
- Probability of Failure: This value is calculated and stored in the DM.

About Mitigated Risk

When you calculate an RBI Criticality Analysis, the [unmitigated risk and unmitigated financial risk](#) for each DM is calculated automatically and stored in the related Degradation Mechanisms record (DM).

By default, the mitigated risk values are set to the same values as the unmitigated risk values. You can modify the mitigated risk values manually using the risk matrix to indicate how the risk could be lowered if certain actions are taken.

Promote an Asset to Asset Strategy Management (ASM)

Before You Begin

- All the PRD Components linked to the Asset must contain an active RBI PRD Criticality Analysis (i.e., in Risk Completed state).
- All the PRD Components linked to the Asset must contain an active RBI PRD Criticality Analysis, that is, analysis in the Risk Completed, Pending Approval, Approved, or Implemented state.

Procedure

1. Access the [Asset Summary workspace](#) for the asset that you want to promote to ASM.
2. In the workspace heading, select , and then select **Promote to ASM**.

The selected asset is [promoted to ASM](#).

Results

- If the selected asset is not currently linked to an Asset Strategy, a new Asset Strategy is created and linked to the asset.
- All the Degradation Mechanisms (DMs) and Recommendations linked to the Asset are promoted to ASM.

Chapter 18

Admin

Topics:



- [Access the Global Preferences Workspace](#)
- [About Global Preferences](#)
- [Configure RBI Overview Preferences](#)
- [About Configuring Multiple Degradation Mechanisms \(DMs\) for a Single RBI Criticality Analysis](#)
- [Enable Inspection Grouping](#)
- [Access RBI 580 Flexible Calculation Preferences](#)
- [Create a Flexible Calculation Configuration](#)
- [Create a Flexible Calculation Validation](#)
- [Create a Flexible Calculation Output Preference](#)
- [Update the Non-Intrusive Requirement Met Query](#)
- [Use the Upgrade APM Version 3 Active Analyses Utility](#)
- [Configure the Asset Info Summary](#)

Access the Global Preferences Workspace

Before You Begin

- You can access the **Global Preferences** workspace only if you are a member of the MI RBI Administrator Security Group or a super user.

Procedure

1. In the **Applications** menu, navigate to **ADMIN > Application Settings > Risk Based Inspection**.
The **RBI Admin Preferences** page appears, displaying the **Global Preferences** workspace.
2. If you want to modify the value in a field:
 - a. Select .
All the fields in the workspace are enabled.
 - b. As needed, modify values in the [available fields](#).
 - c. Select .The value in the field is modified.

About Global Preferences

About RBI Preferences

The Global Preference settings for Risk Based Inspection contain items for the following settings:

- **Allow Override of Calculated Unmitigated Risk Values:** By default, the unmitigated risk is calculated automatically and displayed on a Degradation Mechanism datasheet which you cannot modify. If you use a custom calculator to calculate unmitigated risk and display it on the Risk Matrix and you want to allow the users to modify the calculated unmitigated risk, then you must select this check box.
- **Use Interpolation for Stress Reference Tables:** If you select this check box, linear interpolation is used to calculate the allowable stress based on the value in the Design Temperature field.

Note: In RBI 581 Risk Analysis, linear interpolation is also used to calculate the flow stress based on the value in the Yield Strength and Tensile Strength fields.

If you do not select this check box, and the value in the Design Temperature field is not an exact match of the metal temperature value available in the stress table, the value in the Allowable Stress is populated based on the following conditions:

- If the design temperature is less than the highest temperature available in the stress table, the next highest temperature value is used to determine the allowable stress value.
- If the design temperature is greater than the highest temperature available in the stress table, the allowable stress value for the highest temperature is populated from the stress table.

By default, this check box is cleared.

Tip: For information on the calculation of allowable stress values, refer to the [Allowable Stress Calculation](#) on page 494 topic.

- **Enable Suggestion of Potential Degradation Mechanism:** If you select this check box, the GE Digital APM will suggest Potential Degradation Mechanisms (PDMs) for RBI Components based on the data provided at the component level. You can view and link suggested PDMs to their RBI Components.
- **Recommendation Creation Enabled:** If you select this check box, you can create RBI Recommendation records in RBI. By default, this check box is selected. If you want to recommend actions and manage mitigated risk in ASM, you must modify the baseline configuration by clearing this check box.

Note: When you select this preference, the **Use Alternative Inspection Plan Process** preference is automatically cleared.

- **Enable Recommendations to be Generated at Created State:** Ideally, you must generate Recommendations only for analyses in Risk Completed state. If, however, you want to generate Recommendations for analyses in Created state, you must select this check box.

If you select this check box:

- You can create Recommendations for an analysis in the Created state.
- You cannot create Recommendations for an analysis in the Risk Completed state.

By default, this check box is cleared. You can select it only if the **Recommendation Creation Enabled** check box is selected.

- **Implement Recommended Actions to Tasks in ASM:** This setting allows you to specify where the recommended actions are implemented.

- If you select this check box, the RBI sourced Recommended Actions are implemented in Tasks in ASM.
- If you do not select this check box, the RBI sourced Recommended Actions are implemented in Tasks in the **Inspection Plan** page for the Asset.

Note: This setting is mapped to the **Implement Recommended Actions to Tasks in ASM** setting in the Inspection Management module. Any change in this setting is updated to the corresponding setting in the Inspection Management module.

- **Use Alternative Inspection Plan Process:** If you select this check box, the GE Digital APM creates Inspection Plan details instead of creating the RBI recommendations within the Inspection Plan. This setting allows you to finalize the implementation plan as part of this workflow.

Note:

- When you select this preference, the **Recommendation Creation Enabled** preference is cleared automatically.
- After selecting this preference, you must select **Update Inspection Plan** on pre-existing Inspection Plans to generate Inspection Plan Details.

- **Consider Half-Life when Determining Inspection Task Interval:** This setting determines how the Desired Interval field in ASM action is populated.

The value in the Desired Interval field in ASM action is determined by the minimum values of the following fields:

- RBI Recommendation Interval Scope Value
- RBI Half-Life from Criticality Calculator Internal Corrosion
- TM Half-Life of the Asset

You can select this check box only if the Thickness Monitoring license is active. By default, this check box is cleared.

- **Enable Inspection Grouping:** If you select this check box, the Inspection Grouping workflow is enabled and the **Open Inspection Group** button appears in the **Process Units** section of the **Risk Based Inspection Overview** page.
- **Enable Leak Size Based on Degradation Mechanism:** If you select this check box, the Leak Size used during the Consequence Evaluation will be based on the related Degradation Mechanisms, not

Equipment Type. You must add Degradation Mechanism Leak Size records for each Degradation Mechanism. If you do not provide a value for a Degradation Mechanism, a default value of the minimum of the Diameter and 16 inches will be considered.

If you select this check box, the RBI Criticality Analysis calculation will look up all related Degradation Mechanisms in the Degradation Mechanism Leak Size reference table. The maximum Leak Size for the Degradation Mechanisms will be used in the Criticality Consequence Evaluation calculation.

- **Evaluate all RBI 581 Risk Targets:** This setting allows you to enable or disable Evaluation of All Risk Targets. When you enable the Evaluation of All Risk Targets feature and calculate an RBI 581 analysis, the Safety Health and Environmental (SHE) Risk, the Financial Risk, and the Damage Factor targets are evaluated to determine a new value in the Target Inspection Date field. The Target Inspection Date field is then used to determine the value in the Driving Risk Target field, and the value for Driving Risk Target field is set to the risk target that has the most conservative Target Inspection Date value. The resulting target and Target Inspection Date are also used to determine mitigation of risk.
- **Use Corrosion Rate Adjustment Factors for External Corrosion Damage Mechanisms:** As part of API 581, 3rd edition, Addendum 2, Corrosion Rate Adjustment Factors have been updated to only be applied when the Selected Corrosion Rate is **Calculated** on 581-Ferritic Component Corrosion Under Insulation and 581-Ferritic Component Atmospheric Corrosion Damage Mechanisms. Select this option if you want the factors to be applied regardless of the selected corrosion rate as they were in GE Digital APM V5.0.0.0 and earlier.

Important: With the exception of modifying your administrative settings to use new functionality, you should not modify the administrative settings after you have configured them, and the users have started creating RBI Analyses using those settings.

About RBI Overview Preferences

The RBI Overview Preference settings for Risk Based Inspection contains the following settings:

- **Hide RBI Risk Matrix:** This setting determines the visibility of the RBI RiskMatrix on RBI 580 Analyses.
- **RBI Analysis Type Preference:** This setting determines the preferred RBI Analysis methodology. This preference is used to filter analyses displayed in the RBI Asset Overview, RBI Corrosion Loop Overview, the Evergreening workspace and the Export workspace.
- **RBI Overview Graph Preference:** This allows you to specify which type of analyses to be used to plot risk values on the graphs that appear in the Component Overview section in RBI.

You can select one of the following values in the drop-down list box:

- **RBI 580:** If you select this value, the risk values of only RBI Criticality Analyses, RBI PRD Criticality Analyses, and RBI Pipeline Analyses are plotted.
- **RBI 581:** If you select this value, the risk values of only RBI 581 Risk Analyses are plotted.
- **580 and 581:** If you select this value, the risk values of all types of analyses in RBI are plotted.
- **RBI Overview Table Preference:** This setting allows you to add or remove the columns displayed in the Component Overview page. This section contains two tables:
 - **RBI 580 Selected Columns:** Displays the RBI 580 columns that are selected to display. You can select any field available in the RBI Criticality Analysis family. By default, the Driving Inspection Priority (Unmitigated Risk) and Risk Category columns are selected.

Note: You can see this table only if you have an active Risk Based Inspection license.

- **RBI 581 Selected Columns:** Displays the RBI 581 columns that are selected to display. You can select any field available in the RBI 581 Risk Analysis family. By default, the Total SHE Risk -RBI Date column is selected.

Note: You can see this table only if you have an active RBI 581 license.

Configure RBI Overview Preferences



About This Task

The RBI Overview Preferences allow you to configure the RBI graphs and table preferences in the Asset Overview, Component Overview, Corrosion Loop Overview, and Process Unit Overview sections.

Procedure

1. Access the [Global Preferences workspace](#).
2. Select **RBI Overview Preferences**.
The **RBI Overview Preferences** workspace appears.
3. Select .
All the fields in the section are enabled.
4. As needed, modify values in the following fields:

Option	Description
Hide RBI 580 Risk Matrix	This setting determines the visibility of the RBI Risk Matrix on RBI 580 Analyses.
RBI Analysis Type Preference	This setting determines the preferred RBI Analysis methodology. This preference is used to filter analyses displayed in the RBI Asset Overview, RBI Corrosion Loop Overview, the Evergreening workspace, and the Export workspace.
RBI Overview Graph Preference	<p>This setting allows you to specify which types of analyses should be used to plot risk values on the graph that appears in the Component Overview sections in RBI. You can select one of the following values:</p> <ul style="list-style-type: none">• RBI 580: If you select this value, the risk values of only RBI Criticality Analyses, RBI PRD Criticality Analyses, and RBI Pipeline Analyses are plotted.• RBI 581: If you select this value, the risk values of only RBI 581 Risk Analyses are plotted.• 580 and 581: If you select this value, the risk values of all types of analyses in RBI are plotted.• None: If you select this value, no graph is displayed.
RBI Overview Table Preference	<p>This setting allows you to add or remove the columns displayed in the Component Overview page. This section contains two tables:</p> <ul style="list-style-type: none">• RBI 580 Selected Columns: Displays the RBI 580 columns that are selected to display. You can select any field available in the RBI Criticality Analysis family. By default, the Driving Inspection Priority (Unmitigated Risk) and Risk Category columns are selected. Note: You can see this table only if you have an active Risk Based Inspection license.• RBI 581 Selected Columns: Displays the RBI 581 columns that are selected to display. You can select any field available in the RBI 581 Risk Analysis family. By default, the Total SHE Risk - RBI Date column is selected. Note: You can see this table only if you have an active RBI 581 license.

5. To add a column in the overview pages
 - a) Select  in the table for the family where you want to add the column.
The list of all the available fields within the family appear.
 - b) Select the column that you want to add.
The column is added to the list.
6. To remove a column from the overview pages
 - a) Next to the column name, select .
The column is removed from the list.

7. Select .
The RBI Overview Preferences are updated.

About Configuring Multiple Degradation Mechanisms (DMs) for a Single RBI Criticality Analysis

The baseline RBI workflow uses one driving Internal Corrosion and one driving External Corrosion DM per RBI Criticality Analysis. The driving DM that is used for an RBI Criticality Analysis has the highest corrosion rate.

Your organization, however, may choose to rename Internal Corrosion and External Corrosion DMs or to add multiple Internal Corrosion DMs for a single RBI Criticality Analysis.

Prior to using multiple Internal Corrosion DMs or a configured External Corrosion DM, you must complete the following steps:

1. Add the configured DMs to the Degradation Mechanism Types System Code Table.
2. [Set up PDMs for configured DMs.](#)
3. [Set up Risk Mapping for configured DMs.](#)
4. [Set up RBI Strategy Mapping for configured DMs.](#)
5. [Update the Non-Intrusive Requirement Met query.](#)

Expected Recommendation Behavior

When you use configured External Corrosion and/or multiple Internal Corrosion DMs for a single RBI Criticality Analysis, the expected behavior for some of the fields differs from that of an analysis driven by a baseline DMs. The following baseline field behaviors are affected by the use of configured DMs:

Recommended Interval Value for Recommendations

- For a Recommendation generated for an Internal Corrosion DM, the Recommended Interval value is mapped from the corresponding Internal Corrosion DME.
- For a Recommendation generated for an External Corrosion DM, the Recommended Interval value is:
 - Mapped from the corresponding External Corrosion DME when Appendix F is used to generate the Recommendation.
 - Mapped from the most conservative Half-Life from all Internal Corrosion DMEs linked to the Analysis when Appendices H or I are used to generate the recommendation.
- For a Recommendation generated for a Cracking DM, the Recommended Interval is mapped from the most conservative Half-Life from all Internal Corrosion DMEs linked to the Analysis.

Half-Life Input to Policies (Appendices G, H, and I) in Strategy Mapping

- For a Recommendation generated for an Internal Corrosion DM, the Half-Life policy input value is mapped from the corresponding Internal Corrosion DME.
- For a Recommendation generated for a Cracking or External DM, the Half-Life policy input value is mapped from the most conservative Half-Life from all Internal Corrosion DMEs linked to the Analysis.

Action Interval

When you select the Consider the Half-Life when Determining Inspection Task Interval field on the **RBI Global Preferences** workspace, the interval for the action associated with an Internal DM is set to the Half Life of the correspond Internal Corrosion DME unless the Recommendation Interval is less than the Half-Life value.

Enable Inspection Grouping

Procedure

1. Access the [Global Preferences](#) workspace.
2. Select .

The boxes and check boxes in the **Global Preferences** workspace are enabled.  is replaced with .

3. Select the **Enable Inspection Grouping** check box.
 4. Select .
- The setting is saved, along with any other changes that you have made to the preferences in the **Global Preferences** workspace.

Access RBI 580 Flexible Calculation Preferences

Procedure

1. [Access the Global Preferences Workspace](#) on page 266.
2. Select RBI 580 Flexible Calculation Preferences.
The RBI 580 Flexible Calculation Preferences section appears.
3. As part of the flexible calculation preference, you can do the following tasks:
 - Create or update Flexible Calculation Configurations
 - Create or update Flexible Calculation Validations
 - Create or update Flexible Calculation Output Preferences

Create a Flexible Calculation Configuration

You can create a custom calculation configuration to override the baseline RBI 580 calculation.

Before You Begin

Make sure that a policy is created for the custom calculation.

Procedure

1. [Access RBI 580 Flexible Calculation Preferences](#) on page 271.
2. In the Flexible Calculation Configuration section, select .
3. In the **Master** section:
 - a) In the **Analysis Family** box, select the analysis type that you want to customize.
Note: Currently, GE Digital APM supports customization of only RBI Criticality Analysis.
 - b) In the **Action** box, select the action that you want to perform as part of the customization. The supported actions are:

- Degradation Mechanism Evaluation Calculation
- Consequence Evaluation Calculation
- Degradation Mechanism Roll-Up
- Analysis Roll-Up

Based on the selection, the **Action Family** box is populated with possible family names.

- In the **Action Family** box, select the family that you want to customize.
- In the **Policy Name** box, select the policy that must be used for the calculation.
The Policy Link field is updated with the link to the policy.
- Optional:** Select the link in the **Policy Link** box.
The policy is displayed in the **Policy Designer** workspace.
- In the **Sequence** box, enter the order in which the policy must be executed.

Note: Sequence is grouped by Action and Action Family. If there is only one policy for each Action and Action Family combination, enter 1.

- Select the **Detail** tab.
The **Detail** section of the Flexible Calculation Configuration datasheet appears.
- Enter the following information:
 - In the **Input Entity Family** box, select the family of the Input Entity that you want to include in the custom policy.
 - In the **Policy Node Name** box, enter the name of the Entity node in the policy to which you want the input entity mapped.
- Select .
 - The flexible calculation configuration record is created.
 - The new configuration record appears in the **Flexible Calculation Configuration** section.
 - The Manage Configuration Details link appears, which allows you to modify the record.

Create a Flexible Calculation Validation

You can create a custom validation configuration to override the baseline validation performed before the RBI Criticality Analysis calculation.

Before You Begin

Make sure that a policy is created for the configured validation.

Procedure

- [Access RBI 580 Flexible Calculation Preferences](#) on page 271 workspace.
- Select the **Flexible Calculation Validation** tab.
The **Flexible Calculation Validation** section appears.
- Select .
A new Flexible Calculation Validation datasheet appears, displaying the **Master** section.
- Enter the following information:
 - In the **Analysis Family** box, select the analysis type that you want to customize.
 - In the **Action** box, select one of the following actions that you want to perform:
 - Degradation Mechanism Evaluation Validation
 - Consequence Evaluation Validation
 - Analysis Validation



- Based on the selection, **Action Family** box is populated with possible family names.
- c) In the **Action Family** box, select the family that you want to customize.
 - d) In the **Policy Name** box, select the policy that you want to use for validation.
 - e) **Optional:** Select the link in the **Policy Link** box.
The policy is displayed in the **Policy Designer** workspace.
 - f) In the **Sequence** box, enter the order in which the policy must be executed.
Note: Sequence is grouped by Action and Action Family. If there is only one policy for each Action and Action Family combination, enter 1.
5. Select the **Detail** tab.
The **Detail** section of the Flexible Calculation Validation datasheet appears.
 6. Enter the following information:
 - In the **Input Entity Family** box, select the family of the Input Entity that you want to put in the custom DME validation policy.
 - In the **Policy Node Name** box, enter the name of the Entity node in the validation policy to which you want the input entity mapped.
 7. Select .
 - The flexible calculation validation record is created.
 - The new configuration record appears in the **Flexible Calculation Validation** section.
 - The Manage Validation Details link appears, allowing you to modify the record.

Create a Flexible Calculation Output Preference

About This Task

You can configure the output fields for a family. When the parent RBI Analysis is copied, the specified output field values are not copied to new records and are reset when the analysis is calculated.

Procedure

1. [Access RBI 580 Flexible Calculation Preferences](#) on page 271.
2. Select the **Flexible Calculation Output Preferences** tab.
The **RBI 580 Flexible Calculation Preferences** section appears.
3. Select .
The **Flexible Calculation Family Selection** window appears.
4. In the **Select a Configured Family** box, select the flexible calculation family ID to which you want to add the output preference, and then select **Done**.
A new output preference is created, and a list of all available fields in the family appears in the Flexible Calculation Output Preferences section.
5. In the table, in the Output Field column, for each field that should not be copied when the parent RBI Analysis is copied, select the check box.
6. In the upper-right corner of the section, select .
The Flexible Calculation Output Preferences are saved.

Note: After you create a Flexible Calculation Output Preference, it is available in the **Select Preference** drop-down list box.

Update the Non-Intrusive Requirement Met Query

About This Task

If you are planning to use a single configured Degradation Mechanism (DM), multiple DMs, or an Internal Corrosion DME, you must update both the Valid Inspections for Non-Intrusive Requirement Met query and the Invalid Inspections for Non-Intrusive Requirement Met query in order for the Non-Intrusive Requirement Met check box to be enabled on the Internal Corrosion DME.

Procedure

1. Access the **Query** page.
2. In the upper-right corner of the page, select **Browse**.
The **Select a query from the catalog** window appears.
3. In the left pane, navigate to the following folder: `Public/Meridium/Modules/Risk Based Inspection/Queries`
4. Select the **Invalid Inspections for Non-Intrusive Requirement Met** query, and then select **Open**.
The **Enter Parameter Values** window appears.
5. Select **Cancel**.
The **Results** section appears.
6. Select the **SQL** tab.
The SQL Query for the Invalid Inspections for Non-Intrusive Requirement Met appears.
7. In the query text:
 - Find and replace all instances of `<>` with the text: `NOT IN`.
 - Find and replace all instances of `=` with the text: `IN`.
 - Find all instances of `= 'Criticality Calculator Internal Corrosion'` and add a list of your configured internal corrosion DMs to the clause (for example, `IN ('Criticality Calculator Internal Corrosion', 'Custom Internal', 'Custom External')`).
8. Select , and close the page.
The **Query** page appears.
9. Select **Browse**.
The **Select a query from the catalog** window appears.
10. In the pane, navigate to the following: `Public/Meridium/Modules/Risk Based Inspection/Queries`, then select the **Invalid Inspections for Non-Intrusive Requirement Met** query, and then select **Open**.
The **Enter Parameter Values** window appears.
11. Repeat steps 4-7.
The Non-Intrusive Requirement Met Query is updated.

Use the Upgrade APM Version 3 Active Analyses Utility

Using the Upgrade APM Version 3 Active Analyses Utility, you can create Risk Assessment records for existing RBI 580 and RBI 581 analyses that are in [active state](#) and do not have existing Risk Assessment records. Also, for RBI 580 active analyses, the utility will calculate and set Half-Life for any related Ext. Corr. Deg. Mech Evaluations where the value is blank

Before You Begin

- You must be an administrator to perform the following steps.
- If you are using a custom Risk Matrix, you must configure your Risk Matrix mappings.

Procedure

1. In the **Applications** menu, navigate to **ADMIN > Application Settings > Risk Based Inspection**.
2. In the **Global Preferences** workspace, select **Upgrade Analyses**.
The **Upgrade Analyses Confirmation** window appears, asking you to confirm that you want to create Risk Assessment records for all RBI 580 and RBI 581 active analyses.
3. Select **Yes**.
The **Upgrade Analyses** window appears, stating the job was successfully scheduled.
4. Optional: Select **View Scheduling**.
The **Schedule Logs** page appears, displaying a list of all the operations in GE Digital APM that are in progress, along with the percentages of completion. You can also access a list of operations that have been successful or have failed.

Configure the Asset Info Summary





About This Task

The **Asset Info Configuration** workspace under **RBI Admin Preferences** page allows you to configure the fields and values displayed on the Asset info summary under the RBI **Asset View** page.

Procedure

1. Access the **Global Preferences** workspace.
2. Select the **Asset Info Configuration** tab.
The **Asset Info Configuration** workspace appears.
3. Select .
All the fields and queries in the section are enabled.
4. As needed, modify values in the following fields.

Option	Description
FIELD	<p>This allows you to select the field you want to display in the Asset info summary. The drop-down list box shows the fields from the ASSET_INFO_CONFIGURATION System Code Table.</p> <p>Note:</p> <ul style="list-style-type: none"> • The field you select must be unique. • To configure a new field, you must add the field in the ASSET_INFO_CONFIGURATION System Code Table.
QUERY	<p>This allows you to select the query from the catalog that must be executed, and the result is displayed in the Asset info summary.</p> <p>Note:</p> <ul style="list-style-type: none"> • The value displayed in the Asset info summary will be the first value in the first cell that returned from the selected query. • Choosing a query which is marked as formatted will execute format value rules. • Fields which contain units of measures, will display the unit of measure along with the associated value.

5. To add a new field to the **Asset Info Configuration** workspace:
 - a) Select **Add Field**.
A new FIELD and QUERY row is created.
 - b) From the **FIELD** drop-down list box, select the field you want to add.
 - c) Select  to add a query from the catalog.
 - d) Select .
The Asset Info Configurations are saved.
6. To remove a field and query row from the **Asset Info Configuration** workspace:
 - a) Select  next to the field and query row that you want to remove.
The field and query row is removed.
 - b) Select .
The Asset Info Configurations are saved.

Chapter 19

Data Loaders

Topics:

- [RBI 580 Data Loader](#)
- [Corrosion Loop](#)
- [RBI Components to TML Groups Relationship Data Loader](#)

RBI 580 Data Loader

About RBI Data Loaders

GE Digital APM, through the Risk Based Inspection module, provides the functionality to carry out an RBI Analysis on various types of RBI components to calculate corrosion rate, and the probability and consequence of failure, and then develop intelligent strategies. Using the RBI Data Loaders, you can generate all components for a Process Unit along with the associated analyses.

About the Risk Based Inspection (RBI) 580 Data Loader

Using the Risk Based Inspection (RBI) 580 Data Loader, you can implement Risk Based Inspection when you have RBI data in a legacy system, which is not supported by GE Digital APM. To import data using the Risk Based Inspection (RBI) 580 Data Loader, GE Digital APM provides an Excel template, `RBI_580_Data Loader.xlsx`, which supports baseline Risk Based Inspection GE Digital APM. You must export your legacy system so that the data can be used to populate the template. The data from the template will then be imported into GE Digital APM using the Risk Based Inspection (RBI) 580 Data Loader.

Note: The Excel template is referred to throughout this documentation as the data loader workbook.

The data loader workbook can be used in the following scenarios:

- Create or update components
- Create or update analyses
- Loading components and risk analysis data into GE Digital APM so that you can retain visibility into the analysis details and calculations, and generate recommendations.
- Calculate risk, probability, and consequence of failure, and then utilize the Inspection Planning feature to mitigate the risk by the plan date.

After importing the data, the Risk Based Inspection (RBI) 580 Data Loader creates the following records in GE Digital APM:

- Criticality Calculator RBI Component
- RBI Criticality Analysis
- Criticality Consequence Evaluation
- Criticality Env. Crack. Deg. Mech. Eval.
- Criticality Ext. Corr. Deg. Mech. Eval.
- Criticality Int. Corr. Deg. Mech. Eval.
- Criticality Other Damage Mech. Eval.
- Criticality Custom DME
- RBI Degradation Mechanisms

The data on the (Picklist) worksheet is not loaded when you load data using the Risk Based Inspection (RBI) 580 Data Loader.

Note: This data loader workbook is not backward compatible to earlier versions of GE Digital APM.

About the Risk Based Inspection (RBI) 580 Data Loader Requirements

Before you use the Risk Based Inspection (RBI) 580 Data Loader, you must complete the following steps:

- Ensure that the Risk Based Inspection module is deployed.
- Ensure that the Potential Degradation Mechanism library is configured correctly for custom Degradation Mechanisms.

- Baseline records will be available; however, custom records should be created prior to loading data.
- Ensure that the following data is present:
 - Site Reference
 - Equipment Taxonomy
 - Equipment and Functional Location Families
 - Process Units (i.e., Functional Location records in which the **Is Unit?** check box is selected)
 - RBI Data Mapping
 - Units of Measure Conversion Sets
 - Stress Tables (GE Digital APM provides Stress Tables for Pressure Vessels and Tanks. If you want to use values from these Stress Tables with the data load, you must ensure that the records are imported into your database prior to performing the data load. GE Digital APM does not provide Piping Stress Tables).
Representative Fluids
- If you have added custom fields to Risk Mapping families (e.g., RBI Risk Matrix Mapping, Risk Analysis Mapping), you must ensure that mappings exist for those fields, or data may not be populated as expected after the data load. This is because the Risk Based Inspection (RBI) 580 Data Loader relies on Risk Mapping families to ensure that fields on RBI Criticality Analysis and related records are correctly populated with data, and that resulting risk values can be mapped to the Default Risk Matrix. If you have added custom fields, you must ensure that mappings exist for those fields, or data may not be populated as expected following the data load.
- The Security User performing the data load operation must be associated with either the MI Data Loader User or MI Data Loader Admin Security Role, and must also be associated with the MI RBI Analyst Security Group or a Security Role that is associated with this Security Group.
- The data loader workbook contains sample data in each column. It is only for your reference. You must remove this data before using the data loader workbook.

About the Risk Based Inspection (RBI) 580 Data Loader Data Model

This topic has been intentionally excluded from the GE Digital APM product documentation website. This topic is available to you via the product documentation that is provided within the GE Digital APM system.

About the Risk Based Inspection (RBI) 580 Data Loader General Loading Strategy

The imported data must load in a specific sequence in order to successfully populate fields, to create records, and to link them to the predecessor and successor records.

Best Practices

When importing data using the Risk Based Inspection (RBI) 580 Data Loader, you must use the following best practices:

- ID fields must not include special characters or spaces.
- For Oracle databases, valid cell values are case-sensitive.
- Columns (including columns representing custom fields) in the worksheets should be formatted as Text.
- Import a maximum of 500 assets in each data load. The maximum number of records that you can load per asset using the data loader is specified in the [Best Practices for Loading a Single Asset](#) on page 282 topic.
- Do not try to create and update a component in the same data loader workbook.
- Ensure that you enter values in cells that correspond to [fields required to calculate an analysis](#). Otherwise, warnings will be issued in the log for the analysis and related records with invalid data.

- When a field whose value is required based on the value in another field is blank, a warning is logged in the log file for the import job.
- You must consider the rules described in the [Workbook Layout and Use](#) section of this document while using the Risk Based Inspection (RBI) 580 Data Loader.
- If you have entered data related to an analysis or a DME, then you must always enter data of the associated component in the RBI_Component worksheet, even if the corresponding Criticality Calculator RBI Component record exists in the GE Digital APM database.
- When you use the data loader to create an analysis and a cell that requires a Boolean value is blank, the corresponding field in GE Digital APM is updated with the value False. When you use the data loader to update an analysis and a cell that requires a Boolean value is blank, the corresponding field in GE Digital APM is not updated. Therefore, to avoid ambiguity, we recommend that you enter the value True or False in the cell and not leave it blank.
- If you want to override values that are populated from the associated component, you can include those values in the Risk Based Inspection (RBI) 580 Data Loader. For example, the value for the Operating Temperature field in an RBI Criticality Analysis is populated from the corresponding field in the associated RBI Component. If you want to override this value for the analysis, you must include a column for Operating Temperature in the RBI_Criticality_Analysis worksheet in the data loader workbook, and enter the value in that cell.
- In addition to the fields included in the Risk Based Inspection (RBI) 580 Data Loader, if you want to add values for more fields for a record, you can add columns for those fields in the appropriate worksheet.

Note: The fields that you want to add to the data loader workbook must already exist in the corresponding family. If not, you must add the fields to the family via Configuration Manager.

- You should not add columns that correspond to fields in the **Outputs** and **Intermediate Outputs** sections of a datasheet; Otherwise, the calculations might not be correct.
- You should not add a column that corresponds to the Use Combined Confidence field to any of the following worksheets:
 - DME_Environmental_Cracking
 - DME_External_Corrosion
 - DME_Internal_Corrosion

The Use Combined Confidence field is part of the integration of the Risk Based Inspection and Inspection Management modules. A value should only be set in the GE Digital APM application.

- If you want to add a column to the Criticality RBI Component worksheets that corresponds to the Source of Calculated Corrosion Rate field, you must consider the following:
 - Every row (i.e., every component) on the Criticality RBI Component worksheets will require a value in the Source of Calculated Corrosion Rate column.
 - In the baseline GE Digital APM system, this cell may only contain one of the following System Code IDs:
 - ASSET
 - COMPONENT
 - MANUAL

The list in this field is populated by the MI_RBI_CALC_CORRO_SRC System Code Table. If the System Code Table has been customized, the valid values could be different. To verify which options are acceptable in your GE Digital APM system, via Configuration Manager, reference the appropriate table.

- If you want to set the Source of Calculated Corrosion Rate for a Criticality RBI Component to Component (COMPONENT), that component must be linked to a TML Group. Thickness Monitoring data should be available, and an existing, calculated Corrosion Analysis should exist in Thickness Monitoring so that the Long Term Avg. Corr. Rate and Short Term Avg. Corr. Rate fields can be correctly populated on RBI Criticality Analyses for the component.

- Because the component must already be linked to a TML Group, you should not specify Component as the setting during Insert operations. You should specify Component only for Update operations.
- If you want to set the Source of Calculated Corrosion Rate for a Criticality RBI Component to Asset (ASSET), the corresponding Asset record must already have Thickness Monitoring data available, and an existing, calculated Corrosion Analysis should exist in Thickness Monitoring so that the Long Term Avg. Corr. Rate and Short Term Avg. Corr. Rate fields can be correctly populated on RBI Criticality Analyses for the component.
 - If you want to specify values for the Long Term Avg. Corr. Rate and Short Term Avg. Corr. Rate fields, set the Source of Calculated Corrosion Rate for a Criticality RBI Component to Manual Entry (MANUAL).

By default, the value in the Source of Calculated Corrosion Rate field is Manual. Unless you want to specify one of the other valid values, you do not need to add a Source of Calculated Corrosion Rate column to the Criticality RBI Component worksheets.

Load Sequence

The data is loaded in the following sequence in order to create all necessary relationships between records:

1. The Assets worksheet is processed. The Data Loader searches for the asset that corresponds to the Asset ID, Asset CMMS System, Equipment Technical Number (only for an Equipment asset) and Asset Family information that you provide in the Assets worksheet.
If an asset specified on the worksheet does not exist, it will be skipped, as well as all entries in the subsequent worksheets corresponding to that asset.
2. The RBI_Component worksheet is processed. The Data Loader searches for the RBI Component based on the asset data and the values in the Component and Component Type cells.
If a component exists, it will be updated. If not, a new component will be created and linked to the corresponding asset.
3. The RBI_Criticality_Analysis worksheet is processed. For each row based on the cells specified in steps 1 and 2, a new analysis is created and linked to that component. You cannot update an analysis using the data loader workbook. The value in the Analysis Unique ID cell is not stored but will be used to identify corresponding Degradation Mechanism Evaluations and Consequence Evaluations specified on the subsequent worksheets that should be linked to the analysis.
If there is invalid data for calculating an analysis, the analysis will still be loaded, but warnings will be issued in the log for all fields with incorrect values.
4. The Consequence_Evaluation worksheet is processed. For each row based on the cells specified in steps 1 to 3, a Consequence Evaluation is created and linked to the specified analysis.
5. The worksheets representing Degradation Mechanism Evaluations are processed. For each row based on the cells specified in steps 1 to 3, a Degradation Mechanism Evaluation is created and linked to the specified analysis. Additionally, for each Damage Mechanism specified and linked to the analysis, a corresponding Potential Degradation Mechanism is created and linked to the component, unless a Potential Degradation Mechanism of the same type is already linked.

When the Degradation Mechanism Evaluations are processed, if you have not included a Degradation Mechanism in the worksheet that corresponds to an existing Potential Degradation Mechanism on the component, that Potential Degradation Mechanism will be unlinked.

Data that you specify in the cells on each worksheet will be included in the new records. Additionally, fields in the records will be populated with data based on your RBI Data Mapping. For example, an RBI Criticality Analysis record will be populated with data from the Criticality RBI Component record to which it is linked as expected when normally using Risk Based Inspection in GE Digital APM.

Best Practices for Loading a Single Asset

For optimal performance, we recommend that you load a maximum of 65 Components with three DMEs each or 85 Components with two DMEs each. To avoid performance degradation of the data loader, you must maintain the total number of records within this limit. If you want to load more number of DMEs, you must reduce the maximum number of components.

The following tables provide illustrations of the maximum number of records that you can load per Component or Analysis, as applicable. It also provides the maximum total number of records that you can load per Asset.

Important: The numbers shown in the table are for reference purpose only, and not the maximum number of records that the data loader is designed to load. These numbers are derived based on the test results obtained from the laboratory machines. However, the performance of the data loader may vary based on the database server configuration, application server configuration, load on the servers, network speed, and other performance factors. If you find a degradation in the data loader performance, we recommend that you reduce the number of records in a single batch and upload the records in multiple batches.

Record Name	An example of the maximum number of records you can load per Asset/Component/Analysis	An example of the total number of records you can load per Asset
RBI Component	65 per Asset	65
RBI Criticality Analysis	1 per Component	65
RBI Consequence Evaluation	1 per Analysis	65
Internal DME	1 per Analysis	65
External DME	1 per Analysis	65
Environmental DME	1 per Analysis	65
Total number of records		390

About the Risk Based Inspection (RBI) 580 Data Loader Workbook Layout and Use

To import data using the Risk Based Inspection (RBI) 580 Data Loader, GE Digital APM provides an Excel workbook, *Risk Based Inspection (RBI) 580.xlsx*, which supports baseline Risk Based Inspection in GE Digital APM. This workbook must be used to perform the data load. You can modify the Excel workbook to include custom fields used by your organization.

Note: The Excel workbook is referred to throughout this documentation as the data loader workbook.

Worksheet	Description
Assets	This worksheet is used to specify existing Asset records to which components will be linked.
RBI_Components	This worksheet is used to specify the following types of RBI Component records that will be updated or created and linked to assets. <ul style="list-style-type: none"> • Cylindrical Shell • Exchanger Bundle • Exchanger Tube • Piping • Pump Compressor Casing • Tank Bottom
RBI_Criticality_Analysis	This worksheet is used to define RBI Criticality Analysis records that will be linked to components.
Consequence_Evaluation	This worksheet is used to define Consequence Evaluation records that will be linked to analyses.
DME_Environmental_Cracking	This worksheet is used to define Criticality Env. Crack. Deg. Mech. Eval. records and Degradation Mechanisms that will be linked to analyses.
DME_External_Corrosion	This worksheet is used to define Criticality Ext. Corr. Deg. Mech. Eval. records and Degradation Mechanisms that will be linked to analyses.
DME_Internal_Corrosion	This worksheet is used to define Criticality Int. Corr. Deg. Mech. Eval. records and Degradation Mechanisms that will be linked to analyses.
DME_Other	This worksheet is used to define Criticality Other Damage Mech. Eval. records and Degradation Mechanisms that will be linked to analyses.
DME_Custom	This worksheet is used to define custom Criticality Other Damage Mech. Eval. records and Degradation Mechanisms that will be linked to analyses.
Degradation_Mechanism	This worksheet is used to define or update Damage Mechanisms that are or will be linked to the specified analyses.
(PickList)	This worksheet details the valid values available for fields that have pick lists. The field values listed in the (PickList) worksheet have been detailed in the corresponding worksheet. When you load data using the data loader, the data on this worksheet is <i>not</i> loaded.

Color Coding

Certain columns on the worksheets have different functions and requirements. To illustrate this, certain columns are color-coded. The following table lists the colors and what they represent.

Color	Description	Comments
Grey	Lookup Fields	Indicates columns that contain values that are used by the Risk Based Inspection (RBI) 580 Data Loader to look up and create records. If these columns are removed from the worksheets, the data load will fail. While the worksheets require that these columns be present, values are not necessarily required in these columns.
Red	Fields Required for Calculation	Indicates columns that contain values that are required to perform calculations in Risk Based Inspection. Some cells only require values in certain cases. Such cases are found in parentheses in the first row of each worksheet.
Blue	Recommended Fields	Indicates columns that, according to GE Digital APM Best Practice for Risk Based Inspection, should contain values.
Green	Custom Fields	Indicates columns where you can specify custom fields.

Limitations

The Risk Based Inspection (RBI) 580 Data Loader has the following limitations:

- You must use the data loader workbook. If you modify the format of the values in columns in any of the worksheets, you will not be able to import data.
- The values that you enter in the data loader workbook are case-sensitive.
- If you reimport data, the records that have been created by the Risk Based Inspection (RBI) 580 Data Loader will be updated. While reimporting data, if you remove the data for a field in the data loader workbook, the value for the corresponding field in GE Digital APM will not be updated.
- When you use the data loader to create an RBI Analysis, if the value provided for the field on the Analysis, Consequence, or Degradation Mechanism Evaluation sheets is empty, the field will be skipped and the default value or the value mapped from the RBI Component will remain.
- When you use the data loader to update an RBI Component or RBI Analysis and the associated Consequence Evaluation, Damage Mechanisms, and Damage Mechanism Evaluations:
 - If a cell contains data, the value in the corresponding field will be updated in the database.
 - If a cell is blank, the value in the corresponding field will not be updated with a blank value in the database. The value that previously existed in the field is retained.
- You cannot delete the Consequence Evaluation and the Degradation Mechanism Evaluations associated with an RBI Analysis using the data loader.
- You can set the **Event Type** column to **W** and update an existing What-If Analysis using the data loader; however, you cannot create a new What-If Analysis. If there are more than one What-If Analyses linked to a component, you must enter a unique value in the **Sub ID** column.

Assets Worksheet

On the Assets worksheet, you will specify assets to which you want to link components. The columns that appear on this worksheet also appear on every subsequent worksheet, and are used to identify the records that will be linked, directly or indirectly, to the assets.

Note: Each row in this worksheet represents a unique asset. You should not include the same asset more than once.

Field Caption	Field ID	Data Type (Length)	Comments
Asset ID	MI_EQUIP000_EQUIP_ID_C	Character (255)	This column requires at least one cell to have a value. For a Functional Location Asset the field MI_FNCLOC00_FNC_LOC_C must be used.
Asset CMMS System	MI_EQUIP000_SAP_SYSTEM_C	Character (255)	If the Equipment record for an asset has a value in the CMMS System field, that value is required in this cell. For a Functional Location asset the field MI_FNCLOC00_SAP_SYSTEM_C must be used.
Equipment Technical Number	MI_EQUIP000_EQUIP_TECH_N BR_C	Character (255)	If you are required to enter a value for the CMMS System cell for an equipment asset, and the Equipment has a value in the Equipment Technical Number field, that value is required in this cell. If there is no value in the CMMS System field, this cell can be blank, even if the Equipment record contains a value for the Equipment Technical Number field. Note: This field must be left blank for a Functional Location asset.

RBI_Components Worksheet

On the RBI Components worksheet, you will specify the Criticality RBI Component records that you want to create or update.

Note: Each row represents a unique component, though multiple components may be related to the same asset.

Field Caption	Field ID	Data Type (Length)	Comments
Asset ID	MI_EQUIP000_EQUIP_ID_C	Character (255)	Values in this column must match values entered on the Assets worksheet. Multiple components can be linked to the same asset (i.e., rows may have the same value in this column).
Asset CMMS System	MI_EQUIP000_SAP_SYSTEM_C	Character (255)	Values in this column must match values entered on the Assets worksheet, if they exist. Multiple components can be linked to the same asset (i.e., rows may have the same value in this column).
Equipment Technical Number	MI_EQUIP000_EQUIP_TECH_N BR_C	Character (255)	Values in this column must match values entered on the Assets worksheet, if they exist. Multiple components can be linked to the same asset (i.e., rows may have the same value in this column).
Component	MI_RBICOMPO_COMPO_C	Character (250)	A value is required.

Field Caption	Field ID	Data Type (Length)	Comments
Component Type	MI_RBICOMPO_COMPO_TYPE_ C	Character (60)	<p>A value is required.</p> <p>In the baseline GE Digital APM system, this cell may only contain one of the following values:</p> <ul style="list-style-type: none"> • 1" Pipe • 1.25" Pipe • 1.5" Pipe • 1/2" Pipe • 10" Pipe • 102" Pipe • 12" Pipe • 14" Pipe • 16" Pipe • 18" Pipe • 2" Pipe • 2.5" Pipe • 20" Pipe • 24" Pipe • 26" Pipe • 28" Pipe • 3" Pipe • 3/4" Pipe • 30" Pipe • 32" Pipe • 34" Pipe • 36" Pipe • 4" Pipe • 40" Pipe • 42" Pipe • 48" Pipe • 5" Pipe • 54" Pipe • 56" Pipe • 6" Pipe • 60" Pipe • 8" Pipe • 90" Pipe • Air Cooled Exchanger-Header • Air Cooled Exchanger-Tbs • Balanced Bellows PRD • Column-Bottom • Column-Middle • Column-Top • Compressor • Filter • Fin/Fan Cooler • Heat Exchanger-Bundle • Heat Exchanger-Channel • Heat Exchanger-Shell • Pressure Vessel

Field Caption	Field ID	Data Type (Length)	Comments
Component Family	FAMILY_ID		<p>In the baseline GE Digital APM system, this cell may only contain one of the following values:</p> <ul style="list-style-type: none"> • Criticality RBI Component - Cylindrical Shell • Criticality RBI Component - Exchanger Bundle • Criticality RBI Component - Exchanger Header • Criticality RBI Component - Exchanger Tube • Criticality RBI Component - Piping • Criticality RBI Component - Tank Bottom
Component Description	MI_RBICOMPO_COMPO_DESC R_C	Character (255)	A value is required if the value in the Toxic Mixture cell is True.
Component Date in Service	MI_RBICOMPO_COMP_STRT_D ATE_DT	Date	A value is required if a Criticality Ext. Corr. Deg. Mech. Eval., Criticality Int. Corr. Deg. Mech. Eval., or Criticality Env. Crack. Deg. Mech. Eval. record will be created for an analysis linked to this component.
Circuit From	MI_CCRBICPI_CIRCU_FROM_C	Character (250)	None
Circuit To	MI_CCRBICPI_CIRCU_TO_C	Character (250)	None
Component Comments	MI_RBICOMPO_COMPO_COMM E_TX	Text	None

Field Caption	Field ID	Data Type (Length)	Comments
Operating Pressure	MI_RBICOMPO_OPERA_PRESS_N	Numeric	<p>A value is required.</p> <p>The value in this cell is copied to the Operating Pressure field of the associated RBI Analysis. The value in this cell is compared with the value in the Design cell for the analysis to be created.</p> <p>If the value in the Design Pressure cell is greater than or equal to zero, the value in this cell must be less than or equal to the value in the Design Pressure cell.</p> <p>If the value in the Design Pressure cell is less than zero, the analysis is created with any value in this cell.</p>
Operating Pressure - Shell	MI_CCRBICEB_OPER_PRES_SHEL_N	Numeric	A value is required.
Operating Temperature	MI_RBICOMPO_OPERA_TEMPE_N	Numeric	<p>A value is required.</p> <p>The value in this cell is copied to the Operating Temperature field of the associated RBI Analysis. The value in this cell is compared with the value in the Design Temperature cell for the analysis to be created.</p> <p>If the value in the Design Temperature cell is greater than or equal to zero, the value in this cell must be less than or equal to the value in the Design Temperature cell.</p> <p>If the value in the Design Temperature cell is less than zero, the analysis is created with any value in this cell.</p>
Operating Temperature - Shell	MI_CCRBICEB_OP_TEMP_SHEL_N	Numeric	None

Field Caption	Field ID	Data Type (Length)	Comments
Area Humidity	MI_CCRBICOM_AREA_HUMID_C	Character (100)	<p>A value is required if a Criticality Ext. Corr. Deg. Mech. Eval. record will be created for an analysis linked to this component.</p> <p>In the baseline GE Digital APM system, this cell may only contain one of the following values:</p> <ul style="list-style-type: none"> • Low • Medium • High <p>If the family has been customized, the valid values could be different. This cell may only contain a value that exists in the list in the Area Humidity field for Criticality RBI Component records.</p>
Foundation Type	MI_CCRBICTB_FOUND_TYPE_C	Character (50)	<p>A value is required for RBI Storage Tank Bottom Components.</p> <p>This cell may only contain one of the following values:</p> <ul style="list-style-type: none"> • Clay • Silt • Sand • Gravel • Concrete • Double Floor <p>The list in this field is populated by the FOUNDATION TYPES System Code Table. If the system code table has been customized, the valid values could be different. To verify which options are acceptable in your GE Digital APM system, via Configuration Manager, refer to the appropriate table.</p>

Field Caption	Field ID	Data Type (Length)	Comments
Initial Fluid Phase	MI_RBICOMPO_INIT_FLU_PHAS E_C	Character (20)	<p>A value is required for each row.</p> <p>In the baseline GE Digital APM system, this cell may only contain one of the following System Code IDs:</p> <ul style="list-style-type: none"> • Liquid • Gas <p>The list in this field is populated by the FLUID TYPES System Code Table. If the system code table has been customized, the valid values could be different. To verify which options are acceptable in your GE Digital APM system, via Configuration Manager, refer to the appropriate table.</p>
Initial Fluid Phase - Shell Side	MI_CCRBICEB_INI_FD_PHS_SH _SD_C	Character (20)	<p>A value is required for each row.</p> <p>In the baseline GE Digital APM system, this cell may only contain one of the following System Code IDs:</p> <ul style="list-style-type: none"> • Liquid • Gas <p>The list in this field is populated by the FLUID TYPES System Code Table. If the system code table has been customized, the valid values could be different. To verify which options are acceptable in your GE Digital APM system, via Configuration Manager, refer to the appropriate table.</p> <p>This field is only required for Exchanger Bundle RBI Components.</p>

Field Caption	Field ID	Data Type (Length)	Comments
Process Fluid	MI_RBICOMPO_PROCE_FLUID_C	Character (50)	<p>A value is required.</p> <p>In the baseline GE Digital APM system, this cell may only contain one of the following values:</p> <ul style="list-style-type: none"> • 15% H2 • 2-Methoxyethanol • Acetic Acid • Acetic Anhydride • Acetone • Acetonitrile • Acid • ACR (Acrolein) • AIR • ALCL3 • Amine • AN (Acrylonitrile) • Asphalt • Benzine • BF3 • C1 • C10 (Kerosene) • C11 • C12 • C13-16 (Diesel) • C17-25 (Gas Oil) • C2 • C25+ (Resid) • C3 • C4 • C5 • C6 • C7 • C8 (Gasoline) • C9 • Calcium Acetate • Calcium Chloride • Caustic (20%) • CCL4 • Chlorine • CO • CO2 • Crude • DEE • Diesel • DMDS (Di-methyl disulfide) • DMF (Dimethyl Floride) • DMS (Dimethyl Sulfide) • EDA (Ethylenediamine) • EE • FEA

Field Caption	Field ID	Data Type (Length)	Comments
Process Fluid - Shell Side	MI_CCRBICEB_PROC_FD_SH_S D_C	Character (50)	<p>A value is required.</p> <p>In the baseline GE Digital APM system, this cell may only contain one of the following values:</p> <ul style="list-style-type: none"> • 15% H2 • 2-Methoxyethanol • Acetic Acid • Acetic Anhydride • Acetone • Acetonitrile • Acid • ACR (Acrolein) • AIR • ALCL3 • Amine • AN (Acrylonitrile) • Asphalt • Benzine • BF3 • C1 • C10 (Kerosene) • C11 • C12 • C13-16 (Diesel) • C17-25 (Gas Oil) • C2 • C25+ (Resid) • C3 • C4 • C5 • C6 • C7 • C8 (Gasoline) • C9 • Calcium Acetate • Calcium Chloride • Caustic (20%) • CCL4 • Chlorine • CO • CO2 • Crude • DEE • Diesel • DMDS (Di-methyl disulfide) • DMF (Dimethyl Floride) • DMS (Dimethyl Sulfide) • EDA (Ethylenediamine) • EE • FEA

Field Caption	Field ID	Data Type (Length)	Comments
Toxic Mixture	MI_RBICOMPO_TOXIC_MIX_F	Boolean	Enter True or False. A value is required if the value in the Toxic Mixture cell is True.
Toxic Fluid	MI_RBICOMPO_TOXIC_MODEL_C	Character (50)	<p>A value is required if the value in the Toxic Mixture cell is True.</p> <p>In the baseline GE Digital APM system, this cell may only contain one of the following values:</p> <ul style="list-style-type: none"> • ACR (Acrolein) • ALCL3 • AN (Acrylonitrile) • BF3 • Chlorine • CO • EE • EO • H2S • HCHO • HCl • HCN • HF • Hydrazine • Methyl Mercaptan • NH3 • Nitric Acid • NO2 • Perchloromethylmercaptan • Phosgene • Propionitrile • Propylene Oxide • Sulfur Trioxide • TDI • VAM
Percent Toxic	MI_RBICOMPO_PERCE_TOXIC_N	Numeric	A value is required if the value in the Toxic Mixture cell is True.
Toxic Mixture - Shell Side	MI_CCRBICEB_TOX_MX_SH_SD_C	Boolean	Enter True or False. A value is required if the value in the Toxic Mixture - Shell cell is True.

Field Caption	Field ID	Data Type (Length)	Comments
Toxic Fluid - Shell Side	MI_CCRBICEB_TOX_FLD_SH_SD_C	Character (50)	<p>A value is required if the value in the Toxic Mixture - Shell Side cell is True.</p> <p>In the baseline GE Digital APM system, this cell may only contain one of the following values:</p> <ul style="list-style-type: none"> • ACR (Acrolein) • ALCL3 • AN (Acrylonitrile) • BF3 • Chlorine • CO • EE • EO • H2S • HCHO • HCl • HCN • HF • Hydrazine • Methyl Mercaptan • NH3 • Nitric Acid • NO2 • Perchloromethylmercaptan • Phosgene • Propionitrile • Propylene Oxide • Sulfur Trioxide • TDI • VAM
Percent Toxic - Shell Side	MI_CCRBICEB_PER_TOX_SHELL_SD_N	Numeric	A value is required if the value in the Toxic Mixture - Shell Side cell is True.

Field Caption	Field ID	Data Type (Length)	Comments
Inventory	MI_RBICOMPO_INVEN_N	Numeric	A value is required if: <ul style="list-style-type: none"> The Component Type is Storage Tank. <p>-and-</p> <ul style="list-style-type: none"> The value in the Use Calculated Inventory cell in the corresponding row on the Consequence_Evaluation worksheet is blank or False.
Detection Time	MI_CCRBICOM_DETEC_TIME_N	Numeric	A value is required.
Isolation Time	MI_CCRBICOM_ISOLA_TIME_N	Numeric	A value is required.
Design Pressure	MI_RBICOMPO_DESIG_PRESS_N	Numeric	A value is required for External Damage DMs, AST DMs, or Thinning and Lining DMs. The value in this cell is copied to the Design Pressure field of the associated RBI Analysis. The value in this cell is compared with the value in the Operating Pressure cell for the analysis to be created. If the value in this cell is greater than or equal to zero, the value in the Operating Pressure cell must be less than or equal to the value in this cell. If the value in this cell is less than zero, the analysis is created with any value in the Operating Pressure cell.
Design Pressure - Shell Side	MI_CCRBICEB_DES_PRES_SHELL_SD_N	Numeric	A value is required for a component of type Exchanger Bundle.

Field Caption	Field ID	Data Type (Length)	Comments
Design Temperature	MI_RBICOMPO_DESIG_TEMPE_N	Numeric	<p>A value is required for External Damage DMs, AST DMs, and Thinning and Lining DMs.</p> <p>The value in this cell is copied to the Design Temperature field of the associated RBI Analysis. The value in this cell is compared with the value in the Operating Temperature cell for the analysis to be created.</p> <p>If the value in this cell is greater than or equal to zero, the value in the Operating Temperature cell must be less than or equal to the value in this field.</p> <p>If the value in this cell is less than zero, the analysis is created with any value in the Operating Temperature cell.</p>
Design Temperature - Shell Side	MI_CCRBICEB_DES_TEMP_SH_SD_N	Numeric	A value is required for a component of type Exchanger Bundle.
Diameter	MI_RBICOMPO_DIAME_INNER_N	Numeric	A value is required if the Component Type is Storage Tank.
Length	MI_RBICOMPO LENGT_N	Numeric	A value is required in order to populate the Calculated Inventory field.
Fill Height	MI_CCRBICTB_FILL_HEIGH_N	Numeric	A value is required if the Component Type is Storage Tank.
Nominal Thickness	MI_RBICOMPO_NOMIN_THICK_N	Numeric	A value is required for External Damage DMs, AST DMs, and Thinning and Lining DMs.

Field Caption	Field ID	Data Type (Length)	Comments
Stress Lookup Table	MI_RBICOMPO_STRESS_TABLE_C	Character (50)	<p>A value is required for External Damage DMs, AST DMs, Thinning and Lining DMs, and Brittle Fracture DMs.</p> <p>This cell may only contain one of the following values:</p> <ul style="list-style-type: none"> • Pressure Vessels • Tanks • Piping <p>If the family has been customized, the valid values could be different. This cell may only contain a value that exists in the list in the Stress Lookup Table field for Criticality RBI Component records.</p>
BM CODE	MI_RBICOMPO_BM_CODE_C	Character (30)	<p>A value is required for External Damage DMs, AST DMs, Thinning and Lining DMs, and Brittle Fracture DMs.</p> <p>Refer to the (Picklist) worksheet in the excel workbook for valid values that you enter in this cell.</p>
BM YEAR	MI_RBICOMPO_BM_YEAR_C	Character (50)	<p>A value is required for External Damage DMs, AST DMs, Thinning and Lining DMs, and Brittle Fracture DMs.</p> <p>Refer to the (Picklist) worksheet in the excel workbook for valid values that you enter in this cell.</p>
BM SPEC	MI_RBICOMPO_BM_SPEC_C	Character (50)	<p>A value is required for External Damage DMs, AST DMs, Thinning and Lining DMs, and Brittle Fracture DMs.</p> <p>Refer to the (Picklist) worksheet in the excel workbook for valid values that you enter in this cell.</p>

Field Caption	Field ID	Data Type (Length)	Comments
BM GRADE	MI_RBICOMPO_BM_GRADE_C	Character (50)	<p>A value is required for External Damage DMs, AST DMs, Thinning and Lining DMs, and Brittle Fracture DMs.</p> <p>Refer to the (Picklist) worksheet in the excel workbook for valid values that you enter in this cell.</p>
Weld Joint Effy	MI_RBICOMPO_WELD_JOINT_EFFY_N	Numeric	<p>A value is required for External Damage DMs, AST DMs, and Thinning and Lining DMs.</p> <p>In the baseline GE Digital APM system, this cell may only contain one of the following values:</p> <ul style="list-style-type: none"> • 0.35 • 0.4 • 0.45 • 0.5 • 0.55 • 0.6 • 0.65 • 0.7 • 0.75 • 0.8 • 0.85 • 0.9 • 0.95 • 1.0 <p>If the family has been customized, the valid values could be different. This cell may only contain a value that exists in the list in the Weld Joint Effy field for Criticality RBI Component records.</p>
Specified Tmin	MI_CCRBICOM_SPECIFIED_TMIN_N	Numeric	A value is required if the value in the Override Minimum Required Thickness cell is True.
Insulated?	MI_RBICOMPO_INSUL_F	Boolean	Enter True or False.

Field Caption	Field ID	Data Type (Length)	Comments
Insulation Type	MI_RBICOMPO_INSUL_C	Character (200)	<p>A value is required if the value in the Insulated? cell is True.</p> <p>In the baseline GE Digital APM system, this cell may only contain one of the following values:</p> <ul style="list-style-type: none"> • Asbestos • Calcium Silicate (Cl Free) • Calcium Silicate (Not Cl Free) • Foam/Cellular Glass • Mineral Wool/Fiber Glass • Pearlite • Unknown
Piping Circuit Length	MI_CCRBICPI_PIP_CIR LENG_N	Numeric	A value is required in order to populate the Calculated Inventory field. This field is only required for RBI Pipeline Components.
PWHT	MI_CRENC DME_PWHT_F	Boolean	Enter True or False.
Course Number	MI_CCRBIC TB_COURS_NUM_N	Numeric	None
Is Entry Possible?	MI_CRENC DME_IS_ENTRY_POS S_C	Character (50)	<p>A value is required.</p> <p>In the baseline GE Digital APM system, this cell may only contain one of the following values:</p> <ul style="list-style-type: none"> • Y • N <p>The list in this field is populated by the MI_YES_NO System Code Table. If the system code table has been customized, the valid values could be different. To verify which options are acceptable in your GE Digital APM system, via Configuration Manager, refer to the appropriate table.</p>
Corrosive Product	MI_CCRBICOM_CORRO_PROD U_C	Character (250)	None

Field Caption	Field ID	Data Type (Length)	Comments
Internal Corrosion Type	MI_RBICOMPO_INTER_CORR_T YPE_C	Character (50)	<p>While not required, it is recommended you enter a value in this cell. This field is used when generating RBI Recommendations.</p> <p>In the baseline GE Digital APM system, this cell may only contain one of the following values:</p> <ul style="list-style-type: none"> Localized Pitting General <p>If the family has been customized, the valid values could be different. This cell may only contain a value that exists in the list in the Internal Corrosion Type field for Criticality RBI Component records.</p>
Internal Corrosion Type - Shell Side	MI_CCRBICEB_INT_COR_TP_SH _SD_C	Character (50)	<p>This field is used when generating RBI Recommendations.</p> <p>In the baseline GE Digital APM system, this cell may only contain one of the following values:</p> <ul style="list-style-type: none"> Localized Pitting General <p>If the family has been customized, the valid values could be different. This cell may only contain a value that exists in the list in the Internal Corrosion Type field for Criticality RBI Component records.</p>
Predictable Int. Corr. Location	MI_CCRBICOM_PRED_INT_COR _LOC_F	Boolean	Enter True or False.
Pred_Int_Corr_Location - Shell Side	MI_CCRBICEB_PRD_INT_CR_LC _SH_F	Boolean	Enter True or False.

Field Caption	Field ID	Data Type (Length)	Comments
Estimated Internal Corrosion Rate	MI_RBICOMPO_EXP_INT_CORR_RT_N	Numeric	A value is required in this cell if a Criticality Int. Corr. Deg. Mech. Eval. record will be created for an analysis linked to this component.
Estimated External Corrosion Rate	MI_RBICOMPO_EXP_EXT_CORR_RT_N	Numeric	A value is required in this cell if a Criticality Ext. Corr. Deg. Mech. Eval. record will be created for an analysis linked to this component.
Measured External Corrosion Rate	MI_RBICOMPO_MEAS_EXT_CO R_RT_N	Numeric	None
Source of Calculated Corrosion Rates	MI_CCRBICOM_CALCD_CR_SRC_C	Character (50)	<p>In the baseline GE Digital APM system, this cell may only contain one of the following System Code IDs:</p> <ul style="list-style-type: none"> • ASSET • COMPONENT • MANUAL <p>The list in this field is populated by the MI_RBI_CALC_CORRO_SRC System Code Table. If the system code table has been customized, the valid values could be different. To verify which options are acceptable in your GE Digital APM system, via Configuration Manager, refer to the appropriate table.</p>
Susceptible to CUI	MI_CCRBICOM_SUSC_TO_CUI_C	Character (50)	<p>In the baseline GE Digital APM system, this cell may only contain one of the following values:</p> <ul style="list-style-type: none"> • Y • N

RBI_Criticality_Analysis Worksheet

On the RBI_Criticality_Analysis worksheet, you will specify RBI Criticality Analysis records that you want to create.

Note: Each row represents a unique analysis, though multiple analyses may be related to the same asset.

Field Caption	Field ID	Data Type (Length)	Comments
Asset ID	MI_EQUIP000_EQUIP_ID_C	Character (255)	Values in this column must match values entered on the Assets worksheet. Multiple components can be linked to the same asset (i.e., rows may have the same value in this column).
Asset CMMS System	MI_EQUIP000_SAP_SYSTEM_C	Character (255)	Values in this column must match values entered on the Assets worksheet, if they exist. Multiple components can be linked to the same asset (i.e., rows may have the same value in this column).
Equipment Technical Number	MI_EQUIP000_EQUIP_TECH_N BR_C	Character (255)	Values in this column must match values entered on the Assets worksheet, if they exist. Multiple components can be linked to the same asset (i.e., rows may have the same value in this column).
Component	MI_RBICOMPO_COMPO_C	Character (250)	A value is required.
Component Type	MI_RBICOMPO_COMPO_TYPE_ C	Character (60)	A value is required. This cell may only contain a value that exists in the list in the Component Type field for Criticality RBI Component records.
Analysis Unique ID	MI_ANALYSIS_ID	N/A	This cell is required, but is only used in the context of the workbook. The Risk Based Inspection (RBI) 580 Data Loader uses the value in this cell to match and link Consequence Evaluations and Degradation Mechanism Evaluations to the analysis.
Event Type	MI_CRITANAL_ANAL_TYPE_C	Character (1)	This column is not required. When this column exists and the value is W , the system searches for a What-If Analysis with an Analysis ID that matches the Analysis Unique ID column.

Field Caption	Field ID	Data Type (Length)	Comments
Sub ID	MI_CRITANAL_SUB_ID_C	Character (50)	This column is not required. When this column exists and the value is provided, the value must match the existing Analysis Sub ID field. Note: The Sub ID field must be blank for analyses unless Event Type is set to W .
Scenario ID	MI_CRITANAL_TURNAROUND_I D_C	Character (100)	While not required, it is recommended you enter a value in this cell.
Scenario Reference Date	MI_CRITANAL_TURN_AROUN_ DATE_D	Date	While not required, it is recommended you enter a value in this cell.
Allowable Stress Override	MI_CRITANAL_MTL_A_STRESS_ OVR_F	Boolean	Enter True or False.
Allowable Stress	MI_CRITANAL_MTL_ALLOW_ST RESS_N	Numeric	If the Allowable Stress Override cell is True, a value is required in this cell. Required only for RBI Analysis records that are linked to Criticality Int. Corr. Deg. Mech. Eval. or Criticality Ext. Corr. Deg. Mech. Eval. records.
Override Minimum Required Thickness	MI_CRITANAL_EQ_EST_TCK_OV RDE_F	Boolean	Enter True or False.

Consequence_Evaluation Worksheet

On the Consequence_Evaluation worksheet, you will specify Consequence Evaluations that you want to create and link to RBI Criticality Analysis records.

Note: Each row represents a unique Consequence Evaluation. Only one Consequence Evaluation can be linked to an analysis, unless you specify a different Consequence for each Consequence Evaluation.

Field Caption	Field ID	Data Type (Length)	Comments
Asset ID	MI_EQUIP000_EQUIP_ID_C	Character (255)	Values in this column must match values entered on the Assets worksheet. Multiple components can be linked to the same asset (i.e., rows may have the same value in this column).
Asset CMMS System	MI_EQUIP000_SAP_SYSTEM_C	Character (255)	Values in this column must match values entered on the Assets worksheet, if they exist. Multiple components can be linked to the same asset (i.e., rows may have the same value in this column).
Equipment Technical Number	MI_EQUIP000_EQUIP_TECH_N BR_C	Character (255)	Values in this column must match values entered on the Assets worksheet, if they exist. Multiple components can be linked to the same asset (i.e., rows may have the same value in this column).
Component	MI_RBICOMPO_COMPO_C	Character (250)	A value is required.
Component Type	MI_RBICOMPO_COMPO_TYPE_ C	Character (60)	A value is required. This cell may only contain a value that exists in the list in the Component Type field for Criticality RBI Component records.
Analysis Unique ID	MI_ANALYSIS_ID	N/A	The value in this cell must correspond to a value entered in the Analysis Unique ID column on the RBI_Criticality_Analysis worksheet.
Event Type	MI_CRITANAL_ANAL_TYPE_C	Character (1)	This column is not required. The value in this column must correspond to the value entered in the Event Type column on the RBI_Criticality_Analysis worksheet.

Field Caption	Field ID	Data Type (Length)	Comments
Sub ID	MI_CRITANAL_SUB_ID_C	Character (50)	This column is not required. The value in this column must match the value entered in the Sub ID column in the RBI_Criticality_Analysis worksheet.
Consequence	MI_RCONEVAL_CONS_C	Character (50)	A value is required in this cell if you are creating more than one Consequence Evaluation for the same analysis. If left blank, the Consequence field will be populated with the value RBI Consequence.
Comments	MI_RCONEVAL_COMM_TX	Text	None
Inventory Group	MI_RCONEVAL_INV_GRP_C	Character (100)	None
Number of Towers	MI_CRCOEVAL_NUM_OF_TOW_N	Numeric	None
Number of Storage Tanks	MI_CRCOEVAL_NUM_STO_TNK_S_N	Numeric	None
Number of Vessels	MI_CRCOEVAL_NUM_OF_VESS_N	Numeric	None
Use Calculated Inventory	MI_CRCOEVAL_USE_CALC_INV_F	Boolean	Enter True or False.
Inspection Interval	MI_CRCOEVAL_INSPE_INTER_N	Numeric	A value is required if the component to which the analysis is linked is a Storage Tank or Tank Bottom.
Consequence Near Ignition Source	MI_CRCOEVAL_CON_NEAR_IGN_SRC_F	Boolean	Enter True or False.
Bottom Thickness	MI_CRCOEVAL_BOT_THK_N	Numeric	None
Diked?	MI_CRCOEVAL_DIKED_F	Boolean	Enter True or False.
Diked Area	MI_CRCOEVAL_DIKED_AREA_N	Numeric	None
Persistent Fluid?	MI_CRCOEVAL_PERS_FLUID_F	Boolean	Enter True or False.

Field Caption	Field ID	Data Type (Length)	Comments
Leak Effect	MI_CRCOEVAL_LEAK_EFFEC_C	Character (50)	<p>A value is required if the component to which the analysis is linked is a Storage Tank or Tank Bottom.</p> <p>In the baseline GE Digital APM system, this cell may only contain one of the following values:</p> <ul style="list-style-type: none"> • Ground • Surface Water • Ground Water <p>If the family has been customized, the valid values could be different. This cell may only contain a value that exists in the list in the Leak Effect field for Consequence Evaluation records.</p>
Unit Cleanup Cost	MI_CRCOEVAL_UNIT_CLEAN_COST_N	Numeric	None
Underside Corrosion Rate	MI_CRCOEVAL_UNDER_CORRT_N	Numeric	None
(Flammable) Leak Type	MI_CRCOEVAL_LEAK_TYPE_C	Character (150)	<p>In the baseline GE Digital APM system, this cell may only contain one of the following values:</p> <ul style="list-style-type: none"> • Catastrophic • HC->Utility • Utility->HC <p>If the family has been customized, the valid values could be different. This cell may only contain a value that exists in the list in the Flammable Leak Type field for Consequence Evaluation records.</p>

Field Caption	Field ID	Data Type (Length)	Comments
Toxic Leak Type	MI_CRCOEVAL_TOX_LK_TYPE_C	Character (50)	In the baseline GE Digital APM system, this cell may only contain one of the following values: <ul style="list-style-type: none"> • Catastrophic • Toxic->Utility • Toxic->Process • Leak->Toxic If the family has been customized, the valid values could be different. This cell may only contain a value that exists in the list in the Toxic Leak Type field for Consequence Evaluation records.
Product Unit Value	MI_CRCOEVAL_PROD_UNIT_VAL_C	Character (150)	None

DME_Environmental_Cracking Worksheet

On the DME_Environmental_Cracking worksheet, you will specify Degradation Mechanisms related to Environmental Cracking that you want to create and link to RBI Criticality Analysis records. For each Degradation Mechanism, a Degradation Mechanism Evaluation is created and linked to the specified analysis. Additionally, a corresponding Potential Degradation Mechanism is created and linked to the specified component.

Note: Each row represents a unique Degradation Mechanism. Only one of each type of Degradation Mechanism can be linked to an analysis. For example, the same analysis could have a Carbonate Cracking Degradation Mechanism and a Caustic Cracking Degradation Mechanism, but not two Carbonate Cracking Degradation Mechanisms.

Field Caption	Field ID	Data Type (Length)	Comments
Asset ID	MI_EQUIP000_EQUIP_ID_C	Character (255)	Values in this column must match values entered on the Assets worksheet. Multiple components can be linked to the same asset (i.e., rows may have the same value in this column).
Asset CMMS System	MI_EQUIP000_SAP_SYSTEM_C	Character (255)	Values in this column must match values entered on the Assets worksheet, if they exist. Multiple components can be linked to the same asset (i.e., rows may have the same value in this column).

Field Caption	Field ID	Data Type (Length)	Comments
Equipment Technical Number	MI_EQUIP000_EQUIP_TECH_N BR_C	Character (255)	Values in this column must match values entered on the Assets worksheet, if they exist. Multiple components can be linked to the same asset (i.e., rows may have the same value in this column).
Component	MI_RBICOMPO_COMPO_C	Character (250)	A value is required.
Component Type	MI_RBICOMPO_COMPO_TYPE_ C	Character (60)	A value is required. This cell may only contain a value that exists in the list in the Component Type field for Criticality RBI Component records.
Analysis Unique ID	MI_ANALYSIS_ID	Character (255)	The value in this cell must correspond to a value entered in the Analysis Unique ID column on the RBI_Criticality_Analysis worksheet.
Event Type	MI_CRITANAL_ANAL_TYPE_C	Character (1)	This column is not required. The value in this column must correspond to the value entered in the Event Type column on the RBI_Criticality_Analysis worksheet.
Sub ID	MI_CRITANAL_SUB_ID_C	Character (50)	This column is not required. The value in this column must match the value entered in the Sub ID column in the RBI_Criticality_Analysis worksheet.

Field Caption	Field ID	Data Type (Length)	Comments
Damage Mechanism	MI_RBDEMEEV_DAM_MECH_C	Character (50)	<p>The value in this cell must be a Degradation Mechanism that corresponds to a Criticality Env. Crack. Deg. Mech. Eval. record.</p> <p>In the baseline GE Digital APM system, this cell may only contain one of the following values:</p> <ul style="list-style-type: none"> • Amine Cracking (ASCC) • Carbonate Cracking • Caustic Cracking • Chloride Stress Corrosion Cracking (Cl SCC) • Hydrogen Stress Cracking (HSC)- Hydrofluoric Acid • Polythionic Acid SCC (PTA) • Sulfide Stress Cracking (SSC) • Wet H2S (Blistering, SOHIC, HIC, SSC)
Damage Comments	MI_RBDEMEEV_DAM_COM_T	Text	None
Inspection Date	MI_CRDEMEEV_INSP_DATE_D	Date	None
Number of Inspections	MI_CRDEMEEV_NUM_INSP_N	Numeric	In the baseline GE Digital APM system, this cell may only contain a numeric value between 1 -20.
Inspection Confidence	MI_CRDEMEEV_INSP_CONF_C	Character (50)	<p>A value is required.</p> <p>In the baseline GE Digital APM system, this cell may only contain one of the following values:</p> <ul style="list-style-type: none"> • Low • Medium • High • Very High
Damaged At Last Inspection	MI_CRENCME_DAM_LST_INS_F	Boolean	Enter True or False.
Env. Cracking Higher Levels	MI_CRENCME_ENV_CRK_HI_L EV_F	Boolean	Enter True or False.

Field Caption	Field ID	Data Type (Length)	Comments
Initial Potential	MI_RBDEMEEV_ESTIM_C	Character (50)	<p>A value is required.</p> <p>In the baseline GE Digital APM system, this cell may only contain one of the following values:</p> <ul style="list-style-type: none"> • Low • Medium • High <p>If the family has been customized, the valid values could be different. This cell may only contain a value that exists in the list in the Initial Potential field for Criticality Env. Crack. Deg. Mech. Eval. records.</p>
Cyanides?	MI_RBDEMEEV_CYANI_F	Boolean	Enter True or False.
Free Water	MI_RBDEMEEV_FREE_WATER_N	Numeric	None
H2S Content	MI_RBDEMEEV_H2S_CON_C	Character (50)	None
HIC Resistant Steel	MI_CRENCOME_HIC_RESIS_STE_F	Boolean	Enter True or False.
Stable Scale	MI_CRENCOME_STAB_SCALE_F	Boolean	Enter True or False.
PT or MT Access?	MI_CRENCOME_PT_OR_MT_ACCESS_C	Character (50)	<p>While not required, it is recommended you enter a value in this cell.</p> <p>In the baseline GE Digital APM system, this cell may only contain one of the following values:</p> <ul style="list-style-type: none"> • Y • N <p>The list in this field is populated by the MI_YES_NO System Code Table. If the system code table has been customized, the valid values could be different. To verify which options are acceptable in your GE Digital APM system, via Configuration Manager, refer to the appropriate table.</p>

DME_External_Corrosion Worksheet

On the DME_External_Corrosion worksheet, you will specify Criticality Calculator External Corrosion Degradation Mechanisms that you want to create and link to RBI Criticality Analysis records. For each Degradation Mechanism, a Degradation Mechanism Evaluation is created and linked to the specified analysis. Additionally, a corresponding Potential Degradation Mechanism is created and linked to the specified component.

Note: Each row represents a unique Degradation Mechanism. Only one Criticality Calculator External Corrosion Degradation Mechanism can be linked to an analysis.

Field Caption	Field ID	Data Type (Length)	Comments
Asset ID	MI_EQUIP000_EQUIP_ID_C	Character (255)	Values in this column must match values entered on the Assets worksheet. Multiple components can be linked to the same asset (i.e., rows may have the same value in this column).
Asset CMMS System	MI_EQUIP000_SAP_SYSTEM_C	Character (255)	Values in this column must match values entered on the Assets worksheet, if they exist. Multiple components can be linked to the same asset (i.e., rows may have the same value in this column).
Equipment Technical Number	MI_EQUIP000_EQUIP_TECH_N BR_C	Character (255)	Values in this column must match values entered on the Assets worksheet, if they exist. Multiple components can be linked to the same asset (i.e., rows may have the same value in this column).
Component	MI_RBICOMPO_COMPO_C	Character (250)	A value is required.
Component Type	MI_RBICOMPO_COMPO_TYPE_ C	Character (60)	A value is required. This cell may only contain a value that exists in the list in the Component Type field for Criticality RBI Component records.
Analysis Unique ID	MI_ANALYSIS_ID	Character (255)	The value in this cell must correspond to a value entered in the Analysis Unique ID column on the RBI_Criticality_Analysis worksheet.

Field Caption	Field ID	Data Type (Length)	Comments
Event Type	MI_CRITANAL_ANAL_TYPE_C	Character (1)	This column is not required. The value in this column must correspond to the value entered in the Event Type column on the RBI_Criticality_Analysis worksheet.
Sub ID	MI_CRITANAL_SUB_ID_C	Character (50)	This column is not required. The value in this column must match the value entered in the Sub ID column in the RBI_Criticality_Analysis worksheet.
Damage Mechanism	MI_RBDEMEEV_DAM_MECH_C	Character (50)	The value in this cell must be Criticality Calculator Internal Corrosion.
Damage Comments	MI_RBDEMEEV_DAM_COM_T	Text	None
Insulation Condition	MI_RBDEMEEV_INSUL_CON_C	Character (50)	In the baseline GE Digital APM system, this cell may only contain one of the following values: <ul style="list-style-type: none"> • Good • Fair • Poor If the family has been customized, the valid values could be different. This cell may only contain a value that exists in the list in the Coating Quality field for Criticality Ext. Corr. Deg. Mech. Eval records.

Field Caption	Field ID	Data Type (Length)	Comments
Coating Quality	MI_RBDEMEEV_COAT_QUAL_C	Character (50)	<p>A value is required if the value in the Coating Present? cell is Y.</p> <p>In the baseline GE Digital APM system, this cell may only contain one of the following System Code IDs:</p> <ul style="list-style-type: none"> • NONE • POOR • MEDIUM • HIGH <p>The list in this field is populated by the MI_RBI_Coating_Quality System Code Table. If the system code table has been customized, the valid values could be different. To verify which options are acceptable in your GE Digital APM system, via Configuration Manager, refer to the appropriate table.</p>

Field Caption	Field ID	Data Type (Length)	Comments
Selected Corrosion Rate	MI_RBDEMEEV_SEL_CORR_RATE_N	Numeric	<p>A value is required for each row.</p> <p>In the baseline GE Digital APM system, this cell may only contain one of the following System Code IDs:</p> <ul style="list-style-type: none"> • 0 • 1 • 3 <p>For this field:</p> <ul style="list-style-type: none"> • 0 corresponds to Estimated Rate. • 1 corresponds to Average Rate. • 3 corresponds to Calculated Rate. <p>The list in this field is populated by the RBI_INT_COR_TYP System Code Table. If the system code table has been customized, the valid values could be different. To verify which options are acceptable in your GE Digital APM system, via Configuration Manager, refer to the appropriate table.</p>
Measured Corrosion Rate	MI_RBDEMEEV_BM_MEASUREMENT_N	Numeric	A value is required if the value in the Selected Corrosion Rate column is 1.
Inspection Date	MI_CRDEMEEV_INSP_DATE_D	Date	None
Number of Inspections	MI_CRDEMEEV_NUM_INSP_N	Numeric	A value is required.

Field Caption	Field ID	Data Type (Length)	Comments
Inspection Confidence	MI_CRDEMEEV_INSP_CONF_C	Character (50)	A value is required. This cell may only contain the ID of a System Code listed in the INSPECTION CONFIDENCE, MI_RBI_REFERENCES, and MI_RBI_INSPCONF System Code Tables. To verify which options are acceptable in your GE Digital APM system, via Configuration Manager, refer to the appropriate table.
Near Cooling Tower?	MI_RBDEMEEV_N_COOL_TOWER_F	Boolean	Enter True or False.

DME_Internal_Corrosion Worksheet

On the **DME_Internal_Corrosion** worksheet, you will specify Criticality Calculator Internal Corrosion Degradation Mechanisms that you want to create and link to RBI Criticality Analysis records. For each Degradation Mechanism, a Degradation Mechanism Evaluation is created and linked to the specified analysis. Additionally, a corresponding Potential Degradation Mechanism is created and linked to the specified component.

Note: Each row represents a unique Degradation Mechanism. Only one Criticality Calculator Internal Corrosion Degradation Mechanism can be linked to an analysis.

Field Caption	Field ID	Data Type (Length)	Comments
Asset ID	MI_EQUIP000_EQUIP_ID_C	Character (255)	Values in this column must match values entered on the Assets worksheet. Multiple components can be linked to the same asset (i.e., rows may have the same value in this column).
Asset CMMS System	MI_EQUIP000_SAP_SYSTEM_C	Character (255)	Values in this column must match values entered on the Assets worksheet, if they exist. Multiple components can be linked to the same asset (i.e., rows may have the same value in this column).
Equipment Technical Number	MI_EQUIP000_EQUIP_TECH_NBR_C	Character (255)	Values in this column must match values entered on the Assets worksheet, if they exist. Multiple components can be linked to the same asset (i.e., rows may have the same value in this column).

Field Caption	Field ID	Data Type (Length)	Comments
Component	MI_RBICOMPO_COMPO_C	Character (250)	A value is required.
Component Type	MI_RBICOMPO_COMPO_TYPE_C	Character (60)	A value is required. This cell may only contain a value that exists in the list in the Component Type field for Criticality RBI Component records.
Analysis Unique ID	MI_ANALYSIS_ID	Character (255)	The value in this cell must correspond to a value entered in the Analysis Unique ID column on the RBI_Criticality_Analysis worksheet.
Event Type	MI_CRITANAL_ANAL_TYPE_C	Character (1)	This column is not required. The value in this column must correspond to the value entered in the Event Type column on the RBI_Criticality_Analysis worksheet.
Sub ID	MI_CRITANAL_SUB_ID_C	Character (50)	This column is not required. The value in this column must match the value entered in the Sub ID column in the RBI_Criticality_Analysis worksheet.
Damage Mechanism	MI_RBDEMEEV_DAM_MECH_C	Character (50)	The value in this cell must be Criticality Calculator Internal Corrosion.
Damage Comments	MI_RBDEMEEV_DAM_COM_T	Text	None

Field Caption	Field ID	Data Type (Length)	Comments
Selected Corrosion Rate	MI_RBDEMEEV_SEL_CORR_RATE_N	Numeric	<p>A value is required for each row.</p> <p>In the baseline GE Digital APM system, this cell may only contain one of the following System Code IDs:</p> <ul style="list-style-type: none"> • 0 • 1 • 2 • 3 <p>For this field:</p> <ul style="list-style-type: none"> • 0 corresponds to Estimated Rate. • 1 corresponds to Short Term Avg. • 2 corresponds to Long Term Avg. • 3 corresponds to Controlling Corrosion Rate. <p>The list in this field is populated by the RBI_INT_COR_TYP System Code Table. If the system code table has been customized, the valid values could be different. To verify which options are acceptable in your GE Digital APM system, via Configuration Manager, refer to the appropriate table.</p>
Long Term Avg. Corr. Rate	MI_CRINCDME_LONG_TRM_AVG_RT_N	Numeric	If the Selected Corrosion Rate cell is Long Term Avg., a value is required in this cell.
Short Term Avg. Corr. Rate	MI_CRINCDME_SHRT_TRM_AVG_RT_N	Numeric	If the Selected Corrosion Rate cell is Short Term Avg., a value is required in this cell.
Thinning Type	MI_RBDEMEEV_THIN_TYPE_C	Character (50)	<p>A value is required.</p> <p>In the baseline GE Digital APM system, this cell may only contain one of the following values:</p> <ul style="list-style-type: none"> • General • Localized • Pitting

Field Caption	Field ID	Data Type (Length)	Comments
Inspection Date	MI_CRDEMEEV_INSP_DATE_D	Date	None
Number of Inspections	MI_CRDEMEEV_NUM_INSP_N	Numeric	A value is required. In the baseline GE Digital APM system, this cell may only contain a numeric value between 1 and 20.
Inspection Confidence	MI_CRDEMEEV_INSP_CONF_C	Character (50)	A value is required. In the baseline GE Digital APM system, this cell may only contain one of the following values: <ul style="list-style-type: none"> • Low • Medium • High • Very High
Predictable	MI_CRINCDME_PRED_C	Character (50)	While not required, it is recommended you enter a value in this cell. In the baseline GE Digital APM system, this cell may only contain one of the following System Code IDs: <ul style="list-style-type: none"> • Y • N The list in this field is populated by the MI_YES_NO System Code Table. If the system code table has been customized, the valid values could be different. To verify which options are acceptable in your GE Digital APM system, via Configuration Manager, refer to the appropriate table.

DME_Other Worksheet

On the DME_Other worksheet, you will specify Degradation Mechanisms related that you want to create and link to RBI Criticality Analysis records. For each Degradation Mechanism, a Degradation Mechanism Evaluation is created and linked to the specified analysis. Additionally, a corresponding Potential Degradation Mechanism is created and linked to the specified component.

Note: Each row represents a unique Degradation Mechanism. Only one of each type of Degradation Mechanism can be linked to an analysis. For example, the same analysis could have a Carbonate Cracking Degradation Mechanism and a Caustic Cracking Degradation Mechanism, but not two Carbonate Cracking Degradation Mechanisms.

Field Caption	Field ID	Data Type (Length)	Comments
Asset ID	MI_EQUIP000_EQUIP_ID_C	Character (255)	Values in this column must match values entered on the Assets worksheet. Multiple components can be linked to the same asset (i.e., rows may have the same value in this column).
Asset CMMS System	MI_EQUIP000_SAP_SYSTEM_C	Character (255)	Values in this column must match values entered on the Assets worksheet, if they exist. Multiple components can be linked to the same asset (i.e., rows may have the same value in this column).
Equipment Technical Number	MI_EQUIP000_EQUIP_TECH_N BR_C	Character (255)	Values in this column must match values entered on the Assets worksheet, if they exist. Multiple components can be linked to the same asset (i.e., rows may have the same value in this column).
Component	MI_RBICOMPO_COMPO_C	Character (250)	A value is required.
Component Type	MI_RBICOMPO_COMPO_TYPE_ C	Character (60)	A value is required. This cell may only contain a value that exists in the list in the Component Type field for Criticality RBI Component records.
Analysis Unique ID	MI_ANALYSIS_ID	Character (255)	The value in this cell must correspond to a value entered in the Analysis Unique ID column on the RBI_Criticality_Analysis worksheet.
Event Type	MI_CRITANAL_ANAL_TYPE_C	Character (1)	This column is not required. The value in this column must correspond to the value entered in the Event Type column on the RBI_Criticality_Analysis worksheet.

Field Caption	Field ID	Data Type (Length)	Comments
Sub ID	MI_CRITANAL_SUB_ID_C	Character (50)	<p>This column is not required. The value in this column must match the value entered in the Sub ID column in the RBI_Criticality_Analysis worksheet.</p>
Damage Mechanism	MI_RBDEMEEV_DAM_MECH_C	Character (50)	<p>The value in this cell must be a Degradation Mechanism that corresponds to a Criticality Other Damage Mech. Eval. record.</p> <p>The value in this cell is used to create the Degradation Mechanism for the Degradation Mechanism Evaluation that will be linked to the analysis, as well as the corresponding Potential Degradation Mechanism that will be related to the component.</p> <p>In the baseline GE Digital APM system, this cell may only contain one of the following values:</p> <ul style="list-style-type: none"> • 885 Embrittlement • Brittle Fracture • Carburization • Creep • Erosion • Ext Chloride SCC • Graphitization • Hot Hydrogen Attack • Hydrogen Embrittlement • Hydrogen Induced Cracking • Liquid Metal Embrittlement • Mechanical Fatigue • Microbiologically Induced Corrosion • Phase Change Embrittlement • Refractory Failure • Temper Embrittlement • Thermal Fatigue • Wet H2S Damage

Field Caption	Field ID	Data Type (Length)	Comments
Damage Comments	MI_RBDEMEEV_DAM_COM_T	Text	None

DME_Custom Worksheet

On the DME_Other worksheet, you will specify custom Degradation Mechanisms that you want to create and link to RBI Criticality Analysis records. For each Degradation Mechanism, a Degradation Mechanism Evaluation is created and linked to the specified analysis. Additionally, a corresponding Potential Degradation Mechanism is created and linked to the specified component.

Note: Each row represents a unique custom Degradation Mechanism. Only one of each type of Degradation Mechanism can be linked to an analysis. For example, the same analysis could have a Carbonate Cracking Degradation Mechanism and a Caustic Cracking Degradation Mechanism, but not two Carbonate Cracking Degradation Mechanisms.

Field Caption	Field ID	Data Type (Length)	Comments
Asset ID	MI_EQUIP000_EQUIP_ID_C	Character (255)	Values in this column must match values entered on the Assets worksheet. Multiple components can be linked to the same asset (i.e., rows may have the same value in this column).
Asset CMMS System	MI_EQUIP000_SAP_SYSTEM_C	Character (255)	Values in this column must match values entered on the Assets worksheet, if they exist. Multiple components can be linked to the same asset (i.e., rows may have the same value in this column).
Equipment Technical Number	MI_EQUIP000_EQUIP_TECH_N BR_C	Character (255)	Values in this column must match values entered on the Assets worksheet, if they exist. Multiple components can be linked to the same asset (i.e., rows may have the same value in this column).
Component	MI_RBICOMPO_COMPO_C	Character (250)	A value is required.
Component Type	MI_RBICOMPO_COMPO_TYPE_ C	Character (60)	A value is required. This cell may only contain a value that exists in the list in the Component Type field for Criticality RBI Component records.

Field Caption	Field ID	Data Type (Length)	Comments
Analysis Unique ID	MI_ANALYSIS_ID	Character (255)	The value in this cell must correspond to a value entered in the Analysis Unique ID column on the RBI_Criticality_Analysis worksheet.
Event Type	MI_CRITANAL_ANAL_TYPE_C	Character (1)	This column is not required. The value in this column must correspond to the value entered in the Event Type column on the RBI_Criticality_Analysis worksheet.
Sub ID	MI_CRITANAL_SUB_ID_C	Character (50)	This column is not required. The value in this column must match the value entered in the Sub ID column in the RBI_Criticality_Analysis worksheet.

Field Caption	Field ID	Data Type (Length)	Comments
Damage Mechanism	MI_RBDEMEEV_DAM_MECH_C	Character (50)	<p>The value in this cell must be a Degradation Mechanism that corresponds to a Criticality Other Damage Mech. Eval. record.</p> <p>The value in this cell is used to create the Degradation Mechanism for the Degradation Mechanism Evaluation that will be linked to the analysis, as well as the corresponding Potential Degradation Mechanism that will be related to the component.</p> <p>In the baseline GE Digital APM system, this cell may only contain one of the following values:</p> <ul style="list-style-type: none"> • Amine Cracking (ASCC) • Carbonate Cracking • Caustic Cracking • Chloride Stress Corrosion Cracking (Cl SCC) • Hydrogen Stress Cracking (HSC)- Hydrofluoric Acid • Polythionic Acid SCC (PTA) • Sulfide Stress Cracking (SSC) • Wet H2S (Blistering, SOHIC, HIC, SSC) • Criticality Calculator External Corrosion • Criticality Calculator Internal Corrosion • 885 Embrittlement • Brittle Fracture • Carburization • Creep • Erosion • Ext Chloride SCC • Graphitization • Hot Hydrogen Attack • Hydrogen Embrittlement • Hydrogen Induced Cracking • Liquid Metal Embrittlement • Mechanical Fatigue • Microbiologically Induced Corrosion • Phase Change Embrittlement • Refractory Failure

Field Caption	Field ID	Data Type (Length)	Comments
DME Family	MI_DME_FAMILY	Character (50)	A value is required.

Field Caption	Field ID	Data Type (Length)	Comments																																																		
Probability Category	MI_RBDEMEEV_LIKE_CAT_C	Character (50)	<p>While not required, it is recommended you enter a value in this cell.</p> <p>In the baseline GE Digital APM system, this cell may only contain one of the following values:</p> <table border="1"> <thead> <tr> <th>Degradation Mechanism</th> <th>Ranking</th> </tr> </thead> <tbody> <tr><td>Brittle Fracture</td><td>1</td></tr> <tr><td>Brittle Fracture</td><td>2</td></tr> <tr><td>Brittle Fracture</td><td>3</td></tr> <tr><td>Brittle Fracture</td><td>4</td></tr> <tr><td>Brittle Fracture</td><td>5</td></tr> <tr><td>Carburization</td><td>1</td></tr> <tr><td>Carburization</td><td>2</td></tr> <tr><td>Carburization</td><td>3</td></tr> <tr><td>Carburization</td><td>4</td></tr> <tr><td>Carburization</td><td>5</td></tr> <tr><td>Creep</td><td>1</td></tr> <tr><td>Creep</td><td>2</td></tr> <tr><td>Creep</td><td>3</td></tr> <tr><td>Creep</td><td>4</td></tr> <tr><td>Creep</td><td>5</td></tr> <tr><td>Erosion</td><td>1</td></tr> <tr><td>Erosion</td><td>2</td></tr> <tr><td>Erosion</td><td>3</td></tr> <tr><td>Erosion</td><td>4</td></tr> <tr><td>Erosion</td><td>5</td></tr> <tr><td>Ext Chloride SCC</td><td>1</td></tr> <tr><td>Ext Chloride SCC</td><td>2</td></tr> <tr><td>Ext Chloride SCC</td><td>3</td></tr> <tr><td>Ext Chloride SCC</td><td>4</td></tr> </tbody> </table>	Degradation Mechanism	Ranking	Brittle Fracture	1	Brittle Fracture	2	Brittle Fracture	3	Brittle Fracture	4	Brittle Fracture	5	Carburization	1	Carburization	2	Carburization	3	Carburization	4	Carburization	5	Creep	1	Creep	2	Creep	3	Creep	4	Creep	5	Erosion	1	Erosion	2	Erosion	3	Erosion	4	Erosion	5	Ext Chloride SCC	1	Ext Chloride SCC	2	Ext Chloride SCC	3	Ext Chloride SCC	4
Degradation Mechanism	Ranking																																																				
Brittle Fracture	1																																																				
Brittle Fracture	2																																																				
Brittle Fracture	3																																																				
Brittle Fracture	4																																																				
Brittle Fracture	5																																																				
Carburization	1																																																				
Carburization	2																																																				
Carburization	3																																																				
Carburization	4																																																				
Carburization	5																																																				
Creep	1																																																				
Creep	2																																																				
Creep	3																																																				
Creep	4																																																				
Creep	5																																																				
Erosion	1																																																				
Erosion	2																																																				
Erosion	3																																																				
Erosion	4																																																				
Erosion	5																																																				
Ext Chloride SCC	1																																																				
Ext Chloride SCC	2																																																				
Ext Chloride SCC	3																																																				
Ext Chloride SCC	4																																																				

Field Caption	Field ID	Data Type (Length)	Comments
Damage Comments	MI_RBDEMEEV_DAM_COM_T	Text	None

Degradation_Mechanism Worksheet

On the Degradation_Mechanism worksheet, you will specify related Degradation Mechanisms that you want to create and link to RBI Criticality Analysis records.

Field Caption	Field ID	Data Type (Length)	Comments
Asset ID	MI_EQUIP000_EQUIP_ID_C	Character (255)	Values in this column must match values entered on the Assets worksheet. Multiple components can be linked to the same asset (i.e., rows may have the same value in this column).
Asset CMMS System	MI_EQUIP000_SAP_SYSTEM_C	Character (255)	Values in this column must match values entered on the Assets worksheet, if they exist. Multiple components can be linked to the same asset (i.e., rows may have the same value in this column).
Equipment Technical Number	MI_EQUIP000_EQUIP_TECH_N BR_C	Character (255)	Values in this column must match values entered on the Assets worksheet, if they exist. Multiple components can be linked to the same asset (i.e., rows may have the same value in this column).
Component	MI_RBICOMPO_COMPO_C	Character (250)	A value is required.
Component Type	MI_RBICOMPO_COMPO_TYPE_ C	Character (60)	A value is required. This cell may only contain a value that exists in the list in the Component Type field for Criticality RBI Component records.
Analysis Unique ID	MI_ANALYSIS_ID	N/A	The value in this cell must correspond to a value entered in the Analysis Unique ID column on the RBI_Criticality_Analysis worksheet.

Field Caption	Field ID	Data Type (Length)	Comments
Event Type	MI_CRITANAL_ANAL_TYPE_C	Character (1)	This column is not required. The value in this column must correspond to the value entered in the Event Type column on the RBI_Criticality_Analysis worksheet.
Sub ID	MI_CRITANAL_SUB_ID_C	Character (50)	This column is not required. The value in this column must match the value entered in the Sub ID column in the RBI_Criticality_Analysis worksheet.

Field Caption	Field ID	Data Type (Length)	Comments
Damage Mechanism	MI_RBDEMEEV_DAM_MECH_C	Character (50)	<p>The value in this cell must be a Degradation Mechanism that corresponds to a Criticality Other Damage Mech. Eval. record.</p> <p>The value in this cell is used to create the Degradation Mechanism for the Degradation Mechanism Evaluation that will be linked to the analysis, as well as the corresponding Potential Degradation Mechanism that will be related to the component.</p> <p>In the baseline GE Digital APM system, this cell may only contain one of the following values:</p> <ul style="list-style-type: none"> • Amine Cracking (ASCC) • Carbonate Cracking • Caustic Cracking • Chloride Stress Corrosion Cracking (Cl SCC) • Hydrogen Stress Cracking (HSC)- Hydrofluoric Acid • Polythionic Acid SCC (PTA) • Sulfide Stress Cracking (SSC) • Wet H2S (Blistering, SOHIC, HIC, SSC) • Criticality Calculator External Corrosion • Criticality Calculator Internal Corrosion • 885 Embrittlement • Brittle Fracture • Carburization • Creep • Erosion • Ext Chloride SCC • Graphitization • Hot Hydrogen Attack • Hydrogen Embrittlement • Hydrogen Induced Cracking • Liquid Metal Embrittlement • Mechanical Fatigue • Microbiologically Induced Corrosion • Phase Change Embrittlement • Refractory Failure

Field Caption	Field ID	Data Type (Length)	Comments
Deg Mech Comments	MI_DEGR_MECH_DEG_MECH_COMM_TX	Text	None

About the Risk Based Inspection (RBI) 580 Data Loader Load Verification

About This Task

Following a data load, you should perform the following steps in GE Digital APM to confirm the integrity and accuracy of the data imported from the data loader workbook.

Procedure

1. Access the details of the import job. These details will indicate if any errors, minor or otherwise, were encountered during the import job. The log may help account for any records that are unexpectedly absent after the data load.
2. In Risk Based Inspection or Record Manager, access the assets specified in the data loader workbook, and then verify that the expected components are present or updated, and that any associated records that you expected to be created are also present in the database.

You can enter the following query in the **SQL** workspace of the **Query** page to review a list of components created after a specified date:

```
SELECT [MI_CCRBICOM].LAST_UPDT_DT "LAST_UPDT_DT", [MI_CCRBICOM].
[MI_RBICOMPO_COMPO_C] "Component", [MI_CCRBICOM].
[MI_RBICOMPO_COMPO_TYPE_C] "Component Type", [MI_CCRBICOM].
[MI_RBICOMPO_EQUIP_C] "Asset", [MI_CCRBICOM].ENTY_ID "ENTY_ID" FROM
[MI_CCRBICOM] WHERE [MI_CCRBICOM].LAST_UPDT_DT >=
CONVERT(VARCHAR(255), (? :d :caption='Enter a Date'), 110) ORDER BY
[MI_CCRBICOM].LAST_UPDT_DT Desc, [MI_CCRBICOM].[MI_RBICOMPO_EQUIP_C]
Asc
```

You can enter the following query in the **Oracle** or **Postgres** workspace of the **Query** page to review a list of components created after a specified date:

```
SELECT [MI_CCRBICOM].LAST_UPDT_DT "LAST_UPDT_DT", [MI_CCRBICOM].
[MI_RBICOMPO_COMPO_C] "Component", [MI_CCRBICOM].
[MI_RBICOMPO_COMPO_TYPE_C] "Component Type", [MI_CCRBICOM].
[MI_RBICOMPO_EQUIP_C] "Asset", [MI_CCRBICOM].ENTY_ID "ENTY_ID" FROM
[MI_CCRBICOM] WHERE [MI_CCRBICOM].LAST_UPDT_DT >=
to_date(to_char((? :d :caption='Enter a Date'), 'mm/dd/yyyy'), 'mm/dd/
yyyy') ORDER BY [MI_CCRBICOM].LAST_UPDT_DT Desc, [MI_CCRBICOM].
[MI_RBICOMPO_EQUIP_C] Asc
```

3. When prompted, enter the date on which the data load was performed.

Corrosion Loop

About the Risk Based Inspection (RBI) Corrosion Loop Data Loader

GE Digital APM, through the Risk Based Inspection module, provides the functionality to carry out a Semi-Quantitative Analysis (RBI Criticality Analysis) on Corrosion Loops, which are comprised of various types of linked RBI Components. Using the Risk Based Inspection (RBI) Corrosion Loop Data Loader, you can

generate all Corrosion Loops for a Process Unit along with the related RBI Components and Reference Documents.

Using the Risk Based Inspection (RBI) Corrosion Loop Data Loader, you can create or update Corrosion Loops, link RBI Components, and Reference Documents.

About the Risk Based Inspection (RBI) Corrosion Loop Data Loader Requirements

This documentation assumes that your organization has completed fully the deployment of the Risk Based Inspection module. The Risk Based Inspection (RBI) Corrosion Loop Data Loader should only be used after the Risk Based Inspection module has been implemented.

The data loader can be used to set up an RBI program during implementation. Because the RBI Components must exist prior to the Corrosion Loop data load, the Risk Based Inspection (RBI) 580 Data Loader should be used before the Risk Based Inspection (RBI) Corrosion Loop Data Loader.

When you create or update a Corrosion Loop, it is linked to a Functional Location, which must already exist, and then linked to Criticality RBI Components and Reference Documents that you specify.

The following data must be defined prior to loading Corrosion Loop data:

- Site References
- Equipment Taxonomies
- Functional Location Families

Security Settings

The Security User performing the data load operation must be associated with either the MI Data Loader User or MI Data Loader Admin Security Role, and must also be associated with the MI RBI Analyst Security Group or a Security Role that is associated with this Security Group.

About the Risk Based Inspection (RBI) Corrosion Loop Data Loader Data Model

This topic has been intentionally excluded from the GE Digital APM product documentation website. This topic is available to you via the product documentation that is provided within the GE Digital APM system.

About the Risk Based Inspection (RBI) Corrosion Loop Data Loader General Loading Strategy

Best Practices

When importing data using the Risk Based Inspection (RBI) Corrosion Loop Data Loader, you must use the following best practices:

- ID fields (Row 2 of each worksheet) must not include special characters or spaces.
- The data loader workbook contains sample data in each column. It is only for your reference. You must remove this data before using the data loader workbook.
- Columns (including columns representing custom fields) in the worksheets should be formatted as Text.
- Import a maximum of 500 records in each data load.
- For Oracle databases, valid cell values are case-sensitive.
- For a Corrosion Loop to have associated RBI Components, the RBI Components that will be linked to the Corrosion Loop must already exist in the GE Digital APM system.

- If RBI Components do not exist, the Corrosion Loop Data Loader will create or update Corrosion Loop data, but it will not have any associated RBI Components.

Load Sequence

The RBI Corrosion Loop data load is performed in a specific sequence to create all necessary relationships between records:

Note: Prior to deploying the Risk Based Inspection (RBI) Corrosion Loop Data Loader, the [Risk Based Inspection \(RBI\) 580 Data Loader](#) must be implemented. The Corrosion Loop Data Loader uses the values in the Functional Location field, the Corrosion Loop field, the Asset field, and the Component field to look up the associated component record and to link said RBI Component to a Corrosion Loop. For RBI Components to be linked to a Corrosion Loop, the RBI Components must already exist and be present in the Components worksheet. If RBI Components do not exist, the Corrosion Loop Data Loader will create or update Corrosion Loop data, but it will not have any associated RBI Components.

1. The Corrosion Loops worksheet is processed. An existing Functional Location will be looked up based on the Functional Location (MI_FNCLOC00_FNC_LOC_C) and the RBI Corrosion Loop ID (MI_RBI_SYSTEM_RBI_SYS_ID_C).
If a Corrosion Loop specified on the worksheets exists, it will be updated. If a Corrosion Loop cannot be found, then a new Corrosion Loop will be created.
2. The RBI Components worksheet is processed. An existing RBI Component is looked up based on the the following fields:
 - Asset ID (for Equipment:MI_EQUIP000_EQUIP_ID_C and Functional Location:MI_FNCLOC00_FNC_LOC_C)
 - Asset CMMS System (for Equipment: MI_EQUIP000_SAP_SYSTEM_C and Functional Location: MI_FNCLOC00_SAP_SYSTEM_C)
 - Equipment Technical Number (MI_EQUIP000_EQUIP_TECH_NBR_C)
 - Asset Family
 - Component (MI_RBICOMPO_COMPO_C)
 - Component Type (MI_RBICOMPO_COMPO_TYPE_C)

If found, that RBI Component will be linked to the specified Corrosion Loop (MI_RBI_SYSTEM_RBI_SYS_ID_C). If no RBI Components exist, this worksheet is skipped.

If the RBI Component is specified in the worksheet, but that RBI Component cannot be looked up, an error is added to the log.

Note: When an RBI Component is linked to a Corrosion Loop, the Potential Degradation Mechanisms linked to the Corrosion Loop are added to the RBI Component.

3. The Reference Document worksheet is processed. The Corrosion Loop will be looked up by the Functional Location (MI_FNCLOC00_FNC_LOC_C), the RBI Corrosion Loop (MI_RBI_SYSTEM_RBI_SYS_ID_C), and the Reference Document ID (CTIT_ID).
If a Reference Document specified on the worksheet exists, it is updated. If a Reference Document cannot be found, then a new Reference Document is created.

Data that you specify in the field on each worksheet will be included in the new records.

About the Risk Based Inspection (RBI) Corrosion Loop Data Loader Workbook Layout and Use

In order to import data using the Risk Based Inspection (RBI) Corrosion Loop Data Loader, GE Digital APM provides an Excel workbook, Risk Based Inspection (RBI) Corrosion Loop.xlsx, which supports baseline Risk Based Inspection in GE Digital APM. This workbook must be used to perform the data load. You can modify the Excel workbook to include custom fields used by your organization.

Note: The Excel workbook is referred to throughout this documentation as the data loader workbook.

The following table lists the worksheets that are included in the data loader workbook.

Worksheet	Description
Corrosion_Loops	This worksheet is used to specify which Corrosion Loops the user wants to link to Functional Locations.
Components	This worksheet is used only to lookup fields for unique, existing RBI Components to link to Corrosion Loops.
Reference_Document	This worksheet is used to specify the Functional Location key fields as well as the Corrosion Loop key fields.

Color Coding

Certain columns on the worksheets have different functions and requirements. To illustrate this, certain columns are color-coded. The following table lists the colors and what they represent.

Color	Description	Comments
Gray	Required Key Fields	Indicates columns that contain values that are used by the Risk Based Inspection (RBI) Corrosion Loop Data Loader to look up and create records. If these columns are removed from the worksheets, the data load will fail. While the worksheets require that these columns be present, values are not necessarily required in these columns.
Red	Fields Required for Saving Records	Indicates columns that contain values that are required to save the record.
Blue	Recommended Fields	Indicates columns that, according to GE Digital APM Best Practice for Inspection Management, should contain values.
None	Custom Fields	Indicates columns in which you can specify custom fields.

Limitations

The Risk Based Inspection (RBI) Corrosion Loop Data Loader has the following limitations:

- The values that you enter in the data loader workbook are case-sensitive.
- If you reimport data, the records that have been created by the Data Loader will be updated. Therefore, while reimporting data, if you remove the data for a field in the data loader workbooks, the value for the corresponding field in GE Digital APM will be either a default value or blank.

Corrosion_Loops Worksheet

On the Corrosion_Loops worksheet, you will specify which Corrosion Loops the user wants to link to Functional Locations.

Field Caption	Field ID	Data Type (Length)	Comments
Functional Location	MI_FNCLOC00_FNC_LOC_C	Character (255)	The value in this column is used to break the data into smaller data loads.
CMMS System	MI_FNCLOC00_SAP_SYSTEM_C	Character (255)	A value is required for each row.
RBI Corrosion Loop ID	MI_RBI_SYSTEM_RBI_SYS_ID_C	Character (255)	If this column is populated, the Corrosion Loop referenced in this column will be identified by a combination of the Functional Locations and CMMS System.
RBI Corrosion Loop Description	MI_RBI_SYSTEM_RBI_SYS_DESC_C	Character (2000)	This column is not required for calculations; however, providing a value for this column is considered Best Practice.
RBI Corrosion Loop From	MI_RBI_SYSTEM_RBI_SYS_FROM_C	Character (255)	This column is not required for calculations; however, providing a value for this column is considered Best Practice.
RBI Corrosion Loop To	MI_RBI_SYSTEM_RBI_SYS_TO_C	Character (255)	This column is not required for calculations; however, providing a value for this column is considered Best Practice.

Components Worksheet

On the Components worksheet, you will use lookup fields to find unique, existing RBI Components to link to Corrosion Loops.

Field Caption	Field ID	Data Type (Length)	Comments
Asset ID	MI_EQUIP000_EQUIP_ID_C	Character (255)	A value is required for each row. For a Functional Location asset, the field MI_FNCLOC00_FNC_LOC_C must be used.
Asset CMMS System	MI_EQUIP000_SAP_SYSTEM_C	Character (255)	A value is required for each row. For a Functional Location asset, the field MI_FNCLOC00_SAP_SYSTEM_C must be used.

Field Caption	Field ID	Data Type (Length)	Comments
Asset Family	ASSET_FAMILY_ID	Character (255)	This column is required when loading Functional Location assets. If no value is provided, the asset will be considered an Equipment asset. Note: The following are the valid values: <ul style="list-style-type: none"> • MI_EQUIP000 • MI_FNCLOC00
Functional Location	MI_FNCLOC00_FNC_LOC_C	Character (50)	Values in this column must match values entered on the Corrosion_Loop worksheet, if they exist.
CMMS System	MI_FNCLOC00_SAP_SYSTEM_C	Character (255)	Values in this column must match values entered on the Corrosion_Loop worksheet, if they exist.
RBI Corrosion Loop ID	MI_RBI_SYSTEM_RBI_SYS_ID_C	Character (255)	Values in this column must match values entered on the Corrosion_Loop worksheet, if they exist.
Equipment Technical Number	MI_EQUIP000_EQUIP_TECH_N BR_C	Character (255)	A value is required for each row. Note: This field must be left blank for a Functional Location asset.
Component	MI_RBICOMPO_COMPO_C	Character (250)	A value is required for each row.
Component Type	MI_RBICOMPO_COMPO_TYPE_ C	Character (60)	A value is required for each row. This cell may only contain a value that exists in the list in the Component Type field for Criticality RBI Component records.

Reference_Document Worksheet

On the Reference_Document worksheet, you will specify the Functional Location key fields as well as the Corrosion Loop key fields.

Field Caption	Field ID	Data Type (Length)	Comments
Functional Location	MI_FNCLOC00_FNC_LOC_C	Character (255)	Values in this column must match values entered on the Corrosion_Loop worksheet, if they exist.
CMMS System	MI_FNCLOC00_SAP_SYSTEM_C	Character (255)	Values in this column must match values entered on the Corrosion_Loop worksheet, if they exist.
RBI Corrosion Loop ID	MI_RBI_SYSTEM_RBI_SYS_ID_C	Character (255)	Values in this column must match values entered on the Corrosion_Loop worksheet, if they exist.
Reference Document ID	CTIT_ID	Character (255)	A value is required for each row.
Description	CTIT_DESC_TX	Character (255)	This column is not required for calculations; however, providing a value for this column is considered Best Practice.
Document Path	MIRD_DOC_PATH_CHR	Character (1023)	This column is not required for calculations; however, providing a value for this column is considered Best Practice.

About the Risk Based Inspection (RBI) Corrosion Loop Data Loader Load Verification

About This Task

Following a data load, you should perform the following steps in GE Digital APM to confirm the integrity and accuracy of the data imported from the data loader workbook.

Procedure

1. Access the details of the import job. These details will indicate if any errors, minor or otherwise, were encountered during the import job. The log may help account for any records that are unexpectedly absent after the data load.
2. In Risk Based Inspection or Record Manager, access the Corrosion Loops specified in the data loader workbook, and then verify that the expected components are present or updated, and that any associated records that you expected to be created are also present in the database.

You can enter the following query in the **SQL** workspace of the **Query** page to review a list of components created after a specified date:

```
SELECT [MI_RBiSYS00].LAST_UPDT_DT "LAST_UPDT_DT", [MI_RBiSYS00].
[MI_RBI_SYSTEM_RBI_SYS_ID_C] "RBI Corrosion Loop ID", [MI_RBiSYS00].
[MI_RBI_SYSTEM_RBI_SYS_DESC_C] "RBI Corrosion Loop Description",
[MI_RBiSYS00].[MI_RBI_SYSTEM_RBI_SYS_TO_C] "RBI Corrosion Loop To",
```

```
[MI_RBISYS00].[MI_RBI_SYSTEM_RBI_SYS_FROM_C] "RBI Corrosion Loop
From", [MI_RBICOMPO].[MI_RBICOMPO_COMPO_C] "RBI Component ID",
[MI_RBICOMPO].[MI_RBICOMPO_COMPO_TYPE_C] "Component Type" FROM
[MI_RBISYS00] LEFT JOIN {MIR_HSRBICMP} JOIN [MI_RBICOMPO] ON
{MIR_HSRBICMP}.SUCC_ENTY_KEY = [MI_RBICOMPO].ENTY_KEY ON
[MI_RBISYS00].ENTY_KEY = {MIR_HSRBICMP}.PRED_ENTY_KEY WHERE
[MI_RBISYS00].LAST_UPDT_DT >= CONVERT (VARCHAR (255),
(? :d :caption='Enter a Date'), 110)
```

RBI Components to TML Groups Relationship Data Loader

About the RBI Components To TML Groups Relationship Data Loader

You can map the corrosion rates used in RBI analysis from the TM Analysis at the TML Group level. To do this, you must link the RBI Component to the TML Group. Using the RBI Components To TML Groups Relationship Data Loader, you can link RBI Components to TML Groups. You can link multiple RBI Components to a TML Group and multiple TML Groups to an RBI Component.

Note: The Corrosion rates are copied from TML Group to RBI analysis of the mapped component only if the Source of Calculated Corrosion Rate of the component is set to Component. If the Source of Calculated Corrosion Rate of the component is not set to Component, the Corrosion rates are not copied from the TML Group to the RBI analysis. However, the records are linked.

About the RBI Components To TML Groups Relationship Data Loader Requirements

Before you use the RBI Components To TML Groups Relationship Data Loader, you must complete the following steps:

- Ensure that the Risk Based Inspection and Thickness Monitoring modules are deployed.
- Ensure that the following records are available:
 - RBI Components
 - TML Groups
 - Corrosion data of TM Analysis
 - Asset records

Security Settings

The Security User performing the data load operation must be associated with either the MI Data Loader User or MI Data Loader Admin Security Role, and must also be associated with the MI RBI Analyst Security Group or a Security Role that is associated with this Security Group.

About the RBI Components To TML Groups Relationship Data Loader General Loading Strategy

Best Practices

When importing data using the RBI Components To TML Groups Relationship Data Loader, you must use the following best practices:

- ID fields must not include special characters or spaces.

- The data loader workbook contains sample data in each column. It is only for your reference. You must remove this data before using the data loader workbook.
- Columns (including columns representing custom fields) in the worksheets should be formatted as Text.
- Import a maximum of 500 records in each data load.

Load Sequence

The data is loaded in the following sequence to create all necessary relationships between records:

1. The Assets worksheet is processed. The Data Loader searches for the asset that corresponds to the Asset ID, Asset CMMS System, Equipment Technical Number and Asset Family information that you provide in the Assets worksheet. If an asset specified on the worksheet does not exist, the worksheet and all the entries in the subsequent worksheets corresponding to that asset is skipped.
2. The RBIComponents_To_TMLGroups worksheet is processed. An existing RBI Component is looked up based on the Asset ID, Asset CMMS System, Equipment Technical Number, Component, and Component Type. If found, that RBI Component will be linked to the specified TML Group. If you do not specify any RBI Component, this worksheet is skipped.

If any of the RBI Component or TML Group records specified in the worksheet is not available in the database, an error is added to the log, and the row is skipped.

About the RBI Components To TML Groups Relationship Data Loader Workbook Layout and Use

To import data using the RBI Components To TML Groups Relationship Data Loader, GE Digital APM provides an Excel workbook, RBI Components To TML Groups Relationship.xlsx, which supports baseline Risk Based Inspection in GE Digital APM. This workbook must be used to link RBI Components to TML Groups.

Note: The Excel workbook is referred to throughout this documentation as the data loader workbook.

The following table provides a list of the worksheets that are included in the data loader workbook.

Worksheet	Description
Assets	This worksheet is used to specify existing Asset records to which components are linked.
RBIComponents_To_TMLGroups	This worksheet is used to link RBI Components to TML Groups.
(PickList)	This worksheet details the valid values available for fields that have pick lists. When you load data using the data loader, the data on this worksheet is not loaded.

Color Coding

Certain columns on the worksheets have different functions and requirements. To illustrate this, certain columns are color-coded. The following table lists the colors and what they represent.

Color	Description	Comments
Gray	Required Key Fields	Indicates columns that contain values that are used by the Risk Based Inspection (RBI) Corrosion Loop Data Loader to look up and create records. If these columns are removed from the worksheets, the data load will fail. While the worksheets require that these columns be present, values are not necessarily required in these columns.
Red	Fields Required for Saving Records	Indicates columns that contain values that are required to save the record.
Blue	Recommended Fields	Indicates columns that, according to GE Digital APM Best Practice for Inspection Management, should contain values.
None	Custom Fields	Indicates columns in which you can specify custom fields.

Limitations

The RBI Components To TML Groups Relationship Data Loader has the following limitations:

- The values that you enter in the data loader workbook are case-sensitive.
- If there are multiple components with same ID within an asset, the TML group is mapped only to the first component and the remaining components are ignored.

Assets Worksheet

In the Assets worksheet, you can specify assets. You can link the RBI Components that belongs to the assets specified in this worksheet to the TML groups. The columns that appear on this worksheet also appear on every subsequent worksheet, and are used to identify the records that will be linked, directly or indirectly, to the assets.

Note: Each row in this worksheet represents a unique asset. You should not include the same asset more than once.

Field Caption	Field ID	Data Type (Length)	Comments
Asset ID	MI_EQUIP000_EQUIP_ID_C	Character (255)	This column requires at least one cell to have a value. For a Functional Location asset, the field MI_FNCLOC00_FNC_LOC_C must be used.
Asset CMMS System	MI_EQUIP000_SAP_SYSTEM_C	Character (255)	If the Asset record has a value in the CMMS System field, that value is required in this cell. For a Functional Location asset, the field MI_FNCLOC00_SAP_SYSTEM_C must be used.
Asset Family	ASSET_FAMILY_ID	Character (255)	This column is required when loading Functional Location assets. If no value is provided, the asset is considered as an Equipment asset. Note: The following are the valid values: <ul style="list-style-type: none"> • MI_EQUIP000 • MI_FNCLOC00
Equipment Technical Number	MI_EQUIP000_EQUIP_TECH_N BR_C	Character (255)	If you are required to enter a value for the CMMS System cell for an equipment asset, and the Equipment record has a value in the Equipment Technical Number field, that value is required in this cell. If there is no value in the CMMS System field, this cell can be blank, even if the Equipment record contains a value for the Equipment Technical Number field. Note: This field must be left blank for a Functional Location asset.

RBIComponents_To_TMLGroups

In the RBIComponents_To_TMLGroups worksheet, you can specify the RBI Components and the corresponding TML Groups that you want to link.

Note: Each row represents a unique component, though multiple components may be related to the same asset.

Asset ID	MI_EQUIP000_EQUIP_ID_C	Character (255)	Values in this column must match values entered on the Assets worksheet.
Asset CMMS System	MI_EQUIP000_SAP_SYSTEM_C	Character (255)	Values in this column must match values entered on the Assets worksheet, if they exist.
Equipment Technical Number	MI_EQUIP000_EQUIP_TECH_N BR_C	Character (255)	Values in this column must match values entered on the Assets worksheet, if they exist.
Component	MI_RBICOMPO_COMPO_C	Character (250)	A value is required. Enter the RBI Component ID.
Component Type	MI_RBICOMPO_COMPO_TYPE_ C	Character (60)	A value is required. In the baseline GE Digital APM system, this cell may only contain one of the values available in the (Picklist) worksheet.
TML Group ID	MI_TMLGROUP_ID_C	Character (50)	A value is required. Enter the TML Group ID that you want to link to the specified RBI Component.

Chapter 20

Deployment and Upgrade

Topics:

- [Deployment](#)
- [Upgrade](#)

Deployment

Deployment

Refer to the deployment information here [Deploy RBI for the First Time](#).

Upgrade

Upgrade

Refer to the upgrade information here [Upgrade or Update RBI 580 to V5.1.0.0.0](#).

Chapter 21

Reference

Topics:

- [General Reference](#)
- [Data Models](#)
- [Family Field Descriptions](#)
- [Catalog Items](#)
- [Calculations](#)
- [Family Search Configuration](#)
- [Policies](#)
- [Mappings](#)
- [Reports](#)

General Reference

The MIExecution Service

The MIExecution Service is a service available in the GE Digital APM server, which processes jobs in the Inspection Management, Integrity Mobile, Risk Based Inspection, and Thickness Monitoring module queues. It uses a single shared ActiveMQ queue service across GE Digital APM.

Supported Job Types

- Inspection Management
- Integrity Mobile
- Risk Based Inspection
- Thickness Monitoring

Configuration

You can configure the following parameters of the MIExecution Service:

Parameter	Description	Default Value
ConcurrencyLimit	The maximum number of messages consumed concurrently.	100
Retries	The number of times the service retries to send the messages to ActiveMQ in case of a failure.	5

For instructions of configuring these settings, refer to .

RBI URLs

There is one URL route associated with Risk Based Inspection: rbi. The following table describes the various paths that build on the route, and the elements that you can specify for each.

Element	Description	Accepted Value(s)	Notes
rbi/unit : Opens the Risk Based Inspection Overview page.			
rbi/unit/<UnitEntityKey> : Displays the selected unit on the Risk Based Inspection Overview page.			
<UnitEntityKey>	Specifies the RBI unit that you want to view.	Any Unit Entity Key that corresponds to an asset in the Asset Hierarchy.	The Unit Entity Key must be present in the URL to display the correct page.

Element	Description	Accepted Value(s)	Notes
<p>rbi/processunit/<ProcessUnitEntityKey>: Opens the Unit Summary page for the selected process unit.</p> <p>rbi/processunit/<ProcessUnitEntityKey>/corrosionloop/<CorrosionLoopEntityKey>: Displays the Corrosion Loop Overview section.</p> <p>rbi/processunit/<ProcessUnitEntityKey>/corrosionloop/<CorrosionLoopEntityKey>/component/<ComponentEntityKey>: Displays the selected Component Overview section.</p> <p>rbi/processunit/<ProcessUnitEntityKey>/corrosionloop/<CorrosionLoopEntityKey>/component/<ComponentEntityKey>/analysis/AnalysisEntityKey: Displays the selected Analysis Details section.</p> <p>rbi/processunit/<ProcessUnitEntityKey>/corrosionloop/<CorrosionLoopEntityKey>/component/<ComponentEntityKey>/protectedasset/<ProtectedAssetEntityKey>: Displays the selected protected asset on the Asset Summary page.</p> <p>rbi/processunit/<ProcessUnitEntityKey>/corrosionloop/<CorrosionLoopEntityKey>/component/<ComponentEntityKey>/protectedcomponent/<ProtectedComponentEntityKey>: Displays the Component Details section for the selected protected component.</p> <p>rbi/processunit/<ProcessUnitEntityKey>/corrosionloop/<CorrosionLoopEntityKey>/component/<ComponentEntityKey>/protectedcomponent/<ProtectedComponentEntityKey>/analysis/<AnalysisEntityKey>: Displays the Analysis Details section for the selected protected component.</p> <p>rbi/processunit/<ProcessUnitEntityKey>/asset/<AssetEntityKey>: Displays the selected Asset Overview section.</p> <p>rbi/processunit/<ProcessUnitEntityKey>/asset/<AssetEntityKey>/component/<ComponentEntityKey>: Displays the selected Component Details section.</p> <p>rbi/processunit/<ProcessUnitEntityKey>/asset/<AssetEntityKey>/component/<ComponentEntityKey>/analysis/<AnalysisEntityKey>: Displays the Analysis Details section for the selected analysis.</p> <p>rbi/processunit/<ProcessUnitEntityKey>/asset/<AssetEntityKey>/protectedcomponent/<ProtectedComponentEntityKey>/analysis/<AnalysisEntityKey>: Displays the Analysis Details section for the selected analysis.</p> <p>rbi/processunit/<ProcessUnitEntityKey>/asset/<AssetEntityKey>/component/<ComponentEntityKey>/protectedasset/<ProtectedAssetEntityKey>: Displays the Asset Overview section.</p> <p>rbi/processunit/<ProcessUnitEntityKey>/asset/<AssetEntityKey>/component/<ComponentEntityKey>/protectedcomponent/<ProtectedComponentEntityKey>: Displays the Component Details section.</p>			
<ProcessUnitEntityKey>	Specifies the RBI Process Unit that you want to view.	Any Process Unit Entity Key that corresponds in the RBI tree.	The Process Unit Entity Key must be present in the URL to display the correct page.
<CorrosionLoopEntityKey>	Specifies the Corrosion Loop that you want to view.	Any Corrosion Loop Entity Key that corresponds to a Corrosion Loop in the RBI tree.	The Corrosion Loop Entity Key must be present in the URL to display the correct page.
<ComponentEntityKey>	Specifies the RBI Component that you want to view.	Any Component Entity Key that corresponds to an RBI Component in the RBI tree.	The Component Entity Key must be present in the URL to display the correct page.
<AnalysisEntityKey>	Specifies the RBI Analysis that you want to view.	Any Analysis Entity Key that corresponds to an RBI Analysis in the RBI tree.	The Analysis Entity Key must be present in the URL to display the correct page.
<ProtectedAssetEntityKey>	Specifies the protected asset that you want to view.	Any Protected Asset Entity Key that corresponds to a protected asset in the RBI tree.	The Protected Asset Entity Key must be present in the URL to display the correct page.

Element	Description	Accepted Value(s)	Notes
<ProtectedComponentEntityKey>	Specifies the Protected Component that you want to view.	Any Protected Component Entity Key that corresponds to a Protected Component in the RBI tree.	The protected Component Entity Key must be present in the URL to display the correct page.
<p>rbi/asset/<AssetEntityKey>: Displays the selected asset on the Asset Summary page.</p> <p>rbi/asset/<AssetEntityKey>/component/<ComponentEntityKey>: Displays the selected Component Details section of the Asset Summary page.</p> <p>rbi/asset/<AssetEntityKey>/component/<ComponentEntityKey>/analysis/<AnalysisEntityKey>: Displays the Analysis Details section of the Asset Summary page.</p> <p>rbi/analysis/<AnalysisEntityKey>: Displays the Analysis Details section of the Asset Summary page.</p> <p>rbi/asset/<AssetEntityKey>/protectedcomponent/<ProtectedComponentEntityKey>/analysis/<AnalysisEntityKey>: Displays the Analysis Details section of the Asset Summary page.</p>			
<AssetEntityKey>	Specifies the RBI asset that you want to view in the RBI tree.	Any Asset Entity Key that corresponds to an asset in the RBI tree	The Asset Entity Key must be present in the URL to display the correct page.
<ComponentEntityKey>	Specifies the RBI Component that you want to view in the RBI tree.	Any Component Entity Key that corresponds to an RBI Component in the RBI tree.	The Component Entity Key must be present in the URL to display the correct page.
<AnalysisEntityKey>	Specifies the RBI Analysis that you want to view in the RBI tree.	Any Analysis Entity Key that corresponds to an RBI Analysis in the RBI tree.	The Analysis Entity Key must be present in the URL to display the correct page.
<p>rbi/corrosionloop/<CorrosionLoopEntityKey>: Displays the Corrosion Loop Summary page.</p>			
<CorrosionLoopEntityKey>	Specifies the Corrosion Loop that you want to view in the RBI Tree.	Any Corrosion Loop Entity Key that corresponds to a Corrosion Loop in the RBI Tree.	The Corrosion Loop Entity Key must be present in the URL to display the correct page.
<p>rbi/evergreen/<ContextEntityKey>: Displays the Ready for Evergreening tab in the Evergreening workspace.</p> <p>rbi/evergreen/<ContextEntityKey>/<JobKey>: Displays the Created tab in the Evergreening workspace.</p>			
<ContextEntityKey>	Specifies the Entity Key of the process unit or Functional Location.	The Entity Key of a Functional Location or process unit in the RBI Tree.	The Entity Key must be present in the URL to display the correct page. A value of -1 can be used to access the home level of the Asset Hierarchy.
<JobKey>	Specifies the scheduled job that processes an RBI analysis duplication.	The Job Key of a scheduled job for an RBI analysis duplication.	None.

Element	Description	Accepted Value(s)	Notes
rbi/whatif/<ContextEntityKey>	Displays the Pending What-If Analysis Creation section in the Create What-If Analyses workspace.		
<ContextEntityKey>	Specifies the Entity Key of the process unit or Functional Location.	The Entity Key of a Functional Location or process unit in the RBI Tree.	The Entity Key must be present in the URL to display the correct page. A value of -1 can be used to access the home level of the Asset Hierarchy.

URLs

Example URL	Destination
rbi/unit	The Risk Based Inspection Overview page.
rbi/unit/2305330	The Risk Based Inspection Overview page for the specified unit.
rbi/processunit/64253024663	The Unit Overview section for the specified process unit.
rbi/processunit/64253024663/corrosionloop/64253024702	The Corrosion Loop Overview section for the specified process unit.
rbi/processunit/64253024663/corrosionloop/64253024702/component/64253024704	The Component Overview section for the specified process unit.
rbi/processunit/64253024663/corrosionloop/64253024702/component/64253024704/analysis/64253024712	The Analysis Details section for the specified process unit.
rbi/processunit/64253024663/corrosionloop/64253024702/component/64253024704/protectedasset/2509506	The protected Asset Summary page for the specified process unit.
rbi/processunit/64253024663/corrosionloop/64253024702/component/64253024704/protectedcomponent/64253024705	The protected Component Overview page for the specified process unit.
rbi/asset/2509505	The Asset Summary page for the specified asset.
rbi/asset/2509505/component/3476094	The Component Details section of the Asset Summary page for the specified RBI Component.

Example URL	Destination
rbi/asset/2509505/component/ 3476094/analysis/3221498 -or- rbi/analysis/3221498	The Analysis Details section of the Asset Summary page for the specified RBI Analysis.
rbi/corrosionloop/4842819	The Corrosion Loop Summary page for the specified Corrosion Loop.
rbi/evergreening/64262527134	The Ready for Evergreening or the Created tab in the Evergreening workspace.
rbi/whatif/64262527134	The Pending What-If Analysis Creation section in the Create What-If Analyses workspace.
rbi/processunit/64262527107/ asset/64262527140	The Asset Overview for the selected Asset in the Asset view on the Process Unit Tree.
rbi/processunit/64262527107/ asset/64262527140/ component/64262527710	The Component Details section of the selected Component in the Asset view on the Process Unit Tree.
rbi/processunit/64262527107/ asset/64262527140/ component/64262527710/ analysis/64262527727	The Analysis Details section for the selected analysis in the Asset view on the Process Unit Tree.

Inspection Plan URLs

The following table describes the various paths that are used for the Inspection Plan workflow.

Element	Description	Accepted Value(s)	Notes
cm/asset/<assetKey>	Accesses the Inspection Plan for the specified asset.		
cm/plans	Accesses the Inspection Plan Management page.		
<assetKey>	Specifies the entity key of the asset record which you want to view.	Any asset key that is associated with an asset in the Asset Hierarchy	You should use the asset key of an asset that has an Inspection Plan created. If you select an asset that does not have an Inspection Plan, a warning message appears.

URLs	
Example URL	Destination
cm/asset/3290820029	The Inspection Plan for the selected asset.

Inspection Group URLs

The following table describes the various paths that are used for the Inspection Group workflow.

Element	Description	Accepted Value(s)	Notes
rbi/unit/<UnitKey>/inspectiongroup/: Accesses the Inspection Grouping page.			
rbi/unit/<UnitKey>/inspectiongroup/<InspectionGroupKey>: Accesses the Inspection Grouping page and ensures that the specified group is selected.			
<UnitKey>	Specifies the level of the Asset Hierarchy for the RBI Process Unit that you want to view.	Any Unit Key that corresponds to an asset in the Asset Hierarchy.	The Unit Key must be present in the URL to display the correct page.
<InspectionGroupKey>	Specifies the level of the Inspection Group related to the process unit.	Any Inspection Group key that is related to the given process unit.	This is an optional key, if the Inspection Group key is not provided then it will select the first group in the Inspection Group tree, and if the Inspection Group key is provided then it will select the specified group in the Inspection Group tree.

RBI 580 and Pipeline Management System Code Tables

The following table lists the System Code Tables that are used by RBI 580 and Pipeline Management.

RBI 580

Table ID	Table Description	Function
CORROSION TYPES	Corrosion Types	Populates the Thinning Type list in Grouping Element records.
MI_DAMAGE_FACTOR	Damage Factor Class	The values in this System Code Table are used when you calculate an RBI PRD Analysis.
MI_DEGRADATION_MECHANISM_TYPES	Degradation Mechanism Types	Populates the Degradation Mechanism list in Potential Degradation Mechanism records.
MI_GROUPING_CORR_TYPE	Grouping Corrosion Types	Populates the Corrosion Type list.

Table ID	Table Description	Function
MI_GROUPING_EQP_TYPE	Grouping Equipment Types	Populates the Grouping Equipment Type list.
MI_INSPECTION_RESULT	Inspection Result	Populates the Test Results list in Criticality Over Pressure Deg. Mech. Eval. and Criticality Leak Deg. Mech. Eval. records.
MI_PDM_FILTER	MI RBI, Potential Degradation Filter	Used to limit the Potential Degradation Mechanisms records that can be linked to RBI Components.
MI_PRD_DISCHARGE_LOCATION	MI PRD DISCHARGE LOCATION	Populates the PRD Discharge Location list in RBI PRD Criticality Analysis records.
MI_PROTECTED_EQUIP_TYPES	Protected Equipment Types	Populates the Protected Asset Type list in RBI PRD Criticality Analysis records.
MI_RBI_Area_Humidity	MI RBI Area Humidity	Populates the Area Humidity field in the following records: <ul style="list-style-type: none"> RBI Components RBI Criticality Analysis
MI_RBI_Coating_Quality	MI RBI Coating Quality	Populates the Coating Quality field in Criticality Ext. Corr. Deg. Mech. Eval. records.
RBI_INT_COR_TYPE	RBI Internal Corrosion Type	Populates the Selected Corrosion Rate field on Criticality Int Corr. Deg. Mech. Eval. records. <ul style="list-style-type: none"> 0 = Estimated Rate 1 = Short Term Average Corrosion Rate 2 = Long Term Average Corrosion Rate 3 = Controlling Corrosion Rate
MI_RBI_RISK_CATEGORY	RBI Risk Category	Populates the Risk Category list in Inspection Group records.
MI_SERVICE_SEVERITY	Severity of the Process Fluid	Populates the Service Severity list in RBI PRD Criticality Analysis records.
MI_STRESS_LOOKUP_TABLE	MI_STRESS_LOOKUP_TABLE	Populates the Stress Lookup Table field in the following records: <ul style="list-style-type: none"> RBI Components RBI Criticality Analysis
MI_CONF_CALC_ACTIONS	RBI Flexible Calculation Actions	Populates the list in the Action field in Flexible Calculation Configuration records.
MI_CONF_VAL_ACTIONS	RBI Flexible Validation Actions	Populates the list in the Action field in Flexible Calculation Validation records.

Pipeline Management

The following table lists the System Code Tables that are used by Pipeline Management.

Table ID	Table Description	Function
MI_PIPELINEBELOWWATERSURFACE	Depth Below Water Surface	The values in this table are used to populate the list in the Below Water Surface field in Criticality Third Party Deg. Mech. Eval. records.
MI_PIPELINEPROTECTIONCOVER	Mechanical Pipe Protection	The values in this table are used to populate the list in the Mechanical Pipe Protection field in Criticality Third Party Deg. Mech. Eval. records.
MI_PIPELINEWARNINGSTRIP	Warning Strip	The values in this table are used to populate the list in the Pipeline Marker Tape field in Criticality Third Party Deg. Mech. Eval. records.
MI_PIPELINEBELOWBOTTOMWATERWAY	Depth Below Bottom of Waterway	The values in this table are used to populate the list in the Below Bottom of Waterway field in Criticality Third Party Deg. Mech. Eval. records.
MI_PIPELINECONCRETECOATING	Concrete Coating	The values in this table are used to populate the list in the Concrete Coating field in Criticality Third Party Deg. Mech. Eval. records.
MI_PIPELINEACTIVITYLEVEL	Activity Level	The values in this table are used to populate the list in the Activity Level field in Criticality Third Party Deg. Mech. Eval. records.
MI_PIPELINEABOVEGROUND FACILITY	Above Ground Facilities	The values in this table are used to populate the list in the Above Ground Facilities field in Criticality Third Party Deg. Mech. Eval. records.
MI_PIPELINELINELOCATING	Line Locating (One-Call System)	The values in this table are used to populate the list in the One-Call System field in Criticality Third Party Deg. Mech. Eval. records.
MI_PIPELINE EDUCATION PROGRAM	Public Education Program	The values in this table are used to populate the list in the Public Education field in Criticality Third Party Deg. Mech. Eval. records.
MI_PIPELINERIGHTOFWAY	Right-Of-Way Condition	The values in this table are used to populate the list in the Right-Of-Way Condition field in Criticality Third Party Deg. Mech. Eval. records.

Table ID	Table Description	Function
MI_PIPELINEPATROLFREQ	Patrol Frequency	The values in this table are used to populate the list in the Patrol Frequency field in Criticality Third Party Deg. Mech. Eval. records.
MI_PIPELINEPREVIOUSDAMAGE	Previous Damage	The values in this table are used to populate the list in the Previous Damage field in Criticality Third Party Deg. Mech. Eval. records.
MI_PIPELINELANDMOVEMENTPOTENTIAL	Land Movement Potential	The values in this table are used to populate the list in the the RBI Pipeline Analysis and Criticality RBI Pipeline Segment families.
MI_PIPELINEPRESSURESURGEPOTENTIAL	Pressure Surge Potential	The values in this System Code Table are used by the RBI Pipeline Analysis and Criticality RBI Pipeline Segment families.
MI_PIPELINESCADA	SCADA Level	The values in this table are used to populate the list in the SCADA field in the RBI Pipeline Analysis and Criticality RBI Pipeline Segment families.
MI_PIPELINEPOPULATIONDENSITYADJUSTED	Population Density Adjustment	The values in this System Code Table are used to populate the list in the Population Density field in Pipeline Consequence Evaluation records.
MI_PIPELINESOILTYPEFACTOR	Soil Type Factor	The values in this System Code Table are used to populate the list in the Soil Type field in Pipeline Consequence Evaluation records.
MI_PIPELINEHIGHVALUEAREAFACOR	High Value Area Factor	The values in this System Code Table are used to populate the list in the High Value Area field in Pipeline Consequence Evaluation records.
MI_PIPELINESSUGGESTEDCLEANUPCOSTS	Suggested Clean Up Costs	The values in this System Code Table are used to populate the list in the Suggested Clean Up field in Pipeline Consequence Evaluation records.
MI_PIPELINE_SEGMENT_TYPE	Segment Type	The values in this System Code Table are used to populate the list in the Segment Type field in RBI Pipeline Segment records.
MI_RBI_Area_Humidity	MI RBI Area Humidity	Populates the Area Humidity field in the following records: <ul style="list-style-type: none"> RBI Components RBI Pipeline Analysis

Table ID	Table Description	Function
MI_RBI_Insulation_Condition	MI RBI Insulation Condition	Populates the Insulation Condition field in Criticality Ext. Corr. Deg. Mech. Eval records.
MI_STRESS_LOOKUP_TABLE	MI_STRESS_LOOKUP_TABLE	Populates the Stress Lookup Table field in the following records: <ul style="list-style-type: none"> • RBI Components • RBI Pipeline Analysis

MI RBI COMPONENT FAMILIES System Code Table

The following table lists the Component Families and the Component Types that are supported for each Component Family in the MI RBI COMPONENT FAMILIES system code table.

Component Family	Supported Component Type
Criticality RBI Component-Cylindrical Shell	<ul style="list-style-type: none"> • 1" Pipe • 1.25" Pipe • 1.5" Pipe • 1/2" Pipe • 10" Pipe • 102" Pipe • 12" Pipe • 14" Pipe • 16" Pipe • 18" Pipe • 2" Pipe • 2.5" Pipe • 24" Pipe • 26" Pipe • 28" Pipe • 3" Pipe • 3/4" Pipe • 30" Pipe • 32" Pipe • 34" Pipe • 36" Pipe • 4" Pipe • 40" Pipe • 42" Pipe • 48" Pipe • 5" Pipe • 54" Pipe • 56" Pipe • 6" Pipe • 60" Pipe • 8" Pipe • 90" Pipe • Column-Bottom • Column-Middle • Column-Top • Filter • Heat Exchanger-Shell • Pressure Vessel • Reactor • Storage Tank

Component Family	Supported Component Type
Criticality RBI Component-Piping	<ul style="list-style-type: none"> • 1" Pipe • 1.25" Pipe • 1.5" Pipe • 1/2" Pipe • 10" Pipe • 102" Pipe • 12" Pipe • 14" Pipe • 16" Pipe • 18" Pipe • 2" Pipe • 2.5" Pipe • 20" Pipe • 24" Pipe • 26" Pipe • 28" Pipe • 3" Pipe • 3/4" Pipe • 30" Pipe • 32" Pipe • 34" Pipe • 36" Pipe • 4" Pipe • 40" Pipe • 42" Pipe • 48" Pipe • 5" Pipe • 54" Pipe • 56" Pipe • 6" Pipe • 60" Pipe • 8" Pipe • 90" Pipe

Component Family	Supported Component Type
Criticality RBI Pipeline Segment	<ul style="list-style-type: none"> • 1" Pipe • 1.25" Pipe • 1.5" Pipe • 1/2" Pipe • 10" Pipe • 102" Pipe • 12" Pipe • 14" Pipe • 16" Pipe • 18" Pipe • 2" Pipe • 2.5" Pipe • 20" Pipe • 24" Pipe • 26" Pipe • 28" Pipe • 3" Pipe • 3/4" Pipe • 30" Pipe • 32" Pipe • 34" Pipe • 36" Pipe • 4" Pipe • 40" Pipe • 42" Pipe • 48" Pipe • 5" Pipe • 54" Pipe • 56" Pipe • 6" Pipe • 60" Pipe • 8" Pipe • 90" Pipe
Criticality RBI Component-Exchanger Bundle	Heat Exchanger-Bundle
Criticality RBI Component-Exchanger Header	<ul style="list-style-type: none"> • Air Cooled Exchanger-Header • Fin/Fan Cooler • Heat Exchanger-Channel
Criticality RBI Component-Exchanger Tube	Air Cooled Exchanger-Tbs
Criticality RBI Component-Pump Compressor Casing	<ul style="list-style-type: none"> • Compressor • Pump
Criticality RBI Component-Tank Bottom	<ul style="list-style-type: none"> • Storage Tank • Storage Tank Bottom

Component Family	Supported Component Type
Criticality PRD Component-Relief Valve	<ul style="list-style-type: none"> • Conventional PRD • Balanced Bellows PRD • Pilot-Operated PRD • PRD with Rupture Disk
Criticality PRD Component-Rupture Disk	Rupture Disk Only

About Potential Degradation Mechanisms (PDM)

Potential Degradation Mechanisms (PDM) records are used to represent ways in which a component might fail (e.g., mechanical fatigue). These records can be linked to RBI Components and are used to predict and prevent mechanical failure. Each Potential Degradation Mechanisms record that is linked to a Corrosion Loop represents a degradation mechanism, or a way in which the components in that Corrosion Loop might fail.

After a Corrosion Loop is linked to PDMs, as you link RBI Components to the Corrosion Loop, those RBI Components will be linked automatically to all of the Potential Degradation Mechanisms that are linked to the Corrosion Loop. Each PDM that is linked to an RBI Component represents a way in which that component can fail.

Baseline Potential Degradation Mechanisms (PDMs)

GE Digital APM provides several Potential Degradation Mechanisms that are classified as follows, based on the value in the Methodology Type field:

- Qualitative
- Quantitative

All of the PDMs apply to RBI Components. Pressure Relief Devices (PRDs) have a separate set of PDMs, which are different from the ones related to RBI 580 and RBI 581.

GE Digital APM provides the following Qualitative Potential Degradation Mechanisms:

- 885 Embrittlement
- Amine Cracking (ASCC)
- Brittle Fracture
- Carbonate Cracking
- Carburization
- Caustic Cracking
- Chloride Stress Corrosion Cracking (CI SCC)
- Creep
- Criticality Calculator External Corrosion
- Criticality Calculator Internal Corrosion
- Erosion
- Ext Chloride SCC
- Graphitization
- Hot Hydrogen Attack
- Hydrogen Embrittlement
- Hydrogen Induced Cracking
- Hydrogen Stress Cracking (HSC)- Hydrofluoric Acid
- Liquid Metal Embrittlement
- Mechanical Fatigue

- Phase Change Embrittlement
- Polythionic Acid SCC (PTA)
- Refractory Failure
- Stress Corrosion Cracking
- Sulfide Stress Cracking (SSC)
- Temper Embrittlement
- Thermal Fatigue
- Wet H₂S (Blistering, SOHIC, HIC, SSC)
- Wet H₂S Damage

PDMs for PRD Components:

- Blocked Discharge
- Blocked Discharge - Admin Control
- Control Valve Failure (Fail Opposite)
- Control Valve Failure (Fail Safe)
- Electrical Power Failure
- Exchanger Tube Rupture
- Fire
- Liquid Overfill
- Liquid Overfill - Admin Control
- Loss of Cooling
- Runaway Reaction
- Thermal Relief
- Thermal Relief - Admin Control
- Tower Pump Failures
- Leak

Valid Fluids for RBI Criticality Analyses

The following toxic fluids are valid for RBI 580. When you create an RBI Criticality Analysis, you must select one of the following values in the **Toxic Mixture Fluid** box.

- 15% H₂
- 2-Methoxyethanol
- Acetic Acid
- Acetic Anhydride
- Acetone
- Acetonitrile
- ACR (Acrolein)
- AIR
- Amine
- AN (Acrylonitrile)
- Asphalt
- Benzene
- BF₃
- C1
- C10 (Kerosene)
- C11
- C12

- C13-16 (Diesel)
- C17-25 (Gas Oil)
- C2
- C25+ (Resid)
- C3
- C4
- C5
- C6
- C7
- C8 (Gasoline)
- C9
- Calcium Acetate
- Calcium Chloride
- Caustic (20%)
- CCL4
- Chlorine
- CO
- CO2
- Crude
- Diesel
- DMDS (Di-methyl disulfide)
- DMF (Dimethyl Floride)
- DMS (Dimethyl Sulfide)
- EDA (Ethylenediamine)
- Eliminox
- EO
- ETOH (Ethanol)
- Freon 22
- Fuel Oil
- Furfural
- Gasoline
- Glycol
- H2
- H2O (Water)
- H2S
- H2SO4
- HCHO
- HCl
- HCN
- HF
- Hydrazine
- Hydroquinone
- IPAC (Isopropyl Alcohol)
- Kerosene
- Ketene
- KOH
- MDEA
- MEK (Methyl Ethyl Keytone)

- MEO (Methyl Ethyl Oleate)
- MEOH (Methanol)
- Methanol Brine
- Methyl Mercapta
- Methylene Chloride
- MTBE
- N2
- Na2SO3
- NAOH
- Naptha
- NH3
- Oleum
- Perchloroethylene
- Perchloromethylmercaptan
- Peroxide
- Petroleum Gases
- Phosgene
- Propanol
- Propionitrile
- Propylene Oxide
- Steam
- Sulfur
- Sulfur Dioxide
- Sulfur Trioxide
- TBA (Tert-Butyl Alcohol)
- Toluene
- TSP (Trisodium Phosphate)
- VAM
- Xylene

RBI 580 Representative Fluids

RBI 580 Representative Fluid Contents in GE Digital APM Version V4.3.1.0.0

Fluid	MolWt	DensityLiq	BoilPt	Ambient State	Specific Heat Equation Ref	Ideal Gas Const A	Ideal Gas Const B	Ideal Gas Const C	Ideal Gas Const D	Ideal Gas Const E	AIT	Fluid Type 581	Is Valid for 581 Analysis	Is valid toxic model for 581
C13-16 (Diesel)	205	47.728	502	Liquid	Note 1	-11.7	1.39E+00	-7.72E-04	1.67E-07		396	Type0	true	false
C17-25 (Gas Oil)	280	48.383	651	Liquid	Note 1	-22.4	1.94E+00	-1.12E-03	-2.53E-07		396	Type0	true	false

Fluid	MolWt	DensityLiq	BoilPt	Ambient State	Specific Heat Equation Ref	Ideal Gas Const A	Ideal Gas Const B	Ideal Gas Const C	Ideal Gas Const D	Ideal Gas Const E	AIT	Fluid Type 581	Is Valid for 581 Analysis	Is valid toxic model for 581
C25+ (Resid)	422	56.187	981	Liquid	Note 1	-22.4	1.94E+00	-1.12E-03	-2.53E-07		396	Type0	true	false
C5	72	39.03	97	Liquid	Note 1	-3.626	0.4873	-2.60E-04	5.30E-08		544	Type0	true	false
Chlorine	70	22.05	-30	Liquid							0	Type0	false	true
CO	28	50	-312	Gas	Note 2	2.91E+04	8.77E+03	3.09E+03	8.46E+03	1.54E+03	1128	Type1	true	true
EO	44	55	51	Gas	Note 2	3.35E+04	1.21E+05	1.61E+03	8.24E+04	7.37E+02	804	Type1	true	true
H2O (Water)	18	62.3	212	Liquid	Note 3	2.76E+05	-2.09E+03	8.125	-1.41E-02	9.37E-06	0	Type0	true	false
H2S	34	61.993	-75	Gas	Note 1	31.9	1.44E-03	2.43E-05	-1.18E-08		500	Type0	true	true
HCl	36	74	-121	Gas	Note 1	29.244	-2.62E-03	1.12E-06	4.97E-09	-2.50E-12	3200	Type0	true	true
HF	20	60.37	68	Gas	Note 1	29.1	6.61E-04	-2.03E-06	2.50E-09		0	Type0	true	true
MEOH (Methanol)	32	50	149	Liquid	Note 2	3.93E+04	8.79E+04	1.92E+03	5.37E+04	8.97E+02	867	Type1	true	false
NH3	17.03	38.55	-28.2	Gas	Note 1	27.26	2.31E-04	2.24E-07	2.17E-10	5.41E-14	3200	Type0	true	true
Phosgene	99	86	181	Liquid							0	Type0	true	true
Steam	18	62.3	212	Gas	Note 2	3.34E+04	2.68E+04	2.61E+03	8.90E+03	1.17E+03	0	Type0	true	false

RBI 580 Representative Fluid Contents in GE Digital APM Versions Older than V4.3.1.0.0

Fluid	MolWt	DensityLiq	BoilPt	Ambient State	Specific Heat Equation Reference	Ideal Gas Const A	Ideal Gas Const B	Ideal Gas Const C	Ideal Gas Const D	Ideal Gas Const E	AIT	Fluid Type 581	Is Valid for 581 Analysis	Is valid toxic model for 581
C13-16 (Diesel)	200	47	500	Liquid	Note 1	-11.7	1.39E+00	-7.72E-04	1.67E-07		400	Type0	Y	N
C17-25 (Gas Oil)	300	48	700	Liquid	Note 1	-22.4	1.94E+00	-1.12E-03	-2.53E-07		400	Type0	Y	N
C25+ (Resid)	400	49	800	Liquid	Note 1	-22.4	1.94E+00	-1.12E-03	-2.53E-07		400	Type0	Y	N
C5	71	40	92	Liquid	Note 1	-3.626	0.4873	-2.60E-04	5.30E-08		500	Type0	Y	N
CO	28	50.79	-312	Gas	Note 2	2.91E+04	8.77E+03	3.09E+03	8.46E+03	1.54E+03	0	Type1	Y	Y
EO	44	55.37	56	Gas	Note 2	3.35E+04	1.21E+05	1.61E+03	8.24E+04	7.37E+02	0		Y	Y
H2	2	4.4	-423	Gas	Note 1	27.1	9.27E-03	-1.38E-05	7.65E-09		500	Type0	Y	N
H2O (Water)	18	62.4	212	Liquid	Note 3	2.76E+05	-2.09E+03	8.125	-1.41E-02	9.37E-06	0	Type0	Y	N
H2S	34	6.64	-76	Gas	Note 1	31.9	1.44E-03	2.43E-05	-1.18E-08		0	Type0	Y	Y
HCl	36.47	74.5	-114	Gas							0	Type0	Y	Y
HF	20	61.65	67	Gas	Note 1	29.1	6.61E-04	-2.03E-06	2.50E-09		0	Type0	Y	Y
MEOH (Methanol)	32	49.6	148	Liquid	Note 2	3.93E+04	8.79E+04	1.92E+03	5.37E+04	8.97E+02	400	Type1	Y	N
NH3	17	50.9	-28	Gas							0	Type0	N	Y
Phosgene	99	86.86	47	Liquid							0	Type0	Y	Y
Steam	18	62.4	212	Gas	Note 3	3.34E+04	2.68E+04	2.61E+03	8.90E+03	1.17E+03	0		Y	N

About the RBI RISK MATRIX BY RBI COMPONENT Graph

The **RBI RISK MATRIX BY RBI COMPONENT** graph on the **Risk Based Inspection Overview** page plots the total number of components based on their consequence of failure and probability of failure values. A component is considered while plotting the graph only if the component is linked to an [active](#) RBI Criticality Analysis, RBI PRD Criticality Analysis, or RBI Pipeline Analysis.

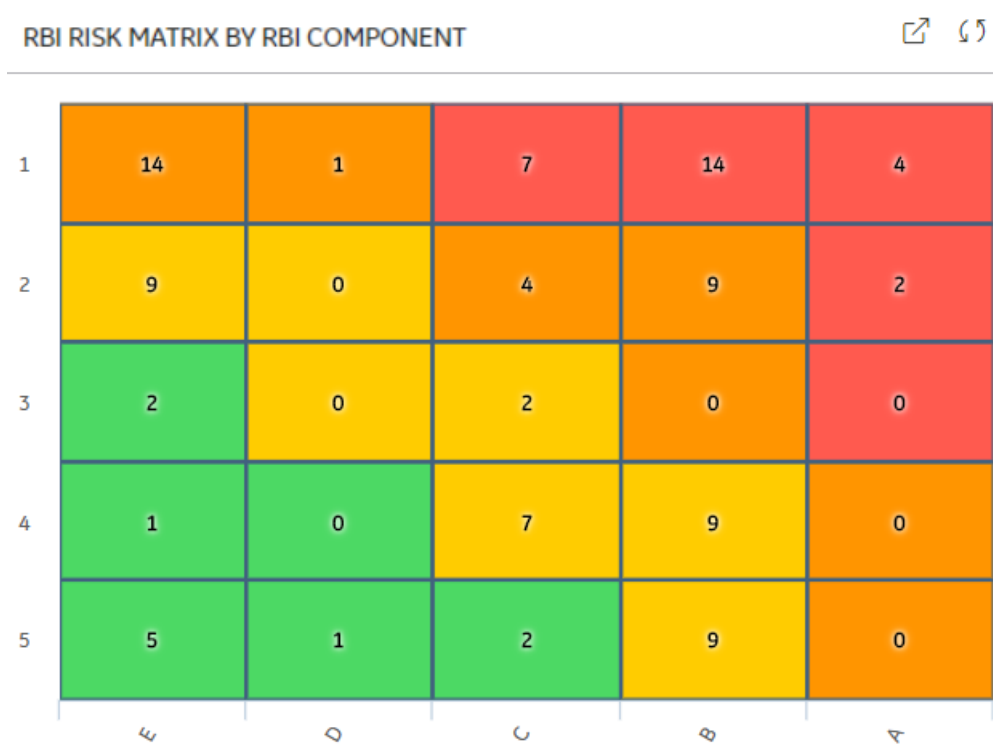

The color of each cell in the graph is based on the risk category, as described in the following table.

Risk Category	Color
Low	Green
Medium	Yellow
Medium High	Orange
High	Red

If you pause over a cell on the graph, the probability of failure and consequence of failure values appear, along with the number of components whose consequence of failure and probability of failure match the value in the cell. If you select the cell, the **RBI Risk Matrix** page appears, displaying the list of components that meet the aforementioned criteria, along with their asset details, inspection priority, risk category, consequence of failure, and probability of failure values.

You can access a component in the list by selecting the hyperlink in the **Component Description** column.

RBI Risk Matrix

Suppose there are five RBI Components (each linked to an active RBI Criticality Analysis) in an asset. The following table provides the consequence of failure and probability of failure values for the components.

Component Name	Consequence of Failure	Probability of Failure
Component 1	E	1
Component 2	E	3
Component 3	B	2
Component 4	E	1
Component 5	B	2

Since there are two components whose consequence of failure and probability of failure are E and 1 respectively, the number 2 appears in the E1 cell in the graph. Similarly, the numbers 2 and 1 appear in the B2 and E3 cells respectively.

When you select the E1 cell, the **RBI Risk Matrix** page appears, displaying the following list of components:

- Component 1
- Component 4

About RBI Criticality Analysis State Assignments and Operations

RBI Criticality Analysis uses specific states and operations from the baseline State Assignments of GE Digital APM.

In RBI, State Configuration is used in the following families:

- RBI Criticality Analyses
- RBI Recommendations
- Inspection Group

RBI State Assignments and Operations Diagram

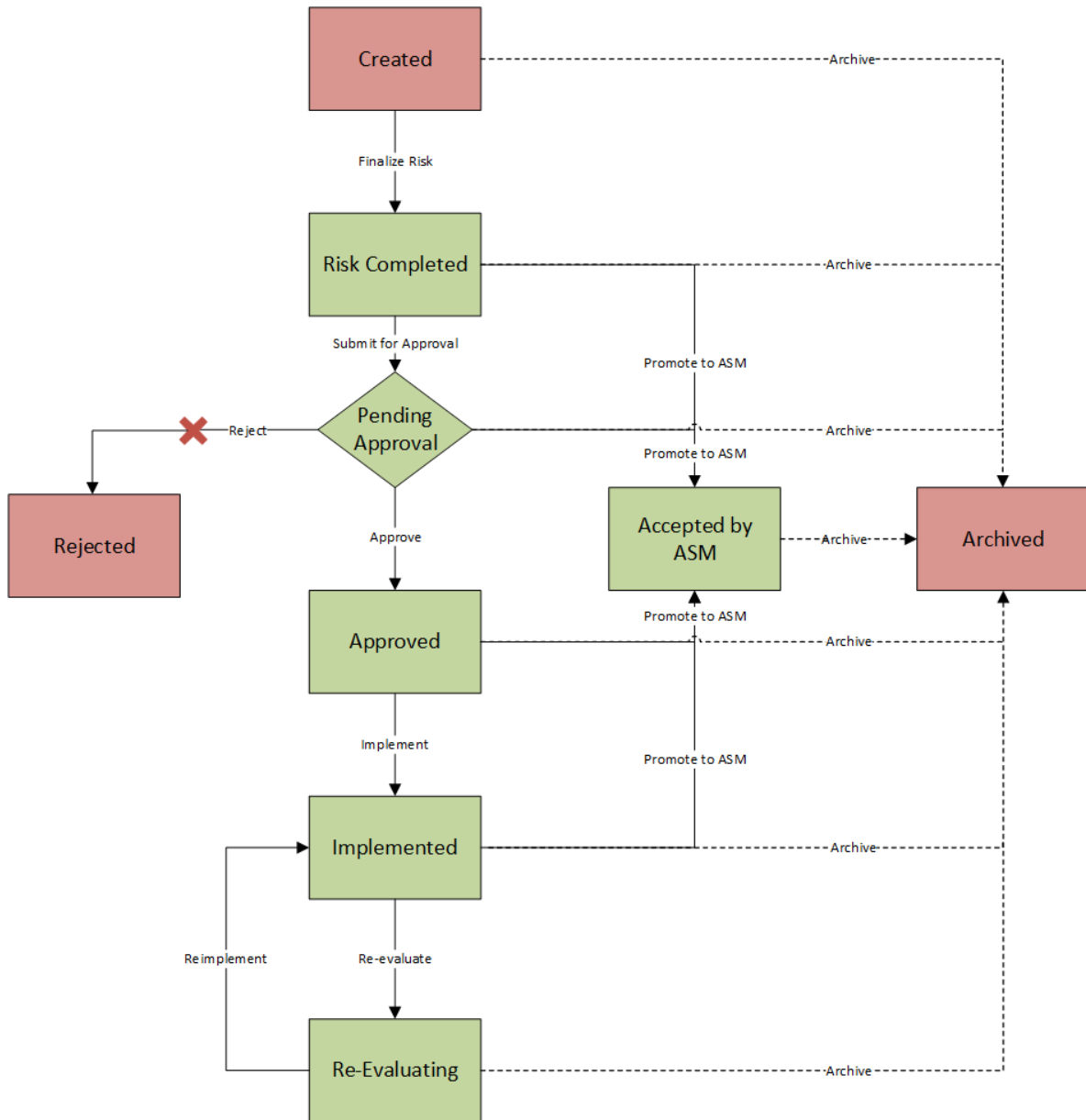

When an RBI Criticality Analysis is set to any of the states highlighted in green, the analysis is **active**. When an RBI Criticality Analysis is set to any of the states highlighted in red, the analysis is **inactive**.

Additionally, in the diagram, you can see dotted lines and solid lines.

- Dotted lines represent operations that are performed automatically when another RBI Criticality Analysis that is linked to the same RBI Component is set to Risk Completed.
- Solid lines represent operations that you can perform manually.

Details

Initial State: The Created state is the initial state of all new RBI Criticality Analyses.

Reserved States and Operations: The following tables state whether or not the baseline states and operations are reserved. You cannot remove or modify reserved states or operations. You can, however, add your own states and operations to State Assignment.

States	Is Reserved?
Approved	Yes
Accepted by ASM	Yes
Archived	Yes
Created	No
Implemented	Yes
Pending Approval	Yes
Re-Evaluating	Yes
Rejected	No
Risk Completed	Yes

Operations	Is Reserved?
Archive (all Archive operations)	Yes
Implement	No
Finalize Risk	No
Reevaluate	No
Approve	No
Reject	No
Reimplement	No
Promote to ASM	Yes
Submit for Approval	No

State Assignment Roles: By default, no State Assignment Roles are assigned to any state in the RBI Criticality Analysis State Assignment.

Analysis Restrictions Based on State

The following table outlines the actions that you can perform on an RBI Criticality Analysis based on its state.

Analysis State	Is Calculation Allowed?	Can Analysis Be Deleted?	Can Analysis Fields Be Modified?	Can RBI Degradation Mechanisms Be Added or Deleted?	Can What-If Analyses Be Created?	Can RBI Recommendations Be Created?
Created	Yes	Yes	Yes	Yes	Yes	No
Risk Completed	No	No	No	No	Yes	Yes
Pending Approval	No	No	No	No	No	No
Approved	No	No	No	No	No	No
Implemented	No	No	No	No	No	No
Archived	No	No	No	No	No	No
Rejected	No	No	No	No	No	No
Re-Evaluating	No	No	No	No	No	No
Accepted by ASM	No	No	No	No	No	No

Datasheet Configuration: By default, states and operations will appear in the datasheet when you access an RBI Criticality Analysis in RBI, the Record Manager, or the Bulk Data Form.

If an RBI Criticality Analysis is set to Risk Completed, however, you can modify the value in the Mitigated Risk field in the RBI Degradation Mechanism to which it is linked.

RBI 580 Security Groups

The following table lists the baseline Security Groups available for users within this module, as well as the baseline Roles to which those Security Groups are assigned.

Important: Assigning a Security User to a Role grants that user the privileges associated with all of the Security Groups that are assigned to that Role. To avoid granting a Security User unintended privileges, before assigning a Security User to a Role, be sure to review all of the privileges associated with the Security Groups assigned to that Role. Also, be aware that additional Roles, as well as Security Groups assigned to existing Roles, can be added via Security Manager.

Security Group	Roles
RBI Security Groups	
MI RBI Administrator	MI Mechanical Integrity Administrator
MI RBI Analyst	MI Mechanical Integrity Administrator MI Mechanical Integrity Power
MI RBI Viewer	MI APM Viewer MI Mechanical Integrity Viewer
RBI Policy Security Groups	
MI RBI Calculation Policy Designer	None

Security Group	Roles
MI RBI Calculation Policy Viewer	MI Mechanical Integrity Administrator MI Mechanical Integrity Power
MI RBI Recommendation Policy Designer	None
MI RBI Recommendation Policy Viewer	MI Mechanical Integrity Administrator MI Mechanical Integrity Power
MI RBI Risk Mapping Policy Designer	None
MI RBI Risk Mapping Policy Viewer	MI Mechanical Integrity Administrator MI Mechanical Integrity Power

The baseline family-level privileges that exist for these Security Groups are summarized in the following table.

Security Group	Privileges to the Policy Family
MI RBI Calculation Policy Designer	View, Update, Insert, Delete
MI RBI Calculation Policy Viewer	View
MI RBI Recommendation Policy Designer	View, Update, Insert, Delete
MI RBI Recommendation Policy Viewer	View
MI RBI Risk Mapping Policy Designer	View, Update, Insert
MI RBI Risk Mapping Policy Viewer	View

For more information about the State Management process for Inspection Plans, refer to State Management for Inspection Plans.

The following table provides a list of the baseline family-level privileges that exist for the MI RBI Administrator, MI RBI Analyst, and MI RBI Viewer Security Groups.

Note: If you have activated only the Risk Based Inspection license (and not the RBI 581 license), privileges to some of the following families do not exist for the MI RBI Administrator, MI RBI Analyst, and MI RBI Viewer Security Groups.

Family	MI RBI Administrator	MI RBI Analyst	MI RBI Viewer
Entity Families			
Inspection Group	View, Update, Insert, Delete	View, Update, Insert, Delete	View
Compliance Recommendation	View	View, Update, Insert, Delete	View
Consequence Evaluation Factors	View, Update, Insert, Delete	View	View
Corrosion	View	View	View
Corrosion Analysis Settings	View	View	View
Criticality Consequence Evaluation	View, Update, Insert, Delete	View, Update, Insert, Delete	View

Family	MI RBI Administrator	MI RBI Analyst	MI RBI Viewer
Criticality Env. Crack. Deg. Mech. Eval.	View, Update, Insert, Delete	View, Update, Insert, Delete	View
Criticality Ext. Corr. Deg. Mech. Eval.	View, Update, Insert, Delete	View, Update, Insert, Delete	View
Criticality Int. Corr. Deg. Mech. Eval.	View, Update, Insert, Delete	View, Update, Insert, Delete	View
Criticality Other Damage Mech. Eval.	View, Update, Insert, Delete	View, Update, Insert, Delete	View
Criticality RBI Component - Cylindrical Shell	View, Update, Insert, Delete	View, Update, Insert, Delete	View
Criticality RBI Component - Exchanger Bundle	View, Update, Insert, Delete	View, Update, Insert, Delete	View
Criticality RBI Component - Exchanger Header	View, Update, Insert, Delete	View, Update, Insert, Delete	View
Criticality RBI Component - Exchanger Tube	View, Update, Insert, Delete	View, Update, Insert, Delete	View
Criticality RBI Component - Piping	View, Update, Insert, Delete	View, Update, Insert, Delete	View
Criticality RBI Component - Tank Bottom	View, Update, Insert, Delete	View, Update, Insert, Delete	View
Data Mapping Column-Field Pair	View, Update, Insert, Delete	View	View
Data Mapping Group	View, Update, Insert, Delete	View	View
Data Mapping Query	View, Update, Insert, Delete	View	View
Degradation Mechanisms Evaluation Factors	View, Update, Insert, Delete	View, Update, Insert, Delete	View
Equipment	View, Update, Insert, Delete	View, Update, Insert, Delete	View
Functional Location	View, Update, Insert, Delete	View, Update, Insert, Delete	View
Grouping Element	View, Update, Insert, Delete	View, Update, Insert, Delete	View
Inspection Plan	View	View, Update, Insert, Delete	View
Inspection Plan Revision	View	View, Update, Insert, Delete	View
Inspection Task	View, Update, Insert, Delete	View, Update, Insert, Delete	View
Inventory Group Configuration	View, Update, Insert, Delete	View	View
General Recommendation	View	View, Update, Insert, Delete	View
Meridium Reference Tables	View, Update, Insert, Delete	View	View
Policy	View	View	View

Family	MI RBI Administrator	MI RBI Analyst	MI RBI Viewer
Potential Degradation Mechanisms	View, Update, Insert, Delete	View	View
RBI 581 Admin Options	View, Update, Insert, Delete	View	View
RBI 581 Brittle Fracture Damage Evaluation	View, Update, Insert, Delete	View, Update, Insert, Delete	View
RBI 581 Consequence Evaluation	View, Update, Insert, Delete	View, Update, Insert, Delete	View
RBI 581 Cracking Damage Evaluation	View, Update, Insert, Delete	View, Update, Insert, Delete	View
RBI 581 Damage Mechanism Evaluation	View, Update, Insert, Delete	View, Update, Insert, Delete	View
RBI 581 External Cracking Damage Evaluation	View, Update, Insert, Delete	View, Update, Insert, Delete	View
RBI 581 External Damage Evaluation	View, Update, Insert, Delete	View, Update, Insert, Delete	View
RBI 581 HTHA Damage Evaluation	View, Update, Insert, Delete	View, Update, Insert, Delete	View
RBI 581 Mechanical Fatigue Damage Evaluation	View, Update, Insert, Delete	View, Update, Insert, Delete	View
RBI 581 Risk Analysis	View, Update, Insert, Delete	View, Update, Insert, Delete	View
RBI 581 Thinning and Lining Evaluation	View, Update, Insert, Delete	View, Update, Insert, Delete	View
RBI Criticality Analysis	View, Update, Insert, Delete	View, Update, Insert, Delete	View
RBI Custom DM Evaluation Configuration	View, Update, Insert, Delete	View	View
RBI Custom DM Evaluation Configuration Details	View, Update, Insert, Delete	View	View
RBI Custom DM Evaluation Validation	View, Update, Insert, Delete	View	View
RBI Custom DM Evaluation Validation Details	View, Update, Insert, Delete	View	View
RBI Degradation Mechanisms	View, Update, Insert, Delete	View, Update, Insert, Delete	View
RBI Inspection Auto-Selection Criteria	View, Update, Insert, Delete	View	View
RBI Recommendation	View, Update, Insert, Delete	View, Update, Insert, Delete	View
RBI Risk Matrix Mapping	View, Update, Insert, Delete	View, Update, Insert, Delete	View
RBI Strategy Mapping Configuration	View, Update, Insert, Delete	View, Update, Insert, Delete	View

Family	MI RBI Administrator	MI RBI Analyst	MI RBI Viewer
RBI Strategy Mapping Details	View, Update, Insert, Delete	View, Update, Insert, Delete	View
RBI System	View, Update, Insert, Delete	View, Update, Insert, Delete	View
Recommendation Revision	View	View, Update, Insert, Delete	View
Reference Document	View, Update, Insert, Delete	View, Update, Insert, Delete	View
Risk Assessment	View, Update, Insert, Delete	View, Update, Insert, Delete	View
Risk Rank	View, Update, Insert, Delete	View, Update, Insert, Delete	View
Risk Translation	View, Update, Insert, Delete	View, Update, Insert, Delete	View
SAP System	View	View	View
Strategy Logic Case	View, Update, Insert, Delete	View	View
Strategy Reference Table	View, Update, Insert, Delete	View, Update, Insert, Delete	View
Task Type	View, Update, Insert, Delete	View, Update, Insert, Delete	View
Time Based Inspection Interval	View, Update, Insert, Delete	View, Update, Insert, Delete	View
Time Based Inspection Setting	View, Update, Insert, Delete	View, Update, Insert, Delete	View
Relationship Families			
Asset Has Inspection Plan	View	View, Update, Insert, Delete	View
Belongs to a Unit	View, Update, Insert, Delete	View, Update, Insert, Delete	View
Data Mapping has Column-Field Pair	View, Update, Insert, Delete	View	View
Data Mapping has Query	View, Update, Insert, Delete	View	View
Data Mapping has Subgroup	View, Update, Insert, Delete	View	View
Has Inspection Group	View, Update, Insert, Delete	View, Update, Insert, Delete	View
Has Child RBI Criticality Analysis	View, Update, Insert, Delete	View, Update, Insert, Delete	View
Has Consequence Evaluation	View, Update, Insert, Delete	View, Update, Insert, Delete	View
Has Consolidated Recommendations	View	View, Update, Insert, Delete	View
Has Corrosion Analyses	View	View	View
Has Corrosion Analysis Settings	View	View	View
Has Datapoints	View	View	View
Has Degradation Mechanisms	View, Update, Insert, Delete	View, Update, Insert, Delete	View
Has Inspections	View, Update, Insert, Delete	View, Update, Insert, Delete	View
Has Inspection Plan Revision	View	View, Update, Insert, Delete	View
Has Inspection Scope	View	View	View

Family	MI RBI Administrator	MI RBI Analyst	MI RBI Viewer
Has Potential Degradation Mechanisms	View, Update, Insert, Delete	View, Update, Insert, Delete	View
Has RBI Components	View, Update, Insert, Delete	View, Update, Insert, Delete	View
Has RBI Criticality Analysis	View, Update, Insert, Delete	View, Update, Insert, Delete	View
Has RBI Custom DME Configuration	View, Update, Insert, Delete	View, Update, Insert, Delete	View
Has RBI Custom DME Validation	View, Update, Insert, Delete	View	View
Has RBI Degradation Mechanisms Evaluation	View, Update, Insert, Delete	View, Update, Insert, Delete	View
Has RBI Strategy Mapping Configuration	View, Update, Insert, Delete	View, Update, Insert, Delete	View
Has RBI Systems	View, Update, Insert, Delete	View, Update, Insert, Delete	View
Has Recommendations	View, Update, Insert, Delete	View, Update, Insert, Delete	View
Has Reference Documents	View, Update, Insert, Delete	View, Update, Insert, Delete	View
Has Reference Values	View	View	View
Has SAP System	View	View	View
Has Superseded Recommendations	View	View, Update, Insert, Delete	View
Has Task Revision	View	View, Update, Insert, Delete	View
Has Tasks	View, Update, Insert, Delete	View, Update, Insert, Delete	View
Has Time Based Inspection Interval	View, Update, Insert, Delete	View, Update, Insert, Delete	View
Has Unmitigated Risk	View, Update, Insert, Delete	View, Update, Insert, Delete	View
Implements Compliance Recommendation	View	View, Update, Insert, Delete	View
Inspection Plan Has Recommendations	View	View, Update, Insert, Delete	View
Is Based on RBI Degradation Mechanisms	View, Update, Insert, Delete	View, Update, Insert, Delete	View
Is Mitigated	View, Update, Insert, Delete	View, Update, Insert, Delete	View
Is Part of Group	View, Update, Insert, Delete	View, Update, Insert, Delete	View
Mapped to RBI Component	View, Update, Insert, Delete	View, Update, Insert, Delete	View
Represents Inspections	View, Update, Insert, Delete	View, Update, Insert, Delete	View

Note: Security privileges for all modules and catalog folders can be found in the [APM documentation](#).

The following families are used only to support integration with the Inspection Management module:

- Has Inspection Scope
- Has Time Based Inspection Interval
- Time Based Inspection Interval
- Time Based Inspection Setting

Specifically, certain features of the Time-Based Inspection Settings functionality, which you can use if the Inspection Management license is active, are facilitated by these privileges.

State Management for Inspection Plans

The following state changes can be applied to the Inspection Plans based on user Security Roles.

The diagram below shows the workflow of the baseline State Management process as it applies to Inspection Plans.

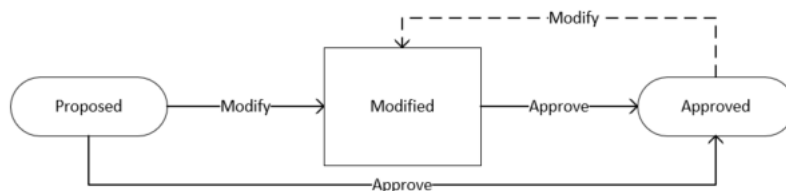

Details

- The Proposed state is the initial state of all Inspection Plans.
- When you change the state of an Inspection Plan from Approved to Modified, an Inspection Plan Revision History record is created.

Reserved States and Operations for Inspection Plans

The following tables indicate whether the baseline states and operations are reserved. You cannot remove or modify reserved states or operations.

State Caption	Reserved State	Security Roles
Approved	No	MI Inspection Plan Approver
Modified	Yes	<ul style="list-style-type: none"> • MI Compliance Analyst • MI Inspection Plan Approver
Proposed	No	<ul style="list-style-type: none"> • MI Compliance Analyst • MI Inspection Plan Approver

Operation ID	Reserved Operation	Predecessor	Successor
MI_APPROVE	No	Proposed	Approved
MI_APPV_MODIFIED	No	Modified	Approved
MI_MODIFY	Yes	Approved	Modified

RBI Recommendation State Management

The following state changes can be applied to RBI Recommendation.

The diagram below shows the workflow of the baseline State Management process as it applies to RBI Recommendations.

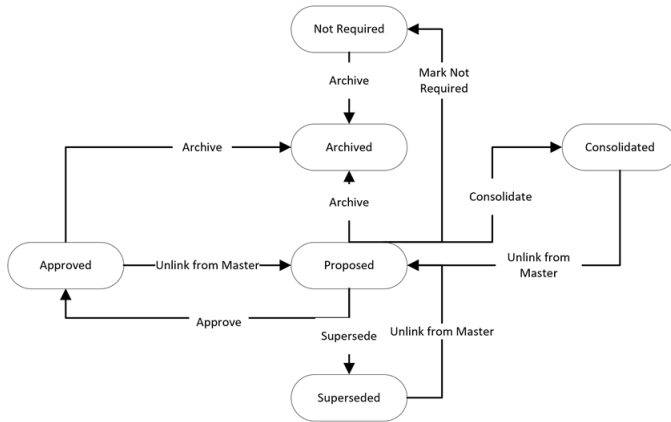

Reserved States and Operations for RBI Recommendations

State Caption	State ID	Reserved State
Proposed (Initial State)	MI_PENDING	Yes
Approved	MI_ACCEPTED	Yes
Consolidated	MI_CONSOLIDATED	Yes
Superseded	MI_SUPERSEDED	Yes
Not Required	MI_NOTREQUIRED	Yes
Archived	MI_ARCHIVED	Yes

Operation	Operation ID	Reserved Operation	Predecessor State	Successor State
Approve	MI_PROMOTE	Yes	Proposed	Approved
Unlink from Master	MI_UN_PROMOTE	Yes	Approved	Proposed
Mark Not Required	MI_NOTREQUIRED	Yes	Proposed	Not Required
Supersede	MI_SUPERSEDE	Yes	Proposed	Superseded
Unlink from Master	MI_UN_SUPERSEDE	Yes	Superseded	Proposed
Consolidate	MI_CONSOLIDATE	Yes	Proposed	Consolidated
Unlink from Master	MI_UN_CONSOLIDATE	Yes	Consolidated	Proposed
Archived	MI_PARCHIVED	Yes	Proposed	Archived

State Management for Inspection Groups

The following state changes can be applied to the Inspection Groups.

The diagram below shows the workflow of the baseline State Management process as it applies to Inspection Groups.

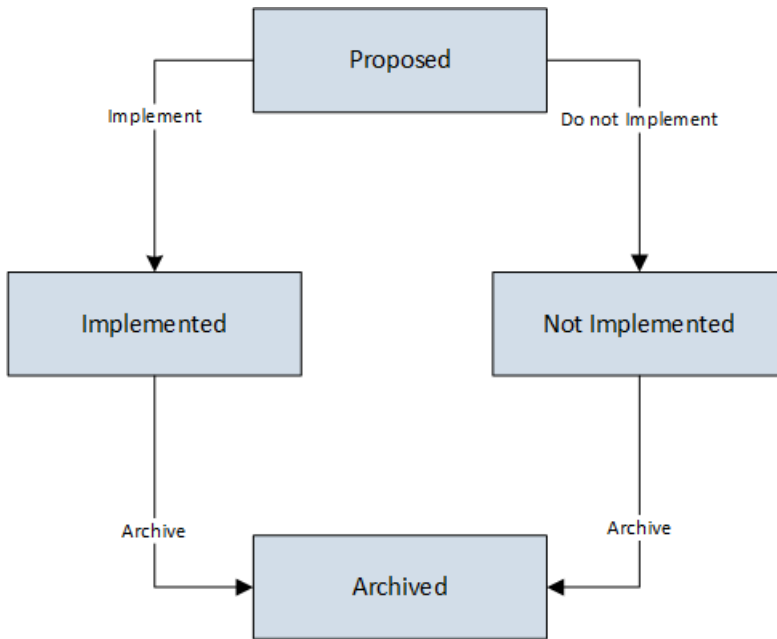

Details

- The Proposed state is the initial state of all Inspection Groups.

Reserved States and Operations for Inspection Groups

The following tables indicate whether the baseline states and operations are reserved. You cannot remove or modify reserved states or operations.

State Caption	State ID	Reserved State
Proposed (Initial State)	MI_PROPOSED	No
Implemented	MI_IMPLEMENTED	No
Not Implemented	MI_NOT_IMPLEMENTED	No
Archived	MI_ARCHIVED	No

Operation	Operation ID	Reserved Operation	Predecessor State	Successor State
Implement	MI_PROPOSED_IMPL ENT	No	Proposed	Implemented
Do not implement	MI_PROPOSED_NOT_IM PL	No	Proposed	Not Implemented
Archive	MI_IMPL_ARCHIVED	Yes	Implemented	Archived
Archive	MI_NOT_IMPL_ARCHIVE	Yes	Not Implemented	Archived

RBI Site Filtering

Example

Consider an organization that has three sites, Site X, Site Y, and Site Z.

Scenario 1: User assigned to only Site X.

This user can access or modify records that are linked to assets only in Site X. However, this user can access all the Potential Degradation Mechanisms in the database.

Scenario 2: User assigned to only Site X and Site Y.

This user can access or modify records that are linked to assets only in Site X or Site Y. However, this user can access all the Potential Degradation Mechanisms in the database.

Scenario 3: Super User

This user can access or modify records that are linked to assets in Site X, Site Y, or Site Z.

Data Models

Criticality Calculator RBI Component Data Model

This topic has been intentionally excluded from the GE Digital APM product documentation website. This topic is available to you via the product documentation that is provided within the GE Digital APM system.

RBI Corrosion Loop Data Model

This topic has been intentionally excluded from the GE Digital APM product documentation website. This topic is available to you via the product documentation that is provided within the GE Digital APM system.

RBI Criticality Analysis Data Model

This topic has been intentionally excluded from the GE Digital APM product documentation website. This topic is available to you via the product documentation that is provided within the GE Digital APM system.

Pipeline Data Model

This topic has been intentionally excluded from the GE Digital APM product documentation website. This topic is available to you via the product documentation that is provided within the GE Digital APM system.

PRD Data Model

This topic has been intentionally excluded from the GE Digital APM product documentation website. This topic is available to you via the product documentation that is provided within the GE Digital APM system.

RBI Data Model

This topic has been intentionally excluded from the GE Digital APM product documentation website. This topic is available to you via the product documentation that is provided within the GE Digital APM system.

RBI Recommendation Data Model

This topic has been intentionally excluded from the GE Digital APM product documentation website. This topic is available to you via the product documentation that is provided within the GE Digital APM system.

Inspection Group Data Model

This topic has been intentionally excluded from the GE Digital APM product documentation website. This topic is available to you via the product documentation that is provided within the GE Digital APM system.

Family Field Descriptions

Consequence Evaluation Records

Consequence Evaluation records are used to determine the consequence of failure while performing an RBI analysis. This topic provides an alphabetical list and description of the fields that exist for the RBI Consequence Evaluation family, whose records store information that is used to determine the probability and cost of failure. The information in the table reflects the baseline state and behavior of these fields.

The following families are enabled for site filtering, which means that the records in these families can be assigned to a specific site, and will then only be accessible to users who are assigned to the same site and have the appropriate license and family privileges. See the Site Filtering section of the documentation for more information on using this feature.

Criticality Consequence Evaluation

Field	Data Type	Description	Behavior and Usage
Main			
Consequence	Character	The outcome of an event or situation expressed qualitatively or quantitatively. This can be a loss, injury, a disadvantage or a gain.	None
Detection Time	Numeric	The time it takes to detect that a loss of containment has occurred.	You can specify a value for this field using the datasheet.
Flexible Calculation Policies Used	Character	The list of policies that were used in flexible calculation.	None
Flexible Calculation Used	Boolean	Indicates whether flexible or baseline calculation is used.	None
Initial Fluid Phase	Character	The phase that the representative fluid is in while under current operating conditions and under containment in the asset.	The value in this cell must be one of the following System Codes stored in the FLUID TYPES System Code table: <ul style="list-style-type: none"> Liquid Gas
Inspection Interval	Numeric	The interval that the inspector or risk analyst has set for the asset.	Required for RBI Analysis records whose Criticality Item Type is Heat Exchanger-Bundle.
Inventory	Numeric	The volume of the asset that could potentially be released in the event of a failure.	You can specify a value for this field using the datasheet.

Field	Data Type	Description	Behavior and Usage
Inventory Group	Character	The volume of the asset and its interconnected assets that could potentially be released in the event of a failure.	You can specify a value for this field using the datasheet.
Isolation Time	Numeric	The time it takes to isolate a loss of containment.	You can specify a value for this field using the datasheet.
Lost Production Category	Numeric	The Product Leak Consequence Category is determined based on the financial impact of having the facility shutdown to make necessary repairs or perform necessary inspections.	<p>Lost Product Value is determined using letters that represent the following scale:</p> <ul style="list-style-type: none"> • A: Indicates any amount greater than \$10,000,000. • B: Indicates an amount that is less than \$10,000,000 and greater than \$1,000,000. • C: Indicates an amount that is less than \$1,000,000 and greater than \$100,000. • D: Indicates an amount that is less than \$100,000 greater than \$10,000. • E: Indicates any amount less than \$10,000.
Percent Toxic	Numeric	The percentage by volume of toxic substances in the process stream.	None
Tank Fill Height	Numeric	The liquid level of an asset under normal operating conditions.	None
Toxic Consequence Category	Character	The toxic risk categories (High, Medium High, Medium, and Low) assigned to the risk matrix.	None
Toxic Fluid	Character	The fluid that represents the greatest toxic volume of the asset. In some cases, the fluid that represents the greatest Consequence of Failure (CoF) may be selected.	None
Toxic Mixture	Boolean	Indicates whether or not the process stream contains toxic substances.	None

Field	Data Type	Description	Behavior and Usage
Use Calculated Inventory	Boolean	Indicates that the analyst has decided to use the inventory based on the dimensions of the asset rather than an estimated value.	None
Flammable Consequence			
Flammable Consequence Category	Character	Flammable risk categories (High, Medium High, Medium, and Low) assigned to the risk matrix.	For inert and reactive leaking fluids, if the Flammable Leak Type is utility leak into HC system, the flammable consequence category can be either D or E based on the leak rate category. If the Leak Rate Category is Major, the consequence category is D, and if the Leak Rate Category is Minor, the consequence category is E.
Near Ignition Source	Boolean	Indicates whether or not the asset is near a possible ignition source.	The value in this field impacts the calculation.
Tank Bottom - Env Consequence			
Bottom Thickness	Numeric	The thickness of the asset bottom.	None
Diked Area	Numeric	The square footage of the containment dikes around the asset.	The value in this field impacts the calculation.
Diked?	Boolean	Indicates whether or not a dike is present.	None
Environmental Consequence Category	Character	The environmental risk categories (High, Medium High, Medium, and Low) assigned to the risk matrix.	None
Foundation Type	Character	Describes the foundation on which an asset is sitting. The selections here will impact the Consequence of Failure (CoF) calculations.	None
Leak Effect	Character	Determines the impact of a loss of containment.	None
Persistent Fluid?	Boolean	A fluid that will remain in a liquid form once it has been released from a storage tank.	None

Field	Data Type	Description	Behavior and Usage
Underside Corrosion Rate	Numeric	The corrosion rate on the underside most portion of the bottom of an asset.	None
Unit Cleanup Cost	Numeric	The expected costs that may be incurred in the event of loss of containment.	None
Tube Bundle Consequence			
Corrosion Rate Channel Side	Numeric	The corrosion rate on the channel side of an exchanger.	None
Corrosion Rate Shell Side	Numeric	The corrosion rate on the shell side of an exchanger.	None
Flammable Leak Type	Character	Determines if the bundle will leak flammable liquid into the process streams.	Required for the RBI Analysis records whose Criticality Item Type is Heat Exchanger-Bundle and Leaking Fluid is flammable.
Initial State Shell	Character	Determines if the shell side contains gas or liquid prior to loss of containment.	None
Operating Pressure Shell Side	Numeric	Internal pressure of the asset under normal operating conditions.	You can specify a value for this field using the datasheet. The Unit of Measure (UOM) for this field is Pounds/Sq Inch Gage (PSIG).
Operating Temperature Shell Side	Numeric	Temperature of the asset under normal operating conditions.	You can specify a value for this field using the datasheet.
Percent Toxic Shell	Boolean	The amount of toxic substances in the process stream by volume.	None

Field	Data Type	Description	Behavior and Usage
Product Leak Category	Character	The Product Leak Consequence Category is determined based on the financial impact of having the facility shutdown to make necessary repairs or perform necessary inspections.	<p>Lost Product Value is determined using letters that represent the following scale:</p> <ul style="list-style-type: none"> • A: Indicates any amount greater than \$10,000,000. • B: Indicates an amount that is less than \$10,000,000 and greater than \$1,000,000. • C: Indicates an amount that is less than \$1,000,000 and greater than \$100,000. • D: Indicates an amount that is less than \$100,000 greater than \$10,000. • E: Indicates any amount less than \$10,000.
Product Unit Value	Numeric	The cost-per-pound of the product in the asset.	Required only for RBI Analysis records whose Criticality Item Type is Heat Exchanger-Bundle.
Rep Fluid Shell Side	Character	The fluid that represents the greatest volume of the asset. In some cases, the fluid that represents the greatest Consequence of Failure (CoF) may be selected.	None
Toxic Fluid Shell Side	Boolean	The fluid that represents or makes up the greatest toxic volume of the asset. In some cases the fluid that represents the greatest Consequence of Failure (CoF) may be selected.	None
Toxic Leak Type	Character	Indicates if the toxic leak would be major or minor.	Required for RBI Analysis records whose Criticality Item Type is Heat Exchanger-Bundle and Leaking Fluid is toxic.
Toxic Mixture Shell	Numeric	Indicates whether or not the process stream contains toxic substances.	None
Pipeline - Env Consequence			
Additional Penalties/Fines	Numeric	Description of the other fines that may be levied in the event of a loss of containment.	None

Field	Data Type	Description	Behavior and Usage
Adjusted Leak Quality - Hole	Numeric	Determines how much product may be lost in the event of a leak failure resulting from a hole.	None
Adjusted Leak Quality - Rupture	Numeric	Determines how much product may be lost in the event of a leak failure resulting from a rupture.	None
Combined Consequence - Hole	Character	The combined consequence category for a failure resulting from a hole is calculated by comparing the consequence categories and assigning the combined consequence category the same value as the most severe.	None
Combined Consequence - Rupture	Character	The combined consequence category for rupture is calculated by comparing the consequence categories and assigning the combined consequence category the same value as the most severe.	None
Detection Time - Hole	Character	The time required to detect that a loss of containment has occurred resulting from a hole.	You can specify a value for this field using the datasheet.
Detection Time - Rupture	Numeric	The time required to detect that a loss of containment has occurred resulting from a rupture.	You can specify a value for this field using the datasheet.
Environment Consequence Category - Hole	Character	The environmental risk categories (High, Medium High, Medium, and Low) assigned to risk matrix associated with hole failure.	None
Environment Consequence Category - Rupture	Character	The environmental risk categories (High, Medium High, Medium, and Low) assigned to risk matrix associated with rupture failure.	None

Field	Data Type	Description	Behavior and Usage
High Value Area	Character	Any locations where a pipeline spill might have significant financial impacts.	Meridium's definition follows those outlined in: Muhlbauer, W. Kent, Pipeline Risk Management Manual, Gulf Publishing Company, Houston, 2004.
High Value Area Factor	Numeric	The value used in the calculation based on the data entered into the High Value Area field.	None
Impact Clean Up Cost - Hole	Numeric	The expected costs that may be incurred in the event of a loss of containment resulting from a hole.	None
Impact Clean Up Cost - Rupture	Numeric	The expected costs that may be incurred in the event of a loss of containment resulting from a rupture.	None
Isolation Time - Hole	Numeric	The time it takes to isolate a loss of containment resulting from a hole.	You can specify a value for this field using the datasheet.
Isolation Time - Rupture	Numeric	Time it takes to isolate a loss of containment resulting from a rupture.	You can specify a value for this field using the datasheet.
Lost Production Category - Rupture	Character	The financial impact of having the facility shutdown to make necessary repairs or to perform necessary inspections.	None
Override Clean Up Cost - Hole	Boolean	Indicates whether or not the risk analyst has decided to override the cleanup costs for a hole failure.	None
Override Clean Up Cost - Rupture	Boolean	Indicates whether or not the risk analyst has decided to override the cleanup costs for a rupture failure.	None
Soil Type	Character	The type of soil in the vicinity of the spill will be used to make an adjustment in the release quantity to account for the differences in fluid velocity and retention for various soil types.	None

Field	Data Type	Description	Behavior and Usage
Soil Type Factor	Numeric	The value used in the calculation based on the selection of soil type.	None
Suggested Clean Up	Character	The recommended methodology to mitigate the loss of containment.	None
Suggested Clean Up Cost	Numeric	The expected costs that may be incurred in the event of loss of containment.	None
Pipeline - Safety Consequence			
Adjusted FAA - Hole	Numeric	The Adjusted Flammable Affected Area (FAA) for a hole failure is a calculated value represented in square feet.	None
Adjusted FAA - Rupture	Numeric	The Adjusted Flammable Affected Area (FAA) for a rupture failure is a calculated value in square feet.	None
Adjusted TAA - Hole	Numeric	The Adjusted Toxic Affected Area (TAA) for a hole failure is a calculated value in square feet.	None
Boiling Point	Numeric	The normal boiling point of the representative fluid.	None
DOT Factor	Numeric	The adjustment factor for the population density.	This is a numeric range from 0.5-2.0.
Flammable Affected Area - Hole	Numeric	The dimensions that represent an area where the expected consequences may be realized for a flammable hole failure.	None
Flammable Affected Area - Rupture	Numeric	The dimensions that represent an area where the expected consequences may be realized for a flammable rupture failure.	None
Flammable Consequence - Hole	Character	The flammable risk categories (High, Medium High, Medium, and Low) assigned to risk matrix associated with hole failure.	None

Field	Data Type	Description	Behavior and Usage
Flammable Consequence - Rupture	Character	The flammable risk categories (High, Medium High, Medium, and Low) assigned to risk matrix associated with rupture failure.	None
High Consequence Area	Character	High Consequence Areas (HCA) are locations where a pipeline spill might have significant adverse impacts to population, the environment or to commercial navigation.	HCAs are defined under CFR 49 part 195.450.
High Consequence Area Factor	Numeric	The value used in the calculation based on the selection made in the High Consequence Area field.	None
Population Density Adjustment	Character	The adjustment factor for the population density.	This is a numeric range from 0.5-2.0.
Toxic Consequence - Hole	Character	The toxic risk categories (High, Medium High, Medium, and Low) assigned to risk matrix associated with hole failure.	None
Toxic Consequence - Rupture	Character	The toxic risk categories (High, Medium High, Medium, and Low) assigned to risk matrix associated with rupture failure.	None
Intermediate Output			
Average Leak Rate	Numeric	The fluid leak rate is a function of the physical properties of the leaking fluid, the pressure of the fluid, and the effective leak size in the floor.	None
Cleanup Cost	Numeric	The expected costs that may be incurred in the event of loss of containment.	None

Field	Data Type	Description	Behavior and Usage
Corrosion Category	Character	<p>The combined corrosion rate is equal to the sum of the Internal Corrosion Rate and the External Corrosion Rate:</p> <ul style="list-style-type: none"> If the combined corrosion rate < 0.005 ipy, the Corrosion Category is "Low"; If the combined corrosion rate is > = 0.005 and < 0.010 ipy, the Corrosion Category is "Medium"; If the combined corrosion rate is > = 0.010 ipy, the Corrosion Category is "High." 	None
Deinventory Time	Numeric	The time needed in a leak scenario to empty the contents of the asset.	None
Delta Pressure	Numeric	The absolute value of the smaller of the shell or channel operating pressure subtracted from the larger of the two pressures.	None
Discharge Rate - Hole	Numeric	The rate at which the contents will escape the asset in the event of a hole failure.	None
Discharge Rate - Rupture	Numeric	The rate at which the contents will escape the asset in the event of a rupture failure.	None
Distance to End Affect	Numeric	The linear distance in which the Consequence of Failure (CoF) could be experienced.	None
Estimated Leak Quantity	Numeric	The amount of fluid that would be released in the event of a failure.	None
Estimated Release Rate	Numeric	The rate at which the contents will escape the asset.	None
Final Phase	Character	The phase of the contents upon release.	None
Final Phase Shell Side	Character	The phase of the shell side contents upon release.	None
Flammable Affected Area	Numeric	The dimensions that represent an area where the expected consequences may be realized.	None

Field	Data Type	Description	Behavior and Usage
Flammable Leak Rate Category	Character	Determines whether the leak rate is minor or major.	None
Initial Leak Rate	Numeric	The rate at which the contents will escape the asset.	None
Leak Area - Hole	Numeric	The rate at which the contents will escape the asset after a hole failure.	None
Leak Area - Rupture	Numeric	The rate at which the contents will escape the asset after a rupture failure.	None
Leak Direction	Character	Indicates if a failure in a tube bundle would result in a leak into the shell side or a leak into the channel side.	None
Leak Quantity - Hole	Numeric	The amount of fluid that would be released in the event of a hole leak failure.	None
Leak Quantity - Rupture	Numeric	The amount of fluid that would be released in the event of a rupture leak failure.	None
Leak Size	Numeric	The size of the opening through which the contents would escape.	None
Lost Product Value	Numeric	A value based on the financial impact of having the facility shutdown to make necessary repairs or to perform necessary inspections.	<p>Lost Product Value is determined using letters that represent the following scale:</p> <ul style="list-style-type: none"> • A: Indicates any amount greater than \$10,000,000. • B: Indicates an amount that is less than \$10,000,000 and greater than \$1,000,000. • C: Indicates an amount that is less than \$1,000,000 and greater than \$100,000. • D: Indicates an amount that is less than \$100,000 greater than \$10,000. • E: Indicates any amount less than \$10,000.

Field	Data Type	Description	Behavior and Usage
Pool Area	Numeric	The distance that a pool may spread when a liquid is released from an asset or pipeline, a liquid pool may form.	None
Probability of Ignition	Numeric	The likelihood of the released substances igniting.	None
Release Duration	Numeric	The time that the leak is expected to last.	None
Toxic Duration	Numeric	The time that the toxic leak is expected to last.	None
Toxic Leak Rate Category	Character	Determines whether the toxic leak rate is minor or major	None
Toxic Mixed Release Rate	Numeric	The rate at which the contents will escape the asset.	None
Toxicity Area	Numeric	When a toxic fluid is released from an asset or pipeline, this field captures the distance that this toxic substance may spread.	None

PRD Consequence Evaluation

Field	Data Type	Description	Behavior and Usage
Consequence	Character	The consequence risk categories (High, Medium High, Medium, and Low) assigned to risk matrix.	None
Consequence for Protected Assets	Character	The consequence risk categories (High, Medium High, Medium, and Low) assigned to risk matrix associated with protected assets.	None
Cost of Fluid	Numeric	Cost-per-pound of fluid contained in the asset.	None
Days to Repair	Numeric	Indicates repair time for the asset.	None
Environment Cost	Numeric	Cost of cleaning up a potential spill.	None

Field	Data Type	Description	Behavior and Usage
Leak Consequence Category	Character	The leak risk categories (High, Medium High, Medium, and Low) assigned to risk matrix.	None
Tolerate Leak	Boolean	Indicates how capable the process is of maintaining operations in the event of a leak.	None
Unit Production Margin	Numeric	The Production Margins are determined based on the financial impact of having the facility shutdown to make necessary repairs or perform necessary inspections.	<p>A value based on the financial impact of having the facility shutdown to make necessary repairs or to perform necessary inspections</p> <ul style="list-style-type: none"> • A = Any amount greater than \$10,000,000. • B = An amount that is less than \$10,000,000 and greater than \$1,000,000. • C = An amount that is less than \$1,000,000 and greater than \$100,000. • D = An amount that is less than \$100,000 greater than \$10,000. • E = Any amount less than \$10,000.

Criticality Calculator RBI Components Records

Criticality Calculator RBI Component records store information about the component on which you will perform an RBI 581 Risk Criticality Analysis.

This topic provides an alphabetical list and description of the fields that exist for the Criticality Calculator RBI Components family. The information in the table reflects the baseline state and behavior of these fields. If the component type is Exchanger Bundle, then, for each field on the RBI Component, there are two fields on the datasheet - one for the channel, and the other for the shell.

The following families are enabled for site filtering, which means that the records in these families can be assigned to a specific site, and will then only be accessible to users who are assigned to the same site and have the appropriate license and family privileges. See the Site Filtering section of the documentation for more information on using this feature.

Criticality Calculator RBI Components

Field	Data Type	Description	Behavior and Usage
The ID Section			
Component	Character	Identifies the RBI Component.	<p>This field is disabled and populated automatically with a value in the following format:</p> <p>RBICOMP-<Asset>-<Component Type>-<Number></p> <p>...where:</p> <ul style="list-style-type: none"> • <Asset> is the value in the Asset field. • <Component Type> is a value based on the type of the component, defined as follows: <ul style="list-style-type: none"> ◦ CS: Cylindrical Shell ◦ EB: Exchanger Bundle ◦ HD: Exchanger Header ◦ ET: Exchanger Tube ◦ PP: Piping ◦ TB: Tank Bottom ◦ RV: Relief Valves ◦ RD: Rupture Disks ◦ PC: Pump Compressor Casing • <Number> is the sequence number of the component.
Component Comments	Text	Comments about the component.	None
Component Date in Service	Date	The date on which the component was first put into service.	You can use the Calendar feature to select the date.
Component Description	Character	A description used to identify the Component.	None
Component Status	Character	Indicates whether a component is active or inactive.	<p>This field is disabled and populated automatically with the value Active.</p> <p>Note: If you inactivate a component, this field is disabled and populated with the value inactive.</p>
Component Type	Character	Identifies which part of the asset the component represents.	<p>The value in this field must be stored in the Criticality Item Type field in one of the Equipment Types records delivered in the GE Digital APM database.</p> <p>This field is disabled and populated automatically.</p>
Asset	Character	Identifies the asset.	This field is populated automatically.
Asset Family	Character	Identifies the asset family.	This field is disabled and populated automatically.
Functional Location	Character	Identifies the Functional Location of the asset.	This field is disabled and populated automatically.
Operating and Process Section			

Field	Data Type	Description	Behavior and Usage
Area Humidity	Character	A value based on the geographical location in which the asset is operated.	This field applies only to RBI Components that are linked to one or more Criticality Ext. Corr. Deg. Mech. Eval. records. This field contains the description of all the System Codes in the MI_RBI_Area_Humidity System Code Table. You can choose from the following baseline values: <ul style="list-style-type: none"> • Low • Medium • High
Calculated Inventory	Numeric	A calculated value based on process fluid properties and dimensions of the component.	This field is disabled and populated automatically. This value is derived from asset dimensions that have been entered in the system instead of an estimated volume.
CUI Inspection Priority Changed	Boolean	Indicates whether the Inspection Priority on the Criticality Calculator External Corrosion Degradation Mechanism for the related RBI Analysis has changed.	If an active RBI Analysis exists, and a new RBI Analysis is moved to the Risk Completed state and activated, the system verifies whether the Inspection Priority on the associated degradation mechanism has changed, and sets the value in this field to True. When an Inspection Group is activated, the value in this field is set to False for all RBI Components within the Inspection Group.
Detection Time	Numeric	The time, in minutes, that is required to detect loss of containment.	None
Fluid Valid for 581 Analysis	Boolean	Indicates whether the process fluid is valid for an RBI 581 Risk Analysis.	This check box is disabled and selected if the fluid that you have selected in the Process Fluid field is valid for RBI 581. If this check box is cleared, and you perform an RBI 581 Risk Analysis, you will not be able to calculate the analysis.
Foundation Type	Character	If the component is a storage tank, then specify the foundation type of the tank.	The value in this field is used to calculate an analysis if the component type is Storage Tank. This field contains the description of all the System Codes in the FOUNDATION TYPES System Code Table. You can choose from the following baseline values: <ul style="list-style-type: none"> • Clay • Concrete • Double Floor • Gravel • Sand • Silt
Initial Fluid Phase	Character	The phase that the representative fluid is in while under containment in current operating conditions.	This field contains the description of all the System Codes in the FLUID TYPES System Code Table. You can choose from the following baseline values: <ul style="list-style-type: none"> • Liquid • Gas

Field	Data Type	Description	Behavior and Usage
Int. Corr. Inspection Priority Changed	Boolean	Indicates whether the Inspection Priority on the Criticality Calculator Internal Corrosion Degradation Mechanism for the related RBI Analysis has changed.	If an active RBI Analysis exists, and a new RBI Analysis is moved to the Risk Completed state and activated, the system verifies whether the Inspection Priority on the associated degradation mechanism has changed, and sets the value in this field to True. When an Inspection Group is activated, the value in this field is set to False for all RBI Components within the Inspection Group.
Inventory	Numeric	The volume of the asset that could potentially be released in the event of a failure.	The value in this field is used to populate the Inventory Component Mass field in the RBI Consequence Evaluation that is linked to an analysis performed on this component.
Inventory Group	Character	The name of the inventory group to which the component is linked.	This field is disabled and blank.
Isolation Time	Numeric	The time, in minutes, that is required to isolate loss of containment.	None
Operating Pressure	Numeric	The internal pressure of the asset under normal operating conditions. It is measured in pounds per square inch gauge.	The value in this field is used to populate the Operating Pressure field in the associated analysis.
Operating Temperature	Numeric	The temperature of the asset under normal operating conditions. It is measured in degrees Fahrenheit.	The value in this field is used to populate the Operating Temperature field in the associated analysis.
Percent Toxic	Numeric	The amount of toxic substances by volume in the process stream.	This field is enabled only if the Toxic Mixture check box is selected.
Process Fluid	Character	The fluid that represents or makes up the greatest volume of the asset. In some cases, the fluid that represents the greatest cause of failure may be selected. Important: If you are going to perform an RBI Criticality Analysis, you must select a fluid that is valid for RBI 580. Similarly, if you are going to perform an RBI 581 Risk Analysis, you must select a fluid that is valid for RBI 581.	The value in this field must be stored in the Fluid field in one of the Representative Fluids records in the GE Digital APM database.

Field	Data Type	Description	Behavior and Usage
Toxic Fluid	Character	The fluid that represents or makes up the greatest toxic volume of the asset. In some cases, the fluid that contributes to the greatest Consequence of Failure (CoF) may be selected.	This field is enabled only if the Toxic Mixture check box is selected. The value in this field must be stored in the Process Fluid field in one of the Representative Fluids records delivered in the GE Digital APM baseline database.
Toxic Fluid Valid for 581 Analysis	Boolean	Indicates whether the toxic fluid is valid for an RBI 581 Risk Analysis.	This check box is disabled and selected if the fluid that you have selected in the Toxic Model field is valid for RBI 581.
Toxic Mixture	Boolean	Indicates whether or not the process stream contains toxic substances.	If you select this check box, the Toxic Fluid and Percent Fluid boxes are enabled.
Design Details Section			
Code Year	Character	The year in which the design code that corresponds to the component was defined.	The value in this field must be stored in the Code Year field in the GE Digital APM Reference Table that corresponds to the value in the Stress Lookup Table field in the RBI Component record. The value in this field is used to populate the Code Year field on the datasheet of the associated analysis.
Construction Code	Character	The code to which the component was originally constructed.	The value in this field is used to populate the Construction Code field on the datasheet of the associated analysis.
Design Pressure	Numeric	The pressure at which the component is designed to operate. It is measured in pounds per square inch gauge.	The value in this field is used to populate the Design Pressure field in the associated analysis. Tip: This value is provided by the manufacturer of the component. You can find it on the nameplate or the UI Form.
Design Temperature	Numeric	The temperature at which the component is designed to operate. It is measured in degrees Fahrenheit.	The value in this field is used to populate the Design Temperature field in the associated analysis. Tip: This value is provided by the manufacturer of the component. You can find it on the nameplate or the UI Form.
Inside Diameter	Numeric	The measurement of the inner diameter of a circular or cylindrical asset, in inches.	The value in this field is used to: <ul style="list-style-type: none"> • Populate the Diameter field of the associated RBI Criticality Analysis. • Calculate Inventory for an RBI Criticality Analysis.
Insulated?	Boolean	Indicates whether or not the component is insulated.	If you select or clear this check box, the Insulated check box on the datasheet of an associated RBI Analysis is selected or cleared accordingly.

Field	Data Type	Description	Behavior and Usage
Insulation Type	Character	Identifies the insulating material used in the component.	<p>This field is enabled only if the Insulated? check box is selected. The value in this field is used to populate the Insulation Type field on an associated RBI Criticality Analysis datasheet.</p> <p>This field must contain one of the following values:</p> <ul style="list-style-type: none"> • Asbestos • Calcium Silicate (Cl Free) • Calcium Silicate (Not Cl Free) • Foam/Cellular Glass • Mineral Wool/Fiber Glass • Pearlite • Unknown
Is Entry Possible?	Boolean	Indicates whether it is possible to physically enter an asset for the purposes of performing an inspection.	<p>This field contains the description of all the System Codes in the MI_YES_NO System Code Table. You can choose from the following baseline values:</p> <ul style="list-style-type: none"> • Yes (Y) • No (N)
Length	Numeric	The total length, in inches, of an asset measured in a straight line from head seam to head seam.	This value is used to calculate inventory for Component types other than Piping in an RBI Criticality Analysis.
Material Grade	Character	Identifies the grade of the material of the component provided by the manufacturer. You can find it on the nameplate or the U1 Form.	<p>The value in this field must be stored in the Material Grade field in the GE Digital APM Reference Table that corresponds with the value the Stress Lookup Table field in the RBI Component.</p> <p>The value in this field is used to populate the Material Grade field on the datasheet of the associated analysis.</p>
Material Spec	Character	Identifies the material of the component that is provided by the manufacturer. You can find it on the nameplate or the U1 Form.	<p>The value in this field must be stored in the Material Spec field in the GE Digital APM Reference Table that corresponds with the value the Stress Lookup Table field in the RBI Component.</p> <p>The value in this field is used to populate the Material Spec field on the datasheet of the associated analysis.</p>
Nominal Thickness	Numeric	An estimated or measured thickness used as the starting point for thickness based Remaining Life calculations.	The value in this field is used to populate the Nominal Thickness field on the datasheet of an associated RBI Criticality Analysis.
PWHT	Boolean	Indicates whether or not Post Weld Heat Treatment (PWHT) has been performed to relieve residual stresses from the construction of the asset.	None

Field	Data Type	Description	Behavior and Usage
Stress Lookup Table	Character	Identifies the type of asset being assessed so that the appropriate design codes are used.	<p>This field contains the description of all the System Codes in the MI_STRESS_LOOKUP_TABLE System Code Table. You can choose from the following baseline values:</p> <ul style="list-style-type: none"> • Piping • Pressure Vessels • Tanks <p>The value in this field is used to populate the Stress Lookup Table field on the datasheet of the associated analysis.</p>
Weld Joint Efficiency	Numeric	Indicates the type of inspection used to ensure the quality of welds and the type of weld joints used during construction.	<p>This field is used to populate the Joint Efficiency field on the datasheet of an RBI Criticality Analysis.</p> <p>This field must contain one of the following values:</p> <ul style="list-style-type: none"> • 0.35 • 0.4 • 0.45 • 0.5 • 0.55 • 0.6 • 0.65 • 0.7 • 0.75 • 0.8 • 0.85 • 0.9 • 0.95 • 1.0
Corrosion Data Section			
Corrosion Type	Character	The type of corrosion to which equipment is susceptible.	You can specify a value for this field using the datasheet.
Corrosive Product	Character	Identifies the elements in the process stream that are responsible for the most aggressive corrosion.	None
Estimated External Corrosion Rate	Numeric	The rate of external degradation given by the subject matter expert during the corrosion study. This value is used in the absence of quality data from the field.	The value in this field is used to populate the Estimated Rate field on an associated Criticality Ext. Corr. Deg. Mech. Eval. datasheet.

Field	Data Type	Description	Behavior and Usage
Estimated Internal Corrosion Rate	Numeric	The rate of internal degradation provided by the subject matter expert during the corrosion study. This value is used in the absence of quality data from the field.	The value in this field is used to populate the Estimated Rate field on an associated Criticality Int. Corr. Deg. Mech. Eval. datasheet.
Internal Corrosion Type	Character	Used in inspection planning to drive different activities for localized and general thinning mechanisms.	This field contains the descriptions of all the System Codes in the CORROSION TYPES System Code Table. You can choose from the following baseline values: <ul style="list-style-type: none"> • General • Localized • Pitting
Measured External Corrosion Rate	Numeric	The corrosion rate, in inches per year, identified by Ultrasonic Thickness or Profile Radiography in the field.	None
Predictable Corr. Location	Boolean	Indicates whether or not it is known where the most aggressive corrosion is happening in the asset.	None

Field	Data Type	Description	Behavior and Usage																
Predictable Int. Corr. Location	Boolean	Indicates whether or not it is known where the most aggressive internal corrosion is happening in the asset.	None																
Source of Calculated Corrosion Rate	Character	The source of the Thickness Monitoring Calculated Corrosion Rate.	<p>The value in this field is used while integrating this module with Thickness Monitoring. This field contains the descriptions of all the System Codes in the MI_RBI_CALC_CORRO_SRC System Code Table. You can choose from the following baseline values:</p> <ul style="list-style-type: none"> Asset Component Manual Entry <p>The following table provides the behavior of the Controlling Corrosion Rate, Short Term Corrosion Rate, and Long Term Corrosion Rate fields in the associated RBI 581 Thinning and Lining Evaluation or Criticality Int. Corr. Deg. Mech. Eval. based on your selection in this field.</p> <table border="1"> <thead> <tr> <th>Source of Calculated Corrosion Rate</th> <th>Controlling Corrosion Rate</th> <th>Long Term Avg Corr Rate</th> <th>Short Term Avg Corr Rate</th> </tr> </thead> <tbody> <tr> <td>Asset</td> <td>Disabled and populated based on the value in the Controlling Corrosion Rate field in the associated Asset Corrosion Analysis</td> <td>Disabled and calculated</td> <td>Disabled and calculated</td> </tr> <tr> <td>Component</td> <td>Disabled and populated based on the highest value in the Controlling Corrosion Rate fields in the associated Asset Corrosion Analyses linked to the TML Groups.</td> <td>Disabled and calculated</td> <td>Disabled and calculated</td> </tr> <tr> <td>Manual Entry</td> <td>Disabled and blank</td> <td>Enabled</td> <td>Enabled</td> </tr> </tbody> </table>	Source of Calculated Corrosion Rate	Controlling Corrosion Rate	Long Term Avg Corr Rate	Short Term Avg Corr Rate	Asset	Disabled and populated based on the value in the Controlling Corrosion Rate field in the associated Asset Corrosion Analysis	Disabled and calculated	Disabled and calculated	Component	Disabled and populated based on the highest value in the Controlling Corrosion Rate fields in the associated Asset Corrosion Analyses linked to the TML Groups.	Disabled and calculated	Disabled and calculated	Manual Entry	Disabled and blank	Enabled	Enabled
Source of Calculated Corrosion Rate	Controlling Corrosion Rate	Long Term Avg Corr Rate	Short Term Avg Corr Rate																
Asset	Disabled and populated based on the value in the Controlling Corrosion Rate field in the associated Asset Corrosion Analysis	Disabled and calculated	Disabled and calculated																
Component	Disabled and populated based on the highest value in the Controlling Corrosion Rate fields in the associated Asset Corrosion Analyses linked to the TML Groups.	Disabled and calculated	Disabled and calculated																
Manual Entry	Disabled and blank	Enabled	Enabled																

Criticality Calculator PRD Components - Relief Valve and Rupture Disk

Field	Data Type	Description	Behavior and Usage
Design Details			
Inlet Size	Numeric	The flange size on the inlet or upstream side of a pressure relief device.	Relief Valve Only

Field	Data Type	Description	Behavior and Usage
Rated Capacity	Numeric	The capacity used as the basis for the application of a pressure relief device. This capacity is determined in accordance with the applicable code or regulation and is provided by the manufacturer.	Relief Valve Only
Set Pressure	Numeric	The inlet gauge pressure at which a pressure relief valve is set to open under service conditions.	Relief Valve Only
Spring Loaded	Boolean	Indicates whether or not a direct spring-loaded pressure relief valve is actuated by the static pressure upstream of the valve and characterized by rapid opening or pop action.	Relief Valve Only

Criticality RBI Pipeline Segment

Field	Data Type	Description	Behavior and Usage
ID			
Above Ground Facilities	Character	Indicates that sections of the pipeline are above ground and are susceptible to specific modes of damage.	None
Activity Level	Character	Indicates the level of human activity in the vicinity of the asset.	Increased activity increases the likelihood that damage may occur.
Below Bottom of Waterway	Character	For pipeline segments that are submerged at a water crossing, credit is given for the depth that they are submerged below the bottom of the waterway.	None
Below Water Surface	Character	A measurement of the depth below the water's surface that the pipeline segment resides.	None
Component Description	Character	A brief description of the component.	None

Field	Data Type	Description	Behavior and Usage
Component Status	Character	Indicates whether a component is active or inactive.	Once an RBI component is set to inactive, it cannot be reactivated.
Component Type	Character	Identifies the segment of the pipeline that is being assessed.	The value in this field must be stored in the Criticality Item Type field in one of the Equipment Types records delivered in the GE Digital APM baseline database.
Date Built	Date	The original date of construction.	You can use the Calendar feature to select the date on which the pipeline segment was built.
Mechanical Pipe Protection	Character	A type of mechanical protection that can shield a pipeline segment from third-party damage by coating the pipe with reinforced concrete, encasing the pipe, or placing a reinforced concrete slab over (but not in contact with) the pipe.	None
Minimal Depth of Cover	Numeric	The depth of coverage at its most shallow point for the pipeline segment.	The average depth of coverage for a pipeline segment directly influences the probability of a loss of containment due to third-party damage.
One-Call System	Character	A one-call system is a service that receives calls regarding upcoming excavation activities and relays the information to the affected utilities.	A line locating program is central in avoiding third-party damage.
Patrol Frequency	Character	An indicator of how often the pipeline is patrolled.	Patrolling the pipeline is a proven method of reducing third-party intrusions. The patrols are a means to identify impending threats to the pipeline (e.g., construction activities).
Pipeline Marker Tape (Warning Mesh)	Character	Marker tape or warning mesh installed above a pipeline is an additional measure to protect against third-party damage.	The brightly colored tape or mesh installed above the pipeline may help avert damage to the pipeline.

Field	Data Type	Description	Behavior and Usage
Previous Damage	Character	Indicates whether or not damage was observed during prior inspection activities.	None
Public Education	Character	The programs put in place to warn those who live or work near pipeline assets.	Public education programs are thought to play a significant role in reducing third-party damage to pipelines.
Right-Of-Way Condition	Character	Pipeline Right-Of-Way is a set of defined parcels of land where pipelines and related asset are installed both underground and above ground.	A clearly marked, easily recognized Right-Of-Way reduces susceptibility to third-party damage.
Submerged at Water Crossing	Character	Indicates whether or not the pipeline segment is underwater at the point of crossing.	None
Operating and Process			
Defects Reported	Character	Identifies any inspection findings from previous inspection events.	Having this data allows the inspector to follow up on these indications.
Flow Rate	Numeric	Indicates the amount of fluid flowing at any given time.	This data impacts corrosion characteristics.
High Consequence Area	Character	Locations where a pipeline spill might have significant adverse impacts to population, the environment, or commercial navigation.	High consequence areas are defined under CFR 49 part 195.450.
High Value Area	Character	Locations where a pipeline spill might have significant financial impacts.	GE Digital APM follows the Pipeline Risk Management Manual model to determine high value area. Muhlbauer, W. Kent. Pipeline Risk Management Manual. Gulf Publishing Company, Houston, 2004.

Field	Data Type	Description	Behavior and Usage
LMPA	Character	Land Movement Potential Adjustment (LMPA) is a value that describes the possibility of land movements based on the geographical region.	GE Digital APM follows the Pipeline Risk Management Manual model to determine LMPA. Muhlbauer, W. Kent. Pipeline Risk Management Manual. Gulf Publishing Company, Houston, 2004.
Representative Fluid	Character	The fluid that represents or makes up the greatest volume of the asset. In some cases, the fluid that represents the greatest Consequence of Failure (CoF) may be selected.	None
SCADA	Character	The Supervisory Control and Data Acquisition System (SCADA) refers to the transmission of pipeline operational data at sufficient points along the pipeline.	This allows monitoring of the - pipeline from a single location.
Segment Length	Numeric	The total length of the segment being assessed.	None
Soil Type	Character	The type of soil in the vicinity of the pipeline.	This value is used to make an adjustment in the release quantity to account for the differences in fluid velocity and retention for various soil types.
SPA	Character	Surge Pressure Adjustment (SPA) is a value attributed to calculate the changes in the velocity or flow of a pipeline system.	None
Suggested Clean Up	Character	The means by which a potential spill will be cleaned.	This data will impact the financial impact of the spill.
Design Details			
Construction Code	Character	The code to which the asset was originally constructed.	The design code associated with the component.
Design Flow Rate	Numeric	The flow rate the pipeline was designed to support.	None
Is CP System Present?	Character	Indicates whether or not the asset has Cathodic Protection	None

Field	Data Type	Description	Behavior and Usage
Is Piggable?	Character	Indicates whether the asset is designed in such a way that it may be inspected using a PIG.	This data will drive the inspection recommendations generated for this asset.
Segment Type	Character	Describes the segment being assessed.	None
Wall Thickness	Numeric	The wall thickness at the time of analysis.	This data is used to derive the remaining life calculations.

Criticality Degradation Mechanism Evaluation Records

RBI Degradation Mechanism Evaluation records are used to determine degradation mechanisms that affect Equipment and Functional Locations. This topic provides an alphabetical list and description of the fields that exist for the RBI Degradation Mechanism Evaluation (DME) family. The information in the table reflects the baseline state and behavior of these fields. The Criticality Degradation Mech, Evaluation table lists common fields shared across several DMEs. Fields that are unique to a specific component type can be viewed by expanding the appropriate drop-down list box in the heading.

The following families are enabled for site filtering, which means that the records in these families can be assigned to a specific site, and will then only be accessible to users who are assigned to the same site and have the appropriate license and family privileges. See the Site Filtering section of the documentation for more information on using this feature.

Criticality Degradation Mech Evaluation

Field	Data Type	Description	Behavior and Usage
Main			
Custom Calculation Policies Used	Character	A list of custom policies that are used to calculate the DME.	The value in this field must be 500 characters or less.
Custom Calculations Used	Boolean	Indicates whether or not the Degradation Mechanism Evaluation was calculated using the method specified in the Custom DME Configuration.	None
Damage Mechanism	Character	A process that induces deleterious micro and/or macro material changes over time that are harmful to the material condition or mechanical properties.	None

Field	Data Type	Description	Behavior and Usage
Probability Category	Character	Extent to which an event is likely to occur within the time frame under consideration. The mathematical definition of probability is a real number in the scale of 0 to 1 and is attached to a random event.	None
Probability Category Description	Character	Category to which an event is likely to occur within the time frame under consideration. The mathematical definition of probability is a real number in the scale 0 to 1 and is attached to a random event.	None
Input Fields			
Date in Service	Date	Indicates the date on which the asset was exposed to the environment, making it susceptible to this Degradation Mechanism.	This date is used as the basis for all the calculations for each Degradation Mechanism.
Equivalent Number of Inspections	Numeric	A value that represents the summation of averaging a group of inspections over a period of time.	This approach is used only with the semi-quantitative risk model in GE Digital APM.
Estimated Rate	Numeric	The corrosion rate given by the subject matter expert for the asset.	Should be used in the absence of quality ultrasonic thickness (UT) data.
Inspection Confidence	Character	Describes how effective the prior inspections were at correctly identifying the presence and extent of internal corrosion.	An input from the following categories: <ul style="list-style-type: none"> • Very High (VH) • High (H) • Medium (M) • Low (L)
Inspection Date	Date	The date on which the inspection was performed on the component.	None
Selected Corrosion Rate	Numeric	Indicates which corrosion rate the risk analyst has chosen as the basis of the analysis.	Used for all remaining life calculations in RBI.
Use Combined Confidence	Boolean	Indicates whether or not the risk analyst has chosen to use the Rule of Threes.	None

Field	Data Type	Description	Behavior and Usage
Wall Thickness Loss	Numeric	Indicates how much of the original wall thickness has been lost at the time of analysis.	None
Intermediate Output			
DF	Numeric	Damage Factor (DF) is a calculated value that quantifies the extent of damage from this Degradation Mechanism at the time of the analysis.	None
Estimated Half Life	Numeric	Half of the calculated remaining life.	The value in this field is the result of the following calculation: $\frac{((\text{Initial Wall Thickness}) - (\text{Ext. Est. Wall Loss}) - (\text{Ext. Est. Min. Thickness}))}{2 * (\text{Ext Corr. Rate})}$ This value will be used to cap the inspection interval.
Estimated Wall Loss	Numeric	Estimates how much of the original wall thickness has been lost at the time of analysis.	None
Failure Frequency	Numeric	A Probability of Failure (PoF) developed for specific component types based on a large population of component data that does not include the effects of specific damage mechanisms.	This data is one of the factors used to determine the PoF.
Fractional Wall Loss	Numeric	The Fractional Wall Loss is calculated by dividing the estimated internal wall loss by the original wall thickness.	None

Field	Data Type	Description	Behavior and Usage
Wall Ratio	Numeric	The estimated remaining wall divided by the required minimum wall thickness.	Used as a tool to validate the data used in the assessment.
Years in Service	Numeric	The number of years an asset item has been in service. This time frame is measured from the initial date in its current service to the time the Probability of Failure Analysis is performed.	None

Criticality Env. Crack. Deg. Mech. Eval.

Field	Data Type	Description	Behavior and Usage
Input Fields			
Cyanides	Boolean	Indicates whether or not cyanides are present.	None
Damage at Last Inspection	Boolean	Indicates whether Wet H2S damage was found at the last inspection.	None
Date in Service	Date	Indicates the date on which the asset was exposed to the environment, making it susceptible to this Degradation Mechanism.	The date in this field must be earlier than or equal to the date in the Inspection Date field. This date is used as the basis for all the calculations for the Degradation Mechanism.
Env. Cracking Higher Levels	Boolean	Allows the risk analyst to add an additional factor if they believe that the likelihood of cracking is much higher.	This affects the results of the cracking assessment by an order of magnitude.
Free Water	Numeric	Water that is available to react with a cracking agent.	None
H2S Content	Character	The percentage of H2S in the process stream.	None
Initial Potential	Character	The potential for cracking based only on material and environmental criteria and not on inspection history.	None

Field	Data Type	Description	Behavior and Usage
Inspection Date	Date	The date on which the inspection was performed on the component.	This field is populated by the value in the Completion Date field for the Inspection. If there is more than one linked Inspection, the latest date is used. If there are no linked Inspections, this field will be blank. You can also enter a value in this field manually.
Is Entry Possible?	Character	Indicates whether or not it is possible to physically enter an asset for the purposes of performing an inspection.	None
PT or MT Access?	Character	Indicates whether or not it is possible to physically enter an asset from a Penetrant Testing (PT) point or a Magnetic Particle Testing (MT) point for the purposes of performing an inspection.	None
PWHT	Boolean	Indicates whether or not Post Weld Heat Treatment (PWHT) has been performed to relieve residual stresses from construction of the asset.	None
Intermediate Output			
Adjusted Env. DF	Numeric	Calculated value for the years in service.	None
Adjusted Years Last Inspection	Numeric	The adjusted number of years since the last inspection. This time is measured from the most recent inspection to the time the Probability of Failure (PoF) Analysis.	This is a calculated value.

Field	Data Type	Description	Behavior and Usage
Updated Potential	Character	The updated potential for damage is based on the number of prior inspections, their respective confidence levels, and whether or not damage was found during the last inspection.	This is a calculated value.
Years Last Inspection	Numeric	The number of years since the last inspection. This time is measured from the last inspection to the time the Probability of Failure (PoF) Analysis is conducted.	This is a calculated value.

Criticality Ext. Corr. Deg. Mech. Eval

Field	Data Type	Description	Behavior and Usage
Input Fields			
Coating Quality	Character	The type of coating applied to the asset before insulating.	This field contains the description of all the System Codes in the MI_RBI_Coating_Quality System Code Table. You can choose from the following baseline values: <ul style="list-style-type: none"> • Best • Average • None The value in this field is used for calculating the value in the Coating Factor field.
Date in Service	Date	Indicates the date on which the asset was exposed to the environment, making it susceptible to this Degradation Mechanism.	The date in this field must be earlier than or equal to the date in the Inspection Date field. This date is used as the basis for all the calculations for the Degradation Mechanism.

Field	Data Type	Description	Behavior and Usage
Inspection Date	Date	The date on which the inspection was performed on the component.	This field is populated by the value in the Completion Date field for the Inspection. If there is more than one linked Inspection, the latest date is used. If there are no linked Inspections, this field will be blank. You can also enter a value in this field manually.
Insulation Condition	Character	The condition of the insulation.	This field contains the description of all the System Codes in the MI_RBI_Insulation_Condition System Code Table. You can choose from the following baseline values: <ul style="list-style-type: none"> • Good • Fair • Poor
Near Cooling Tower?	Boolean	Indicates whether or not the asset is located near a cooling tower.	None
Number of Penetrations	Numeric	Indicates the number of places in the piping circuit where the pipe penetrates the surrounding structure via an insulating cover.	By default, this field contains the value 0. If the DME is associated with a piping component, the value in this field is used in calculating the complexity of the piping circuit, which impacts the value in the Age field.
Number of Terminations	Numeric	Indicates the number of places in the piping circuit where the insulation starts or stops exposing the pipe to the atmosphere.	By default, this field contains the value 0. If the DME is associated with a piping component, the value in this field is used in calculating the complexity of the piping circuit, which impacts the value in the Age field.
Number of Vertical Runs	Numeric	Indicates the number of places in the piping circuit where the insulated pipe is oriented vertically for more than six feet.	By default, this field contains the value 0. If the DME is associated with a piping component, the value in this field is used in calculating the complexity of the piping circuit, which impacts the value in the Age field.

Field	Data Type	Description	Behavior and Usage
Intermediate Output			
Adjusted ECDF	Numeric	The adjusted value of the External Corrosion Damage Factor.	This field is used for RBI Pipeline analyses.

Field	Data Type	Description	Behavior and Usage						
Age	Numeric	Indicated the external age of the component and is measured from the date the asset item was renewed to a like-new condition.	<p>The external age of an asset differs from its years in service. External age is measured from the date of the last painting or coating of the asset.</p> <p>This field is disabled. The value in this field is calculated as follows:</p> <p>Age = Years in Service – (Coating factor x 5)</p> <p>For a piping component, the value in the Age field is based on the Coating Factor and the complexity of the piping circuit. Circuit Complexity is calculated as follows:</p> <p>Circuit Complexity = (Number of Penetrations + Number of Terminations + Number of Vertical Runs) / Piping Circuit Length</p> <p>Based on the Circuit Complexity and the value in the Coating Factor field, the value in the Age field of the piping component is calculated as follows:</p> <ul style="list-style-type: none"> • If the Circuit Complexity > 0.05, then: Age = Years in Service – (Coating factor x 5) • If the Circuit Complexity <= 0.05 and >=0.01, then: Age = Years in Service – (Coating factor x 5) – 5 • If the Circuit Complexity < 0.01, then: Age = Years in Service – (Coating factor x 5) – 10 <p>Piping Circuit complexity has a default value of N/A. There will be no age reduction for Circuit Complexity value N/A and a value > 0.05</p> <table border="1" data-bbox="1149 1818 1414 2097"> <thead> <tr> <th data-bbox="1149 1818 1279 1898">Circuit Complexity</th> <th data-bbox="1279 1818 1414 1898">Complexity Category</th> </tr> </thead> <tbody> <tr> <td data-bbox="1149 1898 1279 2011"><0.01</td> <td data-bbox="1279 1898 1414 2011">Low=Reduced External Age 10 Years</td> </tr> <tr> <td data-bbox="1149 2011 1279 2097"><=0.05</td> <td data-bbox="1279 2011 1414 2097">Medium=Reduced External Age 5</td> </tr> </tbody> </table>	Circuit Complexity	Complexity Category	<0.01	Low=Reduced External Age 10 Years	<=0.05	Medium=Reduced External Age 5
Circuit Complexity	Complexity Category								
<0.01	Low=Reduced External Age 10 Years								
<=0.05	Medium=Reduced External Age 5								

Field	Data Type	Description	Behavior and Usage
Area Humidity Factor	Numeric	Should be set based on the humidity of the geographical region in which the asset is operated.	None
Calculated Corrosion Rate	Numeric	The Calculated Corrosion Rate for Corrosion Under Insulation (CUI) is the product of the external corrosion rate and the humidity factor.	None
Coating Factor	Numeric	That factor that results from the selection made in the Coating Quality field.	<p>The value in the Coating Factor field is calculated as follows:</p> <ul style="list-style-type: none"> • If you selected Coating Quality as None, then: Coating Factor= 0.2 • If you selected Coating Quality as Average, then: Coating Factor= 1 • If you selected Coating Quality as Best, then: Coating Factor= 2 <p>The value in this field impacts the calculation of the value in the Age field.</p>
Corrosion Factor	Numeric	That factor that results from the selection made in the Corrosion field.	The value in this field impacts the calculation.
Estimated Minimum Thickness	Numeric	A user-defined minimum thickness.	The value in this field impacts the calculation.
Insulation Condition Factor	Numeric	The factor that results from the selection made in the Insulation Condition field.	The value in this field impacts the calculation.
Insulation Type Factor	Numeric	The factor that results from the selection made in the Insulation Type field.	The value in this field impacts the calculation.

Criticality Int. Corr. Deg. Mech. Eval

Field	Data Type	Description	Behavior and Usage
Input Fields			

Field	Data Type	Description	Behavior and Usage
Controlling Corrosion Rate	Numeric	The controlling corrosion rate, in inches per year, of the Asset or the TML Group that is associated with the component.	<p>This is the most conservative Controlling Corrosion Rate field on the Asset Corrosion Analysis family from all the TML Groups mapped to RBI Component.</p> <p>This field is disabled. If the value in the Source of Calculated Corrosion Rates field in the associated Component is:</p> <ul style="list-style-type: none"> Asset, then this field is populated based on the value in the Controlling Corrosion Rate field in the associated Asset Corrosion Analysis in Thickness Monitoring. Component, then this field is populated based on the highest value in the Controlling Corrosion Rate fields in the associated Asset Corrosion Analyses linked to the TML Groups. Manual Entry, then this field is blank because controlling corrosion rate is always specified in Thickness Monitoring. You cannot enter a value in this field. <p>Example:</p> <ul style="list-style-type: none"> TML Group 1 – CCR - .3 MIL/Yr TML Group 2 – CCR - .45 MIL/Yr TML Group 3 – CCR - .33 MIL-Yr <p>RBI Component is mapped to:</p> <ul style="list-style-type: none"> TML Group 1 and TML Group 2 <p>Resulting CCR on Internal DME : 00045 Inches/Yr</p> <p>Note: The value in the Controlling Corrosion Rate field in the Asset Corrosion Analysis is in mils per year. This value is converted to inches per year, and then used to populate this field.</p> <p>When you copy the analysis without copying the</p>

Field	Data Type	Description	Behavior and Usage
Date in Service	Date	Indicates the date on which the asset was exposed to the environment, making it susceptible to this Degradation Mechanism.	The date in this field must be earlier than or equal to the date in the Inspection Date field. This date is used as the basis for all the calculations for the Degradation Mechanism.
Inspection Date	Date	The date on which the inspection was performed on the component.	This field is populated by the value in the Completion Date field for the Inspection. If there is more than one linked Inspection, the latest date is used. If there are no linked Inspections, this field will be blank. You can also enter a value in this field manually.
Predictable	Character	Indicates whether or not it is known where the most aggressive corrosion is happening in the asset.	None
Thinning Type	Character	Indicates what type of wall loss is occurring in the asset.	None
Intermediate Output			
Adjusted ICDF	Numeric	The adjusted value of the Internal Corrosion Damage Factor.	This field is used for RBI Pipeline analyses.
Estimated Wall Remaining	Numeric	The estimated remaining wall thickness.	This is a calculated value.
Non-Intrusive Requirement Met	Boolean	Indicates whether you can perform intrusive or non-intrusive inspection on the component.	This check box is disabled and populated automatically.

Criticality Leak Deg. Mech. Eval.

Field	Data Type	Description	Behavior and Usage
Main			
Probability Category – Current Interval	Character	The categorical representation of the Probability of Leak at the current interval. The Probability Category is based on the Probability of Leak field calculated using duration between the calculation date of the PRD analysis and the next inspection date. Next Inspection date is captured at the PRD analysis level.	None
Probability Category – RBI Interval	Character	The categorical representation of the Probability of Leak field. This is based on the RBI recommended interval calculated as a result of PRD analysis.	
Input Fields			
Piping Vibration	Boolean	Indicates whether or not the asset is susceptible to piping vibration.	None
Pulsating/Cycling Service	Boolean	Indicates whether or not the asset has a Pulsating/Cycling service.	None
Service Severity - Leak	Character	Defines the consequences inherent to the particular process in which the devices operate.	None
Soft Seat	Boolean	Indicates whether or not the asset has a Soft Seat.	None
Intermediate Output			
Final Inspection Interval	Numeric	The inspection interval that used for this device.	This is a calculated value.
Operation Ratio	Numeric	The ratio of the maximum system operating pressure to the set pressure.	None

Field	Data Type	Description	Behavior and Usage
Probability of Leak- RBI Interval	Numeric	The data associated with the probability of leakage in failures per year. This is based on the RBI recommended interval calculated as a result of PRD analysis.	This is a calculated value.
Probability of Leak – Current Risk Interval	Numeric	Extent to which a leak is likely to occur within the time frame of the current interval in failures per year. The current interval is calculated by taking the difference of the calculation date and the Next Inspection Date field.	This is a calculated value.
Weibull Updated Characteristic Life	Numeric	A parameter modified to account for: <ul style="list-style-type: none"> • Installation factors • Design features • Overpressure factors • Environmental factors • Years 	None

Criticality Other Damage Mech. Eval.

Field	Data Type	Description	Behavior and Usage
Main			
DF	Numeric	Damage Factor (DF) is a calculated value that quantifies the extent of damage from this Damage Mechanism at the time of analysis.	This is a calculated value.
Failure Frequency	Numeric	The Probability of Failure (PoF) developed for specific component types based on a large population of component data that does not include the effects of specific damage mechanisms.	This data is one of the factors used to determine the Probability of Failure (PoF).

Criticality Over Pressure Deg. Mech. Eval.

Field	Data Type	Description	Behavior and Usage
Main			
Probability Category – Current Interval	Character	The categorical representation of the Probability of Loss of Containment at the current interval. The Probability Category is based on the Probability of Lost of Containment- Current Interval field calculated using duration between the calculation date and the next inspection date.	This is a calculated value.
Probability Category – RBI Interval	Character	The categorical representation of the Probability of Loss of Containment.	This is a calculated value
Intermediate Output			
Consequence of Failure at Overpressure	Character	The Consequence of Failure (CoF) for an overpressure degradation mechanism.	None
Failure Frequency of Protected Asset	Numeric	The Probability of Failure (PoF) developed for specific component types based on a large population of component data that does not include the effects of specific damage mechanisms.	This data is one of the factors used to determine the Probability of Failure (PoF) for the asset.
Final Inspection Interval	Numeric	The inspection interval that will be used for this device.	This is a calculated value.
Modified Characteristic Life	Numeric	A parameter modified to account for: <ul style="list-style-type: none"> • Installation factors • Design features • Overpressure • Environmental factors • Years 	None
Overpressure	Numeric	Events that can cause failure of the asset protected by the device, leading to a loss of containment.	None

Field	Data Type	Description	Behavior and Usage
Overpressure Factor (Fo)	Numeric	The factor that results from the selection made in the Overpressure field.	None
Probability of Failure on Demand – RBI Interval	Numeric	The extent to which an event is likely to occur within the time frame under consideration. This is based on the RBI recommended interval calculated as a result of PRD analysis. The mathematical definition of probability is a real number on the scale 0 to 1 and is attached to a random event.	This is a calculated value.
Probability of Failure on Demand – Current Interval	Numeric	Extent to which a failure is likely to occur within the time frame of the current interval. The current interval is calculated by taking the difference of the calculation date and the Next Inspection Date field.	This is a calculated value.
Probability of Loss of Containment - RBI Interval	Numeric	Extent to which an event is likely to occur within the time frame under consideration. This is based on the RBI recommended interval calculated as a result of PRD analysis. The mathematical definition of probability is a real number in the scale 0 to 1 and is attached to a random event.	This is a calculated value.

Field	Data Type	Description	Behavior and Usage
Probability of Loss of Containment – Current Interval	Numeric	Extent to which a loss of containment is likely to occur within the time frame of the current interval. The current interval is calculated by taking the difference of the calculation date and the Next Inspection Date field.	This is a calculated value.
Weibull Updated Characteristic Life Parameter	Numeric	A parameter modified to account for: <ul style="list-style-type: none"> • Installation factors • Design features • Overpressure • Environmental factors • Years 	This is a calculated value.

Criticality Third Party Deg. Mech. Eval.

Field	Data Type	Description	Behavior and Usage
Input Fields			
Above Ground Facilities	Character	Indicates that sections of the pipeline are above ground and are susceptible to specific modes of damage.	None
Activity Level	Character	Indicates the level of human activity in the vicinity of the asset.	Increased activity increases the likelihood that damage may occur.
Below Bottom of Waterway	Character	In the case of pipeline segments that are submerged at a water crossing, credit is given for depth below water surface and for depth below bottom of waterway.	None
Below Water Surface	Character	The depth below the water's surface.	None
Concrete Coating	Character	A protective coating around the pipeline to prevent damage.	None

Field	Data Type	Description	Behavior and Usage
Mechanical Pipe Protection	Character	<p>Mechanical protection that shields the pipe from third-party damage by one of the following methods:</p> <ul style="list-style-type: none"> Coating the pipe with reinforced concrete. Encasing the pipe. Placing a reinforced concrete slab over, but not in contact with, the pipe. 	None
Minimal Depth of Cover	Numeric	The depth of coverage at the shallowest point for a pipeline segment.	The average depth of cover for a pipeline segment directly influences the probability of a release due to third-party damage.
One-Call System	Character	A one-call system is a service that receives calls regarding upcoming excavation activities and relays the information to the affected utilities.	A line locating program is central in avoiding third-party damage.
Patrol Frequency	Character	Describes how often the pipeline is patrolled.	Patrolling the pipeline is a proven method of reducing third party intrusions. The patrols are a means to identify impending threats to the pipeline (e.g. construction activities).
Pipeline Marker Tape (Warning Mesh)	Character	Marker tape or warning mesh installed above a pipeline is an additional measure to protect against third party damage.	The brightly colored tape or mesh installed above the pipeline may help avert damage to the pipeline.
Previous Damage	Character	Indicates whether or not damage was observed during prior inspection activities.	None
Public Education	Character	The programs put in place to warn those who live or work near pipeline assets.	Public education programs are thought to play a significant role in reducing third-party damage to pipelines.
Right-Of-Way Condition	Character	Pipeline rights of way are defined parcels of land where pipelines and related asset are installed underground and above ground.	A clearly marked, easily recognized Right-of-Way reduces the susceptibility to third-party damage.

Field	Data Type	Description	Behavior and Usage
Submerged at Water Crossing	Boolean	Indicates whether or not the pipeline segment is underwater at the point of crossing.	None
Intermediate Output			
Above Ground	Numeric	Indicates that sections of the pipeline are above ground and are susceptible to specific modes of damage.	None
Activity Level Points	Numeric	The points awarded for the selection made in the Activity Level field.	The value in this field impacts the calculation.
Depth of Cover Points	Numeric	The points awarded for the selection made in the Depth of Cover field.	The value in this field impacts the calculation.
One-Call System Points	Numeric	The points awarded for the selection made in the One-Call System field.	The value in this field impacts the calculation.
Patrol Frequency Points	Numeric	The points awarded for the selection made in the Patrol Frequency field.	The value in this field impacts the calculation.
Previous Damage Points	Numeric	That points awarded for the selection made in the Previous Damage field.	The value in this field impacts the calculation.
Probability of Failure	Numeric	The extent to which a Probability of Failure (PoF) event is likely to occur within the time frame under consideration. The mathematical definition of probability is a real number in the scale 0 to 1 and is attached to a random event.	None
Probability of Failure - TPD	Numeric	The extent to which Third Party Damage (TPD) event is likely to occur within the time frame under consideration. The mathematical definition of probability is a real number in the scale 0 to 1 and is attached to a random event.	None
Public Education Points	Numeric	The points awarded for the selection made in Public Education field.	The value in this field impacts the calculation.

Field	Data Type	Description	Behavior and Usage
Right-Of-Way Condition Points	Numeric	The points awarded for the selection made in Right-Of-Way (RoW) field.	The value in this field impacts the calculation.
Total Points (TPD)	Numeric	The summation of all points resulting from the data used in the analysis.	The value in this field impacts the calculation.

Flexible RBI Methodology Records

Flexible RBI Methodology records store the configuration details for configured calculations and validations. This topic provides an alphabetical list and description of the fields that exist for the following families and their corresponding datasheets:

- RBI Flexible Calculation Configuration
- RBI Flexible Calculation Configuration Details
- RBI Flexible Calculation Validation
- RBI Flexible Calculation Validation Details

The information in the table reflects the baseline state and behavior of these fields.

These families are enabled for site filtering, which means that records in these families can be assigned to a specific site, and will then only be accessible to users who are assigned to the same site and have the appropriate license and family privileges.

Tip: For more information, refer to the Site Filtering section of the documentation.

Field	Data Type	Description	Behavior and Usage
RBI Flexible Calculation Configuration and RBI Flexible Calculation Validation			
Action	Character	A list of available actions for flexible calculation and validation.	A value is required. The values are populated from the MI_CONF_VAL_ACTIONS or MI_CONF_CALC_ACTIONS system code table.
Action Family	Character	The family ID of the family that will use the flexible calculation or validation.	A value is required. This field contains a list of all families that can be configured for the flexible calculation or validation..
Analysis Family	Character	A list of available families that support Flexible RBI Methodology preferences.	By default, this field is populated with the value RBI Criticality Analysis. You cannot modify this value.
Policy Link	Character	A link that points to the policy selected for flexible calculation or validation.	The link is populated automatically when you select a policy in the Policy Name field. The policy opens in the Policy Designer workspace.

Field	Data Type	Description	Behavior and Usage
Policy Name	Character	The name of the policy used for flexible calculation or validation.	A value is required. This field contains a list of all policies in the MI_POLICY family. When you select the policy, a link to the policy is populated in the Policy Link field.
Sequence	Numeric	Defines the order in which the policies associated with this flexible methodology should be fired.	The value in this field must be a numeric value, which is equal to or greater than 1.
RBI Flexible Calculation Configuration Details and RBI Flexible Calculation Validation Details			
Input Entity Family	Character	The family of the Entity type of the policy that creates the flexible calculation or validation. The value in this field will be from the RBI Flexible Calculation Configuration family.	This field contains a list of: <ul style="list-style-type: none"> All DME families configured with the Has RBI Degradation Mechanism Evaluation Relationship Definition to the Analysis family. All Consequence Evaluation families that are configured with the Has Consequence Evaluation Relationship Definition to the Analysis family. The Analysis family.
Policy Node Name	Character	The name of the node in the policy to which the Entity is mapped.	A value is required.

Grouping Element Records

Grouping Element records store information about the RBI Components included in an Inspection Group. The information in the table reflects the baseline state and behavior of fields that exist in the Grouping Element family. This list is not comprehensive.

This family is enabled for site filtering, which means that records in this family can be assigned to a specific site and will only be accessible to users who are assigned to the same site and have the appropriate license and family privileges. For more information, refer to the [Sites](#) section of the documentation.

Field	Data Type	Description	Behavior and Usage
Analysis	Character	Stores the entity key of the RBI Criticality Analysis record associated with the RBI Component that meets the grouping criteria.	This field is disabled and populated automatically with the value in the Analysis ID field from the RBI Criticality Analysis record associated with the RBI Component.
Asset	Character	Stores the entity key of the Asset record associated with the RBI Component that meets the grouping criteria.	This field is disabled and populated automatically with the value from the Asset record associated with the RBI Component.
Component	Character	Stores the entity key of the RBI Component that meets the grouping criteria.	This field is disabled and populated automatically with the value in the Component ID field from the Criticality Calculator RBI Components record associated with the Inspection Group.
Design Pressure	Numeric	Stores the Design Pressure associated with the RBI Component that meets the grouping criteria. It is measured in pounds per square inch gauge.	This field is disabled and populated automatically with the value in the Design Pressure field from the RBI Criticality Analysis record associated with the RBI Component.
Design Temperature	Numeric	Stores the Design Temperature associated with the RBI Component that meets the grouping criteria. It is measured in degrees Fahrenheit.	This field is disabled and populated automatically with the value in the Design Temperature field from the RBI Criticality Analysis record associated with the RBI Component.
Excluded from Group	Boolean	Indicates whether the RBI Component should be excluded from the associated Inspection Group. Components excluded from the group cannot have representative inspections.	This field is disabled. If you select this check box, the RBI Component is excluded from the associated Inspection Group.

Field	Data Type	Description	Behavior and Usage
Exists In Higher Risk Category	Boolean	Indicates whether or not the Asset record associated with the RBI Component included in the Inspection Group is associated with another Inspection Group that has a higher Risk Category.	<p>This field is disabled and populated automatically when you create an Inspection Group.</p> <p>When this field is set to True, it indicates that the Component will not be identified as a Representative RBI Component for the Inspection Group.</p> <p>When this field is set to False, it indicates that the RBI Component can be selected as a Representative RBI Component for the Inspection Group.</p>
Final Fluid Phase	Character	Stores the Final Phase value taken from the Criticality Consequence Evaluation record associated with the RBI Analysis.	This field is disabled.
Initial Fluid Phase	Character	Stores the Initial Fluid Phase value taken from the Criticality Consequence Evaluation record associated with the RBI Analysis.	This field is disabled.
Initial Wall Thickness	Numeric	Stores the Initial Wall Thickness associated with the RBI Component that meets the grouping criteria. It is measured in Inches.	This field is disabled and populated automatically with the value in the Nominal Thickness field from the RBI Criticality Analysis record associated with the RBI Component.
Inspection Priority	Numeric	Stores the Inspection Priority (Unmitigated Risk) associated with the RBI Component included in the Inspection Group.	This field is disabled and populated automatically with the value in the Inspection Priority (Unmitigated Risk) field from the RBI Degradation Mechanisms record related to the RBI Criticality Analysis record associated with the RBI Component.
Material Grade	Character	The material grade of the component.	This field is populated with the value in the Material Grade field in the associated RBI Criticality Analysis record.

Field	Data Type	Description	Behavior and Usage
Material Spec	Character	Stores the Material Spec associated with the RBI Component included in the Inspection Group.	This field is disabled and populated automatically with the value in the Material Spec field from the RBI Criticality Analysis record associated with the RBI Component.
Operating Pressure	Numeric	Stores the Operating Pressure associated with the RBI Component included in the Inspection Group. It is measured in pounds per square inch gauge.	This field is disabled and populated automatically with the value in the Operating Pressure field from the RBI Criticality Analysis record associated with the RBI Component.
Operating Temperature	Numeric	Stores the Operating Temperature associated with the RBI Component included in the Inspection Group. It is measured in degrees Fahrenheit.	This field is disabled and populated automatically with the value in the Operating Temperature field from the RBI Criticality Analysis record associated with the RBI Component.
Representative Fluid	Character	Stores the Representative Fluid associated with the RBI Component included in the Inspection Group.	This field is disabled and populated automatically with the value in the Representative Fluid field from the RBI Criticality Analysis record associated with the RBI Component.
Selected for Inspection	Boolean	Indicates whether or not the RBI Component should be inspected.	<p>This field is populated automatically when an Inspection Group is created.</p> <p>When this field is set to True, it indicates that the RBI Component is selected as the Representative RBI Component for the Inspection Group.</p> <p>When this field is set to False, it indicates that the RBI Component is not selected as the Representative RBI Component for the Inspection Group.</p> <p>This field is enabled only when the associated Inspection Group record is in the Proposed state.</p>

Field	Data Type	Description	Behavior and Usage
Selection Basis	Character	<p>Indicates the basis for which, the Grouping Element record is selected for Inspection. This field is populated with one of the following values:</p> <ul style="list-style-type: none"> • Selected By Engine • Temperature/Pressure Criteria • User Selected 	<p>This field is populated automatically when an Inspection Group is created or modified. This field is populated by the MI_GROUPING_SEL_BASIS System Code Table.</p>
System Selected	Boolean	<p>Indicates whether the RBI Component is automatically selected for inspection by the system or manually selected for inspection by a user.</p>	<p>This field is disabled and populated automatically when you create an Inspection Group.</p> <p>When this field is set to True, it indicates that the RBI Component is automatically selected as the Representative RBI Component for the Inspection Group by the system.</p> <p>When this field is set to False, it indicates that the RBI Component is manually selected as the Representative RBI Component for the Inspection Group by a user.</p> <p>This field does not appear on the Grouping Element datasheet.</p>

Field	Data Type	Description	Behavior and Usage
Thinning Type	Character	Stores the Thinning Type associated with the RBI Component included in the Inspection Group.	<p>This field is disabled and populated automatically with the value in the Thinning Type field from either of the following records related to the RBI Criticality Analysis record associated with the RBI Component:</p> <ul style="list-style-type: none"> • Criticality Ext. Corr. Deg. Mech. Eval. if the corrosion type is CUI (Corrosion Under Insulation). • Criticality Int. Corr. Deg. Mech. Eval. if the corrosion type is ICPC (Internal Corrosion). <p>This field is populated with a system code description stored in the CORROSION TYPES system code table.</p>
Wall Ratio	Numeric	Stores the Wall Ratio associated with the RBI Component included in the Inspection Group.	<p>This field is disabled and populated automatically with the value in the Wall Ratio field from either of the following records associated with the RBI Component:</p> <ul style="list-style-type: none"> • Criticality Ext. Corr. Deg. Mech. Eval. if the corrosion type is CUI (Corrosion Under Insulation). • Criticality Int. Corr. Deg. Mech. Eval. if the corrosion type is ICPC (Internal Corrosion). <p>The values up to four decimal places are displayed in the WALL RATIO column.</p>

Inspection Group Records

Inspection Group records store information about the Inspection Groups that you create for RBI Components that meet certain criteria. The information in the table reflects the baseline state and behavior of fields that exist in the Inspection Group family.

This family is enabled for site filtering, which means that records in this family can be assigned to a specific site and will only be accessible to users who are assigned to the same site and have the appropriate license and family privileges. For more information, refer to the [Sites](#) section of the documentation.

Field	Data Type	Description	Behavior and Usage
Corrosion Type	Character	Stores the type of corrosion, the RBI Components in the Inspection Group are susceptible to.	This field is disabled and populated by the MI_GROUPING_CORR_TYPE system code table.
Creation Date	Date	Stores the date on which the Inspection Group was created.	This field is disabled and populated automatically when an Inspection Group is created.
Current Percentage Selection	Numeric	Indicates the actual percentage of the elements selected for inspection by the system and the additional selections made by the user.	This field is disabled and populated automatically when an Inspection Group is created or modified.
Description	Character	Stores the description used to identify the Inspection Group.	This field is disabled and populated automatically when an Inspection Group is created. This field is enabled only when the Inspection Group record is in the Proposed state.
Grouping Equipment Type	Character	Stores the type of equipment associated with the Inspection Group.	This field is disabled and populated by the MI_GROUPING_EQP_TYPE system code table when an Inspection Group is created.
Material Spec	Character	Identifies the material of the RBI Components in the Inspection Group.	This field is disabled and populated only if the Corrosion Type of the group is ICPC.
Name	Character	Stores the name of the associated Inspection Group.	This field is disabled and populated automatically when an Inspection Group is created.
Operating Temperature Range	Character	Stores the operating temperature range for the Inspection Group.	This field is populated only if the Corrosion Type of the group is CUI. This field is populated with <Operating Temperature Range Lower Bound> - <Operating Temperature Range Upper Bound>.
Operating Temperature Range Lower Bound	Numeric	Stores the lower bound value of the operating temperature range. It is measured in degrees Fahrenheit.	This field is populated only if the Corrosion Type of the group is CUI.
Operating Temperature Range Upper Bound	Numeric	Stores the upper bound value of the operating temperature range. It is measured in degrees Fahrenheit.	This field is populated only if the Corrosion Type of the group is CUI.

Field	Data Type	Description	Behavior and Usage
Percentage Selection	Numeric	Indicates the selection percentage for Representative RBI Components based on the risk category.	This field is disabled and populated automatically when an Inspection Group is created.
Process Fluid	Character	Identifies the process fluid used in the RBI Components in the Inspection Group.	This field is disabled and populated only if the Corrosion Type of the group is ICPC.
Risk Category	Character	Stores the risk level associated with the RBI Components in the Inspection Group.	This field is disabled and populated by the MI_RBI_RISK_CATEGORY system code table when an Inspection Group is created.
Sub Group	Character	Stores the subgroups for CUI and ICPC Inspection Groups.	If the corrosion type of the Inspection Group is ICPC, this field is populated with <Process Fluid> <Material Spec>. If the corrosion type of the Inspection Group is CUI, this field is populated with <Operating Temperature Range Lower Bound> - <Operating Temperature Range Upper Bound>.
Unit	Character	Stores the Functional Location linked to the Inspection Group record.	This field is disabled and populated automatically when an Inspection Group is created.

Piping Stress Records

Records in the Piping Stress family make up the Piping Stress reference table, which GE Digital APM uses to locate the appropriate Allowable Stress value for RBI Criticality Analyses that are linked to RBI Components whose Stress Lookup Table field contains the value Piping. These values are used to calculate Pressure T-min values in RBI and Thickness Monitoring.

This topic provides an alphabetical list and description of the fields that exist in the Piping Stress family. The information in the table reflects the baseline state and behavior of these fields. The Material Type, Minimum Tensile Strength, and Minimum Tensile Yield fields exist in the Piping Stress family, but they are not used to determine the Allowable Stress value.

This family is not enabled for site filtering, which means that records in this family can be accessed by any user with the appropriate license and family privileges. For more information, refer to the [Sites](#) section of the documentation.

Field	Data Type	Description	Behavior and Usage						
Allowable Stress Override	Numeric	The maximum amount of pressure that can a component can safely withstand.	<p>This value in this field, in addition to the following other Piping Stress fields, is used to determine the value that is populated in the Allowable Stress field in the associated RBI Criticality Analysis:</p> <ul style="list-style-type: none"> • Code Year • Construction Code • Design Temperature • Material Grade • Material Spec • Stress Lookup Table 						
Code Year	Character	The year in which the design code that corresponds to the component was defined.	<p>The value in this field is used to populate the Code Year field in the associated RBI Criticality Analysis:</p> <p>This field must contain a value in order for GE Digital APM to retrieve:</p> <ul style="list-style-type: none"> • The value in the Allowable Stress field in the Piping Stress record from the Piping Stress reference table. • Values in the Material Spec list in the Piping Stress record. <p>The options in this field are populated based on the value that you select in the Design Code field. The table below describes the options available in the Design Code field and corresponding values in the Code Year field.</p> <table border="1"> <thead> <tr> <th>Design Code</th> <th>Code Year</th> </tr> </thead> <tbody> <tr> <td>B31.1</td> <td>2014</td> </tr> <tr> <td>B31.3</td> <td>2014</td> </tr> </tbody> </table>	Design Code	Code Year	B31.1	2014	B31.3	2014
Design Code	Code Year								
B31.1	2014								
B31.3	2014								

Field	Data Type	Description	Behavior and Usage
Design Code	Character	The design code associated with the component.	<p>The value in this field is used to populate the Construction Code field in the associated RBI Criticality Analysis.</p> <p>This field must contain a value in order for GE Digital APM to retrieve the value in the Allowable Stress field in the Piping Stress record from the Piping Stress Reference table.</p>
Material Grade	Character	The material grade of the component.	<p>The value in this field is used to populate the Material Grade field in the associated RBI Criticality Analysis.</p> <p>This field must contain a value in order for GE Digital APM to retrieve the value in the Allowable Stress field in the Piping Stress record from the Piping Stress Reference table.</p> <p>If there is no material grade value in the specification, then this field is populated with the value NS, which implies not specified.</p> <p>For Construction Code B31.3 or B31.1 and Code Year 2014, if two or more Piping Stress records have the same values for Material Specification and Material Grade, then the value in this field is populated with a value in the following format: <Material Grade>-<Class>-<Size>-<Notes></p>

Field	Data Type	Description	Behavior and Usage
Material Specification	Character	The material specification of the component.	<p>The value in this field is used to populate the Material Spec field in the associated RBI Criticality Analysis.</p> <p>This field must contain a value in order for GE Digital APM to retrieve:</p> <ul style="list-style-type: none"> The value in the Allowable Stress field in the Piping Stress record from the Piping Stress reference table. Values in the Material Grade list in the Piping Stress record.
Metal Temperature	Numeric	The temperature of the metal of which the component is made.	<p>The value in this field is used to populate the Design Temperature field in the associated RBI Criticality Analysis.</p> <p>This field must contain a value in order for GE Digital APM to retrieve the value in the Allowable Stress field in the Piping Stress record from the Piping Stress reference table.</p>

PV Stress Records

Records in the PV Stress family make up the PV Stress reference table, which GE Digital APM uses to locate the appropriate Allowable Stress value for RBI Criticality Analyses that are linked to RBI Components whose Stress Lookup Table field contains the value Pressure Vessel.

This topic provides an alphabetical list and description of the fields that exist in the PV Stress family. The information in the table reflects the baseline state and behavior of these fields. The Material Type, Minimum Tensile Strength, and Minimum Tensile Yield fields exist in the PV Stress family, but they are not used to determine the Allowable Stress value.

This family is not enabled for site filtering, which means that records in this family can be accessed by any user with the appropriate license and family privileges. For more information, refer to the [Sites](#) section of the documentation.

Field	Data Type	Description	Behavior and Usage						
Allowable Stress	Numeric	The maximum amount of pressure that can safely be withstood by a component.	<p>This value in this field, in addition to the following other PV Stress fields, is used to determine the value that is populated in the Allowable Stress field in the associated RBI Criticality Analysis:</p> <ul style="list-style-type: none"> • Code Year • Construction Code • Design Temperature • Material Grade • Material Spec • Stress Lookup Table 						
Code Year	Character	The year in which the design code that corresponds to the component was defined.	<p>The value in this field is used to populate the Code Year field in the associated RBI Criticality Analysis:</p> <p>This field must contain a value in order for GE Digital APM to retrieve:</p> <ul style="list-style-type: none"> • The value in the Allowable Stress field in the PV Stress record from the PV Stress reference table. • Values in the Material Spec list in the PV Stress record. <p>The options in this field are populated based on the value that you select in the Design Code field. The table below describes the options available in the Design Code field and corresponding values in the Code Year field.</p> <table border="1" data-bbox="1146 1507 1414 1724"> <thead> <tr> <th data-bbox="1146 1507 1279 1556">Design Code</th> <th data-bbox="1279 1507 1414 1556">Code Year</th> </tr> </thead> <tbody> <tr> <td data-bbox="1146 1556 1279 1629">ASME VIII DIV 1</td> <td data-bbox="1279 1556 1414 1629">1998</td> </tr> <tr> <td data-bbox="1146 1629 1279 1724">ASME VIII DIV 1</td> <td data-bbox="1279 1629 1414 1724">2010</td> </tr> </tbody> </table>	Design Code	Code Year	ASME VIII DIV 1	1998	ASME VIII DIV 1	2010
Design Code	Code Year								
ASME VIII DIV 1	1998								
ASME VIII DIV 1	2010								

Field	Data Type	Description	Behavior and Usage
Design Code	Character	The design code associated with the component.	<p>The value in this field is used to populate the Construction Code field in the associated RBI Criticality Analysis.</p> <p>This field must contain a value in order for GE Digital APM to retrieve the value in the Allowable Stress field in the PV Stress record from the PV Stress Reference table.</p>
Material Grade	Character	The material grade of the component.	<p>The value in this field is used to populate the Material Grade field in the associated RBI Criticality Analysis.</p> <p>This field must contain a value in order for GE Digital APM to retrieve the value in the Allowable Stress field in the PV Stress record from the PV Stress Reference table.</p>
Material Specification	Character	The material specification of the component.	<p>The value in this field is used to populate the Material Spec field in the associated RBI Criticality Analysis.</p> <p>This field must contain a value in order for GE Digital APM to retrieve:</p> <ul style="list-style-type: none"> • The value in the Allowable Stress field in the PV Stress record from the PV Stress reference table. • Values in the Material Grade list in the PV Stress record.
Metal Temperature	Numeric	The temperature of the metal of which the component is made.	<p>The value in this field is used to populate the Design Temperature field in the associated RBI Criticality Analysis.</p> <p>This field must contain a value in order for GE Digital APM to retrieve the value in the Allowable Stress field in the PV Stress record from the PV Stress reference table.</p>

Field	Data Type	Description	Behavior and Usage
Minimum Tensile Strength	Numeric	The minimum tensile strength of the material of the component.	
Minimum Yield Strength	Numeric	The minimum yield strength of the material of the component.	

RBI Criticality Analysis Records

RBI Criticality Analysis records are used to determine the results of RBI Analyses. This topic provides an alphabetical list and description of the fields that exist for the RBI Criticality Analysis family. The information in the table reflects the baseline state and behavior of these fields. The Criticality Analysis and What-If Analysis table lists common fields shared across several analysis types. Fields that are unique to a specific component type can be viewed by expanding the proper drop-down heading.

The following families are enabled for site filtering, which means that the records in these families can be assigned to a specific site, and will then only be accessible to users who are assigned to the same site and have the appropriate license and family privileges. See the Site Filtering section of the documentation for more information on using this feature.

RBI Criticality Analysis and What-If Analysis

Field	Data Type	Description	Behavior and Usage
Main			
Analysis ID	Character	Specifies the Record ID of the Equipment or Functional Location Record.	<p>When you create an analysis through the RBI Workflow, the GE Digital APM system automatically populates this field.</p> <p>For a What-If Analysis, the value in this field is in the following format:</p> <p>W <Analysis ID of the main analysis> <Number></p> <p>...where <Number> is the sequential number of the What-If Analysis.</p>
Analysis Start Date	Date	The date on which the analysis began.	<p>You can use the Calendar feature to select the date on which the analysis began.</p> <p>This field is required.</p>
Criticality Item Type	Character	Describes the type of component being assessed.	This data will be used to select which elements are required to calculate risk.

Field	Data Type	Description	Behavior and Usage
Date Criticality Calculated	Date	The date on which the Criticality Analysis was calculated.	This field is disabled and populated with the date on which you calculate the analysis. If the calculation fails, this field will be blank
Effective Date for Risk Analysis	Date	A designated future date at which time the risk data becomes valid.	You can use the Calendar feature to select the date on which you want to access future risk.
Event Type	Character	Indicates whether the analysis is a What-If Analysis.	For a What-If Analysis, this field is populated with the value W. For other types of analyses, this field is blank. This field does not appear on the datasheet.
Generic Failure Frequency	Numeric	A Probability of Failure (PoF) developed for specific component types based on a large population of component data that does not include the effects of specific damage mechanisms.	This data is one of the factors used to determine the PoF.
Evergreen Batch ID	Character	The ID for the evergreening batch during which the analysis was created.	This field does not appear on the datasheet.
Evergreen Copy	Character	The entity key of the child analysis that was created while evergreening.	This field does not appear on the datasheet.
Location ID	Character	Identifies the functional location.	None
Scenario ID	Character	Identifies a particular set of data or activities.	May be used to query data in GE Digital APM that is all related to a common activity or data set.
Scenario Reference Date	Date	The date on which the scenario occurred.	May be used to query data in GE Digital APM that is all related to a common activity or data set.
Process Data			

Field	Data Type	Description	Behavior and Usage
Operating Pressure	Numeric	The internal pressure of the asset under normal operating conditions. It is measured in pounds per square inch gauge.	<p>A value is required in this field.</p> <p>By default, this field populated with the value in the Operating Pressure field in the associated RBI Component. You can, however, modify the value.</p> <p>The value in this field must be less than or equal to the value in the Design Pressure field.</p> <p>If the value in the Design Pressure field is greater than or equal to zero, the value in this field must be less than or equal to the value in the Design Pressure field.</p> <p>If the value in the Design Pressure field is less than zero, you can calculate the analysis with any value in this field.</p>
Operating Temperature	Numeric	The temperature of the asset under normal operating conditions. It is measured in degrees Fahrenheit.	<p>A value is required in this field.</p> <p>By default, this field populated with the value in the Operating Temperature field in the associated RBI Component. You can, however, modify the value.</p> <p>If the value in the Design Temperature field is greater than or equal to zero, the value in this field must be less than or equal to the value in the Design Temperature field.</p> <p>If the value in the Design Temperature field is less than zero, you can calculate the analysis with any value in this field.</p>
Representative Fluid	Character	The fluid that represents or makes up the greatest volume of the asset.	In some cases, the fluid that represents the greatest Consequence of Failure (CoF) may be selected.
Tube Nominal Thickness	Numeric	The manufactured thickness of the tube wall.	None

Field	Data Type	Description	Behavior and Usage
Tube Operating Press Channel	Numeric	The normal operating pressure for a Tube Bundle.	Required only for RBI Analysis records whose Criticality Item Type is Heat Exchanger-Bundle. The value in this field is compared with the value in the Operating Pressure Shell Side field in the Consequence Evaluation family to determine the leaking fluid. The Unit of Measure (UOM) for this field is Pounds/Sq Inch Gage (PSIG).
Tube Operating Temp Channel	Numeric	The normal operating temperature for a Tube Bundle.	None
Tube Rep Fluid Channel	Character	The fluid that represents or makes up the greatest volume of the asset.	In some cases the fluid that represents the greatest Consequence of Failure (CoF) may be selected.
Design Data			
Allowable Stress	Numeric	The maximum amount of pressure that can a component can safely withstand.	If the Allowable Stress Override check box is selected, then this field is enabled, and you can enter a value manually. Otherwise, this field is disabled and populated automatically . Required only for RBI Analysis records that are linked to Criticality Int. Corr. Deg. Mech. Eval. or Criticality Ext. Corr. Deg. Mech. Eval. records.
Allowable Stress Override	Boolean	Identifies whether or not a user can enter his or her own allowable stress value.	If this check box is selected, then the Allowable Stress field is enabled.

Field	Data Type	Description	Behavior and Usage
Area Humidity	Character	A value that based on the humidity of the geographical region in which the asset is operated.	<p>Required only for an RBI Analysis record that is linked to Criticality Ext. Corr. Deg. Mech. Eval. records. This field contains the description of all the System Codes in the MI_RBI_Area_Humidity System Code Table. You can choose from the following baseline values:</p> <ul style="list-style-type: none"> • Low • Medium • High
Code Year	Character	The year in which the design code that corresponds to the component was defined.	<p>The value in this field is used to populate the Code Year field in the associated RBI Criticality Analysis record.</p> <p>This field must contain a value in order for the GE Digital APM system to retrieve:</p> <ul style="list-style-type: none"> • The value in the Allowable Stress field in the Piping Stress record from the Piping Stress reference table. • Values in the Material Spec list in the Piping Stress record. <p>Required only for an RBI Analysis record whose Allowable Stress Override check box is cleared and whose Criticality Item Type is not Storage Tank.</p> <p>Depending on the value in the Stress Lookup Table field, this field contains a list of values that are available in the Code Year field in the associated PV Stress, Piping Stress, or Tank Stress record.</p>

Field	Data Type	Description	Behavior and Usage
Construction Code	Character	The code to which the asset was originally constructed.	<p>Required only for an RBI Analysis record whose Allowable Stress Override check box is not selected.</p> <p>Depending on the value in the Stress Lookup Table field, this field contains a list of values that are available in the Design Code field in the associated PV Stress, Piping Stress, or Tank Stress record.</p>
Course Number	Numeric	Identifies which shell course on an asset is being assessed. The course number will impact how the allowable stressed data is used.	For Tanks, the value in this field is used to calculate the value in the Allowable Stress field.
Design Pressure	Numeric	The pressure at which the component is designed to operate. It is measured in pounds per square inch gauge.	<p>By default, this field is populated with the value in the Design Pressure field in the associated RBI Component. You can, however, modify the value.</p> <p>The value in this field must be greater than or equal to the value in the Operating Pressure field.</p> <p>Tip: This value is provided by the manufacturer of the component. You can find it on the nameplate or the UI Form.</p> <p>If the Allowable Stress Override check box is cleared, then a value is required in this field.</p> <p>If the value in this field is greater than or equal to zero, the value in the Operating Pressure field must be less than or equal to the value in this field.</p> <p>If the value in this field is less than zero, you can calculate the analysis with any value in the Operating Pressure field.</p>

Field	Data Type	Description	Behavior and Usage
Design Temperature	Numeric	The temperature at which the component is designed to operate. It is measured in degrees Fahrenheit.	<p>By default, this field is populated with the value in the Design Temperature Pressure field in the associated RBI Component. You can, however, modify the value.</p> <p>The value in this field must be greater than or equal to the value in the Operating Temperature field.</p> <p>Tip: This value is provided by the manufacturer of the component. You can find it on the nameplate or the UI Form.</p> <p>If the Allowable Stress Override check box is cleared, then a value is required in this field.</p> <p>If the value in this field is greater than or equal to zero, the value in the Operating Temperature field must be less than or equal to the value in this field.</p> <p>If the value in this field is less than zero, you can calculate the analysis with any value in the Operating Temperature field.</p>

Field	Data Type	Description	Behavior and Usage
Diameter	Numeric	The width of a circular or cylindrical Asset measured in a straight line.	<p>Required only for an RBI Analysis record:</p> <ul style="list-style-type: none"> Whose Criticality Item Type is Storage Tank <p>-and-</p> <ul style="list-style-type: none"> Whose Diameter is null or > 200 (Feet) <p>-and-</p> <ul style="list-style-type: none"> That is linked to a Criticality Int. Corr. Deg. Mech. Eval. record whose Estimated Minimum Thickness Override? checkbox is not selected. <p>The value in this field is used to calculate the value in the Calculated Inventory field.</p>
Insulated	Boolean	Indicates whether or not an asset is insulated.	Required only for RBI Analysis records that are linked to Criticality Ext. Corr. Deg. Mech. Eval. records.
Insulation Type	Character	Identifies the insulating material.	The value in this field must be stored in the Insulation Type field in one of the Insulation Type records delivered in the GE Digital APM baseline database
Joint Efficiency	Numeric	Indicates the extent of inspection used to ensure the quality of welds and the type of weld joints used during construction.	<p>This field must contain one of the following values:</p> <ul style="list-style-type: none"> 0.35 0.4 0.45 0.5 0.55 0.6 0.65 0.7 0.75 0.8 0.85 0.9 0.95 1.0

Field	Data Type	Description	Behavior and Usage
Material Grade	Character	The material grade of the component.	Depending on the value in the Stress Lookup Table field, this field contains a list of values that are available in the Material Grade field in the associated PV Stress, Piping Stress, or Tank Stress record.
Material Spec	Character	The material specification of the component.	<p>The value in this field is used to populate the Material Spec field in the associated RBI Criticality Analysis record.</p> <p>This field must contain a value in order for the GE Digital APM system to retrieve:</p> <ul style="list-style-type: none"> The value in the Allowable Stress field in the Piping Stress record from the Piping Stress reference table. Values in the Material Grade list in the Piping Stress record. <p>Required only for an RBI Analysis record whose Allowable Stress Override check box is cleared.</p> <p>Depending on the value in the Stress Lookup Table field, this field contains a list of values that are available in the Material Specification field in the associated PV Stress, Piping Stress, or Tank Stress record.</p>
Minimum Required Thickness	Numeric	The minimum thickness that is used as a flagging thickness.	This is a calculated value. This field value is used in calculation if the Override Minimum Required Thickness check box is cleared.
Minimum Thickness - Pressure	Numeric	The minimum required wall thickness to withstand internal pressure.	This is a calculated value.

Field	Data Type	Description	Behavior and Usage
Nominal Thickness	Numeric	An estimated or measured thickness used as the starting point for thickness based remaining life calculations.	Required only for an RBI Analysis record whose Criticality Item Type is Heat Exchanger-Bundle.
Override Minimum Required Thickness	Boolean	Indicates whether you want to override the Calculated T-min value with the Specified T-min value.	If you select this check box, the Specified Tmin field is required and the value is used in calculation.
Piping Circuit Length	Numeric	Indicates the total length of the piping circuit.	By default, this field is populated with the value in the Piping Circuit Length field in the associated Criticality RBI Component – Piping record. The value in this field is used in calculating the complexity of the piping circuit, which impacts the value in the Age field in the Criticality Ext. Corr. Deg. Mech. Eval record. The value this field is used to calculate inventory for a RBI Component Type Piping. The UOM will be specified in feet.
Specified Tmin	Numeric	Minimum thickness of the component that is specified by the user.	This field is required if the Override Minimum Required Thickness check box is selected. This field is populated with the value in the Specified Tmin field in the associated component.
Stress Lookup Table	Character	Identifies the type of asset being assessed so that the proper design codes are used.	Required only for an RBI Analysis record whose Allowable Stress Override check box is cleared. This field contains the description of all the System Codes in the MI_STRESS_LOOKUP_TABLE System Code Table. You can choose from the following baseline values: <ul style="list-style-type: none"> • Piping • Vessels • Tanks

Field	Data Type	Description	Behavior and Usage												
Structural Minimum Thickness	Numeric	The minimum required wall thickness to withstand the structural design of the asset.	<p>The values are obtained from the Equipment Type reference table.</p> <table border="1"> <thead> <tr> <th>Equipment Type</th> <th>Default Minimum Thickness</th> </tr> </thead> <tbody> <tr> <td>Pressurized Vessels</td> <td>0.125</td> </tr> <tr> <td>Heat Exchanger/ Fin-Fan Tubes</td> <td>0.035</td> </tr> <tr> <td>Piping: 1 ½ "or less</td> <td>0.062</td> </tr> <tr> <td>Piping: 2-8"</td> <td>0.094</td> </tr> <tr> <td>Piping: 8" or greater</td> <td>0.125</td> </tr> </tbody> </table>	Equipment Type	Default Minimum Thickness	Pressurized Vessels	0.125	Heat Exchanger/ Fin-Fan Tubes	0.035	Piping: 1 ½ "or less	0.062	Piping: 2-8"	0.094	Piping: 8" or greater	0.125
Equipment Type	Default Minimum Thickness														
Pressurized Vessels	0.125														
Heat Exchanger/ Fin-Fan Tubes	0.035														
Piping: 1 ½ "or less	0.062														
Piping: 2-8"	0.094														
Piping: 8" or greater	0.125														
Susceptible to CUI	Character	Indicates if a component is susceptible to CUI.	The value in this field must be set to Yes if the component is made of carbon steel and is insulated.												
Analysis Results															
Driving CoF	Character	The highest cause of failure identified on the asset.	None												
Driving Inspection Priority(Unmitigated Risk)	Character	The highest Inspection Priority identified on the asset.	The value in this field is used to drive the inspection recommendations on the asset												
Driving PoF	Character	The highest Probability of Failure (PoF) identified on the asset.	None												
Inspection Priority (Unmitigated Risk) Rolled Up	Numeric	The highest Inspection Priority identified on the asset.	For a multi-component asset, the highest Inspection Priority will be used												
Risk Category	Character	The range of Risk for the asset.	None												

RBI PRD Criticality Analysis

Field	Data Type	Description	Behavior and Usage
Main			
Driving Component	Character	Identifies the RBI Component protected by the PRD device that represents the highest Consequence of Failure (CoF).	The CoF data from this asset will be used to calculate the CoF of the devices.
Input			
Damage Factor Class	Character	A scale from None to Severe that describes the potential damage that a device may be exposed to based on its operating environment.	This value is a factor ranging from 1 - 2000.
Downstream of PD Pump	Boolean	Indicates whether or not the device is downstream of a positive displacement pump.	The value in this field impacts the analysis calculation.
Fired Heat Source	Boolean	Indicates whether or not the device is downstream of a fired heat source	The value in this field impacts the analysis calculation.
History of Chatter	Boolean	Indicates whether or not the device has had a history of chatter.	The value in this field impacts the analysis calculation.
History of Excessive Activation	Boolean	Indicates whether or not the device has had a history of excessive activation.	The value in this field impacts the analysis calculation.
MAWP	Numeric	The Maximum Allowable Working Pressure (MAWP) of the device.	None
Multiple PRDs	Boolean	Indicates whether or not the asset is protected by a single device or if multiple devices have been installed to facilitate the necessary relieving capacity.	The value in this field impacts the analysis calculation.
Next Inspection Date	Date	The date on which the next inspection for PRD is scheduled.	This field is required for calculating PRD Analyses with either Protected Components or Protected Assets.
Operating Pressure	Numeric	The internal pressure of the asset under normal operating conditions. It is measured in pounds per square inch.	You can specify a value for this field using the datasheet.

Field	Data Type	Description	Behavior and Usage
Operating Temperature	Numeric	The temperature of the asset under normal operating conditions. It is measured in degrees Fahrenheit.	You can specify a value for this field using the datasheet.
PRD Discharge Location	Character	Indicates whether or not the device relieves to atmosphere or to a closed header.	The value in this field impacts the analysis calculation.
PRD Relief Area	Numeric	The total relieving capacity of a single device.	The value in this field impacts the analysis calculation.
Protected Asset Type	Character	Defines the type of asset that the device protects.	The value in this field impacts the analysis calculation.
Service Severity	Character	Defines the consequences inherent to the particular process in which the devices operate.	The value in this field impacts the analysis calculation.
Total PRD Relief Area	Numeric	The total combined relieving capacity of all devices are installed.	The value in this field impacts the analysis calculation.
Analysis Results			
Driving CoF – Current Interval	Character	The Consequence of Failure of the damage mechanism with the highest risk for the current interval identified on the asset. This is determined based on Inspection Priority. The current interval is calculated by taking the difference of the calculation date and the Next Inspection Date field.	This is a calculated value.
Driving Inspection Priority (Unmitigated Risk) – Current Interval	Character	The Inspection Priority of the damage mechanism with the highest risk for the current interval identified on the asset. This is determined based on Inspection Priority. The current interval is calculated by taking the difference of the calculation date and the Next Inspection Date field.	This is a calculated value.

Field	Data Type	Description	Behavior and Usage
Driving PoF – Current Interval	Character	The Probability of Failure of the damage mechanism with the highest risk for the current interval identified on the asset. This is determined based on Inspection Priority.	This is a calculated value.
Recommended Inspection Interval – Current Interval	Numeric	The Recommended Inspection Interval of the damage mechanism with the highest risk for the current interval identified on the asset. This is determined based on Inspection Priority. The current interval is calculated by taking the difference of the calculation date and the Next Inspection Date field.	This is a calculated value.
Risk Category – Current Interval	Character	The Risk Category of the damage mechanism with the highest risk for the current interval identified on the asset. This is determined based on Inspection Priority The current interval is calculated by taking the difference of the calculation date and the Next Inspection Date field.	This is a calculated value.
Driving CoF – RBI Interval	Character	The Consequence of Failure of the damage mechanism with the highest risk identified on the asset. This is determined based on Inspection Priority.	This is a calculated value.
Driving Inspection Priority (Unmitigated Risk) – RBI Interval	Character	The Inspection Priority of the damage mechanism with the highest risk identified on the asset. This is determined based on Inspection Priority.	This is a calculated value.
Driving PoF – RBI Interval	Character	The Probability of Failure of the damage mechanism with the highest risk identified on the asset. This is determined based on Inspection Priority.	This is a calculated value.

Field	Data Type	Description	Behavior and Usage
Recommended Inspection Interval – RBI Interval	Numeric	The Recommended Inspection Interval of the damage mechanism with the highest risk identified on the asset. This is determined based on Inspection Priority.	This is a calculated value.
Risk Category – RBI Interval	Character	The Risk Category of the damage mechanism with the highest risk identified on the asset. This is determined based on Inspection Priority.	This is a calculated value.

RBI Pipeline Analysis

Field	Data Type	Description	Behavior and Usage
Main			
Date Calculated	Date	Date on which the analysis was performed.	None
Process Data			
Flow Rate	Numeric	The amount of fluid flowing at any given time for a pipeline segment.	The data in this field impacts corrosion characteristics.
Operating Pressure	Numeric	The internal pressure of the asset under normal operating conditions. It is measured in pounds per square inch gauge.	By default, this field populated with the value in the Operating Pressure field in the associated RBI Component. You can, however, modify the value. The value in this field must be less than or equal to the value in the Design Pressure field.
Operating Temperature	Numeric	The temperature of the asset under normal operating conditions. It is measured in degrees Fahrenheit.	By default, this field populated with the value in the Operating Temperature field in the associated RBI Component. You can, however, modify the value. The value in this field must be less than or equal to the value in the Design Temperature field.
Segment Length	Numeric	The total length of the pipeline segment being assessed.	None

Field	Data Type	Description	Behavior and Usage
Design Data			
Defects Reported	Character	Identifies inspection findings from previous inspection events.	This data allows the inspector to follow up on previously reported defects.
Design Pressure	Numeric	The pressure at which the component is designed to operate. It is measured in pounds per square inch gauge.	<p>By default, this field is populated with the value in the Design Pressure field in the associated RBI Component. You can, however, modify the value.</p> <p>The value in this field must be greater than or equal to the value in the Operating Pressure field.</p> <p>Tip: This value is provided by the manufacturer of the component. You can find it on the nameplate or the UI Form.</p> <p>If the Allowable Stress Override check box is cleared, then a value is required in this field.</p>
Design Temperature	Numeric	The temperature at which the component is designed to operate. It is measured in degrees Fahrenheit.	<p>By default, this field is populated with the value in the Design Temperature Pressure field in the associated RBI Component. You can, however, modify the value.</p> <p>The value in this field must be greater than or equal to the value in the Operating Temperature field.</p> <p>Tip: This value is provided by the manufacturer of the component. You can find it on the nameplate or the UI Form.</p> <p>If the Allowable Stress Override check box is cleared, then a value is required in this field.</p>
FDA	Character	The Fabrication Defect Adjustment (FDA) provides any defect information provided by the manufacturer.	The value in this field impacts the analysis calculation.

Field	Data Type	Description	Behavior and Usage
Is CP System Present?	Character	Indicates whether or not the asset has Cathodic Protection (CP).	None
Is Piggable?	Character	Indicates whether or not the asset is designed in such a way that it may be inspected using a PIG.	This data will drive the inspection recommendations generated for this asset.
LMPA	Character	Land Movement Potential Adjustment (LMPA) is a value that describes the possibility of land movements based on the geographical region.	GE Digital APM follows the Pipeline Risk Management Manual model to determine LMPA. Muhlbauer, W. Kent. Pipeline Risk Management Manual. Gulf Publishing Company, Houston, 2004.
LMPA Factor	Numeric	That factor that results from the selection made in LMPA field.	The value in this field impacts the analysis calculation.
Pipeline Segment Type	Character	Describes the type of pipeline segment being assessed.	None
SCADA Factor	Numeric	That factor that results from the selection made in the Supervisory Control And Data Acquisition (SCADA) field.	The value in this field impacts the analysis calculation.

RBI Corrosion Loop Records

RBI Corrosion Loop records are used to identify the components contained in a Corrosion Loop. This topic provides an alphabetical list and description of the fields that exist for the RBI Corrosion Loop family. The information in the table reflects the baseline state and behavior of these fields.

This family is enabled for site filtering, which means that records in this family can be assigned to a specific site and will only be accessible to users who are assigned to the same site and have the appropriate license and family privileges. For more information, refer to the [Sites](#) section of the documentation.

Field	Data Type	Description	Behavior and Usage
Comments	Text	Details about the corrosion loop.	None
Created By	Character	The name of the user who created the RBI Corrosion Loop.	This field is disabled and populated automatically with the name of the person logged in to GE Digital APM.

Field	Data Type	Description	Behavior and Usage
Created On	Date	The date on which the RBI Corrosion Loop was created.	This field is disabled and populated automatically.
Last Updated By	Character	The first and last name of the most recent user to update the RBI Corrosion Loop.	This field is disabled and populated automatically with the name of the person logged in to GE Digital APM while modifying the record.
Last Updated On	Date	The date on which the most recent update was made to the RBI Corrosion Loop.	This field is disabled and populated automatically.
RBI Corrosion Loop Description	Character	Information about the purpose and contents of the corrosion loop.	None
RBI Corrosion Loop From	Character	The origin designation of the corrosion loop.	This field identifies the asset or feed source of the corrosion loop.
RBI Corrosion Loop ID	Character	A unique value that identifies the RBI Corrosion Loop.	This field is disabled and populated automatically.
RBI Corrosion Loop To	Character	The termination designation of the RBI Corrosion Loop.	This field identifies the asset or landmark at which the corrosion loop ends.

RBI Degradation Mechanisms (DMs) Records

RBI Degradation Mechanisms records are used to determine the corrosion rate and damage factor caused on the component because of a particular DM. This topic provides an alphabetical list and description of the fields that exist for the Degradation Mechanisms family. The information in the table reflects the baseline state and behavior of these fields.

This family is enabled for site filtering, which means that records in this family can be assigned to a specific site and will only be accessible to users who are assigned to the same site and have the appropriate license and family privileges. For more information, refer to the [Sites](#) section of the documentation.

Field	Data Type	Description	Behavior and Usage
Combined Consequence	Character	The category of the combined consequence of failure.	The value in this field is calculated by comparing the four consequence categories, and assigning the combined consequence category the same value as the most severe of the four. The value A indicates the most severe consequence category, and the value E indicates the least severe.
Deg Mech Comments	Character	Comments about the DM.	None
Degradation Mechanism	Character	A process that induces deleterious micro and macro material changes over time that are harmful to the material condition or mechanical properties.	This field contains the description of all the System Codes in the MI_DEGRADATION_MECHANIS M_TYPES System Code Table.
Degradation Mechanism Description	Character	A short description of the degradation mechanism.	None
Inspection Priority (Unmitigated Risk)	Numeric	A value that represents the location of the asset on the risk matrix.	This number is between 1 and 25 and will drive the inspection planning results.
Probability of Failure	Character	Extent to which an event is likely to occur within the time frame under consideration. The mathematical definition of probability is a real number in the scale 0 to 1 and is attached to a random event.	None

RBI Recommendation Records

RBI Recommendation records store information about the recommended actions to mitigate the risk. This topic provides an alphabetical list and description of the fields that exist for the RBI Recommendation family. The information in the table reflects the baseline state and behavior of these fields.

This family is enabled for site filtering, which means that records in this family can be assigned to a specific site and will only be accessible to users who are assigned to the same site and have the appropriate license and family privileges. For more information, refer to the [Sites](#) section of the documentation.

Field	Data Type	Description	Behavior and Usage
Analysis ID	Character	The ID of the RBI Criticality Analysis that is linked to the RBI Recommendation.	This field is populated with the value in the Analysis ID field of the associated RBI Criticality Analysis.
Author Name	Character	The name of the user who created the RBI Recommendation.	This field is populated with the last and first names of the Security User that you represent.
Completion Comments	Text	Comments about the completion of an RBI Recommendation.	This field is required when superseding the RBI Recommendation.
Create Task?	Boolean	Indicates whether or not you want to create a task for the RBI Component.	None
Damage Mechanism	Character	A process that induces deleterious micro or macro material changes over time that are harmful to the material condition or mechanical properties.	This field is populated with the Degradation Mechanism that is linked to the associated RBI Criticality Analysis.
Functional Location	Character	The ID of the Functional Location that the RBI Component belongs to.	This field is populated with the value in the Equipment ID field in the associated RBI Criticality Analysis.
Inspection Confidence	Character	A value that indicates how effective prior inspections were at identifying the degradation mechanism and the rate of degradation.	This field does not appear on the datasheet. The value in this field appears on the Asset Risk Report.
Inspection Strategy ID	Character	The unique ID of the Inspection Strategy.	This field does not appear on the datasheet. This field is used to map the RBI Recommendation with the Inspection Strategy.
Nonrecurring	Boolean	Indicates whether the inspection task that you create for the recommendation is recurring.	This check box is cleared by default.
Originating Reference	Character	The ID of the RBI Criticality Analysis that is linked to the RBI Recommendation.	When you generate an RBI Recommendation, this field is populated with the ID of the RBI Criticality Analysis.
RBI Component	Character	The description of the component that is associated with the RBI Recommendation.	This field is populated with the value in the Component Description field of the associated RBI Component.

Field	Data Type	Description	Behavior and Usage
RBI Recommendation Methodology	Character	Indicates the methodology that is used to generate the RBI Recommendation.	This field is populated with the value RBI 580.
Recommendation Basis	Character	Defines what is driving the RBI Recommendation.	When you generate an RBI Recommendation, this field is populated with the value in the Inspection Strategy Description field in the associated Inspection Strategy.
Recommendation Headline	Character	Identifies the purpose of the recommendation.	This field is populated with a value in the following format: <RBI Component ID>-<Damage Mechanism> ...where: <ul style="list-style-type: none"> • <RBI Component ID> is the Record ID of the associated RBI Component. • <Damage Mechanism> is the value in the Damage Mechanism field in the RBI Recommendation.
Recommended Interval Scope	Numeric	Defines what should be done during this inspection event.	When you generate an RBI Recommendation, this field is populated with the value in the Recommendation Inspection Scope field in the associated Inspection Strategy.

Field	Data Type	Description	Behavior and Usage
Recommended Interval	Text	Defines the time period between inspection events.	When you generate an RBI Recommendation, this field is populated with one of the following values: <ul style="list-style-type: none"> When the Use Calculated Data field in the Inspection Strategy is set to False, the value in the Recommended Inspection Interval field is used. When the Use Calculated Data field in the Inspection Strategy is set to True: <ul style="list-style-type: none"> For RBI Criticality Analyses, the value in the Estimated Half Life field is used. For RBI PRD Analyses, the value in the Recommended Inspection Interval on the analysis is used.
Status	Character	Defines the status of the recommendation in the process flow.	This field is populated with the value Created.
Superseded By Recommendation Number	Character	Identifies the recommendation that will be performed and tracked rather than the selected recommendation.	When you supersede this RBI Recommendation with another one, this field is populated with the ID of the latter.
Task Type	Character	Defines the inspection methodology used.	When you generate an RBI Recommendation, this field is populated with the value in the Inspection Task Type field in the associated Inspection Strategy.

Recommendation Revision Records

The Recommendation Revision family stores information from the related RBI and Compliance Recommendation records and their related Inspection Tasks. These records store information when an Inspection Plan that is in the Approved state is moved to the Modified state.

This topic provides an alphabetical list and description of the fields that exist for the Recommendation Revision family and appear in the Recommendation Revision datasheet unless otherwise specified. This list is not comprehensive.

This family is enabled for site filtering, which means that records in this family can be assigned to a specific site and will only be accessible to users who are assigned to the same site and have the

appropriate license and family privileges. For more information, refer to the [Sites](#) section of the documentation.

Field	Data Type	Description	Behavior and Usage
Damage Mechanism	Character (50)	Stores the Damage Mechanism of the original Recommendation.	This field is disabled.
Inspection Strategy ID	Character (255)	Stores the ID of the Inspection Strategy record from which the original Recommendation was generated.	This field is disabled.
Inspection Task Type	Character (255)	Stores the Task Type from the related Inspection Task.	This field is disabled.
Non Recurring?	Boolean	Indicates whether the Recommendation is to recur.	This field is disabled.
RBI Recommendation Methodology	Character (255)	Indicates the methodology used to create the Recommendation.	<ul style="list-style-type: none"> For RBI Recommendations, the value in this field can be RBI 580 or RBI 581. For Compliance, the value in this field is set to the name of the Compliance Strategy Template.
Recommendation ID	Character (255)	Indicates the unique ID that is assigned to the Recommendation.	<p>This field is populated by automatically by business rules.</p> <p>This field is disabled.</p>
Recommended Inspection Scope	Text	Stores the Inspection Scope that populated the original Recommendation.	This field is disabled.
State	Character (255)	Stores the State ID of the original Recommendation.	<p>This field is populated by the caption of the state.</p> <p>The field is disabled and does not appear in the datasheet.</p>
Task Description	Text	Stores the description from the related Inspection Task.	This field is disabled.
Task Desired Interval	Numeric	Stores the Desired Interval field value from the related Inspection Task.	This field is disabled.
Task Desired Interval Basis	Character (1000)	Stores the Desired Interval Basis from the related Inspection Task.	<p>The value in this field is the description of the corresponding system code from the INSM System Code Table.</p> <p>The field is disabled.</p>

Field	Data Type	Description	Behavior and Usage
Task Desired Interval UOM	Character (50)	Stores the Desired Interval UOM from the related Inspection Task.	This field is disabled.
Task Details	Text	Stores the details from the related Inspection Task.	This field is disabled.
Task ID	Character (255)	Stores the Task ID from the related Inspection Task.	This field is disabled.
Task Last Date	Date	Stores the Last Date from the related Inspection Task.	This field is disabled.
Task Override Interval	Boolean	Stores the Override Interval from the related Inspection Task.	This field is disabled.
Task Next Date	Date	Stores the Next Date from the related Inspection Task.	This field is disabled.
Task Reoccurring	Boolean	Stores the Reoccurring flag value from the related Inspection Task.	This field is disabled.

Tank Stress Records

Tank Stress records are used in the Tank Stress reference table, which is used to determine the Allowable Stress value for RBI Criticality Analyses linked to storage tank components (i.e., RBI Components whose Stress Lookup Table field contains the value Tank). This topic provides a list and description of the fields that exist in the Tank Stress family. The information in the table reflects the baseline state and behavior of these fields.

This family is not enabled for site filtering, which means that records in this family can be accessed by any user with the appropriate license and family privileges. For more information, refer to the [Sites](#) section of the documentation.

Field	Data Type	Description	Behavior and Usage						
Allowable Stress	Numeric	The maximum amount of pressure that the component can withstand.	<p>The value in this field is calculated using the following fields:</p> <ul style="list-style-type: none"> Stress Lookup Table Construction Code Code Year Material Spec Material Grade Course Number Tensile Strength Yeild Strength <p>The value in this field is used to populate the Allowable Stress field in the associated RBI Criticality Analysis.</p>						
Code Year	Character	The year in which the design code that corresponds to the component was defined.	<p>The value in this field is used to:</p> <ul style="list-style-type: none"> Determine the value in the Allowable Stress field. Filter the list of values in the Material Specification field. Populate the Code Year field in the associated RBI Criticality Analysis. <p>The options in this field are populated based on the value that you select in the Design Code field. The table below describes the options available in the Design Code field and corresponding values in the Code Year field.</p> <table border="1"> <thead> <tr> <th>Design Code</th> <th>Code Year</th> </tr> </thead> <tbody> <tr> <td>API 650</td> <td>2008</td> </tr> <tr> <td>API 653</td> <td>2008</td> </tr> </tbody> </table>	Design Code	Code Year	API 650	2008	API 653	2008
Design Code	Code Year								
API 650	2008								
API 653	2008								

Field	Data Type	Description	Behavior and Usage
Design Code	Character	The design code associated with the component.	The value in this field is used to: <ul style="list-style-type: none"> Determine the value in the Allowable Stress field. Populate the Construction Code field in the associated RBI Criticality Analysis.
Material Grade	Character	The material grade of the component.	The value in this field is used to: <ul style="list-style-type: none"> Determine the value in the Allowable Stress field. Populate the Material Grade field in the associated RBI Criticality Analysis.
Material Specification	Character	The material specification of the component.	The value in this field is used to: <ul style="list-style-type: none"> Determine the value in the Allowable Stress field. Filter the list of values in the Material Grade field. Populate the Material Spec field in the associated RBI Criticality Analysis.
Minimum Tensile Strength	Numeric	The minimum tensile strength of the material of the component.	None
Minimum Yield Strength	Numeric	The minimum yield strength of the material of the component.	None

Inspection Plan Records

An Inspection Plan allows you to view, manage, approve, and implement all RBI Recommended Actions related to an Asset. Inspection Plans are created for RBI Assets when one of the related components has an analysis that is moved to the Risk Completed state. This topic provides an alphabetical list and description of the fields that exist for the Inspection Plan family. The information in the table reflects the baseline state and behavior of these fields.

This family is enabled for site filtering, which means that records in this family can be assigned to a specific site and will only be accessible to users who are assigned to the same site and have the appropriate license and family privileges. For more information, refer to the [Sites](#) section of the documentation.

Field	Data Type	Description	Behavior and Usage
RBI Date	Date	The most conservative start date from related risk complete analyses.	This field is populated with the most conservative Date Criticality Calculated field from related risk complete analyses.
Plan Date	Date	The most conservative end date of the planning period on related risk complete analyses.	This field is populated with the date, 10 years greater than the most conservative Date Criticality Calculated field from related risk complete analyses.
Inspection Plan ID	Character	The related assets entity identifier.	This field is set to the associated assets entity ID. This field is disabled.
RBI Risk Category	Character	The most conservative risk category of related risk complete analyses.	This field is disabled.
Comments	Text	Comments related to the Inspection Planning process.	None
Unanalyzed RBI Data	Flag	Flag which is set to true when there is a new RBI data which has not been considered on the current Inspection Plan.	This field is disabled. When the Use Recommended Actions for Inspection Planning preference is set to false, this field will be set to true when an RBI Analysis is moved to Risk Complete. This field will be reset to false when the RBI Inspection plan is created or modified.
Asset Info	Text	Stores the key asset indicators defined by the user in the Asset Info configuration.	This field is disabled.
RBI Driving Component	Text	The entity key of the RBI Component with the most conservative risk category of related risk complete analyses	None

Inspection Plan Detail Records

Inspection Plan Detail records are linked to a parent Inspection Plan. Degradation Mechanisms related to the Inspection Plans asset are mapped one-to-one to the Inspection Plan Detail records.

This family is enabled for site filtering, which means that records in this family can be assigned to a specific site, and will only be accessible to users who are assigned to the same site and have the appropriate license and family privileges. For more information, refer to the Sites section of the documentation.

Field	Data Type	Description	Behavior and Usage
Asset Key	Character	The entity key of the related Inspection Plans asset.	This field is populated with the entity key of the parent Inspection Plans asset.
Methodology	Character	The RBI Analysis Methodology.	This field is populated with RBI 580.
Component	Character	The related RBI components entity key.	This field is set to the mapped Degradation Mechanisms parent RBI Components entity key.
Damage Mechanism	Character	A process that induces deleterious micro or macro material changes over time that are harmful to the material condition or mechanical properties.	This field is mapped from the Degradation Mechanisms Damage Mechanism field.
Analysis	Character	The related analysis entity key.	This field is set to the mapped Degradation Mechanisms parent analysis entity key.
Task Type	Character	Defines the inspection methodology used.	<p>This field is set based on the recommended Inspection Strategy returned from the following policies:</p> <ul style="list-style-type: none"> • Appendix_B • Appendix_D • Appendix_E • Appendix_F • Appendix_G • Appendix_H • Appendix_I <p>The drop-down list is populated with the Task Type field on the Inspection Strategy records relevant to the Damage Mechanism. The relevant Inspection Strategy records are available in the Degradation Mechanism Strategy family</p>

Field	Data Type	Description	Behavior and Usage
Basis	Character	Defines what is driving the recommended action.	<p>This field is set based on the recommended Inspection Strategy returned from the following policies:</p> <ul style="list-style-type: none"> • Appendix_B • Appendix_D • Appendix_E • Appendix_F • Appendix_G • Appendix_H • Appendix_I <p>The drop-down list is populated with the Inspection Strategy Description field on the Inspection Strategy records relevant to the Damage Mechanism filtered by Task Type, Inspection Confidence and Extent. The relevant Inspection Strategy records are available in the Degradation Mechanism Strategy family.</p>
Extent	Character	The extent to which the inspection should be performed.	<p>This field is set based on the recommended Inspection Strategy returned from the following policies:</p> <ul style="list-style-type: none"> • Appendix_B • Appendix_D • Appendix_E • Appendix_F • Appendix_G • Appendix_H • Appendix_I <p>The drop-down list is populated with the Inspection Strategy Description field on the Inspection Strategy records relevant to the Damage Mechanism filtered by Task Type and Inspection Confidence. The relevant Inspection Strategy records are available in the Degradation Mechanism Strategy family.</p>

Field	Data Type	Description	Behavior and Usage
Interval Scope	Numeric	Defines the time period between inspection events.	<p>This field is set based on the recommended Inspection Strategy returned from the following policies:</p> <ul style="list-style-type: none"> • Appendix_B • Appendix_D • Appendix_E • Appendix_F • Appendix_G • Appendix_H • Appendix_I <p>This field is populated with one of the following values:</p> <ul style="list-style-type: none"> • When the Use Calculated Data field in the Inspection Strategy is set to False, the value in the Recommended Inspection Interval field is used. • When the Use Calculated Data field in the Inspection Strategy is set to True: <ul style="list-style-type: none"> ◦ For RBI Criticality Analyses, the value in the Estimated Half Life field is used. ◦ For RBI PRD Analyses, the value in the Recommended Inspection Interval on the analysis is used.
Target Completion Date	Date	None	None
Is Intrusive	Character	None	None
Recurring	Boolean	Indicates whether the inspection task that you create for the inspection plan detail is recurring.	This field is set to True if the methodology field is RBI 580.

Field	Data Type	Description	Behavior and Usage
Inspection Scope	Text	Defines what actions should be taken during this inspection event.	<p>This field is set based on the recommended Inspection Strategy returned from the following policies:</p> <ul style="list-style-type: none"> • Appendix_B • Appendix_D • Appendix_E • Appendix_F • Appendix_G • Appendix_H • Appendix_I <p>The drop-down list is populated with the Inspection Scope field on the Inspection Strategy records relevant to the Damage Mechanism filtered by Task Type and Inspection Confidence. The relevant Inspection Strategy records are available in the Degradation Mechanism Strategy family.</p>
Inspection Confidence	Character	A value that indicates how effective prior inspections were at identifying the degradation mechanism and the rate of degradation.	<p>This field is set based on the recommended Inspection Strategy returned from the following policies:</p> <ul style="list-style-type: none"> • Appendix_B • Appendix_D • Appendix_E • Appendix_F • Appendix_G • Appendix_H • Appendix_I <p>The drop-down list is populated with the Inspection Scope field on the Inspection Strategy records relevant to the Damage Mechanism filtered by Task Type and Inspection Confidence. The relevant Inspection Strategy records are available in the Degradation Mechanism Strategy family.</p>

Field	Data Type	Description	Behavior and Usage												
Highest Level of Inspection	Character	The Recommended Inspection Effectiveness.	<p>The Inspection Confidence field is converted to a Level of Inspection Category (A - E) as follows:</p> <table border="1"> <thead> <tr> <th>Highest Level of Inspection</th> <th>Confidence</th> </tr> </thead> <tbody> <tr> <td>A</td> <td> <ul style="list-style-type: none"> Very High Highly Effective </td> </tr> <tr> <td>B</td> <td> <ul style="list-style-type: none"> High Usually Effective </td> </tr> <tr> <td>C</td> <td> <ul style="list-style-type: none"> Medium Fairly Effective </td> </tr> <tr> <td>D</td> <td> <ul style="list-style-type: none"> Low Poorly Effective </td> </tr> <tr> <td>E</td> <td> <ul style="list-style-type: none"> Ineffective </td> </tr> </tbody> </table>	Highest Level of Inspection	Confidence	A	<ul style="list-style-type: none"> Very High Highly Effective 	B	<ul style="list-style-type: none"> High Usually Effective 	C	<ul style="list-style-type: none"> Medium Fairly Effective 	D	<ul style="list-style-type: none"> Low Poorly Effective 	E	<ul style="list-style-type: none"> Ineffective
Highest Level of Inspection	Confidence														
A	<ul style="list-style-type: none"> Very High Highly Effective 														
B	<ul style="list-style-type: none"> High Usually Effective 														
C	<ul style="list-style-type: none"> Medium Fairly Effective 														
D	<ul style="list-style-type: none"> Low Poorly Effective 														
E	<ul style="list-style-type: none"> Ineffective 														
Implement	Boolean	Indicates whether the detail should be implemented to a task during Inspection Plan approval.	This field is not displayed on the datasheet and is auto-selected by the system when the Task field is updated.												
Task	Character	The entity key of the task to implement during Inspection Plan approval.	<p>This field can be set to one of the following:</p> <ul style="list-style-type: none"> the entity key of any task related to the parent asset Create New Blank 												
Last Date	Date	The date on which the last inspection was performed.	This field is set to the RBI Date of the parent Inspection Plan record.												
Proposed Next Date	Date	Date on which the inspection event is scheduled.	This field is calculated by adding the Interval Scope value to the Last Date.												

Inspection Plan Revision Records

The Inspection Plan Revision family stores information regarding revisions of Inspection Plan.

The table below provides an alphabetical list and description of the fields that exist for the Inspection Plan Revision family. The information in the table reflects the baseline state and behavior of these fields. This list is not comprehensive.

This family is not enabled for site filtering, which means that records in this family can be accessed by any user with the appropriate license and family privileges. For more information, refer to the [Sites](#) section of the documentation.

Field	Data Type	Description	Behavior and Usage
Basis for Revision	Text	Stores the text that is entered by the user when updating an Approved Inspection Plan.	This field is populated by entering a reason for Revision in the dialog box that appears when updating an Inspection Plan that is in the Approved state. This field is disabled in the datasheet.
FK_HAIN_PR_INPL_INPL_R_N	Character	Foreign Key field that stores the entity key of the Inspection Plan,	This field is disabled. This field does not appear in the datasheet.
Revised By	Character	Stores the entity key of the user who modified the Inspection Plan.	This field is populated by the name of the user who modified the Inspection Plan. This field is disabled.
Revision Date	Date	Stores the Revision Date of the Inspection Plan.	This field is disabled.
RBI Date	Date	Stores the RBI Date of the Inspection Plan.	This field is disabled.
Plan Date	Date	Stores the Plan Date of the Inspection Plan.	This field is disabled.
Inspection Plan ID	Character	Stores the Inspection Plan ID of the Inspection Plan.	This field is disabled.
RBI Risk Category	Character	Stores the RBI Risk Category of the Inspection Plan.	This field is disabled.
Comments	Text	Stores the Comments of the Inspection Plan.	This field is disabled.
Unanalyzed RBI Data	Flag	Stores the Unanalyzed RBI Data of the Inspection Plan.	This field is disabled.

Field	Data Type	Description	Behavior and Usage
Asset Info	Text	Stores the Asset Info value of the Inspection Plan.	This field is disabled.
RBI Driving Component	Text	Stores the RBI Driving Component value of the Inspection Plan.	This field is disabled.

Inspection Plan Detail Revision Records

Inspection Plan Detail Revision Family stores information from the related Inspection Plan Detail record. These records store information when an Inspection Plan that is in the Approved state is moved to the Modified state.

This family is enabled for site filtering, which means that records in this family can be assigned to a specific site and will only be accessible to users who are assigned to the same site and have the appropriate license and family privileges. For more information, refer to the [Sites](#) section of the documentation.

Field	Data Type	Description	Behavior and Usage
Asset Key	Character	Stores the Asset Key of the original Inspection Plan Detail.	This field is disabled.
Methodology	Character	Stores the Methodology of the original Inspection Plan Detail.	This field is disabled.
Component	Character	Stores the Component of the original Inspection Plan Detail.	This field is disabled.
Damage Mechanism	Character	Stores the Damage Mechanism of the original Inspection Plan Detail.	This field is disabled.
Analysis	Character	Stores the Analysis of the original Inspection Plan Detail.	This field is disabled.
Task Type	Character	Stores the Task Type of the original Inspection Plan Detail.	This field is disabled.
Basis	Character	Stores the Basis of the original Inspection Plan Detail.	This field is disabled.
Interval Scope	Numeric	Stores the Interval Scope of the original Inspection Plan Detail.	This field is disabled.
Target Completion Date	Date	Stores the Target Completion Date of the original Inspection Plan Detail.	This field is disabled.
Is Intrusive	Character	Stores the Is Intrusive value of the original Inspection Plan Detail.	This field is disabled.

Field	Data Type	Description	Behavior and Usage
Recurring	Boolean	Indicates whether the Inspection Plan Detail is recurring.	This field is disabled.
Inspection Scope	Text	Stores the Inspection Scope of the original Inspection Plan Detail.	This field is disabled.
Inspection Confidence	Character	Stores the Inspection Confidence value of the original Inspection Plan Detail.	This field is disabled.
Highest Level of Inspection	Character	Stores the Highest Level of Inspection of the original Inspection Plan Detail.	This field is disabled.
Implement	Boolean	Indicates whether the Inspection Plan Detail is implemented.	This field is disabled.
Task	Character	Stores the entity key of the related Inspection Task.	This field is disabled.
Last Date	Date	Stores the Last Date of the original Inspection Plan Detail.	This field is disabled.
Proposed Next Date	Date	Stores the Proposed Next Date of the original Inspection Plan Detail.	This field is disabled.

Catalog Items

Overview Graphs Folder

The Catalog folder `\\Public\Meridium\Modules\Risk Based Inspection\Overview Graphs` contains the following items.

Graph Name	Behavior and Usage
Current Risk Overview	Displays the Current Risk Categories for all assets under a Functional Location.
Past Risk Overview	Displays the most recently archived Past Risk Categories for all assets under a Functional Location. This allows the user to see the variations in risk after the completion of inspections.
RBI Risk Matrix	Displays the total number of RBI Components based on their consequence of failure and probability of failure values. This graph appears only if the Risk Based Inspection license is active.

Queries Folder

The Catalog folder `\\Public\Meridium\Modules\Mechanical Integrity\Queries \Dashboard Queries` contains the following items.

Item Name	Behavior and Usage
Percentage Change in External DM for Piping	Returns the number of RBI Components of the Piping Equipment Type where the CUI Inspection Priority Changed field is set to True.
Percentage Change in External DM for Tanks	Returns the number of RBI Components of the Tanks Equipment Type where the CUI Inspection Priority Changed field is set to True.
Percentage Change in External DM for Vessels	Returns the number of RBI Components of the Vessels Equipment Type where the CUI Inspection Priority Changed field is set to True.
Percentage Change in Internal DM for Piping	Returns the number of RBI Components of the Piping Equipment Type where the Int. Corr. Inspection Priority Changed field is set to True.
Percentage Change in Internal DM for Tanks	Returns the number of RBI Components of the Tanks Equipment Type where the Int. Corr. Inspection Priority Changed field is set to True.
Percentage Change in Internal DM for Vessels	Returns the number of RBI Components of the Vessels Equipment Type where the Int. Corr. Inspection Priority Changed field is set to True.

The Catalog folder \\Public\Meridium\Modules\Mechanical Integrity\Queries contains the following items.

Item Name	Behavior and Usage
AssetInfo_OpenRecommendations	Displays the count of open inspection recommendations associated with the given asset. This query is used for the Asset info summary in the Asset Summary workspace.
AssetInfo_RBIRisk	Displays the most critical risk of the analyses contained on an asset. This query is used for the Asset info summary in the Asset Summary workspace.
AssetInfo_RemainingLife	Displays the most conservative remaining life value from the related Asset Corrosion Analyses of a given asset. This query is used for the Asset info summary in the Asset Summary workspace.
AssetInfo_WorkHistory	Displays the count of work history records associated with the given asset. This query is used for the Asset info summary in the Asset Summary workspace.

The Catalog folder \\Public\Meridium\Modules\Risk Based Inspection\Queries contains the following items.

Item Name	Behavior and Usage
Active Analyses for Evergreening - 580	<p>Returns a list of the RBI Criticality Analysis records for RBI Components linked to RBI assets that satisfy the following conditions:</p> <ul style="list-style-type: none"> • Are related to the given Functional Location or Process Unit key. • Are in the <i>active</i> state. • Have an evergreening Batch ID. <p>This query is used on the RBI Bulk Evergreening page, in the Active section when the RBI Analysis Type Preference is set to RBI 580.</p>
Active Analyses For What-If - 580	<p>Returns a list of the RBI Criticality Analysis records for active RBI Components linked to RBI assets that satisfy the following conditions:</p> <ul style="list-style-type: none"> • Are related to the given Functional Location or Process Unit key. • Are in an active state. • Have a Batch ID. <p>This query is used in the Active section in the Create What-If Analyses workspace when the RBI Analysis Type Preference is set to RBI 580.</p>
Analyses Created For Evergreening - 580	<p>Returns a list of the RBI Criticality Analysis records for RBI Components linked to RBI assets that satisfy the following conditions:</p> <ul style="list-style-type: none"> • Are related to the given Functional Location or Process Unit key. • Are in the Created state. • Have an evergreening Batch ID. <p>This query is used on the RBI Bulk Evergreening page, in the Created section when the RBI Analysis Type Preference is set to RBI 580.</p> <p>Important: Do not modify the following columns: Analysis ID, Component, Component Entity Key, Asset ID, ENTY_KEY, Analysis Entity Key, and Risk Category. Modifying these columns may affect the Calculate functionality during the evergreening process.</p>

Item Name	Behavior and Usage
Analyses Created For What-If 580	<p>Returns a list of the RBI Criticality Analysis records for active RBI Components linked to RBI assets that satisfy the following conditions:</p> <ul style="list-style-type: none"> • Are related to the given Functional Location or Process Unit key. • Are in the Created state. • Have a Batch ID. <p>This query is used in the Created section in the Create What-If Analyses workspace when the RBI Analysis Type Preference is set to RBI 580.</p> <p>Important: Do not modify the following columns: Analysis ID, Component, Component Entity Key, ENTY_KEY, Analysis Entity Key. If you do so, it may affect the workflow process.</p>
Analyses Ready for Evergreening - 580	<p>Returns a list of the RBI Criticality Analysis records for RBI Components linked to RBI assets that satisfy the following conditions:</p> <ul style="list-style-type: none"> • Are related to the given Functional Location or Process Unit key. • Are in the active state. • Have not been evergreened. • Have not been calculated in the last five years. <p>This query is used on the Risk Based Inspection Overview page, in the Pending Reassessment section when the RBI Analysis Type Preference is set to RBI 580.</p> <p>Important: Do not modify the ENTY_KEY column. Modifying this column may affect the duplicate functionality during the evergreening process.</p>
Analyses Ready for Evergreening for Unit - 580	<p>Returns a list of the RBI Criticality Analysis records for RBI Components linked to RBI assets that satisfy the following conditions:</p> <ul style="list-style-type: none"> • Are related to the given Functional Location or Process Unit key. • Are in the active state. • Have not been evergreened. <p>This query is used on the RBI Bulk Evergreening page, in the Pending Evergreening section when the RBI Analysis Type Preference is set to RBI 580.</p> <p>Important: Do not modify the ENTY_KEY column. Modifying this column may affect the duplicate functionality during the evergreening process.</p>

Item Name	Behavior and Usage
Analyses Ready For Bulk What-If 580	<p>Returns a list of the RBI Criticality Analysis records for active RBI Components linked to RBI assets that satisfy the following conditions:</p> <ul style="list-style-type: none"> • Are related to the given Functional Location or Process Unit key. • Are not in an archived state. • Are not what-if analyses. <p>This query is used in the Pending What-If Analysis Creation section in the Create What-If Analyses workspace when the RBI Analysis Type Preference is set to RBI 580.</p> <p>Important: Do not modify the ENTY_KEY column. If you do so, it may affect the functionality during the what-if analyses creation.</p>
Asset Components RBI 580	<p>Returns all Active Components that have risk completed 580 analyses related to the given asset.</p> <p>This query is used on the RBI Asset Overview page and RBI Corrosion Loop page in the Components section.</p> <p>Important: Do not modify the Component, Component Entity Key and ENTY_KEY columns. Modifying these columns may affect the functionality.</p>
Asset Corrosion Analysis More Current Than Analyses	<p>Returns a list of all the assets linked to a Functional Location that have a TM Asset Corrosion Analysis more current than the active RBI analysis in the component.</p> <p>This query is used on the Risk Based Inspection Overview page in the Inspection/TM Updates pane if you do not have an active RBI 581 license.</p>
Assets with No Recommendations	<p>Returns a list of all the assets linked to a Functional Location that have no RBI Recommendations and have at least one component with a Risk Completed analysis.</p> <p>This query is used on the Risk Based Inspection Overview page in the No Recommendations pane when both Risk Based Inspection and RBI 581 are licensed.</p> <p>Important: Do not modify the Asset Entity Key field. Modifying this field may affect the generate recommendation functionality.</p>
Assets with No Recommendations (580 Only)	<p>Returns a list of all assets linked to a Functional Location that have no RBI Recommendations and have at least one component with a Risk Completed analysis.</p> <p>This query is used on the Risk Based Inspection Overview page in the No Recommendations pane if you do not have an active RBI 581 license.</p> <p>Important: Do not modify the Asset Entity Key field. Modifying this field may affect the generate recommendation functionality.</p>

Item Name	Behavior and Usage
Criticality Consequence Evaluation	<p>Returns the Criticality Consequence Evaluation records that are associated to an RBI Criticality Analysis. This query is used in the Consequence Evaluations section when you view an RBI Criticality Analysis.</p> <p>Important: Do not modify the ENTY_KEY or FMLY_KEY columns. Modifying these columns may affect the functionality.</p>
Current Risk	<p>Returns a list of the current rolled-up risk for each asset linked to a Functional Location.</p> <p>This query is used under the Current Risk query widget on the Risk Based Inspection Overview page.</p>
Current Risk Overview	<p>Returns a list of the highest Risk Category for each asset linked to a Functional Location and gives a count.</p> <p>This query is used under the Current Risk Overview graph widget on the Risk Based Inspection Overview page.</p>
Data Export Analyses - 580	<p>Returns a list of the RBI Criticality Analyses available for export and that meets the following conditions:</p> <ul style="list-style-type: none"> • Are related to the given Functional Location or Process Unit key. • Are in the active state. • Are in the Created state. <p>This query is used on the RBI Analysis Export page, when the RBI Analysis Type Preference is set to RBI 580.</p>
Export RBI Components by Asset	<p>Returns a list of the Equipment records that are linked to active RBI Components and Equipment records that are not linked to at least one RBI Component.</p>
Inspections More Current Than All Analysis	<p>Returns a list of all the assets linked to a Functional Location that have Inspections more current than the active RBI analysis in the component.</p> <p>This query is used on the Risk Based Inspection Overview page, in the Inspection/TM Updates pane when both Risk Based Inspection and RBI 581 licenses are active.</p> <p>Important: Do not modify the Asset Key column. Modifying this column may affect the functionality.</p>
Inspections More Current Than Analysis	<p>Returns a list of all the assets linked to a Functional Location that have Inspections more current than the active RBI analysis in the component.</p> <p>This query is used on the Risk Based Inspection Overview under the Inspection/TM Updates pane when both Risk Based Inspection and RBI 581 licenses are active.</p> <p>Important: Do not modify the Asset Key column. Modifying this column may affect the functionality.</p>
Invalid Inspections for Non-Intrusive Requirement Met	None.

Item Name	Behavior and Usage
Manage Inspection Groups	None.
Manage RBI Components	None.
Manage RBI System	None.
Maximum Internal Corrosion Rate	Returns a list of the calculated maximum internal corrosion rate for an Internal Corrosion DME.
Past Risk	Returns a list of the past rolled-up risk for each asset under a Functional Location. This query is used under the Past Risk query widget on the Risk Based Inspection Overview page.
Past Risk Overview	Returns a list of the highest Risk Category for each asset Under a Functional Location and gives a count. This query is used under the Past Risk Overview graph widget on the Risk Based Inspection Overview.
PRD Consequence Evaluation	None.
Process Unit Asset View	Returns all RBI Assets related to the given Process Unit and rolled up values from the RBI Assets related Inspection Plan. Important: Do not modify the Asset and the Asset Entity Key columns. Modifying these columns may affect the functionality.
Process Unit Corrosion Loop View	Returns all the Corrosion Loops related to the given Process Unit. Important: Do not modify the Corrosion Loop and the Corrosion Loop Key columns. Modifying these columns may affect the functionality.
Process Unit Query	Returns a list of the underlying Process Units for the selected level of the asset hierarchy. This query is used on the Risk Based Inspection Overview in the Process Units pane. Important: Do not modify the ENTY_KEY column. Modifying this column may affect the functionality.
RBI Asset Risk Query	None.
RBI Asset Risk Sub Query	None.
RBI Assets for a Functional Location	Returns a list of all the assets linked to a Functional Location. This query is used on the Risk Based Inspection Overview page in the Assets pane. Important: Do not modify the Asset Entity Key column. Modifying this column may affect the functionality.
RBI Components for an Asset	Returns a list of all the RBI Components for a given asset. This query is used under the Asset Hierarchy Navigation menu to display the count of components on the Risk Based Inspection hyperlink.

Item Name	Behavior and Usage
RBI Corrosion Loops for a Functional Location	Returns a list of all the Corrosion Loops linked to a given Functional Location.
RBI DM Query	<p>Returns a list of Degradation Mechanism records that are linked to an RBI Criticality Analysis. This query is used on the Degradation Mechanisms tab when viewing an RBI Criticality Analysis.</p> <p>Important: Do not modify the following columns:</p> <ul style="list-style-type: none"> • UnmitigatedRiskKey • MitigatedRiskkey • DMEntityKey <p>Modifying these columns may affect the functionality.</p>
RBI Flexible Configurations	Returns a list of all the flexible calculation records.
RBI Flexible Validation Records	Returns all flexible validation records.
RBI Overview Filter Parameters	None.
RBI Pipeline Consequence Evaluation	None.
Review Analyses by Asset 580	Returns a list of all the RBI Criticality Analysis records not in an Archived state for the Equipment or Functional Location record for which you accessed the RBI asset. This is used for the Finalize Risk button in the Assets section of the Risk Based Inspection Overview page.
Review Analysis by Corrosion Loop 580	<p>Returns a list of all the RBI Criticality Analysis records that are calculated in the Created state for the Corrosion Loop record for which you accessed the RBI asset. This is used for the Finalize Risk button in the Unit Summary page.</p> <p>This query is used when Finalizing Risk from the Process Unit Overview page.</p> <p>Important: The SMST_ID (Alias Name: StateID) is a required field in this query. When using the query:</p> <ul style="list-style-type: none"> • do not remove this field from the query. • do not change the alias of this field. • do not modify the order of this field.
Select Protected Assets	Returns a list of the Asset records in the Select Protected Assets window.
Select Protected RBI Components	Returns a list of the RBI Components in the Select Protected Assets window.
Select RBI Components	<p>Returns a list of the RBI Components that are:</p> <ul style="list-style-type: none"> • Linked to Asset records. • Not linked to a Corrosion Loop record. <p>This query is used to display available components which can be linked to corrosion loops.</p>

Item Name	Behavior and Usage
Unlinked Corrosion Loops	Returns a list of all the Corrosion Loops that are not linked to a Unit. This query is used to display available corrosion loops which can be linked to a process unit.
Valid Inspections for Non-Intrusive Requirement Met	None.
View all Recommendations	Returns a list of all the recommendations for a selected Unit.
View Protected RBI Components	Returns a list of all the Protected RBI Components for a selected Unit.
Policy Queries folder	Contains queries that are used by RBI Strategy Mapping Groups when you generate RBI Recommendations records.

Inspection Plan Queries

The Catalog folder `\\Public\Meridium\Modules\Inspection\Compliance\Queries` contains the following queries used in the Inspection Plan workflow.

Query	Behavior and Usage																										
<p>Compliance Recommendations by Plan</p>	<p>Displays Recommendations based on the Inspection Plan.</p> <p>The following columns in the query must be used, and the aliases must contain the following values.</p> <table border="1" data-bbox="852 401 1414 1398"> <thead> <tr> <th data-bbox="857 407 1133 443">Column</th> <th data-bbox="1133 407 1409 443">Alias</th> </tr> </thead> <tbody> <tr> <td data-bbox="857 443 1133 527">[MI_COMP_RECOMM].ENTY_ID AND [MI_RBIRECOM].ENTY_ID</td> <td data-bbox="1133 443 1409 527">REC_ENTY_ID</td> </tr> <tr> <td data-bbox="857 527 1133 611">[MI_COMP_RECOMM].ENTY_KEY AND [MI_RBIRECOM].ENTY_KEY</td> <td data-bbox="1133 527 1409 611">REC_ENTY_KEY</td> </tr> <tr> <td data-bbox="857 611 1133 653">[MI_TASKINSP].[MI_TASK_ID]</td> <td data-bbox="1133 611 1409 653">Task ID</td> </tr> <tr> <td data-bbox="857 653 1133 695">a."SUCC_ENTY_KEY"</td> <td data-bbox="1133 653 1409 695">Linked Actions</td> </tr> <tr> <td data-bbox="857 695 1133 737">[MI_TASKINSP].ENTY_KEY</td> <td data-bbox="1133 695 1409 737">TASK KEY</td> </tr> <tr> <td data-bbox="857 737 1133 800">{MIR_RBICRAN}.PRED_ENTY_KEY</td> <td data-bbox="1133 737 1409 800">Comp Key</td> </tr> <tr> <td data-bbox="857 800 1133 968"> <p>Note: For Compliance Recommendations, the column must be set to NULL. For RBI Consolidated Recommendations, the column must be set to 0.</p> </td> <td data-bbox="1133 800 1409 968"></td> </tr> <tr> <td data-bbox="857 968 1133 1010">PRED_ENTY_KEY</td> <td data-bbox="1133 968 1409 1010">Analysis Key</td> </tr> <tr> <td data-bbox="857 1010 1133 1178"> <p>Note: For Compliance Recommendations, the column must be set to NULL. For RBI Consolidated Recommendations, the column must be set to 0.</p> </td> <td data-bbox="1133 1010 1409 1178"></td> </tr> <tr> <td data-bbox="857 1178 1133 1220">MI_SM_STATES.SMST_ID</td> <td data-bbox="1133 1178 1409 1220">STATE_ID</td> </tr> <tr> <td data-bbox="857 1220 1133 1304">[MI_COMP_RECOMM].FMLY_KEY AND [MI_RBIRECOM].FMLY_KEY</td> <td data-bbox="1133 1220 1409 1304">FMLY_KEY</td> </tr> <tr> <td data-bbox="857 1304 1133 1388">[MI_RBIRECOM]. [MI_RBIRECOM_NONRE_FLG]</td> <td data-bbox="1133 1304 1409 1388">NonRecurring?</td> </tr> </tbody> </table> <p>Important: \\Public\Meridium\Modules\Inspection\Compliance\Queries\Compliance Superseded Recommendation Counts is a subquery and must not be removed from the parent query. In this subquery, the SUCC_ENTY_KEY column is required, and the alias must not be modified.</p>	Column	Alias	[MI_COMP_RECOMM].ENTY_ID AND [MI_RBIRECOM].ENTY_ID	REC_ENTY_ID	[MI_COMP_RECOMM].ENTY_KEY AND [MI_RBIRECOM].ENTY_KEY	REC_ENTY_KEY	[MI_TASKINSP].[MI_TASK_ID]	Task ID	a."SUCC_ENTY_KEY"	Linked Actions	[MI_TASKINSP].ENTY_KEY	TASK KEY	{MIR_RBICRAN}.PRED_ENTY_KEY	Comp Key	<p>Note: For Compliance Recommendations, the column must be set to NULL. For RBI Consolidated Recommendations, the column must be set to 0.</p>		PRED_ENTY_KEY	Analysis Key	<p>Note: For Compliance Recommendations, the column must be set to NULL. For RBI Consolidated Recommendations, the column must be set to 0.</p>		MI_SM_STATES.SMST_ID	STATE_ID	[MI_COMP_RECOMM].FMLY_KEY AND [MI_RBIRECOM].FMLY_KEY	FMLY_KEY	[MI_RBIRECOM]. [MI_RBIRECOM_NONRE_FLG]	NonRecurring?
Column	Alias																										
[MI_COMP_RECOMM].ENTY_ID AND [MI_RBIRECOM].ENTY_ID	REC_ENTY_ID																										
[MI_COMP_RECOMM].ENTY_KEY AND [MI_RBIRECOM].ENTY_KEY	REC_ENTY_KEY																										
[MI_TASKINSP].[MI_TASK_ID]	Task ID																										
a."SUCC_ENTY_KEY"	Linked Actions																										
[MI_TASKINSP].ENTY_KEY	TASK KEY																										
{MIR_RBICRAN}.PRED_ENTY_KEY	Comp Key																										
<p>Note: For Compliance Recommendations, the column must be set to NULL. For RBI Consolidated Recommendations, the column must be set to 0.</p>																											
PRED_ENTY_KEY	Analysis Key																										
<p>Note: For Compliance Recommendations, the column must be set to NULL. For RBI Consolidated Recommendations, the column must be set to 0.</p>																											
MI_SM_STATES.SMST_ID	STATE_ID																										
[MI_COMP_RECOMM].FMLY_KEY AND [MI_RBIRECOM].FMLY_KEY	FMLY_KEY																										
[MI_RBIRECOM]. [MI_RBIRECOM_NONRE_FLG]	NonRecurring?																										
<p>Compliance Recommendations to Supersede</p>	<p>Displays Recommendations for a given entity keys. This query is used to select the master Recommended Action while superseding Compliance Recommendations in the Recommendation section of the Inspection Plan page.</p> <p>Important: The [MI_RBIRECOM].ENTY_KEY column must not be removed, and the alias REC_ENTY_KEY must not be modified.</p>																										

Query	Behavior and Usage						
Compliance Superseded Recommendations	<p>Displays a list of Consolidated and Superseded Recommendations. This query is used to access the linked actions in the Inspection Plan page.</p> <p>Note: The [MI_RBIRECOM].ENTY_KEY column must not be removed, and the alias REC_ENTY_KEY must not be modified.</p>						
Inspection Tasks for Asset	<p>Displays the Inspection Tasks for an asset. This query is used to access the Existing Tasks in the Inspection Plan page.</p> <p>Important: In the WHERE criteria, the ID of the parameter must be ASSET_ENTY_KEY.</p>						
Compliance Superseded Recommendation Counts	<p>Returns the count of Consolidated and Superseded Recommendations. This query is used in the Recommendation section of the Inspection Plan page.</p>						
Inspection Tasks Available to Implement	<p>Displays the Inspection Tasks available to implement for a Compliance Recommendation. This query is used to access the Inspection tasks after selecting the Implement button in the Inspection Plan page.</p>						
Recommended Actions by Selected Plans	<p>Displays unimplemented actions from a given Inspection Plan. This query is used in the Inspection Plan page. The following columns in the query must be used, and the aliases must not be changed.</p> <table border="1" data-bbox="852 1037 1417 1247"> <thead> <tr> <th>Column</th> <th>Alias</th> </tr> </thead> <tbody> <tr> <td>[MI_COMP_RECOMM].ENTY_ID AND [MI_RBIRECOM].ENTY_ID</td> <td>REC_ENTY_ID</td> </tr> <tr> <td>{MIR_ASST_HAS_INSP_PLAN}.PRED_ENTY_KEY</td> <td>ASSET_KEY</td> </tr> </tbody> </table> <p>Important: In the WHERE clause, the ID of the parameter must be ENTY_KEYS.</p>	Column	Alias	[MI_COMP_RECOMM].ENTY_ID AND [MI_RBIRECOM].ENTY_ID	REC_ENTY_ID	{MIR_ASST_HAS_INSP_PLAN}.PRED_ENTY_KEY	ASSET_KEY
Column	Alias						
[MI_COMP_RECOMM].ENTY_ID AND [MI_RBIRECOM].ENTY_ID	REC_ENTY_ID						
{MIR_ASST_HAS_INSP_PLAN}.PRED_ENTY_KEY	ASSET_KEY						
Link Existing Task to Recommended Action	<p>Returns an Inspection Task to link to a given Recommendation based on Asset and Task Type. This query is used in the Inspection Plan page. The following columns in the query must be used, and the aliases must not be changed.</p> <table border="1" data-bbox="852 1516 1417 1614"> <thead> <tr> <th>Column</th> <th>Alias</th> </tr> </thead> <tbody> <tr> <td>[MI_TASKINSP].ENTY_KEY</td> <td>ENTY_KEY</td> </tr> </tbody> </table> <p>Important: In the WHERE clause, the following parameter IDs must be provided and not modified:</p> <ul style="list-style-type: none"> TASK_TYPE ASSET_KEY 	Column	Alias	[MI_TASKINSP].ENTY_KEY	ENTY_KEY		
Column	Alias						
[MI_TASKINSP].ENTY_KEY	ENTY_KEY						
All Inspection Plans for Unit	<p>Returns all Inspection Plans for the selected location in the hierarchy. This query is used to access all the Inspection plans in the Inspection Plan Management page.</p>						

Query	Behavior and Usage
Active Recommendations of Plans for Unit	Returns all active recommendations for Inspection Plans for the selected location in the hierarchy. This query is used to view active recommendations in the Inspection Plan Management page.
Inspection Plan Revisions	<p>Displays the Inspection Plan Revisions for a given Inspection Plan. This query is used to retrieve the revisions for an Inspection Plan.</p> <p>Important:</p> <ul style="list-style-type: none"> • The column [MI_INSP_PLAN_REV].[MI_INSP_PLAN_REV_REVI_DATE_D] must not be removed and its alias must not be changed. • In the WHERE clause, the ID of the parameter must be PLAN_ENTY_KEY.
Compliance Recommendation Revisions for Inspection Plan	<p>Displays the Recommendation Revision records for a given Inspection Plan Revision. This query is used in the Inspection Plan page to view the revisions for a Recommendation.</p> <p>Important:</p> <ul style="list-style-type: none"> • The column [MI_COMP_REC_REV].[MI_REC_ID] must not be removed and its alias must not be changed. • In the WHERE clause, the ID of the parameter must be PLAN_REV_ENTY_KEY.

Risk Based Inspection Queries Folder

The Catalog folder `\\Public\Meridium\Modules\Risk Based Inspection\Queries` contains the following queries which are relevant to the RBI 581 workflow.

Query	Behavior and Usage
Asset Corrosion Analysis More Current than All Analyses	<p>Returns a list of all the assets linked to a Functional Location that have a TM Asset Corrosion Analysis more current than the active RBI analysis in the component.</p> <p>This query is used on the Risk Based Inspection Overview page under the Inspection/TM Updates pane when both Risk Based Inspection and RBI 581 are licensed.</p> <p>Important: Do not modify the Asset Key column. Modifying this column may affect the functionality.</p>
Assets with No Recommendations	<p>Returns a list of all the assets linked to a Functional Location that have no RBI Recommendations and have at least one component with a Risk Completed analysis.</p> <p>This query is used on the Risk Based Inspection Overview page under the No Recommendations pane when both Risk Based Inspection and RBI 581 are licensed.</p> <p>Important: Do not modify the Asset Entity Key field. Modifying this field may affect the generate recommendation functionality.</p>
Current Risk	<p>Returns a list of the current rolled-up risk for each asset linked to a Functional Location.</p> <p>This query is used under the Current Risk query widget on the Risk Based Inspection Overview page.</p>
Current Risk Overview	<p>Returns a list of the highest Risk Category for each asset linked to a Functional Location and gives a count.</p> <p>This query is used under the Current Risk Overview graph widget on the Risk Based Inspection Overview page.</p>
Inspections More Current Than All Analysis	<p>Returns a list of all the assets linked to a Functional Location that have Inspections more current than the active RBI analysis in the component.</p> <p>This query is used on the Risk Based Inspection Overview under the Inspection/TM Updates tile when both Risk Based Inspection and RBI 581 licenses are active.</p> <p>Important: Do not modify the Asset Key column. Modifying this column may affect the functionality.</p>
Past Risk	<p>Returns a list of the past rolled-up risk for each asset under a Functional Location.</p> <p>This query is used under the Past Risk query widget on the Risk Based Inspection Overview page.</p>
Past Risk Overview	<p>Returns a list of the highest Risk Category for each asset Under a Functional Location and gives a count.</p> <p>This query is used under the Past Risk Overview graph widget on the Risk Based Inspection Overview page.</p>

Query	Behavior and Usage
Process Unit Asset View	<p>Returns all RBI Assets related to the given Process Unit and rolled up values from the RBI Assets related Inspection Plan.</p> <p>Important: Do not modify the Asset and the Asset Entity Key columns. Modifying these columns may affect the functionality.</p>
Process Unit Corrosion Loop View	<p>Returns all the Corrosion Loops related to the given Process Unit.</p> <p>Important: Do not modify the Corrosion Loop and the Corrosion Loop Key columns. Modifying these columns may affect the functionality.</p>
Process Unit Query	<p>Returns a list of the underlying Process Units for the selected level of the asset hierarchy.</p> <p>This query is used on the Risk Based Inspection Overview page under the Process Units tile.</p> <p>Important: Do not modify the ENTY_KEY column. Modifying this column may affect the functionality.</p>
RBI Assets for a Functional Location	<p>Returns a list of all the assets linked to a Functional Location.</p> <p>This query is used on the Risk Based Inspection Overview under the Assets tile.</p> <p>Important: Do not modify the Asset Entity Key column. Modifying this column may affect the functionality.</p>
RBI Components for an Asset	<p>Returns a list of all the RBI Components for a given asset.</p> <p>This query is used under the Asset Hierarchy Navigation menu to display the count of components on the Risk Based Inspection hyperlink.</p>
Review Analyses by Asset 581	<p>Returns a list of all the RBI 581 Risk Analysis records that are calculated in the Created state for the Equipment or Functional Location record for which you accessed the RBI asset.</p> <p>This query is used when Finalizing Risk from the Risk Based Inspection Overview page under the Assets pane.</p>
Review Analysis by Corrosion Loop 581	<p>Returns a list of all the RBI 581 Risk Analysis records that are calculated in Created state for the Corrosion Loop record for which you accessed the RBI asset.</p> <p>This query is used when Finalizing Risk from the Process Unit Overview page.</p>
Select RBI Components	<p>Returns a list of the RBI Components that are:</p> <ul style="list-style-type: none"> • Linked to Asset records • Not linked to Corrosion Loop record <p>This query is used to display available components which can be linked to corrosion loops.</p>

Reports Folder

The Catalog folder \\Public\Meridium\Modules\Risk Based Inspection\Reports contains the following items.

Report Name	Behavior and Usage
RBI Asset Risk Report	Displays an at-a-glance summary of an asset in RBI, Thickness Monitoring, and Inspection Management.
RBI Asset Risk Sub Report	Displays all of the data used for the calculation of each component, the risk for each component, and the recommendations assigned to each risk.

Calculations

Fields Required for RBI Analyses

This topic provides a list of fields that are required in each family to calculate an RBI Criticality Analysis, RBI PRD Criticality Analysis, and an RBI Pipeline Analysis. Some fields are conditionally required, and these conditions are described in the Notes column in the following tables.

Fields Required to Calculate RBI Criticality Analyses

To calculate an RBI Criticality Analysis, values may be required in certain fields in the following families:

- Criticality Consequence Evaluation
- Criticality Env. Crack. Deg. Mech. Eval.
- Criticality Ext. Corr. Deg. Mech. Eval.
- Criticality Int. Corr. Deg. Mech. Eval.
- RBI Criticality Analysis

Criticality Consequence Evaluation family: The following table lists the fields in the Criticality Consequence Evaluation family that require values in order to calculate an RBI Analysis:

Field	Notes
Consequence Detection Time	Required only for RBI Analysis records whose Criticality Item Type is not Heat Exchanger-Bundle.
Consequence Isolation Time	Required only for RBI Analysis records whose Criticality Item Type is not Heat Exchanger-Bundle.
Corrosion Rate	Required only for RBI Analysis records whose Criticality Item Type is Heat Exchanger-Bundle.
Corrosion Rate Shell Side	Required only for RBI Analysis records whose Criticality Item Type is Heat Exchanger-Bundle.
Fill Height	Required only for RBI Analysis records whose Criticality Item Type is Storage Tank.

Field	Notes
Flammable Leak Type	Required only for RBI Analysis records whose Criticality Item Type is Heat Exchanger-Bundle and the leaking fluid is flammable.
Foundation Type	Required only for RBI Analysis records whose Criticality Item Type is Storage Tank.
Initial Fluid Phase	None
Initial State Shell	Required only for RBI Analysis records whose Criticality Item Type is Heat Exchanger-Bundle.
Inspection Interval	Required only for RBI Analysis records: <ul style="list-style-type: none"> • That are linked to Criticality Consequence Evaluation records whose Foundation Type is Sand, Silt, Gravel, or Clay. • Whose Criticality Item Type is Heat Exchanger-Bundle.
Leak Effect	Required only for RBI Analysis records that are linked to Criticality Consequence Evaluation records whose Storage Takes contain Sand, Silt, Gravel, or Clay.
Operating Pressure Shell Side	Required only for RBI Analysis records whose Criticality Item Type is Heat Exchanger-Bundle.
Percent Toxic	Required only for RBI Analysis records that are linked to Criticality Consequence Evaluation records whose Toxic Fluid field contains a value.
Product Unit Value	Required only for the RBI Analysis records whose Criticality Item Type is the Heat Exchanger-Bundle.
Rep Fluid Shell Side	Required only for RBI Analysis records whose Criticality Item Type is Heat Exchanger-Bundle.
Toxic Leak Type	Required only for the RBI Analysis records whose Criticality Item Type is the Heat Exchanger-Bundle and the Leaking Fluid is toxic.

Criticality Env. Crack. Deg. Mech. Eval. family

The following table lists the fields in the Criticality Env. Crack. Deg. Mech. Eval. family that require values in order to calculate an RBI Analysis:

Field	Notes
Date in Service	Required only for RBI Analysis records that are linked to Criticality Env. Crack. Deg. Mech. Eval. records.
Initial Potential	Required only for RBI Analysis records that are linked to Criticality Env. Crack. Deg. Mech. Eval. records.

Field	Notes
Inspection Confidence	Required only for RBI Analysis records that are linked to Criticality Env. Crack. Deg. Mech. Eval. records.
Number of Inspections -or- Equivalent Number of Inspections (whichever is populated)	Required only for RBI Analysis records that are linked to Criticality Env. Crack. Deg. Mech. Eval. records.

Criticality Ext. Corr. Deg. Mech. Eval. family

The following table lists the fields in the Criticality Ext. Corr. Deg. Mech. Eval. family that require values in order to calculate an RBI Analysis:

Field	Notes
Date in Service	Required only for RBI Analysis records that are linked to Criticality Ext. Corr. Deg. Mech. Eval. records.
Estimated Rate	Required only for RBI Analysis records that are linked to Criticality Ext. Corr. Deg. Mech. Eval. records whose Selected Corrosion Rate is Estimated.
Inspection Confidence	Required only for RBI Analysis records that are linked to Criticality Ext. Corr. Deg. Mech. Eval. records.
Average Corrosion Rate	Required only for RBI Analysis records that are linked to Criticality Ext. Corr. Deg. Mech. Eval. records whose Selected Corrosion Rate is Average.
Number of Inspections -or- Equivalent Number of Inspections (whichever is populated)	Required only for RBI Analysis records that are linked to Criticality Ext. Corr. Deg. Mech. Eval. records.
Selected Corrosion Rate	Required only for RBI Analysis records that are linked to Criticality Ext. Corr. Deg. Mech. Eval. records.

Criticality Int. Corr. Deg. Mech. Eval. family

The following table lists the fields in the Criticality Int. Corr. Deg. Mech. Eval. family that require values in order to calculate an RBI Analysis:

Field	Notes
Date in Service	Required only for RBI Analysis records that are linked to Criticality Int. Corr. Deg. Mech. Eval. records.
Inspection Confidence	Required only for RBI Analysis records that are linked to Criticality Int. Corr. Deg. Mech. Eval. records.

Field	Notes
Long Term Avg. Corr. Rate	Required only for RBI Analysis records that are linked to Criticality Int. Corr. Deg. Mech. Eval. records whose Selected Corrosion Rate is Long Term Avg.
Number of Inspections -or- Equivalent Number of Inspections (whichever is populated)	Required only for RBI Analysis records that are linked to Criticality Int. Corr. Deg. Mech. Eval. records.
Selected Corrosion Rate	Required only for RBI Analysis records that are linked to Criticality Int. Corr. Deg. Mech. Eval. records.
Short Term Avg. Corr. Rate	Required only for RBI Analysis records that are linked to Criticality Int. Corr. Deg. Mech. Eval. records whose Selected Corrosion Rate is Short Term Avg.

RBI Criticality Analysis family

The following table lists the fields in the RBI Criticality Analysis family that require values in order to calculate an RBI Analysis:

Field	Notes
Allowable Stress	Required only for RBI Analysis records: <ul style="list-style-type: none"> Whose Criticality Item Type is Storage Tank -and- Whose Allowable Stress is null or 0 (zero) -and- That are linked to Criticality Int. Corr. Deg. Mech. Eval. records whose Estimated Minimum Thickness Override? check box is not selected.
Area Humidity	Required only for RBI Analysis records that are linked to Criticality Ext. Corr. Deg. Mech. Eval. records.
Code Year	Required only for RBI Analysis records whose Allowable Stress Override check box is not selected and whose Criticality Item Type is not Storage Tank.
Criticality Item Type	None
Diameter	Required only for RBI Analysis records: <ul style="list-style-type: none"> Whose Criticality Item Type is Storage Tank -and- Whose Diameter is null or > 200 (Feet) -and- That are linked to Criticality Int. Corr. Deg. Mech. Eval. records whose Estimated Minimum Thickness Override? check box is not selected.

Field	Notes
Construction Code	Required only for RBI Analysis records whose Allowable Stress Override check box is not selected.
Design Pressure	Required only for RBI Analysis records whose Allowable Stress Override check box is not selected.
Design Temperature	Required only for RBI Analysis records whose Allowable Stress Override check box is not selected.
Is Entry Possible?	Required only for RBI Analysis records that are linked to Criticality Ext. Corr. Deg. Mech. Eval. records.
Insulated	Required only for RBI Analysis records that are linked to Criticality Ext. Corr. Deg. Mech. Eval. records.
Joint Efficiency	None
Material Grade	Required only for RBI Analysis records whose Allowable Stress Override check box is not selected and Allowable Stress value is not greater than zero.
Material Spec	Required only for RBI Analysis records whose Allowable Stress Override check box is not selected.
Operating Pressure	None
Operating Temperature	None
Representative Fluid	None
Stress Lookup Table	Required only for RBI Analysis records whose Allowable Stress Override check box is not selected.
Susceptible to CUI	Required only for RBI Analysis records: <ul style="list-style-type: none"> Whose Criticality Item Type is not Heat Exchanger-Bundle -and- Whose Insulated field is set to null -and- That are associated with a Criticality Calculator External Corrosion record.
Nominal Thickness	None
Tube Operating Press Channel	Required only for RBI Analysis records whose Criticality Item Type is Heat Exchanger-Bundle.

Fields Required to Calculate RBI PRD Criticality Analyses

Several fields in RBI families are required to calculate RBI PRD Criticality Analyses. If you try to calculate an RBI PRD Analysis and any required fields do not contain values, the analysis will not be calculated, and the Calculation Status dialog box will appear, displaying a list of the required fields that do not contain values.

Note: At least one Over Pressure Criticality Degradation Mech Evaluation record must be linked on the RBI PRD Criticality Analysis.

The lists are categorized by the family to which the required fields belong.

- Consequence for Protected Assets

Note: The Consequence for Protected Assets field is required only when the pressure relief device protects asset.

- If the Analysis contains a Leak Criticality Degradation Mech Evaluation the following fields are required:
 - Cost of Fluid
 - Environmental Cost
 - Unit Production Margin

Criticality Leak Deg. Mech. Eval :

- Date in Service
- Service Severity – Leak

Criticality Over Pressure Deg. Mech. Eval.:

- Date in Service

RBI PRD Criticality Analysis:

- Criticality Item Type
- Operating Pressure

Note: If the pressure relief device protects RBI Components, the Operating Pressure field is populated automatically from the Operating Pressure field in the driving RBI Component. If, however, the pressure relief device protects asset, you must type a value in this field manually.

- Operating Temperature
- PRD Discharge Location
- Service Severity
- Driving Component

Note: The Driving Component field must contain a value if the pressure relief device protects RBI Components.

- Damage Factor Class

Note: The Damage Factor Class field must contain a value if the pressure relief device protects asset.

- PRD Relief Area

Note: The PRD Relief Area field is required and must contain a value greater than zero if the Multiple PRDs check box is selected.

- PRD Total Relief Area

Note: The PRD Total Relief Area field is required and must contain a value greater than zero if the Multiple PRDs check box is selected.

- MAWP (Maximum Allowable Working Pressure)
- Next Inspection Date

Criticality PRD Component - Relief Valve:

- Inlet Size
- Set Pressure
- Rated Capacity

Fields Required to Calculate RBI Pipeline Analyses

In order to calculate an RBI Pipeline Analysis, you are required to enter values in fields in the following families:

- Criticality Consequence Evaluation
- RBI Pipeline Analysis
- Criticality Ext. Corr. Deg. Mech. Eval.
- Criticality Int. Corr. Deg. Mech. Eval.

Criticality Consequence Evaluation family

The following table lists the fields in the Criticality Consequence Evaluation family that require values in order to calculate an RBI Pipeline Analysis:

Field	Notes
Soil Type	None
High Value Area	None
Population Density Adjustment	None
High Consequence Area	None

Criticality Ext. Corr. Deg. Mech. Eval.

The following table lists the fields in the Criticality Ext. Corr. Deg. Mech. Eval. family that require values in order to calculate an RBI Pipeline Analysis:

Field	Notes
Wall Thickness Loss	None

Criticality Int. Corr. Deg. Mech. Eval.

The following table lists the fields in the Criticality Int. Corr. Deg. Mech. Eval. family that require values in order to calculate an RBI Pipeline Analysis:

Field	Notes
Wall Thickness Loss	None

Criticality Third Party Deg. Mech. Eval.

The following table lists the fields in the Criticality Third Party Deg. Mech. Eval. family that require values in order to calculate an RBI Pipeline Analysis:

Field	Notes
Previous Damage	None
Above Ground Facilities	None

Field	Notes
Public Education	None
One Call System	None

RBI Pipeline Analysis

The following table lists the fields in the RBI Pipeline Analysis family that require values in order to calculate an RBI Pipeline Analysis:

Field	Notes
Allowable Stress	None
Built Prior to 1970	None
Code Year	None
Construction Code	None
Construction/Inspection Records Available	None
Criticality Item Type	None
Defects Reported	None
Design Pressure	None
Design Temperature	None
Diameter	None
Flow Rate	None
Insulated	None
Is CP System Present?	None
Is Piggable?	None
Joint Efficiency	None
LMPA (Land Movement Potential)	None
Material Grade	None
Material Spec	None
Nominal Thickness	None
Operating Pressure	None
Operating Temperature	None
Pipeline Segment Type	None
Representative Fluid	None
SCADA	None
SPA (Pressure Surge Adjustment)	None
Stress Lookup Table	None

Field	Notes
Submerged at Water Crossing	If the value in the Pipeline Segment Type field is Above Ground, then the value in the Submerged at Water Crossing field is always No.
Tube Nominal Thickness	None
Tube Operating Press Channel	None

Calculated Inventory

This topic has been intentionally excluded from the GE Digital APM product documentation website. This topic is available to you via the product documentation that is provided within the GE Digital APM system.

Calculating Equivalent Number of Inspections

This topic has been intentionally excluded from the GE Digital APM product documentation website. This topic is available to you via the product documentation that is provided within the GE Digital APM system.

Allowable Stress Calculation

This topic has been intentionally excluded from the GE Digital APM product documentation website. This topic is available to you via the product documentation that is provided within the GE Digital APM system.

About the Non-Intrusive Requirement Met Field

This topic has been intentionally excluded from the GE Digital APM product documentation website. This topic is available to you via the product documentation that is provided within the GE Digital APM system.

About T-Min Calculations

This topic has been intentionally excluded from the GE Digital APM product documentation website. This topic is available to you via the product documentation that is provided within the GE Digital APM system.

Family Search Configuration

Family Search Configuration

All families from Risk Based Inspection (RBI) 580 have been excluded from the global search except the following:

- Equipment Types
- Representative Fluids
- Piping Stress
- PV Stress
- Tank Stress
- Potential Degradation Mechanisms
- All Analysis families
- All Component families

Note:

You can use search configuration to enable or disable Global Search for families.

Policies

RBI Policies

An RBI Policy allows you to develop and execute strategies based on historical data and dynamic data, which is obtained by monitoring conditions in real time. The policies used in RBI are categorized as follows:

- [Policies used to calculate an analysis](#)
- [Policies used to generate Recommendations](#)
- [Policies used in risk mapping](#)
- [Policies used to suggest PDMs](#)

These policies appear in the **Module Workflow Policies** section of the **Policy Designer Overview** page.

Policy used to Calculate an RBI Pipeline Analysis

To calculate an RBI Pipeline Analysis, the following policy is used: Third Party DME Total Points.

If you want to modify the design of the policy, you must be a member of the following Security Groups:

- MI Policy Designer
- and-
- MI RBI Calculation Policy Designer

If you want to view the policy, you must be a member of the following Security Groups:

- MI Policy Viewer
- and-
- MI RBI Calculation Policy Viewer

RBI Strategy Mapping Configuration

The RBI Strategy Mapping Configuration family defines the Policy records that are used to generate RBI Recommendation records automatically from RBI Analyses. The information in the table reflects the baseline state and behavior of fields that exist in the RBI Strategy Mapping Configuration family.

RBI Strategy Mapping Configuration Details

Field	Data Type	Description	Behavior and Usage
Degradation Mechanism	Character	The value in the Degradation Mechanism field linked to the RBI Analysis for which you are generating RBI Recommendations.	This field is populated by default in each RBI Strategy Mapping Configuration that is delivered to the baseline GE Digital APM database.
Policy Name	Character	The Record ID of the Policy used to generate an RBI Recommendation.	This field is populated by default in each RBI Strategy Mapping Configuration that is delivered to the baseline GE Digital APM database.

RBI Strategy Mapping Details define the Policy Input nodes that are used to generate RBI Recommendation records automatically from RBI Analyses. The information in the table reflects the baseline state and behavior of fields in the RBI Strategy Mapping Details family.

RBI Strategy Mapping Details

Field	Data Type	Description	Behavior and Usage
Policy Input Node Name	Character	The ID of the Input node in the Policy that is defined by the RBI Strategy Mapping Configuration to which the RBI Strategy Mapping Details is linked.	This field is populated by default in each RBI Policy that is delivered to the baseline GE Digital APM database.
Source Family	Character	The family of the source record whose values are used to determine the output of the Input node.	This field is populated by default in each RBI Strategy Mapping Details that is delivered to the baseline GE Digital APM database.
Source Field	Character	The field whose source value is used to determine the output of the Input node.	This field is populated by default in each RBI Strategy Mapping Details that is delivered to the baseline GE Digital APM database.

Policies Used to Generate Recommendations

This topic provides a list of policies used by RBI Strategy Mapping groups to generate RBI Recommendations.

If you want to modify the design of a policy, you must be a member of the following Security Groups:

- MI Policy Designer
- and-
- MI RBI Recommendation Policy Designer

If you want to view a policy, you must be a member of the following Security Groups:

- MI Policy Viewer
- and-
- MI RBI Recommendation Policy Viewer

Criteria Used to Generate RBI Recommendations from RBI Analyses

The following table lists the criteria used by RBI Strategy Mapping Groups to determine the Policy that GE Digital APM uses to select the Inspection Strategy. The selected Inspection Strategy is then used to populate the RBI Recommendation.

Note: The GE Digital APM RBI Best Practice assumes that you will use the RBI Strategy Mapping Configurations, RBI Strategy Mapping Details, and policy queries that GE Digital provides, and that you will not modify them.

The following table provides a list of Policies that are used to generate RBI Recommendations.

Policy Name	Degradation Mechanisms	Policy Inputs	Criticality Item Type	Applicable Logic Case Nodes
Appendix_B	Criticality Calculator Internal Corrosion	<ul style="list-style-type: none"> Estimated Half Life field in the associated Criticality Int. Corr. Deg. Mech. Eval. record General Corrosion field in the associated Criticality Int. Corr. Deg. Mech. Eval. record Non-Intrusive Requirement Met field in the associated Criticality Int. Corr. Deg. Mech. Eval. record Inspection Priority (Unmitigated Risk) field in the associated RBI Degradation Mechanism Criticality item type in the associated policy 	<p>Any value except:</p> <ul style="list-style-type: none"> Air Cooled Exchanger-Header Air Cooled Exchanger-Tbs Storage Tank Bottom Heat Exchanger-Bundle Any value associated with a pipe Any value associated with a pressure relief device <p>Note: Values associated with pressure relief devices are not excluded by the associated policy query. Instead, these criticality item types are not valid for an RBI Analysis whose degradation mechanism is Criticality Calculator Internal Corrosion.</p>	<ul style="list-style-type: none"> LC09 LC10 LC11 LC12 LC13 LC14 LC15 LC16 LC091 LC101 LC111 LC112 LC113 LC121 LC131 LC132 LC133 LC141 LC151 LC152 LC153 LC161

Policy Name	Degradation Mechanisms	Policy Inputs	Criticality Item Type	Applicable Logic Case Nodes
Appendix_D	Criticality Calculator Internal Corrosion	<ul style="list-style-type: none"> Estimated Half Life field in the associated Criticality Int. Corr. Deg. Mech. Eval. record General Corrosion field in the associated Criticality Int. Corr. Deg. Mech. Eval. record Non-Intrusive Requirement Met field in the associated Criticality Int. Corr. Deg. Mech. Eval. record Inspection Priority (Unmitigated Risk) field in the associated RBI Degradation Mechanism Criticality item type in the associated policy 	Any of the following values: <ul style="list-style-type: none"> Air Cooled Exchanger-Header Air Cooled Exchanger-Tbs 	<ul style="list-style-type: none"> LC17 LC18 LC19 LC20 LC21 LC22 LC23 LC171 LC172 LC173 LC181 LC182 LC183 LC191 LC201 LC202 LC203 LC211 LC221 LC222 LC223 LC231
Appendix_E	Criticality Calculator Internal Corrosion	<ul style="list-style-type: none"> Estimated Half Life field in the associated Criticality Int. Corr. Deg. Mech. Eval. record General Corrosion field in the associated Criticality Int. Corr. Deg. Mech. Eval. record Inspection Priority (Unmitigated Risk) field in the associated RBI Degradation Mechanisms Criticality item type in the associated policy 	<ul style="list-style-type: none"> Piping <p>Note: Values associated with pressure relief devices are not excluded by the associated policy query. Instead, these criticality item types are not valid for an RBI Analysis whose degradation mechanism is Criticality Calculator External Corrosion.</p>	<ul style="list-style-type: none"> LC24 LC25 LC26 LC27 LC28 LC29 LC30 LC31 LC241 LC251 LC261 LC271 LC281 LC291 LC301 LC311

Policy Name	Degradation Mechanisms	Policy Inputs	Criticality Item Type	Applicable Logic Case Nodes
Appendix_F	Criticality Calculator External Corrosion	<ul style="list-style-type: none"> Insulated field in the associated RBI Analysis Insulation Damage field in the associated Criticality Ext. Corr. Deg. Mech. Eval. record Estimated Half Life field in the associated Criticality Int. Corr. Deg. Mech. Eval. record Inspection Priority(Unmitigated Risk) field in the associated RBI Degradation Mechanisms Component Type Criticality item type in the associated policy 	<p>Any value except:</p> <ul style="list-style-type: none"> Storage Tank Bottom Heat Exchanger-Bundle Any value associated with a pressure relief device <p>Note: Values associated with pressure relief devices are not excluded by the associated policy query. Instead, these criticality item types are not valid for an RBI Analysis whose degradation mechanism is Criticality Calculator Internal Corrosion.</p>	<ul style="list-style-type: none"> LC32 LC33 LC34 LC35 LC36 LC37 LC38 LC39 LC40 LC41 LC42 LC321 LC331 LC341 LC351 LC361 LC371 LC381 LC391 LC401 LC411 LC421

Policy Name	Degradation Mechanisms	Policy Inputs	Criticality Item Type	Applicable Logic Case Nodes
Appendix_G	<p>Any of the following values:</p> <ul style="list-style-type: none"> • Amine Cracking (ASCC) • Carbonate Cracking • Caustic Cracking • Chloride Stress Corrosion Cracking (CI SCC) • Hydrogen Stress Cracking (HSC)- Hydrofluoric Acid • Polythionic Acid SCC (PTA) • Sulfide Stress Cracking (SSC) • Wet H2S Damage (Blistering, SOHIC, SCC) 	<ul style="list-style-type: none"> • Estimated Half Life field in the associated Criticality Int. Corr. Deg. Mech. Eval. record • Damage Mechanism field in the associated Criticality Env. Crack. Deg. Mech. Eval. record • Damaged At Last Inspection field in the associated Criticality Env. Crack. Deg. Mech. Eval. record • Is Entry Possible field in the associated Criticality Env. Crack. Deg. Mech. Eval. record • PT or MT Access field in the associated Criticality Env. Crack. Deg. Mech. Eval. record • Inspection Priority (Unmitigated Risk) field in the associated RBI Degradation Mechanism. • Estimated Half Life field in the associated Criticality Int. Corr. Deg. Mech. Eval. record • Criticality item type in the associated policy 	<p>Any value except:</p> <ul style="list-style-type: none"> • Air Cooled Exchanger-Header • Air Cooled Exchanger-Tbs • Heat Exchanger-Bundle 	<ul style="list-style-type: none"> • LC44 • LC45 • LC46 • LC49 • LC50 • LC51 • LC54 • LC55 • LC56 • LC59 • LC60 • LC61 • LC62 • LC441 • LC451 • LC461 • LC491 • LC501 • LC511 • LC541 • LC551 • LC561 • LC601 • LC611 • LC621

Policy Name	Degradation Mechanisms	Policy Inputs	Criticality Item Type	Applicable Logic Case Nodes
Appendix_H	<p>Any of the following values:</p> <ul style="list-style-type: none"> Amine Cracking (ASCC) Carbonate Cracking Caustic Cracking Chloride Stress Corrosion Cracking (CI SCC) Hydrogen Stress Cracking (HSC)- Hydrofluoric Acid Hydrofluoric Acid Polythionic Acid SCC (PTA) Sulfide Stress Cracking (SSC) Wet H2S (Blistering, SOHIC, SCC) Criticality Calculator Internal Corrosion Criticality Calculator External Corrosion 	<ul style="list-style-type: none"> Estimated Half Life field in the associated Criticality Int. Corr. Deg. Mech. Eval. record Inspection Priority (Unmitigated Risk) field in the associated RBI Degradation Mechanism Criticality item type in the associated policy <p>Note: The input value of Inner Pipe displayed in the Appendix_H policy is not considered for generating a recommendation.</p>	Heat Exchanger-Bundle	<ul style="list-style-type: none"> LC65 LC66 LC67 LC68 LC69 LC70 LC71 LC72 LC651 LC661 LC671 LC681 LC691 LC701 LC711 LC721
Appendix_I	<p>Any of the following values:</p> <ul style="list-style-type: none"> Amine Cracking (ASCC) Carbonate Cracking Caustic Cracking Chloride Stress Corrosion Cracking (CI SCC) Hydrogen Stress Cracking (HSC)- Hydrofluoric Acid Hydrofluoric Acid Polythionic Acid SCC (PTA) Sulfide Stress Cracking (SSC) Amine Cracking Criticality Calculator Internal Corrosion Criticality Calculator External Corrosion 	<ul style="list-style-type: none"> Estimated Half Life field in the associated Criticality Int. Corr. Deg. Mech. Eval. record Inspection Priority (Unmitigated Risk) field in the associated RBI Degradation Mechanism Criticality item type in the associated policy 	Storage Tank Bottom	<ul style="list-style-type: none"> LC73 LC74 LC75 LC76 LC731 LC741 LC751

Policy Name	Degradation Mechanisms	Policy Inputs	Criticality Item Type	Applicable Logic Case Nodes
PRD_Strategies	<p>Any of the following values:</p> <ul style="list-style-type: none"> Blocked Discharge Blocked Discharge - Admin Control Control Valve Failure (Fail Opposite) Control Valve Failure (Fail Safe) Electrical Power Failure Exchanger Tube Rupture Fire Liquid Overfill Liquid Overfill - Admin Control Loss of Cooling Runaway Reaction Thermal Relief Thermal Relief - Admin Control Tower Pump Failures Leak 	<ul style="list-style-type: none"> Inspection Priority (Unmitigated Risk) field in the associated RBI Degradation Mechanism Criticality item type in the associated policy 	Any value associated with a pressure relief device.	<ul style="list-style-type: none"> PSV01 PSV02 PSV03 RD01 RD02
Pipeline Inspection Strategy	<p>Any of the following values:</p> <ul style="list-style-type: none"> Criticality Calculator External Corrosion Criticality Calculator Internal Corrosion 	<ul style="list-style-type: none"> Is CP System field in the associated RBI Analysis Is Pigging Possible field in the associated RBI Analysis Wall Thickness Loss field in the Criticality Int. Corr. Deg. Mech. Eval. record Wall Thickness Loss field in the Criticality Ext. Corr. Deg. Mech. Eval. record 	Pipeline	<ul style="list-style-type: none"> PLC111 PLC121 PLC122 PLC131 PLC132 PLC141 PLC142 PLC211 PLC221 PLC222 PLC231 PLC323 PLC241 PLC242

Policy Name	Degradation Mechanisms	Policy Inputs	Criticality Item Type	Applicable Logic Case Nodes
Pipeline Cracking Inspection Strategy	Any of the following values: <ul style="list-style-type: none"> Amine Cracking (ASCC) Carbonate Cracking Caustic Cracking Chloride Stress Corrosion Cracking (CI SCC) Hydrogen Stress Cracking (HSC)- Hydrofluoric Acid Polythionic Acid SCC (PTA) Sulfide Stress Cracking (SSC) Wet H2S (Blistering, SOHIC, SCC) 	<ul style="list-style-type: none"> Inspection Priority (Unmitigated Risk) field in the associated RBI Degradation Mechanism Is Pigging Possible field in the associated RBI Analysis 	Pipeline	<ul style="list-style-type: none"> PL001 PL002 PL004 PL006 PL008
TPD Inspection Strategy	Third Party Damage	<ul style="list-style-type: none"> Previous Damage Points field on the associated Third Party Degradation Mechanism Evaluation Inspection Priority field in the associated RBI Degradation Mechanism 	Pipeline	<ul style="list-style-type: none"> ILC-P1 ILC-P2 ILC-P3 ILC-P4 ILC-P11 ILC-P21 ILC-P31

Policies Used in Risk Mapping

This topic provides a list of policies that are used in risk mapping in Pipeline, Risk Based Inspection, and Pressure Relief Devices (PRDs).

If you want to modify the design of a policy, you must be a member of the following Security Groups:

- MI Policy Designer
- and-
- MI RBI Risk Mapping Policy Designer

If you want to view a policy, you must be a member of the following Security Groups:

- MI Policy Viewer
- and-
- MI RBI Risk Mapping Policy Viewer

Risk Based Inspection

The following policies are used in risk mapping in Risk Based Inspection:

- DEFAULT-RISK_MAPPING-ENVIRONMENT
- DEFAULT-RISK_MAPPING-FINANCIAL
- DEFAULT-RISK_MAPPING-OPERATIONS
- DEFAULT-RISK_MAPPING-SAFETY
- RISK_MAPPING-ENVIRONMENT
- RISK_MAPPING-FINANCIAL
- RISK_MAPPING-OPERATIONS
- RISK_MAPPING-SAFETY

Pipeline

The following policies are used in risk mapping in Pipeline:

- PL-DEF-RISK_MAPPING-ENVIRONMENT
- PL-DEF-RISK_MAPPING-FINANCIAL
- PL-DEF-RISK_MAPPING-OPERATIONS
- PL-DEF-RISK_MAPPING-SAFETY
- PL-RISK_MAPPING-ENVIRONMENT
- PL-RISK_MAPPING-FINANCIAL
- PL-RISK_MAPPING-OPERATIONS
- PL-RISK_MAPPING-SAFETY

PRD

The following policies are used in risk mapping in PRD:

- PRD-DEF-RISK_MAPPING-OPERATIONS
- PRD-DEF-RISK_MAPPING-SAFETY
- PRD-RISK_MAPPING-OPERATIONS
- PRD-RISK_MAPPING-SAFETY

Policies Used to Suggest PDMs

The RBI Degradation Mechanism Screening Policy is used to screen the PDMs for the RBI Component. The policy contains a sub-policy, such as RBI 581 DM Screening - Thinning and Lining, which suggests the following Thinning and Lining Damage Mechanisms for the components based on the criteria:

- 581-Atmospheric Tank Bottom Corrosion
- 581-Cooling Water Corrosion
- 581-Soil Side Corrosion
- 581-Internal Component Lining Damage
- 581-High Temperature Oxidation
- 581-High Temperature Sulfidic and Naphthenic Acid
- 581-Sulfuric Acid Corrosion
- 581-Hydrofluoric Acid Corrosion
- 581-Hydrochloric Acid Corrosion

You can add sub-policies for all other Damage Mechanism types that you want to screen.

You must be a member of the MI Policy Designer Security Groups to modify the design of a policy.

You must be a member of the MI Policy Viewer Security Groups to view a policy.

RBI 581 DM Screening - Thinning and Lining policy follows the below guidelines. If there are adequate measures to eliminate or minimize corrosion you can deselect the suggested PDMs from linking.

Suggested Thinning DM	Available field in RBI Component	Screening Criteria	Notes
581-High Temperature Sulfidic and Naphthenic Acid	Operating Temperature	Operating temperature shall be greater than 400 degrees Fahrenheit	Majority of all Base Materials are suspected. Thus, system is not checking Base Material field.
	Sulphur Concentration	Process Fluid shall contain sulphur compounds	
581-High Temperature Oxidation	Operating Temperature	Operating temperature shall be greater than 900 degrees Fahrenheit	
	Is Air or Oxidant Present?	Air or Oxidant shall be present	
581-Hydrochloric Acid Corrosion	Process Fluid	The representative fluid shall be HCL	
	Free Water	Presence of Water shall be detected	
	pH of Water	Reported pH shall less than 7	
581-Hydrofluoric Acid Corrosion	Process Fluid	The representative fluid shall be HF	
581-Sulfuric Acid Corrosion	Process Fluid	The representative fluid shall be H ₂ SO ₄ (Sulfuric Acid)	
581-Cooling Water Corrosion	Cooling System Type	Presence of a Cooling water system	
581-Soil Side Corrosion	Soil Type 581	Equipment is partially or fully exposed to soil.	Defining a Soil Type in RBI component shall screen the component for soil side corrosion.
581-Internal Component Lining Damage	Liner Present	A liner provided to protect the base material shall be present.	NA
581-Atmospheric Tank Bottom Corrosion	Component Type	Component Type shall be Tank Bottom	Tank Bottom is suspected since it is expected to be degraded from either process side or soil side.

RBI Values Used as Inputs to Policy Record Logic

The following table lists the fields in RBI records that are used as inputs to Policy record logic. This logic determines the Inspection Strategy record that populates the RBI Recommendation record. Additionally, the table lists the corresponding Input node for each field whose value is used in the policy.

Field	Family	Corresponding Input Node
Appendix_B		
Criticality Item Type	RBI Criticality Analysis	Component Type
Estimated Half Life	Criticality Int. Corr. Deg. Mech. Eval.	Half-Life
General Corrosion	Criticality Int. Corr. Deg. Mech. Eval.	General Corrosion
Inspection Priority (Unmitigated Risk)	RBI Degradation Mechanisms	Inspection Priority
Non-Intrusive Requirement Met	Criticality Int. Corr. Deg. Mech. Eval.	Non Intrusive Req met
Appendix_D		
Criticality Item Type	RBI Criticality Analysis	Component Type
Estimated Half Life	Criticality Int. Corr. Deg. Mech. Eval.	Half-Life
General Corrosion	Criticality Int. Corr. Deg. Mech. Eval.	General Corrosion
Inspection Priority (Unmitigated Risk)	RBI Degradation Mechanisms	Inspection Priority
Non-Intrusive Requirement Met	Criticality Int. Corr. Deg. Mech. Eval.	Non Intrusive Req met
Appendix_E		
Criticality Item Type	RBI Criticality Analysis	Component Type
Estimated Half Life	Criticality Int. Corr. Deg. Mech. Eval.	Half-Life
General Corrosion	Criticality Int. Corr. Deg. Mech. Eval.	General Corrosion
Inspection Priority (Unmitigated Risk)	RBI Degradation Mechanisms	Inspection Priority
Appendix_F		
Criticality Item Type	RBI Criticality Analysis	Component Type
Estimated Half Life	Criticality Ext. Corr. Deg. Mech. Eval.	Half-Life
Inspection Priority (Unmitigated Risk)	RBI Degradation Mechanisms	Inspection Priority
Insulated	RBI Criticality Analysis	Insulated
Insulation Damage	Criticality Ext. Corr. Deg. Mech. Eval.	Insulation Damage
Appendix_G		
Criticality Item Type	RBI Criticality Analysis	Component Type
Damaged At Last Inspection	Criticality Env. Crack. Deg. Mech. Eval.	Evidence of Cracking
Damage Mechanism	Criticality Env. Crack. Deg. Mech. Eval.	Internal Inspection
Estimated Half Life	Criticality Int. Corr. Deg. Mech. Eval.	Half-Life
Inspection Priority (Unmitigated Risk)	RBI Degradation Mechanisms	Inspection Priority
Is Entry Possible	Criticality Env. Crack. Deg. Mech. Eval.	Is Entry Possible

Field	Family	Corresponding Input Node
PT or MT Access	Criticality Env. Crack. Deg. Mech. Eval.	PT or MT Access
Appendix_H		
Criticality Item Type	RBI Criticality Analysis	Component Type
Estimated Half Life	Criticality Int. Corr. Deg. Mech. Eval.	Half-Life
Inspection Priority (Unmitigated Risk)	RBI Degradation Mechanisms	Inspection Priority
Appendix_I		
Criticality Item Type	RBI Criticality Analysis	Component Type
Estimated Half Life	Criticality Int. Corr. Deg. Mech. Eval.	Half-Life
Inspection Priority (Unmitigated Risk)	RBI Degradation Mechanisms	Inspection Priority
PRD_Strategies		
Criticality Item Type	RBI Criticality Analysis	Component Type
Inspection Priority (Unmitigated Risk)	RBI Degradation Mechanisms	Inspection Priority

Note the following details about Input nodes that are used in these policies but are not listed in this table:

- The following policies contain the following Input nodes that are not used by the GE Digital APM system when selecting an Inspection Strategy record:
 - Appendix_G: Internal Inspection
 - Appendix_I: Evidence of Cracking
- In the following policies, the data that is used for the Input node Non Intrusive Req met is calculated based upon the inspection history that is associated with an RBI Analysis:
 - Appendix_B
 - Appendix_D

Policy Queries Folder

Policy queries are used by RBI Strategy Mapping Groups when you generate RBI Recommendations records automatically. The baseline query captions are the same as the query names.

Important: You should not modify the name of these queries or move them to another Catalog folder.

Query Details

The Catalog folder `\\Public\Meridium\Modules\Risk Based Inspection\Queries\Policy Queries` contains the queries listed in the following table, which are used to [select policy records](#).

Query	Filters out	Behavior and Usage
Appendix B - Component Type Filter	<ul style="list-style-type: none"> • Pipe • Air-Cooled • Storage Tank Bottom • Heat Exchanger Bundle 	Defines the criticality item types for which the Policy Appendix_B will be selected when you generate an RBI Recommendation automatically.
Appendix D - Component Type Filter	Component types that are not like Air Cooled	Defines the criticality item types for which the Policy Appendix_D will be selected when you generate an RBI Recommendation automatically.
Appendix E - Component Type Filter	Component types that are not like Pipe	Defines the criticality item types for which the Policy Appendix_E will be selected when you generate an RBI Recommendation automatically.
Appendix F - Component Type Filter	Component types that are not like Storage Tank Bottom and Heat Exchanger Bundle	Defines the criticality item types for which the Policy Appendix_F will be selected when you generate an RBI Recommendation automatically.
Appendix G - Component Type Filter	Component types that are not like Air Cooled and Heat Exchanger Bundle	Defines the criticality item types for which the Policy Appendix_G will be selected when you generate an RBI Recommendation automatically.
Appendix H - Component Type Filter	Component types that are not like Heat Exchanger Bundle	Defines the criticality item types for which the Policy Appendix_H will be selected when you generate an RBI Recommendation record automatically.
Appendix I - Component Type Filter	Component types that are not like Storage Tank Bottom	Defines the criticality item types for which the Policy record Appendix_I will be selected when you generate an RBI Recommendation automatically.
PRD Strategies - Component Type Filter	Component types that are not like Rupture Disk	Defines the criticality item types for which the Policy PRD_Strategies will be selected when you generate an RBI Recommendation automatically.

Mappings

About Values Mapped to RBI Recommendations

When you generate RBI Recommendations, the fields in RBI Recommendations are populated with values from:

- The RBI Criticality Analysis or the RBI PRD Criticality Analysis to which the RBI Recommendation is linked.
- The RBI Components that are linked to the associated RBI Criticality Analysis or the RBI PRD Criticality Analysis.
- The Asset that is linked to the associated RBI Components.

- The Degradation Mechanisms record that is linked to the associated RBI Criticality Analysis.
- The Inspection Strategy that was used to generate the RBI Recommendation.

Additionally, some RBI Recommendations may be populated with values from the Criticality Int. Corr. Deg. Mech. Eval. linked to the associated RBI Criticality Analysis.

RBI Recommendation Fields Populated from Related Records

The following table lists the RBI Recommendation fields that are populated automatically from these sources.

Note: Some of the fields listed in the table are not available on any of the datasheets that are configured for the RBI Recommendation family.

This RBI Recommendation field:	...is populated with:	...from the following record:
Analysis ID	The value in the Analysis ID field.	The associated RBI Criticality Analysis.
Asset ID	The value in the Asset ID field.	The related Asset.
Author Name	The last and first name of the Security User who created the RBI Recommendation.	The Security User who initiated the generation of the RBI Recommendation.
Damage Mechanism	The value in the Degradation Mechanism field.	The RBI Degradation Mechanism that is linked to the associated RBI Criticality Analysis.
Functional Location ID	The value in the Equipment ID field.	The associated RBI Criticality Analysis.
Nonrecurring?	FALSE	None
Originating Reference	The Recommendation ID.	The associated RBI Criticality Analysis.
RBI Component	The value in the Component Description field.	The associated RBI Component.
RBI Recommendation Methodology	The value Criticality Calculator.	The associated RBI Criticality Analysis.
Recommendation Basis	The value in the Inspection Strategy Description field.	The Inspection Strategy that generated the RBI Recommendation.

This RBI Recommendation field:	...is populated with:	...from the following record:
Recommendation Headline	<p>The value RBI- <RBI Components Record ID>-<Damage Mechanism></p> <p>...where:</p> <ul style="list-style-type: none"> • <RBI Components Record ID> is the Record ID of the associated RBI Component. • <Damage Mechanism> is the value in the Damage Mechanism field in the RBI Recommendation. <p>For example, given the following values:</p> <ul style="list-style-type: none"> • RBI Components Record ID = Storage Tank • Damage Mechanism = Brittle Fracture <p>The Recommendation Headline would be: RBI- Storage Tank- Brittle Fracture</p>	The associated RBI Component.
Recommended Inspection Scope	The value in the Recommended Inspection Scope field.	The Inspection Strategy that generated the RBI Recommendation.
Recommended Interval Scope	<p>One of the following values, depending on the following scenarios:</p> <ul style="list-style-type: none"> • When the Use Calculated Data field in the Inspection Strategy that generated the RBI Recommendation is set to: <ul style="list-style-type: none"> ◦ False, then the value in the Recommended Inspection Interval field in the Inspection Strategy is used. ◦ True, then the value in the Estimated Half Life field in the Criticality Int. Corr. Deg. Mech. Eval. that is linked to the associated RBI Criticality Analysis is used. ◦ For all RBI Recommendations associated with RBI PRD Criticality Analyses, the value in the Recommended Inspection Interval field in the associated RBI PRD Criticality Analysis. 	<p>One of the following:</p> <ul style="list-style-type: none"> • Inspection Strategy • Criticality Int. Corr. Deg. Mech. Eval.. • PRD Analysis
Status	The value Created.	None
Task Type	The value in the Inspection Task Type field.	The Inspection Strategy that generated the RBI Recommendation.

About Values Mapped to Risk

When you promote an asset to Asset Strategy Management (ASM), a Risk is created in ASM for each Degradation Mechanisms record (DM) in active RBI Criticality Analyses. This Risk contains the details of unmitigated and mitigated risks defined in the DM.

The following table provides a list of fields on the Risk datasheet that are populated from the DM or the associated RBI Criticality Analysis.

This Risk field:	...is populated with:	...from the following associated records:
Name	A value in the following format: <Equipment Description> ~ <Degradation Mechanism> If there is no value in the Equipment Description field, then the value in the Equipment Type field is used.	RBI Criticality Analysis and DM
Description	A value in the following format: <Equipment Description> ~ <Degradation Mechanism> If there is no value in the Equipment Description field, then the value in the Equipment Type field is used.	RBI Criticality Analysis and DM
Failure Mode	The value in the Degradation Mechanism field	DM
Maintainable Item	A value in the following format: <RBI Component Entity ID> ~ <Equipment Description or Equipment Type>	RBI Criticality Analysis and Criticality Calculator RBI Component
Failure Cause	The value in the Degradation Mechanism field	DM
Unmitigated Financial Risk	The value in the Unmitigated Financial Risk Rank field	DM
Risk Basis	The value Risk Based Inspection	None

RBI Values Mapped to ASM

When you promote an Asset record to ASM, several fields in the ASM records are populated automatically. The following tables list the source RBI records whose field values are mapped, the target ASM records to which the values are mapped, and the datasheet captions of the fields that are populated automatically.

Values Mapped to the Asset Strategy Record

Datasheet Caption of Asset Strategy Field	Source RBI Record	Datasheet Caption of Source RBI Field
Strategy ID	RBI Criticality Analysis	Component
Asset Name	Asset	This will vary. Rather than mapping the value in a specific field in the source Asset record, the Record ID is used as the default value in the Asset Name field in the Asset Strategy.

Values Mapped to the Active Strategy Record

- Datasheet Caption of Active Strategy Field: Strategy ID
- Source RBI Record: RBI Criticality Analysis
- Datasheet Caption of Source RBI Field: Component

Values Mapped to the Proposed Strategy Record

- Datasheet Caption of Active Strategy Field: Strategy ID
- Source RBI Record: RBI Criticality Analysis
- Datasheet Caption of Source RBI Field: Component

Values Mapped to Risk Records

Datasheet Caption of Risk Assessment Field	Source RBI Record	Datasheet Caption of Source RBI Field
Risk ID	RBI Criticality Analysis	Component
Risk Rank	RBI Degradation Mechanisms	On the datasheet, the source value appears at the intersection of the Unmitigated Risk row and the Strategy Risk Rank column.
Financial Risk	RBI Degradation Mechanisms	On the datasheet, the source value appears at the intersection of the Unmitigated Financial Risk row and the Strategy Risk Rank column.
Name	RBI Degradation Mechanisms -and- RBI Criticality Analysis	Degradation Mechanism -and- Criticality Item Description
Description	RBI Degradation Mechanisms -and- RBI Criticality Analysis	Degradation Mechanism -and- Criticality Item Description
Failure Mode	RBI Degradation Mechanisms	Degradation Mechanism
Failure Cause	RBI Degradation Mechanisms	Degradation Mechanism

Values Mapped to Risk Assessment Records

Datasheet Caption of Risk Assessment Field	Source RBI Record	Datasheet Caption of Source RBI Field
Risk Rank	RBI Degradation Mechanisms	On the datasheet, the source value appears at the intersection of the Mitigated Risk row and the Strategy Risk Rank column.
Financial Risk	RBI Degradation Mechanisms	On the datasheet, the source value appears at the intersection of the Mitigated Financial Risk row and the Strategy Risk Rank column.

Values Mapped to Risk Rank Records

Datasheet Caption of Risk Assessment Field	Source RBI Record	Datasheet Caption of Source RBI Field
Risk	RBI Degradation Mechanisms	<p>The source values that are mapped to the Risk field in Risk Rank records come from the values that appear on the Risk Matrix that is accessible from the RBI Degradation Mechanisms record.</p> <p>This mapping is best understood through an example. Suppose you access the Risk Matrix from the Brittle Fracture RBI Degradation Mechanisms record, and the unmitigated risk on the Safety tab is 10. In this case, if you open the Risk Rank records that are linked to the Risk Assessment record to which the Brittle Fracture Risk record is linked, the Risk Rank record with the value Safety in the Category field will contain the value 10 in the Risk field.</p>
Production Loss	RBI Degradation Mechanisms	<p>The source values that are mapped to the Production Loss field in Risk Rank records come from the values that appear on the Risk Matrix that is accessible from the RBI Degradation Mechanisms record.</p> <p>This mapping is best understood through an example. Suppose you access the Risk Matrix from the Brittle Fracture RBI Degradation Mechanisms record, and the Production Loss on the Financial tab is 100. In this case, if you query the Risk Rank records that are linked to the Risk Assessment record to which the Brittle Fracture Risk record is linked, the Risk Rank record with the value Financial in the Category field will contain the value 100 in the Production Loss field.</p>

Datasheet Caption of Risk Assessment Field	Source RBI Record	Datasheet Caption of Source RBI Field
Maintenance Cost	RBI Degradation Mechanisms	<p>The source values that are mapped to the Maintenance Cost field in Risk Rank records come from the values that appear on the Risk Matrix that is accessible from the RBI Degradation Mechanisms record.</p> <p>This mapping is best understood through an example. Suppose you access the Risk Matrix from the Brittle Fracture RBI Degradation Mechanisms record, and the Maintenance Cost on the Financial tab is 100. In this case, if you query the Risk Rank records that are linked to the Risk Assessment record to which the Brittle Fracture Risk record is linked, the Risk Rank record with the value Financial in the Category field will contain the value 100 in the Maintenance Cost field.</p>

Values Mapped to Action Records

Datasheet Caption of Risk Assessment Field	Source RBI Record	Datasheet Caption of Source RBI Field
Action ID	RBI Criticality Analysis	Component
Action Type	RBI Recommendation	Action Type
Cost	RBI Recommendation	Estimated Cost
Cost Basis	RBI Recommendation	Estimated Cost Basis
Description	RBI Recommendation -AND- Recommendation	Recommended Inspection Scope -AND- Recommendation Basis
Interval	RBI Recommendation	RBI Recommendation
Name	RBI Recommendation	Task Type
Nonrecurring	RBI Recommendation	NonRecurring?
Shutdown Required	Shutdown Required	Shutdown Required
Target Completion Date	RBI Recommendation	Target Completion Date

Hard-Coded Values

When you promote an Asset record to ASM, some values in the ASM records are hard-coded to be populated with a default value that is different from the standard default value for these values. The fields and their default values are listed in the following table.

ASM Record	Datasheet Caption	Default Value
Asset Strategy	Description	This strategy was automatically generated from RBI
Active Strategy	Description	This strategy was automatically generated from RBI
Proposed Strategy	Description	This strategy was automatically generated from RBI
Risk	Risk Basis	Risk Based Inspection
Risk	Source	RBI Analysis
Recommendation	Interval Units	Months
Recommendation	Action Basis	RBI Recommendation

In addition, if you promote an Asset record that is associated with an RBI Degradation Mechanisms record that is not linked to an RBI Recommendation record, for the Risk record that is created from that RBI Degradation Mechanisms record, the Strategy Mitigated Risk Rank in ASM will be set to the value in the Unmitigated Risk Rank field in the Risk record.

About Values Mapped to Action

When you promote an asset to Asset Strategy Management (ASM), an Action is created in ASM for each RBI Recommendation in active RBI Criticality Analyses. This Action contains the details of the Recommendation.

The following table provides a list of the fields on an Action datasheet that are populated from the RBI Recommendation.

This Action field:	...is populated with:
Action Basis	The value RBI Recommendation.
Action Source	The value RBI.
Action Task Type	The value in the Task Type field.
Action Basis	The value in the Action Type field.
Cost	The value in the Estimated Cost field.
Cost Basis	The value in the Estimated Cost Basis field.
Description	<Recommendation Inspection Scope> ~ <Recommendation Basis>
Interval	The least value among the following: <ul style="list-style-type: none"> The value in the Interval field in the RBI Recommendation The value in the RBI Half-Life field in the associated Degradation Mechanism Evaluation The value in the TM Half-Life field in the associated Asset Corrosion Analysis. Time Based Inspection Settings

This Action field:	...is populated with:
Interval Basis	The value of the Interval Basis that corresponds to the Interval field (only if the value in the Override Interval field in the Task is set to False).
Interval Units	The value Months.
Name	<Damage Mechanism> ~ <Task Type>
Nonrecurring	The value in the NonRecurring? field.
Shutdown Required	The value in the Asset Shutdown Required? field.

About Values Mapped to Inspection Task

When you promote an asset to Asset Strategy Management (ASM), and create an Inspection Task based on an Action, the fields in the Inspection Task are populated with the values in the various records. The following table provides a list of fields on an Inspection Task datasheet that are populated automatically from these sources.

This Inspection Task field:	...is populated with:	...from the following record:
Asset ID	The entity key of the Asset that is associated with the Asset Strategy.	Asset Strategy
Asset Key	The entity key of the Asset that is associated with the Asset Strategy.	Asset Strategy
Desired Interval	The highest value among the values in the RBI Half-Life, TM Half Life, Recommendation Interval, and Time-Based Settings fields.	<ul style="list-style-type: none"> RBI Recommendation Degradation Mechanism Evaluation Asset Corrosion Analysis
Desired Interval Basis	The value of the Interval Basis that corresponds to the Desired Interval field (only if the value in the Override Interval field in the Task is set to False).	Action
Next Date	Not applicable.	RBI Recommendation
Next Date Basis	Not applicable.	RBI Recommendation
Override Interval	FALSE	None
Reason	The value in the Action basis field	Action
Rejectable	<ul style="list-style-type: none"> The value False if the value in the Mandatory field is set to True. The value True if the value in the Mandatory field is set to False. 	Action
Reoccurring	TRUE	None
Task Details	The value in the Description field.	Action

This Inspection Task field:	...is populated with:	...from the following record:
Task ID	The value in the Name field.	Action
Task Type	The value in the Action Task Type field.	Action

Risk Analysis Mapping

The Risk Analysis Mapping family defines the Policy records that are used to populate the RBI Risk Matrix automatically from RBI Analyses. The following table provides the baseline state and behavior of fields that exist in the Risk Analysis Mapping family.

Note: The Risk Analysis Mapping family supports RBI Criticality, RBI Pipeline, and RBI PRD Criticality Analyses. These mappings support both the default and the Standard Practice risk matrices.

Field	Caption	Data Type	Description	Behavior and Usage
MI_RRSKMAP_ANLY_FAM_C	Analysis Family	Character	The Family ID of the analysis.	This field is populated automatically.
MI_RRSKMAP_DEG_MECH_C	Degradation Mechanism	Character	The Degradation Mechanism that stores values that are used to populate the Risk Matrix.	This field is populated automatically.
MI_RRSKMAP_POLICY_NAME_C	Policy Name	Character	The name of the Policy that is used to populate the Risk Matrix.	This field is populated automatically.
MI_RRSKMAP_RISK_CTG_C	Risk Category	Character	The Risk Category that is populated on the Risk Matrix (e.g., Environment, Financial Risk, Operations, Safety).	This field is populated automatically.

The Policy Input Nodes that are used by the Risk Analysis Mapping family to populate the RBI Risk Matrix depend on both the type of Risk Category that you choose and the Degradation Mechanism that you apply to the family. The information in the following tables indicates which policy nodes and input fields are used when populating your selected RBI Risk Matrix.

Note: When you calculate an RBI Criticality Analysis or RBI Pipeline Analysis, the Failure Frequency field is populated by Degradation Mechanism Evaluation that corresponds to each Degradation Mechanism in the selected RBI Analysis.

The following table provides the range of the financial loss based on the consequence category.

Consequence Category	Description	Range in USD
A	Catastrophic	> \$10,000,000
B	Very Serious	\$1,000,000 - \$10,000,000
C	Serious	\$100,000 - \$1,000,000

Consequence Category	Description	Range in USD
D	Significant	\$10,000 - \$100,000
E	Minor	< \$10,000

The value in the Production Loss Category field in a Criticality Consequence Evaluation indicates the amount of financial loss expected from an event. By default, the value in the Production Loss Category field is converted to a numeric equivalent, and mapped to the Production Loss input node in the risk mapping policies. The lowest value in each range is the default production loss value. The following table provides the default value of production loss based on the value in the Production Loss Category field.

Production Loss Category	Default Production Loss Value in USD
A	\$10,000,000
B	\$1,000,000
C	\$100,000
D	\$10,000
E	\$5,000

Risk Analysis Mapping for RBI Criticality Analyses

Risk Category - Environment: The following table provides the values in the Policy Input Node, Source Family, and Source Field fields in the Risk Analysis Mapping Details record for the RISK_MAPPING-ENVIRONMENT and DEFAULT-RISK_MAPPING-ENVIRONMENT policies.

Policy Input Node	Source Family	Source Field
Component Type	RBI Criticality Analysis	Criticality Item Type
Environment Category	Criticality Consequence Evaluation	Environmental Consequence Category
Failure Frequency	<ul style="list-style-type: none"> Criticality Ext. Corr. Deg. Mech. Eval. Criticality Int. Corr. Deg. Mech. Eval. Criticality Env. Crack. Deg. Mech. Eval. Criticality Other Damage Mech. Eval. 	Failure Frequency
Risk Category	Risk Analysis Mapping	Risk Category

Risk Category - Financial Risk: The following table provides the values in the Policy Input Node, Source Family, and Source Field fields in the Risk Analysis Mapping Details record for the RISK_MAPPING-FINANCIAL and DEFAULT-RISK_MAPPING-FINANCIAL policies.

Policy Input Node	Source Family	Source Field
Failure Frequency	Criticality Degradation Mech Evaluation	Failure Frequency
Maintenance Cost	Criticality Consequence Evaluation	Cleanup Cost
Production Loss	Criticality Consequence Evaluation	Lost Production Category
Risk Category	Risk Analysis Mapping	Risk Category

Risk Category - Operations: The following table provides the values in the Policy Input Node, Source Family, and Source Field fields in the Risk Analysis Mapping Details record for the RISK_MAPPING-OPERATIONS and DEFAULT-RISK_MAPPING-OPERATIONS policies.

Policy Input Node	Source Family	Source Field
Consequence (only for Criticality Int. Deg. Mech. Eval. and Criticality Env. Crack. Deg. Mech. Eval.)	Criticality Consequence Evaluation	Product Leak Category
Failure Frequency	<ul style="list-style-type: none"> Criticality Ext. Corr. Deg. Mech. Eval. Criticality Int. Corr. Deg. Mech. Eval. Criticality Env. Crack. Deg. Mech. Eval. Criticality Other Damage Mech. Eval. 	Failure Frequency
Lost Production Category	Criticality Consequence Evaluation	Lost Production Category
Risk Category	Risk Analysis Mapping	Risk Category

Risk Category - Safety: The following table provides the values in the Policy Input Node, Source Family, and Source Field fields in the Risk Analysis Mapping Details record for the RISK_MAPPING-SAFETY and DEFAULT-RISK_MAPPING-SAFETY policies.

Policy Input Node	Source Family	RBI Analysis Source Field
Failure Frequency	<ul style="list-style-type: none"> Criticality Ext. Corr. Deg. Mech. Eval. Criticality Int. Corr. Deg. Mech. Eval. Criticality Env. Crack. Deg. Mech. Eval. Criticality Other Damage Mech. Eval. 	Failure Frequency
Risk Category	Risk Analysis Mapping	Risk Category
Toxic Category	Criticality Consequence Evaluation	Toxic Consequence Category
Flammable Category	Criticality Consequence Evaluation	Flammable Consequence Category

Risk Analysis Mapping for PRD Criticality Analyses

Risk Category - Operations: The following table provides the values in the Policy Input Node, Source Family, and Source Field fields in the Risk Analysis Mapping Details record for the PRD-DEF-RISK_MAPPING-OPERATIONS and PRD-RISK_MAPPING-OPERATIONS policies.

Policy Input Node	Source Family	Source Field
Consequence	PRD Consequence Evaluation	Leak Consequence Category
Probability	Criticality Over Pressure Deg. Mech. Eval.	Failure Frequency of Protected Asset
	Criticality Leak Deg. Mech. Eval.	Probability of Leak
Risk Category	Risk Analysis Mapping	Risk Category

Risk Category - Safety: The following table provides the values in the Policy Input Node, Source Family, and Source Field fields in the Risk Analysis Mapping Details record for the PRD-DEF-RISK_MAPPING-SAFETY and PRD-RISK_MAPPING-SAFETY policies.

Policy Input Node	Source Family	Source Field
Consequence	Criticality Over Pressure Deg. Mech. Eval.	Consequence of Failure at Overpressure
	PRD Consequence Evaluation	Leak Consequence Category
Probability	Criticality Leak Deg. Mech. Eval.	Probability of Leak
	Criticality Over Pressure Deg. Mech. Eval.	Failure Frequency of Protected Asset
Risk Category	Risk Analysis Mapping	Risk Category

Risk Analysis Mapping for Pipeline Analyses

Risk Category - Environment: The following table provides the values in the Policy Input Node, Source Family, and Source Field fields in the Risk Analysis Mapping Details record for the PL-RISK_MAPPING-ENVIRONMENT and PL-DEF-RISK_MAPPING-ENVIRONMENT policies.

Policy Input Node	Source Family	Source Field
Component Type	RBI Pipeline Analysis	Criticality Item Type
Environment Consequence Category - Hole	Criticality Consequence Evaluation	Environment Consequence Category - Hole
Environment Category - Rupture	Criticality Consequence Evaluation	Environment Consequence Category - Rupture
Failure Frequency	<ul style="list-style-type: none"> • Criticality Third Party Deg. Mech. Eval. • Criticality Ext. Corr. Deg. Mech. Eval. • Criticality Int. Corr. Deg. Mech. Eval. • Criticality Env. Crack. Deg. Mech. Eval. 	Failure Frequency
Risk Category	Risk Analysis Mapping	Risk Category

Risk Category - Financial Risk: The following table provides the values in the Policy Input Node, Source Family, and Source Field fields in the Risk Analysis Mapping Details record for the PL-RISK_MAPPING-FINANCIAL and PL-RISK_MAPPING-FINANCIAL policies.

Policy Input Node	Source Family	Source Field
Failure Frequency	Criticality Degradation Mech Evaluation	Failure Frequency
Maintenance Cost- Hole	Criticality Consequence Evaluation	Impact Clean Up Cost - Hole
Maintenance Cost - Rupture	Criticality Consequence Evaluation	Impact Clean Up Cost - Rupture
Production Loss - Hole	Criticality Consequence Evaluation	Lost Production Category - Hole
Production Loss - Rupture	Criticality Consequence Evaluation	Lost Production Category - Rupture
Risk Category	Risk Analysis Mapping	Risk Category

Risk Category - Operations: The following table provides the values in the Policy Input Node, Source Family, and Source Field fields in the Risk Analysis Mapping Details record for the PL-RISK_MAPPING-OPERATIONS and PL-DEF-RISK_MAPPING-OPERATIONS policies.

Policy Input Node	Source Family	Source Field
Failure Frequency	<ul style="list-style-type: none"> Criticality Ext. Corr. Deg. Mech. Eval. Criticality Third Party Deg. Mech. Eval. Criticality Env. Crack. Deg. Mech. Eval. 	Failure Frequency
Lost Production Category - Hole	Criticality Consequence Evaluation	Lost Production Category - Hole
Lost Production Category - Rupture	Criticality Consequence Evaluation	Lost Production Category - Rupture
Risk Category	Risk Analysis Mapping	Risk Category

Risk Category - Safety: The following table provides the values in the Policy Input Node, Source Family, and Source Field fields in the Risk Analysis Mapping Details record for the PL-RISK_MAPPING-SAFETY and PL-RISK_MAPPING-SAFETY policies.

Policy Input Node	Source Family	Source Field
Failure Frequency	<ul style="list-style-type: none"> Criticality Third Party Deg. Mech. Eval. Criticality Ext. Corr. Deg. Mech. Eval. Criticality Int. Corr. Deg. Mech. Eval. Criticality Env. Crack. Deg. Mech. Eval. 	Failure Frequency
Flammable Category - Hole	Criticality Consequence Evaluation	Flammable Consequence - Hole
Flammable Category - Rupture	Criticality Consequence Evaluation	Flammable Consequence - Rupture
Risk Category	Risk Analysis Mapping	Risk Category
Toxic Category - Hole	Criticality Consequence Evaluation	Toxic Consequence - Hole
Toxic Category - Rupture	Criticality Consequence Evaluation	Toxic Consequence - Rupture

Create Data Mapping Group

About This Task

To map fields from Component to a custom DME family, you must create and configure a Data Mapping Group.

Procedure

- On the top navigation bar, select , and then navigate to and select **Data Mapping Group**. The **Record Manager** page appears, displaying a new Data Mapping Group datasheet.
- On the Data Mapping Group datasheet, in the **ID** box, enter a value in the following format:
RBI_CNAFC_<Component Family ID>-<New DME Family ID> (for example, RBI-CNAFC MI_CCRBICTB-TEST_CUST_DME)
- In the **Source Family** box, select the component family ID.
- In the **Target Family** box, select the new DME family ID.
- Update the baseline query for the component by adding the new fields required for the mapping. The baseline query is located in `Public\Meridium\Modules\Risk Based Inspection\Queries\Mapping Queries\RBI-CNAFC Query MI_CCRBICOM`.
- Create a linked Data Mapping Query record to the newly created Data Mapping Group record.
- Set the newly created Data Mapping Query record as the root record.

8. Create a linked Data Mapping Column-Field Pair record to the newly created Data Mapping Query record.
 - a) In the **Source Query Field** box, select the field from the modified query.
 - b) In the **Target Field(s)** box, select the corresponding target field.

Results

The Data Mapping Group is configured.

Reports

About the Asset Summary Report

The Asset Summary report provides a list of records that are associated with the asset. These records are created via the Risk Based Inspection, Inspection Management, and Thickness Monitoring modules.

The Asset Summary report contains the following sections:

- RBI Analysis Summary
- Inspection Management Summary
- Thickness Monitoring Summary

RBI Analysis Summary

This section contains a list of Components that are linked to the asset, along with their Inspection Priority and Driving Risk values. The following table provides a list of items that appear in this section and their corresponding fields in RBI.

Report Item	Corresponding Field in RBI (Family Name)
Asset	Asset ID (Asset)
Component	Component (RBI Component)
Component Type	Component Type (RBI Component)
Inspection Priority	Inspection Priority (Unmitigated Risk) (RBI Degradation Mechanism) - The most conservative value among the inspection priorities of all the degradation mechanisms associated with each component appears.
Driving Risk	Risk Category (RBI Criticality Analysis) - The most conservative value among the risk categories of all the analyses linked to each component appears.

Inspection Management Summary

This section contains a list of Inspection Tasks that have been created based on the RBI Recommendations linked to the asset, along with details on the task type, last date, and task state. The following table provides a list of items that appear in this section and their corresponding fields in Inspection Management.

Report Item	Corresponding Field in Inspection Management (Family Name)
Task ID	Task ID (Inspection Task)
Asset ID	Equipment ID (Equipment) or Functional Location (Functional Location)
Task Type	Task Type (Inspection Task)
Last Date	Last Date (Inspection Task)
Task State	Task State (Inspection Task)

Thickness Monitoring Summary

This section contains a list of TML Groups that are linked to the asset or its components, along with the remaining life and controlling corrosion rate values. The following table provides a list of items that appear in this section and their corresponding fields in Thickness Monitoring.

Report Item	Corresponding Field in Thickness Monitoring (Family Name)
TML Group ID	TML Group ID (TML Group)
Remaining Life	Asset Controlling Remaining Life (Asset Corrosion Analysis)
Controlling Corrosion Rate	Controlling Corrosion Rate (Asset Corrosion Analysis)

About the Asset Risk Report

The Asset Risk report provides information about the risk assessment on each Degradation Mechanism (DM) linked to each component in the asset, along with a risk matrix and supporting data.

The Asset Risk report contains the following sections:

- Risk Assessment
- Inspection Prioritization Matrix
- Supporting Data

Risk Assessment

The following table provides a list of items that are included in the Risk Assessment section of the report and their corresponding fields in RBI.

Report Item	Corresponding Field in RBI (Family Name)
Component	Component (RBI Component)
Degradation Mechanism	Degradation Mechanism (RBI Degradation Mechanism)
Risk Assessment Ref	Date Criticality Calculated (RBI Criticality Analysis)
Date of Analysis	Analysis Start Date (RBI Criticality Analysis)

Report Item	Corresponding Field in RBI (Family Name)
Corrosion Rate	One of the following fields depending on the value in the Selected Corrosion Rate field in the RBI Degradation Mechanism Evaluation family: <ul style="list-style-type: none"> Controlling Corrosion Rate Estimated Rate Long Term Avg. Corr. Rate Short Term Avg. Corr. Rate Measured Corrosion Rate
Estimated Half Life	Estimated Half Life (Criticality Int. Corr. Deg. Mech. Eval. and Criticality Ext. Corr. Deg. Mech. Eval.)
FLAM-COF	Flammable Consequence Category (Criticality Consequence Evaluation)
TOX-COF	Toxic Consequence Category (Criticality Consequence Evaluation)
PL-COF	Lost Production Category (Criticality Consequence Evaluation)
POF	Probability of Failure (RBI Degradation Mechanism)
Priority	Inspection Priority (Unmitigated Risk) (RBI Degradation Mechanism)
Risk Category	Risk Category (RBI Criticality Analysis)
Inspection Technique	Task Type (RBI Recommendation)
Periodicity	Recommended Interval Scope (RBI Recommendation)
Required Effectiveness	Inspection Confidence (RBI Recommendation)
Recommendation ID	Recommendation ID (RBI Recommendation)
Recommendation Scope	Recommended Inspection Scope (RBI Recommendation)

Inspection Prioritization Matrix

This section provides the matrix that is used to plot Inspection Priority based on the consequence of failure and probability of failure (likelihood) values.

INSPECTION PRIORITIZATION MATRIX

Likelihood	Greater than 1/10	1	Medium High 11	Medium High 7	High 4	High 2	High 1
	1/100 to 1/10	2	Medium 16	Medium 16	Medium High 8	Medium High 6	High 3
	1/1,000 to 1/100	3	Low 20	Medium 16	Medium 16	Medium High 9	High 5
	1/10,000 to 1/1,000	4	Low 20	Low 20	Medium 16	Medium 16	Medium High 11
	Less than 1/10,000	5	Low 20	Low 20	Low 20	Medium 16	Medium High 11
			E	D	C	B	A
			Less than \$10,000	\$10,000 to \$100,000	\$100,000 to \$1,000,000	\$1,000,000 to \$10,000,000	Greater than \$10,000,000
			Consequence				

Supporting Data

This section provides a list of fields (and their values) that are used to generate the Asset Risk report.

SUPPORTING DATA

Component	D0001-097-CS-2		
Component Description	D0001 Reactor		
Circuit From (Piping Only)		Circuit To (Piping Only)	
Design Data			
Design Code	ASME SEC VIII DIV. 1	Code year	1994
Material Specification	SA 516	Material Grade	70
Initial Wall Thickness	0.6299	Joint Efficiency	1
Inside Diameter		Length/Height	0
Post Weld Heat Treated	False	Coating Quality	None
Insulated	True	Insulation Condition	Poor
Insulation Type	Calcium Silicate (CI Free)	Allowable Stress	17505
Internal Entry Possible			
Design Pressure	45.00	Design Temperature	1025.00
Date in Service	01/01/1984 00:00:00		
Operating Data			
Representative Fluid	C4	Initial Fluid Phase	Gas
Operating Pressure	36.9	Operating Temperature	190.00
Tube Operating Press – Channel	0	Tube Operating Temp – Channel	0
Tube Operating Press – Shell(barg)	0	Tube Operating Temp – Shell(°C)	0
Toxic Mixture Fluid		Containment Area	
Inventory	40000	% Toxic	0.3
Isolation Time	5	Detection Time	5