



Hazards Analysis



Contents

Chapter 1: Overview	1
Overview of the Hazards Analysis Module	2
Access the Hazards Analysis Overview Page for All Hierarchy Levels	3
Access the Hazards Analysis Overview Page for a Hierarchy Level	4
HAZOP Analysis Workflow	5
What If Analysis Workflow	5
Chapter 2: Workflows	7
HAZOP Analysis Workflow	8
What If Analysis Workflow	11
Chapter 3: Hazards Analysis	14
About the Hazards Analysis Team	15
About Revision History	15
Create a Hazards Analysis	16
Access a Hazards Analysis	16
Access a List of Assets Linked to an Analysis	17
Access the Recommended Actions Pane	17
Create a Recommendation	18
Access the PHA Re-Validation Schedule	18
Access the Hazards Analysis Team Members Section	19
Access the Reference Documents Section in Hazards Analysis	19
Access the Revision History of a Hazards Analysis	19
Change the State of a Hazards Analysis	20
Generate the Report of a Hazards Analysis	21
Delete a Hazards Analysis	21
Chapter 4: Components in a Hazards Analysis	23
About Components in a Hazards Analysis	25
About Defining Components for a HAZOP Analysis	25

About Defining Components for a What If Analysis	26
About Assessing Risks	28
About Independent Layers of Protection	28
About Defining the Mitigated Risk Rank	29
About Asset Groups in Hazards Analysis	30
About Integration with SIS Management	31
Create a System/Node	31
Access a System/Node	32
Copy a System/Node	32
Link Assets to a System/Node	33
Unlink Assets from a System/Node	34
Delete a System/Node	34
Access a Component	35
Create a Component	35
Create a LOPA From a Consequence	36
Copy a Component	37
Assess the Unmitigated Risk	38
Assess the Mitigated Risk	40
Link an Asset to a Cause or a Safeguard	41
Link a LOPA to a Consequence	42
Unlink a LOPA From a Consequence	43
Delete a Component	44
Chapter 5: Admin	45
Specify Different Search Queries	46
Chapter 6: Data Loader	47
About the Hazards Data Loader	48
About the Hazards Data Loader Requirements	48
About the Hazards Data Loader General Loading Strategy	48
About the Hazards Data Loader Load Verification	49
About the Hazards Data Loader Data Model	52
About the Hazards Data Loader Workbook Layout and Use	53

Chapter 7: Deployment and Upgrade	74
Deployment	75
Upgrade	75
Chapter 8: Reference	76
General Reference	77
Family Field Descriptions	90
Catalog Items	110

Copyright GE Digital

© 2023 General Electric Company.

GE, the GE Monogram, and Predix are either registered trademarks or trademarks of All other trademarks are the property of their respective owners.

This document may contain Confidential/Proprietary information of and/or its suppliers or vendors. Distribution or reproduction is prohibited without permission.

THIS DOCUMENT AND ITS CONTENTS ARE PROVIDED "AS IS," WITH NO REPRESENTATION OR WARRANTIES OF ANY KIND, WHETHER EXPRESS OR IMPLIED, INCLUDING BUT NOT LIMITED TO WARRANTIES OF DESIGN, MERCHANTABILITY, OR FITNESS FOR A PARTICULAR PURPOSE. ALL OTHER LIABILITY ARISING FROM RELIANCE UPON ANY INFORMATION CONTAINED HEREIN IS EXPRESSLY DISCLAIMED.

Access to and use of the software described in this document is conditioned on acceptance of the End User License Agreement and compliance with its terms.

Chapter 1

Overview

Topics:

- [Overview of the Hazards Analysis Module](#)
- [Access the Hazards Analysis Overview Page for All Hierarchy Levels](#)
- [Access the Hazards Analysis Overview Page for a Hierarchy Level](#)
- [HAZOP Analysis Workflow](#)
- [What If Analysis Workflow](#)

Overview of the Hazards Analysis Module

Hazards Analysis is the process of identifying hazardous processes in a facility, assessing the risks, and providing ways to mitigate them.

Using the Hazards Analysis module, you can:

- Examine the processes that are performed by one or more assets.
- Identify existing and potential hazards that are associated with those processes.
- Identify and assess risks. How probable is it that the risk will have a negative safety or environmental impact? How would the team rate the severity of this safety or environmental impact?
- Define the characteristics of the scenarios, including the risks that they include.
- Identify ways to prevent the risk in each scenario from occurring.
- Make recommendations for actions that can be taken within the facility to prevent the risks in each scenario from occurring or to mitigate the risks in some way (e.g., lower the severity of the safety or environmental impact).

Hazards Analysis

Suppose that in your facility, you have two tanks that are connected with a pipe or a piping system, where hazardous chemicals in one tank are transferred to the other tank through the pipe or the piping system. The continual process of monitoring the liquid level in each tank, increasing or decreasing it as needed, and transporting the chemicals from the source tank to the target tank is a potentially hazardous process that involves risk. During this process, for example, if the level control malfunctions, the pressure in the pipe or the source tank could increase too rapidly and cause the chemicals in the source tank to leak out, causing damage to the environment or personnel.

After you identify the hazardous scenarios associated with a process, you can use Hazards Analysis to:

- Define the characteristics of the scenarios, including the risks that they include.
- Assess the likelihood of the risks in each scenario actually occurring.
- Identify ways to prevent the risk in each scenario from occurring.
- Make recommendations for actions that can be taken within the facility to prevent the risks in each scenario from occurring or to mitigate the risks in some way (e.g., lower the severity of the safety or environmental impact).

Suppose that, for the preceding process (transporting hazardous chemicals between two tanks), you identify a risk that the pressure monitor will stop working and a chemical spill will occur. Through a risk assessment, you also determine that the chemical spill is very likely to cause a negative impact to both human safety and the environment. Based on this assessment, you might determine that the only way to prevent the risk is to be alerted when the pressure in the tank is increasing too quickly. In this case, you may recommend that a high pressure alarm be put in place to alert someone if the pressure in the tank is rising too quickly. You may recommend to test the alarm on a periodic basis to ensure the availability of the alarm.

Access the Hazards Analysis Overview Page for All Hierarchy Levels

Before You Begin

- You can access the **Hazards Analysis Overview** page only if you are a member of the following Security Groups:
 - MI HA Administrator
 - MI HA Owner
 - MI HA Facilitator
 - MI HA Member

You can perform the various tasks on this page based on [the privileges granted to these Security Groups](#).

About This Task

This topic describes how to access the **Hazards Analysis Overview** page, which displays Hazards Analysis information for all hierarchy levels. You can also access the [Hazards Analysis Overview page for a particular hierarchy level](#).

Procedure

In the **Applications** menu, navigate to the **INTEGRITY** section, and then select **Hazards Analysis**.

The **Hazards Analysis Overview** page appears, displaying the following information that is related to all the hierarchy levels:

- [The Hazards Analysis Risk Overview graph](#): Plots the unmitigated and mitigated risk ranks for each System/Node in all the Hazards Analyses.
- The **Hazop** tab: Displays a list of HAZOP Analyses. You can create a new HAZOP Analysis, or access or modify an existing one. The number on the tab indicates the number of HAZOP Analyses.
- The **What If** tab: Displays a list of What If Analyses. You can create a new What If Analysis, or access or modify an existing one. The number on the tab indicates the number of What If Analyses.
- The **PHA Re-Validation Schedule** tab: Displays a list of Hazards Analyses that are overdue or must be re-validated in the next 30 days. The number on the tab indicates the number of Hazards Analyses that are listed.

Hazards Analysis Overview
Asset: Home

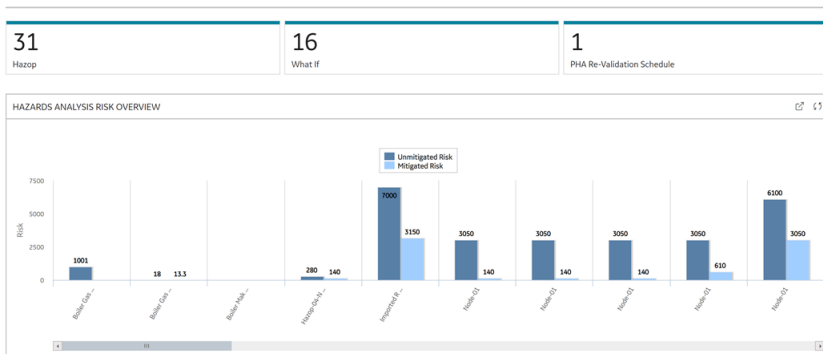

By default, the hierarchy level is set to Home and the information that appears on the **Hazards Analysis Overview** page is related to all Hierarchy Levels, including records that are not associated with any Asset.

You can filter the information that appears on the page based on a specific Asset by selecting  in the upper-left corner of the page.

Access the Hazards Analysis Overview Page for a Hierarchy Level

Before You Begin

- You can access the **Hazards Analysis Overview** page only if you are a member of the following Security Groups:
 - MI HA Administrator
 - MI HA Owner
 - MI HA Facilitator
 - MI HA Member

You can perform the various tasks on this page based on [the privileges granted to these Security Groups](#).

About This Task

This topic describes how to select a hierarchy level, and then access the **Hazards Analysis Overview** page for that hierarchy level. You can also [access the Hazards Analysis Overview page for all the hierarchy levels](#).

Procedure

1. In the top navigation bar, select .
The **Asset Hierarchy** page appears.
2. In the left pane, navigate to the hierarchy level for which you want to access the **Hazards Analysis Overview** page.

A list of types of analyses performed on the selected hierarchy level appears in the workspace, in the **Health** section.

3. In the workspace, select the **Integrity** tab.
The **Integrity** section appears.
4. In the section, in the **Hazards Analysis** row, select the link.

The **Hazards Analysis Overview** page appears, displaying the following information related to the selected hierarchy level:

- **The Hazards Analysis Risk Overview graph:** Plots the unmitigated and mitigated risk ranks for each System/Node in all the Hazards Analyses conducted on the selected hierarchy level.
- **The Hazop tab:** Displays a list of HAZOP Analyses conducted on the selected hierarchy level. You can create or a new HAZOP Analysis, or access or modify an existing one.
- **The What If tab:** Displays a list of What If Analyses conducted on the selected hierarchy level. You can create a new What If Analysis, or access or modify an existing one.
- **The PHA Re-Validation Schedule tab:** Displays a list of Hazards Analyses (conducted on the selected hierarchy level) that are overdue or must be re-validated in the next 30 days. The number on the tab indicates the number of Hazards Analyses that are listed.

You can filter the hierarchy level by selecting  in the upper-left corner of the page.

HAZOP Analysis Workflow

This workflow provides the basic, high-level steps for using this module. The steps and links in this workflow do not necessarily reference every possible procedure.

Using the Hazards Analysis module, you can conduct the following types of Hazards Analyses:

- **Hazards and Operability (HAZOP) Analysis:** Lets you document the known hazardous scenarios associated with a process, assess the likelihood of the risks in those scenarios occurring, and determine the best way to mitigate the risk in those scenarios.
- **What-If Analysis:** Lets you hypothesize about the possible hazardous scenarios, determine the risk associated with them, and determine the best way to mitigate those risks.

Conducting a HAZOP analysis includes completing the following steps:

1. [Create a Hazards Analysis](#), which stores the details of the HAZOP analysis that you want to perform, including the start and end dates for the analysis.
2. [Identify the Systems/Nodes](#) in which the hazardous scenario originates.
3. [Define components](#), which includes identifying the following items:
 - The system in which the hazardous scenario originates.
 - The condition under which the scenario may appear.
 - What causes the condition to occur.
 - The risks associated with that scenario.
 - The safeguards that are currently in place to mitigate the risk in that scenario.
 - The probability and severity of the safety, operational (commercial), and environmental impact of the risk associated with the scenario if a safeguard is in place.
4. Assess the [unmitigated](#) and [mitigated](#) risks.
5. [Link a LOPA to a Consequence](#).
6. [Link Assets](#) to each System/Node in the HAZOP Analysis.
7. Define the Hazards Analysis team, who will conduct the analysis.

Tip: For details about working with teams and the **Team Members** section, refer to the Teams section of the documentation.

8. Link the Hazards Analysis to a Reference Document, which contains the reference material relevant to the analysis.

Tip: For more information, refer to the [Manage Reference Documents](#) section of the Record Manager module for additional options when working with reference documents.

9. [Propose a Recommendation](#) for actions that should be taken to mitigate the risk in that scenario.

What If Analysis Workflow

This workflow provides the basic, high-level steps for using this module. The steps and links in this workflow do not necessarily reference every possible procedure.

Using the Hazards Analysis module, you can conduct the following types of Hazards Analyses:

- **Hazards and Operability (HAZOP) Analysis:** Lets you document the known hazardous scenarios associated with a process, assess the likelihood of the risks in those scenarios occurring, and determine the best way to mitigate the risk in those scenarios.

- **What If Analysis:** Lets you hypothesize about the possible hazardous scenarios, determine the risk associated with them, and determine the best way to mitigate those risks.

Conducting a What If Analysis includes completing the following steps:

1. [Create a Hazards Analysis](#), which stores the details of the What If Analysis that you want to perform, including the start and end dates for the analysis.
2. [Identify the Systems/Nodes](#) in which the hazardous scenario originates.
3. [Define components](#), which includes identifying the following items:
 - The system in which the hazardous scenario originates.
 - The condition under which the scenario may occur.
 - What causes the condition to occur.
 - The risks associated with that scenario.
 - The safeguards that are currently in place to mitigate the risk in that scenario.
 - The probability and severity of the safety, operational (commercial), and environmental impact of the risk associated with the scenario if a safeguard is in place.
4. Assess the [unmitigated](#) and [mitigated](#) risks.
5. [Link a LOPA to a Consequence](#).
6. Link [Assets](#) to each System/Node in the What If Analysis.
7. Define the Hazards Analysis team, who will conduct the analysis.

Tip: For details about working with teams and the **Team Members** section, refer to the Teams section of the documentation.

8. Link the Hazards Analysis to a Reference Document, which contains the reference material relevant to the analysis.

Tip: For more information, refer to the [Manage Reference Documents](#) section of the Record Manager module for additional options when working with reference documents.

9. [Propose a Recommendation](#) for actions that should be taken to mitigate the risk in that scenario.

Chapter 2

Workflows

Topics:

- [HAZOP Analysis Workflow](#)
- [What If Analysis Workflow](#)

HAZOP Analysis Workflow

Hazards Analysis: HAZOP Analysis

This workflow describes the process for conducting a Hazards and Operability (HAZOP) analysis by:

- Defining the deviations, causes, consequences, and safeguards in the analysis.
- Assessing the unmitigated and mitigated risks.

In the following workflow diagram, the blue text in a shape indicates that the corresponding description has been provided in the sections that follow the diagram. For more information, refer to the [Interpreting the Workflow Diagrams](#) topic in the [APM Product Workflows](#) documentation.

Note: For information on the personas associated with a GE Digital APM module, refer to the [APM Product Workflows](#) documentation.

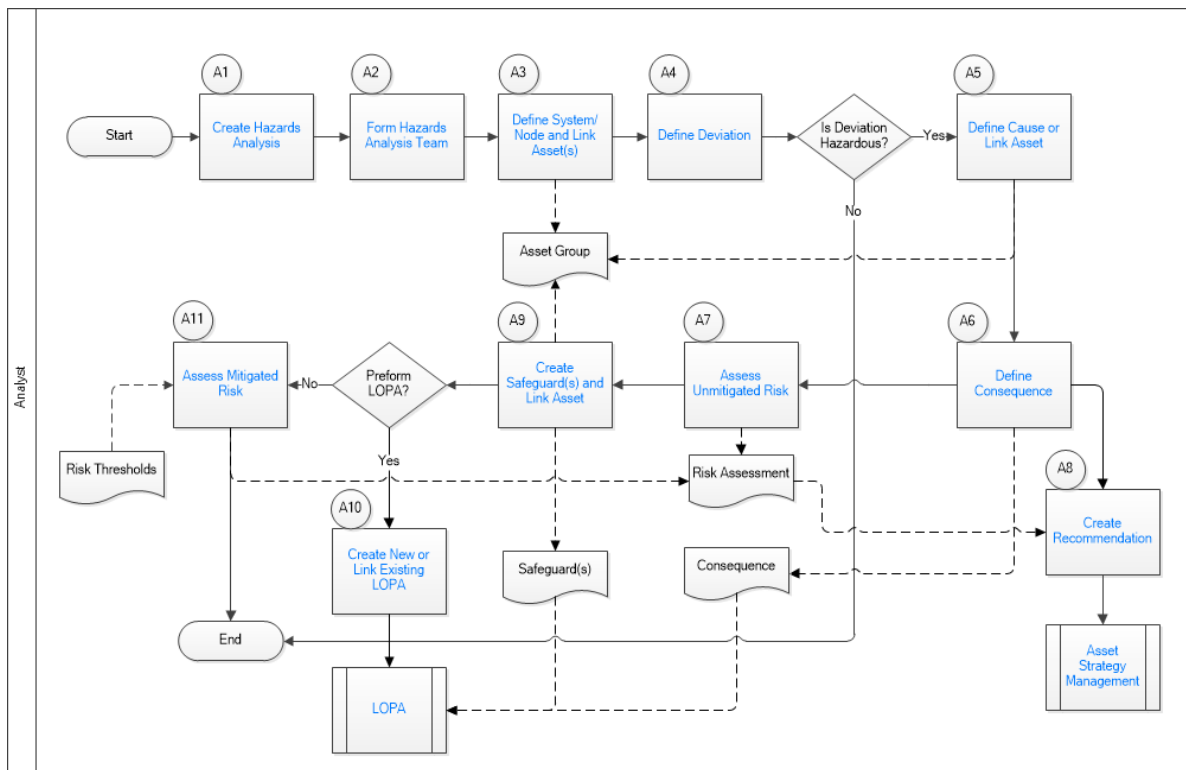

1. [Create Hazards Analysis](#) on page 9
2. [Form Hazards Analysis Team](#) on page 12
3. [Define System/Node and Link Assets\(s\)](#) on page 12
4. [Define Deviation](#) on page 9
5. [Define Cause and Link Asset](#) on page 12
6. [Assess Mitigated Risk](#) on page 13
7. [Define Safeguard \(or Layer of Protection\)](#) on page 13
8. [Assess Unmitigated Risk](#) on page 12
9. [Define Consequence](#) on page 12
10. [Create Recommendation](#) on page 13
11. [Asset Strategy Management](#) on page 13

12. [Create New or Link Existing LOPA](#) on page 13

13. [LOPA](#) on page 13

Create Hazards Analysis

Persona: Analyst

Create a Hazards Analysis (of the type HAZOP) to record the details of the Hazards and Operability (HAZOP) analysis. This will analyze the known causes of a hazard.

Form Hazards Analysis Team

Persona: Analyst

Form a multi-disciplinary team that will perform the Hazards Analysis. Assign the Facilitator role to one of the team members, and the Owner role to another.

Define System/Node and Link Assets(s)

Persona: Analyst

Identify the system or node for which you want to perform the HAZOP analysis. Create a System/Node and define it. You can link a System/Node to assets (i.e., Equipment and Functional Locations). GE Digital APM creates an Asset Group for all the assets that are linked to a System/Node and to the Causes and Safeguards in the System/Node.

Define Deviation

Persona: Analyst

Create a Deviation to record the details of a process that has deviated from normal conditions, which could result in a hazard.

Define Cause and Link Asset

Persona: Analyst

Create a Cause record to store the details of each cause that resulted in or may result in a hazardous condition. You can link a Cause to assets (i.e., Equipment and Functional Locations). GE Digital APM creates an Asset Group for all the assets that are linked to a System/Node and to the Causes and Safeguards in the System/Node.

Define Consequence

Persona: Analyst

Create a Consequence record to store the details of the impact of the hazard.

Assess Unmitigated Risk

Persona: Analyst

Before a safeguard is defined, assess the severity and frequency of the consequence for each aspect defined in a risk matrix. By default, these aspects are Safety, Health, Environment, and Financial. Depending on the Risk Matrix associated with the site, these aspects may vary. You can refer to the failure rate data of the piece of equipment or trip reports to assess the unmitigated risk.

Create Recommendation

Persona: Analyst

Create a Strategic Recommendation to provide suggestions about how to mitigate the risk. You can also promote the Recommendation to Asset Strategy Management (ASM).

Asset Strategy Management

Persona: Analyst

Asset Strategy Management defines the health monitoring requirements for an asset, or asset class, based on understanding the underlying failure modes and effects, in combination with the criticality of the asset. This process identifies candidate failure modes where health monitoring offers a significant reduction in risk. This workflow assumes that the Strategy has been approved, an Action has been created for each Risk where a health indicator is the identified mitigation, and the Actions are not yet implemented.

Go to the Asset Strategy Management workflow.

Define Safeguard (or Layer of Protection)

Persona: Analyst

Create a Safeguard record to store the details of the safeguard that will mitigate the risk, and specify if the safeguard is an Independent Protection Layer. If the Safeguard is a safety instrumented function (SIS), you must link the Instrumented Function to the Safeguard. The protective instrument loops installed on the instrumented function can mitigate the risk. The SIS Management module allows you to assess the SIL value for the instrumented function. You can link a Safeguard to assets (i.e., Equipment and Functional Locations). GE Digital APM creates an Asset Group for all the assets that are linked to a System/Node and to the Causes and Safeguards in the System/Node.

Create New or Link Existing LOPA

Persona: Analyst

You can create a LOPA to access the Safety Integrity Level (SIL) for a scenario. When you create a LOPA from a Consequence in a Hazards Analysis, the LOPA is automatically linked with the Consequence. You can also link an existing LOPA to a Consequence in the Hazards Analysis. The Safeguards defined in the Hazards Analysis will appear in the LOPA. Similarly, the Safeguards defined in the LOPA will appear in the Hazards Analysis. Changes made to the Safeguards will be reflected in both the LOPA and the Hazards Analysis.

Assess Mitigated Risk

Persona: Analyst

After a safeguard is put into use, assess the severity and frequency of the consequence for each aspect defined in a risk matrix. By default, these aspects are Safety, Health, Environment, and Financial. Depending on the Risk Matrix associated with the site, these aspects may vary.

LOPA

Persona: Analyst

Go to the LOPA workflow.

What If Analysis Workflow

Hazards Analysis: What-If Analysis

This workflow describes the process for conducting a What-If analysis by:

- Defining the what ifs, causes, consequences, and safeguards in the analysis.
- Assessing the unmitigated and mitigated risks

In the following workflow diagram, the blue text in a shape indicates that the corresponding description has been provided in the sections that follow the diagram. For more information, refer to the [Interpreting the Workflow Diagrams](#) topic in the [APM Product Workflows](#) documentation.

Note: For information on the personas associated with a GE Digital APM module, refer to the [APM Product Workflows](#) documentation.

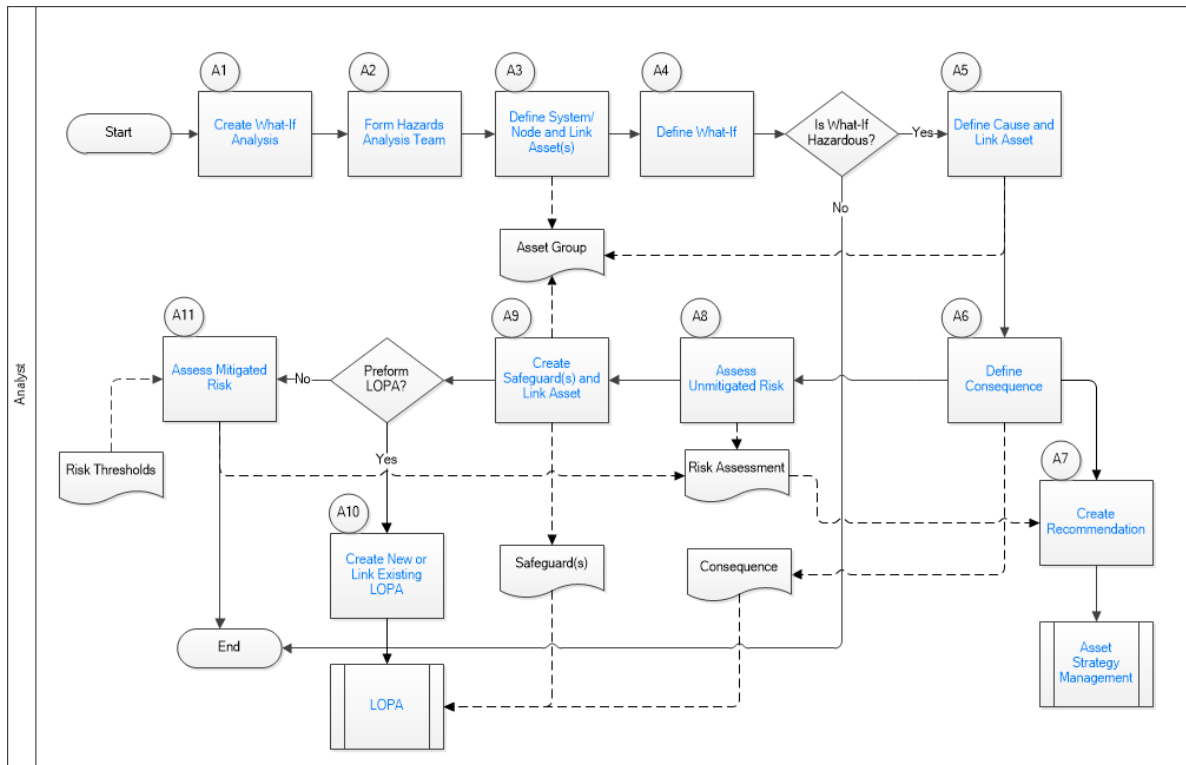

1. [Create What-If Analysis](#) on page 12
2. [Form Hazards Analysis Team](#) on page 12
3. [Define System/Node and Link Assets\(s\)](#) on page 12
4. [Define What-If](#) on page 12
5. [Define Cause and Link Asset](#) on page 12
6. [Assess Mitigated Risk](#) on page 13
7. [Define Safeguard \(or Layer of Protection\)](#) on page 13
8. [Assess Unmitigated Risk](#) on page 12
9. [Define Consequence](#) on page 12
10. [Create Recommendation](#) on page 13
11. [Asset Strategy Management](#) on page 13

12. [Create New or Link Existing LOPA](#) on page 13

13. [LOPA](#) on page 13

Create What-If Analysis

Persona: Analyst

Create a Hazards Analysis (of type What-If) to record the details of the What-If analysis. This is to analyze the potential causes of a hazard.

Form Hazards Analysis Team

Persona: Analyst

Form a multi-disciplinary team that will perform the Hazards Analysis. Assign the Facilitator role to one of the team members, and the Owner role to another.

Define System/Node and Link Assets(s)

Persona: Analyst

Identify the system or node for which you want to perform the HAZOP analysis. Create a System/Node and define it. You can link a System/Node to assets (i.e., Equipment and Functional Locations). GE Digital APM creates an Asset Group for all the assets that are linked to a System/Node and to the Causes and Safeguards in the System/Node.

Define What-If

Persona: Analyst

Create a What-If record to store the details of a process that can potentially deviate from normal conditions, which could result in a hazard.

Define Cause and Link Asset

Persona: Analyst

Create a Cause record to store the details of each cause that resulted in or may result in a hazardous condition. You can link a Cause to assets (i.e., Equipment and Functional Locations). GE Digital APM creates an Asset Group for all the assets that are linked to a System/Node and to the Causes and Safeguards in the System/Node.

Define Consequence

Persona: Analyst

Create a Consequence record to store the details of the impact of the hazard.

Assess Unmitigated Risk

Persona: Analyst

Before a safeguard is defined, assess the severity and frequency of the consequence for each aspect defined in a risk matrix. By default, these aspects are Safety, Health, Environment, and Financial. Depending on the Risk Matrix associated with the site, these aspects may vary. You can refer to the failure rate data of the piece of equipment or trip reports to assess the unmitigated risk.

Create Recommendation

Persona: Analyst

Create a Strategic Recommendation to provide suggestions about how to mitigate the risk. You can also promote the Recommendation to Asset Strategy Management (ASM).

Asset Strategy Management

Persona: Analyst

Asset Strategy Management defines the health monitoring requirements for an asset, or asset class, based on understanding the underlying failure modes and effects, in combination with the criticality of the asset. This process identifies candidate failure modes where health monitoring offers a significant reduction in risk. This workflow assumes that the Strategy has been approved, an Action has been created for each Risk where a health indicator is the identified mitigation, and the Actions are not yet implemented.

Go to the Asset Strategy Management workflow.

Define Safeguard (or Layer of Protection)

Persona: Analyst

Create a Safeguard record to store the details of the safeguard that will mitigate the risk, and specify if the safeguard is an Independent Protection Layer. If the Safeguard is a safety instrumented function (SIS), you must link the Instrumented Function to the Safeguard. The protective instrument loops installed on the instrumented function can mitigate the risk. The SIS Management module allows you to assess the SIL value for the instrumented function. You can link a Safeguard to assets (i.e., Equipment and Functional Locations). GE Digital APM creates an Asset Group for all the assets that are linked to a System/Node and to the Causes and Safeguards in the System/Node.

Create New or Link Existing LOPA

Persona: Analyst

You can create a LOPA to access the Safety Integrity Level (SIL) for a scenario. When you create a LOPA from a Consequence in a Hazards Analysis, the LOPA is automatically linked with the Consequence. You can also link an existing LOPA to a Consequence in the Hazards Analysis. The Safeguards defined in the Hazards Analysis will appear in the LOPA. Similarly, the Safeguards defined in the LOPA will appear in the Hazards Analysis. Changes made to the Safeguards will be reflected in both the LOPA and the Hazards Analysis.

Assess Mitigated Risk

Persona: Analyst

After a safeguard is put into use, assess the severity and frequency of the consequence for each aspect defined in a risk matrix. By default, these aspects are Safety, Health, Environment, and Financial. Depending on the Risk Matrix associated with the site, these aspects may vary.

LOPA

Persona: Analyst

Go to the LOPA workflow.

Chapter 3

Hazards Analysis

Topics:

- [About the Hazards Analysis Team](#)
- [About Revision History](#)
- [Create a Hazards Analysis](#)
- [Access a Hazards Analysis](#)
- [Access a List of Assets Linked to an Analysis](#)
- [Access the Recommended Actions Pane](#)
- [Create a Recommendation](#)
- [Access the PHA Re-Validation Schedule](#)
- [Access the Hazards Analysis Team Members Section](#)
- [Access the Reference Documents Section in Hazards Analysis](#)
- [Access the Revision History of a Hazards Analysis](#)
- [Change the State of a Hazards Analysis](#)
- [Generate the Report of a Hazards Analysis](#)
- [Delete a Hazards Analysis](#)

About the Hazards Analysis Team

The hazards analysis team is a group of individuals who will complete the hazards analysis. You can add GE Digital APM users and non-GE Digital APM users to the hazards analysis team.

- GE Digital APM users will have an existing GE Digital APM Security User and an associated Human Resource record that was created automatically when the Security User was created.
- Non-GE Digital APM users will not have a GE Digital APM Security User or a Human Resource record. To add a non-GE Digital APM user to the SIL analysis team, you will need to create a Human Resource record for that user. You can do so via the SIL Analysis Team Members page or using GE Digital APM Tools.

Note: A GE Digital APM Security User record is required for logging in to the GE Digital APM application and using Hazards Analysis. Hazards analysis team members who do not have a Security User account may participate in and contribute to the analysis but will not be able to use GE Digital APM .

Team Member Roles

Hazards analysis team member roles is used to as a reference to understand which team member is responsible for a given task related to the analysis. Any member of the team can be assigned a role. The following roles are available for a hazards analysis:

- **Owner:** The team member who is responsible for completing the hazards analysis. After you assign a team member the role of Owner, the name of that team member will appear in the Owner field in the Hazards Analysis.
- **Facilitator:** The team member who is in charge of conducting the analysis and organizing the team.

There can be only one Owner and one Facilitator per analysis.

About Revision History

You can use the revision history in a hazards analysis to manage the revisions made for an entire analysis (i.e., HAZOP or What If). When you create an analysis, you link records in multiple families to the Hazards Analysis. When you complete an analysis (i.e., it has been approved), you will change the state of the Hazards Analysis to Complete. When you do so, a snapshot is taken of the Hazards Analysis and each record linked to it.

When the state of a Hazards Analysis is changed to Complete, one record in each of the following families will be created:

- Hazards Analysis Revision
- Hazards Analysis System/Node Revision
- HAZOP Deviation Revision (for HAZOP Analyses)
- What If Revision (for What If Analyses)
- Hazards Analysis Cause Revision
- Hazards Analysis Consequence Revision
- Hazards Analysis Safeguard Revision
- IPL Checklist Revision

In other words, after the record state for the Hazards Analysis is changed to Complete, one Revision record is created for each record that is linked to the Hazards Analysis (with the exception of the Human Resource, Risk Assessment Recommendation, and Risk Assessment families). Each Revision record stores a snapshot of the source record as it appeared when the state of the Hazards Analysis was changed.

If you re-evaluate the Hazards Analysis, the state of the Hazards Analysis will change to Complete. A second set of Revision records will be created, and so on.

Create a Hazards Analysis

Procedure

1. Access the [Hazards Analysis Overview](#) page.

Tip: You can also [access the Hazards Analysis Overview](#) page for a particular hierarchy level.

2. In the workspace heading:

- If you are conducting a HAZOP Analysis, select the **Hazop** tab.
- If you are conducting a What If Analysis, select the **What If** tab.

The selected section appears, displaying a list of Hazards Analyses of the selected type.

3. In the upper-left corner of the workspace, select  .
A blank datasheet for the Hazards Analysis appears.
4. As needed, enter values in the [available fields](#).
5. In the lower-right corner of the datasheet, select **Save**.
The Hazards Analysis is created.

Next Steps

- [Create a System/Node](#)
- Add Team Members to the Hazards Analysis

Access a Hazards Analysis

Procedure

1. Access the [Hazards Analysis Overview](#) page.

Tip: You can also [access the Hazards Analysis Overview](#) page for a particular hierarchy level.

2. In the workspace heading:

- If you want to access a HAZOP Analysis, select the **Hazop** tab.
- If you want to access a What If Analysis, select the **What If** tab.

The selected section appears, displaying a list of Hazards Analyses of the selected type.

3. Select the Hazards Analysis that you want to access.
The **Analysis Overview** section appears, displaying [the Risk Assessment graph](#).
4. In the workspace, select the **Definition** tab.
The datasheet for the Hazards Analysis appears.
5. If needed, modify values in the [available fields](#).

Tip: You can modify a Hazards Analysis only if it is in the Planning state.

6. In the upper-right corner of the datasheet, select  .
The changes made to the Hazards Analysis are saved.

Results

- A list of Systems/Nodes for the Hazards Analysis appears in the left pane.

Access a List of Assets Linked to an Analysis

About This Task

This topic describes how to access a list of Assets (Equipment and Functional Locations) that are linked to each System/Node, Cause, and Safeguard in a Hazards Analysis.

Procedure

1. Access the [Hazards Analysis Overview](#) page.

Tip: You can also [access the Hazards Analysis Overview page](#) for a particular hierarchy level.

2. In the workspace:

- If you want to access the Assets linked to a HAZOP Analysis, select the **Hazop** tab.
- If you want to access the Assets linked to a What If Analysis, select the **What If** tab.

The selected section appears, displaying a list of Hazards Analyses of the selected type.

3. Select the Hazards Analysis for which you want to access a list of linked Assets.

The **Analysis Overview** section appears, displaying [the Risk Assessment graph](#).

4. In the workspace, select the **Linked Assets** tab.

The **Linked Assets** section appears, displaying a list of Assets linked to the Systems/Nodes, Causes, and Safeguards in the Hazards Analysis.

Access the Recommended Actions Pane

About This Task

The Recommendations that appear on the **Recommended Actions** pane are filtered based on your selection.

- If you access a Hazards Analysis, the **Recommended Actions** pane displays a list of Risk Assessment Recommendations linked to all the Consequences in the Hazards Analysis.
- If you access a System/Node, Deviation, What If, or a Cause, the **Recommended Actions** pane displays a list of Risk Assessment Recommendations linked to all the Consequences in the System/Node.
- If you access a Consequence, the **Recommended Actions** pane displays a list of Risk Assessment Recommendations linked to the Consequence.

Important: You can create a Recommendation only for a Consequence.

Procedure

1. Access the [Hazards Analysis](#), [System/Node](#), or the [Consequence](#) that is linked to the Recommendation.

2. In the upper-right corner of the page, select .



The **Recommended Actions** pane appears, displaying a list of Recommendations linked to the Hazards Analysis, System/Node, or the Consequence.

Tip: For information about additional options available when working with the Recommendation records, refer to the Action Management section of the documentation.

Tip: If you want to create a Recommendation, you must first select the Consequence, and then access the **Recommended Actions** pane.

Create a Recommendation

Procedure

1. [Access the Consequence](#) for which you want to create a Risk Assessment Recommendation.
2. In the upper-right corner of the page, select .
The **Recommended Actions** pane appears, displaying a list of Risk Assessment Recommendations linked to the Consequence.
3. In the upper-left corner of the pane, select .
A blank datasheet for Risk Assessment Recommendation appears.
4. As needed, enter values in the [available fields](#), and then in the upper-right corner of the datasheet, select .
The Recommendation is created.

Tip: For information about additional options available when working with the Recommendation records, refer to the Action Management section of the documentation.

Results

- The Risk Assessment Recommendation that you have created is listed in the **Recommended Actions** pane for the related Hazards Analysis, System/Node, Deviation or What If, and the Cause that are linked to the Consequence.

Access the PHA Re-Validation Schedule

About This Task

The Hazards Analysis module allows you to view a list of analyses for which revalidation (also called reevaluation) is overdue or must be completed in the next 30 days.

The **PHA Re-Validation Schedule** section on the **Hazards Analysis Overview** page displays a list of Hazards Analyses that satisfy any of the following conditions:

- The value in the Next Reevaluation Date field falls within the next 30 days.
- The value in the Next Reevaluation Date field is a past date.

Procedure

1. [Access the Hazards Analysis Overview](#) page.

Tip: You can also [access the Hazards Analysis Overview](#) page for a particular hierarchy level.

2. Select the **PHA Re-Validation Schedule** tab.

The **PHA Re-Validation Schedule** section appears, displaying a list of Hazards Analyses for which revalidation is overdue or due within the next 30 days. The following columns appear in the section:

- **Analysis ID:** Contains a link, which you can select to view the details of the Hazards Analysis.
- **Revision:** Contains a value indicating the number of revisions performed on the Hazards Analysis.

- **Revision Date:** Contains the value in the Revision Date field of the Hazards Analysis.
- **Next Reevaluation Date:** Contains the value in the Next Reevaluation Date field of the Hazards Analysis.

By default, the hierarchy level on the **Hazards Analysis Overview** page is set to Home and the information that appears in the **PHA Re-Validation Schedule** section is related to all Hierarchy Levels, including records that are not associated with any asset. You can filter the information that appears on the page based on a specific asset by selecting  in the upper-left corner of the page.

Access the Hazards Analysis Team Members Section

About This Task

This topic describes how to access the **Team Members** section of a Hazards Analysis, from where you can access the list of team members in the analysis, add new ones, assign roles to team members, or modify or delete them.

Procedure

1. [Access the Hazards Analysis](#) whose Team Members you want to access.
2. In the workspace, select the **Team Members** tab.
The **Team Members** section appears, displaying a list of Team Members in the analysis.

Tip: For details about working with teams and the **Team Members** section, refer to the Teams section of the documentation.

Access the Reference Documents Section in Hazards Analysis

About This Task

This topic describes how to access the **Reference Documents** section in Hazards Analysis, from where you can access a list of Reference Documents linked to a Hazards Analysis, create a new one, or modify or delete an existing one.

Procedure

1. [Access the Hazards Analysis](#) whose Reference Documents you want to access.
2. In the workspace, select the **Reference Documents** tab.
The **Reference Documents** section appears, displaying a list of Reference Documents linked to the Hazards Analysis.

Tip: For more information, refer to the [Manage Reference Documents](#) section of the Record Manager module for additional options when working with reference documents.

Access the Revision History of a Hazards Analysis

About This Task

This topic describes how to access the revision history of a Hazards Analysis for each revision of the analysis.

Procedure

1. [Access the Hazards Analysis](#) for which you want to access the revision history.
2. In the upper-right corner of the page, select **Revisions**.
The **Revision History** page appears, displaying a list of revisions for the analysis.
3. Select the revision that you want to access.
The datasheet of the Hazards Analysis for the selected revision appears. The left pane displays a hierarchical structure of the Systems/Nodes and their elements.
4. If you want to view the changes that have been made for a particular record in that revision, select the record in the left pane, and then, in the upper-right corner of the page, select **Show Changes**.
The **Changes For Selected Datasheet** window appears, displaying a list of old values (i.e., values in the preceding revision) and new values (i.e., values in the selected revision) for all the fields that were modified in the selected revision for the selected record.

Accessing the Revision of a Hazards Analysis

Suppose that a Hazards Analysis has been re-evaluated (i.e., cycled through the states, Planning to Complete) twice. Therefore, this creates two revisions of the analysis.

If you want to view Revision 1 of the analysis, then:

1. [Access the Hazards Analysis](#).
2. In the upper-right corner of the page, select **2 Revisions**.
The **Revision History** page appears, displaying the two revisions.
3. Select the hyperlink that corresponds to Revision 1.
The **Analysis Summary** workspace for Revision 1 of the analysis appears. The left pane displays a hierarchical structure of the Systems/Nodes and their elements.
4. If you want to view the changes that have been made for a System/Node in Revision 1, then select the System/Node, and then, in the upper-right corner of the page, select **Show Changes**.
The **Changes for Selected Datasheet** window appears, displaying a list of old and new values for each field that was modified in Revision 1 compared to Revision 0.

Change the State of a Hazards Analysis

About This Task

This topic describes how to change the state of a Hazards Analysis, while assigning the state to a user.

Important: You can modify a Hazards Analysis in a particular state only if you are an administrator or the assignee for that state.

Procedure

1. [Access the Hazards Analysis](#) for which you want to change the state.
2. In the upper-right corner of the workspace, select the button that indicates the current state of the analysis. For example, if the current state of the analysis is Planning, select the **Planning** button.

A menu appears, displaying a list of operations that you can perform on the analysis to change its

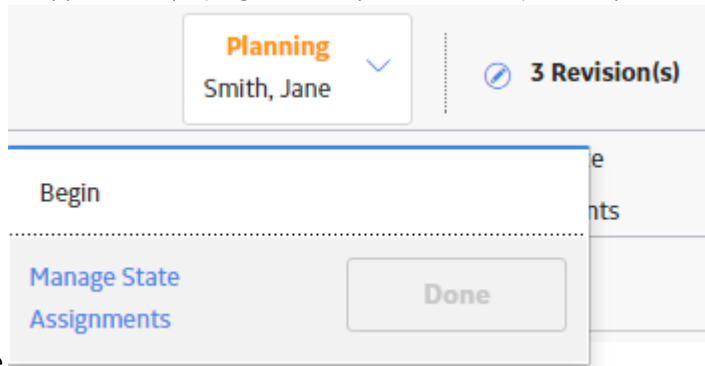

state.

3. Select **Manage State Assignments**.
The **State Assignments** window appears.
4. If not already done, assign the next state of the analysis to the appropriate user, and then select **Done**.
The **State Assignments** window closes.
5. In the workspace heading, select the button that indicates the current state of the analysis. For example, if the current state of the analysis is Planning, select the **Planning** button.
A menu appears, displaying the operation that you can perform to change the state of the project.
6. Select the [necessary operation](#) that will change the state of the analysis, and then select **Done**. For example, if you want to change the state of the analysis from Planning to Active, select **Begin**, and then select **Done**.
The state of the analysis is changed.

Generate the Report of a Hazards Analysis

Procedure

1. [Access the Hazards Analysis](#) whose report you want to generate.
2. In the upper-right corner of the page, select .

The Hazards Analysis report is generated. You can print, save, or export the report, or attach it to an email.

Delete a Hazards Analysis



About This Task

Note: You can delete a Hazards Analysis only if it is in the Planning state.

Important: Deleting a Hazards Analysis deletes the following associated records: System/Nodes, Deviations or What Ifs, Causes, Consequences, and Safeguards. If the Consequence is linked to a LOPA, the related Safeguards are not deleted. The LOPA records associated with the Consequences and the Risk Assessments and Recommendations associated with the System/Nodes are not deleted.

Procedure

1. [Access the Hazards Analysis](#) that you want to delete.
2. In the workspace, select the **Definition** tab.
The **Definition** section appears, displaying the datasheet for the Hazards Analysis.

3. In the upper-right corner of the datasheet, select , and then select  **Delete**.
The **Confirm Delete** dialog box appears, asking if you really want to delete the Hazards Analysis and all the related records.
4. Select **Yes**.
The Hazards Analysis is deleted.

Chapter 4

Components in a Hazards Analysis

Topics:

- [About Components in a Hazards Analysis](#)
- [About Defining Components for a HAZOP Analysis](#)
- [About Defining Components for a What If Analysis](#)
- [About Assessing Risks](#)
- [About Independent Layers of Protection](#)
- [About Defining the Mitigated Risk Rank](#)
- [About Asset Groups in Hazards Analysis](#)
- [About Integration with SIS Management](#)
- [Create a System/Node](#)
- [Access a System/Node](#)
- [Copy a System/Node](#)
- [Link Assets to a System/Node](#)
- [Unlink Assets from a System/Node](#)
- [Delete a System/Node](#)
- [Access a Component](#)
- [Create a Component](#)
- [Create a LOPA From a Consequence](#)
- [Copy a Component](#)
- [Assess the Unmitigated Risk](#)
- [Assess the Mitigated Risk](#)
- [Link an Asset to a Cause or a Safeguard](#)
- [Link a LOPA to a Consequence](#)

- Unlink a LOPA From a Consequence
- Delete a Component



About Components in a Hazards Analysis

A Hazards Analysis is made up of records and links as defined by the Hazards Analysis data model. Groups of records and links make up the main elements of the analysis.

A Hazards Analysis consists of the following components:

- **Process:** A series of actions that are performed by multiple pieces of equipment or locations in a single system.
- **Risk:** An event that might occur that threatens safety, either human or environmental.
- **Scenario:** For a given process, the combination of a risk and its risk assessment and the negative outcome associated with that event (e.g., human injury). You can define multiple scenarios for a single process.

While at a high level a scenario is a combination of a risk and its risk assessment, each scenario can be broken down into the following more granular parts:

- **Deviation:** A condition that deviates from the normal behavior of the process and directly leads to a risk.
- **What If:** A condition that can potentially deviate from the normal behavior of the process and directly leads to a risk.
- **Cause:** The event that results from the deviation and leads to a negative safety or environmental outcome.
- **Consequence:** The negative safety or environmental outcome that results from the cause. Together, the cause and the consequence define the risk.
- **Risk Assessment:** Identifies the probability that the risk will have a negative safety or environmental impact and the severity of that negative safety or environmental impact.
- **Safeguard:** A system or device that prevents the risk from occurring or lowers the probability or severity identified by the risk assessment.

About Defining Components for a HAZOP Analysis

To define components for a HAZOP Analysis, the HAZOP Analysis team will:

- Review the hazardous processes that take place in a facility.
- Identify the steps in those processes that cause abnormal or unsafe results.
- Create records to represent the various scenarios for each process. These scenarios are the components of the analysis.

As part of defining the components, the [HAZOP analysis team](#) will:

- Assess the risk associated with the components.
- Determine actions that should be taken to mitigate the risk associated with the component and create records to represent those actions.

For example, assume the HAZOP Analysis team has discussed a process that is controlled by System 1A. During the discussion, the team describes the following scenario for System 1A:

When the pressure monitor stops working, the pressure switch is not triggered to open or close appropriately, causing hazardous chemicals to leak out of the connector, which may result in human injury. To prevent this condition, a toxicity detector is in place, which sounds an alarm when the toxicity levels in the facility reach a high-risk level.

To define this scenario within a hazards analysis, the team creates one record in each family described in the following table. The third column contains an item from the previous example and serves as a reference for the type of information that record represents in the HAZOP Analysis.

A record in this family...	Stores...	In this example, this record represents...
Hazards Analysis System/Node	Details on the asset, asset group, or functional location that is used to perform the process.	System 1A
HAZOP Deviation	Details about the condition that deviates from the normal behavior of that process and directly leads to a risk. This condition is referred to as a deviation or guideword. A Deviation is linked to a Cause.	Pressure switch is not triggered to open or close appropriately.
Hazards Analysis Cause	Details on what has caused the deviation, including how frequently it may occur, and the asset that is associated with it. Causes can include human error, equipment failure, or other factors.	Chemicals leak
Hazards Analysis Consequence	Details on the negative outcome that results from the event that is defined in the Cause.	Multiple fatalities
Hazards Analysis Safeguard	Details on the safety precautions that are currently in place to prevent or lessen the impact of the negative outcome that is defined in the Consequence. Additional details about a safeguard defined in a Safeguard that is considered to be an independent layer of protection . Not all safeguards are independent layers of protection.	Toxicity detector

Note: If the safeguard is an instrumented function that exists within a safety system and is represented by an Instrumented Function in the GE Digital APM database, you can link that Instrumented Function to the Safeguard. For more details on instrumented functions and safety systems, see the SIS Management section of this Help system.

In addition to the records described in the table, the HAZOP Analysis team creates two Risk Assessments, where:

- One is linked to the Consequence to store the unmitigated risk value associated with the scenario without a safeguard in place. In other words, the team will define the risk value that is associated with that scenario without the toxicity detector.
- One is linked to the Safeguard to store the mitigated risk rank value of the scenario with that safeguard in place. In other words, the team will define the risk value associated with a scenario when the toxicity detector is in place.

Once all the safeguards that are available have been applied, the team determines if additional risk mitigation is required to meet tolerable level of risk. If the risk is to be mitigated further, then the team proposes one or more recommendations to reduce the risk to tolerable limits. A Recommendation created in a Hazards Analysis is called a strategic recommendation. It can be leveraged within a strategy to define Actions that will mitigate the risk further.

About Defining Components for a What If Analysis

To define components for a What If Analysis, the What If Analysis team will:

- Hypothesize about the hazardous processes that take place in a facility.
- Identify steps in those processes that have the potential to cause abnormal or unsafe results.
- Create records to represent the various scenarios for each process.

As part of defining the components, the What If Analysis team will:

- Assess the risk associated with the components.
- Determine actions that should be taken to mitigate the risk associated with the component and create records to represent those actions.

For example, assume the What If Analysis team has discussed a process that is controlled by System 1A. During the discussion, the team defines the following scenario, which is a scenario that could occur.

When the pressure monitor stops working, the pressure switch is not be triggered to open or close appropriately, causing hazardous chemicals to leak out of the connector, which may result in environmental degradation. To prevent this condition, a toxicity detector is in place, which sounds an alarm when the toxicity levels in the facility reach a high-risk level.

To define this scenario within a hazards analysis, the team creates one record in each family described in the following table. The third column contains an item from the previous example and serves as a reference for the type of information that record represents in the What If Analysis.

A record in this family...	Stores...	In this example, this record represents...
Hazards Analysis System/Node	Details on the asset, asset group, or functional location that is used to perform the process.	System 1A
What If	Details about the condition that may deviate from the normal behavior of that process and directly leads to a risk. This condition is referred to as a what if. A What If is linked to a Cause.	Pressure increases
Hazards Analysis Cause	Details on what could cause the deviation described in the What If, including how frequently it may occur, and the asset that is associated with it. Causes can include human error, equipment failure, or other factors.	Chemicals leak
Hazards Analysis Consequence	Details on the negative outcome that results from the event that is defined in the Cause.	Multiple fatalities
Hazards Analysis Safeguard	Details on the safety precautions that are currently in place to prevent or lessen the impact of the negative outcome that is defined in the Consequence. Additional details about a safeguard defined in a Safeguard that is considered to be an independent layer of protection . Not all safeguards are independent layers of protection.	Toxicity detector

Note: If the safeguard is an instrumented function that exists within a safety system and is represented by an Instrumented Function in the GE Digital APM database, you can link that Instrumented Function to the Safeguard. For more details on instrumented functions and safety systems, see the SIS Management section of this Help system.

In addition to the records described in the table, the What If Analysis team creates two Risk Assessments, where:

- One is linked to the Consequence to store the unmitigated risk value associated with the scenario without a safeguard in place. In other words, the team will define the risk value that is associated with that scenario without the toxicity detector.
- One is linked to the Safeguard to store the mitigated risk rank value of the scenario with that safeguard in place. In other words, the team will define the risk value associated with a scenario when the toxicity detector is in place.

Once all the safeguards that are available have been applied, the team determines if additional risk mitigation is required to meet tolerable level of risk. If the risk is to be mitigated further, then the team proposes one or more recommendations to reduce the risk to tolerable limits. A Recommendation created in a Hazards Analysis is called a strategic recommendation. It can be leveraged within a strategy to define Actions that will mitigate the risk further.

About Assessing Risks

When you conduct a Hazards Analysis, you will assess the risk associated with a given hazardous scenario to help you determine what actions should be taken to prevent or lessen the consequences of that scenario. Using a risk matrix, you will specify the following risk rank values for each scenario:

- **Unmitigated:** The risk level associated with that scenario before any safeguards have been put in place. Based on this risk level, the analysis team may decide on the safeguards that would mitigate the risk. To do this, the team conducts a LOPA to determine if the safeguards that are currently in place reduce the risk to tolerable levels. For example, the team may create a Risk Assessment Recommendation to recommend that a safety system be put in place. The unmitigated risk rank is stored in a Risk Assessment that is linked to the Consequence.
- **Mitigated:** The risk level associated with that scenario after safeguards have been put in place. The safeguards lessen the risk of a hazardous scenario or prevent the scenario from occurring. Based on this risk level, the analysis team may decide that additional actions need to be taken to further mitigate the risk. The mitigated risk rank is stored in a Risk Assessment that is linked to the Safeguard.

To assess the risk associated with a scenario, you will create the following records:

- A Risk Assessment record, which will store the unmitigated risk rank value and is linked to the Consequence. The unmitigated risk rank value indicates the probability and consequence of the risk if it occurs.
- A Risk Assessment record, which will store the mitigated risk rank value and is linked to a Safeguard. The mitigated risk rank value indicates the probability and consequence of the risk occurring if:
 - The safeguard represented by the Hazards Analysis Safeguard is in place to mitigate the risk.
 - The safeguard is also an independent layer of protection (IPL).

When you create the Risk Assessments, if the Hazards Analysis for the current analysis is associated with a specific site, the Risk Assessment interface will display the Risk Matrix that is associated with that site. If the analysis is not associated with a specific site, the default Risk Matrix will be used.

Note: See the Overview of the Risk Matrix section of the documentation for additional options when working with the Risk Matrix.

About Independent Layers of Protection

An independent layer of protection is a system, action, or an item that mitigates the risk associated with a hazardous scenario.

All independent layers of protection are safeguards, but not all safeguards are independent layers of protection.

By default, the following criteria are required to be true for a safeguard to be considered as an independent protection layer:

- The safeguard must be independent of the initiating event such that a failure associated with the risk will not cause the safeguard to fail.
- The safeguard must be testable and verifiable using an industry standard (e.g., a risk based inspection).
- The safeguard must be specific in detecting a potential hazard and taking action to prevent the hazard from occurring.
- The safeguard must be capable and available at least 90 percent of the time.
- The safeguard must increase the Risk Reduction Factor (RRF) of the LOPA to a value greater than or equal to 10.

These criteria can be modified in the administrative settings for the LOPA administrative settings for LOPA. In HAZOP Analyses and What If Analyses, Safeguards that are independent layers of protection will [store additional information about the risk reduction provided by the safeguard](#). For additional information about Safeguards and IPLs, refer to the LOPA section of the documentation.

Independent Layer of Protection in a Hazards Analysis

Suppose that in a hazardous scenario a high pressure separator releases liquid to downstream equipment. If the liquid level in the high pressure separator decreases to a certain level, pressure could be released to downstream equipment and cause it to rupture. In this scenario, a controller monitors the liquid level. If the level gets too low, the controller closes a valve so that the pressure is not released to downstream equipment.

An independent layer of protection for this scenario would be a low level alarm because it meets all the following criteria:

- The safeguard is independent because if the first controller fails, the low level alarm has independent process connections and independent BPCS hardware from the failed controller.
- The safeguard is auditable because the low level alarm can be routinely inspected.
- The safeguard is capable because it is available at least 90 percent of the time.
- The safeguard is specific because the alarm detects potential hazards by measuring the liquid level and will alert the operator when the potential failure is detected.
- The safeguard increases the Risk Reduction Factor (RRF) to a value greater than or equal to 10.



Therefore, the level alarm along with an operator response can reduce the risk associated with the hazards scenario.

About Defining the Mitigated Risk Rank

When the Risk Assessment that will store the mitigated risk rank is created, the GE Digital APM system will populate values in the Risk Assessment interface based on criteria defined in other records.

The GE Digital APM system uses the relationship between the Consequence and the Safeguard to:

- Automatically populate the Risk Matrix with the unmitigated risk rank value that you specified in the Risk Assessment that is linked to the Consequence.
- Disable the cells in the Risk Matrix that represent a risk rank that is higher than the unmitigated risk.

Before you select a mitigated risk value, the unmitigated and mitigated risk values are the same, and the  icon and  icon appear in the same cell. When you select the mitigated risk value, the  icon appears in the selected cell.

Mitigated Risk

Assume that you have:

- One Risk Assessment with the unmitigated risk rank value 830 that is linked to the Consequence, Flame out which could lead to explosion.
- One Hazards Analysis Safeguard High Gas Pressure Indicator and Alarm that is a Frequency Reducing IPL, which is linked to the Consequence Flame out which could lead to explosion.

If you create a Risk Mitigation Assessment to link to the Safeguard High Gas Pressure Indicator and Alarm, the unmitigated risk rank value will be populated automatically in the Risk Matrix.

About Asset Groups in Hazards Analysis

When you create a Cause or a Safeguard, you can link it to an Asset (a piece of Equipment and a Functional Location). Similarly, when you create a System/Node, you link it to one or more Assets. In addition to the Assets that you have linked to the System/Node, the GE Digital APM system links the System/Node to the Assets linked to each Cause and Safeguard in the System/Node.

All the Assets linked to a System/Node form an Asset Group. This group is named in the following format: <ID of the Hazards Analysis>/<ID of the System Node> Asset Group. You can also access a list of these Assets in the **Linked Assets** section of a System/Node.

Asset Groups in Hazards Analysis

Assume that you have created a Hazards Analysis, a System/Node, Deviation, Cause, Consequence, and a Safeguard with the following IDs:

- Hazards Analysis 1
- System/Node 1
- Deviation 1
- Cause 1
- Consequence 1
- Safeguard 1

Suppose you have linked Equipment and Functional Locations to System/Node 1, Cause 1, and Safeguard 1 as shown in the following image.

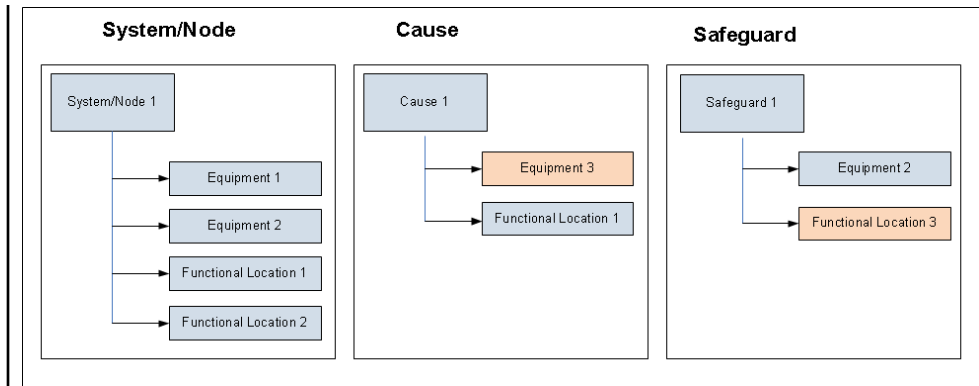

The GE Digital APM system links Equipment 3 and Functional Location 3 to System/Node 1, although you have not linked them directly to System/Node 1.

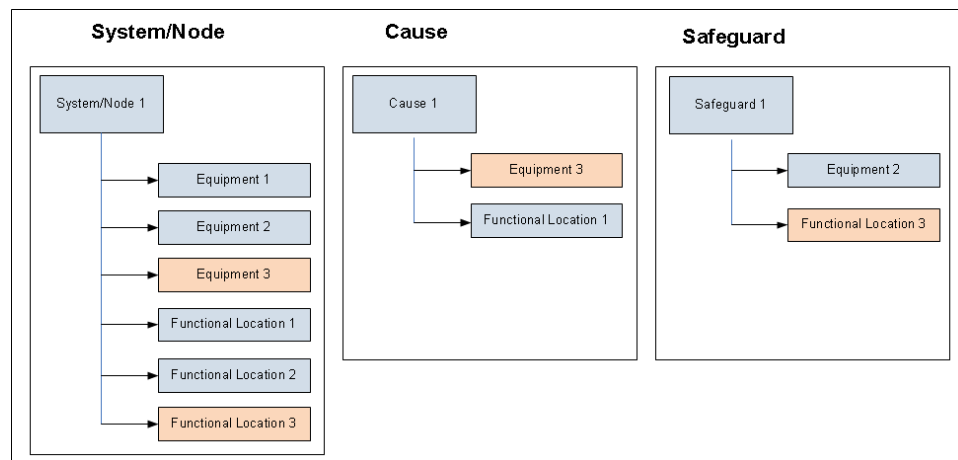

The GE Digital APM system also creates an Asset Group with the ID Hazards Analysis 1/ System/Node 1 Asset Group. This group contains all the Equipment and Functional Locations linked to System/Node 1.

About Integration with SIS Management

After you assess risk for a scenario in a hazards analysis, you can use that information in the SIS Management module as a Safety Integrity Level (SIL) Assessment for an instrumented function within an SIL Analysis.

Risk assessments from Hazards Analysis that are used in SIS Management in this way cannot be modified via SIS Management. If you want the changes that you made to a risk assessment in the Hazards Analysis module to also appear in the SIS Management module, you must assess the SIL value using the modified PHA Internal Risk Assessment.

Create a System/Node

Before You Begin

- [Create a Hazards Analysis.](#)

About This Task

This topic describes how to create a System/Node using a blank datasheet. You can also [copy a System/Node](#).

Tip: You can create a System/Node only if the corresponding Hazards Analysis is in the Planning state.

Procedure

1. [Access the Hazards Analysis](#) for which you want to create a System/Node.
2. In the left pane, select , and then select **Create New**.
A blank datasheet for the System/Node appears.
3. As needed, enter values in the [available fields](#).
4. Select **Save**.
The System/Node is created.

Results

- An [Asset Group](#) is created for the System/Node.

Next Steps

- [Create a Component](#)
- [Link Assets to a System/Node](#)

Access a System/Node

Procedure

1. [Access the Hazards Analysis](#) that is linked to the that you want to access.
2. In the left pane, select the System/Node that you want to access.

Tip: You can also filter and search for the System/Node by selecting .

The datasheet for the selected System/Node appears.

3. As needed, modify values in the [available fields](#).

Note: You can modify a System/Node only if the corresponding Hazards Analysis is in the Planning state.

4. In the upper-right corner of the datasheet, select .
- The changes made to the System/Node are saved.

Copy a System/Node



About This Task

This topic describes how to copy a System/Node. You can also [create a new System/Node](#). When you copy a System/Node, the related Deviations or What Ifs, Causes, Consequences, Safeguards, and Risk Assessments are also copied and associated with the copy of the System/Node.

Tip: You can copy a System/Node only if the Hazards Analysis into which you want to copy the System/Node is in the Planning state.

Note: When you copy a System/Node, the linked assets are not copied.

Procedure

1. [Access the Hazards Analysis](#) to which you want to copy the System/Node.
2. In the left pane, select , and then select  **Copy**.
The **Search** window appears.
3. In the upper-right corner of the window, select .
A list of Systems/Nodes appears.
4. Select the System/Node that you want to copy, and then select **OK**.
A copy of the System/Node is created and associated with the Hazards Analysis. All related Deviations or What Ifs, Causes, Consequences, Safeguards, and Risk Assessments are also copied and associated with the copy of the System/Node.

Next Steps

- [Link Assets to a System/Node](#)



Link Assets to a System/Node

About This Task

This topic describes how to link one or more Assets (Equipment and Functional Locations) to a System/Node.

Tip: You can link Assets to a System/Node only if the corresponding Hazards Analysis is in the Planning state.

Procedure

1. [Access the System/Node](#) that you want to link to Assets.
2. In the workspace, select the **Linked Assets** tab.
The **Linked Assets** section appears, displaying a list of Assets linked to the System/Node and also to all the Causes and Safeguards in the System/Node.
3. In the upper-left corner of the section, select .
The **Asset Finder** window appears.
4. Navigate to the Assets that you want to link to the System/Node, and then select  next to the Asset ID.
The selected Assets appears in the right pane of the **Asset Finder** window.
Note: You can only select assets that belong to the same site as that of the Hazards Analysis.
5. Select **Done**.
The selected Assets are linked to the System/Node.

Results

- The Assets that you have linked to the System/Node are automatically [linked to the corresponding Hazards Analysis](#).
- The Asset Group that corresponds to the System/Node is updated with the newly added Assets.

Unlink Assets from a System/Node

About This Task

This topic describes how to unlink one or more Assets (Equipment and Functional Locations) from a System/Node.

Tip: You can unlink Assets from a System/Node only if the corresponding Hazards Analysis is in the Planning state.

Note: You cannot unlink an Asset that is linked to the System/Node through a Cause or a Safeguard. You can, however, link the Cause or the Safeguard to a different Asset, which will also:

- Unlink the Asset from the Hazards Analysis.
- Unlink the Asset from the System/Node.
- Remove the Asset from the corresponding Asset Group.

Procedure

1. [Access the System/Node](#) from which you want to unlink Assets.
2. In the workspace, select the **Linked Assets** tab.
The **Linked Assets** section appears, displaying a list of Assets linked to the System/Node (which also includes the Assets linked to all the Causes and Safeguards in the System/Node).
3. Select the check boxes that correspond to the Assets that you want to unlink.
4. In the upper-right corner of the section, select .
A dialog box appears, asking if you want to unlink the Assets.
5. Select **OK**.
The selected Assets are unlinked from the System/Node.

Results

- The Assets that you have unlinked from the System/Node are automatically unlinked from the corresponding [Hazards Analysis](#) and the [Asset Group](#).



Delete a System/Node

About This Task

Note: You can delete a System/Node only if the corresponding Hazards Analysis is in the Planning state.

Important: Deleting a System/Node deletes the following associated records: Deviations or What Ifs, Causes, and Consequences. If the Consequence is linked to a LOPA, the related Safeguards are not deleted. The LOPA records associated with the Consequences and the Risk Assessments and Recommendations associated with the System/Nodes are not deleted.

Procedure

1. [Access the Hazards Analysis](#) that is linked to the System/Node that you want to delete.
2. In the upper-right corner of the datasheet, select , and then select  **Delete**.
A confirmation message appears, asking you if you really want to delete the System/Node and its components.

3. Select **Yes**.

The System/Node and its components are deleted.

Results

- All the Assets that are linked to the System/Node are unlinked from the Hazards Analysis.

Access a Component

About This Task

This topic describes how to access the datasheet of the following types of components of a hazards analysis:

- Deviation (in case of a HAZOP Analysis)
- What If (in case of a What If Analysis)
- Cause
- Consequence
- Safeguard

Procedure

1. [Access the System/Node](#) that is linked to the component that you want to access.
2. Select the **Hazards Worksheets** tab.

The **Hazards Worksheets** section appears, displaying a hierarchical view of the components (Deviations or What Ifs, Causes, Consequences, and Safeguards) associated with the System/Node.

3. Select the component that you want to access, and then, in the upper-left corner of the workspace, select .

The datasheet for the selected component appears.

4. If needed, modify values in the available fields for [Deviation](#), [What If](#), [Cause](#), [Consequence](#), or [Safeguard](#).

Tip: You can modify a Component only if the corresponding Hazards Analysis is in the Planning state.

5. In the upper-right corner of the datasheet, select .
- The changes made to the component are saved.

Tip: You can select  in the upper-left corner of the workspace to return to close the datasheet.

Create a Component

Before You Begin

- [Create a System/Node](#).

About This Task

This topic describes how to create the following components of a hazards analysis using a blank datasheet:

- Deviation (in case of a HAZOP Analysis)

- What If (in case of a What If Analysis)
- Cause
- Consequence
- Safeguard

You can also [copy a Component](#).

Procedure

1. [Access the System/Node](#) for which you want to create a component.
2. Select the **Hazards Worksheets** tab.
The **Hazards Worksheets** section appears, displaying a hierarchical view of the components (Deviations or What Ifs, Causes, Consequences, and Safeguards) associated with the System/Node.
3. In the hierarchical level that corresponds to the component that you want to create, select , and then select **Create New <type of the component>**.

Where <type of component> can be one of the following values:

- Deviation (in case of a HAZOP Analysis)
- What If (in case of a What If Analysis)
- Cause
- Consequence
- Safeguard

For example, if you want to create a new Deviation, then in the **Deviations** hierarchical level, select , and then select **Create New Deviations**.

A blank datasheet for the type of component appears.

4. As needed, enter values in the available fields for [Deviation](#), [What If](#), [Cause](#), [Consequence](#), or [Safeguard](#).
5. Select **Save**.
A new component is created and listed in the corresponding hierarchical level. For example, if you have created a new Deviation, it will be listed in the **Deviations** hierarchical level.

Next Steps

- If you have created a Consequence, then [assess the unmitigated risk for the Consequence](#).
- If you have created a Safeguard, then [assess the mitigated risk for the Safeguard](#).

Create a LOPA From a Consequence

About This Task

This topic describes how to create a LOPA from a Consequence.

When you create a LOPA from a Cause-Consequence pair in Hazards Analysis, the LOPA that is created is automatically linked to the Consequence. You can also create a LOPA from the LOPA module in GE Digital APM.

Note: You can create, or link a LOPA to a Consequence only if the associated Hazards Analysis is in the Planning State.

Procedure

1. [Access the System/Node](#) that is linked to the Consequence that you want to access.
2. Select the **Hazards Worksheets** tab.
The **Hazards Worksheets** section appears, displaying a hierarchical view of the components (Deviations or What Ifs, Causes, Consequences, and Safeguards) associated with the System/Node.
3. Select the Consequence for which you want to perform the LOPA.
4. In the Consequence that you selected, select **Create**.

Note: If a Consequence is already linked to a LOPA, the links **Edit** and **Unlink** appear. You can either select another Consequence, or unlink the LOPA from the Consequence, and then create a new LOPA for the Consequence.

A blank datasheet for LOPA appears, displaying the **Definition** section.

Note: The Initiating Event field and the Frequency of Initiating Event field in the LOPA record are populated with the values in the CCPS Cause Type field and Cause Frequency (per year) field in the Hazards Analysis Cause record associated with the Consequence.

5. As needed, enter values in the [LOPA Records](#).
6. In the upper-right corner of the **Definition** section, select .
The LOPA is created.

Note: You can select **Edit** to modify the LOPA, or **Unlink** to unlink the LOPA from the Consequence.

Results

- The LOPA is linked to the Consequence and the LOPA ID appears in the Consequence. You can select the LOPA ID to view the summary of the LOPA.
- The LOPA that you created for the Consequence appears in the list of LOPA in the **LOPA Overview** page, in the **Under Review** tab.
- The Safeguards that are associated with the LOPA are automatically linked to the Consequence. They appear in the **Hazards Worksheet** section of the Hazards Analysis. Similarly, the Safeguards that are associated with the Consequence are automatically linked to the LOPA. Hence, you can modify the Safeguard only if the associated LOPA and the Hazards Analysis are in the Planning state.

Copy a Component

About This Task

This topic describes how to copy the datasheet of the following types of components of an analysis:



- Deviation (in case of a HAZOP Analysis)
- What If (in case of a What If Analysis)
- Cause
- Consequence
- Safeguard

Tip: You can copy a Component only if the Hazards Analysis into which you want to copy the Component is in the Planning state.

The ID of the copied component is appended with the word Copy at the end. For example, if the ID of the Cause that you want to copy is Gas Pipe Leakage, the name of the copied Cause is Gas Pipe Leakage Copy. However, when you copy a Deviation, the ID of the copied record is the same as that of the original record.

You can also create a component [using a blank datasheet](#).

Procedure

1. [Access the System/Node](#) into which you want to copy the component.
2. Select the **Hazards Worksheets** tab.
The **Hazards Worksheets** section appears, displaying a hierarchical view of the components (Deviations or What Ifs, Causes, Consequences, and Safeguards) associated with the System/Node.
3. In the hierarchical level that corresponds to the type of component that you want to copy, select , and then select **Copy <type of the component>**. For example, if you want to copy a Deviation, then in the **Deviations** hierarchical level, select , and then select **Copy Deviations**.
The **Search** window appears.
4. In the upper-right corner of the window, select .
A list of records of the selected component type appears.
5. Select the check box that corresponds to the component that you want to copy, and then select **OK**.
The component is added to the System/Node.

Assess the Unmitigated Risk

Before You Begin

- [Create a Consequence](#).

About This Task

This topic describes how to perform an unmitigated risk assessment for a Consequence in a hazards analysis.

Note: You can assess the unmitigated risk for a Consequence only if the corresponding Hazards Analysis is in the Planning state.

Procedure

1. [Access the Consequence](#) for which you want to assess the unmitigated risk.
If you have already performed a risk assessment for the Consequence, the overall risk rank and the risk ranks for each category appear above the datasheet.
2. Above the datasheet for the Consequence, select the section that displays the unmitigated risk rank.

The **Unmitigated Risk Assessment** window appears, displaying the risk matrix for each category.

Unmitigated Risk Assessment

Total Risk 830

	Probability	Consequence				
		Very Low	Low	Medium	High	Very High
Safety 500		1	10	100	500	1,000
Environm... 30	Frequent 5	5	50	500	2,500	5,000
Operations 300	Probable 1	1	10	100	500	1,000
Financial	Possible 0.3	0.3	3	30	150	300
	Remote 0.1	0.1	1	10	50	100
	Improbable 0.05	0.05	0.5	5	25	50

Not Applicable
 Mitigated Risk:
 Unmitigated Risk

Basis for Assessment

HAZOP Analysis, BR-1001 Steam Boiler Analysis - Boiler Gas Feed

Cancel Save

- Specify the unmitigated risk rank for each category as applicable, and then select **Save**. The overall unmitigated risk rank and the risk ranks for individual categories are displayed above the datasheet for the Consequence. Depending on your configuration, the overall risk rank can be the highest or the sum of all the ranks for all the categories.

Note: See the Overview of the Risk Matrix section of the documentation for additional options when working with the risk matrix.

Results

Important: If you change the unmitigated risk rank after assessing the mitigated risk rank, the previously completed mitigated risk assessments for all Safeguards are deleted. You will need to [assess the mitigated risk rank](#) again.

Next Steps

- [Assess the Mitigated Risk](#)
- [Link an Asset to a Cause or a Safeguard](#)

Assess the Mitigated Risk

Before You Begin

- [Assess the unmitigated risk](#) of the Consequence that is linked to the Safeguard.
- [Create a Safeguard](#).

About This Task

This topic describes how to perform a mitigated risk assessment for a Safeguard in a hazards analysis.

Note: You can assess the mitigated risk for a Safeguard only if the corresponding Hazards Analysis is in the Planning state.

Procedure

1. [Access the Safeguard](#) for which you want to assess the mitigated risk.
If you have already performed a risk assessment for the Safeguard, the overall risk rank and the risk ranks for each category are displayed above the datasheet for the Safeguard. If a risk assessment has not yet been performed for the Safeguard, then only the unmitigated risk ranks are displayed.
2. Above the datasheet for the Safeguard, select the section that displays the risk rank.

The **Mitigated Risk Assessment** window appears, displaying the risk matrix for each category.

Mitigated Risk Assessment

Total Risk 110

Category	Probability	Consequence				
		Very Low	Low	Medium	High	Very High
Safety 50		1	10	100	500	1,000
Environm... 10	Frequent 5	5	50	500	2,500	5,000
Operations 50	Probable 1	1	10	100	500	1,000
Financial	Possible 0.3	0.3	3	30	150	300
	Remote 0.1	0.1	1	10	50	100
	Improbable 0.05	0.05	0.5	5	25	50

Not Applicable
 Mitigated Risk :
 Unmitigated Risk

Basis for Assessment

- Specify the mitigated risk rank for each category as applicable, and then select **Save**. The overall mitigated risk rank and risk ranks for individual categories are displayed above the datasheet for the Safeguard. Depending on your configuration, the overall risk rank can be the highest or the sum of all the ranks for all the categories.

Note: See the Overview of the Risk Matrix section of the documentation for additional options when working with the risk matrix.

Next Steps

- [Link an Asset to a Cause or a Safeguard.](#)





Link an Asset to a Cause or a Safeguard

About This Task

You can link only one asset (one Equipment and one Functional Location) to a Cause or a Safeguard. If an asset is already linked to the Cause or the Safeguard and you link another asset, only the latter one is linked to the Cause or the Safeguard.

Tip: You can link an asset to a Cause or a Safeguard only if the corresponding Hazards Analysis is in the Planning state.

Procedure

1. [Access the Cause or the Safeguard](#) that you want to link to an Asset.
The datasheet for the selected Cause or Safeguard appears.
2. If you want to link an Equipment, follow these steps:
 - a. On the datasheet, in the **Equipment ID** box, select .
The **Asset Finder** window appears.
 - b. Navigate to the Equipment that you want to link to the Cause or Safeguard, and then select  next to the Equipment ID.
In the right pane of the **Asset Finder** window, the selected Equipment appears.
 - c. Select **Done**.
The Equipment is linked to the Cause or the Safeguard.
Note: When you link an Equipment to the Cause or Safeguard, the Functional Location to which the Equipment belongs is automatically linked to the Cause or Safeguard, and appears in the **Functional Location ID** box on the datasheet.
3. If you want to link a Functional Location, follow these steps:
 - a. In the **Functional Location ID** box on the datasheet, select .
The **Asset Finder** window appears.
 - b. Navigate to the Functional Location that you want to link to the Cause or Safeguard, and then select  next to the Functional Location ID.
In the right pane of the **Asset Finder** window, the selected Functional Location appears.
 - c. Select **Done**.
The Functional Location is linked to the Cause or the Safeguard.

Results

- The asset that you have linked to the Cause or the Safeguard is also linked to the corresponding System/Node and the Hazards Analysis, and thus added to the [Asset Group created for the System/Node](#).

Next Steps

- Add Team Members to the Hazards Analysis

Link a LOPA to a Consequence

Before You Begin

- Create the LOPA that you want to link with the Consequence.

About This Task

This topic describes how to link a LOPA to a Consequence in Hazards Analysis.

Note: You can create or link a LOPA to a Consequence only if the associated Hazards Analysis is in the Planning State.

Procedure

1. [Access the System/Node](#) that is linked to the Consequence that you want to access.
2. Select the **Hazards Worksheets** tab.
The **Hazards Worksheets** section appears, displaying a hierarchical view of the components (Deviations or What Ifs, Causes, Consequences, and Safeguards) associated with the System/Node.
3. Select the Consequence to which you want to link the LOPA.

4. In the Consequence that you selected, select  **Link**.

Note: If a Consequence is already linked to a LOPA, the link **Unlink** will appear. You can either select another Consequence, or unlink the LOPA from the Consequence, and then link to a different LOPA.

The **LOPA** window appears, displaying a list of LOPA that belong to the same site as that assigned to the Hazards Analysis.

5. Select the row containing the LOPA that you want to link to the Consequence.
6. Select **Link**.
The LOPA is linked to the Consequence.

Results

- The LOPA ID appears in the Consequence. You can select the LOPA ID to view the summary of the LOPA, or you can select **Edit** to modify the LOPA.
- The Safeguards that are associated with the LOPA are automatically linked to the Consequence. They appear in the **Hazards Worksheet** section of the Hazards Analysis. Similarly, the Safeguards that are associated with the Consequence are automatically linked to the LOPA. You can add or modify a Safeguard only if the associated LOPA and the Hazards Analysis are in the Planning state.

Unlink a LOPA From a Consequence

Before You Begin

- [Link a LOPA to a Consequence](#).

Procedure

1. [Access the System/Node](#) that is linked to the Consequence that you want to access.
2. Select the Consequence from which you want to unlink the LOPA.

Note: You can unlink a LOPA from a Consequence only if the associated Hazards Analysis is in the Planning State.

3. In the Consequence that you selected, select  **Unlink**.

The LOPA is unlinked from the Consequence.

Results

- GE Digital APM system creates copies of the Safeguards associated with the LOPA, and then links them to the Consequence. The copied Safeguards appear in the **Hazards Worksheet** section of the Hazards Analysis.

Delete a Component

About This Task

This topic describes how to delete the following types of components of a hazards analysis:

- Deviation (in case of a HAZOP Analysis)
- What If (in case of a What If Analysis)
- Cause
- Consequence
- Safeguard

Tip: You can delete a component only if the corresponding Hazards Analysis is in the Planning state.

Important: Deleting a component deletes all the subordinate records.

Procedure

1. [Access the System/Node](#) that is linked to the component that you want to delete.
2. In the hierarchical level that corresponds to the component that you want to delete, select the component, and then in the upper-right corner of the workspace, select .

A confirmation message appears, asking if you really want to delete the component.

3. Select **OK**.
The component and its subordinate records are deleted.

Chapter 5

Admin

Topics:

- [Specify Different Search Queries](#)

Specify Different Search Queries

About This Task

On the **Hazards Analysis Overview** page, when you select **Hazop** or **What If**, the following queries are executed:

- **HAZOP_ANALYSIS_ASSET_OVERVIEW**: Returns a list of HAZOP Analyses. This query is executed when you select **Hazop** on the **Hazards Analysis Overview** page.
- **WHATIF_ANALYSIS_ASSET_OVERVIEW**: Returns a list of What If Analyses. This query is executed when you select **What If** on the **Hazards Analysis Overview** page.

This topic describes how to specify different search queries for Hazards Analysis, replacing the default ones.

Procedure

1. In the **Applications** menu, navigate to **ADMIN > Application Settings > Hazards Analysis**.
The **Hazards Administration** page appears, displaying the default search queries for HAZOP Analysis and What If Analysis.
2. Select the **Select** button next to the query that you want to replace.
The baseline Catalog folder appears.
3. Navigate to the folder that contains the query that you want to specify.
4. Select the query, and then select **Open**.
5. Repeat steps 3 - 5 for the other query that you want to replace.
6. In the upper-right corner of the page, select **Save**.
The default queries are replaced by the ones that you have selected.

Results

- On the **Hazards Analysis Overview** page, when you select **Hazop** or **What If**, the queries that you have specified are executed.

Chapter 6

Data Loader

Topics:

- [About the Hazards Data Loader](#)
- [About the Hazards Data Loader Requirements](#)
- [About the Hazards Data Loader General Loading Strategy](#)
- [About the Hazards Data Loader Load Verification](#)
- [About the Hazards Data Loader Data Model](#)
- [About the Hazards Data Loader Workbook Layout and Use](#)

About the Hazards Data Loader

Using the Hazards Data Loader, you can implement HAZOP Analysis when you have data in a legacy system. To import data using the Hazards Data Loader, GE Digital APM provides an Excel workbook, `Hazards.xlsx`, which supports baseline Hazards Analysis in GE Digital APM. You must export your legacy system so that the data can be used to populate the workbook. The data from the workbook will then be imported into GE Digital APM using the Hazards Data Loader.

Note: The Excel template is referred to throughout this documentation as the data loader workbook.

The data loader workbook can be used in the following scenario:

- Loading existing legacy HAZOP analysis data into GE Digital APM so that you can retain visibility into previous HAZOP analyses, view the risk mitigation graph and re-validation schedules.

After importing the data, the Hazards Data Loader creates the following records in GE Digital APM:

- Hazards Analysis
- Hazards Analysis System/Node
- Hazards Analysis Deviation
- Hazards Analysis Cause
- Hazards Analysis Consequence
- Hazards Analysis Safeguard
- Independent Layer of Protection
- Risk Assessment
- Risk Assessment Recommendation
- Human Resource

Note: This data loader workbook is not backward compatible to earlier versions of GE Digital APM.

About the Hazards Data Loader Requirements

Before importing data using the data loader workbook, you must have completed the deployment of the Hazards Analysis module. You must also have populated the Equipment and Functional Location to establish relationship with the families in Hazards Analysis, and have entered a valid Equipment entity key and Functional Location entity key into the data loader workbook. To do this, the Equipment and Functional Locations must exist in the GE Digital APM database.

Security Settings

The Security User performing the data load operation must be associated with either the MI Data Loader User or MI Data Loader Admin Security Role.

About the Hazards Data Loader General Loading Strategy

The imported data must load in a specific sequence in order to successfully populate fields, to create records, and to link them to the predecessor and/or successor records.

Best Practices

When importing data using the data loader workbook, you must use the following best practices:

- ID fields (Row 2 of each worksheet) must not include special characters (other than underscores) or spaces.
- Columns (including columns representing custom fields) in the worksheets should be formatted as Text.
- You should not try to create and update a component in the same data loader workbook.
- You must consider the rules described in the [Workbook Layout and Use section](#) of this document while using the Hazards Data Loader.

Load Sequence

When importing data using the data loader workbook, you must use the following workflow:

1. Download the data loader workbook provided by GE Digital APM
2. Identify the data requirements for exporting the data in to the data loader workbook.
3. Extract data from legacy applications to populate the data loader workbook.
4. Import data into GE Digital APM.
5. Monitor the status of the data load, and verify the results in the log.
6. Conduct tests in GE Digital APM to ensure that the imported data loaded accurately.

For each row in the data loader workbook, the Hazards Loader creates a new record in GE Digital APM. However, if records have already been created and you reimport the data, the existing records will be updated.

About the Hazards Data Loader Load Verification

About This Task

Following a successful data load, the user is able to navigate to any of the imported templates, to view the details associated with the template, and to import template content into an analysis.

Procedure

1. In the data loader worksheet, enter the following values:

Worksheet	Field Caption	Value
MI_HAZANANA	Analysis ID	Hazop-DL-Testing-01
	Analysis Type	HAZOP
	Site Reference Name	ISO Site
MI_HAZANNOD	Analysis ID	Hazop-DL-Testing-01
	System/Node ID	Node-01
	System/Node Number	1
	Analysis ID	Hazop-DL-Testing-01
	System/Node ID	Node-02
	System/Node Number	2

Worksheet	Field Caption	Value
Node_Assets	Analysis ID	Hazop-DL-Testing-01
	System/Node ID	Node-01
	System/Node Number	1
	Equipment Technical Number	A001
MI_HAZOPDEV	Analysis ID	Hazop-DL-Testing-01
	System/Node Number	1
	Deviation Sequence Number	1
	Deviation/Guideword	More Temperature
	Analysis ID	Hazop-DL-Testing-01
	System/Node Number	2
	Deviation Sequence Number	1
	Deviation/Guideword	Less Flow
MI_HAZANSAF	Analysis ID	Hazop-DL-Testing-01
	System/Node ID	Node-01
	System/Node Number	1
	Deviation Sequence Number	1
	Cause Sequence Number	1
	Consequence Sequence Number	1
	Safeguard ID	Node-01 Safeguard
	Safeguard Sequence Number	1
MI_HAZANCAU	Analysis ID	Hazop-DL-Testing-01
	System/Node Number	1
	Deviation Sequence Number	1
	Cause Sequence Number	1
	Cause ID	Cause-01
MI_HAZANCON	Analysis ID	Hazop-DL-Testing-01
	System/Node Number	1
	Deviation Sequence Number	1
	Cause Sequence Number	1
	Consequence ID	Consequence-01
	Consequence Sequence Number	1
MI_IPL_CHEC	Safeguard Sequence Number	1
	IPL Criteria	Is the IPL independent of the initiating cause of the hazardous scenario?
	IPL Criteria Value	FALSE

Worksheet	Field Caption	Value
MI_RISKASSE	Analysis ID	Hazop-DL-Testing-01
	System/Node ID	Node-01
	System/Node Number	1
	Deviation Sequence Number	1
	Cause Sequence Number	1
	Consequence Sequence Number	1
	Safeguard Sequence Number	1
	(ENVIRONMENT) Consequence	1
	(ENVIRONMENT) Probability	1
	(FINANCIAL) Consequence	550
	(FINANCIAL) Maintenance Cost	50
	(FINANCIAL) Probability	5
	(FINANCIAL) Production Loss	500
	(OPERATIONS) Consequence	100
	(OPERATIONS) Probability	0.1
	(SAFETY) Consequence	100
(SAFETY) Probability	0.3	

Note: In the MI_RISKASSE worksheet, when you enter values for both Consequence Sequence Number and Safeguard Sequence Number, the values in the following fields are considered as Mitigated Risk Values, and when you enter a value for only the Consequence Sequence Number, the values in these fields are considered as Unmitigated Risk Values.

- (ENVIRONMENT) Consequence
 - (ENVIRONMENT) Probability
 - (ENVIRONMENT) Protection Level
 - (FINANCIAL) Consequence
 - (FINANCIAL) Maintenance Cost
 - (FINANCIAL) Probability
 - (FINANCIAL) Production Loss
 - (FINANCIAL) Protection level
 - (OPERATIONS) Consequence
 - (OPERATIONS) Probability
 - (OPERATIONS) Protection Level
 - (SAFETY) Consequence
 - (SAFETY) Probability
2. Import the data loader worksheet into GE Digital APM.
 3. Access the **Hazards Analysis Overview** page.
 4. Select the **HAZOP** tab, and then select **Hazop-DL-Testing-01**.

The **Analysis Summary workspace** appears, displaying the risk graph. The two Systems/Nodes, Node-01 and Node-02, appear in the left pane.

5. In the left pane, select **Node-01**, and then select the **Hazards Worksheet** tab.

The **Hazards worksheet** section appears, displaying the hierarchical structure of the elements in Node-01.

About the Hazards Data Loader Data Model

The following data model illustrates the records that the Data Loader supports.

Note: Equipment and Functional Location records must exist prior to importing data.

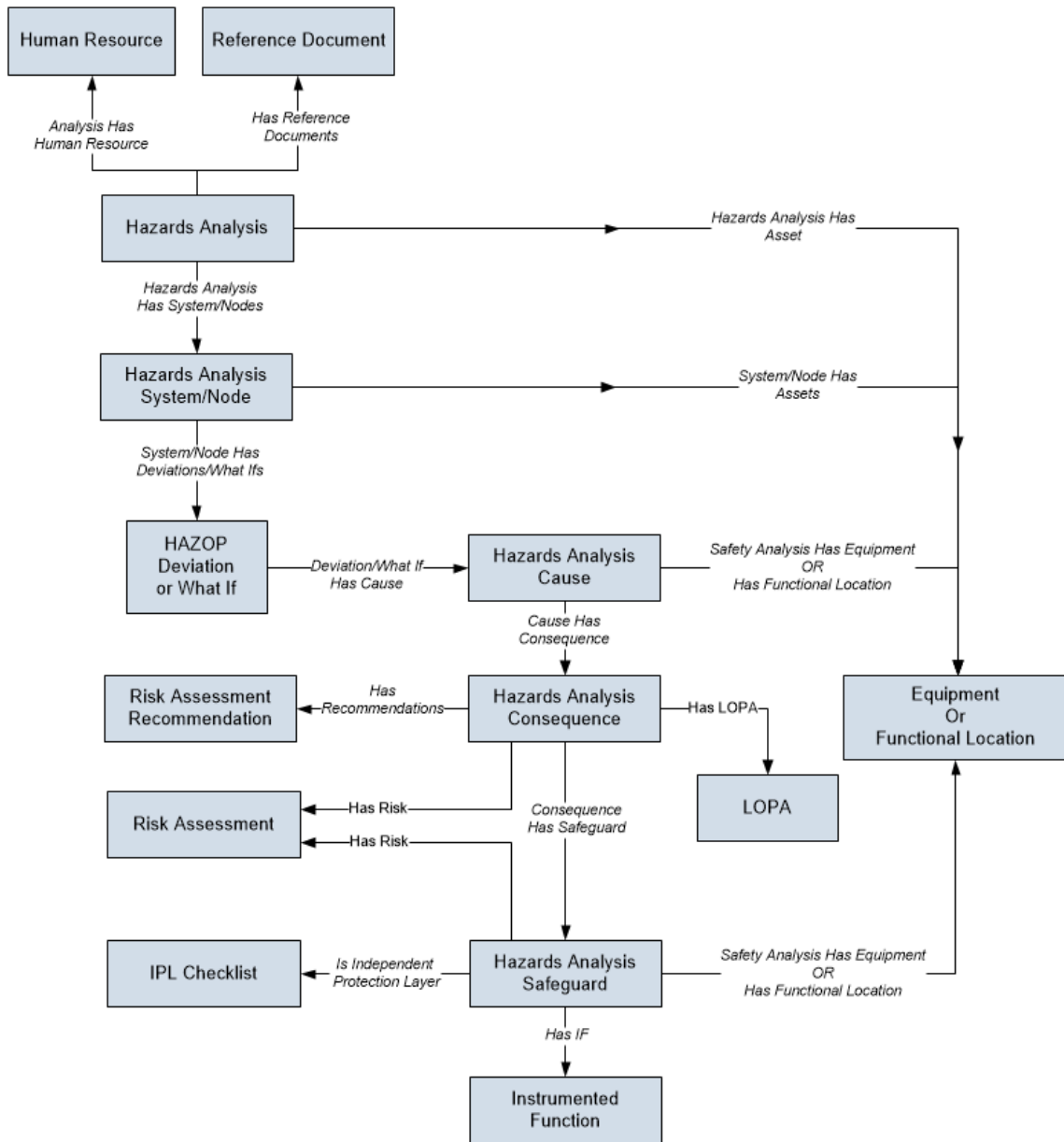

About the Hazards Data Loader Workbook Layout and Use

To import Hazards Analysis data, GE Digital APM provides the data loader workbook (`Hazards.xlsx`). This workbook supports baseline Hazards Analysis in GE Digital APM. You can modify the workbook to include custom fields used by your organization.

The following table lists the worksheets that are included in the data loader workbook.

Worksheet	Description
MI_HAZANANA	This worksheet is used to define the Hazards Analysis records.
MI_HAZANNOD	This worksheet is used to define Hazards Analysis System/Node records.
Node_Assets	This worksheet is used to identify Equipment and Functional Location records.
MI_HAZOPDEV	This worksheet is used to define HAZOP Deviation records.
MI_HAZANCAU	This worksheet is used to define Hazards Analysis Cause records.
MI_HAZANCON	This worksheet is used to define Hazards Analysis Consequence records.
MI_HAZANSAF	This worksheet is used to define Hazards Analysis Safeguard records.
MI_IPL_CHEC	This worksheet is used to define IPL Checklist records
MI_RISKASSE	This worksheet is used to define Risk Assessment records.
MI_RSKASREC	This worksheet is used to define Risk Assessment Recommendation records.
MI_Human_Resource	This worksheet is used to define Human Resource records.

Limitations

The Hazards Data Loader has the following limitations:

- You can import data related to HAZOP Analysis only.
- You must use the data loader workbook. If you modify the format of the values in columns in any of the worksheets, you will not be able to import data.
- The values that you enter in the data loader workbook are case-sensitive.
- If you reimport data, the records that were created by the Hazards Data Loader will be updated. Therefore, while reimporting data related to a record, if you remove the data for a field in the data loader workbook, the value for the corresponding field in GE Digital APM will be blank.

MI_HAZANANA Worksheet

The MI_HAZANANA worksheet stores the details of the Hazards Analysis records.

Field Caption	Field ID	Data Type (Length)	Comments
Analysis ID	MI_AN_ANALY_ID_CHR	Character (255)	A value is required and must be unique. This value identifies the Hazards Analysis.
Site Reference Name	MI_SITE_NAME	Character (50)	This field is required and must match an existing Site name. Note: If you want to set the site reference to be a Global Site Reference, in the MI_SITE_NAME column on the spreadsheet, enter the constant *Global*.
Unit Description	MI_HAZANANA_UNIT_DESCR_C	Character (255)	None
Unit ID	MI_HAZANANA_UNIT_ID_C	Character (50)	None
Process Type	MI_HAZANANA_PROCE_TYPE_C	Character (50)	None
Process Description	MI_HAZANANA_PROCE_DESCR_T	Text	None
Summary	MI_HAZANANA_SUMMA_T	Text	None
Last Modified By	MI_HAZANANA_LAST_MODIF_BY_C	Character (255)	None
Last Modified Date	MI_HAZANANA_LAST_MODIF_DATE_D	Date	None
State	MI_SM_STATE_ID_C	Character (50)	None
State Owner	MI_SM_STATE_OWNER_ID_C	Character (255)	None
Revision Number	MI_HAZANANA_REVIS_NUMBE_C	Character (50)	None
Revision Date	MI_HAZANANA_REVIS_DATE_D	Date	Enter a value in the following format: YYYY-MM-DD hh:mm:ss
MI_SM_STATE_ENTERED_D	MI_SM_STATE_ENTERED_D	Date	Enter a value in the following format: YYYY-MM-DD hh:mm:ss
Analysis Purpose	MI_HAZANANA_ANALY_PURP_O_T	Text	None
Analysis Scope	MI_HAZANANA_ANALY_SCOPE_T	Text	None
Analysis Objective	MI_HAZANANA_ANALY_OBJEC_T	Text	None

Field Caption	Field ID	Data Type (Length)	Comments
Analysis End Date	MI_AN_ANALY_END_DATE_DT	Date	Enter a value in the following format: YYYY-MM-DD hh:mm:ss
Analysis Start Date	MI_AN_ANALY_START_DATE_DT	Date	Enter a value in the following format: YYYY-MM-DD hh:mm:ss
Process Life Cycle Phase	MI_HAZANANA_PROCE_LIFE_CYCLE_C	Character (255)	<p>By default, in GE Digital APM system, this field may contain one of the following System Code IDs:</p> <ul style="list-style-type: none"> • Design and Development • Construction and Startup • Operate and Maintain • Decommissioning <p>The list in this field is populated by the MI_HAZARDS_ANALYSIS_LIFE_CYCLE_PHASE System Code Table. If the system code table has been modified, the valid values could be different. To verify which options are acceptable in your GE Digital APM system, via Configuration Manager, refer to the MI_HAZARDS_ANALYSIS_LIFE_CYCLE_PHASE System Code Table.</p>
Analysis Description	MI_AN_SHORT_DESCR_CHR	Character (255)	None
Is Deleted	MI_HAZANANA_IS_DELET_L	Boolean	Enter TRUE or FALSE.
Reevaluation Interval	MI_HAZANANA_ANALY_REEV_N	Numeric	None
Analysis Type	MI_AN_ANALY_TYPE_CHR	Character (59)	<p>By default, in GE Digital APM system, this fields may contain one of the following values:</p> <ul style="list-style-type: none"> • HAZOP • What If
Next Reevaluation Date	MI_HAZANANA_NEXT_REEVA_DATE_D	Date	Enter a value in the following format: YYYY-MM-DD hh:mm:ss
Production Unit Key	MI_ANLY_PROD_UNIT_KEY_N	Numeric	None
State Key TEST	MI_SM_STATE_KEY_N	Numeric	None
Visual Attributes	MI_AN_VISUA_ATTRI_TX	Character	None

MI_HAZANNOD Worksheet

The MI_HAZANNOD worksheet stores the details of the Hazards Analysis System/Node records.

Field Caption	Field ID	Data Type (Length)	Comments
Analysis ID	MI_AN_ANALY_ID_CHR	Character (255)	A value is required and must match one of the values that you enter in the MI_HAZANANA worksheet. Additionally, all the records that are linked to one another must contain the same Analysis ID.
System/Node ID	MI_HAZANNOD_NODE_ID_C	Character (255)	A value is required and must be unique.
System/Node Number	MI_HAZANNOD_NODE_NUMB E_N	Numeric	A value is required and must follow a sequence. For example, if there are three Systems/Nodes in a Hazards Analysis, then the values in this column for the three Systems/Nodes must be 1, 2, and 3.
Modified By	MI_TST_EQUIP_HIST_DATE_C	Character (255)	None
Modified Date	MI_HAZANNOD_MODIF_BY_C	Date	Enter a value in the following format: YYYY-MM-DD hh:mm:ss
Reference Drawing	MI_HAZANNOD_MODIF_DATE_ D	Character (255)	None
System/Node Description	MI_HAZANNOD_REFER_DRAW I_C	Text	None
System/Node Equipment Type	MI_HAZANNOD_NODE_DESCR _T	Character (255)	None
System/Node Process Type	MI_HAZANNOD_NODE_EQUIP _TYPE_C	Character (255)	None
System/Node Comments	MI_HAZANNOD_COMME_T	Text	None

Node_Assets Worksheet

The Node_Assets worksheet identifies the Equipment and Functional Location records, and links them to each Hazards Analysis.

Field Caption	Field ID	Data Type (Length)	Comments
Analysis ID	MI_AN_ANALY_ID_CHR	Character (255)	A value is required and must match one of the values that you enter in the MI_HAZANANA worksheet. Additionally, all the records that are linked to one another must contain the same Analysis ID.
System/Node ID	MI_HAZANNOD_NODE_ID_C	Character (255)	A value is required and must match the ID of a System/Node that exists in GE Digital APM or one of the values that you enter in the MI_HAZANNOD worksheet.
System/Node Number	MI_HAZANNOD_NODE_NUMB E_N	Numeric	A value is required and must match the value in the System/Node Number field of the System/Node whose ID you have provided in the System/Node ID column.
Equipment Technical Number	MI_EQUIP000_EQUIP_TECH_N BR_C	Character (255)	None
Function Location ID	MI_FNCLOC00_INTERNAL_ID_ C	Character (255)	None

MI_HAZOPDEV Worksheet

The MI_HAZOPDEV worksheet stores the details of the HAZOP Deviation records.

Field Caption	Field ID	Data Type (Length)	Comments
Analysis ID	MI_AN_ANALY_ID_CHR	Character (255)	A value is required and must match one of the values that you enter in the MI_HAZANANA worksheet. Additionally, all the records that are linked to one another must contain the same Analysis ID.
System/Node Number	MI_HAZANNOD_NODE_NUMB E_N	Numeric	A value is required and must match one of the values that you enter in the System/Node Number field, in the MI_HAZANNOD worksheet.

Field Caption	Field ID	Data Type (Length)	Comments
Deviation Sequence Number	MI_HAZOPDEV_SEQUE_NUMB E_N	Numeric	A value is required and must follow a sequence. For example, if there are three Deviations in a System/Node, then the values in this column for the three Deviations must be 1, 2, and 3.
Deviation/Guideword	MI_HAZOPDEV_DEVIA_C	Character (255)	None

MI_HAZANCAU Worksheet

The MI_HAZANCAU worksheet stores details of the Hazards Analysis Cause records.

Field Caption	Field ID	Data Type (Length)	Comments
Analysis ID	MI_AN_ANALY_ID_CHR	Character (255)	A value is required and must match one of the values that you enter in the MI_HAZANANA worksheet. Additionally, all the records that are linked to one another must contain the same Analysis ID.
System/Node Number	MI_HAZANNOD_NODE_NUMB E_N	Numeric	A value is required and must match one of the values that you enter in the MI_HAZANNOD worksheet.
Deviation Sequence Number	MI_HAZOPDEV_SEQUE_NUMB E_N	Numeric	A value is required and must match one of the values that you enter in the MI_HAZOPDEV worksheet.
Cause Sequence Number	MI_HAZANCAU_SEQUE_NUMB E_N	Numeric	A value is required and must follow a sequence. For example, if there are three Causes for a Deviation, then the values in this column for the three Causes must be 1, 2, and 3.
Cause ID	MI_HAZANCAU_CAUSE_ID_C	Character (255)	A value is required.
Functional Location ID	MI_HAZANCAU_FUNCT_LOCAT _ID_C	Character (255)	None
Equipment Technical Number	MI_EQUIP000_EQUIP_TECH_N BR_C	Character (255)	None
Cause Comment	MI_HAZANCAU_CAUSE_COMM E_T	Text	None

Field Caption	Field ID	Data Type (Length)	Comments
Cause Description	MI_HAZANCAU_CAUSE_DESCR_T	Text	None
Cause Type	MI_HAZANCAU_CAUSE_TYPE_CHR	Character (100)	In the baseline GE Digital APM system, this cell is the CCPS Cause Type field and may contain is populated by the value in the Initiating Event ID field of the Initiating Event records. The Cause Frequency (per year) field is populated with the default value of frequency specified in the Initiating Event record based on your selection in the CCPS Cause Type field. For more information, refer to the Initiating Events section of the documentation.

MI_HAZANCON Worksheet

The MI_HAZANCON worksheet stores details of the Hazards Analysis Consequence records.

Field Caption	Field ID	Data Type (Length)	Comments
Analysis ID	MI_AN_ANALY_ID_CHR	Character (255)	A value is required and must match one of the values that you enter in the MI_HAZANANA worksheet. Additionally, all the records that are linked to one another must contain the same Analysis ID.
System/Node Number	MI_HAZANNOD_NODE_NUMBE_N	Numeric	A value is required and must match one of the values that you enter in the MI_HAZANNOD worksheet.
Deviation Sequence Number	MI_HAZOPDEV_SEQUE_NUMBE_N	Numeric	A value is required and must match one of the values that you enter in the MI_HAZOPDEV worksheet.
Cause Sequence Number	MI_HAZANCAU_SEQUE_NUMBE_N	Numeric	A value is required and must match one of the values that you enter in the MI_HAZANCAU worksheet.
Consequence ID	MI_HAZANCON_CONSE_ID_C	Character (255)	A value is required.

Field Caption	Field ID	Data Type (Length)	Comments
Consequence Sequence Number	MI_HAZANCON_SEQUE_NUMBE_N	Numeric	A value is required and must follow a sequence. For example, if there are three Consequences for a Cause, then the values in this column for the three Consequences must be 1, 2, and 3.
Consequence Description	MI_HAZANCON_CONSE_DESCRIPTOR_T	Text	None
Consequence Comment	MI_HAZANCON_CONSE_COMMENT_T	Text	None
Consequence Type	MI_HAZANCON_CONSE_TYPE_CHARACTER	Character (100)	None

MI_HAZANSAF Worksheet

The MI_HAZANSAF worksheet stores details of the Hazards Analysis Safeguard records.

Field Caption	Field ID	Data Type (Length)	Comments
Analysis ID	MI_AN_ANALY_ID_CHARACTER	Character (255)	A value is required and must match one of the values that you enter in the MI_HAZANANA worksheet. Additionally, all the records that are linked to one another must contain the same Analysis ID.
System/Node Number	MI_HAZANNOD_NODE_NUMBE_N	Numeric	A value is required and must match one of the values that you enter in the MI_HAZANNOD worksheet.
Deviation Sequence Number	MI_HAZOPDEV_SEQUE_NUMBE_N	Numeric	A value is required and must match one of the values that you enter in the MI_HAZOPDEV worksheet.
Cause Sequence Number	MI_HAZANCAU_SEQUE_NUMBE_N	Numeric	A value is required and must match one of the values that you enter in the MI_HAZANCAU worksheet.

Field Caption	Field ID	Data Type (Length)	Comments
Consequence Sequence Number	MI_HAZANCON_SEQUE_NUMBE_N	Numeric	A value is required and must follow a sequence. For example, if there are three Consequences for a Cause, then the values in this column for the three Consequences must be 1, 2, and 3.
Safeguard ID	MI_HAZANSAF_SAFEG_ID_C	Character (255)	A value is required.
Safeguard Sequence Number	MI_HAZANSAF_SEQUE_NUMBE_N	Numeric	A value is required and must follow a sequence. For example, if there are three Safeguards for a Consequence, then the values in this column for the three Safeguards must be 1, 2, and 3.
Functional Location ID	MI_HAZANSAF_FUNCT_LOCAT_ID_C	Character (255)	Enter a value that matches the value in the Functional Location ID field of a Functional Location that exists in the database.
Equipment Technical Number	MI_EQUIP000_EQUIP_TECH_NBR_C	Character (255)	Enter a value that matches the value in the Equipment Technical Number field of an Equipment that exists in the database.
Safeguard Comment	MI_HAZANSAF_SAFEG_COMM E_T	Character	None
Safeguard Type	MI_HAZANSAF_SAFEG_TYPE_C	Character (100)	None
Safeguard Description	MI_HAZANSAF_SAFEG_DESCR _T	Text	None
IF ID	MI_HAZANSAF_PIF_ID_C	Character (255)	You must enter a value that matches the value in the PIF ID field of an Instrumented Function that exists in the database.
Is the IPL independent of the initiating cause of the hazardous scenario?	MI_HAZANSAF_IS_IPL_INDEP_ L	Boolean	Enter TRUE or FALSE.
Is the IPL specific in that it has the ability to detect the hazardous scenario?	MI_HAZANSAF_IS_IPL_SPCFC_ L	Boolean	Enter TRUE or FALSE.
Is the IPL auditable with applicable industry standard?	MI_HAZANSAF_IS_IPL_ADTBL_ L	Boolean	Enter TRUE or FALSE.

Field Caption	Field ID	Data Type (Length)	Comments
Is the IPL capable with respect to its availability?	MI_HAZANSAF_IS_IPL_CPBL_L	Boolean	Enter TRUE or FALSE.
IPL Type	MI_HAZANSAF_IPL_TYPE_C	Character (50)	<p>In the baseline GE Digital APM system, this cell may contain one of the following System Code IDs:</p> <ul style="list-style-type: none"> • Consequence Reducing IPL • Frequency Reducing IPL <p>The list in this field is populated by the MI_HAZOP_IPL_TYPE System Code Table. If the system code table has been customized, the valid values could be different. To verify which options are acceptable in your GE Digital APM system, using Configuration Manager, access and verify with the appropriate System Code table.</p>
IPL Credits	MI_HAZANSAF_IPL_CREDI_N	Numeric	In the baseline GE Digital APM system, this cell may contain a value between 1 and 10.

Field Caption	Field ID	Data Type (Length)	Comments
Type	MI_HAZANSAF_TYPE_C	Character (50)	<p>This field is stored only if the values for all the IPL Criteria associated with the Safeguard is TRUE.</p> <p>In the baseline GE Digital APM system, this cell may contain one of the following System Code IDs:</p> <ul style="list-style-type: none"> • Active IPL • Passive IPL • Human IPL <p>The list in this field is populated by the MI_IPL_TYPES_SAFEGUARD System Code Table. If the System Code Table has been customized, the valid values could be different. To verify which options are acceptable in your GE Digital APM system, using Configuration Manager, access and verify with the MI_IPL_TYPES_SAFEGUARD System Code Table.</p>

Field Caption	Field ID	Data Type (Length)	Comments
IPL Sub Type	MI_HAZANSAF_IPL_SUB_TYPE_ C	Character (250)	<p>This field is stored only if the values for all the IPL Criteria associated with the Safeguard is TRUE.</p> <p>In the baseline GE Digital APM system, this cell may contain System Codes from one of the following System Code Tables:</p> <ul style="list-style-type: none"> • MI_ACTIVE_IPL System Code table if the value in the IPL Type field is Active IPL. • MI_PASSIVE_IPL System Code table if the value in the IPL Type field is Passive IPL. • MI_HUMAN_IPL System Code table if the value in the IPL Type field is Human IPL. <p>To verify which options are acceptable in your GE Digital APM system, using Configuration Manager, access and verify with the appropriate System Code Table.</p>

Field Caption	Field ID	Data Type (Length)	Comments
PFD	MI_HAZANSAF_PFD_N	Numeric	<p>This field is stored only if the values for all the IPL Criteria associated with the Safeguard is TRUE.</p> <p>The default value for the PFD field for each IPL Sub Type is provided in the following records:</p> <ul style="list-style-type: none"> Active IPL record if the value in the IPL Type field is Active IPL. Passive IPL record if the value in the IPL Type field is Passive IPL. Human IPL record if the value in the IPL Type field is Human IPL. <p>For more information, refer to the Layers of Protection Analysis section of the documentation.</p> <p>To verify which value is acceptable in your GE Digital APM system, using Record Manager, access and verify with the appropriate record.</p> <p>For more information, refer to the Manage Records section of the documentation.</p>

MI_IPL_CHEC Worksheet

The MI_IPL_CHEC worksheet stores details of the IPL Checklist records.

Field Caption	Field ID	Data Type (Length)	Comments
Analysis ID	MI_AN_ANALY_ID_CHR	Character (255)	<p>A value is required and must match one of the values that you enter in the MI_HAZANANA worksheet. Additionally, all the records that are linked to one another must contain the same Analysis ID.</p>
System/Node Number	MI_HAZANNOD_NODE_NUMBE_N	Numeric	<p>A value is required and must match one of the values that you enter in the MI_HAZANNOD worksheet.</p>

Field Caption	Field ID	Data Type (Length)	Comments
Deviation Sequence Number	MI_HAZOPDEV_SEQUE_NUMB E_N	Numeric	A value is required and must match one of the values that you enter in the MI_HAZOPDEV worksheet.
Cause Sequence Number	MI_HAZANCAU_SEQUE_NUMB E_N	Numeric	A value is required and must match one of the values that you enter in the MI_HAZANCAU worksheet.
Consequence Sequence Number	MI_HAZANCON_SEQUE_NUMB E_N	Numeric	A value is required and must follow a sequence. For example, if there are three Consequences for a Cause, then the values in this column for the three Consequences must be 1, 2, and 3.
Safeguard ID	MI_HAZANSAF_SAFEG_ID_C	Character (255)	A value is required.
Safeguard Sequence Number	MI_HAZANSAF_SEQUE_NUMB E_N	Numeric	A value is required and must follow a sequence. For example, if there are three Safeguards for a Consequence, then the values in this column for the three Safeguards must be 1, 2, and 3.

Field Caption	Field ID	Data Type (Length)	Comments
IPL Criteria	MI_IPL_CHEC_IPL_CRIT_C	Character (250)	<p>In the baseline GE Digital APM system, this cell may contain one of the following values:</p> <ul style="list-style-type: none"> Is the IPL Independent of the initiating cause of the hazardous scenario? Is the IPL Auditable with applicable industry standard? Is the IPL Specific in that has the ability to detect the hazardous scenario? Is the IPL Capable with respect to its availability? Is the Risk Reduction Factor (RRF) ≥ 10? <p>The list in this field is populated by the Asset Safety Preferences records. If the records have been customized, the valid values could be different. To verify which options are acceptable access the administrative settings for LOPA, to view the list of criteria configured in your GE Digital APM system.</p>
IPL Criteria Value	MI_IPL_CHEC_IPL_CRIT_VALU_F	Boolean	Enter TRUE or FALSE.

MI_RISKASSE Worksheet

The MI_RISKASSE worksheet stores details of the Risk Assessment records.

Field Caption	Field ID	Data Type (Length)	Comments
Analysis ID	MI_AN_ANALY_ID_CHR	Character (255)	A value is required and must match one of the values that you enter in the MI_HAZANANA worksheet. Additionally, all the records that are linked to one another must contain the same Analysis ID.
System/Node Number	MI_HAZANNOD_NODE_NUMB E_N	Numeric	A value is required and must match one of the values that you enter in the MI_HAZANNOD worksheet.

Field Caption	Field ID	Data Type (Length)	Comments
Deviation Sequence Number	MI_HAZOPDEV_SEQUE_NUMB E_N	Numeric	A value is required and must match one of the values that you enter in the MI_HAZOPDEV worksheet.
Cause Sequence Number	MI_HAZANCAU_SEQUE_NUMB E_N	Numeric	A value is required and must match one of the values that you enter in the MI_HAZANCAU worksheet.
Consequence Sequence Number	MI_HAZANCON_SEQUE_NUMB E_N	Numeric	A value is required and must match one of the values that you enter in the MI_HAZANCON worksheet.
Safeguard Sequence Number	MI_HAZANSAF_SEQUE_NUMB E_N	Character (10)	A value is required and must match one of the values that you enter in the MI_HAZANSAF worksheet.
(ENVIRONMENT) Consequence	ENVIRONMENT MI_CONSE_N	Numeric	None
(ENVIRONMENT) Probability	ENVIRONMENT MI_PROB_N	Numeric	None
(ENVIRONMENT) Protection Level	ENVIRONMENT MI_PROT_N	Numeric	None
(FINANCIAL) Consequence	FINANCIAL MI_CONSE_N	Numeric	None
(FINANCIAL) Maintenance Cost	FINANCIAL MI_RISK_MAIN_COST_N	Numeric	None
(FINANCIAL) Probability	FINANCIAL MI_PROB_N	Numeric	None
(FINANCIAL) Production Loss	FINANCIAL MI_RISK_PROD_LOSS_N	Numeric	None
(FINANCIAL) Protection level	FINANCIAL MI_PROT_N	Numeric	None
(OPERATIONS) consequence	OPERATIONS MI_CONSE_N	Numeric	None
(OPERATIONS) Probability	OPERATIONS MI_PROB_N	Numeric	None
(OPERATIONS) Protection Level	OPERATIONS MI_PROT_N	Numeric	Enter TRUE or FALSE.
(SAFETY) Consequence	SAFETY MI_CONSE_N	Numeric	None
(SAFETY) Probability	SAFETY MI_PROB_N	Numeric	None

MI_RSKASREC Worksheet

The MI_RSKASREC worksheet stores details of the Risk Assessment Recommendation records.

Field Caption	Field ID	Data Type (Length)	Comments
Analysis ID	MI_AN_ANALY_ID_CHR	Character (255)	A value is required and must match one of the values that you enter in the MI_HAZANANA worksheet. Additionally, all the records that are linked to one another must contain the same Analysis ID.
System/Node Number	MI_HAZANNOD_NODE_NUMB E_N	Numeric	A value is required and must match one of the values that you enter in the MI_HAZANNOD worksheet.
Deviation Sequence Number	MI_HAZOPDEV_SEQUE_NUMB E_N	Numeric	A value is required and must match one of the values that you enter in the MI_HAZOPDEV worksheet.
Cause Sequence Number	MI_HAZANCAU_SEQUE_NUMB E_N	Numeric	A value is required and must match one of the values that you enter in the MI_HAZANCAU worksheet.
Consequence Sequence Number	MI_HAZANCON_SEQUE_NUMB E_N	Numeric	A value is required and must match one of the values that you enter in the MI_HAZANCON worksheet.
Recommendation ID	MI_REC_ID	Character (255)	A value is required.
Target Completion Date	MI_REC_TARGE_COMPL_DATE_ DT	Date	A value is required. Enter the value in the following format: YYYY-MM-DD hh:mm:ss

Field Caption	Field ID	Data Type (Length)	Comments
Status	MI_REC_STATU_CHR	Character (50)	<p>In the baseline GE Digital APM system, this cell may contain one of the following System Code IDs:</p> <ul style="list-style-type: none"> • APPROVED • CREATED • PENDING REVIEW • REVIEWED • REJECTED • CANCELLED • SUPERCEDED • IN PROGRESS • IMPLEMENTED <p>The list in this field is populated by the MI_STATUS System Code Table. If the system code table has been customized, the valid values could be different. To verify which options are acceptable in your GE Digital APM system, via Configuration Manager, refer to the appropriate table.</p>
Equipment Technical Number	MI_EQUIP000_EQUIP_TECH_N BR_C	Character (255)	None
Days Before Due Date to be Notified	MI_REC_DAYS_BEF_DUE_DT_N OT_NBR	Numeric	None
Reevaluate?	MI_REC_REEVAL_FLG	Boolean	Enter TRUE or FALSE.
Reevaluation Notification List	MI_REC_REEVAL_NOTIF_LIST_C HR	Character (2000)	None
Work Request Reference	MI_REC_WK_REQ_REF_CHR	Character (50)	None
Work Order Number	MI_REC_WORK_ORDER_NUMB _CHR	Character (50)	None
Generate Work Request	MI_REC_WO_INTERFACE_FLAG _F	Boolean	Enter TRUE or FALSE.
Meridium Task ID	MI_REC_WO_INTERFACE_FLAG _F	Date	Enter a value in the following format: YYYY-MM-DD hh:mm:ss
Reviewer ID	MI_REC_REVIE_CHR	Character (255)	Enter TRUE or FALSE.
Alert Assignee When Due?	MI_REC_NOTIFY_RP_FLG	Boolean	None

Field Caption	Field ID	Data Type (Length)	Comments
Reevaluation Date	MI_REC_REEVAL_DT	Date	Enter a value in the following format: YYYY-MM-DD hh:mm:ss
Implementation Alert Text	MI_REC_NOTIF_EMAIL_TEXT_C HR	Text	None
Required Equipment Status	MI_REC_REQUI_EQUIP_STATU_ CHR	Character (50)	None
Business Impact	MI_REC_IMPAC_CHR	Character (100)	None
Published Flag	MI_REC_PUB_FLAG_F	Boolean	Enter TRUE or FALSE.
Final Approver ID	MI_REC_FINAL_APPRO_ID_C	Character (255)	None
Associated Reference	MI_REC_EVTNREF_CHR	Character (255)	None
Generate Meridium Task	MI_REC_GENERATE_MERID_TA SK_F	Boolean	Enter TRUE or FALSE.
Final Approver Name	MI_REC_FINAL_APPROVE_NA ME_C	Character (255)	None
Reviewer Name	MI_REC_REVIE_NM_CHR	Character	None
Reevaluation Alert Body Text	MI_REC_REEVAL_EMAIL_TX	Text	None
Final State Lock	MI_REC_FINAL_STATE_LOCK_F	Boolean	Enter TRUE or FALSE.
Completed Date	MI_REC_COMPL_DATE_DT	Date	Enter a value in the following format: YYYY-MM-DD hh:mm:ss
Recommendation Priority	MI_REC_PRIORITY_C	Character (50)	None
Recommendation Description	MI_REC_LONG_DESCR_TX	Text	None
Recommendation Headline	MI_REC_SHORT_DESCR_CHR	Character (255)	None
Frequency of Alert After Due Date	MI_REC_NOTIF_AFTER_DD_CH R	Character (50)	None
Recommendation Basis	MI_REC_BASIS	Character (255)	None
Author Lock	MI_REC_AUTHOR_LOCK_F	Boolean	Enter TRUE or FALSE.
Author Name	MI_REC_AUTHO_NM_CHR	Character (255)	None
Assigned To Name	MI_REC_ASSIG_NM_CHR	Character (255)	None
Author User ID	MI_REC_AUTHO_CHR	Character (255)	None
State	MI_SM_STATE_ID_C	Character	None
Mandatory Date	MI_SM_STATE_ID_C	Date	Enter a value in the following format: YYYY-MM-DD hh:mm:ss
State Owner	MI_SM_STATE_OWNER_ID_C	Character	None

Field Caption	Field ID	Data Type (Length)	Comments
State Entered	MI_SM_STATE_ENTERED_D	Date	Enter a value in the following format: YYYY-MM-DD hh:mm:ss
Analysis ID	MI_REC_ANALY_ID_CHR	Character (255)	None
Create Work Request?	MI_REC_CREATE_SAP_NOTIF_FLG	Boolean	Enter TRUE or FALSE.
Work Request Functional Location	MI_REC_WR_LOC_C	Character (255)	None
Work Request Equipment	MI_REC_WR_EQUIP_C	Character (255)	None
Notification Type	MI_REC_NOTIF_TYPE_C	Character (2)	None
Assigned To User ID	MI_REC_ASSIG_TO_CHR	Character (255)	None
Recommendation Type	MI_REC_TYPE_CHR	Character (255)	None
Completion Comments	MI_REC_CLOSE_COMME_TX	Text	None
Functional Location Key	MI_RSKASREC_FUNCT_LOCAT_KEY_N	Numeric	None
Functional Location ID	MI_REC_LOC_ID_CHR	Character (2000)	None
Recommendation Closure Date	MI_REC_CLOSE_DATE_DT	Date	Enter a value in the following format: YYYY-MM-DD hh:mm:ss
Last Change Date	MI_REC_LAST_CHANG_DATE_DT	Date	Enter a value in the following format: YYYY-MM-DD hh:mm:ss
Last Changed By	MI_REC_LAST_CHANG_BY_CHR	Character (255)	None
Technical Number	MI_REC_TECHNICAL_NUM_C	Character (50)	None
Asset Description	MI_REC_ASSET_DESCR_C	Character (255)	None
Action Interval Units	MI_RSKASREC_INTER_UNITS_C	Character (50)	None
Action Interval	MI_RSKASREC_INTER_UNITS_C	Numeric	None
State Key	MI_SM_STATE_KEY_N	Numeric	None

MI_Human_Resource Worksheet

The MI_Human_Resource worksheet stores details of the Human Resource records.

Field Caption	Field ID	Data Type (Length)	Comments
Analysis ID	MI_AN_ANALY_ID_CHR	Character (255)	A value is required and must match one of the values that you enter in the MI_HAZANANA worksheet. Additionally, all the records that are linked to one another must contain the same Analysis ID.
First Name	MI_HR_FIRST_NAME_CHR	Character (255)	A value is required.
Last Name	MI_HR_LAST_NAME_CHR	Character (255)	A value is required.
Resource ID	MI_RES_ID_CHR	Character (255)	A value is required.
Badge Id	MI_HR_BADGE_ID	Character (20)	None
Company Id	MI_HR_COMPANY_CHR	Character (255)	None
Department	MI_HR_DEPT_CHR	Character (255)	None
Address1	MI_HR_ADDR1_CHR	Character (255)	None
Address2	MI_HR_ADDR2_CHR	Character (255)	None
Area of Responsibility	MI_HR_AREA_RESPONSIBILITY_TX	Character (100)	None
Facility	MI_HR_AREA_RESPONSIBILITY_TX	Character (50)	None
Business Unit	MI_HR_BUSINESS_UNIT_TX	Character (50)	None
Domain	MI_HR_DOMAIN_TX	Character (50)	None
Culture	MI_HR_CULTURE_ID	Character (10)	None
City	MI_HR_CITY_CHR	Character (255)	None
State	MI_HR_STATE_CHR	Character (255)	None
Postal Code	MI_HR_POSTCODE_CHR	Character (100)	None
Country	MI_HR_COUNTRY_CHR	Character (50)	None
Phone1	MI_HR_PHONE1_CHR	Character (50)	None
Phone2	MI_HR_PHONE2_CHR	Character (50)	None
Fax	MI_HR_FAX_CHR	Character (50)	None
Email Address	MI_HR_EMAIL_TX	Character (500)	None
Comments	MI_HR_COMMENTS_TX	Text	None
Available?	MI_HR_AVAIL_CHR	Character (10)	None
Site Code	MI_SITE_CD_CHR	Character (20)	None

Chapter 7

Deployment and Upgrade

Topics:

- [Deployment](#)
- [Upgrade](#)

Deployment

Deployment

Refer to the deployment information here [Deploy Hazards Analysis for the First Time](#).

Upgrade

Upgrade

Refer to the upgrade information here [Upgrade or Update Hazards Analysis to V5.0.3.0.0](#).

Chapter 8

Reference

Topics:

- [General Reference](#)
- [Family Field Descriptions](#)
- [Catalog Items](#)

General Reference

Hazards Analysis Data Model

The following diagram shows how the families used in a HAZOP Analysis are related to one another.

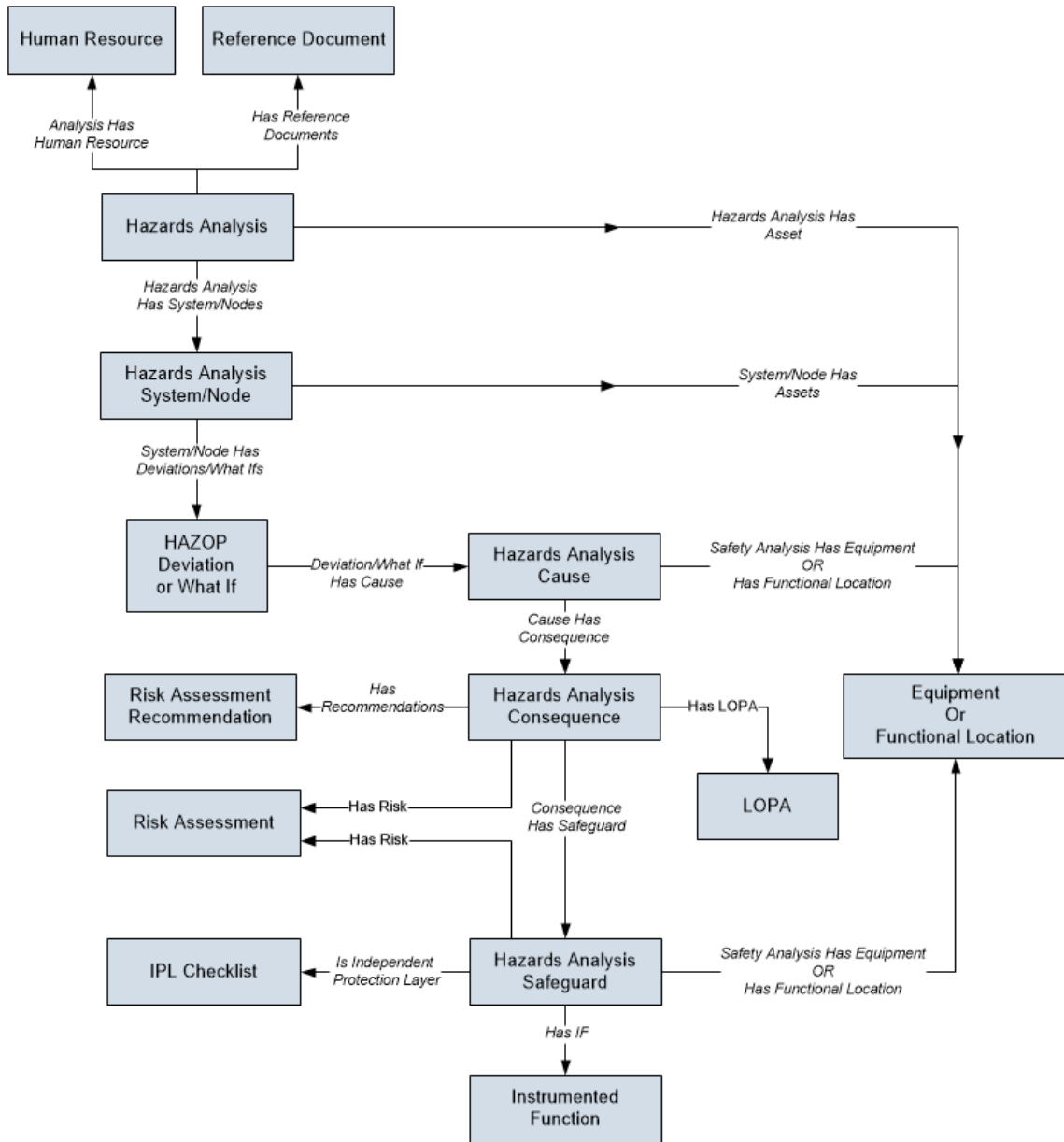

The following diagram shows how the families used in a What If Analysis are related to one another.

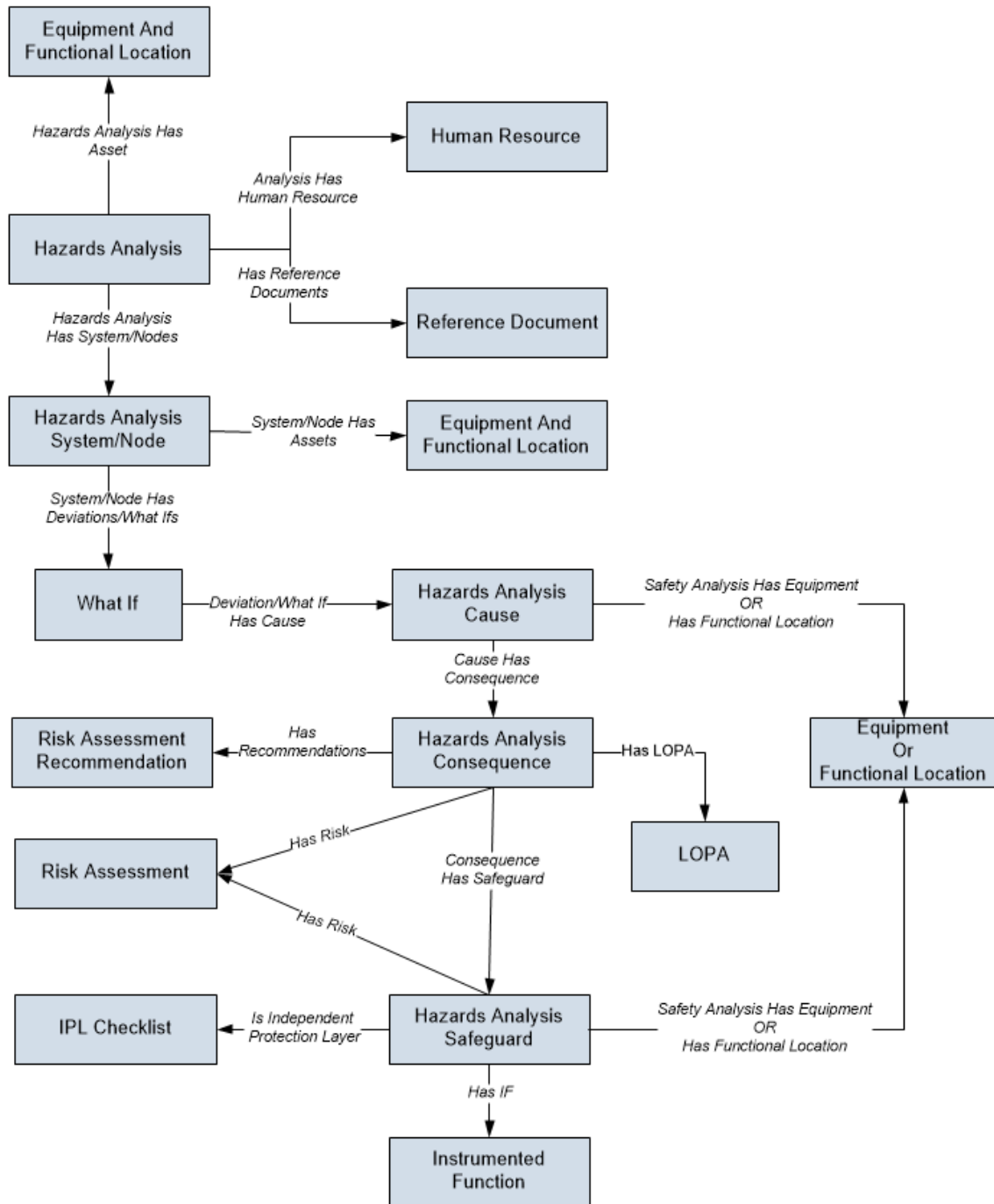

Note: In the preceding diagrams, boxes represent entity families and arrows represent relationship families that are configured in the baseline database. You can determine the direction of the each relationship definition from the direction of the arrow head: the box from which the arrow originates is the predecessor, and the box to which the arrow head points is the successor.

All HAZOP Analyses and What If Analyses begin with a Hazards Analysis. Each Hazards Analysis is linked to:

- **Equipment** records.
- **Functional Location** records.

- **Human Resource** records.
- **Reference Document** records.
- **System/Node** records.

Depending on whether you are conducting a HAZOP Analysis or a What If Analysis, each System/Node is linked to:

- **HAZOP Deviation** records (for a HAZOP Analysis).
- or-
- **What If** records (for a What If Analysis).
- **Equipment** records.
- **Functional Location** records.

Note: The record to which the System/Node is linked is the only difference between the HAZOP Analysis data model and the What If Analysis data model.

Each **HAZOP Deviation** or **What If** is linked to one or more **Cause** records.

Each **Cause** is linked to:

- One **Equipment** record.
- One **Functional Location** record.
- **Hazards Analysis Consequence** records.

Each **Consequence** is linked to:

- **Risk Assessment Recommendation** records.

Note: Risk Assessment Recommendations can be linked to Equipment through the Safety Analysis Has Equipment relationship. To simplify the data model images, this relationship is not included in the images.

- One **Risk Assessment** record.
- **Hazards Analysis Safeguard** records.
- One **LOPA** record.

Each **Safeguard** can be linked to:

- One **Equipment** record.
- One **Functional Location** record.
- One **Risk Assessment** record.
- One **Instrumented Function** record.

Note: Instrumented Functions are also used by SIS Management to store details on the instrumented function for a given safety system.

In addition to the relationships explained previously, families exist that are used by Hazards Analysis to support Revision History. The family caption for these families matches the source family name, appended with Revision to indicate that the family is a Revision family.

Hazards Analysis Security Groups

The following table lists the baseline Security Groups available for users within this module, as well as the baseline Roles to which those Security Groups are assigned.

Important: Assigning a Security User to a Role grants that user the privileges associated with all of the Security Groups that are assigned to that Role. To avoid granting a Security User unintended privileges, before assigning a Security User to a Role, be sure to review all of the privileges associated with the Security Groups assigned to that Role. Also, be aware that additional Roles, as well as Security Groups assigned to existing Roles, can be added via Security Manager.

Security Group	Roles
MI HA Administrator	MI HA Administrator MI Safety Admin
MI HA Facilitator	MI HA Facilitator MI Safety Admin MI Safety Power MI Safety User
MI HA Member	MI HA Member MI Safety Admin MI Safety Power MI Safety User
MI HA Owner	MI HA Owner MI Safety Admin MI Safety Power
MI Hazards Viewer	MI APM Viewer MI Hazards Viewer MI Safety Admin MI Safety Power MI Safety User

The baseline family-level privileges that exist for these Security Groups are summarized in the following table.

Note: The baseline family-level privileges available in the LOPA module are also applicable to Security Groups in Hazards Analysis module.

Family	MI HA Administrator	MI HA Facilitator	MI HA Member	MI HA Owner	MI Hazards Viewer
Entity Families					
Alert	View, Update, Insert, Delete	View, Update, Insert, Delete	None	View, Update, Insert, Delete	View
Consequence	View, Update, Insert, Delete	View	View	View	View
Equipment	View	View	View	View	View
Functional Location	View	View	View	View	View
Hazards Analysis	View, Update, Insert, Delete	View, Update, Insert, Delete	View	View, Update, Insert, Delete	View
Hazards Analysis Cause	View, Update, Insert, Delete	View, Update, Insert, Delete	View	View, Update, Insert, Delete	View

Family	MI HA Administrator	MI HA Facilitator	MI HA Member	MI HA Owner	MI Hazards Viewer
Hazards Analysis Consequence	View, Update, Insert, Delete	View, Update, Insert, Delete	View	View, Update, Insert, Delete	View
Hazards Analysis Safeguard	View, Update, Insert, Delete	View, Update, Insert, Delete	View	View, Update, Insert, Delete	View
Hazards Analysis System/Node	View, Update, Insert, Delete	View, Update, Insert, Delete	View	View, Update, Insert, Delete	View
HAZOP Deviation	View, Update, Insert, Delete	View, Update, Insert, Delete	View	View, Update, Insert, Delete	View
Human Resource	View, Update, Insert, Delete	View, Update, Insert, Delete	View	View, Update, Insert, Delete	View
Initiating Event	View, Update, Insert, Delete	View	View	View	View
Instrumented Function	View	View	View	View	View
Probability	View, Update, Insert, Delete	View	View	View	View
Protection Level	View, Update, Insert, Delete	View, Insert	View, Insert	View, Insert	View
Reference Document	View, Update, Insert, Delete	View, Update, Insert, Delete	View	View, Update, Insert, Delete	View
Risk Assessment	View, Update, Insert, Delete	View, Update, Insert, Delete	View	View, Update, Insert, Delete	View
Risk Assessment Recommendation	View, Update, Insert, Delete	View, Update, Insert, Delete	View	View, Update, Insert, Delete	View
Risk Category	View, Update, Insert, Delete	View, Update, Insert, Delete	View	View, Update, Insert, Delete	View
Risk Matrix	View, Update, Insert, Delete	View, Update, Insert, Delete	View	View, Update, Insert, Delete	View
Risk Rank	View, Update, Insert, Delete	View, Update, Insert, Delete	View	View, Update, Insert, Delete	View
Risk Threshold	View, Update, Insert, Delete	View	View	View	View
Site Reference	View	View	View	View	View
What If	View, Update, Insert, Delete	View, Update, Insert, Delete	View	View, Update, Insert, Delete	View
Relationship Families					
Analysis Has Human Resource	View, Update, Insert, Delete	View, Update, Insert, Delete	View	View, Update, Insert, Delete	View

Family	MI HA Administrator	MI HA Facilitator	MI HA Member	MI HA Owner	MI Hazards Viewer
Cause Has Consequence	View, Update, Insert, Delete	View, Update, Insert, Delete	View	View, Update, Insert, Delete	View
Cause Revision Has Consequence Revision	View, Update, Insert, Delete	View, Update, Insert, Delete	View	View, Update, Insert, Delete	View
Consequence Has Safeguard	View, Update, Insert, Delete	View, Update, Insert, Delete	View	View, Update, Insert, Delete	View
Consequence Revision Has Safeguard Revision	View, Update, Insert, Delete	View, Update, Insert, Delete	View	View, Update, Insert, Delete	View
Deviation\What If Has Cause	View, Update, Insert, Delete	View, Update, Insert, Delete	View	View, Update, Insert, Delete	View
Deviation\What If Revision Has Cause Revision	View, Update, Insert, Delete	View, Update, Insert, Delete	View	View, Update, Insert, Delete	View
Equipment Has Equipment	View	View	View	View	View
Functional Location Has Equipment	View	View	View	View	View
Functional Location Has Functional Location	View	View	View	View	View
Has Functional Location	View, Update, Insert, Delete	View, Update, Insert, Delete	View	View, Update, Insert, Delete	View
Has Hazards Analysis Revision	View, Update, Insert, Delete	View, Update, Insert, Delete	View	View, Update, Insert, Delete	View
Has HAZOP Reference	View, Update, Insert, Delete	View, Update, Insert, Delete	View	View, Update, Insert, Delete	View
Has IF	View, Update, Insert, Delete	View, Update, Insert, Delete	View	View, Update, Insert, Delete	View
Has LOPA	View, Update, Insert, Delete	View, Update, Insert, Delete	View	View	View
Has Recommendations	View, Update, Insert, Delete	View, Update, Insert, Delete	View	View, Update, Insert, Delete	View
Has Reference Documents	View, Update, Insert, Delete	View, Update, Insert, Delete	View	View, Update, Insert, Delete	View
Has Reference Values	View, Update, Insert, Delete	View	View	View	View
Has Risk	View, Update, Insert, Delete	View, Update, Insert, Delete	View	View, Update, Insert, Delete	View

Family	MI HA Administrator	MI HA Facilitator	MI HA Member	MI HA Owner	MI Hazards Viewer
Has Risk Category	View, Update, Insert, Delete	View, Update, Insert, Delete	View	View, Update, Insert, Delete	View
Has Risk Matrix	View, Update, Insert, Delete	View, Update, Insert, Delete	View	View, Update, Insert, Delete	View
Has Site Reference	View, Update, Insert, Delete	View, Update, Insert, Delete	View	View, Update, Insert, Delete	View
Hazards Analysis Has Assets	View, Update, Insert, Delete	View, Update, Insert, Delete	View	View, Update, Insert, Delete	View
Hazards Analysis Revision Has Systems/Nodes Revision	View, Update, Insert, Delete	View, Update, Insert, Delete	View	View, Update, Insert, Delete	View
Is Independent Protection Layer	View, Update, Insert, Delete	View, Update, Insert, Delete	View	View, Update, Insert, Delete	View
Mitigates Risk	View, Update, Insert, Delete	View, Update, Insert, Delete	View	View, Update, Insert, Delete	View
Safety Analysis Has Equipment	View, Update, Insert, Delete	View, Update, Insert, Delete	View	View, Update, Insert, Delete	View
System/Node Has Deviations/What Ifs	View, Update, Insert, Delete	View, Update, Insert, Delete	View	View, Update, Insert, Delete	View
System/Node Has Deviations/What Ifs Revision	View, Update, Insert, Delete	View, Update, Insert, Delete	View	View, Update, Insert, Delete	View

Hazards Analysis URLs

There is one URL route associated with Hazards Analysis: **asset-safety/hazards**. The following table describes the various paths that build on the route, and the elements that you can specify for each.

Tip: For more information, refer to the URLs section of the documentation.

Element	Description	Accepted Value(s)	Notes
asset-safety/hazards/overview: Displays the Hazards Analysis Overview page.			
asset-safety/hazards/<AnalysisType>/<EntityKey>: Displays the Analysis Summary workspace for the analysis with the specified type and Entity Key.			
<AnalysisType>	Specifies the type of the analysis.	hazop	None
		whatIf	
<EntityKey>	Specifies the analysis that you want to access.	Any numeric Entity Key that corresponds to an existing analysis.	Opens the specified analysis in a new tab.

URLs	
Example URL	Destination
asset-safety/hazards/overview	Hazards Analysis Overview page
asset-safety/hazards/hazop/64251874508	Analysis Summary workspace of the Hazards Analysis of the type HAZOP with the Entity Key 64251874508
asset-safety/hazards/whatif/64251874509	Analysis Summary workspace of the Hazards Analysis of the type What If with the Entity Key 64251874509

An Example of a Hazards Analysis

This topic illustrates how Hazards Analysis is applied to a hazardous process involving transfer of chemicals from one tank to another.

The following image illustrates the process of transferring hazardous chemicals from Tank E-1 to Tank E-2.

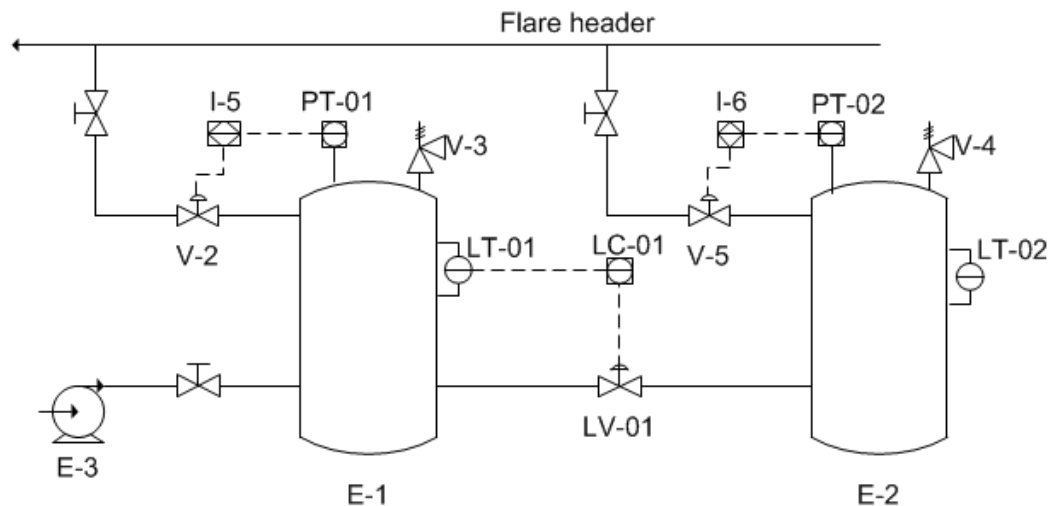

LEGEND

- E-1 and E-2: Process Vessels
- E-3: Pump
- LT-01, LC-01, LV-01: Level Control Loop
- V-3 and V-4: PSV
- PT-01, I-5, V2: High Pressure Instrumented Function
- PT-02, I6, V5: High Pressure Instrumented Function

The liquid level in E-1 is maintained by the level control loop that contains the following elements:

- level sensor (LT-01)
- level controller (LC-01)
- level valve (LV-01)

When the level increases above the set point the valve moves in the open direction. Conversely, when the level is below the set point the valve moves in the close direction.

Failure of any component in the level control loop can cause an excess pressure event in E-1. The probability of the event is reduced by the presence and proper operation of the following two safeguards:

- **High Pressure Instrumented Functions:** Open a vent line to the flare system where excess pressure can safely be burned off. The set point of the instrumented function is 80% of the maximum allowable working pressure (MAWP)
- **Pressure Safety Valves:** Vent out excess pressure to the atmosphere when the pressure reaches a point of 90% of the MAWP

Note: This example represents a simplified process and is provided to explain the terminology and concepts that you will need to understand in order to work with the Hazards Analysis module. Depending on the types of processes in your facility, the complexity of your analyses will differ. For example, your process might include multiple deviations, or it might include deviations that are also causes of other deviations.

Scenario 1: Failure of the Level Control in E-1

Suppose that a scenario occurs, where the level control in E-1 fails, leading to a catastrophic failure of E-1 and ultimately causing multiple fatalities. This scenario includes the following risk and risk assessment:

- **Risk:** Hazardous chemicals leak out of the connector, causing multiple fatalities.
- **Risk Assessment:** The probability of multiple fatalities having a negative safety impact is very high, and the severity of the impact is also very high. However, multiple fatalities are not likely to cause a negative environmental impact.

The specific parts of the scenario are outlined in the following list:

- **System/Node:** The chemical transfer system that consists of E-1 and E-2, two pressure sensors, pressure switches, and valves.
- **Deviation:** More pressure in E-1.
- **Cause:** Failure of the pressure switch and the valve connected to E-1.
- **Consequence:** Multiple people around the connector at the time of the leak are killed.
- **Risk Assessment:** The probability of multiple fatalities having a negative safety impact is very high, and the consequence of the impact is also very high. However, multiple fatalities are not likely to cause a negative environmental impact.
- **Safeguard:** The Pressure Safety Valve (PSV).

Scenario 2: Failure of the Transfer System

Suppose that a scenario occurs, where hazardous chemicals leak out of the connector causing an environmental degradation. This scenario includes the following risk and risk assessment:

- **Risk:** Hazardous chemicals leak out of the connector, causing environmental degradation.
- **Risk Assessment:** The probability of environmental degradation having a negative safety impact is very low. However, the probability of environmental degradation having a negative environmental impact is very high, but the severity of the impact is medium.

The specific parts of the Scenario are outlined in the following list:

- **System/Node:** The chemical transfer system that consists of E-1, E-2, and valves.

- **Deviation:** More pressure in the piping system between E-1 and E-2.
- **Cause:** Failure of the valve connected to E-1.
- **Consequence:** Environmental degradation.
- **Risk Assessment:** The probability of environmental degradation having a negative safety impact is very low. However, the probability of environmental degradation having a negative environmental impact is very high, but the severity of the impact is medium.
- **Safeguard:** A toxicity detector, which sounds an alarm when the toxicity levels in the facility reach high-risk levels.

Hazards Analysis System Code Tables

The following table lists the System Code Tables that are used by Hazards Analysis.

Table ID	Table Description	Function
MI_HAZARDS_ANALYSIS_LIFE_CYCLE_PHASE	Hazards Analysis Life Cycle Process Phase	Populates the Process Life Cycle Phase field in a Hazards Analysis.
MI_HAZOP_CAUSE_TYPE	HAZOP Cause Type	Populates the Cause Type field in a Cause.
MI_HAZOP_CONSEQUENCE_TYPE	HAZOP Consequence Type	Populates the Consequence Type field in a Consequence.
MI_HAZOP_DEVIATIONS	HAZOP Deviation	Populates the Deviation/Guideword field in a Deviation.
MI_HAZOP_IPL_TYPE	IPL Type	Populates the IPL Type field in a Safeguard.
MI_HAZOP_SAFEGUARD_TYPE	HAZOP Safeguard Type	Populates the Safeguard Type field in a Safeguard.

About the Risk Assessment Graph

The Risk Assessment graph plots the unmitigated and the mitigated risk ranks for each System/Node.

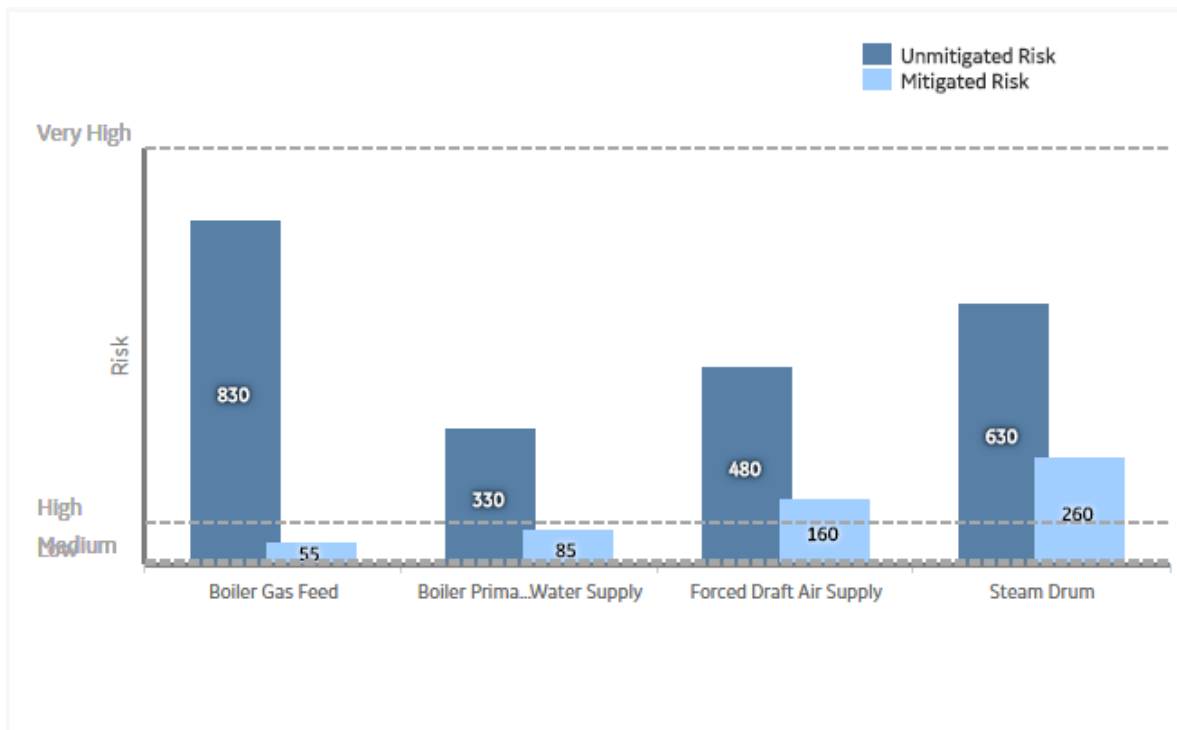

On the Risk Assessment graph:

- The x-axis displays the System/Node ID.
- The y-axis displays the risk rank.
- The risk thresholds are indicated as dashed lines on the graph.

Note: The names for the risk thresholds are based on what the user defined in the risk matrix. By default, they are very high, high, medium, and low.

- The ID of the System/Node, the unmitigated and the mitigated risk ranks for each System/Node are displayed when you pause on or select the corresponding bar on the graph.

You can sort the risk assessment graph by selecting a value in the drop-down box in the upper-left corner of the graph. The available options are:

- **Highest Mitigated Risk:** Plots the highest mitigated risk rank among all the safeguards of a System/Node and the unmitigated risk rank of the corresponding consequence.
- **Highest Unmitigated Risk:** Plots the highest unmitigated risk rank of all the consequences of a System/Node and the lowest mitigated risk among all the safeguards of the consequence.
- **Lowest Mitigated Risk:** Plots the lowest mitigated risk rank among all the safeguards of a System /Node and the unmitigated risk rank of the corresponding consequence.
- **Lowest Unmitigated Risk:** Plots the lowest unmitigated risk rank of all the consequences of a System/Node and the lowest mitigated risk among all the safeguards of the consequence.

About State Management in Hazards Analysis

The following baseline record states are configured for the Hazards Analysis family:

- **Planning:** Indicates that the analysis is in the Planning state. You can modify or delete a Hazards Analysis and its related records only if it is in the Planning state. Also, you can create, or link a LOPA to a Consequence only if the analysis is in the Planning state
- **Active:** Indicates that the analysis is active.
- **Review:** Indicates that the analysis has been sent for review.

- **Pending Approval:** Indicates that the analysis has been reviewed and is awaiting approval.
- **Complete:** Indicates that the analysis is complete. After a Hazards Analysis state is changed to Complete:
 - The numeric value in the Revision Number field in the Hazards Analysis is increased by one.
 - A Hazards Analysis Revision is created, which stores a snapshot of the Hazards Analysis when the state was changed to Complete.

Note: You can change the state of a Hazards Analysis, only if you are a Super User, a member of the MI HA Owner Security Group, or a member of the MI HA Facilitator Security Group.

Illustration of the Hazards Analysis State Configuration

By default, the following baseline State Configuration exists for the Hazards Analysis family:

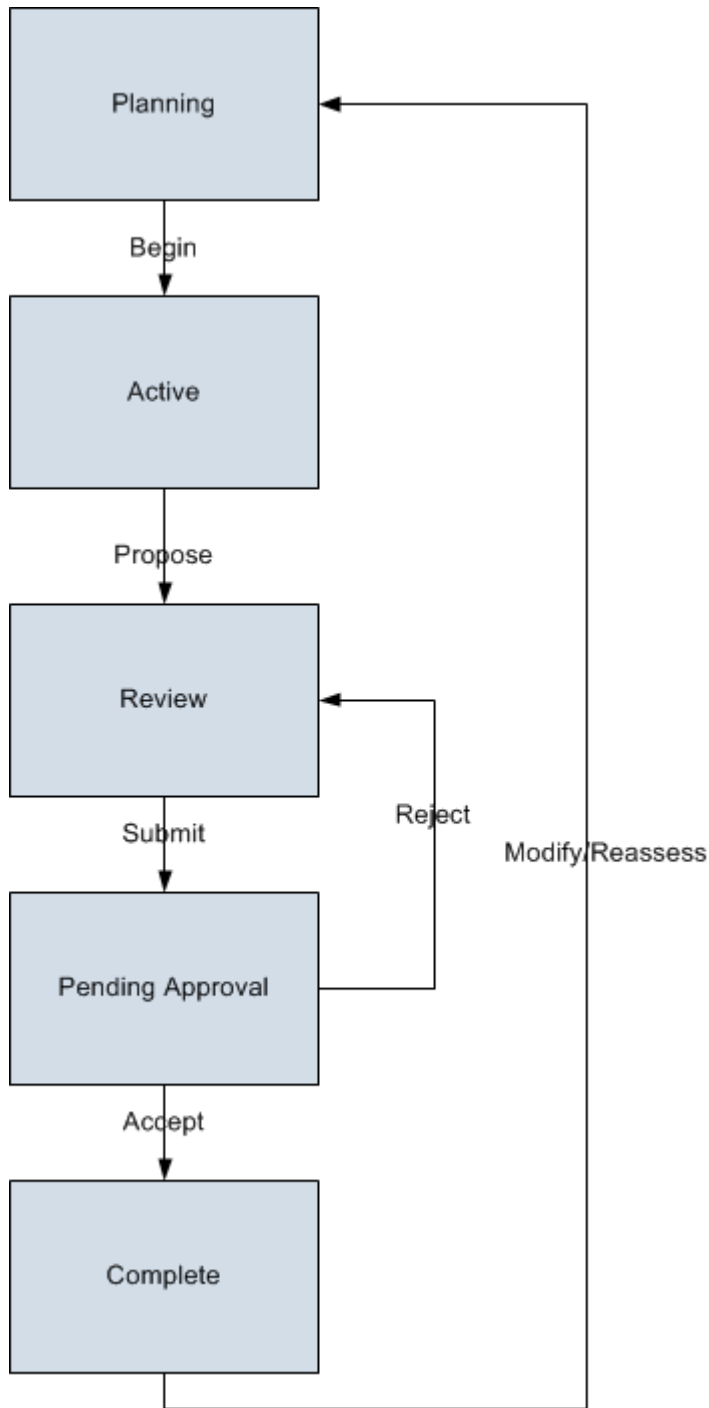

Hazards Analysis Site Filtering

In Hazards Analysis, a Hazards Analysis is assigned a site on the **Definition** workspace and that site assignment is spread to all the related records, such as Hazards Analysis System/Node records, HAZOP deviation records, What If records, Hazards Analysis Cause records, Hazards Analysis Consequence records, Hazards Analysis Safeguard records, and Instrumented Function records. The site assigned to the Hazards Analysis also determines the Risk Matrix used to assess mitigated and unmitigated risks.

Tip: For more information, refer to the Site Filtering section of the documentation.

In Hazards Analysis, users will see only Hazards Analyses that are assigned to their site(s) or that are global records.

Example

Consider an organization that has three sites, Site X, Site Y, and Site Z. The following Hazards Analysis records exist:

- Hazards Analysis A: Assigned to Site X
- Hazards Analysis B: Assigned to Site Y
- Hazards Analysis C: Assigned to Site Z
- Hazards Analysis D: No site assigned (global records)

Scenario 1: User assigned to only Site X

This user will see Hazards Analysis A and Hazards Analysis D.

Scenario 2: User assigned to both Site X and Site Y

This user will see Hazards Analysis A, B, and D.

Scenario 3: Super User

This user will see Hazards Analysis A, B, C, and D.

Important: If a multi-site user or a Super User, links child records from multiple sites to a parent record designated as **Global**, another user who does not have access to all sites may only see a portion of the data associated with that record. In the previous example, even though Hazards Analysis D has records from Site X and Site Y, the Site X user will be not be able to see the records from Site Y.

Family Field Descriptions

Hazards Analysis Cause Records

Hazards Analysis Cause records store details on the cause of a particular event or condition within a process. This topic provides an alphabetical list and description of the fields that exist for the Hazards Analysis Cause family. These fields appear on the Hazards Analysis Cause datasheet, unless otherwise specified. The information in this table reflects the baseline state and behavior of these fields. This list is not comprehensive.

This family is enabled for site filtering, which means that records in this family can be assigned to a specific site and will only be accessible to users who are assigned to the same site and have the appropriate license and family privileges. For more information, refer to the [Sites](#) section of the documentation.

Field	Data Type	Description	Behavior and Usage
Cause Comment	Text	Comments about the cause.	None
Cause Description	Text	A detailed description of the cause.	None

Field	Data Type	Description	Behavior and Usage
Cause Frequency (per year)	Number	A numeric value that represents the number of times per year the cause may occur.	This field is disabled and populated with the default value of frequency specified in the Initiating Event record based on your selection in the CCPS Cause Type field.
Cause ID	Character	A brief description of the cause.	This is a required field.
Cause Number	Character	A set of three numeric values, separated by decimal points, which represents the location in which the Cause appears in the hierarchical view of the components in the Systems/ Nodes.	<p>This field is disabled and populated with a set of three numbers, separated by decimal points (e.g., 2.1.1).</p> <ul style="list-style-type: none"> The first two numbers correspond to the value that exists in the What If Number field in the What If or the Deviation/ Guideword Number field in the Deviation to which the Cause is linked. The third number is the value that exists in the Sequence Number field in the Cause.
Cause Type	Character	The type of cause.	<p>This field contains the description of the System Codes that exist in the MI_HAZOP_CAUSE_TYPE System Code Table. You can choose from the following baseline values:</p> <ul style="list-style-type: none"> Equipment Failure Human Error Process Upset Flooding Lightning Power Loss Terrorism

Field	Data Type	Description	Behavior and Usage
CCPS Cause Type	Character	The type of cause as defined by CCPS.	This field is populated by the value in the Initiating Event ID field of the Initiating Event records. When you create a LOPA from a cause-consequence pair in Hazards Analysis module, the Initiating Event Type field in the LOPA is disabled and automatically populated with the value in the CCPS Cause Type field.
Equipment Entity Key	Number	The Entity Key for the Equipment whose Record ID appears in the Equipment ID field.	This field does not appear on the datasheet.
Equipment ID	Character	The ID of the Equipment that is linked to the Cause through the Safety Analysis Has Equipment Relationship family.	This field contains a  button, which you can select to link an Equipment to the Cause.
Functional Location Key	Number	The Entity Key for the Functional Location whose ID appears in the Functional Location ID field.	This field does not appear on the datasheet.
Functional Location ID	Character	The ID of the Functional Location that is linked to the Cause through the Has Functional Location Relationship family.	This field contains a  button, which you can select to link a Functional Location to the Cause.
Sequence Number	Number	A numeric value that represents the position in which the Cause appears in the hierarchical view of the components in the System/Node, relative to the other Causes that are linked to the same Deviation or What If.	This field does not appear on the datasheet.

Hazards Analysis Consequence Records

Hazards Analysis Consequence records store details on the specific risk that is associated with a given scenario. This topic provides an alphabetical list and description of the fields that exist for the Hazards Analysis Consequence family. By default, these fields appear on the Hazards Analysis Consequence datasheet, unless otherwise specified. The information in the table reflects the baseline state and behavior of these fields. This list is not comprehensive.

This family is enabled for site filtering, which means that records in this family can be assigned to a specific site and will only be accessible to users who are assigned to the same site and have the

appropriate license and family privileges. For more information, refer to the [Sites](#) section of the documentation.

Field	Data Type	Description	Behavior and Usage
Consequence Comment	Text	Comments about the risk.	None
Consequence Description	Text	A detailed description of the risk.	None
Consequence ID	Character	A brief description of the risk.	This is a required field.
Consequence Number	Character	A set of four numeric values, separated by a decimal point, which represents the location in which the Consequence appears in the hierarchical view of the components in the System/Node.	This field is disabled and populated with numbers, separated by decimal points (e.g., 2.1.1.1). <ul style="list-style-type: none"> The first three numbers correspond to the value that exists in the Cause Number field in the Cause to which the Consequence is linked. The fourth number is the value that exists in the Sequence Number field in the Consequence.
Consequence Type	Character	The type of risk.	This field contains the description of the System Codes that exist in the MI_HAZOP_CONSEQUENCE_TY PE System Code Table. You can choose from the following baseline values: <ul style="list-style-type: none"> Fire Explosion Single Fatality Multiple Fatalities Equipment Damage Production Loss
Sequence Number	Number	A numeric value that represents the position in which the Consequence appears in the hierarchical view of the components in the System/Node, relative to the other Consequences that are linked to the same Cause.	This field is used to populate the Consequence Number field, and does not appear on the datasheet by default.

Hazards Analysis Deviation Records

HAZOP Deviation records store details on the condition within a process that deviates from the normal behavior during that process, resulting in a risk. This topic provides an alphabetical list and description of

the fields that exist for the HAZOP Deviation family. These fields appear on the HAZOP Deviation datasheet, unless otherwise specified. The information in this table reflects the baseline state and behavior of these fields.

This family is enabled for site filtering, which means that records in this family can be assigned to a specific site and will only be accessible to users who are assigned to the same site and have the appropriate license and family privileges. For more information, refer to the [Sites](#) section of the documentation.

Field	Data Type	Description	Behavior and Usage
Deviation/Guideword	Character	A brief description of the deviation.	<p>This field contains the description of the System Codes that exist in the MI_HAZOP_DEVIATIONS_TYPE System Code table. You can choose from the following baseline values:</p> <ul style="list-style-type: none"> • More Pressure • Less Pressure • More Temperature • Less Temperature • More Flow • Less Flow • No Flow <p>This value appears in the list of Deviations in the hierarchical view of the components of the System/Node.</p>
Deviation/Guideword Number	Character	A set of numeric values, separated by a decimal point, which represents the location in which the Deviation appears in the hierarchical view of the components of the System/Node.	<p>This field is disabled and populated with a set of numeric values, separated by a decimal point.</p> <ul style="list-style-type: none"> • The first number is the value that exists in the System/Node Number field in the System/Node record to which the Deviation is linked. • The second number is the value that exists in the Sequence Number field in the Deviation.
Sequence Number	Number	A numeric value that represents the sequence in which the Deviation appears in the hierarchical view of the components of the System/Node, relative to the other Deviations that are linked to the same System/Node.	<p>This field does not appear on the datasheet by default. This value in this field is used to populate the Deviation/Guideword Number field.</p>

Hazards Analysis Records

Hazards Analysis records store details about the hazards analysis that you are conducting. This topic provides an alphabetical list and description of the fields that exist for the Hazards Analysis family and appear on the Hazards Analysis datasheet, unless otherwise specified. The information in the table reflects the baseline state and behavior of these fields. This list is not comprehensive.

This family is enabled for site filtering, which means that records in this family can be assigned to a specific site and will only be accessible to users who are assigned to the same site and have the appropriate license and family privileges. For more information, refer to the [Sites](#) section of the documentation.

Field	Data Type	Description	Behavior and Usage
Analysis Description	Character	A brief description for the analysis.	None
Analysis End Date	Date	The date on which the analysis will end or has ended.	On the datasheet, this field contains a  button, which you can select to access the Calendar feature. The date in this field must be later than the date in the Analysis Start Date field, or an error message will appear. When you copy a Hazards Analysis, the value in this field is not copied.
Analysis ID	Character	The ID for the analysis.	A value is required and must be unique.
Analysis Objective	Text	A description of the goals for the analysis.	None
Analysis Owner	Character	The analysis team member whose name appears in the Process Owner field.	The value for this field is based on the process owner that you have defined in the team. To change this value, modify the team members by assigning a new person as the process owner. Tip: For details about working with teams and the Team Members section, refer to the Teams section of the documentation.
Analysis Purpose	Text	A description of the purpose of the analysis.	None
Analysis Scope	Text	The scope of the analysis. This can be (but not limited to) geographic boundaries or process-related boundaries.	None

Field	Data Type	Description	Behavior and Usage
Analysis Start Date	Date	The date on which the analysis will begin or has already begun.	This field contains a  button, which you can select to access the Calendar feature. This date must be earlier than the date in the Analysis End Date field, or an error message will appear. When you copy or create a Hazards Analysis, this field is populated with the current date in the new record.
Analysis Type	Character	The type of analysis that you are conducting (HAZOP or What If).	This field does not appear on the datasheet by default. This field is disabled and populated automatically.
Facilitator	Character	The name of analysis team member who is specified as the Facilitator.	This field does not appear on the datasheet by default.
Is Deleted	Logical	Indicates whether the Hazards Analysis has been removed from searches within the Hazards Analysis module.	This field does not appear on the datasheet by default. This check box is selected automatically when you flag a Hazards Analysis as complete. This value is used by the GE Digital APM system, so you should not modify it manually.
Last Modified By	Character	The name of the user who was logged in when the Hazards Analysis was last modified.	This field is disabled and populated automatically. When you copy a Hazards Analysis, the value in this field is not copied.
Last Modified Date	Date	The date on which the Hazards Analysis was last modified.	This field is disabled and populated automatically. When you copy a Hazards Analysis, the value in this field is not copied.
Next Reevaluation Date	Date	The date on which the Hazards Analysis should be re-evaluated.	This field is disabled, and calculated as follows: Next Reevaluation Date = Revision Date + Reevaluation Interval
Process Description	Text	A longer description of the process that you are studying.	None

Field	Data Type	Description	Behavior and Usage
Process Life Cycle Phase	Character	The phase within the life cycle for the process that you are analyzing.	This field contains the description of all System Codes in the MI_HAZARDS_ANALYSIS_LIFE_CYCLE_PHASE System Code Table. You can choose from the following baseline values: <ul style="list-style-type: none"> • Design and Development • Construction and Startup • Operate and Maintain • Decommissioning
Process Owner	Character	The name of the analysis team member who is specified as the Process Owner.	This field does not appear on the datasheet by default and is populated when you assign the role of a Process Owner to a Team Member. This value is populated in the Analysis Owner field. <p>Tip: For details about working with teams and the Team Members section, refer to the Teams section of the documentation.</p>
Process Type	Character	A brief description of the process that you are studying.	None
Reevaluation Interval	Number	The number of years between evaluations of the Hazards Analysis.	Enter the value that is prescribed by the applicable governing body.
Revision Date	Date	The date and time on which the revision of the Hazards Analysis was created.	This field is disabled and populated with the date and time of the most recent revision. When you copy a Hazards Analysis, this field is populated with the current date and time in the new record.
Revision Number	Character	A number that represents the number of times the Hazards Analysis state has been changed to Complete. This field contains the value 0 by default.	On the datasheet, this field is disabled and populated. Each time you cycle the Hazards Analysis state from Planning to Complete, the value in this field is incremented by 1. <p>When you copy a Hazards Analysis, this field is populated with 0 in the new record.</p>

Field	Data Type	Description	Behavior and Usage
Site Description	Character	A description of the site that is specified in the Site ID field.	This field does not appear on the datasheet by default. This value is populated when you select a site ID in the Site ID field.
Site ID	Character	The ID of the site that is associated with the Hazards Analysis.	This field contains the values stored in the Name field in Site Reference records. The value that you select in the list is used to identify which risk matrix to display when you create Risk Assessment records in Hazards Analysis. If this field is blank, the default risk matrix will be used.
Summary	Text	A summary of the analysis that was conducted.	None
Unit Description	Character	A description of the unit that is specified in the Unit ID field.	This field does not appear on the datasheet by default.
Unit ID	Character	The ID for the unit that is associated with the processes for which you are conducting a Hazards Analysis.	None

Hazards Analysis Safeguard Records

Hazards Analysis Safeguard records store details on safeguards that can be used to mitigate the risk. If the safeguard is an IPL, then these records also store the details of the IPL Type and the corresponding PFD value. The Hazards Analysis Safeguard family is also used in the Layers of Protection Analysis to store details about Safeguards. This topic provides an alphabetical list and description of the fields that exist for the Hazards Analysis Safeguard family. These fields appear on the Hazards Analysis Safeguard datasheet and in the **IPL Checklist** section of a Safeguard. The information in this table reflects the baseline state and behavior of these fields. This list is not comprehensive.

This family is enabled for site filtering, which means that records in this family can be assigned to a specific site and will only be accessible to users who are assigned to the same site and have the appropriate license and family privileges. For more information, refer to the [Sites](#) section of the documentation.

Field	Data Type	Description	Behavior and Usage
Equipment ID	Character	The identification of the Equipment that is linked to the Safeguard through the Safety Analysis Has Equipment Relationship family.	You can select an Equipment to associate with the Safeguard. When you associate an Equipment with the Safeguard, the Functional Location to which the Equipment belongs is automatically associated with the Safeguard, and appears in the Functional Location ID box on the datasheet.
Equipment Key	Numeric	The Entity Key of the Equipment whose ID appears in the Equipment ID field.	This field does not appear on the datasheet by default.
Functional Location ID	Character	The identification of the Functional Location that is linked to the Safeguard through the Has Functional Location Relationship family.	You can select a Functional Location to associate with the Safeguard.
Functional Location Key	Numeric	The Entity Key for the Functional Location whose ID appears in the Functional Location ID field.	This field does not appear on the datasheet by default.
IF ID	Character	The ID of the Instrumented Function that is linked to the Safeguard.	You can select an Instrumented Function to associate with the Safeguard.
IF Key	Numeric	The Entity Key for the Instrumented Function whose ID appears in the IF ID field.	This field does not appear on the datasheet by default.
IPL Credits	Numeric	Indicates the order of magnitude by which the independent protection layer reduces the risk.	You can select a value from 1 through 10 from the drop-down list box. This field appears in the IPL Checklist section of the Safeguard.
IPL Reference Key	Numeric	The Entity Key for the Independent Layer of Protection that is linked to the Hazards Analysis Safeguard.	This field does not appear on the datasheet by default.

Field	Data Type	Description	Behavior and Usage
IPL Sub Type	Character	Indicates the classification of the independent layer of protection that you selected in the IPL Type field in the Safeguard records.	<p>This field is disabled by default, indicating that the safeguard is not an independent layer of protection.</p> <p>If the safeguard is an independent layer of protection, then this field is enabled.</p> <p>This field is populated based on your selection in the IPL Type field of the Safeguard datasheet:</p> <ul style="list-style-type: none"> • If the value in the IPL Type field is Active IPL, this field is populated as defined in the Active IPL record. These values are retrieved using the Catalog query <code>Public \Meridium \Modules \Hazards Analysis \Queries \Active IPL List</code>. • If the value in the IPL Type field is Passive IPL, this field is populated as defined in the Passive IPL record. These values are retrieved using the Catalog query <code>Public \Meridium \Modules \Hazards Analysis \Queries \Passive IPL List</code>. • If the value in the IPL Type field is Human IPL, this field is populated as defined in the Human IPL record. These values are retrieved using the Catalog query <code>Public \Meridium \Modules \Hazards Analysis \Queries \Active IPL</code>

Field	Data Type	Description	Behavior and Usage
PFD	Numeric	A number representing the probability that the independent layer of protection will fail to mitigate the risk.	<p>By default, this field is disabled.</p> <p>Based on you selection in the IPL Sub Type field, this field is populated with the value in the Default Value field of one of the following record:</p> <ul style="list-style-type: none"> Active IPL record if the value in the IPL Type field is Active IPL. Passive IPL record if the value in the IPL Type field is Passive IPL. Human IPL record if the value in the IPL Type field is Human IPL. <p>This field appears in the IPL Checklist section of the Safeguard.</p> <p>For more information, refer to the Layers of Protection Analysis section of the documentation.</p>
IPL Type	Character	Indicates the type of risk reduction that is provided by the independent layer of protection.	<p>You can select one of the following values in this field:</p> <ul style="list-style-type: none"> Consequence Reducing IPL Frequency Reducing IPL <p>This field is labeled as Risk Reduction Type and appears on the IPL Checklist section of the Safeguard.</p>
Safeguard Comment	Text	A comment about the safeguard.	You can enter a value manually.
Safeguard Description	Text	A detailed description of the safeguard.	You can enter a value manually.
Safeguard ID	Character	The identification of the safeguard.	<p>You can enter a value manually.</p> <p>This field is required.</p>

Field	Data Type	Description	Behavior and Usage
Safeguard Type	Character	The type of the safeguard.	<p>This field contains the description of the System Codes that exist in the MI_HAZOP_SAFEGUARD_TYPE System Code Table. You can select a value from the following options:</p> <ul style="list-style-type: none"> • Process Design • Process Control System • PSV • Operations • Deluge System • Fire Alarm • Process Alarm • SIS
Sequence Number	Numeric	A number that represents the position in which the Safeguard appears in the grid, relative to the other Safeguards that are linked to the same Consequence.	<p>This field is used to populate the Safeguard Number field.</p> <p>This field does not appear on the datasheet by default.</p>
Type	Character	If the safeguard is an independent layer of protection, this value indicates the type of risk the independent layer of protection mitigates.	<p>By default, this field is disabled, indicating that the safeguard is not an independent layer of protection.</p> <p>If the safeguard is an independent layer of protection, then this field is enabled.</p> <p>This field contains the description of the System Codes that exist in the MI_IPL_TYPES_SAFEGUARD System Code Table. You can select a value from the following options:</p> <ul style="list-style-type: none"> • Active IPL • Passive IPL • Human IPL <p>This field is labeled IPL Type in the IPL Checklist section of the Safeguard datasheet.</p>

Hazards Analysis System/Node Records

Hazards Analysis System/Node records store details on the group of equipment or functional locations that perform the process that you are studying. This topic provides an alphabetical list and description of the fields that exist for the Hazards Analysis System/Node family. These fields appear on the Hazards Analysis System/Node datasheet, unless otherwise specified. The information in the table reflects the baseline state and behavior of these fields.

This family is enabled for site filtering, which means that records in this family can be assigned to a specific site and will only be accessible to users who are assigned to the same site and have the appropriate license and family privileges. For more information, refer to the [Sites](#) section of the documentation.

Field	Data Type	Description	Behavior and Usage
Hazards Analysis Key	Number	A numeric value identifying the Hazards Analysis that is linked to the System/Node.	This field does not appear on the datasheet.
Modified By	Character	The name of the user who was logged in when the System/Node was last modified.	This field does not appear on the datasheet.
Modified Date	Date	The date on which the System/Node was last modified.	This field does not appear on the datasheet.
Reference Drawing	Character	A value identifying the reference document. This value exists in the Name field in the corresponding Reference Document.	This field contains the IDs of the Reference Documents that are linked to the Hazards Analysis that is linked to the System/Node.
System/Node Comments	Text	Comments about the System/Node.	None
System/Node Description	Text	Description of the System/Node.	None
System/Node Equipment Type	Character	The type of equipment that corresponds to the system that the System/Node represents.	This field contains the System Codes in the MI Equipment Type System Code Table.
System/Node ID	Character	A brief description of the System/Node.	A value is required.

Field	Data Type	Description	Behavior and Usage
System/Node Number	Number	A numeric value representing the sequence in which the System/Node record appears.	This field is disabled and populated automatically.
System/Node Process Type	Character	The type of the process that you are studying.	This field contains the following values: <ul style="list-style-type: none"> Gas/Oil Feed Steam Boiler (Steam Generation) Ethylene Oxide storage (EO Storage) FCCU (Fluid Catalytic Cracking Unit)

Risk Assessment Recommendation Records

Risk Assessment Recommendation records store details about the recommendation that you have proposed to mitigate the risk. This topic provides an alphabetical list and description of the fields that exist for the Risk Assessment Recommendation family. These fields appear on the Risk Assessment Recommendation datasheet, unless otherwise specified. The information in this table reflects the baseline state and behavior of these fields. This list is not comprehensive.

This family is enabled for site filtering, which means that records in this family can be assigned to a specific site and will only be accessible to users who are assigned to the same site and have the appropriate license and family privileges. For more information, refer to the [Sites](#) section of the documentation.

Field	Data Type	Description	Behavior and Usage
Action Interval	Number	The interval at which the Action related to the Recommendation needs to be performed. This Action is created as part of an Asset Strategy after the Recommendation is promoted to ASM.	For example, if the value in this field is 4, and if the value in the Interval Units field is Days, then that Action must be performed every four days. This field appears in the Alert datasheet.
Action Interval Units	Character	The units of the interval at which the Action related to the Recommendation needs to be performed. This Action is created as part of an Asset Strategy after the Recommendation is promoted to ASM.	For example, if the value in this field is Days, and if the value in the Interval field is 4, then that Action must be performed every four days. This field appears in the Alert datasheet.
Alert Assignee When Due?	Logical	Indicates whether an email notification must be sent to the user selected in the Assigned To Name field when the Risk Assessment Recommendation is due.	This field appears in the Alert section of the datasheet.

Field	Data Type	Description	Behavior and Usage
Assigned To Name	Character	The name of the user who is assigned the Risk Assessment Recommendation.	You can select a user from the list.
Author Name	Character	The first and last name of the Security User who created the Risk Assessment Recommendation.	This field is populated with the name of the user who was logged in while creating the Recommendation.
Business Impact	Character	The impact to the business if the recommended action is performed.	This field contains a list of System Codes that exist in the MI BUSINESS IMPACT System Code Table. You can choose from the following baseline values: <ul style="list-style-type: none"> • Facility Shutdown (FACILITY SHUTDOWN) • Facility Slowdown (FACILITY SLOWDOWN) • Unit Shutdown (UNIT SHUTDOWN) • Unit Slowdown (UNIT SLOWDOWN) • System Shutdown (SYSTEM SHUTDOWN) • System Slowdown (SYSTEM SLOWDOWN)
Completed Date	Date	The date on which the recommended action was performed.	This field contains a  button, which you can select to access the Calendar feature.
Create SAP Notification?	Logical	Indicates whether a notification should be created in an external EAM system when this Risk Assessment Recommendation is saved.	None
Days Before Due Date to be Notified	Number	The number of days before the Target Completion Date that an email notification must be sent to the user selected in the Assigned To Name field.	This field appears in the Alert section of the datasheet. This field is required when the Alert Assignee When Due check box is selected.
Equipment ID	Character	The Equipment that is associated with the Consequence for which you are proposing the Risk Assessment Recommendation.	This field is disabled and populated with the value stored in the Equipment ID field in the Cause datasheet.

Field	Data Type	Description	Behavior and Usage
Final Approver Name	Character	The name of the user who must grant the final approval for the Risk Assessment Recommendation.	You can select a user from the list.
Frequency of Alert After Due Date	Number	Specifies how often email messages will be sent after the completion date has passed.	You can choose any of the following options: <ul style="list-style-type: none"> • Never • Daily • Weekly • Monthly • Yearly This field appears in the Alert section of the datasheet. This field is required when the Alert Assignee When Due check box is selected.
Functional Location ID	Character	The Functional Location that is associated with the Consequence for which you are proposing the Risk Assessment Recommendation.	This field is disabled and populated with the value stored in the Functional Location ID field in the Cause datasheet.
Implementation Alert Text	Character	The text that will be included in the email notification sent to the approver.	This field appears in the Alert section of the datasheet.
Mandatory Date	Date	The date by which the recommended action must be completed if it was not completed by the target completion date.	This field contains a  button, which you can select to access the Calendar feature.
Reevaluate?	Logical	Indicates whether you want to reevaluate the Risk Assessment Recommendation.	This field appears in the Alert section of the datasheet.
Reevaluation Alert Body Text	Character	The text that will be included in the reevaluation email message.	This field appears in the Alert section of the datasheet. This field is enabled only when the Reevaluate? check box is selected.
Reevaluation Date	Date	The date on which a reevaluation email message will be sent to the users selected in the Reevaluation Notification List field.	This field appears in the Alert section of the datasheet. This field is required when the Reevaluate? check box is selected.

Field	Data Type	Description	Behavior and Usage
Reevaluation Notification List	Character	The users to whom the reevaluation email message will be sent.	This field appears in the Alert section of the datasheet. This field is enabled and is required when the Reevaluate? check box is selected.
Recommendation Basis	Character	The basis for the Risk Assessment Recommendation.	None
Recommendation Description	Character	A description of the Risk Assessment Recommendation.	None
Recommendation Headline	Character	A short description of the Risk Assessment Recommendation.	If you select the Alert Assignee When Due check box, the value that you provide in the Recommendation Headline field becomes the subject of the alert email.
Recommendation ID	Character	The ID for the Risk Assessment Recommendation.	This value must be unique.
Recommendation Priority	Character	The priority of the recommended action.	This field contains a list of System Codes that exist in the MI PRIORITY System Code Table. You can choose from the following baseline values: <ul style="list-style-type: none"> • High (HIGH) • Medium (MEDIUM) • Low (LOW)
Required Equipment Status	Character	The state in which the equipment should exist before performing the recommended action against it.	This field contains a list of System Codes that exist in the MI STATUS System Code Table. You can choose from the following baseline values: <ul style="list-style-type: none"> • On-line (ON-LINE) • Off-line (OFF-LINE) • Not Applicable (N/A)
Reviewer Name	Character	The name of the user who will review the Risk Assessment Recommendation.	You can select a user from the list.

Field	Data Type	Description	Behavior and Usage
Status	Character	The status of the Risk Assessment Recommendation.	This field contains a list of the following states: <ul style="list-style-type: none"> • Created (CREATED) • Pending Review (PENDING REVIEW) • Reviewed (REVIEWED) • Rejected (REJECTED) • Cancelled (CANCELLED) • Superseded (SUPERSEDED)
Target Completion Date	Date	The date by which the recommended action should be completed.	This field contains a  button, which you can select to access the Calendar feature.
Work Request Equipment	Character	The ID of the external equipment that is associated with the external work request that was created from this Risk Assessment Recommendation (e.g., using functionality provided with the SAP Interfaces, Oracle EBS EAM Interfaces, and Maximo Interfaces).	This field is disabled and populated after the external work request is created.
Work Request Functional Location	Character	The ID of the external location that is associated with the external work request that was created from this Risk Assessment Recommendation (e.g., using functionality provided with the SAP Interfaces, Oracle EBS EAM Interfaces, and Maximo Interfaces).	This field is disabled and populated after the external work request is created.
Work Request Reference	Character	The ID of the external work request that was created from this Risk Assessment Recommendation (e.g., using functionality provided with the SAP Interfaces, Oracle EBS EAM Interfaces, and Maximo Interfaces).	This field is disabled and populated after the SAP Notification or Oracle EBS EAM Work Request is created.

What If Records

What If records store details about the hypothetical condition that may occur during process and lead to a risk. This topic provides an alphabetical list and description of the fields that exist for the What If family.

These fields appear on the What If datasheet, unless otherwise specified. The information in this table reflects the baseline state and behavior of these fields.

This family is enabled for site filtering, which means that records in this family can be assigned to a specific site and will only be accessible to users who are assigned to the same site and have the appropriate license and family privileges. For more information, refer to the [Sites](#) section of the documentation.

Field	Data Type	Description	Behavior and Usage
Sequence Number	Number	A numeric value that represents the position in which the What If appears in the hierarchical view of the components of the System/Node, relative to the other What Ifs that are linked to the same System/Node.	This field does not appear on the datasheet by default. This field is used to populate the What If Number field.
What If Description	Text	A detailed description of the specific event or condition within a scenario that deviates from the normal behavior of that process and directly leads to a risk.	None
What If ID	Character	A brief description of the event or condition within the scenario that deviates from the normal behavior of the process.	This value appears in the What If ID field in the hierarchical view of the components of the System/Node. This field is required.
What If Number	Character	A set of numeric values, separated by a decimal point, which represents the location in which the What If appears in the hierarchical view of the components in the System/Node.	This field is disabled and populated with a set of numeric values. <ul style="list-style-type: none"> The first number is the value that exists in the System/Node Number field in the System/Node to which the What If is linked. The second number is the value that exists in the Sequence Number field in the What If.

Catalog Items

Catalog Items

The Hazards Analysis Catalog folders contain queries, graphs, and reports that appear throughout Hazards Analysis and display information contained in the records that make up a HAZOP Analysis or a What If Analysis.

HAZOP Folder

The Catalog folder `\\Public\Meridium\Modules\Hazards Analysis\HAZOP` contains the following folders:

- Graphs
- Queries
- Reports

Graphs

The Catalog folder `\\Public\Meridium\Modules\Hazards Analysis\HAZOP\Graphs` contains the following items:

Item Name	Behavior and Usage
Hazards Analysis Mitigated Risk	A graph that displays a prompt for the Entity Key of a Hazards Analysis whose HAZOP Analysis data you want to view in the Graph Viewer.
Subgraphs	A subfolder that contains the Hazards Analysis Mitigated Risk graph, which supports the Hazards Analysis Mitigated Risk graph.

Queries

The Catalog folder `\\Public\Meridium\Modules\Hazards Analysis\HAZOP\Queries` contains the following queries:

Item Name	Behavior and Usage
Hazards Analysis Deviation Mitigated Risk Query	Displays a prompt for the Entity Key of the desired System/Node, and then displays the unmitigated and mitigated risk rank values organized by the Deviations with which they are associated. This query supports the Hazards Analysis Mitigated Risk graph that is stored in the following folder: <code>\\Public\Meridium\Modules\Hazards Analysis\HAZOP\Graphs</code>
Hazards Analysis Mitigated Risk Query	Displays a prompt for the Entity Key of the desired Hazards Analysis, and then displays the unmitigated and mitigated risk rank values organized by the Systems/Nodes with which they are associated. This query supports the Hazards Analysis Mitigated Risk graph that is stored in the following folder: <code>\\Public\Meridium\Modules\Hazards Analysis\HAZOP\Graphs</code>
Hazards Analysis Query	Displays a prompt for the Entity Key of the desired Hazards Analysis, and then displays various information about the HAZOP Analysis, including values that appear in the Hazards Analysis record and IDs of the records that are linked to the HAZOP Analysis. This query supports the Hazards Analysis Report that is stored in the Reports folder.

Item Name	Behavior and Usage
Hazop_Reference_Documents_Query	Displays a prompt for the Entity Key of the desired Hazards Analysis, and then displays a list of Reference Documents and various details from those records that are linked to the specified System/Node. This query supports the Hazop_Reference_Document_Report, which is stored in the following folder: \\Public\Meridium\Modules\Hazards Analysis\HAZOP\Reports\Subreports
Hazop_Team_Member_Query	Displays a prompt for the Entity Key of the desired Hazards Analysis, and then displays the list of Human Resource records that are linked to the specified Hazards Analysis. This query supports the Hazop_Team_Member_Report, which is stored in the following folder: \\Public\Meridium\Modules\Hazards Analysis\HAZOP\Reports\Subreports

Reports

The Catalog folder \\Public\Meridium\Modules\Hazards Analysis\HAZOP\Reports contains the following items:

Item Name	Behavior and Usage
Hazards Analysis Report	A report that displays a prompt for the Entity Key of the desired Hazards Analysis, and then displays in the Report Viewer various information about the HAZOP Analysis, including the field values from the Hazards Analysis and details on the records that make up that analysis.
Subreports	A folder that contains the reports with the following names, which support the Hazards Analysis Report: <ul style="list-style-type: none"> Hazop_Analysis_Assets_Report Hazop_Reference_Document_Report Hazop_Team_Member_Report

Queries Folder

The Catalog folder \\Public\Meridium\Modules\Hazards Analysis\Queries contains the following queries, which are used to display search results for Hazards Analysis records for HAZOP Analyses and What If Analyses:

Important: The queries in the following table may contain required parameters. Therefore:

- Do not remove the required fields from a query.
- Do not change the alias of required fields.
- Do not modify the order of the required fields.
- Do not modify the IDs of query parameters.

Query Name	Behavior and Usage
Active IPL List Query	Returns a list of active IPLs. This query is used to populate the IPL Subtype field in under IPL Checklist in a Hazards Analysis Safeguard record if the value in the IPL Type field is Active IPL.
Human IPL List Query	Returns a list of human IPLs. This query is used to populate the IPL Subtype field in under IPL Checklist in a Hazards Analysis Safeguard record if the value in the IPL Type field is Human IPL.
Passive IPL List Query	Returns a list of passive IPLs. This query is used to populate the IPL Subtype field in under IPL Checklist in a Hazards Analysis Safeguard record if the value in the IPL Type field is Passive IPL.

What If Folder

The Catalog folder `\\Public\Meridium\Modules\Hazards Analysis\What If` contains the following folders:

- Graphs
- Queries
- Reports

Graphs

The catalog folder `\\Public\Meridium\Modules\Hazards Analysis\What If\Graphs` contains the following items:

Item Name	Behavior and Usage
What If Analysis Mitigated Risk	A graph that displays a prompt for the Entity Key of a Hazards Analysis whose What If Analysis data you want to view in the Graph Viewer.
Subgraphs	A subfolder that contains the What If Analysis Mitigated Risk graph, which supports the What If Analysis Mitigated Risk graph.

Queries

The catalog folder `\\Public\Meridium\Modules\Hazards Analysis\What If\Queries` contains the following queries:

Item Name	Behavior and Usage
What If Analysis Query	Displays a prompt for the Entity Key of the desired Hazards Analysis, and then displays various information about the What If Analysis, including values that appear in the Hazards Analysis and IDs of the records that are linked to the What If Analysis.
What If Mitigated Risk Query	Displays a prompt for the Entity Key of the desired Hazards Analysis, and then displays unmitigated and mitigated risk rank values organized by the Systems/Nodes with which they are associated.

Item Name	Behavior and Usage
What If Risk Query	Displays a prompt for the Entity Key of the desired System/Node, and then displays the Entity Keys for the Equipment and Functional Locations that are associated with the specified System/Node.
HAZOP Max Risk Rank for Node	Displays a prompt for the Entity Key of the desired Hazards Analysis, and then displays the mitigated and unmitigated risk rank values organized by the Hazards Analysis with which they are associated.

Reports

The catalog folder \\Public\Meridium\Modueles\Hazards Analysis\What If\Reports contains the following items:

Item Name	Behavior and Usage
What If Analysis Report	A report that displays a prompt for the Entity Key of the desired Hazards Analysis, and then displays in the Report Viewer various information about the What If Analysis, including the field values from the Hazards Analysis and details on the records that make up that analysis.
Subreports	A folder that contains the reports with the following names, which support the Hazards Analysis Report: <ul style="list-style-type: none"> • Hazop_Analysis_Assets_Report • Hazop_Reference_Document_Report • Hazop_Team_Member_Report