



Reliability Analytics



Contents

Chapter 1: Reliability Analytics: Overview	1
Overview of the Reliability Analytics Module	2
Access the RA Overview Page	2
Chapter 2: Automation Rules	5
Automation Rules: Overview	6
Automation Rules: Workflow	6
Automation Rules	8
Chapter 3: Probability Distribution	16
Probability Distribution: Overview	17
Probability Distribution: Workflow	18
Probability Distribution Analyses	20
Chapter 4: Production Analysis	43
Production Analysis: Overview	44
Production Analysis: Workflow	45
Production Analyses	47
Production Data	59
Production Lines	62
Chapter 5: Reliability Distribution	73
Reliability Distribution: Overview	74
Reliability Distribution: Workflow	74
Reliability Distribution Analyses	76
Confidence Level and P Value	86
Failure Probability	100
Chapter 6: Reliability Growth	102

Reliability Growth: Overview	103
Reliability Growth: Workflow	104
Reliability Growth Analyses	105
Measurement Data	127
Chapter 7: Spares Analysis	131
Spares Analysis: Overview	132
Spares Analysis: Workflow	133
Spares Analyses	135
Spares	150
Spare Applications	153
Spare Application Populations	155
Failure Distributions	157
Monte Carlo Simulations	163
Chapter 8: System Reliability	166
System Reliability: Overview	167
System Reliability: Workflow	168
System Reliability Analyses	173
Resources	199
System Scenario	200
Diagrams	202
Risks	217
Actions	237
Global Events	250
Grid View	256
Simulations	260
Chapter 9: Admin	264
Access the RA Administrator Page	265
Configure a Reliability Report	265
Access a Recommendation	265
Create a Recommendation Alert for an Analysis	266

Chapter 10: Data Loader	267
About the System Reliability Data Loader	268
About the System Reliability Data Loader Requirements	268
About the System Reliability Data Loader Data Model	268
About the System Reliability Data Loader General Loading Strategy	269
About the System Reliability Data Loader Workbook Layout and Use	270
About the System Reliability Data Loader Load Verification	281
Chapter 11: Deployment and Upgrade	283
Deployment	284
Upgrade	284
Chapter 12: Reference	285
General Reference	286
Family Field Descriptions	353
Catalog Items	449
Distribution Types	456
Calculations	463
Failure Data	476

Copyright GE Digital

© 2023 General Electric Company.

GE, the GE Monogram, and Predix are either registered trademarks or trademarks of All other trademarks are the property of their respective owners.

This document may contain Confidential/Proprietary information of and/or its suppliers or vendors. Distribution or reproduction is prohibited without permission.

THIS DOCUMENT AND ITS CONTENTS ARE PROVIDED "AS IS," WITH NO REPRESENTATION OR WARRANTIES OF ANY KIND, WHETHER EXPRESS OR IMPLIED, INCLUDING BUT NOT LIMITED TO WARRANTIES OF DESIGN, MERCHANTABILITY, OR FITNESS FOR A PARTICULAR PURPOSE. ALL OTHER LIABILITY ARISING FROM RELIANCE UPON ANY INFORMATION CONTAINED HEREIN IS EXPRESSLY DISCLAIMED.

Access to and use of the software described in this document is conditioned on acceptance of the End User License Agreement and compliance with its terms.

Chapter 1

Reliability Analytics: Overview

Topics:

- [Overview of the Reliability Analytics Module](#)
- [Access the RA Overview Page](#)

Overview of the Reliability Analytics Module

The Reliability Analytics module provides a collection of tools that apply reliability engineering principles to help you make tactical (short-term) and strategic (long-term) decisions for maintenance and operational equipment management activities. It also provides:

- A means for analyzing historical failure data to identify trends and predict future failures.
- A mechanism for simulating what if scenarios regarding the reliability of a system to determine if a new or modified strategy will be effective.

The Reliability Analytics module provides the following types of tools:

- Production Analysis
- System Reliability Analysis
- Spares Analysis
- Reliability Distribution Analysis
- Probability Distribution Analysis
- Reliability Growth Analysis
- Automation Rules

Each tool provides a unique set of features that allow you to analyze data to develop strategies to improve reliability.

Access the RA Overview Page

About This Task

This topic describes how to access the **RA Overview** page, on which you can view all the information and perform various tasks to improve reliability of various Asset Hierarchy Levels.

You can perform the various tasks on this page based on the Security Groups you are assigned.

Tip: For more information, refer to the Security Group topic for this module.

Procedure

In the **Applications** menu, navigate to the **RELIABILITY** section, and then select **Reliability Analytics**.

The **RA Overview** page appears.

28 Automation Ru...	66 Probability Distr...	26 Production Anal...	109 Reliability Distri...	85 Reliability Grow...	14 Spares Analyses	111 System Reliabili...
------------------------	----------------------------	--------------------------	------------------------------	---------------------------	-----------------------	----------------------------

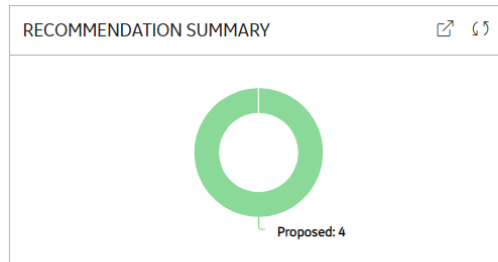
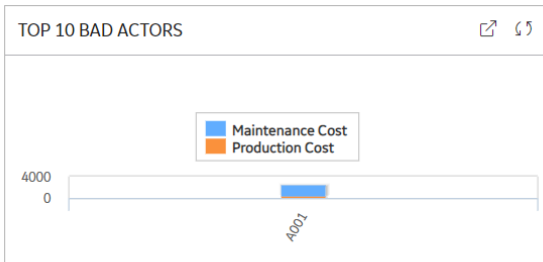
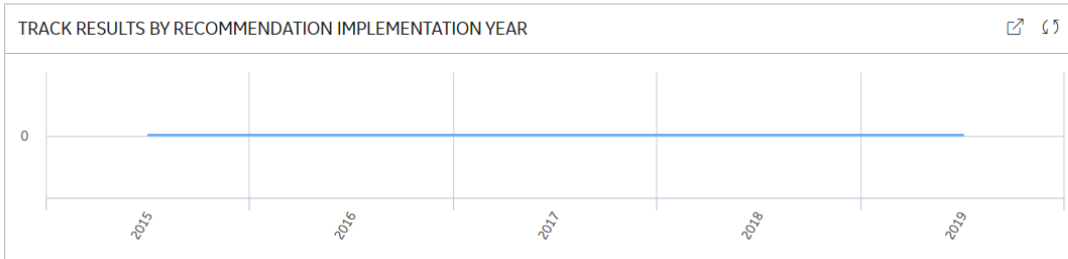

The tabs at the top of the page summarize the number of items in each category. You can select a tab to view one of the following lists:

- **Automation Rule:** Contains a list of Automation rules available in the database. To access this tab, you must be a member of the MI Reliability Administrator Security Group or a Super User.
- **Probability Distribution:** Contains a list of Probability Distribution Analyses available in the database.
- **Production Analyses:** Contains a list of Production Analyses available in the database.
- **Reliability Distribution:** Contains a list of Reliability Distribution Analyses available in the database.
- **Reliability Growth :** Contains a list of Reliability Growth Analyses available in the database.
- **Spares Analyses:** Contains a list of Spares Analyses available in the database.
- **System Reliability:** Contains a list of System Reliability Analyses available in the database.

On the page, you can also view the following sections:

- **Track Results By Recommendation Implementation Year:** Contains a line chart that displays yearly performance of Hierarchy Levels on which Reliability Recommendations have been implemented. The chart displays the sum of all the maintenance costs and production costs associated with all the Hierarchy Levels related to the Reliability Recommendation. The chart plots the sum of the maintenance costs and production costs of the Hierarchy Levels for the current year and the previous four years.

By default, the **Track Results By Recommendation Implementation Year** graph excludes the production costs associated with Production Loss Analysis (PLA). If you want to include the production costs associated with PLA in this graph, you need an active license for PLA, access to the required PLA families, and use **RATrackResultsByRecommendationWithPLA** graph, which is available in the `Public\Meridium\Modules\Reliability Manager` location. To use this graph, you must

modify the [Reliability Dashboard Dashboard configuration](#) in the Public\Meridium\Modules\Reliability Manager folder.

- **Top 10 Bad Actors:** Contains a chart that plots the losses that were contributed by the top 10 causing Hierarchy Levels for a given time period. The losses represented here are the sum of Maintenance Costs and the Production Losses caused by the causing Hierarchy Levels. You can also include the sum of Total Losses in the graph by modifying the query. When you include this category, the graph is updated to include one additional slice, which represents the Total Losses. By default, this chart shows values for last 90 days.

You can hover or tap on any datapoint for a Hierarchy Level to view:

- The name of the causing Hierarchy Level.
- Losses contributed by the causing Hierarchy Level.

By default, the **Top 10 Bad Actors** chart excludes production costs associated with Production Loss Analysis (PLA). If you want to include the production costs associated with PLA in this graph, you need an active license for PLA, access to the required PLA families, and use of the

RATrackResultsByRecommendationWithPLA graph. To use this graph, you must [modify the configuration of the Reliability Dashboard](#), which is found in the folder Public\Meridium\Modules\Reliability Manager.

- **Recommendation Summary:** Contains a chart that displays the number of Reliability recommendations filtered by state.

While viewing any of the charts, you can select  to customize the appearance of the chart by using standard graph features.

By default, the hierarchy level is set to Home. You can filter the hierarchy level by selecting  on the upper-left corner of the page. When setting to an asset or functional location in the hierarchy, only those analyses linked to the selected asset and its children, or to the selected functional location will appear. You can specify the time period for information that appears on the tabs or charts by entering the desired time period in the **Period** box.

Chapter 2

Automation Rules

Topics:

- [Automation Rules: Overview](#)
- [Automation Rules: Workflow](#)
- [Automation Rules](#)

Automation Rules: Overview

Overview of Automation Rules

Reliability Analytics

The Reliability Analytics module provides a collection of tools that apply reliability engineering principles to help you make tactical (short-term) and strategic (long-term) decisions for maintenance and operational equipment management activities. It also provides:

- A means for analyzing historical failure data to identify trends and predict future failures.
- A mechanism for simulating what if scenarios regarding the reliability of a system to determine if a new or modified strategy will be effective.

The Reliability Analytics module provides the following types of tools:

- Production Analysis
- System Reliability Analysis
- Spares Analysis
- Reliability Distribution Analysis
- Probability Distribution Analysis
- Reliability Growth Analysis
- Automation Rules

Each tool provides a unique set of features that allow you to analyze data to develop strategies to improve reliability.

Automation Rules

Automation Rules is a tool that helps you make rules to generate analyses for an entire hierarchy of equipment and locations that have related events or for a list of equipment that are returned by a query. The analysis results help you make tactical (short-term) and strategic (long-term) decisions for maintenance and operational equipment management activities that will help you analyze data and determine actions to take to improve reliability.

Automation Rules: Workflow

Reliability Analytics: Automation Rule Workflow

This workflow describes the process for creating multiple distribution or growth analyses at a single time based on the execution of a query or an asset/event relationship.

In the following workflow diagram, the blue text in a shape indicates that the corresponding description has been provided in the sections that follow the diagram. For more information, refer to the [Interpreting the Workflow Diagrams](#) topic in the [APM Product Workflows](#) documentation.

Note: For information on the personas associated with a GE Digital APM module, refer to the [APM Product Workflows](#) documentation.

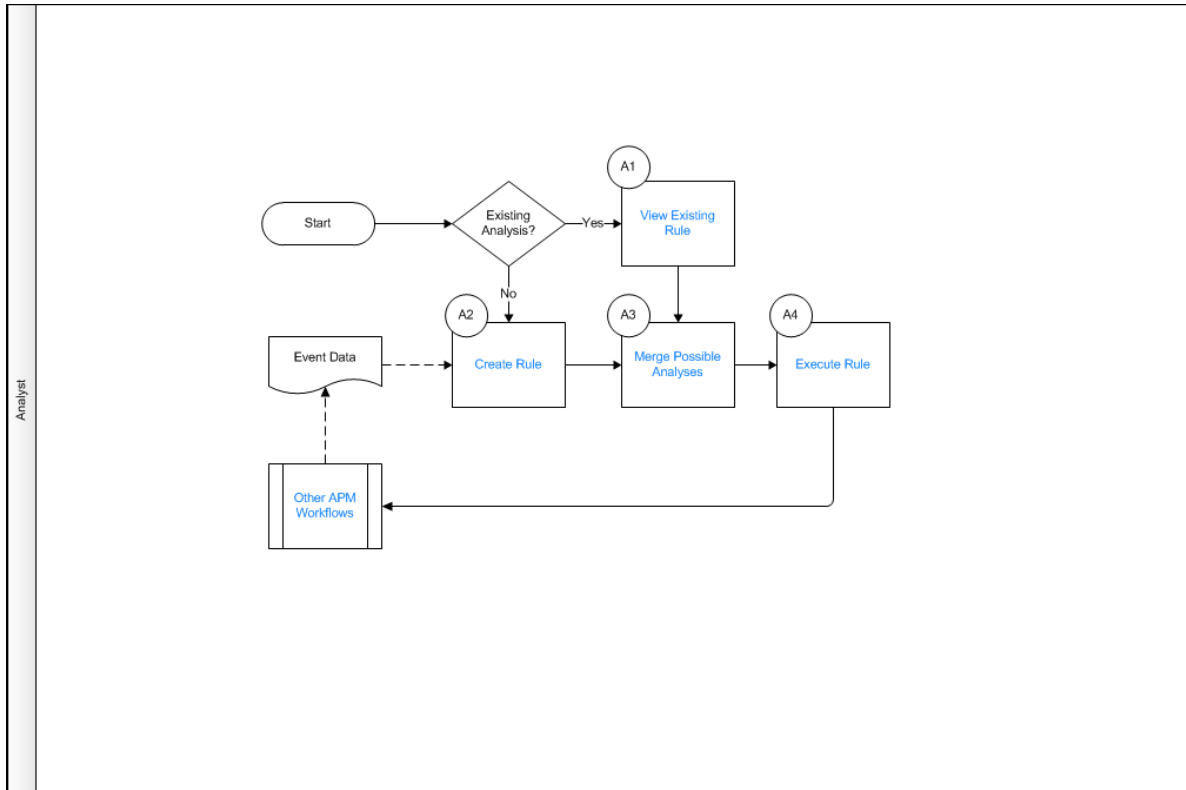

1. [View Existing Rule](#) on page 7
2. [Create Rule](#) on page 7
3. [Merge Possible Analyses](#) on page 7
4. [Execute Rule](#) on page 7
5. [Other Workflows](#) on page 8

View Existing Rule

Persona: Analyst

Open an existing automation rule that has been saved on the database and is accessible via hyperlinks from the **Automation Rules** section in Reliability Analytics

Create Rule

Persona: Analyst

Create a new automation rule using the wizard provided.

Merge Possible Analyses

Persona: Analyst

Merge sections of insufficient data to create enough data to support an analysis.

Execute Rule

Persona: Analyst

Queue the service that runs the rule that provides progress feedback and shows the details of the analyses.

Other Workflows

Persona: Analyst

Other workflows provide production data from: SAP, EAM, Recommendations.

Automation Rules

About Automation Rules

Reliability Distribution and Reliability Growth Analyses can be generated interactively or through Reliability Automation Rules. These rules can generate multiple Reliability Analyses for an entire hierarchy of equipment and locations that have related events or for a list of equipment that are returned by a query.

Using Reliability Automation Rules, you can analyze an entire family or elements of several families in a single step. Based on the parameters that you define for the automation rule query, the system will automatically generate the analysis calculations and generate the appropriate reliability analyses. The calculations can be based on an entire selected family, or on the results of a query, which could contain members of multiple families.

Note: To generate a Reliability Analysis, equipment and location families and failure data for the equipment and location must already be defined in the database.

About Creating Queries for Use with the Automation Rule Builder

In the Reliability Automation Rule Builder window, you can select an existing query to provide the data on which auto-generated Reliability Analyses will be built for a query-based Automation Rule. Before you can use the Reliability Automation Rule Builder window, one or more appropriate queries must be defined.

Note: After these queries have been created and used to build rules, they should not be deleted. Without the queries, the Automation Rules that are based on them cannot update the analyses that they generated.

Details

Automation Rule queries must contain:

- All of the fields needed for mapping to the selected analysis type (Reliability Distribution, Reliability Growth). For all analysis types, the following fields should be selected:
 - Asset ID (required).
 - Asset Installation Date (optional).
 - Failure Date (required).
 - Downtime (optional).
- The fields that will be used for grouping populations of events (including system fields such as Family ID and Family Key and the entity family caption)
- Filtering criteria.

Note: Filtering is disabled in the Reliability Automation Rule Builder if a query is used to build analyses.

We recommend that you use a query that contains the metadata information in the Asset ID and Failure Date fields (which are required fields) and that these two fields are defined in two separate entity families. This precludes the use of Group By queries, complex (non metadata-based) queries in the SQL Editor, and system fields or calculated fields for Asset ID and Failure Date information.

The master query cannot contain parameters. The master query should be stored in a public directory in the Catalog and must not be deleted. We recommend that you store this query in the GE Digital APM Catalog in the following folder: \\Public\Meridium\Modules\ReliabilityManager.

If you require additional fields for mapping or population grouping in the Reliability Automation Rule, you must change the master query. The master query should be accessible to members of the MI Reliability Administrators Security Group who will be working with Reliability Automation Rules. When the Reliability Automation Rule is executed to generate the analyses, sub-queries will be created using the master query as the source. If the master query is deleted, the sub-queries will cease to operate.

Access an Automation Rule

Procedure

1. Access the [RA Overview](#) page.
2. Select the **Automation Rules** tab.

A list of Reliability Automation Rules available in the database appears.

3. In the list, select the hyperlink of a Reliability Automation Rule that you want to view.

The **Automation** page appears, displaying the following tabs:

- **Definition:** Contains a description of the criteria that identifies the rule, including the type of analysis that will be generated from the rule.

If the rule is based on a query, the Rule Basis field will read Query and the Query field that specifies the related query the rule uses.

If the rule is based on Asset-Event data structure, the name of the family for Family-based events (i.e. Rule Basis, Asset Family, Event Family, and the relationship between the Asset and Event families) will be displayed in this section. If filters or groupings have been applied to the rule, they will also be included in this section.

- **Rule Information :** Contains a list of analyses that will be generated when you run the rule. This tab is selected by default. The following columns provide details on each of the analyses:
 - **Analysis Name:** Contains the list of analyses. You can select the name of the desired analysis.
 - **Number of Assets:** Contains the number of assets included in the analysis.
 - **Number of Failure Events:** Contains the number of Failure events for the specified Asset.

A Reliability Analysis will be created for each potential analysis listed that contains a minimum of two failure events the next time the automated rule is executed. You can select any link in the list to view a preview of the data that will be included in that analysis.

- For Reliability Automation Rules based on an Asset-Event data structure, the name of the analysis is populated automatically by the GE Digital APM system based on the name of the Asset family that you selected on the **Choose an Asset Family** builder screen.
 - If you made no selections on the **Select Population Grouping** screen, the GE Digital APM system will use only the Asset family name as the name of the analysis.
 - If you make Group By selections on the **Select Population Grouping** screen, the GE Digital APM system will append the name of each member of the selected population group(s) on this screen to the name of the analysis.

For example, suppose that Equipment is the name of the selected equipment/location family. If you selected the Manufacturer field for population grouping, the name of each manufacturer is listed next to the Equipment family name.

- For Reliability Automation Rules based on a query, the name of the analysis is populated automatically using values that correspond to the fields you selected on the **Select Population Grouping** screen. If you did not select any groupings, the new analysis will be named New Analysis.

Create an Automation Rule Based on a Query

Before You Begin

- To create a Reliability Automation Rule based on a query, the [query must exist](#) in the Catalog.

Procedure

1. [Access the RA Overview page](#).
2. In the upper-right corner of the page, select **New Analysis**, and then select **Automation Rule**.
The **Reliability Automation Rule Builder** window appears, displaying the **Welcome** screen.
3. Select **Next**.
The **Select Analysis Type** screen appears. You can use this screen to determine whether the rule will be created for a Reliability Distribution Analysis or a Reliability Growth Analysis.
4. If you want to create an Automation Rule for a Reliability Distribution Analysis, accept the default selection, and then select **Next**.
-or-
If you want to create an Automation Rule for a Reliability Growth Analysis, select **Reliability Growth Analysis**, and then select **Next**.
The **Define New Rule** screen appears.
5. Enter values in the **Rule Name** and **Rule Description** boxes for the new rule, and then select **Next**.
The **Rule Name** is a required field.
The **Select Data Source Type** screen appears. The **Use Query to provide data on top of which all analyses will be built** option is selected automatically.
6. Select **Next**.
The **Select Query** screen appears.
7. Select **Browse** to search for an existing query in the GE Digital APM Catalog.
The **Select a query from the catalog** window appears.
8. Select the needed query, and then select **Open**.
The complete path to the query or dataset is displayed in the **Query** box. The fields that exist for the selected query appear in the **Available Fields** list.
9. In the **Includes Data From the Following Sites** list, select the site(s) whose data from which you want to create an analysis.
If you are creating an analysis in a database that has [only one site stored in the Site Reference family](#), then the **Includes Data From the Following Sites** list will not appear on the **Select Query** screen.
10. Select **Next**.
The **Identify the Fields that are Necessary for the Analysis** screen appears.
11. As needed, specify values in the following fields:

- In the **Asset ID** list, select the name of the field in the query that contains the Asset ID. This is a required field and must be a character field.
- In the **Asset Installation Date** list, select the field in the query that contains the date when the piece of equipment was installed. This is an optional field.
- In the **Failure Date** list, select the field from your query that contains the date when the piece of equipment or location failed. This is a required field.
- In the **Downtime** list, select the field from your query that contains the downtime. The downtime is the amount of time that a piece of equipment or location is not available for any reason. This is an optional field.

12. Select **Next**.

The **Select Population Grouping** screen appears.

13. Select check box(es) next to the fields that will allow you to create populations of events for analyses.

Note: You are not required to select any population grouping(s). If you select a population grouping, the data will be filtered by that population into different groups. For example, if you select the Asset ID field to be a population field, a potential analysis will be generated on the **Automation Rule Information** page for every piece of equipment and location. The fields listed on the **Select Population Grouping** screen consist of fields from the equipment/location family, relationship family, and event family selected in the query.

14. Select **Finish**.

The new Reliability Automation Rule is created. The **Automation** page appears, displaying the **Definition** and **Rule Information** tabs. The **Rule Information** tab is selected by default, displaying a list of analyses that will be generated when the rule is executed.

Note: Based on the selections that you choose in the **Reliability Automation Rule Builder** window, a query is generated for an analysis. If you want to access the query containing the failure data for the analysis that will be generated when the Reliability Automation Rule is executed, in the **Rule Information** section, in the **Analysis Name** column, select the name of the desired analysis. The **View Query and Failure Data** window appears. The **Analysis Failure Data Query** section displays the query that is being used to retrieve the failure data for the selected analysis. The grid displays the result set of the query based on the mapping fields you selected in the **Reliability Automation Rule Builder** window. You cannot edit the fields listed in the query results.

Create an Automation Rule Based on Asset-Event Data Structure

About This Task

This topic describes how to create an Automation Rule based on Asset-Event Data structure. You can also [create an Automation Rule Based on a Query](#).

Procedure

1. Access the [RA Overview](#) page.
2. In the upper-right corner of the page, select **New Analysis**, and then select **Automation Rule**.

The **Reliability Automation Rule Builder** window appears, displaying a welcome screen.

3. Select **Next**.

The **Select Analysis Type** screen appears. You can use this screen to determine whether the rule will be created for a Reliability Distribution Analysis or a Reliability Growth Analysis.

4. If you want to create an Automation Rule for a Reliability Distribution Analysis, accept the default selection, and then select **Next**.

-or-

If you want to create an Automation Rule for a Reliability Growth Analysis, select **Reliability Growth Analysis**, and then select **Next**.

The **Define New Rule** screen appears.

5. Enter values in the **Rule Name** and **Rule Description** boxes for the new rule, and then select **Next**. This field is required.

The **Select Data Source Type** screen appears.

6. Select the **Select entity families that will form an Asset-Event data structure** check box, and then select **Next**.

The **Choose an Asset Family** screen appears.

7. In the **Select Asset Family** list, select the desired family. Alternatively, you can select 
8. Determine the level at which to perform the analysis by selecting one of the following options, and then select **Next**:
 - If you want to generate an analysis only for the selected family, accept the default selection, **Generate analyses for selected family**.
 - If you want to include all of the subfamilies of the selected family in the analysis, select the **Generate analyses for selected family and all of its sub-families** option. If you choose to include subfamilies, the **Generate analyses only for the sub-families located at the bottom of the selected hierarchy** check box below this option will become enabled. Select the check box if you want to generate analyses only for the subfamilies that are located at the bottom of the hierarchy for the selected family.

Note: If you select this option and then choose to add filters or grouping to the Reliability Automation Rule later in the builder, you must select the appropriate filters or grouping to ensure that the data is grouped or filtered correctly. This will result in analyses based on data that matches the desired criteria. If you are not able to get correct results, you may need to create automation rules individually for families at the bottom of a family hierarchy.

The **Choose Relationship and Event Family** screen appears.

9. As necessary, specify values in the following fields, and then select **Next**:
 - In the **Select Relationship Family** list, select the relationship family that identifies the relationship that should exist between the family that you selected on the previous screen and the Event family that you will select on this screen.
 - In the **Select Event Family** list, select the desired family. If you want to include assets that do not include event data in the analysis, select the **Include assets even if they do not include event data** check box. The **Select Event Family** list is disabled until you select a relationship family in the **Select Relationship Family** list.
 - In the **Includes Data From the Following Sites** list, select the site(s) whose data from which you want to create an analysis.

If you are creating an analysis in a database that has [only one site stored in the Site Reference family](#), then the **Includes Data From the Following Sites** list will not appear on the **Select Query** screen.

The **Identify the Fields that are Necessary for the Analysis** screen appears.

10. As necessary, specify values in the following fields, and then select **Next**:
 - In the **Asset ID** list, select the name of the field from your query that contains the Asset ID. This is a required field and must be a character field.
 - In the **Asset Installation Date** list, select the field from your query that contains the date when the piece of equipment was installed. This is an optional field.

Note: Mean Time Between Failures (MTBF) can be calculated based on different dates only. If installation date is not listed or is not known, the analysis can only count the time between the first

failure and any subsequent failures. In such cases, the time between the analysis start and the first failure will be automatically censored.

- In the **Failure Date** list, select the field from your query that contains the date when the piece of equipment or location failed. This is a required field.
- In the **Downtime** list, select the field from your query that contains the downtime. The downtime is the amount of time that a piece of equipment or location is not available for any reason. This field is required only if you need to calculate the TTF values.

The **Apply any Desired Filters** screen appears.

11. In the **Define Filters** list, select a field.
12. In the **Condition** list, select one of the field condition operators. The field conditions that you can select are the same as those that are available in the Advanced search. The list of operators will change depending on the type of field that you select (i.e., numeric, character, date, or logical).
13. In the **Value** box, enter the value that should meet the condition specified in the previous step. When entering dates or a number in this field, insert single quotes around the value.
14. Select **Add Filter**.

The filter criteria appears in the **Define Filters** box.

Tip: You can apply multiple filters by repeating step 10 to 14. After specifying new filter criteria, you must select **Add Filter** each time.

15. In the **Match** section, select either **All Conditions** or **Any Conditions** to apply to the filter results, and then select **Next**.

The **Select Population Grouping** screen appears.

16. Select **Next**.

The **Select Population Grouping** screen appears.

17. Select check box(es) next to the fields that will allow you to create populations of events for analyses.

Note: You do not need to select any population grouping(s). If you select a population grouping, the data will be sorted into groups by that population. For example, if you select the **Asset ID** field to be a population grouping field, a potential analysis will be displayed in the **Rule Information** section for every piece of equipment. The fields listed on the **Select Population Grouping** screen consist of fields from the equipment family, relationship family, and event family selected in the query.

18. Select **Finish**.

The new Reliability Automation Rule is created. The **Automation** page appears, displaying the **Definition** and **Rule Information** tabs. The **Rule Information** tab is selected by default. This section displays a list of analyses that will be generated when the rule is executed.

Note: Based on the selections that you choose in the **Reliability Automation Rule Builder**, a query is generated for analysis. If you want to access the query containing the failure data for the analysis that will be generated when the Reliability Automation Rule is executed, in the **Rule Information** section, in the **Analysis Name** column, select the name of the desired analysis. The **View Query and Failure Data** window appears. The Analysis Failure Data Query section displays the query that is being used to retrieve the failure data for the selected analysis. The grid displays the result set of the query based on the mapping fields you selected in the **Reliability Automation Rule Builder**. You cannot edit the fields listed in the query results.

Modify an Automation Rule

Procedure

1. [Access an Automation Rule](#) that you want to modify.

2. In the **Rule Information** section, in the upper-left corner, select .
 - The **Reliability Automation Rule Builder** window appears, displaying a welcome message.
 3. Proceed through the **Reliability Automation Rule Builder** window to modify the details of the Automation Rule.
- The Reliability Automation Rule is updated.

Merge Analyses

About This Task

If two or more analyses share similar characteristics, you may find it useful to merge them and produce one analysis instead of separate analyses. Also, if an analysis does not have the minimum number of failure events required to create an analysis, you can merge it with another analysis.

Procedure

1. [Access an Automation Rule](#) for which you want to merge the analyses.
2. In the **Rule Information** section, select check box to the left of at least two analyses that you want to merge.
3. In the upper-right corner of the section, select .
- The **Merge Analysis Grouping Fields** window appears.
4. In the **Grouping Name** section, select a grouping for the analyses.
- The fields related to the selected grouping appear in the **Grouping Value** section.
5. In the **Grouping Value** section, select a field to act as a reference field. The field(s) that you do not select are the alternate field(s).
6. Select **OK**.

The reference field now contains the values for the alternate field(s), and one analysis will be generated based on the reference field when the rule is executed. The system updates the list of analyses in the **Rule Information** section.

Unmerge Analyses

Procedure

1. [Access an Automation Rule](#) for which you want to unmerge analyses.
2. In the **Rule Information** section, select the check box to the left of a merged analysis.
3. In the upper-right corner of the section, select .
- The **Unmerge Analyses** window appears, displaying the list of existing merge conditions.
4. Select the desired merge condition(s), and then select **OK**.

The merge conditions are deleted, and the updated list of analyses appears in the **Rule Information** section. The separate analyses appear in the list.

Execute an Automation Rule

About This Task

When a rule is executed, only the potential analyses that contain the minimum number of failure points for an analysis will be created or updated. The following number of failure points is required for each analysis that can be created from a Reliability Automation Rule.

- Reliability Growth Analysis: 3 failure points
- Reliability Distribution Analysis: 2 failure points

If the potential analysis does not contain the corresponding number of failures or more, when the rule is executed, the analysis will not be created.



Note: Before you use a rule to create an analysis, you should review the data required for the type of analysis you are creating. If you use invalid data, the analysis will still be created, but the results will not be valid.

Important: Reliability Simulation Service is required to execute this task.

Procedure

1. [Access an Automation Rule](#) that you want to execute.
2. On the **Automation** page, in the upper-right corner, select **Execute Rule**.

The status of the rule execution appears below the **Execute Rule** button, indicating the progress of execution in percentage.

Note: You can select  to view the details of the execution. When you select , the **GE Digital APM** page appears in a new tab, displaying the **In Progress**, **Successful**, and **Failed** tabs. The number on each tab indicates the number of executions in the corresponding state.

The system executes the rule(s) and generates the resulting analyses.

Tip: At the bottom of the page, you can view the Information related to the selected Automation Rule.

Delete an Automation Rule

Procedure

1. [Access the RA Overview page](#).
2. Select the **Automation Rule** tab.

A list of Reliability Automation Rules available in the database appears.

3. Select the check box in the row for each the Automation Rule that you want to delete, and then select .

The **Delete Reliability Automation Rule** dialog box appears, asking you to confirm that you want to delete the selected Rules and all of the analyses created by the Rules.

4. Select **Yes**.

The selected Automation Rules and all of the analyses created by the Rules are deleted.

Chapter 3

Probability Distribution

Topics:

- [Probability Distribution: Overview](#)
- [Probability Distribution: Workflow](#)
- [Probability Distribution Analyses](#)

Probability Distribution: Overview

Overview of Probability Distribution Analysis

Reliability Analytics

The Reliability Analytics module provides a collection of tools that apply reliability engineering principles to help you make tactical (short-term) and strategic (long-term) decisions for maintenance and operational equipment management activities. It also provides:

- A means for analyzing historical failure data to identify trends and predict future failures.
- A mechanism for simulating what if scenarios regarding the reliability of a system to determine if a new or modified strategy will be effective.

The Reliability Analytics module provides the following types of tools:

- Production Analysis
- System Reliability Analysis
- Spares Analysis
- Reliability Distribution Analysis
- Probability Distribution Analysis
- Reliability Growth Analysis
- Automation Rules

Each tool provides a unique set of features that allow you to analyze data to develop strategies to improve reliability.

Probability Distribution Analysis

Probability Distribution Analysis is a tool that allows you to create a statistical distribution with a specific pattern to describe the Time to Failure. An independent variable based on a query, dataset, or manually entered data is used to generate an analysis, which will help you make tactical (short-term) and strategic (long-term) decisions for maintenance and operational equipment management activities and analyze data to identify trends and predict future failures.

Probability Distribution Analysis Workflow

This workflow provides the basic, high-level steps for developing Probability Distribution Analysis. The steps and links in this workflow do not necessarily reference every possible procedure.

1. **Collect failure data.**
2. Create a new Probability Distribution Analysis [from an existing query or dataset](#), or [from manually entered data](#). The Probability Distribution Analysis should be based on the failure data collected in the previous step.
3. **Evaluate the results** of performing the Probability Distribution Analysis.

Probability Distribution: Workflow

Reliability Analytics: Probability Distribution Analysis Workflow

This workflow describes the process for analyzing changes to a measured value over time to determine the mathematical median and mean values associated with analyzed data.

In the following workflow diagram, the blue text in a shape indicates that the corresponding description has been provided in the sections that follow the diagram. For more information, refer to the [Interpreting the Workflow Diagrams](#) topic in the [APM Product Workflows](#) documentation.

Note: For information on the personas associated with a GE Digital APM module, refer to the [APM Product Workflows](#) documentation.

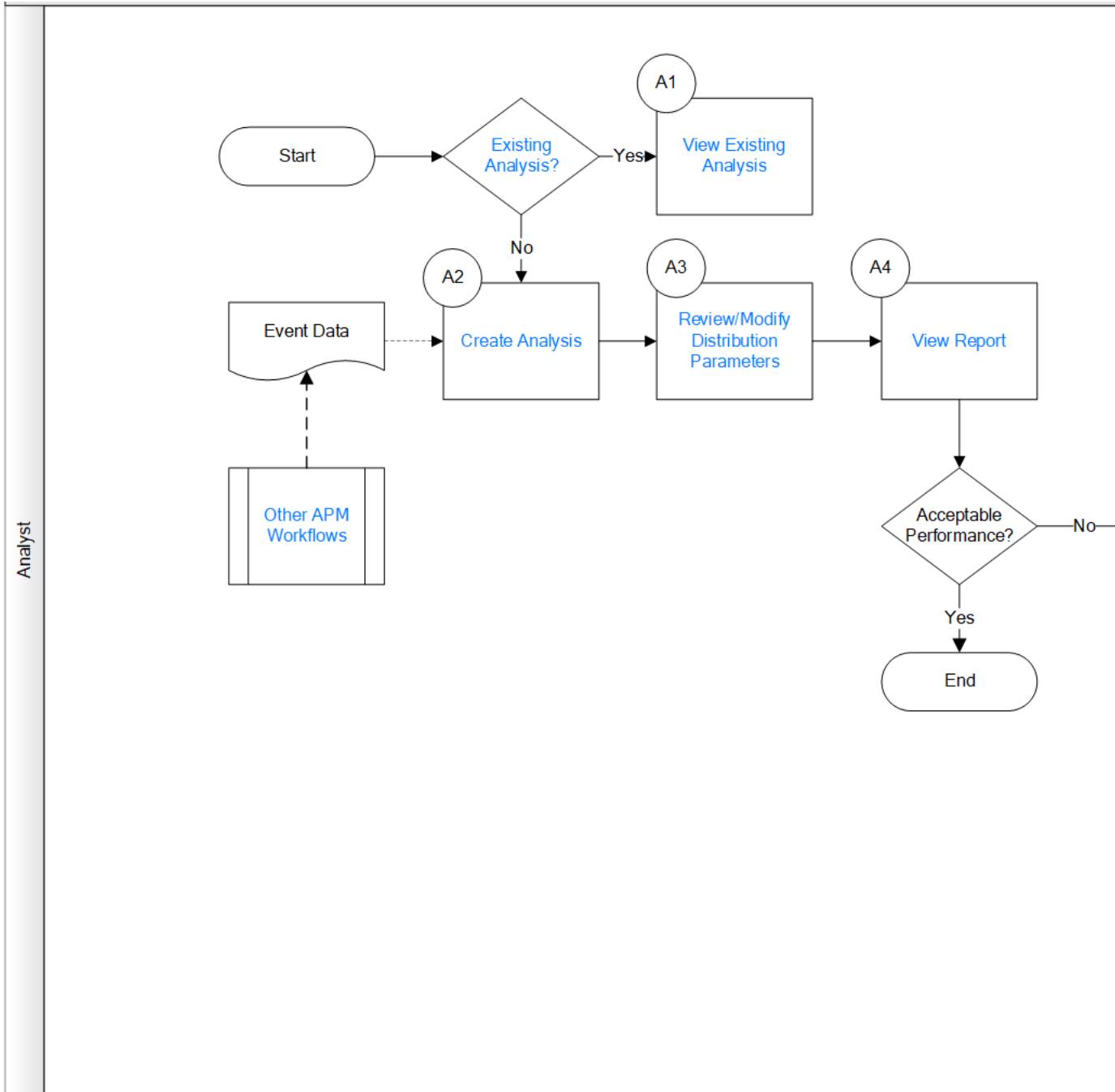

1. [Existing Analysis?](#) on page 75
2. [View Existing Analysis](#) on page 75
3. [Create Analysis](#) on page 76
4. [Review/Modify Distribution Parameters](#) on page 76
5. [View Report](#) on page 76
6. [Other Workflows](#) on page 76
7. [Manage Performance Recommendations](#) on page 76

Existing Analysis?

Persona: Analyst

Is the analysis one that was created previously and saved to the database?

View Existing Analysis

Persona: Analyst

View the details of an existing analysis.

Create Analysis

Persona: Analyst

Create an analysis based on production data or event data.

Review/Modify Distribution Parameters

Persona: Analyst

If Distribution Parameters have been updated, review/modify them. Distribution Parameters are updated when a different distribution type is selected (e.g., when changing from Lognormal to Auto).

View Report

Persona: Analyst

View and save the analysis report.

Manage Performance Recommendations

Persona: Analyst

Create any number of performance recommendations and Approve them using state management.

Note: Performance recommendations are not required.

Go to the Manage Performance Recommendations workflow.

Other Workflows

Persona: Analyst

Other workflows provide production data from SAP, EAM, and Recommendations.

Probability Distribution Analyses

About Probability Distribution Analysis

Probability Distribution Analysis allows you to describe the Time to Failure (TTF) as a statistical distribution, which usually is characterized by a specific pattern.

Based on a query, dataset, or data that you manually enter, you can use an independent variable to generate a Probability Distribution Analysis. GE Digital APM Reliability supports four Distribution types:

- **Normal**
- **Weibull**
- **Exponential**
- **Lognormal**
- **Triangular**
- **Gumbel**
- **Generalized Extreme Value**

About Data Censoring in a Probability Distribution Analysis

Probability Distribution Analysis supports the functionality of censoring, which accounts for the period of time from the last failure date to the analysis end date. You can censor or ignore datapoints in a Probability Distribution Analysis to estimate the probability when a failure might occur. Censoring is based on failure modes.

Censoring a datapoint means that the datapoint is excluded as a failure but included in the operating time of the Asset. If you select the **Censored** check box, the data in the selected row is excluded. When you create a Probability Distribution Analysis using a query or dataset as the data source, the GE Digital APM system automatically censors time values from the beginning of the Analysis Period to the first event and the time value from the last event to the end of the analysis. After the calculations for the analysis have been performed, each time that the query or dataset is refreshed, the failure data will be automatically censored.

Regardless of the data source you use, you can censor any failure data. Consider the following:

- For Maximum Likelihood Estimators (MLE), the maximum number of censored datapoints is one (1) less than the total number of datapoints.
- For Least Squares estimation, the maximum number of censored datapoints is two (2) less than the total number of datapoints.

Pump Failure

Assume that you want to determine the reasons for a pump failure.

A pump might have failed due to multiple reasons, such as rusted part, motor overheating, insufficient power supply, or power outage. Each of these reasons will have its own specific failure rate and probability density function. To determine the failure rate of "motor overheating," you must censor all other failure modes from the analysis.

Further, motor overheating might be caused due to multiple reasons, such as improper operation, improper application, and improper maintenance. The censoring feature allows you to separate the failure modes, and determine which is the dominant failure mode. Based on this information, you can decide what is needed to improve the motor performance.

Access a Probability Distribution Analysis

Procedure

1. Access the **RA Overview** page.
2. Select the **Probability Distribution** tab.

A list of Probability Distribution Analyses available in the database appears.

3. Select the Probability Distribution Analysis whose details you want to view.

The **Analysis Summary** workspace for the selected analysis appears, displaying a preview of the [Probability Distribution Function \(PDF\) plot](#) and the [Cumulative Density Function \(CDF\) plot](#). The workspace also contains the following sections at the bottom of the workspace:

- **Distribution Options**: Contains the summary of [distribution properties](#) for the selected Probability Distribution Analysis and allows you to modify these properties.
- **Distribution Parameters**: Contains the distribution parameters, which are determined by the distribution type.
- **Goodness of Fit Test**: Displays the [results](#) of the Goodness of Fit (GOF) test and includes the Statistic, P-Value and Passed fields.

The left pane contains the following tabs:

- **Probability Plot**
- **PDF Plot**
- **CDF Plot**

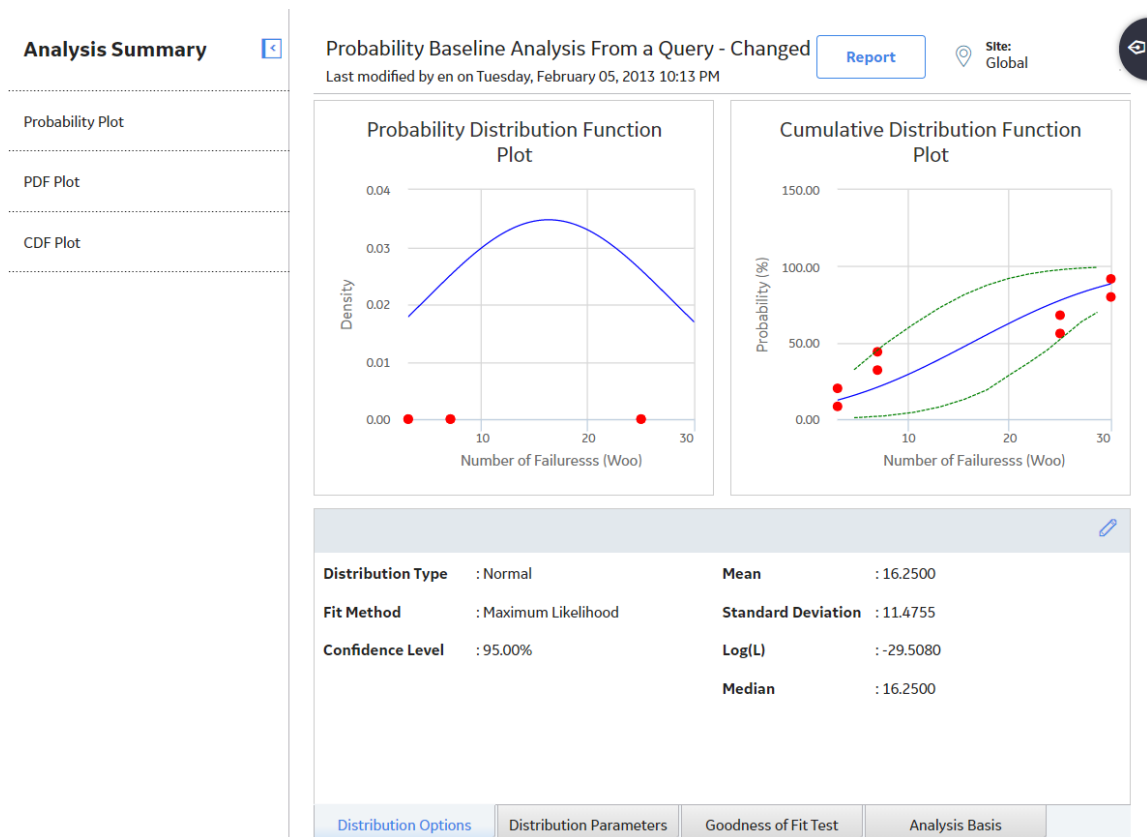

About Probability Plot

The Probability Plot is a log-log plot with data overlay and confidence limits that graphically displays the probability (expressed as a percentage) of each possible value of the random variable (CDF Occurrence % vs. time). CDF Occurrence % used here is numerically equal to the value from the cumulative distribution.

Note: Time used here refers to life data, not calendar data.

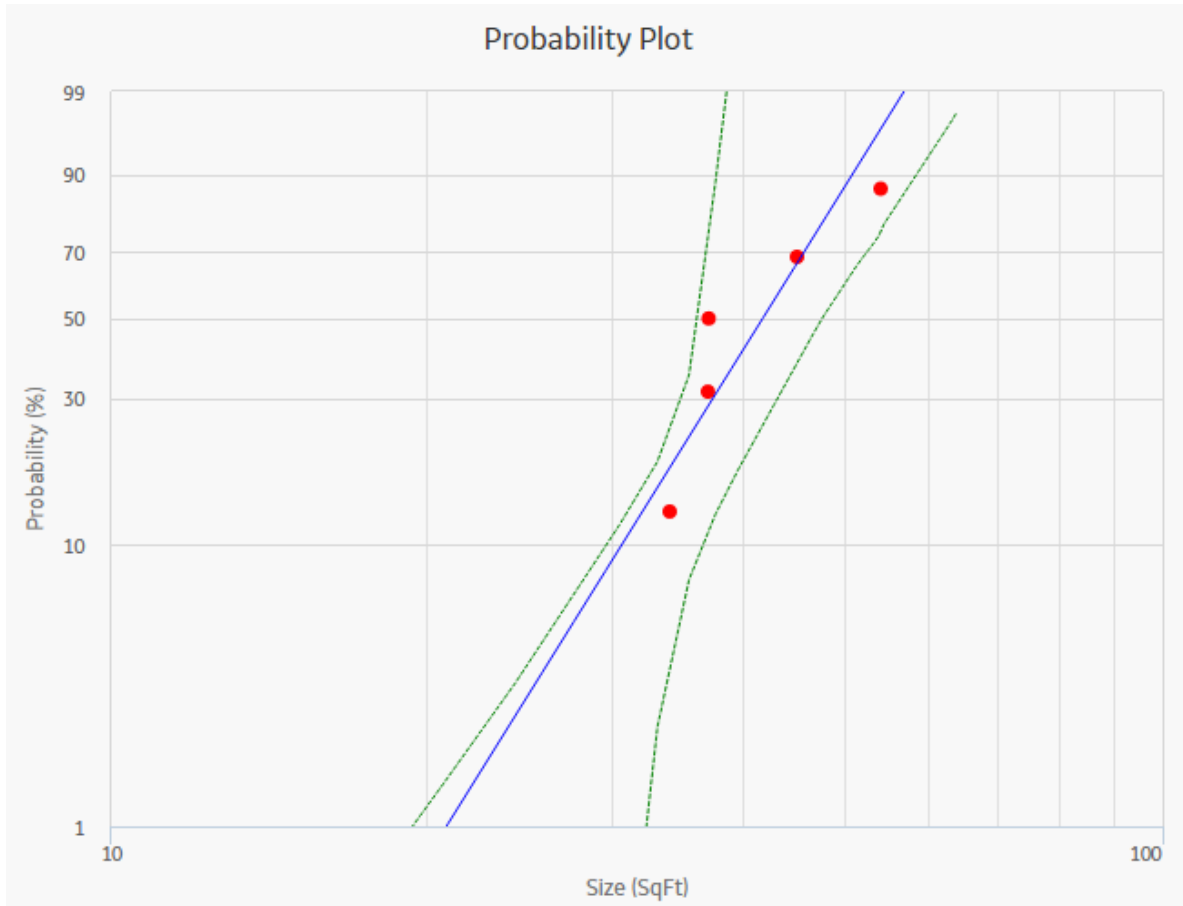

The Probability Plot shows the same data as the [CDF plot](#), just represented in a log-log format. The log-log format reflects the standard technique for representing Weibull Distribution. Log-log format Data overlay gives a visual estimate of Goodness of Fit (GOF). Data overlay also gives clues to the presence of multiple failure modes. If a single or multiple inflection points exist in the data, then there is a possibility of multiple failure modes.

Note: Interaction with charts is not available on [touch-screen devices](#).

Graph Features

While accessing a Probability Plot, you can:

- Hover or tap on any datapoint to view the coordinates and the details of a datapoint.
 - For an Estimated datapoint, you can view the type of distribution, the distribution parameters, and the value of R-Squared.
 - For an Observed datapoint, you can view the name and the value of Variable.
- Click or double-tap on any observed datapoint to view the data on the [Distribution Data](#) window.
- [Censor a datapoint](#).
- Customize the appearance of the plot by using standard [graph features](#).
- Customize the data displayed in the graph by adjusting the x-axes to vary the display range.

About Failure Rate Plot

The Failure Rate Plot shows the instantaneous failure rate of the population.

- If the function is increasing, then equipment is wearing out.
- If the function is decreasing, then equipment is subject to infant mortality.

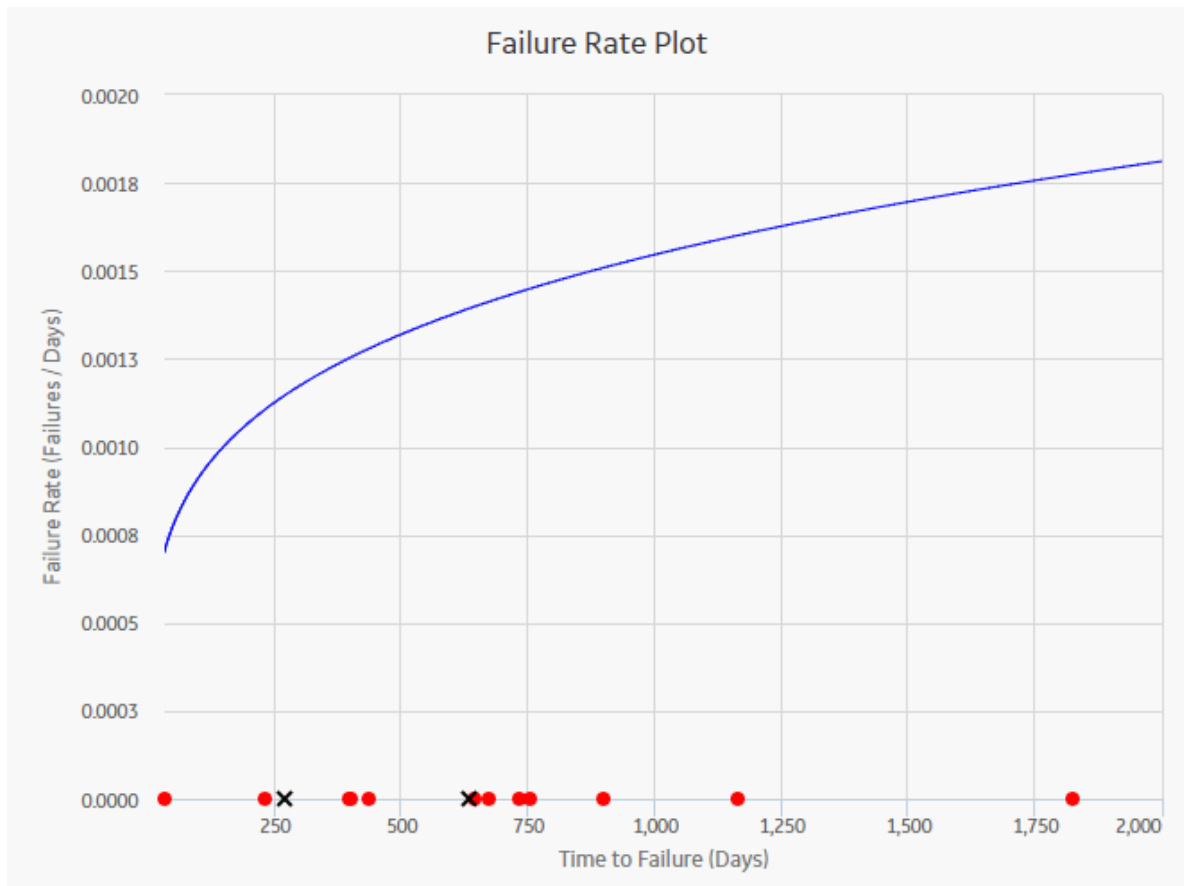

Note: Interaction with graphs is not available on [touch-screen devices](#).

Graph Features

When you access a Failure Rate Plot, GE Digital APM displays [auto-censored datapoints](#) that represent the life between the last date of the failure and the end of the analysis.

While viewing a Failure Rate Plot, you can:

- Hover or tap on any datapoint to view the coordinates and the details of a datapoint.
 - For an Estimated datapoint, you can view the type of distribution, the distribution parameters, and the value of R-Squared.
 - For an Observed datapoint, you can view the name and the value of Variable.
- Select an observed datapoint to open the **Point Information** window. You can then select **Go To Editor** to view data.
- [Censor a datapoint](#).
- Customize the appearance of the graph by using standard [graph features](#).

About PDF Plot

The Probability Density Function (PDF) plot is a lin-lin plot that counts the number of failures (or any other data) between certain time periods, creating a curve fit that estimates how many failures (failure data or any other data) you can expect to occur at a given point of time. This plot shows Density vs. Size. The term

Density is used here with failure data to describe the size of the population that failed at the particular value of size (SqFt). A PDF plot helps you to answer a question such as, "What is the chance of a member of the population failing at exactly the time in question?"

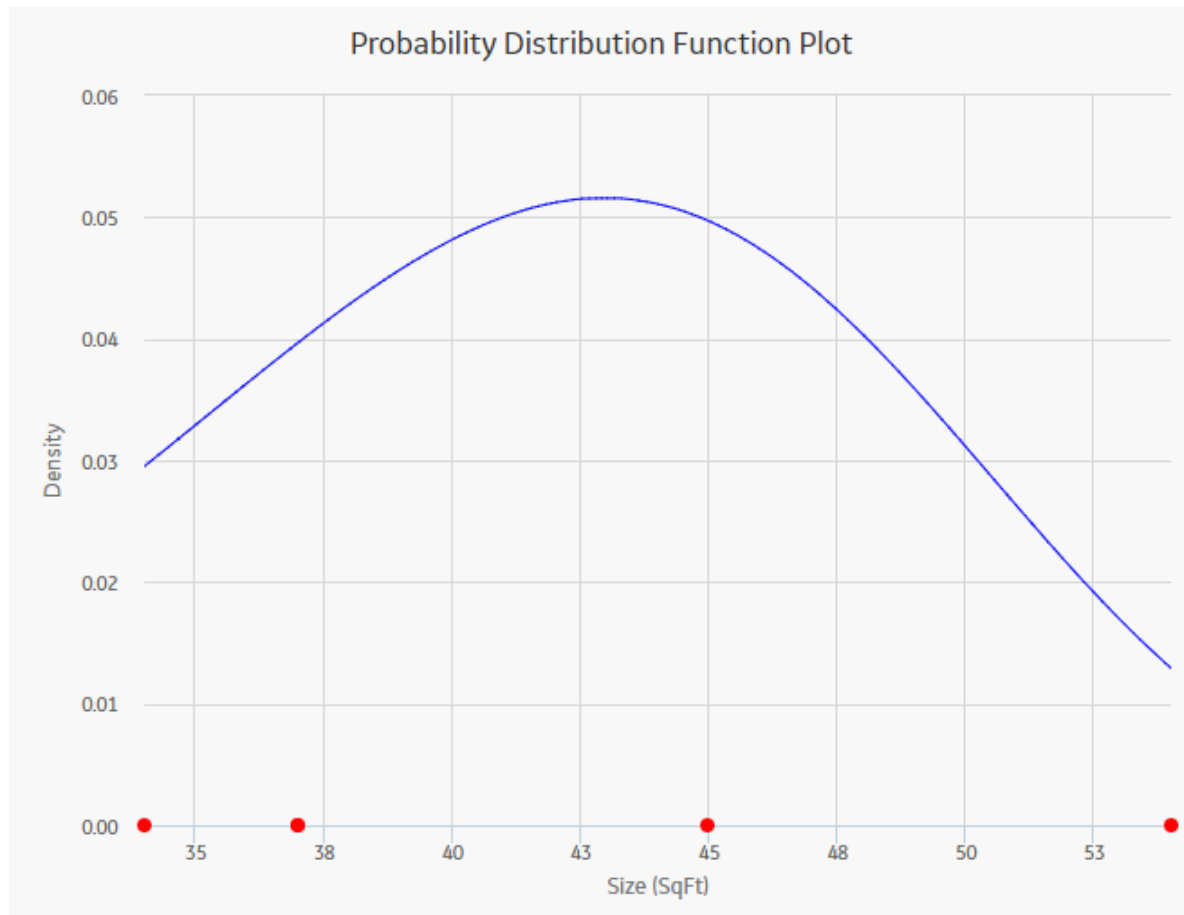

Note: Interaction with charts is not available on [touch-screen devices](#).

Graph Features

While accessing a PDF plot, you can:

- Hover or tap on any datapoint to view the coordinates and the details of a datapoint.
 - For an Estimated datapoint, you can view the type of distribution, the distribution parameters, and the value of R-Squared.
 - For an Observed datapoint, you can view the name and the value of Variable.
- Click or double-tap on any observed datapoint to view the data on the **Distribution Data** window.
- [Censor a datapoint](#).
- Customize the appearance of the plot by using standard [graph features](#).
- Customize the data displayed in the graph by adjusting the x-axis to vary the display range.

About CDF Plot

The Cumulative Distribution Function (CDF) plot is a lin-lin plot with data overlay and confidence limits. It shows the cumulative density of any data set over time (i.e., Probability vs. size). The term Probability is used in this instance to describe the size of the total population that will fail (failure data or any other data) by size (SqFt).

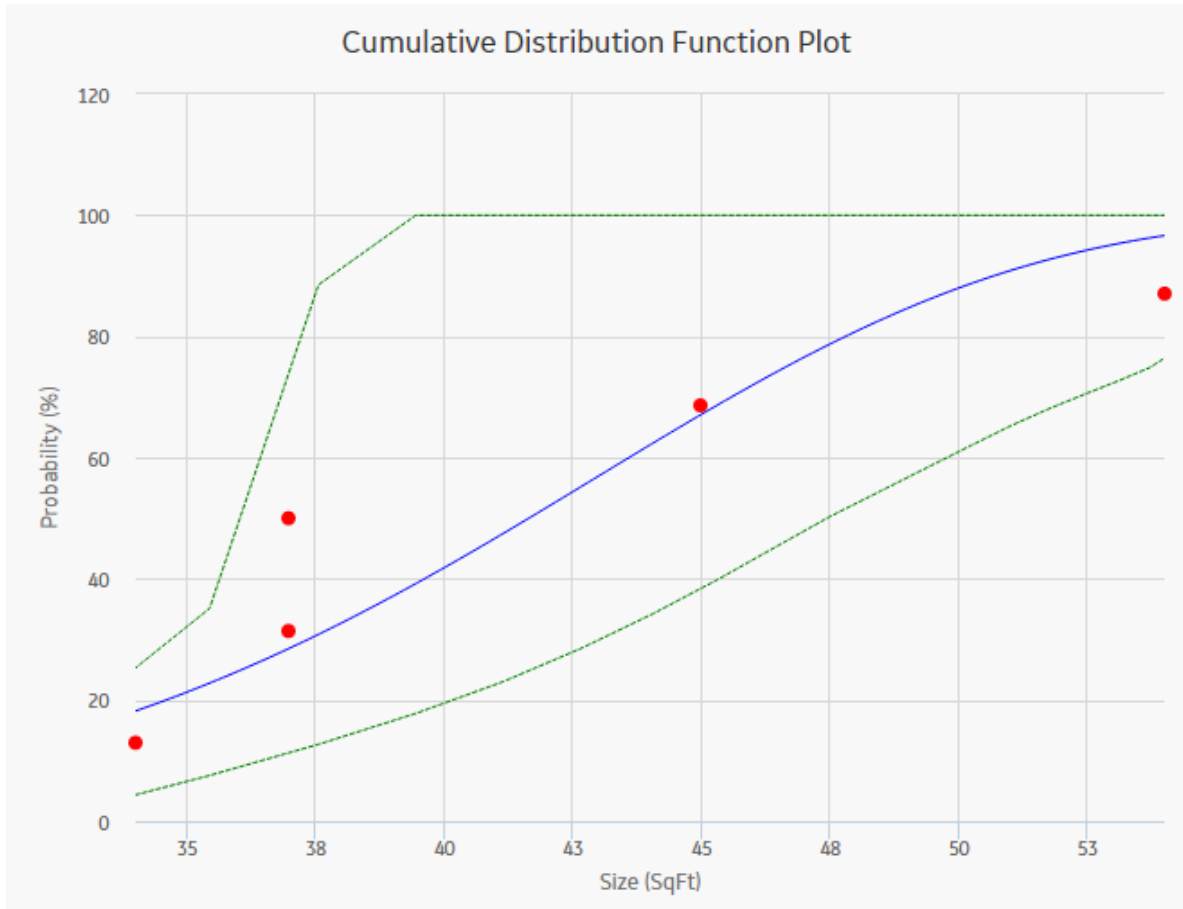

CDF plot answers a different question than PDF. For example, "What is the probability of failure at Size (SqFt)?" The CDF curve is the area under the PDF curve. The CDF accumulates all probability of failure up to the point in time in question. Since the number of failures increases with increasing size, the slope of the curve is always positive, always increasing.

Note: Interaction with charts is not available on [touch-screen devices](#).

Graph Features

While accessing a CDF plot, you can:

- Hover or tap on any datapoint to view the coordinates and the details of a datapoint.
 - For an Estimated datapoint, you can view the type of distribution, the distribution parameters, and the value of R-Squared.
 - For an Observed datapoint, you can view the name and the value of Variable.
- Click or double-tap on any observed datapoint to view the data on the [Distribution Data](#) window.
- [Censor a datapoint](#).
- Customize the appearance of the plot by using standard [graph features](#).
- Customize the data displayed in the graph by adjusting the x-axes to vary the display range.

About Preventive Maintenance Optimization

Preventative Maintenance (PM) Optimization uses the results of a Reliability Distribution Analysis to measure the optimum time to perform a Planned (Restorative) Maintenance (PM) procedure on a piece of equipment. PM optimization does not calculate minor maintenance schedules but determines the optimal

time to perform major repairs or replace a piece of equipment until there is a minimal amount of cost and risk. PM optimization is only valid for wear-out failure modes and will not give accurate results for a Weibull analysis where Beta is less than 1.

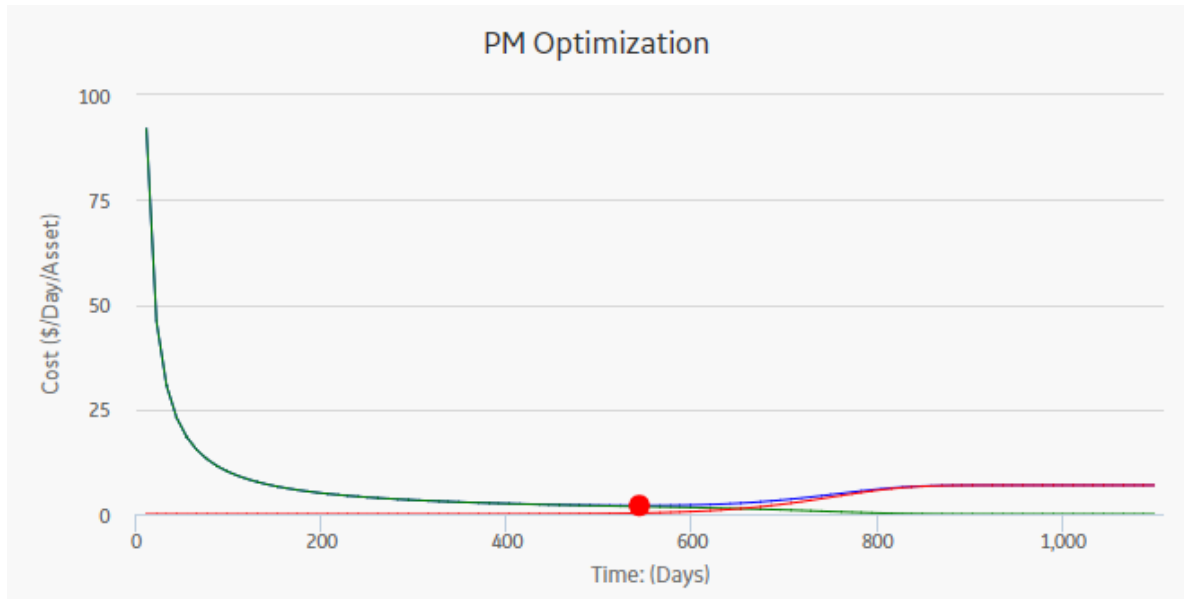

Note: Interaction with graphs is not available on [touch-screen devices](#).

Details

A PM optimization is composed of the following steps:

1. The calculation model is configured to acquire the necessary parameters, including Mean Time Between Failures (MTBF). MTBF is used to determine the probability that a piece of equipment will fail.
2. The cost ratio is determined. This ratio is the cost of planned Preventative Maintenance (PM) events versus the cost of unplanned maintenance events. You can manually enter the cost or select an existing query as the source of the cost data.
3. Based on the MTBF and the calculation of the ratios, the GE Digital APM system estimates the optimum time (interval) to maintain equipment. The cost per piece of equipment based on the Optimized Preventative Maintenance Interval is also displayed.
4. The GE Digital APM system creates optimization graphs, which gives the analyst the optimum time to conduct a repair or overhaul based upon the ratio of planned to unplanned repair costs. This ensures that repairs are conducted in a cost-effective manner, minimizing risk while maximizing time in service.

The limitation to using a PM optimization is it will always give a result for the statistical distribution on which it is based. This does not mean that it will always make sense to do a PM at the interval specified. In particular, design flaws that manifest themselves as poor reliability can more effectively be addressed through redesign rather than PM.

Collect Data for Probability Distribution Analysis

To create a Probability Distribution Analysis, you must select the field that contains the value that you want to analyze.

The following table shows the typical data needed to build and analyze Probability Distribution Analyses.

Data Required	Data Type	Description	Behavior and Usage
Censored	Logical	As needed, select the field to provide censoring information. Select the field from the data source that contains a value that indicates censored values.	This field is optional.
Random Variable	Character	If the data source is a query, the name of the random variable and the units of measure will be pre-populated based on the selection you made in the Value field on the previous screen. If you selected a different data source, type the name of the random variable in the Random Variable field and the units of measure for the random variable in the Units field.	This field is optional.
Units	Character	Select the units of measure for the random variable.	This field is optional.
Value	Numeric	Select the field that contains the value you want to analyze.	This is a required field.

Access Multiple Probability Distribution Analyses

About This Task

You can access multiple Probability Distribution Analyses and compare multiple plots for the selected analyses. You cannot modify the details of the analyses based on which the Comparison Plot is generated.

Procedure

1. Access the [RA Overview](#) page.
2. Select the **Probability Distribution** tab.

A list of Probability Distribution Analyses available in the database appears.

3. Select two or more Probability Distribution Analyses whose plots you want to compare.

Note: You can select up to 20 analyses to compare plots.

4. In the upper-right corner of the grid, select .

The **Multiple Probability Distribution Analysis** page appears, displaying the **Comparison Plot**. By default, [Probability Plot](#) for the selected analyses appears. You can also view the following types of plots:

- [PDF plot](#)
- [CDF plot](#)

Multiple Probability Distribution Analyses

2 plots are being viewed now



Create a Probability Distribution from an Existing Query or Dataset

Procedure

1. Access the [RA Overview](#) page.
2. In the upper-right corner, select **New Analysis**, and then select **Probability Distribution**.
The **Probability Distribution Builder** window appears, displaying the **Define New Analysis** screen.
Note: All required information is provided, but for additional information, consult the [Distribution Analysis Families](#) topic.
3. Enter values in the **Analysis Name** and **Description** boxes for the new analysis, and then select **Next**.
The **Select Data Source Type** screen appears. The **Data will be based on an existing Query** option is selected by default.
4. If you want to load data using an existing query, select **Next**.
The **Select Query** screen appears.
-or-
If you want to load data using an existing dataset, select **Data will be based on an existing Dataset**, and then select **Next**.
The **Select Dataset** screen appears.
5. Select **Browse** to search for an existing query or dataset in the GE Digital APM Catalog.

The **Select a query from the catalog** or **Select a dataset from the catalog** window appears, depending on whether you selected **Data will be based on an existing Query** or **Data will be based on an existing Dataset** in the previous step.

6. Select the required query or dataset, and then select **Open**.

The complete path to the query or dataset is displayed in the **Query** or **Dataset** box. The fields that exist for the selected query or dataset appear in the **Available Fields** list.

7. In the **Includes Data From the Following Sites** list, select the site(s) whose data from which you want to create an analysis.

If you are creating an analysis in a database that has [only one site stored in the Site Reference family](#), then the **Includes Data From the Following Sites** list will not appear on the **Select Query** screen.

8. Select **Next**.

The **Select Data Fields** screen appears.

9. As necessary, specify values in the following fields:

- a. In the **Random Variable** list, select a numeric value. This is a required field. A random variable associates a numerical value with every event. It describes a (possibly infinite) set of different events having a related probabilistic structure. The probability distribution of the random variable is a function that maps each possible value of the random variable to a particular probability.
- b. In the **Censored** list, select a field that indicates censored values (i.e., not included in the Probability Distribution Analysis calculations). The selected field must be a logical field. This is an optional field.

10. Select **Next**.

The **Specify Random Variable** screen appears.

11. In the **Random Variable Name** box, enter the name of the random variable.

12. In the **Units of Random Variable** box, enter the units of measure for the random variable selected above.

13. Select **Finish**.

The GE Digital APM system generates the analysis and the **Probability Distribution** page appears, displaying the analysis results.

Create a Probability Distribution from Manually Entered Data

Procedure

1. [Access the RA Overview page](#).

2. In the upper-right corner, select **New Analysis**, and then select **Probability Distribution**.

The **Probability Distribution Builder** appears, displaying the **Define New Analysis** screen.

Note: All required information is provided, but for additional information, consult the [Distribution Analysis Families](#) topic.

3. Enter values in the **Analysis Name** and **Description** boxes for the new analysis, and then select **Next**.

The **Select Data Source Type** screen appears.

4. Select **I will manually enter data**, and then select **Next**.

The **Select Data Format** screen appears.

5. In the **Random Variable Name** box, enter the name of the Random Variable.

6. In the **Units of Random Variable** box, enter the units of measure for the Random Variable selected above.

7. Select **Finish**.

The **Probability Distribution Data Editor** window appears.

8. Enter the information about the random variables that you want to include in the analysis. By default, the following **columns** are listed on the grid:

- **Random Variable** : Provide the value of the random variable.
- **Censored** : Select the check box to censor data.
- **Ignore** : Select the check box if you do not want to include the data on the selected row in the calculations.
- **Remarks** : Provide comments about the event.

Note: A minimum of three failure data points are needed to perform a calculation or you will receive a warning message and the analysis will not be generated.

Tip: You can add more rows of data by selecting **Add** at the bottom of the grid. You can remove any row of data by selecting the **Remove** next to the row of data that you want to delete.

9. Select **OK**.

The GE Digital APM system generates the analysis. The **Distribution Data** window closes and the **Probability Distribution** page appears, displaying the analysis results.

Change the Distribution Type of a Probability Distribution Analysis

About This Task

When you create a Probability Distribution Analysis, the Distribution Type is set to Weibull by default. After the analysis is created, you can change the Distribution Type to one of the following:



- **Normal**
- **Weibull**
- **Exponential**
- **Lognormal**
- **Triangular**
- **Gumbel**
- **Generalized Extreme Value**

Note: Select **Auto** if you want the GE Digital APM system to select the appropriate Distribution Type based on the results of the Goodness of Fit test.

You can change the Distribution Type from the **Analysis Summary** workspace or from any of the plot tabs in the left pane.

Procedure

1. [Access a Probability Distribution Analysis](#) for which you want to modify the Distribution Type.
2. If you want to change the Distribution Type from the **Analysis Summary** workspace:

- a. In the bottom section, select **Distribution Options**, and then select  .
The **Distribution Type** field is enabled.
- b. In the **Distribution Type** box, select the desired Distribution Type, and then select  .
The analysis is recalculated based on the selected Distribution Type.

-or-

If you want to change the Distribution Type from one of the plot tabs (e.g., **Probability Plot** tab):

- a. In the left pane, select the **Probability Plot** tab.

The **Probability Plot** appears in the workspace.

Note: You can also change the Distribution Type via the **PDF Plot** or **CDF Plot** tabs.

- b. In the upper-right corner of the workspace, select **Distribution Options**, and then select **Distribution Type**.

The **Edit Distribution Type** window appears, displaying the following options:

- Normal
 - Exponential
 - Traingular
 - Generalized Extreme Value
 - Weibull
 - Lognormal
 - Gumbel
 - Auto (Selection based on Goodness of Fit)
- c. Select the desired Distribution Type, and then select **OK**.
The analysis is recalculated based on the selected Distribution Type.

Change the Distribution Parameters in a Probability Distribution Analysis



About This Task

This topic describes how to modify the values of the distribution parameters in a Probability Distribution Analysis.

You can change the distribution parameters from the **Analysis Summary** workspace or from any of the plot tabs in the left pane.

Procedure

1. [Access a Probability Distribution Analysis](#) for which you want to modify the Distribution Parameters.
2. If you want to modify the values of the Distribution Parameters from the **Analysis Summary** workspace:

- a. In the bottom section, select **Distribution Parameters**, and then select  .
The **Calculate** check boxes appear below each of the parameters.
- b. Clear the **Calculate** check box next to the parameter(s) whose value you want to modify.
The parameter field(s) are enabled.
- c. Enter the desired value for the parameter.
- d. Select .

Note: If you reselect the **Calculate** check box after manually entering data, the manually entered data for the parameter will not be retained. If you decide not to use the parameters you entered, select , and the previous selection will be used in the calculations.

The system recalculates the analysis based on the selected distribution parameter.

-or-

If you want to modify the values of the distribution parameters from one of the plot tabs (e.g., **Probability Plot** tab):

- a. In the left pane, select the **Probability Plot** tab.
The **Probability Plot** appears in the workspace.

- Note:** You can also change distribution parameter via the **PDF Plot** or **CDF Plot** tabs.
- b. In the upper-right corner of the workspace, select **Distribution Options**, and then select **Distribution Parameters**.
The **Edit Distribution Parameters** window appears.
 - c. Clear the **Calculate** check box next to the parameter(s) whose value you want to modify.
The parameter field(s) are enabled.
 - d. Enter the desired value for the parameter, and then select **OK**.

Note: If you reselect the **Calculate** check box after manually entering data, the manually entered data for the parameter will not be retained. If you decide not to use the parameters you entered, select **Cancel**, and the previous selection will be used in the calculations.

The system recalculates the analysis based on the selected distribution parameter.

Change the Fit Method of a Probability Distribution Analysis

About This Task

The [Kolmogorov-Smirnov test](#) is a Goodness of Fit (GOF) test applied to a Probability Distribution Analysis to determine how well the data fits the analytical curve. When you create an analysis, the fit method is set to Least Squares by default.



After the analysis is created, you can modify the fit method to one of the following:

- Least Squares: A curve-fitting estimation method that relies on linear regression techniques to estimate the parameters for the distribution.
- Maximum Likelihood Estimators: A curve-fitting estimation method that maximizes the likelihood function for a given population. This method includes a survivor function that estimates changes in reliability as the piece of equipment or location survives beyond a certain age.

You can change the fit method from the **Analysis Summary** workspace or from any of the plot tabs in the left pane.

Procedure

1. [Access a Probability Distribution Analysis](#) for which you want to modify the Fit Method.
2. If you want to change the Fit Method from the **Analysis Summary** workspace:

- a. In the bottom section, select **Distribution Options**, and then select .
The **Fit Method** field is enabled.
- b. In the **Fit Method** box, select the desired Fit Method, and then select .
The analysis is recalculated based on the selected Fit Method.

-or-

If you want to change the Fit Method from one of the plot tabs (e.g., **Probability Plot** tab):

- a. In the left pane, select the **Probability Plot** tab.
The **Probability Plot** appears in the workspace.
Note: You can also change the Fit Method via the **PDF Plot** or **CDF Plot** tabs.
- b. In the upper-right corner of the workspace, select **Distribution Options**, and then select **Fit Method**.
The **Edit Fit Method** window appears, displaying the following options:
 - Least Squares

- Maximum Likelihood
- c. Select the desired Fit Method, and then select **OK**.
The analysis is recalculated based on the selected Fit Method.

Modify the Confidence Level for a Probability Distribution Analysis

About This Task

The Confidence Level specifies how the optimistic and realistic scenarios will be selected in a Monte Carlo Simulation for TTR Distributions in an analysis. The Confidence Level indicates whether the distribution is within the confidence limits or not. The default Confidence Level for an analysis is 90 percent.

You can modify the Confidence Level from the **Analysis Summary** workspace or from any of the plot tabs in the left pane.

Procedure

1. [Access a Probability Distribution Analysis](#) for which you want to modify the Confidence Level.
2. If you want to change the Confidence Level from the **Analysis Summary** workspace:

- a. In the bottom section, select **Distribution Options**, and then select  .
The **Confidence Level** field is enabled.

Note: If the **Confidence Level** field is disabled, select the **Use Confidence** check box to activate the confidence level and enable the **Confidence Level** field.

- b. In the **Confidence Level** box, select the desired Confidence Level, and then select  .
The GE Digital APM system displays the confidence intervals for the analysis based on the percentage you entered in the Confidence Level field.

-or-

If you want to change the Confidence Level from one of the plot tabs (e.g., **Probability Plot** tab):

- a. In the left pane, select the **Probability Plot** tab.
The **Probability Plot** appears in the workspace.
Note: You can also change the Confidence Level via the **PDF Plot** or **CDF Plot** tabs.
- b. In the upper-right corner of the workspace, select **Distribution Options**, and then select **Fit Method**.
The **Select Confidence Level** window appears.
- c. Select the desired Confidence Level, and then select **OK**.
The GE Digital APM system displays the confidence intervals for the analysis based on the percentage you entered in the Confidence Level field.

Modify the Random Variable and Specify Units for a Probability Distribution Analysis

Procedure

1. [Access a Probability Distribution Analysis](#) for which you want to modify the value of Random Variable and specify units.
2. In the left pane, select the **Probability Plot** tab.
The **Probability Plot** appears in the workspace.

Note: You can also modify the value of Random Variable and specify units via the **PDF Plot** or **CDF Plot** tabs.

3. In the upper-right corner of the workspace, select **Analysis Task**, and then select **Change Units**.
The **Specify the Random Variable** window appears.
4. In the **Random Variable** box, enter the name of the Random Variable.
5. In the **Units** box, enter the corresponding units, and then select **OK**.

The analysis is recalculated using the new Random Variable.

Rename a Probability Distribution Analysis

Procedure

1. [Access a Probability Distribution Analysis](#) whose name you want to change.
2. In the left pane, select the **Probability Plot** tab.

The **Probability Plot** appears in the workspace.

Note: You can also modify the value of Random Variable and specify units via the **PDF Plot** or **CDF Plot** tabs.

3. In the upper-right corner of the workspace, select **Analysis Task**, and then select **Rename**.
The **Set Analysis Name** window appears.
4. In the **Name** box, enter a new name for the analysis.
5. In the **Description** box, enter a new description for the analysis, and then select **OK**.

The analysis name is updated in all the appropriate sections on the **Probability Distribution** page. In addition, the **Description** field in any appropriate sections will reflect any changes.

Access the Source Data for a Probability Distribution Analysis

Procedure

1. [Access a Probability Distribution Analysis](#) for which you want to view the data.
2. In the left pane, select **Probability Plot**.

The **Probability Plot** appears in the workspace.

Note: You can also view the data via the **PDF Plot** or **CDF Plot** tabs.

3. In the upper-right corner of the workspace, select **Analysis Data**, and then select **Go To Source**.

The fields on the page that appears display the analysis data associated with the selected Probability Distribution Analysis correspond to [values that were used to create the analysis](#).

- For an analysis based on a query, the information returned by the query appears.
- For an analysis based on a dataset, the information stored in the dataset appears.
- For an analysis based on manually-entered data, you will receive the following error message:
There is no source data to view since the analysis is based on manually entered data.

To view data for an analysis based on manually-entered data, you can [access the Probability Distribution Data window](#).

Modify Data in a Probability Distribution Analysis

Procedure

1. [Access a Probability Distribution Analysis](#) for which you want to modify the data.
2. In the left pane, select **Probability Plot**.

The **Probability Plot** appears in the workspace.

Note: You can also modify the data via the **PDF Plot** or **CDF Plot** tabs.

3. In the upper-right corner of the workspace, select **Analysis Data**, and then select **View Data**.

The **Probability Data Editor** window appears, displaying the data associated with the selected Probability Distribution Analysis.

4. As needed, modify the data in any [enabled field](#), and then select **OK**.

The analysis is updated to reflect any changes that you made.

Results

- For an analysis that is based on manually entered data, the changes that you make via the **Probability Distribution Data** window will be saved for the analysis.
- For an analysis that is based on a query or a dataset:
 - The query or dataset will not be modified with the updated data. Additionally, any record returned by the query will not be updated with your changes. The changes will be saved to the analysis only.
 - After you modify the data and save the analysis, the modified data will appear each time you open the analysis. If you want to revert to the original data, you can reload the original data to the analysis. In addition, if a query or dataset has changed in the database, you can [reload the data](#) in order for your analysis to contain those changes.

Reload Analysis Data in a Probability Distribution Analysis

About This Task

When you create and save an analysis that is based on a query or dataset, the GE Digital APM system takes a snapshot of the data that exists at the time of creation and saves it along with the analysis. When you open an existing analysis, the GE Digital APM system loads the data that was last saved with the analysis. This means that any changes to the underlying query or dataset will not be reflected automatically when you open an existing analysis.

Note: If the query or dataset has been deleted or renamed, when you try to open an associated analysis, an error message will be displayed and the data will not be refreshed.

If you want to refresh an analysis based upon changes to the underlying query or dataset or to load new data that has been added since the analysis was last saved (e.g., the analysis is based on a query that retrieves failures for a piece of equipment or location, and a new failure record has been added to the database), you will need to reload the analysis manually after opening it. When you reload the data, any manual changes made to the analysis data set will be deleted.

Note: Reloading analysis data resets the analysis period only if it is based on the analysis data. Start Dates and End Dates that have been set explicitly will not be overwritten.

Procedure

1. [Access a Probability Distribution Analysis](#) for which you want to reload the data.

2. In the left pane, select **Probability Plot**.

The **Probability Plot** appears in the workspace.

Note: You can also reload the data via the **PDF Plot** or **CDF Plot** tabs.

3. In the upper-right corner of the workspace, select the **Analysis Data** list, and then select **Reload Data**.

A confirmation message appears, asking you to confirm that you want to overwrite the current data with the data stored in the database.

Note:

For an analysis based on manually-entered data, you will receive the following error message:

There is no source data to reload since the analysis is based on manually entered data.

4. Select **Yes**.

The analysis is updated to reflect the data currently stored in the query or dataset.

Note: If you are reloading analysis data that is based on a query and an index out of range error message appears, there is an error in the query. You should modify the query or recreate the analysis in order to reload the correct data.

Censor Data in a Probability Distribution Analysis

Procedure

1. [Access the Probability Distribution Analysis](#), which contains the plot in which you want to censor a datapoint.
2. In the left pane, select the plot in which you want to censor a datapoint.
3. In the plot, select the desired datapoint.

The **Probability Data Editor** window appears.

4. In the **Censored** column, select the check box for the desired datapoint.

The selected datapoint is censored or ignored in the Probability Distribution Analysis.

Delete a Probability Distribution Analysis

Procedure

1. [Access the RA Overview page](#).
2. Select the **Probability Distribution** tab.

A list of Probability Distribution Analyses available in the database appears.

3. Select the row containing the Probability Distribution Analysis that you want to delete, and then select .

The **Delete Probability Distribution Analysis** dialog box appears, asking you to confirm that you want to delete the selected analysis.

4. Select **Yes**.

The selected analysis is deleted.

Access Probability Distribution Report

Procedure

1. [Access the Probability Distribution Analysis](#) whose report you want to access.
2. In the upper-right corner of any workspace within the selected Probability Distribution Analysis, select **Report**.

The Probability Distribution Analysis report appears in a new tab.

By default, the report contains the following [sections](#):

- **Analysis Plots**
- **Analysis Summary**
- **Statistical Distribution Information**
- **Distribution Data**

About Probability Distribution Report

The baseline GE Digital APM database includes the Probability Distribution report, which you can use to view a summary of the results of a Probability Distribution Analysis.

The Probability Distribution report is built from the following Catalog items:

- The subreport, SubReportProbDist, which is stored in the Catalog folder `\\Public\Meridium\Modules\Reliability Manager\Reports`.
- The supporting queries that supply data in the main report and subreport, which are stored in the Catalog folder `\\Public\Meridium\Modules\Reliability Manager\Reports`. The following supporting queries are available:
 - ProbabilityDistributionQuery
 - Weibull Distribution Query
 - Lognormal Distribution Query
 - Normal Distribution Query
 - Exponential Distribution Query

Throughout this documentation, we refer to the main report, the subreport, and the supporting queries collectively as the Probability Distribution report.

The Probability Distribution report contains a prompt on the ENTY KEY and Distribution Type fields in the Distribution family. When you run the Probability Distribution report via the Probability Distribution module, the ENTY KEY and Distribution Type of the Distribution record associated with the current analysis is passed automatically to the prompt, and the results for the current Probability Distribution Analysis are displayed. If you run the main report or any of the queries in the preceding list directly from the Catalog, however, you will need to supply the ENTY KEY and Distribution Type of a Distribution record manually to retrieve results. The subreport (i.e., Catalog item SubReportProbDist) cannot be run directly from the Catalog.

Analysis Summary Section

The **Analysis Summary** section of the Probability Distribution report displays information that is stored in a [Distribution record](#). Distribution records are categorized into one of four Distribution subfamilies: Exponential, Lognormal, Normal, or Weibull.

The following table lists each item in the **Analysis Summary** section and the corresponding Distribution record field whose data is displayed in the report.

Report Item	Distribution record
Analysis Name	Analysis ID
Analysis Description	Short Description
Random Variable	Random Variable Field
Units	Units
Last Modified	LAST UPDT DT
Modified By	LAST UPBY SEUS KEY Note: The name of the Security User associated with this value is displayed in the report.

Statistical Distribution Information Section

The **Statistical Distribution Information** section of the Probability Distribution report displays information that is stored in the [Distribution record](#) (i.e., Exponential, Lognormal, Normal, or Weibull record).

The following subsections are displayed within the **Statistical Distribution Information** section:

The **Distribution Type** subsection displays information that is stored in the Distribution record. Throughout the documentation, we will refer to this subsection as the Distribution subsection.

The following table lists each item in the **Distribution** subsection and the corresponding Distribution record field whose data is displayed in the report.

Report Item	Distribution Field
Distribution Type	Distribution Type
Fit Method	Fit Method
Use Confidence	Use Confidence
Confidence Level	Confidence Level
Mean	Mean
Standard Deviation	Standard Deviation
Median	Median
R2	R-Squared

The **Parameters** subsection contains information stored in the Distribution record. The type of information that appears in the Parameters subsection depends on the [distribution type](#) (i.e., Weibull, Lognormal, Exponential, or Normal).

The following table lists each item in the **Parameters** subsection for a Weibull record whose data is displayed in the report. One row is displayed for each of the following field captions: Beta, Eta, and Gamma.

Report Item	Weibull Field
Beta	
Value	Beta
Low	Beta Low
High	Beta High
Calculated	Beta Fixed
Eta	
Value	Eta
Low	Eta Low
High	Eta High
Calculated	Eta Fixed
Gamma	
Value	Gamma
Low	Gamma Low
High	Gamma High
Calculated	Gamma Fixed

The following table lists each item in the **Parameters** subsection for a Lognormal record whose data is displayed in the report. For a Lognormal record, one row is displayed for each of the following field captions: Mu, Sigma, and Gamma.

Report Item	Lognormal Field
Mu	
Value	Mu
Low	Mu Low
High	Mu High
Calculated	Mu Fixed
Sigma	
Value	Sigma
Low	Sigma Low
High	Sigma High
Calculated	Sigma Fixed
Gamma	
Value	Gamma
Low	Gamma Low

Report Item	Lognormal Field
High	Gamma High
Calculated	Gamma Fixed

The following table lists each item in the **Parameters** subsection for an Exponential record whose data is displayed in the report. For an Exponential record, one row is displayed for the field caption MTBF.

Report Item	Exponential Field
MTBF	
Value	MTBF
Low	MTBF Low
High	MTBF High
Calculated	MTBF Fixed

The following table lists each item in the Parameters subsection for a Normal record whose data is displayed in the report. For a Normal record, one row is displayed for each of the following field captions: Mean, Standard Deviation.

Report Item	Normal Field
Mean	
Value	Mean
Low	Mean Low
High	Mean High
Calculated	Mean Fixed
Standard Deviation	
Value	Standard Deviation
Low	Standard Deviation Low
High	Standard Deviation High
Calculated	Standard Deviation Fixed

The **Goodness of Fit Test** subsection displays information from the Distribution record.

The Kolmogorov-Smirnov test is the only test used to measure goodness of fit, so the **Name** column in the report is populated with the value Kolmogorov-Smirnov Test.

The following table lists each remaining item in the **Goodness of Fit Test** subsection and the Distribution record field whose data is displayed in the report.

Report Item	Weibull Field
Statistic	GOF Statistic
P-Value	GOF P-Value
Passed	Passed

Distribution Data Section

The **Distribution Data** section of the Probability Distribution report displays information that is stored in the Data field in the Distribution record.

The following values are displayed in the **Distribution Data** section, and they are stored in the Data field in the Reliability Distribution record:

- **X** (i.e., the Random Variable)
- **Censored**
- **Ignored**
- **Remarks**

Plots Section

The Plots section of the Probability Distribution report displays the plots that are displayed on the **Analysis Summary** workspace or accessed via the Plots tabs in the left pane on the **Probability Distribution** page.

The Plots section displays the following graphs:

- [Probability Plot](#)
- [Probability Density Function Plot](#)
- [Cumulative Distribution Function Plot](#)

Chapter 4

Production Analysis

Topics:

- [Production Analysis: Overview](#)
- [Production Analysis: Workflow](#)
- [Production Analyses](#)
- [Production Data](#)
- [Production Lines](#)

Production Analysis: Overview

Overview of Production Analysis

Reliability Analytics

The Reliability Analytics module provides a collection of tools that apply reliability engineering principles to help you make tactical (short-term) and strategic (long-term) decisions for maintenance and operational equipment management activities. It also provides:

- A means for analyzing historical failure data to identify trends and predict future failures.
- A mechanism for simulating what if scenarios regarding the reliability of a system to determine if a new or modified strategy will be effective.

The Reliability Analytics module provides the following types of tools:

- Production Analysis
- System Reliability Analysis
- Spares Analysis
- Reliability Distribution Analysis
- Probability Distribution Analysis
- Reliability Growth Analysis
- Automation Rules

Each tool provides a unique set of features that allow you to analyze data to develop strategies to improve reliability.

Production Analysis

Production Analysis is a tool that allows you to quantify production losses and the cost associated with them using a visual representation of production output. The analysis will help you evaluate your production for weaknesses and develop strategies for improving production reliability.

Production Analysis Workflow

This workflow provides the basic, high-level steps to develop a Production Analysis. The steps and links in this workflow do not necessarily reference every possible procedure.

1. **Collect production output data**, which are numeric values representing the production output of a production process being analyzed over some period of time.
2. **Create a new Production Analysis from a GE Digital APM query or dataset**, or **from manually entered data**. The Production Analysis should be based on the production output data collected in the previous step.
3. Define the unit of measure for your production output data. Unit of measure is not taken into account when you first create the analysis, even if a unit of measure is associated with your production output values. After the analysis has been created, however, you can label the production output data with the appropriate unit by **setting the unit of measure** for the analysis.
4. **Define the cost associated with each unit of production output** to calculate the cost of your production losses.
5. **Draw the Demonstrated Line**, which represents the demonstrated production output when the unit is operating at its observed rate of capability.

6. **Draw the Process Reliability Line** , which is the first point at which production output begins to deviate significantly from the Demonstrated Line.
7. **Draw the Nameplate Line** , which represents the ideal production output of the unit under ideal conditions.
8. **Draw one or more Custom Lines** , which let you make a visual comparison between your demonstrated production output and other observed or theoretical production outputs.
9. **Evaluate the results** by viewing the calculations in the **Production Loss Regions** pane.

Production Analysis: Workflow

Reliability Analytics: Production Analysis Workflow

This workflow describes the process for determining the performance of the asset in production terms, as well as the process reliability.

In the following workflow diagram, the blue text in a shape indicates that the corresponding description has been provided in the sections that follow the diagram. For more information, refer to the [Interpreting the Workflow Diagrams](#) topic in the [APM Product Workflows](#) documentation.

Note: For information on the personas associated with a GE Digital APM module, refer to the [APM Product Workflows](#) documentation.

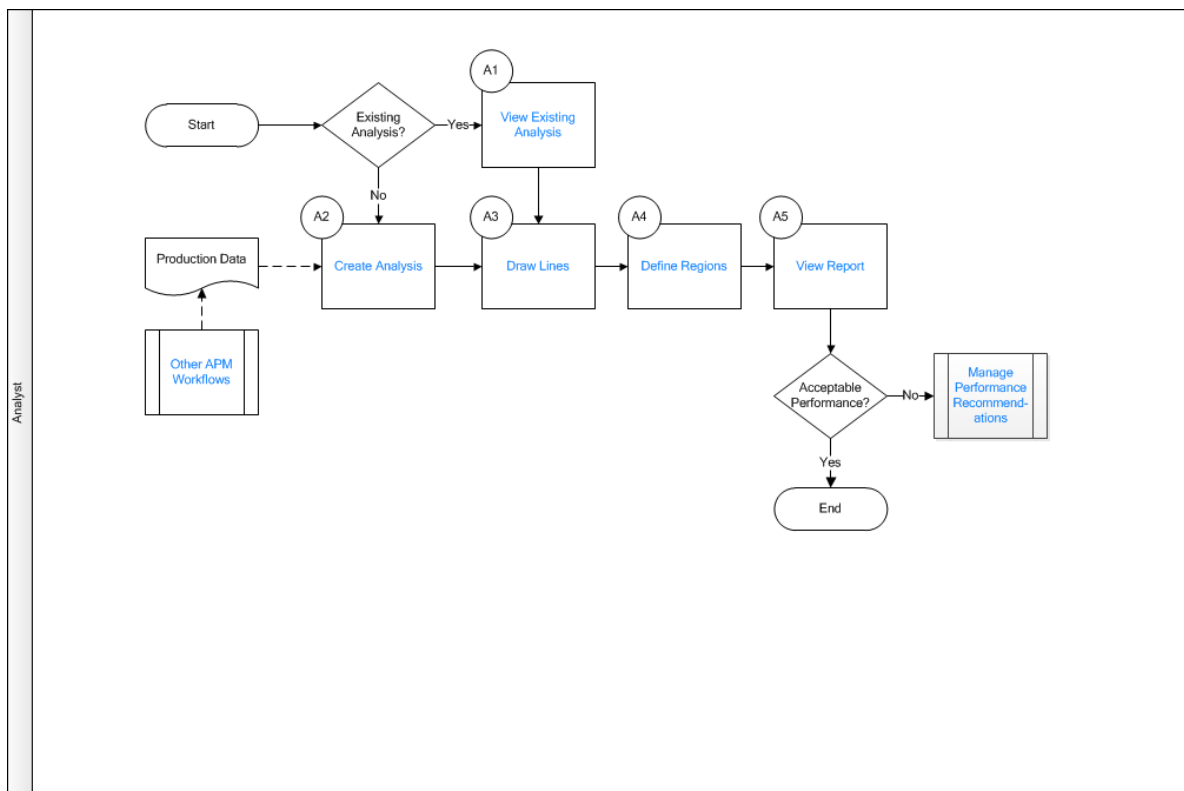

1. [View Existing Analysis](#) on page 46
2. [Create Analysis](#) on page 46
3. [Draw Lines](#) on page 46
4. [Define Regions](#) on page 46
5. [View Report](#) on page 46

6. [Other Workflows](#) on page 46
7. [Manage Performance Recommendation](#) on page 46

View Existing Analysis

Persona: Analyst

View the details of an existing analysis.

Create Analysis

Persona: Analyst

Create an analysis based on production data or event data.

Draw Lines

Persona: Analyst

Draw one or more nameplate lines, demonstrated lines, reliability lines, or custom lines through one of the following methods: Regression Fit, Drawing, Enter Beta/Eta, or Specify Point.

Define Regions

Persona: Analyst

Select a datapoint on the chart to define a region that explains the reason for production quantity.

View Report

Persona: Analyst

View and save the analysis report.

Manage Performance Recommendation

Persona: Analyst

Create any number of performance recommendations and Approve them using state management.

Note: Performance recommendations are not required.

Go to the Manage Performance Recommendations workflow.

Other Workflows

Persona: Analyst

Other workflows provide production data from SAP, EAM, Recommendations, and manually entered production data provided by individual customers.

Production Analyses

About Production Analysis

Production Analysis provides a visual representation of production output and allows you to quantify production losses and the cost associated with them. With regular use of Production Analysis, your company can determine where you are losing the most money and then take corrective actions that will help yield higher production and earn greater profits.

Production Analysis allows you to evaluate the reliability of manufacturing processes. GE Digital APM Production Analysis analyzes production output data to help you see patterns in the output and determine the reliability of those processes.

Often, a great amount of profit is lost due to production problems, rather than just Asset problems. Therefore, analyzing losses due to operational problems is necessary for conducting a comprehensive analysis of production losses. To quantify losses due to operational problems, in addition to analyzing individual Asset, you must also analyze the process in which they are involved. To do this, you can use a Production Analysis.

Within a Production Analysis, you can plot production output data and then:

- Define the observed production output with a [Demonstrated Line](#).
- Determine the reliability of the production process by defining a [Process Reliability Line](#).
- Define the ideal production output with a [Nameplate Line](#).
- Draw one or more [Custom Lines](#) to exhibit losses and gains compared to other observed production output or based on theoretical scenarios.
- Compare the observed output to the ideal output to [calculate the efficiency and utilization costs](#).

Production Process

The following example explains a simple production process.

Consider the process of manufacturing bottled water, which might consist of the following steps:

1. Collect water from spring.
2. Fill bottles.
3. Attach labels.
4. Attach caps.
5. Sort bottles, discard any that fail quality inspection, and package for shipping.

All of these steps must be completed to produce a finished product. In our example, the production unit consists of the individual pieces of equipment that together perform the steps in the process. The production output of this unit is bottles of water ready to be sold.

For our example, we will assume that we collect production output as the number of bottles produced per day. We will also assume that we began producing bottled water on January 1, 2000. Once a year we generate a Production Analysis to evaluate the actual production output, to calculate losses compared to the ideal production output, and to establish goals for improving production the following year.

About Breakpoint

On a Production Data Plot, you will draw the Process Reliability Line to identify your Reliability Loss Region. Datapoints below the Process Reliability Line help make up the Reliability Loss Region. Typically, the Reliability Loss Region will show large variations in output that can be attributed to problems that impact the production process significantly, such as equipment and location failures, system shutdowns, and intentional cutbacks. For example, if you collect production output data daily and the system is shut down completely for five days during your collection period, then five datapoints will have near-zero values. These values should be easily distinguishable from the rest of the values in the Reliability Loss Region.

To calculate your Reliability Losses accurately, you may want to separate the datapoints associated with shutdowns from the datapoints where losses are attributed to actual equipment slowdowns or intentional cutbacks. You can use the breakpoint tool to separate the Reliability Loss Region into these categories. The breakpoints will be taken into account in calculations so that your Reliability Losses represent losses due to actual equipment and location problems. Breakpoints also can be used to identify areas of distinct change in output when you do not know the reason for the change.

Breakpoints for Bottled Water Production Process

Consider our [example of a bottled water production process](#). In the following example, you can view the datapoints associated with unplanned shutdowns due to uncontrollable issues (e.g., lack of raw material), where the production output is near zero.

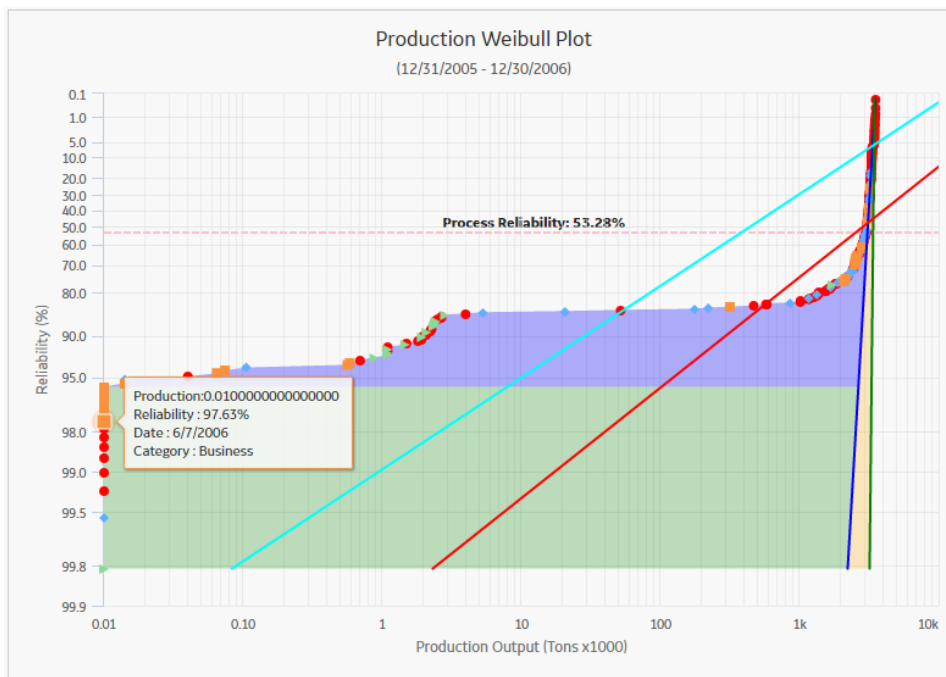

To separate this region from the rest of the reliability losses, we can create a breakpoint on the highest Reliability value within that distinct region. After the breakpoint has been created, GE Digital APM automatically shades the different regions of production output.

Now two shaded Reliability Loss regions are visible on the Production Data Plot. The gray area represents losses associated with unplanned and planned shutdowns, and the purple area represents the losses due to equipment and location failures and

intentional cutbacks. All reliability losses will be calculated for each region and will appear as Sub Reliability Loss regions on the **Production Loss Regions** section.

Note: You can create more than one breakpoint when your production output displays more than two regions of shutdowns, Asset failures, intentional cutbacks, or other unknown variations.

About Results of a Production Analysis

After you have created your Production Analysis, defined your production lines, defined a Process Reliability Line, created any desired breakpoints, and customized the analysis to your liking, you can interpret the results to determine where to take corrective actions. Consider the following completed Production Analysis for our bottled water process.

In the previous image, we have labeled three shaded regions:

- **Sub Reliability Loss Region 1** (gray): The area between the first datapoint above the breakpoint datapoint and the Demonstrated Line, below the Process Reliability Line. This represents the production from all unintentional equipment slowdowns and intentional cutbacks.
- **Sub Reliability Loss Region 2** (purple): The area between the breakpoint datapoint below the breakpoint datapoint and the Demonstrated Line, below the Process Reliability Line. This represents the production from all intentional and unintentional shutdowns.
- **Efficiency/Utilization Losses** (pink): The area between the Demonstrated Line (blue) and the Nameplate Line (green).

Each area represents the production losses associated with the corresponding set of datapoints. The losses are calculated and appear on the Production Loss Regions pane. In the following table, we list our losses from least to greatest.

Region	Quantity Lost	Cost
Efficiency/Utilization Losses	279,586.89	\$838,762
Sub Reliability Loss Region 1	214,000.54	\$642,002
Sub Reliability Loss Region 2	31,447.89	\$94,344

Note: The shaded regions in the plot can sometimes be misleading. For example, in this case the **Sub Reliability Loss Region 2** is the largest region on the graph. If you look at the loss calculations, however, this region is associated with the second least amount of loss. You should always refer to the loss calculations to determine which region is responsible for the highest loss.

The loss calculations can help you determine where to focus your attention to make improvements. You should focus first on the area that is responsible for the greatest amount of loss.

Many companies automatically focus their attention on Asset failures. In this example, however, Asset reliability problems account for less loss than process problems. Therefore, in this case, we should focus on improving the process before we focus on improving equipment and location reliability. The analysis indicates that even if we repair the equipment, we will probably still experience losses due to process problems.

If, as in our example, your analysis indicates that you should focus on correcting process problems, the steps you take will vary, depending upon the process itself and what you suspect the problems to be. For example, if we suspect that poor employee performance is the cause of our process problems, attempts at lowering the process problems for our bottled water process example might begin with monitoring the employees and possibly creating individual Production Analyses with production output for each employee every month. Also, we might ask a manager to monitor the work of the employees and report any observed problems. Employees might need to be replaced based on production numbers and observations. This would be the first step in helping us achieve the stretch goal for the end of 2007.

If, on the other hand, the analysis indicated that equipment and location problems were responsible for the greatest production loss, then conducting a Reliability Distribution Analysis on the piece of equipment or location may be useful to predict the next Time to Failure and make repairs or replacements before failures occur.

Access a Production Analysis

Procedure

1. Access the [RA Overview](#) page.
2. Select the **Production Analyses** tab.

A list of Production Analyses available in the database appears.

3. Select the Production Analysis whose details you want to view.

The **Analysis Summary** workspace for the selected analysis appears, displaying the following tabs:

- **Definition:** Displays the details of the selected Production Analysis.
- **Summary:** This tab is selected by default and contains the following information:
 - **Production Data Plot :** Contains a plot based on the production output values. The range of dates that the datapoints represent is displayed above the plot.
 - **Production Lines :** Contains a grid that shows a row for each Production Line, displaying its Beta and Eta values in the Production Data Plot.
 - **Production Loss Regions :** Contains a grid that displays the results of the cost calculations for each specified loss region.

Tip: You can hide the **Production Lines** and **Loss Regions** panes by selecting . You can also view them in full screen by selecting .

The left pane contains the following tab:

- **Production Data :** Contains the **Production Data Plot**.

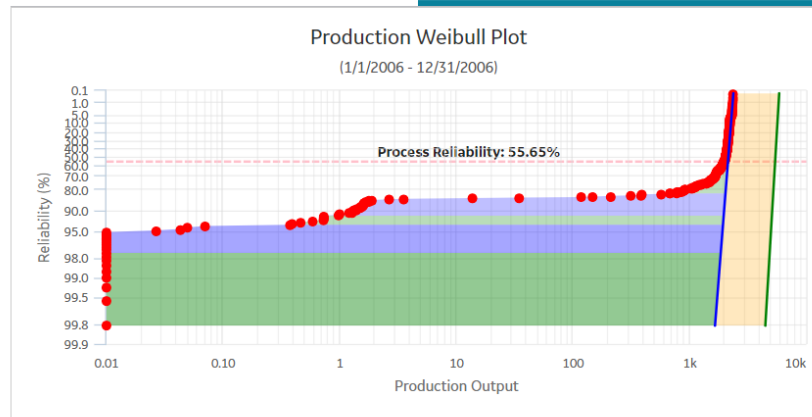

Production Lines

Name	Beta	Eta
Demonstrated Line	22.3786	2,181.4543
Nameplate Line	29.5913	5,500.5534

Production Loss Regions

Name	Quantity	Cost (\$)
Total Loss	1,365,881.22	1,365,881.22
Reliability Loss	172,266.65	172,266.65

Access Multiple Production Analyses

About This Task

You can access multiple Production Analyses and compare multiple plots for the selected analyses. You cannot modify the details of the analyses from which the **Comparison Plot** is generated.

Procedure

1. Access the [RA Overview](#) page.
2. Select the **Production Analyses** tab.
A list of Production Analyses available in the database appears.
3. Select two or more Production Analyses whose plots you want to compare.

Note: You can select up to 20 analyses to compare plots.

4. In the upper-right corner of the grid, select 

The **Multiple Production Analyses** page appears, displaying the **Comparison Plot**.

Note: You cannot save the plot as a separate entity.

Multiple Production Analyses

2 plots are being viewed now

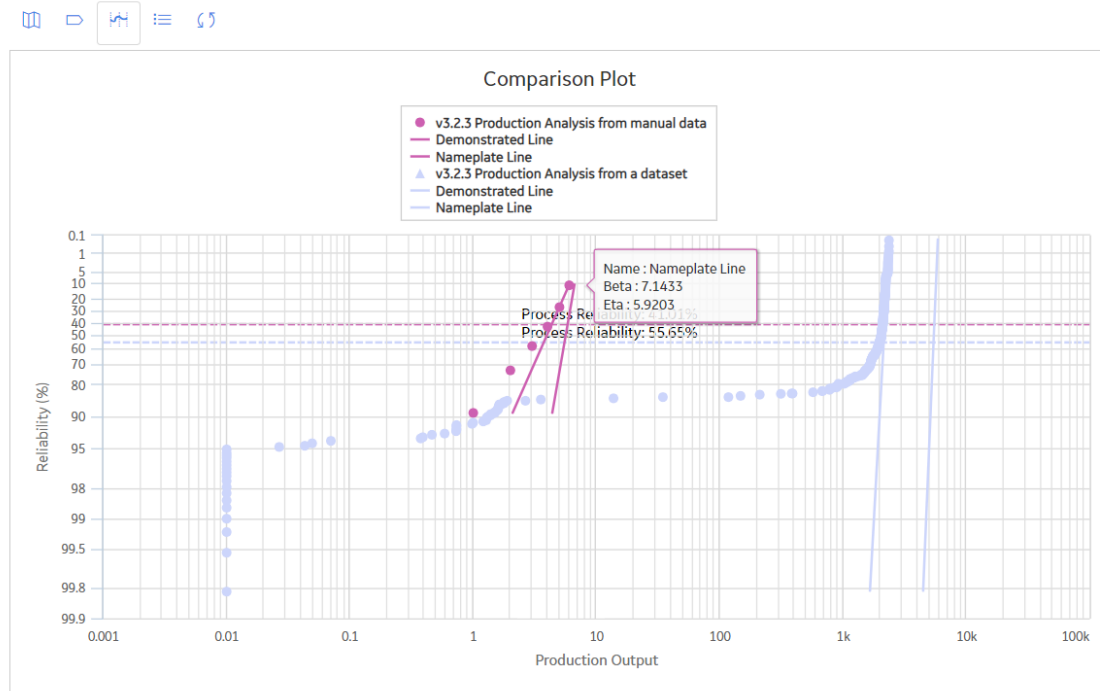

Collect Data for a Production Analysis

To create a Production Analysis, you must collect production output information, which consists of numeric values representing the output of a process over some period of time. How you collect the output data and how often you collect it is up to you and may be determined based on a variety of factors, including the type of process, how often the process produces measurable output, and how often you want to record it. While the amount of time between output readings is up to you, you must collect the output data at regular intervals (e.g., hourly, daily, weekly, or monthly) to create a meaningful analysis. This will ensure that you are able to compare the output values to one another.

Details

When you create a Production Analysis from within the Production Analysis module, you can supply data to the analysis using a [GE Digital APM query or dataset](#), or you can [enter data manually](#). To use a query as the basis for your analysis, the production output data must be stored in the GE Digital APM database so that it can be queried. For example, you might store production data in custom Production Output records that you create and associate with the systems for which you record regular output readings.

You can also create a Production Analysis from within the Production Loss Analysis (PLA) module. PLA allows you to create production plans and then record daily production output against the plan. You can use these production output values as the starting point for a Production Analysis.

Note: If you are using PLA to collect production data, the GE Digital APM system provides the Production Data family to store the output readings.

The production output data is collected for a [process](#), not for individual pieces of equipment. A single process may involve one or more pieces of equipment. Throughout this documentation and in the GE Digital APM Production Analysis tool, we refer to this collection of equipment as the production unit. The

term unit refers to the process and all the pieces of equipment involved in it. It does not imply a GE Digital APM family or a specific record in the database.

Note: If you are using PLA to collect production data, the GE Digital APM system provides the Production Unit family for use within the PLA workflow.

Production Data

If you are using a query or dataset to store production output data, the following table lists the fields whose values you can provide to the analysis (through the Production Analysis Builder). The source data must include at least production output values.

Data	Description	Notes
Production Output	Values representing the amount of output produced by the unit during the specified period of time (e.g., hourly, daily, weekly, or monthly).	These values must be numeric. You can define the units of measure for the output values after you create the analysis. Production Output values are required for creating a Production Analysis.
Production Date	The date on which the production output value was recorded. If you have a date field within your query or dataset and you choose not to map it to the Production Analysis Builder, you can see the dates used to build the analysis in the Production Analysis Points Editor window .	Production Dates are optional.
Unit ID	A value that describes the production unit, which consists of the individual pieces of equipment that work together to produce the production output. You may have more than one Unit ID value within the Production Analysis and may group your datapoints by that specific value.	Units are optional.

Create a Production Analysis from an Existing Query or Dataset

Procedure

1. [Access the RA Overview page](#).
2. In the upper-right corner, select **New Analysis**, and then select **Production Analysis**.
The **Production Analysis Builder** window appears.
Note: All required information is provided, but for additional information, consult the [Production Analysis](#) topic.
3. Enter values in the **Analysis Name** and **Description** fields for the new analysis, and then select **Next**.
The **Select Data Source Type** screen appears.
4. If you want to load data using an existing query, select **Data will be based on an existing Query**, and then select **Next**.
The **Select Query** screen appears.

-or-

If you want to load data using an existing dataset, select **Data will be based on an existing Dataset**, and then select **Next**.

The **Select Dataset** screen appears.

5. Select **Browse** to search for an existing query or dataset in GE Digital APM Catalog.

The **Select a query from the catalog** or **Select a dataset from the catalog** window appears, depending on whether you selected **Data will be based on an existing Query** or **Data will be based on an existing Dataset** in the previous step.

6. Select the needed query or dataset, and then select **Open**.

The complete path to the query or dataset is displayed in the **Query** or **Dataset** box. The fields that exist for the selected query or dataset appear in the **Available Fields** list.

7. In the **Includes Data From the Following Sites** list, select the site(s) whose data from which you want to create an analysis.

If you are creating an analysis in a database that has [only one site stored in the Site Reference family](#), then the **Includes Data From the Following Sites** list will not appear on the **Select Query** screen.

8. Select **Next**.

The **Select Product Fields** screen appears.

9. In the **Production Output** list, select the value that represents the production amount that you want to use in your analysis. The list displays all the numeric fields that exist in your query or dataset; the first numeric field is selected by default. This is a required field.
10. In the **Production Date** list, select the value that will be used as the date of production for the analysis. The list displays all date fields that exist in your query or dataset, the first date field is selected by default. This is an optional field.
11. In the **Unit ID** field, select the value that identifies the production unit for which the production data has been recorded. The list displays all character fields but is not populated. This is an optional field.
12. Select **Finish**.

The **Production Analysis Builder** window closes.

If GE Digital APM finds zeros or negative numbers for the **Production Output** value in the dataset or the query results, the **Set Minimum Production Output** window appears.

13. In the **Minimum Production Output** box, enter the value that you want to use to replace zero and negative production output values. The suggested value is calculated based on the highest production output. Zero and negative values cannot be plotted and will instead be plotted using the value specified here. You can also [change the Minimum Production value](#) after the Production Analysis has been created.

Note: To determine the suggested value, 0.00001 is multiplied by the highest production output value and then rounded up. For example, if the highest production output value is 823, that value is multiplied by 0.00001 to equal .00823. That value is then rounded up to one at the first non-zero decimal place, or 0.001 in this example, to become the default value in the **Minimum Production Output** box.

14. Select **OK**.

The **Production Analysis** page appears, displaying the results of the analysis.

Create a Production Analysis From Manually Entered Data

Procedure

1. [Access the RA Overview page](#).
2. In the upper-right corner, select **New Analysis**, and then select **Production Analysis**.

The **Production Analysis Builder** appears.

Note: All required information is provided, but for additional information, consult the [Production Analysis](#) topic.

3. Enter values in the **Analysis Name** and **Description** fields for the new analysis, and then select **Next**.

The **Select Data Source Type** screen appears.

4. Select **I will manually enter data**, and then select **Finish**.

The **Production Data Editor** window appears, displaying a blank grid.



5. Select .

A new row appears.

6. Enter the information in the following fields:

- **Production Output:** Enter the first production output value. This field is required.

Note: If you do not have any data for a given date, you must type 0 (zero). If you enter a null value, it will be converted to the minimum selected value.

- **Date:** Select or enter a date associated with the first production output value. This field is optional.
- **Ignore:** Select the check box if you want to exclude this output value from calculations performed by the Production Analysis. The datapoint will be plotted but will be displayed as an X.
- **Note:** You can add more rows of data by selecting  at the top of the **Production Data Editor** window. You can remove any row of data by selecting the row, and then selecting .

7. Select **OK**.

The **Production Data Editor** window closes.

If you entered zeros or negative numbers for the Production Output values, the **Set Minimum Production Output** window appears.

8. In the **Minimum Production Output** box, enter the value that you want to use to replace zero and negative production output values. The suggested value is calculated based on the highest production output. Zero and negative values cannot be plotted and will instead be plotted using the value specified here. You can also [change the Minimum Production value](#) after the Production Analysis has been created.

Note: To determine the suggested value, **0.00001** is multiplied by the highest production output value and then rounded up. For example, if the highest production output value is **823**, that value is multiplied by **.00001** to equal **.00823**. That value is then rounded up to one at the first non-zero decimal place, or **.001** in this example, to become the default value in the **Minimum Production Output** box.

9. Select **OK**.

The **Production Analysis** page appears, displaying the results of the analysis.

Create a Breakpoint

Procedure

1. [Access a Production Analysis](#) for which you want to create a breakpoint.
2. In the left pane, select **Production Data**.

The **Production Data** workspace appears.

3. On the [Production Analysis plot](#), select the datapoint where you want to insert the breakpoint.

The **Point Tooltip** window appears.

4. Select **Break**.

GE Digital APM separates the Production Loss region into two shaded regions. The [Production Loss Regions pane](#) includes the values for the Sub Reliability Loss regions and the Total Loss region.

Tip: If you want to remove the breakpoint, select the data point to open the **Point Tooltip** window, and then select **Unbreak**.

Change the Margin Currency

About This Task

In the **Production Loss Regions** section, values in the **Cost** column represent the cost associated with the calculated production losses. For the cost calculations to be accurate, the values must be displayed in the correct currency. If you want to modify the currency that is currently associated with the analysis, you can change it on the **Set Currency** window.

Note: When you create a new Production Analysis, if you are logged in as a user with a GE Digital APM Culture setting that has an associated currency, the Margin Currency will be set by default to that currency and saved with the analysis.

Procedure

1. [Access the Production Analysis](#), whose Margin Currency you want to change.
2. In the left pane, select the **Production Data** tab.

The **Production Data** workspace appears.

3. In the upper-right corner of the workspace, select **Analysis Tasks**, and then select **Margin Currency**.

The **Set Currency** window appears.

4. In the **Currency** box, enter the desired currency code, and then select **OK**.

The **Production Loss Regions** section displays the new currency code in the **Cost** column heading.

Change the Minimum Production Output

About This Task

The Minimum Production Output is the value used to replace all zeros and negative numbers in the Production Analysis. When you create a new analysis, if the source data contains zeros or negative numbers, you will be prompted to specify a Minimum Production Output value. You will also be prompted to set the Minimum Production Output value if you modify or reload the data to contain zeros and negative numbers in an existing analysis that did not previously contain zeros or negative numbers. You can use the following instructions to modify the value that is currently saved with the analysis.

Procedure

1. [Access the Production Analysis](#) whose Minimum Production Output you want to change.
2. In the left pane, select the **Production Data** tab.

The **Production Data** workspace appears.

3. In the upper-right corner of the workspace, select **Analysis Tasks**, and then select **Minimum Production Output**.

The **Set Minimum Production Output** window appears. By default, the Minimum Production Output value is set to the value that was selected when the analysis was last saved.

4. In the **Minimum Production Output** box, enter the value that you want to use to replace zeros and negative numbers, and then select **OK**.

The Production Analysis is generated with the new Minimum Production Output value.

Rename a Production Analysis

Procedure

1. [Access the Production Analysis](#), whose name you want to change.
2. In the left pane, select the **Production Data** tab.

The **Production Data** workspace appears.

3. In the upper-right corner of the workspace, select **Analysis Tasks**, and then select **Rename**.

The **Set Analysis Name** window appears.

4. In the **Analysis Name** box, enter a new name for the analysis.
5. In the **Analysis Description** box, enter a new description for the analysis, and then select **OK**.

The analysis name is updated in any appropriate sections on the **Production Analysis** page to reflect the change. In addition, the **Description** field in any appropriate sections will reflect any changes.

Change the Unit of Measure

About This Task

When viewing the results of a Production Analysis, Production Output is displayed in the Production Data plot and in the **Production Loss Regions** section. If the data is from a query, the unit of measure is taken into account for production data when the analysis is first created. If the data is from a dataset or manually entered data, then there is no unit of measure associated with the Production Analysis and it has to be set manually. After the analysis exists, you can label the output for the production data with the appropriate unit by setting the unit of measure.

Procedure

1. [Access the Production Analysis](#) for which you want to change the unit of measure.
2. In the left pane, select the **Production Data** tab.

The **Production Data** workspace appears.

3. In the upper-right corner of the workspace, select **Analysis Tasks**, and then select **Unit Of Measure**.

The **Set Unit Of Measure** window appears.

4. In the **Unit Of Measure** box, enter the value that characterizes the unit of measure used to collect the data for the Production Analysis, and then select **OK**.

The Production Analysis is updated. The unit of measure is displayed on the x-axis of the Production Data plot and in the **Production Loss Region** section on the **Quantity** column heading. The values in the **Quantity** column change appropriately.

Change the Margin Value

About This Task

In the **Production Loss Regions** section, values in the **Cost** column represents the expense associated with the production loss. By default, GE Digital APM assumes a one-to-one ratio of lost production to cost. For example, if your production loss data is recorded in tons, then GE Digital APM assumes one dollar of

cost for every ton of lost production. To make the Cost value accurate, you may want to change the default loss-to-cost ratio.

Procedure

1. [Access the Production Analysis](#) whose Margin value you want to change.
2. In the left pane, select the **Production Data** tab.
The **Production Data** workspace appears.
3. In the upper-right corner of the workspace, select **Analysis Tasks**, and then select **Margin Value**.
The **Set Margin** window appears.
4. In the **Margin Value** box, enter the value by which GE Digital APM will multiply the production loss to determine the cost. For example, if each ton of lost production costs two dollars, enter 2 in the **Margin Value** box.
5. Select **OK**.
The **Production Loss Regions** section displays the new calculations for the Cost values.

Delete a Sub Reliability Loss Region

Procedure

1. [Access the Production Analysis](#) within which you want to delete a Sub Reliability Loss region.
2. Locate the row containing the Sub Reliability Loss region that you want to delete, and then select **Delete**.

The **Delete Sub Reliability Loss Region** dialog box appears, asking you to confirm that you want to delete the selected Sub Reliability Loss region.

3. Select **OK**.

The selected Sub Reliability Loss region is deleted.

Access Production Analysis Report

Procedure

1. [Access a Production Analysis](#) whose report you want to access.
2. In the upper-right corner of any workspace within the selected Production Analysis, select **Report**.

The Production Analysis report appears in a new browser tab.

By default, the report contains the following [sections](#):

- **Analysis Summary**
- **Production Lines**
- **Production Loss Regions**
- **Production Weibull Plot**
- **Production Data**

Delete a Production Analysis

Procedure

1. [Access the RA Overview](#) page.
2. Select **Production Analyses**.

A list of Production Analyses available in the database appears.

3. Select the Production Analysis that you want to delete, and then select .

The **Delete Production Analysis** dialog box appears, asking you to confirm that you want to delete the selected analysis.

4. Select **Yes**.

The selected analysis is deleted.

Production Data

Access the Source Data for Production Analysis

Procedure

1. [Access a Production Analysis](#) for which you want to view the source data.
2. In the left pane, select the **Production Data** tab.

The **Production Data** workspace appears.

3. In the upper-right corner of the workspace, select **Analysis Data**, and then select **Go To Source**.

The fields on the page that appears display the analysis data associated with the selected Production Analysis and correspond to [values that were used to create the analysis](#).

- For an analysis based on a query, the information returned by the query appears.
- For an analysis based on a dataset, the following information stored in the dataset appears:
 - **Date**
 - **Production**
 - **Lost Production**
 - **Modified Production**
 - **GAUR Category**
 - **GAUR Sub-Category**
 - **Comments**
- For an analysis based on manually-entered data, you will receive the following error message:
There is no source data to view since the analysis is based on manually entered data.
To view data for an analysis based on manually-entered data, you can [access the Production Data window](#).

Modify Production Analysis Data

Procedure

1. [Access a Production Analysis](#) whose data you want to modify.
2. In the left pane, select the **Production Data** tab.

The **Production Data** workspace appears.

3. In the upper-right corner of the workspace, select **Analysis Data**, and then select **Edit Data**.

Note: You can also view data for an analysis by selecting an observed datapoint in the plot, and then select **Go To Editor**. The **Production Data** window for the selected Production Analysis appears. The row containing the data for the selected observed datapoint is highlighted.

The **Production Data Editor** window appears.

4. Modify the data in any [enabled field](#), and then select **OK**.

The analysis is updated.

Results

- For an analysis that is based on manually entered data, the changes that you make via the **Production Data** window will be saved for the analysis.
- For an analysis that is based on a query or a dataset:
 - The query or dataset will not be modified with the updated data. Additionally, any record returned by the query will not be updated with your changes. The changes will be saved to the analysis only.
 - After you modify the data and save the analysis, the modified data will appear each time you open the analysis. If you want to revert to the original data, you can reload the original data to the analysis. In addition, if a query or dataset has changed in the database, you can [reload the original data to the analysis](#) in order for your analysis to contain those changes.

Group Production Data

About This Task

When a Production Analysis has been created using fields including Production Output and Date, you can color code the datapoints according to the values in any of those fields.

[Consider our example of the bottled water production process.](#) The dataset used to create our Bottled Water Production Analysis contains three columns: Date, Production, and Category. We used the Category field to record the reasons for the Production Output on a given day, such as Equipment Failure, Process Variability, Budgeted Maintenance, and so on. We can use the Group By feature to color code our datapoints for each of these categories.

Procedure

1. [Access the Production Analysis](#) whose datapoints you want to group.
2. In the left pane, select the **Production Data** tab.

The **Production Data** workspace appears.

3. In the upper-right corner of the workspace, select **Analysis Tasks**, and then select **Group Data By**.

The **Group Data By** window appears, displaying a list of fields available in the query or datasheet.

4. Select the field that you want to use to group data.

The datapoints within the Production Data plot change color to correspond to the values in the field. A different color is assigned automatically to each unique value.

Tip: You can tap on a datapoint in the Production Data plot to get information on how it is grouped. You can use Legend to group the datapoints.

Ignore Production Output Values

Procedure

1. [Access a Production Analysis](#) within which you want to exclude a production output value.
2. In the left pane, select the **Production Data** tab.

The **Production Data** workspace appears.

3. In the **Production Data** plot, select the datapoint that you want to exclude.

The **Point Tooltip** window appears.

4. Select **Ignore**.

The selected datapoint is excluded. GE Digital APM recalculates the losses on the Production Loss Regions pane, taking the ignored datapoints into account. The ignored datapoints are still plotted on the analysis, but are represented by a black dot.

Tip: You can also exclude a datapoint via the **Production Data Editor** window for a Production Analysis. To do so, in the row containing the production data that you want to exclude, select the check box in the **Ignore** cell of that row, and then select **OK**. The selected datapoint will be excluded.

Note: If you want to include the datapoint, you can select the excluded datapoint to open the **Point Tooltip** window, and then select **Include**.

Reload Production Analysis Data

About This Task

When you create and save an analysis that is based on a query or dataset, the GE Digital APM system saves the data that exists at the time of creation. When you open an existing analysis, changes made to the underlying query or dataset since the analysis was created will not be reflected automatically.

Note: If the query or dataset has been deleted or renamed, when you try to open an associated analysis, an error message will appear and the data will not be refreshed.

If you want to refresh an analysis to reflect changes to the underlying query or dataset or to load new data that has been added since the analysis was last saved (e.g., the analysis is based on a query that retrieves failures for a piece of equipment or location, and a new failure record has been added to the database), you will need to reload the analysis manually after opening it. When you reload the data, any manual changes made to the analysis data set will be deleted.

Note: Reloading analysis data resets the analysis period only if it is based on the analysis data. Start Dates and End Dates that have been set explicitly will not be overwritten.

Procedure

1. [Access a Production Analysis](#) whose data you want to modify.
2. In the left pane, select the **Production Data** tab.

The **Production Data** workspace appears.

3. In the upper-right corner of the workspace, select **Analysis Data**, and then select **Reload Data**.

A confirmation message appears, asking you to confirm that you want to overwrite the current data with the data stored in the database.

Note:

For an analysis based on manually-entered data, you will receive the following error message:

There is no source data to reload since the analysis is based on manually entered data.

4. Select **Yes**.

The analysis is updated to reflect the data currently stored in the query or dataset.

Note: If you are reloading analysis data that is based on a query and an index out of range error message appears, there is an error in the query. You should modify the query or recreate the analysis to reload the correct data.



Production Lines

About the Production Lines

Production Line is a way to study or assess the results of a Production Analysis. When you view the results of a Production Analysis, you can define the following types of lines:

- Reliability Line : Represents the components of the system and how they are connected, which marks the location at which datapoints begin to trend away from the Demonstrated Line.
- Demonstrated Line: Represents the production output when the unit is operating at its observed rate of its capability. The region between the Demonstrated Line and the Nameplate Line is represented as the **Efficiency/Utilization Loss** region in the **Production Loss Regions** pane.
- Nameplate Line : Represents the most ideal production output of the unit.
- Custom Line: Provides a visual comparison between the Demonstrated Line and other observed or theoretical production rates. You can have more than one Custom Line per analysis.

The **Production Lines** pane contains rows representing Production lines created on the [Production Data plot](#). The color and background of each row corresponds to the color of the line on the analysis. Optionally, within the **Production Lines** pane, you can choose any line color from the color palette that appears when you select the color palette in the **Color** column.

Name	Beta	Eta	Color	
Nameplate Line	1.4370	5,002.1233		Delete
Demonstrated Line	0.5410	110.2068		Delete

For each row, the **Production Lines** section provides following columns of information:

- **Name**: Contains the names of the production lines that exist in the analysis.
- **Beta**: Contains the Beta value for the line. In a Production Analysis, the Beta value indicates how reliable the production process is. The closer the line is to vertical, the higher the Beta value. A higher Beta value indicates less variation in the production process (more reliable); a lower Beta value indicates more variation in the production process (less reliable). You can use the following general guidelines to evaluate the production process according to the Beta value.
 - Beta = 5: Large variation in production output; a very poor production process.
 - Beta = 10: Moderate variation in production output; a fair production process.
 - Beta = 25: Some variation in production output; a good production process.
 - Beta = 50: Minimal variation in production output; a very good production process.
 - Beta = 100: Only minor variations in production output; an excellent production process.
 - Beta = 200: Almost no variation in production output; an outstanding production process.
- **Eta** : Contains the Eta value for the line. You can delete the column and differentiate it with colors.

You can manually change the Beta and Eta values for the selected line by selecting any Beta and Eta value field from the **Production Lines** list, deleting the current value, and defining a different one.

Demonstrated Line

Somewhere on the Production Analysis, you should be able to identify a group of datapoints that represent your typical output. This output is represented by a Demonstrated Line. The Demonstrated Line extends beyond the plotted datapoint to show what the production would have been if the production rate had not started to drop off due to reliability problems, such as Asset failures, cutbacks, and downtime. Drawing the Demonstrated Line first can help you determine where to draw the Process Reliability Line. You will want to draw the Process Reliability Line where the datapoints begin to deviate from the Demonstrated Line.

The following image shows an example of a Demonstrated Line:

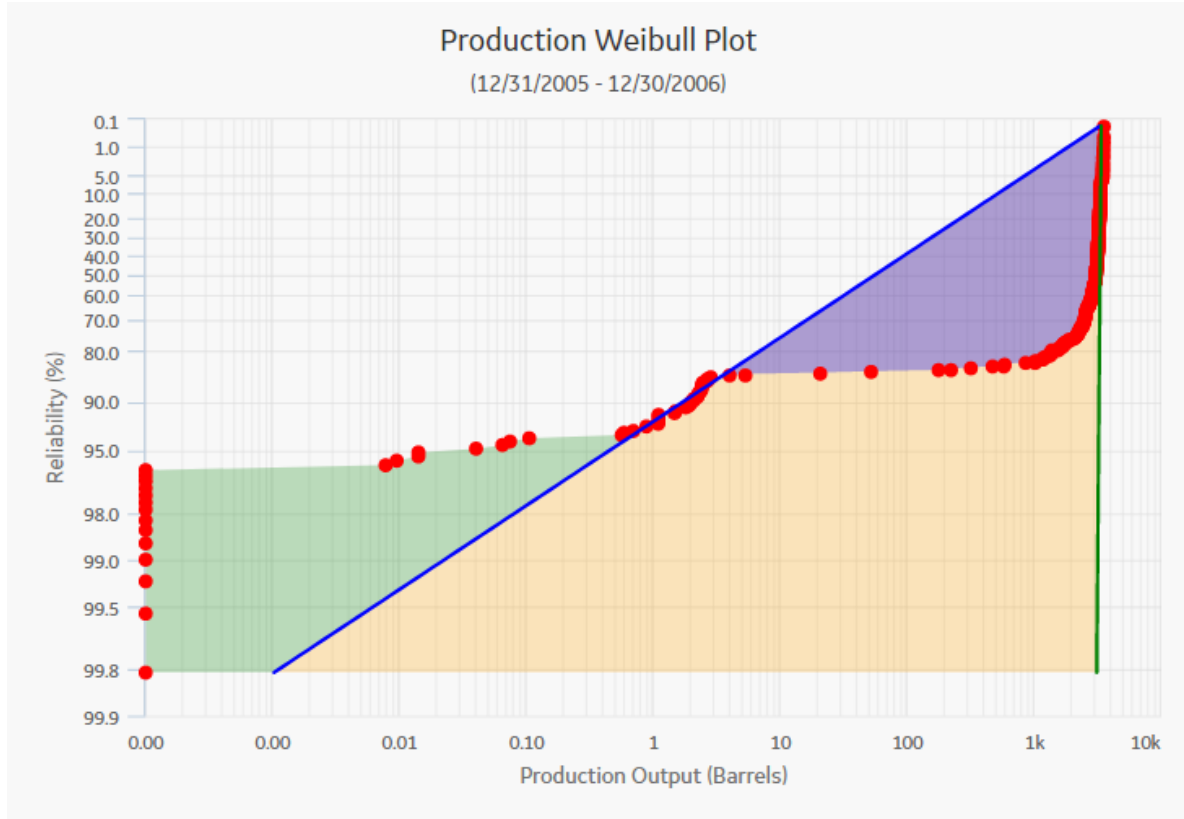

Process Reliability Line

An ideal process will produce the maximum possible output at all times, but actual processes demonstrate variation in output over time. The variation in output can be caused by various factors, including process problems, Asset problems, shutdowns, and cutbacks.

The Process Reliability Line marks the location at which datapoints begin to trend away from the Demonstrated Line. This is the location at which variation in output shifts from being attributed to production losses to being attributed to reliability losses. It defines the reliability of the process, expressed as a percentage. It is the point at which the process shifts from being fairly reliable to being unreliable.

The decision of where to draw the Process Reliability Line is somewhat subjective and will be determined by how your datapoints look after they have been plotted and how you interpret the plot. If your datapoints do not exhibit a distinct trend away from the Demonstrated Line, and are plotted in a fairly straight, diagonal line, it may not be appropriate to draw the Process Reliability Line at all.

The following image shows an example of a Process Reliability line showing that reliability of the process is 53.28%:



Nameplate Line

Every process will have both ideal output value and actual output values. Ideally, a process should always produce the maximum possible output. The maximum possible output is determined by a variety of factors and is often influenced most significantly by manufacturer specifications. Many manufacturers specify a nameplate value for their equipment to indicate the highest capacity of a given piece of equipment under ideal operating conditions. Together, the nameplate values for the individual pieces of equipment can help you determine the nameplate value for the entire unit, which is the maximum production output for the process under ideal operating conditions.

After you have plotted your production data, you will want to draw a Nameplate Line on the Production Analysis Plot to indicate the ideal output. GE Digital APM will calculate the difference between the ideal output and your observed output values (represented by the Demonstrated Line) to determine your Efficiency/Utilization Losses.

It may not always be appropriate to use the manufacturer's nameplate value as the nameplate value for your process. The maximum production capacity based on manufacturers' specifications may be unrealistic if you intentionally operate under conditions that do not meet those specifications. For example, you may operate at a lower temperature due to environmental constraints. If you calculate your production losses based on an impossible goal, your losses may appear inflated. In this case, you may want to take these factors into account to determine a more realistic nameplate value: one that actually can be achieved.

The following image shows an example of a Nameplate Line:



Custom Line

After you have drawn the Demonstrated Line, the Process Reliability Line, and the Nameplate Line, you can optionally draw one or more additional Custom Lines to compare historical or projected production rates to the observed production rate. For example, you might draw a Custom Line:

- To compare the current year's production to the previous year's production.
- To compare your company's production rates with the production rates of another company that is using the same process.
- To project how much more you could produce the next year if you improved your process to achieve a projected production rate.

The following image shows a Custom line drawn using a Beta value of 10 and Eta value of 1:

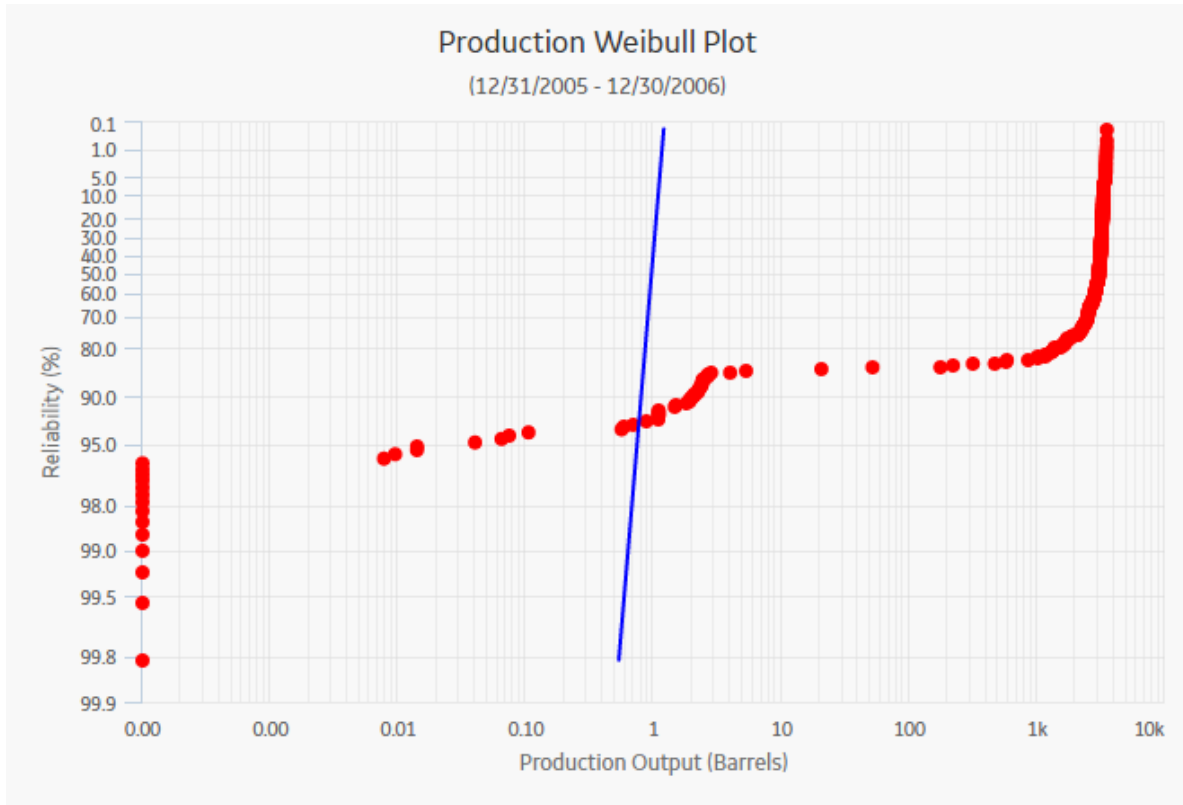

Define a New Production Line

About This Task

This topic describes how to define the following types of lines:

- Demonstrated Line
- Nameplate Line
- Custom Line

You can also [define a Process Reliability line](#).

Procedure

1. [Access Production Analysis](#) for which you want to define a Production Line.
2. In the left pane, select the **Production Data** tab.
The **Production Data** workspace appears.
3. In the upper-right corner of the workspace, select **Production Lines**.
4. In the list, select the type of Production Line that you want to define. You can define one of the following types of Production Lines:
 - **Demonstrated Line (DL)** : Represents the production output when the unit is operating at its observed rate of its capability. The region between the Demonstrated Line and the Nameplate Line is represented as the **Efficiency/Utilization Loss** region in the **Production Loss Regions** pane.
 - **Nameplate Line (NL)** : Represents the most ideal production output of the unit.
 - **Custom Line (CL)** : Provides a visual comparison between the Demonstrated Line and other observed or theoretical production rates. You can have more than one Custom Line per analysis.

- **Reliability Line** : You must select a datapoint before [defining a Reliability Line](#).

The **Add/Modify <Production Line>** window appears, where <Production Line> is type of the Production Line that you selected. The window displays various methods to define a Production Line.

For example, the following image displays the window for adding a Demonstrated Line:

Add/Modify Demonstrated Line

Regression Fit

Select a group of at least 2 observed data points to define a regression fit line.

Draw Line

Drag between any two points on the plot to draw a line.

Specify Beta and Select a Point

Beta

Specify Beta & Eta.

Beta

Eta

Cancel

OK

Note: If you selected Custom Line, then the **Add Custom Line** window appears.

5. Select one of the following methods:

- **Regression Fit:** This option allows you to select a group of datapoints and then calculates the best-fit method to draw a line for that set of datapoints.
- **Draw Line** : This option allows you to draw a line manually anywhere on the current analysis.
- **Specify Beta and Select a Point** : This option allows you to specify the Beta value to determine the slope of the line, and then define a line by selecting a datapoint.
- **Specifying Beta and Eta** : This option allows you to draw a line by specifying both the Beta and Eta values.

6. Select **OK**.

The selected type of Production Line is drawn.

Use Regression Fit

About This Task

The **Regression Fit** option allows you to select a group of datapoints, and then calculate the best-fit method to draw a line for that set of datapoints. For example, the following steps demonstrate how to draw a Demonstrated Line using **Regression Fit** option.

Procedure

1. Define a Demonstrated Line.
2. On the **Add/Modify Demonstrated Line** window, select **Regression Fit**, and then select **OK**.

The **Production Data** plot appears in a new window.

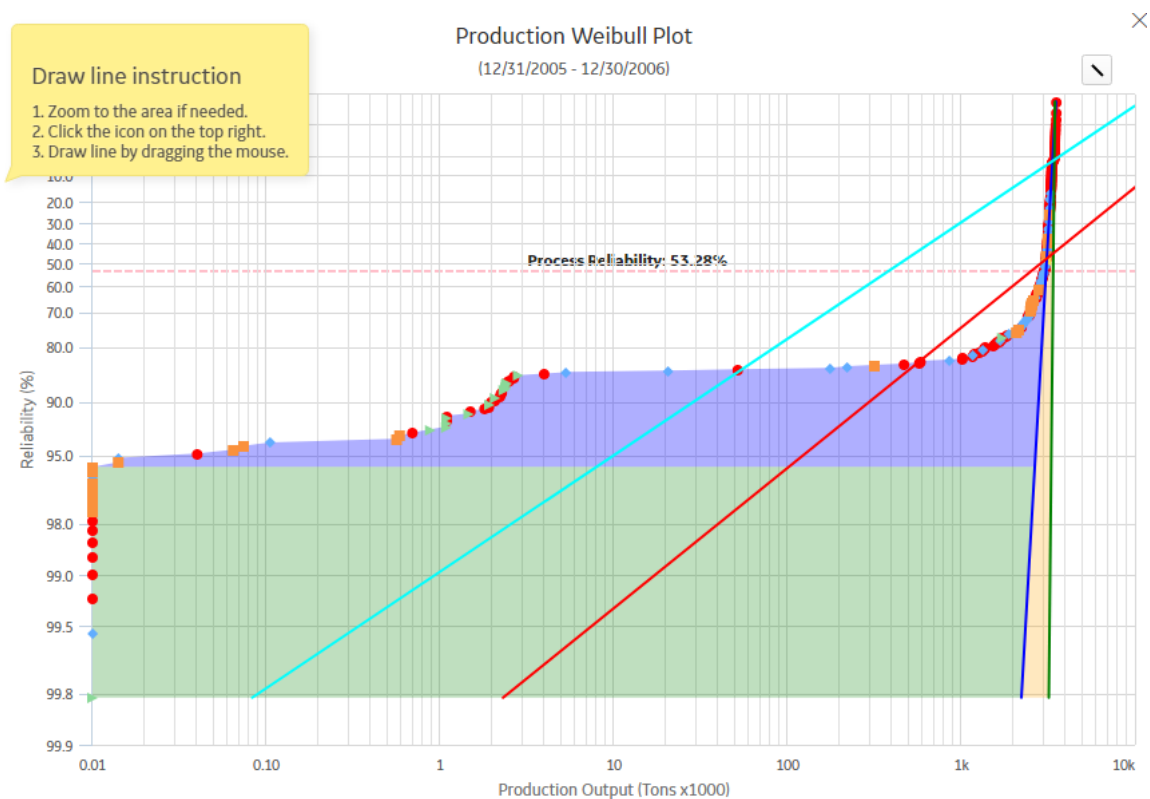

3. Select .
4. Drag the pointer or use the standard spread move to create a box around at least two datapoints.

The Demonstrated Line is added to the Production Data plot.

Note: If you attempt to draw a regression fit around datapoints where the Beta value will be close to zero or too vertical and Eta will be too large or small or not present on the graph, an error message appears, explaining that Eta is out of range.

The following image shows an example of a line drawn using the Regression Fit method:

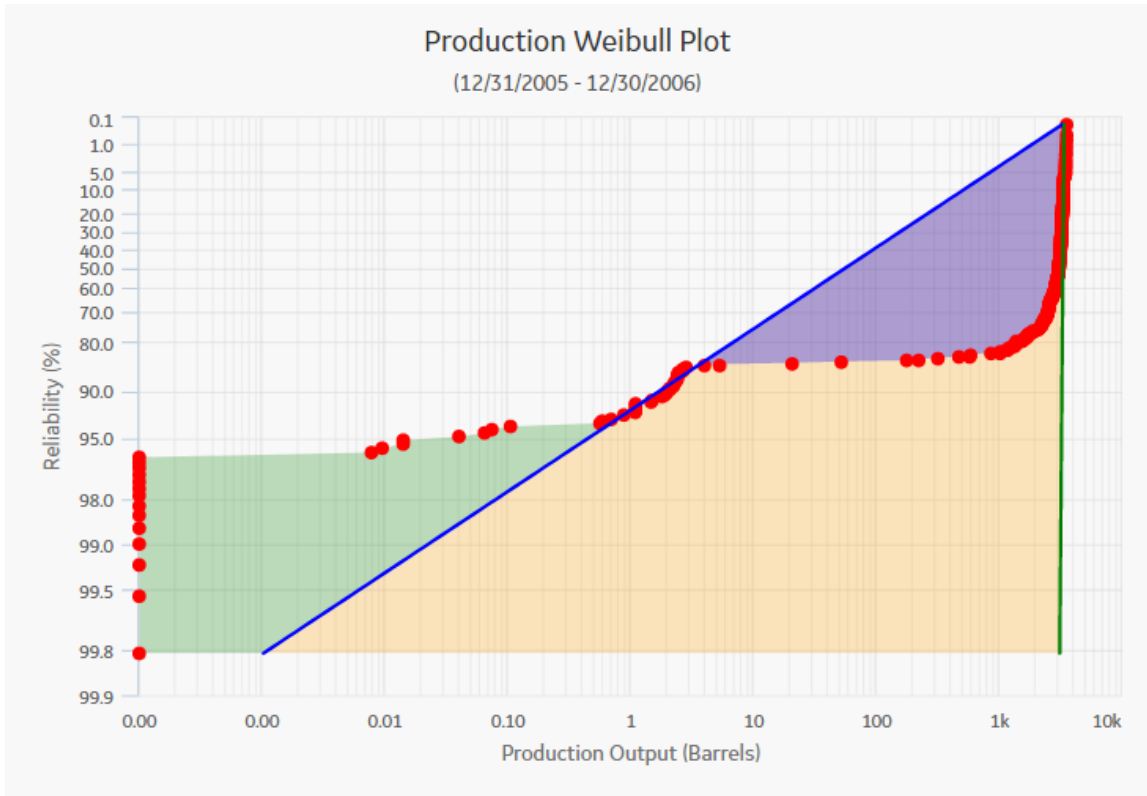

Draw Line Manually

About This Task

The **Draw Line** option allows you to draw a Production Line manually anywhere on the current analysis. For example, the following steps demonstrate how to draw a Nameplate Line using **Draw Line** option.

Procedure

1. [Define a Nameplate Line](#).
2. On the **Add/Modify Nameplate Line** window, select **Draw Line**, and then select **OK**.

The **Production Data** plot appears in a new window.

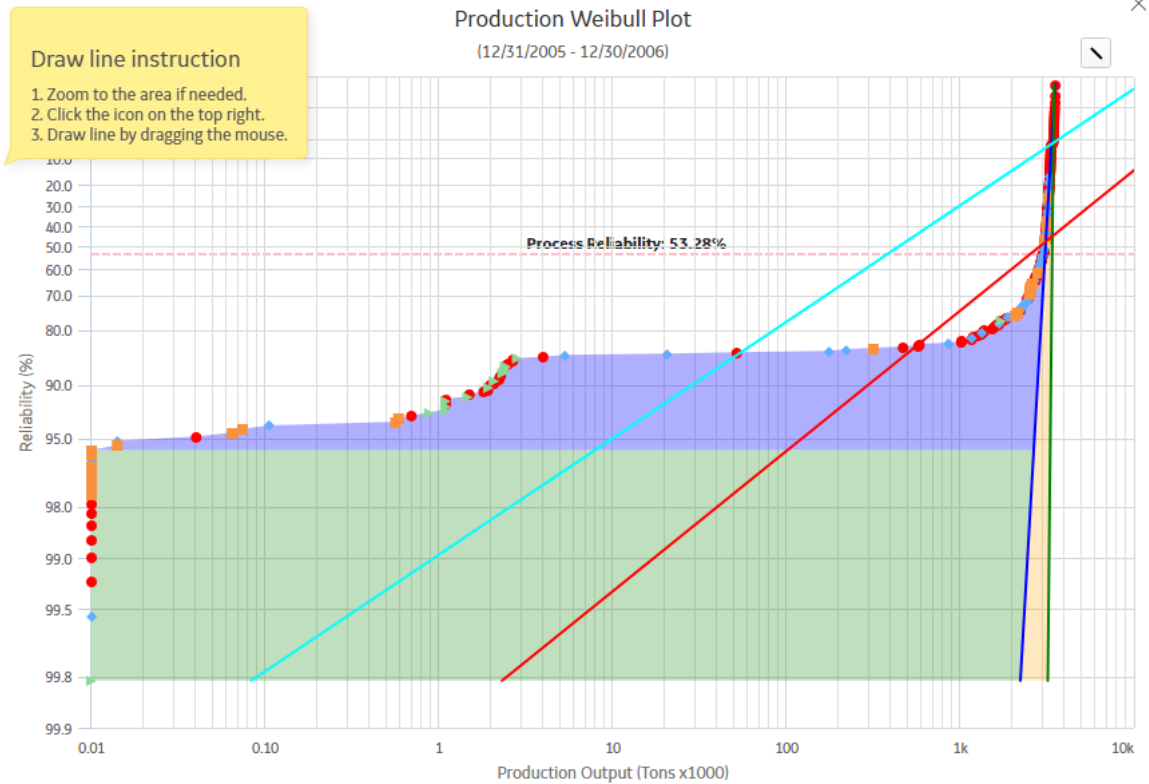

3. Select .
 4. Drag the pointer where you want the line to appear.
- The Nameplate Line is added to the Production Data plot.

Specify Beta Value and Select a Point

About This Task

When you define a new Production Line, selecting the **Specify Beta and Select a Point** option allows you to enter the **Beta value** to determine the slope of the line by selecting a datapoint. For example, the following steps demonstrate how to draw a Nameplate Line using the **Specify Beta and Select a Point** option.

Procedure

1. [Define a Nameplate Line.](#)
2. On the **Add/Modify Demonstrated Line** window, select **Specify Beta & Select Point**.
3. In the **Beta** box, enter the desired Beta value, and then select **OK**.

Note: If a Nameplate Line does not currently exist, the value for Beta is set by default to 0, but can be changed to any number between .001 and 1000. If a Nameplate Line does exist, the value for Beta is set to the value of that line but can be changed to any number between .001 and 1000. Keep in mind that the higher the Beta value, the more vertical the line will be.

4. Select **OK**.

The Nameplate Line is drawn through the selected datapoint, its slope determined by the specified Beta value.

Specify Beta and Eta

About This Task

The **Specify Beta & Eta** option allows you to draw a line by entering both the [Beta and Eta values](#). This tool may be useful when you create a Production Line to indicate the production rate of output used in another Production Analysis. You can copy the Beta and Eta values for the Demonstrated Line from that analysis and then provide them when using this option. For example, the following steps demonstrate how to create a Custom Line using the **Specify Beta & Eta** option.

Procedure

1. [Define a Custom Line](#).
2. On the **Add/Modify Custom Line** window, select **Specify Beta & Eta**.
The **Beta** and **Eta** boxes are enabled.
3. In the **Beta** box, enter the desired Beta value. The Beta value is set to 1 by default, but can be changed to any number between .001 and 1000.
4. In the **Eta** box, enter the desired Eta value. The Eta value is set to 1 by default, but can be changed to any number less than 1000000000.
5. Select **OK**.

The Custom line is added.

Define a Process Reliability Line

Procedure



1. [Access the Production Analysis](#) for which you want to define a Reliability Line.
2. In the left pane, select the **Production Data** tab.
The **Production Data** workspace appears.
3. In the upper-right corner of the workspace, select **Production Lines**.
4. In the list, select **Reliability Line**.
5. In the **Production Data** plot, select the point at which datapoints begin to trend away from the Demonstrated Line.

A dotted line appears and is labeled **Process Reliability: <Percentage>**, where <Percentage> indicates the reliability of the process.

Delete a Production Line

Procedure

1. [Access the Production Analysis](#) from which you want to delete a Production Line.
 2. In the left pane, select **Production Data** tab.
The **Production Data** workspace appears.
 3. In the lower-left corner of the workspace, select **Production Lines**, and then select .
- A grid appears, displaying a row for each Production Line.

Name	Beta	Eta	Color	
Nameplate Line	1.4370	5,002.1233		Delete
Demonstrated Line	0.5410	110.2068		Delete

Tip: You can also view them in full screen by selecting .

4. Locate the row containing the Production Line that you want to delete, and then select **Delete**.

The **Delete Production Line** dialog box appears, asking you to confirm that you want to delete the selected Production Line.

5. Select **OK**.

The selected Production Line is deleted.

Chapter 5

Reliability Distribution

Topics:

- [Reliability Distribution: Overview](#)
- [Reliability Distribution: Workflow](#)
- [Reliability Distribution Analyses](#)
- [Confidence Level and P Value](#)
- [Failure Probability](#)

Reliability Distribution: Overview

Overview of Reliability Distribution Analysis

Reliability Analytics

The Reliability Analytics module provides a collection of tools that apply reliability engineering principles to help you make tactical (short-term) and strategic (long-term) decisions for maintenance and operational equipment management activities. It also provides:

- A means for analyzing historical failure data to identify trends and predict future failures.
- A mechanism for simulating what if scenarios regarding the reliability of a system to determine if a new or modified strategy will be effective.

The Reliability Analytics module provides the following types of tools:

- Production Analysis
- System Reliability Analysis
- Spares Analysis
- Reliability Distribution Analysis
- Probability Distribution Analysis
- Reliability Growth Analysis
- Automation Rules

Each tool provides a unique set of features that allow you to analyze data to develop strategies to improve reliability.

Reliability Distribution Analysis

Reliability Distribution Analysis is a tool that allows you to create a statistical distribution that describes how Time to Failure is distributed over the lifetime of equipment. With a closer look at the individual failure mode over one or multiple pieces of equipment, you will be able to identify trends and predict future failures.

Reliability Distribution Analysis Workflow

This workflow provides the basic, high-level steps for developing Reliability Distribution Analysis. The steps and links in this workflow do not necessarily reference every possible procedure.

1. **Collect failure data**.
2. **Create a new Reliability Distribution analysis** from [a GE Digital APM query or dataset](#), or from [manually entered data](#). The Reliability Distribution Analysis should be based on the failure data collected in the previous step.
3. **Evaluate the results** of conducting the Reliability Distribution Analysis.

Reliability Distribution: Workflow

Reliability Analytics: Reliability Distribution Analysis Workflow

This workflow describes the process for analyzing changes to a measured value over time to determine the mathematical median and mean values associated with analyzed data.

In the following workflow diagram, the blue text in a shape indicates that the corresponding description has been provided in the sections that follow the diagram. For more information, refer to the [Interpreting the Workflow Diagrams](#) topic in the [APM Product Workflows](#) documentation.

Note: For information on the personas associated with a GE Digital APM module, refer to the [APM Product Workflows](#) documentation.

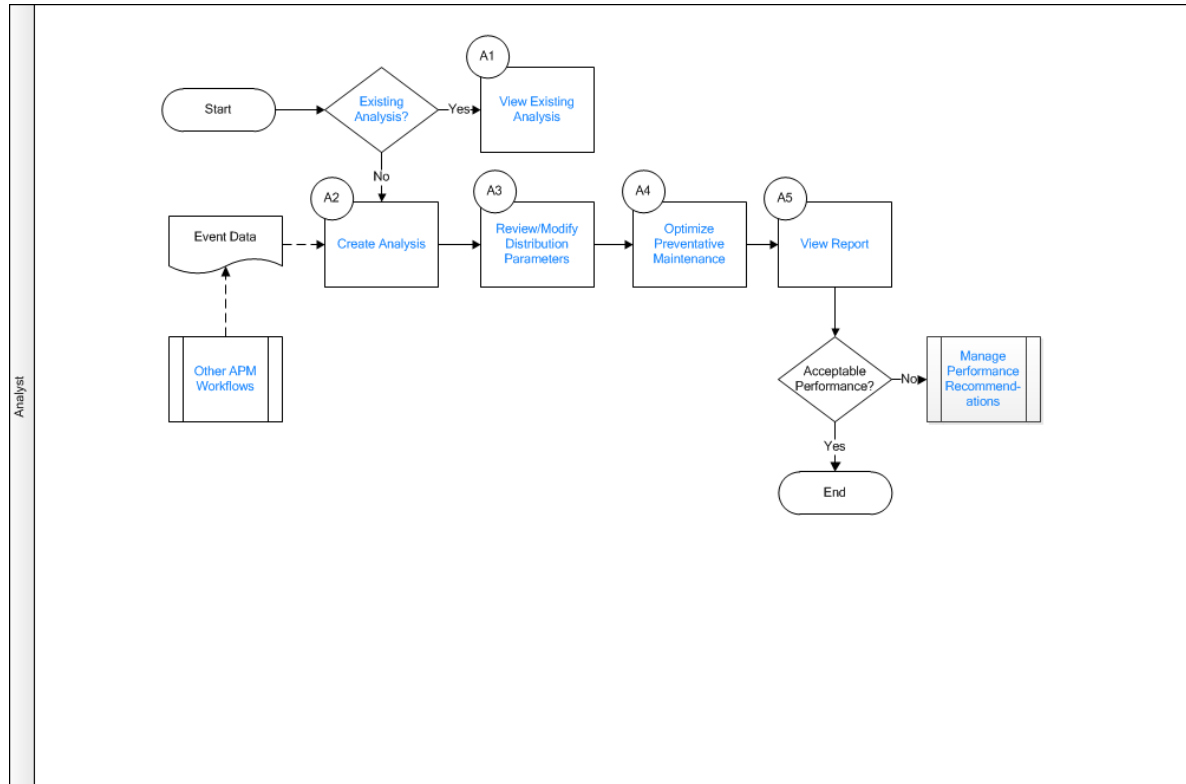

1. [Existing Analysis?](#) on page 75
2. [View Existing Analysis](#) on page 75
3. [Create Analysis](#) on page 76
4. [Review/Modify Distribution Parameters](#) on page 76
5. [Optimize Preventative Maintenance](#) on page 76
6. [View Report](#) on page 76
7. [Other Workflows](#) on page 76
8. [Manage Performance Recommendations](#) on page 76

Existing Analysis?

Persona: Analyst

Is the analysis one that was created previously and saved to the database?

View Existing Analysis

Persona: Analyst

View the details of an existing analysis.

Create Analysis

Persona: Analyst

Create an analysis based on production data or event data.

Review/Modify Distribution Parameters

Persona: Analyst

If Distribution Parameters have been updated, review/modify them. Distribution Parameters are updated when a different distribution type is selected (e.g., when changing from Lognormal to Auto).

Optimize Preventative Maintenance

Persona: Analyst

Determine the optimal time to perform Preventive Maintenance based on a failure rate.

View Report

Persona: Analyst

View and save the analysis report.

Manage Performance Recommendations

Persona: Analyst

Create any number of performance recommendations and Approve them using state management.

Note: Performance recommendations are not required.

Go to the Manage Performance Recommendations workflow.

Other Workflows

Persona: Analyst

Other workflows provide production data from SAP, EAM, and Recommendations.

Reliability Distribution Analyses

About Reliability Distribution Analysis

A Reliability Distribution Analysis allows you to describe the Time to Failure (TTF) as a statistical distribution, which is usually characterized by a specific pattern. The following distribution types are supported:

- **Normal**
- **Weibull**
- **Exponential**
- **Lognormal**
- **Triangular**

- **Gumbel**
- **Generalized Extreme Value**

The Reliability Distribution Analysis characterizes how failures are distributed over the life of equipment. Analyzing the distribution of failures means examining a particular failure mode over one or multiple pieces of equipment. Generating a Distribution Analysis will help you find the answers to the following questions:

- Do most of the equipment failures occur early on?
- Does the equipment fail more at the end of its span of service?
- Are the failures fairly evenly distributed throughout the life of the equipment or randomly occurring?

In a Reliability Distribution Analysis, you are trying to determine the probability of failure at a certain point in time. A Distribution Analysis can help you determine the pattern of failures, and the results can be compared to industry data.

If Time to Repair (TTR) information is available, a Reliability Distribution Analysis will also be calculated to describe the maintainability of the piece of equipment.

PM Optimization and Failure Probability calculations can be performed on any piece of equipment that has a valid Time to Failure (TTF) distribution.

Collect Data for Reliability Distribution Analysis

To create a Reliability Distribution Analysis, you must collect the Asset ID, Failure Date, and Failure Mode information for a piece of equipment.

The following table shows the typical data needed to build a Reliability Distribution Analysis in GE Digital APM.

Data Needed	Description	Notes
Asset ID	Select a field that uniquely describes a piece of equipment, such as Equipment ID. Reliability Distribution Analyses can be conducted on any number of pieces of equipment.	This is a required field. Select a text field.
Downtime	If this information is available, it can be used to make the estimation more accurate. Fields like "return to service date" or "date repaired" can be used to estimate downtime.	This field is optional.
Failure Date	Select the field that contains the last date on which the piece of equipment failed. This data can have many different descriptions (e.g., Out of Service Date, Shutdown Date, or Failure Date).	Select a text field. This is a required field.
Failure Mode	Sometimes users put failed parts in this field, or even a description like "worn out" or "broken down". These descriptions can be very useful when deciding to include or not include a particular failure in the failure history for the purpose of censoring.	Needed for Distribution Analysis only.

Data Needed	Description	Notes
Installation Date	Select the field that contains the date on which the piece of equipment was installed.	This field is optional. Select a date field.
Time Units	Select the Downtime time units.	None.

Access a Reliability Distribution Analysis

Procedure

1. Access the [RA Overview](#) page.
2. Select the **Reliability Distribution** tab.
A list of Reliability Distribution Analyses available in the database appears.
3. Select the Reliability Distribution Analysis whose details you want to view.

The **Analysis Summary** workspace for the selected analysis appears, displaying the following sections:

- **Time to Failure Distribution:** Provides a summary of details for the Time to Failure (TTF) distribution, which calculates the expected time to failure for a non-repairable system (i.e., the failed component must be replaced). This is based on the time between when the component or group of components was placed into service and when failure(s) occur. The period which is being analyzed can end at a fixed date or time, or after a fixed number of failures have taken place. TTF may be expressed as days, hours, cycles, units processed, and so on. This section also displays the [Probability Plot](#) and [Failure Rate Plot](#).
- **Time to Repair Distribution:** Provides a summary of the details for the Time to Repair (TTR) distribution, which calculates the time it took to repair an asset. This time is generally referred to as the time from when an item fails to when it is returned to productive service. This section also displays the [Probability Plot](#) and [Failure Rate Plot](#).
- **Failure Data:** Displays the [failure history by asset](#) in a chart.

The **Analysis Summary** workspace contains the following sections at the bottom of the workspace:

Note: If **Time to Failure Distribution** tab is selected, the bottom section displays information associated with the Time to Failure Distribution. If **Time to Repair Distribution** tab is selected, the bottom section displays information associated with Time to Repair Distribution.

- **Distribution Options :** Contains the summary of [distribution properties](#) for the selected Reliability Distribution Analysis and allows you to modify these properties.
- **Distribution Parameters:** Contains the distribution parameters, which are determined by the distribution type.
- **Goodness of Fit Test:** Contains the [results](#) of the Goodness of Fit (GOF) test and includes the Statistic, P-Value and Passed fields.
- **Analysis Basis:** Displays the number of failures contained in the Failure Data that were used to generate MTBF, the number of those failures from the data that were censored when the calculations were last performed, and the number of pieces of equipment contained in the Failure Data. The Failure Type that was selected when creating the analysis is also listed in this section.
 - If the analysis is based on the **Failures With Replacements** failure type, the following information is displayed: Components are always replaced after each failure.
 - If the analysis is based on the **Failures Without Replacements** failure type, the following information is displayed: Components are not automatically replaced after each failure.

The left pane contains the following tabs:

- **Probability Plot** : Contains the [Probability plot](#) for the selected analysis.
- **Failure Rate Plot** : Contains the [Failure Rate plot](#) for the selected analysis.
- **PDF Plot**: Contains the [Probability Density Function plot](#) for the selected analysis.
- **CDF Plot**: Contains the [Cumulative Distribution Function plot](#) for the selected analysis.
- **PM optimization** : Contains the optimal preventive maintenance interval and a graphical plot of the Planned Cost, Unplanned Cost, and Total Cost if a [PM Optimization](#) has been previously performed. The Optimal Value inflection point is identified on the total cost curve.
- **Failure Probability** : Contains the [Failure Probability](#) information in a grid, which is calculated by the system using the Future Age that you specify and the information available for the Distribution Analysis.

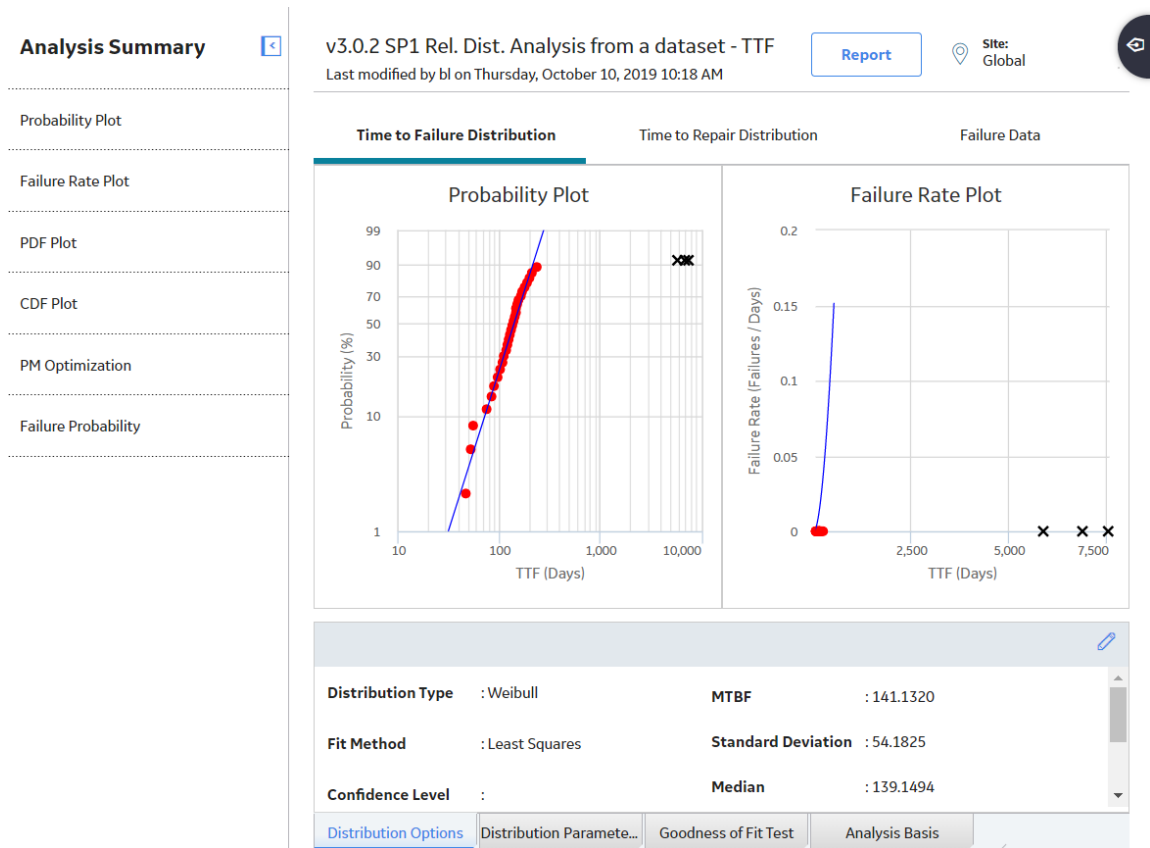

Access Multiple Reliability Distribution Analyses

About This Task

You can access multiple Reliability Distribution Analyses and compare multiple plots for the selected analyses. You cannot modify the details of the analyses based on which the **Comparison Plot** is generated.

Procedure

1. [Access the RA Overview page.](#)
2. Select the **Reliability Distribution** tab.

A list of Reliability Distribution Analyses available in the database appears.

3. Select two or more Reliability Distribution Analyses whose plots you want to compare.

Note: You can select up to 20 analyses to compare plots.

4. In the upper-right corner of the grid, select 

The **Multiple Reliability Distribution Analyses** page appears, displaying the **Comparison Plot**. By default, [Probability plot](#) for the selected analyses appears. You can also view the following types of plots:

- [Failure Rate plot](#)
- [PDF plot](#)
- [CDF plot](#)

By default, the plots appear in the Time to Failure Distribution format. You can also view multiple plots in the Time to Repair Distribution format.

Multiple Reliability Distribution Analyses

2 plots are being viewed now

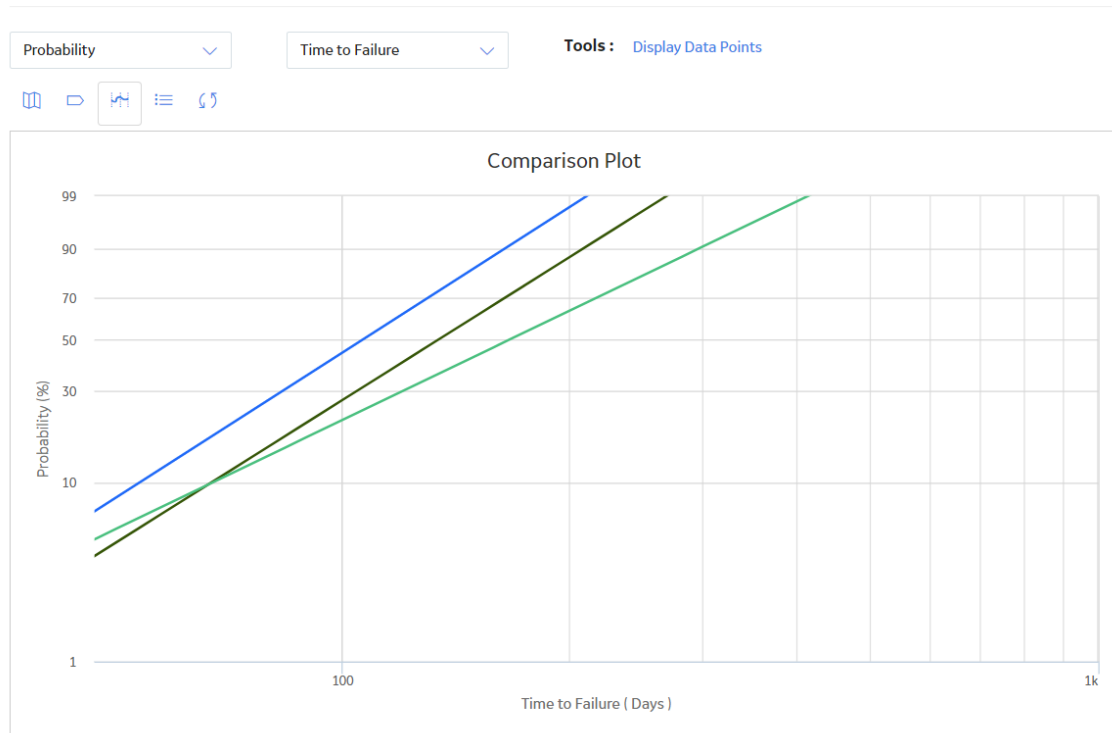

Create a Reliability Distribution Analysis From an Existing Query or Dataset

Procedure

1. [Access the RA Overview](#) page.
2. In the upper-right corner of the page, select **New Analysis**, and then select **Reliability Distribution**.

The **Reliability Distribution Builder** window appears, displaying the **Define New Analysis** screen.

Note: All required information is provided, but for additional information, consult the [Distribution Analysis Families](#) topic.

3. Enter values in the **Analysis Name** and **Description** boxes for the new analysis, and then select **Next**.
The **Select Data Source Type** screen appears. The **Data will be based on an existing Query** option is selected by default.
4. If you want to load data using an existing query, select **Next**.
The **Select Query** screen appears.
-or-
If you want to load data using an existing dataset, select **Data will be based on an existing Dataset**, and then select **Next**.
The **Select Dataset** screen appears.
5. Select **Browse** to search for an existing query or dataset in the GE Digital APM Catalog.
The **Select a query from the catalog** or **Select a dataset from the catalog** window appears, depending on whether you selected **Data will be based on an existing Query** or **Data will be based on an existing Dataset** in the previous step.
6. Select the required query or dataset, and then select **Open**.
The complete path to the query or dataset is displayed in the **Query** or **Dataset** box. The fields that exist for the selected query or dataset appear in the **Available Fields** list.
7. In the **Includes Data From the Following Sites** list, select the site(s) whose data from which you want to create an analysis.
If you are creating an analysis in a database that has [only one site stored in the Site Reference family](#), then the **Includes Data From the Following Sites** list will not appear on the **Select Query** screen.
8. Select **Next**.
The **Select Data Format** screen appears.
9. If the failure data contains failure dates, select **Failure data contains failure dates**, and then select **Next**.
-or-
If the failure data contains numbers representing the time to failure, select **Failure data contains time to failure**, and then select **Next**.
The **Failure Type** screen appears.
10. If the piece of equipment is replaced after each failure, select **I have failures with replacement (as good as new)**, and then select **Next**.
-or-
If the piece of equipment is not replaced after each failure, select **I have failures without replacement (as good as old)**, and then select **Next**. Select this option if a failure does not require replacement of the entire unit (e.g., for heat exchangers, boiler tubes, or piping).
The **Select Failure Fields** screen appears. This screen may look different depending on the option that you selected on the previous screen.
11. Specify values in the fields:
 - In the **Asset ID** list, select the name of the field that contains the IDs of the failed entities. This is a required field and must be a character field.
 - In the **Installation Date** list, select the name of the field that contains the installation date, which is the date when the piece of equipment was installed. This is an optional field.
 - In the **Failure Date** list, select the name of the field that contains the failure date, which is the date on which the failure events occurred (e.g., the Out of Service date). This is a required field.
12. If you selected **I have failures without replacement (as good as old)**, enter values in the following additional fields, which appear only when you have made this selection:

- **Number of Subcomponents:** The name of the field that contains the number of subcomponents contained by the piece of equipment that you selected in the **Asset ID** field.
Note: If this field is not mapped, a warning message will appear, indicating that the number of subcomponents must be entered for every analyzed piece of equipment. You must enter those values in the **Assets** section of the **Reliability Distribution Failure Data** window to include non-failed elements. Failure probability cannot be calculated if this value is left blank.
 - **Number of Failures:** The name of the field that contains the number of failed elements at each failure event.
 - **Replacement?:** The field that indicates whether replacement is made following each equipment failure. It must be mapped to a field of the type **Logical**. A replacement causes the entire piece of equipment to be renewed, thus resetting calculation of the time to failure.
13. If you selected a query or dataset that includes downtime data, select **Next**.
The **Provide Information for Downtime** screen appears.
- or-
- If you selected a query or dataset that does not include downtime data, select **Finish**, and then skip to the end of these instructions.
14. In the **Downtime Field** list, select the necessary field (e.g., Total Time to Repair). This is an optional field, and the value entered must be numeric.
15. In the **Time Units** list, select the time units associated with downtime from the following options:
- **Hours**
 - **Days**
 - **Weeks**
 - **Months**
 - **Quarters**
 - **Years**
- Note:** The time units that you select here will apply to downtime only. Operating time will be set by default to days. After the analysis has been created, you can [change the units for both downtime and operating time](#).
16. Select **Finish**.
The GE Digital APM system generates the analysis. The **Reliability Distribution Analysis** page appears, displaying the results of the analysis.

Create a Reliability Distribution Analysis From Manually Entered Data

Procedure

1. Access the [RA Overview](#) page.
2. In the upper-right corner, select **New Analysis**, and then select **Reliability Distribution**.
The **Reliability Distribution Builder** window appears, displaying the **Define New Analysis** screen.
Note: All required information is provided, but for additional information, consult the [Distribution Analysis Families](#) topic.
3. Enter values in the **Analysis Name** and **Description** fields for the new analysis, and then select **Next**.
The **Select Data Source Type** screen appears.
4. Select **I will manually enter failure data**, and then select **Next**.
The **Select Data Format** screen appears.
5. If the failure data contains failure dates, select **Failure data contains failure dates**.

-or-

If the failure data contains numbers representing the time to failure, select **Failure data contains time to failure**.

6. Select **Next**.

The **Failure Type** screen appears.

7. If the piece of equipment is replaced after each failure, select **I have failures with replacement (as good as new)**.

-or-

If the piece of equipment is not replaced after each failure, select **I have failures without replacement (as good as old)**. Select this option if a failure does not require replacement of the entire unit (e.g., for heat exchangers, boiler tubes, or piping).

8. Select **Finish**.

The **Reliability Distribution Data** window appears, displaying the **Failures** and **Assets** tabs. This screen may look different depending on the option that you selected on the previous screen.

9. Enter information about the **Failures** and **Assets** that you want to include in the analysis. When you provide the information, consider the following:
 - A minimum of three failure datapoints are needed to perform a calculation.
 - If you enter downtime values that exceed the next failure date, the GE Digital APM system will highlight the downtime values on the **Reliability Distribution Failure Data** window. When you close the **Reliability Distribution Failure Data** window, an error message appears in the **Analysis Information** section.
 - Days will be assumed to be the units for both downtime and operating time for the data that you enter. After you create the analysis, you can [change the time units](#).

Tip: You can add more rows of data by selecting **Add** at the bottom of the **Reliability Distribution Failure Data** window. You can remove any row of data by selecting **Remove** next to the row of data that you want to remove.

10. Select **OK**.

The **Reliability Distribution Analysis** page appears, displaying the results of the analysis.

Change the Distribution Type of a Reliability Distribution Analysis

About This Task



When you create a Reliability Distribution Analysis, the distribution type is set to Weibull by default. After the analysis is created, you can change the distribution type to one of the following:

- **Normal**
- **Weibull**
- **Exponential**
- **Lognormal**
- **Triangular**
- **Gumbel**
- **Generalized Extreme Value**

Note: Select **Auto** if you want the GE Digital APM system to select the appropriate Distribution Type based on the results of the Goodness of Fit test.

You can change the Distribution Type in the **Analysis Summary** workspace or from one of the plot tabs in the left pane.

Procedure

1. [Access a Reliability Distribution Analysis](#) for which you want to modify the Distribution Type.
2. If you want to change the distribution type in the **Analysis Summary** workspace:
 - a. Select the **Time to Failure Distribution** tab.
 - b. In the bottom section, select **Distribution Options**, and then select  .
The **Distribution Type** list is enabled.
 - c. In the **Distribution Type** list, select the necessary Distribution Type, and then select  .
The analysis is recalculated based on the selected Distribution Type.

-or-

If you want to change the Distribution Type from one of the plot tabs (e.g., **Probability Plot** tab):

- a. In the left pane, select the **Probability Plot** tab.
The Probability Plot appears in the workspace.
Note: You can also change the Distribution Type via the **PDF Plot** tab, **Failure Rate Plot** tab, **CDF Plot** tab, or the **Failure Probability** tab.
- b. In the upper-right corner of the workspace, select **Distribution Options**, and then select **Distribution Type**.
The **Select Distribution Type** window appears.
- c. Select the necessary Distribution Type, and then select **OK**.
The analysis is recalculated based on the selected Distribution Type.



Change the Distribution Parameters in a Reliability Distribution Analysis

About This Task

This topic describes how to modify the values of the distribution parameters in a Reliability Distribution Analysis.

You can change the distribution parameters from the **Analysis Summary** workspace or from any of the plot tabs in the left pane.

Procedure

1. [Access a Reliability Distribution Analysis](#) for which you want to modify the Distribution Parameters.
2. If you want to modify the values of the Distribution Parameters from the **Analysis Summary** workspace:
 - a. In the bottom section, select **Distribution Parameters**, and then select  .
The **Calculate** check boxes appear below each of the parameters.
 - b. Clear the **Calculate** check box next to the parameter(s) whose value you want to modify.
The parameter field(s) are enabled.
 - c. Enter the desired value for the parameter.
 - d. Select  .

Note: If you reselect the **Calculate** check box after manually entering data, the manually entered data for the parameter will not be retained. If you decide not to use the parameters you entered, select  , and the previous selection will be used in the calculations.

The system recalculates the analysis based on the selected distribution parameter.

-or-

If you want to modify the values of the distribution parameters from one of the plot tabs (e.g., **Probability Plot** tab):

- a. In the left pane, select the **Probability Plot** tab.
The **Probability Plot** appears in the workspace.

Note: You can also change distribution parameter via the **PDF Plot**, **CDF Plot**, and **Failure Rate Plot** tabs.

- b. In the upper-right corner of the workspace, select **Distribution Options**, and then select **Distribution Parameters**.

The **Edit Distribution Parameters** window appears.

- c. Clear the **Calculate** check box next to the parameter(s) whose value you want to modify.
The parameter field(s) are enabled.
- d. Enter the desired value for the parameter, and then select **OK**.

Note: If you reselect the **Calculate** check box after manually entering data, the manually entered data for the parameter will not be retained. If you decide not to use the parameters you entered, select **Cancel**, and the previous selection will be used in the calculations.

The system recalculates the analysis based on the selected distribution parameter.

Change the Fit Method of a Reliability Distribution Analysis

About This Task

The [Kolmogorov-Smirnov test](#) is a Goodness of Fit (GOF) test applied to Reliability Distribution Analyses to determine how well the data fits the analytical curve. When you create an analysis, by default, the fit method is set to Least Squares.

After the analysis is created, you can modify the fit method to one of the following:

- **Least Squares:** A curve-fitting estimation method that relies on linear regression techniques to estimate the parameters for the distribution.
- **Maximum Likelihood Estimators:** A curve-fitting estimation method that maximizes the likelihood function for a given population. This method includes a survivor function that estimates changes in reliability as the piece of equipment or location survives beyond a certain age.

You can change the fit method in the **Analysis Summary** workspace or after selecting any of the plot tabs in the left pane.

Procedure

1. [Access a Reliability Distribution Analysis](#) for which you want to modify the fit method.
2. If you want to change the fit method from the **Analysis Summary** workspace:

- a. In the bottom section, select **Distribution Options**, and then select .
The **Fit Method** list is enabled.

- b. From the **Fit Method** list, select the desired fit method, and then select .
The analysis is recalculated based on the selected fit method.

-or-

If you want to change the fit method after selecting one of the plot tabs (e.g., **Probability Plot** tab):

- a. In the left pane, select the **Probability Plot** tab.

- The **Probability Plot** appears in the workspace.
- b. In the upper-right corner of the workspace, select **Distribution Options**, and then select **Fit Method**.
The **Select Fit Method** window appears.
 - c. Select the desired fit method, and then select **OK**.
The analysis is recalculated based on the selected fit method.

Delete a Reliability Distribution Analysis

Procedure

1. Access the [RA Overview](#) page.
2. Select the **Reliability Distribution** tab.
A list of Reliability Distribution Analyses available in the database appears.
3. Select the row containing the Reliability Distribution Analysis that you want to delete, and then select .
The **Delete Reliability Distribution Analysis** dialog box appears, asking you to confirm that you want to delete the selected analysis.
4. Select **Yes**.
The selected analysis is deleted.

Confidence Level and P Value

About Confidence Level and P-Value

In a Distribution Analysis, the Confidence Level and the P-Value are used to determine whether the data passes the Goodness of Fit test.

The Confidence Level indicates the percentage of uncertainty of the Goodness of Fit method. This percentage is usually determined by experience or an industry standard and limits how closely the data must fit the model in order for it to pass the Goodness of Fit test. The higher the Confidence Level, the farther apart your confidence bounds will be, and the easier it will be for your data to pass the Goodness of Fit test. The lower the Confidence Level and the closer together the bounds are, the harder it will be for your data to pass the Goodness of Fit test. If the data does pass, however, the data will be a very close fit to the model.

Note: When you [enter a Confidence Level](#), you must specify a value that is greater than one (1) but less than one hundred (100).

About Data Censoring in a Reliability Distribution Analysis

Reliability Distribution Analysis supports the functionality of censoring, which accounts for the period of time from the last failure date to the analysis end date. You can censor or ignore datapoints in a Reliability Distribution Analysis to estimate the probability of when a failure might occur. Censoring is based on failure modes.

Details

Censoring a datapoint means that the datapoint is excluded as a failure but included in the operating time of the piece of equipment. If you select the **Censored** check box, the data in the selected row is excluded.

When you create a Reliability Distribution Analysis using a query or dataset as the data source, the GE Digital APM system automatically censors time values from the beginning of the Analysis Period to the first event and the time value from the last event to the end of the analysis. After the calculations for the analysis have been performed, each time that the query or dataset is refreshed, the censoring settings will be reset using the default criteria. Therefore, if you select a check box and refresh the data, the check boxes will no longer be selected.

Regardless of the data source you use, you can censor any failure data. Consider the following:

- For Maximum Likelihood Estimators (MLE), the maximum number of censored datapoints is one (1) less than the total number of datapoints.
- For Least Squares estimation, the maximum number of censored datapoints is two (2) less than the total number of datapoints.

Pump Failure

Assume that you want to determine the reasons due to which a pump failed.

A pump might have failed due to multiple reasons, such as rusted part, motor overheating, insufficient power supply, or power outage. Each of these reasons will have its own specific failure rate and probability density function. To determine the failure rate of "motor overheating", you must censor all other failure modes from the analysis.

Further, motor overheating might be caused due to multiple reasons, such as improper operation, improper application, and improper maintenance. The censoring feature allows you to separate the failure modes, and determine which is the dominant failure mode. Based on this information, you can decide what is needed to improve the motor performance.

Auto-Censoring

When you first create a Reliability Distribution Analysis, an automatically censored datapoint for each defined asset will appear on the plot. Each automatically censored datapoint represents the analysis End Date (specified on the [Set Analysis Period window](#)) for each defined asset.

GE Digital APM can:

- Censor failures automatically when it cannot calculate the time between events. For example, failure on a specific asset where the analysis does not contain a start date.
- Alert you that a datapoint is suspect. For example, in a Time to Failure type of distribution, an alert will be generated when the start date of an event overlaps the end date of a different event for the same asset. For this asset, suspect data is displayed in the **Analysis Summary** workspace.

Note: Although automatically censored datapoints appear on the plots, they do not appear in the **Failures** grid and, therefore, cannot be uncensored.

For a Reliability Distribution Analysis, when you pause on an automatically censored datapoint, the following information appears:

- Auto-Censored
- Name: Specified on the [Assets tab](#) of the **Reliability Distribution Data Editor** window.
- Installation Date: Specified in the [Assets section](#) of the **Reliability Distribution Data Editor** window.
- TTF value: Represents the time between the last failure date and the analysis End Date.

Modify the Confidence Level for a Reliability Distribution Analysis

About This Task

The Confidence Level specifies how the optimistic and realistic scenarios will be selected in a Monte Carlo Simulation for TTR Distributions in an analysis. The Confidence Level indicates whether the distribution is within the confidence limits or not. The default Confidence Level for an analysis is 90 percent.

You can modify the Confidence Level in the **Analysis Summary** workspace or after selecting any of the plot tabs in the left pane.

Procedure

1. [Access a Reliability Distribution Analysis](#) for which you want to modify the Confidence Level.
2. If you want to modify the Confidence Level in the **Analysis Summary** workspace:

- a. In the bottom section, select **Distribution Options**, and then select  .
The **Confidence Level** box is enabled.

Note: If the **Confidence Level** box is disabled, select the **Use Confidence** check box to activate the Confidence Level and enable the **Confidence Level** box.

- b. In the **Confidence Level** box, enter a numeric value between zero (0) and 100 to represent the desired Confidence Level, and then select  .
The GE Digital APM system displays the confidence intervals for the analysis based on the percentage you entered in the Confidence Level box.

-or-

If you want to change the Confidence Level after selecting one of the plot tabs (e.g., **Probability Plot** tab):

- a. In the left pane, select the **Probability Plot** tab.
The **Probability Plot** appears in the workspace.
- b. In the upper-right corner of the workspace, select the **Distribution Options** list, and then select **Confidence Level**.
The **Set Confidence Level** window appears.
- c. Select the **Use Confidence** check box to activate the Confidence Level and enable the **Confidence Level** box.
- d. In the **Confidence Level** box, enter a numeric value between zero (0) and 100 to represent the desired Confidence Level, and then select **OK**.
The GE Digital APM system displays the confidence intervals for the analysis based on the percentage you entered in the Confidence Level box.

Change the Failure Type in a Reliability Distribution Analysis

About This Task

You can change the failure type in the any of the plots selectable via the plot tabs in the left pane (i.e., **Probability Plot** tab, **Failure Rate Plot** tab, **PDF Plot** tab, **CDF Plot** tab, and **Failure Probability** tab). These instructions describe how to change the failure type in the **Probability Plot**

Procedure

1. [Access a Reliability Distribution Analysis](#) for which you want to change the failure type.
2. In the left pane, select the **Probability Plot** tab.
The **Probability Plot** appears in the workspace.
3. In the upper-right corner of the workspace, select **Analysis Tasks**, and then select **Failure Type**.
The **Select Failure Type** window appears.
4. Select the necessary failure type, and then select **OK**.

Note: If you change the failure type to **Failures without replacement (as good as old)**, and then select the **PM optimization** tab, a red dot and line appears on the plot and a warning is displayed in the bottom section, indicating that PM Optimization calculations are not supported for failures without replacement and that the results are not valid.

The analysis is recalculated based on the selected failure type.

Modify the Analysis Period

Procedure

1. [Access a Reliability Distribution Analysis](#) for which you want to modify the Analysis Period.
2. In the left pane, select the **Probability Plot** tab.
The **Probability Plot** appears in the workspace.
Note: You can also modify the Analysis Period for a plot via the **Failure Rate Plot, PDF Plot, CDF Plot, and Failure Probability**.
3. In the upper-right corner of the workspace, select **Analysis Tasks**, and then select **Analysis Period**.
The **Set Analysis Period** window appears.
4. Clear the **I want to use the first failure dates as the start date for this analysis** check box, and then enter or select the desired date.

Note: To ensure that all failure dates appear on the plots, make sure that the start date is before the date associated with the first datapoint. Only failures that occur after the start date will appear on the plots.

5. Clear the **I want to use today's date as the end date for this analysis** check box, and then enter or select the desired date.
6. Select **OK**.

The GE Digital APM system saves the Analysis Period and recalculates the analysis using the selected dates.

Note: If you want to change the Analysis Period back to the default Analysis Period, select the **Start Date** and **End Date** check boxes.

Choose the Time Units for an Analysis

About This Task

The time units are used for expressing time values for calculations performed within an analysis. For example, a calculation may indicate the amount of time that lapsed between a failure event and the end date of the analysis period. This value would be expressed in the Time Units for the analysis.

Your Time Units selection will depend on what type of data you are using and what type of analysis you are performing. For example, in an analysis that shows the distribution of failures for a number of pieces

of equipment or locations over many years, years might be an appropriate unit of time. For an analysis designed to evaluate failures for a single piece of equipment or location within a very specific time period, a smaller unit of time would be appropriate. For this reason, you can choose the Time Units that are most appropriate for a given analysis.

Note: Downtime for TTF calculations should always be provided using days. When the failure data contains downtime, the system selects Days by default.

Procedure

1. [Access a Reliability Distribution Analysis](#) for which you want to modify the Time Units.
2. In the left pane, select the **Probability Plot** tab.

The **Probability Plot** appears in the workspace.

Note: You can also modify the analysis period for a plot via the **Failure Rate Plot, PDF Plot, CDF Plot,** and **Failure Probability.**

3. In the upper-right corner of the workspace, select **Analysis Tasks**, and then select **Time Unit**.

The **Select Time Units** window appears.

4. In the **Operating Time Unit** list, select one of the following options:

- **Hours**
- **Days**
- **Weeks**
- **Months**
- **Quarters**
- **Years**

5. In the **Downtime Unit** list, select one of the following options:

- **Hours**
- **Days**
- **Weeks**
- **Months**
- **Quarters**
- **Years**

6. Select **OK**.

The GE Digital APM system automatically recalculates the analysis based on the new time units and displays the new units on the plots.

Rename a Reliability Distribution Analysis

Procedure

1. [Access the Reliability Distribution Analysis](#) whose name you want to change.
2. In the left pane, select the **Probability Plot** tab.

The **Probability Plot** appears in the workspace.

Note: You can also modify the analysis period for a plot via the **Failure Rate Plot, PDF Plot, CDF Plot,** and **Failure Probability.**

3. In the upper-right corner of the workspace, select **Analysis Tasks**, and then select **Rename**.

The **Set Analysis Name** window appears.

4. In the **Analysis Name** box, enter a new name for the analysis.

5. In the **Analysis Description** box, enter a new description for the analysis, and then select **OK**.

The analysis name is updated in any appropriate sections on the **Reliability Distribution** page to reflect the change. In addition, the Description field in any appropriate sections will reflect any changes.

Access the Source Data for a Reliability Distribution Analysis

About This Task

You can access the source data only if the analysis is based on a query or a dataset.

Procedure

1. [Access a Reliability Distribution Analysis](#) for which you want to view the source data.
2. In the left pane, select the **Probability Plot** tab.

The **Probability Plot** appears in the workspace.

Note: You can also view data for a plot via the **Failure Rate Plot, PDF Plot, CDF Plot, or Failure Probability**.

3. In the upper-right corner of the workspace, select **Analysis Data**, and then select **Go To Source**.

The fields on the page that appears display the analysis data associated with the selected Reliability Distribution Analysis and correspond to [values that were used to create the analysis](#).

- For an analysis based on a query, the information returned by the query appears.
- For an analysis based on a dataset, the information stored in the dataset appears.
- For an analysis based on manually-entered data, you will receive the following error message:
There is no source data to view since the analysis is based on manually entered data.

To view data for an analysis based on manually-entered data, you can [access the Reliability Distribution window](#).

Modify the Data in a Reliability Distribution Analysis

Procedure

1. [Access a Reliability Distribution Analysis](#) for which you want to modify the data.
2. In the left pane, select the **Probability Plot** tab.

The **Probability Plot** appears in the workspace.

Note: You can also modify the data for a plot via the **Failure Rate Plot, PDF Plot, CDF Plot, PM optimization, and Failure Probability**.

3. In the upper-right corner of the workspace, select **Analysis Data**, and then select **Edit Data**.

The **Reliability Distribution Data Editor** window appears, displaying the data associated with the selected Reliability Distribution Analysis.

4. As needed, modify the data in **Failures** and **Assets** tab.
5. Select **OK**.

The analysis is updated.

Results

- For an analysis that is based on manually entered data, the changes that you make via the **Reliability Distribution Data** window will be saved for the analysis.

- For an analysis that is based on a query or a dataset:
 - The query or dataset will not be modified with the updated data. Additionally, any record returned by the query will not be updated with your changes. The changes will be saved to the analysis only.
 - After you modify the data and save the analysis, the modified data will appear each time you open the analysis. If you want to revert to the original data, you can reload the original data to the analysis. In addition, if a query or dataset has changed in the database, you can [reload the original data to the analysis](#) in order for your analysis to contain those changes.

Reload Analysis Data in a Reliability Distribution Analysis

About This Task

When you create and save an analysis that is based on a query or dataset, the GE Digital APM system takes a snapshot of the data that exists at the time of creation and saves it along with the analysis. When you open an existing analysis, the GE Digital APM system loads the data that was last saved with the analysis. This means that any changes to the underlying query or dataset will not be reflected automatically when you open an existing analysis.

Note: If the query or dataset has been deleted or renamed, when you try to open an associated analysis, an error message will appear, and the data will not be refreshed.

If you want to refresh an analysis based on changes to the underlying query or dataset or to load new data that has been added since the analysis was last saved (e.g., the analysis is based on a query that retrieves failures for a piece of equipment or location, and a new failure record has been added to the database), you will need to reload the analysis manually after opening it. When you reload the data, any manual changes made to the analysis data set will be deleted.

Note: Reloading analysis data resets the analysis period only if it is based on the analysis data. Start Dates and End Dates that have been set explicitly will not be overwritten.

Procedure

1. [Access a Reliability Distribution Analysis](#) for which you want to reload the data.
2. In the left pane, select **Probability Plot**.

The **Probability Plot** appears in the workspace.

Note: You can also reload the data for a plot via the **Failure Rate Plot**, **PDF Plot**, **CDF Plot**, **PM optimization**, and **Failure Probability**.

3. In the upper-right corner of the workspace, select **Analysis Data**, and then select **Reload Data**.

A confirmation message appears, asking you to confirm that you want to overwrite the current data with the data stored in the database.

Note: For an analysis based on manually-entered data, you will receive the following error message: There is no source data to reload since the analysis is based on manually entered data.

4. Select **Yes**.

The analysis is updated to reflect the data currently stored in the query or dataset.

Note: If you are reloading analysis data that is based on a query and an index out of range error message appears, there is an error in the query. You should modify the query or recreate the analysis to reload the correct data.

Censor Data in a Reliability Distribution Analysis

Procedure

1. [Access the Reliability Distribution Analysis](#) that contains the plot within which you want to censor a datapoint.
2. In the left pane, select the plot within which you want to censor a datapoint.
3. In the plot, select the desired datapoint.

The **Point Tooltip** window appears, displaying the following fields:

- Asset ID
 - Failure Date
 - Downtime
 - Is Valid
 - Number of Failures
 - Observed Time to Failure
4. Select **Censor**.

The selected datapoint is censored or ignored in the Reliability Distribution Analysis.

Perform a Preventive Maintenance Optimization

About This Task

A [PM Optimization](#) involves several steps. Based on the MTBF and the calculation of the ratios, the system estimates the optimum time interval to maintain equipment.

Note:

- PM Optimization is available only if **Failures With Replacements** was selected as the failure type via the **Reliability Distribution Builder** or **Failure Type** window.
- PM Optimization is not available when Beta is less than or equal to one ($\text{Beta} \leq 1$).

Procedure

1. [Access the Reliability Distribution Analysis](#) on which you want to perform a Preventive Maintenance optimization.
2. In the left pane, select the **PM optimization** tab.

The **PM optimization** plot appears in the workspace.

3. In the upper-right corner of the workspace, select **Maintenance Cost**.

The **Maintenance Cost** window appears.

Note: If a PM Optimization has been performed previously, the Preventive Maintenance Optimization dialog box displays the results of the previous calculation.

4. Enter values in the **Planned Cost** box and the **Unplanned Cost** box. You can manually enter the cost or you can select a query and use it to populate a cost box.

Note: The value in the **Unplanned Cost** box must be greater than the value in the **Planned Cost** box.

To select an existing query stored in the catalog that contains the data that you want to use to populate a cost field:

- a. Select **Query** next to the **Planned Cost** box or the **Unplanned Cost** box.

- The **Select a query from the catalog** window appears.
- b. Select the needed query, and then select **Open**.

Note: If you attempt to select a query that does not have any numeric fields, you will receive an error message.

The cost box is populated with the name of the query you selected.

Repeat steps 1 and 2 to select a query for the second cost field.

5. In the **Currency** box, enter the currency symbol for the cost.
6. Select **OK**.

The system validates the data, and the **PM optimization** workspace displays the **PM optimization** plot and following information:

- **Planned Cost:** The planned maintenance cost you entered on the **Preventative Maintenance Optimization** window.
- **Unplanned Cost:** The unplanned maintenance cost you entered on the **Preventative Maintenance Optimization** window.
- **Optimal Preventative Maintenance Interval:** The optimum interval during which you should perform maintenance on the piece of equipment you are analyzing.
- **Estimated Maintenance Cost:** The estimated maintenance cost per day for each piece of equipment during the optimal PM interval.
- **Optimal Value inflection point:** A value identified on the total cost curve.

About Preventive Maintenance Optimization

Preventative Maintenance (PM) Optimization uses the results of a Reliability Distribution Analysis to measure the optimum time to perform a Planned (Restorative) Maintenance (PM) procedure on a piece of equipment. PM optimization does not calculate minor maintenance schedules but determines the optimal time to perform major repairs or replace a piece of equipment until there is a minimal amount of cost and risk. PM optimization is only valid for wear-out failure modes and will not give accurate results for a Weibull analysis where Beta is less than 1.

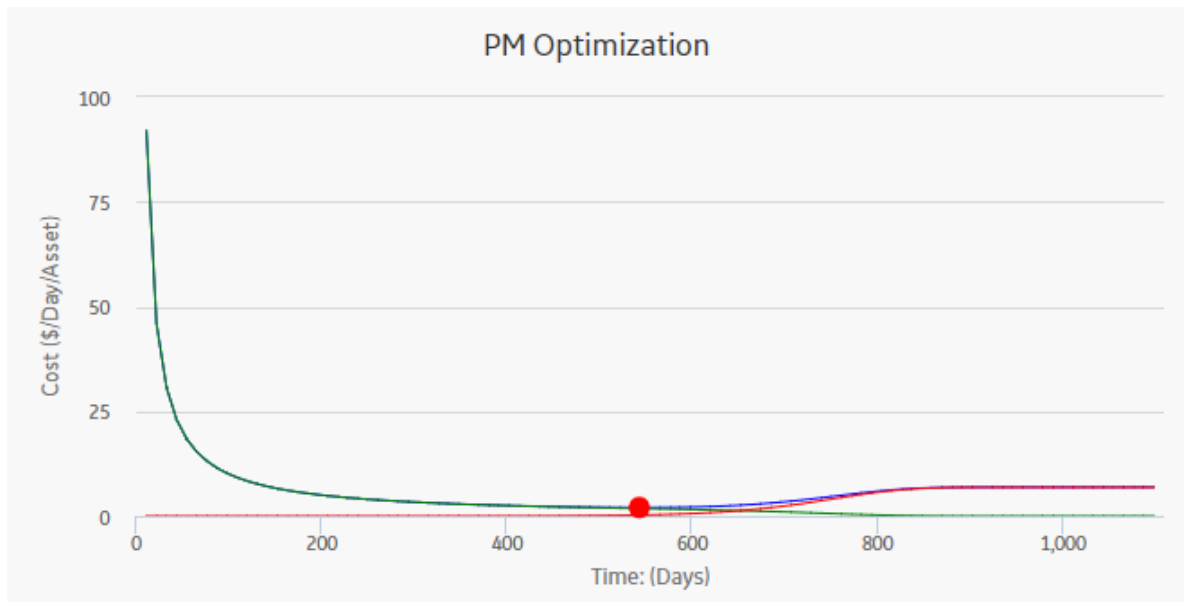

Note: Interaction with graphs is not available on [touch-screen devices](#).

Details

A PM optimization is composed of the following steps:

1. The calculation model is configured to acquire the necessary parameters, including Mean Time Between Failures (MTBF). MTBF is used to determine the probability that a piece of equipment will fail.
2. The cost ratio is determined. This ratio is the cost of planned Preventative Maintenance (PM) events versus the cost of unplanned maintenance events. You can manually enter the cost or select an existing query as the source of the cost data.
3. Based on the MTBF and the calculation of the ratios, the GE Digital APM system estimates the optimum time (interval) to maintain equipment. The cost per piece of equipment based on the Optimized Preventative Maintenance Interval is also displayed.
4. The GE Digital APM system creates optimization graphs, which gives the analyst the optimum time to conduct a repair or overhaul based upon the ratio of planned to unplanned repair costs. This ensures that repairs are conducted in a cost-effective manner, minimizing risk while maximizing time in service.

The limitation to using a PM optimization is it will always give a result for the statistical distribution on which it is based. This does not mean that it will always make sense to do a PM at the interval specified. In particular, design flaws that manifest themselves as poor reliability can more effectively be addressed through redesign rather than PM.

Access Reliability Distribution Analysis Report

Procedure

1. [Access the Reliability Distribution Analysis](#) whose report you want to access.
2. In the upper-right corner of any workspace within the selected Probability Distribution Analysis, select **Report**.

The Reliability Distribution Analysis report appears in a new browser tab. By default, the report contains the following [sections](#):

- **Plots**
- **Analysis Summary**
- **Statistical Distribution Information**
- **Assets**
- **Failure Data**

About Reliability Distribution Analysis Report

The baseline GE Digital APM database includes the Reliability Distribution Analysis report, which you can use to view a summary of the results of a Reliability Distribution Analysis.

The Reliability Distribution Analysis report is built from the following Catalog items:

- The main report, DistributionAnalysisReport, which is stored in the Catalog folder \\Public\Meridium\Modules\Reliability Manager\SSRS.
- The subreport, SubreportDistributionAnalysis, which is stored in the Catalog folder \\Public\Meridium\Modules\Reliability Manager\Reports.
- The subreport, assetSubreportDistribution, which is stored in the Catalog folder \\Public\Meridium\Modules\Reliability Manager\Reports.
- The supporting queries that supply data in the main report and subreports, which are stored in the Catalog folder \\Public\Meridium\Modules\Reliability Manager\Reports. The following supporting queries are available:
 - ReliabilityDistributionQuery

- ReliabilityDistributionTTR
- ReliabilityExponentialTTF
- ReliabilityExponentialTTR
- ReliabilityLognormalTTF
- ReliabilityLognormalTTR
- ReliabilityNormalTTF
- ReliabilityNormalTTR
- ReliabilityWeibullTTF
- ReliabilityWeibullTTR

Throughout this documentation, we refer to the main report, the subreports, and the supporting queries collectively as the Reliability Distribution Analysis report.

Analysis Summary Section

The **Analysis Summary** section of the Reliability Distribution report displays information that is stored in the Reliability Distribution record and Distribution records that are linked to the Reliability Distribution record.

The following table lists each item in the **Analysis Summary** section and the corresponding Reliability Distribution or Distribution record field whose data is displayed in the report.

Report Item	Record	Record Field
Analysis Name	Reliability Distribution	Analysis ID
Analysis Description	Reliability Distribution	Short Description
Analysis Start	Reliability Distribution	Analysis Start Date
Analysis End	Reliability Distribution	Analysis End Date
Number of Assets	Reliability Distribution	Assets
Number of Failures	Reliability Distribution	Number of Failures
Censored Failures	Reliability Distribution	Censored Failures
MTBF	Reliability Distribution	MTBF
MTRR	Reliability Distribution	MTRR
Use Confidence	Reliability Distribution	Use Confidence
Confidence Level	Distribution	Confidence Level
Last Modified	Reliability Distribution	LAST UPDT DT
Modified By	Reliability Distribution	LAST UPBY SEUS KEY Note: The name of the Security User associated with this value is displayed in the report.

Statistical Distribution Information Section

The **Statistical Distribution Information** section of the Reliability Distribution report displays information that is stored in each Distribution record that is linked to the Reliability Distribution record. Each Distribution record is a member of one of four Distribution subfamilies in which records can exist: Exponential, Lognormal, Normal, or Weibull.

The following subsections are displayed for each Distribution record that is linked to the Reliability Distribution:

In the **<Variable> Distribution** subsection, **<Variable>** is the value that is stored in the Variable field in the Distribution record that is linked to the Reliability Distribution record. Throughout the documentation, we will refer to this subsection as the **Distribution** subsection.

The following table lists each item in the **Distribution** subsection and the corresponding Distribution record field whose data is displayed in the report.

Report Item	Distribution Field
Distribution Type	Distribution Type
Operating Time Units	Units
Fit Method	Fit Method
R2	R-Squared
Mean	Mean
Standard Deviation	Standard Deviation
Median	Median

The **Parameters** subsection contains information stored in a Distribution record (i.e., Weibull, Lognormal, Exponential, or Normal record). The Weibull, Lognormal, Exponential, or Normal record is linked to the Reliability Distribution record. The items that appear in the **Parameters** subsection will be different, depending on the type of Distribution record.

The following table lists each item in the **Parameters** subsection for a Weibull record whose data is displayed in the report. For a Weibull record, one row is displayed for each of the following field captions: Beta, Eta, and Gamma.

Report Item	Weibull Field
Beta	
Value	Beta
Low	Beta Low
High	Beta High
Calculated	Beta Fixed
Eta	
Value	Eta
Low	Eta Low
High	Eta High
Calculated	Eta Fixed
Gamma	
Value	Gamma

Report Item	Weibull Field
Low	Gamma Low
High	Gamma High
Calculated	Gamma Fixed

The following table lists each item in the **Parameters** subsection for a Lognormal record whose data is displayed in the report. For a Lognormal record, one row is displayed for each of the following field captions: Mu, Sigma, and Gamma.

Report Item	Lognormal Field
Mu	
Value	Mu
Low	Mu Low
High	Mu High
Calculated	Mu Fixed
Sigma	
Value	Sigma
Low	Sigma Low
High	Sigma High
Calculated	Sigma Fixed
Gamma	
Value	Gamma
Low	Gamma Low
High	Gamma High
Calculated	Gamma Fixed

The following table lists each item in the **Parameters** subsection for an Exponential record whose data is displayed in the report. For an Exponential record, one row is displayed for the field caption MTBF.

Report Item	Exponential Field
MTBF	
Value	MTBF
Low	MTBF Low
High	MTBF High
Calculated	MTBF Fixed

The following table lists each item in the **Parameters** subsection for a Normal record whose data is displayed in the report. For a Normal record, one row is displayed for each of the following field captions: Mean, Standard Deviation.

Report Item	Normal Field
Mean	
Value	Mean
Low	Mean Low
High	Mean High
Calculated	Mean Fixed
Standard Deviation	
Value	Standard Deviation
Low	Standard Deviation Low
High	Standard Deviation High
Calculated	Standard Deviation Fixed

The **Goodness of Fit Test** subsection displays information from the corresponding Distribution record.

The Kolmogorov-Smirnov test is the only test used to measure goodness of fit, so the **Name** column in the report is populated automatically with the value Kolmogorov-Smirnov test. The following table lists each remaining item in the **Goodness of Fit Test** subsection and the corresponding Distribution record field whose data is displayed in the report.

Report Item	Distribution Field
Statistic	GOF Statistic
P-Value	GOF P-Value
Passed	Passed

Assets Section

The **Assets** section of the Reliability Distribution report displays information that is stored in the Failure Data field in the [Reliability Distribution record](#).

The following values are displayed in the **Assets** section:

- Asset ID
- Installation Date
- Last Replacement
- Present Age
- Future Age
- Present Failure Probability
- Future Failure Probability

Functional Failures Section

The **Functional Failures** section of the Reliability Distribution report displays information that is stored in the Failure Data field in the [Reliability Distribution record](#).

The following values are displayed in the **Failure Data** section:

- Asset ID

- Failure Date
- TTF
- Downtime
- Ignore
- Censored
- Remarks

Analysis Plots Section

The **Analysis Plots** section of the Reliability Distribution report displays the graphs that are displayed in the **Time to Failure Distribution** section or accessed via the left pane in the **Analysis Summary** workspace for the selected analysis.

The Plots section displays the following graphs:

- [Probability Plot](#)
- [Failure Rate Plot](#)
- [Probability Density Function Plot](#)
- [Cumulative Distribution Function Plot](#)
- [Preventative Maintenance Optimization Plot](#)

Failure Probability

About Failure Probability

The GE Digital APM system can perform calculations on the data used in a Reliability Distribution Analysis to estimate how likely it is that a piece of equipment will fail today. Then, using future values that you supply, the GE Digital APM system can calculate how likely it is that a piece of equipment will fail at some point in the future.

- The current failure probability is based on the current age of the piece of equipment, which is the amount of time that has passed between the last replacement date (i.e., the last failure date) and the End Date of the [Analysis Period](#).
- Two options are available for calculating future [failure probability calculations](#):
 - You can [specify an operating time](#) to define a future age for the piece of equipment, and then the GE Digital APM system will determine how likely it is that a piece of equipment will fail when it has reached that age.
 - You can [specify a failure probability](#), and the GE Digital APM system will determine the age at which the piece of equipment will reach that likelihood of failing.

The grid in the **Failure Probability** workspace contains the following columns of information:

- **Asset ID:** Contains the Asset ID for each piece of equipment included in the analysis.
- **Installation Date:** Contains the initial date that the piece of equipment was installed.
- **Last Replacement:** Contains the date the piece of equipment last failed and, as a result, was replaced.
- **Present Age:** Contains the current age of the piece of equipment. The value in the **Present Age** column represents the amount of time between the date in the **Last Replacement** column and the end date of the [Analysis Period](#), expressed in the [Time Units](#) selected for the analysis.
- **Future Age:** The age that is used for determining the value in the **Future Failure Probability** column. The value in the **Future Age** column is determined by adding the [Operating Time you specified](#) to the Present Age of the piece of equipment.

- **Present Failure Probability:** The current probability of failure for each piece of equipment based on the present age of the piece of equipment.
- **Future Failure Probability:** The probability that the piece of equipment will fail between the present time and the value in the **Future Age** column. The Future Failure Probability is based on the assumption that at the Present Age the piece of equipment has not failed.

Note: Since pieces of equipment contain multiple sub-elements, probability of failure calculations will be affected when the failure type is Failures Without Replacements.

Calculate the Probability of Failure at a Specified Age

Procedure

1. [Access the Reliability Distribution Analysis](#) for which you want to specify the future age to calculate the future probability of failure.
2. In the left pane, select the **Failure Probability** tab.
The [Failure Probability](#) information appears in a grid.
3. In the upper-right corner of the grid, select the **Distribution Options** list, and then select **Future Age**.
The **Set Future Age** window appears. The **Future Age** box displays the value that was last used to perform the calculation.
4. As needed, enter value in the **Future Age** box, and then select **OK**.
The system recalculates the future probability of failure values and displays them for each piece of equipment in the grid.

Calculate the Age When a Certain Probability of Failure will be Reached

Procedure

1. [Access the Reliability Distribution Analysis](#) for which you want to specify the probability of failure.
2. In the left pane, select the **Failure Probability** tab.
The [Failure Probability](#) information appears in a grid.
3. In the upper-right corner of the grid, select the **Distribution Options** list, and then select **Future Probability**.
The **Set Future Probability** window appears.
4. As needed, enter value in the **Future Probability** box, and then select **OK**.
The system recalculates the future probability of failure values and displays them for each piece of equipment in the grid.

Chapter 6

Reliability Growth

Topics:

- [Reliability Growth: Overview](#)
- [Reliability Growth: Workflow](#)
- [Reliability Growth Analyses](#)
- [Measurement Data](#)

Reliability Growth: Overview

Overview of Reliability Growth Analysis

Reliability Analytics

The Reliability Analytics module provides a collection of tools that apply reliability engineering principles to help you make tactical (short-term) and strategic (long-term) decisions for maintenance and operational equipment management activities. It also provides:

- A means for analyzing historical failure data to identify trends and predict future failures.
- A mechanism for simulating what if scenarios regarding the reliability of a system to determine if a new or modified strategy will be effective.

The Reliability Analytics module provides the following types of tools:

- Production Analysis
- System Reliability Analysis
- Spares Analysis
- Reliability Distribution Analysis
- Probability Distribution Analysis
- Reliability Growth Analysis
- Automation Rules

Each tool provides a unique set of features that allow you to analyze data to develop strategies to improve reliability.

Reliability Growth Analysis

Reliability Growth Analysis is a tool that indicates whether your data measurements are random or follow a trend. After analyzing the analysis, you will be able to make strategic decisions to determine if a new or modified strategy will be effective in improving your reliability.

Reliability Growth Analysis Workflow

This workflow provides the basic, high-level steps for developing Reliability Growth Analysis. The steps and links in this workflow do not necessarily reference every possible procedure.

1. **Collect data** for the elements that you want to analyze.
2. Create a new Reliability Growth Analysis from an existing query, dataset, or [manually entered data](#). For an analysis from an existing query or dataset, you can create the analysis using [Failure Dates](#) or [Cumulative Operating Time](#).
3. **Evaluate the results** in the following ways using the features of the **Reliability Growth Analysis** tool.
 - Determine whether the data follows a trend using the [Goodness of Fit test](#).
 - Predict how the data will look in the future by [using the extrapolation tool](#).
 - Determine at what point in time trends in the data changed in the data by [using the segment tool](#).

Reliability Growth: Workflow

Reliability Analytics: Reliability Growth Analysis Workflow

This workflow describes the process for analyzing changes to a measured value over time.

In the following workflow diagram, the blue text in a shape indicates that the corresponding description has been provided in the sections that follow the diagram. For more information, refer to the [Interpreting the Workflow Diagrams](#) topic in the [APM Product Workflows](#) documentation.

Note: For information on the personas associated with a GE Digital APM module, refer to the [APM Product Workflows](#) documentation.

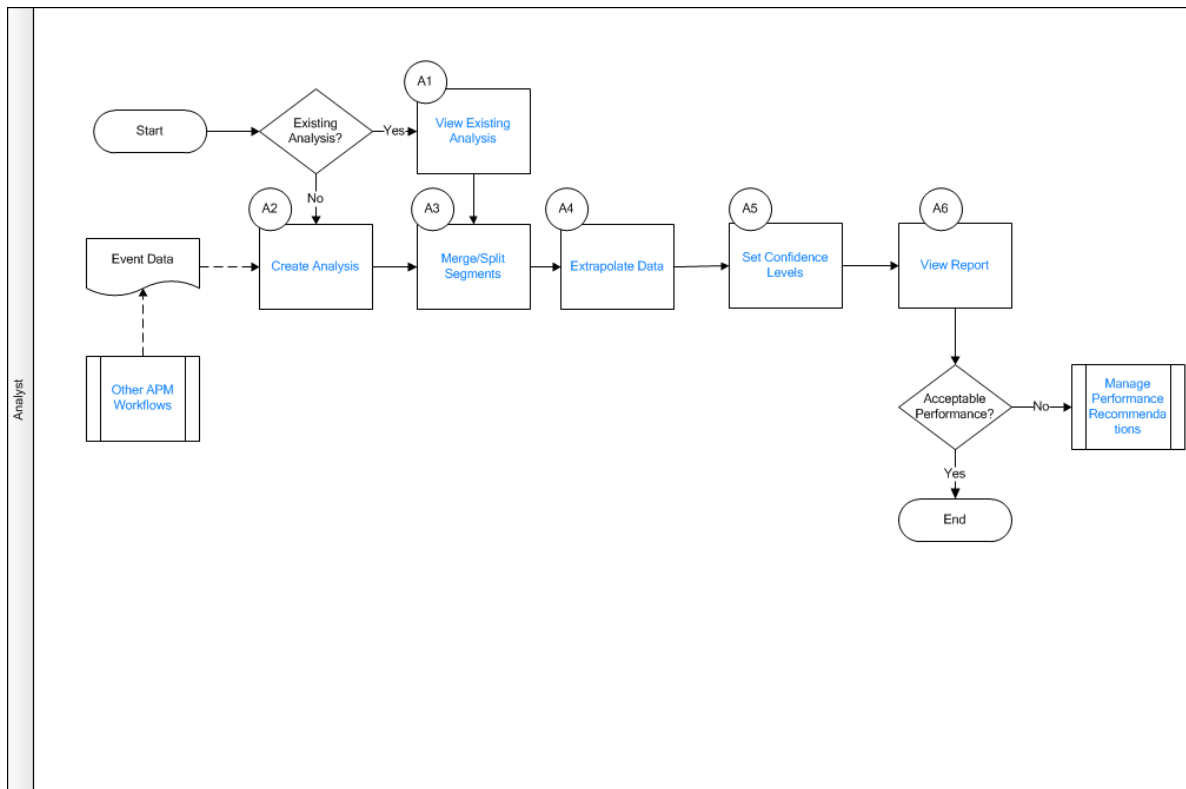

1. [View Existing Analysis](#) on page 104
2. [Create Analysis](#) on page 105
3. [Merge/Split Segments](#) on page 105
4. [Extrapolate Data](#) on page 105
5. [Set Confidence Level](#) on page 105
6. [View Report](#) on page 105
7. [Other Workflows](#) on page 105
8. [Manage Performance Recommendations](#) on page 105

View Existing Analysis

Persona: Analyst

View the details of an existing analysis.

Create Analysis

Persona: Analyst

Create an analysis based on production data or event data.

Merge/Split Segments

Persona: Analyst

Merge or split growth analyses into segments based on calculated parameters.

Extrapolate Data

Persona: Analyst

Extrapolate segments to a future date that will be charted for each segment.

Set Confidence Level

Persona: Analyst

Establish and set the confidence levels applicable to the analysis results.

View Report

Persona: Analyst

View and save the analysis report.

Manage Performance Recommendations

Persona: Analyst

Create any number of performance recommendations and Approve them using state management.

Note: Performance recommendations are not required.

Go to the Manage Performance Recommendations workflow.

Other Workflows

Persona: Analyst

Other workflows provide production data from SAP, EAM, and Recommendations.

Reliability Growth Analyses

About Reliability Growth Analysis

A Reliability Growth Analysis can help you make strategic decisions by indicating whether your data measurements are random or if they follow a trend. The graphs produced by a Reliability Growth Analysis

will show any time-dependent trends, allowing you to make decisions based on past behavior and predict how your data will behave in the future.

Details

When you access the results of a Reliability Growth Analysis, if you see the data is trending in one direction until a certain point in time and then begins trending in another direction, you can examine what changed at the point in time when the trend shifted to determine the impact of those changes. In addition, if you make a strategy change and then examine whether the data worsens or begins to improve at that point, you can determine the impact of the strategy change. For example, a distinct change in a Mean Time Between Failures (MTBF) plot can identify the point at which improved maintenance strategies were put into place for a piece of equipment.

Similarly, when you observe data that is trending at the same rate over time without distinct changes, you can use those trends to predict the data's future behavior. For example, if you are tracking the cost associated with running a piece of equipment over a certain period of time, and the cost is consistently higher during winter months, you can predict how much more it will cost to run the piece of equipment in December than it will in July.

Trend charts generated by Reliability Growth Analysis can also show outlying events that may have had significant effects on the overall trend of strategy effectiveness. For example, a thunderstorm that results in a two-day power outage at a plant should not reflect poorly on a piece of equipment's reliability. Reliability Growth Analysis allows you to ignore these types of events.

You can perform a Reliability Growth Analysis and examine trend charts for one piece of equipment or location or a group of similar pieces of equipment or locations. For example, you may want to examine trends for one pump that is constantly breaking down, or you may want to examine trends for a set of pumps to detect any improvement after you installed a new maintenance strategy.

Access a Reliability Growth Analysis

Procedure

1. Access the [RA Overview](#) page.
2. Select the **Reliability Growth** tab.

A list of Reliability Growth Analyses available in the database appears.

3. In the **Analysis ID** column, select the hyperlink for the analysis that you want to view.

The **Reliability Growth** page appears, displaying the **Analysis Summary** workspace.

The **Analysis Summary** workspace contains the [Cumulative <Measurement>](#) plot and the [MTB<Measurement>](#) plot. These plots are read-only plots. To edit a plot, you must select the corresponding tab from the left pane. The information displayed on this tab will look different depending on the type of data that you use for your analysis.

The bottom section of the workspace contains the **Information** and **Segments** tabs.

The **Information** tab displays the following information:

- **Analysis Period:** Contains the start and end dates of the analysis. If the analysis is based on [cumulative operating time](#), it will be the start and end times of the analysis (e.g., 11,000 miles - 303,000 miles).
- **Total Operating Time:** Contains the total amount of cumulative time that the Assets are in operation during the specified analysis period. For example, if you run one piece of equipment for 10 days, the total operating time is 10 days. If multiple Assets are included in the analysis, their operating time will be added together. Therefore, two Assets running for 10 days would have a total operating time of 20 days.

- **Number of Assets:** Contains the number of Assets included in the analysis.
- **Total <Measurement> :** Contains the total number of measurements (e.g., failures, cost) for all Assets in the analysis. The caption of this item will change depending on the [measurement name](#).
- **Initial Mean Time Between <Measurement> :** Contains the Mean Time Between <Measurement> at the beginning of the analysis. This item is displayed only for analyses using event-based data.
- **Final Mean Time Between <Measurement> :** Contains the Mean Time Between <Measurement> at the end of the analysis. This item is displayed only for analyses using event-based data.
- **Last Event Date:** Contains the last <Measurement> date in the analysis. This item appears only for an analysis using event-based data.
- **Next Estimated Event Date:** The next estimated <Measurement> date, calculated by the GE Digital APM system. This item only appears for an analysis using event-based data.

The **Segments** tab displays the following columns:

- **Segment:** Contains a hyperlink, which you can select to view the [details of the AMSAA model](#).
- **Start Date:** Contains the start date for the segment. For the first segment, this is the same as the analysis start date. For subsequent segments, this is the end date of the previous segment.
- **End Date:** Contains the end date for the segment. For the last segment, this date is the same as the analysis end date. For multi-segment analyses, the end date of one segment is always the start date of the next segment.

Note: For a Reliability Growth Analysis based on cumulative operating time, the **Start Date** and **End Date** columns will be **Start Time <units>** and **End Time <units>**.

- **Termination Type:** Contains a value that indicates whether the end date is event-based, time-based or grouped data. If you select the **Time-Based** option on the **Set Analysis Period** window, the value in the **Termination Type** column will be Time-Based. Likewise, if you select the **Event-Based** option on the **Set Analysis Period** window, the value in the **Termination Type** column will be Event-Based. If the analysis contains grouped data, the value in the **Termination Type** column will be Grouped-Data.

Note: If the **Cumulative <Measurement>** plot contains more than one segment, the Termination Type may vary between segments. If the analysis is Event-Based, all segments will be event-based. If the analysis is Time-Based, however, the last segment will be Time-Based, but the Termination Type for all other segments will be Event-Based.

- **Beta:** Contains a value representing the slope of the line in the [Cumulative <Measurement> Plot](#). The [Beta value](#) helps serve as an indicator of whether the Mean Time Between <Measurement> is increasing, decreasing, or staying the same.
- **Lambda:** Contains a scale parameter that equals the Y-intercept of the [Cumulative <Measurement> Plot](#) at time $t=1$. This value is used to calculate the time to next measurement (e.g., failure, cost).
- **GOF Statistic:** Contains a value calculated by a Cramer-von Mises or Chi-squared test that [indicates the preciseness of the fit](#).
- **Critical Value:** Contains a standard value used to determine whether the analysis [passes the goodness of fit \(GOF\) test](#).
- **Passed GOF:** Contains a value that indicates [whether the segment passes the GOF test](#).
 - The analysis passes the GOF test (i.e., the **Passed GOF** check box is selected) when the GOF Statistic is lower than the Critical Value.
 - The analysis fails the GOF test (i.e., the **Passed GOF** check box is cleared) when the GOF Statistic is higher than the Critical Value.

The left pane in the workspace contains the following tabs:

- **Cumulative <Measurement> Plot:** Contains the [Cumulative <Measurement> plot](#) for the selected analysis.

- **Mean Time Between <Measurement> Plot:** Contains the [Mean Time Between <Measurement> plot](#) for the selected analysis.
- **<Measurement> Rate Plot :** Contains the [<Measurement> Rate plot](#) for the selected analysis.

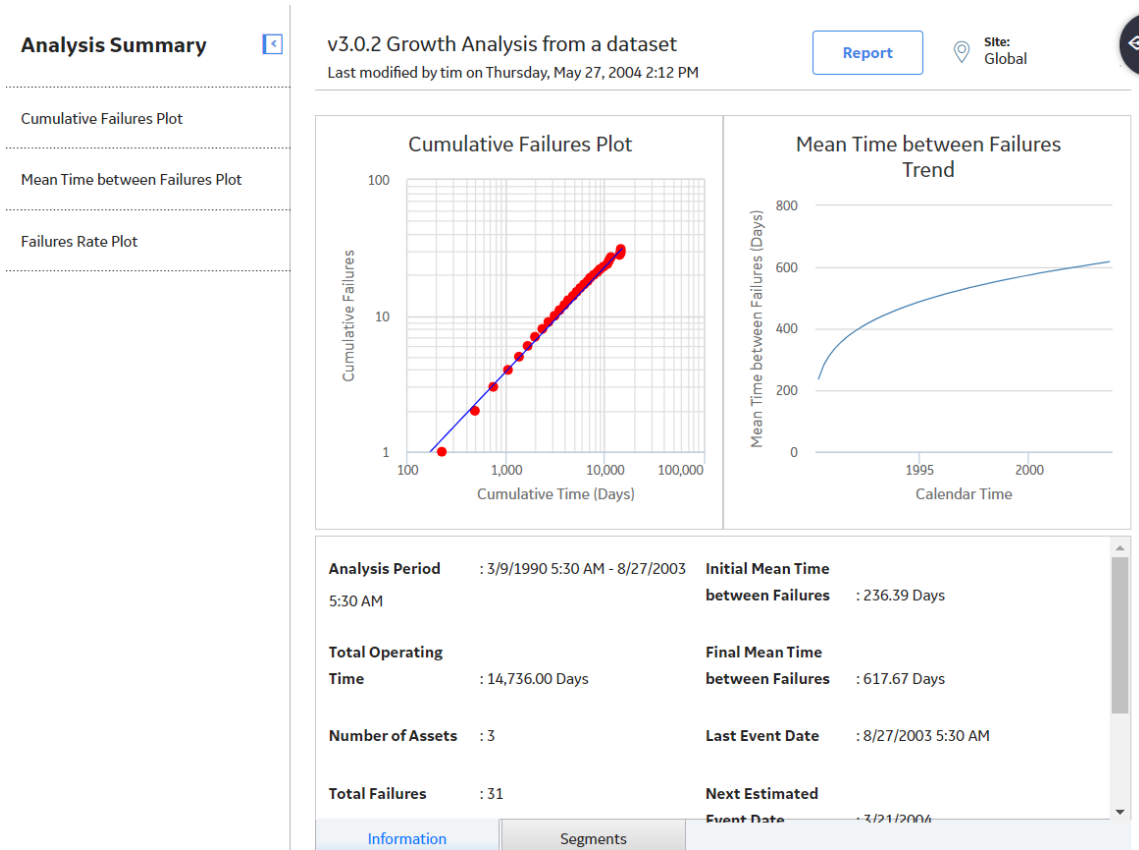

Types of Reliability Growth Analysis

Before you can perform a Reliability Growth Analysis, you must collect data, or numeric values representing some variable's performance, over some period of time. All data that you collect will be:

- Based on events (e.g., a failure).
- or-
- Not based on an event, i.e. based on the consequence of an event (e.g., repair cost).

Both data that is event-based and not event-based will also be:

- Grouped (i.e., datapoints represent multiple measurements or an amount).
- or-
- Non-grouped (i.e., datapoints represent a single measurement).

By default, the GE Digital APM system assumes that your data is not grouped. You can specify that your analysis includes grouped data by including the amount of data per datapoint on the **Select Data Fields** screen. Data that is not event-based typically measures an amount (e.g., repair cost) and is grouped data.

Event-based data can be derived from:

- Failure Dates: Specific dates on which failures occurred. (e.g., 1/3/2012)
- Cumulative Operating Time: An amount of time that has passed since the piece of equipment was put into service (e.g., 10 days).

Data that is not event-based is usually derived from cumulative operating time.

About Evaluating Results of a Reliability Growth Analysis

Reliability Growth Analysis results are made up of multiple parts that together demonstrate an overall picture of your data. You can view the results in graphical form, use calculated values to interpret the results, and perform additional tasks to help you determine the trends in your data and whether they are getting better or worse.

Viewing the Data Trends

The following list gives a brief description of the graphs that display the data:

- **Cumulative <Measurement> plot:** Displays the number of measurements recorded for the Asset as a function of time. Since the log (cumulative measurement) versus the log (cumulative time) is linear, the plot line is a straight line. You can use this plot to see how your data is trending over time.
- **Mean Time Between <Measurement> Trend plot:** Reflects how frequently measurements are being recorded for pieces of equipment or locations (e.g., failures, cost) as a function of time (cumulative operating time). If the trend in this plot is:
 - Increasing, measurements are being recorded less often (e.g., if a measurement is taken every time the Asset fails, the Asset is failing less often). This indicates that the Asset is becoming more reliable.
 - Decreasing, measurements are being recorded more frequently (e.g., if a measurement is taken every time the Asset fails, the piece of Asset is failing more often). This indicates that the Asset is becoming less reliable.
- **<Measurement> Rate Trend plot:** Reflects the rate of your measurements (e.g., failures, cost). This plot can tell you a measurement per time unit, so that you can see per day or per month when measurements increase or decrease.

Interpreting the Data Trends

The following list gives a brief description of the values calculated by the GE Digital APM system that you can use to interpret trends within your data:

- **Goodness of Fit:** Helps you determine if the measurements are following a pattern or occurring at random.
- **Confidence:** Indicates the percentage of uncertainty of the Goodness of Fit method. The [confidence level you select for your data](#) helps determine whether or not the data will pass the Goodness of Fit test.
- **The Beta Value:** Helps you [interpret the MTB<Measurement> Trend plot](#). This value is displayed on the [Reliability Growth page](#).
- **Next Estimated Event Date:** Provides an estimate of the amount of time you can expect to pass before the next event will occur for the piece of equipment or location. The value is calculated using the last datapoint and the MTBF or measurement rate. The approximate date (or time) when the next event will occur is displayed on the [Reliability Growth page](#).
- **Initial and Final MTBF or Initial or Final <Measurement> Rate:** Helps you compare how the piece of equipment or location is behaving at the beginning of the analysis versus the end of the analysis. Using these values, you can determine if the piece of equipment's or location's measurement rate has improved or deteriorated over the analysis period. These values are displayed on the [Reliability Growth page](#).

Additionally, you can view the [AMSAA Reliability Growth Model](#) page for an overview of the formulas used by the GE Digital APM system to calculate the model results.

Using Tools to Enhance Results

The following tools can further assist you in interpreting and applying analysis results:

- **Splitting an analysis:** Allows you to [divide an analysis](#) into multiple parts so that you can see multiple trends in the data (e.g., data before and after a strategy change).
- **Extrapolation:** Allows you to [estimate the number of measurements](#) (e.g., failures, amount of cost) that will have occurred by some point in the future.

Based on the analysis results, you can generate recommendations for the maintenance and reliability activities that should be executed in the future to maintain best practices in your organization.

About the Beta Value and MTBE

The [Reliability Growth](#) page displays the Beta and Lambda values as calculated by the application based on your data. The Beta value indicates whether MTBE is increasing, decreasing, or remaining constant.

Details

The following table lists the relationship between Beta value and MTBF and how they affect the reliability of an equipment:

Beta Value	MTBF	Equipment Reliability
$\beta = 1$	Unchanging MTBE (predictable failures)	If the Beta value is equal to or close to one (1), then the reliability is constant, and time is not a major factor.
$\beta < 1$	Increasing MTBE (improving reliability)	If the value of Beta is less than one, the reliability of the equipment is improving over time.
$\beta > 1$	Decreasing MTBE (deteriorating reliability)	If the value of Beta is greater than one (1), then the reliability of the equipment is deteriorating over time.

If the Beta value indicates that the MTBE is increasing or decreasing, you can try splitting the failure data up by time, failure mode, operating time, or some other appropriate value to create a set of data where the Beta value is closer to one. If you choose to split the data into time periods, you might try to [split a single analysis into multiple segments](#).

Collect Data for a Reliability Growth Analysis

The following table lists the data that you must collect to build a Reliability Growth Analysis.

Data Needed	Description	Notes
Asset ID	An ID that uniquely describes a piece of equipment or location, such as Asset ID or Tag ID. Reliability Growth Analyses can be conducted on any number of Assets.	This field is required and must be a character field. If the value in this field is blank, a blank Asset ID will be assigned to the data.
Cumulative Operating Time	The total amount of time that has passed since the piece of equipment or location was placed into service.	This field is required for an analysis based on cumulative operating time.

Data Needed	Description	Notes
Downtime	The amount of time the piece of equipment or location is not in operation. You can use the date a piece of equipment or location is repaired or the day it returns to service to help estimate downtime. If this information is available, it can be used to make the analysis more accurate.	This field is optional for an analysis based on failure dates. Downtime is not used by analyses based on cumulative operating time.
Downtime Units	The downtime units.	This field is used only by analyses based on failure dates that are using downtime. This field must be in calendar time. By default, the time in this field is measured in days.
Failure Date	The date on which the piece of equipment or location failed. This data can have many different descriptions such as Out of Service Date, Shutdown Date, or Failure Date.	This field is required for an analysis based on failure dates and optional for an analysis based on cumulative operating time. For an analysis based on cumulative operating time: <ul style="list-style-type: none"> All failures must have a failure date, or no dates will appear in the analysis. Failure dates should be in the same order as cumulative operating time.
Installation Date	The date on which the piece of equipment or location was installed.	This field is optional. Note: Providing Installation Date will improve the accuracy of the analysis.
Operating Time Units	The operating time units.	For an analysis based on failure dates, this field must be in calendar time. For an analysis based on cumulative operating time, you can use custom time units, such as miles. By default, the time in this field is measured in days.
Measurement Name	The type of the measurements you are collecting (e.g., failures, safety events, or cost). Throughout the documentation, we use the term measurement to represent the pieces of data that are being collected.	This value is required for all analyses.
Number of Failures	The number of failures or amount of data that is recorded at each measurement.	This field is optional. If no data is provided for this field, the GE Digital APM system will assume there is one failure for each datapoint. If you are using grouped data, this field is required.

Access Multiple Reliability Growth Analyses

About This Task

You can access multiple Reliability Growth Analyses and compare multiple plots for the selected analyses. You cannot modify the details of the analyses from which the **Comparison Plot** is generated.

Procedure

1. Access the [RA Overview](#) page.
2. Select the **Reliability Growth** tab.

A list of Reliability Growth Analyses available in the database appears.

3. Next to the **Analysis ID**, select two or more Reliability Growth Analyses whose plots you want to compare.

Note: You can select up to 20 analyses to compare plots.

4. In the upper-right corner of the grid, select .

The **Multiple Reliability Growth Analysis** page appears, displaying the **Comparison Plot**. By default, [Cumulative <Measurement> plot](#) for the selected analyses appears. You can also view the following types of plots:

- [MTB<Measurement> Trend plot](#)
- [<Measurement> Rate Trend plot](#)

Multiple Reliability Growth Analyses

2 plots are being viewed now

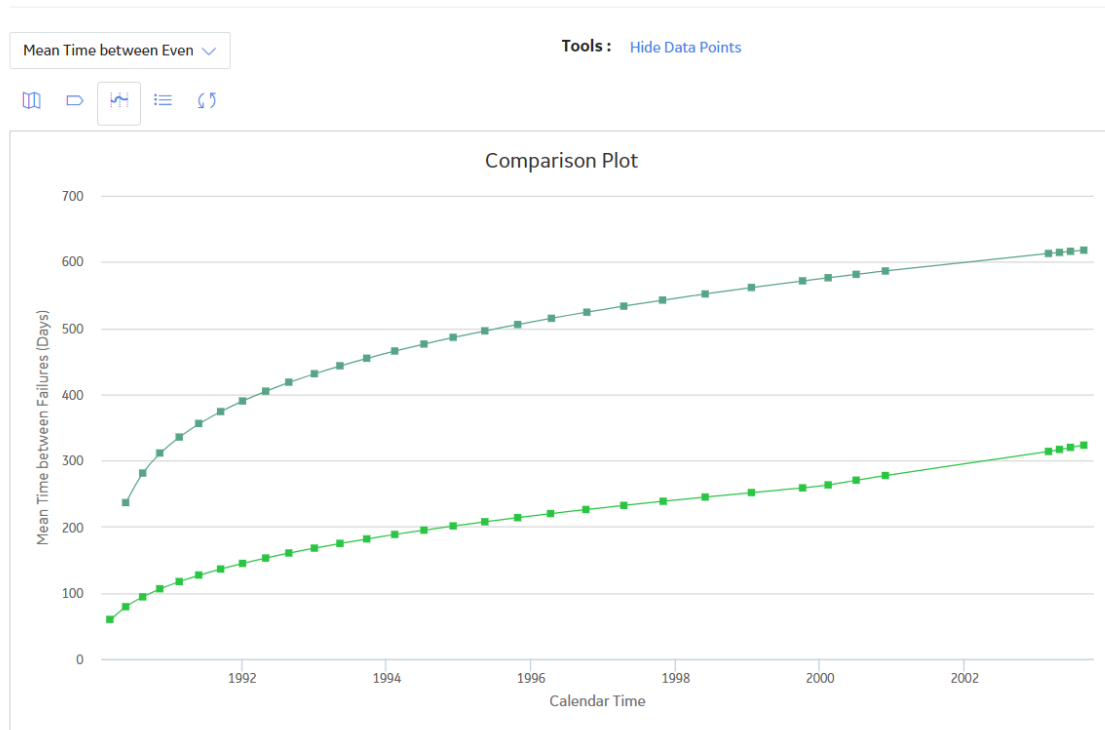

Create a Reliability Growth Analysis From Failure Dates Using an Existing Query or Dataset

About This Task

If you record event-based data, such as failure dates (e.g., a failure was recorded on 5/5/12), you can create a Reliability Growth Analysis using event-based data and data containing dates.

Note: A minimum of three failure datapoints are necessary to perform a calculation.

Procedure

1. [Access the RA Overview page](#).
2. In the upper-right corner of the page, select **New Analysis**, and then select **Reliability Growth**.
The **Reliability Growth Builder** window appears.
Note: All required information is provided, but for additional information, consult the [Reliability Growth](#) and [Measurement Data](#) topics.
3. Enter values in the **Analysis Name** and **Description** boxes for the new analysis, and then select **Next**.
The **Select Data Source Type** screen appears. The **Data will be based on an existing Query** is selected by default.
4. If you want to load data using an existing query, select **Data will be based on an existing Query**, and then select **Next**.
The **Select Query** screen appears.
-or-
If you want to load data using an existing dataset, select **Data will be based on an existing Dataset**, and then select **Next**.
The **Select Dataset** screen appears.
5. Select **Browse** to search for an existing query or dataset in the GE Digital APM Catalog.
The **Query Browser** or **Dataset Browser** screen appears, depending on whether you selected **Data will be based on an existing Query** or **Data will be based on an existing Dataset** in the previous step.
6. Select the needed query or dataset from the Catalog, and then select **Open**.
The complete path to the query or dataset is displayed in the **Query** or **Dataset** box. The fields that exist for the selected query or dataset appear in the **Available Fields** list.
7. In the **Includes Data From the Following Sites** list, select the site(s) whose data from which you want to create an analysis.
If you are creating an analysis in a database that has [only one site stored in the Site Reference family](#), then the **Includes Data From the Following Sites** list will not appear on the **Select Query** screen.
8. Select **Next**.
The **Select Data Format** screen appears.
9. On the **Select Data Format** screen, specify the following:
 - In the **Time Data Format** section, select **Data contains dates**. This option indicates the datasource with data that contains specific event dates (e.g., 5/5/2012).
 - In the **Measurement Data Format** section:

If you want to use the datasource with data that contains event counts, such as number of equipment failures, safety incidents, or equipment repairs, select **Data is event count (e.g. Number of failures)**.

-or-

If you want to use the datasource with data that does not contain event counts but contains an amount, such as cost or hours, select **Data is not event count (e.g. Costs)**.

- In the **Measurement Name** box, enter the name of the data you are measuring throughout the analysis (e.g., cost, events). This is a required field. By default, this value is Failures. The measurement name that you select will be displayed throughout the analysis results.

Note: These instructions assume that you will select **Data is event count**, and leave the **Measurement Name** box with the default value Failures.

10. Select **Next**.

The **Select Data Fields** screen appears.

11. Select the columns from your query or dataset that you want to map to the Reliability Growth Analysis. The available columns are:

- **Asset ID:** Contains the IDs of the failed equipment or locations. You must select a column that contains alphanumeric values. This is a required field.
- **Installation Date:** Contains the installation dates of the Assets. This field appears only for an analysis based on failure dates. This is an optional field.
- **Date:** Contains the failure date of the equipment or locations. This is a required field.
- **Failures:** Contains the number of failures recorded at each measurement. If you do not select a value from the list, the GE Digital APM system will assume that one failure exists for each datapoint. If the number of failures is 1, the calculation will be based on an event-terminated or time-terminated analysis. If the number of failures is more than 1, the calculation will be based on a grouped-data analysis.

12. Select **Next**.

The **Provide Information for Downtime** screen appears.

13. In the **Downtime** list, select the query or dataset column that contains downtime values for the failed Assets (e.g., Total Time to Repair). This value is optional but must be numeric.

14. In the **Time Unit** list, select the time units associated with the selected downtime from the following options:

- **Hours**
- **Days**
- **Weeks**
- **Months**
- **Quarters**
- **Years**

The default value is Days.

15. Select **Finish**.

The GE Digital APM system generates the analysis and the **Reliability Growth** page appears, displaying the analysis results.

Create a Reliability Growth Analysis From Cumulative Operating Time Using an Existing Query or Dataset

About This Task

If you record event-based data using operating time instead of failure dates (e.g., a failure occurred after the piece of equipment was running for 10 days), then you can create a Reliability Growth Analysis using event-based data and cumulative operating time (COT).

Note: A minimum of three failure datapoints are necessary to perform a calculation.

Procedure

1. [Access the RA Overview page](#).
2. In the upper-right corner of the page, select **New Analysis**, and then select **Reliability Growth**.
The **Reliability Growth Builder** window appears.
Note: All required information is provided, but for additional information, consult the [Reliability Growth](#) and [Measurement Data](#) topics.
3. Enter values in the **Analysis Name** and **Description** boxes for the new analysis, and then select **Next**.
The **Select Data Source Type** screen appears. The **Data will be based on an existing Query** is selected by default.
4. If you want to load data using an existing query, select **Next**.
The **Select Query** screen appears.
-or-
If you want to load data using an existing dataset, select **Data will be based on an existing Dataset**, and then select **Next**.
The **Select Dataset** screen appears.
5. Select **Browse** to search for an existing query or dataset in the GE Digital APM Catalog.
The **Query Browser** or **Dataset Browser** screen appears, depending on whether you selected **Data will be based on an existing Query** or **Data will be based on an existing Dataset** in the previous step.
6. Select the needed query or dataset from the Catalog, and then select **Open**.
The complete path to the query or dataset is displayed in the **Query** or **Dataset** box. The fields that exist for the selected query or dataset appear in the **Available Fields** list.
7. In the **Includes Data From the Following Sites** list, select the site(s) whose data from which you want to create an analysis.
If you are creating an analysis in a database that has [only one site stored in the Site Reference family](#), then the **Includes Data From the Following Sites** list will not appear on the **Select Query** screen.
8. Select **Next**.
The **Select Data Format** screen appears.
9. On the **Select Data Format** screen, specify the following:
 - In the **Time Data Format** section, select **Data contains cumulative operating time**. This option indicates that the datasource contains data that contains operation time values (e.g., 10 days).
 - In the **Measurement Data Format** section:

If you want to use the datasource with data that contains event counts, such as number of equipment failures, safety incidents, or equipment repairs, **Data is event count (e.g. Number of failures)**.

-or-

If you want to use the datasource with data that does not contain event counts but contains an amount, such as cost or hours, select **Data is not event count (e.g. Costs)**.

- In the **Measurement Name** box, enter the name of the data you are measuring throughout the analysis (e.g., cost, events). This is a required field. By default, this value is Failures. The measurement name that you select will be displayed throughout the analysis results.

Note: These instructions assume that you will select **Data is event count (e.g. Number of failures)** and leave the **Measurement Name** box with the default value Failures.

10. Select **Next**.

The **Select Data Fields** screen appears.

11. Select the columns from your query or dataset that you want to map to the Reliability Growth Analysis. The available columns are:

- **Cumulative Operating Time:** Contains the piece of equipment's or location's cumulative operating time, or the time that has passed since it was placed into service. This field appears only for an analysis based on cumulative operating time. This is a required field.
- **Time Units:** Indicates the units for cumulative operating time from the following options: Hours, Days, Weeks, Months, Quarters, Years, or Custom. By default, Days is selected in the **Time Units** box. If you select Custom, the second box is enabled and you can specify any units of your choice (e.g., miles). This field appears only for an analysis based on cumulative operating time. This is a required field.
- **Asset ID:** Contains the IDs of the failed Assets. This is an optional field.
- **Date:** Contains the failure date of the Assets. This is an optional field, but if you do not select a field in this list, all labels in the Reliability Growth Analysis will display cumulative operating time only. This will result in allowing you to extrapolate based on time only, not date.
- **Failures:** Select the query or dataset column that contains the number of failures recorded at each measurement. If you do not select a value in the list, the GE Digital APM system will assume that one failure exists for each datapoint. If the number of failures is 1, the calculation will be based on an event-terminated or time-terminated analysis. If the number of failures is more than 1, the calculation will be based on a grouped-data analysis.

12. Select **Next**.

The **Analysis Start Time** screen appears. The **I want to use the time of the first data point as the start time for this analysis** check box is selected by default.

13. Specify the start time of the analysis.

Note: If you did not select a field in the **Date** list on the **Select Data Fields** screen, the field is disabled. If you selected a field that did not contain a date in every row, a message will appear, stating that one or more failure dates are missing and that dates will not be estimated in the analysis.

14. Select **Finish**.

The GE Digital APM system generates the analysis and the **Reliability Growth** page appears, displaying the analysis results.

Create a Reliability Growth Analysis from Manually Entered Data

Procedure

1. [Access the RA Overview page.](#)

2. In the upper-right corner of the page, select **New Analysis**, and then select **Reliability Growth**.
The **Reliability Growth Builder** window appears.
Note: All required information is provided, but for additional information, consult the [Reliability Growth](#) and [Measurement Data](#) topics.
3. Enter values in the **Analysis Name** and **Description** boxes for the new analysis, and then select **Next**.
The **Select Data Source Type** screen appears. The **Data will be based on an existing Query** is selected by default.
4. Select **I will manually enter data**, and then select **Next**.
The **Select Data Format** screen appears.
5. On the **Select Data Format** screen, specify the following:
 - In the **Time Data Format** section, select **Data contains dates**. This option indicates that the datasource will include data that contains specific event dates (e.g., 5/5/2012).
 - In the **Measurement Data Format** section:
 - If you want to use the datasource with data that contains event counts, such as number of equipment failures, safety incidents, or equipment repairs, select **Data is event count (e.g. Number of failures)**.
 - or-
 - If you want to use the datasource with data that does not contain event counts but contains an amount, such as cost or hours, select **Data is not event count (e.g. Costs)**.
 - In the **Measurement Name** box, enter the name of the data you are measuring throughout the analysis (e.g., cost, events). This is a required field. By default, this value is Failures. The measurement name that you select will be displayed throughout the analysis results.
6. Select **Finish**.
The **Reliability Growth Data Editor window** appears. The **Reliability Growth Data Editor** window will look different depending on whether your analysis is using failure dates or cumulative operating time.
7. Enter information about the [Failures and Assets](#) that you want to include in the analysis.
A minimum of three failure datapoints are necessary to perform a calculation.
Note: If you enter any downtime values that exceed the next failure date, the GE Digital APM system will highlight the downtime values on the **Reliability Growth Data** window. The cumulative time between failures will be calculated assuming that the downtime is not accurate and that the failure dates are accurate. When you close the **Reliability Growth Data** window, an error message will appear. The same error message will also appear in the **Analysis Summary** workspace.
Tip: You can add more rows of data by selecting **Add** at the bottom of the **Probability Distribution Data** grid. You can remove any row of data by selecting **Remove** next to the row of data that you want to delete.
8. Select **OK**.
The **Reliability Growth Data** window closes. The GE Digital APM system generates the analysis and the **Reliability Growth** page appears, displaying the analysis results.

Modify the Analysis Period

Procedure

1. [Access a Reliability Growth Analysis](#) for which you want to modify the analysis period.
2. In the left pane, select the **Cumulative <Measurement> Plot** tab.

The **Cumulative <Measurement> Plot** appears in the workspace.

Note: You can also specify the analysis period for a plot via the **Mean Time Between <Measurement> Plot**, and **<Measurement> Rate Plot** tabs.

3. In the upper-right corner of the workspace, select **Growth Options**, and then select **Analysis Period**.

The **Analysis Period** window appears.

4. If you want the start date to be the first datapoint, select the **I want to use the first data point as the start date for this analysis** check box. When this check box is selected, the corresponding date field is disabled automatically and displays the date on which the first event occurred.

-or-

If you want the start date to be different than the first datapoint, clear the **I want to use the first data point as the start date for this analysis** check box, and then enter or select the desired date and time.

Note: To ensure that all failure dates appear on the plots, make sure the start date is before the date associated with of the first datapoint. Only failures that occur after the start date will appear on the plots.

5. If you want the end date to correspond with the last event (i.e., datapoint) in the analysis, select **Event-Based**. When this option is selected, the date field below the **I want to use today's date as the end date for the analysis** check box is disabled automatically and displays the date on which the last event occurred.

-or-

If you want the end date to correspond with a certain time, select **Time-Based**. If you do not want today's date to be the end date, clear the **I want to use today's date as the end date for this analysis** check box, and then enter or select the desired date and time.

Note: An Event-Based end time occurs when the last event and the end of the observation period (i.e., the end date) are the same. If some time has accumulated since the last event, this time is not included in the reliability model. If you want to include that time in the reliability model, you should select a Time-Based end time and enter the latest time in the observation period.

6. Select **OK**.

The GE Digital APM system recalculates the analysis using the dates that you selected for the analysis period.

Note: If you have not included enough failures to calculate the results, a warning message will appear. A minimum of three failures must exist for each segment in the specified analysis period.

Rename a Reliability Growth Analysis

Procedure

1. [Access a Reliability Growth Analysis](#) whose name you want to change.
2. In the left pane, select the **Cumulative <Measurement> Plot** tab.

The **Cumulative <Measurement> Plot** appears in the workspace.

Note: You can also change the name of the analysis via the **Mean Time Between <Measurement> Plot**, and **<Measurement> Rate Plot** tabs.

3. In the upper-right corner of the workspace, select **Analysis Tasks**, and then select **Rename**.

The **Set Analysis Name** window appears.

4. In the **Analysis Name** box, enter a new name for the analysis.
5. In the **Analysis Description** box, enter a new description for the analysis.

6. Select **OK**.

The analysis name is updated in any appropriate sections on the summary page and in the site map to reflect the change. In addition, the Analysis Description field in any appropriate sections will reflect any changes.

Choose the Time Units for an Analysis

About This Task

The time units are used for expressing time values for calculations performed within an analysis. For example, a calculation may indicate the amount of time that lapsed between a failure event and the end date of the analysis period. This value would be expressed in the Time Units for the analysis.

Your Time Units selection will depend on what type of data you are using and what type of analysis you are performing. For example, in an analysis that shows the distribution of failures for a number of Assets over many years, years might be an appropriate unit of time. For an analysis designed to evaluate failures for a single Asset within a very specific time period, a smaller unit of time would be appropriate. For this reason, you can choose the Time Units that are most appropriate for a given analysis.

Procedure

1. [Access a Reliability Growth Analysis](#) for which you want to modify the Time Units.
2. In the left pane, select the **Cumulative <Measurement> Plot** tab.

The **Cumulative <Measurement> Plot** appears in the workspace.

Note: You can also modify the analysis period for a plot via the **Mean Time Between <Measurement> Plot**, and **<Measurement> Rate Plot** tabs.

3. In the upper-right corner of the workspace, select **Growth Options**, and then select **Time Units**.

The **Select Time Units** window appears.

4. In the **Operating Time Units** list, select **Hours, Days, Weeks, Months, Quarters, or Years**. The default value is Days.
5. In the **Downtime Units** list, select **Hours, Days, Weeks, Months, Quarters, or Years**. The default value is Days.
6. Select **OK**.

The GE Digital APM system automatically recalculates the analysis based on the new time units and displays the new units on the plot pages.

Specify the Data Format for a Reliability Growth Analysis

About This Task

When you create an analysis, you will choose whether or not your data is event-based and select the measurement name that will be used throughout the analysis via the **Select Data Format** screen in the **Reliability Growth Builder**. By default, the **Measurement Name** will be set to Failures.

Procedure

1. [Access a Reliability Growth Analysis](#) for which you want to specify the data format.
2. In the left pane, select the **Cumulative <Measurement> Plot** tab.

The **Cumulative <Measurement> Plot** appears in the workspace.

Note: You can also specify the data format for a plot via the **Mean Time Between <Measurement> Plot**, and **<Measurement> Rate Plot** tabs.

3. In the upper-right corner of the workspace, select **Growth Options**, and then select **Data Format**.

The **Select Growth Data Format** window appears.

4. If the data that you are measuring is based on events, such as failures, safety incidents, or equipment repairs, select **Data is event count**.

-or-

if the data that you are measuring is not an event, but an amount, such as cost or hours, select **Data is not event count**.

5. In the **Measurement Name** box, enter a value that corresponds with the type of data used in the analysis (e.g., cost, events). By default, this box contains the measurement value you entered on the **Select Data Format** screen in the **Reliability Growth Builder** when you created the analysis. If you modify this value, labels throughout the analysis will change automatically.
6. Select **OK**.

The **Reliability Growth Analysis** page appears, displaying the Reliability Growth Analysis with updated data or measurement labels.

Modify the Confidence Level for a Reliability Growth Analysis

Procedure

1. [Access the Reliability Growth Analysis](#) for which you want to modify the confidence level.
2. In the left pane, select the **Cumulative <Measurement> Plot** tab.

The **Cumulative <Measurement> Plot** appears in the workspace.

Note: You can also change the confidence level via the **Mean Time Between <Measurement> Plot**, and **<Measurement> Rate Plot** tabs.

3. In the upper-right corner of the workspace, select **Growth Options**, and then select **Confidence Level**.

The **Select Confidence Level** window appears.

Note: If the **Confidence Level** box is disabled, select the **Use Confidence** check box to activate the confidence level and enable the **Confidence Level** box.

4. In the **Confidence Level** box, select a value from the drop-down to represent the desired Confidence Level.
5. Select **OK**.

The GE Digital APM system displays the confidence intervals for the analysis based on the percentage you selected in the **Confidence Level** box.

Estimate Data in the Future

Procedure

1. [Access a Reliability Growth Analysis](#) for which you want to estimate data in future.
2. In the left pane, select the **Cumulative <Measurement> Plot** tab.

The **Cumulative <Measurement> Plot** appears in the workspace.

Note: You can also estimate data in future via the **Mean Time Between <Measurement> Plot**, and **<Measurement> Rate Plot** tabs.

3. In the upper-right corner of the workspace, select **Analysis Task**, and then select **Extrapolate**.

The **Segment Extrapolation** window appears.

Note: If you have not yet extrapolated the analysis, the **No Extrapolation** option is selected.

4. If you want to estimate data by specific date, select **Date**, and then enter or select the date on which you want to know how many failures will have occurred.

Note: You can extrapolate by date only if your analysis data contains dates. If the analysis does not contain dates, the **Date** option will not appear, and you will not be able to extrapolate based on dates.

-or-

If you want to estimate data by specific time, select **Time**, and then specify the number of time units at which you want to know how many failures will have occurred.

Note: The date or time that you specify must be greater than the default date or time, which is the analysis end date or time.

5. Select **OK**.

The **Cumulative <Measurement> Plot** workspace appears, displaying the **Cumulative <Measurement>** plot with [several lines added based on the extrapolation specification](#).

Split an Analysis Into Segments

About This Task

A Reliability Growth Analysis may, in some cases, indicate that your data is trending in an undesirable direction (e.g., failures are occurring very often, costs are too high). In these cases, you will probably decide to make significant adjustments to your work process to improve the results. You can create a Reliability Growth Analysis that is split into segments to represent periods of time before and after you made changes to improve the reliability of your equipment and locations.

When you generate a report for an analysis that has been split into segments, the report will contain information about each segment and the analysis as a whole.

Procedure

1. [Access the Reliability Growth Analysis](#) that you want to split into segments.
2. In the left pane, select the **Cumulative <Measurement> Plot** tab.

The **Cumulative <Measurement> Plot** appears in the workspace.

Note: You can also split an analysis into segments via the **Mean Time Between <Measurement> Plot**, and **<Measurement> Rate Plot** tabs.

3. In the upper-right corner of the workspace, on the **Cumulative <Measurement> Plot**, select the datapoint that represents the last measurement recorded before you made a significant change to your work process.

The **Point Tooltip** window appears.

4. Select **Split**.

Note: The **Split** option is enabled only if there are at least three datapoints to the left and to the right of the datapoint you selected.

The plot line bends at the datapoint you selected, representing two segments instead of one.

Although the analysis still has an overall Initial and Final MTBF, each individual segment now also has its own Initial and Final MTBF. The **AMSAA Reliability Growth Model** page for an [analysis based on event](#) or an [analysis not based on an event](#) will also display different information for each segment.

Each segment is colored according to whether it passed the GOF test. If the segment is blue, it passed the GOF Test. If the segment is orange, it failed the GOF test.

Note: When you split the analysis manually via the **Cumulative <Measurement> Plot** tab, the **MTBE Trend Plot** and **<Measurement> Rate Plot** tabs will also reflect the split.

Merge Segments With Previous Segments

After you have split an analysis into multiple segments, you can merge the segments back into one segment.

Procedure

1. [Access the Reliability Growth Analysis](#) for which you want to merge the segments.
2. In the left pane, select **Cumulative <Measurement> Plot**.

The **Cumulative <Measurement> Plot** appears in the workspace.

Note: You can also merge the segments of an analysis via the **Mean Time Between <Measurement> Plot**, and **<Measurement> Rate Plot** tabs.

3. In the upper-right corner of the workspace, on the **Cumulative <Measurement> Plot**, locate the segment that you want to merge.
4. Click or tap on the segment.

The **Segment Actions** window appears.

5. If you want to merge the selected segment with the previous segment, select **Merge with previous segment**.

-or-

If you want to merge the selected segment with the immediate next segment, select **Merge with next segment**.

The segments are merged and a single plot line appears for the analysis.

The **AMSAA Reliability Growth Model** page for an [analysis based on event](#) or an [analysis not based on an event](#) will also display different information for each segment.

Note: When you merge the segments manually via the **Cumulative <Measurement> Plot** tab, the **MTBE Trend Plot** and **<Measurement> Rate Plot** tabs will also reflect the merge.

Access Reliability Growth Analysis Report

Procedure

1. [Access the Reliability Growth Analysis](#) for which to you want view the report.
2. In the upper-right corner of any workspace within the selected Reliability Growth Analysis, select the **Report** button.

The Reliability Growth Analysis report appears in a new browser tab.

By default, the report contains the following [sections](#):

- **Analysis Plots**
- **Analysis Summary**
- **Growth Model Segments**
- **Assets**
- **<Measurement> Data**

About Reliability Growth Analysis Reports

The baseline GE Digital APM database includes the Reliability Growth report, which you can use to view the summary of the results of a Reliability Growth Analysis.

The Reliability Growth Report is built from the following Catalog items:

- The main report, GrowthAnalysisReport, which is stored in the Catalog folder \\Public\Meridium\Modules\Reliability Manager\Reports.
- The subreport, AssetsubreportGrowth, which is stored in the Catalog folder \\Public\Meridium\Modules\Reliability Manager\Reports.
- The subreport, FailuresubreportGrowth, which is stored in the Catalog folder \\Public\Meridium\Modules\Reliability Manager\Reports.
- The supporting query that supplies data in the main report and subreports, GrowthAnalysisQuery, which is stored in the Catalog folder \\Public\Meridium\Modules\Reliability Manager\Reports.

Throughout this documentation, we refer to the main report, the subreports, and the supporting query collectively as the Reliability Growth report.

The Reliability Growth report contains a prompt on the ENTY_KEY field in the Reliability Growth family. When you run the Reliability Growth Report while viewing a Reliability Growth Analysis, the ENTY_KEY of the Reliability Growth record associated with the current analysis is passed automatically to the prompt, and the results for the current Reliability Growth Analysis are displayed. If you run the main report (i.e., GrowthAnalysisReport) or the supporting query (i.e., GrowthAnalysisQuery) directly from the Catalog, however, you will need to supply the ENTY_KEY of a Reliability Growth record manually to retrieve results. The subreports (i.e., Catalog items AssetsubreportGrowth and FailuresubreportGrowth) cannot be run directly from the Catalog.

Analysis Summary Section

The **Analysis Summary** section of the Reliability Growth Analysis report displays information that is stored in the [Reliability Growth record](#) and the [Growth Model record](#) that is linked to the Reliability Growth record. The **Analysis Summary** section will look different depending on whether or not your analysis data is event-based and the [value you enter in the Measurement Name box](#). Also, the values in the **Analysis Summary** section will come from different fields in the Reliability Growth and Growth Model records, depending on whether the analysis is based on dates or cumulative operating time.

The following table lists each item in the **Analysis Summary** section for an analysis based on dates that contains event-based data and the corresponding Reliability Growth or Growth Model record field whose data is displayed in the report.

Report Item	Reliability Growth or Growth Model record	Record field
Analysis Name	Reliability Growth	Analysis ID
Analysis Description	Reliability Growth	Short Description
Analysis Start	Reliability Growth	Analysis Start Date Note: If the analysis is based on cumulative operating time, the report will use the value in the Analysis Start Time field.

Report Item	Reliability Growth or Growth Model record	Record field
Analysis End	Reliability Growth	Analysis End Date Note: If the analysis is based on cumulative operating time, the report will use the value in the Analysis End Time field.
Number of Assets	Reliability Growth	Assets
Total <Measurement>	Growth Model	Number of Failures
Time Units	Reliability Growth	Time Units
Observation Time	Growth Model Reliability Growth	Total Observation Time Time Units
Initial MTBF	Reliability Growth	Initial MTBF Time Units
Final MTBF	Reliability Growth	Final MTBF Time Units
Next Estimated Event Date	Reliability Growth	TTNF Time Units
Use Confidence	Reliability Growth	Use Confidence
Confidence	Reliability Growth	Confidence Level
Last Modified	Reliability Growth	LAST UPDT DT
Modified By	Reliability Growth	LAST UPBY SEUS KEY Note: The name of the Security User associated with this value is displayed in the report.

The **Analysis Summary** section for an analysis that is not event-based will appear mostly the same as the **Analysis Summary** section for an analysis that is event-based, with the following exceptions.

- The Next Estimated Event Date field will not be displayed in the **Analysis Summary** section.
- The Initial MTBF and Final MTBF fields will be labeled Initial <Measurement> Rate and Final <Measurement> Rate, respectively.

Note: Although the values used in the report are stored in Reliability Growth or Growth Model records, the report contains additional logic in order to display the values in this format. In other words, the values in the records are not in the exact form in which they appear in the report.

Growth Model Segments Section

The **Growth Model Segments** section of the Reliability Growth report displays information that is stored in the [Reliability Growth record](#) and the [Growth Model record](#) that is linked to the Reliability Growth record. The **Growth Model Segments** section will look different depending on whether the analysis is based on dates or cumulative operating time.

The following table lists each item in the **Growth Model Segments** section for an analysis based on dates and the corresponding Reliability Growth or Growth Model record field whose data is displayed in the report.

Report Item	Reliability Growth or Growth Model record	Record field
Segment	Growth Model	Sequence
Start Date	Growth Model	Model Start Date
End Date	Reliability Growth	Analysis End Date
Termination Type)	Reliability Growth	Is Grouped Data Time Terminated Note: If the value in the Is Grouped Data field is True, the Termination Type is Grouped-Data. If the value is False, the Termination Type depends on the value in the Time Terminated field. If the value in the Time Terminated field is False, the Termination Type is Event-Based. If the value in this field is True, the Termination Type is Time-Based.
Beta	Growth Model	Beta
Lambda	Growth Model	Lambda
Statistic	Growth Model	GOF Statistic
Critical Value	Growth Model	GOF P-Value
Passed	Growth Model	Passed GOF

The **Growth Model Segments** section for an analysis that contains cumulative operating time will appear mostly the same as the **Growth Model Segments** section for an analysis that contains dates, with the following exceptions.

- The Start Date and End Date fields will not be displayed in the **Growth Model Segments** section.
- The **Growth Model Segments** section will display the following fields.

Report Item	Reliability Growth or Growth Model record	Record field
Start Time	Reliability Growth	Analysis Start Time
End Time	Reliability Growth	Analysis End Time

Assets Section

The **Assets** section of the Reliability Growth report displays values that are stored in the [Failures](#) field in the Reliability Growth record. The Assets section will look different depending on whether the analysis is based on dates or cumulative operating time.

The following columns in the **Assets** section contain data that is stored in the Failures field in the Reliability Growth record:

- **Asset ID**
- **Installation Date**
- **Last Replacement**

Note: The **Installation Date** column appears only for analyses based on dates.

<Measurement> Data Section

The <Measurement> Data section of the Reliability Growth report displays information that is stored in the [Failures](#) field of the Reliability Growth record. The <Measurement> Data section will look different depending on whether the analysis is based on dates or cumulative operating time. It will also look different depending on the [value you enter in the Measurement Name box](#).

The following columns in the <Measurement> Data section contain data that is stored in the [Failures](#) field in the Reliability Growth record:

- **Asset ID**
- **Date**
- **Time**

Note: The **Time** column appears only for analyses based on dates.

- **Downtime**

Note: The **Downtime** column appears only for analyses based on dates.

- **COT**

Note: The **COT** column appears only for analyses based on cumulative operating time.

- **<Measurement>**
- **Ignore**
- **Remarks**
- **Cumulative Time**

Plots Section

The **Plots** section of the Reliability Growth report displays the graphs that are accessed via the [Reliability Growth](#) page.

The **Plots** section contains the following graphs:

- [Cumulative <Measurement> Plot](#)
- [MTB <Measurement> Trend](#)
- [<Measurement> Rate Trend](#)

Delete a Reliability Growth Analysis

Procedure

1. Access the [RA Overview](#) page.
2. Select the **Reliability Growth** tab.

A list of Reliability Growth Analyses available in the database appears.

3. In the **Analysis ID** column, select the row containing the Reliability Growth Analysis that you want to delete, and then select .

The **Delete Reliability Growth Analysis** dialog box appears, asking you to confirm that you want to delete the selected analysis.

4. Select **Yes**.

The selected analysis is deleted.

Measurement Data

About Measurement Data

The **Reliability Growth Data Editor** window allows you to view the data associated with a Reliability Growth Analysis. For an analysis based on manually-entered data, the **Reliability Growth Data Editor** window displays the information that you entered when you create the analysis.

The **Reliability Growth Data Editor** window contains following two tabs:

- **<Measurement Name>**: Provides information about the event data. The columns that appear on this tab are based on the following [type of Reliability Growth Analysis](#) for which you are viewing data. You need to select any combination to view Measurement data for the selected analysis.
 - **Time Data Format:**
 - Data contains dates.
 - Data contains cumulative operating time.
 - **Measurement Data Format:**
 - Data is event count (e.g. Number of failures):
 - Data is not event count (e.g. Costs).

The following [columns](#) of information are displayed on the **<Measurement>** tab for event-based analyses using failure dates:

- **Asset ID**
- **Date**
- **Time** <units>
- **Downtime** <units>
- **Failures**
- **Ignore**
- **Remarks**
- **Cumulative Time**
- **Segment**

The following [columns](#) of information on the **<Measurement>** tab behave differently for an event-based analysis based on cumulative operating time:

- **Date**
- **COT** <units>
- **Downtime**<units>
- **Cumulative Time** <units>

The following [column](#) of information behaves differently for an analysis that is not based on events and user grouped data:

- **Cost**
- **Assets:** Contains a grid with information about each Asset that is related to a measurement. The following [columns](#) of information are displayed in the grid on the **Assets** tab:
 - **Asset ID**
 - **Installation Date**
 - **Last Replacement**

Access the Source Analysis Data for a Reliability Growth Analysis

Procedure

1. [Access a Reliability Growth Analysis](#) for which you want to view the analysis data.
2. In the left pane, select the **Cumulative <Measurement> Plot** tab.

The **Cumulative <Measurement> Plot** appears in the workspace.

Note: You can also view data for a plot via the **Mean Time Between <Measurement> Plot**, and **<Measurement> Rate Plot** tabs.

3. In the upper-right corner of the workspace, select **Analysis Data**, and then select **Go To Source**.

The fields on the page that appear display the analysis data associated with the selected Probability Distribution Analysis and correspond to [values that were used to create the analysis](#).

- For an analysis based on a query, the information returned by the query appears.
- For an analysis based on a dataset, the information stored in the dataset appears.
- For an analysis based on manually-entered data, you will receive the following error message:
There is no source data to view since the analysis is based on manually entered data.

To view data for an analysis based on manually-entered data, in the plot area, select an observed datapoint, and then select **Go To Editor**. The **Reliability Growth Data window** for the selected Reliability Growth Analysis appears. The row containing the data for the selected observed datapoint is highlighted.

Note:

As needed, you can modify the values in the [enabled fields](#), and then select **Finish** to save your changes.

- For an analysis that is based on manually entered data, the changes that you make via the **Reliability Growth Data window** will be saved for the analysis.
- For an analysis that is based on a query or a dataset:
 - The query or dataset will not be modified with the updated data. Additionally, any record returned by the query will not be updated with your changes. The changes will be saved to the analysis only.
 - After you modify the data and save the analysis, the modified data will appear each time you open the analysis. If you want to revert to the original data, you can reload the original data to the analysis. In addition, if a query or dataset has changed in the database, you can [reload the data](#) in order for your analysis to contain those changes.

Modify Data in a Reliability Growth Analysis

About This Task

You can use the **Reliability Growth Data** window to modify the data in any enabled field. This allows you to correct errors in the data or adjust data as needed. Only certain fields in the **Reliability Growth Data** window can be modified. Fields that contain calculations by the GE Digital APM system are disabled.

Procedure

1. [Access a Reliability Growth Analysis](#) for which you want to modify the analysis data.
2. In the left pane, select the **Cumulative <Measurement> Plot** tab.

The **Cumulative <Measurement> Plot** appears in the workspace.

Note: You can also modify data for a plot via the **Mean Time Between <Measurement> Plot**, and **<Failures> Rate Plot** tabs.

3. In the upper-right corner of the workspace, select **Analysis Data**, and then select **Edit Data**.

The **Reliability Growth Data** window appears, displaying the data associated with the selected Probability Distribution Analysis.

4. As needed, modify the data in any [enabled field](#), and then select **OK**.

The analysis is updated to reflect any changes that you made.

5. Select **Finish**.

The analysis is updated to reflect any changes that you made.

Results

- For an analysis that is based on manually entered data, the changes that you make via the **Reliability Growth Data** window will be saved for the analysis.
- For an analysis that is based on a query or a dataset:
 - The query or dataset will not be modified with the updated data. Additionally, any record returned by the query will not be updated with your changes. The changes will be saved to the analysis only.
 - After you modify the data and save the analysis, the modified data will appear each time you open the analysis. If you want to revert to the original data, you can reload the original data to the analysis. In addition, if a query or dataset has changed in the database, you can [reload the data](#) in order for your analysis to contain those changes.

Reload Analysis Data in a Reliability Growth Analysis

About This Task

When you create and save analyses that are based on a query or dataset, the GE Digital APM system takes a snapshot of the data that exists at the time of creation and saves it along with the analysis. When you open an existing analysis, the GE Digital APM system loads the data that was last saved with the analysis. This means that any changes to the underlying query or dataset will not be reflected automatically when you open an existing analysis.

Note: If the query or dataset has been deleted or renamed, when you try to open an associated analysis, an error message will be displayed, and the data will not be refreshed.

If you want to refresh an analysis based on changes to the underlying query or dataset or to load new data that has been added since the analysis was last saved (e.g., the analysis is based on a query that retrieves failures for a piece of equipment or location, and a new failure record has been added to the database), you will need to reload the analysis manually after opening it.

Note: Reloading analysis data resets the analysis period only if it is based on the analysis data. Start Dates and End Dates that have been set explicitly will not be overwritten.

Procedure

1. [Access a Reliability Growth Analysis](#) for which you want to reload the analysis data.
2. In the left pane, select the **Cumulative <Measurement> Plot** tab.

The **Cumulative <Measurement> Plot** appears in the workspace.

Note: You can also reload the data for an analysis via the **Mean Time Between <Measurement> Plot**, and **<Measurement> Rate Plot** tabs.

3. In the upper-right corner of the workspace, select **Analysis Data**, and then select **Reload Data**.

A confirmation message appears, asking you to confirm that you want to overwrite the current data with the data stored in the database.

Note:

For an analysis based on manually-entered data, you will receive the following error message:

There is no source data to reload since the analysis is based on manually entered data.

4. Select **Yes**.

The analysis is updated to reflect the data currently stored in the query or dataset.

Note: If you are reloading analysis data that is based on a query and an index out of range error message appears, there is an error in the query. You should modify the query or recreate the analysis to reload the correct data.

Chapter 7

Spares Analysis

Topics:

- [Spares Analysis: Overview](#)
- [Spares Analysis: Workflow](#)
- [Spares Analyses](#)
- [Spares](#)
- [Spare Applications](#)
- [Spare Application Populations](#)
- [Failure Distributions](#)
- [Monte Carlo Simulations](#)

Spares Analysis: Overview

Overview of Spares Analysis

Reliability Analytics

The Reliability Analytics module provides a collection of tools that apply reliability engineering principles to help you make tactical (short-term) and strategic (long-term) decisions for maintenance and operational equipment management activities. It also provides:

- A means for analyzing historical failure data to identify trends and predict future failures.
- A mechanism for simulating what if scenarios regarding the reliability of a system to determine if a new or modified strategy will be effective.

The Reliability Analytics module provides the following types of tools:

- Production Analysis
- System Reliability Analysis
- Spares Analysis
- Reliability Distribution Analysis
- Probability Distribution Analysis
- Reliability Growth Analysis
- Automation Rules

Each tool provides a unique set of features that allow you to analyze data to develop strategies to improve reliability.

Spares Analysis

Spares Analysis is a tool that uses delivery time and cost, downtime, lost production costs, and failure and repair data to calculate the amount of spare parts you need to keep at any specific time. Analyses provide you with the data needed to ensure that you have the necessary spare parts for unplanned failures, while also making sure you do not have a surplus of unneeded parts.

Spares Analysis Workflow

This workflow provides the basic, high-level steps for developing Spares Analyses. The steps and links in this workflow do not necessarily reference every possible procedure.

To create a Spares Analysis, you must complete the following steps:

1. [Create a Spares Analysis](#) , which contains data for the analysis.
2. [Create a Spare](#) , which contains data about the spare part that you want to analyze. A Spare is used to define delivery time, cost, and spare level data for the spare part that you are analyzing. There might be more than one Spare to represent each spare part related to a piece of equipment.
3. [Create a Spare Application](#) , which contains the failure and repair data for the spare part that you want to analyze. You might have more than one Spare Application for each Spare. For example, a spare part might be used in a piece of equipment that is located in an indoor environment, and the same type of spare part might be used in another piece of equipment located in an outdoor environment. The failure data and repair data might be different for both spare parts. Therefore, you would want to create one Spare Application for the spare part that is used in the indoor environment and another Spare Application for the spare part that is used in the outdoor environment.

4. [Create a Spare Application Population](#) , which contains age data for the equipment that contains the spare part that you are analyzing. A Spare Application Population is used to record the population age of a group of equipment that together use the data in the Spare Application to which it is linked. An analysis might have more than one group of equipment with different ages using the same failure and repair data from the linked Spare Application.
5. [Create one or more Failure Distributions](#), which allows you to define the ways in which a spare part can fail, requiring a replacement (or repaired to as good as new) spare part. You can define one or multiple Failure Distributions for a Spare Application record, and you can [define the Failure distribution manually](#) or by [importing the information from an existing Reliability Distribution or Reliability Growth Analysis](#).
6. [Run the Monte Carlo simulation](#) , which allows you to view the cost differences between spare levels on the [Spares Analysis plots](#).

After you complete these initial steps, you can modify existing records, add additional records, rerun the Monte Carlo simulation, and view the updated results as needed.

Spares Analysis: Workflow

Reliability Analytics: Spares Analysis Workflow

This workflow describes the process for determining the optimum stock holdings of spares in relation to the reliability distributions for the subject assets.

In the following workflow diagram, the blue text in a shape indicates that the corresponding description has been provided in the sections that follow the diagram. For more information, refer to the [Interpreting the Workflow Diagrams](#) topic in the [APM Product Workflows](#) documentation.

Note: For information on the personas associated with a GE Digital APM module, refer to the [APM Product Workflows](#) documentation.

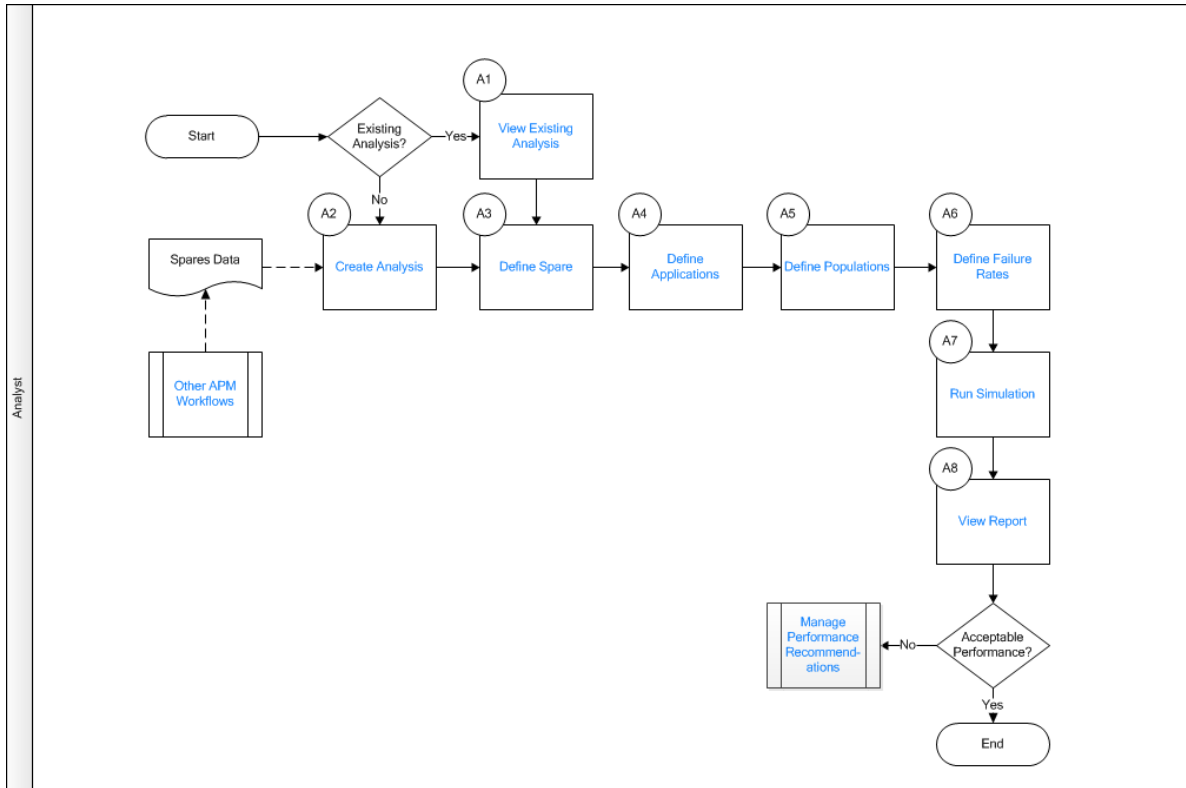

1. [View Existing Analysis](#) on page 134
2. [Create Analysis](#) on page 134
3. [Define Spare](#) on page 134
4. [Define Applications, Populations, and Failure Rates](#) on page 135
5. [Define Applications, Populations, and Failure Rates](#) on page 135
6. [Define Applications, Populations, and Failure Rates](#) on page 135
7. [Run Simulation](#) on page 135
8. [View Report](#) on page 135
9. [Manage Performance Recommendations](#) on page 135
10. [Other Workflows](#) on page 135

View Existing Analysis

Persona: Analyst

View the details of an existing analysis.

Create Analysis

Persona: Analyst

Create an analysis based on production data or event data.

Define Spare

Persona: Analyst

For a new analysis, define each category of spare to be modeled within the workflow.

Define Applications, Populations, and Failure Rates

Persona: Analyst

Create one or more spares applications, populations, or failure rates based on the usage base to determine the optimal spares value.

Run Simulation

Persona: Analyst

Queue the simulation service to run a selected number of iterations based on the applications, populations, failure rates, and uncertainties associated with the analysis parameters to find the optimal spares values.

View Report

Persona: Analyst

View and save the analysis report.

Manage Performance Recommendations

Persona: Analyst

Create any number of performance recommendations and Approve them using state management.

Note: Performance recommendations are not required.

Go to the Manage Performance Recommendations workflow.

Other Workflows

Persona: Analyst

Other workflows provide production data from SAP, EAM, and Recommendations.

Spares Analyses

About Spares Analysis

Spares Analysis is a tool that helps you maintain the optimal number of spare parts. Spares Analysis uses delivery time and cost, downtime, lost production costs, and failure and repair data to calculate how many spare parts should be kept on hand at any given time.

GE Digital APM Reliability Analytics offers various tools that help you analyze the reliability of your equipment and locations so that you can make decisions about when to repair and replace those pieces of equipment and locations. For example, a Reliability Distribution Analysis lets you analyze historical failure data to help predict future failures. Based on those predictions, you can make plans for replacing equipment and making repairs to prevent future failures. As part of making plans to replace equipment in

the future, you will want to make sure that you have an adequate number of spare parts available. Having spare parts on hand will help reduce the amount of downtime associated with unplanned failures.

The key to a successful spares program is maintaining a balance between:

- Optimizing the spares level so that you have enough spare parts to handle unplanned failures.
- Not having a surplus of parts that are not actually needed.

You can modify the input data for a Spares Analysis to evaluate the potential savings or losses associated with changing the spares level. For example, if you currently keep three spare seals for a pump, you could use a Spares Analysis to determine whether it would benefit your company financially to store either more or fewer spare seals instead.

Access a Spares Analysis

Procedure

1. Access the [RA Overview](#) page.
2. Select **Spares Analyses**.



A list of Spares Analyses available in the database appears.

3. Select the Spares Analysis whose details you want to view.

The **Analysis Summary** workspace for the selected analysis appears.

The workspace contains the following tabs:

- **Definition:** Displays the details of the selected Spares Analysis.

Note: As needed, in the **Definition** section, you can select  to modify the values in the [available fields](#), and then select  to save your changes.

- **Summary:** The **Summary** tab is selected by default and displays the [Spare Level plot](#) for all the Spares within the selected Spares Analysis. You can also view the following plots for all the Spares within the selected Spares Analysis:
 - Downtime plot
 - Spare Usage plot
 - Sensitivity plot
 - Optimal Holding plot

The left pane contains a list of [Spares](#) available for the selected Spares Analysis.

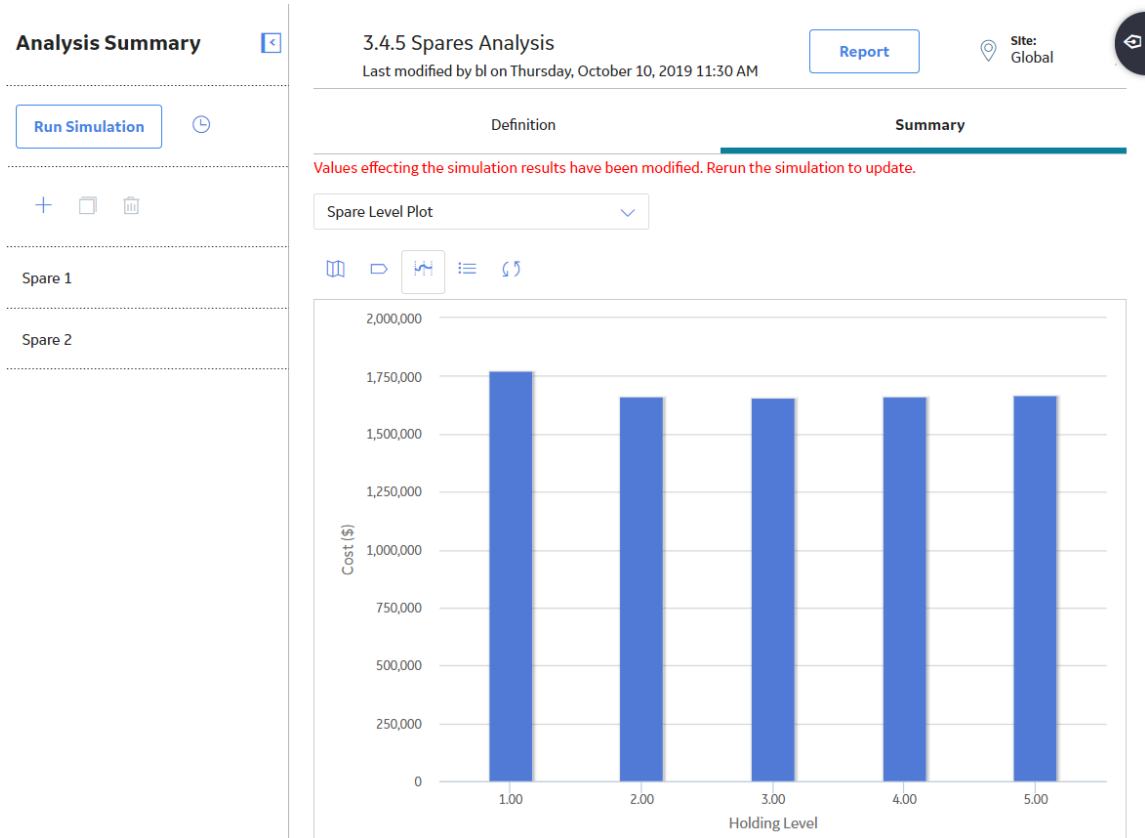

Create a Spares Analysis

Procedure

1. Access the [RA Overview](#) page.
2. In the upper-right corner, select **New Analysis**, and then select **Spares Analysis**.

The **Spares Analysis** page appears, displaying a blank datasheet in the **Analysis Summary** workspace.

3. As needed, enter the values in the [available fields](#), and then select .

The Spares Analysis is saved.

Next Steps

- [Create a Spare](#)

Example of a Spares Analysis

This example of a Spares Analysis demonstrates how you can use Spares Analyses to evaluate spare parts. We will refer to this example throughout the Spares Analysis documentation as needed.

Assume that you want to create a Spares Analysis for a group of pumps, which contain seals, bearings, and impellers, each of which can fail. Because you may need to replace seals, bearings, and impellers on the pumps when they fail, you can use a Spares Analysis to determine the optimal level for each spare part. Currently, two spare seals, two spare bearings, and no spare impellers are stored in the warehouse. By conducting a Spares Analysis, you can determine if this number of spare parts is adequate.

In the Spares Analysis, you will include failure data for each part of the pump, run the Monte Carlo simulation, and then view the plots to see the optimal level of each spare part. By implementing the recommended spare level, you will be able to limit the amount of downtime and reduce failure costs.

The following records will be defined for the Spares Analysis example. Data that exists within each record in the Spares Analysis example can be found in the example data tables.

- **Spares Analysis Example** (Spares Analysis record)
 - **Seals** (Spare record)
 - **Inboard Application** (Spare Application record)
 - **Inboard Population 1** (Spare Application Population record)
 - **Inboard Population 2** (Spare Application Population record)
 - **Outboard Application** (Spare Application record)
 - **Outboard Population 1** (Spare Application Population record)
 - **Outboard Population 2** (Spare Application Population record)
 - **Outboard Population 3** (Spare Application Population record)
 - **Bearings** (Spare record)
 - **Inboard Application** (Spare Application record)
 - **Inboard Population 1** (Spare Application Population record)
 - **Inboard Population 2** (Spare Application Population record)
 - **Outboard Application** (Spare Application record)
 - **Outboard Population 1** (Spare Application Population record)
 - **Outboard Population 2** (Spare Application Population record)
 - **Outboard Population 3** (Spare Application Population record)
 - **Impellers** (Spare record)
 - **All Applications** (Spare Application record)
 - **Pump Population 1** (Spare Application Population record)
 - **Pump Population 2** (Spare Application Population record)
 - **Pump Population 3** (Spare Application Population record)
 - **Pump Population 4** (Spare Application Population record)

When viewing this list of records, you can see that each Spare record is linked to the Spares Analysis record, each Spare Application record is linked to a Spare record, and each Spare Application Population record is linked to a Spare Application record.

This example represents only one approach to creating a Spares Analysis. There are many alternate workflows that can be used for developing a Spares Analysis. For example, instead of creating a Spares Analysis at the pump level (e.g., the equipment level), you can create a Spares Analysis for each of the individual spare parts. After you are familiar with the functionality of a Spares Analysis, you can implement any workflow that works best for your organization.

Example Spare Analysis Record Data

The following table shows the data stored in the Spares Analysis record for the Spares Analysis example.

Record	Section	Values Specified
Spares Analysis Example	Analysis	Name: Spares Analysis Example Description: This is a sample Spares Analysis example. Simulation Start Date: 1/1/2015 Simulation End Date: 1/1/2025 Currency: \$
Spares Analysis Example	Simulation Options	Number of Iterations: 100 Random Seed: No

Example Spare Record Data

The following table shows the data stored in the Spare records that are included in the Spares Analysis example.

Record	Section	Values Specified
Seals	Spare	Name: Seals On-site Delivery Time: 4 Hours Normal Order Time: 25 Days Normal Cost: 100 Expedited Order Time: 3 Days Expedited Cost: 300 Holding Cost Rate: 20 per Year Minimum Holding Level: 0 Maximum Holding Level: 10 Current Holding Level: 1
Bearings	Spare	Name: Bearings On-site Delivery Time: 4 Hours Normal Order Time: 25 Days Normal Cost: 100 Expedited Order Time : 3 Days Expedited Cost: 300 Holding Cost Rate: 20 per Year Minimum Holding Level: 0 Maximum Holding Level: 10 Current Holding Level: 1
Impellers	Spare	Name: Impellers On-site Delivery Time: 4 Hours Normal Order Time: 25 Days Normal Cost: 100 Expedited Order Time: 3 Days Expedited Cost: 300 Holding Cost Rate: 20 per Year Minimum Holding Level: 0 Maximum Holding Level: 10 Current Holding Level: 0

Example Spare Application Record Data

The following table shows the data stored in the Spare Application record that are included in the Spares Analysis example.

Section	Values Specified
Seals - Indoor Application	
Application	Name: Indoor Application
Failure Distribution	Distribution Name: Failure Distribution Distribution Description: Manually entered based on manufacturer data. Units: Months Distribution Type: Exponential MTBF: 60
Failure Consequence	Preparation Time: 4 Hours Repair Time: 8 Hours Total Correction Time: 12 Hours Labor Cost: 1000 Fixed Lost Production Cost: 0 Variable: Lost Production Cost Rate: 100000 per Day # of Required Spares: 1
Preventive Maintenance	Enable Preventive Maintenance: No Time-based Replacement Interval: No Labor Cost: No Downtime: No
Seals - Outdoor Application	
Application	Name: Outdoor Application
Failure Distribution	Distribution Name: Failure Distribution Distribution Description: Manually entered based on manufacturer data. Units: Months Distribution Type: Exponential MTBF: 48
Failure Consequence	Preparation Time: 4 Hours Repair Time: 8 Hours Total Correction Time: 12 Hours Labor Cost: 1000 Fixed Lost Production Cost: 0 Variable: Lost Production Cost Rate: 100000 per Day # of Required Spares: 1

Section	Values Specified
Preventive Maintenance	Enable Preventive Maintenance: No Time-based Replacement Interval: No Labor Cost: No Downtime: No
Bearings - Indoor Application	
Application	Name: Indoor Application
Failure Distribution	Distribution Name: Failure Distribution Distribution Description: Manually entered based on manufacturer data. Units: Months Distribution Type: Exponential MTBF: 60
Failure Consequence	Preparation Time: 4 Hours Repair Time: 4 Hours Total Correction Time: 8 Hours Labor Cost: 500 Fixed Lost Production Cost: 0 Variable: Lost Production Cost Rate: 100000 per Day # of Required Spares: 1
Preventive Maintenance	Enable Preventive Maintenance: No Time-based Replacement Interval: No Labor Cost: No Downtime: No
Bearings - Outdoor Application	
Application	Name: Outdoor Application
Failure Distribution	Distribution Name: Failure Distribution Distribution Description: Manually entered based on manufacturer data. Units: Months Distribution Type: Exponential MTBF: 48

Section	Values Specified
Failure Consequence	Preparation Time: 4 Hours Repair Time: 4 Hours Total Correction Time: 8 Hours Labor Cost: 500 Fixed Lost Production Cost: 0 Variable: Lost Production Cost Rate: 100000 per Day # of Required Spares: 1
Preventive Maintenance	Enable Preventive Maintenance: No Time-based Replacement Interval: No Labor Cost: No Downtime: No
Impellers - All Applications	
Application	Name: All Applications
Failure Distribution	Distribution Name: Failure Distribution Distribution Description: Manually entered based on manufacturer data. Units: Months Distribution Type: Exponential MTBF: 72
Failure Consequence	Preparation Time: 4 Hours Repair Time: 4 Hours Total Correction Time: 8 Hours Labor Cost: 500 Fixed Lost Production Cost: 0 Variable: Lost Production Cost Rate: 100000 per Day # of Required Spares: 1
Preventive Maintenance	Enable Preventive Maintenance: No Time-based Replacement Interval: No Labor Cost: No Downtime: No

Spare Application Population Record Data



The following table shows the data stored in the Spare Application Population records that are included in the Spares Analysis example.

Population Name	Values Specified
Seals - Inboard Application	
Inboard Population 1	Population Size: 2 Age Value: 2 Years
Inboard Population 2	Population Size: 1 Age Value: 4 Years
Seals - Outboard Application	
Outboard Population 1	Population Size: 4 Age Value: 2 Years
Outboard Population 2	Population Size: 2 Age Value: 3 Years
Outboard Population 3	Population Size: 1 Age Value: 5 Years
Bearings - Inboard Application	
Inboard Population 1	Population Size: 2 Age Value: 2 Years
Inboard Population 2	Population Size: 1 Age Value: 4 Years
Bearings - Outboard Application	
Outboard Population 1	Population Size: 4 Age Value: 2 Years
Outboard Population 2	Population Size: 2 Age Value: 3 Years
Outboard Population 3	Population Size: 1 Age Value: 5 Years
Impellers - All Applications	
Pump Population 1	Population Size: 6 Age Value: 2 Years
Pump Population 2	Population Size: 1 Age Value: 4 Years

Population Name	Values Specified
Pump Population 3	Population Size: 2 Age Value: 3 Years
Pump Population 4	Population Size: 1 Age Value: 5 Years

Link an Asset or Functional Location to an RA

Procedure

1. [Access a Spares Analysis](#) on page 136 to which you want to link an asset.
2. Select the **Linked Assets** tab in the **Analysis Summary** page.
A list of assets associated with the selected analysis appears.
3. Select .
The **Asset Finder** window appears.
4. Navigate the asset hierarchy to locate the asset that you want to link to the analysis.
Tip: Use the **Search** option to search the asset.
Note: You can only link assets with the same site key as the parent analysis.
5. Select the asset or functional location that you want to link to the analysis.
6. Select .
The assets appear in the **Asset Finder**.
7. Select **Done**.
The selected asset or functional location is now linked to the analysis and appears in the **Linked Assets** section.

Delete a Spares Analysis

Procedure

1. [Access the RA Overview](#) page.
2. Select **Spares Analyses**.
A list of Spares Analyses available in the database appears.
3. Select the row containing the Spares Analysis that you want to delete, and then select .
The **Delete Spares Analysis** dialog box appears, asking you to confirm that you want to delete the selected Spares Analysis.
4. Select **Yes**.
The selected Spares Analysis is deleted.

Results

- Any associated Spares are deleted.
- Any associated Spare Applications are deleted.
- Any associated Spare Application Populations are deleted.

Access Spares Analysis Report

Procedure

1. [Access the Spares Analysis](#) whose report you want to access.
2. In the upper-right corner of any workspace within the selected Spares Analysis, select **Report**.

The Spares Analysis report appears in a new browser tab.

By default, the report contains the following [sections](#):

- **Analysis Plots**
- **Analysis Properties**
- **Spare Properties**
- **Application Properties**

About Spares Analysis Report

The baseline GE Digital APM database includes the Spares Analysis Report, which you can use to view a summary of Spares Analysis results.

The Spares Analysis Report is built from the following Catalog items:

- The main report, Spares Analysis, which is stored in the Catalog folder `\\Public\Meridium\Modules\Reliability Manager\Reports`.
- The subreport, Spares, which is stored in the Catalog folder `\\Public\Meridium\Modules\Reliability Manager\Reports`.
- The subreport, SparesApplication, which is stored in the Catalog folder `\\Public\Meridium\Modules\Reliability Manager\Reports`.
- The subreport, SparesChart, which is stored in the Catalog folder `\\Public\Meridium\Modules\Reliability Manager\Reports`.
- The supporting queries that supply data in the main report and subreports, which are stored in the Catalog folder `\\Public\Meridium\Modules\Reliability Manager\Reports`. The following supporting queries are available:
 - Spares Analysis - Applications
 - Spares Analysis - Charts
 - Spares Analysis - ChartsMain
 - Spares Analysis - Main
 - Spares Analysis - Spares
 - Spares Analysis - SparesMain

Throughout this documentation, we refer to the main report, the subreports, and the supporting queries collectively as the Spares Analysis Report.

Analysis Properties Section

The **Analysis Properties** section of the Spares Analysis Report displays information that is stored in the Spares Analysis record. The name of the analysis, which is stored in the Analysis ID field of the Spares Analysis record, is displayed in blue at the top of the **Analysis Properties** section.

The following table lists each item in the **Analysis Properties** section and the corresponding Spares Analysis record field whose data is displayed in the report.

Report Item	Record Field(s)
Analysis Properties	
Description	Short Description
Start Date	Analysis Start Date
End Date	Analysis End Date
Currency	Number
Simulation Options	
Iteration	Iteration Number
Random Seed	Random Seed
Events Logged	Enable Event Log

Spares Properties Section

Each Spare Analysis record can be linked to multiple Spare records. In the Spares Analysis report, a **Spare Properties** section will appear for each Spare record that is linked to the Spare Analysis record. The name of the spare, which is stored in the Spare ID field of the Spare record, is displayed in blue at the top of each **Spare Properties** section.

The following table lists each item in the **Spare Properties** section and the corresponding Spares Analysis record field whose data is displayed in the report.

Report Item	Record Field(s)
On-site Delivery Time	Onsite Delivery Time Value On-site Delivery Time Unit
Normal Order Time	Normal Order Time Value Normal Order Time Unit
Expedited Order Time	Expedited Order Time Value Expedited Order Time Unit
Normal Cost	Normal Cost
Expedited Cost	Expedited Cost
Holding Cost Rate	Holding Cost Rate Holding Cost Unit
Inventory level range	Min Inventory Level Max Inventory Level
Current Holding Level	Current Holding Level

Application Properties Section

Spare records can be linked to multiple Spare Application records. For each Spare record in the Spares Analysis report, there can be multiple **Application Properties** sections. The name of the corresponding

Application, which is stored in the Application ID field of each Spare Application record, is displayed at the beginning of each **Application Properties** section.

Each **Application Properties** section contains the following grids:

The **Populations** grid displays information stored in Spare Application Population records. There can be multiple Spare Application Population records linked to each Spare Application record. For each Spare Application Population record, one row exists in the **Populations** grid.

The following table lists each item in the **Populations** grid and the corresponding Spare Application Population record field whose data is displayed in the report.

Report Item	Record Field(s)
Population Name	Name
Population Size	Population Size
Population Age	Age Age Time Unit

The **Failure Distribution** grid displays information that is stored in Distribution records that are linked to the Spare Application record. There can be multiple Distribution records linked to each Spare Application record. For each Distribution record, one row exists in the **Failure Distribution** grid.

The following table lists each item in the **Failure Distribution** grid and the corresponding Distribution record field whose data is displayed in the report. The values in the **Parameter 1**, **Parameter 2**, and **Parameter 3** columns will be different depending on whether the Distribution record is an Exponential, Lognormal, Normal, or Weibull distribution.

Report Item	Family	Record Field(s)
Name	Distribution	Onsite Delivery Time Value On-site Delivery Time Unit
Distribution Type	Distribution	Normal Order Time Value Normal Order Time Unit
Time Unit	Distribution	Expedited Order Time Value Expedited Order Time Unit
Parameter 1	Exponential Lognormal Normal Weibull	MTBF Mu Fix Mean Beta

Report Item	Family	Record Field(s)
Parameter 2	Lognormal Normal Weibull	Sigma Fix Standard Deviation Eta Note: If the Distribution Type is Exponential, no value is displayed.
Parameter 3	Lognormal Weibull	Gamma Gamma Note: If the Distribution Type is Exponential or Normal, no value is displayed.

The **Failure Consequence** grid displays information stored in the Spare Application record.

The following table lists each item in the **Failure Consequence** grid and the corresponding Spare Application record field whose data is displayed in the report.

Report Item	Record Field(s)
Preparation Time	Preparation Time Value Preparation Time Unit
Repair Time	Repair Time Value Repair Time Unit
Labor Cost	Repair Labor Cost
Fixed Lost Production Cost	Fixed Lost Production Cost
Variable Lost Production Cost Rate	Variable Lost Production Cost Variable Lost Production Unit
# of Required Spaces	Required Spares

The **Preventive Maintenance** grid displays information stored in the Spare Application record.

The following table lists each item in the **Preventive Maintenance** grid and the corresponding Spare Application record field whose data is displayed in the report.

Report Item	Record Field(s)
Time-based Replacement Interval	PM Interval Value PM Interval Unit
Labor Cost	PM Labor Cost
Downtime	PM Downtime Value PM Downtime Unit

Plots Section

If you have [run a Monte Carlo simulation](#), the [Spares Analysis graphs](#) will appear in the Spares Analysis report with the results from the last simulation that was run.

Spares



Access a Spare

Procedure

1. [Access the Spares Analysis](#) whose associated Spare you want to view.
2. In the left pane, select the Spare whose details you want to view.

The details of the selected Spare appears in the workspace, displaying the following tabs:

- **Definition:** Contains the values that you provided while creating a Spare.

Note: As needed, in the **Definition** section, you can select  to modify the values in the [available fields](#), and then select  to save your changes.

- **Applications:** Contains the list of Applications associated with the selected Spare.
- **Result:** The **Result** tab is selected by default, displaying the [Spare Level plot](#) for the selected Spare. You can also view the following plots for the selected Spare:
 - Downtime plot
 - Spare Usage plot
 - Sensitivity plot
 - Optimal Holding plot

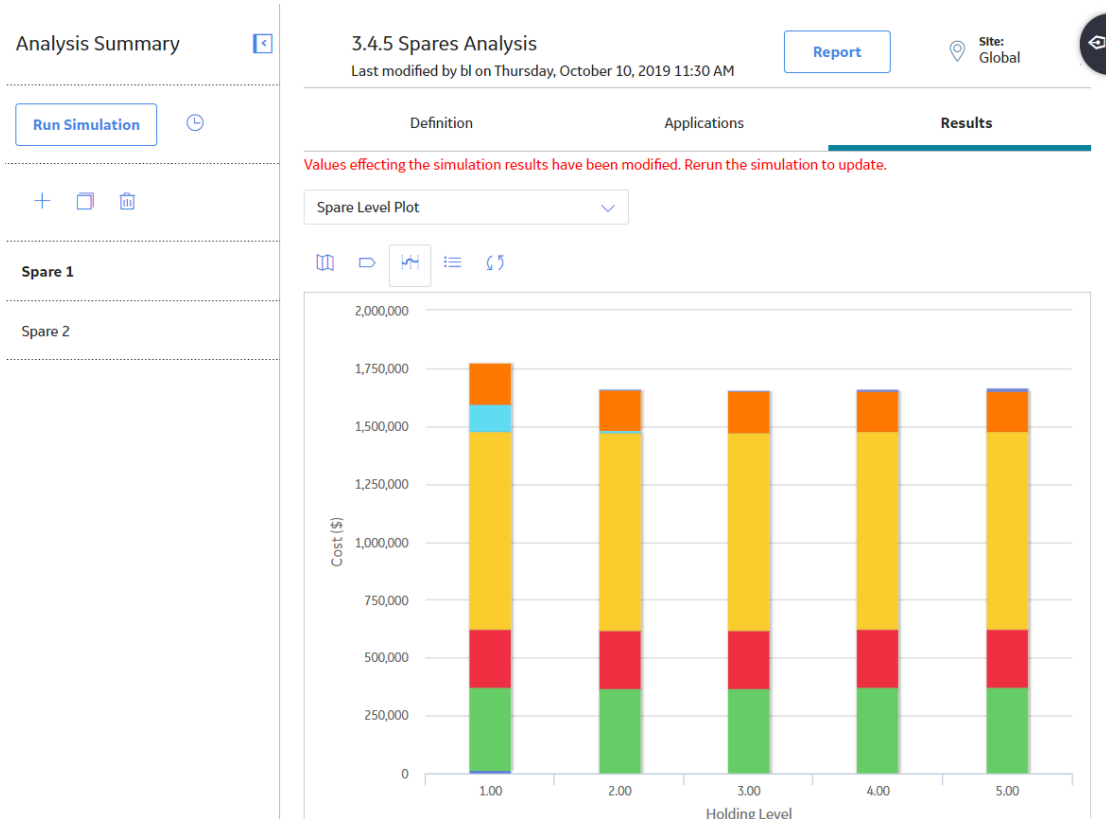

Create a Spare

This topic describes how to create a new Spare. You can also [copy an existing Spare](#).

Before You Begin

- [Create a Spares Analysis](#)

Procedure

1. [Access the Spares Analysis](#) for which you want to create a Spare.
2. In the left pane, select +.
The datasheet for the new spare appears.
3. As needed, enter values in the [available fields](#), and then select 💾.
The Spare is created.

Results

- The Spare is linked to the Spares Analysis.

Copy a Spare

This topic describes how to copy a Spare. You can also create a new Spare.

Before You Begin

- [Create a Spares Analysis](#)

Procedure

1. [Access the Spares Analysis](#) for which you want to create a Spare.
2. In the left pane, select the Spare that you want to copy, and then select .



The **Copy Spare** dialog box appears, asking for a confirmation to copy the selected Spare.

3. Select **Yes**.

The new Spare is created and appears in the left pane in the following format:

<Name of the original Spare> - 1

Where, <Name of the original Spare> is the name of the Spare that you copied.

Note: If you want to change the name of the Spare, you can select the **Definition** tab, and then select . To save your changes, select . The name of each Spare must be unique to the root record.

Results

- The Spare is linked to the Spares Analysis.
- Any associated Spare Applications are copied.
- Any associated Spare Application Populations are copied.
- Values in the Failure Consequence and Preventive Maintenance section are copied.

Delete a Spare

About This Task

When you delete a Spare, any associated Spare Applications and Spare Application Populations are also deleted.

Procedure

1. [Access the Spares Analysis](#) whose associated Spare you want to delete.
2. In the left pane, select the row containing the Spare that you want to delete, and then select .

The **Delete Spare** dialog box appears, asking if you really want to delete the selected Spare record.

3. Select **Yes**.

The selected Spare record is deleted.

Results

- Any associated Spare Applications are deleted.
- Any associated Spare Application Populations are deleted.

Spare Applications

Access a Spare Application

Procedure



1. [Access the Spare](#) for which you want to view a Spare Application.
2. Select the **Applications** tab.

A list of Applications associated with the selected Spare appears.

3. In the list, select the hyperlink for the Spare Application whose details you want to view.

The details of the selected Spare Application appear in the workspace. The following tabs appear in the workspace:

- **Definition:** Displays the name of the selected Spare Application.

Note: As needed, in the **Definition** section, you can select  to modify the name of the Spare Application, and then select  to save your changes.

- **Populations:** Displays a list of any Spare Application Populations that are linked to the selected Spare Application. This tab is selected by default.
- **Failure Distributions:** Displays a list of any Failure Distributions that are linked to the selected Spare Application.
- **Failure Consequence:** Displays the failure consequence information for the selected Spare Application.
- **Preventive Maintenance:** Displays the preventive maintenance information for the selected Spare Application.

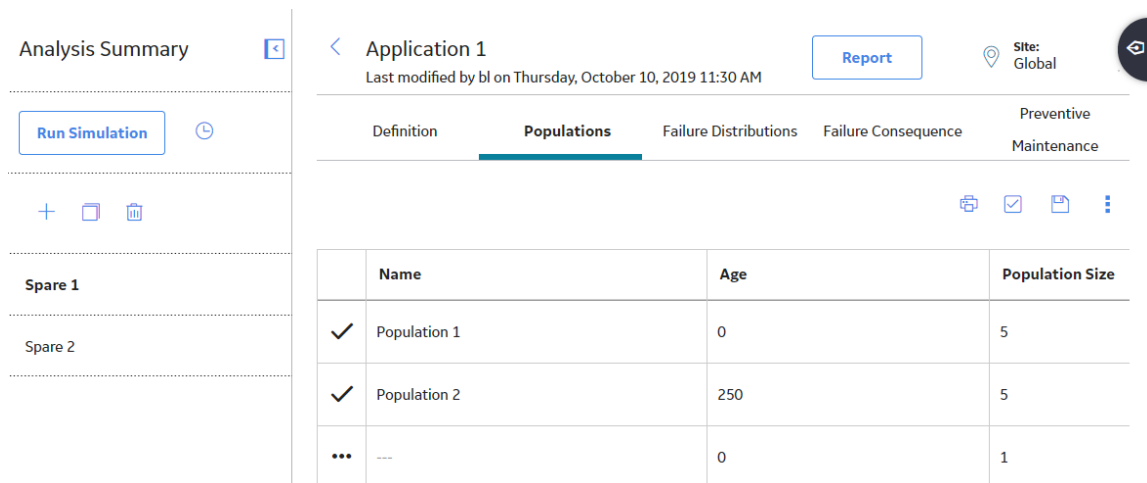

The screenshot shows the workspace for 'Application 1'. The left sidebar contains an 'Analysis Summary' section with a 'Run Simulation' button and a list of spare applications: 'Spare 1' and 'Spare 2'. The main workspace has a header for 'Application 1' with a 'Report' button and a 'Site: Global' indicator. Below the header are tabs for 'Definition', 'Populations', 'Failure Distributions', 'Failure Consequence', and 'Preventive Maintenance'. The 'Populations' tab is active, displaying a table with the following data:

	Name	Age	Population Size
✓	Population 1	0	5
✓	Population 2	250	5
...	---	0	1



Create a Spare Application

This topic describes how to create a new Spare Application. You can also [copy an existing Spare Application](#).

Before You Begin

- [Create a Spare](#)

Procedure

1. [Access the Spare](#) for which you want to create a new Spare Application.
 2. Select **Applications**, and then select .
The workspace for the new Spare Application appears.
 3. In the **Application Name** box, enter the name of the application. The name of each Spare Application must be unique to the root record.
 4. Select .
- The Spare Application is saved. The workspace for the Spare appears, displaying the **Populations** section.

Results

The new Spare Application is linked to the Spare automatically.

Next Steps

- [Create a Spare Application Population.](#)
- [Create a Failure Distribution.](#)

Copy a Spare Application

This topic describes how to copy a Spare Application. You can also [create a new Spare Application](#).

Before You Begin

- [Create a Spare](#)

Procedure

1. [Access the Spare](#) for which you want to create a new Spare Application.
2. Select **Applications**.
The list of Spare Applications associated with the selected Spare appears.
3. In the **Application** section, select the row that contains the Application that you want to copy, and then select .



The **Copy Application** dialog box appears, asking you to confirm that you want to copy the selected Spare Application.

4. Select **Yes**.

The new Spare Application appears in the list of available Spare Applications in the following format:

<Name of the original SpareApplication> - Copy 1

Where, <Name of the original SpareApplication> is the name of the Spare Application that you copied.

Note: If you want to modify the name of the Spare Application, you can select the **Definition** tab, and then select . To save your changes, select . The name of each Spare Application must be unique to the root record.

Results

- The new Spare Application is linked to the Spare automatically.
- Any associated Spare Application Populations are copied.

- Failure Consequence and Preventive Maintenance information is copied.

Next Steps

- [Create a Spare Application Population.](#)
- [Create a Failure Distribution.](#)

Delete a Spare Application

About This Task

When you delete a Spare Application, any associated Spare Application Populations are also deleted.

Procedure

1. [Access the Spare](#) for which you want to delete an associated Spare Application.
2. Select **Application**.

A list of Spare Applications associated with the selected Spare appears.

3. Select the row containing the Spare Application that you want to delete, and then, in the upper-right corner of the section, select .

The **Delete Application** dialog box appears, asking you to confirm that you want to delete the selected Spare Application.

4. Select **Yes**.

The selected Spare Application is deleted. The updated list of Spare Applications appears in the **Applications** section.

Results

- Any associated Spare Application Populations are deleted.

Spare Application Populations

Access a Spare Application Population

Procedure

[Access the Spare Application](#) for which you want to view an associated Spare Application Population.

The **Populations** section appears, displaying the list of Application Populations associated with the selected Spare Application.

The details of the selected Spare Application Populations appear in the following columns:

- **Name:** The name of the Spare Application Population. This is a required field. The name of each Spare Application Population must be unique to the root Spare Application.
- **Age:** The operational age of the population of equipment that is associated with the data in the linked Spare Application and Spare. Age value is the amount of time that the population has been in use.
- **Population Size:** The number of pieces of equipment that share the same age.
- **Age Time Unit:** The unit of measure associated with the **Age**. By default, the **Age Time Unit** list is set to Years.

Note: As needed, you can modify the values in the [available fields](#), and then select  to save your changes.

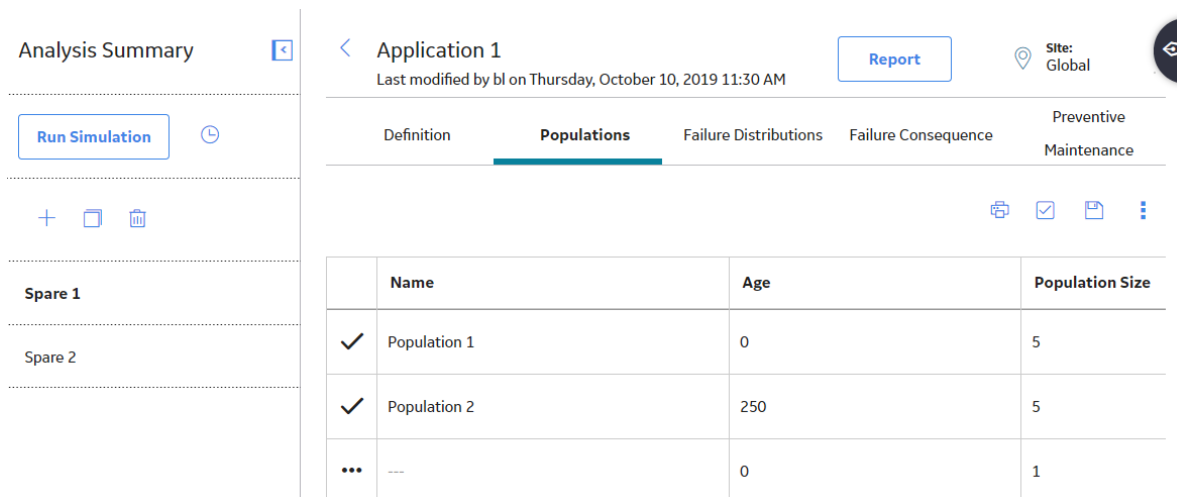

	Name	Age	Population Size
✓	Population 1	0	5
✓	Population 2	250	5
...	---	0	1

Create a Spare Application Population

Before You Begin

- [Create a Spare Application](#)

Procedure

1. [Access the Spare Application](#) for which you want to create a new Spare Application Population.
2. In the grid in the **Populations** section, in the last row, enter the information in the [available fields](#), and then select . The name of each Spare Application Population must be unique to the root record.

Tip: You can add more than one Spare Application Population and save them all together.

The Spare Application Population is saved.

Results

The new Spare Application Population is linked to the Spare automatically.

Next Steps



- [Run a Monte Carlo Simulation](#)

Delete a Spare Application Population

Procedure

1. [Access the Spare Application Population](#) that you want to delete.
2. In the upper-right corner of the **Populations** section, select .
3. Select the check box for a Spare Application Population that you want to delete.

Tip: You can select more than one Spare Application Population to delete.

4. In the upper-right corner of the Populations section, select , and then select .
- The **Alert** window appears, asking you to confirm that you want to delete the selected Spare Application Population.
5. Select **Yes**.
- The selected Spare Application Population is deleted. The updated list of Spare Application Populations appears in the **Populations** section.

Failure Distributions

Access a Failure Distribution

About This Task

You can access and modify the details of a Failure Distribution only if you have created a new Failure Distribution.

If you associate the Failure Distribution information, you cannot access and modify the Failure Distribution information in the **Failure Distributions** section. You can, however, [refresh the distribution](#) to retrieve the latest data.

Procedure

1. [Access the Spare Application](#) for which you want to view a Failure Distribution.
2. Select the **Failure Distributions** tab.

The list of Failure Distributions associated with the selected Spare Application appears in the workspace.

Following [columns](#) of information appear in the workspace:

- Distribution Name
- Distribution Type
- Time Unit
- Parameter 1
- Parameter 2
- Parameter 3

3. Select the row containing the Spare Failure Distribution that you want to view, and then select .
- The **Update Distribution** window appears, displaying the details of the selected Failure Distribution.

Note: As needed, you can modify the values in the [available fields](#), and then select **OK** to save your changes.

Create a Failure Distribution

Before You Begin

- [Create a Spare Application](#)

About This Task

When you create a Failure Distribution and associate it with a Spare Application, you are defining the time interval during which a spare part can fail, requiring a replacement (or repaired to as good as new) spare part.

This topic describes how to create a new Failure Distribution for a Spare Application. You can also [associate Existing Failure Distribution](#).

Procedure

1. [Access the Spare Application](#) for which you want to create a new Failure Distribution.
2. Select the **Failure Distributions** tab, and then select **+**.

The datasheet for the new Failure Distribution appears.

3. As needed, enter values in the [available fields](#), and then select **OK**.

The Failure Distribution details are saved and appear in the **Failure Distributions** section.

Results

- The New Failure Distribution is associated with the Spare Application.
- When you define multiple Failure Distributions for a Spare Application:
 - After a failure occurs and a replacement (or repaired to as good as new) spare part is put into service, the time in-service for the spare part is reset to zero (0) for all the Failure Distributions defined for that Spare Application to reflect that a replacement (or repaired to as good as new) spare part is placed into service.

- After you complete preventive maintenance on a spare part to mitigate one failure, the time in service for the spare part is reset to zero (0) for all the Failure Distributions defined for that Spare Application to reflect that conducting preventive maintenance on a spare part is equivalent to replacing (or repairing to as good as new) the spare part.

Next Steps

- [Run a Monte Carlo Simulation](#)

Associate Failure Distribution Information

Before You Begin

- The Spares Analysis must contain the Spare Application for which you want to associate Failure Distribution information.
- You cannot associate an analysis that uses the unit of measure Quarters.
- Associated analyses must be assigned to the same site.

About This Task

If an existing Reliability Distribution or Reliability Growth Analysis contains failure distribution information for the piece of equipment that you are analyzing in a Spares Analysis, you can associate that Failure Distribution information with the Spare Application.

This topic describes how to associate Failure Distribution information with a Spare Application. You can also [create a new Failure Distribution](#).

Procedure

1. [Access the Spare Application](#) for which you want to create a new Failure Distribution.
2. Select the **Failure Distributions** tab.
The list of Failure Distributions associated with the selected Spare Application appears.
3. In the upper-right corner of the grid, select **Add From Analysis**.
The **Search** window appears.
4. Specify the search criteria that will return the Reliability Distribution or Reliability Growth Analysis containing the Failure Distribution information that you want to associate, and then select .
The search results appear in the grid below the search criteria.
5. Select the analysis with the failure distribution information that you want to associate with the Spares record, and then select **OK**.

The failure distribution information from the selected analysis appears in the **Failure Distributions** section.

Note: If you select a row containing an analysis that uses the unit of measure Quarters, an error message appears, indicating that the unit of measure Quarters is not supported in Spares Analysis, and the Failure Distribution information for that Analysis is not added to the **Failure Distributions** section.

Results

- After you associate the Failure Distribution information, you cannot modify the Failure Distribution information in the **Failure Distributions** section. You can, however, [refresh the distribution](#) to retrieve the latest data.

Refresh Failure Distribution Information

Before You Begin

- [Associate Failure Distribution Information](#)

About This Task

After you [associate failure distribution information](#) with an existing Reliability Distribution or Reliability Growth Analysis, if the source analysis is modified, you can refresh the distribution to retrieve the latest data.

Procedure

1. [Access the Spare Application](#) that contains Failure Distribution for which you want to refresh information.
2. Select the **Failure Distributions** tab.
The list of Failure Distributions associated with the selected Spare Application appears in the workspace.
3. Select the row containing the Spare Failure Distribution that you want to refresh, and then select **Refresh Distribution**.

The **Refresh Distribution** dialog box appears, asking you to confirm that you want to refresh the selected Failure Distribution information.

4. Select **OK**.

The Failure Distribution information is refreshed.

Remove Failure Distribution Information Association

Before You Begin

- [Associate Failure Distribution Information](#)

About This Task

After you [associate failure distribution information](#) with an existing Reliability Distribution or Reliability Growth Analysis, if the source analysis is modified, you can refresh the distributions to retrieve the latest data. If you want to modify the data manually after associating the failure distribution information, you can remove the association between the Failure Distribution record and the Reliability Growth or Reliability Distribution record.

Procedure

1. [Access the Spare Application](#) that contains Failure Distribution for which you want to remove association.
2. Select the **Failure Distributions** tab.
The list of Failure Distributions associated with the selected Spare Application appears in the workspace.
3. Select the row containing the Failure Distribution for which you want to remove the association, and then select  .

The **Edit Distribution** message appears, asking you to confirm that you want to modify the distribution.

4. Select **OK**.

The **Update Distribution** window appears.

5. As needed, modify the values in the [available fields](#), and then select **OK**.

The Failure Distribution information is saved and the association is removed.

Results

When you modify a Failure Distribution that is associated with an existing Reliability Distribution or Reliability Growth Analysis, the connection between the following is removed:

- The Failure Distribution to which the Spare Application is linked.
- and-
- The Reliability Growth or Reliability Distribution to which you associated the failure distribution information.

Delete a Failure Distribution Record

Procedure

1. [Access the Spare Application](#) that contains Failure Distribution that you want to delete.
2. Select the **Failure Distributions** tab.

The list of Failure Distributions associated with the selected Spare Application appears in the workspace.

3. Select the row containing the Failure Distribution that you want to delete, and then select .

The **Delete Spare Application Failure Distribution** dialog box appears, asking you to confirm that you want to delete the selected Failure Distribution.

4. Select **OK**.

The selected Failure Distribution is deleted. The updated list of Failure Distributions is displayed in the **Failure Distributions** section.

Specify Failure Consequences

Before You Begin

- [Create a Spare Application](#)

Procedure

1. [Access the Spare Application](#) for which you want to specify failure consequences.
2. Select the **Failure Consequence** tab.

The **Failure Consequence** section appears.

3. Enter values in the following fields:

- **Preparation Time:** The amount of time it takes to prepare for the repair of a part. Preparation tasks might include setting up equipment that may be used for the repair or disassembling any equipment. The spare parts are not required to be in stock for preparation tasks to be performed. The list to the right of the **Preparation Time** box lets you define the unit of measure for the specified period of time. By default, Days is selected as the unit of measure.

- **Repair Time:** The amount of time it takes to complete the actual repair. The list to the right of the **Repair Time** field lets you define the unit of measure for the specified period of time. By default, Days is selected as the unit of measure.
- **Total Correction Time:** The sum of the values in the **Preparation Time** and **Repair Time** boxes. This box is populated automatically after you enter values in the **Preparation Time** and **Repair Time** boxes. This value is not stored in the Spare Application record; it appears only in the **Failure Consequence** section of the Spare Application record. The list to the right of the **Total Correction Time** box contains the unit of measure for the specified period of time. The list is populated automatically with the unit of measure that is the largest between the selections in the **Preparation Time** and **Repair Time** lists.
- **Labor Cost(\$)** : The cost of the labor associated with the value in the **Total Correction Time** box.
- **Fixed Lost Production Cost (\$):** The lost production cost that is incurred each time the piece of equipment fails, regardless of the length of downtime. For example, when a piece of equipment fails, there might be incomplete products that must be thrown away, therefore costing your organization a total of \$20,000 each time the piece of equipment fails.
- **Variable Lost Production Cost Rate (\$):** For a piece of equipment failure, the lost production cost per unit of downtime. For example, your organization might lose \$100,000 per day that the piece of equipment is down. The list to the right of the **Variable Lost Production Cost Rate (\$)** field lets you define the unit of measure for the specified cost. By default, Day is selected as the unit of measure.
- **# of Required Spares :** The number of spare parts that will be used for this particular repair.

4. Select .

The values are saved in the **Failure Distributions** section.

Specify Preventive Maintenance

Before You Begin

- [Create a Spare Application](#)

Procedure

1. [Access the Spare Application](#) for which you want to specify preventive maintenance.
2. Select the **Preventive Maintenance** tab.

The **Preventive Maintenance** section appears.

3. Enter values in the following fields:
 - **Enable Preventive Maintenance:** Indicates whether or not you want to include any preventive maintenance work that is done for the spare part(s) in the calculations of the Monte Carlo simulation. When you select this check box, the analysis results will include a calculation of the preventive maintenance cost based on the values that you specify in the **Preventive Maintenance** section.
 - **Time-based Replacement Interval:** The operational time between subsequent planned maintenance activities. This box becomes enabled only if you selected the **Enable Preventive Maintenance** check box. The list to the right of the **Time-based Replacement Interval** field lets you define the unit of measure for the specified period of time. By default, Days is selected as the unit of measure.
 - **Labor Cost(\$):** The cost of labor for each time the maintenance work is performed on the spare part(s). This option is enabled only if you select the **Enable Preventive Maintenance** check box.
 - **Downtime:** The amount of time that the piece of equipment is not functional during the preventive maintenance work. When you run the Monte Carlo simulation, the GE Digital APM system will use

this value and the values that you specify in the **Variable Lost Production Cost Rate** and **# of Required Spares** boxes in the **Failure Consequence** section to calculate the cost of the preventive maintenance activity. The list to the right of the **Downtime** field lets you define the unit of measure for the specified period of time. By default, Days is selected as the unit of measure.

4. Select .

The values are saved in the **Preventive Maintenance** section.

Monte Carlo Simulations

About Monte Carlo Simulations

There are some instances in which conditions are too complex to use the typical analytical methods to answer certain questions. Monte Carlo simulations can be used to predict results in these situations.

Details

Consider the following simple questions with seemingly unpredictable answers:

- How many people will be in the check-out line at the grocery store at 7 P.M. on Wednesday?
- How many cars will be on Main Street at 9 P.M. on Friday?
- When will the next power outage occur in our neighborhood?

The answers to these questions vary based on a number of factors, including:

- The probability of previous occurrences in these situations.
- Actual conditions leading up to the event.
- Variable values that provide inputs to calculated outputs.

Now, consider the following more complex questions:

- How long will the piece of equipment continue to operate before the next failure?
- How many spare parts should be stored to handle unplanned failures but not result in a surplus of parts that are not needed?

When these types of questions arise, a Monte Carlo simulation can be run to look at the random variables and probability for a complex piece of equipment to calculate the most predictable results. You can specify the number of iterations to indicate the amount of times that you want the Monte Carlo simulation to run. The larger the number of iterations, the more accurate the Monte Carlo results will be.

Rolling a Seven Using two Dice

Suppose you want to determine the probability of rolling a seven using two dice with values one through six. There are 36 possible combinations for the two dice, six of which will total seven, which means that mathematical probability of rolling a seven is six in 36, or 16.67 percent. But is the mathematical probability the same as the actual probability? Or are there other factors that might affect the mathematical probability, such as the design of the dice themselves, the surface on which they are thrown, and the technique that is used to roll them?

To determine the actual probability of rolling a seven, you might physically roll the dice 100 times and record the outcome each time. Assume that you did this and rolled a seven 17 out of 100 times, or 17 percent of the time. Although this result would represent an actual, physical result, it would still represent an approximate result. If you continued to roll the dice again and again, the result would become less and less approximate.

A Monte Carlo simulation is the mathematical representation of this process. It allows you to simulate the act of physically rolling the dice and lets you specify how many times to roll them. Each roll of the dice represents a single iteration in the overall simulation; as you increase the number of iterations, the simulation results become more and more accurate. For each iteration, variable inputs are generated at random to simulate conditions such as dice design, rolling surface, and throwing technique. The results of the simulation would provide a statistical representation of the physical experiment described above.

Run a Monte Carlo Simulation

Before You Begin

- [Create a Spares Analysis](#)
- The Spare analysis must contain at least one:
 - [Spare record](#)
 - [Spare Application record](#)
 - [Spare Application Population record](#)

If the analysis does not meet this minimum requirement, when you attempt to run the Monte Carlo simulation, an error message appears, explaining which record(s) are missing.

About This Task

When you run a [Monte Carlo simulation](#), calculations are performed on the delivery time, downtime, lost production costs, and failure and repair data to determine how many spare parts should be kept on hand at any given time. A Monte Carlo simulation performs these calculations many times for every spare part. The exact number of times the calculations are performed is determined by the value in the [Number of Iterations box](#) in the **Analysis Summary** workspace for the selected Spares Analysis. After a Monte Carlo simulation has been run, you can view its results on any of the [Spares Analysis plots](#).

The plots will contain results from the last time the Monte Carlo simulation was run. Therefore, if you edit any data on any record that might affect the results of the Monte Carlo simulation, you should re-run the simulation before viewing the plots. Otherwise, the plots might contain results that do not match the most current data.

You can run only one simulation at a time for an analysis. For example, if you are running a simulation for Analysis A, you cannot run another simulation for Analysis A. You can, however, run a simulation for Analysis A while running the simulation for Analysis B. While a simulation is running, you can continue working in other areas of the GE Digital APM Framework.

Procedure

1. [Access the Spares Analysis](#) for which you want to run a simulation.

Note: The **Run Simulation** link is only enabled when the simulation is first created or when changes have been made that affect the simulation results. If changes are made to an existing simulation, only the modified scenario will run.

Important: Reliability Simulation Service is required to execute this task.

2. In the left pane, select **Run Simulation**.

Simulation begins and the status appears in the left pane, indicating the progress of the simulation in percentage.

After the simulation is complete, a confirmation message appears in the top right corner of the page. The [plots](#) display the updated results.

Chapter

8

System Reliability

Topics:

- [System Reliability: Overview](#)
- [System Reliability: Workflow](#)
- [System Reliability Analyses](#)
- [Resources](#)
- [System Scenario](#)
- [Diagrams](#)
- [Risks](#)
- [Actions](#)
- [Global Events](#)
- [Grid View](#)
- [Simulations](#)

System Reliability: Overview

Overview of System Reliability Analysis

Reliability Analytics

The Reliability Analytics module provides a collection of tools that apply reliability engineering principles to help you make tactical (short-term) and strategic (long-term) decisions for maintenance and operational equipment management activities. It also provides:

- A means for analyzing historical failure data to identify trends and predict future failures.
- A mechanism for simulating what if scenarios regarding the reliability of a system to determine if a new or modified strategy will be effective.

The Reliability Analytics module provides the following types of tools:

- Production Analysis
- System Reliability Analysis
- Spares Analysis
- Reliability Distribution Analysis
- Probability Distribution Analysis
- Reliability Growth Analysis
- Automation Rules

Each tool provides a unique set of features that allow you to analyze data to develop strategies to improve reliability.

System Reliability Analysis

System Reliability Analysis is a tool that allows you to model different system scenarios (often referred to as RAM, i.e., Reliability, Availability, and Modelling) and then run Monte Carlo simulations to simulate the behavior of the system so that you can predict the cost and reliability of the system and its elements.

System Reliability Analysis Workflow

This workflow provides the basic, high-level steps to develop a System Reliability Analysis. The steps and links in this workflow do not necessarily reference every possible procedure.

1. [Define Analysis Parameters](#) Provide values for the analysis parameters that will serve as inputs to the simulation.
2. **Develop Scenarios:** To develop a Scenario, you must [create a System Scenario record](#) and then [build a Diagram](#) for the Scenario. You can create multiple Scenarios to model different design options for a single system. For each Scenario, you can define [Risks](#), [Actions](#), and [Global Events](#).
Note: Interaction with diagramming and design canvases is not available on [touch-screen devices](#).
3. **Run simulations:** You can [perform a Monte Carlo simulation](#) of a System Scenario to calculate the availability and cost of failure for an entire system and the individual elements included in each Scenario.
4. **Evaluate results:** Running the simulation will result in the generation of various calculations and plots. By [evaluating the results](#), you will be able to determine the cost and reliability of each Scenario relative to other Scenarios in the analysis.
5. **Modify Scenarios and rerun simulations:** By [modifying Scenarios](#) and [rerunning the simulation](#), you can determine the impact of those changes to the overall cost and reliability of the system. You can

complete this step as many times as needed until you feel that the analysis cannot be refined any further.

6. Make recommendations: After you have modified the Scenarios and have rerun the simulation various times, you should be able to identify the conditions that will result in the lowest cost and the highest reliability. You can then make recommendations about measures that should be implemented based on the analysis results.

System Reliability: Workflow

Reliability Analytics: System Reliability Analysis Workflow

This workflow describes the process for determining the impact of changes from a series of scenarios to determine the overall cost and reliability of the system.

In the following workflow diagram, the blue text in a shape indicates that the corresponding description has been provided in the sections that follow the diagram. For more information, refer to the [Interpreting the Workflow Diagrams](#) topic in the [APM Product Workflows](#) documentation.

Note: For information on the personas associated with a GE Digital APM module, refer to the [APM Product Workflows](#) documentation.

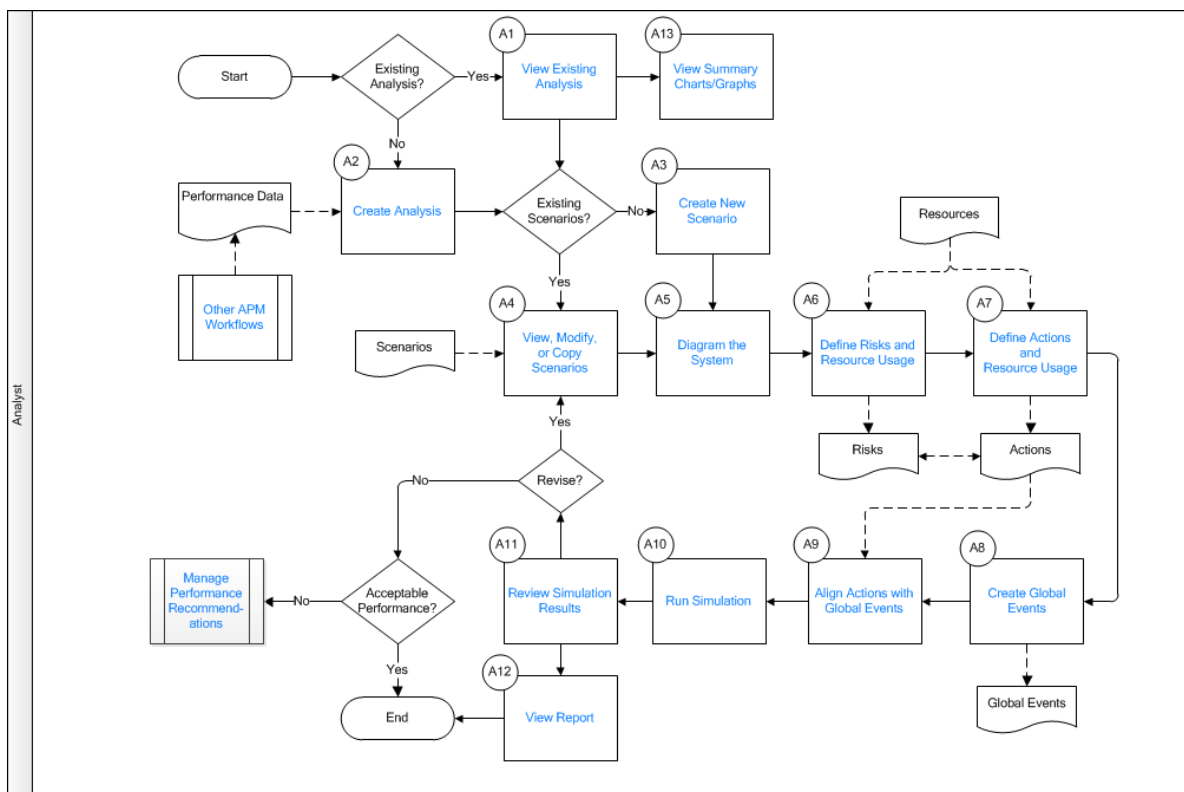

1. [View Existing Analysis](#) on page 169
2. [Create Analysis](#) on page 169
3. [Create New Scenario](#) on page 169
4. [View, Modify, or Copy Scenario](#) on page 169
5. [Diagram the System](#) on page 169
6. [Define Risks and Resource Usage](#) on page 171

7. [Define Actions and Resource Usage](#) on page 171
8. [Create Global Events](#) on page 172
9. [Align Actions with Global Events](#) on page 172
10. [Run Simulation](#) on page 172
11. [Review Simulation Results](#) on page 172
12. [View Report](#) on page 172
13. [Manage Performance Recommendations](#) on page 173
14. [Other Workflows](#) on page 173
15. [View Summary Charts/Graphs](#) on page 172

View Existing Analysis

Persona: Analyst

Find and view an existing analysis on the **Analysis Summary** page. From this page, charts and graphs can be viewed, or the analysis can be modified.

Create Analysis

Persona: Analyst

Create an analysis to set-up all of the required data fields and families that are needed to conduct the remainder of the analysis.

Create New Scenario

Persona: Analyst

Scenario creation is the initial step required to set-up all of the required data fields and families that are needed to model the Reliability Availability and Maintainability of the scenario

View, Modify, or Copy Scenario

Persona: Analyst

Copy a scenario to create a version that contains all Risks, Actions, Diagram elements, and Global Events. The copy feature allows users to make small changes to a scenario and compare one scenario against the next

Diagram the System

Persona: Analyst

Diagram the system using the palette containing the following diagram elements: Assets, Sub-System, Buffer, Link Switch, and Sensor. The diagram tools allow the user to connect elements to one another to diagrammatically express a physical system.

Add a Subsystem

Add a subsystem to present a new diagram palette. A diagram does not require subsystems, but can contain as many subsystems as you require.

Add an Asset to the Subsystem

Add an Asset diagram element to the subsystem to express an entity that is essential to system function (e.g., a pumping system would likely have an asset of Pump).

Import a Growth Analysis

Import a Growth Analysis by searching and selecting a growth analysis from the generated list. The imported growth analysis will be expressed in the diagram as an Asset, where the asset has a failure rate that is based on the growth analysis.

Import a Reliability Distribution

Import a Reliability Distribution by searching and selecting a reliability distribution from the generated list. The imported reliability distribution will be expressed in the diagram as an Asset where the asset has a failure rate (TTF) and repair rate (TTR) that is based on the reliability distribution.

Import an Asset

Import an Asset by searching and selecting an asset from the hierarchy. The imported asset will be expressed in the diagram as an Asset where the failure rates of the asset are based on previous reliability distributions or growth analyses. Additionally, this will create a relationship between the analysis and the asset

Build K Out of N Subsystem

Build K out of N Subsystems, where K is the number of assets required in order to meet the system requirements (e.g., a pumping system could have three pumps in parallel, where each pump has a production contribution of 50% and the system requirement is met by having any two of the three pumps available).

Simulate Partial Production Loss

Simulate partial production loss using a model of parallel assets where one asset does not imply total failure of a system, but instead reduces the system capacity.

Build a Subsystem with a Buffer

Build a subsystem with a buffer, which can be used to simulate time delays.

Build a Backup Subsystem

Build a backup subsystem by using a model where K number of assets are required to be available to meet the system requirements.

For example, a pumping system could have three pumps in parallel, where each pump has a production contribution of 50% and the system requirement is met by having any two of the three pumps available. In this case, one of the assets will have the initial setting of Off and the other two assets will have initial settings of On. Through the application of switches and sensors, the system does not experience a failure because the backup asset will be turned On when a failure occurs in either of the other two assets

Define Risks and Resource Usage

Persona: Analyst

Define a risk to express the financial impact of a failure of an asset.

Edit Distribution (TTF)

Edit the TTF Distribution to define the rate at which failures occur to the asset.

Edit Distribution (TTR)

Edit the TTR Distribution to define the rate at which repairs occur to the asset.

Add Resource Usage (Planned)

Add a Planned Resource Usage to define usages of resources and their associated costs. Associated costs include, but are not limited to, Parts, Personnel, Fuel, and Equipment Rental that are incurred on a planned basis.

Add Resource Usage (Unplanned)

Add an Unplanned Resource Usage to define usages of resources and their associated costs. Associated costs include, but are not limited to, Parts, Personnel, Fuel, and Equipment Rental that are incurred on an unplanned basis. In many instances, unplanned resource usage incurs a larger cost to the organization than planned usages of the same resource.

Reset Related Risks

Reset Related Risks to reset specific failures based on the execution of an Action.

For example a pumping system could have three failure modes, such as bearing failure, seal failure, and impeller failure. If a rebuild Action took place, then this could effectively reset the risk of each of these failure modes.

Import Reliability Distribution Values

Import Reliability Distribution Values by searching and selecting a reliability distribution from the list. The failure rates of the distribution will be associated with the given risk

Import Reliability Growth Values

Import Reliability Growth Values by searching and selecting a growth analysis from the list. The failure rates of the growth analysis will be associated with the given risk.

Define Actions and Resource Usage

Persona: Analyst

Define actions to mitigate the severity and frequency of risks.

Add Resource Usage

Add Resource Usage to define usages of resources and their associated costs. Associated costs include, but are not limited to, Parts, Personnel, Fuel, and Equipment Rental that are incurred as part of the Action.

Mitigate Risks

Mitigate risks by selecting which of the risks the action will mitigate within the context of an Action.

Create Global Events

Persona: Analyst

Create Global Events to define one-time or recurring events that take the system out of service for a period of time.

Align Actions with Global Events

Persona: Analyst

Align specific Actions with global events (e.g., during this scheduled two-week maintenance outage, I will perform the Pump Rebuild Action, and omit the Weekly Lubrication check).

Run Simulation

Persona: Analyst

Queue the simulation service to run a selected number of iterations based on the costs, rates, and uncertainties associated with the analysis parameters to find the mean reliability, availability, and maintainability values.

Review Simulation Results

Persona: Analyst

Review table and chart values of the various scenarios to determine the optimal scenario that will provide the best reliability, availability, and maintainability at the lowest operating cost.

View Report

Persona: Analyst

View a report containing GE Digital APM data in a clear and concise format. By viewing a report, the analysis can be saved as a file and reused at a later time by other applications

View Summary Charts/Graphs

Persona: Analyst

View summary charts and graphs in the analysis summary, where a number of charts and graphs display the costs associated with each of the scenarios. For more details, see the test plan for this workflow

Manage Performance Recommendations

Persona: Analyst

Create any number of performance recommendations and approve them using state management.

Note: Performance recommendations are not required.

Go to the Manage Performance Recommendations workflow.

View a Recommendation in ASM (Optional)

View existing asset strategies to view the details of a performance recommendation.

Other Workflows

Persona: Analyst

Other workflows provide production data from SAP, EAM, and Recommendations.

System Reliability Analyses

About System Reliability Analysis

System Reliability is a feature of GE Digital APM Reliability Analytics that allows you to [model different system scenarios](#) (often referred to as RAM, i.e., Reliability, Availability, and Modelling) and then run [Monte Carlo simulations](#) to simulate the behavior of the system so that you can predict the cost and reliability of the system and its elements.

System Reliability can be a useful tool in various situations:

- When you are constructing a new system, you can use a System Reliability Analysis to model various options for the construction of the system and then choose the option that is the most reliable and cost-effective.
- For existing systems, you can use a System Reliability Analysis to evaluate how the system could be modified to increase reliability and production output.

Using a System Reliability Analysis, you can:

- Estimate the overall reliability and cost of a system, including the estimated reliability for each of the included pieces of equipment and locations.
- Use equipment and location information that is already stored in the database or create new equipment and locations to use in the analysis.
- Add maintenance and downtime to the system and recalculate the effects of additions.
- View a graphical summary of the cost and reliability predictions for a system.
- Model different scenarios to compare reliability and cost across multiple systems.

Access a System Reliability Analysis

Procedure

1. [Access the RA Overview page](#).
2. Select the **System Reliability** tab.



A list of System Reliability Analyses available in the database appears.

3. Select a System Reliability Analysis whose summary you want to view.

The **Analysis Summary** workspace for the selected analysis appears.

The workspace contains the following tabs:

- **Definition:** Contains the details of the selected System Reliability Analysis.

Note: As needed, in the **Definition** section, you can select  to modify the values in the [available fields](#), and then select  to save your changes.

- **Summary:** The **Summary** tab is selected by default, displaying the [Total Cost graph](#) for all the Scenarios within the selected System Reliability Analysis. You can also view the following graphs for all the Scenarios within the selected System Reliability Analysis:
 - [Total Cost Trend graph](#)
 - [Annual Action Cost graph](#)
 - [Action Cost Trend graph](#)
 - [Resource Occurrence graph](#)
 - [Resource Time graph](#)
 - [Resource Cost graph](#)
- **Resources:** Contains a list of the resources that can be applied to Risks and Actions in the selected System Reliability Analysis.

The left pane contains the following tabs:

- **Simulation Results :** Contains the [Simulation Results](#).

The left pane also contains a list of Scenarios available for the selected System Reliability Analysis.

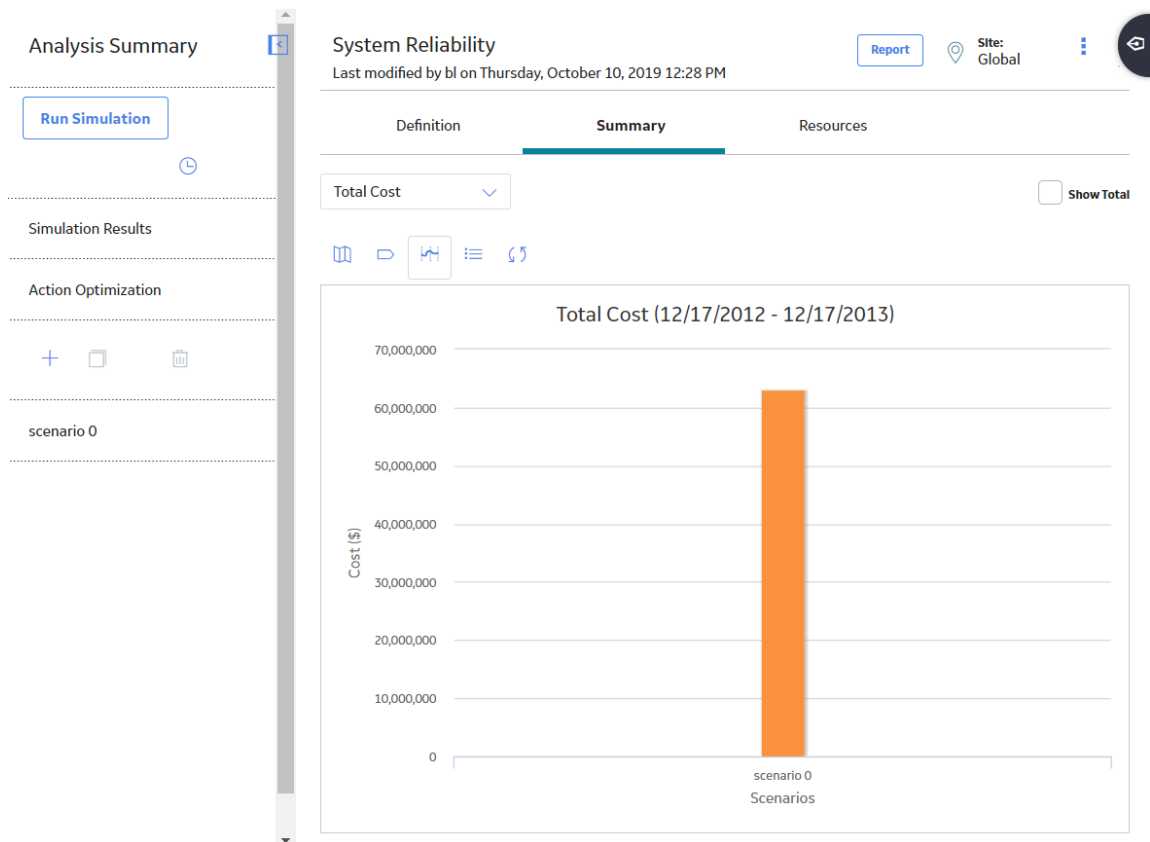

Create a System Reliability Analysis

About This Task

To develop a System Reliability Analysis, you must first define the parameters of the analysis, and then [create a System Scenario](#). The analysis parameters serve as inputs to the simulation and will affect the simulation results. You can modify the analysis parameters and [rerun the simulation](#) to see the effect that they have on the results.

Procedure

1. [Access the RA Overview page](#).
2. In the upper-right corner, select **New Analysis**, and then select **System Reliability**.

The **System Reliability** page appears, displaying a blank datasheet in the **Analysis Summary** workspace.

3. As needed, enter the values in the [available fields](#), and then select .

The System Reliability Analysis is created.

Next Steps

- [Create a System Scenario](#)

About Components in a System Reliability Analysis

A System Reliability Analysis is made up of records and links as defined by the [System Reliability data model](#). At a conceptual level, groups of records and links make up the main elements of the analysis, as defined in the following list:

- **System Reliability analysis**: A collection of Scenarios, Resources, and simulation results that make up a given analysis. A System Reliability Analysis is represented by a [System analysis record](#), which stores identifying information about the analysis and is linked to other records that make up the analysis.
- **Scenario**: A representation of one design option for a given system. A Scenario is represented by a [System Scenario record](#), which contains all the identifying information for the Scenario and is linked to other records that help define the Scenario. Each Scenario can contain the following components:
 - **Diagram**: A logical, visual representation of the physical structure of a system, including all the elements in the system and the connections between them. A Diagram might be the representation of a system as it physically exists at your work site, or it might represent a variation of a physical system developed for the purpose of analyzing how changes to the system could impact maintenance and production costs. Each Scenario contains one Diagram.
A Diagram is represented by a [System Subsystem record](#), which can be linked to [System Subsystem](#), [System Sensor](#), [System Buffer](#), [System Link](#), [System Asset](#), and [System Switch](#) records. The items that these records represent are referred to as elements, which are simply the components that make up the Diagram itself.
 - **Risk**: A component that identifies a specific way that a piece of equipment or location can fail and specifies the consequences of the failure and includes Time to Failure (TTF) and Time to Repair (TTR) distribution data. A Risk is represented by a [System Risk record](#), which contains all of the identifying information for the Risk.
 - **Action**: A component that identifies a specific operation that can be performed against a piece of equipment or location. Actions include condition-based maintenance, procedures, redesigns, time-based maintenance, and training, and may or may not mitigate Risks. Actions are represented by records in the [System Condition Monitor](#), [System Inspection](#), [System Preventive Maintenance](#), or [System Special Action](#) families, which contain all the identifying information for the Action.

- **Global Event** : A component that groups together Actions that require a system shutdown. Scheduling a Global Event can make a system more efficient by providing more time in which to run the system while still allowing maintenance and other Actions to take place. A Global Event is represented by a **System Global Event record**, which contains all the identifying information for the Global Event.
- **Resource**: A component of a System Reliability Analysis that associates a cost with an occurrence of an Action or Risk. Resources are defined for a System Reliability Analysis and are represented by a **System Resource record**.
- **Simulation Results** : The outcome of running a simulation against all Scenarios included in a given System Reliability Analysis. Simulation results are stored in **System Element Result**, **System Action Result**, or **System Resource Result** records, which are linked to the root System analysis record.

Example of a System Reliability Analysis

This topic provides an example of a System Reliability Analysis. This example will be referred to as necessary throughout the System Reliability Analysis documentation.

This System Reliability Analysis example involves a water bottling facility, which contains a system that performs the following steps in the water bottling process:

1. Collects water from a source via a pump.
2. Runs the water through a bottling subsystem, which fills bottles and attaches caps and labels to the bottles.

Note: In this example, we assume that the bottles, labels, and caps are produced at a separate facility and utilized in this process.

For our example, we will use three different scenarios to evaluate the reliability and cost associated with three different models for this system:

Scenario A

Diagram

Scenario A represents the current structure of the system as shown in the following image.

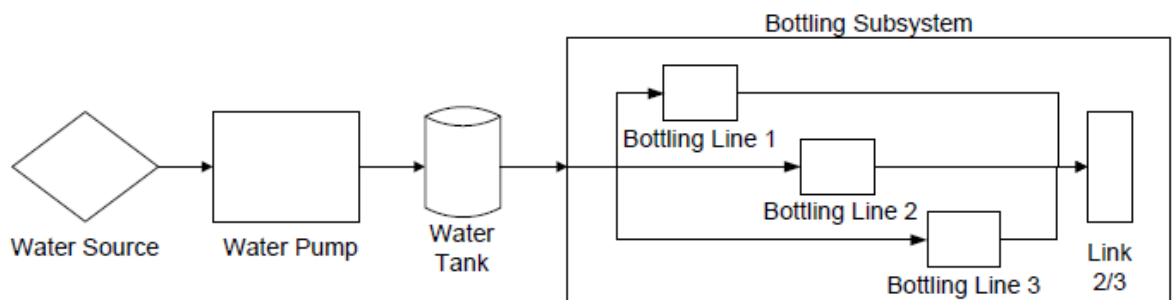

The physical model for Scenario A includes the following components:

- **Water Source**: Produces water that can be used in the water bottling process. For our example, we will assume that the Water Source is a naturally occurring spring. This component is represented by an Asset element in the Diagram for Scenario A.
- **Water Pump**: Pulls water from the Water Source and into the Buffer. This component is represented by an Asset element in the Diagram for Scenario A.
- **Water Tank**: Stores water and feeds it into the Bottling Subsystem. This component is represented by a Buffer element in the Diagram for Scenario A.

- **Bottling Subsystem:** Fills bottles and attaches labels and caps. This subsystem is comprised of three Asset elements (Bottling Line 1, Bottling Line 2, and Bottling Line 3) and a Link. This component is represented by a Subsystem element in the Diagram for Scenario A.
- **Link:** Combines and manages the production of the Bottling Lines within the Bottling Subsystem. The Link specifies that two of the three Bottling Lines must be running for the entire Subsystem to run. This component is represented by a Link in the Diagram for Scenario A.

Risks

When the Water Pump element fails due to a risk, the entire system will fail and accrue lost production costs. The following risks are assigned to the Water Pump element in Scenario A:

- Seal Failure.
- Bearing Failure.
- Impeller Failure.

Every time the Water Pump experiences an unplanned Bearing Failure, the correction will require the use of the Bearing, Mechanic, and Seal Resources. If the Water Pump requires a bearing replacement as the result of a planned correction, only the Bearing and Mechanic Resources will be needed. Therefore, the following Resources have been assigned to the Bearing Failure Risk:

- **Unplanned Resources:** Mechanic, Bearings, and Seal.
- **Planned Resources:** Mechanic and Bearings.

Actions

There are no actions defined for Scenario A.

Scenario B

Diagram

Scenario B represents the current structure of the system as shown in the following image.

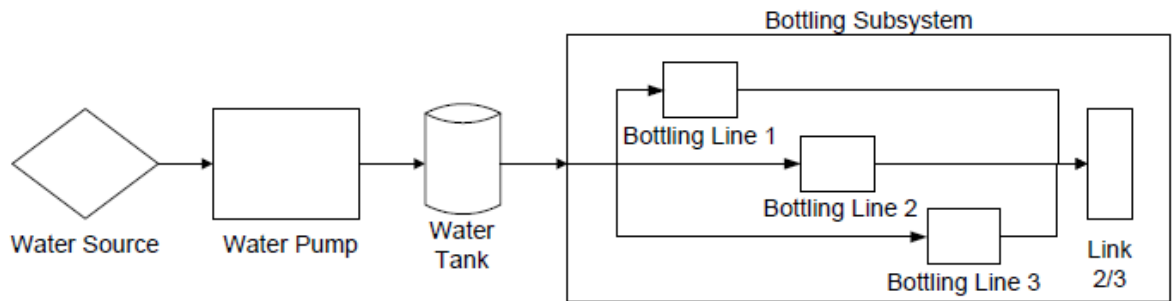

The physical model for Scenario B is shown in this image. It is identical to Scenario A, but Actions and additional Resources have been assigned to the Water Pump in this Scenario to mitigate Risks.

Risks

The same Risks are defined for Scenario B as are defined for Scenario A. The same Resources are assigned to these Risks.

Actions

For Scenario B, the following Actions have been defined for the Water Pump:

- **Replace Seal:** A time-based maintenance Action that mitigates the Seal Failure Risk.
- **Vibration Analysis:** An inspection or periodic condition-based maintenance Action that mitigates the Bearing Failure Risk. The Vibration Technician Resource has been assigned to the Vibration Analysis Action.

- **Redesign Impeller:** A redesign Action that mitigates the Impeller Failure Risk.

Scenario C

Diagram

Scenario C represents the current structure of the system as shown in the following image.

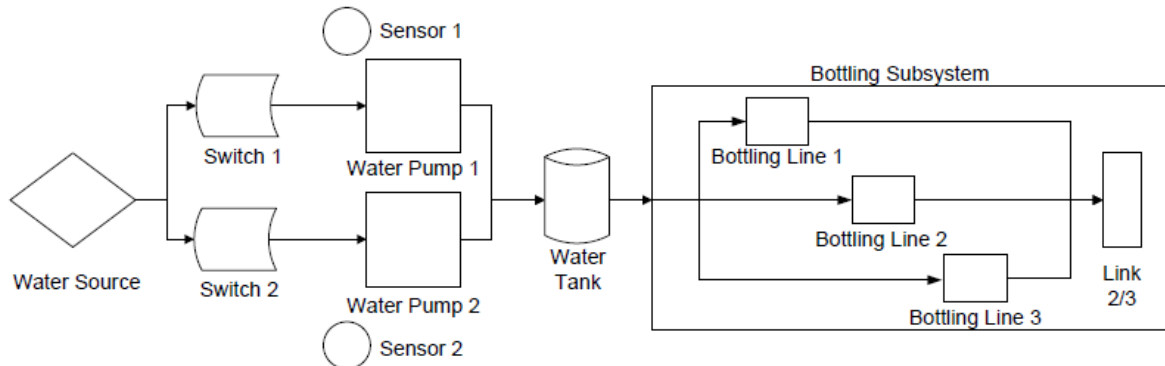

The physical model for Scenario C is shown in this image. It is similar to Scenario A but contains the following additional components:

- **Water Pump 2:** Pulls water from the Water Source and into the Water Tank. Water Pump 2 serves as a backup or standby for Water Pump 1 and is represented by an Asset element in the Diagram for Scenario C.
- **Sensor 1:** Monitors Water Pump 1 for failure. When Water Pump 1 fails, Sensor 1 activates Switch 2, indicating that Water Pump 2 will start running, and deactivates Switch 1 to indicate that Water Pump 1 has stopped running. Sensor 1 is represented by a Sensor element in the Diagram for Scenario C.
- **Sensor 2:** Monitors Water Pump 2 for failure. When Water Pump 1 fails, Water Pump 2 will start running and will continue to run until it fails. When Water Pump 2 fails, Sensor 2 will activate Switch 1, indicating that Pump 1 is running, and will deactivate Switch 2 to indicate that Water Pump 2 has stopped running. Sensor 2 is represented by a Sensor element in the Diagram for Scenario C.
- **Switch 1:** Is initially set to On, indicating that Water Pump 1 is initially running. When activated by Sensor 1, connects the Water Source and Water Pump 1 so that Pump 1 will feed water into the Water Tank. When deactivated by Sensor 1, Switch 1 disconnects Water Source and Water Pump 1. Switch 1 is represented by a Switch element in the Diagram for Scenario C.
- **Switch 2:** Is initially set to Off, indicating that Pump 2 is not running initially. When activated by Sensor 2, connects the Water Source and Water Pump 2 so that Pump 2 will feed water into the Water Tank. When deactivated by Sensor 2, Switch 2 disconnects Water Source and Water Pump 2. Switch 2 is represented by a Switch element in the Diagram for Scenario C.

Risks

The same Risks are defined for Scenario C as are defined for Scenarios A and B. The same Resources are assigned to these Risks.

Actions

There are no Actions defined for Scenario C.

In addition to these scenarios, we will define the following resources for our example:

- **Bearing:** A replacement bearing.
- **Seal:** A replacement seal.
- **Mechanic:** A mechanic who will perform needed maintenance.
- **Vibration Technician:** A professional who will perform vibration analysis.

- **Redesign Impeller:** A redesign action that mitigates the Impeller Failure Risk.

Conclusions

By comparing Scenario A, Scenario B, and Scenario C, we will be able to view each scenario's reliability and cost and identify the scenario that has the highest reliability and lowest cost associated with it. Scenario A represents the current design, and both Scenario B and Scenario C represent modifications to the original design. These modifications support different hypotheses about modifying our current system:

- Scenario B proposes that by implementing certain Actions that mitigate Risks associated with the Water Pump, we may be able to increase the reliability and decrease the cost of the system.
- Scenario C proposes that by introducing an additional Water Pump, which will prevent a full system failure when Water Pump 1 fails, we may be able to increase the reliability and decrease the cost of the system.

By modeling and comparing the three different Scenarios, we should be able to draw conclusions and make recommendations about changes that should be implemented to improve the reliability of the system.

This is a simple example and is limited to three scenarios only. As you develop a System Reliability Analysis, you may want to develop additional scenarios that model other variations to the system. As we continue to use this example throughout the System Reliability documentation, we will provide suggestions for where you might modify or extend our example to take advantage of the System Reliability features to create a more complex, in-depth analysis.

Example System Analysis Record Data

This example contains one root System Analysis record. The following values exist in the fields of that record:

Fields	Values
Name	System Reliability Analysis Example
Currency	\$
Start Date	1/1/2010 12:00:00 AM
Period	7 Years
Iterations	1000
Time Analysis Type	Yearly
Confidence (%)	90
Histogram Bins	20
Enable Event Log	False
Random Seed	True

System Scenario Record Data

The following table shows the data stored in the System Scenario records in this example:

Scenarios	Values Specified
Scenario A	Name: Scenario A Description: Current Structure
Scenario B	Name: Scenario B Description: Current Structure With Actions
Scenario C	Name: Scenario C Description: Redesigned Structure With Backup Pump

System Subsystem Record Data

Each Scenario in this example contains two System Subsystem records. One System Subsystem record contains the Diagram structure for each Scenario, and the other System Subsystem record contains the Bottling Lines, which are used in all three Scenarios. The following table lists the data that exist in each record.

Subsystem	Values Specified
Diagram for Scenario A	Name: Diagram for Scenario A Production Contribution: 100 Fixed Cost: 0 Variable Cost: 0 Variable Cost Units: Per Day Lost Production Cost: 100000 Lost Production Cost Units: Per Day
Diagram for Scenario B	Name: Diagram for Scenario B Production Contribution: 100 Fixed Cost: 0 Variable Cost: 0 Variable Cost Units: Per Day Lost Production Cost: 100000 Lost Production Cost Units: Per Day

Subsystem	Values Specified
Diagram for Scenario C	Name: Diagram for Scenario C Production Contribution: 100 Fixed Cost: 0 Variable Cost: 0 Variable Cost Units: Per Day Lost Production Cost: 100000 Lost Production Cost Units: Per Day
Bottling Subsystem	Name: Bottling Subsystem Production Contribution: 100 Fixed Cost: 0 Variable Cost: 0 Variable Cost Units: Per Day Lost Production Cost: 0 Lost Production Cost Units: Per Day

System Asset Record Data

The following table shows the data stored in the System Asset records in this example. The light blue row identifies the Scenario(s) in which each Asset element is used.

Asset	Values Specified
All Scenarios	
Water Source	Name: Water Source Production Contribution: 100 Fixed Cost: 0 Variable Cost: 0 Variable Cost Units: Per Day Lost Production Cost: 0 Lost Production Cost Units: Per Day

Asset	Values Specified
Bottling Line	<p>Name: <Bottling Line 1, Bottling Line 2, or Bottling Line 3></p> <p>All Bottling Lines use the same data with the exception of the Name field, whose value is different for each Asset element.</p> <p>Production Contribution: 40</p> <p>Fixed Cost: 0</p> <p>Variable Cost: 0</p> <p>Variable Cost Units: Per Day</p> <p>Lost Production Cost: 0</p> <p>Lost Production Cost Units: Per Day</p>
Scenario A	
Water Pump	<p>Name: Water Pump</p> <p>Production Contribution: 100</p> <p>Fixed Cost: 5000</p> <p>Variable Cost: 50</p> <p>Variable Cost Units: Per Hour</p> <p>Lost Production Cost: 0</p> <p>Lost Production Cost Units: Per Day</p>
Scenario B	
Water Pump	<p>Name: Water Pump</p> <p>Production Contribution: 100</p> <p>Fixed Cost: 5000</p> <p>Variable Cost: 50</p> <p>Variable Cost Units: Per Hour</p> <p>Lost Production Cost: 0</p> <p>Lost Production Cost Units: Per Day</p>
Scenario C	

Asset	Values Specified
Water Pump 1	Name: Water Pump 1 Production Contribution: 100 Fixed Cost: 5000 Variable Cost: 50 Variable Cost Units: Per Hour Lost Production Cost: 0 Lost Production Cost Units: Per Day
Water Pump 2	Name: Water Pump 2 Production Contribution: 100 Fixed Cost: 5000 Variable Cost: 50 Variable Cost Units: Per Hour Lost Production Cost: 0 Lost Production Cost Units: Per Day

System Buffer Record Data

The following table shows the data stored in the System Buffer record for this example:

Field	Value
Name	Water Tank
Production Contribution	100
Initial Quantity in Percentage	50
Time to Empty	0.5
Time to Empty Units	Days
Time to Refill	5
Time to Refill Units	Days

System Link Record Data

The following table shows the data stored in the System Link record for this example:

Field	Value
Name	Link
Minimum Predecessors:	2

System Sensor Record Data

The following table shows the data stored in the System Sensor records for this example:

Sensor	Values Specified
Sensor 1	Name: Sensor 1 Monitored Elements: Water Pump 1 Activated Switches : Switch 2 Deactivated Switches: Switch 1
Sensor 2	Name: Sensor 2 Monitored Elements: Water Pump 2 Activated Switches: Switch 1 Deactivated Switches: Switch 2

Switch Element Data

The following table shows the data stored in the System Switch records in this example:

Element	Values Specified
Switch 1	Name: Switch 1 Is Initially On: Yes Production Contribution: 100 Fixed Cost: 0 Variable Cost: 0 Variable Cost Units: Per Day Lost Production Cost: 0 Lost Production Cost Units: Per Day
Switch 2	Name: Switch 2 Is Initially On: No Product Contribution: 100 Fixed Cost: 0 Variable Cost: 0 Variable Cost Units: Per Day Lost Production Cost: 0 Lost Production Cost Units: Per Day

Risk Data

The following table shows the data for the Risks used in this example:

Note: The Source column identifies the entity family name of the record in which the associated data is stored. The data from all source records is combined to create the comprehensive Risk data.

Risk	Assigned To	Source	Values Specified
Water Source Failure	Water Source Asset in all Scenarios	System Risk Record	<p>Name: Water Source Failure</p> <p>Last Failure: 1/1/1999 12:00:00 AM</p> <p>Fixed Unplanned Correction Cost: 0</p> <p>Variable Unplanned Correction Cost: 0 Per Day</p> <p>Planned Correction Cost: 0</p> <p>Planned Correction Duration: 0 Hours</p> <p>Is Active: True</p> <p>Is Latent: False</p> <p>Failure Without Replacement: False</p> <p>Number of Subcomponents: 1</p> <p>PF Interval: 0 Days</p> <p>Repair Immediately: True</p> <p>Percentage of PF Interval to Wait(%): 0</p>
		Exponential	<p>Name: TTF Distribution</p> <p>Distribution Type: Exponential</p> <p>Time Unit: Years</p> <p>MTBF: 20</p> <p>Enable Distribution Association: No</p>
		Exponential	<p>Name: TTR Distribution</p> <p>Distribution Type: Exponential</p> <p>Time Unit: Weeks</p> <p>MTBF: 2</p> <p>Enable Distribution Association: No</p>

Risk	Assigned To	Source	Values Specified
Bottling Line Failure	Bottling Line Asset in all Scenarios	System Risk Record	<p>Name: Bottling Line Failure</p> <p>Last Failure: 1/1/1999 12:00:00 AM</p> <p>Fixed Unplanned Correction Cost: 0</p> <p>Variable Unplanned Correction Cost: 0 Per Day</p> <p>Planned Correction Cost: 0</p> <p>Planned Correction Duration: 0 Hours</p> <p>Is Active: True</p> <p>Is Latent: False</p> <p>Failure Without Replacement: False</p> <p>Number of Subcomponents: 1</p> <p>PF Interval: 0 Days</p> <p>Repair Immediately: True</p> <p>Percentage of PF Interval to Wait (%): 0</p>
		Exponential	<p>Name: TTF Distribution</p> <p>Distribution Type: Exponential</p> <p>Time Unit: Months</p> <p>MTBF: 12</p> <p>Enable Distribution Association: No</p>
		Normal	<p>Name: TTR Distribution</p> <p>Distribution Type: Exponential</p> <p>Time Unit: Days</p> <p>MTTR: 1</p> <p>Enable Distribution Association: No</p>

Risk	Assigned To	Source	Values Specified
Seal Failure	<ul style="list-style-type: none"> Water Pump Assembly Set in Service on B Water Pump and Water Pump 2 As 	System Risk Record	<p>Name: Seal Failure</p> <p>Last Failure: 1/1/1999 12:00:00 AM</p> <p>Fixed Unplanned Correction Cost: 1500</p> <p>Variable Unplanned Correction Cost: 1000 Per Day</p> <p>Planned Correction Cost: 1000</p> <p>Planned Correction Duration: 4 Hours</p> <p>Is Active: True</p> <p>Is Latent: False</p> <p>Failure Without Replacement: No</p> <p>Number of Subcomponents: 1</p> <p>PF Interval: 30 Days</p> <p>Repair Immediately: True</p> <p>Percentage of PF Interval to Wait (%): 0</p>
		Weibull	<p>Name: TTF Distribution</p> <p>Distribution Type: Weibull</p> <p>Time Unit: Years</p> <p>Beta: 4</p> <p>Eta: 3</p> <p>Gamma: 0</p> <p>Enable Distribution Association: No</p>
		Normal	<p>Name: TTR Distribution</p> <p>Distribution Type: SingleValue</p> <p>Time Unit: Hours</p> <p>Value: 12</p> <p>Enable Distribution Association: No</p>

Risk	Assigned To	Source	Values Specified
Bearing Failure	<ul style="list-style-type: none"> Walter Pumps Associates Inc. SCENARIO A and B 	System Risk Record	<p>Name: Bearing Failure</p> <p>Last Failure: 1/1/1999 12:00:00 AM</p> <p>Fixed Unplanned Correction Cost: 2000</p> <p>Variable Unplanned Correction Cost: 1000 Per Day</p> <p>Planned Correction Cost: 1000</p> <p>Planned Correction Duration: 4 Hours</p> <p>Is Active: True</p> <p>Is Latent: False</p> <p>Failure Without Replacement: False</p> <p>Number of Subcomponents: 1</p> <p>PF Interval: 6 Weeks</p> <p>Repair Immediately: True</p> <p>Percentage of PF Interval to Wait (%): 0</p>
		Exponential	<p>Name: TTF Distribution</p> <p>Distribution Type: Exponential</p> <p>Time Unit: Months</p> <p>MTBF: 60</p> <p>Enable Distribution Association: No</p>
		Exponential	<p>Name: TTR Distribution</p> <p>Distribution Type: Exponential</p> <p>Time Unit: Hours</p> <p>MTTR: 8</p> <p>Enable Distribution Association: No</p>

Risk	Assigned To	Source	Values Specified
Impeller Failure	<ul style="list-style-type: none"> Walter Pumps Associates Inc. Scednarioro Aand B 	System Risk Record	<p>Name: Impeller Failure</p> <p>Last Failure: 1/1/1999 12:00:00 A.M.</p> <p>Fixed Unplanned Correction Cost: 1500</p> <p>Variable Unplanned Correction Cost: 1000 Per Day</p> <p>Planned Correction Cost: 1000</p> <p>Planned Correction Duration: 4 Hours</p> <p>Is Active: True</p> <p>Is Latent: False</p> <p>Failure Without Replacement: False</p> <p>Number of Subcomponents: 1</p> <p>PF Interval: 0 Days</p> <p>Repair Immediately: True</p> <p>Percentage of PF Interval to Wait (%): 0</p>
		Exponential	<p>Name: TTF Distribution</p> <p>Distribution Type: Exponential</p> <p>Time Unit: Months</p> <p>MTBF: 24</p> <p>Enable Distribution Association: No</p>
		Normal	<p>Name: TTR Distribution</p> <p>Distribution Type: Single Value</p> <p>Time Unit: Hours</p> <p>Value: 12</p> <p>Enable Distribution Association: No</p>

Action Data

The following table shows the data used in the Actions in this example. This information defines the properties of the Actions associated with the Water Pump element in Scenario B.

Note: The Source column identifies the entity family name of the record in which the associated data is stored. The data from all source records is combined to create comprehensive Action data.

Action	Mitigated Risk	Source	Values Specified
Redesign Impellers Impeller Failure		System Special Action Record	Name: Redesign Impellers Action Cost: 1600 Interval: 2 Years Duration: 2 Days Shutdown Required: True One Time Action: True Replace Failure Consequence: True Replace TTF Distribution: True
		System Risk Assessment	Mitigated Unplanned Correction Cost: 10001 Note: When you associate a Risk to an Action that is represented by a System Special Action record, and select the hyperlinked Action name in the Actions pane on the System Reliability Scenarios - Actions page, the Mitigated Unplanned Correction Cost field appears in the New Failure Consequence section on the Mitigated Risks tab and is labeled Fixed Unplanned Correction Cost.
		Weibull	Name: New TTF Distribution Distribution Type: Weibull Time Unit: Months Beta: 4 Eta: 48 Gamma: 0

Action	Mitigated Risk	Source	Values Specified
Replace Seals	Seal Failure	System Preventive Maintenance Record	Name: Replace Seals Action Type: Time-Based Maintenance (Preventive) (PM) Action Cost: 2000 Interval: 2 Years Duration: 4 Hours Shut Down Required: True One Time Action: False
Vibration Analysis	Bearing Failure	System Inspection Record	Name: Vibration Analysis Action Type: Condition-Based Maintenance (Predictive) (CM) Condition Monitoring Type: Periodic Action Cost: 0 Interval: 3 Weeks Duration: 1 Hours Shut Down Required: False One Time Action: False Detection Probability(%): 90

System Resource Record Data

The following table shows the data stored in the System Resource records in this example:

Resource	Values Specified
Bearing	Name: Bearing Fixed Cost: 200 Variable Cost: 0 Per Day Count Occurrences: True
Mechanic	Name: Mechanic Fixed Cost: 0 Variable Cost: 100 Per Hour Count Occurrences: False
Seal	Name: Seal Fixed Cost: 250 Variable Cost: 0 Per Day Count Occurrences: True
Vibration Technician	Name: Vibration Technician Fixed Cost: 0 Variable Cost: 100 Per Hour Count Occurrences: False

System Resource Usage Record Data

The following table shows the data stored in the System Resource Usage records in this example:

Resource	Linked To	Values Specified
Vibration Technician	Vibration Analysis Action	Resource: Vibration Technician Quantity: 1 Duration: 1 Duration Units: Hours
Mechanic	Bearing Failure Risk	Planned Resource Usage Resource: Mechanic Quantity: 1 Duration: 4 Duration Units: Hours Unplanned Resource Usage Resource: Mechanic Quantity: 1 Duration: 8 Duration Units: Hours

Resource	Linked To	Values Specified
Bearing	Bearing Failure Risk	Planned Resource Usage Resource: Bearing Quantity: 2 Duration: 0 Duration Units: Hours Unplanned Resource Usage Resource: Bearing Quantity: 2 Duration: 0 Duration Units: Hours
Seal	Bearing Failure Risk	Unplanned Resource Usage Resource: Seal Quantity: 1 Duration: 0 Duration Units: Hours

Delete a System Reliability Analysis

Procedure

1. Access the [RA Overview](#) page.
2. Select **System Reliability**.

A list of System Reliability Analysis available in the database appears.

3. Select the row containing the System Reliability Analysis that you want to delete, and then select .

The **Delete System Reliability Analysis** dialog box appears, asking you to confirm that you want to delete the selected System Reliability Analysis.

4. Select **Yes**.

The selected System Reliability Analysis is deleted.

Results

- Any associated Scenarios and the components of each of the Scenario are deleted.

Access System Reliability Report

Procedure

1. [Access the System Reliability Analysis](#) whose report you to want access.
2. In the upper-right corner of any workspace within the selected System Reliability Analysis, select **Report**.

The System Reliability report appears in a new browser tab.

By default, the report contains the following [sections](#):

- **Summary**
- **Simulation Result Summary**
- **Plots**
- **Simulation Results - Elements**
- **Simulation Results - Actions**
- **Simulation Results - Resources**

About System Reliability Analysis Report

The baseline GE Digital APM database includes the System Reliability Report, which you can use to view a summary of the results of a System Reliability Analysis.

The following table provides a list and description of the Catalog items that are used to generate the System Reliability Report. Each report provides a formatted view of the supporting query identified in the table. For additional details on the data that is included in the subreport, you can run any of the queries, which are stored in the Catalog folder \\Public\Meridium\Modules\Reliability Manager\Reports.

Report	Supporting Query	Description
SystemReliability	System Reliability - Main	Provides the information that is displayed in the Summary and Plots sections of the System Reliability Report.
SystemReliabilitySummaryResultReport	SystemReliability - SummaryResult	Provides the information that is displayed in the Simulation Result Summary section of the System Reliability Report.
SystemReliabilityElementResultReport	SystemReliability - ElementResult	Provides the information that is displayed in the Simulation Results - Elements section of the System Reliability Report.
SystemReliabilityActionResultReport	System Reliability - ActionResult	Provides the information that is displayed in the Simulation Results - Actions section of the System Reliability Report.
SystemReliabilityResourceResultReport	SystemReliability - ResourceResult	Provides the information that is displayed in the Simulation Results - Resources section of the System Reliability Report.

Each report query contains a prompt on the ENTY_KEY field of the System Analysis family. When you run the System Reliability Report while viewing a System Reliability Analysis, the ENTY_KEY of the System Analysis record associated with the current analysis is passed automatically to the prompt, and the results for the current System Analysis will be displayed. If you run one of the reports or queries listed in

the table directly from the Catalog, however, you will need to supply the ENTY_KEY of a System Analysis record manually to retrieve results.

Throughout this documentation, we refer to the main report, the subreports, and the supporting queries collectively as the System Reliability Report.

Summary Section

The **Analysis Summary** section of the System Reliability Report displays general summary information that is stored in the [System Analysis record](#).

The following table lists each item in the **Analysis Summary** section and the corresponding [Systems Analysis record](#) fields whose data is displayed in the report:

Report Item	Record Field (s)
Name	Analysis ID
Description	Description
Analysis Start Date	Analysis Start Date
Analysis End	Analysis End Date
Analysis Period	Period Period Units
Iterations	Iterations
Confidence	Confidence
Last Updated Date	LAST UPDT DT
Last Updated By	LAST UPBY SEUS KEY Note: The name of the Security User associated with this value is displayed in the report.

Simulation Result Summary Section

The **Simulation Result Summary** section of the System Reliability Report displays a summary of the information that is displayed in the **Elements** section in the [Simulation Results workspace](#). Results for each scenario are stored in a System Element Result record. Additional information about each element within a scenario is displayed in the **Simulation Results - Elements** section of the System Reliability Report.

The following table lists each item in the **Simulation Results Summary** section and the corresponding System Element Result record field whose data is displayed in the report.

Report Item	Record Field (s)
Scenario	Scenario
Element	Element
Failures	Failures
Downtime	Downtime

Report Item	Record Field (s)
Cost	Cost
Reliability	Reliability Note: The values in the Reliability column are formatted as decimals rather than as percentages, as in the Elements section.
Availability	Availability Note: The values in the Availability column are formatted as decimals rather than as percentages, as in the Elements section.
Next Failure	TTNF

Plots Section

The **Plots** section of the System Reliability Report displays the graphs that are shown on the **Summary** section of the **Analysis Summary workspace** for the selected analysis.

The **Plots** section displays the following graphs:

- [Total Cost](#)
- [Total Cost Trend](#)
- [Annual Action Cost](#)
- [Action Cost Trend](#)
- [Resource Occurrence](#)
- [Resource Time](#)
- [Resource Cost](#)

Simulation Results Elements Section

The **Simulation Results - Elements** section of the System Reliability Report displays results for each Scenario and any Subsystems, Assets, Risks, Switches or Buffers that belong to it. This information, which is stored in System Element Result records, also appears in the **Elements** section in the **Simulation Results workspace**.

The results for each element are stored in a separate System Element Result record, and one row exists for each record. The following table lists each item in the **Simulation Results - Elements** section and the corresponding System Element Result record field whose data is displayed in the report.

Report Item	Record Field (s)
Element	Element Note: The elements are listed below the root Subsystem of the Scenario to which they belong, with elements appearing below the element to which they belong.
Failures	Failures
Downtime	Downtime
Cost	Cost

Report Item	Record Field (s)
Reliability)	Reliability Note: The values in the Reliability column are formatted as decimals rather than as percentages, as in the Elements section.
Availability	Availability Note: The values in the Availability column are formatted as decimals rather than as percentages, as in the Elements section.
Next Failure	TTNF

Simulation Results Actions Section

The **Simulation Results - Actions** section of the System Reliability Report displays results for the Actions that belong to each Scenario, which are stored in System Action Result records. This is the same information that appears in the **Actions** section in the [Simulation Results workspace](#).

Report Item	Record Field (s)
Action	Action Note: Actions are listed below the Scenario to which they belong.
Occurrences	Occurrences
Cost	Cost
Detected Failures	Detected Failures

Simulation Results Resources Section

The **Simulation Results - Resources** section of the System Reliability Report displays results for each Resource used in the System Reliability Analysis, which are stored in System Resource Result records. This is the same information that appears in the **Resources** section in the [Simulation Results workspace](#).

The results for each element are stored in a separate System Resource Result record, and one row exists for each record. The following table lists each item in the **Simulation Results - Resources** section and the corresponding System Resources Result record field whose data is displayed in the report.

Report Item	Record Field (s)
Resource	Action Note: The Resources are listed below the Scenario to which they belong.
Occurrences	Occurrences
Time	Time
Cost	Cost

Resources

About Resources

Resources are optional components in a System Reliability Analysis that represent physical parts or materials, such as spare bearings or seals, or human resources, such as mechanics or technicians, that you may want to use within the analysis.

Associating a Resource with an Action or a Risk will create a [System Resource Usage Record](#), which is linked to the appropriate [System Action](#) or [System Risk](#) record, which will store information that specifies how the resource will be used (e.g., the quantity and duration).

Access a Resource

Procedure

1. [Access the System Reliability Analysis](#) whose resource you want to view.
2. In the **Analysis Summary** workspace, select the **Resources** tab.

The **Resources** section appears, displaying a list of resources for the selected System Reliability Analysis.

The screenshot shows the 'Analysis Summary' workspace for 'System Reliability'. The 'Resources' tab is selected, displaying a table with the following data:

Definition		Summary	Resources	
NAME	DESCRIPTION	FIXED COST	VARIABLE COST	VARIABLE COST UNITS
resource 2		1,000	100	Days
resource 3		1,000	100	Days
resource 0		1,000	100	Days
resource 1		1,000	100	Days
resource 4		1,000	100	Days

Create a Resource

Procedure

1. [Access the Resources section](#).
2. Select . The **Add New Resource** subsection appears.
3. As needed, enter values in the [available fields](#).
4. Select . The resource is created.

Delete a Resource

Procedure

1. Access the **Resources** section.
2. Select the row containing the resource that you want to delete, and then select . A dialog box with a confirmation message appears.
3. Select **OK**.
The selected resource is deleted.



System Scenario

Access a System Scenario

Procedure

1. Access the **System Reliability Analysis** for which you want to view a scenario.
2. In the left pane, select the System Scenario whose details you want to view.
The details of the selected Scenario appear in the workspace in the following sections:

- **Diagram**
- **Definition**: This section is displayed by default.

Note: As needed, in the **Definition** section, you can select  to modify the values in the **available fields**, and then select  to save your changes.

- **Risks**
- **Actions**
- **Global Events**
- **Grid View**

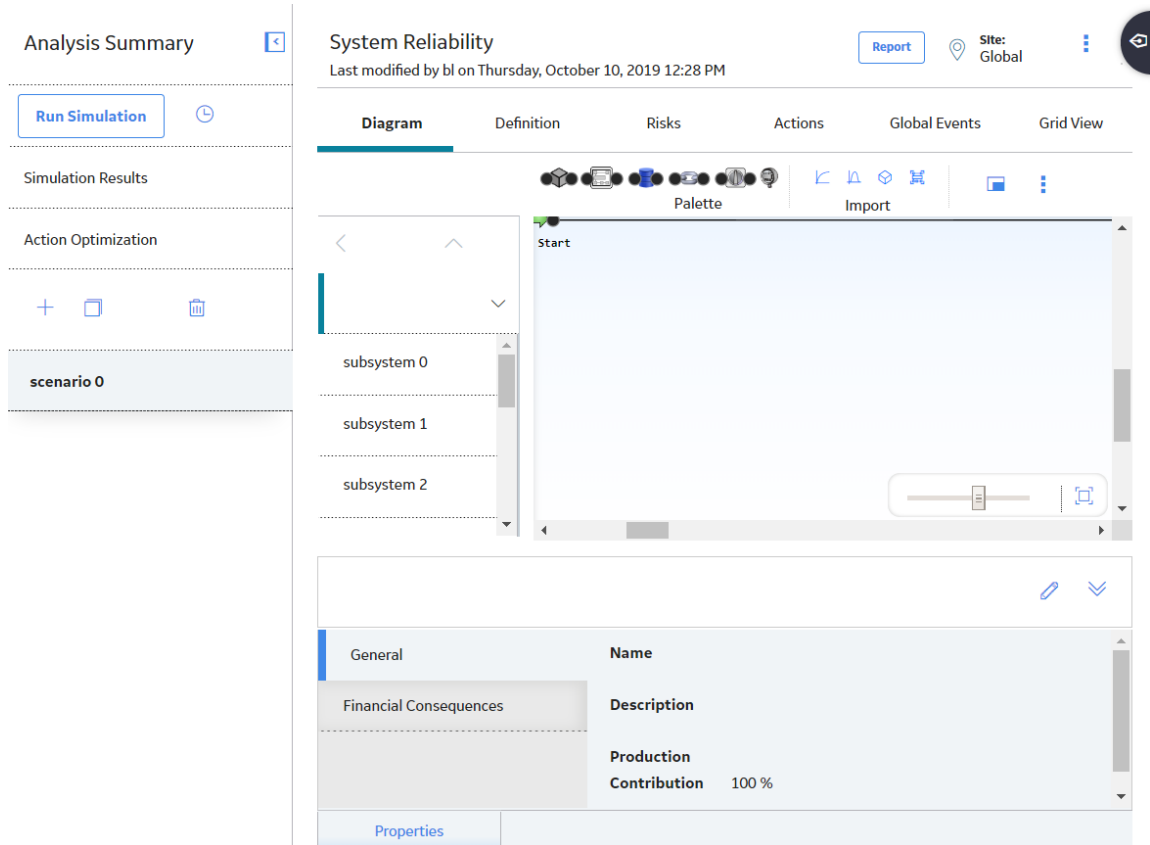

Create a System Scenario

About This Task



Each System Reliability Analysis must contain at least one Scenario.

Procedure

1. [Access the System Reliability Analysis](#) for which you want to create a new Scenario.
2. In the left pane, select **New Analysis**.
A new System Scenario is created. The name of the Scenario appears in the left pane in the following format:

New Scenario <n>

Where, <n> is the number of the Scenario that you created.

Note: If you want to change the name of the System Scenario, in the **Definition** section, select . To save your changes, select . The name of each System Scenario must be unique to the root record.

Delete a System Scenario

About This Task

Deleting a Scenario from a System Reliability Analysis will delete the System Scenario record and all Diagrams that are associated with it.

Procedure

1. [Access the System Reliability Analysis](#) for which you want to delete a scenario.
2. In the left pane, select the scenario that you want to delete, and then select . A confirmation message appears.
3. Select **Yes**.
The selected System Scenario is deleted.

Results

- Any of the following associated components are deleted:
 - Elements
 - Resources
 - Risks
 - Actions
 - Global Events

Diagrams



About Diagrams

A Diagram represents one option for the physical layout and construction of a system. A Diagram consists of a root System Subsystem record, which is linked to System Subsystem, System Sensor, System Buffer, System Link, System Asset, and System Switch records that together make up the Diagram.



When you create a System Scenario record, a System Subsystem record is created automatically and linked to the System Scenario record. Therefore, after you have created a Scenario, there is no manual step required to create a Scenario Diagram. You can build out the Scenario Diagram by adding the necessary elements and connections.



Elements of a Diagram

The following table lists the elements that are available in a Diagram and the associated records that are created automatically in the GE Digital APM database when you add each element to the Diagram. Select the element in the **Element** column in the following table to view the properties associated with that element.

Icon	Element	Record	Description
	Start	None	<p>Represents the starting point for all paths in the Diagram. This element is created by default when you create a new Diagram. You cannot enter data for this element in the Properties pane because no record is associated with this element.</p>
	End	None	<p>Represents the ending point for all paths in the Diagram. This element is created by default when you create a new Diagram. You cannot enter data for this element in the Properties pane because no record is associated with this element.</p>
	Asset	System Asset	<p>Represents a piece of equipment or location in the system. An Asset element can either be imported from an Equipment or Functional Location record that exists within the GE Digital APM database, or it can be added manually.</p>

Icon	Element	Record	Description
	Buffer	System Buffer	<p>Represents an intermediate storage container between two other elements. For example, consider Scenario A in our System Reliability Analysis example without a Water Tank element. The Water Pump produces output (water) that is fed into the Bottling Subsystem. If the Water Pump were to fail, the Bottling Subsystem would not receive any input (water) and the entire system would fail. Similarly, if the Bottling Subsystem were to fail, then the output of the Water Tank would have nowhere to go, and the entire system would fail.</p> <p>Alternatively, and as is constructed in the Scenarios in our System Reliability Analysis example, a Buffer element (Water Tank) is inserted between the Water Pump and the Bottling Subsystem. If the Water Pump were to fail, the Bottling Subsystem could continue to function as long as input (water) was available from the Water Tank. If the Bottling Subsystem were to fail, the Water Tank could serve as storage for output (water) until the Bottling Subsystem could be restored or until the Water Tank could accept no more additional output. In either case, a failure of the entire system could be avoided or minimized.</p>

Icon	Element	Record	Description
	Link	System Link	<p>Connects other elements that work together to produce output. For example, consider the Bottling Subsystem in our System Reliability Analysis example. Each of the three Bottling Lines produces bottles filled with water. In the Link element, the Bottling Lines combine their respective outputs into one stream of output for further use beyond our example. A Link represents the "hub" where the outputs of equipment and locations meet before connecting to the rest of the Diagram.</p>
	Sensor	System Sensor	<p>Detects the failure of a piece of equipment or location and notifies Switches of the failure. A Sensor cannot be connected to any other elements in the Diagram. If an Asset element in the Diagram fails, the Sensor that is monitoring that element will activate designated Switches to start elements running and deactivate other Switches to put other elements in standby. If the Asset element is deleted from the Diagram, then the connection between the Asset element and the Sensor will be deleted as well.</p> <p>For example, consider Scenario C in our System Reliability Analysis example. Sensor 1 monitors Water Tank 1 for failures. When a failure is detected, Sensor 1 deactivates Switch 1, which deactivates the failed Water Tank 1, and activates Switch 2, which activates the available Water Tank 2.</p>

Icon	Element	Record	Description
	Switch	System Switch	Represents a component that is activated or deactivated by a Sensor when a failure occurs. Switches allow you to connect or disconnect an entire branch of the Diagram when failures are detected. For example, consider Scenario C in our System Reliability Analysis example . Switch 1 is deactivated by Sensor 1 when a failure of Water Pump 1 is detected.
	Subsystem	System Subsystem	Represents an entire system of equipment and locations. You can build Subsystems within other Subsystems within the main Diagram to model production units.

Connecting Elements

After you [add elements](#) to a Diagram, you must [connect the elements](#) to create the Diagram. Depending on the structure of the system for which you are creating a Diagram, you will want to connect elements to each other in a series or parallel to one another.

Note: Interaction with diagramming and design canvases is not available on [touch-screen devices](#).

Elements Connected in a Series

When you connect elements to each other in a series, every element has one preceding connection and one succeeding connection, with only one path from the Start element to the End element. For example, in the following image of Scenario A in the [System Reliability Analysis example](#), the elements in the Diagram for Scenario A root subsystem are connected in a series: every element between the Start and End elements has one connection from an element and one connection to an element, and you can reach the End element from the Start element in only one way.

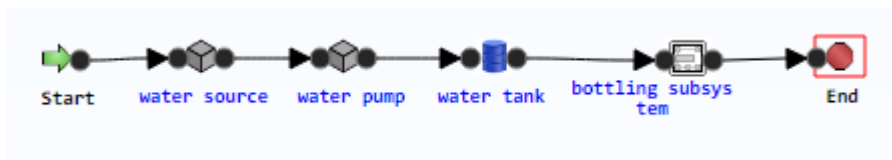

Elements Connected in Parallel

When you connect elements in parallel to one another, one or more elements will be connected to multiple elements, and there will be multiple paths from the Start element to the End element. For example, in the [System Reliability Analysis example](#), the Bottling Line elements in the Bottling Subsystem root subsystem are connected in parallel. In this case, the Start element and the Link element are connected to three Subsystem elements: Bottling Line 1, Bottling Line 2, and Bottling Line 3. Therefore, there are three different paths from the Start element to the End element, depending on which of the three Bottling Lines that you pass through.

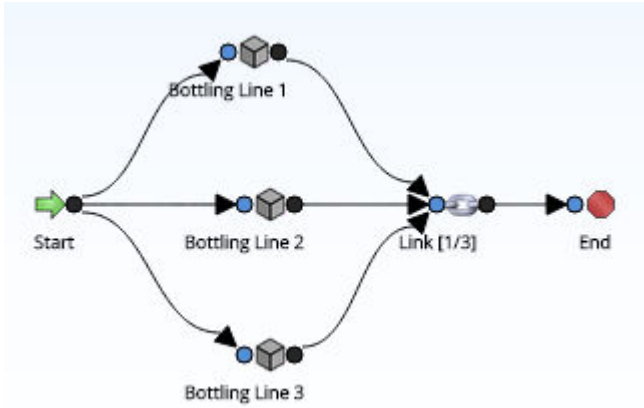

Access a Diagram

Procedure

1. [Access the System Scenario](#) for which you want to view system diagram.
2. In the workspace, select the **Diagram** tab.
A list of system subsystems, a design canvas, and the **Properties** pane appear.

The screenshot shows the 'System Reliability' workspace. On the left is a sidebar with 'Analysis Summary', 'Run Simulation', 'Simulation Results', and 'Action Optimization'. Below these is a list of scenarios, with 'scenario 0' selected. The main workspace has tabs for 'Diagram', 'Definition', 'Risks', 'Actions', 'Global Events', and 'Grid View'. The 'Diagram' tab is active, showing a design canvas with a 'Start' node and a 'Properties' pane. The 'Properties' pane is open to the 'General' tab, showing the following information:

General	
Name	
Financial Consequences	Description
Production Contribution	100 %

3. In the pane to the left of the design canvas, select the root system subsystem for which you want to view the diagram.

The diagram associated with the selected system subsystem appears in the design canvas.

Tip: Select  to display the diagram in full screen.

Access an Element

You can access an element for a Subsystem to view the properties of that element.

Procedure

1. [Access the Diagram](#) that contains the System Subsystem for which you want to view properties of an element.

The Diagram associated with the selected System Subsystem appears in the design canvas.

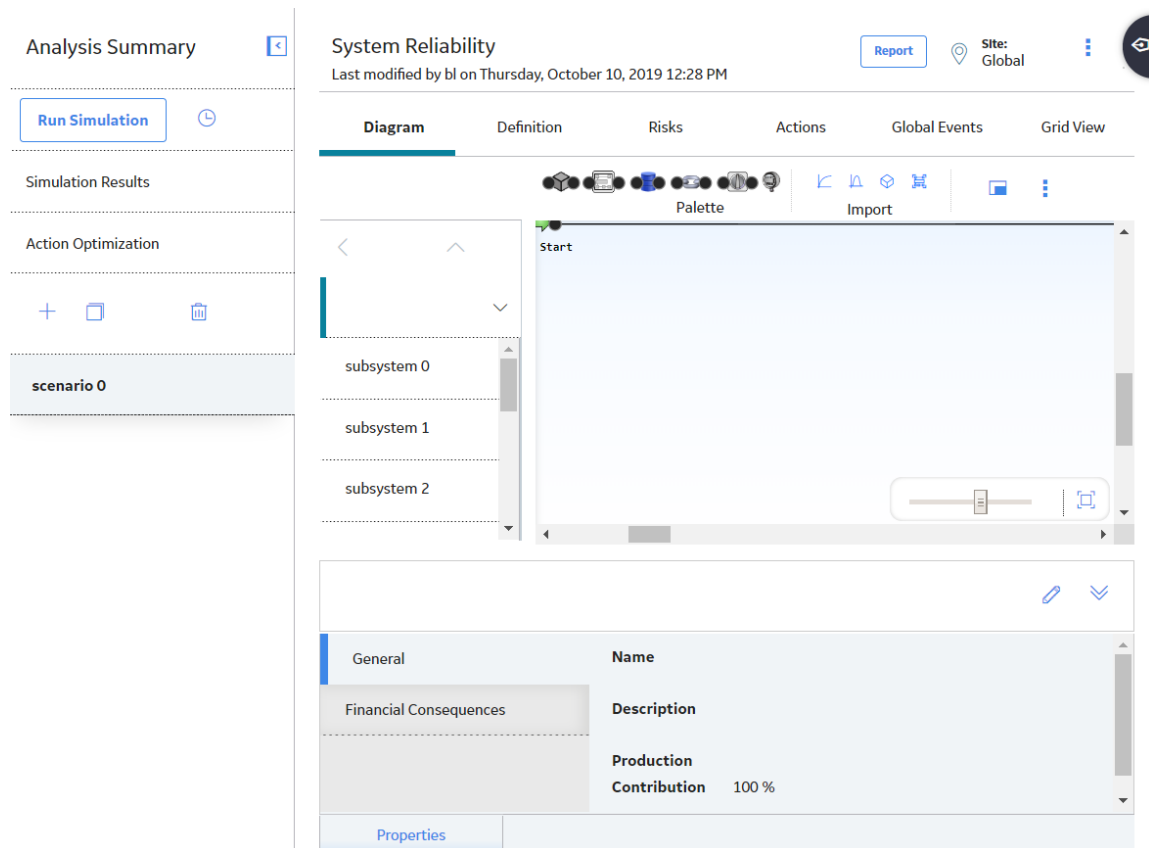

The screenshot displays the 'System Reliability' application interface. On the left, there is a sidebar with 'Analysis Summary' and 'Run Simulation' buttons. Below this, there are sections for 'Simulation Results' and 'Action Optimization'. A 'scenario 0' is selected. The main area is titled 'System Reliability' and shows a 'Diagram' view. The diagram canvas contains a 'Start' element and a list of subsystems: 'subsystem 0', 'subsystem 1', and 'subsystem 2'. Below the diagram, the 'Properties' pane is open, showing the 'General' tab with the following details:

General	
Name	
Description	
Production Contribution	100 %

2. In the design canvas, select the element whose properties you want to view.
The properties of the selected element appear in the **Properties** pane.

The screenshot displays the 'System Reliability' software interface. On the left, the 'Analysis Summary' sidebar includes a 'Run Simulation' button, 'Simulation Results', 'Action Optimization', and a 'scenario 0' section. The main workspace is titled 'System Reliability' and shows a 'Diagram' view of a subsystem. A 'Palette' and 'Import' toolbar are visible above the diagram. Below the diagram, a 'Properties' pane is open for 'subsystem 3', showing fields for Name, Description, Production, and Contribution.

General	Name	subsystem 3
Financial Consequences	Description	
	Production	
	Contribution	56.0473209973645 %

Results

Depending on the element that is selected in the workspace, different fields are displayed in the **Properties** pane. When you select an element, the **Properties** pane will display the fields that belong to the record that is associated with the selected element.

You can select any of the following elements to view the fields in the associated record in the **Properties** pane:

- [Asset](#)
- [Buffer](#)
- [Link](#)
- [Sensor](#)
- [Subsystem](#)
- [Switch](#)

Add an Element

About This Task

After you create a Scenario, you can build the Diagram by adding [elements](#) and [connections](#). This topic describes how to add an element to a diagram. You can also [import existing elements](#) to a diagram.

Procedure

1. [Access the Diagram](#) to which you want to add an element.

- In the **Palette** section, select the icon that represents the element that you want to add and use the drag-and-drop method to add the element to the required location on the design canvas. The element appears on the design canvas. It is selected automatically, and the **Properties** pane displays the properties of the new element.

The screenshot shows the GE Digital APM software interface. The top navigation bar includes 'Analysis Summary', 'System Reliability', and a 'Report' button. Below the navigation bar, there are tabs for 'Diagram', 'Definition', 'Risks', 'Actions', 'Global Events', and 'Grid View'. The 'Diagram' tab is active, showing a design canvas with a 'New Asset' element connected to 'Subsystem 0'. A 'Palette' and 'Import' section are visible above the canvas. The 'Properties' pane is open at the bottom, showing the following details:

General	Name	New Asset
Financial Consequences	Description	
	Production Contribution	0 %

Depending on the element that you selected, different fields appear in the **Properties** pane. You can select any of the following elements:

- [Asset](#)
 - [Buffer](#)
 - [Link](#)
 - [Sensor](#)
 - [Subsystem](#)
 - [Switch](#)
- In the **Properties** pane, in the upper-right corner, select . The fields are enabled.
 - As needed, enter the values in the available fields, and then select . The details of the element are saved. An appropriate record will be created in the GE Digital APM database to store information for that element. The new record is linked to the System Subsystem that represents the Diagram.

Next Steps

- [Connect Elements](#)

Connect Elements

Before You Begin

- [Add an Element](#)

About This Task

After you add elements to a Diagram, you must connect the elements to create the Diagram. Depending on the structure of the system for which you are creating a Diagram, you will want to [connect elements to each other in a series or parallel to one another](#).

Procedure

1. [Access the Diagram](#) within which you want to connect elements.
2. In the design canvas, select the circle on the element from which you want to initiate the connection, and then drag your pointer to the required destination (i.e., the circle on the element that will serve as the end of the connection). An arrow is drawn automatically in the direction that you drag your pointer.
3. When your pointer touches the port of the required destination, release the pointer to set the connection.
The connection will be completed automatically.

Import a Reliability Growth Analysis

About This Task

You can create new Asset elements by importing existing Reliability Growth Analyses into a Diagram. You can import one or multiple analyses in a single operation. One Asset element will be created for each record that you import, and a new System Asset record will be created to store information for that element. Fields from the Reliability Growth record will be mapped to the System Asset record, as described in the Results section.

This topic describes how to add an element by importing a Reliability Growth Analysis. You can also [add an element directly to a diagram](#).

Procedure

1. [Access the Diagram](#) within which you want to import a Reliability Growth Analysis.
2. In the **Import** section, select .
3. Select check box to the left of the Reliability Growth Analysis that you want to import.

Tip: You can select more than one Reliability Growth Analysis.

4. In the upper-right corner of the workspace, select **Import**.

A new Asset element is added to the Diagram for each selected Reliability Growth Analysis.

Results

When you import an existing Reliability Growth record into the Diagram, a new [System Asset record](#) is created, and information from the imported record is mapped to the System Asset record. Information is also mapped to System Risk and Distribution records, which are created when a record is imported and linked to the System Asset record.

The following table contains the values that are imported from fields in a Reliability Growth record and the System Analysis record and fields to which they are mapped. All other values in System Analysis records are populated automatically with default values.

Note: If you [import an asset](#) and import the Reliability Growth Analysis associated with that asset, all of the fields in the following table will be mapped except the Analysis ID field. The Analysis ID field will not be mapped to the Name field in the System Asset record.

Reliability Growth Record Field	System Analysis Record	System Analysis Record Field	Notes
Analysis ID	System Asset	Name	None
Analysis ID	System Risk	Name	None
Short Description	Distribution	Short Description	This value is mapped to the TTF Distribution record that is linked to the System Risk record and appears in the TTF column in the Risks section.
Final MTBF	Exponential	MTBF	This value is mapped to the TTF Distribution record that is linked to the System Risk record and appears in the TTF column in the Risks section.
Time Units	Distribution	Units	This value is mapped to the TTF Distribution record that is linked to the System Risk record and appears in the TTF column in the Risks section.

Import a Reliability Distribution Analysis

About This Task

You can create new Asset elements by importing existing Reliability Distribution Analyses into a Diagram. You can import one or more analyses in a single operation. One Asset element will be created for each record that you import, and a new System Asset record will be created to store information for that element. Fields from the Reliability Distribution record will be mapped to the System Asset record, as described in the Results section.

This topic describes how to add an element by importing a Reliability Distribution Analysis to a Diagram. You can also [add an element directly to a diagram](#).

Procedure

1. [Access the Diagram](#) within which you want to import a Reliability Distribution Analysis.
2. In the **Import** section, select .

A list of available Reliability Distribution Analyses appears.
3. Select check box to the left of the Reliability Distribution Analysis that you want to import.

Tip: You can select more than one Reliability Distribution Analysis.
4. In the upper-right corner, select **Import**.

A new Asset element is added to the Diagram for each selected Reliability Distribution Analysis.

Results

When you import an existing Reliability Distribution record into the Diagram, a new [System Asset record](#) is created, and information from the imported record is mapped to the System Asset record. Information is also mapped to System Risk and Distribution records, which are created when a record is imported and linked to the System Asset record.

The following table contains the values that are imported from fields in records from a Distribution Analysis and the System Analysis record and field to which they are mapped. All other values in System Analysis records are populated automatically with default values.

Note: If you [import an asset](#) and import the Reliability Distribution Analysis associated with that asset, all of the fields in the following table will be mapped except the Analysis ID field will not be mapped to the Name field in the System Asset record.

Reliability Distribution Analysis Record	Reliability Growth Record Field	System Analysis Record	System Analysis Record Field	Notes
Reliability Distribution	Analysis ID	System Asset	Name	None
Reliability Distribution	Analysis ID	System Risk	Name	None
Reliability Distribution	Failures Without Replacement	System Risk	Failures Without Replacement	None
Distribution	Short Description	Distribution	Short Description	This value is mapped from the TTF and TTR Distribution records that are linked to the Reliability Distribution record to the corresponding TTF and TTR Distribution records that are linked to the System Risk records.
Distribution	Distribution Type	Distribution	Distribution Type	This value is mapped from the TTF and TTR Distribution records that are linked to the Reliability Distribution record to the corresponding TTF and TTR Distribution records that are linked to the System Risk records.

Reliability Distribution Analysis Record	Reliability Growth Record Field	System Analysis Record	System Analysis Record Field	Notes
Distribution	Units	Distribution	Units	This value is mapped from the TTF and TTR Distribution records that are linked to the Reliability Distribution record to the corresponding TTF and TTR Distribution records that are linked to the System Risk records.
Exponential	MTBF	Exponential	MTBF	This value is mapped from the TTF and TTR Distribution records with a Distribution Type of Exponential that are linked to the Reliability Distribution record to the TTF and TTR Distribution records with a Distribution Type of Exponential that are linked to the System Risk records.
Lognormal	Mu Sigma Gamma	Lognormal	Mu Sigma Gamma	This value is mapped from the TTF and TTR Distribution records with a Distribution Type of Lognormal that are linked to the Reliability Distribution record to the TTF and TTR Distribution records with a Distribution Type of Lognormal that are linked to the System Risk records.

Reliability Distribution Analysis Record	Reliability Growth Record Field	System Analysis Record	System Analysis Record Field	Notes
Normal	Mean Standard Deviation	Normal	Mean Standard Deviation	This value is mapped from the TTF and TTR Distribution records with a Distribution Type of Normal that are linked to the Reliability Distribution record to the TTF and TTR Distribution records with a Distribution Type of Normal that are linked to the System Risk records.
Weibull	Beta Eta Gamma	Weibull	Beta Eta Gamma	This value is mapped from the TTF and TTR Distribution records with a Distribution Type of Weibull that are linked to the Reliability Distribution record to the TTF and TTR Distribution records with a Distribution Type of Weibull that are linked to the System Risk records.

Import an Asset

About This Task

You can also import the Reliability Distribution Analysis or Reliability Growth Analysis associated with the Asset record that you selected. Values from fields in the Reliability Growth or Reliability Distribution record will be mapped to System Risk and Distribution records, which are created when the corresponding record is imported and linked to the System Asset record, as described in the **Results** section.

This topic describes how to add an element by importing an Asset to a Diagram. You can also [add an element directly to a diagram](#).

Procedure

1. [Access the Diagram](#) within which you want to import an asset.
2. In the **Import** section, select .

The **Search** window appears.
3. Enter the search criteria.

A list of available assets appears.

4. Select check box to the left of the asset that you want to import.

The **Import Asset** window appears.

Tip: You can select more than one asset.

5. Select **OK**.

A new Asset element is added to the Diagram for each selected asset.

Results

When you import an Asset record into the Diagram, a new [System Asset record](#) is created, and information from the imported record is mapped to the System Asset record.

The following table contains the values that are imported from fields in Asset records and the System Analysis record and field to which they are mapped. All other values in System Analysis records are populated automatically with default values.

Asset Record Field	System Analysis Record	System Analysis Record Field	Notes
ID	System Asset	Name	None

When you are importing an Asset record, if you choose to import the Reliability Distribution Analysis or Reliability Growth Analysis associated with the Asset record that you selected, values from records in Reliability Distribution Analyses or Reliability Growth Analyses will also be mapped to records in the System Reliability Analysis.

The values that will be mapped are the same values that are mapped when a [Reliability Distribution Analysis](#) or [Reliability Growth Analysis](#) is imported without an Asset record, with the following exception:

- The value in the ID field of the Asset record will be mapped to the Name field in the System Asset record. The values in the Analysis ID field in the Reliability Growth or Reliability Distribution record will not be mapped to the System Asset record.

Import a Subsystem

About This Task

This topic describes how to add an element by importing a System Subsystem to a Diagram. You can also [add an element directly to a diagram](#).

Procedure

1. [Access the Diagram](#) within which you want to import a Subsystem.

2. In the **Import** section, select .

A list of available Subsystems appears.

3. Select the check box to the left of the Subsystem that you want to import.

Tip: You can select more than one Subsystem.

4. In the upper-right corner of the workspace, select **Import**.

A new Subsystem element is added to the Diagram for each selected System Subsystem.

Results

For each System Subsystem that you import:

- An element will be created in the diagram.
- A copy of the record will be created and linked to the [System Analysis record](#).
- All related records within the subsystem (e.g., System Asset records) will also be imported. An element and copy of each record will be created for each related record.



Delete an Element

About This Task

You can delete any element from a Diagram. As you delete elements from a Diagram, note that:

- If you delete an Asset element that was created by importing an Equipment or Functional Location record, when you delete the Asset element, only the Asset element will be deleted. The source record will not be deleted. Additionally, if the source record is linked to the System analysis, the link will also be deleted.
- You cannot delete the **Start** or the **End** node.

Procedure

1. [Access the Diagram](#) containing an element that you want to delete.
2. Select the element that you want to delete.
3. In the Diagram section, select , and then select . A confirmation message appears, asking you to confirm that you want to delete the selected element.
4. Select **Yes**. The element is deleted from the Diagram.

Delete a Connection Between Elements

About This Task

When you delete a connector between two nodes in the Diagram, you are deleting the link between the two records.

Procedure

1. [Access the Diagram](#) containing the elements and the associated connectors that you want to delete.
2. In the design canvas, point to the connection that you want to delete, and then select . A message appears, asking you to confirm that you want to delete the selected connection.
3. Select **Yes**. The connection is deleted from the Diagram.

Risks

About Risks

In System Reliability, a Risk identifies one way in which an Asset can fail. If the Risk occurs, then the piece of equipment or location will fail, and the system cannot run. In System Reliability Analyses, Risks are stored in System Risks, which can be linked to System Assets and System Switches.

A piece of equipment or location may have multiple Risks to represent multiple ways in which that piece of equipment or location can fail. As such, System Assets and System Switches can be linked to multiple System Risks.

Each Risk has a characteristic pattern of causing an Asset to fail as defined by its TTF distribution data or maximum operating time. Risks also have TTR distribution data, which characterizes the time needed to correct the failure that occurs as the result of the Risk and get the system running again. This distribution data is stored in Distributions, which are linked to Risks.

About Actions and Risks

After you create an Action in a System Reliability Analysis, you can assign a single Risk or multiple Risks to that Action. When you assign a Risk to an Action, a link is created between a System Risk Assessment record, which stores the GUID of the mitigated Risk in the Risk GUID field, and the Action. This allows the Action to mitigate the Risk. An Action may mitigate a Risk by changing certain properties, such as failure consequences or the failure distribution, of the Risk. Actions mitigate Risks in different ways depending on the type of Action that is assigned to the Risk. The different types of Actions mitigate Risks in the following ways:

- **Preventive Maintenance Action:** Can mitigate the Time to Fail (TTF) distribution of the Risk by increasing the maximum operating time of the Risk, as defined by the fields in the Distribution record that defines the TTF distribution associated with the Risk. For example, the Replace Seal Action in Scenario B of the [System Reliability Analysis Example](#) mitigates the Seal Failure Risk by creating more operating time by replacing the existing seals, which have a smaller amount of operating time, with new seals that have a larger amount of operating time.
- **Condition Monitor or Inspection Action:** Can mitigate the consequences of failure by fixing potential failures before they occur. This allows proactive repairs, or planned corrections, to be made to the system instead of fixing a failure using an unplanned correction. Planned corrections can consume less Resources and lower the costs of a Scenario. For example, the Vibration Analysis Action in Scenario B of the [System Reliability Analysis Example](#) mitigates the Bearing Failure Risk by identifying a potential Bearing Failure and executing a planned correction, which requires less Resources and less Resource usage than executing an unplanned correction.
- **Special Action:** Can mitigate the failure consequences of the Risk, as defined in the Fixed Unplanned Correction Cost field of the System Risk record, and the TTF distribution, as defined by the Distribution record that represents the TTF distribution associated with the Risk. For example, the occurrence of the Redesign Impeller Action in Scenario B of the [System Reliability Analysis Example](#) mitigates the Impeller Failure by reducing the fixed unplanned correction cost and extending the TTF distribution of the Impeller Failure Risk.

Note: An Action does not have to mitigate a Risk, but associating an Action with a Risk and mitigating the Risk creates a more reliable system.

Potential and Functional Risks

After you [add elements](#) to a Diagram, you must [connect the elements](#) to create the Diagram. Depending on the structure of the system for which you are creating a Diagram, you will want to connect elements to each other in a series or parallel to one another.

Note: Interaction with diagramming and design canvases is not available on [touch-screen devices](#).

Elements Connected in a Series

When you connect elements to each other in a series, every element has one preceding connection and one succeeding connection, with only one path from the Start element to the End element. For example, in the following image of Scenario A in the [System Reliability Analysis example](#), the elements in the Diagram for Scenario A root subsystem are connected in a series: every element between the Start and

End elements has one connection from an element and one connection to an element, and you can reach the End element from the Start element in only one way.

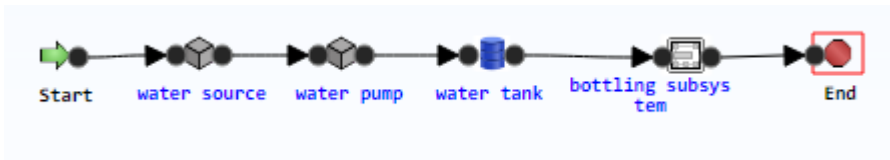

Elements Connected in Parallel

When you connect elements in parallel to one another, one or more elements will be connected to multiple elements, and there will be multiple paths from the Start element to the End element. For example, in the [System Reliability Analysis example](#), the Bottling Line elements in the Bottling Subsystem root subsystem are connected in parallel. In this case, the Start element and the Link element are connected to three Subsystem elements: Bottling Line 1, Bottling Line 2, and Bottling Line 3. Therefore, there are three different paths from the Start element to the End element, depending on which of the three Bottling Lines that you pass through.

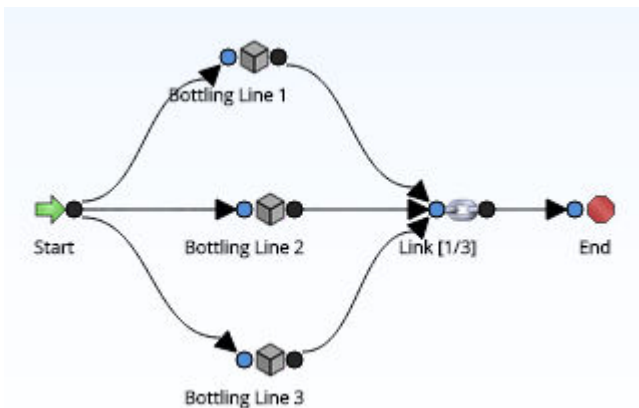

Resetting Risks

When a simulation is run, the occurrence of the Risks that are defined for a piece of equipment, location, or switch are simulated, based on the TTF Distribution associated with that Risk. After a Risk occurs or after actions are performed that mitigate the occurrence of that Risk in the simulation, that Risk will be reset automatically. This means that the time in-service for the component associated with the Risk will be changed to zero (0), indicating that the component was replaced (or repaired to as good as new).

Conditions for Resetting a Risk

When a Risk will be reset automatically is determined by the failure type of that Risk. A Risk whose failure type is Failure With Replacement will be reset automatically when any of the following scenarios occur:

- An unplanned correction takes place following the occurrence of a Risk.
- A planned correction takes place to mitigate the occurrence of a Risk.
- Preventive Maintenance is performed against a piece of equipment to mitigate the occurrence of a Risk.
- A Special Action with a TTF replacement is performed against a piece of equipment to mitigate the occurrence of a Risk.

A Risk whose failure type is Failure Without Replacement will be reset automatically when any of the following scenarios occurs:

- Preventive Maintenance is performed against a piece of equipment to mitigate the occurrence of a Risk.
- A Special Action with a TTF replacement is performed against a piece of equipment to mitigate the occurrence of a Risk.

Conditions for Resetting a Risk

Suppose that the following Risks with a failure type of Failure With Replacement are defined in your simulation for a Water Pump:

- Bearing Failure
- Impeller Failure
- Seal Failure

In the simulation, after unplanned correction is completed following the occurrence of the Bearing Failure Risk, the time in-service for the Bearing will be reset automatically to zero (0) to indicate that you will replace the Bearing after it fails so that the Bearing Failure Risk will not occur again until the defined TTF Distribution is reached.

Specifying Additional Risks

In addition to Risks being reset automatically as described in the preceding scenarios, you can specify that additional Risks be reset following the planned or unplanned correction of a given Risk. In other words, you can specify a Risk as a source Risk, whose planned or unplanned correction triggers additional Risks to be reset at that time. This means that the time in-service for the components associated with the additional Risks will be changed to zero (0), indicating that the additional components were also replaced (or repaired to as good as new) following the planned or unplanned correction of the source Risk.

Throughout the documentation we will use the term source Risk to refer to a Risk whose planned or unplanned correction triggers the resetting of additional Risks. We will use the term additional Risk to refer to Risks that are reset by the planned or unplanned correction of a source Risk.

You can specify that additional Risks should be reset only when:

- An unplanned correction takes place following the occurrence of a source Risk.
- or-
- A planned correction takes place to mitigate the occurrence of a source Risk.

Source Risks that are mitigated as a result of Special Action with a TTF replacement or Preventive Maintenance will not trigger any additional Risks to be reset.

Specifying Additional Risks

Suppose that:

- You will replace the Seal, in addition to the Bearing, when the Bearing Failure Risk occurs.
- or-
- The planned correction that you perform to mitigate the occurrence of the Bearing Failure Risk will also mitigate the occurrence of the Seal Failure Risk.

In this case, you want to indicate in your simulation that the Bearing Failure Risk (i.e., the source Risk) should reset the Seal Failure Risk (i.e., the additional Risk). In other words, the time that the Seal has been in-service will also be changed to zero (0) to reflect that the Seal will be replaced (or repaired to as good as new) following the planned or unplanned correction of the Bearing Failure Risk.

Rules for Resetting Risks

You can specify any Risk that is defined for an Asset as a source Risk or an additional Risk, with a few exceptions. When you set up a simulation to include source Risks and additional Risks, you must follow these rules:

- You can specify a Risk as a source Risk if the failure type for that Risk is:
 - Failure With Replacement
 - or-
 - Failure Without Replacement
- You can specify a Risk as an additional Risk only if the failure type for that Risk is Failure With Replacement.

In the simulation, only Risks whose failure type is Failure With Replacement are reset following a planned or unplanned correction. Risks whose failure type is Failure Without Replacement are not reset following planned or unplanned correction because the components associated with these Risks are not replaced (or repaired to as good as new). Specifically, this means that a Risk whose failure type is Failure Without Replacement:

- Can be specified as a source Risk. In other words, the planned or unplanned correction of these Risks can trigger additional Risks to be reset, if the failure type of the additional Risks is Failure With Replacement.
- Cannot be specified as additional Risks. The rows containing Risks whose failure type is Failure Without Replacement are disabled.

Example: Rules for Resetting Risks

Suppose that the following Risks with the following failure types are defined for a Shell and Tube Heat Exchanger:

- A Tube Bundle Failure Risk whose failure type is Failure Without Replacement.
- A Shell Head Failure Risk whose failure type is Failure With Replacement.
- A Seals (gaskets) Failure Risk whose failure type is Failure With Replacement.

Now suppose that when you complete planned or unplanned correction for the Tube Bundle Failure Risk, though you will not replace (or repair to as good as new) the Tube Bundle, you will replace (or repair to as good as new) the Seals (gaskets). In this case, you want to indicate in your simulation that the Tube Bundle Failure Risk is a source Risk that should trigger the resetting of the Seals (gaskets) Failure Risk (i.e., an additional Risk). In other words, the time that the Seals (gaskets) has been in service will be changed to zero (0) to reflect that the Seals (gaskets) will be replaced (or repaired to as good as new) following the planned or unplanned correction of the Tube Bundle Failure Risk.



Access a Risk

Procedure

1. [Access the System Scenario](#) for which you want to view details of a Risk.
2. In the workspace, select the **Risks** tab.

A list of System Subsystems, a grid containing a list of Risks associated with the selected System Scenario, and the **Properties** pane appears.

The screenshot displays the 'System Reliability' application interface. On the left, there is a sidebar with 'Analysis Summary' and a 'Run Simulation' button. Below this are sections for 'Simulation Results' and 'Action Optimization'. The main content area is titled 'System Reliability' and shows a 'Last modified by bl on Thursday, October 10, 2019 1:12 PM'. The 'Risks' tab is active, showing a table of risks. The table has columns for 'NAME', 'DESCRIPTION', and 'TTF DISTRIB'. The first row is 'Auto RM Growth Segments and Extrapolation'. Below it are several rows of 'risk 0'. A dropdown menu on the left shows 'subsystem 3' selected. Below the table is a 'Properties' pane for 'subsystem 3' with fields for 'Name', 'Description', 'Production', and 'Contribution' (56.0473209973645 %).

Note: As needed, in the **Properties** pane, you can select  to modify the values in the **available fields**, and then select  to save your changes.

The grid contains the following columns of information:

- **Name:** Contains the value in the Name field in the System Risk record.
 - **Description:** Contains the value in the Description field in the System Risk record.
 - **TTF Distribution:** Contains the **TTF Distribution** link, which you can select to open the **TTF Distribution** window and view the Time to Failure (TTF) distribution data for the associated System Risk.
 - **TTR Distribution:** Contains the **TTR Distribution** link, which you can select to open the **TTR Distribution** window and view the Time to Repair (TTR) distribution data for the associated System Risk.
 - **Planned Resource Usages:** Contains the **Planned Resource Usages** link, which you can select to open the **Planned Resource Usages** window and view any planned Resource usages that have been assigned to the Risk.
 - **Unplanned Resource Usages:** Contains the **Unplanned Resource Usages** link, which you can select to open the **Unplanned Resource Usages** window and view any unplanned Resource usages that have been assigned to the Risk.
 - **Risks to Reset:** Contains a number that represents the number of additional Risks that will be reset following the planned or unplanned correction of the Risk in that row. This number appears as a hyperlink, which you can select to [access the <Risk>/Risks to Reset window](#), where you can manage the additional Risks that will be reset in the simulation following the planned or unplanned correction of the source Risk.
3. In the pane to the left of the grid, select the Asset for which you want to view Risks.

The list of Risks associated with the selected Asset appears in the grid.

The screenshot displays the 'System Reliability' interface. On the left, there is a sidebar with 'Analysis Summary', 'Run Simulation', 'Simulation Results', 'Action Optimization', and 'scenario 0'. The main area shows a navigation menu with 'Diagram', 'Definition', 'Risks', 'Actions', 'Global Events', and 'Grid View'. The 'Risks' tab is active, showing a table with one row: 'risk 0'. Below the table is a pagination control '1 - 1 of 1 Results'. A 'Properties' pane is open at the bottom, showing details for 'component 1' under the 'General' tab. The 'Production Contribution' is listed as 78.1279274626299 %.

NAME	DESCRIPTION	TTF DISTRIBUTION	TTR DISTRIBUTION	PLANNED CORRECTION
risk 0		TTF Distribution	TTR Distribution	Planned

General	
Name	component 1
Description	
Production Contribution	78.1279274626299 %

4. In the grid, select the Risk whose details you want to view.

The **properties** of the selected Risk appear in the **Properties** pane, displaying the **General** tab, the **Planned Correction** tab, and the **Simulations Options** tab.

System Reliability
Last modified by bl on Thursday, October 10, 2019 1:12 PM

Diagram Definition **Risks** Actions Global Events Grid View

+ [trash] [filter] [refresh] [Show Mitig...](#) [Associate D...](#) [Open Analy...](#)

NAME	DESCRIPTION	TTF DISTRIBUTION	TTR DISTRIBUTION	PLANNE
risk 0		TTF Distribution	TTR Distribution	Planne

1 - 1 of 1 Results Page 1 of 1

Properties

General	Name	risk 0
Correction	Description	
Simulation Options	Last Failure	

Add a Risk

Procedure

1. [Access the System Scenario](#) to which you want to add a Risk.
2. In the workspace, select the **Risks** tab.

Tip: You can also [add a Risk via the Actions](#) tab.

A list of Risks associated with the selected Scenario appears.

The screenshot displays the 'System Reliability' application interface. On the left, a sidebar shows navigation options: 'Analysis Summary', 'Run Simulation', 'Simulation Results', 'Action Optimization', and 'scenario 0'. The main workspace is titled 'System Reliability' and shows a 'Risks' section. A table lists risks with columns for NAME, DESCRIPTION, and TTF DISTRIB. A dropdown menu is open over 'subsystem 3', showing a list of components: 'component 0', 'component 1', and 'component 10'. Below the table, a properties panel for 'subsystem 3' is visible, showing 'Production Contribution' as 56.0473209973645 %.

- In the **Risks** section, in the pane to the left of the grid, select the Asset for which you want to add a risk, and then select . The datasheet for the new Risk appears.
- As needed, enter the values in the [available fields](#), and then select . The Risk is saved.

Assign a New Resource to a Risk

About This Task

This topic describes how to create and assign a new Resource to a Risk. You can also [assign an existing Resource to a Risk](#).

Procedure

- [Access a Risk](#) to which you want to assign a resource.
- In the grid, locate the row containing the Risk to which you want to assign a Resource.
- If you want to assign a planned Resource, select the **Planned Resource Usages** link.

-or-

If you want to assign unplanned resource, select the **Unplanned Resource Usages** link.

The **<Risk> - <Resource Usage>** grid appears, displaying the list of resources that are assigned to the selected Risk. **<Risk>** is the name of the Risk that you selected and **<Resource Usages>** is the type of Resource Usage that you selected.

The following image shows the grid when you select Unplanned Resource Usage:

The screenshot displays the 'System Reliability' interface. The top navigation bar includes 'Diagram', 'Definition', 'Risks' (selected), 'Actions', 'Global Events', and 'Grid View'. The main content area is titled 'risk 0 / Unplanned Resource Usages' and contains a table with the following data:

RESOURCE	QUANTITY	DURATION	DURATION UNITS	TOTAL FIXED C
resource 4	2	0.5	Hours	2,000.00

Below the table, a detailed view for 'component 1' is shown, including fields for Name, Description, and Production Contribution (78.1279274626299%).

4. Select **+**.

The datasheet for new System Resource Usage appears.

5. As needed, enter the value in the [available fields](#), and then select .

A new Resource is created and assigned to the Risk.

Assign an Existing Resource to a Risk

About This Task

After a Resource exists for a System Reliability Analysis, you can assign the resource to a Risk. When you do so, you associate the cost of that Resource with each failure that occurs as a result of that Risk. This allows you to assign a realistic, financial cost to the consequences of the Risk that can be included in the simulation results.

When you assign a Resource to a Risk, a [System Resource Usage record](#) will be created and will store information that specifies how the Resource will be used (e.g., the quantity and duration). There are two ways to assign Resources to Risks:

- Planned Resource Usage
- Unplanned Resource Usage

This topic describes how to assign an existing Resource to a Risk. You can also [create and assign a new Resource to a Risk](#).

Procedure

1. [Access the Risk](#) to which you want to assign a Resource.
2. In the grid, locate the row containing the Risk to which you want to assign a Resource.
3. If you want to assign planned Resource, select the **Planned Resource Usages** link.

-or-

If you want to assign unplanned Resource, select the **Unplanned Resource Usages** link.

The **<Risk> - <Resource Usage>** grid appears, displaying the list of resources that are assigned to the selected Risk. **<Risk>** is the name of the Risk that you selected and **<Resource Usages>** is the type of Resource Usage that you selected.

The following image shows the grid when you select Unplanned Resource Usage:

The screenshot displays the 'System Reliability' interface. On the left is a sidebar with 'Analysis Summary', 'Run Simulation', 'Simulation Results', and 'Action Optimization'. The main area shows a 'Risks' tab with a sub-tab for 'risk 0 / Unplanned Resource Usages'. Below this is a table with the following data:

RESOURCE	QUANTITY	DURATION	DURATION UNITS	TOTAL FIXED C
resource 4	2	0.5	Hours	2,000.00

Below the table is a 'Properties' panel for 'component 1' with the following details:

Name	component 1
Description	
Production Contribution	78.1279274626299 %

4. In the upper-left corner of the grid, select .

The **New Resource Usage from Existing Resources** window appears.

New Resource Usage from Existing Resources

Resources List	<input type="text" value="resource 2"/>
Quantity	<input type="text" value="1"/>
Duration	<input type="text" value="0"/>
Duration Units	<input type="text" value="Days"/>

Cancel

Finish

5. As needed, enter the value in the [available fields](#), and then select **Finish**.

The selected Resource is assigned to the Risk.

Modify a Resource Assigned to a Risk

About This Task

When you modify a Resource that is assigned to a Risk, you are modifying the System Resource Usage record. The actual System Resource record is not changed.

Procedure

1. [Access the Risk](#) whose resource you want to modify.
2. In the grid, locate the row containing the Risk for which you want to modify a Resource.
3. If you want to modify a planned Resource, select the **Planned Resource Usages** link.

-or-

If you want to modify an unplanned resource, select the **Unplanned Resource Usages** link.

The **<Risk> - <Resource Usage>** grid appears, displaying the list of resources that are assigned to the selected Risk. **<Risk>** is the name of the Risk that you selected and **<Resource Usages>** is the type of Resource Usage that you selected.

The following image shows the grid when you select Unplanned Resource Usage:

The screenshot shows the 'System Reliability' interface. On the left is a navigation sidebar with 'Analysis Summary', 'Run Simulation', 'Simulation Results', 'Action Optimization', and 'scenario 0'. The main area is titled 'System Reliability' and shows a 'Report' button and 'Site: Global'. Below this are tabs for 'Diagram', 'Definition', 'Risks', 'Actions', 'Global Events', and 'Grid View'. The 'Risks' tab is active, showing a sub-tab for 'risk 0 / Unplanned Resource Usages'. A grid displays resource usage data:

RESOURCE	QUANTITY	DURATION	DURATION UNITS	TOTAL FIXED COST
resource 4	2	0.5	Hours	2,000.00

Below the grid, a properties panel for 'component 1' is visible, showing 'Name: component 1', 'Description', 'Production Contribution: 78.1279274626299 %', and a 'Properties' button.

4. In the grid, select the row containing the Resource that you want to modify, and then select .
The **Edit Resource Usage** datasheet appears.
5. Modify values in the [available fields](#), and then select .
Your changes are saved.

Remove a Resource Assigned to a Risk

About This Task

When you remove a Resource from a Risk, you delete the System Resource Usage record so that the Resource is no longer used by the selected Risk. The actual System Resource record is still available for the System Reliability Analysis and can be used if needed.

Procedure

1. [Access the Risk](#) to which you want to modify a resource.
2. In the grid, locate the row containing the Risk for which you want to modify a Resource.

- If you want to remove a planned Resource, select the **Planned Resource Usages** link.

-or-

If you want to remove an unplanned Resource, select the **Unplanned Resource Usages** link.

The **<Risk> - <Resource Usage>** grid appears, displaying the list of resources that are assigned to the selected Risk. **<Risk>** is the name of the Risk that you selected and **<Resource Usages>** is the type of Resource Usage that you selected.

The following image shows the grid when you select Unplanned Resource Usage:

The screenshot displays the 'System Reliability' interface. On the left is a navigation pane with 'Analysis Summary', 'Run Simulation', 'Simulation Results', 'Action Optimization', and 'scenario 0'. The main area shows 'System Reliability' with a 'Report' button and 'Site: Global'. Below this are tabs for 'Diagram', 'Definition', 'Risks', 'Actions', 'Global Events', and 'Grid View'. The 'Risks' tab is active, showing 'risk 0 / Unplanned Resource Usages'. A grid lists resources with columns: RESOURCE, QUANTITY, DURATION, DURATION UNITS, and TOTAL FIXED COST. One row is highlighted: resource 4, 2, 0.5, Hours, 2,000.00. Below the grid is a detailed view for 'component 1' with fields for Name, Description, and Production Contribution (78.1279274626299%).

- In the grid, select the row containing the resource that you want to remove, and then select .

A message appears, you to confirm that you want to remove the selected Resource.

- Select **OK**.

The Resource is removed from the grid, and the System Resource Usage record is deleted from the database.

Specify Risks to Reset

The following instructions provide details on specifying which additional Risks should be reset by a source Risk.

Procedure

- Access the Risk for which you want to specify risks to reset.
- In the grid, locate the row containing the Risk for which you want to reset additional risks.
- In the **Risks to Reset** column, select the hyperlinked number.

The **<Risk>/Risks to Reset** grid appears, displaying all the Risks that are defined for the selected Asset element, except for the currently selected Risk. **<Risk>** is the name of the Risk that you selected.

4. Locate the row containing the additional Risk that you want to be reset by the source Risk.

Tip: You can select more than one row.

5. In the **Selected** column, select the check box, and then select .

The grid in the Risks section appears, and the hyperlinked number in the **Risks to Reset** cell for the source System Risk record changes to reflect the number of additional Risks you selected. When you run the simulation, the time in-service for the components associated with the additional Risks will be changed to zero (0), following the planned or unplanned correction of the source Risk.

Access an Associated Analysis

You can access the Reliability Growth or Reliability Distribution Analysis that is associated with a Risk.

Procedure

1. [Access the Risk](#) whose associated Distribution Analysis you want to open.
2. Select the row that contains the Risk whose associated Distribution Analysis you want to open.
3. In the upper-right corner of the grid, select **Open Analysis**.

Note: If your System Reliability Analysis has any unsaved changes, you will be prompted to save them.

The Reliability Growth or Reliability Distribution Analysis appears in a new tab.

Define Distribution Data Manually

About This Task

This topic describes how to define distribution data for Risks manually. You can also [associate distribution data from existing Reliability Distribution Analyses and Reliability Growth Analyses](#).

Procedure

1. [Access the Risk](#) for which you want to define Distributions data.
2. In the grid, locate the row containing the Risk for which you want to define Distribution data:
3. If you want to define TTF Distribution data, select **TTF Distribution**.

-or-

If you want to define TTR Distribution data, select **TTR Distribution**.

The details of the Distribution appear in the workspace.

Analysis Summary

v3.3.2 SP2 Sys. Model with DB component
Last modified by tim on Friday, November 13, 2009 12:08 PM

Diagram Definition **Risks** Actions Global Events Grid View

v3.1.0 Rel. Dist. Analysis from a query / TTF Distribution

Name : v3.1.0 Rel. Dist. Analysis from a query

Description :

Distribution : Weibull

Type

Time Units : Days

Beta : 2.72438312043926



153.087802638595

v3.3.2 SP2 Sys. Model with DB component

Baseline-101

General	Name	Baseline-101
Financial Consequences	Description	Baseline-101
	Production	
	Contribution	100 %

Properties

4. Select 
5. As needed, enter the values in the available fields, and then select .
The new distribution data is saved.

Associate Existing Distribution Data with Risks

About This Task

This topic describes how to associate distribution data from existing Reliability Distribution Analyses and Reliability Growth Analyses to Risks. You can also [define distribution data for Risks manually](#).

When you associate existing distribution data with Risks, you use data stored in a Reliability Growth or Reliability Distribution Analysis in a system.

After existing distribution data has been associated with a Risk, you can update the information periodically. When you associate the distribution data, the Entity Key and Family Key of the Reliability Distribution and Reliability Growth Analysis are stored in the System Risk record, thereby establishing a connection between the two records that allows for future updates. This way your System Reliability Analysis uses the most current information available to calculate the simulation results.

Procedure

1. [Access the Risk](#) to which you want to associate existing Distributions data.
2. In the grid, locate the row that contains the Risk with which you want to associate Distribution data.
3. In the upper-right corner of the grid, select **Associate Distribution**.

The **Search** window appears, where you can search for a Reliability Growth Analysis or Reliability Distribution Analysis whose distribution data you want to associate with a Risk.

4. Perform a search to locate your desired analysis.

A list of analyses based on the search criteria appears.

5. Select the analysis with the failure distribution information that you want to associate with the Risk, and then select **OK**.

The distribution data from the selected record is imported, and a connection is established between the Risk and the selected Reliability Growth Analysis or Reliability Distribution Analysis.

Refresh Distribution Data

Procedure

1. [Access the Risk](#) whose distribution data you want to refresh.
2. In the grid, select the row that contains the Risk whose distribution data you want to refresh.
3. Select .

The distribution data is refreshed.

Remove the Association Between a Risk and a Distribution Analysis

Procedure



1. [Access the Risk](#) for which you want to remove an analysis association.
2. In the row containing the Risk for which you want to remove an analysis association:

Select **TTF Distribution**.

-or-

Select **TTR Distribution**.

The **<Risk> /<Distribution>** window appears, where **<Risk>** is the name of the Risk that you selected and **<Distribution>** is the type of Distribution that you selected.

3. In the upper-right corner, select  **Enable Distribution Association**
 4. Clear the **Enable Distribution Association** check box.
The fields in the **<Risk>/<Distribution>** window are enabled.
Note: You can keep the last values that have been imported from the associated analysis or you can enter new distribution data manually.
 5. Select .
- Your changes are saved.

Access a Mitigating Action

Procedure

1. [Access a Risk](#) for which you want to view a mitigating Action.
2. In the grid, select the row containing the Risk whose Mitigating Action you want to view.
3. In the upper-right corner of the Risks section, select **Show Mitigating Action**.

The **Risks/Mitigating Actions** grid appears, displaying the Mitigating Actions associated with the selected Risk. **<Risk>** is the name of the Risk that you selected.

The screenshot displays the 'Risks' section of the software. The main area shows a table of risks with the following columns: NAME and DESCRIPTION. A detailed view of a risk is shown below the table, including fields for Name, Description, and Last Failure.

NAME	DESCRIPTION
Monthly check	

General	Name	v3.1.0 Rel. Dist. Analysis from a query
Correction	Description	Description for v3.1.0 Rel. Dist. Analysis from a query
Simulation Options	Last Failure	1/24/1999 12:00 AM

The grid contains the following [columns](#) of information:

- **Name:** Displays the value in the Name field in the System Action record.
- **Description:** Displays the value in the Description field in the System Action record.

Assign an Action to a Risk

Procedure

1. [Access a Risk](#) to which you want to assign an Action.
2. In the grid, select the row containing the appropriate Risk.
3. In the upper-right corner of the **Risks** section, select **Show Mitigating Action**.

The **Risks/Mitigating Actions** grid appears, displaying the Mitigating Actions associated with the selected Risk. **<Risk>** is the name of the Risk that you selected.

4. If you want to assign a new Action, in the upper-right corner of the grid, select **Assign New Action**. The datasheet for new Action appears.

You can [enter values in the available fields](#) to add an Action, and then select  to add the Action to the Risk.

-or-

If you want to assign an existing Action, in the upper-right corner of the grid, select **Assign Existing Actions**.

The **<Risk>/Mitigating Actions/From Existing** grid appears, displaying a list of Actions. **<Risk>** is the name of the Risk that you selected.

5. In the grid, locate the row that contains the Action that you want to assign to the Risk.
6. In the **Selected** column, select the check box.
7. In the upper-right corner of the grid, select **Submit**.

The selected Action is assigned to the Risk.

Delete a Risk

Procedure

1. [Access the System Scenario](#) for which you want to delete a Risk.
2. In the workspace, select the **Risks** tab.

A list of System Subsystems, a grid containing a list of Risks associated with the selected System Scenario, and the **Properties** pane appear.

3. In the grid, select the Risk that you want to delete, and then select .

The selected Risk is deleted.

Actions

About Actions

In a System Reliability Analysis, an Action represents an operation that can be performed against a piece of equipment, location, or a switch. Actions can represent inspections, general maintenance, or specific events that mitigate Risks, such as training or procedures.

Actions can be unique events that happen only once during a simulation period, or they can be repeated at certain times during the simulation period. You can optionally assign Resources to Actions to associate a specific cost with the Action. When you assign Resources to Actions, a [System Resource Usage record](#) will be created.

Details

Actions in System Reliability Analyses are stored in the following records, which can be linked to System Asset and System Switch records:

- [System Condition Monitor Records](#): Store information about continuous, condition-based maintenance Actions. An example of this type of Action would be an Action that continuously monitors the level of fluid in a gauge.
- [System Inspection Records](#): Store information about periodic, condition-based maintenance Actions. An example of this type of Action is the Vibration Analysis Action in Scenario B of our [System Reliability Analysis Example](#).
- [System Preventive Maintenance Records](#): Store information about time-based maintenance Actions. An example of this type of Action is the Replace Seals Action in Scenario B of our [System Reliability Analysis Example](#).
- [System Special Action Records](#): Store information about procedural, redesign, or training Actions. An example of this type of Action is the Redesign Impeller Action in Scenario B of our [System Reliability Analysis Example](#).

About Actions and Risks

After you create an Action in a System Reliability Analysis, you can assign a single Risk or multiple Risks to that Action. When you assign a Risk to an Action, a link is created between a System Risk Assessment record, which stores the GUID of the mitigated Risk in the Risk GUID field, and the Action. This allows the Action to mitigate the Risk. An Action may mitigate a Risk by changing certain properties, such as failure consequences or the failure distribution, of the Risk. Actions mitigate Risks in different ways depending on the type of Action that is assigned to the Risk. The different types of Actions mitigate Risks in the following ways:

- **Preventive Maintenance Action:** Can mitigate the Time to Fail (TTF) distribution of the Risk by increasing the maximum operating time of the Risk, as defined by the fields in the Distribution record that defines the TTF distribution associated with the Risk. For example, the Replace Seal Action in Scenario B of the [System Reliability Analysis Example](#) mitigates the Seal Failure Risk by creating more operating time by replacing the existing seals, which have a smaller amount of operating time, with new seals that have a larger amount of operating time.
- **Condition Monitor or Inspection Action:** Can mitigate the consequences of failure by fixing potential failures before they occur. This allows proactive repairs, or planned corrections, to be made to the system instead of fixing a failure using an unplanned correction. Planned corrections can

consume less Resources and lower the costs of a Scenario. For example, the Vibration Analysis Action in Scenario B of the [System Reliability Analysis Example](#) mitigates the Bearing Failure Risk by identifying a potential Bearing Failure and executing a planned correction, which requires less Resources and less Resource usage than executing an unplanned correction.

- **Special Action:** Can mitigate the failure consequences of the Risk, as defined in the Fixed Unplanned Correction Cost field of the System Risk record, and the TTF distribution, as defined by the Distribution record that represents the TTF distribution associated with the Risk. For example, the occurrence of the Redesign Impeller Action in Scenario B of the [System Reliability Analysis Example](#) mitigates the Impeller Failure by reducing the fixed unplanned correction cost and extending the TTF distribution of the Impeller Failure Risk.

Note: An Action does not have to mitigate a Risk, but associating an Action with a Risk and mitigating the Risk creates a more reliable system.

Access an Action

Procedure

1. [Access the System Scenario](#) for which you want to view details of an Action.
2. In the workspace, select the **Actions** tab.

A list of System Subsystems, a grid containing a list of Actions associated with the selected System Scenario, and the **Properties** pane appear.

The screenshot displays the software interface for viewing an Action. On the left, the 'Analysis Summary' sidebar contains a 'Run Simulation' button, 'Simulation Results', 'Action Optimization', and 'Scenario 1'. The main workspace shows the 'v3.3.2 SP2 Sys. Model with DB component' with the 'Actions' tab selected. A table lists actions, with 'Baseline-101' highlighted. The 'Properties' pane for 'Baseline-101' is open, showing the following details:

General	Name	Baseline-101
Financial Consequences	Description	Baseline-101
	Production Contribution	100 %

Note: As needed, in the **Properties** pane, you can select to modify the values in the [available fields](#), and then select to save your changes.

The grid contains the following columns of information:

- **Name:** Displays the value in the Name field in the System Action record.
 - **Description:** Displays the value in the Description field in the System Action record.
 - **Resource Usages:** Displays the **Resource Usages** link, which provides access to any Resources that have been assigned to the Action.
3. In the pane to the left of the grid, select the Asset for which you want to view Actions.

The list of Actions associated with the selected Asset appears in the grid.

4. In the grid, select the Action whose details you want to view.

The properties of the selected Action appear in the **Properties** pane at the bottom of the page. The tabs in the **Properties** pane appear based on the [Action Type](#).

About Action Optimization

Action Optimization allows you to optimize a group of actions associated with an analysis to determine the optimum interval at which to perform an inspection or preventative maintenance.

After you have found the optimal interval for an action, you can apply it to that action. When you do so, in the **Actions** section of the workspace for the System Reliability Analysis, the value in the Interval field in the System Action record will be overwritten with the value that exists in the Optimal Interval field.

After you apply the optimal interval, you can then [run the simulation for the System Reliability Analysis](#) to update the results based upon the optimized interval.

Add a Periodic Condition-Based Maintenance Action

Procedure

1. [Access the System Scenario](#) for which you want to add an Action.
2. In the **Actions** section, in the pane to the left of the grid, select the Asset to which you want to add an Action, and then select .

The **Action Type** subsection appears in the workspace.

3. In the **Action Type** list, select **Condition-Based Maintenance (Predictive) (CM)**.
4. In the **Condition Monitoring Type** list, select **Periodic**.
5. As needed, in the **New Inspection** sub-section, enter the values in the [available fields](#), and then select .

The newly added Periodic Condition-Based Maintenance Action appears in the Actions section.

Add a Continuous Condition-Based Maintenance Action

Procedure

1. [Access the System Scenario](#) for which you want to add an Action.
2. In the **Actions** section, in the pane to the left of the grid, select the Asset for which you want to add an Action, and then select .

The **Action Type** subsection appears in the workspace.

3. In the **Action Type** list, select **Condition-Based Maintenance (Predictive) (CM)**.
4. In the **Condition Monitoring Type** list, select **Continuous**.

The **New Condition Monitor** sub-section appears in the workspace.

5. As needed, in the **New Inspection** sub-section, enter the values in the [available fields](#), and then select .

The Continuous Condition-Based Maintenance Action is saved and appears in the **Actions** section.

Add a Time-Based Maintenance Action

Procedure

1. [Access the System Scenario](#) for which you want to add an Action.
2. In the **Actions** section, in the pane to the left of the grid, select the Asset for which you want to add an Action, and then select .

The **Action Type** subsection appears in the workspace.

3. In the **Action Type** list, select **Time-Based Maintenance (Preventative) (PM)**.

Note: The **Condition Monitoring Type** list is hidden.

The **New Preventive Maintenance** subsection appears in the workspace.

4. As needed, enter the values in the [available fields](#), and then select .

The Time-Based Maintenance Action is saved and appears in the **Actions** section.

Add a Special Action

Procedure

1. [Access the System Scenario](#) for which you want to add an Action.
2. In the **Actions** section, in the pane to the left of the grid, select the Asset to which you want to add an Action, and then select .

The **Action Type** subsection appears in the workspace.

3. In the **Action Type** list, select one of the following:

- **Procedure (PROC)**
- **Redesign (DSN)**
- **Training (TRN)**

Note: The **Condition Monitoring Type** list is hidden.

The **New Special Action** sub-section appears in the workspace.

4. As needed, enter the values in the [available fields](#), and then select .

The Special Action appears in the **Actions** section.

Assign a New Resource to an Action

About This Task

This topic describes how to create and assign a new Resource to an Action. You can also [assign an existing Resource to an Action](#).

Procedure

1. [Access the Action](#) to which you want to assign a resource.

- In the grid, locate the row containing the Action to which you want to assign a Resource.
- Select the **Resource Usage** link.

The **<Action> - Resource Usage** grid appears, displaying the list of resources that are assigned to the selected Action. **<Action>** is the name of the Action that you selected.

The screenshot shows the 'Resource Usage' grid for the action 'Monthly check / Resource Usage'. The grid has the following data:

RESOURCE	QUANTITY	DURATION	DURATION UNITS	TOTAL FIXED C
Mechanic	1	1	Days	0.00

Below the grid, the properties panel for 'Baseline-101' is visible:

General	Name	Baseline-101
Financial Consequences	Description	Baseline-101
	Production	
	Contribution	100 %

- Select **+**.
The datasheet for new System Resource Usage appears.
- As needed, enter the value in the **available fields**, and then select .
A new Resource is created and assigned to the Action.

Assign an Existing Resource to an Action

About This Task

After Resources exist for a System Reliability Analysis, you can assign them to Actions. When you do so, you associate the cost of that Resource with each occurrence of the Action. This allows you to assign a realistic cost to the Action that can be included in the simulation results.

When you assign a Resource to an Action, a System Resource Usage record will be created and will store information that specifies how the Resource will be used (e.g., the quantity and duration).

This topic describes how to assign an existing Resource to an Action. You can also [create and assign a new Resource to an Action](#).

Procedure

1. [Access the Action](#) to which you want to assign a resource.
2. In the grid, locate the row containing the Action to which you want to assign a Resource.
3. Select the **Resource Usage** link.

The **<Action> - Resource Usage** grid appears, displaying the list of resources that are assigned to the selected Action. **<Action>** is the name of the Action that you selected.

The screenshot shows a software interface with a sidebar on the left containing 'Analysis Summary', 'Run Simulation', 'Simulation Results', 'Action Optimization', and 'Scenario 1'. The main area displays a project titled 'v3.3.2 SP2 Sys. Model with DB component'. Below the title are tabs for 'Diagram', 'Definition', 'Risks', 'Actions', 'Global Events', and 'Grid View'. The 'Actions' tab is active, showing a grid for 'Monthly check / Resource Usage'. The grid has columns: RESOURCE, QUANTITY, DURATION, DURATION UNITS, and TOTAL FIXED C. A row is visible for 'Mechanic' with a quantity of 1 and a duration of 1 day. A dropdown menu is open, showing 'v3.3.2 SP2 Sys. Model with DB component' and 'Baseline-101'. Below the grid is a 'Properties' section with fields for 'Name' (Baseline-101), 'Description' (Baseline-101), and 'Production Contribution' (100 %).

4. In the upper-left corner of the grid, select .
The **New Resource Usage from Existing Resources** window appears.
5. As needed, enter the value in the [available fields](#), and then select **Finish**.
The selected Resource is assigned to the Action.

Modify a Resource Assigned to an Action

About This Task

When you modify a Resource that is assigned to an Action, you are modifying the [System Resource Usage record](#). The actual [System Resource record](#) is not changed.

Procedure

1. [Access the Action](#) for which you want to modify a resource.
2. In the row containing the Action for which you want to modify an assigned Resource, select **Resource Usage**.

The **<Action> - Resource Usage** grid appears, displaying the list of Resources that are assigned to the selected Action. **<Action>** is the name of the Action that you selected.

The screenshot shows a software interface with a sidebar on the left containing 'Analysis Summary', 'Run Simulation', 'Simulation Results', 'Action Optimization', and 'Scenario 1'. The main area displays a model 'v3.3.2 SP2 Sys. Model with DB component' and a 'Monthly check / Resource Usage' grid. The grid has the following data:

RESOURCE	QUANTITY	DURATION	DURATION UNITS	TOTAL FIXED C
Mechanic	1	1	Days	0.00

Below the grid is a properties panel for 'Baseline-101' with the following details:

General	Name	Baseline-101
Financial Consequences	Description	Baseline-101
	Production Contribution	100 %

3. Select the row containing the Resource that you want to modify, and then select . The **Edit Resource Usage** datasheet appears.
4. As needed, modify values in the [available fields](#), and then select . Your changes are saved.

Remove a Resource from an Action

About This Task

When you remove a Resource from an Action, you delete the System Resource Usage record so that the Resource is not used by the selected Action. The actual System Resource record is still available for the System Reliability Analysis and can be used again if needed.

Procedure

1. [Access the Action](#) for which you want to delete an assigned resource.
2. In the row containing the Action for which you want to delete an assigned Resource, select **Resource Usage**.

The **<Action> - Resource Usage** grid appears, displaying the list of resources that are assigned to the selected Action. **<Action>** is the name of the Action that you selected.

The screenshot displays the 'Actions' section of the software. The main heading is 'Monthly check / Resource Usage'. Below this is a table with the following data:

RESOURCE	QUANTITY	DURATION	DURATION UNITS	TOTAL FIXED C
Mechanic	1	1	Days	0.00

A dropdown menu on the left shows 'v3.3.2 SP2 Sys. Model with DB component' and 'Baseline-101' is selected. Below the table, a properties panel for 'Baseline-101' is shown with the following details:

General	Name	Baseline-101
Financial Consequences	Description	Baseline-101
	Production	
	Contribution	100 %

- In the grid, select a row containing the resource that you want to delete, and then select . A message appears, asking you to confirm that you want to remove the selected Resource.
- Select **OK**. The Resource is removed from the grid, and the System Resource Usage record is deleted from the database.

Access a Mitigated Risk

Procedure

- [Access the Action](#) for which you want to view a mitigated risk.
- In the grid, select the row containing the Action whose mitigating risk you want to view.
- In the upper-right corner of the **Actions** section, select **Show Mitigated Risk**.

The grid for the selected mitigated risk appears, displaying the list of Risks associated with the selected Action.

Note: The **New TTF Distribution** and **New Failure Consequence** columns appear only if the Action Type is Redesign (DSN), Procedure (PROC), or Training (TRN).

The screenshot displays the 'Actions' tab in a software application. The main content area shows a table of risks with columns for NAME, DESCRIPTION, NEW TTF DISTRIBUTION, and NEW FAILURE CON:. A single row is visible for 'Impellar failure', with 'No' in the 'NEW TTF DISTRIBUTION' and 'NEW FAILURE CON:' columns. Above the table, there are buttons for 'Assign Existing Risk' and 'Assign New Risk'. Below the table, a 'Properties' window is open for the 'Bi-weekly check' action, showing fields for 'Name' (Bi-weekly check), 'Description', and 'Action Type' (Training). The left sidebar contains navigation options like 'Run Simulation', 'Simulation Results', and 'Action Optimization'.

Specify TTF Distribution Values for the Simulation

For each Mitigated Risk that is associated with the Special Action, you can specify the TTF Distribution values that you want to be used in the simulation when the Special Action is completed to mitigate the occurrence of the given Risk.

Procedure

1. [Access the Mitigated Risk](#) for which you want to specify the TTF Distribution values.
2. Locate the row containing the Risk for which you want to specify the TTF Distribution values.
3. In the **New TTF Distribution** column, select the hyperlink.

The **TTF Distribution** window appears.

4. In the lower-left corner, select the **Replace TTF Distribution** check box.

The fields in the **TTF Distribution** window are enabled.

5. In the remaining fields, modify the values as desired.
6. Select **OK**.

The changes are saved, and the values that you specified will be used the next time the simulation is run.

Specify Failure Consequence Values for the Simulation

For each Mitigated Risk that is associated with the Special Action, you can specify the Failure Consequence values that you want to be used in the simulation when the Special Action is completed to mitigate the occurrence of the given Risk.

Procedure

1. [Access the Mitigated Risk](#) for which you want to specify the Failure Consequence values.
2. Locate the row containing the Risk for which you want to specify the Failure Consequence values.
3. In the **New Failure Consequence** column, select the hyperlink.

The **Failure Consequence** window appears.

4. In the lower-left corner, select the **Replace Failure Consequence** check box.

The fields in the **Failure Consequence** window are enabled.

5. In the **Fixed Unplanned Correction Cost** text box, modify the value as desired.
6. Select **OK**.

The changes are saved, and the values that you specified will be used the next time the simulation is run.

Add a Risk to an Action

Procedure

1. [Access an Action](#) to which you want to assign a Risk.
2. In the grid, select the row containing the appropriate Action.
3. In the upper-right corner of the **Actions** section, select **Show Mitigated Risk**.

The **Actions/Mitigated Risks** grid appears.

The screenshot displays the 'Actions' tab in the software. The main table shows the following data:

NAME	DESCRIPTION	NEW TTF DISTRIBUTION	NEW FAILURE CON:
Impellar failure		No	No

The 'Properties' panel for the selected action shows:

- Name:** Bi-weekly check
- Description:** (empty field)
- Action Type:** Training

- If you want to assign a new Risk, in the upper-right corner of the grid, select **Assign New Risk**. The datasheet for new Risk appears.

You can [enter values in the available fields](#) to add a Risk, and then select  to add the Risk to the Action.

-or-

If you want to assign an existing Risk, in the upper-right corner of the grid, select **Assign Existing Risk**. The **/Mitigating Actions/From Existing** grid appears, displaying a list of Risks.

- In the grid, locate the row that contains the Risk that you want to assign to the Action.
- In the **Selected** column, select the check box.
- In the upper-right corner of the grid, select **Submit**. The selected Risk is assigned to the Action.

Run Action Optimization

Before You Begin

- To run Action Optimization, you must have [existing actions](#) in your System Reliability Analysis.

Procedure

- [Access the System Reliability Analysis](#) whose actions you want to optimize.
- In the pane, select **Action Optimization**. The Action Optimization details for the selected System Reliability Analysis appear in the workspace.

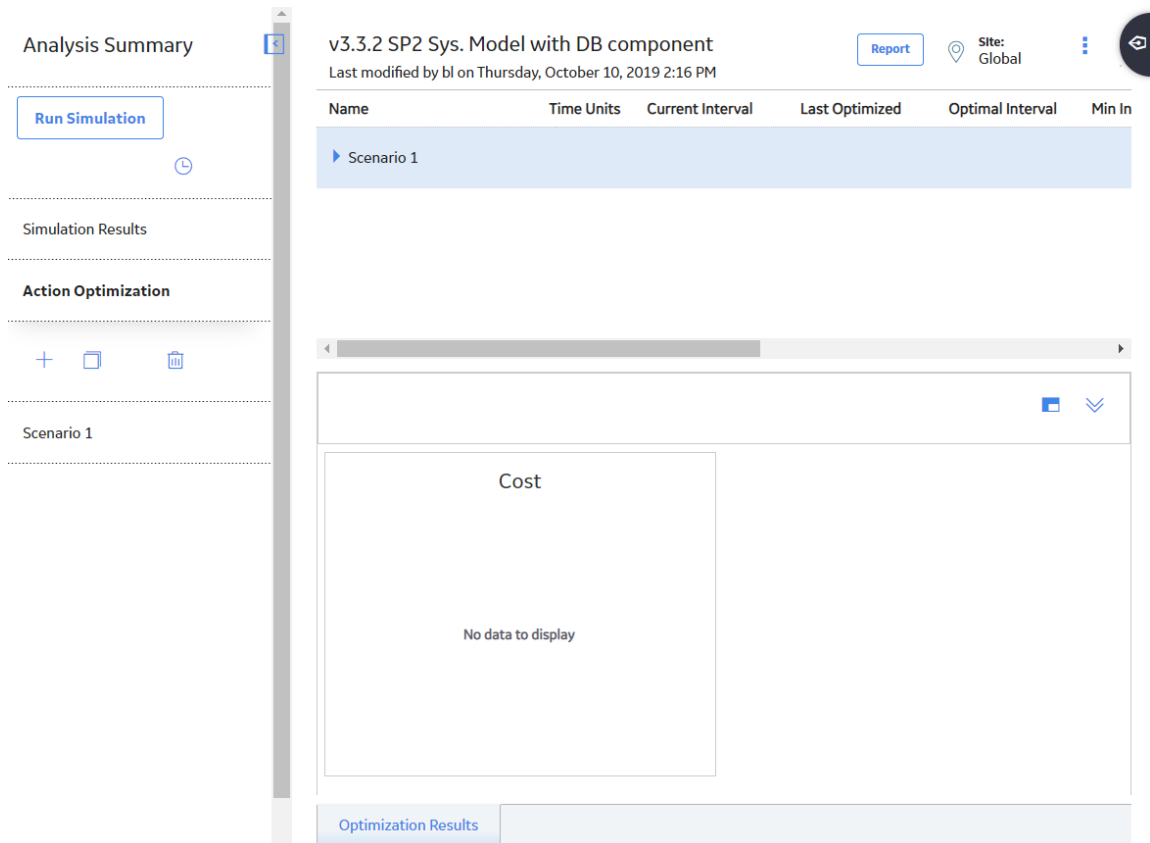



3. In the workspace, next to the name of the scenario containing the action that you want to optimize, select , and then navigate to the specific action that you want to optimize. The details of the actions appear.

4. Next to the action you want to optimize, select **Run Optimization**.

Note: The **Run Optimization** link is only enabled when there is no optimization in progress for the selected action.

Important: Reliability Simulation Service is required to execute this task.

The optimization begins, and the status indicating the progress of the optimization appears in the details of the action.

Note: You can select  to view the details of the optimization. When you select , the **Schedule Logs** page appears, displaying the **In Progress**, **Successful**, and **Failed** tabs. The number on each tab indicates the number of optimizations in the corresponding state.

The Action Optimization details for the selected System Reliability Analysis appear in the workspace.

5. In the workspace, next to the name of the scenario containing the action that you want to optimize, select , and then navigate to the action you optimized. The details of the Optimized Action appear, with values populated in the **Last Optimized** and **Optimal Interval** columns.

6. Next to the value in the Optimal Interval field, select **Apply** to set the optimized interval value in the Optimal Interval field as the value in the Current Interval field. The value in the Current Interval field is optimized for the System Reliability Analysis.

Next Steps

[View the Action Optimization results.](#)

View Action Optimization Results

Before You Begin

- [Run Action Optimization.](#)

Procedure

1. [Access the System Reliability Analysis](#) whose Action Optimization results you want to view.
2. In the pane, select **Action Optimization**.
The Action Optimization details for the selected System Reliability Analysis appear in the workspace.

The screenshot shows a software interface for viewing Action Optimization results. On the left is a sidebar with sections: 'Analysis Summary' (containing a 'Run Simulation' button), 'Simulation Results', and 'Action Optimization' (containing a plus icon, a square icon, and a trash icon). Below the sidebar, 'Scenario 1' is selected. The main workspace displays the following information:

v3.3.2 SP2 Sys. Model with DB component
Last modified by bl on Thursday, October 10, 2019 2:16 PM

Report Site: Global

Name	Time Units	Current Interval	Last Optimized	Optimal Interval	Min In
▶ Scenario 1					

Below the table, a 'Cost' chart is displayed with the message 'No data to display'. At the bottom of the workspace, there is a tab labeled 'Optimization Results'.

3. In the workspace, next to the name of the scenario containing the action optimization results that you want to view, select ▶, and then navigate to the specific action.
The details of the actions appear.
4. In the workspace, select the action whose Action Optimization results you want to view.
The **Cost** chart appears in the workspace. You can hover over an item in the chart to view specific details used in the optimization process.

Next Steps

[Run the simulation for the System Reliability Analysis](#) to update the results based upon the optimized action interval.

Delete an Action

Procedure

1. [Access the System Scenario](#) whose Action you want to delete.
2. In the workspace, select the **Actions** tab.
A list of System Subsystems, a grid containing a list of Risks associated with the selected System Scenario, and the **Properties** pane appear.
3. In the grid, select the Action that you want to delete, and then select .
The selected Action is deleted.

Global Events

About Global Events

A Global Event is an optional component of a System Reliability Analysis that groups together Actions requiring a system shutdown so that they will be performed at the same time, thereby maximizing the availability of the system.

When you [create a Global Event](#), you select Actions that may be rescheduled and performed as part of the Global Event. The execution of the selected Actions is called a Global Event. To be performed with the Global Event, Actions must occur during the time period defined by the Max Delay and Max Advance values in the System Global Event record. Actions assigned to the Global Event that are performed outside of this time period will not be included in the Global Event, and their occurrence is not affected by the occurrence of the Global Event. The next occurrence of any recurring Actions that have been rescheduled and performed as part of a Global Event will be performed according to the values in the Interval and Interval Units fields in the System Action record.

Note: Actions that are represented by a [System Condition Monitor](#) occur continuously and cannot be assigned to a Global Event. All other Actions can be performed in a Global Event.

Consider [Scenario B in our System Reliability Analysis Example](#), which contains two Actions that require a system shutdown: Redesign Impellers and Replace Seals. The Redesign Impellers Action has a duration of one week, and the Replace Seals Action has a duration of one day. Performed independently of one another, they would result in a system shutdown lasting a total of eight days.

Now, assume that you group the two Actions together using a Global Event with a Max Delay value of 3 months and a Max Advance value of 4 weeks. This Global Event specifies that the two Actions will be rescheduled and performed together during the same system shutdown, as long as the Actions fall into the time period from 3 months before the Global Event and 4 weeks after the Global Event. Managing the Actions in this way would result in a shutdown lasting the longest of the two durations, or seven days. This approach is preferable, as it would save one day of costs associated with the system shutdown.

Types of Global Events

System Reliability Analyses support the use of two types of Global Events:

- **Action-driven Global Events:** A collection of Actions that may occur based on the occurrence of a driving Action. When the driving Action occurs, any Actions that fall into the time range specified by the Max Advance and Max Delay values are triggered to be rescheduled and performed with the driving Action. Action-driven Global Events can occur only one time in a simulation. If you select a recurring Action as the driving Action, the Global Event will occur the first time that the driving Action occurs. If you select more than one Action as the driving Action, then the first driving Action that occurs will trigger the other Actions in the Global Event.

For example, in [Scenario B of our System Reliability Analysis Example](#), you might create an Action-driven Global Event, which is assigned both the Redesign Impellers and Replace Seal Actions, with the Redesign Impellers Action designated as the driving Action. In this case, when the Redesign Impellers Action occurs according to the properties specified in the System Action record that represents it, the Global Event will trigger any Replace Seals Action that falls within the time period specified by the Max Delay and Max Advance values to be rescheduled and completed with the occurrence of the Redesign Impellers Action.

- **Date-driven Global Events:** A date-driven Global Event is a collection of Actions that may occur on a certain date. When the simulation reaches the date of the Global Event, any assigned Actions that fall into the time range specified by the Max Advance and Max Advance Duration values are triggered to be performed on the date of the Global Event. A date-driven Global Event can occur one or more times throughout the simulation period.

For example, in [Scenario B of our System Reliability Analysis Example](#), you might create a date-driven Global Event and specify that it should occur on a date halfway through the simulation. To this Global Event you would assign the Redesign Impellers and Replace Seals Actions. In this case, the Global Event would trigger both of the Actions that fall into the time period specified by the Max Advance Duration and Max Delay Duration values, almost three and a half years into the simulation, regardless of what properties existed in the System Action records that represent the Redesign Impellers and Replace Seal Actions.

Note: While Global Events limit downtime and the history of a Global Event can be seen in the Event Logs generated from a System Reliability Analysis which contains a Global Event, the effects of Global Events are not presented explicitly anywhere in the simulation results. The effects of the Global Events are expressed as less downtime for the system, which means lower lost production costs.

Access a Global Event

Procedure

1. [Access the System Scenario](#) for which you want to view details of a Global Event.
2. In the workspace, select the **Global Events** tab.

A list of Global Events associated with the selected System Scenario appears.

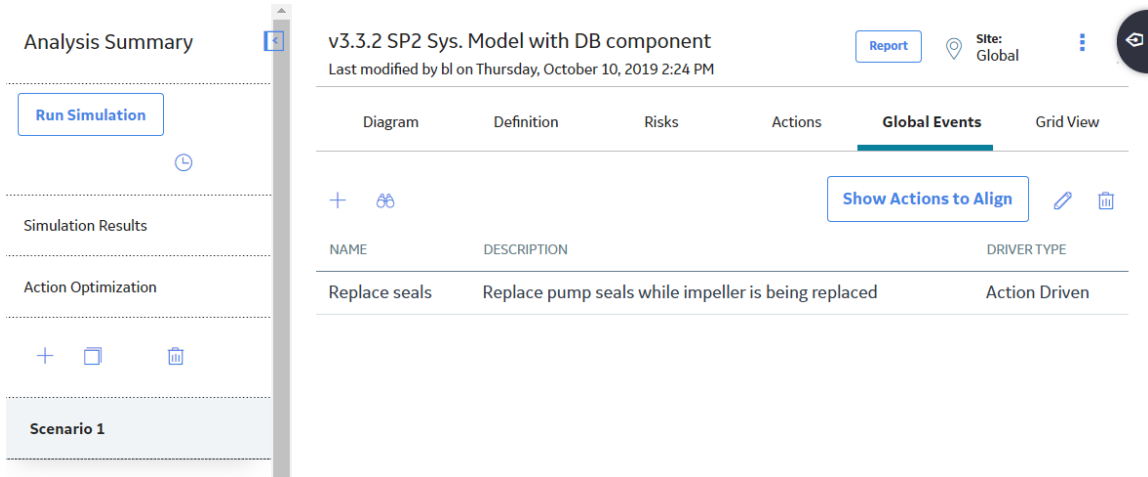

The grid contains the following [columns](#) of information:

- **Name**
 - **Description**
 - **Driver Type**
3. Select the row containing the Global Event that you want to view, and then select .

The **Edit Global Event** section appears, displaying the details of the selected Global Event.

Note: As needed, you can modify the values in the [available fields](#), and then select  to save your changes.

Create a Global Event

Procedure

1. [Access the System Scenario](#) for which you want to add a Global Event.
2. Select the **Global Events** tab.

A list of Global Events associated with the selected Scenario appears.

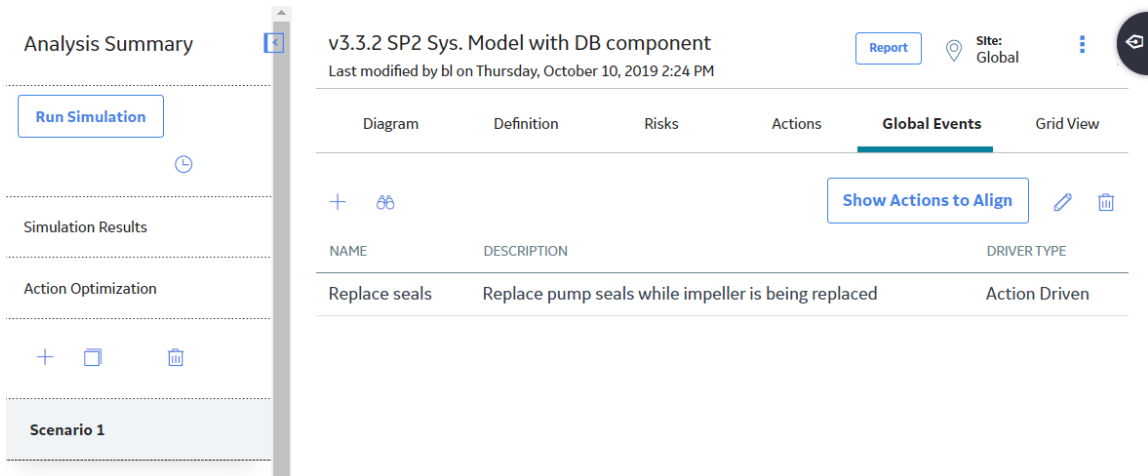

3. Select .

The datasheet for new Global Event appears in the workspace.

4. As needed, enter the values in the [available fields](#), and then select .
- The Global Event is saved.

Next Steps

- [Assign Actions to Global Events](#)

Access Actions Assigned to a Global Event

Procedure

1. [Access the System Scenario](#) which contains the desired Global Event.
2. In the workspace, select the **Global Events** tab.

A list of Global Events associated with the selected System Scenario appears.

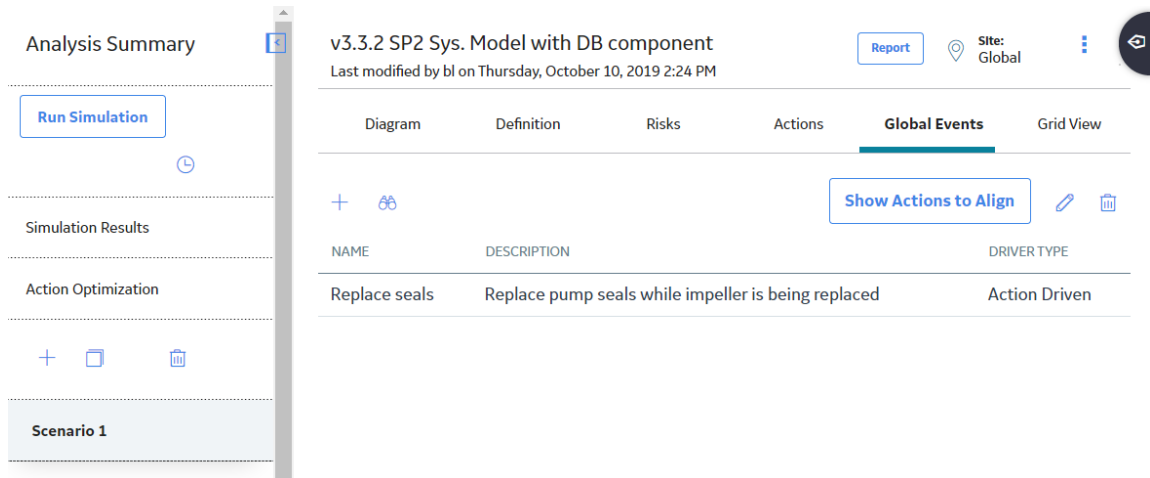

The screenshot displays a software workspace for a system scenario. On the left is a sidebar with sections: 'Analysis Summary' (containing a 'Run Simulation' button), 'Simulation Results', 'Action Optimization', and 'Scenario 1'. The main workspace is titled 'v3.3.2 SP2 Sys. Model with DB component' and includes a 'Report' button and 'Site: Global' information. A navigation bar at the top has tabs for 'Diagram', 'Definition', 'Risks', 'Actions', 'Global Events' (which is selected), and 'Grid View'. Below the tabs is a table with columns 'NAME', 'DESCRIPTION', and 'DRIVER TYPE'. A 'Show Actions to Align' button is located in the top right of the table area. The table contains one row: 'Replace seals' with description 'Replace pump seals while impeller is being replaced' and driver type 'Action Driven'.

NAME	DESCRIPTION	DRIVER TYPE
Replace seals	Replace pump seals while impeller is being replaced	Action Driven

3. Select the row containing the Global Event for which you want to view the assigned Actions.
4. In the upper-right corner of the **Global Events** section, select **Show Actions to Align**.

The **Align Actions** grid appears, displaying a list of Actions that are assigned to the selected Global Event.

The following columns appear in the **Align Actions** workspace:

- **Action Name**
- **Action Type**
- **Element**
- **Is Driver?**

Assign Actions to Global Events

About This Task

When you assign Actions to a Global Event, you select the Actions that will be executed at the same time, as defined by the Global Event. Any Actions that should be performed during the qualifying time period, as defined by the values in the Max Delay Duration and Max Advance Duration fields, will be executed together.

Procedure

1. [Access the Actions assigned to a Global Event](#) to which you want to assign Actions.
2. In the upper-right corner, select **Add/Edit Actions**.

The **Select Actions From** and the **Selected Actions** sections appear. The **Select Actions From** section contains a list of Actions available for the selected System Scenario. The **Selected Actions** section contains a list of Actions assigned to the selected Global Event.

The screenshot shows a software interface for managing actions. On the left is a sidebar with 'Analysis Summary', 'Run Simulation', 'Simulation Results', 'Action Optimization', and 'Scenario 1'. The main area is titled 'Scenario 1 / Replace seals' and includes a 'Last modified by bl on Thursday, October 10, 2019 2:29 PM' timestamp and an 'OK' button. Below this are two panels: 'Select Actions From' and 'Selected Actions'. Both panels contain a table with columns for 'ACTION NAME' and 'ACTION TYPE' (or 'ELEMENT'). In the 'Selected Actions' panel, the 'Monthly check' action is assigned to 'Baseline-101'.

	ACTION NAME	ACTION TYPE
<input type="checkbox"/>	Bi-weekly check	Training

	ACTION NAME	ELEMENT
<input type="checkbox"/>	Monthly check	Baseline-101

3. In the **Select Actions From** section, select the check box to the left of an action that you want to assign.
4. Select .
- The selected action appears in the **Selected Actions** section.
5. In the upper-right corner, select **Assigned Actions** to return to **Align Actions** grid.
- The selected action appears in the list of Actions that are assigned to the selected Global Event.

Remove Actions from Global Events

About This Task

When you remove an Action from a Global Event, it will no longer be delayed or advanced in time to be executed with the other grouped Actions in the Global Event.

Procedure

1. [Access the Actions assigned to a Global Event](#) from which you want to remove Actions.
2. In the upper-right corner, select **Add/Edit Actions**.

The **Select Actions From** and the **Selected Actions** sections appear. The **Select Actions From** section contains a list of Actions available for the selected System Scenario. The **Selected Actions** section contains a list of Actions assigned to the selected Global Event.

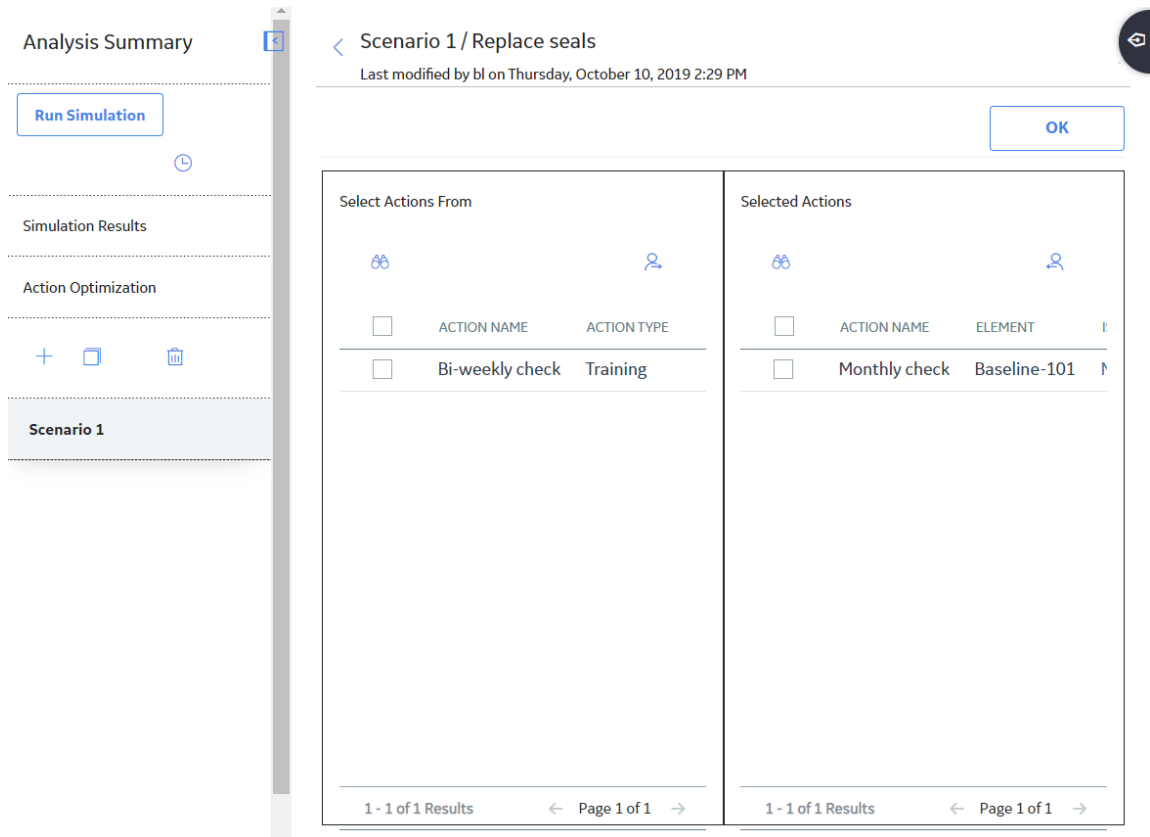

3. In the **Selected Actions** section, select the check box to the left of an Action that you want to remove.
4. Select .

The selected Action is removed and appears in the **Select Actions From** section.
5. In the upper-right corner, select **Assigned Actions** to return to **Align Actions** grid.

The selected action does not appear in the list of Actions that are assigned to the selected Global Event.

Delete a Global Event

Deleting a Global Event removes the properties of the Global Event, such as the interval at which the Global Event may be repeated and which Actions may be performed with the Global Event, but the System Actions that exist in the Scenario are not modified or deleted.

Procedure

1. [Access the System Scenario](#) from which you want to delete a Global Event.
2. Select the **Global Events** tab.

A list of Global Events associated with the selected Scenario appears.
3. In the grid, select the Global Event that you want to delete, and then select .

The selected Global Event is deleted.

Grid View

Access Grid View for a Scenario

Procedure

1. [Access the System Scenario](#) for which you want to view information in a grid.
2. In the workspace, select the **Grid View** tab.

A grid appears, displaying information for the elements that exist in the selected Scenario.

The screenshot shows a software interface with a sidebar on the left and a main content area. The sidebar contains sections for 'Analysis Summary', 'Run Simulation', 'Simulation Results', 'Action Optimization', and 'Scenario 1'. The main content area displays the title 'v3.3.2 SP2 Sys. Model with DB component' and a 'Report' button. Below the title are tabs for 'Diagram', 'Definition', 'Risks', 'Actions', 'Global Events', and 'Grid View'. A dropdown menu is set to 'Action'. The grid below has columns for 'Name', 'Action Cost (\$)', 'Interval', 'Interval Units', 'Duration', and 'Duration Units'. The data rows are:



Name	Action Cost (\$)	Interval	Interval Units	Duration	Duration Units
v3.3.2 SP2 Sys. Model with DB com...					
Baseline-101					
Monthly check	0	1	Days	0	Days
Bi-weekly check	0	1	Days	0	Days

By default, the data that appears in the grid is filtered by [Action](#). You can also filter the data specific to one of the following elements:

- [Asset](#)
- [Buffer](#)
- [Distribution](#)
- [Link](#)
- [Risk](#)
- [Subsystem](#)
- [Switch](#)

Different columns in the grid appear based on the element selected from the list.

In the grid, under the **Name** column, a hierarchy displays an organizational view of the elements in the Diagram associated with the selected Scenario. The root Subsystem is displayed at the top, with any elements belonging to the root Subsystem listed below it. Any other subsystems are listed below the root Subsystem, with any elements belonging to them listed below them.

Note: Within the grid, you can modify the properties of the Scenario elements. To do so, locate the row containing the element whose properties you want to modify, and then select  to enable the fields. As needed, modify the values in the available fields, and then select  to save your changes.

About Filtering Grid View by Action

When you filter the grid view by Action, the grid displays data related to the Actions that exist in the selected Scenario. Following columns of information appear in the grid.

- **Name:** Contains a hierarchy that lists the Subsystems, Assets, Switches, and Actions that exist in the Scenario. Actions appear in the hierarchy below the Asset, Switch, or Subsystem element to which they belong.
- **Action Cost(\$):** Contains the value that exists in the Action Cost field in the [System Action record](#).
- **Interval:** Contains the value that exists in the Interval field in the [System Action record](#)
- **Interval Units:** Contains the value that exists in the Interval Units field in the [System Action record](#).
- **Duration:** Contains the value that exists in the Duration field in the [System Action record](#).
- **Duration Units:** Contains the value that exists in the Duration Units field in the [System Action record](#).
- **Shut Down Required:** Contains the value that exists in the Shutdown Required field in the [System Action record](#).
- **One Time Action:** Contains the value that exists in the One Time Action field in the [System Action record](#).

About Filtering Grid View by Asset

When you filter the grid view by Asset, the grid displays data related to the Assets and Subsystems that exist in the selected Scenario. Following columns of information appear in the grid.

- **Name:** Contains a hierarchy that lists the Subsystems and Assets that exist in the Scenario. Assets appear below the Subsystem element to which they belong.
- **Production Contribution (%)**: Contains the value that exists in the Production Contribution field in the [System Asset](#) or [System Subsystem record](#).
- **Fixed Cost (%)**: Contains the value that exists in the Fixed Cost field in the [System Asset](#) or [System Subsystem record](#).
- **Variable Cost Units:** Contains the value that exists in the Variable Cost Units field in the [System Asset](#) or [System Subsystem record](#).
- **Lost Production Cost (\$)**: Contains the value that exists in the Lost Production Cost field in the [System Asset](#) or [System Subsystem record](#).
- **Lost Production Cost Units:** Displays the value that exists in the Lost Production Cost Units field in the [System Asset](#) or [System Subsystem record](#).

About Filtering Grid View by Buffer

When you filter the grid view by Buffer, the grid displays data related to the Buffers that exist in the selected Scenario. Following columns of information appear in the grid.

- **Name:** Contains a hierarchy that lists the Buffers that exist in the Scenario, including Buffers that belong directly to the root Subsystem and Buffers that belong to any Subsystem elements. Buffers appear in the hierarchy below the Subsystem element to which they belong.
- **Description:** Contains the value that exists in the Description field in the [System Buffer record](#).

- **Production Contribution (%)**: Contains the value that exists in the Production Contribution field in the [System Buffer](#) or [System Subsystem record](#).
- **Initial Quantity (%)**: Contains the value that exists in the Initial Quantity in Percentage field in the [System Buffer record](#).
- **Time to Empty Units**: Contains the value that exists in the Time to Empty Units field in the [System Buffer record](#).
- **Time to Refill**: Contains the value that exists in the Time to Refill field in the [System Buffer record](#).
- **Time to Refill Units**: Contains the value that exists in the Time to Refill Units field in the [System Buffer record](#).

About Filtering Grid View by Distribution

When you filter the grid view by Distribution, the grid displays data related to the Distribution records that are associated with the selected Scenario. In the [Grid View section](#), Distribution records are shown as properties of the Risk elements with which they are associated.

Following columns of information appear in the grid.

- **Name**: Contains a hierarchy that lists the Subsystems, Assets, Switches, Risks, and distributions that exist in the Scenario. Distributions appear in the hierarchy below the Risk to which they belong.
- **Distribution Type**: Contains the name of the family to which the Distribution record belongs.
- **Time Unit**: Contains the value that exists in the Unit field of the Distribution record.
- **Parameter 1**: Contains the value that exists in the Beta field in a Weibull record, the MTBF field in an Exponential record, the Mean field in a Normal record, or the Mu field in a Lognormal record.

Note: When you select the value Single Value in the **Distribution Type** list on the **TTF Distribution** or **TTR Distribution** window, you create a Normal record with a Standard Deviation value of 0 (zero). For these records, the Parameter 1 column displays the value that exists in the Value field, rather than the Mean field.

- **Parameter 2**: Contains the value that exists in the Eta field in a Weibull record, the Standard Deviation for a Normal record, or the Sigma field for a Lognormal record.
- **Parameter 3**: Contains the value that exists in the Gamma field in the Weibull record or Lognormal record.

About Filtering Grid View by Link

When you filter the grid view by Link, the grid displays data related to the Links that exist in the selected Scenario. Following columns of information appear in the grid.

- **Name**: Contains a hierarchy that lists only the Subsystems which contain Links and the Links that exist in the Scenario. Links appear in the hierarchy below the Subsystem element to which they belong.
- **Minimum Predecessors**: Contains the value that exists in the Minimum Predecessors field in the [System Link record](#). You cannot modify this value in the [Grid View section](#).

About Filtering Grid View by Risk

When you filter the grid view by Risk, the grid displays data related to the Risks that exist in the selected Scenario. Following columns of information appear in the grid.

- **Name**: Contains a hierarchy that lists the Subsystems, Assets, Switches, and Risks that exist in the Scenario. Risks appear in the hierarchy placed below the Asset or Switch element to which they belong.
- **Fixed Unplanned Correction Cost (\$)**: Contains the value that exists in the Fixed Unplanned Correction Cost field in the [System Risk record](#).
- **Variable Unplanned Correction Cost (\$)**: Contains the value that exists in the Variable Unplanned Correction Cost field in the [System Risk record](#).

- **Variable Unplanned Correction Cost Units:** Contains the value that exists in the Planned Correction Cost Units field in the [System Risk record](#).
- **Planned Correction Cost (\$):** Contains the value that exists in the Planned Correction Cost field in the [System Risk record](#).
- **Planned Correction Duration:** Contains the value that exists in the Planned Correction Duration field in the [System Risk record](#).
- **Planned Correction Duration Units:** Contains the value that exists in the Planned Correction Duration Units field in the [System Risk record](#).
- **PF Interval:** Contains the value that exists in the PF Interval field in the [System Risk record](#).
- **PF Interval Units:** Contains the value that exists in the PF Interval Units field in the [System Risk record](#).

About Filtering Grid View by Subsystem

When you filter the grid view by Subsystem, the grid displays data related to the Subsystems that exist in the selected Scenario. Following columns of information appear in the grid.

- **Name:** Contains a hierarchy that lists the Subsystems that exist in the Scenario.
- **Production Contribution (%):** Contains the value that exists in the Production Contribution field in the [System Subsystem record](#).
- **Fixed Cost (%):** Contains the value that exists in the Fixed Cost field in the [System Subsystem record](#).
- **Variable Cost (\$):** Contains the value that exists in the Variable Cost field in the [System Subsystem record](#).
- **Variable Cost Units:** Contains the value that exists in the Variable Cost Units field in the [System Subsystem record](#).
- **Lost Production Cost (\$):** Contains the value that exists in the Lost Production Cost field in the [System Subsystem record](#).
- **Lost Production Cost Units:** Contains the value that exists in the Lost Production Cost Units field in the [System Subsystem](#).

About Filtering Grid View by Switch

When you filter the grid view by Switch, the grid displays data related to the Switches that exist in the selected Scenario. Following columns of information appear in the grid.

- **Name:** Contains a hierarchy that lists the Switches that exist in the Scenario, including Switches that belong directly to the root Subsystem and Switches that belong to any Subsystem elements. Switches appear in the hierarchy below the Subsystem element to which they belong.
- **Is Initially On:** Contains the value that exists in the Is Initially On field in the [System Switch record](#).
- **Fixed Cost (\$):** Contains the value that exists in the Fixed Cost field in the [System Switch](#).
- **Variable Cost (\$):** Contains the value that exists in the Variable Cost field in the [System Switch](#).
- **Variable Cost Units:** Contains the value that exists in the Variable Cost Units field in the [System Switch](#).
- **Lost Production Cost (\$):** Contains the value that exists in the Lost Production Cost field in the [System Switch](#).
- **Lost Production Cost Units:** Contains the value that exists in the Lost Production Cost Units field in the [System Switch](#).

Simulations

About Monte Carlo Simulations

GE Digital APM System Reliability Analysis uses Monte Carlo simulations to predict the reliability of a system. Monte Carlo methods offer a common statistical model for simulating physical systems and are especially useful for modeling systems with variable and uncertain inputs. When you create a System Reliability Analysis, you will specify certain values that will serve as inputs to the simulation. Other inputs will be generated at random to simulate possible conditions. Outputs will be generated based on the inputs and combined to provide a summary the projected system reliability.

Details

When you [run a simulation](#), you start the process of running Monte Carlo iterations for each Scenario in a System Reliability Analysis and [accessing the results](#) calculated from those simulations. When you run the simulation, all Diagrams are validated.

You need to run a simulation, if you make changes to a System Reliability Analysis that would affect the simulation results, such as changing the simulation parameters or modifying a Scenario.

It takes time to run simulations. Various factors influence the speed of the simulation process, including:

- The number of iterations defined.
- The complexity of the Scenarios (i.e., the number of Assets, Risks, Actions, and Subsystems).
- The frequency at which Actions occur.
- The frequency at which failures occur.

To shorten the run time of your simulation, you can reduce the number of iterations or the complexity of the analysis.

You can run only one simulation at a time for an analysis. For example, if you are running a simulation for Analysis A, you cannot run another simulation for Analysis A. You can, however, run simulation for Analysis B while running the simulation for Analysis A. While a simulation is running, you can continue working in other areas of GE Digital APM.

Rolling a Dice

Consider a simple example of rolling dice. Assume that you want to determine the probability of rolling a seven using two dice with values one through six. There are 36 possible combinations for the two dice, six of which will total seven, as shown in the following image.

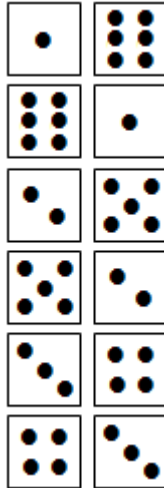

This means that mathematical probability of rolling a seven is six in 36, or 16.67 percent.

But is the mathematical probability the same as the actual probability? Or are there other factors that might affect the mathematical probability, such as the design of the dice themselves, the surface on which they are thrown, and the technique that is used to roll them?

To determine the actual probability of rolling a seven, you might physically roll the dice 100 times and record the outcome each time. Assume that you did this and rolled a seven 17 out of 100 times, or 17 percent of the time. Although this result would represent an actual, physical result, it would still represent an approximate result. If you continued to roll the dice again and again, the result would become less and less approximate.

A Monte Carlo simulation is the mathematical representation of this process. It allows you to simulate the act of physically rolling the dice and lets you specify how many times to roll them. Each roll of the dice represents a single iteration in the overall simulation; as you increase the number of iterations, the simulation results become more and more accurate. For each iteration, variable inputs are generated at random to simulate conditions such as dice design, rolling surface, and throwing technique. The results of the simulation would provide a statistical representation of the physical experiment described above.

Run a Simulation

Before You Begin

- Be sure that you understand the [principles of running a Simulation](#).

Procedure

1. [Access the System Reliability Analysis](#) for which you want to run simulation.

Note: The **Run Simulation** link is only enabled when the analysis is first created or when changes have been made that affect the simulation results. If changes are made to an existing simulation, only the modified scenario will run.

Important: Reliability Simulation Service is required to execute this task.

2. In the left pane, select **Run Simulation**.

The simulation begins, and the status indicating the progress of the simulation appears in the left pane.

After the simulation is complete, a confirmation message appears in the upper-right corner of the page.

Next Steps

- [Access Simulation Results](#)

Access Simulation Results

Before You Begin

- [Run a simulation](#).

Procedure

1. [Access the System Reliability Analysis](#) you want to view.
2. In the left pane, select **Simulation Results**.

The **Simulation Results** workspace appears.

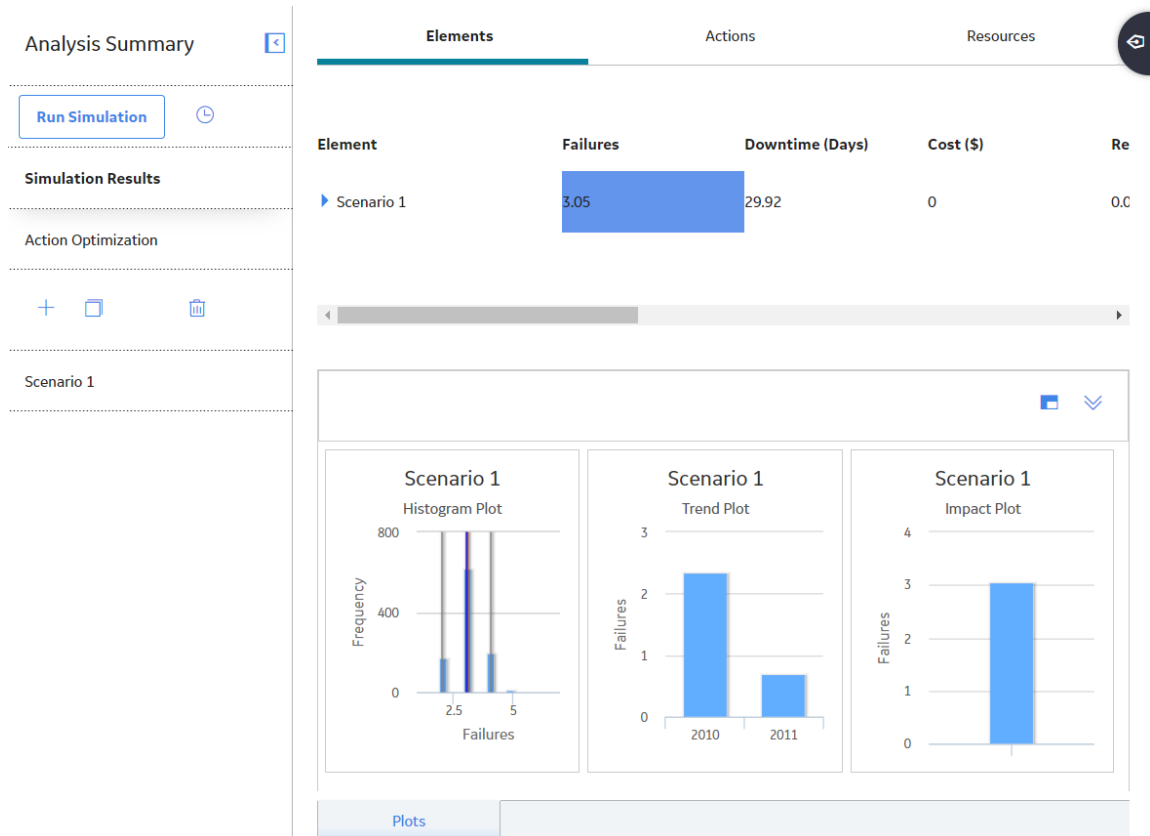

The workspace displays the following information:

- **Elements** tab
- **Actions** tab

- [Resources tab](#)

By selecting a cell in the grid, you can view detailed information in the following graphs:

- [Histogram plot](#)
- [Trend plot](#)
- [Impact plot](#)

Note: If values that will affect the simulation results have been modified since the simulation was last run, a message will be displayed at the top of the page indicating that the simulation needs to be rerun to view the latest results. Whenever this message appears, we recommend that you rerun the simulation to ensure that valid results are displayed.

Chapter 9

Admin

Topics:

- [Access the RA Administrator Page](#)
- [Configure a Reliability Report](#)
- [Access a Recommendation](#)
- [Create a Recommendation Alert for an Analysis](#)

Access the RA Administrator Page

Procedure

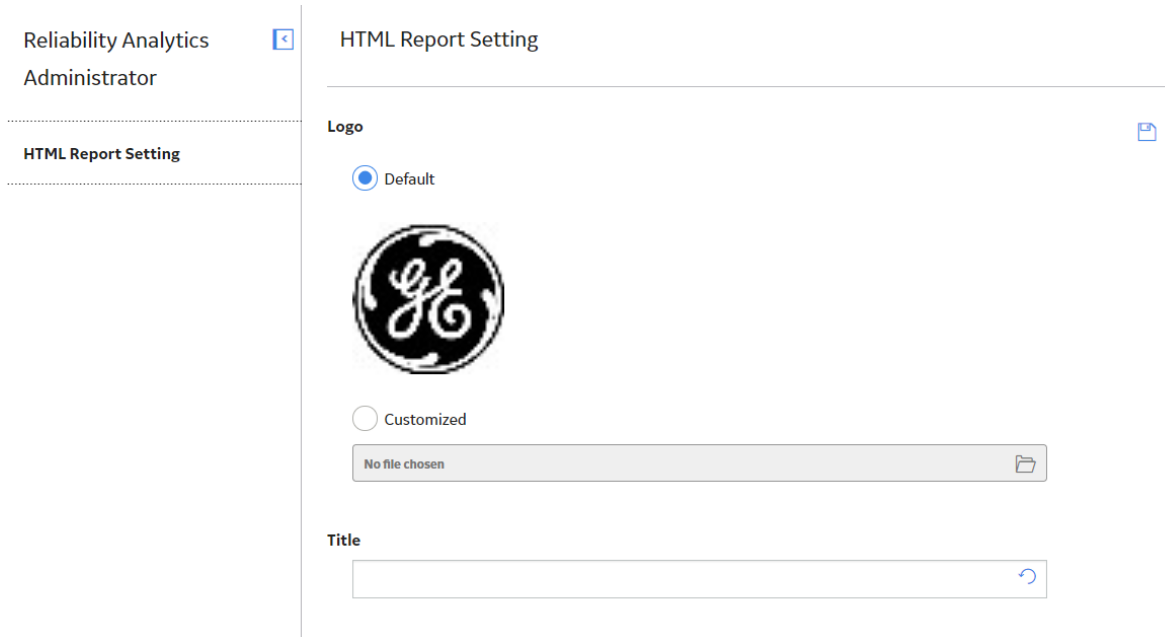

In the **Applications** menu, navigate to **ADMIN > Application Settings > Reliability Analytics**. The **RA Administrator** page appears, displaying the **HTML Report Setting** workspace by default.



The screenshot shows the 'HTML Report Setting' workspace. On the left, there is a navigation pane with 'Reliability Analytics Administrator' and 'HTML Report Setting' (highlighted). The main area is titled 'HTML Report Setting' and contains a 'Logo' section with a 'Default' radio button selected and a 'Customized' radio button. Below the 'Customized' option is a file selection box labeled 'No file chosen'. At the bottom, there is a 'Title' text input field.

Configure a Reliability Report

Procedure

1. Access the **RA Administrator** page.
2. In the **Logo** section, select **Customized**.
3. In the **Customized** box, select , and then select the image that you want to appear on the report.
4. In the **Title** box, enter a title.
5. Select .
The report settings are saved.

Access a Recommendation

Procedure

1. Access the analysis for which you want to create a recommendation.
2. In the right corner of the workspace, select the .

The Recommendations pane appears, displaying a list of recommendations associated with the selected analysis.

3. Select the row containing the recommendation that you want to view.
The [Reliability Recommendation datasheet](#) appears, displaying the **General Information** and **Alert** tabs.

Create a Recommendation Alert for an Analysis

Procedure

1. Access the analysis from which you want to generate an alert.
The [Reliability Recommendation datasheet](#) appears.
2. Select the **Alert** tab.
The Alert datasheet appears.
3. As needed, enter values in the [available fields](#), and then select .
The Alert is saved.

Chapter 10

Data Loader

Topics:

- [About the System Reliability Data Loader](#)
- [About the System Reliability Data Loader Requirements](#)
- [About the System Reliability Data Loader Data Model](#)
- [About the System Reliability Data Loader General Loading Strategy](#)
- [About the System Reliability Data Loader Workbook Layout and Use](#)
- [About the System Reliability Data Loader Load Verification](#)

About the System Reliability Data Loader

The System Reliability Data Loader allows both primary and third-party content to be delivered to GE Digital APM through the System Reliability Data Model.

Using the System Reliability Data Loader, you can import the following types of primary and third-party data from a fixed-format Excel workbook into the System Reliability Data Model:

- System Analysis records
- System Scenario records
- System Subsystem records
- System Asset records
- System Buffer records
- System Link records
- System Switch records
- System Sensor records
- System Risk records
- System Action records
- System Risk Assessment records

Note: The System Reliability Data Loader will not be backwards compatible to earlier versions of GE Digital APM.

About the System Reliability Data Loader Requirements

To use the System Reliability Data Loader, your organization must have completed the deployment of the Reliability Analytics module.

Security Settings

The Security User performing the data load operation must be associated with either the MI Data Loader User or MI Data Loader Admin Security Role, and must also be associated with the MI Reliability Administrator Security Group, the MI Reliability User Security Group, or a Security Role that is associated with this Security Group.

About the System Reliability Data Loader Data Model

System Reliability Data Loader Data Model

The following diagram shows how the families used in System Reliability Data Loader are related to one another.

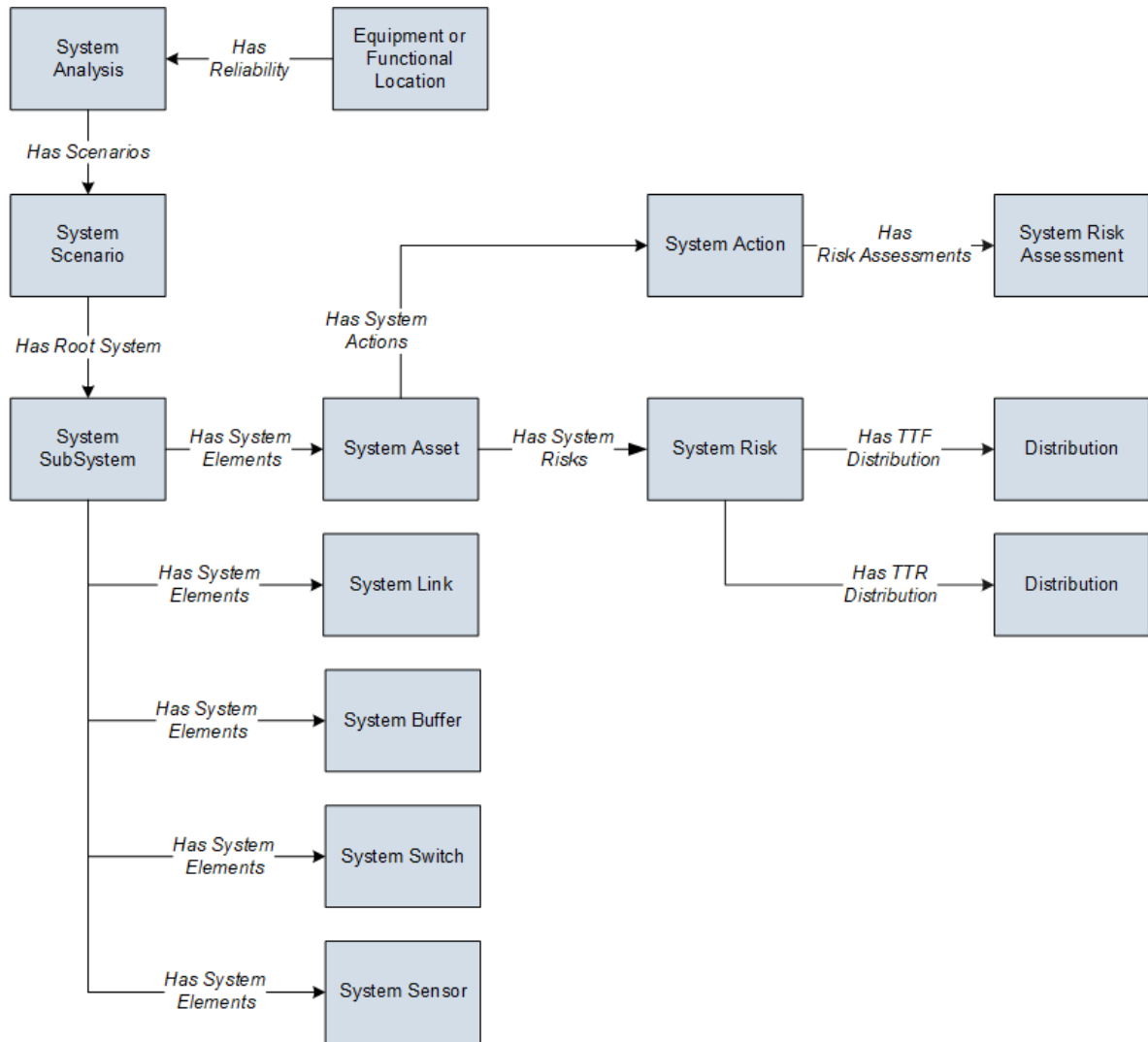

Note: In the diagram, boxes represent entity families and arrows represent relationship families that are configured in the baseline database. You can determine the direction of each relationship definition from the direction of the arrow head: the box from which the arrow originates is the predecessor, and the box to which the arrow head points is the successor.

About the System Reliability Data Loader General Loading Strategy

Best Practices

When importing data using the System Reliability Data Loader, you must use the following best practices:

- ID fields (row 2 of each worksheet) must not include special characters or spaces.
- Columns in the worksheets should be formatted as either text or dates.
- The first two rows of each worksheet should not be edited.
- Only import a maximum of 500 analyses in each data load.

Limitations

This section documents a list of the limitations for the System Reliability Data Loader:

1. The user must use the System Reliability Data Loader workbook (`System Reliability.xlsx`). Any modifications made by the user to the values in column headings in any of the worksheets will not be imported.

Note: Any column values in a customized format will not be imported by the System Reliability Data Loader.

2. If the user imports the same data multiple times, multiple analyses will be created.

Load Sequence

1. Create System Analysis record.
2. Link a System Analysis record to a System Scenario record through the Has Scenarios Relationship.
3. Link a System Scenario record to a System Subsystem record through the Has Root System Relationship.
4. Link a System Subsystem record to a System Asset record through the Has System Elements Relationship.
5. Link a System Subsystem record to a System Buffer record through the Has System Elements Relationship.
6. Link a System Subsystem record to a System Link record through the Has System Elements Relationship.
7. Link a System Subsystem record to a System Switch record through the Has System Elements Relationship.
8. Link a System Subsystem record to a System Sensor record through the Has System Elements Relationship.
9. Link a System Asset record to a System Action record through the Has System Actions Relationship, and then link the System Action Record to a System Risk Assessment record.
10. Link a System Asset record to a System Risk record through the Has System Risks Relationship, and then link the System Risk record to a Distribution.

About the System Reliability Data Loader Workbook Layout and Use

In order to import data using the System Reliability Data Loader, GE Digital APM provides an Excel workbook (`System Reliability.xlsx`) that supports baseline System Reliability in GE Digital APM. This template must be used to perform the data load.

The following table lists the worksheets that are included in the System Reliability workbook.

Worksheet	Description
System Analysis	This worksheet is used to define System Analysis records.
System Scenario	This worksheet is used to define System Scenario records.
System Subsystem	This worksheet is used to define System Subsystem records.
System Asset	This worksheet is used to define System Asset records.
System Buffer	This worksheet is used to define System Buffer records.

Worksheet	Description
System Link	This worksheet is used to define System Link records.
System Switch	This worksheet is used to define System Switch records.
System Sensor	This worksheet is used to define System Sensor records.
System Diagram	This worksheet is used to define connections between System Element records.
System Risk	This worksheet is used to define System Risk records.
System Action	This worksheet is used to define System Action records.
System Risk Assessment	This worksheet is used to determine the System Risk Assessment records used for a System Scenario record.

Example: System Scenario Worksheet

The following table depicts a System Scenario record for a Parallel Motor/Pump Configuration. You can enter the details of a System Scenario record into the System Scenario worksheet provided by the System Reliability Data Loader workbook.

System Reliability Analysis Key	Scenario Key	Scenario Name
MI_STRATANA_A NALY_KEY	MI_STRATSCE_K EY	MI_STRATSCE_N AME_C
1234	4567	Parallel Motor/ Pump Configuration

System Code Tables

The following table lists the fields from the Reliability Analytics System Codes table that must be configured.

Field Name	Field ID
Action Type	MI_ACTION_TYPE
Action - Condition Monitoring Type	MI_CONDITION_MONITORING_TYPE

System Analysis

System Analysis records store general information about a System Analysis.

Field Caption	Field ID	Data Type (Length)	Comments
System Reliability Analysis Key	MI_STRATANA_ANALY_KEY	Numeric	This field is required and must be unique.
Analysis ID	MI_STRATANA_NAME_C	Character (255)	This field is required and must be unique.
Site ID	MI_SITE_ID	Character (50)	This field is required and must be unique. If the value in this field is black, then the site will be set to Global by default.

System Scenario

System Scenario records store general information about a scenario in a System Reliability Analysis.

Field Caption	Field ID	Data Type (Length)	Comments
System Reliability Analysis Key	MI_STRATANA_ANALY_KEY	Numeric	This field is required and must match the System Reliability Analysis Key in the System Analysis worksheet.
Scenario Key	MI_STRATSCE_KEY	Numeric	This field is required. The value in the field must be unique. This field must be associated with the System Reliability Analysis Key in the System Analysis worksheet .
Scenario Name	MI_STRATSCE_NAME_C	Character (255)	This field is required. The value in the field must be unique. This field must be associated with the System Reliability Analysis Key in the System Analysis worksheet .

System Subsystem

System Subsystem records store information about a system of equipment or locations.

Field Caption	Field ID	Data Type (Length)	Comments
System Reliability Analysis Key	MI_STRATANA_ANALY_KEY	Numeric	This field is required and must match the System Reliability Analysis Key in the System Analysis worksheet.
Scenario Key	MI_STRATSCE_KEY	Numeric	This field is required and must match the Scenario Key in the System Scenario worksheet.

Field Caption	Field ID	Data Type (Length)	Comments
Parent Subsystem Key	MI_ASOSUBSYSTEM_PARENT_KEY	Numeric	This field must be blank or match the Subsystem Key in another row of the same worksheet.
Subsystem Key	MI_ASOSUBSYSTEM_KEY	Numeric	This field is required. The value in the field must be unique. The field must be associated with the System Reliability Analysis Key in the System Analysis worksheet and with the Scenario Key in the System Scenario worksheet.
Name	MI_ASOSUBSYSTEM_NAME_C	Character (255)	This field is required. The value in the field must be unique. The field must be associated with the System Reliability Analysis Key in the System Analysis worksheet and with the Scenario Key in the System Scenario worksheet.

System Asset

System Asset records store information about equipment and locations that exist in the System Analysis diagram.

Field Caption	Field ID	Data Type (Length)	Comments
System Reliability Analysis Key	MI_STRATANA_ANALY_KEY	Numeric	This field is required and must match the System Reliability Analysis Key in the System Analysis worksheet.
Scenario Key	MI_STRATSCE_KEY	Numeric	This field is required and must match the Scenario Key in the System Scenario worksheet.
Subsystem Key	MI_ASOSUBSYSTEM_KEY	Numeric	This field is required and must match the Subsystem Key in the System Subsystem worksheet.

Field Caption	Field ID	Data Type (Length)	Comments
Asset Key	MI_ASOASSET_KEY	Numeric	This field is required. The value in the field must be unique. This field must be associated with the System Reliability Analysis Key in the System Analysis worksheet and with the System Scenario Key in the System Scenario worksheet.
Asset Name	MI_ASOASSET_NAME_C	Character (255)	This field is required. The value in the field must be unique. The field must be associated with the System Reliability Analysis Key in the System Analysis worksheet and with the System Scenario Key in the System Scenario worksheet.
Equipment ID	MI_EQUIP000_EQUIP_ID_C	Character (255)	This field is optional.
Functional Location ID	MI_FNCLOC00_ID	Character (50)	This field is optional.

System Buffer

System Buffer records store information about buffer elements that exist in the System Analysis diagram.

Field Caption	Field ID	Data Type (Length)	Comments
System Reliability Analysis Key	MI_STRATANA_ANALY_KEY	Numeric	This field is required and must match the System Reliability Analysis Key in the System Analysis worksheet.
Scenario Key	MI_STRATSCE_KEY	Numeric	This field is required and must match the Scenario Key in the System Scenario worksheet.
Subsystem Key	MI_ASOSUBSYSTEM_KEY	Numeric	This field is required and must match the Subsystem Key in the System Subsystem worksheet.
Buffer Key	MI_ASOBUFFE_KEY	Numeric	This field is required. The value in the field must be unique. The field must be associated with the System Reliability Analysis Key in the System Analysis worksheet and with the System Scenario Key in the System Scenario worksheet.

Field Caption	Field ID	Data Type (Length)	Comments
Name	MI_ASOBUFFE_NAME_C	Character (255)	This field is required. The value in the field must be unique. The field must be associated with the System Reliability Analysis Key in the System Analysis worksheet and with the System Scenario Key in the System Scenario worksheet.
Initial Quantity in Percentage	MI_ASOBUFFE_INI_QUA_IN_P R_N	Numeric	This field is required.
Time to Empty	MI_ASOBUFFE_TIME_TO_EMP_ N	Numeric	This field is required.
Time to Empty Units	MI_ASOBUFFE_TIME_TO_EMPU NS_C	Character (50)	This field is required.
Time to Refill	MI_ASOBUFFE_TIME_TO_REF_N	Numeric	This field is required.
Time to Refill Units	MI_ASOBUFFE_TIME_TO_REFU NS_C	Character (50)	This field is required.

System Link

System Link records store information about link elements that exist in the System Analysis diagram.

Field Caption	Field ID	Data Type (Length)	Comments
System Reliability Analysis Key	MI_STRATANA_ANALY_KEY	Numeric	This field is required and must match the System Reliability Analysis Key in the System Analysis worksheet.
Scenario Key	MI_STRATSCE_KEY	Numeric	This field is required and must match the Scenario Key in the System Scenario worksheet.
Subsystem Key	MI_ASOSUBSYSTEM_KEY	Numeric	This field is required and must match the Subsystem Key in the System Subsystem worksheet.
Link Key	MI_ASOLINK_KEY	Numeric	This field is required. The value in the field must be unique. The field must be associated with the System Reliability Analysis Key in the System Analysis worksheet and with the System Scenario Key in the System Scenario worksheet.

Field Caption	Field ID	Data Type (Length)	Comments
Name	MI_ASOLINK_NAME_C	Character (255)	This field is required. The value in the field must be unique. The field must be associated with the System Reliability Analysis Key in the System Analysis worksheet and with the System Scenario Key in the System Scenario worksheet.
Minimum Predecessors	MI_ASOLINK_MINIM_PREDE_N	Numeric	This field is required.

System Switch

System Switch records store information about switch elements that exist in the System Analysis diagram.

Field Caption	Field ID	Data Type (Length)	Comments
System Reliability Analysis Key	MI_STRATANA_ANALY_KEY	Numeric	This field is required and must match the System Reliability Analysis Key in the System Analysis worksheet.
Scenario Key	MI_STRATSCE_KEY	Numeric	This field is required and must match the Scenario Key in the System Scenario worksheet.
Subsystem Key	MI_ASOSUBSYSTEM_KEY	Numeric	This field is required and must match the Subsystem Key in the System Subsystem worksheet.
Switch Key	MI_ASOSWIT_KEY	Numeric	This field is required. The value in the field must be unique. The field must be associated with the System Reliability Analysis Key in the System Analysis worksheet and with the System Scenario Key in the System Scenario worksheet.
Name	MI_ASOSWIT_NAME_C	Character (255)	This field is required. The value in the field must be unique. The field must be associated with the System Reliability Analysis Key in the System Analysis worksheet and with the System Scenario Key in the System Scenario worksheet.
Is Initially On	MI_ASOSWIT_IS_INIT_ON_F	Boolean	This field is required.

System Sensor

System Sensor records store information about sensor elements that exist in the System Analysis diagram.

Field Caption	Field ID	Data Type (Length)	Comments
System Reliability Analysis Key	MI_STRATANA_ANALY_KEY	Numeric	This field is required and must match the System Reliability Analysis Key in the System Analysis worksheet.
Scenario Key	MI_STRATSCE_KEY	Numeric	This field is required and must match the Scenario Key in the System Scenario worksheet.
Subsystem Key	MI_ASOSUBSYSTEM_KEY	Numeric	This field is required and must match the Subsystem Key in the System Subsystem worksheet.
Name	MI_ASOSENSO_NAME_C	Character (255)	This field is required. The value in the field must be unique. The field must be associated with the System Reliability Analysis Key in the System Analysis worksheet and with the System Scenario Key in the System Scenario worksheet.
Monitored Elements	MI_ASOSENSO_MONIT_ELEMENT	Text	This field is required. The field contains the comma-separated keys of System Subsystem/Asset/Buffer/Switch records.
Deactivated Switches	MI_ASOSENSO_DEACTI_SWITCH	Text	This field is required. The field contains the comma-separated keys of System Switch records.
Activated Switches	MI_ASOSENSO_ACTI_SWITCH	Text	This field is required. The field contains the comma-separated keys of System Switch records.

System Diagram

System Diagram records store information about element connections that exist in the System Analysis diagram.

Field Caption	Field ID	Data Type (Length)	Comments
System Reliability Analysis Key	MI_STRATANA_ANALY_KEY	Numeric	This field is required and must match the System Reliability Analysis Key in the System Analysis worksheet.
Scenario Key	MI_STRATSCE_KEY	Numeric	This field is required and must match the Scenario Key in the System Scenario worksheet.
Subsystem Key	MI_ASOSUBSYSTEM_KEY	Numeric	This field is required and must match the Subsystem Key in the System Subsystem worksheet
Predecessor Node Key	MI_ASODIAG_PRED_KEY	Numeric	This field is required and must match the System Subsystem key in the System Analysis worksheet. If the value in the field is blank, the asset will be connected to the Start node. Note: This is a complex field storing xml text.
Successor Node Key	MI_ASODIAG_SUCC_KEY	Numeric	This field is required and must match the System Subsystem key in the System Analysis worksheet. If the value in the field is blank, the asset will be connected to the End node. Note: This is a complex field storing xml text.

System Risk

System Risk records store details about a Risk in a System Analysis and the cost of an equipment or location failure due to that risk.

Field Caption	Field ID	Data Type (Length)	Comments
System Reliability Analysis Key	MI_STRATANA_ANALY_KEY	Numeric	This field is required and must match the System Reliability Analysis Key in the System Analysis worksheet.
Scenario Key	MI_STRATSCE_KEY	Numeric	This field is required and must match the Scenario Key in the System Scenario worksheet.
Asset Key	MI_ASOASSET_KEY	Numeric	This field is required and must match the Asset Key in the System Asset worksheet.

Field Caption	Field ID	Data Type (Length)	Comments
Risk Key	MI_ASORISK_KEY	Numeric	This field is required. The value in the field must be unique. The field must be associated with the System Reliability Analysis Key in the System Analysis worksheet and the Asset Key in the System Asset worksheet.
Risk Name	MI_ASORISK_NAME	Character (255)	This field is required. The value in the field must be unique. The field must be associated with the System Reliability Analysis Key in the System Analysis worksheet and the Asset Key in the System Asset worksheet.
TTF	MI_DISTRIB_EXP_N_TTF	Numeric	This field is required. It must be associated with the TTF Distribution in the Exponential family with the MTBF field.
TTF Units	MI_DISTRIB_UNIT_TTF	Character (20)	This field is required. It must be associated with the TTF Distribution in the Exponential family with the Units field.
TTR	MI_DISTRIB_EXP_N_TTR	Numeric	This field is required. It must be associated with the TTR Distribution in the Exponential family with the MTBF field.
TTR Units	MI_DISTRIB_UNIT_TTR	Character (20)	This field is required. It must be associated with the TTR Distribution in the Exponential family with the Units field.

System Action

System Action records store information about Condition-Based Maintenance, Procedure, Redesign, Time-Based Maintenance, and Training Actions.

Field Caption	Field ID	Data Type (Length)	Comments
System Reliability Analysis Key	MI_STRATANA_ANALY_KEY	Numeric	This field is required and must match the System Reliability Analysis Key in the System Analysis worksheet.
Scenario Key	MI_STRATSCE_KEY	Numeric	This field is required and must match the Scenario Key in the System Scenario worksheet.
Asset Key	MI_ASOASSET_KEY	Numeric	This field is required and must match the Asset Key in the System Asset worksheet.
Action Key	MI_ASOACT_KEY	Numeric	This field is required. The value in the field must be unique. The field must be associated with the System Reliability Analysis Key in the System Analysis worksheet, the Scenario Key in the System Scenario worksheet, and the Asset Key in the System Asset worksheet.
Action Name	MI_ASOACT_NAME_C	Character (255)	This field is required. The value in the field must be unique. The field must be associated with the System Reliability Analysis Key in the System Analysis worksheet, the Scenario Key in the System Scenario worksheet, and the Asset Key in the System Asset worksheet.
Action Type	MI_STRATACT_ACTIO_TYPE_C	Character (50)	This field is required.
Action - Condition Monitoring Type	MI_STRATACT_COND_MONI_TY PE_C	Character (50)	This field is required only if the value in the Action Type field is Condition-Based Maintenance (Preventative). The values in the field are populated by the MI_ACTION_TYPE System Code Table.

Field Caption	Field ID	Data Type (Length)	Comments
Action Cost	MI_STRATACT_FIXED_COST_N	Numeric	This field is required. The value in the field represents an expense that is incurred every time the action occurs. By default, the value in the field is 0 (zero).
Action Interval	MI_STRATINSP_INTER_N	Numeric	This field is required.
Action Interval UOM	MI_STRATINSP_INTER_UNITS_C	Character (50)	This field is required.
Action Duration	MI_STRATINSP_DURAT_N	Numeric	This field is required.
Action Duration UOM	MI_STRATINSP_DURAT_UNITS_C	Character (50)	This field is required.

System Risk Assessment

System Risk Assessment records store information about the Risks and Actions included in a specific scenario.

Field Caption	Field ID	Data Type (Length)	Comments
System Reliability Analysis Key	MI_STRATANA_ANALY_KEY	Numeric	This field is required and must match the System Reliability Analysis Key in the System Analysis worksheet.
Scenario Key	MI_STRATSCE_KEY	Numeric	This field is required and must match the Scenario Key in the System Scenario worksheet.
Asset Key	MI_ASOASSET_ASSET_KEY_N	Numeric	This field is required and must match the Asset Key in the System Asset worksheet.
Action Key	MI_STRATACT_KEY	Numeric	This field is required and must match the Action Key in the System Action worksheet.
Risk Key	MI_ASORISK_KEY	Numeric	This field is required and must match the Risk Key in the System Risk worksheet.

About the System Reliability Data Loader Load Verification

About This Task

Following a successful data load, you can navigate to the **System Reliability** section of the **RA Overview** page and view the analysis created from the imported workbook.

A successful import can also be defined as an event where partial data on a worksheet was loaded into GE Digital APM, and where the user was given appropriate messaging that enabled him or her to identify and correct issues resulting from the import.

Chapter 11

Deployment and Upgrade

Topics:

- [Deployment](#)
- [Upgrade](#)

Deployment

Deployment

Refer to the deployment information here [Deploy Reliability Analytics for the First Time](#).

Upgrade

Upgrade

Refer to the upgrade information here [Upgrade or Update Reliability Analytics to V5.0.3.0.0](#).

Chapter 12

Reference

Topics:

- [General Reference](#)
- [Family Field Descriptions](#)
- [Catalog Items](#)
- [Distribution Types](#)
- [Calculations](#)
- [Failure Data](#)

General Reference

Reliability Analytics Security Groups

Reliability Analytics Security Groups

The following table lists the baseline Security Groups available for users within this module, as well as the baseline Roles to which those Security Groups are assigned.

Important: Assigning a Security User to a Role grants that user the privileges associated with all of the Security Groups that are assigned to that Role. To avoid granting a Security User unintended privileges, before assigning a Security User to a Role, be sure to review all of the privileges associated with the Security Groups assigned to that Role. Also, be aware that additional Roles, as well as Security Groups assigned to existing Roles, can be added via Security Manager.

Security Group	Roles
MI Reliability Viewer	MI APM Viewer
MI Reliability User	MI FE PowerUser MI FE User
MI Reliability Administrator	MI APM Viewer MI FE Admin MI FE PowerUser MI FE User

The baseline family-level privileges that exist for these Security Groups are summarized in the following table.

Family	MI Reliability Administrator	MI Reliability User	MI Reliability Viewer
Analysis	View	View	View
Distribution	View, Update, Insert, Delete	View, Update, Insert, Delete	View
Exponential	View, Update, Insert, Delete	View, Update, Insert, Delete	View
Growth Model	View, Update, Insert, Delete	View, Update, Insert, Delete	View
Lognormal	View, Update, Insert, Delete	View, Update, Insert, Delete	View
Normal	View, Update, Insert, Delete	View, Update, Insert, Delete	View
Production Analysis	View, Update, Insert, Delete	View, Update, Insert, Delete	View
Production Losses	View, Update, Insert, Delete	View, Update, Insert, Delete	View
Reliability Automation Rule	View, Update, Insert, Delete	View	View
Reliability Distribution	View, Update, Insert, Delete	View, Update, Insert, Delete	View
Reliability Growth	View, Update, Insert, Delete	View, Update, Insert, Delete	View
Reliability Recommendation	View, Update, Insert, Delete	View, Update, Insert, Delete	View

Family	MI Reliability Administrator	MI Reliability User	MI Reliability Viewer
Spare	View, Update, Insert, Delete	View, Update, Insert, Delete	View
Spares Analysis	View, Update, Insert, Delete	View, Update, Insert, Delete	View
Spare Analysis Chart	View, Update, Insert, Delete	View, Update, Insert, Delete	View
Spare Application	View, Update, Insert, Delete	View, Update, Insert, Delete	View
Spare Application Population	View, Update, Insert, Delete	View, Update, Insert, Delete	View
System Action	View, Update, Insert, Delete	View, Update, Insert, Delete	View
System Action Mapping	View, Update, Insert, Delete	View, Update, Insert, Delete	View
System Action Optimization	View, Update, Insert, Delete	View, Update, Insert, Delete	View
System Action Result	View, Update, Insert, Delete	View, Update, Insert, Delete	View
System Analysis	View, Update, Insert, Delete	View, Update, Insert, Delete	View
System Asset	View, Update, Insert, Delete	View, Update, Insert, Delete	View
System Buffer	View, Update, Insert, Delete	View, Update, Insert, Delete	View
System Condition Monitor	View, Update, Insert, Delete	View, Update, Insert, Delete	View
System Element	View, Update, Insert, Delete	View, Update, Insert, Delete	View
System Element Result	View, Update, Insert, Delete	View, Update, Insert, Delete	View
System Global Event	View, Update, Insert, Delete	View, Update, Insert, Delete	View
System Inspection	View, Update, Insert, Delete	View, Update, Insert, Delete	View
System Link	View, Update, Insert, Delete	View, Update, Insert, Delete	View
System Preventative Maintenance	View, Update, Insert, Delete	View, Update, Insert, Delete	View
System Resource	View, Update, Insert, Delete	View, Update, Insert, Delete	View
System Resource Result	View, Update, Insert, Delete	View, Update, Insert, Delete	View
System Resource Usage	View, Update, Insert, Delete	View, Update, Insert, Delete	View
System Risk	View, Update, Insert, Delete	View, Update, Insert, Delete	View
System Risk Assessment	View, Update, Insert, Delete	View, Update, Insert, Delete	View
System Scenario	View, Update, Insert, Delete	View, Update, Insert, Delete	View
System Sensor	View, Update, Insert, Delete	View, Update, Insert, Delete	View
System Special Action	View, Update, Insert, Delete	View, Update, Insert, Delete	View
System Subsystem	View, Update, Insert, Delete	View, Update, Insert, Delete	View
System Switch	View, Update, Insert, Delete	View, Update, Insert, Delete	View
Weibull	View, Update, Insert, Delete	View, Update, Insert, Delete	View
Analysis Link	View, Update, Insert, Delete	View, Update, Insert, Delete	View
Has Global Events	View, Update, Insert, Delete	View, Update, Insert, Delete	View

Family	MI Reliability Administrator	MI Reliability User	MI Reliability Viewer
Has Mitigated TTF Distribution	View, Update, Insert, Delete	View, Update, Insert, Delete	View
Has Planned Resource Usages	View, Update, Insert, Delete	View, Update, Insert, Delete	View
Has Consolidated Recommendations	View	View	View
Has Recommendations	View, Update, Insert, Delete	View, Update, Insert, Delete	View
Has Reliability	View, Update, Insert, Delete	View, Update, Insert, Delete	View
Has Resource Usage	View, Update, Insert, Delete	View, Update, Insert, Delete	View
Has Risk Assessments	View, Update, Insert, Delete	View, Update, Insert, Delete	View
Has Root System	View, Update, Insert, Delete	View, Update, Insert, Delete	View
Has Scenarios	View, Update, Insert, Delete	View, Update, Insert, Delete	View
Has System Actions	View, Update, Insert, Delete	View, Update, Insert, Delete	View
Has System Elements	View, Update, Insert, Delete	View, Update, Insert, Delete	View
Has System Optimization	View, Update, Insert, Delete	View, Update, Insert, Delete	View
Has System Resources	View, Update, Insert, Delete	View, Update, Insert, Delete	View
Has System Results	View, Update, Insert, Delete	View, Update, Insert, Delete	View
Has System Risks	View, Update, Insert, Delete	View, Update, Insert, Delete	View
Has TTF Distribution	View, Update, Insert, Delete	View, Update, Insert, Delete	View
Has Unplanned Resource Usages	View, Update, Insert, Delete	View, Update, Insert, Delete	View

Reliability Analytics URLs

Reliability Analytics URLs

There is one URL route associated with Reliability Analytics: **reliability**. The following table describes the various paths that build on the route, and the elements that you can specify for each.

Tip: For more information, refer to the URLs section of the documentation.

Element	Description	Accepted Value(s)	Notes
reliability/dashboard/<EntityKey>: Displays the Reliability Analytics overview page.			
<EntityKey>	Specifies Asset context for the RA Overview page.	Any numeric Entity Key that corresponds to an existing Asset.	Entering 0 for an Entity Key displays a generic RA overview.
reliability/automation/<EntityKey>/summary: Displays Automation rules.			
<EntityKey>	Specifies which Reliability Automation Rules you want to view.	The Entity Key of the desired automation rule.	This parameter is required and it refers to the analysis. Without the Entity Key, then the URL will not be supported.

Element	Description	Accepted Value(s)	Notes
reliability/probability/<EntityKey>/<WorkspaceName>: Displays Probability Distribution Analyses.			
<EntityKey>	Specifies which Probability Distribution you want to view.	The Entity Key of the desired analysis.	This parameter is required and it refers to the analysis. Without the Entity Key, then the URL will not be supported.
<WorkspaceName>	Specifies the type of Probability Distribution Analysis information you want to view.	cdfplot	Displays the CDF Plot workspace.
		pdfplot	Displays the PDF Plot workspace.
		probabilityplot	Displays the Probability Plot workspace.
		summary	Displays the Analysis Summary workspace.
reliability/production/<EntityKey>/<WorkspaceName>: Displays Production Analyses.			
<EntityKey>	Specifies which Production Analysis you want to view.	The Entity Key of the desired analysis.	This parameter is required and it refers to the analysis. Without the Entity Key, then the URL will not be supported.
<WorkspaceName>	Specifies the type of Production Analysis information you want to view.	overview	Displays the Analysis Summary workspace.
		production-plot	Displays the Production Data workspace.
reliability/distribution/<EntityKey>/<WorkspaceName>: Displays Reliability Distribution Analyses.			
<EntityKey>	Specifies which Reliability Distribution Analysis you want to view.	The Entity Key of the desired analysis.	This parameter is required and it refers to the analysis. Without the Entity Key, then the URL will not be supported.

Element	Description	Accepted Value(s)	Notes
<WorkspaceName>	Specifies the type of Reliability Distribution Analysis information that you want to view.	cdfplot	Displays the CDF Plot workspace.
		failureprobability	Displays the Failure Probability workspace.
		failurerateplot	Displays the Failure Rate Plot workspace.
		pdfplot	Displays the PDF Plot workspace.
		pmoptimization	Displays the PM Optimization workspace.
		probabilityplot	Displays the Probability Plot workspace.
		summary	Displays the Analysis Summary workspace.
reliability/growth/<EntityKey>/<WorkspaceName>: Displays Reliability Growth Analyses.			
<EntityKey>	Specifies which Reliability Growth Analysis you want to view.	The Entity Key of the desired analysis.	This parameter is required and refers to the analysis. Without the Entity Key, the URL will not be supported.
<WorkspaceName>	Specifies the type of Reliability Growth Analysis information that you want to view.	failurerateplot	Displays the Failure Rate Plot workspace.
		failuresplot	Displays the Cumulative Failures Plot workspace.
		mtbfplot	Displays the MTBF Plot workspace.
		summary	Displays the Analysis Summary workspace.
reliability/spares/<EntityKey>/<WorkspaceName>: Displays Spares Analyses.			
reliability/spares/<EntityKey>/spareoverview/<SpareEntityKey>: Displays a Spare.			
reliability/spares/<EntityKey>/spareappoverview/<SpareEntityKey>/<SpareApplicationEntityKey>: Displays Spare Application.			
<EntityKey>	Specifies which Spares Analysis you want to view.	The Entity Key of the desired analysis.	This parameter is required and refers to the analysis. Without the Entity Key, the URL will not be supported.
<WorkspaceName>	Specifies the type of Spares Analysis information you want to view.	overview	Displays the Analysis Summary workspace.

Element	Description	Accepted Value(s)	Notes
<SpareEntityKey>	Specifies which Spare you want to view.	The Entity Key of the desired Spare.	This parameter is required and refers to the Spare. Without the Spare Entity Key, the URL will not be supported. Displays the Spare workspace.
<SpareApplicationEntityKey>	Specifies which Spare Application you want to view.	The Entity Key of the desired Spare Application.	This parameter is required and refers to the Spare Application. Without the Spare Application Entity Key, the URL will not be supported. Displays the Applications section.
reliability/system/<EntityKey>/<WorkspaceName>: Displays System Reliability Analyses. reliability/system/<EntityKey>/scenario/<ScenarioEntityKey>: Displays System Reliability Scenarios.			
<EntityKey>	Specifies which System Reliability Analysis you want to view.	The Entity Key of the desired analysis.	This parameter is required and refers to the analysis. Without the Entity Key, the URL will not be supported.
		simulation	Displays the Simulation Results workspace.
		summary	Displays the Analysis Summary workspace.
<ScenarioEntityKey>	Specifies which System Reliability Scenario you want to view.	The Entity Key of the desired Scenario.	Displays the Scenario workspace.

Table 1: Example URLs

Example URL	Destination
reliability/dashboard/0	Reliability Analytics Overview page.
reliability/automation/3228505/summary	Automation page with the Entity Key 3228505.
reliability/probability/3228505/summary	Probability Distribution page, displaying the Analysis Summary workspace with the Entity Key 3228505.
reliability/production/4924257/overview	Production Analysis page, displaying the Analysis Summary workspace with the Entity Key 4924257.
reliability/distribution/2842417/summary	Reliability Distribution page, displaying the Analysis Summary workspace with the Entity Key 2842417.
reliability/growth/2842411/summary	Reliability Growth page, displaying the Analysis Summary workspace with the Entity Key 2842411.

Example URL	Destination
reliability/spares/2841956/overview	Spares Analysis page, displaying the Summary workspace with the Entity Key 2841956.
reliability/spares/2841956/spareoverview/2841957	Spare Analysis Summary workspace with the Entity Key 2841956 and the Spare Entity Key 2841957.
reliability/spares/2841956/spareappoverview/ 2841957/2841959	Spare Critical Applications workspace with the Entity Key 2841956, the Spare Entity Key 2841957 and the Spare Application Key 2841959.
reliability/system/3352307/summary	System Reliability page, displaying the Summary workspace with the Entity Key 3352307.
reliability/system/3352307/scenario/3352304	System Reliability Analysis page, displaying the Diagram workspace with the Entity Key 3352307 and the Scenario Entity Key 3352304.

Reliability Analytics System Code Tables

Reliability Analytics System Code Tables

The following table lists the System Code Tables that are used by Reliability Analytics.

Table ID	Table Description	Function
MI_ACTION_TYPE	Action Type	Populates a list of options for the Action Type field in System Reliability records.
MI_CONDITION_MONITORING_TYPE	Condition Monitoring Type	Populates a list of options for the Condition Monitoring Type field in System Reliability records.
MI_RATE_UNITS	Rate Units	Populates a list of Rate Unit options for multiple System Reliability records.
MI_TIMEANAL_TYPE	Time Analysis Type	Populates a list of options for the Time Analysis Type field in System Reliability Analysis Definition records.
MI_TIME_UNITS	Time Units	Populates a list of Time Unit options for multiple System Reliability records.

Automation Rules

About Site Filtering in Automation Rules

In Automation Rules, when a rule is created, the site is assigned based on the user's selection in the **Site** control, and all subsequent analyses that are executed will inherit the Site Reference Key from the rule.

Tip: For more information, refer to the Site Filtering section of the documentation.

Automation Rules that are created for a single site and that are based on a query containing multi-site data will contain multi-site data. A single-site user with access to the Automation Rule can open the Automation Rule and view all of the multi-site data in it.

When creating query-based and event/date-based automation rules, you can specify the sites of data on which the analyses are based. When the rule is executed, the analyses will use data from the specified sites.

Note: Reloading the data will re-run the query, limiting the results displayed to the data points based on those to which the single-site user has access.

In Automation Rules, users will see only data that is assigned to their site(s) or that is global data.

Consider an organization that has three sites, Site X, Site Y, and Site Z. The following Automation Rule records exist:

- Automation Rule A: Assigned to Site X
- Automation Rule B: Assigned to Site Y
- Automation Rule C: Assigned to Site Z
- Automation Rule D: No site assigned (global record)

Scenario 1: User assigned to only Site X

This user will see Automation Rules A and D.

If a child record assigned to Site X and a child record assigned to Site Y are linked to Automation Rule D, the Site X user will see only the records assigned to Site X.

Scenario 2: User assigned to both Site X and Site Y

This user will see Automation Rules A, B, and D.

Scenario 3: Super User

This user will see Automation Rules A, B, C, and D.

Important: If a multi-site user, or a Super User, links child records from multiple sites to a parent record designated as **Global**, another user who does not have access to all sites may only see a portion of the data associated with that record.

Reliability Automation Rule Data Model

The following diagram shows how the families used in Reliability Automation Rules are related to one another.

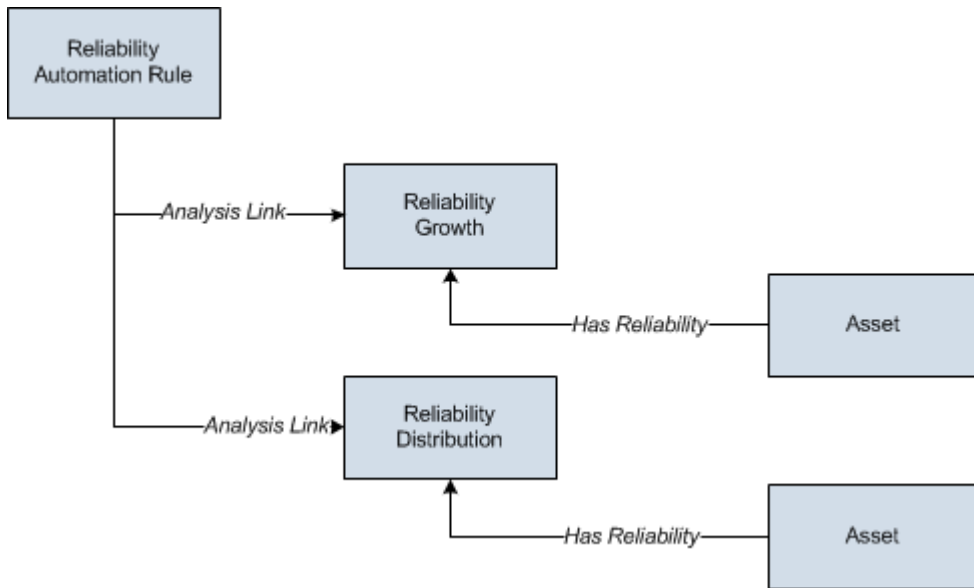

Note: In the diagram, boxes represent entity families and arrows represent relationship families that are configured in the baseline database. You can determine the direction of the each relationship definition from the direction of the arrow head: the box from which the arrow originates is the predecessor, and the box to which the arrow head points is the successor.

Probability Distribution

About Site Filtering in Probability Distribution Analysis

In Probability Distribution, the site is assigned based on the user's selection in the **Site** control, but the data for the analysis can be generated by a query that contains records from multiple sites.

Tip: For more information, refer to the Site Filtering section of the documentation.

Note: Reloading the data will re-run the query, limiting the results displayed to the data points based on those to which the single-site user has access.

Analyses that are created for a single site and that are based on a query containing multi-site data will contain multi-site data. A single-site user with access to the analysis can open the analysis and view all of the multi-site data in an analysis.

Note: Probability Distribution does not create a link between the analysis and the asset(s) in the data the analysis is based on.

Tip: To prevent analyses from being modified by other users, save the query on which the analysis is based to a personal or private folder.

Consider an organization that has three sites, Site X, Site Y, and Site Z. The following Probability Distribution records exist:

- Probability Distribution A: Assigned to Site X
- Probability Distribution B: Assigned to Site Y
- Probability Distribution C: Assigned to Site Z
- Probability Distribution D: No site assigned (global record)

Scenario 1: User assigned to only Site X

This user will see Probability Distributions A and D.

Scenario 2: User assigned to both Site X and Site Y

This user will see Probability Distributions A, B, and D.

Scenario 3: Super User

This user will see Probability Distributions A, B, C, and D.

Important: If a Super User modifies the site assignment of a child record from the site assignment that it inherited from a parent record, data integrity will be compromised.

Probability Distribution Analysis Data Model

The following diagram shows how the families used in Probability Distribution Analysis are related to one another.

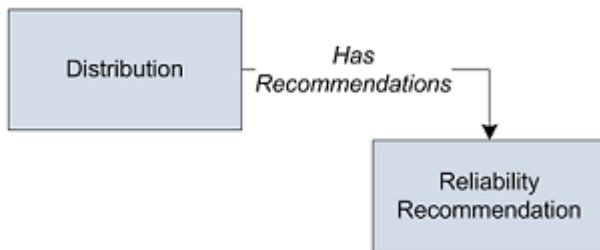

Note: In the diagram, boxes represent entity families and arrows represent relationship families that are configured in the baseline database. You can determine the direction of the each relationship definition from the direction of the arrow head: the box from which the arrow originates is the predecessor, and the box to which the arrow head points is the successor.

In the above image, the Distribution box represents one of four Distribution subfamilies in which records can exist: Normal, Weibull, Exponential, Lognormal, Triangular, Gumbel, or Generalized Extreme Value.

As you develop a Probability Distribution Analysis, you will create records in these families and link them together, either manually or automatically via the options in the GE Digital APM Framework. Throughout this documentation, we use the term Probability Distribution Analysis to mean the combination of the Distribution record and all the records that are linked to it.

About Data Mapped to the Baseline Analysis <Source Type> Window

When you create a Probability Distribution Analysis from a query or dataset, the **Probability Distribution Builder** window will prompt you to map values from columns in the query or dataset to certain values in the Probability Distribution Analysis. The values that you select to map on the **Select Data Fields** screen in the **Probability Distribution Builder** window will then appear in the associated columns in the **Baseline Analysis <Source Type>** window. The <Source Type> is Query or Dataset on which your analysis is based.

Note: If the analysis is based on a query or a dataset and contains additional columns that are not mapped to columns in the analysis dataset, those columns will appear in the **Baseline Analysis <Source Type>** window with the column name in parentheses.

This family is enabled for site filtering, which means that records in this family can be assigned to a specific site and will only be accessible to users who are assigned to the same site and have the appropriate license and family privileges. For more information, refer to the [Sites](#) section of the documentation.

Details

The following table displays which columns are mapped from fields in the **Probability Distribution Builder** window to columns in the **Baseline Analysis <Source Type>** window:

Probability Distribution Builder Screen	Probability Distribution Builder Field	Baseline Analysis <Source Type> Window Column
Select Data Fields	Value	X
Select Data Fields	Censored	Censored

Production Analysis

About Site Filtering in Production Analysis

In Production Analysis, the site is assigned based on the user's selection in the **Site** control.

Tip: For more information, refer to the Site Filtering section of the documentation.

Data for the analysis can be generated by a query that contains records from multiple sites. Analyses that are created for a single site and that are based on a query containing multi-site data will contain multi-site data. A single-site user with access to the analysis can open and view all of the multi-site data in an analysis.

A user that has been assigned, at a minimum, to all of the sites that are associated with the records queried by the analysis will have full access to modify the analysis. If this user reloads the analysis, the query will return data based on the sites that were assigned at the time the analysis was created.

A user that has not been assigned to all of the sites that are associated with the records queried by the analysis will be able to view the analysis, but will not be able to reload or edit the data.

Consider an organization that has three sites, Site X, Site Y, and Site Z. The following Production Analysis records exist:

- Production Analysis A: Assigned to Site X
- Production Analysis B: Assigned to Site Y
- Production Analysis C: Assigned to Site Z
- Production Analysis D: No site assigned (global record)

Scenario 1: User assigned to only Site X

This user will see Production Analyses A and D.

Scenario 2: User assigned to both Site X and Site Y

This user will see Production Analyses A, B, and D.

Scenario 3: Super User

This user will see Production Analyses A, B, C, and D.

Important: If a Super User modifies the site assignment of a child record from the site assignment that it inherited from a parent record, data integrity will be compromised.

Production Analysis Data Model

The following diagram shows how the families used in Production Analysis are related to one another.

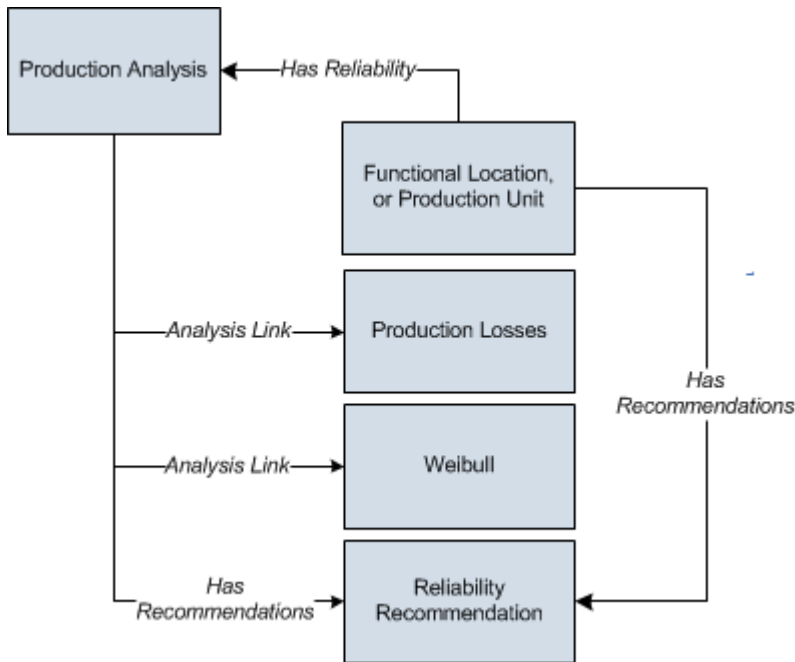

Note: In the diagram, boxes represent entity families and arrows represent relationship families that are configured in the baseline database. You can determine the direction of the each relationship definition from the direction of the arrow head: the box from which the arrow originates is the predecessor, and the box to which the arrow head points is the successor.

As you develop a Production Analysis, you will create records in these families and link them together, either manually or automatically via the options in the GE Digital APM system. Throughout this documentation, we use the term Production Analysis to mean the combination of the Production Analysis record and all the records that are linked to it.

A Production Analysis is meant to be conducted at the unit level, and can be linked to a Functional Location record representing a unit or a Production Unit record representing the same unit.

Data Mapped to the Production Data Editor Window

When you create a Production Analysis from a query or dataset, the **Production Analysis Builder** will prompt you to map values from columns in the query or dataset to certain values in the Production Analysis. The values that you select to map on the **Select Product Fields** screen in the **Production Analysis Builder** will then appear in the associated columns in the **Production Data Editor** window.

Note: If the analysis is based on a query or a dataset and contains additional columns that are not mapped to columns in the analysis dataset, those columns will appear in the **Production Data Editor** window with the column name in parentheses.

The following table contains which columns are mapped from fields in the Production Analysis Builder to columns in the Edit Production Data window.

This family is enabled for site filtering, which means that records in this family can be assigned to a specific site and will only be accessible to users who are assigned to the same site and have the appropriate license and family privileges. For more information, refer to the [Sites](#) section of the documentation.

Production Analysis Builder Screen	Production Analysis Builder Field	Production Data Editor Window Column
Select Product Fields	Production Output	Production Output
Select Product Fields	Production Date	Date

About the Production Data Plot

The Production Data (Weibull) plot provides visual representation of the production output values in a log-log format. The log-log format reflects the standard technique for representing Weibull Distribution.

Note: Interaction with charts is not available on [touch-screen devices](#).

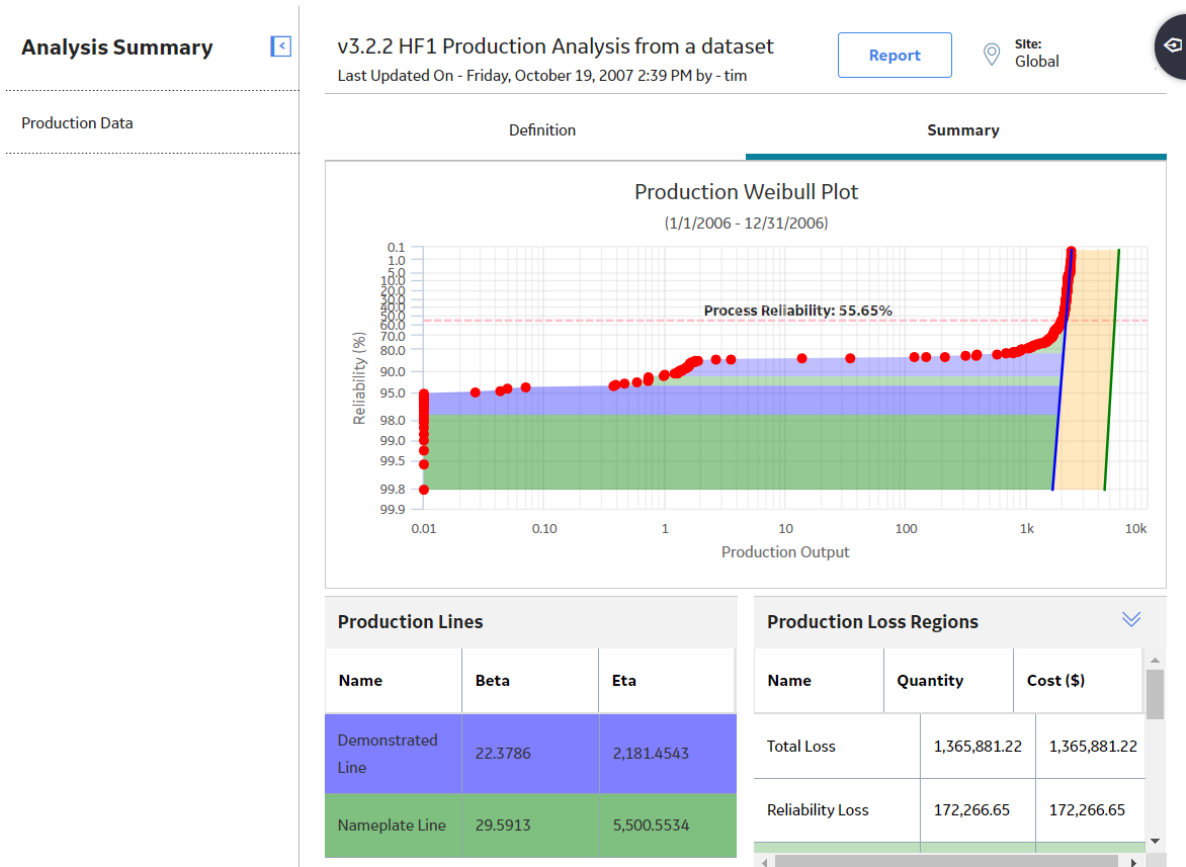

You can view the Production Weibull Plot as datapoints on a graph. The dates that the datapoints represent are displayed as a subtitle above the graph. The output values are plotted along the x-axis, and the Reliability Percentage values for each datapoint are plotted along the y-axis. The Reliability Percentage is calculated by first determining the median rank of each output value, and then using the median rank in a second equation that converts it to the Reliability Percentage. The following simplified equation can be used to determine an approximated median rank for each output value:

$$\text{Median Rank} = 1 - (i - .3) / (N + .4)$$

Where,

- i is the order of each datapoint with respect to other datapoints. To determine the i value of each datapoint, the output values are sorted from highest to lowest. The highest output value is assigned a value of $i=1$. The second-highest value is assigned $i=2$, and so on until all the output values have been numbered.

- N is the number of output values. For example, if your Production Analysis has a year's worth of datapoints, then **N=365**. If your Production Analysis has only a month's worth of datapoints, then **N=31** or **N=30**, depending on what month you are using.

After the median rank has been calculated, the Reliability Percentage is calculated using the following equation and then plotted along the y-axis:

$$\text{Reliability Percentage} = 100 - (\text{Median Rank} * 100)$$

The general shape of the plot can provide you with basic information about your production process:

- Ideally, the datapoints will be plotted to form a vertical line at the highest possible X-value. This means that your process is producing the highest rate of output at all times, with no variation, and that you have no reliability or process problems. While this scenario is not realistic, visualizing the ideal plot compared to your actual plot can be useful in understanding how far your actual data deviates from ideal data.
- If the datapoints are plotted in a straight, diagonal line that slopes upward from left to right with no sharp change in production rate, then any variation in output is due to process problems; you have no equipment or location reliability problems.
- If the datapoints show a sharp change in production, then you have both process problems and Asset related reliability problems. You will [draw the Process Reliability Line](#) where you notice this sharp change in production output.
- Within the [Reliability Loss region](#), you may notice distinct areas where the production output varies greatly from the rest of the datapoints in the region. These variations may be due to different types of reliability problems, such as system shutdowns, intentional cutbacks, and equipment or location failures. You can [create breakpoints](#) to divide the reliability loss region into separate areas where you notice these changes.

Graph Features

While [accessing the plot](#), you can:

- Hover on any datapoint to access the coordinates, Production value, Reliability percentage, date of the observation, and the category.

Note: This feature may not be available on all the devices based on the screen resolution. On tablets and smaller devices, you can tap on the datapoint to view the details of an observed datapoint.

- You can select an observed datapoint to open **Point Tooltip** window.

Tip: You can zoom into a graph area by dragging the left mouse button. To zoom out, on the graph, select **Reset zoom**. You can also do this on a tablet using the standard spread move.

On the **Point Tooltip** window, you can:



- View Production value, Reliability percentage, date of the observation, and category.
- Select **Go To Editor** to open the **Production Analysis Points Editor** window, where you can modify and save the highlighted datapoint [details](#).
- [Break the Reliability Loss region](#) into two shaded regions, and you can [unbreak a breakpoint](#) between regions.
- [Ignore the datapoint](#).
- Customize the appearance of the plot by using standard [graph features](#).
- You can [reload the data](#) stored in the database after asking for confirmation to overwrite any existing data. This option appears in the **Analysis Data** list, and you will get an error message if the analysis is based on a manually entered data.
- [Group the Production Datapoints](#).
- [Interpret results of a Production Analysis](#).

About Production Loss Regions

The **Production Loss Regions** section of the Production Analysis Report contains a grid that displays information that is stored in the [Production Losses](#) records that are linked to the [Production Analysis](#) record. Each row in the grid represents one Production Losses record that is linked to the Production Analysis record. The color of each name label corresponds to the color of the loss regions on the Production Data plot. Optionally, within the **Production Loss Regions** pane, you can choose any line color from the color palette that appears when you select the color palette in the **Color** column.

Details

The **Production Loss Regions** section displays the calculations that summarize your Reliability Losses and your Efficiency and Utilization Losses. The **Production Loss Regions** section contains various rows, depending on which lines have been created on the analysis.

Name	Quantity (Tons x1000)	Cost (\$)	Color	
Total Loss	347,450.89	1,737,254.46		
▲ Reliability Loss	233,767.91	1,168,839.54		
Sub Reliability Loss 53.28% ~ 95.71%	196,175.74	980,878.70		Delete
Sub Reliability Loss 95.71% ~ 99.81%	37,667.50	188,337.49		Delete
Efficiency/Utilization Loss	113,682.98	568,414.92		

The **Production Loss Regions** section provides following rows of information:

- **Total Loss:** Contains the sum of the Reliability Loss and the Efficiency/Utilization Loss.
- **Reliability Loss:** Contains the sum of the production loss and is the region that lies between the Minimum Production Output value and the [Demonstrated Line](#), below the Process Reliability Line. If breakpoints exist, then the **Reliability Loss** is also the sum of all the **Sub Reliability Loss** regions.
- **Sub Reliability Loss:** For the first **Sub Reliability Loss** row, contains the sum of the losses between the Demonstrated Line and the first breakpoint below the Process Reliability Line. For subsequent **Sub Reliability Loss** rows, contains the sum of the losses between the previous breakpoint and the next breakpoint below the Process Reliability Line.

Note: Sub Reliability Loss rows will appear only if breakpoints exist on the Production Analysis. The number of **Sub Reliability Loss** rows will correspond to the number of breakpoints that you have inserted.

All the Reliability Losses are calculated below the Process Reliability Line, therefore, the values for the **Quantity** and **Cost** will change if you change the location of the Process Reliability Line.

- **Efficiency/Utilization Loss:** The sum of the production losses between the Demonstrated Line and the Nameplate Line.

For each row on the **Production Loss Regions** section, the following columns are displayed:

- **Name:** Contains the name of the production loss region.
- **Quantity:** Contains a value representing the total Production Loss for each region. To specify the units used to calculate these losses, you can [change the unit of measure](#).
- **Cost:** Contains a value representing the amount of profit that was lost due to the Production Loss in each region. This value is always rounded up to the nearest dollar. To specify the currency, you can [change the margin currency](#).

About Production Analysis Reports

The baseline GE Digital APM database includes the Production Analysis Report, which you can use to view a summary of the results of a Production Analysis.

The Production Analysis Report is built from the following Catalog items:

- The main report, ProductionAnalysisReport, which is stored in the Catalog folder `\\Public\Meridium\Modules\Reliability Manager\SSRS`.
- The subreport, SubreportProductionAnalysis, which is stored in the Catalog folder `\\Public\Meridium\Modules\Reliability Manager\Reports`.
- The supporting queries that supply data in the main report and subreport, which are stored in the Catalog folder `\\Public\Meridium\Modules\Reliability Manager\Reports`. The following supporting queries are available:
 - ProductionAnalysisQuery
 - ProductionAnalysisQueryLines: Provides the information that is displayed in the **Analysis Summary, Production Lines, Production Weibull Plot**, and Production Data sections of the Production Analysis report.
 - ProductionAnalysisQueryRegions: Provides the information that is displayed in the Production Loss Regions section of the Production Analysis Report.

Throughout this documentation, we refer to the main report, the subreport, and the supporting queries collectively as the Production Analysis Report.

The Production Analysis report contains a prompt on the ENTY KEY field in the Production Analysis family. When you run the Production Analysis report via the Production Analysis module, the ENTY KEY of the Production Analysis record associated with the current analysis is passed automatically to the prompt, and the results for the current Production Analysis are displayed. If you run the main report or any of the queries in the preceding list directly from the Catalog, however, you will need to supply the ENTY KEY of a Production Analysis record manually to retrieve results. The subreport (i.e., Catalog item SubreportProductionAnalysis) cannot be run directly from the Catalog.

Analysis Summary Section

The **Analysis Summary** section of the Production Analysis report displays information that is stored in the Production Analysis record.

The following table lists each item in the **Analysis Summary** section and the corresponding Production Analysis record field whose data is displayed in the report.

Report Item	Production Analysis Field
Analysis Name	Analysis ID
Analysis Description	Short Description
Start Date	Analysis Start Date
End Date	Analysis End Date
Process Reliability	Pro Reliability
Total Data Points	Total Data Points
Ignored Data Points	Ignored Data Points
Min Production	Min Production
Unit Of Measure	Unit Of Measure
Margin	Margin Value
Last Modified	LAST UPDT DT
Modified By	LAST UPBY SEUS KEY Note: The name of the Security User associated with this value is displayed in the report.

Production Lines Section

The **Production Lines** section of the Production Analysis report contains a grid that displays information that is stored in the Weibull records that are linked to the [Production Analysis](#) record. Each row in the grid represents one Weibull record that is linked to the Production Analysis record.

The following table lists each column in the grid in the **Production Lines** section and the corresponding Weibull record field whose data is displayed in the report.

Column	Weibull Field
Name	Analysis ID
Beta	Beta
Eta	Eta
R ²	R -Squared
Goodness of Fit	Passed

Production Regions Section

The **Production Regions** section of the Production Analysis report contains a grid that displays information that is stored in the [Production Losses](#) records that are linked to the Production Analysis record. Each row in the grid represents one Production Losses record that is linked to the Production Analysis record.

The following table lists each column in the grid in the **Production Loss Regions** section and the corresponding Production Losses record field whose data is displayed in the report.

Column	Production Losses Field
Name	Losses Type
Region Start	Area Start
Region End	Area End
Quantity	Production Losses
Cost	Losses Cost

Production Weibull Plot Section

The **Production Weibull Plot** section of the Production Analysis report displays the **Production Weibull Plot**.

Production Data Section

The **Production Data** section of the Production Analysis report contains a grid that displays information that is stored in the Production Data field in the **Production Analysis** record.

The following columns of information are displayed in the grid in the **Production Data** section. The values displayed in these columns are stored in the Production Data field in the **Production Analysis** record:

- **Production Output**
- **Date**
- **Ignored**

Reliability Distribution

About Site Filtering in Reliability Distribution Analysis

In Reliability Distribution Analysis, the site is assigned based on the user's selection in the **Site** control.

Tip: For more information, refer to the Site Filtering section of the documentation.

Data for the analysis can be generated by a query that contains records from multiple sites. Analyses that are created for a single site and that are based on a query containing multi-site data will contain multi-site data. A single-site user with access to the analysis can open the analysis and view all of the multi-site data in an analysis.

A user that has been assigned, at a minimum, to all of the sites that are associated with the records queried by the analysis will have full access to modify the analysis. If this user reloads the analysis, the query will return data based on the sites that were assigned at the time the analysis was created.

A user that has not been assigned to all of the sites that are associated with the records queried by the analysis will be able to view the analysis, but will not be able to reload or edit the data.

Consider an organization that has three sites, Site X, Site Y, and Site Z. The following Reliability Distribution Analysis records exist:

- Reliability Distribution Analysis A: Assigned to Site X
- Reliability Distribution Analysis B: Assigned to Site Y
- Reliability Distribution Analysis C: Assigned to Site Z
- Reliability Distribution Analysis D: No site assigned (global record)

Scenario 1: User assigned to only Site X

This user will see Reliability Distribution Analyses A and D.

Scenario 2: User assigned to both Site X and Site Y

This user will see Reliability Distribution Analyses A, B, and D.

Scenario 3: Super User

This user will see Reliability Distribution Analyses A, B, C, and D.

Important: If a Super User modifies the site assignment of a child record from the site assignment that it inherited from a parent record, data integrity will be compromised.

Reliability Distribution Analysis Data Model

The following diagram shows how the families used in Reliability Distribution Analysis are related to one another.

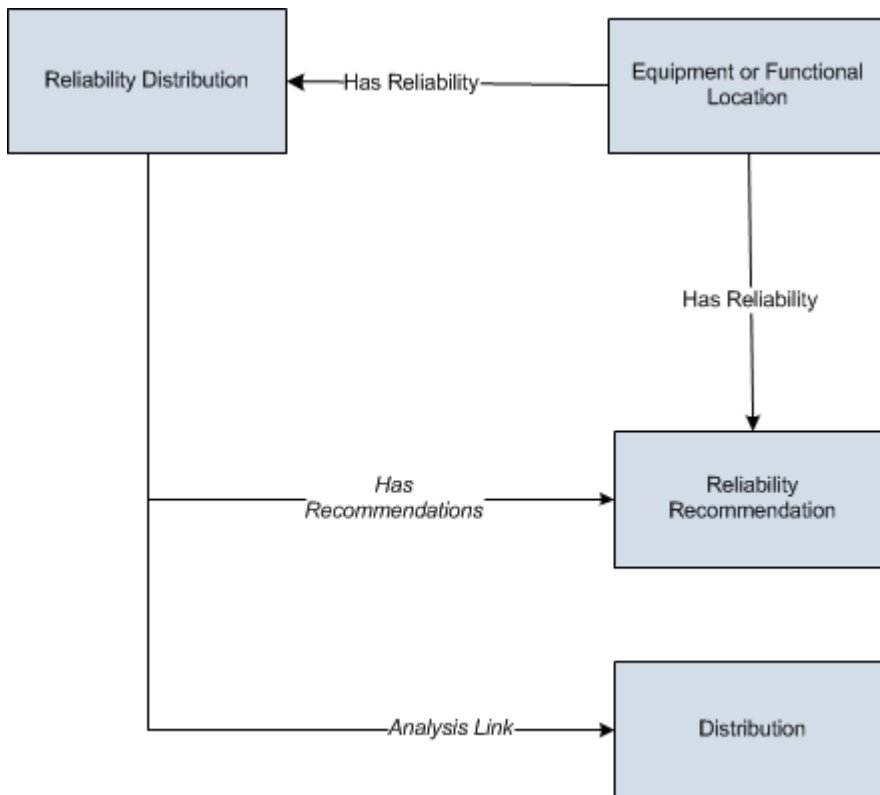

Note: In the diagram, boxes represent entity families and arrows represent relationship families that are configured in the baseline database. You can determine the direction of the each relationship definition from the direction of the arrow head: the box from which the arrow originates is the predecessor, and the box to which the arrow head points is the successor.

In the above image, the Distribution box represents one of four Distribution subfamilies in which records can exist: Normal, Weibull, Exponential, Lognormal, Triangular, Gumbel, or Generalized Extreme Value. When you create a Distribution record using the Reliability Distribution Analysis workflow, the specific family to which that Distribution record will belong will depend on the distribution type that is selected in the **Time To Failure Distribution** or **Time To Repair Distribution** section.

As you develop a Reliability Distribution Analysis, you will create records in these families and link them together, either manually or automatically via the options in the GE Digital APM system. Throughout this

documentation, we use the term Reliability Distribution Analysis to mean the combination of the Reliability Distribution record and all the records that are linked to it.

About Data Mapped to the Baseline Analysis <Source Type> Window

When you create a Reliability Distribution Analysis from a query or dataset, the **Reliability Distribution Builder** window will prompt you to map values from columns in the query or dataset to certain values in the Reliability Distribution Analysis. The values that you select to map on the **Select Failure Fields** and **Provide Information For Downtime** screens in the **Reliability Distribution Builder** window will then appear in the associated columns in the **Baseline Analysis <Source Type>** window. The <Source Type> is Query or Dataset on which your analysis is based.

Note: If the analysis is based on a query or a dataset and contains additional columns that are not mapped to columns in the analysis dataset, those columns will appear in the **Baseline Analysis <Source Type>** window with the column name in parentheses.

This family is enabled for site filtering, which means that records in this family can be assigned to a specific site and will only be accessible to users who are assigned to the same site and have the appropriate license and family privileges. For more information, refer to the [Sites](#) section of the documentation.

Details

The following table displays which columns are mapped from fields in the **Reliability Distribution Builder** window to columns in the **Baseline Analysis <Source Type>** window:

Reliability Distribution Builder Screen	Reliability Distribution Builder Field	Baseline Analysis <Source Type> Window Column
Provide Information for Downtime	Downtime Field	Downtime
Select Failure Fields	Asset ID	Asset ID
Select Failure Fields	Failure Date	Failure Date
Select Failure Fields	Number of Failures	Number of Failures
Select Failure Fields	Replacement?	Replaced
Select Failure Fields	Installation Date	Installation Date
Select Failure Fields	Number of Subcomponents	Number of Subcomponents

About Failure History By Asset

The Failure History By Asset plot allows you to determine patterns in the failures such as if they are occurring at random, or close together, or more frequently over time. You can view a timeline that shows when each failure occurred for an asset if the data for an analysis contains failure dates for one or more assets. If the data for an analysis contains failure dates for one or more pieces of equipment, you can view a timeline that shows when each failure occurred for each piece of equipment.

Note: Interaction with charts is not available on [touch-screen devices](#).

Details

For each piece of equipment included in your analysis, **Failure History By Asset** shows when each failure occurred. The pieces of equipment are listed along the y-axis of the timeline. Dates are listed along the x-axis. The timeline illustrates the general distribution of failures over time for the pieces of equipment included in the analysis. It can also be used as a tool for identifying which pieces of equipment do not fit

the normal failure distribution pattern. The timeline is not intended to provide specific information about failures and dates.

The range of dates displayed along the x-axis is determined by the failure dates that exist. The timeline will always include all failure dates, including those that occurred outside the [Analysis Period](#).

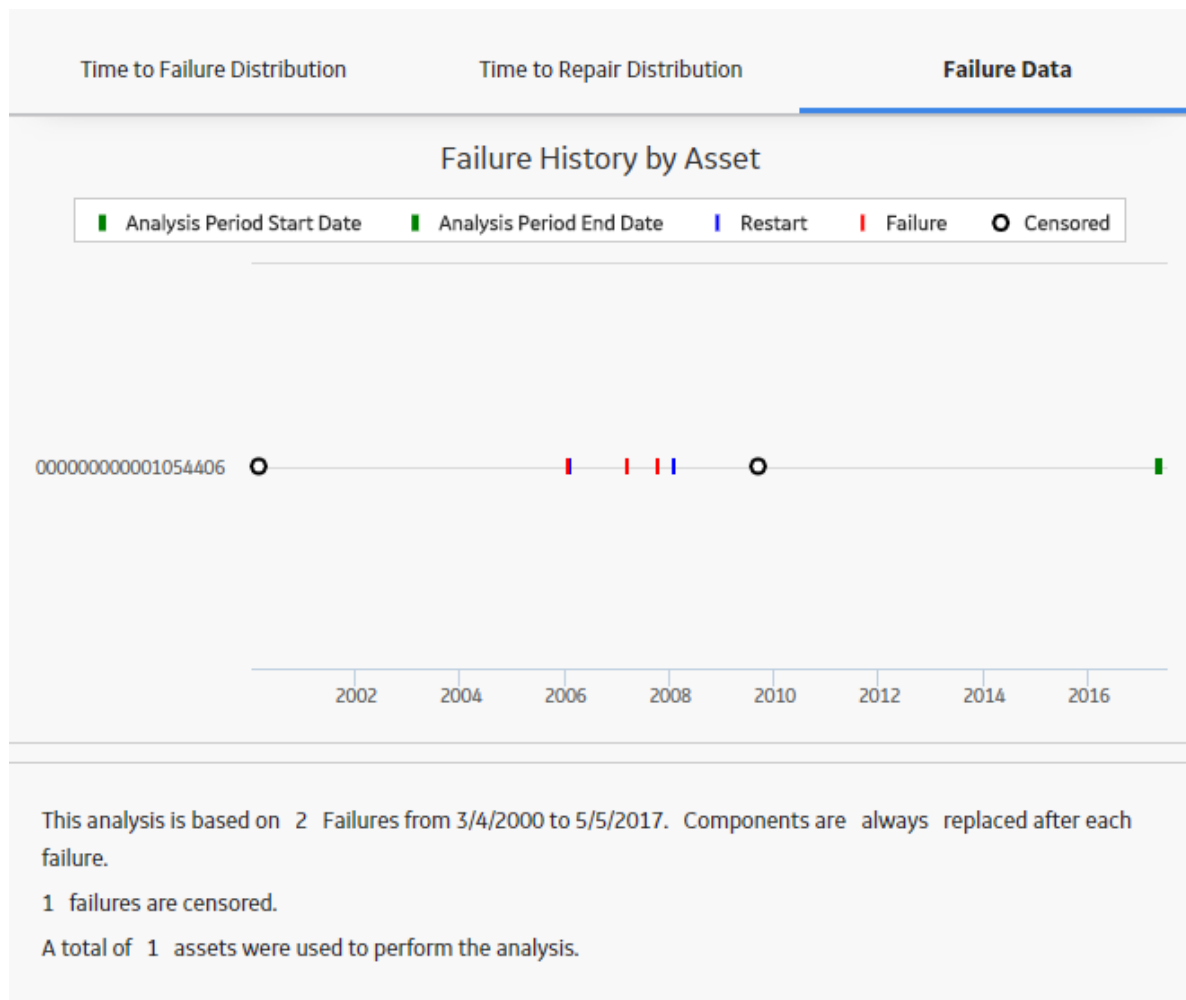

The start date of the analysis period is always designated on the timeline by a green line. If the start date is the same as the first failure date, the green mark will appear directly on the y-axis. The end date of the analysis period is indicated on the timeline by a green line if it is set to a specific date. The end date is not shown on the timeline if you have selected **I want to use today's date as the end date for this analysis**.

About Results of a Reliability Distribution Analysis

After you have created a Reliability Distribution Analysis, the following options are available:

- Analysis results can include confidence intervals and parameters for the selected Distribution and goodness of fit measures.
- Distribution fitting can be done by Least Squares or Maximum Likelihood (MLE).
- The four different types of Reliability plots (Probability of Failure, Failure Rate, Probability Density Function, and Cumulative Distribution Function) can be displayed. In addition, you can select between 2 and 10 Distribution Analyses and choose to view and compare all four of the plot types for the selected analyses using the Competing Failure Plots feature.

- Reliability Distribution Analyses can support Failures without Replacement, which are needed to calculate reliability for heat exchangers, boiler tubes, piping, and other pieces of equipment where a repair does not necessarily involve changing the whole unit.
- The Preventive Maintenance Optimization calculator can utilize the results of the Distribution Analysis and allow you to input the estimated costs of an unplanned repair versus a planned repair. Based on the MTBF and the ratio of unplanned cost to planned cost, the system calculates the optimal time to maintain equipment.
- A Failure Probability calculator can utilize the results of a Distribution Analysis; based on MTBF, Beta, and the last Failure Date, the system calculates the probability of equipment failure at the time in the future that you specify. The system also provides the capability to calculate future life based upon a failure probability that the user specifies.
- Based on the analysis results, you can generate recommendations for the maintenance and reliability activities that should be executed in the future to maintain best practices in your organization.

Time to Failure

The most important piece of data for distributions is Time to Failure (TTF), which is also sometimes known as Time to Event (TTE) or Time Between Failures (TBF).

Suppose that you have the following timeline, where each number represents the amount of time that passes between failures.

Installation	5	11	23	38	16	22	44	32	Out of Service
---------------------	---	----	----	----	----	----	----	----	-----------------------

You could fit a Weibull Distribution to this data. A Probability Density Function (PDF) is similar to a histogram of the raw TTF data:

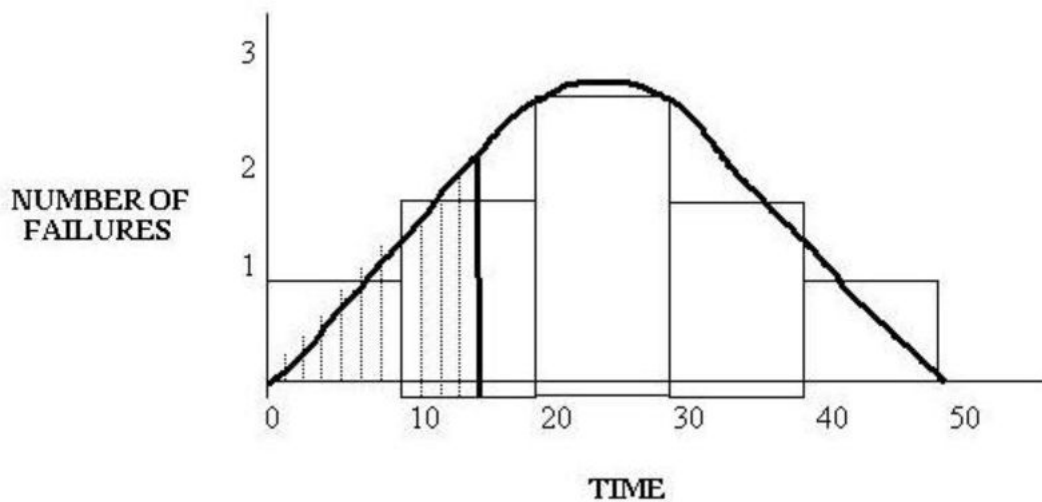

The distribution shows:

- One failure occurring between time 0 and 10.
- Two failures occurring between time 11 and 20.
- Three failures occurring between time 21 and 30.
- Two failures occurring between time 31 and 40.
- One failure occurring between time 41 and 50 (Out of service).

This type of graph counts the number of failures between certain periods. This creates a curve, which you can examine and ask: At 15 time units, how many failures can I expect to have? The answer: Between two

and three failures. You are distributing the failures over the life of the equipment so that at any given point in that life, you can calculate the probability that the equipment will fail. This calculation is generated based on the area under the curve, as shown in the previous graphic. In practice, the PDF is adjusted in such a way that the area under the curve is exactly one, and the number on the y-axis represents the number of failures per time unit.

You select your historical data: other pieces of equipment by the same manufacturer, other pieces of equipment in the same location, other pieces of equipment of the same type, etc. For example, suppose that you want to buy a new pump. You could perform a Distribution Analysis on the other pumps of the same model to predict the reliability of the new pump.

Asset Data for a Reliability Distribution Analysis

The **Assets** section provides following information for each piece of equipment belonging to a Reliability Distribution Analysis:

This family is enabled for site filtering, which means that records in this family can be assigned to a specific site and will only be accessible to users who are assigned to the same site and have the appropriate license and family privileges. For more information, refer to the [Sites](#) section of the documentation.

Field Caption	Data Type	Description	Behavior and Usage
Asset ID	Character	The ID of the piece of equipment that failed. This is a required field.	You can enter the ID manually.
Datasheet	Character	A link that displays the datasheet associated with the failure event.	This column appears only when a query is the data source for the analysis.
Future Age	Numeric	The future age of the piece of equipment.	The value for this field is calculated by the GE Digital APM system by adding the specified operating time to the current age of the piece of equipment and is read-only.
Future Failure Probability	Numeric	The future probability of equipment failure.	The value for this field is calculated by the GE Digital APM system using the specified operating time and is read-only. You can specify the future time to calculate the future probability of failure.
Installation Date	Date	The date on which the piece of equipment was installed.	You can enter or select a date.
Last Replacement Date	Date	The last date on which the failed piece of equipment was replaced.	The value for this field is calculated by the GE Digital APM system and is read-only. This field does not appear in the grid.

Field Caption	Data Type	Description	Behavior and Usage
Number of Subcomponents	Numeric	The number of subcomponents contained by the piece of equipment that is selected in the Asset ID column. A piece of equipment can contain multiple subcomponents, such as tubes in a heat exchanger bundle.	This field is displayed in the grid only when the failure type is Failures Without Replacements.
Present Age	Numeric	The current age of the piece of equipment.	The value for this field is calculated by the GE Digital APM system and is read-only.
Present Failure Probability	Numeric	The current probability of failure for each piece of equipment.	The value for this field is calculated by the GE Digital APM system based on the present age of the piece of equipment and is read-only.

Failure Data for a Reliability Distribution Analysis

The **Failures** section provides following information for each failure belonging to a Reliability Distribution Analysis:

This family is enabled for site filtering, which means that records in this family can be assigned to a specific site and will only be accessible to users who are assigned to the same site and have the appropriate license and family privileges. For more information, refer to the [Sites](#) section of the documentation.

Field Caption	Data Type	Description	Behavior and Usage
Asset ID	Character	The ID of the piece of equipment that failed. This value is mapped from a query or dataset.	For manually entered data, you can select the first cell in the column and select the Asset ID belonging to the piece of equipment that you added in the Assets section or enter the ID in the cell.
Censored	Logical	A value that indicates whether or not the datapoint is excluded.	Select the check box to censor the data in the selected row.
Datasheet	Character	A link that displays the datasheet associated with the failure event.	This column appears only when a query is the data source for the analysis.
Downtime	Numeric	The amount of corrective maintenance time for the piece of equipment after the failure occurs.	This value is mapped from a query or dataset or manually entered when you create the analysis.

Field Caption	Data Type	Description	Behavior and Usage
Failure Date	Date	The date on which the failure of the piece of equipment occurred.	This value is mapped from a query or dataset or manually entered when you create the analysis and is required.
Ignore	Logical	Specifies whether the data in the associated row is excluded or included from analysis calculations.	When selected, excludes the data in the associated row from the analysis calculations and plots. When cleared, includes the data in the associated row in the analysis calculations.
Number of Failures	Numeric	The number of failed elements at each failure event.	This column appears only when the failure type is Failures Without Replacements. This value is mapped from a query or dataset or manually entered when you create the analysis.
Remarks	Character	Additional comments about the failure.	You can enter a value in this column manually.
Replaced	Boolean	A value that indicates whether replacements were made following each equipment failure. A replacement causes the entire piece of equipment to be renewed, thus resetting calculation of the time to failure.	This column appears only when the failure type is Failures Without Replacements. This value is mapped from a logical field in a query or dataset or manually entered when you create the analysis.
TTF	Numeric	The Time to Failure is the duration of time from when the piece of equipment is placed into service until it fails.	TTF may be expressed in terms of days, hours, cycles, units processed, etc. TTF values are calculated by the GE Digital APM system based on the failure dates and are shown in gray to indicate that they are read-only.

Reliability Growth

About Site Filtering in Reliability Growth Analysis

In Reliability Growth Analysis, the site is assigned based on the user's selection in the **Site** control.

Tip: For more information, refer to the Site Filtering section of the documentation.

Data for the analysis can be generated by a query that contains records from multiple sites. Analyses that are created for a single site and that are based on a query containing multi-site data will contain multi-site data. A single-site user with access to the analysis can open the analysis and view all of the multi-site data in an analysis.

A user that has been assigned, at a minimum, to all of the sites that are associated with the records queried by the analysis will have full access to modify the analysis. If this user reloads the analysis, the query will return data based on the sites that were assigned at the time the analysis was created.

A user that has not been assigned to all of the sites that are associated with the records queried by the analysis will be able to view the analysis, but will not be able to reload or edit the data.

Consider an organization that has three sites, Site X, Site Y, and Site Z. The following Reliability Growth Analysis records exist:

- Reliability Growth Analysis A: Assigned to Site X
- Reliability Growth Analysis B: Assigned to Site Y
- Reliability Growth Analysis C: Assigned to Site Z
- Reliability Growth Analysis D: No site assigned (global record)

Scenario 1: User assigned to only Site X

This user will see Reliability Growth Analyses A and D.

Scenario 2: User assigned to both Site X and Site Y

This user will see Reliability Growth Analyses A, B, and D.

Scenario 3: Super User

This user will see Reliability Growth Analyses A, B, C, and D.

Important: If a Super User modifies the site assignment of a child record from the site assignment that it inherited from a parent record, data integrity will be compromised.

Reliability Growth Analysis Data Model

The following diagram shows how the families used in Reliability Growth Analysis are related to one another.

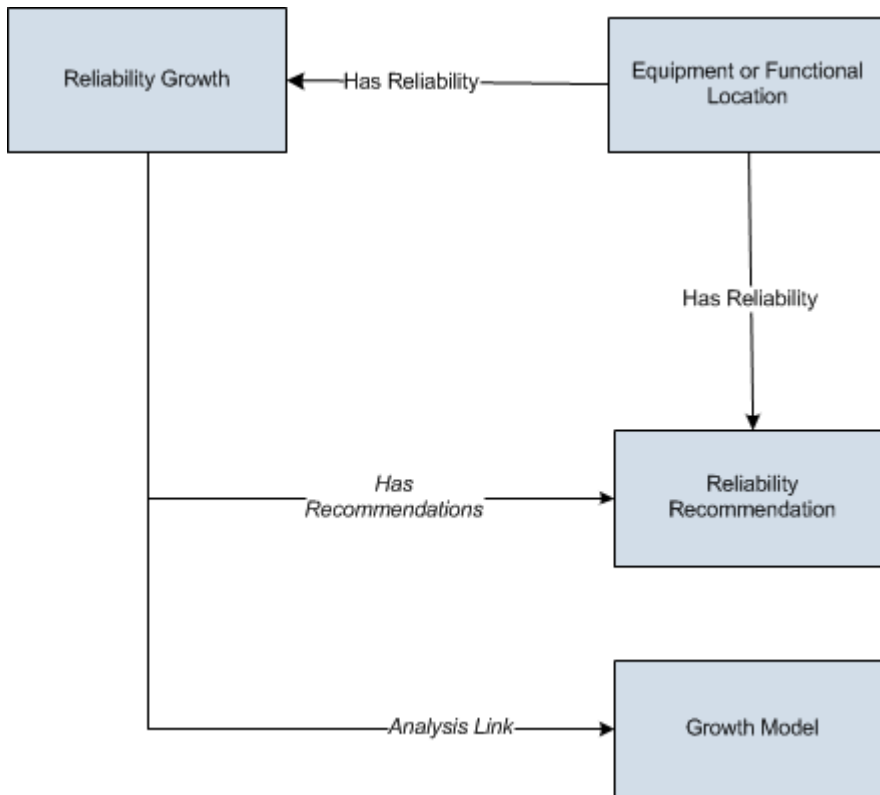

Note: In the diagram, boxes represent entity families and arrows represent relationship families that are configured in the baseline database. You can determine the direction of the each relationship definition from the direction of the arrow head: the box from which the arrow originates is the predecessor, and the box to which the arrow head points is the successor.

As you develop a Reliability Growth Analysis, you will create records in these families and link them together, either manually or automatically via the options in the GE Digital APM Framework. Throughout this documentation, we use the term Reliability Growth Analysis to mean the combination of the Reliability Growth record and all the records that are linked to it.

About Data Mapped to the Baseline Analysis <Source Type> Window

When you create a Reliability Growth Analysis from a query or dataset, the Reliability Growth Builder will prompt you to map values from columns in the query or dataset to certain values in the Reliability Growth Analysis. The values that you select to map on the **Select Data Fields** and **Provide Information For Downtime** screens in the Reliability Growth Builder will then appear in the associated columns in the **Baseline Analysis <Source Type>** window. The <Source Type> is Query or Dataset on which your analysis is based.

Note: If the analysis is based on a query or a dataset and contains additional columns that are not mapped to columns in the analysis dataset, those columns will appear in the **Baseline Analysis <Source Type>** window with the column name in parentheses.

This family is enabled for site filtering, which means that records in this family can be assigned to a specific site and will only be accessible to users who are assigned to the same site and have the appropriate license and family privileges. For more information, refer to the [Sites](#) section of the documentation.

Details

The following table displays which columns are mapped from fields in the Reliability Growth Builder to columns in the <Measurement> Data window:

Reliability Growth Builder Screen	Reliability Growth Builder Field	Baseline Analysis <Source Type> Window Column
Provide Information for Downtime	Downtime Field	Downtime
Select Data Fields	Asset ID	Asset ID
Select Data Fields	Date	Failure Date
Select Data Fields	Cumulative Operating Time	COT(units)
Select Data Fields	<Measurement>	<Measurement>
Select Data Fields	Installation Date	Installation Date

Examples for Reliability Growth

The following examples explain how a Reliability Growth Analysis can be used as an evaluation tool in different scenarios.

Example 1: Analysis Using Failure Event Dates

The following example demonstrates a scenario where you would create a Reliability Growth Analysis with event-based data that is measured using failure dates.

If you track events (e.g., safety events or failures) by specific date, then you can create a Reliability Growth Analysis using event-based data that is measured using failure dates.

Centrifugal Pump 1051700 was installed at the Springfield plant on July 20, 1998. Since its installation, the pump has failed several times, and each time the pump fails it is repaired immediately without any significant downtime. You have collected data noting which days the pump failed. You want to use the following data to perform a Reliability Growth Analysis to determine the mean time between pump failures.

Failure Dates	Number of Failures
12/14/1998	1
2/7/1999	1
6/26/1999	1
8/1/1999	1
9/5/1999	1
1/1/2001	1
1/2/2001	1
2/7/2002	1
7/11/2002	1

Failure Dates	Number of Failures
12/10/2002	1
5/12/2003	1
7/2/2003	1
11/28/2005	1
1/30/2006	1

In this case, you would use event-based data derived from failure dates to predict:

- The date when the pump will fail next.
- How many times the pump will fail by a certain date.
- If the number of failures increased or decreased as a result of a strategy change (e.g., a new preventative maintenance schedule), which was implemented after the failure on September 5, 1999.

Example 2: Analysis Using Cumulative Operating Time

The following example demonstrates a scenario where you would create a Reliability Growth Analysis with event-based data that is measured using cumulative operating time.

Sometimes the specific days on which a piece of equipment or location fails may not be available, or the piece of equipment or location may not operate for the same amount of time every day. In these cases, it would be more valuable to predict future failures using cumulative operating time (COT), or the amount of time the piece of equipment or location has been in operation.

Haul Truck 1 was purchased for a shipping firm as a used vehicle with 11,028 miles. The truck now runs varied routes depending on the number of shipments to which it is assigned. Because the truck does not always travel the same number of miles each day, you collect the data representing the mileage points at which the truck broke down. You want to use the following data to perform a Reliability Growth Analysis to determine the mean operating time (i.e., number of miles) between failures.

Cumulative Operating Time (Miles)	Number of Failures
27,393	1
41,675	1
60,400	1
66,128	1
72,132	1
77,314	1
113,888	1
146,671	1
205,424	1
224,624	1
243,841	1

Cumulative Operating Time (Miles)	Number of Failures
260,828	1
279,951	1
303,156	1

In this case, you would use event-based data derived from cumulative operating time to predict:

- The mileage point at which the next failure will occur.
- How many failures will occur by a certain mileage point (e.g., five failures will have occurred after 1,000 miles).
- If the number of failures increased or decreased as a result of a strategy change (e.g., more routine oil changes), which was implemented after the failure at 77,314 miles.

Example 3: Analysis Using Grouped and Non-Event Data

In Examples 1 and 2, each datapoint represents a single measurement or failure. In some datasets, each datapoint may represent more than one measurement, or an amount of data. Throughout this documentation, this type of data is referred to as grouped data. To perform Reliability Growth Analyses on grouped data, when you create a dataset, you must use datapoints that represent multiple measurements or an amount of data. Datasets containing grouped data can be based on either failure dates or cumulative operating time.

For example, if you want to analyze a pump for which you record data every six months and every time you record data you record multiple failures (one datapoint represents multiple failures), you would create a Reliability Growth Analysis based on event-based, grouped data that is derived from cumulative operating time.

In Examples 1 and 2, each datapoint was also based on an event. Examples of event-based failures include equipment or location failures, safety incidents, or equipment or location repairs. Sometimes, you may want to perform a Reliability Growth Analysis on a variable that does not measure a specific event (e.g., an amount). For the correct labels to appear throughout the analysis, these datasets should be entered as non-event data. Datasets containing non-event data can be based on either failure dates or cumulative operating time.

Using a Reliability Growth Analysis to measure cost is the most common example of evaluating grouped data and non-event data.

The following example demonstrates a scenario where you would create a Reliability Growth Analysis with grouped data that is not event-based that is measured using cumulative operating time.

You want to measure the cost of equipment failures at the Springfield plant in order to determine how you should plan a budget for that plant in the future. Individual pieces of equipment fail at different rates, so you measure the total cost of replacement parts and mechanic labor for the entire plant every few months. You want to use the following data to perform a Reliability Growth Analysis to view the cost trends at this plant.

Cumulative Operating Time (Months)	Cost
6.5	1,120
13	996
17	1,052
23	1,085

Cumulative Operating Time (Months)	Cost
37	1,075
49.5	1,096
62	1,001

In this case, you would use non-event, grouped data that is derived from cumulative operating time to predict:

- The repair costs that the plant will incur by some point in the future.
- If the repair costs have increased or decreased as a result of a strategy change (e.g., changing the mechanic who replaces parts), which was implemented after 23 months.

Cumulative <Measurement> Plot

The **Cumulative <Measurement> Plot** is a log-log graph with data overlay. The graph uses logarithmic scales on both the horizontal and vertical axes. The graph represents the cumulative <Measurement> as a function of the cumulative time (Cumulative Failures vs. Cumulative Operating Time), which is the total amount of time the Asset has been in operation since the start of the analysis.

The following image displays the Cumulative Failures Plot:

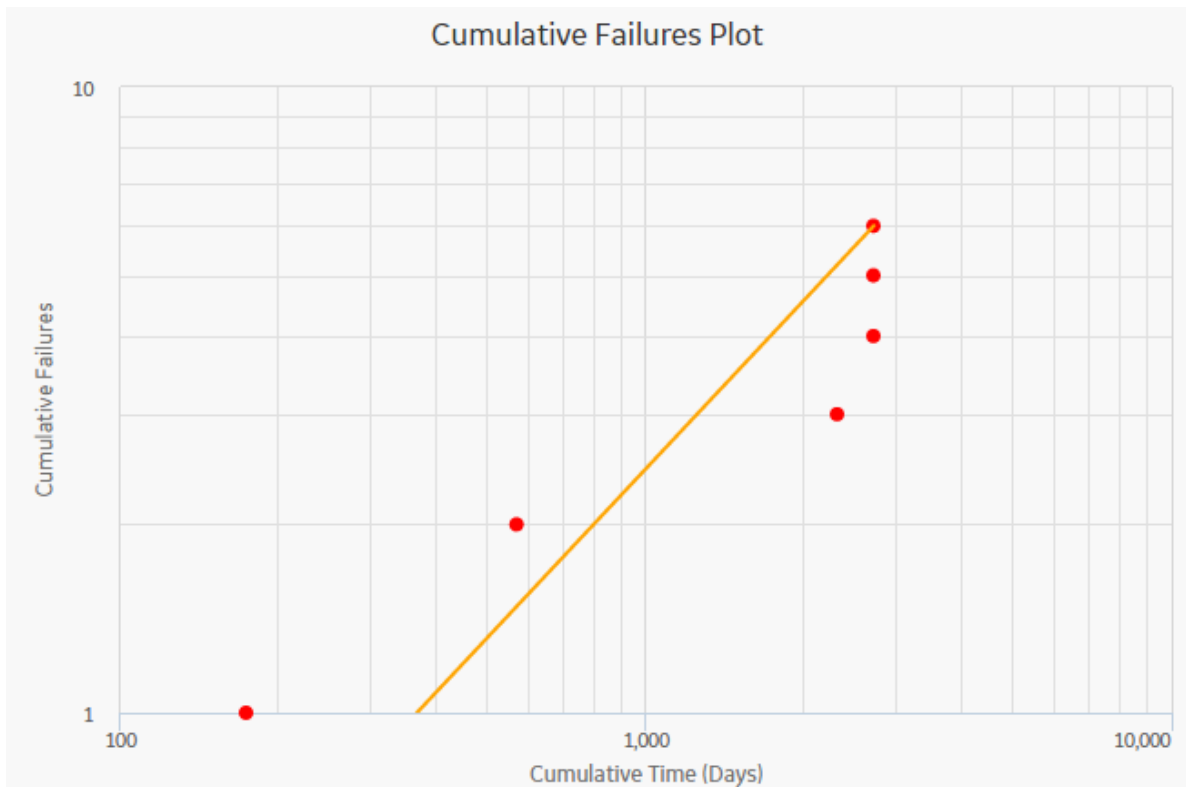

Note: Interaction with graphs is not available on [touch-screen devices](#).

Graph Features

While viewing the graph, you can:

- Hover on any datapoint to view the coordinates and the details of a datapoint.

Note: This feature may not be available on all the devices based on the screen resolution. On tablets and smaller devices, you can select the datapoint to view the details of an observed datapoint.

- For an observed datapoint, you can access the name of the asset, date of the observation, cumulative time in the analysis at the specified time, and number of cumulative <measurements> till the specified date.
- For a datapoint on the estimated data line, you can access the name of the segment, cumulative time at the selected point on the line, number of cumulative <measurements> at the selected point on the line, value of beta and lambda, and determine whether the analysis passed the GOF test or not.

You can also determine whether the analysis passed the GOF test by the color of the plot line. If the graph line is blue, it passed the GOF test. If the plot line is orange, it failed the GOF test.

- Select an observed datapoint to open **Point Tooltip** window and view the data.

On the **Point Tooltip** window, you can:

- Access the name of the asset, date of the observation, cumulative time in the analysis at the specified time, and number of cumulative <measurements> till the specified date.
- Select **Split** to [Split the analysis into segments](#).

Note: If you have already split the data, **Split** will be replaced with **Merge**. You can select **Merge** to [merge the segments again](#).

- Select **Go to Editor** to access the [Reliability Growth Data window](#), where you can modify the datapoint details.
- Customize the appearance of the graph by using standard [graph features](#).
- [Estimate how many failures will have occurred at some date in the future](#).

MTB <Measurement> Trend

The **Mean Time between <Measurement> Trend** graph displays how the mean time between <Measurement> changes over time. The mean time between <Measurement> is calculated from the distribution of the <Measurement> over time. The datapoints represent observed failure dates included in the analysis. The **Mean Time between <Measurement> Trend** graph displays:

- How mean time between <Measurement> has decreased or increased over time.
- Whether the strategy changes have improved mean time between <Measurement> or not.

The following image displays a **Mean Time Between Failures Trend** graph:

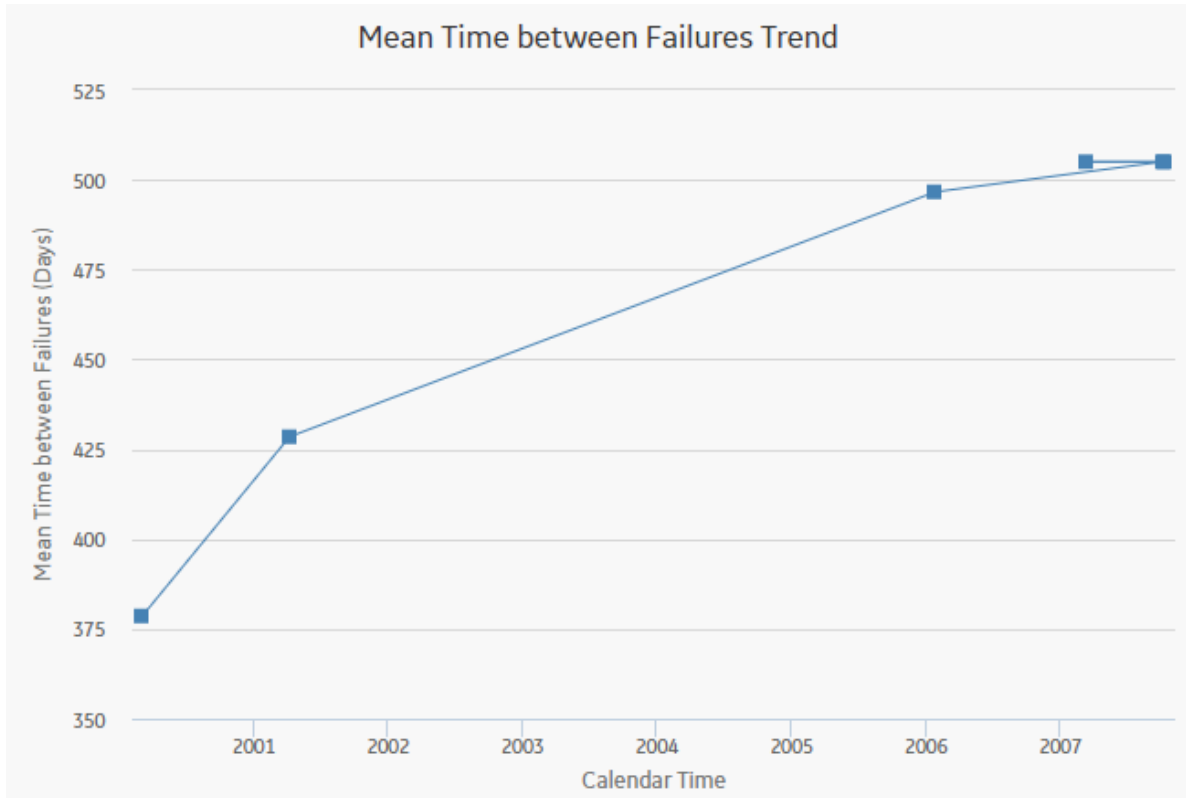

Note: Interaction with graphs is not available on [touch-screen devices](#).

Graph Features

While viewing the graph, you can:

- Hover on any datapoint to access the coordinates and the details of a datapoint. You can access the number of cumulative <measurements> on the specified date, date of the observation, and mean time between <measurements> at the specified time.

Note: This feature may not be available on all the devices. On tablets and smaller devices, you can select on the datapoint to view the details of an observed datapoint.

- Select an observed datapoint to display the **Point Tooltip** window and access the data.

On the **Point Tooltip** window, you can:

- Access the number of cumulative <measurements> on the specified date, date of the observation, and mean time between <measurements> at the specified time.
- Select the **Split** to [Split the analysis into segments](#).

Note: If you have already split the data, the **Split** will be replaced with **Merge**. You can select **Merge** to [merge the segments again](#).

- Select the **Go to Editor** to display the **Reliability Growth Data** window, where you can modify the data.
- Customize the appearance of the graph by using standard [graph features](#).
- [Estimate how many <measurements> will have occurred \(and what the MTB<measurement> would be\) at some date in the future.](#)

<Measurement> Rate Trend

The <Measurement> Rate Trend graph displays the <Measurement> rate of a piece of equipment or location changes over time. This graph is the inverse of the [Measurement Time between <Measurement> Trend graph](#). The datapoints represent observed <Measurement> dates included in the analysis. You can use the <Measurement> Rate Trend graph to view changes in the rate that <measurements> are occurring. You can also view the number of <measurements> occurring per day, rather than the number of days between <measurements>.

The following image displays a Failures Rate Trend graph:

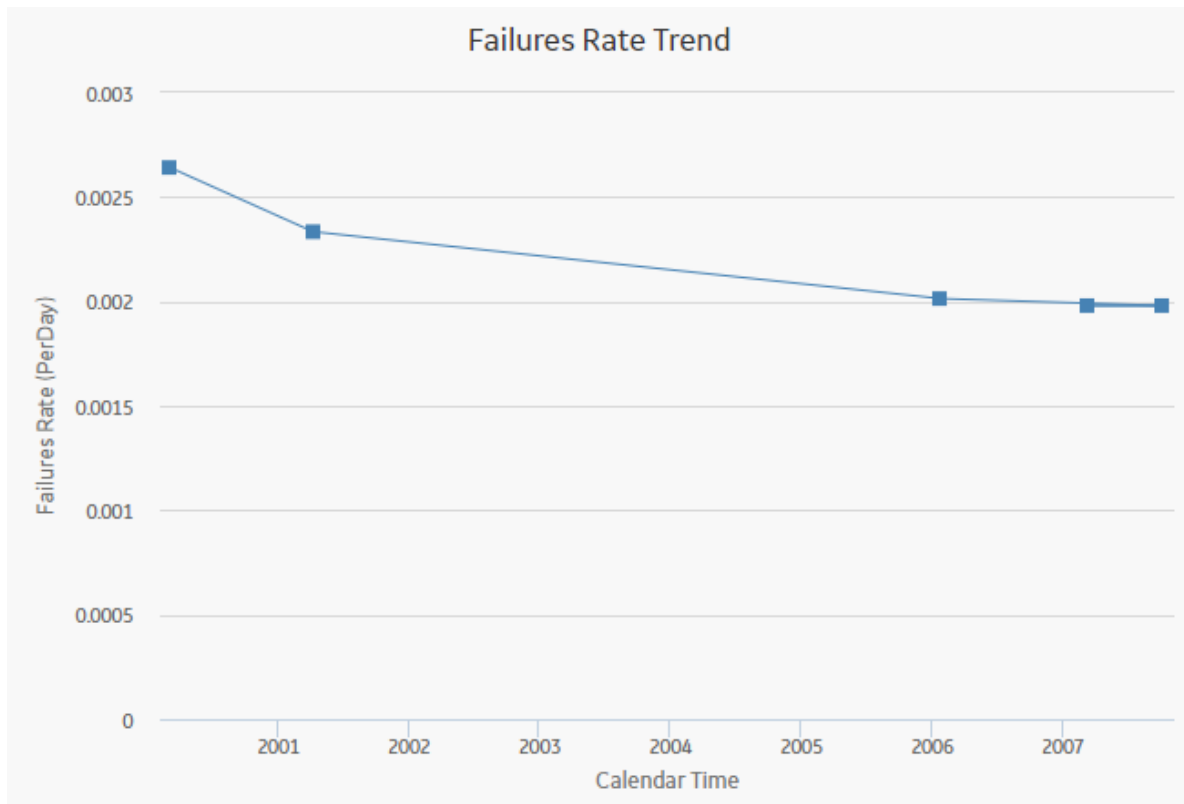

Note: Interaction with graphs is not available on [touch-screen devices](#).

Graph Features

While viewing the graph, you can:

- Hover on any datapoint to view the coordinates and the details of a datapoint. You can view the number of cumulative <measurements> on the specified date, date of the observation, and <measurement> rate at the specified time.

Note: This feature may not be available on all devices. On tablets and smaller devices, you can tap on the datapoint to view the details of an observed datapoint.

- Select an observed datapoint to display the **Point Tooltip** window and view the data.

On the **Point Tooltip** window, you can:

- View number of cumulative <measurements> on the specified date, date of the observation, and <measurement> rate at the specified time.
- Select **Split** to [Split the analysis into segments](#).

- Note:** If you have already split the data, **Split** will be replaced with **Merge**. You can select **Merge** to [merge the segments again](#).
- Select the **Go to Editor** to access the **Reliability Growth Data** window, where you can modify the data.
 - Customize the appearance of the graph by using standard [graph features](#).
 - [Estimate how many <measurements> will have occurred at some date in the future](#).

AMSAA Detailed Results (Event-Based)

The **AMSAA Reliability Growth Model** section displays the results of the Reliability Growth Analysis calculations. If the Reliability Growth Analysis has been split into multiple segments, a separate set of results will be displayed for each segment. The labels on the AMSAA Reliability Growth Model section will look different depending on whether or not the analysis contains event-based data. If the data is event-based, certain labels will also look different depending on whether or not the data contains dates.

The **AMSAA Reliability Growth Model** section displays the following information:

- **Initial Mean time Between <Measurement>:** Contains the mean time between <Measurement> that was calculated at the beginning of the analysis, or the beginning of the segment.
- **Final Mean Time Between <Measurement>:** Contains the mean time between <Measurement> that was calculated at the end of the analysis, or end of the segment.

Additionally, for analyses based on event-based data that do not include dates, references to dates will be displayed as the units you chose for your analysis (e.g., At 303,156.00 Miles, the MTBF is 20,757.81 Miles).

◀ Segment 1: AMSAA Reliability Growth Model

This model was calculated using Failures that occurred in the period between 9/5/1999 11:12:00 PM and 10/12/2007 2:24:00 PM. The total Failures is 6.

At 174.35 Days (first data point of the current segment), the Mean Time between Failures is 378.60 Days .

At 2,711.95 Days (end of the current segment), the Mean Time between Failures is 505.01 Days .

AMSAA Detailed Results (Non-Event)

The **AMSAA Reliability Growth Model** section displays the results of the Reliability Growth Analysis calculations. If the Reliability Growth Analysis has been split into multiple segments, a separate set of results will be displayed for each segment.

The **AMSAA Reliability Growth Model** section for an analysis based upon non-event data will look mostly the same as the [AMSAA Reliability Growth Model section for an event-based analysis](#). Instead of showing the Initial Mean time Between <Measurement> and Final Mean time Between <Measurement>, however, the following items will be displayed:

- **Initial <Measurement> Rate:** Contains the <Measurement> rate, calculated from when the first datapoint is recorded for the segment.
- **Final <Measurement> Rate:** Contains the <Measurement> rate at the end of the segment.

Additionally, for an analysis that is based on data that includes cumulative operating time and does not include dates, references to dates will be displayed as the units you chose for your analysis (e.g., At 62 Months, the Cost Rate is 83.7040 Per Month).

About Interpreting Extrapolation Results

After you select an extrapolation method (by date or by amount of time), for each segment in the analysis, a dotted green line extends from the last failure date for that segment to the specified date in the future.

The future date is calculated based on the date or time units you provided in the **Select Extrapolation** window. At the end of the dotted green line, a number appears, representing the estimated number of failures that would have occurred at that point in time.

A solid green line also intersects the end date for each segment, and the cumulative operating time at the end of that segment appears on the solid green line.

Spares Analysis

About Site Filtering in Spares Analysis

In Spares Analysis, the site is assigned based on the user's selection in the **Site** control, and all of the imports and recommendations of a Spare Analysis must match the analysis's site assignment.

Tip: For more information, refer to the Site Filtering section of the documentation.

Consider an organization that has three sites, Site X, Site Y, and Site Z. The following Spares Analysis records exist:

- Spares Analysis A: Assigned to Site X
- Spares Analysis B: Assigned to Site Y
- Spares Analysis C: Assigned to Site Z
- Spares Analysis D: No site assigned (global record)

Scenario 1: User assigned to only Site X

This user will see Spares Analyses A and D.

Scenario 2: User assigned to both Site X and Site Y

This user will see Spares Analyses A, B, and D.

Scenario 3: Super User

This user will see Spares Analyses A, B, C, and D.

Important: If a multi-site user, or a Super User, links child records from multiple sites to a parent record designated as Global, another user who does not have access to all sites may only see a portion of the data associated with that record.

Spares Analysis Data Model

The following diagram shows how the families used in Spares Analysis are related to one another.

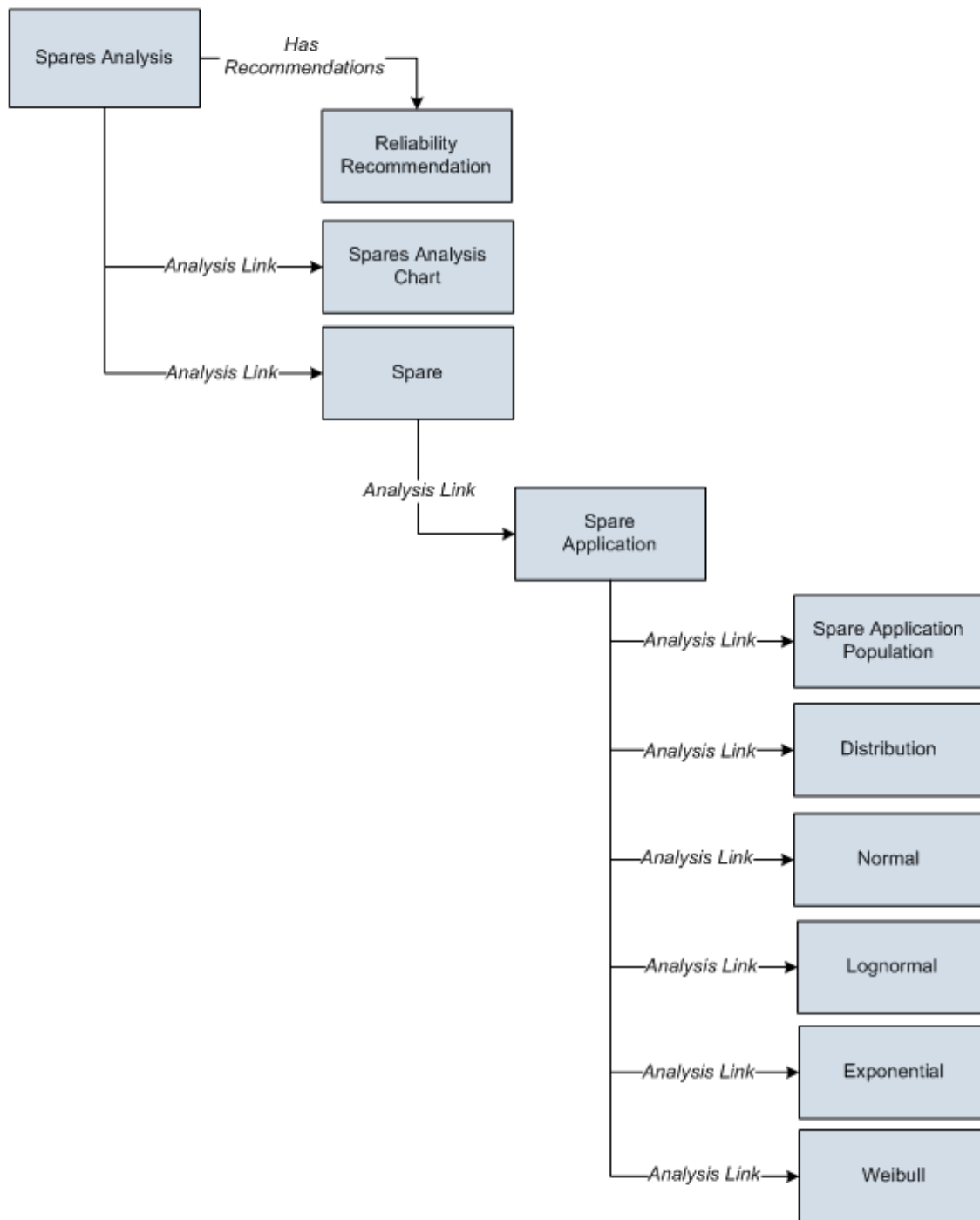

Note: In the diagram, boxes represent entity families and arrows represent relationship families that are configured in the baseline database. You can determine the direction of the each relationship definition from the direction of the arrow head: the box from which the arrow originates is the predecessor, and the box to which the arrow head points is the successor.

As you develop a Spares Analysis, you will create records in these families and link them together, either manually or automatically via the options in the GE Digital APM system. Throughout this documentation,

we use the term Spares Analysis to mean the combination of the Spares Analysis record and all the records that are linked to it.

About Spares Analysis Plots

On the **Spares Analyses** page, you can access any of the following graphs from the **Analysis Summary** workspace:

- Spare Level Plot
- Downtime Plot
- Spare Usage Plot
- Sensitivity Plot
- Optimal Holding Plot

When you run the Monte Carlo simulation for a Spares Analysis, each of the graphs will be generated for each Spare in the analysis. If more than one Spare exists in the Spares Analysis, multiple spares level graphs will be generated, according to the number of Spares in the analysis.

You can customize the appearance of the graph by using standard [graph features](#).

Spare Level Plot

The Spare Level Plot is a bar graph that displays the cost associated with each possible spare level included in the range between the Min Inventory Level and Max Inventory Level values, which were specified in the [Spare record](#).

Note: Interaction with graphs is not available on [touch-screen devices](#).

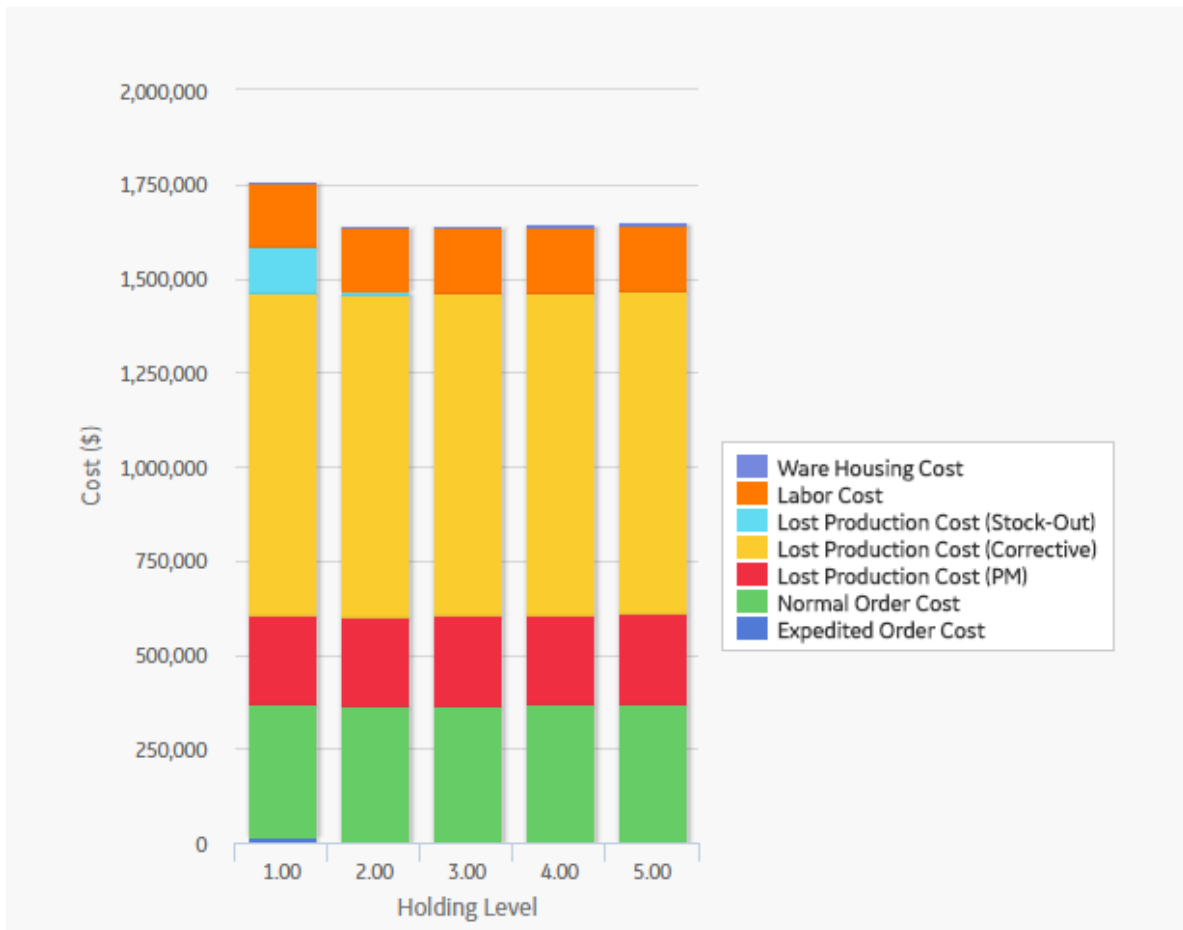

By default, each bar in the Spares Level Plot is divided into the following cost categories, which are shaded with different colors that are represented in the legend to the right of the graph:

- **Warehousing Cost:** The cost of storing the spare parts between failures.
- **Labor Cost:** The total cost of labor associated with every spare level.
- **Lost Production Cost (Stock-Out):** The total lost production cost accrued as a result of waiting for the spare to arrive when one must be ordered.
- **Lost Production Cost (Corrective):** The total lost production cost accrued as a result of the downtime due to preparation and repair after a failure.
- **Lost Production Cost (PM):** The total cost of lost production cost accrued as a result of the preventive maintenance activities. If the **Enable Preventive Maintenance** check box is selected in the Preventive Maintenance section, values from the **Preventive Maintenance** section will be included in this cost category.
- **Normal Order Cost:** The total cost of all normal orders placed for the spare parts.
- **Expedited Order Cost:** The total cost of all rushed orders placed for the spare parts.

The Warehousing Cost, Labor Cost, Lost Production Cost (Stock-Out), Lost Production Cost (Corrective), Lost Production Cost (PM), Normal Order Cost, and Expedited Order Cost values are displayed when you pause over the corresponding bar on the graph.

Tip: If you select the **Show Total Only** check box in the upper-right corner of the graph, then you can view the total costs associated with each spare level.

In addition to providing a Spare Level Plot graph for each Spare record in the analysis, GE Digital APM also provides the [Spare Level Plot for all the Spares within the selected Spares](#), which compares all Spare

records according to the cost associated with each possible spare level. This graph enables you to estimate how much money your company might lose by not storing the optimal level of spare parts. The following image displays an example of the Spare Level Plot for all the Spares.

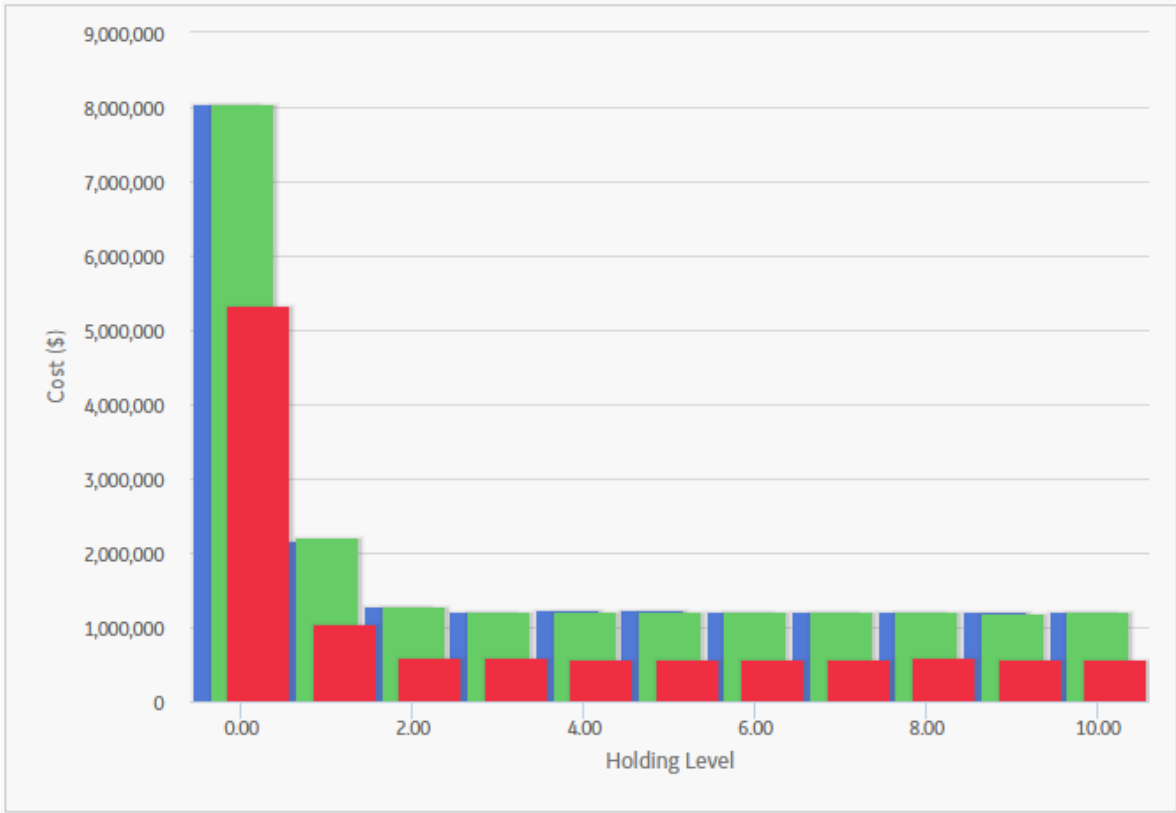

Downtime Plot

The Downtime Plot is a bar graph that displays the calculated downtime period during which the piece of equipment is expected not to be operating throughout the analysis period. The Downtime Plot displays the specific downtime associated with each spare level in the range indicated in the [Spares section](#) of the appropriate Spare record.

Note: Interaction with graphs is not available on [touch-screen devices](#).

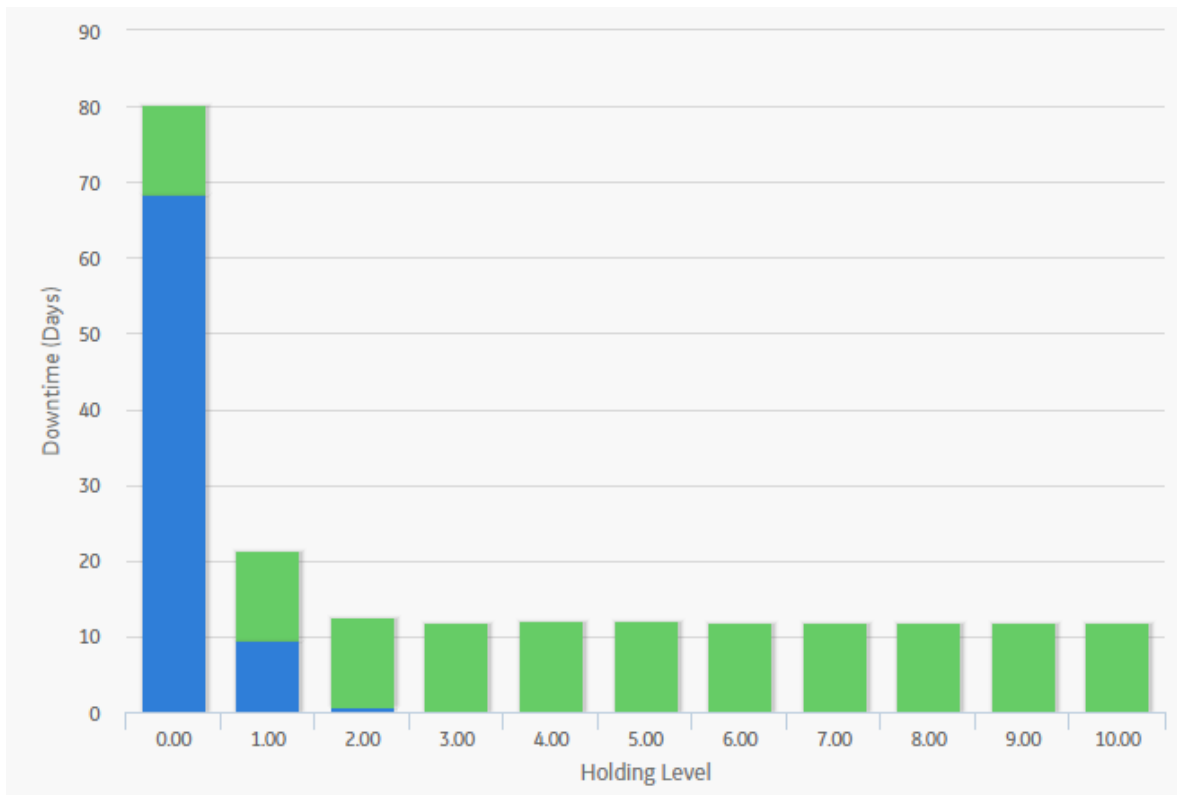

By default, each bar in the Downtime Plot is divided into the following downtime categories, which are shaded with different colors that are represented in the legend to the right of the graph:

- **PM Downtime:** The downtime that results from performing preventive maintenance. PM Downtime is calculated only if the **Enable Preventive Maintenance** check box is selected in the **Preventive Maintenance** section. If the **Enable Preventive Maintenance** check box is not selected, PM Downtime will always be zero.
- **Corrective Downtime:** The sum of the time spent preparing for the repair of the piece of equipment and actually repairing the piece of equipment (specified in the **Preparation Time**, **Repair Time**, and **Total Correction Time** fields in the **Failure Consequence** section).
- **Stock-Out Downtime:** The time period during which there was no spare part available for the necessary repair. For example, if you do not have any spare parts stored when a piece of equipment fails, you will need to order a spare part. If the sum of the values in **Normal Order Time** and **On-site Delivery Time** fields (both specified in the **Spare** section) takes longer than the value specified in the **Preparation Time** field (specified in the **Failure Consequence** section), then there will be a period of stock-out downtime while you wait for the spare part(s) to arrive at the repair site.

The PM Downtime, Corrective Downtime, and Stock-Out Downtime values are displayed when you pause over the corresponding bar on the graph.

Tip: If you select the **Show Total Only** check box in the upper-right corner of the plot, you can view the total downtime associated with each spare level.

In addition to providing a Downtime Plot graph for each Spare record in the analysis, GE Digital APM also provides the [Downtime plot for all the Spares within the selected Spares](#), which compares all Spare records according to the amount of downtime associated with each possible spare level. This graph enables you to estimate how many days of downtime that you might have per possible spare level for each piece of equipment. The following image displays an example of the Downtime Plot for All Spares.

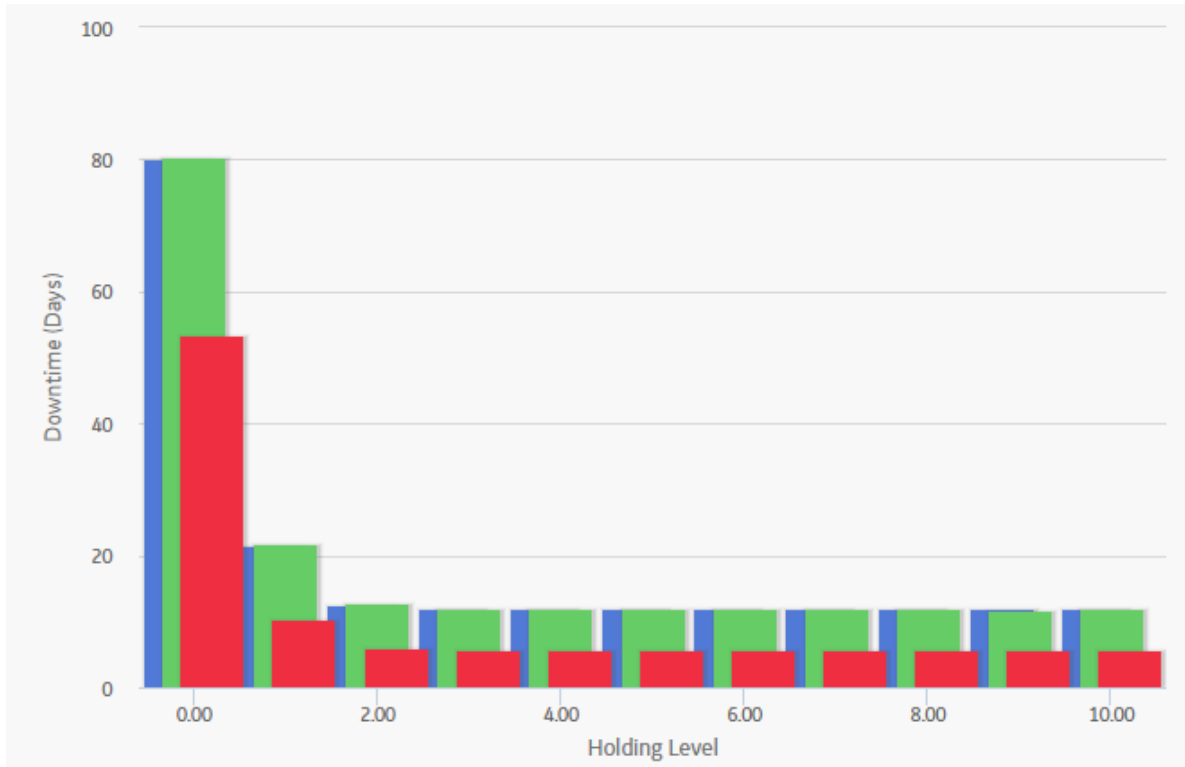

Spare Usage Plot

The Spare Usage Plot is a bar graph that displays the calculated spare usage for each year in the analysis period. The spares usage is based on failure rates that the user entered for a given population, and the quantity and ages of the population.

Note: Interaction with graphs is not available on [touch-screen devices](#).

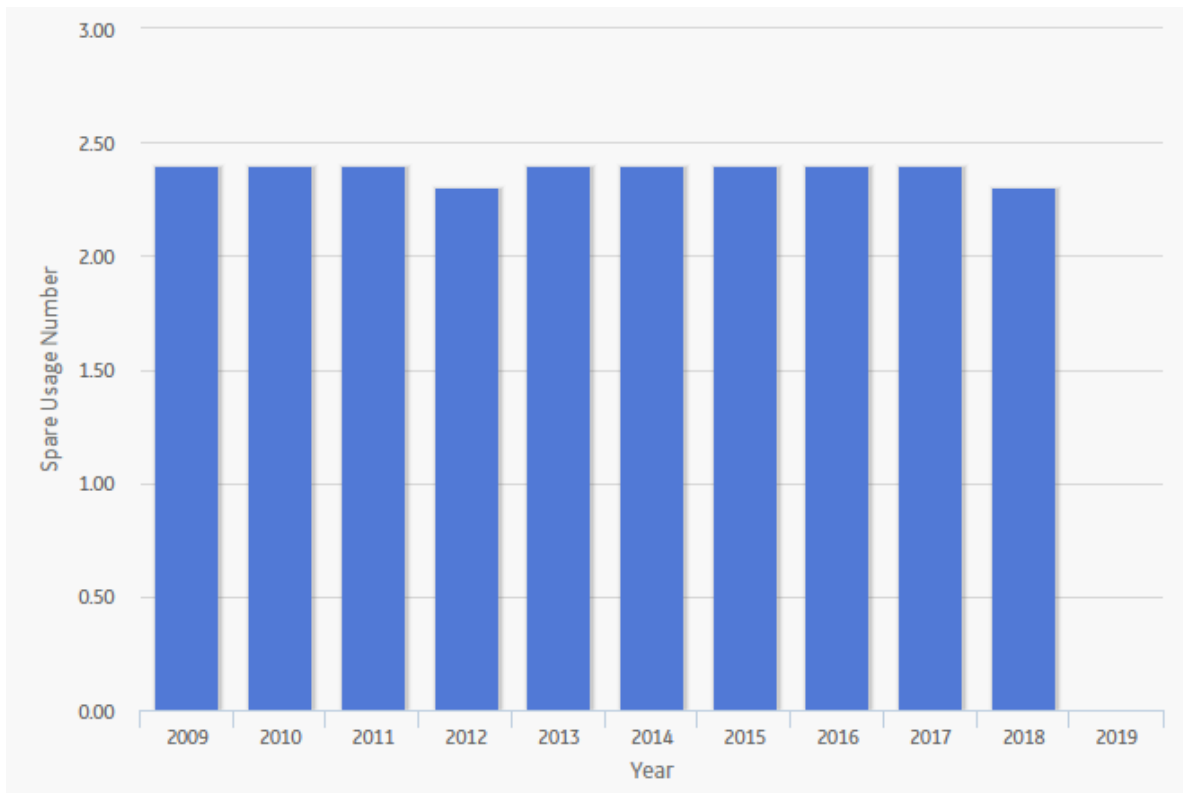

In this image, the Simulation Start Date is **1/1/2015**, and the Simulation End Date is **1/1/2025**. The x-axis displays the years for the analysis period, and the y-axis displays the number of spares that are calculated to be used in that year.

By default, each bar in the Spare Usage Plot is divided into the following spare usage categories, which are shaded with different colors that are represented in the legend to the right of the graph:

- **PM Usage:** The total number of spare parts used for Preventive Maintenance (specified in the **# of Required Spares** field in the **Failure Consequence** section). If the **Enabled Preventive Maintenance** check box in the **Preventive Maintenance** section is not selected, PM Usage will not be included in this graph.
- **Corrective Usage:** The total number of spare parts used for repairing equipment failures (specified in the **Failure Consequence** section).

The PM Usage and the Corrective Usage values are displayed when you pause over the corresponding bar on the graph.

Tip: If you select the **Show Total Only** check box in the upper-right corner of the graph, you can view the total usage associated with each year in the analysis period.

In addition to providing a Spare Usage Plot for each Spare record in the Analysis, GE Digital APM provides the [Spare Usage Plot for all the Spares within the selected Spares](#), which compares all Spare records within a given analysis. The comparison is based on the spare usage for each year. This graph enables you to estimate how many of each spare part you might need each year.

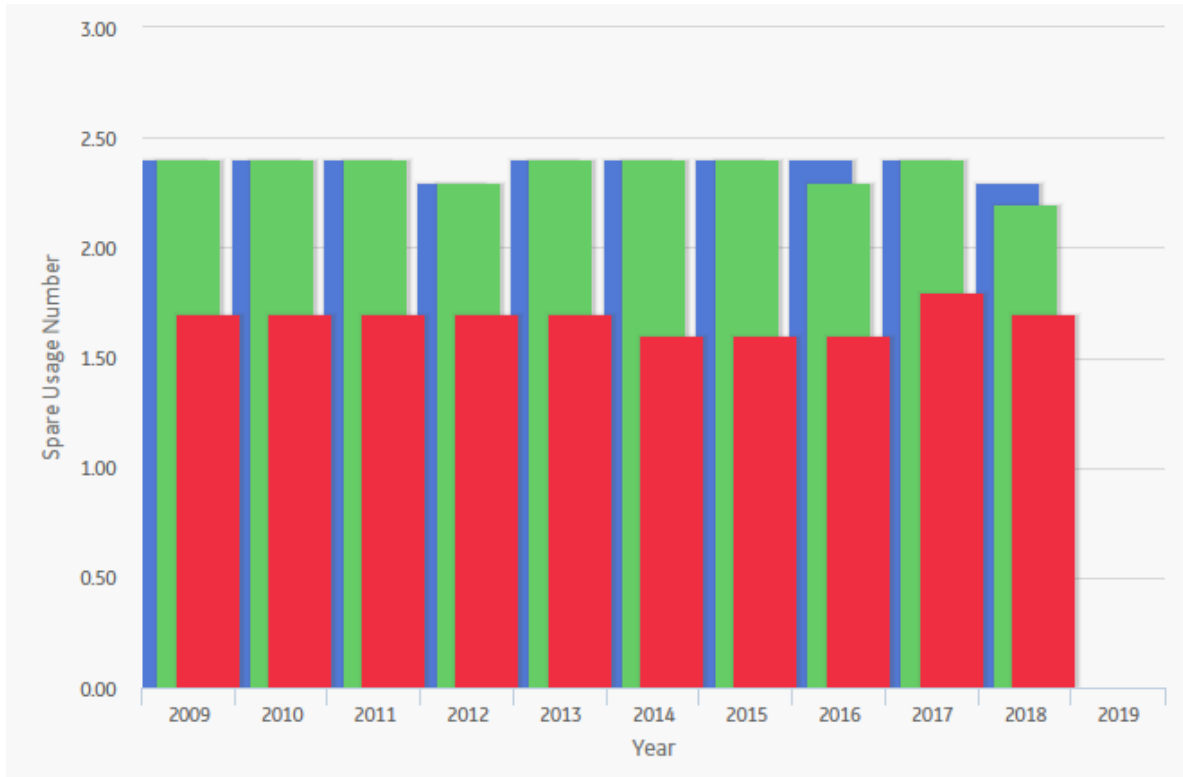

Sensitivity Plot

The Sensitivity Plot is a line graph that displays for each year in the analysis period:

- The cost associated with holding the optimal number of spare parts.
- The cost of holding one less spare part than the optimal number.
- The cost of holding one more spare part than the optimal number.

For example, if the optimal level determined by the Monte Carlo simulation is three, then the Sensitivity Plot will display the cost associated with holding three spare parts, two spare parts, and four spare parts.

Note: Interaction with graphs is not available on [touch-screen devices](#).

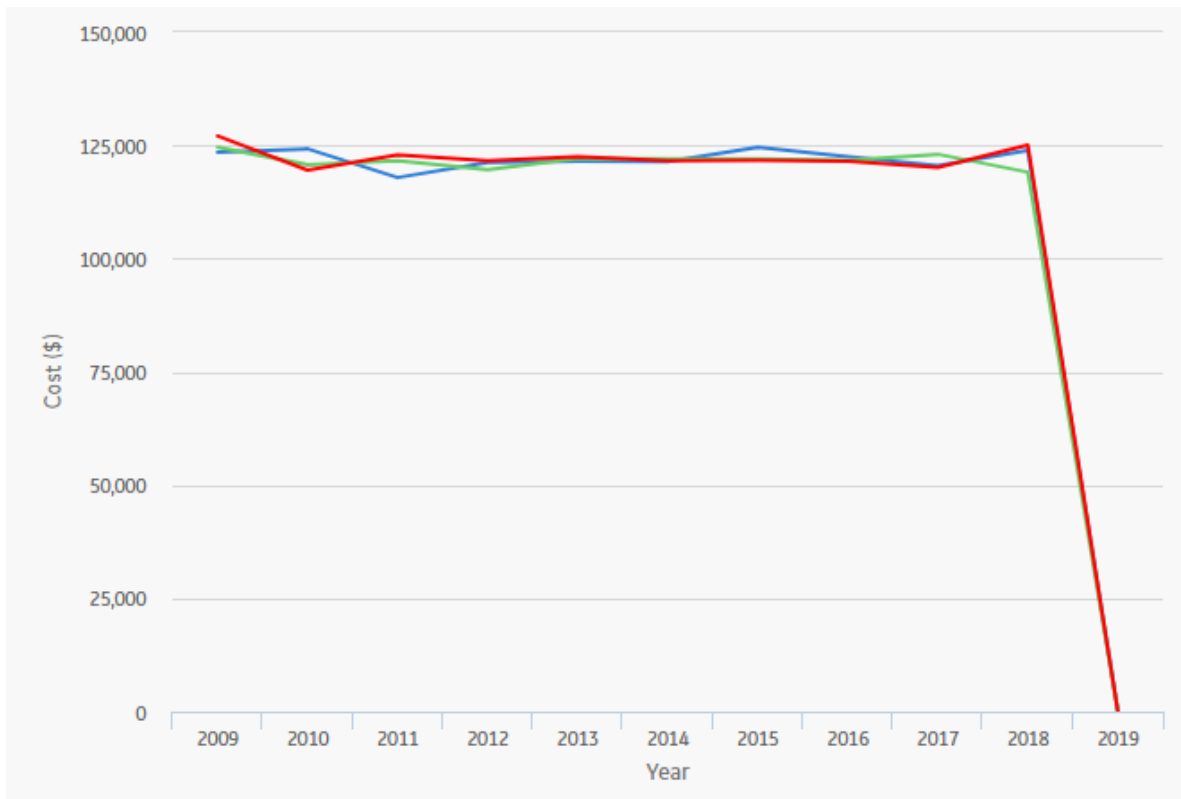

In this image, the x-axis displays the years for the analysis period, and the y-axis displays the costs that you can expect to incur in each year.

By default, each line in the Sensitivity Plot is divided into the following cost categories, which are shaded with different colors that are represented in the legend to the right of the graph:

- **Total Cost (+):** The total cost when storing one spare part more than the recommended number of spare parts.
- **Total Cost (Optimal):** The total cost when storing the recommended number of spare parts. The Optimal Spare Level, or recommended number of spare parts, is located at the top of the Spare Level Plot.
- **Total Cost (-):** The total cost when storing one spare part less than the recommended number of spare parts.

The Total Cost (+), Total Cost (Optimal), and Total Cost (-) values are displayed when you pause over the corresponding bar on the graph.

Note: If the Min Inventory Level is **0** (zero), the Max Inventory Level is **1**, and the Optimal Spare Level is **1**, then the **Total Cost (+)** line will not appear on the Sensitivity Plot. With this inventory range specified on the Spare record, the Total Cost (+) line would represent the holding level of two spare parts, and that value is not within the inventory range.

In addition to providing a Sensitivity Plot for each Spare record in the analysis, GE Digital APM provides the [Sensitivity Plot for all the Spares within the selected Spares](#), which compares all Spare records within a given analysis. The comparison is based on the cost of storing the optimal amount of the spare part, one spare part more than the optimal amount, and one spare part less than the optimal amount. This graph enables you to estimate the cost of storing the optimal amount, one more than the optimal amount, and one less than the optimal amount of each spare part during analysis period. The following image shows an example of the Sensitivity Plot for All Spares.

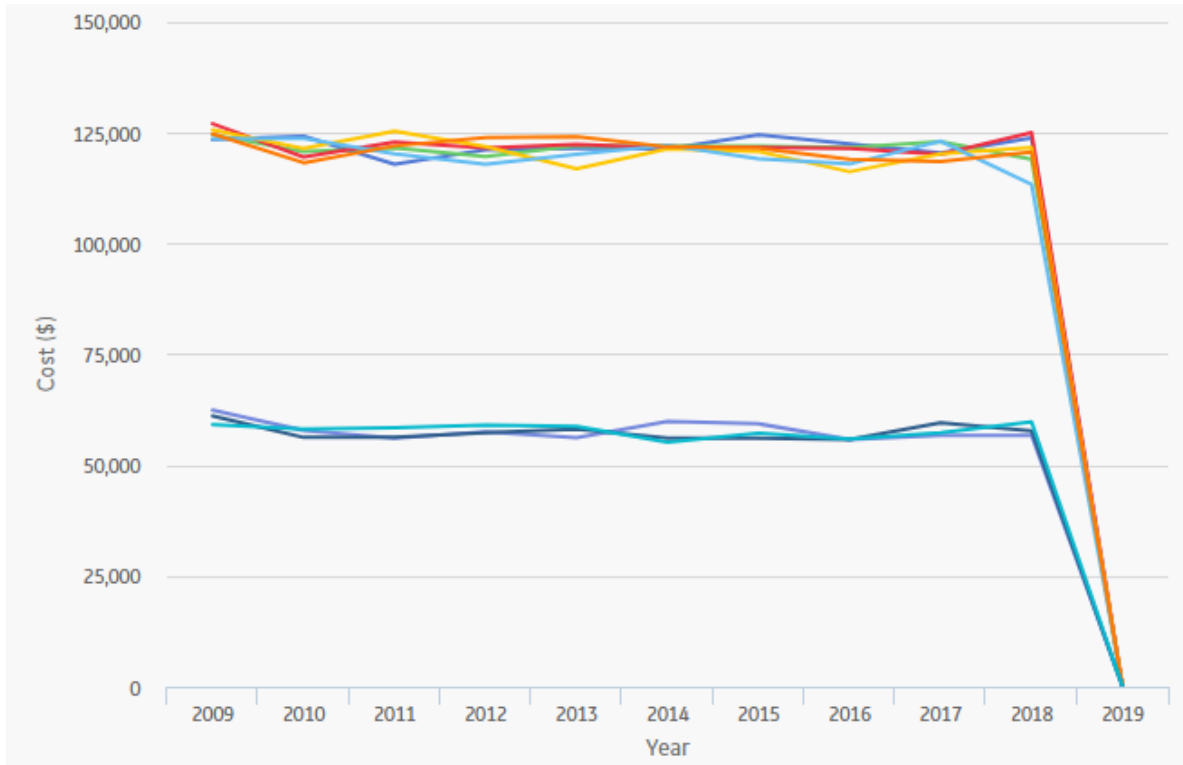

Optimal Holding Plot

The optimal spare level is determined as the most conservative value over the entire analysis period. Because failure data might change each year, the optimal inventory level might change for each year within the analysis period. The Optimal Holding Plot displays the optimal spare level for the whole period and for each individual year of the analysis period.

Note: Interaction with graphs is not available on [touch-screen devices](#).

Consider the following Optimal Holding Plot from the data used in the [Spares Analysis example](#).

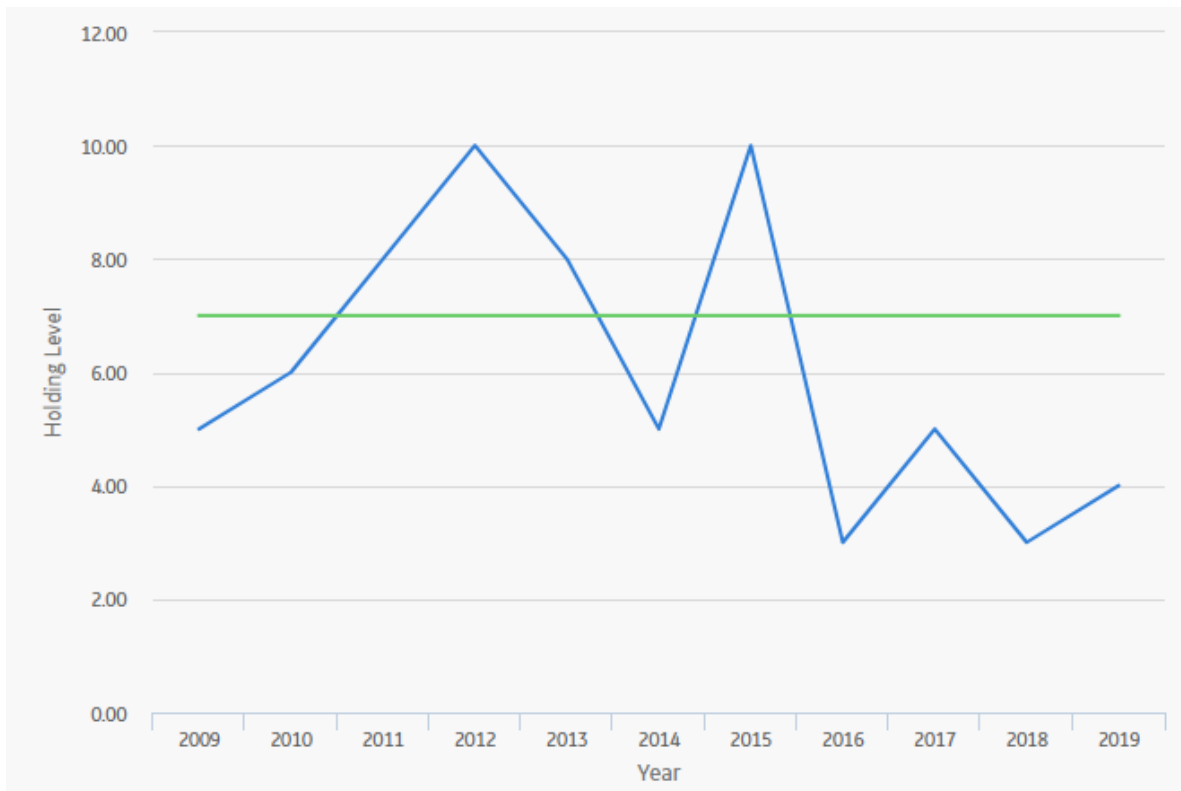

In this image, the Simulation Start Date is set to **6/1/2009**, and the Simulation End Date is set to **6/1/2019** in the [Spares Analysis record](#). The x-axis displays the years included in the analysis period, and the y-axis displays the inventory level associated with the lowest cost of spares levels for each year.

By default, each bar in the Optimal Holding Plot is divided into the following cost categories, which are shaded with different colors that are represented in the legend to the right of the graph:

- **Optimal Spare Level (Yearly):** The lowest cost of spare levels associated with each year included in the analysis period.
- **Optimal Spare Level (Whole Period):** The recommended number of spare parts associated with the entire analysis period.

The Optimal Spare Level (Yearly) and the Optimal Spare Level (Whole Period) values are displayed when you pause over the corresponding bar on the graph.

In addition to providing an Optimal Holding Plot for each Spare record in the analysis, GE Digital APM provides the [Optimal Holding Plot for all the Spares](#) within the selected Spares, which compares all Spare records within a given analysis. The comparison is based on the optimal holding level for the whole period and for each individual year during the analysis period. The following image displays an example of the Optimal Holding Plot for All Spares, which you can use to compare the optimal holding levels for each piece of equipment.

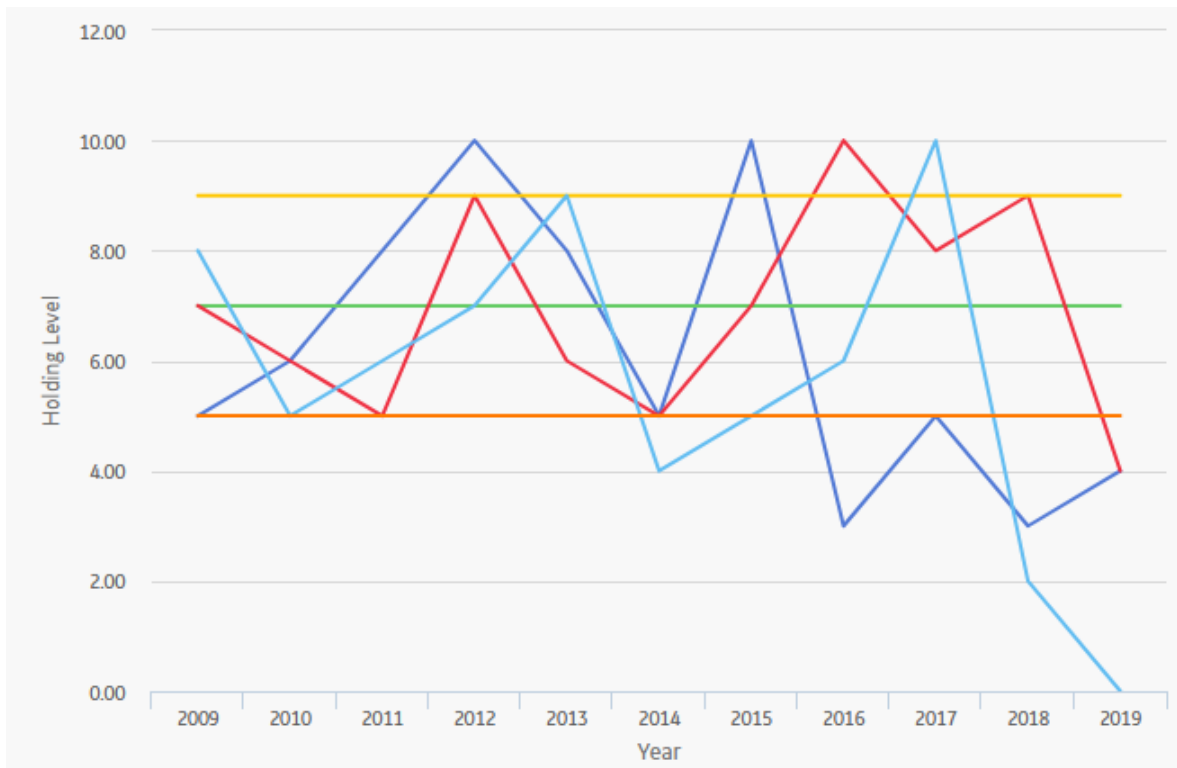

System Reliability

About Site Filtering in System Reliability Analysis

In System Reliability Analysis, the site is assigned based on the user's selection in the **Site** control, and all data added or imported to the System Reliability Analysis must match the analysis's site assignment.

Tip: For more information, refer to the Site Filtering section of the documentation.

In System Reliability Analysis, Rules, users will see only data that is assigned to their site(s) or that is global data.

Consider an organization that has three sites, Site X, Site Y, and Site Z. The following System Reliability Analysis records exist:

- System Reliability Analysis A: Assigned to Site X
- System Reliability Analysis B: Assigned to Site Y
- System Reliability Analysis C: Assigned to Site Z
- System Reliability Analysis D: No site assigned (global record)

Scenario 1: User assigned to only Site X

This user will see System Reliability Analyses A and D.

Scenario 2: User assigned to both Site X and Site Y

This user will see System Reliability Analyses A, B, and D.

Scenario 3: Super User

This user will see System Reliability Analyses A, B, C, and D.

Important: If a multi-site user, or a Super User, links child records from multiple sites to a parent record designated as **Global**, another user who does not have access to all sites may only see a portion of the data associated with that record.

System Reliability Data Model

The following diagram shows how the families used in System Reliability Analysis are related to one another.

In the above image:

- **Black arrows and boxes** represent entity families, relationship families, and associated relationship definitions that are configured in the baseline database and do not require customization for the baseline functionality to work.
- **Red arrows and boxes** represent entity families, relationship families, and associated relationship definitions that may require customization.
- The **System Action** box represents one of four System Action subfamilies in which records can exist: System Condition Monitor, System Inspection, System Preventive Maintenance, or System Special Action. The specific family that is used will depend upon the type of Action that is created for a given Asset or Switch element.
- The **Distribution** box represents one of four Distribution subfamilies in which records can exist: Normal, Weibull, Exponential, Lognormal, Triangular, Gumbel, or Generalized Extreme Value record. The specific family that is used will depend upon the distribution type selected for the associated Risk.

Throughout this documentation, we use the term System Reliability Analysis to mean the combination of the root System Analysis record and all records that are linked to it.

About Results of a System Reliability Analysis

When you run a Monte Carlo simulation, the GE Digital APM system analyzes statistics about cost, performance, and reliability from the iterations of the analysis to calculate the simulation results. The simulation results display average values as well as the specific values that were used to calculate the averages.

What Can You Learn from a System Reliability Analysis?

By reviewing the results of a System Reliability Analysis, you will be able to answer questions such as:

- Which Scenario has the lowest overall cost associated with it?
- Which Scenario is the least reliable?
- Which Scenario has the highest failure rate?
- Which Actions were successful in mitigating risk and reducing cost?
- How many times were Resources used?
- How much did the Resources cost?
- For how long were the Resources used?
- How many times was an Action required?

After reviewing the results of a System Reliability Analysis, you can identify which Scenario consistently provides the best reliability and produces the least amount of downtime and cost. Based upon the results, you might decide to complete any of the following steps:

- Refine the Scenarios by modifying the [analysis parameters](#) or [components](#) within the analysis or create new components to further analyze reliability and costs.
- Create Recommendations to implement changes to the current physical system to align it with the most desirable Scenario.

Understanding the Analysis Results

The [Summary tab](#) on the **System Reliability** page provides an overview of the costs and Resource statistics for the simulation using graphs on the following tabs:

- [Total Cost](#)
- [Total Cost Trend](#)
- [Annual Action Cost](#)
- [Action Cost Trend](#)

- [Resource Occurrence](#)
- [Resource Time](#)
- [Resource Cost](#)

The simulation results are also presented in more detail in the following sections, which are used to organize the data in the [Simulation Results workspace](#):

- [Elements](#) section
- [Actions](#) section
- [Resources](#) section

By selecting a cell in the grid in the above sections, you can view more detailed information in the following graphs:

- [Histogram](#) plot
- [Trend](#) plot
- [Impact](#) plot

About Total Cost Graph

The Total Cost graph displays the [average total cost](#) for each Scenario. The total cost represents the sum of costs in the following categories:

- Lost Production Cost
- Action Cost
- Planned Correction Cost
- Unplanned Correction Cost

Note: Interaction with graphs is not available on [touch-screen devices](#).

Details

The following image displays an example of the Total Cost graph.

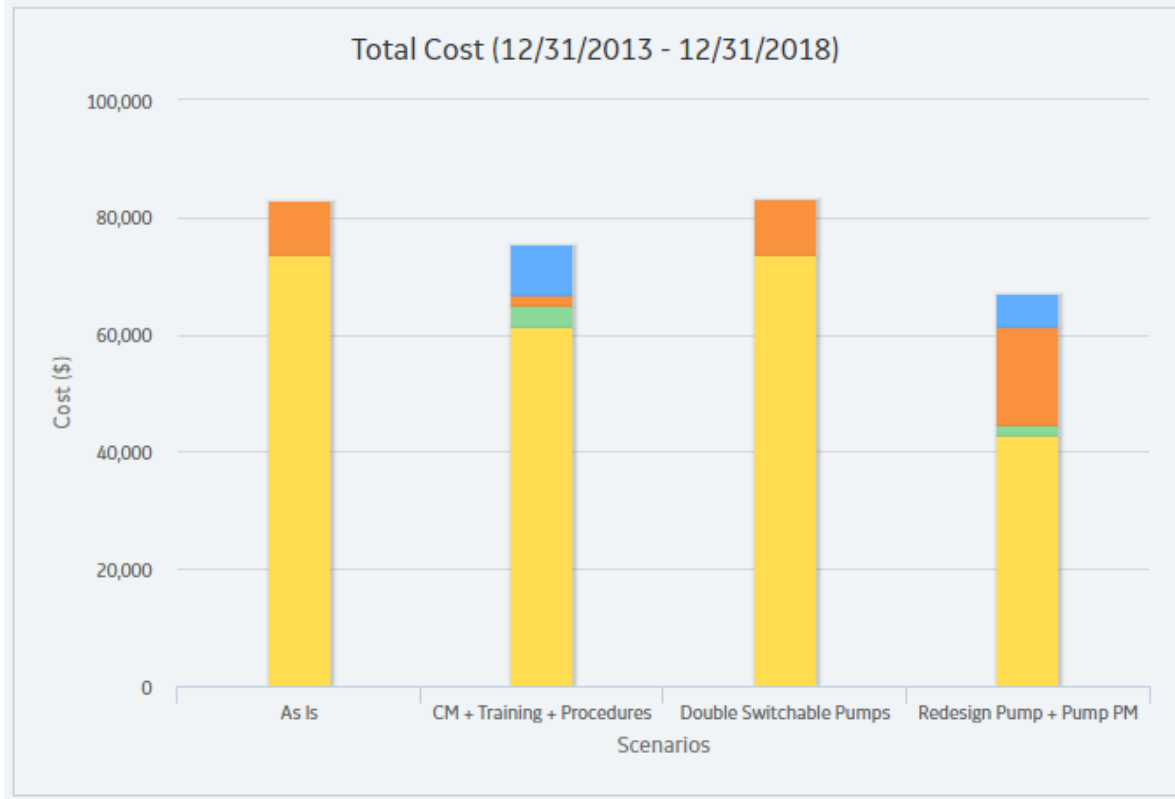

Note: If you prefer to see the various cost categories added together and presented in a single column for each Scenario, in the upper-right corner of the **Summary** section, select the **Show Total** check box.

The categories in the Total Cost graph are calculated for each Scenario as described here:

- **Action Cost:** The average Action cost across all the iterations. Action cost includes any materials or personnel needed to complete any Actions that exist in the Scenario and any Resources used to complete the Actions. The following fields are used to calculate Action costs:
 - **System Action record:** Action Cost.
 - **System Resource record:** Fixed Cost, Variable Cost, and Variable Cost Units.
 - **System Resource Usage record:** Duration, Duration Units, and Quantity.
- **Lost Production Cost:** The average lost production cost across all iterations. Lost production cost includes the cost of lost production for any element when it is stopped or unable to run, according to the value in the Lost Product Cost field of the record that represents that element.
- **Planned Correction Cost:** The average planned correction cost across all the iterations. Planned correction cost includes the cost to repair an element that is identified as having a potential failure by an inspection or condition monitoring Action and any Resources used. The following fields are used to calculate planned correction costs:
 - **System Subsystem record:** Variable Cost, and Variable Cost Units.
 - **System Asset record:** Variable Cost and Variable Cost Units.
 - **System Switch record:** Variable Cost and Variable Cost Units.
 - **System Risk record:** Planned Correction Cost, Planned Correction Duration, and Planned Correction Duration Units.
 - **System Resource record:** Fixed Cost, Variable Cost, and Variable Cost Units.
 - **System Resource Usage record:** Duration, Duration Units, and Quantity.

- **Unplanned Correction Cost:** The average unplanned correction cost across all the iterations. Unplanned correction cost includes the cost to repair any failed element and any Resources used to do so. The following fields are used to calculate unplanned correction costs:
 - **System Asset record:** Fixed Cost, Variable Cost, and Variable Cost Units.
 - **System Switch record:** Fixed Cost, Variable Cost, and Variable Cost Units.
 - **System Risk record:** Fixed Unplanned Correction Cost, Variable Unplanned Correction Cost, and Variable Unplanned Correction Cost Units.
 - **System Resource record:** Fixed Cost, Variable Cost, and Variable Cost Units.
 - **System Resource Usage record:** Duration, Duration Units, and Quantity.

About Total Cost Trend Graph

The Total Cost Trend graph displays the **average total cost** for each Scenario for each analysis time interval in the **simulation period**.

The following image displays an example of the Total Cost Trend graph.

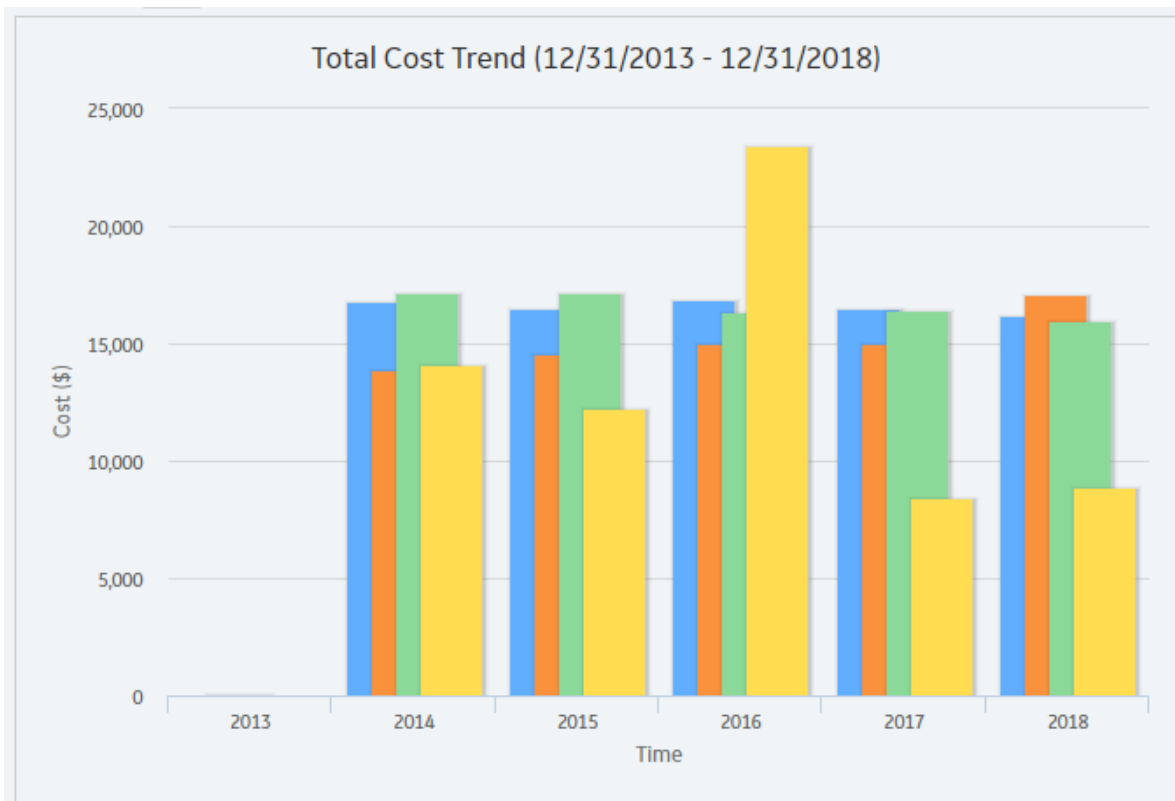

Note: Interaction with graphs is not available on [touch-screen devices](#).

About Annual Action Cost Plot

The Annual Action Cost graph displays the average cost of actions per year for each Scenario.

The following image displays an example of the Annual Action Cost graph.

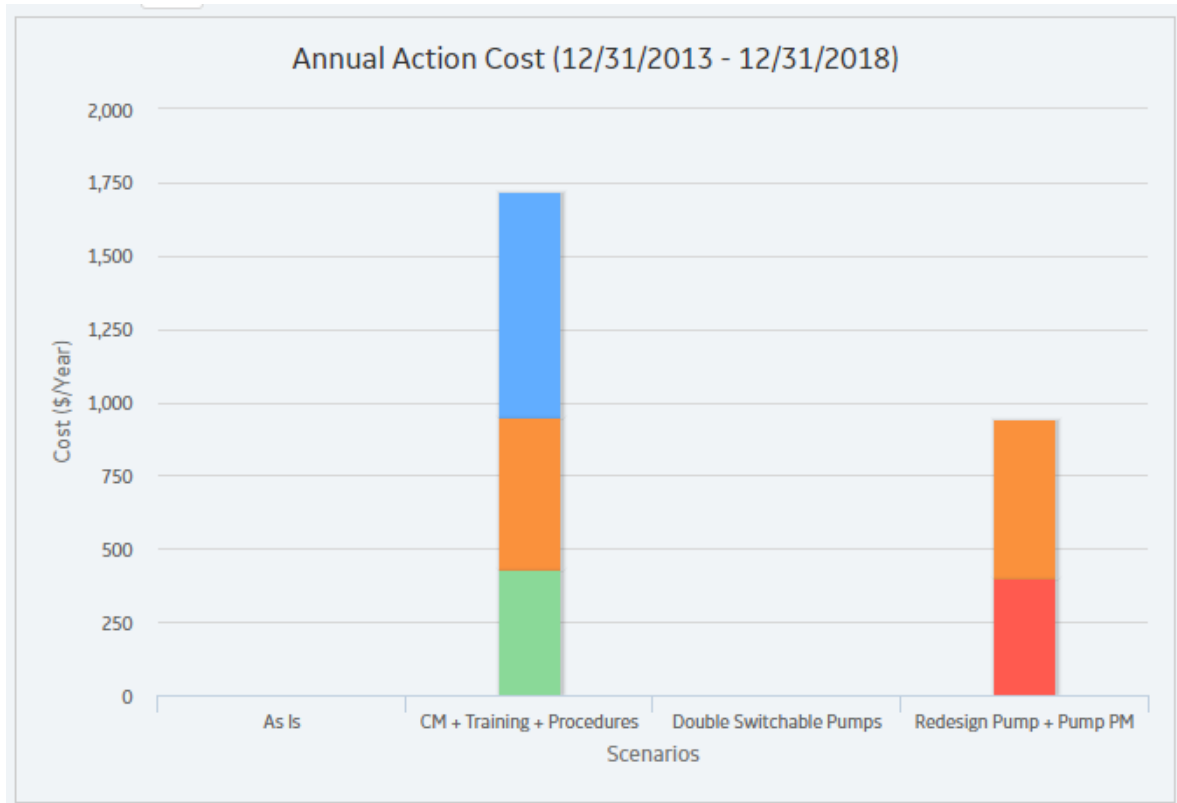

Note: If you prefer to see the various cost categories added together and presented in a single column for each Scenario, in the upper-right corner of the [Summary](#) section, select the [Show Total](#) check box.

You can also compare the cost of different types of actions on this graph.

Note: Interaction with graphs is not available on [touch-screen devices](#).

About Action Cost Trend Graph

The Action Cost Trend graph displays the average total cost for actions in each Scenario for the analysis time interval in the [simulation period](#).

The following image displays an example of the Action Cost Trend graph.

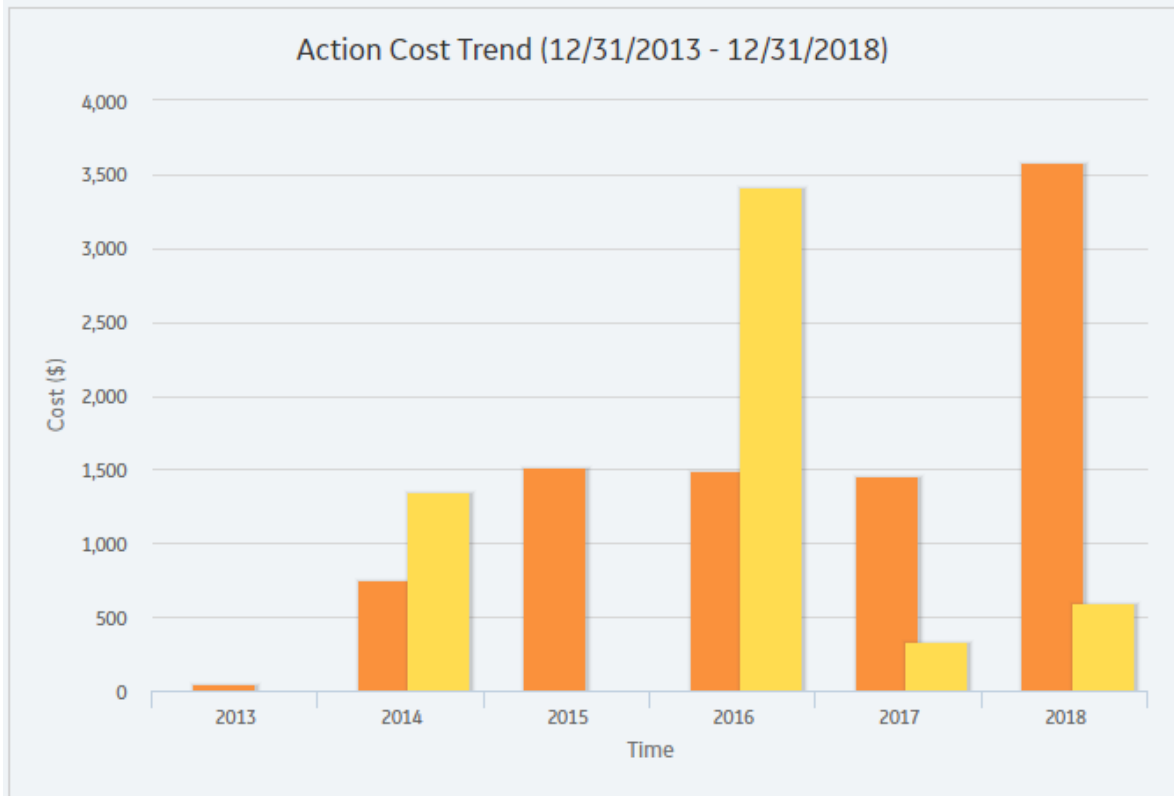

Note: Interaction with graphs is not available on [touch-screen devices](#).

About Resource Occurrence Graph

The Resource Occurrence graph displays statistics about the total use of each Resource when the value in the Count Occurrence field of the associated System Resource record is set to True. The Resource occurrence count is calculated from the average total usage across all iterations.

Note: For System Resource records where the Count Occurrence field is set to False, the occurrence count of that Resource will be zero, and it will not be displayed on the graph. The Mechanic Resource, whose Count Occurrence field value is False, does not appear on the Resource Occurrence graph but is still used in the simulation and appears in both the [Resource Time graph](#) and the [Resource Cost graph](#).

The following image displays an example of the Resource Occurrence plot:

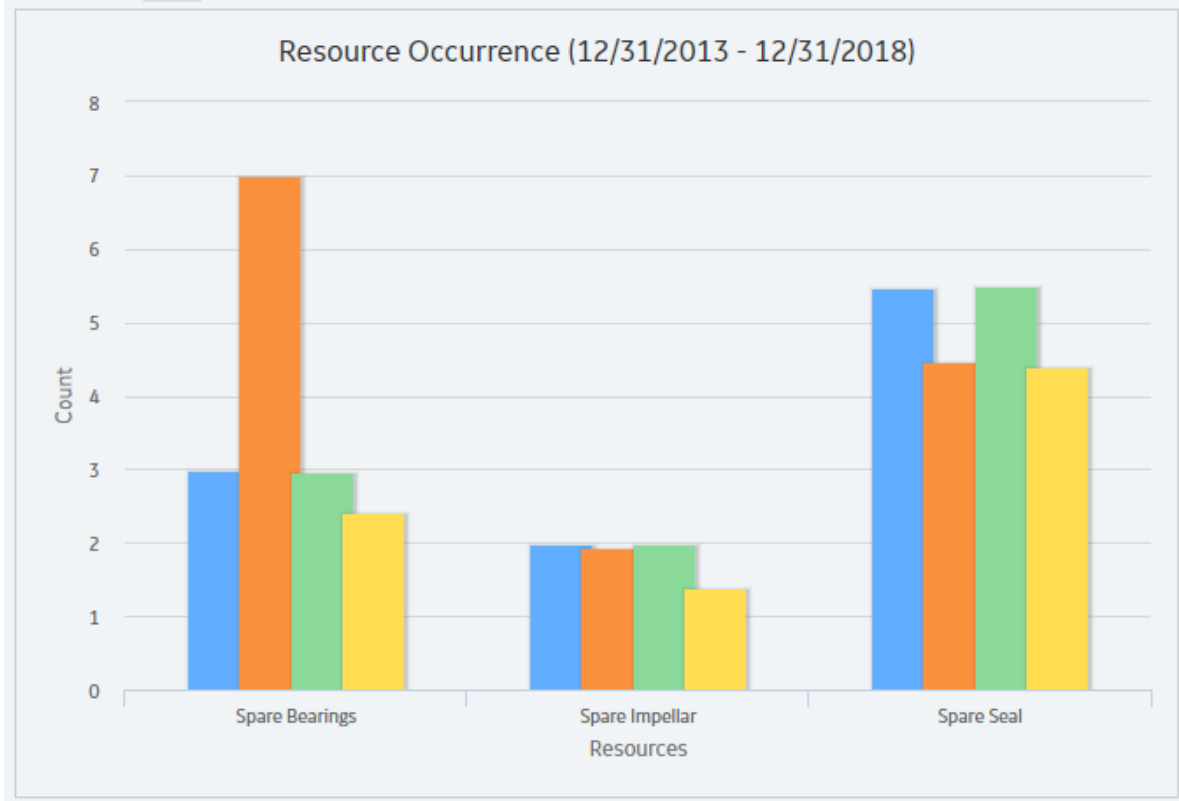

Note: Interaction with graphs is not available on [touch-screen devices](#).

About Resource Time Graph

The Resource Time graph displays the total amount of time that each Resource is used per Scenario. The total amount of time is calculated as the [average total](#) amount of time that the Resource is used for all the iterations.

The following image displays an example of the Resource Time graph:

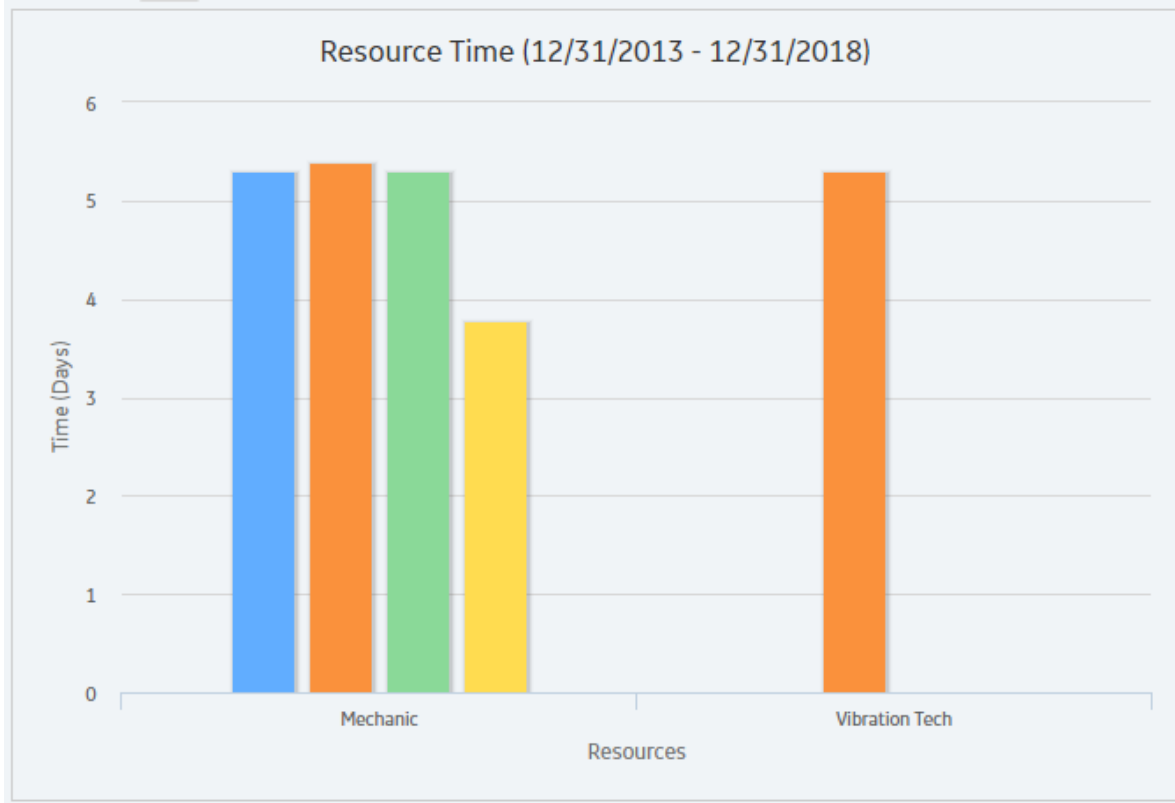

Note: Interaction with graphs is not available on [touch-screen devices](#).

About Resource Cost Graph

The Resource Cost graph displays the total cost of all Resources used in the Scenario. The total cost is calculated for each Scenario as the [average total](#) Resource costs for all the iterations.

The following image displays an example of the Resource Cost graph:

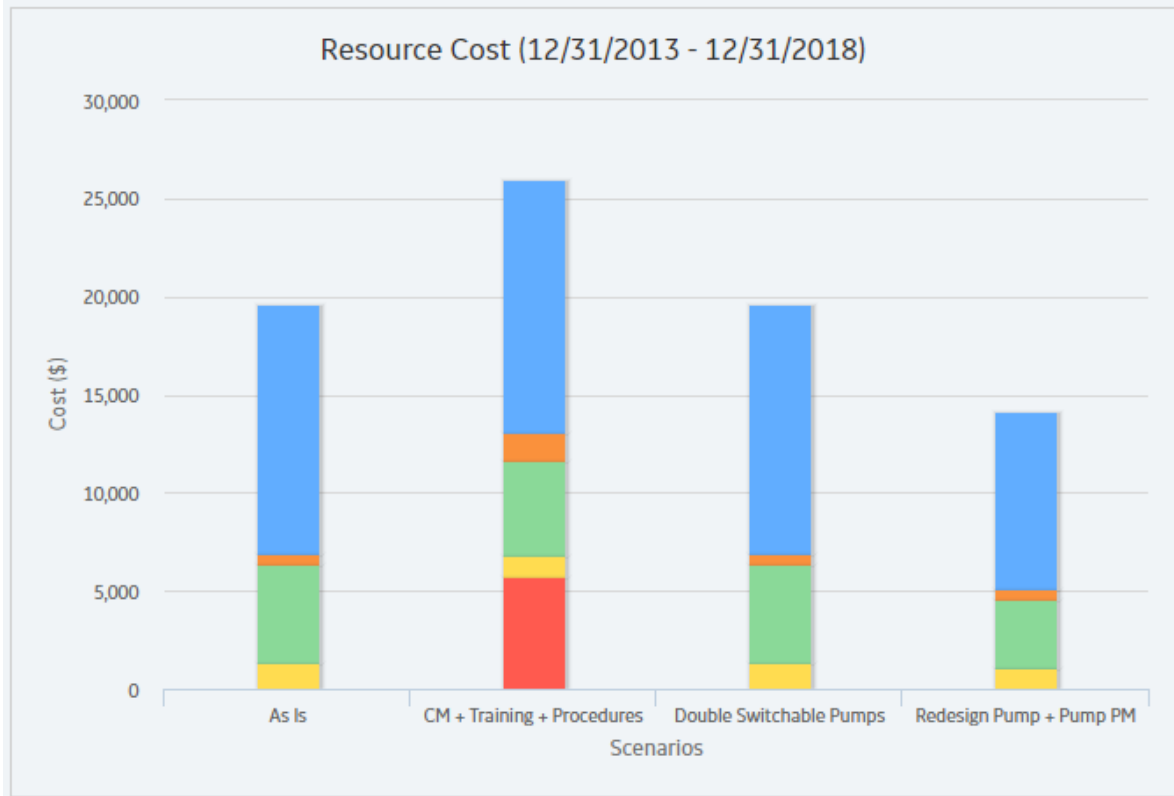

Note: Interaction with graphs is not available on [touch-screen devices](#).

About Elements Section

The **Elements** section contains a grid that displays specific results for the elements that exist in a System Reliability Analysis.

Elements		Actions		Resources	
Element	Failures	Downtime (Days)	Cost (\$)	Re	
▶ As Is	0.25	0.76	82,812	79	
▶ CM + Training + Procedures	0.18	0.01	75,592	83	
▶ Double Switchable Pumps	0.20	0.77	83,149	81	
▶ Redesign Pump + Pump PM	1.23	1.50	67,053	0.0	

The grid contains the following columns of information:

- **Element:** Contains a hierarchy that lists the components in the System Reliability Analysis.

- **Failures:** Contains a value that indicates the average number of times the selected item failed during the analysis period for all iterations of the Scenario to which it belongs.
- **Downtime (Days):** Contains a value that indicates the average number of days that the selected item was out of service due to failures or shutdowns for all iterations of the Scenario to which it belongs.
- **Cost (Currency):** Contains a value that indicates the average total cost of the selected item for all iterations of the Scenario to which it belongs. This includes the cost of any items that belong to the item, lost production costs, fixed costs, variable costs, Action costs, planned or unplanned correction costs, and Resource costs.
- **Reliability:** Contains a value that indicates the percentage of iterations that the selected item never failed across the total number of iterations in the Scenario to which it belongs.

Note: Reliability is calculated from actual data collected from the iterations and does not represent an average value.

- **Availability:** Contains a value that indicates the average percentage of the time that the selected item was available and running for the Scenario to which it belongs.
- **Next Failure (Days):** Contains a value that indicates the average amount of time, in days, from the analysis Start Date until the next failure occurs for the selected item.
- **Action Cost (currency):** Contains a value that specifies the average Action cost across all the iterations. Action cost includes any materials or personnel needed to complete any Actions that exist in the Scenario and any Resources used to complete the Actions.
- **Lost Production Cost (currency):** Contains a value that indicates the average lost production cost across all iterations. Lost production cost includes the cost of lost production for any element when it is stopped or unable to run, according to the value in the Lost Product Cost field of the record that represents that element.
- **Planned Correction Cost (currency):** Contains a value that indicates the average planned correction cost across all the iterations. Planned correction cost includes the cost to repair an element that is identified as having a potential failure by an inspection or condition monitoring Action and any Resources used.
- **Unplanned Correction Cost (currency):** Contains a value that indicates the average unplanned correction cost across all the iterations. Unplanned correction cost includes the cost to repair any failed element and any Resources used to do so.

By selecting a cell in the grid, you can view detailed information in the following graphs:

- [Histogram plot](#)
- [Trend plot](#)
- [Impact plot](#)

About Actions Section

The **Actions** section contains a grid that displays specific results for the Actions that exist in a System Reliability Analysis.

Elements	Actions		Resources
Action	Occurrences	Cost (\$)	Detected Failures
As Is			
▲ CM + Training + Procedures			
▲ Pump			
CM on Pump Vibrations	86.07	3,873	1.37
Implement Vibration Monitoring	0.00	0	0.00

The grid contain the following columns of information:

- **Action** : Contains a hierarchy that lists the Actions that exist in a System Reliability Analysis. The Actions appear below the element in the Diagram to which they belong.
- **Occurrences** : Contains a value that indicates the average number of occurrences of the Action from all iterations of the Scenario to which it belongs.
- **Cost (currency)**: Contains a value that indicates the average cost of the Action, including any Resources used by the Action, for the Scenario to which it belongs.
- **Detected Failures**: Contains a value that indicates the average number of potential failures detected in advance by the Action. This result is calculated only for [Inspection Actions](#) and [Condition Monitoring Actions](#), which are the only Actions that can detect potential failures.

By selecting a cell in the grid, you can view detailed information in the following graphs:

- [Histogram plot](#)
- [Trend plot](#)

About Resources Section

The **Resources** section contains a grid that displays specific results for the Resources that exist in a System Reliability Analysis.

Elements		Actions	Resources	
Resource	Occurrences	Time (Days)	Cost (\$)	Ac
▲ As Is				
Mechanic	NA	5.29	12,706	0
Spare Bearings	2.97	NA	595	0

The grid contains the following columns of information:

- **Resource**: Displays a hierarchy that lists the Resources that exist in the System Reliability Analysis. The Resources appear below the Scenario in the hierarchy to which they belong.
- **Occurrences**: Contains a value that indicates the average number of times the Resource is used during the simulation period.
Note: For [System Resource records](#) in which the Count Occurrences field is set to False, the value in this column will be 0 (zero).
- **Time (Days)**: Contains a value that indicates the average amount of time, in days, accumulated by the Resource.
- **Cost (currency)**: Contains a value that indicates the average cost accrued by the selected Resource.
- **Action Resource Cost**: Contains a value that indicates the total cost of Resource needed for Actions.
- **Planned Correction Resource Cost (currency)**: Contains a value that indicates the total cost of all planned Resources needed for Actions.
- **Unplanned Correction Cost (currency)**: Contains a value that indicates the total cost of all unplanned Resources needed for Actions.

By selecting a cell in the grid, you can view detailed information in the following graphs:

- [Histogram plot](#)
- [Trend plot](#)

About Histogram Plot

The Histogram Plot provides a visual representation of the frequency distribution of the result that you selected in the grid in the **Elements** section.

Note: Interaction with graphs is not available on [touch-screen devices](#).

Details

The Histogram Plot shows the distribution of the actual values from all iterations that were used to calculate the average value. The distribution of the actual values spreads across a series of data ranges, which are called bins and are represented by columns on the Histogram Plot. When an actual value from an iteration falls into a bin, it is included in the associated column. The higher the column is, the more values have fallen into the bin.

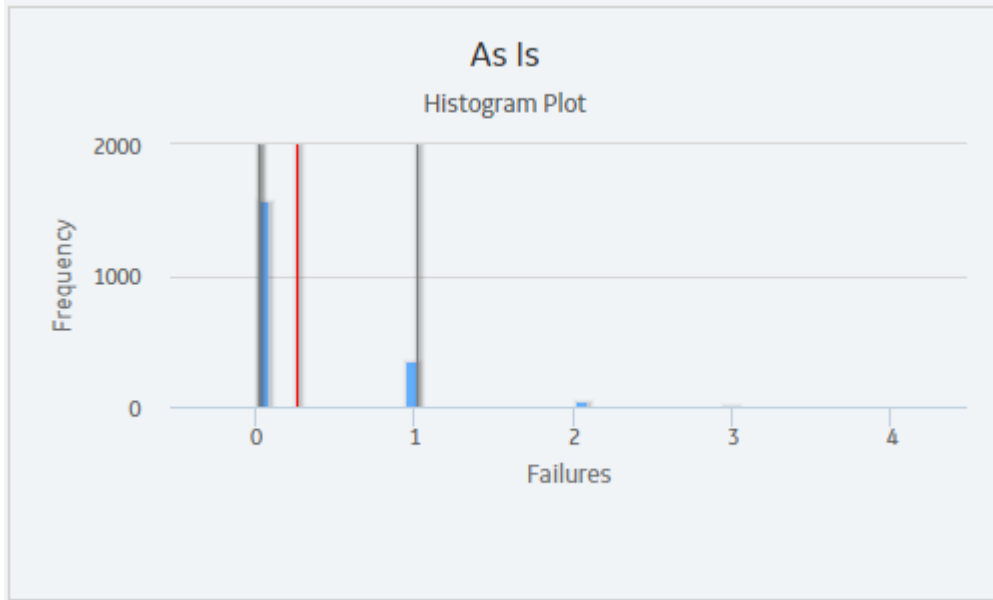

Note: The number of columns that appear in the Histogram Plot is determined by the value in the Histogram Bins field in the root [System analysis](#).

Additional values are represented by the following lines in the Histogram Plot:

- Optimistic Value: Leftmost gray vertical line in the Histogram Plot. This line represents the lower level of the confidence interval.
- Average Value: Red line in the Histogram Plot. This line represents the mean value, which is the mean value of the values from the iterations of the Scenario.
- Realistic Value: Blue line in the Histogram Plot. This line represents the median value, which is the median value of the values from the iterations of the Scenario.

Note: If the median value falls in between two values, then the larger value will be used as the Realistic value.

- Pessimistic Value: Rightmost gray vertical line in the Histogram Plot. This line represents the upper level of the confidence interval.

About Trend Plot

The Trend Plot provides the average value for each analysis time interval, as defined by the value in the Time Analysis Type field in the root [System Analysis record](#), of the result that you selected in the grid.

If the Time Analysis Type field is set to:

- Yearly, the Cost Trend Plot will display the Cost Trend for each year in the simulation period.
- Monthly, the Cost Trend Plot will display the Cost Trend for each month in the simulation period.

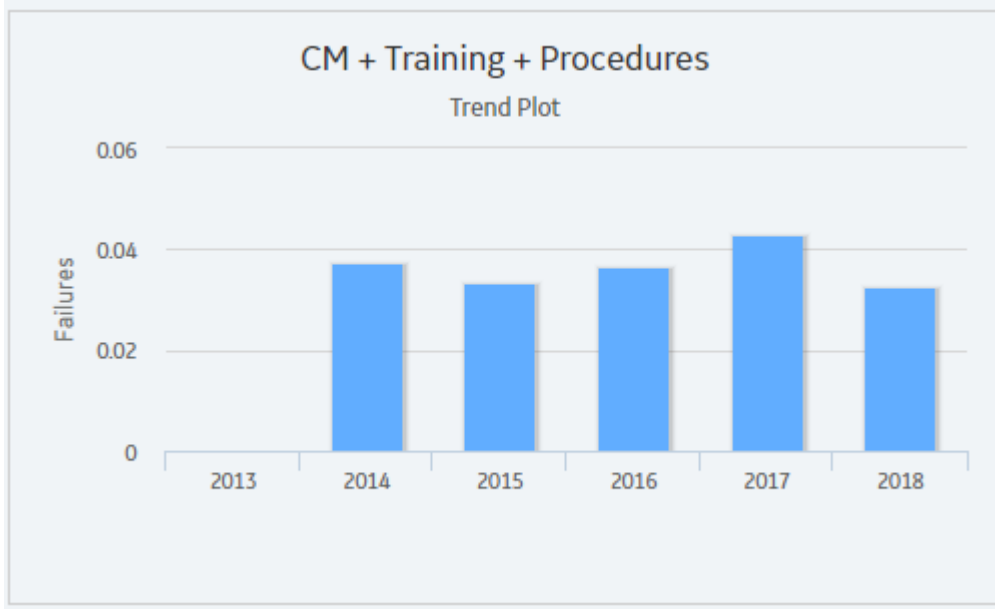

Note: Interaction with graphs is not available on [touch-screen devices](#).

About Impact Plot

The Impact Plot provides visual representation of the average values that are combined to make up the average value of the result that you selected in the grid.

The Impact Plot displays how the average failure value is calculated as a total of the individual Risk failure averages.

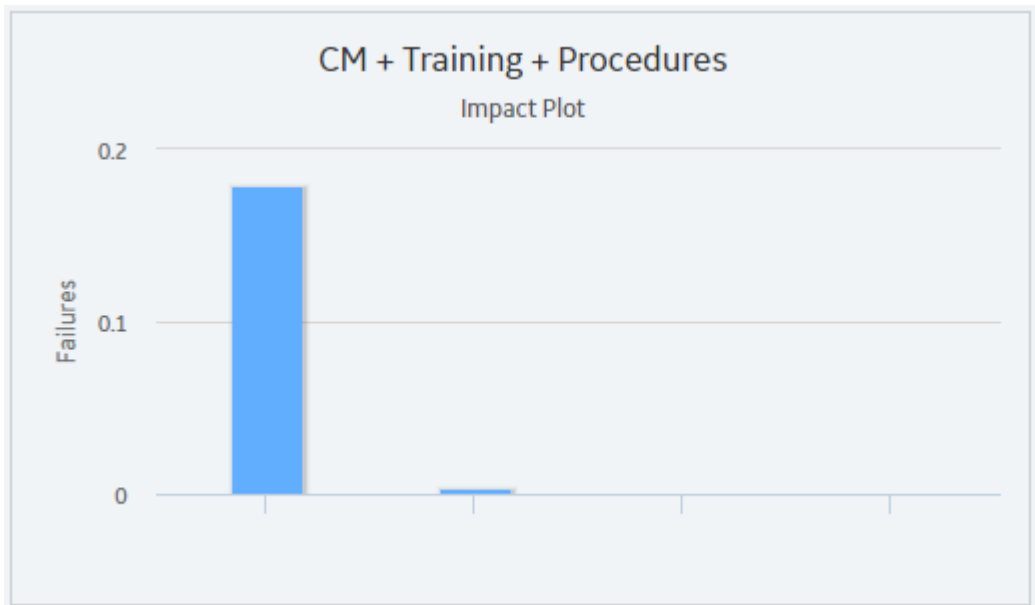

Note:

The Impact Plot is not available for the Actions and Resources tab.

- Interaction with graphs is not available on [touch-screen devices](#).

About Interpreting Simulation Results That Include Source and Additional Risks

The results for a simulation will appear differently depending on whether or not the simulation includes source and additional Risks. It is important that you understand how to interpret simulation results that include source and additional Risks. This documentation assumes that you are familiar with System Risk records and their role in a System Reliability Analysis.

When you set up a simulation to include source and additional Risks, you should consider the following information:

- If an unplanned correction causes a source Risk and any additional Risks to be reset, in the simulation results, the Failure associated with the unplanned correction of the source Risk will be attributed only to the source Risk.
- If a planned correction of a source Risk results in additional Risks being reset, in the simulation results, the following values will be attributed to each individual Risk:
 - Planned Correction Cost
 - Planned Resource Usages
 - Downtime

Downtime for each Risk will be calculated based on the planned correction duration for that Risk.

- If an unplanned correction of a source Risk results in additional Risks being reset, in the simulation results, the following values will be attributed to each individual Risk:
 - Fixed Unplanned Correction Cost
 - Variable Unplanned Correction Cost
 - Unplanned Resource Usagess
 - Downtime

Variable unplanned correction cost and downtime for each Risk will be calculated based on the TTR distribution for that Risk.

- If planned or unplanned correction of a source Risk results in additional Risks being reset, in the simulation results, the Equipment or Functional Location record to which the System Risk records are linked will be populated with the largest downtime value of all the Risks (i.e. source and additional). For example, suppose that the following Risks are defined for a Water Pump:
 - A Bearing failure Risk that is a source Risk and whose downtime value is 1 day.
 - A Seal failure Risk that is an additional Risk and whose downtime value is 2 days.

In this case, when the Bearing failure Risk resets the Seal failure Risk, in the simulation results, a downtime value of 2 days will be attributed to the Water Pump.

- If planned or unplanned correction has started for an additional Risk, and then, planned or unplanned correction starts for the source Risk that resets that additional Risk, the additional Risk will be reset only once, as a result of its own planned or unplanned correction. The additional Risk will not be reset two times as a result of its own planned or unplanned correction and the planned or unplanned correction of the source Risk. This will be reflected in the simulation results.

About Average Total

The average total is the average of all the totals across all iterations of a simulation, which is calculated by the GE Digital APM system for each simulation. Average totals are calculated for various types of numeric values in a simulation, such as cost in the [Total Cost Trend plot](#) or time in the [Resource Time plot](#).

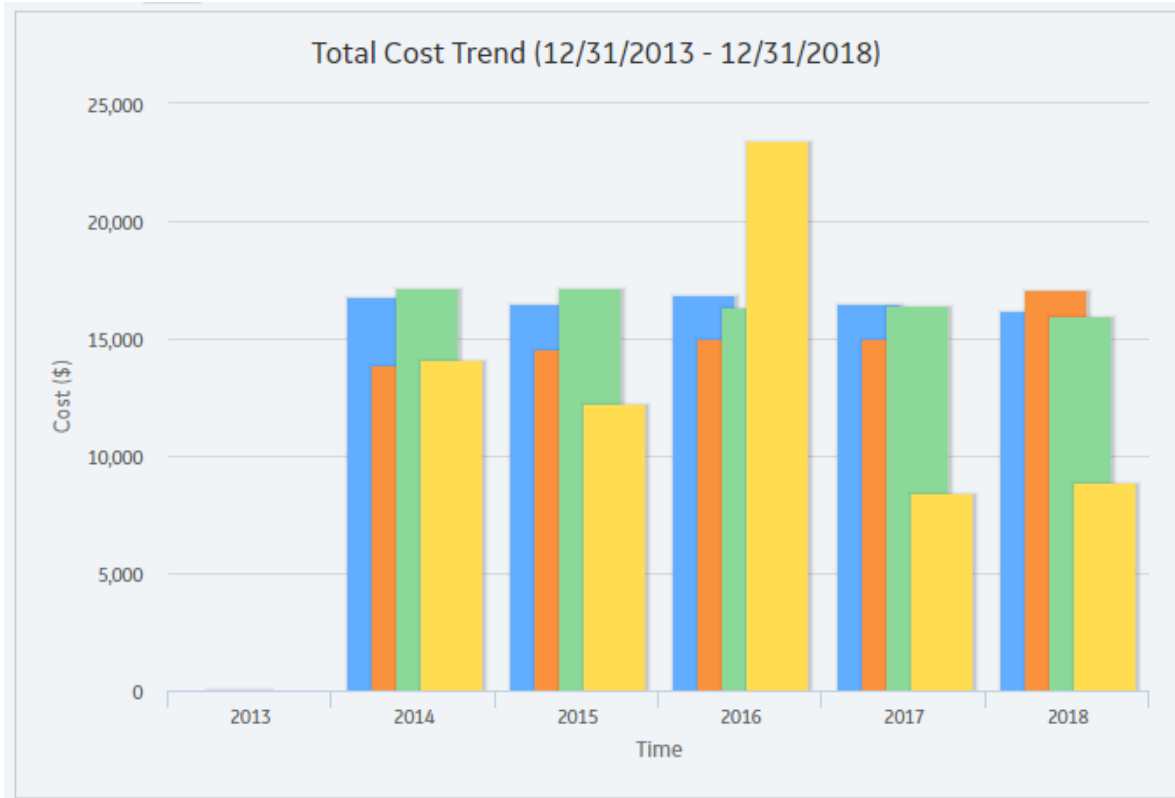

About Simulation Period

Some results of a System Reliability Analysis are presented according to the simulation period that you have selected. The simulation period is defined by the values in the [System Analysis record](#):

- The values in the two **Period** boxes. The **Period** boxes represent the Period and Period Units fields in the System Analysis record and determine the length of the simulation.
- The value in the **Time Analysis Type** box. The **Time Analysis Type** box represents the Time Analysis Type field in the System Analysis record, and the value determines whether results are calculated for each year or each month of the simulation. If the Time Analysis Type is set to:
 - Yearly, the graphs display values for each year included in the simulation period, which is defined by the values in the Period, Period Units, and Analysis Start Date fields in the System Analysis record.
 - Monthly, the graphs display values for each month included in the simulation period, which is determined by the values in the Period, Period Units, and Analysis Start Date fields in the System Analysis record.

About Show Total Check Box

The **Show Total** check box is a feature that is available on the following System Reliability Analysis results plots:

- [Total Cost plot](#)
- [Annual Action Cost plot](#)
- [Resource Cost plot](#)

In these graphs, each column represents a separate Scenario. The **Show Total** check box determines how the columns are displayed, as described in the following list:

- When the **Show Total** check box is cleared, the plots display one column that is divided into sections representing the individual cost types or resources within that Scenario. In addition, the legend displays labels for the individual categories that are represented in each column.
- When the **Show Total** check box is selected, the plots display one column that is not divided into sections but instead displays the total cost associated with all categories in that Scenario. In addition, the legend displays the label Total.

The following image shows the Total Cost plot for our System Reliability Analysis Example when the **Show Total** check box is selected.

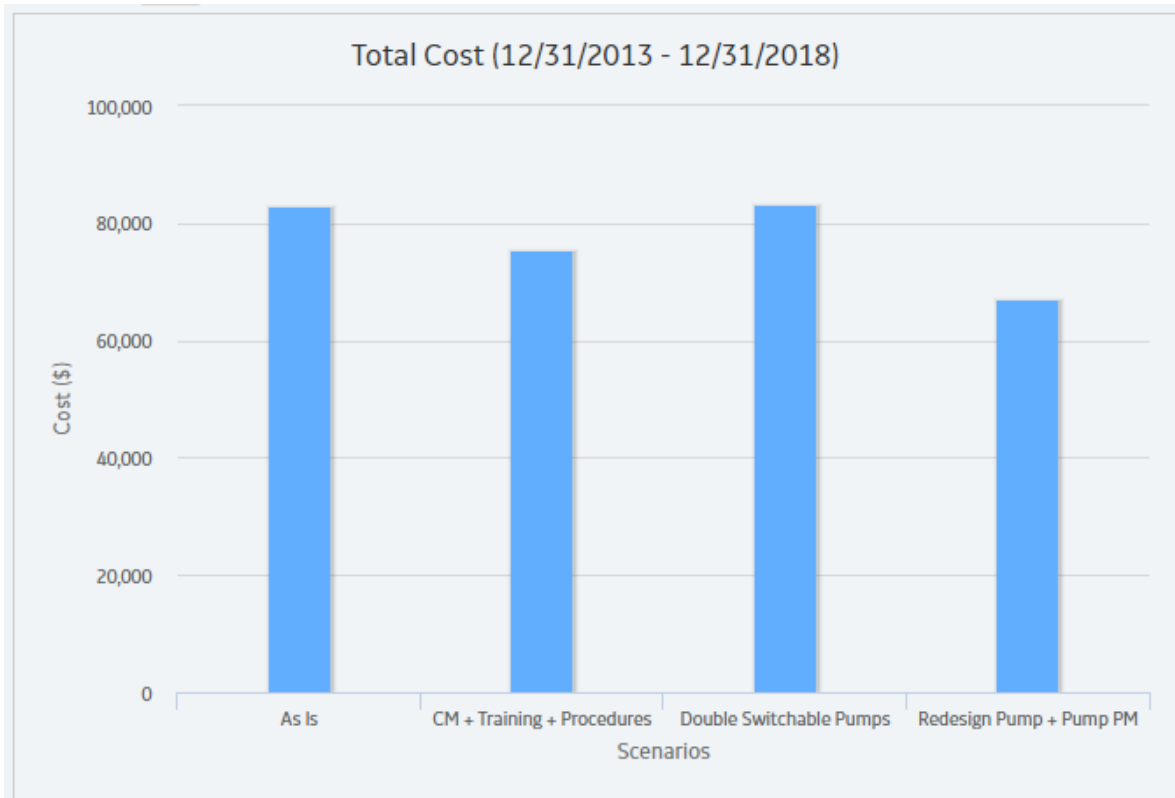

The following image, on the other hand, shows the Total Cost plot for our System Reliability Analysis Example when the **Show Total** check box is cleared.

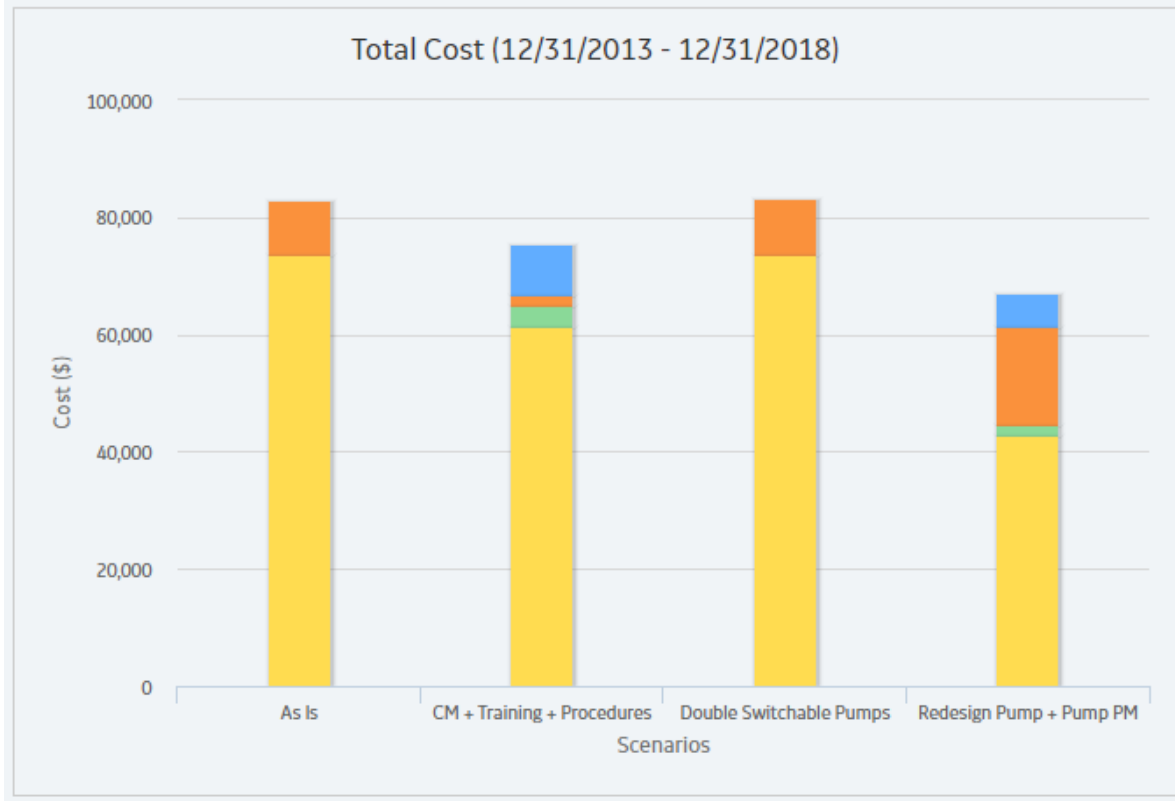

Family Field Descriptions

Reliability Recommendation Records

Reliability Recommendation Records

Recommendation records in Reliability Analytics store details of a recommendation and the progress associated with getting the recommendation approved and implemented. The following table provides an alphabetical list and description of the fields that exist for the Reliability Recommendation family. The information in the table reflects the baseline state and behavior of these fields. This list is not comprehensive.

This family is enabled for site filtering, which means that records in this family can be assigned to a specific site and will only be accessible to users who are assigned to the same site and have the appropriate license and family privileges. For more information, refer to the [Sites](#) section of the documentation.

Field	Data Type	Description	Behavior and Usage
Alert Assignee When Due?	Logical	An option that lets you send an alert to the person responsible for implementing the recommendation.	<p>If this field is selected, the GE Digital APM system will send an alert to the person in the Assigned to Name field on the date defined in the Target Completion Date field.</p> <p>This field is labeled Alert Responsible Party When Due? and is available on the Alert tab on the datasheet.</p>
Analysis ID	Character	The ID of the analysis associated with the recommendation.	This field is populated automatically with the Record ID of the analysis to which the Reliability Recommendation record will be linked when it is saved.
Asset ID	Character	The ID for the Equipment associated with the recommendation.	<p>You can define this field by selecting <insert ellipsis icon> and searching for the required Equipment. You can then selecting the Equipment, then select OK to link it to the Recommendation.</p> <p>This field is labeled Equipment ID and is available on the General Information tab on the datasheet.</p>
Assigned to Name	Character	The name of the person responsible for ensuring the recommendation is implemented.	<p>This field contains a list of all Security Users in the database, presented in the following format:</p> <p><last name>, <first name>, <user ID></p> <p>This field is optional. You can select a user from the list.</p> <p>This field is available on the General Information tab on the datasheet.</p>
Author Name	Character	The name of the person proposing the recommendation.	<p>You can select a team member from a list of current human resources.</p> <p>This field is available on the General Information tab on the datasheet.</p>

Field	Data Type	Description	Behavior and Usage
Business Impact	Character	The impact to the manufacturing process during the recommendation implementation.	You can choose this value from a list of the following options: <ul style="list-style-type: none"> • Safety • Environmental • Production • Economic This field is available on the General Information tab on the datasheet.
Completed	Logical	Indicates that the recommendation is complete.	You can set this value to True to indicate that this recommendation is complete.
Completion Comments	Text	Details about the completed recommendation.	This field is required if the value in the Status field is Rejected, Cancelled, or Superseded. This field is labeled Close-Out Comments and is available on the General Information tab on the datasheet.
Creation Date	Date	The date the recommendation was created.	This field is disabled and populated automatically with the date on which the RA Recommendation was created. This field is available on the General Information tab on the datasheet.
Date Reviewed	Date	The date the recommendation status was changed to Reviewed.	This field is populated automatically with the current date when the Status field is updated to Reviewed.
Days before Due Date to be Notified	Number	The numbers of days prior to the target date that the email message should be sent.	This field is enabled only when the Alert Responsible Part When Due? field is set to True, in which case this field is required. This field is labeled Days before Due Date to be Alerted and is available on the Alert tab on the datasheet.

Field	Data Type	Description	Behavior and Usage
Equipment Technical Number	Character	The technical number of the piece of equipment for which the recommendation is being made.	When you select a value in the Equipment ID field, this field is populated automatically with the value in the Equipment Technical Number field of the associated Equipment. This field is labeled Technical Number and is available on the General Information tab on the datasheet.
Final Action Taken	Text	The actions taken to implement the recommendation.	You can define this field manually by typing a description of final actions in this field.
Final Approver Name	Character	The name of the person responsible for approving the recommendation and the associated cost.	This field contains a list of all Security Users in the database, presented in the following format: <last name>, <first name>, <user ID> You can select a user from the list. Note: An email alert will be sent only if the user specified in the Final Approver Name field has logged in to GE Digital APM system. This field is available on the General Information tab on the datasheet.
Frequency of Alert After Due Date	Character	The frequency after the target date that the alert will be resent.	This field is enabled only when the value in the Alert Responsible Part When Due? field is True, in which case this field is required, and you can choose a value from the list of following values: <ul style="list-style-type: none"> • Never • Daily • Weekly • Monthly • Yearly This field is available on the Alert tab on the datasheet.

Field	Data Type	Description	Behavior and Usage
Functional Location ID	Character	The ID of the Functional Location that is either linked to the Equipment that appears in the Equipment ID field or linked separately to the RA Recommendation.	This value is populated automatically if a Functional Location exists and is linked to the Equipment that appears in the Equipment ID field. You can also select <insert ellipsis icon> to search for the desired Functional Location, select it. When you select OK , the Functional Location is linked to the RA Recommendation. This field is available on the General Information tab on the datasheet.
Implemented Date	Date	The date the recommendation was implemented.	This field is populated automatically when the RA Recommendation is implemented. When this occurs, the field becomes disabled. This field is available on the General Information tab on the datasheet.
Implementation Alert Text	Text	Text the user can add that will be sent in the body of the alert to the assignee to remind them the recommendation must be met by the target date.	You can type the text you wish to appear in the Alert email. This field is available on the Alert tab on the datasheet.
Mandatory Date	Date	The date by which the recommendation must be implemented.	You can select a date using the Calendar tool. This field is available on the General Information tab on the datasheet.
Recommendation Basis	Character	Background information about why the recommendation is being made. The reason the recommended action is needed.	You can type any necessary background information in this field. This field is available on the General Information tab on the datasheet.
Recommendation Closure Date	Date	The date the recommendation status is changed to Implemented, Rejected, or Superseded.	This field is populated automatically with the current date when the value in the status field is changed to Implemented, Rejected, or Superseded.

Field	Data Type	Description	Behavior and Usage
Recommendation Description	Text	A detailed description of the recommendation.	You can type a description of the recommendation in this field. This field is available on the General Information tab on the datasheet.
Recommendation Headline	Character	A brief summary of the recommendation.	You can type a brief summary of the recommendation in this field. This field is available on the General Information tab on the datasheet.
Recommendation ID	Character	The ID for the RA Recommendation.	This field is populated automatically with a unique name (e.g., REC_888) when the recommendation is created. You can change this value if desired. This field is available on the General Information tab on the datasheet.
Recommendation Priority	Character	A value that represents the priority or criticality level of the recommendation for implementation.	You can chose from a list of the following values: <ul style="list-style-type: none"> • High • Medium • Low This field is available on the General Information tab on the datasheet.
Reevaluate?	Logical	Indicates whether team members should evaluate the recommendation again.	If this check box is selected, an alert will be sent to users specified in the Reevaluation Notification List field. This field is available on the Alert tab on the datasheet.
Reevaluation Alert Body Text	Text	The message text in the body of the reevaluation alert, which will be sent to users in the reevaluation notification list.	This field is enabled only when the Reevaluate? field check box is selected. Then the field is required. This field is available on the Alert tab on the datasheet.

Field	Data Type	Description	Behavior and Usage
Reevaluation Notification List	Character	Individuals that will be sent to the reevaluation alert.	<p>This field is enabled only when the Reevaluate? field is set to True. Then the field is required. You can select from a list of names with Human Resources.</p> <p>This field is labeled Reevaluation Alert List and is available on the Alert tab on the datasheet.</p>
Reevaluation Date	Date	The date on which an alert is sent out to tell the alert recipient to re-evaluate the recommendation.	<p>This field is enabled only when the Reevaluate? field is set to True. Then the field is required. You can select a date using the Calendar tool.</p> <p>This field is available on the Alert tab on the datasheet.</p>
Required Equipment Status	Character	The operating status the piece of equipment must be under, in order for the recommendation to be implemented.	<p>You can choose from a list of the following values:</p> <ul style="list-style-type: none"> • On-line • Off-line • Not Applicable <p>This field is available on the General Information tab on the datasheet.</p>
Reviewer Name	Character	The first and last name of the person who should review the information in the Recommendation before the recommended action is performed.	<p>This field contains a list of all Security Users in the database, presented in the following format:</p> <p><last name>, <first name>, <user ID></p> <p>You can select a user from a list of security users in the database.</p> <p>This field is available on the General Information tab on the datasheet.</p>

Field	Data Type	Description	Behavior and Usage
Status	Character	The status of the recommendation.	<p>You can choose from a list of the following values:</p> <ul style="list-style-type: none"> • Approved • Created • Pending Review • Reviewed • Rejected • Canceled • Superseded • In Progress • Implemented <p>When the is created, the field is set to Created, but can be modified if needed. This field is required.</p> <p>You can send an alert only if the Status field is set to Approved or In Progress value.</p> <p>This field is available on the General Information tab on the datasheet.</p>
Status Changed By	Character	The ID of the user who last changed value in the Status field.	<p>This field is populated automatically when the Status field is updated.</p> <p>This value does not appear on the datasheet by Work default.</p>
Status Changed by Name	Character	The name of the person who last changed the Status field.	<p>This field is populated automatically when the Status field is updated.</p> <p>This value does not appear on the datasheet by default.</p>
Status Date	Date	The date the Status field was most recently changed.	<p>This field is populated automatically with the current date when the Status field is updated.</p> <p>This value does not appear on the datasheet by default.</p>
Target Completion Date	Date	The date the recommendation is intended to be implemented.	<p>You can select a date using the Calendar tool. This field is required.</p> <p>This field is available on the General Information tab on the datasheet.</p>

Field	Data Type	Description	Behavior and Usage
Work Order Number	Character	The ID of the work order arising from the work request.	This field is populated automatically after a notification has been created in SAP. This value does not appear on the datasheet by default.
Work Request Equipment	Character	The ID of the Equipment in SAP that is associated with the SAP Notification that was created.	This field is populated automatically after a notification has been created in SAP. This field is available on the General Information tab on the datasheet.
Work Request Functional Location	Character	The ID of the Functional Location in SAP that is associated with the SAP Notification that was created.	This field is populated automatically after a notification has been created in SAP. This field is available on the General Information tab on the datasheet.
Work Request Reference	Character	The ID of the SAP Notification.	This field is populated automatically after a notification has been created in SAP. This field is available on the General Information tab on the datasheet.

Probability Distribution

Distribution Data for a Probability Distribution Analysis

The following table contains a list of fields available on the **Probability Distribution Data** window for a Probability Distribution Analysis:

This family is enabled for site filtering, which means that records in this family can be assigned to a specific site and will only be accessible to users who are assigned to the same site and have the appropriate license and family privileges. For more information, refer to the [Sites](#) section of the documentation.

Field	Data Type	Description	Behavior and Usage
Censored	Logical	A value that indicates whether or not the datapoint is excluded as a failure but included in the operating time of the Asset.	Select the check box if you want to censor the data on the selected row.
Datasheet	Character	A link that displays the datasheet associated with the failure event.	If you have the appropriate privileges, after you select the View link, you can edit the data and select Save to save any changes. This column appears only when a query is the data source for the analysis.
Ignore	Logical	A value that indicates whether or not the data on the selected row is excluded from the analysis calculations and plots.	When selected, the data in the associated row will be excluded from the analysis. When cleared, data in the selected row will be included in the analysis. You can modify this value manually. Note: A minimum of three datapoints is required to perform a calculation. If you exceed the maximum number of ignored datapoints, the application will display a warning message after you select OK . The events marked as ignored will not appear on the plots.
Remarks	Text	Comments about the event.	You can enter a value manually in the box.
X	Numeric	The value of the random variable.	This value can be mapped from a query or dataset using the or manually entered when you create the analysis.

Production Analysis

Production Analysis Records

A Production Analysis record stores information about an analysis used to determine the reliability of a production process. The following table provides an alphabetical list and description of the fields that exist for the Production Analysis family. The information in the table reflects the baseline state and behavior of these fields. This list is not comprehensive.

This family is enabled for site filtering, which means that records in this family can be assigned to a specific site and will only be accessible to users who are assigned to the same site and have the

appropriate license and family privileges. For more information, refer to the [Sites](#) section of the documentation.

Field Caption	Data Type	Description	Behavior and Usage
Analysis End Date	Date	The last date that production output is measured for the analysis.	This field is populated with the latest date in your dataset in the field defined in the Production Date list on the Select Production Fields screen of the Production Analysis Builder. This field is labeled End Date on the datasheet. hidden
Analysis Name	Character	The name of the Production Analysis.	This value is populated with the value that you type in the Analysis Name box when you save or rename the Production Analysis. This field is labeled Analysis ID on the datasheet.
Analysis Start Date	Date	The first date that production output is measured for the analysis.	This field is populated with the earliest date in your dataset in the field defined in the Production Date list on the Select Production Fields screen of the Production Analysis Builder. This field is labeled Start Date on the datasheet.
Analysis Type	Character	The type of analysis being conducted.	This field is populated with the value Production Analysis. You can modify this value to something more specific.
Description	Description	A text field that stores any additional information about the analysis.	You can define this value by entering text manually.
Ignored Points	Number	The number of datapoints that were ignored because they would inaccurately skew the Reliability Loss calculations.	This field is populated with the number of points that have been ignored via the Point Tooltip window.
Margin Unit	Number	The unit, or currency, of the cost associated with the calculated production losses.	This field is set to \$ by default. Alternatively, you can change the margin units via the Set Unit Of Measure window. This field is labeled Margin Value Unit on the datasheet.

Field Caption	Data Type	Description	Behavior and Usage
Margin Value	Number	The value by which the GE Digital APM system will multiply the Production Loss to determine the cost. For example, if production was lost for 10 cases of bottles, and a production loss for one case costs 10 dollars, the Margin Value would be 10. $\text{Production Loss (10 cases)} \times \text{Margin Value (\$10)} = \text{a cost of \$100.}$	This field is populated with the value 1 by default. Alternatively, you can change the margin value via the Set Margin window.
Minimum Production Output	Number	The minimum production value, or the value that is to replace data that cannot be plotted (i.e., zero or negative output values). If your data contains zeros or negative values, they will be replaced with the minimum production value.	If your dataset contains zeros or negative values, this field is populated automatically with the minimum production value you chose when you created the analysis. Alternatively, you can change the minimum production value via the Set Minimum Production Output .
Pro Reliability	Number	The percentage of time in the Analysis Period that the process is reliable. For example, if the Pro Reliability value is 65%, the process would be reliable 65% of the time.	This field is populated with the value of the Process Reliability line that you define on the Production Analysis plot.
Production Date	Date	The date on which the production output value was recorded. If you have a date field within your query or dataset and you choose not to map it to the Production Analysis Builder, you can see the dates used to build the analysis in the Production Analysis Points Editor window.	This field is optional.
Production Output	Number	Values representing the amount of output produced by the unit during the specified period of time (e.g., hourly, daily, weekly, or monthly).	This field is required. You can define the units of measure for the output values after you create the analysis.

Field Caption	Data Type	Description	Behavior and Usage
Total Points	Number	The total number of datapoints in the analysis.	This field is populated with the number of points in the dataset that you defined when creating the analysis.
Unit ID	Character	The name of the unit on which the analysis is being performed.	This field is populated with values from your dataset in the field defined in the Unit ID list on the Select Product Fields screen of the Production Analysis Builder.
Unit Of Measure	Character	The units of production output (e.g., barrels).	This value will be populated with the value you define in the Set Unit Of Measure window. This value will be the basis for the units along the x-axis in the Production Analysis plot and in the Production Loss Regions pane.

Data Mapped to the Production Data Editor Window

When you create a Production Analysis from a query or dataset, the **Production Analysis Builder** will prompt you to map values from columns in the query or dataset to certain values in the Production Analysis. The values that you select to map on the **Select Product Fields** screen in the **Production Analysis Builder** will then appear in the associated columns in the **Production Data Editor** window.

Note: If the analysis is based on a query or a dataset and contains additional columns that are not mapped to columns in the analysis dataset, those columns will appear in the **Production Data Editor** window with the column name in parentheses.

The following table contains which columns are mapped from fields in the Production Analysis Builder to columns in the Edit Production Data window.

This family is enabled for site filtering, which means that records in this family can be assigned to a specific site and will only be accessible to users who are assigned to the same site and have the appropriate license and family privileges. For more information, refer to the [Sites](#) section of the documentation.

Production Analysis Builder Screen	Production Analysis Builder Field	Production Data Editor Window Column
Select Product Fields	Production Output	Production Output
Select Product Fields	Production Date	Date

Production Losses Records

A Production Losses record stores information about a loss of production and the cost associated with it. The following table provides an alphabetical list and description of the fields that exist for the Production Losses family, which appear by default on the Production Losses datasheet. The information in the table reflects the baseline state and behavior of these fields.

This family is enabled for site filtering, which means that records in this family can be assigned to a specific site and will only be accessible to users who are assigned to the same site and have the

appropriate license and family privileges. For more information, refer to the [Sites](#) section of the documentation.

Field Caption	Data Type	Description	Behavior and Usage
Area End	Number	The end of the area measured for losses.	This field depends on the value identified in the Losses Type field. This field is applicable only to Sub-Reliability Losses.
Area Start	Number	The value of the datapoint that marks the beginning of the area measured for losses.	The value in this field depends on the value identified in the Losses Type field. This field is applicable only to Reliability and Sub-Reliability Losses.
Losses Cost	Number	The total monetary amount that was lost as a result of the production loss.	This field is populated with the cost of the production loss, which is calculated by multiplying the production loss in the defined region with the Margin Value. This value also appears in the Cost column of the Production Loss Regions window for the corresponding loss.
Losses Type	Character	A description of the type of production loss calculated by the Production Analysis.	<p>The value in this field is populated with one of the following values:</p> <ul style="list-style-type: none"> • Efficiency/Utilization Loss • Reliability Loss • Sub Reliability Loss • Total Loss <p>The value in this field will also serve as the Record ID for the Production Loss record.</p>
Production Losses	Number	The amount of production that was lost as a result of the reliability of the production process.	This field is populated with the amount of production output that was lost in the defined region. This value also appears in the Quantity column in the Production Loss Regions window for the corresponding loss.

Field Caption	Data Type	Description	Behavior and Usage
Unit of Cost	Character	The unit, or currency, of the cost associated with the production loss.	This value is populated with \$ by default. Alternatively, you can change the margin units via the Set Currency window.
Unit Of Measure	Character	The units of production output (e.g., barrels).	This value will be populated with the value you define in the Set Unit Of Measure window .

Reliability Distribution

Distribution Analysis Records

A Distribution record stores information about the distribution of failures over the life of equipment. The following table provides an alphabetical list and description of the fields that exist for the Distribution family, which appear by default on the Normal, Weibull, Exponential, Lognormal, Triangular, Gumbel, or Generalized Extreme Value datasheets. The information in the table reflects the baseline state and behavior of these fields. This list is not comprehensive.

This family is enabled for site filtering, which means that records in this family can be assigned to a specific site and will only be accessible to users who are assigned to the same site and have the appropriate license and family privileges. For more information, refer to the [Sites](#) section of the documentation.

Field Caption	Data Type	Description	Behavior and Usage
Analysis ID	Character	The name of the Reliability or Probability Distribution Analysis associated with the Distribution record.	This field is populated automatically with the value in the Analysis ID field of the Reliability or Probability Distribution record to which the Distribution record is linked.
Analysis Name	Character	The name of the Reliability or Probability Distribution Analysis.	You can enter the name manually. This field is required.
Asset ID	Text	Fields that describe a piece of equipment, such as Equipment ID.	You can select the value that describes a piece of equipment for which you are performing an analysis. This field is required. Reliability Analysis can be conducted on any number of equipment.

Field Caption	Data Type	Description	Behavior and Usage
Confidence Level	Number	Indicates the percentage of uncertainty in a Goodness of Fit method.	The confidence level is used to indicate that you want the model to fit with a particular level of certainty. This value is set to 90 by default. You can enter a value between one (1) and one hundred (100).
Description	Text	The description of the Reliability or Probability Distribution Analysis.	You can enter the description manually. This field is optional.
Downtime	Text	Field that contains the specific period during which the piece of equipment is not operating during the analysis period.	This field is optional but must be numeric. If this information is available, it can be used to make the estimation more accurate. Fields like "return to service date" or "date repaired" can be used to estimate downtime.
Failure Date	Text	The field that contains the last date on which the piece of equipment failed. This data can have many different descriptions (e.g., Out of Service Date, Shutdown Date, or Failure Date).	This field is required.
Failure Mode	Text	The mode of failure.	Sometimes users put failed parts in this field, or even a description like "worn out" or "broke down." These descriptions can be very useful when deciding to include or not include a particular failure in the failure history for purposes of censoring. This field is not available on the datasheet.

Field Caption	Data Type	Description	Behavior and Usage
Fit Method	Character	The type of method used to estimate distribution parameters.	In a Reliability Distribution Analysis, this value is displayed in the Distribution Options section in the Time to Repair Distribution and Time to Failure Distribution sections. In a Probability Distribution Analysis, this value is displayed in the Distribution Options section on the Analysis Summary workspace. The method of fit for a Distribution Analysis can be either Least Squares or Maximum Likelihood Estimators (MLE) .
Installation Date	Character	The field that contains the date on which the piece of equipment was installed.	You can select a date field. This field is optional.
Mean	Number	The average point of the distribution. This is not necessarily the same as the average point of the dataset.	This value is calculated by the GE Digital APM system and is populated automatically. The value is calculated using distribution parameters, which vary depending on the type of distribution. For example, for a Weibull distribution, this value is calculated using the following formula: $Mean = Eta \times Gamma(1 + \frac{1}{Beta})$
Median	Number	The middle point of the distribution. This is not necessarily the same as the middle point of the dataset.	This value is calculated by the GE Digital APM system and is populated automatically. The value is calculated using distribution parameters, which vary depending on the type of distribution. For example, for a Weibull distribution, this value is calculated using the following formula: $Median = Eta \times (Ln(2))^{\frac{1}{Beta}}$

Field Caption	Data Type	Description	Behavior and Usage
Passed	Logical	Indicates whether the model passed the Goodness-of-Fit test or not.	<p>A value of Yes or No that indicates if the fit test was successful (the distribution fits the data based on the test performed).</p> <p>If the P-value is less than or equal to 1 minus the confidence level, the goodness of fit test has failed and this value is set automatically to No by the GE Digital APM system. Otherwise, the goodness of fit test is successful and this value is set to Yes.</p>
Published	Logical	Indicates whether the analysis has been published.	If the analysis has been published, this value is set to True. If the analysis has not been published, this value is set to False.
P-Value	Number	The probability that the GOF Statistic is greater than the value in the Statistic field.	This value is calculated by the GE Digital APM system. The value used to determine whether the analysis passed the goodness of fit (GOF) test. The P-value is interpreted as the probability that the test statistic is due to random error. Typically, the higher the P-value, the more likely the model is appropriate and the more likely that the fit will pass the test.
Random Variable	Character	The name of the independent variable, which associates a numerical value with every event (e.g., Downtime).	This value is only populated for a Distribution record associated with a Probability Distribution Analysis. This value is populated automatically with the value you specify in the Random Variable box on the Specify the Random Variable window.

Field Caption	Data Type	Description	Behavior and Usage
R-Squared	Number	The R-Squared Correlation Coefficient, which describes the strength of a linear model.	This value is calculated by the GE Digital APM system and populated automatically. This value measures how closely the points fall to the least squares line, providing an indication of how confident one can be of predictions made with the line. An R-Squared value greater than 0.9 is considered a good fit for linear regression.
Standard Deviation	Number	The variability of the random variable around the mean.	This value is calculated by the GE Digital APM system and populated automatically.
Statistic	Number	A value that indicates the preciseness of the fit of the data to the model.	This value is calculated automatically by the GE Digital APM system. Typically, the lower the GOF Statistic, the better the fit.
Time Units	Character	Time units for downtime.	This field contains a list of the following values: <ul style="list-style-type: none"> • Hours • Days • Weeks • Months • Quarters • Years The time units that you select here will apply to downtime only.
Units of Random Variable	Character	The time units associated with the independent variable.	This value is associated with the value in the Variable field. This value is only populated for a Distribution record associated with a Probability Distribution Analysis. This value is populated automatically with the value you specify in the Units box on the Specify the Random Variable window.

Reliability Growth

Reliability Growth Records

A Reliability Growth record stores information about an analysis that tracks changes in Mean Time Between Failure (MTBF) over a specified period of time to determine strategies or repairs necessary to increase the reliability of a product. The following table provides an alphabetical list and description of the fields that exist for the Reliability Growth family. The information in the table reflects the baseline state and behavior of these fields. This list is not comprehensive.

This family is enabled for site filtering, which means that records in this family can be assigned to a specific site and will only be accessible to users who are assigned to the same site and have the appropriate license and family privileges. For more information, refer to the [Sites](#) section of the documentation.

Field Caption	Data Type	Description	Behavior and Usage
Analysis End Date	Date	The date on which the Reliability Growth Analysis will end.	This field is only used for analyses based on dates. This value is populated with the value in the End Date section of the Set Analysis Period window. This field does not exist by default on the Reliability Growth datasheet.
Analysis End Time	Number	The cumulative operating time at which the analysis will end.	This field is only used for analyses based on cumulative operating time. This value is populated with the value in the End Time section of the Set Analysis Period window. This field does not exist by default on the Reliability Growth datasheet.
Analysis Name	Character	The name of the Growth Analysis.	This field is populated with the value that you entered in the Analysis Name box when you save the Growth Analysis. This field does not exist by default on the Reliability Growth datasheet.

Field Caption	Data Type	Description	Behavior and Usage
Analysis Start Date	Date	The date on which the Reliability Growth Analysis will begin.	This field is only used for analyses based on dates. This value is populated automatically with the value in the Start Date section of the Set Analysis Period window. This field does not exist by default on the Reliability Growth datasheet.
Analysis Start Time	Time	The cumulative operating time at which the Reliability Growth Analysis will begin.	This field is only used for analyses based on cumulative operating time. This value is populated automatically with the value in the Start Time section of the Set Analysis Period window. This field does not exist by default on the Reliability Growth datasheet.
Asset Installation Field	Character	The name of the field in the query or dataset that contains Asset installation data.	This field is populated automatically with the value you select in the Installation Date list on the Select Data Fields screen in the Reliability Growth Builder when you create an analysis based on dates. This field does not exist by default on the Reliability Growth datasheet.
Date Based Extrapolation	Logical	Indicates if the user specified the extrapolation based on a date.	If you extrapolate the analysis results based on failure dates, this value is set automatically to True. If you choose to extrapolate based on time or there is no extrapolation at all, this value is set to False.
Description	Character	A brief description of the analysis.	This field is populated automatically with the value that you entered in the Analysis Description box when you save the Growth Analysis. This field does not exist by default on the Reliability Growth datasheet.

Field Caption	Data Type	Description	Behavior and Usage
Downtime Units	Character	The units associated with downtime.	<p>This field is populated automatically with the value you select in the Time Units list on the Provide Information for Downtime screen when you create an analysis based on dates. You can select one of the following options:</p> <ul style="list-style-type: none"> • Hours • Days • Weeks • Months • Quarters • Years <p>This field does not exist by default on the Reliability Growth datasheet.</p>
Extrapolated	Logical	Indicates if the analysis results will be extrapolated beyond the analysis end date.	If you choose to extrapolate the results, this value will be set to True.
Extrapolation Date	Date	Indicates the date and time you extrapolated the analysis.	If the Date Based Extrapolation field is set to True, this field is populated automatically with the date and time you extrapolated the analysis in the GE Digital APM Framework.
Extrapolation Time	Numeric	Indicates the total operating time that will be cumulated when the extrapolation point is reached.	If the Extrapolated field is set to True and the Date Based Extrapolation field is set to False, this field is populated with the cumulative operating time that corresponds with the extrapolation time you set in the Select Extrapolation window.
Failure Date Field	Character	The name of the field in the query or dataset that contains the dates on which the Asset failed.	<p>This field is populated with the value you select in the Date list on the Select Data Fields screen when you create an analysis based on dates.</p> <p>This field does not exist by default on the Reliability Growth datasheet.</p>

Field Caption	Data Type	Description	Behavior and Usage
Failure Number Field	Character	The name of the field in the query or dataset that contains the number of failures recorded at each measurement.	<p>This field is populated with the value you select in the <Measurement> list on the Select Data Fields screen when you create an analysis.</p> <p>This field does not exist by default on the Reliability Growth datasheet.</p>
Failure Rate Plot	Binary	Contains an image of the <Measurement> Rate Trend plot.	<p>This field is used to display the <Measurement> Rate Trend graph in the Plots section in the Reliability Growth report.</p> <p>This field does not exist by default on the Reliability Growth datasheet.</p>
Failures	Text	Contains the data that is displayed in the Reliability Growth Data window.	<p>This field is used to populate the Assets and <Measurement> Data sections in the Reliability Growth report.</p> <p>This field does not exist by default on the Reliability Growth datasheet.</p>
Failures Plot	Binary	Contains an image of the Cumulative <Measurement> plot.	<p>This field is used to display the Cumulative <Measurement> plot in the Plots section in the Reliability Growth report.</p> <p>This field does not exist by default on the Reliability Growth datasheet.</p>
Failure Time Field	Character	The name of the field in the query or dataset that contains the cumulative operating time at which the piece of equipment or location failed.	<p>This field is populated with the value you select in the Cumulative Operating Time list on the Select Data Fields screen when you create an analysis based on cumulative operating time.</p> <p>This field does not exist by default on the Reliability Growth datasheet.</p>

Field Caption	Data Type	Description	Behavior and Usage
Is Grouped Data	Logical	Indicates whether or not the data is grouped.	<p>If this value is True, the data is grouped data and contains more than one failure at each measurement. If this value is False, the data is not grouped and contains only one failure at each measurement. This value depends on the type of data that is mapped to the Failure Number field.</p> <p>This field does not exist by default on the Reliability Growth datasheet.</p>
Is Non-Event Data	Logical	Indicates whether or not the data is event count.	<p>If this value is True, the data is not event count (e.g., cost). If this value is False, the data is event count (e.g., number of failures). This field is populated depending on the value you select in the Measurement Data Format section of the Select Data Format screen when you create the analysis.</p> <p>This field does not exist by default on the Reliability Growth datasheet.</p>

Field Caption	Data Type	Description	Behavior and Usage
Measurement Name	Character	The name of the data you are measuring throughout the analysis (e.g., cost, events).	<p>This field is populated automatically with the value you enter in the Measurement Name box on the Select Data Format screen when you create an analysis. After you create an analysis, you can change the value in the Measurement Name field via the Select Growth Data Format window. The measurement name is displayed throughout the analysis results.</p> <p>This field does not exist by default on the Reliability Growth datasheet.</p>
MTBF Plot	Binary	Contains an image of the MTB<Measurement> Trend plot.	<p>This field is used to display the MTB<Measurement>Trend plot in the Plots section in the Reliability Growth report.</p> <p>This field does not exist by default on the Reliability Growth datasheet.</p>

Growth Model Records

A Growth Model record stores information about the Reliability Growth model used to develop a Reliability Growth Analysis. The following table provides an alphabetical list and description of the fields that exist for the Growth Model family, which appear by default on the Growth Model datasheet. The information in the table reflects the baseline state and behavior of these fields.

This family is enabled for site filtering, which means that records in this family can be assigned to a specific site and will only be accessible to users who are assigned to the same site and have the appropriate license and family privileges. For more information, refer to the [Sites](#) section of the documentation.

Field Caption	Data Type	Description	Behavior and Usage
Analysis ID	Character	The name of the Reliability Growth Analysis.	This field is populated with the value in the Analysis ID field of the Reliability Growth record to which the Growth Model is linked.
Beta	Number	A value that represents the slope of the Cumulative Failures plot.	This field is populated with the Beta value calculated by the GE Digital APM system. The Beta value indicates whether the MTBF is increasing, decreasing, or remaining constant.
GOF Critical Value	Number	The value used to determine whether the analysis passed the goodness of fit (GOF) test.	This value is calculated by the GE Digital APM system. If the value in this field is greater than the value in the GOF Statistic field, the Passed GOF field is set to True.
GOF Statistic	Number	A value that demonstrates the preciseness of fit.	This value is calculated by the GE Digital APM system. If the value in this field is less than the value in the GOF Critical Value field, the Passed GOF field is set to True.
Lambda	Number	The scale parameter that equals the Y-intercept of the Cumulative Failures Plot at time $t = 1$.	This field is populated with the value calculated by the GE Digital APM system.
Model Start Date	Date	The date the model was started.	This field is populated with the start date of the segment.
Number of Failures	Number	The total number of failures in the dataset used to calculate the growth model.	This field is populated with the total number of failures in the Failure Data grid.
Offset	Number	The operating time offset for this model relative to the beginning of the analysis.	If there beginning operating time and the beginning observation time are the same, this field will be populated with 0. If there is a difference, this field will be populated with the difference between beginning operating time and beginning observation time.

Field Caption	Data Type	Description	Behavior and Usage
Passed GOF	Logical	Indicates whether the model passed the Goodness-of-Fit test or not.	The analysis passes the GOF test when the value in the GOF Statistic field is less than the value in the GOF Critical Value field.
Sequence	Number	The chronological order of this model in the analysis.	This field is populated with the segment number that corresponds to the Growth Model record. If there is only one segment, this field is populated automatically with 1 (None).
Time Terminated	Logical	Indicates if the end date of the model is time-based.	If this field is set to True, then the end of the model is time-based. Otherwise, the end of the model is failure-based.
Total Observation Time	Number	The total amount of time that the equipment is in operation during the specified analysis period.	This field is populated automatically with the total operating time calculated from your dataset. This value appears in the Analysis Period section of the Reliability Growth page and is the value in the AMSAA Reliability Growth Model.

Measurement Data Records

<Measurement> Data record stores information about the Reliability Growth Analysis, which is a data format used to create a Reliability Growth Analysis. The following table provides an alphabetical list and description of the fields that exist for the Reliability Growth Analysis family, which appear when you manually enter data on the Reliability Growth Analysis window. The information in the table reflects the baseline state and behavior of these fields.

This family is enabled for site filtering, which means that records in this family can be assigned to a specific site and will only be accessible to users who are assigned to the same site and have the appropriate license and family privileges. For more information, refer to the [Sites](#) section of the documentation.

Data for event-based analysis using failure dates

<Measurement Name>Tab

Field Caption	Data Type	Description	Behavior and Usage
Asset ID	Character	The ID of the Asset that failed.	This value is mapped from a query or dataset or manually entered when you create the analysis.
Cumulative Time <units>	Number	The Cumulative Time to Failure, which is the total runtime for a population of Assets at the moment that a failure occurs in one of them.	Values in this field are calculated by the GE Digital APM system and are read-only.
Date	Date	The date on which the failure occurred.	This value is mapped from a query or dataset or manually entered when you create the analysis and is required. If you delete a value in the Date field for an event-based analysis that is based on dates, when you select Finish , an error message will appear.
Downtime Units	Number	The amount of time that passed from the time the Asset failed until it was returned to service.	This information helps determine the total operating time of a piece of equipment or location. <Units> corresponds with the value selected in the Time Units list on the Provide Information for Downtime screen for the analysis.
Failures	Number	The number of failures represented by each datapoint. Cells in this column will contain the value 1 (one) by default, which indicates that the analysis data is not grouped, and one datapoint represents one failure. A value that is not equal to 1 (one) indicates that the analysis data is grouped, and each datapoint represents more than one failure or an amount of data.	This value can optionally be mapped from a query or dataset or manually entered when you create the analysis.
Ignore	Logical	A check box field that indicates whether or not the data on the selected row is ignored.	When selected, the data in the associated row will be excluded from the analysis. When cleared, data in the selected row will be included in the analysis. You can modify this value manually.

Field Caption	Data Type	Description	Behavior and Usage
Remarks	Character	Comments about the failure.	You can enter a value in this field manually.
Segment	Logical	The segment to which the data belongs.	Values displayed in this field are read-only.
Time <units>	Number	The Time to Failure, which is the amount of time between the date the Asset was put into service until the date that it failed. If the data includes an installation date for the Asset, this value is calculated from the installation date. If the data does not include an installation date, this value is calculated from the first failure. <Units> corresponds to the value selected in the Operating Time Units list on the Time Unit field for the analysis.	This value is calculated automatically by the GE Digital APM system. If the value in this field is greater than the value in the GOF Statistic field, the Passed GOF field is set to True.

Assets Tab

Field Caption	Data Type	Description	Behavior and Usage
Asset ID	Character	The Record ID of the Asset that is being analyzed.	This value is mapped from a query or dataset or manually entered when you create the analysis.
Installation Date	Date	The date on which the Asset was installed.	This field appears only for analyses based on failure dates. This value is mapped from a query or dataset or manually entered when you create the analysis.
Last Replacement Date	Number	The last date or time at which the Asset failed.	Values in this column are calculated by the GE Digital APM system and are read-only. For data that contains cumulative operating time, this field is Last Replacement <Measurement> .

Data for event-based analysis using cumulative operating time

<Measurement Name> Tab

Field Caption	Data Type	Description	Behavior and Usage
Asset ID	Character	The ID of the Asset that failed.	This value is mapped from a query or dataset or manually entered when you create the analysis.
COT <units>	Number	The Cumulative Operating Time, which is the total amount of time that has passed since the Asset was placed into service.	<p><Units> corresponds with the value selected in the Time Units list on the Select Data Fields screen for the analysis. This field is sorted in ascending order by default. This value is mapped from a query or dataset or manually entered when you create the analysis, and is required.</p> <p>Note: For analyses based on cumulative operating time, if the values in the Failure Date column are not in the same order as the values in the COT (units) column (e.g., if the Failure Date 1/1/2012 has a COT of 1000 and the Failure date 1/2/2012 has a COT of 990), when you select OK, a message will appear, stating that sorting cumulative operating time values from smallest to largest will result in failure dates that are not in order from earliest to latest. As a result, no dates will be shown in the analysis results; only cumulative operating time will be shown.</p>

Field Caption	Data Type	Description	Behavior and Usage
Cumulative Time <units>	Number	The Cumulative Time to Failure, which is the total runtime for a population of Assets at the moment that a failure occurs in one of them.	<p>Values in this field are calculated by the GE Digital APM system and are read-only.</p> <p>Note: The Cumulative Time is the total runtime for a piece of equipment or location after the analysis has started. This may be different from the COT, which is the total runtime of the piece of equipment or location since it was created. In our example, the haul truck has a mileage of 11,028 before the analysis starts, and fails at a mileage of 27,393. The COT is the total mileage on the truck, 27,293. The Cumulative Time is the mileage the truck has run since the analysis started (27,393-11,028=16,365). If the piece of equipment or location is brand new (i.e., the truck has a mileage of 0), the Cumulative Time and the COT will be the same.</p>

Field Caption	Data Type	Description	Behavior and Usage
Date	Date	The date on which the failure occurred.	<p>This value is mapped from a query or dataset or manually entered when you create the analysis and is required. If you delete a value in the Date field for an event-based analysis that is based on dates, when you select Finish, an error message will appear.</p> <p>This value is optional, but in order for dates to be displayed throughout the analysis, ALL failures must have a failure date. If one or more failure dates are missing, then no dates will be shown in the analysis; only cumulative operating time will be shown. For instance, in Example 2, the data does not include dates on which the haul truck broke down, so the analysis results will be able to predict the next failure in cumulative operating times only (e.g., the next failure will occur at 324,001 miles).</p>
Failures	Number	The number of failures represented by each datapoint. Cells in this column will contain the value 1 (one) by default, which indicates that the analysis data is not grouped, and one datapoint represents one failure. A value that is not equal to 1 (one) indicates that the analysis data is grouped, and each datapoint represents more than one failure or an amount of data.	This value can optionally be mapped from a query or dataset or manually entered when you create the analysis.
Ignore	Logical	A check box field that indicates whether or not the data on the selected row is ignored	When selected, the data in the associated row will be excluded from the analysis. When cleared, data in the selected row will be included in the analysis. You can modify this value manually.

Field Caption	Data Type	Description	Behavior and Usage
Remarks	Character	Comments about the failure.	You can enter a value in this field manually.
Segment	Logical	The segment to which the data belongs.	Values displayed in this field are read-only.

Assets Tab

Field Caption	Data Type	Description	Behavior and Usage
Asset ID	Character	The Record ID of the Asset that is being analyzed.	This value is mapped from a query or dataset or manually entered when you create the analysis.
Last Replacement	Number	The last date or time at which the Asset failed.	Values in this column are calculated by the GE Digital APM system and are read-only. For data that contains cumulative operating time, this field is Last Replacement <Measurement> .

Data for grouped non-event based analysis

<Measurement Name> Tab

Field Caption	Data Type	Description	Behavior and Usage
Cost	Number	The cost measured at each datapoint. For grouped data, values in this column represent the amount of data (e.g., cost) recorded between that datapoint and the previous datapoint. For non-grouped data, which is used in Examples 1 and 2, the values in this field are always 1 (one). For grouped data, the values can be greater than or less than 1 (one) but must be greater than 0 (zero).	This value is mapped from a query or dataset or manually entered when you create the analysis. The name of this column depends on the measurement name you are using for your analysis.

Assets Tab

Field Caption	Data Type	Description	Behavior and Usage
Asset ID	Character	The Record ID of the Asset that is being analyzed.	This value is mapped from a query or dataset or manually entered when you create the analysis.
Installation Date	Date	The date on which the Asset was installed.	This field appears only for analyses based on failure dates. This value is mapped from a query or dataset or manually entered when you create the analysis.
Last Replacement	Number	The last date or time at which the Asset failed.	Values in this column are calculated by the GE Digital APM system and are read-only. For data that contains cumulative operating time, this field is Last Replacement <Measurement> .

Spares Analysis

Failure Distributions Records

A Failure Distributions record stores information about the distribution of failures over the life of the spare part that you are analyzing. The following table provides an alphabetical list and description of the fields that exist for the Failure Distributions family and appear on the **Failure Distributions** tab in the workspace for a Spare by default.

This family is enabled for site filtering, which means that records in this family can be assigned to a specific site and will only be accessible to users who are assigned to the same site and have the appropriate license and family privileges. For more information, refer to the [Sites](#) section of the documentation.

Field	Data Type	Description	Behavior and Usage
Distribution Type	Character	The distribution type of the Failure Distribution.	<p>For Failure Distribution information that you want to define manually, a list appears in which you can select the desired value. The value is set to Exponential by default, but you can select any of the following additional distribution types:</p> <ul style="list-style-type: none"> • Normal • Weibull • Exponential • Lognormal • Triangular • Gumbel • Generalized Extreme Value <p>For Failure Distribution information that you have imported, this column displays the read-only distribution type of the analysis from which you have imported failure distribution information.</p>

Field	Data Type	Description	Behavior and Usage
Name	Character	The name of the Failure Distribution.	<p>This is a required field. The name of each Failure Distribution must be unique to the root Spare Application record. This field is labeled Distribution Name on the datasheet.</p> <ul style="list-style-type: none"> For Failure Distribution information that you want to define manually, you can enter a name in the Distribution Name field. For Failure Distribution information that you have imported, the Distribution Name field displays the hyperlinked value that is stored in the Analysis ID field in the Reliability Distribution or Reliability Growth record with which you associated failure distribution information. You can select the hyperlink to open the analysis.
<Parameter 1>	Number	The value of the <Parameter 1>	<p>Displays one of the following parameters, depending on the distribution type:</p> <ul style="list-style-type: none"> For a Weibull distribution, displays the Beta value. For an Exponential distribution, displays the Mean Time Between Failures value. For a Normal distribution, displays the Mean value. For a Lognormal distribution, displays the Mu value. <p>By default, values up to four decimal places are displayed in the <Parameter 1> column. If you select a cell in the <Parameter 1> column for a parameter that can be modified, all decimal places for the value will be displayed.</p>

Field	Data Type	Description	Behavior and Usage
<Parameter 2>	Number	The value of the <Parameter 2>	<p>Displays one of the following parameters, depending on the distribution type:</p> <ul style="list-style-type: none"> • For a Weibull distribution, displays the Eta value. • For an Exponential distribution, nothing is displayed. The Mean Time Between Failures value that is displayed in the <Parameter 1> column is the only parameter in an Exponential distribution. • For a Normal distribution, displays the Standard Deviation value. • For a Lognormal distribution, displays the Sigma value. <p>By default, values up to four decimal places are displayed in the <Parameter 2> column. If you select a cell in the <Parameter 2> column for a parameter that can be modified, all decimal places for the value will be displayed.</p>

Field	Data Type	Description	Behavior and Usage
<Parameter 3>	Number	The value of the <Parameter 3>	<p>Displays one of the following parameters, depending on the distribution type:</p> <ul style="list-style-type: none"> • For a Weibull distribution, displays the Gamma value. • For an Exponential distribution, nothing is displayed. The Mean Time Between Failures value displayed in the <Parameter 1> column is the only parameter in an Exponential distribution. • For a Normal distribution, nothing is displayed. The Mean and Standard Deviation values that are displayed in the <Parameter 1> and <Parameter 2> columns are the only parameters in a Normal distribution. • For a Lognormal distribution, displays the Gamma value. <p>By default, values up to four decimal places are displayed in the <Parameter 3> column. If you select a cell in the <Parameter 3> column for a parameter that can be modified, all decimal places for the value will be displayed.</p>

Field	Data Type	Description	Behavior and Usage
Time Unit	Character	The unit of measure that applies to the distribution type that appears in the Distribution Type column.	<p>For Failure Distribution information that you want to define manually, a list appears in which you can select the desired value. The value is set to Days by default, but you can select any of the following additional units of measure:</p> <ul style="list-style-type: none"> • Hours • Weeks • Months • Years <p>For Failure Distribution information that you have imported, this column displays the read-only unit of measure used in the analysis from which you have imported Failure Distribution information.</p>

Spares Records

A Spares record stores data related to the spare part that you want to analyze. The following table provides an alphabetical list and description of the fields that exist for the Spare family and appear on the Spare datasheet by default.

This family is enabled for site filtering, which means that records in this family can be assigned to a specific site and will only be accessible to users who are assigned to the same site and have the appropriate license and family privileges. For more information, refer to the [Sites](#) section of the documentation.

Field	Data Type	Description	Behavior and Usage
Current Holding Level	Number	The actual number of spare parts that you are currently storing.	The current holding level must be greater than or equal to the minimum inventory level but less than or equal to the maximum inventory level. If you enter a value in the Current Holding Level box that is less than the value in the Minimum Holding Level box or greater than the value in the Minimum Holding Level box, an error message appears and the value in the Current Holding Level box reverts back to the original value
EAM Stock Number	Number	The unique value associated with a Spare in the Enterprise Asset Management (EAM) system of the user that is used to identify a spare part.	A user can query GE Digital APM using an EAM Stock Number to determine the optimum holding value for a given spare part. This information can then be shared with the department of the organization that is responsible for procuring the spare part.
Expedited Cost(\$)	Number	The cost associated with placing a rush order for the spare part.	The expedited cost must be greater than the normal cost. If you enter a value in the Expedited Cost (\$) box that is less than the value in the Normal Cost (\$) box, an error message will appear, and the value in the Expedited Cost (\$) box will revert back to the value that existed before you modified it.
Expedited Order Time	Number	The amount of time it will take to place a rush order for the part and receive it at the location where it is stored on-site (i.e., warehouse).	The list to the right of the Expedited Order Time box lets you define the unit of measure for the specified period of time. The expedited order time must be less than the normal order time.
Holding Cost Rate(\$)	Number	The cost of storing the spare part for the amount of time selected in the Per list.	The list to the right of the Holding Cost Rate(\$) box lets you define the unit of measure that applies to the specified cost for storing a spare part.

Field	Data Type	Description	Behavior and Usage
Maximum Holding Level	Number	The maximum number of spare parts that you want to analyze using the Spares Analysis.	The maximum inventory level must be greater than the minimum inventory level. If you enter a value in the Maximum Holding Level box that is less than the value in the Minimum Holding Level box, an error message will appear, and the value in the Maximum Holding Level box will revert back to the value that existed before you modified it.
Minimum Holding Level	Number	The minimum number of spare parts that you want to analyze using the Spares Analysis.	The minimum holding level must be less than or equal to the maximum holding level. If you enter a value in the Minimum Holding Level box that is greater than the value in the Maximum Holding Level box, the Maximum Holding Level box will be updated automatically with the value in the Minimum Holding Level box. For example, if the Maximum Holding Level box contains the value 3 and you enter 4 in the Minimum Holding Level box, the value in the Maximum Holding Level box will be set automatically to 4.
Normal Cost (\$)	Number	The cost associated with a standard (i.e., not expedited) order for the spare part. The normal cost must be less than or equal to the expedited cost.	If you enter a value in the Normal Cost (\$) box that is greater than the value in the Expedited Cost (\$) box, the Expedited Cost (\$) box will be updated automatically with the value in the Normal Cost (\$) box. For example, if the Expedited Cost (\$) box contains the value 1000 and you enter 1500 in the Normal Cost (\$) box, the value in the Expedited Cost (\$) box will be set automatically to 1500.

Field	Data Type	Description	Behavior and Usage
Normal Order Time	Number	The amount of time that it takes to order the spare part from the manufacturer and receive it at the location where it is stored on-site (i.e., warehouse).	The list to the right of the Normal Order Time box lets you define the unit of measure for the specified period of time.
On-site Delivery Time	Number	The amount of time that it takes to have the spare part transferred from where it is stored on-site (e.g., warehouse) to the repair location.	The list to the right of the On-site Delivery Time box lets you define the unit of measure for the specified period of time.
Spare Name	Character	The name of the Spare record.	This is a required field. The name of each Spare must be unique to the root Spares Analysis.

Spare Application Populations Records

A Spare Application record stores information about age data for the equipment that contains the spare part that you are analyzing. The following table provides an alphabetical list and description of the fields that exist for the Spare Application Population family and appear in the grid by default.

This family is enabled for site filtering, which means that records in this family can be assigned to a specific site and will only be accessible to users who are assigned to the same site and have the appropriate license and family privileges. For more information, refer to the [Sites](#) section of the documentation.

Field	Data Type	Description	Behavior and Usage
Age	Number	The operational age of the population of equipment that is associated with the data in the linked Spare Application record and Spare record. Age value is the amount of time that the population has been in use.	You can enter a value manually to define this value.
Age Time Unit	Character	The unit of measure associated with the Age .	The Age Time Unit list is set to Years by default.
Name	Character	The name of the Spare Application record.	This is a required field. The name of each Spare Application must be unique to the root record.
Population Size	Number	The number of pieces of equipment that share the same age.	You can enter a value manually to define this value.

Spares Analysis Records

A Spares Analysis record stores information about an analysis that helps you maintain the optimal number of spare parts. The following table provides an alphabetical list and description of the fields that exist for the Spares Analysis family and appear on the Spares Analysis datasheet by default.

This family is enabled for site filtering, which means that records in this family can be assigned to a specific site and will only be accessible to users who are assigned to the same site and have the appropriate license and family privileges. For more information, refer to the [Sites](#) section of the documentation.

Field	Data Type	Description	Behavior and Usage
Analysis Name	Character	The name of the Spares Analysis.	You can modify the default value in this box to change the name of the existing analysis. The name of each Spare Analysis must be unique. This field is required.
Currency	Character	The currency that will be used as a label throughout the Spares Analysis for all cost boxes and in the plots.	You can enter symbols and text in the Currency box. For example, you can enter the symbol for U.S. currency, \$, or you can enter text for U.S. currency, US Dollars . Any data that you enter in the Cost boxes throughout the analysis must be appropriate for the type of currency that you enter in the Currency box.
Description	Character	A text field that stores any additional information about the Spares Analysis.	You can enter text manually to define this value.
Enable Random Seed	Logical	Specifies whether or not you want to run the Monte Carlo simulation for random results.	If you select the Enable Random Seed check box, you will generate different results each time you run the Monte Carlo simulation.

Field	Data Type	Description	Behavior and Usage
Number of Iterations	Number	The number of times the GE Digital APM system will perform calculations on the Spares Analysis data when you run the Monte Carlo simulation.	<p>When you create a new Spares Analysis, the Number of Iterations is set to 1000 by default. You can enter a different number of iterations. If the number of iterations is large, it will take longer for the simulation results to run and will result in more accurate Monte Carlo results.</p> <p>An Event Log is created for each holding level for every Spare for each iteration in a Spares Analysis. If you enable Event Logs for a Spares Analysis with a large number of iterations, a large number of Event Logs will be created, and the simulation will take longer to complete. When you enable Event Logs, you should change the number of iterations to a small number (i.e., one) so a small number of Event Log files will be created and the simulation will run in the shortest amount of time.</p>

Field	Data Type	Description	Behavior and Usage
Simulation End Date	Date	A date that defines the end of the analysis period.	When you create a new analysis, the end date of the analysis is set by default to the first day of the year that is 10 years after the current date. For example, if the start date is 1/1/2015 by default, then the end date will be set to 1/1/2025 by default. You can enter or select a different end date. The end date must be after the start date. If the end date is before the specified start date, an error message appears when you attempt to save the analysis.
Simulation Start Date	Date	A date that defines the beginning of the analysis period.	When you create a new analysis, the start date is set by default to the first day of the current year. For example, for the analyses created in the year 2015, the start date will be set to 1/1/2015 by default. You can enter or select a different start date. If the start date is after the specified end date, an error message appears when you attempt to save the analysis.

System Reliability

System Action Families

This topic provides a listing of all the System Action families with links to the family fields information.

System Action Records

System Action records store information about Condition-Based Maintenance, Procedure, Redesign, Time-Based Maintenance, and Training Actions. The following table provides an alphabetical list and description of the fields that exist for the System Action family and appear by default in the System Action datasheet. The information in the table reflects the baseline state and behavior of these fields. This list is not comprehensive.

This family is enabled for site filtering, which means that records in this family can be assigned to a specific site and will only be accessible to users who are assigned to the same site and have the appropriate license and family privileges. For more information, refer to the [Sites](#) section of the documentation.

Field Caption	Data Type	Description	Behavior and Usage
Action Cost	Numeric	A numeric value that specifies the cost associated with any materials or personnel needed to complete an action.	This value represents an expense that is incurred every time the action occurs. By default, the value in this field is set to 0 (zero).
Action Type	Character	The category into which the action can be classified.	You can select a value from the following options when you create the System Action record: <ul style="list-style-type: none"> • Condition-Based Maintenance (Predictive) • Procedure • Redesign • Time-Based Maintenance (Preventative) • Training After you create an action, this field is disabled. The values in this field are populated by the MI_ACTION_TYPE System Code Table.
Condition Monitoring Type	Character	Indicates whether the action occurs continuously or periodically.	You can select a value from the following options when you create or modify the System Action record: <ul style="list-style-type: none"> • Periodic • Continuous By default, the value in this field is set to Continuous. The values in this field are populated by the MI_CONDITION_MONITORING_TYPE System Code Table.
Description	Text	A text field that stores any additional information about the action.	You can define this value manually by entering text in the Description box.

Field Caption	Data Type	Description	Behavior and Usage
GUID	Character	A value that uniquely identifies the record within a System Reliability Analysis.	This value is generated automatically by the GE Digital APM system and does not appear in the System Action datasheet. In System Reliability Analyses, GUIDs are used to identify records because Entity Keys will not exist until a record is saved. Because a System Reliability Analysis may contain unsaved records, it is necessary to use a value that uniquely identifies those records within the system.
Name	Character	The name of the action.	You can define this field manually. This value is used to identify Actions in the System Reliability Analyses. For instance, the Name column appears by default in the Actions section in the workspace and displays values that exist in the Name field to identify the System Action records that are displayed in the workspace.

System Action Optimization Records

System Action Optimization records store information about the action intervals used when performing optimizations on an action. The following table provides an alphabetical list and description of the fields that exist for the System Action Optimization family and appear by default in the System Action Optimization datasheet. The information in the table reflects the baseline state and behavior of these fields. This list is not comprehensive.

This family is enabled for site filtering, which means that records in this family can be assigned to a specific site and will only be accessible to users who are assigned to the same site and have the appropriate license and family privileges. For more information, refer to the [Sites](#) section of the documentation.

Field Caption	Data Type	Description	Behavior and Usage
Interval Increment	Numeric	The delta used to increase the action interval when performing Action Optimization.	You can modify the value in this field to adjust the accuracy when performing Action Optimization to determine the action interval.
Last Optimized	Date	The date on which Action Optimization was last performed.	This field is read-only. This value is populated automatically after performing Action Optimization.
Max Value	Numeric	The maximum action interval allowed when performing Action Optimization.	The value in this field must be greater than the value in the Min Value field. You can modify the value in this field to adjust the search range when performing Action Optimization.
Min Value	Numeric	The minimum action interval allowed when performing Action Optimization.	The value in this field must be less than the value in the Max Value field. You can modify the value in this field to adjust the search range when performing Action Optimization.
Optimal Value	Numeric	The optimal interval at which an action should be performed.	This field is read-only. This value is populated automatically after performing Action Optimization.
Time Units	Character	The unit of time attributed to the action interval.	This field contains a list of the following values: <ul style="list-style-type: none"> • Hours • Days • Weeks • Months • Years

System Condition Monitor Records

System Condition Monitor records store information about continuous, condition-based maintenance Actions. The following table provides an alphabetical list and description of the fields that exist for the System Condition Monitor family and appear by default on the System Condition Monitor datasheet. The information in the table reflects the baseline state and behavior of these fields. This list is not comprehensive.

This family is enabled for site filtering, which means that records in this family can be assigned to a specific site and will only be accessible to users who are assigned to the same site and have the

appropriate license and family privileges. For more information, refer to the [Sites](#) section of the documentation.

Field Caption	Data Type	Description	Behavior and Usage
Action Cost	Number	A numeric value that specifies the cost associated with any materials or personnel needed to complete the Action.	By default, this value represents a one-time expense that is incurred when the Action is started. This value is set to 0 (zero). This field is available in the General section of the Properties pane.
Action Type	Character	The category into which the Action can be classified.	By default, this value is set to Condition-Based Maintenance (Predictive) (CM). After you create an Action, this field is disabled. This field is available in the General section of the Properties pane.
Condition Monitoring Type	Character	A field that contains a value indicating whether the Action occurs continuously or periodically at regular intervals.	By default, this value is set to Continuous. After you create an Action, this field is disabled. This field is available in the General section of the Properties pane.
Description	Text	A text field that stores any additional information about the Action.	You can enter text manually in the Description box. This field is available in the General section of the Properties pane.

Field Caption	Data Type	Description	Behavior and Usage
Detection probability (%)	Number	A numeric value representing the probability that the Action will identify a potential failure resulting from any Risk and correct that failure before it occurs.	<p>By default, this value is set to 100 by default. For an Action with no assigned Risks, any value stored in this field will be ignored.</p> <p>For example, a System Condition Monitor record with the Detection Probability value 50 has a 50% chance of identifying a potential failure resulting from a Risk. In other words, the Action will detect one out of two potential failures resulting from any Risks assigned to the Action.</p> <p>This field is available in the Condition Monitor section of the Properties pane.</p>
GUID	Character	A value that uniquely identifies the record within a System Reliability Analysis.	<p>This value is generated automatically by the GE Digital APM system and does not appear on the System Condition Monitor datasheet. In System Reliability Analyses, GUIDs are used to identify records because Entity Keys will not exist until a record is saved. Since a System Reliability Analysis may contain unsaved records, it is necessary to use a value that uniquely identifies those records within the system.</p>
Name	Character	The name of the Action.	<p>You can define this value manually. This value is used to identify Actions in the System Reliability Analyses. For example, the Name column appears by default in the Actions tab in the workspace and displays values that exist in the Name field to identify the System Action records that are displayed in the workspace.</p> <p>This field is available in the General section of the Properties pane.</p>

System Inspection Records

System Inspection records store information about periodic, condition-based maintenance Actions. The following table provides an alphabetical list and description of the fields that exist for the System Inspection family and appear by default on the System Inspection datasheet. The information in the table reflects the baseline state and behavior of these fields. This list is not comprehensive.

This family is enabled for site filtering, which means that records in this family can be assigned to a specific site and will only be accessible to users who are assigned to the same site and have the appropriate license and family privileges. For more information, refer to the [Sites](#) section of the documentation.

Field Caption	Data Type	Description	Behavior and Usage
Action Cost	Number	A numeric value that specifies the cost associated with any materials or personnel needed to complete the Action.	This value represents an expense that is incurred every time the Action occurs. By default, this value is set to 0 (zero). This field is available in the General section in the Properties pane.
Action Type	Character	The category into which the Action can be classified.	By default, this value is set to Condition-Based Maintenance (Predictive) (CM). After you create an Action, this field is disabled. This field is available in the General section of the Properties pane.
Condition Monitoring Type	Character	A value that indicates whether the Action occurs continuously or periodically at regular intervals.	By default, this value is set to Periodic. After you create an Action, this field is disabled. This field is available in the General section of the Properties pane.
Description	Text	A text field that stores any additional information about the Action.	You can enter text manually in the Description box. This field is available in the General section of the Properties pane.

Field Caption	Data Type	Description	Behavior and Usage
Detection Probability	Number	A numeric value representing the probability that the Action will identify a potential failure resulting from any Risk and correct that failure before it occurs.	<p>By default, this value is set to 100. For an Action with no assigned Risks, any value stored in this field will be ignored.</p> <p>An Action can detect a potential failure only when the Action occurs during a Risk's PF Interval, as defined by the value in the PF Interval and PF Interval Units fields in the System Risk record. If the Action does not occur during the PF Interval, the Action cannot identify the potential failure, and the value in the Detection Probability field will be ignored. To make the Action occur during the PF Interval of a Risk, you can manually modify the values in the PF Interval and PF Interval Units fields of the System Risk record, or you can optimize the Action.</p> <p>For example, setting the Detection Probability to 50 would indicate that the Action has a 50% chance of identifying a potential failure resulting from any Risk if the Action occurs during the PF Interval of the Risks. In other words, the Action will detect one out of two potential failures resulting from any Risks assigned to the Action when the Action occurs during the PF Interval of the Risks.</p> <p>This field is available in the Inspection section of the Properties pane.</p>

Field Caption	Data Type	Description	Behavior and Usage
Duration	Number	<p>A numeric value that, combined with the value in the Duration Units field, identifies the total time needed to complete the Action.</p> <p>For example, if the value in the Duration field is 4 and the value in the Duration Units field is Hours, then the Action will take four hours to complete.</p>	<p>By default, this value is set to 0 (zero).</p> <p>This field is available in the Inspection section of the Properties pane.</p>
Duration Units	Character	<p>The time units associated with the value in the Duration field.</p>	<p>You can select a value from the following options:</p> <ul style="list-style-type: none"> • Minutes • Hours • Days • Weeks • Months • Years <p>By default, the value in this field is set to Days. This field is available in the Inspection section of the Properties pane.</p>
GUID	Character	<p>A value that uniquely identifies the record within a System Reliability Analysis.</p>	<p>This value is generated automatically by the GE Digital APM system and does not appear on the System Inspection datasheet. In System Reliability Analyses, GUIDs are used to identify records because Entity Keys will not exist until a record is saved. Since a System Reliability Analysis may contain unsaved records, it is necessary to use a value that uniquely identifies those records within the system.</p>

Field Caption	Data Type	Description	Behavior and Usage
Interval	Number	<p>A numeric value that, combined with the value in the Interval Units field, indicates how often the Action will occur.</p> <p>For example, if the value in the Interval field is 4 and the value in the Interval Units field is Months, then the Action will occur every four months during the simulation period.</p>	<p>By default, this value is set to 1.</p> <p>This field is available in the Inspection section of the Properties pane.</p>
Interval Units	Character	<p>The time units associated with the value in the Interval field.</p>	<p>You can select a value from the following options:</p> <ul style="list-style-type: none"> • Minutes • Hours • Days • Weeks • Months • Years <p>By default, the value in this field is set to Days. This field is available in the Inspection section of the Properties pane.</p>
Name	Character	<p>The name of the Action.</p>	<p>You can define this value manually. This value is used to identify Actions in the System Reliability Analyses.</p> <p>For example, the Name column appears by default in the grid in the Actions section and displays values that exist in the Name field to identify the System Action records that are displayed in the grid.</p> <p>This field is available in the General section of the Properties pane.</p>

Field Caption	Data Type	Description	Behavior and Usage
One Time Action	Logical	Indicates whether the Action will occur one time or will be repeated more than once.	<p>If this check box is selected, the Action will occur once. If this check box is cleared, the Action will occur more than once. For example, an Action to inspect the vibration level of a pump might occur several times a year. In this case, the One Time Action check box of the corresponding System Inspection record would be cleared. An Action to inspect a newly installed pump for any installation errors might occur only once, in which case the One Time Action check box of the corresponding System Inspection record would be selected. By default, this check box is cleared.</p> <p>This field is available in the Inspection section of the Properties pane.</p>
Shutdown Required	Logical	Indicates whether the Action requires the piece of equipment or location to be shut down in order for the Action to be completed.	<p>If this check box is selected, the piece of equipment or location must be shut down in order for the Action to be completed. If this check box is cleared, the Action can be completed while the piece of equipment or location is running.</p> <p>For example, an Action to inspect the vibration level of a pump could be completed while the pump is running, so the Shutdown Required check box would be cleared. An Action to inspect the internal components of a pump would be completed while the pump is not running, so the Shutdown Required check box would be selected. By default, this check box is cleared.</p> <p>This field is available in the Inspection section of the Properties pane.</p>

System Preventive Maintenance Records

System Preventative Maintenance records store information about time-based maintenance Actions. The following table provides an alphabetical list and description of the fields that exist for the System Preventative Maintenance family and appear by default on the System Preventative Maintenance datasheet. The information in the table reflects the baseline state and behavior of these fields. This list is not comprehensive.

This family is enabled for site filtering, which means that records in this family can be assigned to a specific site and will only be accessible to users who are assigned to the same site and have the appropriate license and family privileges. For more information, refer to the [Sites](#) section of the documentation.

Field Caption	Data Type	Description	Behavior and Usage
Action Cost	Number	A numeric value that specifies the cost associated with any materials or personnel needed to complete the Action.	This value represents an expense that is incurred every time the Action occurs. By default, this value is set to 0 (zero). This field is available in the General section of the Properties pane.
Action Type	Character	The category into which the Action can be classified.	By default, this value is set to Time-Based Maintenance (Preventive) (PM). After you create an Action, this field is disabled. This field is available in the General section of the Properties pane.
Condition Monitoring Type	Character	A value that indicates whether the Action occurs continuously or periodically at regular intervals.	This field is not used for System Preventive Maintenance records and is disabled. This field is available in the General section of the Properties pane.
Description	Text	A text field that stores any additional information about the Action.	You can define this value manually by entering text in the Description box. This field is available in the General section of the Properties pane.

Field Caption	Data Type	Description	Behavior and Usage
Duration	Number	A numeric value that, combined with the value in the Duration Units field, identifies the total time needed to complete the Action. For example, if the value in the Duration field is 4 and the value in the Duration Units field is Hours, then the Action will take four hours to complete.	By default, this value is set to 0 (zero). This field is available in the Preventive Maintenance section of the Properties pane.
Duration Units	Character	The time units associated with the value in the Duration field.	You can select a value from the following options: <ul style="list-style-type: none"> • Minutes • Hours • Days • Weeks • Months • Years By default, the value in this field is set to Days by default. This field is available in the Preventive Maintenance section of the Properties pane.
GUID	Character	A value that uniquely identifies the record within a System Reliability Analysis.	This value is generated automatically by the GE Digital APM system and does not appear on the System Preventative Maintenance datasheet. In System Reliability Analyses, GUIDs are used to identify records because Entity Keys will not exist until a record is saved. Since a System Reliability Analysis may contain unsaved records, it is necessary to use a value that uniquely identifies those records within the system.

Field Caption	Data Type	Description	Behavior and Usage
Interval	Number	<p>A numeric value that, combined with the value in the Interval Units field, indicates how often the Action will occur.</p> <p>For example, if the value in the Interval field is 4 and the value in the Interval Units field is Months, then the Action will occur every four months during the simulation period.</p>	<p>By default, this value is set to 1.</p> <p>This field is available in the Preventive Maintenance section of the Properties pane.</p>
Interval Units	Character	<p>The time units associated with the value in the Interval field.</p>	<p>You can select a value from the following options:</p> <ul style="list-style-type: none"> • Minutes • Hours • Days • Weeks • Months • Years <p>This field is available in the Preventive Maintenance section of the Properties pane.</p>
Name	Character	<p>The name of the Action.</p>	<p>You can define this value manually. This value is used to identify Actions in the System Reliability Analyses. For instance, the Name column appears by default in the Actions section of the workspace and displays values that exist in the Name field to identify the System Action records that are displayed in the workspace.</p> <p>This field is available in the General section of the Properties pane.</p>

Field Caption	Data Type	Description	Behavior and Usage
One Time Action	Logical	Indicates whether the Action will occur one time or will be repeated more than once.	<p>If this check box is selected, the Action will occur once. If this check box is cleared, the Action will occur more than once.</p> <p>For example, an Action to inspect the vibration level of a pump might occur several times a year. In this case, the One Time Action check box of the corresponding System Inspection record would be cleared. An Action to inspect a newly installed pump for any installation errors might occur only once, in which case the One Time Action check box of the corresponding System Inspection record would be cleared. By default, this value is set to cleared.</p> <p>This field is available in the Preventive Maintenance section of the Properties pane.</p>

Field Caption	Data Type	Description	Behavior and Usage
Shutdown Required	Logical	Indicates whether the Action requires the piece of equipment or location to be shut down in order for the Action to be completed.	<p>If this check box is selected, the piece of equipment or location must be shut down for the Action to be completed. If this check box is cleared, the Action can be completed while the piece of equipment or location is running.</p> <p>For example, an Action to inspect the vibration level of a pump could be completed while the pump is running, so the Shutdown Required check box would be cleared. An Action to inspect the internal components of a pump would be completed while the pump is not running, so the Shutdown Required check box would be selected. By default, this check box is selected.</p> <p>This field is available in the Preventive Maintenance section of the Properties pane.</p>

System Special Action Records

System Special Action records store information about procedural, redesign, or training Actions. The following table provides an alphabetical list and description of the fields that exist for the System Special Action family and appear by default on the System Special Action datasheet. The information in the table reflects the baseline state and behavior of these fields. This list is not comprehensive.

This family is enabled for site filtering, which means that records in this family can be assigned to a specific site and will only be accessible to users who are assigned to the same site and have the appropriate license and family privileges. For more information, refer to the [Sites](#) section of the documentation.

Field Caption	Data Type	Description	Behavior and Usage
Action Cost	Number	A numeric value that specifies the cost associated with any materials or personnel needed to complete the Action.	This value represents an expense that is incurred every time the Action occurs. By default, this value is set to 0 (zero). This field is available in the General section of the Properties pane.
Action Type	Character	The category into which the Action can be classified.	You can select a value from the following options when you create the System Special Action record: <ul style="list-style-type: none"> • Procedure (PROC) • Redesign (DSN) • Training (TRN) After you create an Action, this field is disabled. This field is available in the General section of the Properties pane.
Description	Text	A text field that stores any additional information about the Action.	You can define this value manually by entering text in the Description box. This field is available in the General section of the Properties pane.
Duration	Number	A numeric value that, combined with the value in the Duration Units field, identifies the total time needed to complete the Action. For example, if the value in the Duration field is 4 and the value in the Duration Units field is Hours, then the Action will take four hours to complete.	By default, this value is set to 0 (zero). This field is available in the Special section of the Properties pane.

Field Caption	Data Type	Description	Behavior and Usage
Duration Units	Character	The time units associated with the value in the Duration field.	<p>You can select a value from the following options:</p> <ul style="list-style-type: none"> • Minutes • Hours • Days • Weeks • Months • Years <p>By default, this value is set to Days. This field is available in the Special section of the Properties pane.</p>
GUID	Character	A value that uniquely identifies the record within a System Reliability Analysis.	<p>This value is generated automatically by the GE Digital APM system and does not appear on the System Special Action datasheet. In System Reliability Analyses, GUIDs are used to identify records because Entity Keys will not exist until a record is saved. Because a System Reliability Analysis may contain unsaved records, it is necessary to use a value that uniquely identifies those records within the system.</p>
Interval	Number	<p>A numeric value that, combined with the value in the Interval Units field, indicates how often the Action will occur.</p> <p>For example, if the value in the Interval field is 4 and the value in the Interval Units field is Months, then the Action will occur every four months during the simulation period.</p>	<p>By default, this value is set to 1.</p> <p>This field is available in the Special section of the Properties pane.</p>

Field Caption	Data Type	Description	Behavior and Usage
Interval Units	Character	The time units associated with the value in the Interval field.	<p>You can select a value from the following options:</p> <ul style="list-style-type: none"> • Minutes • Hours • Days • Weeks • Months • Years <p>By default, this value is set to Days. This field is available in the Special section of the Properties pane.</p>
Name	Character	The name of the Action.	<p>You can define this field manually. This value is used to identify Actions in the System Reliability Analyses. For instance, the Name column appears by default in the Actions tab in the workspace and displays values that exist in the Name field to identify the System Action records that are displayed in the workspace.</p> <p>This field is available in the General section of the Properties pane.</p>

Field Caption	Data Type	Description	Behavior and Usage
One Time Action	Logical	Indicates whether the Action will occur one time or will be repeated more than once.	<p>If this check box is selected, the Action will occur once. If this check box is cleared, the Action will occur more than once.</p> <p>For example, an Action to inspect the vibration level of a pump might occur several times a year. In this case, the One Time Action check box of the corresponding System Special Action record would be cleared. An Action to inspect a newly installed pump for any installation errors might occur only once, in which case the One Time Action check box of the corresponding System Special Action record would be selected. By default, this check box is selected.</p> <p>This field is available in the Special section of the Properties pane.</p>

Field Caption	Data Type	Description	Behavior and Usage
Shutdown Required	Logical	Indicates whether the Action requires the piece of equipment or location to be shut down in order for the Action to be completed.	<p>If this check box is selected, the piece of equipment or location must be shut down in order for the Action to be completed. If this check box is cleared, the Action can be completed while the piece of equipment or location is running.</p> <p>For example, an Action to inspect the vibration level of a pump could be completed while the pump is running, so the Shutdown Required check box would be cleared. An Action to inspect the internal components of a pump would be completed while the pump is not running, so the Shutdown Required check box would be selected. By default, this check box is selected.</p> <p>This field is available in the Special section of the Properties pane.</p>

System Analysis Records

System Analysis records store general information about a System Analysis. The following table provides an alphabetical list and description of the fields that exist for the System Analysis family. The information in the table reflects the baseline state and behavior of these fields. This list is not comprehensive.

Note: In the following table, the bold field captions identify properties that can be defined for a System Reliability Analysis on the datasheet in the **Analysis Summary** workspace.

This family is enabled for site filtering, which means that records in this family can be assigned to a specific site and will only be accessible to users who are assigned to the same site and have the appropriate license and family privileges. For more information, refer to the [Sites](#) section of the documentation.

Field	Data Type	Description	Behavior and Usage
Action Cost Plot	Binary	A field that is used internally by the GE Digital APM system to store the image of the Annual Action Cost plot .	<p>You should not modify the value in this field. Doing so will cause the analysis to become corrupt, and you will no longer be able to open it.</p> <p>This field does not appear by default on the System Analysis datasheet.</p>
Action Cost Trend Plot	Binary	A field that is used internally by the GE Digital APM system to store the image of the Action Cost Trend plot .	<p>You should not modify the value in this field. Doing so will cause the analysis to become corrupt, and you will no longer be able to open it.</p> <p>This field does not appear by default on the System Analysis datasheet.</p>
Analysis End Date	Date	The date on which the analysis ends (i.e., when the simulation will stop running).	<p>This value is calculated by adding the amount of time defined by the values in the Period and Period Units fields to the value in the Analysis Start Date field. This field is populated automatically.</p> <p>This field does not appear by default on the System Analysis datasheet.</p>
Analysis Name	Character	A value that identifies the System Reliability Analysis throughout System Reliability.	<p>This value is populated automatically with New Analysis 1. You can define this field manually. The Analysis Name field appears by default in the Definition section in the Analysis Summary workspace and displays values that exist in the Analysis Name field to identify the System Analysis records that are displayed in the grid.</p> <p>This field is labeled Name on the datasheet.</p>

Field	Data Type	Description	Behavior and Usage
Analysis Result	Binary	A field that is used internally by the GE Digital APM system to store the data that appears in the Elements , Actions , and Resources grids.	<p>You should not modify the value in this field. Doing so will cause the analysis to become corrupt, and you will no longer be able to open it.</p> <p>This field does not appear by default on the System Analysis datasheet.</p>
Analysis Start Date	Date	The first date of the analysis.	<p>You can define this field manually. This field is labeled Start Date in the Definition section of the Analysis Summary workspace. The amount of time defined by the values in the Period and Period Units fields is added to the value in this field to determine how long the simulation will run.</p> <p>This field is labeled Start Date on the datasheet.</p>
Confidence	Number	A numeric value that represents the confidence level of simulation results.	<p>This value determines the Optimistic and Pessimistic values in the Histogram plot in the Simulation Results workspace. The default value for this field is 90. If you accept the default value, when you look at the Histogram plot, you will know that there is a 90% chance that the value in any cell in the grids in the Simulation Results workspace in the analysis lies within the range between the Optimistic and Pessimistic values.</p> <p>This field is labeled Confidence Level on the datasheet.</p>

Field	Data Type	Description	Behavior and Usage
Cost Plot	Binary	A field that is used internally by the GE Digital APM system to store the image of the Total Cost plot .	You should not modify the value in this field. Doing so will cause the analysis to become corrupt, and you will no longer be able to open it. This field does not appear by default on the System Analysis datasheet.
Cost Trend Plot	Binary	A field that is used internally by the GE Digital APM system to store the image of the Total Cost Trend plot .	You should not modify the value in this field. Doing so will cause the analysis to become corrupt, and you will no longer be able to open it. This field does not appear by default on the System Analysis datasheet.
Currency	Character	The currency used to display financial results in various places throughout System Reliability.	This value is set to \$ by default. The Cost column appears by default in the Elements section of the Simulation Results workspace. The value that exists in the Currency field is included in the Cost column header. For example, if you specify \$ in the Currency field, the label for the Cost column will be Cost (\$). This field is labeled Select Currency on the datasheet.
Description	Text	A text field that stores any additional information about the analysis.	You can define this value by entering text manually. This field is labeled Analysis Description on the datasheet.
Histogram Bins	Number	A numeric value that defines the number of bins, or columns, that will be displayed on the Histogram plot .	The default value for this field is 20. If you accept the default value, when you look at the Histogram plot on the Simulation Results workspace, there will be 20 bins on the Histogram plot.

Field	Data Type	Description	Behavior and Usage
Number of Iterations	Number	A numeric value that identifies the number of times the system will be simulated in order to compile simulation results.	<p>In the simple Monte Carlo example provided in this documentation, one iteration represents a single roll of the dice. The more iterations you use in an analysis, the more reliable the simulation results will be. The default value for this field is 1,000.</p> <p>The value you specify in the Iterations field must be compatible with the value that you specify in the Confidence field. The required number of iterations is dependent on the confidence boundary, as defined by the value in the Confidence field. The following equation is used to determine the required number of iterations:</p> <p>Minimum Number of Iterations = 40/(1-Confidence Field Value)</p> <p>In other words, the number of iterations must be high enough to provide a statistically significant confidence level. For example, a System Reliability Analysis with a value of 90 in the Confidence field would require a value of at least 400 in the Iterations field, as shown in the following calculation:</p> <p>Minimum Number of Iterations = 40/(1-90%)</p> <p>Minimum Number of Iterations = 40/.1</p> <p>Minimum Number of Iterations = 400</p> <p>If you enter a value in the Iterations field that is below the desired value, an error message will appear, and you will be required to specify another value before you can save the analysis.</p>

Field	Data Type	Description	Behavior and Usage
Period	Number	A numeric value that identifies the time period over which an analysis occurs.	By default, this value is set to 1. The value in the Period Units field determines the time units that will be applied to the value in the Period field.
Period Units	Character	The time units associated with the value in the Period field.	You can select a value from one of the following options: <ul style="list-style-type: none"> • Hours • Days • Weeks • Months • Years
Random Seed	Logical	Indicates whether or not different random numbers will be used for the system-generated inputs for each run of the simulation so that different results are returned each time.	By default, this value is set to False. If the Random Seed field is set to True, different inputs will be used for each simulation so that different results will be generated each time the simulation is run even if you have made no changes to the analysis. If the Random Seed field is set to False, the same results will be generated each time you run the simulation, provided that you have made no changes to the analysis. This field is labeled Enable Random Seed on the datasheet.
Resource Cost Plot	Binary	A field that is used internally by the GE Digital APM system to store the image of the Resource Cost plot .	You should not modify the value in this field. Doing so will cause the analysis to become corrupt, and you will no longer be able to open it. This field does not appear by default on the System Analysis datasheet.
Resource Occurrence Plot	Binary	A field that is used internally by the GE Digital APM system to store the image of the Resource Occurrence plot .	You should not modify the value in this field. Doing so will cause the analysis to become corrupt, and you will no longer be able to open it. This field does not appear by default on the System Analysis datasheet.

Field	Data Type	Description	Behavior and Usage
Time Analysis Type	Character	A field whose value determines how results are displayed in the Total Cost Trend Plot and Trend Plot .	By default, this value is Yearly. If this field is set to Yearly, the x-axis will display results for every year in the simulation period. If this field is set to Monthly, the x-axis will display results for every month in the simulation period.
Visual Attributes	Text	A field that is used internally by GE Digital APM and stores visual information, such as chart settings and diagram positioning.	You should not modify the value in this field. Doing so will cause the analysis to become corrupt, and you will no longer be able to open it. This field does not appear by default on the System Analysis datasheet.

System Asset Records

System Asset records store information about equipment and locations that exist in the System Analysis diagram. The following table provides an alphabetical list and description of the fields that exist for the System Asset family and appear by default on the System Asset datasheet. The information in the table reflects the baseline state and behavior of these fields. This list is not comprehensive.

This family is enabled for site filtering, which means that records in this family can be assigned to a specific site and will only be accessible to users who are assigned to the same site and have the appropriate license and family privileges. For more information, refer to the [Sites](#) section of the documentation.

Field Caption	Data Type	Description	Behavior and Usage
Description	Text	A detailed description that allows you to identify the piece of equipment or location and distinguish it from other pieces of equipment and locations.	You can define this value manually by entering text in the Description box. This field appears in the General section.
Fixed Cost	Number	The fixed cost of the piece of equipment or location when it fails. Fixed cost does not change as a result of other variables such as downtime. An example of fixed unplanned correction cost is the cost of a new piece of equipment.	By default, the Fixed Cost is set to 0 (zero). This field appears in the Financial Consequences section.

Field Caption	Data Type	Description	Behavior and Usage
GUID	Character	A value that uniquely identifies the record within a System Reliability Analysis.	This value is generated automatically by the GE Digital APM system and disabled. In System Reliability Analyses, GUIDs are used to identify records because Entity Keys will not exist until a record is saved. Since a System Reliability Analysis may contain unsaved records, it is necessary to use a value that uniquely identifies those records within the system. This field does not appear in the Properties pane.
Has Strategy	Logical	This field indicates whether the current record has a corresponding Asset Strategy.	This field does not appear in the Properties pane.
Lost Production Cost	Number	The financial amount of lost production per unit of time when the system is stopped or unable to run.	By default, the Lost Production Cost is set to 0 (zero) by default. This field appears in the Financial Consequences section.
Lost Production Cost Units	Character	The time units associated with the value in the Lost Production Cost field.	You can select a value from the following options: <ul style="list-style-type: none"> • Per Hour • Per Day • Per Week • Per Month • Per Year This field appears in the Financial Consequences section.
Name	Character	The name of the piece of equipment or location.	This value is populated automatically with Asset. You can define this value manually. This field appears in the General section.

Field Caption	Data Type	Description	Behavior and Usage
Production Contribution	Number	<p>The percentage that this piece of equipment or location will contribute to the overall production capacity of its parent system, with respect to other elements that are running in parallel to the piece of equipment or location.</p> <p>For example, if two pieces of equipment are running in parallel with one another and each one contributes 50% to the overall production output, you would enter a value of 50 in the Production Contribution field of each piece of equipment or location. The Production Contribution of each element in the Diagram will be used to calculate the overall production loss of the parent system when one or more elements are down.</p>	<p>By default, the Production Contribution is set to 100. If the piece of equipment or location does not contribute to the overall production output of its parent system, you can set the Production Contribution to 0 (zero).</p> <p>This field appears in the General section.</p>
Variable Cost	Number	<p>The cost incurred during downtime due to failures or shutdowns.</p>	<p>By default, the Variable Cost is set to 0 (zero).</p> <p>This field appears in the Financial Consequences section.</p>
Variable Cost Units	Character	<p>The time units associated with the value in the Variable Cost field.</p>	<p>You can select a value from the following options:</p> <ul style="list-style-type: none"> • Per Hour • Per Day • Per Week • Per Month • Per Year <p>This field appears in the Financial Consequences section.</p>

System Buffer Records

System Buffer records store information about buffers that exist in the System Analysis diagram. The following table provides an alphabetical list and description of the fields that exist for the System Buffer family and appear by default on the System Buffer datasheet. The information in the table reflects the baseline state and behavior of these fields. This list is not comprehensive.

This family is enabled for site filtering, which means that records in this family can be assigned to a specific site and will only be accessible to users who are assigned to the same site and have the

appropriate license and family privileges. For more information, refer to the [Sites](#) section of the documentation.

Field Caption	Data Type	Description	Behavior and Usage
Description	Text	Any additional information regarding the buffer.	On the System Buffer datasheet, you can define this value manually by entering text in the Description box. This field appears in the General section.
GUID	Character	A value that uniquely identifies the record within a System Reliability Analysis.	This value is generated automatically by the GE Digital APM system and disabled. In System Reliability Analyses, GUIDs are used to identify records because Entity Keys will not exist until a record is saved. Because a System Reliability Analysis may contain unsaved records, it is necessary to use a value that uniquely identifies those records within the system. This field does not appear in the Properties pane.
Initial Quantity in Percentage	Number	The percentage of product that the storage tank contains at the time of a failure.	By default, the value is set to 100. This field appears in the Buffer section.
Name	Character	The name of the buffer.	This value is populated automatically with Buffer. You can define this value manually. This field appears in the General section.

Field Caption	Data Type	Description	Behavior and Usage
Production Contribution	Number	The percentage that this piece of equipment or location will contribute to the overall production capacity of its parent system, with respect to other elements that are running in parallel to the piece of equipment or location. For example, if two pieces of equipment are running in parallel with one another and each one contributes 50% to the overall production output, you would enter a value of 50 in the Production Contribution field of each piece of equipment. The Production Contribution of each element in the Diagram will be used to calculate the overall production loss of the parent system when one or more elements are down.	By default, the Production Contribution is set to 100. If the piece of equipment does not contribute to the overall production output of its parent system, you can set the Production Contribution to 0 (zero). This field appears in the General section.
Time to Empty	Number	The time that it will take for the contents of a full buffer to empty when it is used.	By default, the Time to Empty is set to 0 (zero). This field appears in the Buffer section.
Time to Empty Units	Character	The time units that apply to the value in the Time to Empty field.	You can select a value from the following options: <ul style="list-style-type: none"> • Hours • Days • Weeks • Months • Years This field appears in the Buffer section.

Field Caption	Data Type	Description	Behavior and Usage
Time to Refill	Number	The time that it will take for the contents of an empty buffer to refill completely after it has been emptied.	By default, the Time to Refill is set to 0 (zero). This field appears in the Buffer section.
Time to Refill Units	Character	The time units that apply to the value in the Time to Refill field.	You can select a value from the following options: <ul style="list-style-type: none"> • Hours • Days • Weeks • Months • Years This field appears in the Buffer section.

System Global Event Records

System Global Event records store information about global events, which group together Actions requiring a system shutdown so that they will be performed at the same time, thereby maximizing the availability of the system. The following table provides an alphabetical list and description of the fields that exist for the System Global Event family. The information in the table reflects the baseline state and behavior of these fields. This list is not comprehensive.

This family is enabled for site filtering, which means that records in this family can be assigned to a specific site and will only be accessible to users who are assigned to the same site and have the appropriate license and family privileges. For more information, refer to the [Sites](#) section of the documentation.

Field Caption	Data Type	Description	Behavior and Usage
Description	Text	A text field that stores any additional information about the Global Event.	You can enter text manually to define this value.
Driver Type	Character	Indicates whether the Global Event will be started with an action or on a certain date.	<p>This value is required. The following options are available:</p> <ul style="list-style-type: none"> • Action Driven: The Global Event will start on the date the driving Action(s) begin and will trigger the start of any other Actions that are assigned to the Global Event. If more than one Action has been designated as a driving Action, the Global Event will occur when the first driving Action occurs. If no Action has been designated as a driving Action, the Global Event will not occur. • Date Driven: The Global Event will start on the date in the First Date field. If no date exists in the First Date field, the Global Event will start one interval period, as defined by the values in the Interval and Interval Units fields, into the simulation.
Event Definition	Text	The Actions assigned to the Global Event.	<p>This value that is used internally by the GE Digital APM system to store information identifying the Actions assigned to the Global Event.</p> <p>This field does not appear on the System Global Event datasheet.</p>

Field Caption	Data Type	Description	Behavior and Usage
First Date	Date	The date on which the Global Event will occur for the first time.	If no value exists in the First Date field, date-driven Global Events will start one interval period, as defined by the values in the Interval and Interval Units fields, into the simulation. This field is disabled in System Global Event records that contain the value Action Driven in the Driver Type field.
GUID	Character	A value that uniquely identifies the record within a System Reliability Analysis.	This value is generated automatically by the GE Digital APM system. In System Reliability Analyses, GUIDs are used to identify records because Entity Keys will not exist until a record is saved. Since a System Reliability Analysis may contain unsaved records, it is necessary to use a value that uniquely identifies those records within the system. This field does not appear on the System Global Event datasheet.
Interval	Number	A numeric value that indicates how often the Global Event will occur. For example, if the value in the Interval field is 4 and the value Months exists in the Interval Units field, then the Global Event will occur every 4 months during the simulation period.	This field is enabled only if the value in the Driver Type field is Date Driven and the One Time Event check box is cleared.
Interval Units	Character	The time units associated with the value in the Interval field.	You can select a value from the following options: <ul style="list-style-type: none"> • Hours • Days • Weeks • Months • Years

Field Caption	Data Type	Description	Behavior and Usage
Max Advance Duration	Number	<p>A numeric value that identifies the maximum time that an Action can be advanced forward to be completed with the other Actions assigned to the Global Event.</p> <p>For example, if the Max Advance Duration field contains the value 3 and the Max Advance Duration Units field contains the value Months, then any Action that would be performed 3 months or less after the Global Event can be moved forward in time and completed with the rest of the Actions that are assigned to the Global Event.</p>	<p>This value is set to 0 (zero) by default.</p>
Max Advance Duration Units	Character	<p>The time units associated with the value in the Max Advance Duration field.</p>	<p>You can select a value from the following options:</p> <ul style="list-style-type: none"> • Hours • Days • Weeks • Months • Years
Max Delay Duration	Number	<p>A numeric value that identifies the maximum time that an Action can be delayed to be completed with the other Actions that are assigned to the Global Event.</p> <p>For example, if the Max Delay Duration field contains the value 2 and the Max Advance Duration Units field contains the value Weeks, then any Action that would be performed 2 weeks or less before the Global Event can be delayed in time and completed with the rest of the Actions that are assigned to a Global Event.</p>	<p>By default, this value is set to 0 (zero).</p>

Field Caption	Data Type	Description	Behavior and Usage
Max Delay Duration Units	Character	The time units associated with the value in the Max Delay Duration field.	You can select a value from the following options: <ul style="list-style-type: none"> • Hours • Days • Weeks • Months • Years
Name	Character	The name of the Global Event.	You can define this value manually. This value is used to identify Global Events in System Reliability Analyses.
One Time Event	Logical	Indicates whether the Global Event will occur one time or can be repeated more than once.	If this check box is selected, the Global Event will occur once. If this check box is cleared, the Global Event will occur more than once. For example, you might create an Action to replace an expensive piece of machinery. If the Action requires a complete shutdown, to reduce total downtime of the system, you could create a one-time Global Event with the One Time Event check box selected that would reschedule any assigned Actions to be completed during the desired shutdown. In contrast, Actions that are repeated several times would be assigned to a recurring Global Event with the One Time Event check box cleared because the Global Event would be needed several times to minimize downtime in a simulation period.

System Link Records

System Link records store information about links that connect other elements that work together to produce output. The following table provides an alphabetical list and description of the fields that exist for the System Link family and appear by default on the System Link datasheet. The information in the table reflects the baseline state and behavior of these fields. This list is not comprehensive.

This family is enabled for site filtering, which means that records in this family can be assigned to a specific site and will only be accessible to users who are assigned to the same site and have the appropriate license and family privileges. For more information, refer to the [Sites](#) section of the documentation.

Field Caption	Data Type	Description	Behavior and Usage
Description	Text	Any additional information regarding the buffer.	On the System Link datasheet, you can define this value manually by entering text in the Description box.
GUID	Character	A value that uniquely identifies the record within a System Reliability Analysis.	This value is generated automatically by the GE Digital APM system and disabled. In System Reliability Analyses, GUIDs are used to identify records because Entity Keys will not exist until a record is saved. Because a System Reliability Analysis may contain unsaved records, it is necessary to use a value that uniquely identifies those records within the system. This field does not appear in the Properties pane.
Minimum Predecessors	Number	The minimum number of predecessors that the link can have.	The value in this field cannot exceed the actual number of predecessors. Attempting to enter a number greater than the number of actual predecessors results in the value reverting to the previous value.
Name	Character	The name of the link.	This value is populated automatically with Link. You can define this value manually.

System Resource Records

System Resource records store information about physical parts or materials, such as spare bearings or seals, or human resources, such as mechanics or technicians, or tools needed to complete an action (e.g. crane or hoist), or any other item which has a cost per use or per time associated with it. The following table provides an alphabetical list and description of the fields that exist for the System Resource family and appear by default on the System Resource datasheet. The information in the table reflects the baseline state and behavior of these fields.

This family is enabled for site filtering, which means that records in this family can be assigned to a specific site and will only be accessible to users who are assigned to the same site and have the appropriate license and family privileges. For more information, refer to the [Sites](#) section of the documentation.

Field Caption	Data Type	Description	Behavior and Usage
Count Occurrences	Boolean	Indicates whether the occurrences of the associated Resource Usages will be displayed in the Resource Occurrence plot.	If this check box is selected, the associated Resource Usages will be displayed on the Resource Occurrence Plot. If this check box is cleared, the Resource Usages will not be displayed. By default, this check box is selected.
Description	Text	Any additional information regarding the Resource.	You can enter text to define this value manually.
Fixed Cost	Number	The expense of the Resource that is not dependent on the amount of time the Resource is used.	By default, this value is set to 0 (zero).
GUID	Character	A value that uniquely identifies the record within a System Reliability Analysis.	This value is generated automatically by the GE Digital APM system and does not appear on the System Resource datasheet by default. In System Reliability Analyses, GUIDs are used to identify records because Entity Keys will not exist until a record is saved. Because a System Reliability Analysis may contain unsaved records, it is necessary to use a value that uniquely identifies those records within the system.
Name	Character	The name of the Resource (e.g., Mechanic).	You can define this value manually by typing a value into the Name field.
Quantity	Number	The quantity of a Resource that will be used by an Action or Risk. If an Action requires three Mechanic Resources, then the quantity would be three.	By default, this value is set to 1 (one).

Field Caption	Data Type	Description	Behavior and Usage
Variable Cost	Number	The cost of the Resource that is dependent on the Variable Cost Units.	By default, the Variable Cost is set to 0 (zero).
Variable Cost Units	Character	The time units associated with the Variable Cost Field.	You can select a value from the following options: <ul style="list-style-type: none"> • Per Hour • Per Day • Per Week • Per Month • Per Year By default, the Variable Cost Units is set to Per Day.

System Resource Usage Records

System Resource records store information about how a Resource will be used. The following table provides an alphabetical list and description of the fields that exist for the System Resource Usage family and appear by default on the System Resource Usage datasheet. The information in the table reflects the baseline state and behavior of these fields.

This family is enabled for site filtering, which means that records in this family can be assigned to a specific site and will only be accessible to users who are assigned to the same site and have the appropriate license and family privileges. For more information, refer to the [Sites](#) section of the documentation.

Field Caption	Data Type	Description	Behavior and Usage
Duration	Number	The length of time that a Resource will be used by an Action or Risk. If an Action requires a Mechanic Resource for four hours, then the Duration would be four.	By default, this value is set to 0 (zero).
Duration Units	Character	The units of time associated with the value in the Duration field. If an Action requires a Mechanic Resource for four hours, then the Duration Units would be Hours.	You can select a value from the following options: <ul style="list-style-type: none"> • Hours • Days • Weeks • Months • Years

Field Caption	Data Type	Description	Behavior and Usage
GUID	Character	A value that uniquely identifies the System Resource Usage record within a System Reliability Analysis.	This value is generated automatically by the GE Digital APM system and disabled. In System Reliability Analyses, GUIDs are used to identify records because Entity Keys will not exist until a record is saved. Because a System Reliability Analysis may contain unsaved records, it is necessary to use a value that uniquely identifies those records within the system.
Quantity	Number	The quantity of a Resource that will be used by an Action or Risk. If an Action requires three Mechanic Resources, then the quantity would be three.	By default, this value is set to 1 (one).
Resource List	Character	Contains a list of resources that can be assigned to a Risk or an Action.	You can select a Resource from the list to assign to a Risk or an Action.

System Risk Records

System Risk records store details about a Risk in a System Analysis and the cost of an equipment or location failure due to that Risk. Multiple System Risk records can be linked to a single System Asset record to represent multiple ways in which that piece of equipment or location can fail. The following table provides an alphabetical list and description of the fields that exist for the System Risk family and appear on the System Risk datasheet by default. The information in the table reflects the baseline state and behavior of these fields. This list is not comprehensive.

This family is enabled for site filtering, which means that records in this family can be assigned to a specific site and will only be accessible to users who are assigned to the same site and have the appropriate license and family privileges. For more information, refer to the [Sites](#) section of the documentation.

Field Caption	Data Type	Description	Behavior and Usage
Description	text	Additional information that is used to identify the Risk.	You can enter a description of the Risk into this field manually. This field appears in the General section.
Failures Without Replacement	Logical	Indicates whether or not the piece of equipment or location is replaced after each failure that results from the Risk.	By default, this check box is cleared. If this check box is selected, the piece of equipment or location is not replaced after each failure (as good as old). If this check box is cleared, the piece of equipment or location is replaced after each failure (as good as new).
Fixed Unplanned Correction Cost	Number	Indicates the set cost of a piece of equipment or location when it fails as a result of the Risk. Fixed cost does not change as a result of other variables, such as downtime. An example of fixed unplanned correction cost is the cost of a new piece of equipment.	By default, this field contains the value 0. This field appears in the Correction section.
Is Active	Logical	Indicates whether or not the piece of equipment's or location's operating time accumulates while the system is running. After a potential failure is detected, this value indicates whether the piece of equipment's or location's remaining life is reduced when the system is active or latent.	This value is a characteristic of the piece of equipment or location to which the Risk is related and should be the same for all Risks related to the same piece of equipment or location. By default, this check box is selected. If the check box is selected, the piece of equipment's or location's operating time will accumulate while the system is running, and the Is Latent check box should be cleared. This means that the v or location will lose lifetime while the system is running. For example, when a car (i.e., the system) is moving, a tire's (i.e., piece of equipment's) lifetime is being used up. The tire is active. This field is available in the Simulations Options section.

Field Caption	Data Type	Description	Behavior and Usage
Is Latent	Logical	Indicates whether or not the piece of equipment's or location's operating time accumulates while the system is idle. After a potential failure is detected, this value indicates whether the piece of equipment's or location's remaining life is reduced when the system is active or latent.	<p>This value is a characteristic of the piece of equipment or location to which the Risk is related and should be the same for all Risks related to the same piece of equipment or location. By default, this check box is cleared. If check box is selected, the piece of equipment's or location's operating time will accumulate while the system is idle, and the Is Active check box should be cleared. This means the piece of equipment or location will lose lifetime when the system is not running.</p> <p>For example, when a car (i.e., the system) is idle and not being used, failures can occur that will affect the hydraulic braking system (i.e., piece of equipment's). The rate of these failures is not impacted by the car being used or being idle, and is therefore latent in nature.</p>
Last Failure	Date	Indicates the most recent date that the piece of equipment or location failed due to the Risk.	You can use the Calendar tool to select the date of the most recent equipment or location replacement.
Name	Character	The name of the Risk.	You can enter the name of the Risk in this field manually. This value is used to identify Risks in the System Reliability Analysis.
Number of Subcomponents	Number	The number of subcomponents to which the Risk applies.	By default, this field contains the value 1. The value should be greater than 1 only if the Failure Without Replacement check box is selected.

Field Caption	Data Type	Description	Behavior and Usage
Percentage of PF Interval to Wait	Number	A numeric value that indicates how long to wait to repair the piece of equipment or location after detecting a potential failure due to this Risk.	By default, this field contains the value 0 and should be used only if the Repair Immediately check box is cleared. This value indicates at what percentage of the value in the PF Interval field the piece of equipment or location should be repaired. For example, an engineer monitors a Risk more frequently after a potential failure is detected and does not want to repair the piece of equipment or location immediately. If a potential failure is detected at the start of the PF Interval, and the engineer knows that the piece of equipment or location will not actually fail for 10 more days (i.e., a PF Interval of 10), he might decide to initiate a repair strategy six days later, or at 60 percent of the PF Interval. In this case, the Percentage of PF Interval to Wait is 60 percent.
PF Interval	Number	The time between when a potential failure is detectable and when an actual failure will occur.	By default, this field contains the value 0. This value is used along with the value in the Percentage of PF Interval to Wait field to determine when a piece of equipment or location should be repaired after a failure. The P-F Interval is determined by the user and is not calculated by the system.
PF Interval Units	Character	The time units associated with the PF Interval.	by default, this value is set to Days. You can select from a list of the following options: <ul style="list-style-type: none"> • Minutes • Hours • Days • Weeks • Months • Years

Field Caption	Data Type	Description	Behavior and Usage
Planned Correction Cost	Number	The total cost (i.e., fixed cost plus variable cost) of a planned correction that will prevent the Risk from resulting in a functional failure. An example of a planned correction is a routine equipment cleaning.	By default, this field contains the value 0. A planned correction does not happen as a result of a failure.
Planned Correction Duration	Number	The time needed to implement a planned correction.	By default, this field contains the value 0.
Planned Correction Duration Units	Character	The time units associated with the Planned Correction Duration.	By default, this value is set to Days. You can select from a list of the following options: <ul style="list-style-type: none"> • Hours • Days • Weeks • Months • Years
Repair Immediately	Logical	A value that indicates whether or not the piece of equipment or location should be repaired immediately if a potential failure due to this Risk is detected.	By default, this check box is selected. If the check box is selected, the piece of equipment or location should be repaired as soon as an inspection detects a failure, regardless of the remaining life of the piece of equipment or location. If the check box is cleared, the piece of equipment or location should be repaired according to the value in the Percentage of PF Interval to Wait field.

Field Caption	Data Type	Description	Behavior and Usage
Variable Unplanned Correction Cost	Number	A number that indicates the variable cost associated with the downtime of a piece of equipment or location when it fails due to the Risk. An example of variable unplanned correction cost is the cost of labor per time period of the mechanic that repairs the piece of equipment or location.	By default, this field contains the value 0.
Variable Unplanned Correction Cost Units	Character	The time units associated with the Variable Unplanned Correction Cost.	By default, this value is set to Per Day. You can select from a list of the following options: <ul style="list-style-type: none"> • Per Hour • Per Day • Per Week • Per Month • Per Year

System Scenario Records

System Scenario records store general information about a scenario in a System Reliability Analysis. The following table provides an alphabetical list and description of the fields that exist for the System Scenario family. The information in the table reflects the baseline state and behavior of these fields. This list is not comprehensive.

This family is enabled for site filtering, which means that records in this family can be assigned to a specific site and will only be accessible to users who are assigned to the same site and have the appropriate license and family privileges. For more information, refer to the [Sites](#) section of the documentation.

Field Caption	Data Type	Description	Behavior and Usage
Description	Text	A brief description that helps distinguish a given Scenario from other Scenarios that exist within a certain System Reliability Analysis. For example, the value in the Description field may indicate how the Diagram associated with one Scenario differs from the Diagram associated with another.	You can define this value manually by entering text in the Description box.
GUID	Character	Contains a value that uniquely identifies the record within a System Reliability Analysis.	This value is generated automatically by the GE Digital APM system. In System Reliability Analyses, GUIDs are used to identify records because Entity Keys will not exist until a record is saved. Since a System Reliability Analysis may contain unsaved records, it is necessary to use a value that uniquely identifies those records within the system. This field does not appear in the Definition section.
Is Result Valid	Boolean	A logical value that indicates whether the current simulation results are valid.	If this value is True, the current simulation results are valid. If the simulation has been modified or changed in any way, this field will be set to False until the simulation has been run again. This field does not appear in the Definition section.
Name	Character	The name of the scenario.	This value is populated automatically with New Scenario 1. You can modify this value by selecting  .

System Sensor Records

System Sensor records store information about a sensor that detects the failure of a piece of equipment or location and notifies Switches of the failure. The following table provides an alphabetical list and description of the fields that exist for the System Sensor family. The information in the table reflects the baseline state and behavior of these fields.

This family is enabled for site filtering, which means that records in this family can be assigned to a specific site and will only be accessible to users who are assigned to the same site and have the

appropriate license and family privileges. For more information, refer to the [Sites](#) section of the documentation.

Field Caption	Data Type	Description	Behavior and Usage
Activated Switches	Text	Identifies the switches that the sensor activates.	The Activated Switches cell contains a list of all Switch elements in the diagram. In the list, you can select a switch that the sensor activates. After you make your selections, the names of those Switch elements will appear in the Activated Switches cell. These values are stored as text in the Activated Switches field. This field appears in the Detail section.
Deactivated Switches	Text	Identifies the switches that the sensor deactivates.	The Deactivated Switches cell contains a list of all Switch elements in the diagram. In the list, you can select A switch that the sensor deactivates. After you make your selections, the names of those Switch elements will appear in the Deactivated Switches cell. These values are stored as text in the Deactivated Switches field. This field appears in the Detail section.
Description	Text	Any additional information about the sensor.	On the System Sensor datasheet, you can define this value manually by entering text in the Description box. This field appears in the General section.

Field Caption	Data Type	Description	Behavior and Usage
GUID	Character	A value that uniquely identifies the record within a System Reliability Analysis.	This value is generated automatically by the GE Digital APM system and disabled. In System Reliability Analyses, GUIDs are used to identify records because Entity Keys will not exist until a record is saved. Because a System Reliability Analysis may contain unsaved records, it is necessary to use a value that uniquely identifies those records within the system. This field does not appear in the Properties pane.
Monitored Elements	Text	Identifies the Diagram elements that the sensor monitors.	The Monitored Elements cell contains a list of all elements in the diagram. In the list, you can select an element that a given sensor monitors. After you make your selections, the names of those elements will appear in the Monitored Elements cell. These values are stored as text in the Monitored Elements field. This field appears in the Detail section.
Name	Character	The name of the sensor.	This value is populated automatically with Sensor. You can define this value manually. This field appears in the General section.

System Subsystem Records

System Subsystem records store information about a system of equipment or locations. The following table provides an alphabetical list and description of the fields that exist for the System Subsystem family. The information in the table reflects the baseline state and behavior of these fields. This list is not comprehensive.

This family is enabled for site filtering, which means that records in this family can be assigned to a specific site and will only be accessible to users who are assigned to the same site and have the appropriate license and family privileges. For more information, refer to the [Sites](#) section of the documentation.

Field Caption	Data Type	Description	Behavior and Usage
Connections	Text	This field is used internally by the GE Digital APM system to store connections in the diagram.	This field does not appear in the Properties pane.
Description	Text	Any additional information regarding the subsystem.	On the System Subsystem datasheet, you can define this value manually by entering text in the Description box. This field appears in the General section.
Diagram	Binary	This field is used internally by the GE Digital APM system to store the diagram.	This field does not appear in the Properties pane.
Element Properties	Text	This field is used internally by the GE Digital APM system to store element properties.	This field does not appear in the Properties pane.
Fixed Cost	Number	The cost of lost production when the subsystem fails. Fixed cost does not change as a result of other variables such as downtime.	By default, this value is set to 0 (zero). This field appears in the Financial Consequences section.
GUID	Character	A value that uniquely identifies the record within a System Reliability Analysis.	This value is generated automatically by the GE Digital APM system and disabled. In System Reliability Analyses, GUIDs are used to identify records because Entity Keys will not exist until a record is saved. Because a System Reliability Analysis may contain unsaved records, it is necessary to use a value that uniquely identifies those records within the system. This field does not appear in the Properties pane.
Has Strategy	Logical	This field indicates whether the current record has a corresponding System Strategy.	This field does not appear in the Properties pane.
Lost Production Cost	Number	The cost of lost production per unit of time when the subsystem is not running.	By default, the Lost Production Cost is set to 0 (zero). This field appears in the Financial Consequences section.

Field Caption	Data Type	Description	Behavior and Usage
Lost Production Cost Units	Character	The time units for the Lost Production Cost field.	<p>You can select a value from the following options:</p> <ul style="list-style-type: none"> • Per Hour • Per Day • Per Week • Per Month • Per Year <p>This field appears in the Financial Consequences section.</p>
Name	Character	The name of the Subsystem.	<p>This value is populated automatically with Subsystem. You can define this value manually.</p> <p>This field appears in the General section.</p>
Production Contribution	Number	<p>The percentage that this piece of equipment or location will contribute to the overall production capacity of its parent system, with respect to other elements that are running in parallel to the piece of equipment or location.</p> <p>For example, if two pieces of equipment are running in parallel and each one contributes 50% to the overall production output, you would enter a value of 50 in the Production Contribution field for each piece of equipment. The Production Contribution of each element in the Diagram will be used to calculate the overall production loss of the parent system when one or more elements are down.</p>	<p>By default, the Production Contribution is set to 100. If the piece of equipment or location does not contribute to the overall production output of its parent system, you can set the Production Contribution to 0 (zero). The value in the Production Contribution field of the Default subsystem or Root Subsystem is disabled on that subsystem's Properties pane.</p> <p>This field appears in the General section.</p>

Field Caption	Data Type	Description	Behavior and Usage
Variable Cost	Number	The cost incurred during the downtime due to subsystem failures or shutdowns.	By default, the Variable Cost is set to 0 (zero). This field appears in the Financial Consequences section.
Variable Cost Units	Character	The time units associated with the value in the Variable Cost field.	You can select a value from the following options: <ul style="list-style-type: none"> • Per Hour • Per Day • Per Week • Per Month • Per Year This field appears in the Financial Consequences section.

System Switch Records

System Switch records store information about components that are activated or deactivated by a Sensor when a failure occurs. The following table provides an alphabetical list and description of the fields that exist for the System Switch family and appear by default on the System Switch datasheet. The information in the table reflects the baseline state and behavior of these fields. This list is not comprehensive.

This family is enabled for site filtering, which means that records in this family can be assigned to a specific site and will only be accessible to users who are assigned to the same site and have the appropriate license and family privileges. For more information, refer to the [Sites](#) section of the documentation.

Field Caption	Data Type	Description	Behavior and Usage
Description	Text	Any additional information regarding the buffer.	You can define this value manually by entering text in the Description box. This field appears in the General section.
Fixed Cost	Number	The cost to fix the switch when it fails. Fixed cost does not change as a result of other variables such as downtime.	By default, the value is set to 0 (zero). This field appears in the Financial Consequences section.

Field Caption	Data Type	Description	Behavior and Usage
GUID	Character	A value that uniquely identifies the record within a System Reliability Analysis.	This value is generated automatically by the GE Digital APM system and disabled. In System Reliability Analyses, GUIDs are used to identify records because Entity Keys will not exist until a record is saved. Because a System Reliability Analysis may contain unsaved records, it is necessary to use a value that uniquely identifies those records within the system. This field does not appear in the Properties pane.
Lost Production Cost	Number	The cost of lost production per unit of time when the switch is not running.	The Lost Production Cost is set to 0 (zero) by default. This field appears in the Financial Consequences section.
Lost Production Cost Units	Character	The time units for the Lost Production Cost field.	You can select a value from the following options: <ul style="list-style-type: none"> • Per Hour • Per Day • Per Week • Per Month • Per Year This field appears in the Financial Consequences section.
Name	Character	The name of the switch.	This value is populated automatically with Switch. You can define this value manually. This field appears in the General tab.

Field Caption	Data Type	Description	Behavior and Usage
Production Contribution	Number	<p>The percentage that this piece of equipment or location will contribute to the overall production capacity of its parent system, with respect to other elements that are running in parallel to the piece of equipment or location.</p> <p>For example, if two pieces of equipment are running in parallel with one another and each one contributes 50% to the overall production output, you would enter a value of 50 in the Production Contribution field of each piece of equipment. The Production Contribution of each element in the Diagram will be used to calculate the overall production loss of the parent system when one or more elements are down.</p>	<p>By default, the Production Contribution is set to 100. If the piece of equipment does not contribute to the overall production output of its parent system, you can set the Production Contribution to 0 (zero).</p> <p>This field appears in the General section.</p>
Variable Cost	Number	<p>The cost incurred during the downtime due to failures or shutdowns.</p>	<p>By default, the Variable Cost is set to 0 (zero).</p> <p>This field appears in the Financial Consequences section.</p>
Variable Cost Units	Character	<p>The time units associated with the value in the Variable Cost field.</p>	<p>You can select a value from the following options:</p> <ul style="list-style-type: none"> • Per Hour • Per Day • Per Week • Per Month • Per Year <p>This field appears in the Financial Consequences section.</p>

Catalog Items

Analyses Folder

The Catalog folder \\Public\Meridium\Modules\Reliability Manager\Analyses contains the following items.

Item Name	Behavior and Usage
All Production Data	This query is used to create a Production Analysis from PLA Production Data.
Combined Production Data Codes	This subquery is used by the All Production Data query.
Production Event Code - Max Loss	This subquery is used by the Combined Production Data Codes subquery.
Production Impact Code - Max Loss	This subquery is used by the Combined Production Data Codes subquery.
Production OEE Code - Max Loss	This subquery is used by the Combined Production Data Codes subquery.

Queries Folder

The Catalog folder \\Public\Meridium\Modules\Reliability Manager\Queries contains the following items.

Item Name	Behavior and Usage
Dashboard - Recommendation Summary	Displays the Recommendation Summary chart on the RA Overview page.
Dashboard - Top 10 - Cost from Work History by Equipment	Displays the top 10 Equipment based on costs from Work Histories in the Top 10 Bad Actors chart on the RA Overview page.
Dashboard - Top 10 - Cost from Work History by Functional Location	Displays the top 10 Functional Locations based on costs from Work Histories in the Top 10 Bad Actors chart on the RA Overview page.
Dashboard - Top 10 - Equipment Linked to Reliability	Displays the top 10 Equipment linked by the Reliability family in the Top 10 Bad Actors chart on the RA Overview page.
Dashboard - Top 10 - Functional Location Linked to Reliability	Displays the top 10 Functional Locations linked by the Reliability family in the Top 10 Bad Actors chart on the RA Overview page.
Dashboard - Top 10 - LPO from PLA by Equipment	Displays the LPO from PLA by Equipment in the Top 10 Bad Actors chart on the RA Overview page.
Dashboard - Top 10 - Production Cost from PLA by Equipment	Displays the production costs from PLA by Equipment in the Top 10 Bad Actors chart on the RA Overview page.
Dashboard - Top 10 Bad Actors with PLA	Displays the top 10 assets or Functional Locations that are costing you the most with PLA in the Top 10 Bad Actors chart on the RA Overview page.
Dashboard - Top 10 Bad Actors without PLA	Displays the top 10 assets or Functional Locations that are costing you the most without PLA in the Top 10 Bad Actors chart on the RA Overview page.

Item Name	Behavior and Usage
Dashboard - Track Result - Cost from Work History	Displays the costs from work history in the Track Results By recommendation Implementation Year chart on the RA Overview page.
Dashboard - Track Result - Costs of Functional Location	Displays the sum of maintenance costs and production costs of a Functional Location in the Track Results By recommendation Implementation Year chart on the RA Overview page.
Dashboard - Track Result - Equipment with FE Recommendations Implemented	Displays the equipment with FE recommendations implemented in the Track Results By recommendation Implementation Year chart on the RA Overview page.
Dashboard - Track Result - Equipment with FE Recommendations Implemented - All Years	Displays the equipment with FE recommendations implemented for all years in the Track Results By recommendation Implementation Year chart on the RA Overview page.
Dashboard - Track Result - Last 5 Years	Displays the results of the last 5 years in the Track Results By recommendation Implementation Year chart on the RA Overview page.
Dashboard - Track Result - Maintenance Costs	Displays maintenance costs in the Track Results By recommendation Implementation Year chart on the RA Overview page.
Dashboard - Track Result - Production Loss Costs	Displays production loss costs in the Track Results By recommendation Implementation Year chart on the RA Overview page.
Dashboard - Track Result - Production Loss Costs - Sub Query	Displays subquery production loss costs in the Track Results By recommendation Implementation Year chart on the RA Overview page.
Dashboard - Track Result - Total Cost from Work History	Displays the total cost from work history in the Track Results By recommendation Implementation Year chart on the RA Overview page.
Dashboard - Track Result - Total Cost from Work History and PLA	Displays total cost from work history and PLA in the Track Results By recommendation Implementation Year chart on the RA Overview page.
Dashboard - Track Result with PLA	Displays results with PLA in the Track Results By recommendation Implementation Year chart on the RA Overview page.
Dashboard - Track Result without PLA	Displays results without PLA in the Track Results By recommendation Implementation Year chart on the RA Overview page.
RAPageFilter	Returns the page filters for the RA Overview page.

Reliability Manager Folder

The Catalog folder \\Public\Meridium\Modules\Reliability Manager contains the following items.

Item Name	Behavior and Usage
RARecommendationSummary	Displays the Recommendation Summary graph on the RA Overview page.
RATop10BadActors	Displays the Top 10 Bad Actors chart on the RA Overview page.
RATop10BadActorsWithPLA	Displays the Top 10 Bad Actors chart with PLA data on the RA Overview page.
RATrackResultsByRecommendation	Displays the Track Results By Recommendation Implementation Year graph on the RA Overview page.
RATrackResultsByRecommendationWithPLA	Displays the Track Results By Recommendation Implementation Year graph with PLA data on the RA Overview page.
Reliability Dashboard	Displays the Reliability Dashboard that contains the Recommendation Summary graph, Top 10 Bad Actors chart, and Track Results By Recommendation Implementation Year graph.

Reports Folder

The Catalog folder \\Public\Meridium\Modules\Reliability Manager\Reports contains the following items.

Item Name	Behavior and Usage
AssetSubreportDistribution	Displays the subreport for Asset Data in the Reliability Distribution Analysis Report.
AssetsSubreportGrowth	Displays the subreport for Asset Data in the Reliability Growth Analysis Report.
Distribution Analysis Report	Displays the SSRS Report for Distribution Analysis in the Reliability Distribution Analysis Report.
Exponential Distribution Query	Returns data for Exponential Distributions in the Probability Distribution Report.
FailuresSubreportGrowth	Displays the subreport for Failure data in the Reliability Growth Analysis Report.
GrowthAnalysisQuery	Displays data in the main and subreports in the Reliability Growth Analysis Report.
GrowthAnalysisReport	Displays the main report of the SSRS Reliability Growth Analysis Report.

Item Name	Behavior and Usage
Lognormal Distribution Query	Returns data for Lognormal Distributions of failure data in the Probability Distribution Report.
Normal Distribution Query	Returns data for Normal Distributions in the Probability Distribution Report.
ProbabilityDistributionQuery	Returns data for the Probability Distribution Report.
ProbDistReport	Displays the SSRS Probability Distribution Report for Probability Distribution Analysis.
ProductionAnalysisQuery	This is the main query that returns data for the Production Analysis Report.
ProductionAnalysisQueryLines	Returns the Lines data for the Production Analysis Report.
ProductionAnalysisQueryRegions	Returns Regions data for the Production Analysis Report.
Production Analysis Report	Displays the SSRS Production Analysis Report.
ReliabilityDistributionQuery	Returns data for the Reliability Distribution Report, including TTF data.
ReliabilityDistributionTTR	Returns TTR data for the Reliability Distribution Analysis Report.
ReliabilityExponentialTTF	Returns TTF data for the Exponential Distribution in the Reliability Distribution Analysis Report.
ReliabilityExponentialTTR	Returns TTR data for the Exponential Distribution in the Reliability Distribution Analysis Report.
ReliabilityLognormalTTF	Returns TTF data for the Lognormal Distribution in the Reliability Distribution Analysis Report.
ReliabilityLognormalTTR	Returns TTR data for the Lognormal Distribution in the Reliability Distribution Analysis Report.
ReliabilityNormalTTF	Returns TTF data for the Normal Distribution in the Reliability Distribution Analysis Report.
ReliabilityNormalTTR	Returns TTR data for the Normal Distribution in the Reliability Distribution Analysis Report.
ReliabilityWeibullTTF	Returns TTF data for the Weibull Distribution in the Reliability Distribution Analysis Report.
ReliabilityWeibullTTR	Returns TTR data for the Weibull Distribution in the Reliability Distribution Analysis Report.
Spares	<p>Displays the Spare information for a Spares Analysis in the Spares Analysis Report.</p> <p>This is a subreport to the Spares Analysis report, named SparesApplication.</p>
Spares Analysis - Applications	Returns application information corresponding to a particular Spare in a Spares Analysis.

Item Name	Behavior and Usage
Spares Analysis - Charts	Returns chart data tied to a particular Spares Analysis.
Spares Analysis - ChartsMain	Returns a list of charts for a particular Spares Analysis.
Spares Analysis - Main	Returns property information for a particular Spares Analysis.
Spares Analysis - Spares	Returns Spare information related to a particular Spares Analysis.
Spares Analysis - SparesMain	Returns a list of Spares for a particular Spares Analysis.
SparesAnalysis	Displays information and graphs for a Spares Analysis. This report also uses the SparesChart and Spares subreports.
SparesApplication	Displays application information for a Spares Analysis. This is a subreport to the Spares report.
SparesChart	Displays charts for a Spares Analysis. This is a subreport to the SparesAnalysis report.
SubreportDistributionAnalysis	Displays the subreport for Reliability Distribution Analyses containing failure data.
SubReportProbDist	Displays the subreport for Probability Distribution Analyses containing failure data.
SubreportProductionAnalysis	Displays the subreport for Production Analyses containing Production Data.
System Reliability - ActionResult	Returns a list of action simulation results for a particular System Reliability Analysis.
System Reliability - ElementResult	Returns a list of element simulation results for a particular System Reliability Analysis.
System Reliability - Main	Returns property information for a particular System Reliability Analysis.
System Reliability - ResourceResult	Returns a list of resource simulation results for a particular System Analysis.
System Reliability - SummaryResult	Returns root element simulation results for a particular System Analysis.
SystemReliabilityActionResultReport	Displays the subreport for System Reliability Analyses containing Action Simulation Result Data.
SystemReliabilityElementResultReport	Displays the subreport for System Reliability Analyses containing Element Simulation Result Data.
SystemReliabilityMainReport	Displays the SSRS report for System Reliability Analysis.
SystemReliabilityResourceResultReport	Displays the subreport for System Reliability Analyses containing Resource Simulation Result Data.

Item Name	Behavior and Usage
SystemReliabilitySummaryResultReport	Displays the subreport for System Reliability Analyses containing Root Element Simulation Result Data.
Weibull Distribution Query	Returns data for Weibull Distributions in the reports in the Reliability Analytics module.

Automation Rule Folder

The Catalog folder `\\Public\Meridium\Modules\Reliability Manager\Automation Rule` contains the following items.

Item Name	Behavior and Usage
Queries Subfolder	
TileListOfAutomationRule	Returns the list of Automation Rules in the Automation Rules list on the RA Overview page.

Probability Distribution Folder

The Catalog folder `\\Public\Meridium\Modules\Reliability Manager\Probability Distribution` contains the following items.

Item Name	Behavior and Usage
Queries Subfolder	
TileListOfProbabilityDistribution	Returns the list of Probability Distribution Analyses in the Probability Distribution list on the RA Overview page.

Production Analysis Folder

The Catalog folder `\\Public\Meridium\Modules\Reliability Manager\Production Analysis` contains the following items.

Item Name	Behavior and Usage
Queries Subfolder	
TileListOFRAProductionAnalysis	Returns the list of Production Analyses in the Production Analyses list on the RA Overview page.

Reliability Distribution Folder

The Catalog folder `\\Public\Meridium\Modules\Reliability Manager\Reliability Distribution` contains the following items.

Item Name	Behavior and Usage
Queries Subfolder	
TileListOfReliabilityDistribution	Returns the list of Reliability Distribution Analyses in the Reliability Distribution list on the RA Overview page.

Reliability Growth Folder

The Catalog folder \\Public\Meridium\Modules\Reliability Manager\Reliability Growth contains the following items.

Item Name	Behavior and Usage
Queries Subfolder	
TileListOfReliabilityGrowth	Returns the list of Reliability Growth Analyses in the Reliability Growth list on the RA Overview page.

Spares Folder

The Catalog folder \\Public\Meridium\Modules\Reliability Manager\Spares contains the following items.

Item Name	Behavior and Usage
Queries Subfolder	
TileListOfSpares	Returns the list of Spares Analyses used in the Spares Analyses list on the RA Overview page.

System Reliability Folder

The Catalog folder \\Public\Meridium\Modules\Reliability Manager\System Reliability contains the following items.

Item Name	Behavior and Usage
Queries Subfolder	
TileListOfSystemReliability	Returns the list of System Reliability Analyses in the System Reliability list on the RA Overview page.

Distribution Types

About Normal Distribution

A Normal Distribution describes the spread of data values through the calculation of two parameters: mean and standard deviation. When using the Normal Distribution on time to failure data, the mean exactly equals MTBF and is a straight arithmetic average of failure data. Standard deviation (denoted by sigma) gives estimate of data spread or variance.

A Normal Distribution uses the following parameters:

- Mean: The arithmetic average of the datapoints.
- Standard Deviation: A value that represents the scatter (how tightly the datapoints are clustered around the mean).

About Weibull Distribution

A Weibull Distribution describes the type of failure mode experienced by the population (infant mortality, early wear out, random failures, rapid wear-out). Estimates are given for Beta (shape factor) and Eta (scale). MTBF (Mean Time Between Failures) is based on characteristic life curve, not straight arithmetic average.

A Weibull Distribution uses the following parameters:

- **Beta:** Beta, also called the shape factor, controls the type of failure of the element (infant mortality, wear-out, or random).
- **Eta:** Eta is the scale factor, representing the time when 63.2 % of the total population is failed.
- **Gamma:** Gamma is the location parameter that allows offsetting the Weibull distribution on time. The Gamma parameter should be used if the datapoints on the Weibull plot do not fall on a straight line.

If the value of Beta is greater than one (1), you can [perform Preventative Maintenance \(PM\) Optimizations](#). A Gamma different from a value zero (0) means that the distribution is shifted to fit the datapoints more closely.

Note: This is an advanced feature and should be used in the proper context and with a good understanding of how to apply a three-parameter Weibull distribution.

Weibull Analysis Information

You can use the following information to compare the results of individual Weibull analyses. The following results are for good populations of equipment.

Beta Values Weibull Shape Factor						
Components	Low	Typical	High	Low (days)	Typical (days)	High (days)
Ball bearing	0.7	1.3	3.5	583	1667	10417
Roller bearings	0.7	1.3	3.5	375	2083	5208
Sleeve bearing	0.7	1	3	417	2083	5958
Belts drive	0.5	1.2	2.8	375	1250	3792
Bellows hydraulic	0.5	1.3	3	583	2083	4167
Bolts	0.5	3	10	5208	12500	4166667
Clutches friction	0.5	1.4	3	2792	4167	20833
Clutches magnetic	0.8	1	1.6	4167	6250	13875
Couplings	0.8	2	6	1042	3125	13875
Couplings gear	0.8	2.5	4	1042	3125	52083

Beta Values Weibull Shape Factor						
Cylinders hydraulic	1	2	3.8	375000	37500	8333333
Diaphragm metal	0.5	3	6	2083	2708	20833
Diaphragm rubber	0.5	1.1	1.4	2083	2500	12500
Gaskets hydraulics	0.5	1.1	1.4	29167	3125	137500
Filter oil	0.5	1.1	1.4	833	1042	5208
Gears	0.5	2	6	1375	3125	20833
Impellers pumps	0.5	2.5	6	5208	6250	58333
Joints mechanical	0.5	1.2	6	58333	6250	416667
Knife edges fulcrum	0.5	1	6	70833	83333	695833
Liner recip. comp. cyl.	0.5	1.8	3	833	2083	12500
Nuts	0.5	1.1	1.4	583	2083	20833
"O"-rings elastomeric	0.5	1.1	1.4	208	833	1375
Packings recip. comp. rod	0.5	1.1	1.4	208	833	1375
Pins	0.5	1.4	5	708	2083	7083
Pivots	0.5	1.4	5	12500	16667	58333
Pistons engines	0.5	1.4	3	833	3125	7083
Pumps lubricators	0.5	1.1	1.4	542	2083	5208
Seals mechanical	0.8	1.4	4	125	1042	2083
Shafts cent. pumps	0.8	1.2	3	2083	2083	12500
Springs	0.5	1.1	3	583	1042	208333
Vibration mounts	0.5	1.1	2.2	708	2083	8333
Wear rings cent. pumps	0.5	1.1	4	417	2083	3750

Beta Values Weibull Shape Factor						
Valves recip comp.	0.5	1.4	4	125	1667	3333
Equipment Assemblies	Low	Typical	High	Low (days)	Typical (days)	High (days)
Circuit breakers	0.5	1.5	3	2792	4167	58333
Compressors centrifugal	0.5	1.9	3	833	2500	5000
Compressor blades	0.5	2.5	3	16667	33333	62500
Compressor vanes	0.5	3	4	20833	41667	83333
Diaphragm couplings	0.5	2	4	5208	12500	25000
Gas turb. comp. blades/vanes	1.2	2.5	6.6	417	10417	12500
Gas turb. blades/vanes	0.9	1.6	2.7	417	5208	6667
Motors AC	0.5	1.2	3	42	4167	8333
Motors DC	0.5	1.2	3	4	2083	4167
Pumps centrifugal	0.5	1.2	3	42	1458	5208
Steam turbines	0.5	1.7	3	458	2708	7083
Steam turbine blades	0.5	2.5	3	16667	33333	62500
Steam turbine vanes	0.5	3	3	20833	37500	75000
Transformers	0.5	1.1	3	583	8333	591667
Instrumentation	Low	Typical	High	Low (days)	Typical (days)	High (days)
Controllers pneumatic	0.5	1.1	2	42	1042	41667
Controllers solid state	0.5	0.7	1.1	833	4167	8333
Control valves	0.5	1	2	583	4167	13875
Motorized valves	0.5	1.1	3	708	1042	41667
Solenoid valves	0.5	1.1	3	2083	3125	41667

Beta Values Weibull Shape Factor						
Transducers	0.5	1	3	458	833	3750
Transmitters	0.5	1	2	4167	6250	45833
Temperature indicators	0.5	1	2	5833	6250	137500
Pressure indicators	0.5	1.2	3	4583	5208	137500
Flow instrumentation	0.5	1	3	4167	5208	416667
Level instrumentation	0.5	1	3	583	1042	20833
Electro-mechanical parts	0.5	1	3	542	1042	41667
Static Equipment	Low	Typical	High	Low (days)	Typical (days)	High (days)
Boilers condensers	0.5	1.2	3	458	2083	137500
Pressure vessels	0.5	1.5	6	52083	83333	1375000
Filters strainers	0.5	1	3	208333	208333	8333333
Check valves	0.5	1	3	4167	4167	52083
Relief valves	0.5	1	3	4167	4167	41667
Service Liquids	Low	Typical	High	Low (days)	Typical (days)	High (days)
Coolants	0.5	1.1	2	458	625	1375
Lubricants screw compr.	0.5	1.1	3	458	625	1667
Lube oils mineral	0.5	1.1	3	125	417	1042
Lube oils synthetic	0.5	1.1	3	1375	2083	10417
Greases	0.5	1.1	3	292	417	1375

Weibull Results Interpretation

GE Digital APM Reliability shows the failure pattern of a single piece of equipment or groups of similar equipment using Weibull analysis methods. This helps you determine the appropriate repair strategy to improve reliability.

Is the Probability Plot a good fit?

Follow these steps to determine whether or not the plot is a good fit:

- Identify Beta (slope) and its associated failure pattern.
- Compare Eta (characteristic life) to standard values.
- Check goodness of fit, compare with Weibull database.
- Make a decision about the nature of the failure and its prevention.

The following chart demonstrates how to interpret the Weibull analysis data using the Beta parameter, Eta parameter, and typical failure mode to determine a failure cause.

Weibull Results			Interpretation
Beta	Eta	Typical Failure Mode	Failure Cause
Greater than 4	Low compared with standard values for failed parts (less than 20%)	Old age, rapid wear out (systematic, regular)	Poor machine design
Greater than 4	Low compared with standard values for failed parts (less than 20%)	Old age, rapid wear out (systematic, regular)	Poor material selection
Between 1 and 4	Low compared with standard values for failed parts (less than 20%)	Early wear out	Poor system design
Between 1 and 4	Low	Early wear out	Construction problem
Less than 1	Low	Infant Mortality	Inadequate maintenance procedure
Between 1 and 4	Between 1 and 4	Less than manufacturer recommended PM cycle	Inadequate PM schedule
Around 1	Much less than	Random failures with definable causes	Inadequate operating procedure

Goodness of Fit (GOF) Tests for a Weibull Distribution

A Goodness of Fit test is a statistical test that determines whether the analysis data follows the distribution model.

- If the data passes the Goodness of Fit test, it means that it follows the model pattern closely enough that predictions can be made based on that model.
- If the data fails the Goodness of Fit test, it means that the data does not follow the model closely enough to confidently make predictions and that the data does not appear to follow a specific pattern.

Weibull results are valid if Goodness of Fit (GOF) tests are satisfied. Goodness of Fit tests for a Weibull distribution include the following types:

- **R-Squared Linear regression (least squares):** An R-Squared test statistic greater than 0.9 is considered a good fit for linear regression.
- **Kolmogorov-Smirnov:** The GE Digital APM system uses confidence level and P-Value to determine if the data is considered a good fit. If the P-Value is greater than 1 minus the confidence level, the test passes.

Note: The R-Squared test statistic is calculated only for reference. The GE Digital APM system uses the Kolmogorov-Smirnov test as the Goodness of Fit test.

About Exponential Distribution

An Exponential Distribution is a mathematical distribution that describes a purely random process. It is a single parameter distribution where the mean value describes MTBF (Mean Time Between Failures). It is simulated by the Weibull distribution for value of Beta = 1. When applied to failure data, the Exponential distribution exhibits a constant failure rate, independent of time in service. The Exponential Distribution is often used in reliability modeling, when the failure rate is known but the failure pattern is not.

An Exponential Distribution uses the following parameter:

- MTBF: Mean time between failures calculated for the analysis.

About Lognormal Distribution

In Lognormal Distributions of failure data, two parameters are calculated: Mu and Sigma. These do not represent mean and standard deviation, but they are used to calculate MTBF. In Lognormal analysis, the median (antilog of mu) is often used as the MTBF. The standard deviation factor (antilog of sigma) gives the degree of variance in the data.

A Lognormal Distribution uses the following parameters:

- Mu: The logarithmic average for the Distribution function.
- Sigma: The scatter.
- Gamma: A location parameter.

About Triangular Distribution

Triangular Distribution is typically used as a subjective description of a population for which there is only limited sample data, and especially in cases where the relationship between variables is known, but data is scarce (possibly because of the high cost of collection). It is based on a knowledge of the minimum (a) and maximum (b) and an inspired guess as to the modal value (c).

A Triangular Distribution is a continuous Probability Distribution with:

- Lower limit a
- Upper limit b
- Mode c

...where $a < b$ and $a \leq c \leq b$.

About Gumbel Distribution

The Gumbel Distribution is a continuous probability distribution. Gumbel distributions are a family of distributions of the same general form. These distributions differ in their location and scale parameters: the mean of the distribution defines its location, and the standard deviation, or variability, defines the scale.

The Gumbel Distribution is a probability distribution of extreme values.

In probability theory and statistics, the Gumbel distribution is used to model the distribution of the maximum (or the minimum) of a number of samples of various distributions.

About Generalized Extreme Value Distribution

In probability theory and statistics, the Generalized Extreme Value (GEV) Distribution is a family of continuous probability distributions developed within extreme value theory.

By the Extreme Value Theorem, the GEV Distribution is the only possible limit distribution of properly normalized maxima of a sequence of independent and identically distributed random variables.

Calculations

Calculate Failure Probability

Probability of failure can be calculated for all Distribution models. The GE Digital APM system uses the following formula to determine failure probability:

$$P(t1|t0) = 1 - \frac{(1 - D(t1))^n}{(1 - D(t0))^n}$$

Where:

- $P(t1|t0)$ is the failure probability at any given time assuming that the equipment has not yet failed at the current age. If you specify a failure probability, the GE Digital APM system will use this value to calculate the future age of the equipment.
- $D(t)$ is the cumulative distribution function, or the failure probability at time t for a new piece of equipment. The curve in the CDF plot represents this function.
- $t0$ is the current age of the piece of equipment.
- $t1$ is the future age of the piece of equipment. If you specify an operating time, this value is determined by adding the time to the current age of the piece of equipment, and the resulting value is then used to calculate the failure probability.
- n is the number of subcomponents the piece of equipment contains (e.g., tubes in a heat exchanger bundle). If the failure type of the Reliability Distribution Analysis is Failure with replacement, the number of subcomponents is 1. If the failure type is Failure without replacement, this value is mapped from a query or dataset or manually entered when you create the Reliability Distribution Analysis.

Calculate GOF for a Reliability Growth Analysis

A Goodness of Fit (GOF) test determines how well your analysis data fits the calculated data model.

- If your data passes the GOF test, your data follows the data model closely, and you can rely on the predictions made by model.
- If your data fails the GOF test, it may not follow the model closely enough to confidently rely on model predictions.

On the **Reliability Growth** page, in the Segment pane, the **Passed GOF** check box is selected when your data passes the test and cleared when your data fails the test.

To determine whether the data passes the GOF test, the GE Digital APM system uses the following values:

- **GOF Statistic:** Determines how precisely the data fits the model. This value is calculated from a Cramer-von Mises or Chi-squared test and is displayed in the **GOF Statistic** column in the **Segment** pane on the **Reliability Growth** page.

- **Alpha Value:** Determines what critical value to use for the GOF test. This value depends on the Confidence Level you select for the analysis.
- **Critical Value:** Determines whether the data passes the GOF test. This standard value depends on the number of datapoints included in the analysis and the alpha value. It is displayed in the **Critical Value** column in the **Segment** pane on the **Reliability Growth** page.

Test Statistics

GE Digital APM uses two different methods to calculate GOF for Reliability Growth Analyses, depending on whether or not the analyses use grouped data.

Goodness of Fit (GOF) for a Reliability Growth Analyses based on data that is not grouped is calculated using the Cramer-von Mises test.

For analyses whose [end date is time-based](#), Cramer-von Mises test uses the following formula to calculate the GOF Statistic:

$$C_M^2 = \frac{1}{12N} + \sum_{i=1}^N \left[\left(\frac{t_i}{T} \right)^{\hat{\beta}} - \frac{2i-1}{2N} \right]^2$$

For analyses whose [end date is event-based](#), Cramer-von Mises test uses the following formula to calculate the GOF statistic:

$$C_M^2 = \frac{1}{12(N-1)} + \sum_{i=1}^{N-1} \left[\left(\frac{t_i}{t_N} \right)^{\hat{\beta}} - \frac{2i-1}{2(N-1)} \right]^2$$

Goodness of Fit for a Reliability Growth Analysis based on grouped data is calculated using a Chi-squared test. This test uses the following formula to calculate a test statistic:

$$\chi^2 = \sum_{i=1}^k \frac{(n_i - \hat{\theta}_i)^2}{\hat{\theta}_i}$$

Critical Value: Cramer-von Mises Test

For non-grouped data, the Cramer-von Mises test is used to determine whether the data passes the GOF test. This test compares the GOF Statistic to a Critical Value. The Critical Value depends on two values:

- **Alpha** = 1- Confidence Level
- **N** = The number of datapoints in the population.

Alpha is determined using the Confidence Level, which you can [define manually for each analysis](#). The Confidence Level indicates the percentage of uncertainty of the Goodness of Fit method. This percentage is usually determined by experience or an industry standard and limits how closely the data must fit the model in order for it to pass the Goodness of Fit test. The higher the Confidence Level, the easier it will be for your data to pass the Goodness of Fit test. The lower the Confidence Level, the harder it will be for your data to pass the Goodness of Fit test. If the data does pass, however, the data will be a very close fit to the model.

Note: When you [select a Confidence Level](#), you must specify 80, 90, 95, or 98 percent. If you do not modify the confidence level, alpha is automatically set to 0.1 (i.e., a confidence level of 90%).

After a Confidence Level has been determined, the GE Digital APM system uses the following Critical Values for Cramer-von Mises Test chart to find the Critical Value. The chart displays critical values at five confidence levels (80%, 85%, 90%, 95% and 98%) which in turn calculate 5 alpha values (0.2, 0.15, 0.1, 0.05, 0.02).

$N \backslash \alpha$	0.2	0.15	0.1	0.05	0.01
2	0.138	0.149	0.162	0.175	0.186
3	0.121	0.135	0.154	0.184	0.23
4	0.121	0.134	0.155	0.191	0.28
5	0.121	0.137	0.16	0.199	0.3
6	0.123	0.139	0.162	0.204	0.31
7	0.124	0.14	0.165	0.208	0.32
8	0.124	0.141	0.165	0.21	0.32
9	0.125	0.142	0.167	0.212	0.32
10	0.125	0.142	0.167	0.212	0.32
11	0.126	0.143	0.169	0.214	0.32
12	0.126	0.144	0.169	0.214	0.32
13	0.126	0.144	0.169	0.214	0.33
14	0.126	0.144	0.169	0.214	0.33
15	0.126	0.144	0.169	0.215	0.33
16	0.127	0.145	0.171	0.216	0.33
17	0.127	0.145	0.171	0.217	0.33
18	0.127	0.146	0.171	0.217	0.33
19	0.127	0.146	0.171	0.217	0.33
20	0.128	0.146	0.172	0.217	0.33
30	0.128	0.146	0.172	0.218	0.33
60	0.128	0.147	0.173	0.22	0.33
100	0.129	0.147	0.173	0.22	0.34

Critical Value: Chi-squared Test

For grouped data, the Chi-squared test is used to determine whether the analysis passed the GOF test. This test uses Degrees of Freedom (i.e., the number of datapoints - 2) and the [Confidence Level](#) to calculate a Critical Value, which is then compared to the GOF Statistic to determine whether the analysis passed the GOF test. The Confidence Level is defined the same way it is in the Cramer-von Mises test (i.e., it indicates the percentage of uncertainty of the Goodness of Fit method).

The following formula is used to calculate the Chi-squared distribution.

$$F(x; k) = \frac{\gamma\left(\frac{k}{2}, \frac{x}{2}\right)}{\Gamma\left(\frac{k}{2}\right)} = P\left(\frac{k}{2}, \frac{x}{2}\right)$$

In the formula, k is degrees of freedom and F(x;k) is the Confidence Level. These values are used to find the Critical Value, x.

Determining the Results

For both the Cramer-von Mises test and the Chi-squared test, if the GOF statistic is greater than the Critical Value at the chosen Confidence Level, the data fails the GOF test. This means the data does not follow the analysis pattern closely enough to confidently predict future measurements. If the GOF Statistic is lower than the Critical Value, the population passes the test, which means data is more likely to occur in a pattern and therefore is more predictable.

For example, if you run a Reliability Growth Analysis on a set of failure data, and the data fails the GOF test, it may mean that the piece of equipment or location does not fail in a predictable pattern (i.e., the piece of equipment or location fails at random). If this is the case, any predictions you make based on this data will not be as reliable as predictions made against data that has passed the GOF test.

If the analysis fails a GOF test, it does not necessarily mean that you cannot use the data model. The Reliability Growth Analysis might fail a GOF test because there is more than one trend within the data. If you suspect this is the case, you can [split the analysis into segments](#) at the points where it looks like a change occurred. Afterwards, the separate segments may individually pass the GOF test because they have been split up into multiple failure patterns.

Additionally, if the analysis fails the GOF test, you should also check for a visual goodness of fit. Models can sometimes still be used even if the analysis does not pass the GOF test.

Calculations for Crow-AMSAA Growth

Failure Rate

$$\hat{\rho}(t) = \hat{\lambda} \bar{\beta} t^{\beta-1}$$

Grouped Data

MTBF

$$MTBF(t) = 1/\hat{\rho}(t)$$

Cumulative Failures

$$N(t) = \lambda t^{\beta}$$

Non-grouped Data

Time-Terminated

The parameters λ and β are estimated using the following equations:

$$\hat{\beta} = \frac{N}{N \ln T - \sum_{i=1}^N \ln X_i}$$

where, the unbiased β estimate is

$$\bar{\beta} = \left(\frac{N-1}{N} \right) \hat{\beta}$$

$$\bar{\lambda} = \frac{N}{T^{\bar{\beta}}}$$

Where,

- N is the number of observations.
- T is the total time of observation.
- Xi is the cumulative failure times.

Failure-Terminated

The parameters λ and β are estimated using the following equations:

$$\hat{\beta} = \frac{N}{(N-1)\ln(T) - \sum_{i=1}^{N-1} \ln X_i}$$

, where, the unbiased β estimate is

$$\bar{\beta} = \left(\frac{N-2}{N}\right)\hat{\beta}$$

.

$$\bar{\lambda} = \frac{N}{T^{\bar{\beta}}}$$

Where,

- N is the number of observations.
- T is the total time of observation.
- Xi is the cumulative failure times..

Calculations for Distribution Fit Methods

MLE

$$\ln Lik = \sum_{i=1}^r \ln \left\{ \left(\frac{1}{\sigma} \exp(t_i) \right) \phi \left[\frac{(t_i - \mu)}{\sigma} \right] \right\} + \sum_{i=r+1}^n \ln \left\{ 1 - \Phi \left[\frac{(t_i - \mu)}{\sigma} \right] \right\}$$

Where,

t_i

is the failure time (in t-space) of component i, i=1,..., r or the censoring time (in t-space) of component i, i=r+1,..., n. If there is no censoring (complete data), r = n and the last term in the Likelihood function disappears. The terms

$\phi()$

and

$\Phi()$

are the standard normal probability density and standard normal cumulative distribution.

Least Square

$$F(t) = \int_{-\infty}^t \frac{1}{\sigma\sqrt{2\pi}} \exp\left(-\frac{1}{2}\left(\frac{x-\mu}{\sigma}\right)^2\right) dx = \Phi\left(\frac{t-\mu}{\sigma}\right)$$

$$\Phi^{-1}(F(t)) = \frac{t-\mu}{\sigma}$$

$$\Phi^{-1}(F(t)) = \left(\frac{1}{\sigma}\right)t + \left(-\frac{\mu}{\sigma}\right)$$

Let us denote : n = total cases, r = uncensored cases, and $n - r = k$ = censored cases

if

$$y_i = t_i$$

,

$$x_i = \Phi^{-1}(F(t))$$

, then the parameters for

$$y = bx + a$$

are estimated using the following equations:

$$b = \frac{r \sum_{i=1}^r x_i y_i - \sum_{i=1}^r x_i \sum_{i=1}^r y_i}{r \sum_{i=1}^r x_i^2 - \left(\sum_{i=1}^r x_i\right)^2}$$

$$a = \bar{y} - b\bar{x}$$

In this case,

$$\sigma_{t-space} = b$$

and

$$\mu_{t-space} = a$$

.

Calculations for Exponential Distribution

Failure Rate

$$h(t) = 1/\eta$$

PDF

$$f(t) = (1/\eta) \exp(-t/\eta)$$

CDF

$$F(t) = 1 - \exp(-t/\eta)$$

Reliability

$$R(t) = 1 - F(t) = \exp(-t/\eta)$$

Note: In GE Digital APM, there is only one MTBF parameter (η) for exponential distribution.

MLE

$$\ln Lik = \sum_{i=1}^r [-\ln \eta - (t_i / \eta)] + \sum_{i=r+1}^n (-t_i / \eta)$$

Where,

t_i

is the failure time of component i , $i=1, \dots, r$ or the censoring time of component i , $i=r+1, \dots, n$. If there is no censoring (complete data), $r = n$ and the last term in the Likelihood function disappears.

Least Square

Suppose,

$$y_i = -\ln(1 - F(t_i))$$

and

$$x_i = t_i$$

Using these transformed data, we can obtain the parameter estimate using the following equation:

$$b = \frac{\sum_{i=1}^r x_i y_i}{\sum_{i=1}^r x_i^2}$$

→

$$\eta = 1/b$$

Calculations for GOF Methods

R-Squared

If

$$\bar{x} = \frac{1}{r} \sum_{i=1}^r x_i$$

and

$$\bar{y} = \frac{1}{r} \sum_{i=1}^r y_i$$

, then the parameters for

$$y = bx + a$$

are estimated using the following equations:

$$b = \frac{r \sum_{i=1}^r x_i y_i - \sum_{i=1}^r x_i \sum_{i=1}^r y_i}{r \sum_{i=1}^r x_i^2 - \left(\sum_{i=1}^r x_i \right)^2}$$

$$a = \bar{y} - b\bar{x}$$

$$R^2 = 1 - \frac{b^2 \sum_{i=1}^r x_i^2 + ra^2 + \sum_{i=1}^r y_i^2 + 2ab \sum_{i=1}^r x_i - 2b \sum_{i=1}^r x_i y_i - 2a \sum_{i=1}^r y_i}{\sum_{i=1}^r y_i^2 - \left(\sum_{i=1}^r y_i \right)^2 / r}$$

Kolmogorov-Smirnov Test

- Calculating modified failure order for sample dataset

$$O_j = O_p + I_j$$

$$I_j = \frac{(n+1) - O_p}{1+c}$$

Where,

- O_j is the order of the jth failure
- I_j is the increment for the jth failure
- n is the total number of data points, both censored and uncensored
- O_p is the order of previous failure
- c is the number of data points remaining in the data set, including the current data point

Note: When there are no censored data, the above equation can be simplified to O_j = j.

- Calculating median rank from modified failure order

Median rank is the median value of the rank distribution. Rank distribution is the distribution of the probability of jth ordered value x out of a sample n.

$$\int_0^{MR} \frac{n!}{(j-1)!(n-j)!} p^{j-1} (1-p)^{n-j} dp = 0.5$$

Incomplete beta function is used to find median rank of the above equation

$$\frac{B_{MR}(j, n-j+1)}{B(j, n-j+1)} = 0.5$$

- Finding statistics of the KS test

Statistics refers to the maximum difference between median rank calculated from dataset and probability calculated from the reference distribution. This steps does not considers the censored data.

$$D_n = \sup |F_n(x) - F(x)|$$

- Calculating p-value from KS test statistics and sample size

$$\Pr(K \geq x) = 2 \sum_{i=1}^{\infty} (-1)^{i-1} e^{-2i^2 x^2}$$

Where,

$$x = \sqrt{n} D_n$$

- Calculating significant level (alpha)
alpha = 1-confidence level
- Failing the Goodness of Fit test
If the p-value <= alpha, Goodness of Fit test fails because there is statistically significant difference between the sample dataset and the reference distribution.

Calculations for LogNormal Distribution

Failure Rate

$$h(t) = \frac{f(t)}{R(t)}$$

PDF

$$f(t) = \frac{1}{\sigma\sqrt{2\pi}} \exp\left(-\frac{1}{2}\left(\frac{t-\mu}{\sigma}\right)^2\right)$$

CDF

$$F(t) = \int_{-\infty}^t \frac{1}{\sigma\sqrt{2\pi}} \exp\left(-\frac{1}{2}\left(\frac{x-\mu}{\sigma}\right)^2\right) dx = \Phi\left(\frac{t-\mu}{\sigma}\right)$$

Reliability

$$R(t) = \int_t^{\infty} \frac{1}{\sigma\sqrt{2\pi}} \exp\left(-\frac{1}{2}\left(\frac{x-\mu}{\sigma}\right)^2\right) dx$$

MLE

$$\ln Lik = \sum_{i=1}^r \ln \left\{ \left(\frac{1}{\sigma \exp(t_i)} \right) \phi \left[\frac{(t_i - \mu)}{\sigma} \right] \right\} + \sum_{i=r+1}^n \ln \left\{ 1 - \Phi \left[\frac{(t_i - \mu)}{\sigma} \right] \right\}$$

Where,

t_i

is the failure time (in t-space) of component $i, i=1, \dots, r$ or the censoring time (in t-space) of component $i, i=r+1, \dots, n$. If there is no censoring (complete data), $r = n$ and the last term in the Likelihood function disappears. The terms

$$\phi(\cdot)$$

and

$$\Phi(\cdot)$$

are the standard normal probability density and standard normal cumulative distribution.

Least Square

$$F(t) = \int_{-\infty}^t \frac{1}{\sigma\sqrt{2\pi}} \exp\left(-\frac{1}{2}\left(\frac{x-\mu}{\sigma}\right)^2\right) dx = \Phi\left(\frac{t-\mu}{\sigma}\right)$$

$$\Phi^{-1}(F(t)) = \frac{t-\mu}{\sigma}$$

$$\Phi^{-1}(F(t)) = \left(\frac{1}{\sigma}\right)t + \left(-\frac{\mu}{\sigma}\right)$$

Let us denote : n = total cases, r = uncensored cases, and $n - r = k$ = censored cases

If

$$y_i = t_i$$

,

$$x_i = \Phi^{-1}(F(t))$$

, then the parameters for

$$y = bx + a$$

are estimated using the following equations:

$$b = \frac{r \sum_{i=1}^r x_i y_i - \sum_{i=1}^r x_i \sum_{i=1}^r y_i}{r \sum_{i=1}^r x_i^2 - \left(\sum_{i=1}^r x_i\right)^2}$$

$$a = \bar{y} - b\bar{x}$$

In this case,

$$\sigma_{t-space} = b$$

and

$$\mu_{t-space} = a$$

.

Note: You can obtain \hat{Y} by minimizing R-squared of least square line fit.

Calculations for Normal Distribution

Failure Rate

$$h(t) = \frac{f(t)}{R(t)}$$

PDF

$$f(t) = \frac{1}{\sigma\sqrt{2\pi}} \exp\left(-\frac{1}{2}\left(\frac{t-\mu}{\sigma}\right)^2\right)$$

CDF

$$F(t) = \int_{-\infty}^t \frac{1}{\sigma\sqrt{2\pi}} \exp\left(-\frac{1}{2}\left(\frac{x-\mu}{\sigma}\right)^2\right) dx = \Phi\left(\frac{t-\mu}{\sigma}\right)$$

Reliability

$$R(t) = \int_t^{+\infty} \frac{1}{\sigma\sqrt{2\pi}} \exp\left(-\frac{1}{2}\left(\frac{x-\mu}{\sigma}\right)^2\right) dx$$

Note: In GE Digital APM, there are two parameters: Mean, represented as μ , and Standard Deviation, represented as σ .

MLE

$$\ln Lik = \sum_{i=1}^r \ln \left\{ \frac{1}{\sigma} \phi\left[\frac{t_i - \mu}{\sigma}\right] \right\} + \sum_{i=r+1}^n \ln \left\{ 1 - \Phi\left[\frac{t_i - \mu}{\sigma}\right] \right\}$$

Where,

t_i

is the failure time of component i , $i=1, \dots, r$ or the censoring time of component i , $i=r+1, \dots, n$. If there is no censoring (complete data), $r = n$ and the last term in the Likelihood function disappears. The terms

$\phi(\)$

and

$\Phi(\)$

are the standard normal probability density and standard normal cumulative distribution.

Least Square

$$F(t) = \int_{-\infty}^t \frac{1}{\sigma\sqrt{2\pi}} \exp\left(-\frac{1}{2}\left(\frac{x-\mu}{\sigma}\right)^2\right) dx = \Phi\left(\frac{t-\mu}{\sigma}\right)$$

$$\Phi^{-1}(F(t)) = \frac{t-\mu}{\sigma}$$

$$\Phi^{-1}(F(t)) = \left(\frac{1}{\sigma}\right)t + \left(-\frac{\mu}{\sigma}\right)$$

Let us denote : n = total cases, r = uncensored cases, and $n - r = k$ = censored cases

If

$$y_i = t_i$$

and

$$x_i = \Phi^{-1}(F(t))$$

, then the parameters for

$$y = bx + a$$

are estimated using the following equations:

$$b = \frac{r \sum_{i=1}^r x_i y_i - \sum_{i=1}^r x_i \sum_{i=1}^r y_i}{r \sum_{i=1}^r x_i^2 - \left(\sum_{i=1}^r x_i\right)^2}$$

$$a = \bar{y} - b\bar{x}$$

In this case,

$$\sigma = b$$

and

$$\mu = a$$

.

Calculations for PF Interval Properties

Risk Properties

- PF Interval: The time period before a failure in which a potential failure could be detected.
- Repair Immediately: If this field value is True, then you should trigger a planned correction immediately to fix the potential failure if a potential failure is detected in advance. Otherwise, wait until the value in the Percentage of PF Interval to Wait (%) field reaches 0.
- Percentage of PF Interval to Wait (%): A numeric value that indicates how long to wait to repair the piece of equipment or location, presented as a percentage of the PF Interval value.

Inspection Properties

- Detection Probability (%): The probability of finding potential failures when the monitored risk is in its PF interval. The simulation engine randomly determines whether a potential failure could be detected

according to the Detection Probability. The inspection will notify the simulation engine once a potential failure is determined to be detectable.

Note: For System Inspection records in a condition-based maintenance Action, the probability of finding the potential failure is defined by the Detection Probability (%) for each occurrence of the inspection.

Condition Monitor Properties

- Detection Probability (%): The probability of finding potential failures when the monitored risk is in its PF Interval. The simulation engine randomly determines whether a potential failure could be detected according to the Detection Probability. The inspection will notify the simulation engine once a potential failure is determined to be detectable. This is randomly chosen and evenly distributed in the PF Interval of the risk.

Note: For Condition Monitor records in a condition-based maintenance Action, the probability of finding the potential failure is defined by the Detection Probability (%). This probability is evenly distributed over the PF Interval of the risk.

Calculations for Weibull Distribution

Failure Rate

$$h(t) = (1/\eta)^\beta \beta (t - \gamma)^{\beta-1}$$

Note: For Weibull Distribution with two parameters, $\gamma=0$.

PDF

$$f(t) = (\beta/\eta) * ((t - \gamma)/\eta)^{\beta-1} * \exp(-((t - \gamma)/\eta)^\beta)$$

CDF

$$F(t) = 1 - \exp(-((t - \gamma)/\eta)^\beta)$$

MLE

$$\ln Lik = r \ln(\beta/\eta) + (\beta - 1) \sum_{i=1}^r \ln((t_i - \gamma)/\eta) - \sum_{i=1}^n ((t_i - \gamma)/\eta)^\beta$$

Where

t_i

is the failure time of component i , $i=1, \dots, r$ or the censoring time of component i , $i=r+1, \dots, n$. If there is no censoring (complete data), $r = n$.

Least Square

$$y_i = \ln(t_i - \gamma)$$

$$x_i = \ln(-\ln(1 - F(t_i)))$$

$$\bar{x} = \frac{1}{r} \sum_{i=1}^r x_i$$

$$\bar{y} = \frac{1}{r} \sum_{i=1}^r y_i$$

$$b = \frac{r \sum_{i=1}^r x_i y_i - \sum_{i=1}^r x_i \sum_{i=1}^r y_i}{r \sum_{i=1}^r x_i^2 - \left(\sum_{i=1}^r x_i \right)^2}$$

$$a = \bar{y} - b\bar{x}$$

→

$$\beta = 1/b$$

$$\eta = \exp(a)$$

Note: For Weibull distribution with 3 parameters, γ can be obtained by minimizing r-squared of the least square line fit.

Failure Data

About Failure Data

This topic provides a listing of all overviews and high level explanatory information to help you understand failure data.

Introduction to Failure Data

A failure is the inability of a piece of equipment to perform its intended function. A failure may involve the complete loss of function, a partial loss of function, or the potential loss of function.

Reliability describes how likely it is that a piece of equipment will perform its intended function without failure for a given period of time. Reliability is expressed as a percentage and is expressed mathematically as (1 - The Probability of Failure).

The GE Digital APM Reliability Analytics module allows you to analyze failure data so that you can draw conclusions and make predictions about the reliability of your equipment and locations. To perform an analysis in Reliability Analytics, you must first collect failure data and store it in GE Digital APM. Examples of important data include:

- Equipment type and location.
- Failure modes.
- Failure type, class, repair actions, and cost.
- Design, process, diagnostic, and work order data.

After the data has been collected, you will need to format the data, and [supply it to the GE Digital APM Reliability Analytics tools](#). Throughout this documentation, we assume that you are collecting and can access the data that is necessary to perform a Reliability Analysis.

About Supplying Failure Data to Reliability Analytics

When you create a new analysis in Reliability Analytics, you will need to select a query or dataset on which to base the analysis or manually enter the data that you want to analyze. One of the easiest and most efficient ways to conduct an analysis is to create one based on a query. The advantage of using queries is that each time you view the analysis, GE Digital APM will run the underlying query to retrieve the most current information from the database. Analysis based on datasets and manually entered data, on the other hand, require more manual intervention to reflect updates.

Note: Throughout this documentation, we assume you have entered all important data and will be creating analysis based on queries.

The specific data that you need to create an analysis will vary, depending on the type of analysis that you are creating, the specific information that is available, and the results that you want to see.

Note: The type of failure data you collect will influence the conclusions you can make about your equipment. If you have one pump or several pumps with a specific failure mode, then you can perform a very specific analysis. If you have many pumps with many different failure modes, then your analysis will be less specific.

For additional information on creating queries, refer to the Queries section of the documentation.

The Importance of Failure Modes

Failure modes, and the type of data that you capture will influence the conclusions you can make about your equipment. If you have one pump or several pumps with a specific failure mode, then you can perform a very specific analysis. If you have many pumps with many different failure modes, then your analysis will be less specific.

For example, if you want to know the chances of a certain part on the pump failing, and in your dataset you have several pumps that have failed in that way, then your analysis will be more accurate than using data with multiple failure modes. If you are analyzing all of the pumps at your site, and you have many different reasons for failure, you will be able to determine overall failure statistics. This analysis, however, will not be particularly useful in determining the probability of failure of a specific piece of equipment.

Failure modes can be classified as independent and dependent failures. An independent failure is not caused by another failure but a dependent failure is caused by another failure. As a reliability analyst, you must evaluate which failures should be part of an analysis to obtain correct and specific results. You can follow failure coding standards, such as ISO 14224:2006 for best results. These standards provide guidelines to collect reliability and maintenance data in a standard format for equipment in all facilities in an organization.

About Failure Probability

Conditional Reliability is used in GE Digital APM's Failure Probability Calculator. The calculator is available for all distribution models and uses conditional probability to compute the probability of failure at time, t .

The concept of Conditional Reliability involves the following questions:

1. What is the probability of failure given that the item has survived until today?
-or-
2. How many days until I reach a certain % probability of failure?

Understanding the results of a failure probability analysis is a learned skill that will improve the more it is used. For example, the user may find the current probability of failure for a given element to be 90% or more after 3 years of operating time. If the user were to calculate the future probability of failure 10 days from the current date, the estimate of future failure probability might be around 1%. This is accurate. This often occurs when the future is small compared to the total life experienced by the elements under study.

Wear out, Beta > 1

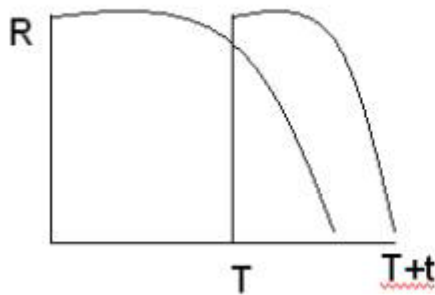

Infant Mortality, Beta < 1

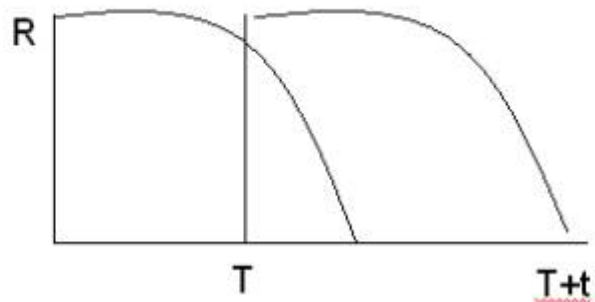

$$R(T,t) = R(T+t)/R(T)$$

The Probability of surviving (T + t) days equals the Probability of surviving (T) days and then surviving additional (t) days.

GE Digital APM Reliability allows you to specify the operating time and calculate the probability of equipment failure. Or you can choose to specify the probability of equipment failure and then calculate the future age when the specified probability will be reached.