



Metrics and Scorecards



Contents

Chapter 1: Overview	1
Overview of the Metrics and Scorecards Module	2
Metrics and Scorecards Features	3
Access the Metrics and Scorecards Overview Page	3
Metrics and Scorecards Workflow	4
Chapter 2: Workflow	5
Metrics and Scorecards: Manage SSAS Cubes Workflow	6
Metrics and Scorecards: Manage Metric Views Workflow	7
Metrics and Scorecards: Manage KPIs Workflow	9
Metrics and Scorecards: Manage Scorecards Workflow	11
Chapter 3: Manage Cubes	14
Overview of Cubes	15
How Cubes are Used	16
About Scheduling Cubes for Processing	16
About Full Processing and Incremental Processing	17
Access the Manage Cubes Page	17
Register a Cube	18
Modify a Cube	19
Delete a Cube	19
Chapter 4: Manage Scorecards	20
Overview of Scorecards	21
About Viewing the Details of a Scorecard	21
About Designing a Scorecard	22
Access the Scorecard Details Page	22
Access the Scorecard Design Page	23
Access the Associated Pages for a Scorecard	24
Access Reference Document for a Scorecard	24

Create a Scorecard	25
Create a Copy of a Scorecard	25
Update Measures for KPIs in a Scorecard	25
Set a Scorecard as Home Page	26
Filter KPIs in a Scorecard	26
Export a Scorecard	27
Delete a Scorecard	27

Chapter 5: Manage Key Performance Indicators (KPIs) 28

Overview of Key Performance Indicators (KPIs)	29
About Viewing the Details of a Key Performance Indicator	29
About Updating Measurements	30
About Automatically Updating Measures	30
About Specifying Limits for a KPI	31
How Number Formats Are Applied to KPIs	32
About KPI Scores	32
Access the KPI Details Page	33
Access the KPI Design Page	33
Access the Associated Pages for a KPI	34
Access Reference Document for a KPI	34
Create a KPI	34
Create a Copy of a KPI	48
View a KPI Score	48
Update the Measures of a KPI	49
Export a KPI	49
Delete a KPI	49

Chapter 6: Manage Metric Views 50

Overview of Metric Views	52
About Viewing a Metric View	52
About the MDX Queries	53
About Including Actions in a Metric View	54
About the Drillthrough Feature	55
About Drilldown and Drillup	55
About Right and Left Y-Axis Scales in a Metric View	56

Access the View Page of a Metric View	56
Access the Metric Views Design Page	56
Access an MDX Query	57
Create a Metric View	57
Create a Copy of a Metric View	58
Sort the Table	58
Create a Calculated Measure	59
Basic Definitions of Calculations in Work History Cube	63
Work History Cube Calculations	64
Add Filters to a Metric View	70
Modify the Filters Applied to a Metric View	73
Modify the Graph Settings	73
Zoom In and Out of the Graph in a Metric View	77
Invoke Actions in a Graph for Metric Views	78
Drill Down a Metric View	78
Drill Down a Metric View in the Tabular View	78
Drill Through a Metric View	79
Export a Metric View	79
Export a Drill Through Result	80
Add Slicer Members When Viewing a Metric View	80
Transpose a Metric View	80
Delete a Metric View	81
Chapter 7: Manage Privileges	82
About Security in Metrics and Scorecards	83
About Cube Privileges	83
About KPI Privileges	83
About Scorecard Privileges	84
Modify Access Rights to an Analysis Services Cube Record	84
Modify Access Rights to a Scorecard	85
Modify Access Rights to a KPI	85
Chapter 8: Deployment and Upgrade	87
Deployment	88
Upgrade	88

Chapter 9: Reference

89

General Reference

90

Family Field Descriptions

95

Queries Folder

98

Copyright GE Digital

© 2023 General Electric Company.

GE, the GE Monogram, and Predix are either registered trademarks or trademarks of All other trademarks are the property of their respective owners.

This document may contain Confidential/Proprietary information of and/or its suppliers or vendors. Distribution or reproduction is prohibited without permission.

THIS DOCUMENT AND ITS CONTENTS ARE PROVIDED "AS IS," WITH NO REPRESENTATION OR WARRANTIES OF ANY KIND, WHETHER EXPRESS OR IMPLIED, INCLUDING BUT NOT LIMITED TO WARRANTIES OF DESIGN, MERCHANTABILITY, OR FITNESS FOR A PARTICULAR PURPOSE. ALL OTHER LIABILITY ARISING FROM RELIANCE UPON ANY INFORMATION CONTAINED HEREIN IS EXPRESSLY DISCLAIMED.

Access to and use of the software described in this document is conditioned on acceptance of the End User License Agreement and compliance with its terms.

Chapter 1

Overview

Topics:

- [Overview of the Metrics and Scorecards Module](#)
- [Metrics and Scorecards Features](#)
- [Access the Metrics and Scorecards Overview Page](#)
- [Metrics and Scorecards Workflow](#)

Overview of the Metrics and Scorecards Module

Metrics and Scorecards integrates performance management theory with sophisticated data analysis tools to prompt and facilitate actions that can improve organizational performance.

GE Digital APM Metrics and Scorecards uses Microsoft SQL Server Analysis Services that enable the selection of dimensions and measures for easy access to data, multidimensional views, drill-down analysis, Scorecards, and Key Performance Indicators (KPIs). Using GE Digital APM Metrics and Scorecards functionality, you can measure and examine your company's work requests, locations, equipment, work orders, and task information. Through data analysis, you can regulate your maintenance and reliability measurements. Using KPIs, you can track progress by focusing on specific areas within the organization. These KPIs allow you to monitor the most important variables that reflect mission success and company performance.

Note: To use an OLAP data cube as datasource for Metrics or KPI, GE Digital APM must be connected to SQL Server Analysis Services.

The primary tools that you will use within GE Digital APM Metrics and Scorecards include:

- **Metric View:** A tool for authoring and delivering multidimensional reports. It is a visual representation of a multidimensional cube that has been defined in SQL Server Analysis Services. When you create a Metric View, you can choose the dimensions and measures from the cube. After the Metric View is created, it can be presented in charts or in a tabular format. By default, the Metric View is presented in chart format.
- **Key Performance Indicator (KPI):** A list of metrics that are identified as the most important variables reflecting mission success or organizational performance. A KPI is a measure that is monitored over time, at a predetermined frequency. You can create KPIs, schedule updates, add data sources for KPIs, and define alerts for KPIs. A KPI can also be displayed on a dashboard in a dial representation. By monitoring a list of KPIs, you can identify the performance issues.
- **Scorecards:** Reports that reflect the status of the KPIs. Via Scorecards, users can organize KPIs that help the organization achieve various objectives. The tabular view summarizes the status of multiple KPIs, helping you see the overall trends in a succinct format. You can also drill down into a single KPI to view more details.

Note: You must have the Metrics Manager license to create, edit, or delete a Metric View, KPI, or Scorecard.

The following table provides a list of functionality that is accessible depending on the status of the license.

Functionality	License Status: Active	License Status: Inactive
Metrics Views	Create, Update, Delete, and View	View
Scorecard	Create, Update, Delete, and View	View
Key Performance Indicators	Create, Update, Delete, and View	<ul style="list-style-type: none"> • View • Update the following features of KPI design page: <ul style="list-style-type: none"> ◦ Limits ◦ Schedule ◦ Alerts ◦ Privileges

Metrics and Scorecards Features

The Metrics and Scorecards module allows you to work with three distinct items: Scorecards, Key Performance Indicators (KPIs), and Metric Views.

GE Digital APM leverages its fundamental entity and relationship family infrastructure to store data related to Scorecards, Metric Views, and KPIs. It may be useful to remember that Scorecards, Metric Views, and KPIs are simply customized views of individual records and Catalog items that work together.

A Scorecard is represented by a Scorecard record and all the records to which it is linked. Each Scorecard record can be linked to the following records:

- One or more KPI records.
- One or more KPI Objective records.
- One or more KPI Perspective records.

A KPI is represented by a KPI record and all the records to which it is linked. Each KPI record can be linked to the following records:

- One or more KPI records.
- One or more KPI Measurement records.
- One or more Scorecard records.

A Metric View is a Catalog item that displays data from an Analysis Services Cube, which is represented by an Analysis Services Cube record. In order to build a Metric View, the following items must be configured:

- A SQL Server connection, which is defined in an SSAS Servers record.
- An Analysis Services Cube, whose connection information is stored in the Analysis Services Cube record.

Access the Metrics and Scorecards Overview Page

About This Task

The **Metrics and Scorecards** page provides a quick access to Metric View, Scorecard, or Key Performance Indicators (KPI). For MI Metrics Administrator and Super Users, this page also provides access to registered cubes through the **Manage Cubes** button.

Procedure

In the **Applications** menu, navigate to the **TOOLS** section, and then select **Metrics and Scorecards**. The **Metrics and Scorecards** page appears.



SCORECARD ID	LAST MODIFIED ON	LAST MODIFIED BY	CREATED DATE	CREATED BY
APM Best Practice Scorecard (Monthly)	8/28/2017 3:49:40 PM	Administrator, Meridium	10/20/2015 4:17:21 PM	Administrator, Meridium
New Sort Feature	3/10/2005 11:55:09 AM	Administrator, Meridium		
Everyone Scorecard	7/28/2004 9:45:11 AM	Administrator, Meridium		

Note: The query for the Scorecard and KPI list displayed on the **Metrics and Scorecards** page are stored in the Catalog folder(..../<filepath>). You can modify the columns displayed on the grid by editing the source query. However, you must not change the query name and the location. For KPI, the path is: public/

meridium/modules/core/queries/allKpis and for Scorecard the path is: public/meridium/modules/core/queries/allScorecards.

The **Metrics and Scorecards** page displays the following sections:

- **Scorecards:** Displays a list of existing scorecards. In the **Scorecards** section, you can [create a new Scorecard](#) or [view an existing Scorecard](#).
- **Key Performance Indicators:** Displays a list of existing KPIs. In the **Key Performance Indicators** section, you can [create a new KPI](#) or [view an existing KPI](#).
- **Metric Views:** Displays a list of existing Metric Views. In the **Metric Views** section, you can [create a new Metric View](#) or [view an existing Metric View](#).

Note:

To search for a specific Metric View, Scorecard, or KPI, you can select the search button () and then enter the name of a Metric View, Scorecard, or KPI.

When you select an item listed in the any of the three sections, the details appear on a new page.

Metrics and Scorecards Workflow

The following workflow provides the basic, high-level steps for using this module. The steps and links in this workflow do not necessarily reference every possible procedure.

1. [Add a cube.](#)
2. [Create a Metric View](#) by using the cube.

Note: Interaction with the view or design page of a Metric View, such as drill through, is not available on GE Digital APM mobile application.

3. Create a KPI by providing the following details:
 - a. [Adding a datasource.](#)
 - b. [Scheduling a KPI](#) and setting the alerts.
4. [Create a Scorecard.](#)
5. Add the KPI to the dashboard as widget.

Chapter 2

Workflow

Topics:

- [Metrics and Scorecards: Manage SSAS Cubes Workflow](#)
- [Metrics and Scorecards: Manage Metric Views Workflow](#)
- [Metrics and Scorecards: Manage KPIs Workflow](#)
- [Metrics and Scorecards: Manage Scorecards Workflow](#)

Metrics and Scorecards: Manage SSAS Cubes Workflow

This workflow describes the process of connecting to an SSAS Cube.

In the following workflow diagram, the blue text in a shape indicates that the corresponding description has been provided in the sections that follow the diagram. For more information, refer to the [Interpreting the Workflow Diagrams](#) topic in the [APM Product Workflows](#) documentation.

Note: For information on the personas associated with a GE Digital APM module, refer to the [APM Product Workflows](#) documentation.

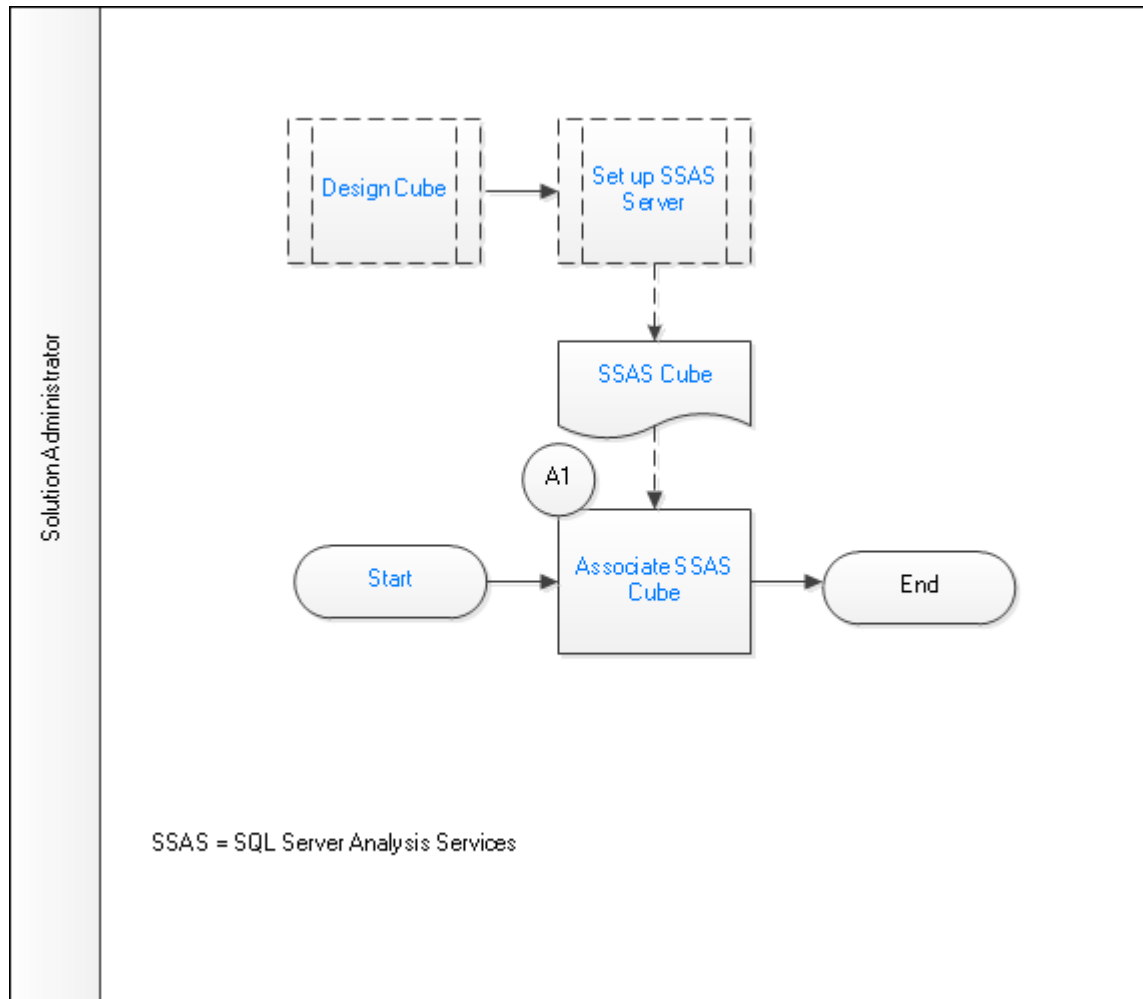

1. [Start](#) on page 6
2. [Design Cube](#) on page 7
3. [Set up SSAS Server](#) on page 7
4. [SSAS Cube](#) on page 7
5. [Associate SSAS Cube](#) on page 7

Start

Persona: Solution Administrator

This process will associate the predefined SSAS data cubes with a particular instance of GE Digital APM, and initiate cube management.

Design Cube

Persona: Solution Administrator

Create OLAP cube in SQL Server Analysis Services. The cube stores data in an optimized way to provide a quick response to various types of complex queries by utilizing dimensions and measures.

Set up SSAS Server

Persona: Solution Administrator

Set up an SSAS Server to host solutions. For example, Analysis Services is an analytical database server that hosts multidimensional cubes that you can access from the GE Digital APM Metrics and Scorecards module.

SSAS Cube

Persona: Solution Administrator

A list of registered cubes that the user has access to based on the cube privileges.

Associate SSAS Cube

Persona: Solution Administrator

Associate the predefined SSAS data cube with a particular instance of GE Digital APM.

Metrics and Scorecards: Manage Metric Views Workflow

This workflow describes the process for designing and analyzing Metric Views.

In the following workflow diagram, the blue text in a shape indicates that the corresponding description has been provided in the sections that follow the diagram. For more information, refer to the [Interpreting the Workflow Diagrams](#) topic in the [APM Product Workflows](#) documentation.

Note: For information on the personas associated with a GE Digital APM module, refer to the [APM Product Workflows](#) documentation.

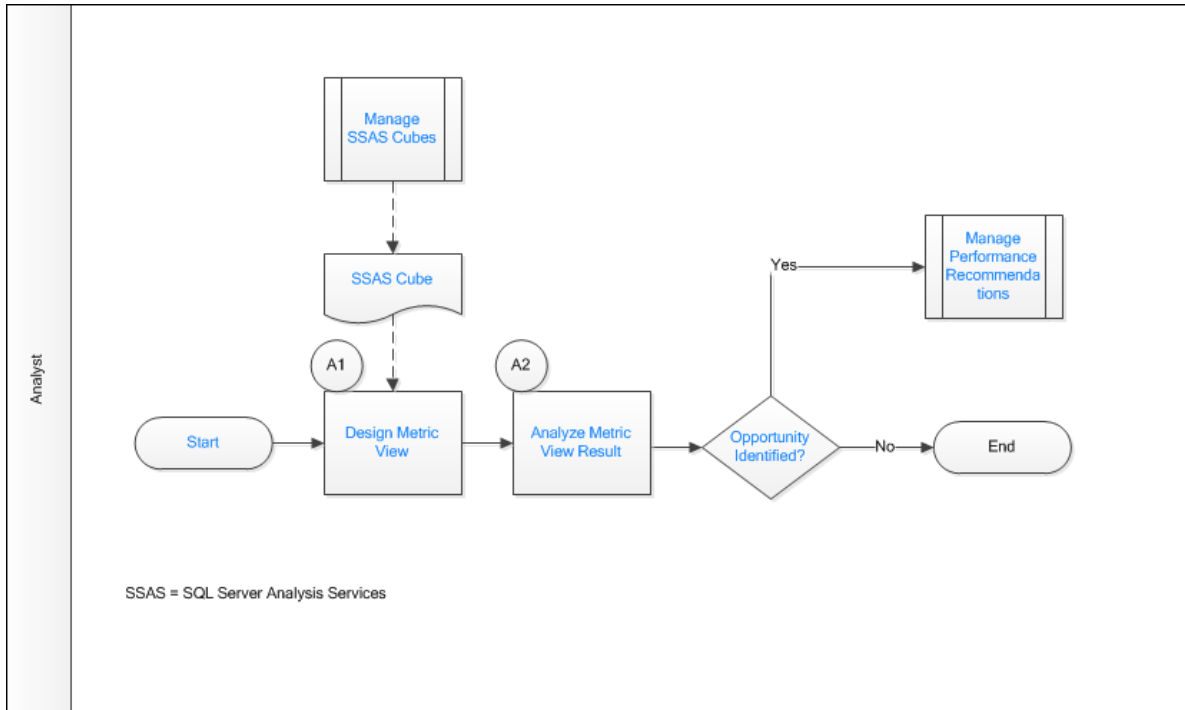

1. [Start](#) on page 8
2. [Manage SSAS Cubes](#) on page 8
3. [SSAS Cube](#) on page 8
4. [Design Metric View](#) on page 9
5. [Analyze Metric View Result](#) on page 9
6. [Opportunity Identified?](#) on page 9
7. [Manage Performance Recommendations](#) on page 9

Start

Persona: Analyst

This process will create a Metric View by applying standard data analysis techniques to analyze a specific business problem, and initiate Metric Views.

Manage SSAS Cubes

Persona: Analyst

A cube record registered in the Manage SSAS Cubes workflow will be used as a data source to design a Metric View.

Go to the [Manage SSAS Cubes workflow](#).

SSAS Cube

Persona: Analyst

A list of registered cubes that the user has access to based on the cube privileges.

Design Metric View

Persona: Analyst

Design a Metric View to display specific data from existing SSAS cubes to analyze a specific business need. The dimension and measure will display all the dimensions pertaining to the selected cube.

Analyze Metric View Result

Persona: Analyst

Analyze the Metric View results. The Metric View can identify bad actors or high impact failures for further analysis.

Opportunity Identified?

Persona: Analyst

Review the Metric View to determine if there is an opportunity or need for improvement. If such an opportunity is determined to exist, then a Performance Recommendation is raised to communicate the need and track the required work. Otherwise, the workflow ends.

Manage Performance Recommendations

Persona: Analyst

If an opportunity or need for improvement is identified in Metrics View, then raise a Performance Recommendation to communicate and track the required work.

Refer to the Manage Performance Recommendations workflow documentation for more information.

Metrics and Scorecards: Manage KPIs Workflow

This workflow describes the process of designing, analyzing, and updating Key Performance Indicators (KPIs).

In the following workflow diagram, the blue text in a shape indicates that the corresponding description has been provided in the sections that follow the diagram. For more information, refer to the [Interpreting the Workflow Diagrams](#) topic in the [APM Product Workflows](#) documentation.

Note: For information on the personas associated with a GE Digital APM module, refer to the [APM Product Workflows](#) documentation.

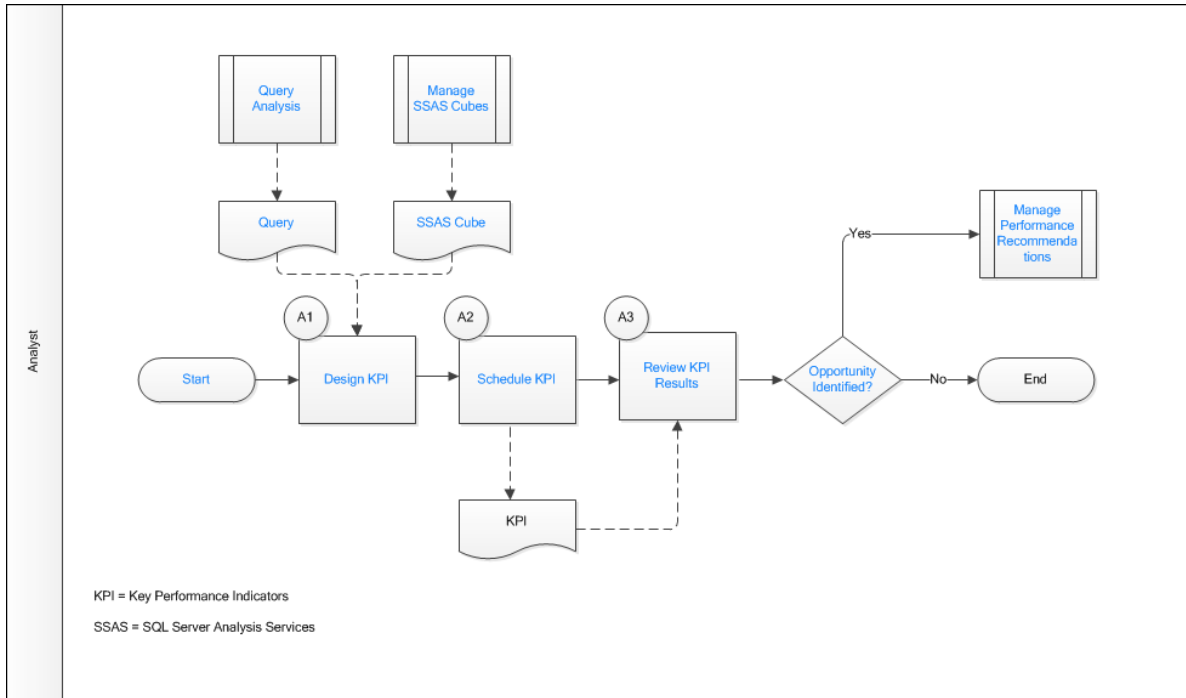

1. [Start](#) on page 10
2. [Query Analysis](#) on page 10
3. [Query](#) on page 10
4. [Manage SSAS Cubes](#) on page 11
5. [SSAS Cube](#) on page 11
6. [Design KPI](#) on page 11
7. [Schedule KPI](#) on page 11
8. [Review KPI Results](#) on page 11
9. [Opportunity Identified?](#) on page 11
10. [Manage Performance Recommendations](#) on page 11

Start

Persona: Analyst

This process will create a KPI by applying standard data analysis techniques to evaluate the success of reaching targets, and initiate Key Performance Indicators (KPIs).

Query Analysis

Persona: Analyst

The GE Digital APM query created for the analysis can be used as a data source for a KPI.

Refer to the Query Analysis workflow for more information.

Query

Persona: Analyst

The GE Digital APM Query that will serve as a data source for the Key Performance Indicator (KPI).

Manage SSAS Cubes

Persona: Analyst

A cube record registered in the Manage SSAS Cube workflow can be used as a data source for a KPI.

Go to the [Manage SSAS Cubes workflow](#).

SSAS Cube

Persona: Analyst

The SSAS Cube that will serve as a data source for the Key Performance Indicators (KPIs).

Design KPI

Persona: Analyst

Design a Key Performance Indicator (KPI) to display specific data from existing SSAS cubes or a GE Digital APM Query that satisfies a specific business need. Measures are used to create KPIs.

Schedule KPI

Persona: Analyst

Schedule the Key Performance Indicator (KPI) to run at a particular date and time, either once or on a repeating basis, to update KPI measures. Add the recipients to whom the KPI updates will be sent.

Review KPI Results

Persona: Analyst

Analyze the Key Performance Indicator (KPI) measure. The KPI query can identify bad actors or high impact failures for further analysis. If needed, you can add the KPI as a dashboard widget. As a dashboard widget, the KPIs will be easily accessible and will provide users with a comprehensive view of data.

Opportunity Identified?

Persona: Analyst

Review a Key Performance Indicator (KPI) to determine if there is an opportunity or need for improvement. If such an opportunity is determined to exist, then a Performance Recommendation is raised to communicate the need and track the required work. Otherwise, the workflow ends.

Manage Performance Recommendations

Persona: Analyst

If an opportunity or need for improvement is identified from a KPI, then raise a Performance Recommendation to communicate and track the required work.

Refer to the Manage Performance Recommendations workflow documentation.

Metrics and Scorecards: Manage Scorecards Workflow

This workflow describes the process for designing and analyzing Scorecards.

In the following workflow diagram, the blue text in a shape indicates that the corresponding description has been provided in the sections that follow the diagram. For more information, refer to the [Interpreting the Workflow Diagrams](#) topic in the [APM Product Workflows](#) documentation.

Note: For information on the personas associated with a GE Digital APM module, refer to the [APM Product Workflows](#) documentation.

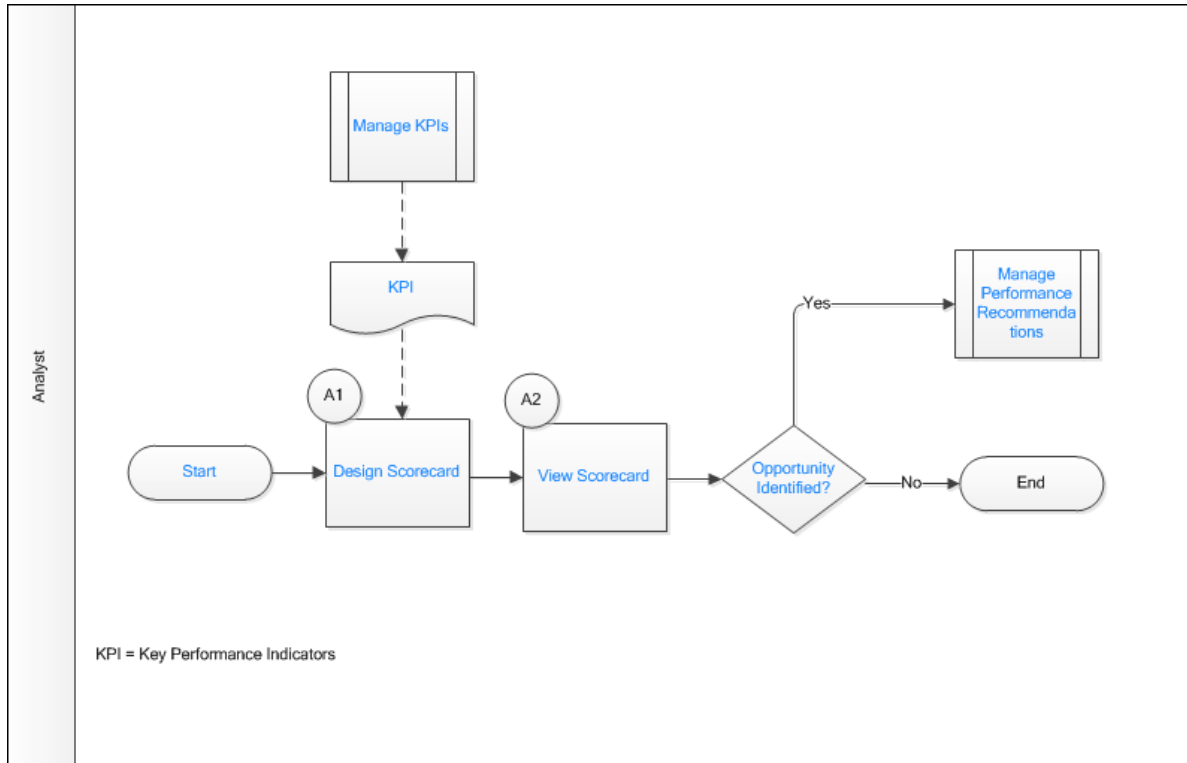

1. [Start](#) on page 12
2. [Manage KPIs](#) on page 12
3. [KPI](#) on page 13
4. [Design Scorecard](#) on page 13
5. [View Scorecard](#) on page 13
6. [Opportunity Identified?](#) on page 13
7. [Manage Performance Recommendations](#) on page 13

Start

Persona: Analyst

This process will measure the business Perspectives and Objectives that result from adding Key Performance Indicators (KPIs) to the Scorecard, and initiate Scorecard.

Manage KPIs

Persona: Analyst

The KPIs created in the Manage KPIs workflow will be used to create the Scorecard.

Go to the [Metrics and Scorecards: Manage KPIs workflow](#).

KPI

Persona: Analyst

The KPI from the existing repository that will be added as an Objective to the Scorecard.

Design Scorecard

Persona: Analyst

Design a Scorecard to display specific KPIs from the existing KPI repository. The user can assign View privileges for a Scorecard.

View Scorecard

Persona: Analyst

Analyze the perspective and objectives of a Scorecard. The KPIs in a Scorecard can identify bad actors or high impact failures for further analysis. If needed, you can add the Scorecard as a homepage.

Opportunity Identified?

Persona: Analyst

Review a Scorecard to determine if there is an opportunity or need for improvement. If such an opportunity is determined to exist, then a Performance Recommendation is raised to communicate the need and track the required work. Otherwise, the workflow ends.

Manage Performance Recommendations

Persona: Analyst

If an opportunity or need for improvement is identified in Scorecard, then raise a Performance Recommendation to communicate and track the required work.

Refer to the Manage Performance Recommendations workflow documentation.

Chapter 3

Manage Cubes

Topics:

- [Overview of Cubes](#)
- [How Cubes are Used](#)
- [About Scheduling Cubes for Processing](#)
- [About Full Processing and Incremental Processing](#)
- [Access the Manage Cubes Page](#)
- [Register a Cube](#)
- [Modify a Cube](#)
- [Delete a Cube](#)

Overview of Cubes

A cube is an Analysis Services object that provides a multidimensional representation of data. When you build a cube in Analysis Services, you define measures and dimensions. Measures are the quantitative values in the database that you want to analyze (e.g., Mean Time Between Failures and Total Costs). Dimensions define exactly what you want to measure (e.g., Location or Equipment Type). Hierarchies define how the dimensions are aggregated.

Measures, dimensions, and hierarchies define a cube. For each intersection of a dimension and measure, a value is calculated. For example, the Mean Time Between Failures for Centrifugal Pumps in FCC Unit during 1999 could equal 152 Days.

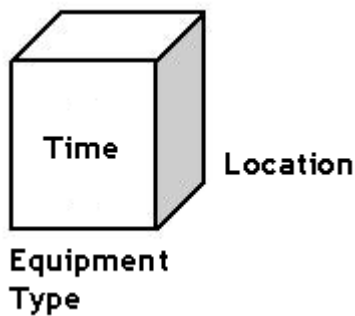

Defining Measures for the Cube

Measures are the quantitative values in the database that you want to analyze. For example, In Work History cube, typical measures are total maintenance cost, total cost, event count, asset count, proactive work cost and so on. Measures are analyzed against the different dimension categories of a cube. For example, you may want to analyze total maintenance cost and event count (your measures) for a particular equipment (a dimension) across functional location during two particular years (levels of a time dimension).

Defining Dimensions for the Cube

The dimensions of a cube represent distinct categories for analyzing business data. Categories such as time, geography, or product line breakdowns are typical cube dimensions.

Dimensions are usually organized into hierarchies of information that map to columns in a relational database. Dimension hierarchies are grouped into levels consisting of dimension members. Each level in a dimension can be rolled together to form the values for the subsequent level. For example, in a time dimension, days roll into months, and months roll into quarters. The following hierarchy provides an example how different levels might be arranged within a dimension:

Refinery

- Unit
 - Function Location

Equipment

- Rotating
 - Pumps

Year

- Month
 - Day

How Cubes are Used

The **Metrics and Scorecards** module provides access through the GE Digital APM application to the cubes that exist in SQL Server Analysis Services, and allows you to develop Metric Views and KPIs using the data that is stored in those cubes.

Before you can access Analysis Services cubes through GE Digital APM, you will need to complete various configuration tasks. Configuring cubes for use with GE Digital APM Metrics and Scorecards functionality consists of the following tasks:

- [Create cubes in Analysis Services](#). Cubes are Analysis Services objects that can be created, modified, and managed using tools that can be installed with SQL Server Analysis Services. The first step in enabling GE Digital APM Metrics and Scorecards functionality is to create the desired cubes in Analysis Services.

For details on creating and managing cubes in Analysis Services, consult the documentation that was included with your SQL Server Analysis Services installation.

- [Create Analysis Services Cube records in GE Digital APM](#). After you have created the desired Analysis Services cubes, you can create GE Digital APM objects (i.e., Metric Views and KPIs) that are based upon those cubes. Before you can do so, you must first establish a link between the cubes and GE Digital APM. To establish this link, you will create an Analysis Services Cube record in GE Digital APM to contain all the identifying information for the cube. Doing so will allow GE Digital APM to connect to the appropriate Analysis Server to access the information associated with that cube.
- [Configure privileges for Analysis Services Cube records](#). After you have created the necessary Analysis Services Cube records to make the desired cubes available in GE Digital APM, you will need to configure privileges for those Analysis Services Cube records. In addition to GE Digital APM standard family-level security, Metrics uses entity-level security to control access to individual records. Users must be able to access Analysis Services Cube records in order to access and manage the GE Digital APM objects (i.e., Metric Views and KPIs) that are based upon the associated cubes.

About Scheduling Cubes for Processing

An Analysis Services cube is a combination of measures and dimensions that together determine how a set of data can be viewed and analyzed. A cube is a static object and initially represents the data that existed in Analysis Services for the selected measures and dimensions when the cube was created. To keep a cube current, it must be processed regularly, whereby the cube is updated with the most current data in Analysis Services.

To make sure that a cube always provides users with the most current data, you should schedule it for processing regularly, usually on a daily basis. One way to process cubes and shared dimensions successfully is to do so manually on the Analysis Server. Using this method, you can process shared dimensions first, and then process the related cubes. Processing cubes manually, however, is not a viable option if you have many cubes that you want to process on a daily basis.

Instead, a preferable option would be to schedule cubes for processing using Data Transformation Services (DTS). This functionality is available in the SQL Server Business Intelligence Development Studio, which is included in SQL Server Standard Edition. For details on creating a DTS package that can be used to process objects according to a custom schedule, see your SQL Server documentation.

About Full Processing and Incremental Processing

When you process a cube on the Analysis Server, either manually or by using a schedule, you have the option of choosing full processing or incremental processing.

- You should use full processing whenever structural changes have been made to the cube. Structural changes include:
 - Deleting GE Digital APM records that will delete Members from a Dimension.
 - Updating GE Digital APM records that will result in changing Member names.
 - Rearranging levels or adding and deleting dimensions.
- You can use incremental processing whenever you want to update the cube based on the most recent data, as long as changes to the data do not have any affect on the structure of the cube.

Note that when full processing is performed, Metric Views will become inaccessible to users who are currently logged in to the GE Digital APM and have already accessed the Views. Users will need to restart the GE Digital APM application to access Views after a cube has been processed using full processing, if they are logged in at the time the processing occurred. GE Digital APM does not need to be restarted when incremental processing is used.

Therefore, if you are scheduling cubes for processing and need to use the full processing option, you should schedule the processing so that it occurs at a time when users are not using the GE Digital APM system. If you are scheduling cubes that are unlikely to change, you can use incremental processing and schedule the processing to occur at any time.

Access the Manage Cubes Page

Procedure

1. [Access the Metrics and Scorecards Overview Page](#) on page 3.
2. In the upper-right corner of the page, select **Manage Cubes**.

Note: You can access the **Manage Cubes** page only if you are a member of the MI Metrics Administrator Security Group.

The **Manage Cubes** page appears.

The **Manage Cubes** page displays a list of existing Analysis Services Cube records. The left pane displays the list of cubes that are available to create a Metric View or a KPI. On selecting a cube, the workspace for that cube appears.

Next Steps

- [Register a cube.](#)
- [Assign privileges to a cube.](#)

Cube Fields

The **Manage Cubes** page displays a list of existing Analysis Services Cube records. For a cube, the following details are required.

Field	Data Type	Description	Behavior and Usage
Analysis Services Server	N/A	The server name on which the Analysis Services instance running this cube.	N/A
Analysis Server Type	N/A	The version of the server.	This field is populated automatically depending on the server name that you have provided. You cannot modify this field.
Cube ID	N/A	The cube ID for the cube.	Provide an ID for the Analysis Services Cube record. The ID must be unique.
Cube Name	Character	Displays the available cube.	The list is populated automatically.
Database Name	Character	Displays the available data source name.	The list is populated automatically.
Password	N/A	The password that you have provided when creating a user on the Analysis Server.	This field appears if you have provided HTTP or HTTPS in the Analysis Services Server .
Short Description	Text	The description of the cube.	N/A
User Id	N/A	The user ID that you have provided when creating a user on the Analysis Server.	This field appears if you have provided HTTP or HTTPS in the Analysis Services Server .

Note: If a connection cannot be made to SQL Server Analysis Services, either because the server is unavailable or because no value exists in the **Analysis Services Server** box of the Analysis Services Cube record, then the **Last processed on** date will not appear.



Register a Cube

This topic describes how to register a new Analysis Services Cube, which will store the information of a cube that has been defined in SQL Server Analysis Services.

Before You Begin

- You must have the Metrics Manager license to register a new cube.
- You must be a Super User or an MI Metrics Administrator.

Procedure

1. Access the [Manage Cubes](#) page.
2. In the left pane, select .
A blank **Analysis Services Cube** form appears.
3. As needed, enter the values in the [available fields](#).
4. Grant privileges to a User or a Group to access the cube.
5. Select .
The cube is registered.

Next Steps

- [Create a Metric View.](#)

Modify a Cube

Before You Begin

- You must have [access to a cube](#) to modify its record.

Procedure

1. [Access the Manage Cubes page.](#)
2. Select the cube that you want to modify.
The fields for the selected cube appear.
3. As needed, modify the values in the [available fields](#).
4. Select .
The cube is modified.

Delete a Cube

Before You Begin

- [You must have privilege to delete the cube.](#)
- An Analysis Services Cube record cannot be deleted if it is being used by a Metric View or a KPI. Therefore, to delete an Analysis Services Cube record, you must first delete all of the associated Metric Views or KPIs.

About This Task

Note: Deleting an Analysis Services Cube from GE Digital APM does not delete the associated cube from Analysis Services.

Procedure

1. [Access the Manage Cubes page.](#)
2. Select the cube that you want to delete.
The selected cube appears.
3. In the upper-right corner of the page, select .
The **Delete Cube** dialog box appears, asking you to confirm that you want to delete the cube.
4. Select **OK**.
The Analysis Services Cube record is deleted.

Chapter 4

Manage Scorecards

Topics:

- [Overview of Scorecards](#)
- [About Viewing the Details of a Scorecard](#)
- [About Designing a Scorecard](#)
- [Access the Scorecard Details Page](#)
- [Access the Scorecard Design Page](#)
- [Access the Associated Pages for a Scorecard](#)
- [Access Reference Document for a Scorecard](#)
- [Create a Scorecard](#)
- [Create a Copy of a Scorecard](#)
- [Update Measures for KPIs in a Scorecard](#)
- [Set a Scorecard as Home Page](#)
- [Filter KPIs in a Scorecard](#)
- [Export a Scorecard](#)
- [Delete a Scorecard](#)

Overview of Scorecards

A Scorecard allows you to monitor various performance aspects of your organization. Scorecards allow you to monitor performance from different perspectives, based on specific objectives and KPIs identified by your organization.

A complete Scorecard contains multiple instances of the following items, which appear in a hierarchy:

- **Perspectives:** Areas on which you want your company to focus. For example, Cost Optimization.
- **Objectives:** Specific goals towards which you want the company and the employees to strive. Each Objective is categorized under a specific Perspective. For example, an Objective under the Cost Optimization Perspective might be to optimize day-to-day tasks.
- **KPIs :** Key Performance Indicators that measure the company's ability to meet its objectives. Each KPI is categorized under a specific Objective. For example, to measure the company's ability to optimize day-to-day tasks, you can have a KPI that measures the percent of equipment that has a new or reviewed Asset Strategy.

Note: You can use a KPI in more than one Scorecard.

You can create or modify a Scorecard using the [Scorecard design page](#). After a Scorecard is designed, as data is collected and tracked using the KPIs, you can view a summary of the data on the [Scorecard details page](#).

About Viewing the Details of a Scorecard

The page displaying the details of a Scorecard is labeled as <Scorecard_Name>, where <Scorecard_Name> is the name of the selected Scorecard. This page displays a hierarchical view of Perspectives, Objectives, and KPIs.

The page displays the following details:

- The name of the Scorecard.
- The last modified date and time, and the name of the person who modified the Scorecard.
- The Perspective and the Objective names.
- The KPIs associated with the Scorecard.

On the Scorecard details page, Perspectives and Objectives will be sorted alphabetically irrespective of the order that you have specified in the Scorecard design page.

On this page, KPIs appear in tiles and display the values that are stored in the individual KPI records such as current value, percentage change, and a plus or minus sign that indicates the status of the KPI. For example, if there is a plus sign, it indicates that the current value is higher than the previous value. The KPIs are highlighted according to where the value falls within the values assigned to the worst value, critical value, target value, stretch value, and best value. For example, if an actual value is 10.00, and the target value is 5.00, the KPI would be highlighted in green, which indicates that the value falls between the stretch value and the best value.

You can select the name of the KPI to view its details. On selecting the KPI name, the [KPI details page](#) for the selected KPI appears, displaying additional information about the selected KPI.

You can add filters to view a subset of the KPIs that are currently displayed in the details page of a Scorecard. You can filter and view the KPIs associated with a Scorecard based on their performance. The following are the filter options that you can use.

- Worst-Critical (KPIs appears in Red color)

- Critical-Target (KPIs appears in Yellow color)
- Target-Stretch (KPIs appears in Light Green color)
- Stretch-Best (KPIs appears in Dark Green color)

You can select  to see the grid view of the Scorecard. In this view, you can see the following additional information:

- **KPI Name:** The name of the associated KPIs.
- **Current Value:** The current value of the KPIs.
- **Previous Value:** The KPI value at its last measurement date.
- **Change:** The percentage change when compared with the **Previous Value**.
- **Event Date:** The last updated date of KPI. The update can either be a measure update or a KPI field update.

You can modify the Scorecard details by selecting .

About Designing a Scorecard

On the [Scorecard form](#), you can design a new Scorecard or modify an existing Scorecard.

On this page, you can do the following:

- Add the following content to a Scorecard:
 - [Perspectives](#)
 - [Objectives](#)
 - [KPIs](#)
- [Modify data associated with contents of a Scorecard.](#)
- [Delete contents from a Scorecard.](#)

Access the Scorecard Details Page

Procedure

1. [Access the Metrics and Scorecards Overview Page](#) on page 3.
2. In the **Scorecards** section, select the Scorecard that you want to view.

Note: To search for a specific Scorecard, you can select , and then enter the name of a Scorecard.

The Scorecard details page appears.

Note: When you search for a Scorecard by using , the Scorecard will appear on the Scorecard details page. This is because the Scorecard details route `#metrics/scorecard-tile-view/{ENTY_KEY}` is specified in Families Managed by Product Module in Configuration Manager for the Scorecard family.

You can select Grid view () or Tabular view () to switch between Scorecard views.

Note: When you log in for the first time, the content appears in Grid View by default. When you change the Scorecard view, it is saved as your user preference. For all future logins, when you access any Scorecard, the Scorecard details appear as per the saved user preference until you change the view.

Example of a Scorecard Details Page

The following image shows an example of a completed Scorecard on the [Scorecard details page](#).

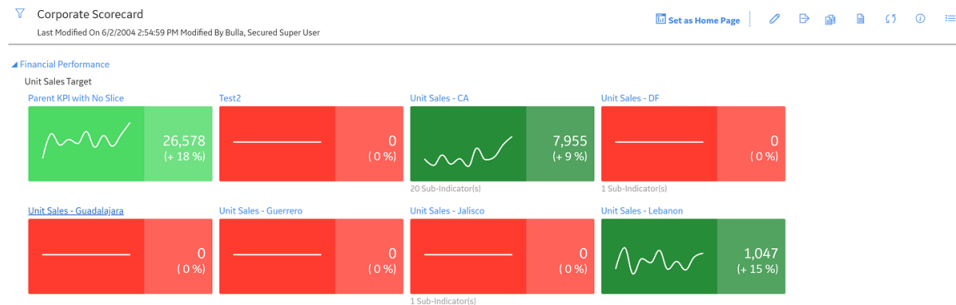

In this example, the Scorecard uses a Corporate Perspective, Asset Perspective, and Process Perspective. The objective for the Corporate Perspective is to minimize the maintenance expenses of the equipment, and the objective for the Process Perspective is to minimize reactive work and increase the proactive work.

Access the Scorecard Design Page

Procedure

1. [Access the Scorecard details page for a Scorecard](#).
2. In the upper-right corner of the page, select . A page containing details about the Scorecard appears, displaying the **Perspectives** section.
3. If needed, modify the values in the **Perspectives** and **Privileges** sections.
4. Select .
5. If needed, select to view the details page of the Scorecard. The Scorecard details page appears.

Example of Scorecard Design Page

The following image shows an example of a completed Scorecard on the [Scorecard design page](#), including labels to indicate the perspectives, objectives, and KPIs.

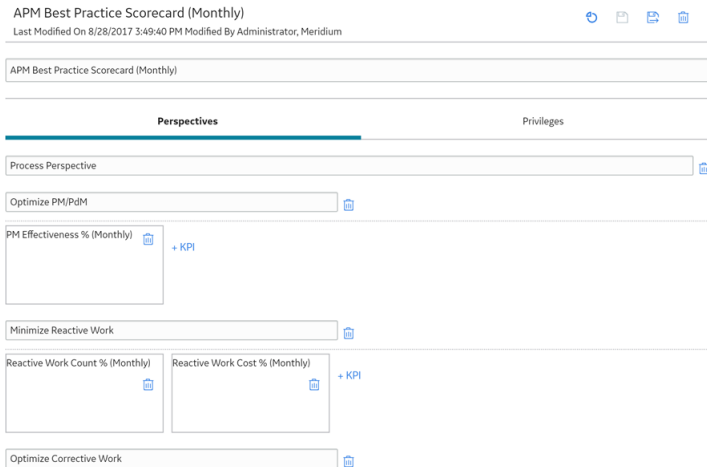



In this example, the Average Corrective Work Cost and Corrective Work Cost is using a Corporate Perspective to reach the objectives, or goal, of improving the corrective cost. The company is also measuring its ability to improve the asset reliability by using Asset Perspective that uses the 12 M Rolling MTBF and 12 M Rolling MTBR as the objective.

Access the Associated Pages for a Scorecard

About This Task

If you need to add more associated pages to a Scorecard, you can do so by accessing the Scorecard family and the Associated Pages functionality of Configuration Manager.

Procedure

1. [Access the Scorecard details page.](#)
2. In the right side of the page, select . The **Associated Pages** pane appears. The **Associated Pages** hierarchy contains links to associated pages. In the hierarchy, where a  button appears next to an associated page name, you can select the button to view the additional sub-pages.

Access Reference Document for a Scorecard

Procedure

1. [Access the details page of an existing Scorecard.](#)
2. Select . The **Reference Documents** window appears.

Tip: For more information, refer to the [Manage Reference Documents](#) section of the Record Manager module for additional options when working with reference documents.

Create a Scorecard

Procedure

1. [Access the Metrics and Scorecards Overview Page](#) on page 3.
2. In the **Scorecard** section, select .
The **New Scorecard** page appears, displaying the **Perspectives** section.
3. Select **Add Perspective**, and then, in the **Add Perspective** box, enter the Perspective name.
The **Add Objective** link appears.
4. Select **Add Objective** and then enter the Objective name in the **Enter Objective Name** box.
The **Add KPI** link appears.
5. Select the **Add KPI** link.
The **Select KPIs** window appears, displaying the list of KPIs.
6. Select the check box appearing next to each KPI that you want to add, and then select **OK**.
The **Select KPIs** window closes and the selected KPIs appear in a tile format in the **Perspectives** section.
7. If you want to add another Objective and KPIs to the current Perspective, repeat steps 4 through 6.

-or-

If you want to add another Perspective to the Scorecard, repeat steps 3 through 6.

Note: To remove a Perspective, Objective, or a KPI from the Scorecard, select . Removing a KPI from a Scorecard indicates that the KPI is no longer associated with that Scorecard.

8. Select .
- A confirmation message appears, indicating that the Scorecard has been created. The name of the Scorecard appears on the page and the name of the Scorecard also appears in the **Scorecards** section of the **Metrics and Scorecards** page.

Create a Copy of a Scorecard

About This Task

You can create a new Scorecard by using the values of an existing Scorecard. To do this, you need to create a copy of an existing Scorecard. You can also modify the values of this Scorecard as needed.

Procedure



1. [Access the Scorecard design page](#) for an existing Scorecard.
2. In the upper-right corner of the page, select .
Copy of <Label> page appears, where <Label> is the name of the Scorecard that you have selected.

Update Measures for KPIs in a Scorecard

About This Task

You can bulk update the measures of all the Key Performance Indicators associated with a Scorecard.

Procedure

1. [Access the Scorecard details page.](#)
2. In the upper-right corner of the page, select .
The measures for all the KPIs are updated.
3. If you want to view the status of the update, select .
The **KPI Measure Update Log** window appears, displaying the statuses of all the KPIs.

Set a Scorecard as Home Page

About This Task

You can set an existing Scorecard as your Home Page.

Procedure



1. [Access the details page of an existing Scorecard.](#)
2. Select **Set as Home Page**.
The **Set as Home Page** dialog box appears, asking you to confirm that you want to set the page as the Home Page.
3. Select **Yes**.
The selected Scorecard appears as Home Page.
4. If you want to check that the Scorecard is set as your Home Page, then in the top navigation bar, select .
The details page of the Scorecard that is set as Home Page appears.

Filter KPIs in a Scorecard

About This Task

You can filter the KPIs associated with a Scorecard [based on their performance](#).

Procedure

1. [Access the Scorecard details page.](#)
2. Select .
The **Filters** menu appears, displaying the list of filter options.
Note: The list displayed will contain only the filter options that are applicable for the KPIs in that Scorecard.
3. To select the filter options, select the appropriate check boxes.
The result for the selected filter options appears on the Scorecard details page. The selected filters will appear selected on the **Filters** menu. At any time, you can remove the filter option by selecting the  button that appears next to it.

Export a Scorecard

Before You Begin

- [Create a Scorecard.](#)

About This Task

You can export a Scorecard to a PDF format.

Procedure

1. [Access the Scorecard details page.](#)
2. In the upper-right corner of the page, select  to export the Scorecard in PDF file format. The .PDF file appears.

Delete a Scorecard

Procedure

1. [Access the Scorecard design page of the Scorecard that you want to delete.](#)
2. In the upper-right corner of the page, select . The **Delete Scorecard** dialog box appears.
3. Select **OK**.
A confirmation message appears, indicating that the Scorecard has been deleted. The Scorecard no longer appears in the **Scorecards** section of the **Metrics and Scorecards** page.

Chapter 5

Manage Key Performance Indicators (KPIs)

Topics:

- [Overview of Key Performance Indicators \(KPIs\)](#)
- [About Viewing the Details of a Key Performance Indicator](#)
- [About Updating Measurements](#)
- [About Automatically Updating Measures](#)
- [About Specifying Limits for a KPI](#)
- [How Number Formats Are Applied to KPIs](#)
- [About KPI Scores](#)
- [Access the KPI Details Page](#)
- [Access the KPI Design Page](#)
- [Access the Associated Pages for a KPI](#)
- [Access Reference Document for a KPI](#)
- [Create a KPI](#)
- [Create a Copy of a KPI](#)
- [View a KPI Score](#)
- [Update the Measures of a KPI](#)
- [Export a KPI](#)
- [Delete a KPI](#)

Overview of Key Performance Indicators (KPIs)

KPIs are metrics that an organization can use to monitor their performances. Every KPI should be linked directly to a business goal. If the variables within a metric are performing successfully, a business goal can be attained for a company. Likewise, if certain variables within the metric are not performing successfully, a company may fall short of its business goal. By closely tracking the variables within a KPI, the problem areas can be assessed and targeted, and efficient areas can continue to improve.

The first step to establishing an efficient KPI monitoring process is developing KPIs. After KPIs are developed, they can be tracked and monitored on a continual basis. When developing KPIs, you must focus on:

- Developing a set of metrics that reflect the objectives of the company in delivering outputs. These metrics will be aligned with business unit objectives and KPIs within each relevant perspective.
- Developing indicators of processes and activities that measure drivers and enablers of performance and point to action.



About Viewing the Details of a Key Performance Indicator

The Key Performance Indicator (KPI) details page displays the values that are recorded for a KPI, indicating where the actual value falls within the defined limits by using the dial chart or bullet chart. It also shows how the values have changed over time by using the trend-line chart.

On this page, you can see the following details of a KPI:

- **Name:** Displays the name of the selected KPI.
 - **Last Modified On:** Displays the date when the last scheduled update was run on the KPI and the name of the person who created or updated the KPI. This field is updated when:
 - You manually update the KPI by selecting **Update Measures**.
 - An automatic schedule is run based on the schedule defined for the KPI in the [Schedule, Alerts and Privileges](#) section.
 - **More Information:** Displays links to all the associated Scorecards. The Scorecard name appears as a link that you can select to view the Scorecard details.
 - **Description:** A description of the KPI.
 - Dial chart button (.
- Note:** You can add a KPI as a dashboard widget either in dial chart or bullet chart format. For more information, see the Dashboards documentation.
- **History:** Displays the KPI results in a trend line chart, for a set period of time. You can view the data for a specific period of time by selecting a time period in the **Zoom** section or by using the trend line

slider provided below the graph. When you hover or tap on the datapoints on the trend-line, it provides an indication of where each value falls within the determined range.

- Tabular View button (). The tabular view displays the **Date** and **Value/Score** columns. The table provides the date and the history of the measures for the selected time period. To change the tabular format to trend-line format, select the line view button (.
- **Sub-Indicators:** Displays the list of sub-indicator KPIs that are assigned to the current KPI. The sub-indicator KPIs appear in tile format and the name of the sub-indicators appear as a link. On selecting the sub-indicator KPI name, the details page for the sub-indicators KPI appears.

Note: If you update a parent KPI, all other KPIs in that hierarchy will also be updated.

In addition to this, you can also perform the following on a KPI details page:

- [Modify the KPI.](#)
- [Export a KPI in .PDF format.](#)
- [Manually update the KPI.](#)

About Updating Measurements

Measurements can be updated using the following methods:

- [By using the !\[\]\(13dd0e1ab3baa23f7c1ed52b3eec2756_img.jpg\) button.](#)
- [Through scheduled execution.](#)

When measurements are updated via either of these methods, the GE Digital APM system will:

- Update the measurement of the KPI with the current value.
- When KPIs updated by schedule job cross the threshold value, an event is triggered and [notifications are sent to the associated email addresses](#). The user receives notification according to their subscription to the alert condition.

For example, you might have a trigger that is evaluating based on schedule, but that sends notifications only when the KPI value reaches the highest of its defined ranges.

About Automatically Updating Measures

KPI measurements can be updated automatically according to a schedule. You can define the desired schedule for each KPI via the **Schedule, Alerts, and Privileges** section, which you can access from [the KPI design page](#).

Scheduled updates are typically performed on KPIs built from Analysis Services or Queries, or aggregated from sub-indicators. To avoid confusion and eliminate the possibility of reviewing and analyzing out-of-date information, you should schedule an update of KPI measurements at the same time that measurements are scheduled to be taken. For example, if you are going to collect measurements on the first day of each month, you should also schedule the updates to run on the first day of each month.

[KPIs can be scheduled](#) for automatic updates one time or on a recurring basis. The following table describes the schedules by which you can configure the KPI measurements to be updated.

Frequency	Example
Every x minutes from start time or after last occurrence.	Every thirty minutes from the start time. Every thirty minutes after the last update.
Every x hours from start time or after last occurrence.	Every one hour from the start time. Every one hour after the last update.
Every x number of days from start time or after last occurrence.	Every two days from the start time. Every two days after the last update.
Every x day from start time or after last occurrence where you define the day of the week.	Every third day from the start time. Every third day after the last update.
Every x month from start time or after last occurrence.	Every three months from the start time. Every three months after the last scheduled update.
Every x year from start time or after last occurrence.	Every two years from the start time. Every two years after the last scheduled update.

Note: The Daylight Saving Time (DST) is supported for the schedules defined for a KPI. If you have specified the schedule for a KPI in days, weeks, months, or in years since the last occurrence, the schedules will adjust according to the DST. However, the schedules defined in n hours since last occurrence do not support DST. However, it is recommended that you avoid scheduling the jobs near to the transition hours of Daylight Savings Time.

About Specifying Limits for a KPI

When you create a KPI for a piece of equipment, you will specify the limit values for the KPI. The limits that you specify define a performance range for the KPI based on your expectations for the equipment. The actual performance of the equipment will be evaluated based on this range. For example, your monthly water bill could be a Key Performance Indicator of the plumbing system in your home. This means that, based on your expectations, a high water bill (i.e., the Actual value) could indicate leaks in your system, and a low water bill should indicate a leak-free plumbing system.

The KPI limit range is essentially a scale from Worst to Best, and the limit values are essentially thresholds within that range. The following image shows the KPI ranges and where the limit values that define these ranges appear. When measurements are taken, the Actual value may fall between or equal the limit values, which indicates how well the equipment is performing (e.g., If the Actual value falls between the Target and Stretch Limit values, the KPI is in the Target-Stretch range).

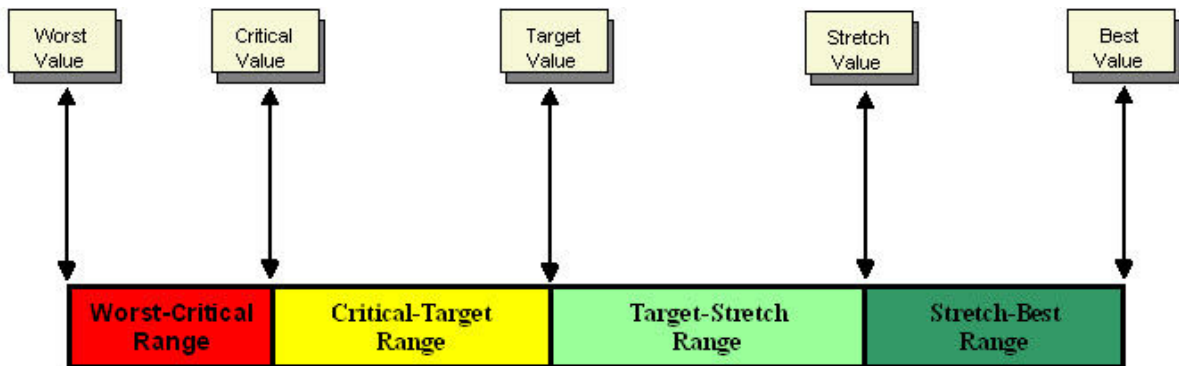

The limit values may vary depending on what you want to measure. For example, if you create a KPI based on your monthly water bill, the range values will be measured in dollars, and your Best value would be a

low number (e.g., \$30.00), while your Worst Value would be a high number (e.g., \$300.00). In another case, the KPI may be based on a water heater, which would require that Best value to be a high number, and the range to be measured in degrees Fahrenheit.

To continue with the water bill example, the monthly cost for water usage in your home would be the key indicator of the overall performance of the equipment involved in the plumbing system. A high water bill might indicate that the usage of water is high, that there is a leakage in a pipe, that a piece of equipment is malfunctioning, or all of the above. The KPI should serve as the first step in tracking the performance of the system.

How Number Formats Are Applied to KPIs

When you define a number format for a KPI, information about that format is stored in the data source (MI_KPI_DATAS_TX field) of the KPI record. Within the KPI family, baseline rules exist on the following fields to format values in those fields according to the rules that exist in the data source (MI_KPI_DATAS_TX field):

- Alert Value
- Best value
- Critical Value
- Stretch Value
- Target Value
- Worst Value

In other words, these fields contain rules that will apply any number formatting that has been defined. Because this feature is implemented via baseline rules, the number format will not be applied if you have defined custom rules for any of these fields.

About KPI Scores

When a KPI is created, it is automatically assigned a score. A score is a normalized value between 0.0 and 1.0 representing the relative strength of the Actual Value. The formula is either:

- **$(\text{Actual Value} - \text{Worst Value}) / (\text{Best Value} - \text{Worst Value})$**
If the Best Value > Worst Value
- or-
- **$(\text{Actual Value} - \text{Best Value}) / (\text{Worst Value} - \text{Best Value})$**
If the Best Value < Worst Value

The closer the score is to 1.0, the higher the strength of the Actual Value.

Scores are useful when comparing measures whose values cover a wide range. It becomes difficult to work with such vastly different numbers, but working with scores allows you to compare relatively close numbers. For example, when comparing ten Actual Values that range from 20 to 500, the gap is almost too large to manage. When you compare the scores of the measures, however, you only have to examine numbers between 0.0 and 1.0, thus making it easier to make comparisons and conclusions.

The score is calculated using the Actual Value, Best Value, and Worst Value of the current KPI, as indicated in the specified equations. In case of Data Source Type as Manual, Analysis Services, and APM Query, when Show Score Only is selected, the Actual Value is calculated to display the score.

By using the [Show Score Only](#) check box on the KPI design page, you can choose to view a [KPI score](#) instead of Actual, Target, Critical, and Stretch Values in the trend-line chart and dial sections of the [KPI details page](#).

In case of a KPI with Data Source Type as Aggregate, the **Aggregate Score only** option is available in the KPI designer page. Only the Score will be displayed for that KPI by aggregating scores of its sub-indicators using the selected aggregation function (i.e., Average, Weighted Average, Minimum, or Maximum).

Access the KPI Details Page

About This Task

You can view the details of a KPI by using the KPI details page. The page displays the values that are recorded for the KPI, indicates where the values fall within the defined limits, and shows how the values have changed over time.

Procedure

1. [Access the Metrics and Scorecards Overview Page](#) on page 3.
2. In the **Key Performance Indicator** section, select the KPI that you want to view.

Note: To search for a specific KPI, you can select , and then enter the name of a KPI.

The KPI details page appears as <KPI_Name>, where <KPI_Name> is the name of the selected KPI. This page displays the [details](#) for the selected KPI.

For the sub-indicator, the KPI details page will contain the hyperlinked name of the parent KPI above the KPI name. You can use this hyperlink to navigate to the parent KPI.

Note: When you search for a KPI by using , the KPI will appear on the KPI details page. This is because the KPI details route #metrics/kpi-viewer/{ENTY_KEY} is specified in Families Managed by Product Module in Configuration Manager for the KPI family.

Access the KPI Design Page



About This Task

When you create a new KPI, the **New KPI** page appears displaying an empty form where you can enter the details of a KPI. When you save the KPI, the page name changes to the KPI name.

Procedure

1. [Access the KPI details page](#).
2. Select .

The KPI design page appears, displaying the name of the selected KPI. The KPI design page contains two sections, **KPI Datasheet**, and [Schedule, Alerts, and Privileges](#) where you can provide or modify the details of a KPI.

3. If needed, modify the values in the **KPI Datasheet** and [Schedule, Alerts, and Privileges](#) sections, and then, to save your changes, select .
4. If needed, select  to view the details page for the KPI.

The KPI details page appears.

Next Steps

- [Create a KPI.](#)



Access the Associated Pages for a KPI

About This Task

You can access the list of associated pages for a KPI via KPI details page or by KPI design page.

If you need to add the associated pages to a KPI, you can do so by accessing the KPI family and the Associated Pages functionality of Configuration Manager.

Procedure

1. [Access the KPI details page.](#)
2. In the right side of the page, select  .
The **Associated Pages** pane appears. The **Associated Pages** hierarchy contains links to associated pages. In the hierarchy, when a  appears next to an associated page name, it can be expanded to view the sub pages.

Access Reference Document for a KPI

Procedure

1. [Access the details page of a KPI.](#)
2. Select  .
The **Reference Documents** window appears.

Tip: For more information, refer to the [Manage Reference Documents](#) section of the Record Manager module for additional options when working with reference documents.

Create a KPI

Before You Begin

- You must have the privilege to create a KPI.
- You must have the required privilege to use a cube as KPI datasource.

Procedure

1. [Access the Metrics and Scorecards Overview Page](#) on page 3.
2. In the **Key Performance Indicator** section, select  .
The **New KPI** page appears, displaying the **KPI Datasheet** section.
3. As needed, enter values in the [available fields](#).
4. Select the **Schedule, Alerts, and Privileges** tab.
The **Schedule, Alerts, and Privileges** section appears.

Note: You can view the log for the scheduled status log for a KPI in the **Scheduled Logs** page of the Operations Manager.

5. As needed, enter values in the [available fields](#).

Note: The parent KPI schedule will be saved to its sub-indicator KPIs. However, when you disassociate a sub-indicator from the parent KPI, the scheduler from the sub-indicator will be removed and you have to reschedule it.

6. Select .

The name of the KPI appears on the page, indicating that the new KPI is created and saved. The new KPI name also appears in the **Key Performance Indicators** section of the **Metrics and Scorecards** page.

KPI Datasheet

The [KPI Datasheet section](#) contains fields where you can provide the basic information such as KPI Name, Parent KPI, Description, and so on. The following table provides information about the fields in this section.

Field	Data Type	Description	Behavior and Usage
Actual	Number	Displays the type of aggregation that you want to use for calculating the Actual Value.	<p>This is a required field. This field appears in the Data Source Fields section when you select the Data Source Type as Aggregate.</p> <p>In all these fields, you can select any of the following calculations:</p> <ul style="list-style-type: none"> • Sum: The addition of all the sub-indicators • Average: The calculated average of the sub-indicators. • Weighted Average: The value of the KPI is calculated from the value of its sub-indicators (e.g., V1, V2, V3, and V4) and the value of pre-determined weight factor associated with each sub-indicator (e.g., K1, K2, K3, and K4). The weighted average is usually calculated as $(K1 \times V1 + K2 \times V2 + K3 \times V3 + K4 \times V4) / (K1 + K2 + K3 + K4)$. • Minimum: The minimum value from the sub-indicators. • Maximum: The maximum value from the sub-indicators.
Add Measures	N/A	Displays the table where you can provide the values.	<p>This field appears in the Data Source Fields section when you select the Data Source Type as Manual.</p> <p>This field displays a table with following columns :</p> <ul style="list-style-type: none"> • Dates • Values

Field	Data Type	Description	Behavior and Usage
Aggregate Score only	N/A	If you want a normalized score to be calculated from sub-indicators, select the Aggregate Score Only check box. The aggregated score will be calculated and displayed depending upon the aggregation type selected in Actual field in the Data Source Fields section.	This field appears in the Data Source Fields section when you select the Data Source Type as Aggregate. If you have selected the Aggregate Score only check box, then you need to determine the function used to calculate the score value in the Data Source Fields section.
Best value	N/A	The optimal output level.	This field appears in the Data Source Fields section when you select the Data Source Type as APM Query. This field lists all the columns that contains number value. You can either select the value in these fields or provide the value in the Limit section. This value is used to calculate the normalized score that is assigned to the KPI when it is created.
Bullet Chart	N/A	Displays the KPI in bullet chart format.	This field appears in the Data Source Fields section. By default, the dial chart is selected. However, you can select this option to display the KPI in a bullet chart format in the KPI details page.

Field	Data Type	Description	Behavior and Usage
Critical	Number	Displays the type of aggregation that you want to use for calculating the Critical Value.	<p>This field appears in the Data Source Fields section when you select the Data Source Type as Aggregate.</p> <p>You can either select the value in these fields by using the drop-down list box or provide the value in the Limits section. In any of the cases, you must provide value to the Actual field.</p> <p>In all these fields, you can select any of the following calculations:</p> <ul style="list-style-type: none"> • Sum: The addition of all the sub-indicators • Average: The calculated average of the sub-indicators. • Weighted Average: The value of the KPI is calculated from the value of its sub-indicators (e.g., V1, V2, V3, and V4) and the value of pre-determined weight factor associated with each sub-indicator (e.g., K1, K2, K3, and K4). The weighted average is usually calculated as $(K1 \times V1 + K2 \times V2 + K3 \times V3 + K4 \times V4) / (K1 + K2 + K3 + K4)$. • Minimum • Maximum
Critical Value	Number	The value that indicates that the KPI is not reaching its potential target.	<p>This field appears in the Data Source Fields section when you select the Data Source Type as APM Query.</p> <p>This field list all the columns that contains number value. You can either select the value in these fields or provide the value in the Limit section.</p>
Cube	N/A	The cubes that are registered in the Analysis Services data source are displayed as a list of values.	This field appears in the Data Source Fields section when you select the Data Source Type as Analysis Services.

Field	Data Type	Description	Behavior and Usage
Data Source Type	N/A	Contains the list of data sources that can be assigned to this KPI.	<p>The values for a KPI measurement are pulled from a specified data source. You can create KPI by using the following options.</p> <ul style="list-style-type: none"> • Analysis Services: By using an Analysis Services, you are extracting data from a Cube that is configured in the Analysis Services. • APM Query: By using a GE Digital APM query, you are extracting data from the GE Digital APM database. • Aggregate: By using aggregation, you specify that the sub-indicators, or the lower level variables of the KPI, should be calculated together for the data source. An aggregation is a table or structure containing pre-calculated data for a Cube. You can aggregate sub-indicators by using a sum, an average, a weighted average, a minimum, or a maximum function. The values that can be aggregated are the actual value, the target value, the stretch value and the critical value. • Manual: By using the data source as Manual, you define input for a KPI by providing specific values instead of using an external data source. <p>Depending upon the data source that you select, the related fields appear.</p>

Field	Data Type	Description	Behavior and Usage
Dates	Date	Specify the date for the actual values.	<p>This field appears in the Add Measures section when you select the Data Source Type as Manual.</p> <p>You can select the dates by using .</p> <p>Note: The dates must be unique. You must not enter two values for the same date.</p>
Description	Text	Provide a brief description of the new KPI.	In this field, you can provide the description about the KPI.
Dial Chart	N/A	Displays the KPI in dial chart format.	<p>This field appears in the Data Source Fields section.</p> <p>By default, this option is selected and the KPI appears in a dial chart format in the KPI details page.</p>
Hierarchy Member	N/A	<p>A member from a hierarchy in the cube that you want to monitor.</p> <p>For example, you can select Country as a hierarchy member.</p>	This field appears in the Data Source Fields section when you select the Data Source Type as Analysis Services.
Limit	N/A	Specifies the range of limits for a KPI.	<p>You can provide the values manually in this section. The Limits section contains the following fields:</p> <ul style="list-style-type: none"> • Worst Value • Critical Value • Target Value • Stretch Value • Best value

Field	Data Type	Description	Behavior and Usage
Limiting Level	N/A	The level to which you want to view the KPI.	<p>This field appears in the Data Source Fields section when you select the Data Source Type as Analysis Services.</p> <p>The value in this field depends on the value that you select in the Hierarchy Member list. When you select a hierarchy member and its limiting level, the KPIs are created for every level and member in the Limiting Level.</p> <p>For example, If you select Country as the hierarchy member and City as the limiting level, then the KPIs are created for each state and cities in that selected country.</p>
Measure	N/A	The measure that you want to use for the KPI. For example, you can select Total Maintenance Cost as a measure that you want to monitor over a period of time.	<p>This field appears in the Data Source Fields section when you select the Data Source Type as Analysis Services.</p> <p>This field is enabled only when you select a Cube. This is a required field.</p>
Measurement Date	Date	Contains a list of only Date fields from the query.	<p>This field appears in the Data Source Fields section when you select the Data Source Type as APM Query.</p> <p>In the Measurement Date list, you select a field from the query that represents the measurement date.</p>
Measurement Value	Number	The measure that you want to use for the KPI.	<p>This field appears in the Data Source Fields section when you select the Data Source Type as APM Query.</p> <p>This field is enabled only when you select a query. This is a required field.</p>
Name	Character	Specify the name of the KPI that you want to create.	This is a required field.

Field	Data Type	Description	Behavior and Usage
Number Format	Number	The format for the numeric values.	<p>This field appears when you select the Data Source Type as Analysis Services, APM Query, and Aggregate. You can choose the following number formats:</p> <ul style="list-style-type: none"> • Number: The numeric format. • Number with 0 precision: The number with no decimals. • Number with 1 precision: The number with one digit after the decimal. • Number with 2 precision: The number with two digit after decimal. • Percentage: Specifies that the field will be formatted as a percentage, including multiplying the base value by 100 and including a percent sign (%). • Currency: Specifies that numeric values will be formatted as currency, according to the browser culture on which the GE Digital APM application is being accessed and the number of digits past the decimal that you specify. When you select this option, the example that appears on the KPI Number Format dialog box uses the currency symbol associated with the browser culture on which the GE Digital APM application is being accessed.
Parent KPI	N/A	Contains the list of KPIs that can be assigned as parent KPI to this new KPI.	If the KPI should function as a sub-indicator for another KPI, then in the Parent KPI list, select the parent KPI for which this KPI will be a sub-indicator.

Field	Data Type	Description	Behavior and Usage
Query	N/A	The query from which you want to extract the data.	This field appears in the Data Source Fields section when you select the Data Source Type as APM Query. You can select the query from the Catalog folder.
Show Score Only	N/A	If you want only a score to be calculated for the KPI, select the Show Score Only check box. The actual value will not be populated.	Via the Show Score Only check box on the KPI design page, you can choose to view a KPI score instead of Actual, Target, Critical, and Stretch Values in the Dial chart, trend-line chart and tabular view of the KPI details page.
Slices	N/A	The slice members that can be used to further filter KPI data.	This field appears in the Data Source Fields section when you select the Data Source Type as Analysis Services. You can add slices by selecting + Slices . The Add to Slice window appears displaying all the dimensions. You can select a dimension member from the list.

Field	Data Type	Description	Behavior and Usage
Stretch	Number	A much higher quantitative measurement than a Target Value, demanding breakthrough performance for achievement.	<p>This field appears in the Data Source Fields section when you select the Data Source Type as Aggregate.</p> <p>You can either select the value in these fields by using the drop-down list box or provide the value in the Limits section. In any of the cases, you must provide value to the Actual field.</p> <p>In all these fields, you can select any of the following calculations:</p> <ul style="list-style-type: none"> • Sum: The addition of all the sub-indicators • Average: The calculated average of the sub-indicators. • Weighted Average: The value of the KPI is calculated from the value of its sub-indicators (e.g., V1, V2, V3, and V4) and the value of pre-determined weight factor associated with each sub-indicator (e.g., K1, K2, K3, and K4). The weighted average is usually calculated as $(K1 \times V1 + K2 \times V2 + K3 \times V3 + K4 \times V4) / (K1 + K2 + K3 + K4)$.
Stretch Value	Number	A much higher quantitative measurement than a Target Value , demanding breakthrough performance for achievement.	<p>This field appears in the Data Source Fields section when you select the Data Source Type as APM Query.</p> <p>This field list all the columns that contains number value. You can either select the value in these fields or provide the value in the Limits section.</p>
Sub-Indicators	N/A	Contains the list of KPIs that can be assigned as the sub-indicator KPIs.	You cannot assign the KPI that is already assigned to another parent KPI.

Field	Data Type	Description	Behavior and Usage
Target	Number	A quantitative measurement of a performance metric that is to be achieved by a given time.	<p>This field appears in the Data Source Fields section when you select the Data Source Type as Aggregate.</p> <p>You can either select the value in these fields by using the drop-down list box or provide the value in the Limits section. In any of the cases, you must provide value to the Actual field.</p> <p>In all these fields, you can select any of the following calculations:</p> <ul style="list-style-type: none"> • Sum: The addition of all the sub-indicators • Average: The calculated average of the sub-indicators. • Weighted Average: The value of the KPI is calculated from the value of its sub-indicators (e.g., V1, V2, V3, and V4) and the value of pre-determined weight factor associated with each sub-indicator (e.g., K1, K2, K3, and K4). The weighted average is usually calculated as $(K1 \times V1 + K2 \times V2 + K3 \times V3 + K4 \times V4) / (K1 + K2 + K3 + K4)$.
Target Value	Number	A quantitative measurement of a performance metric that is to be achieved by a given time.	<p>This field appears in the Data Source Fields section when you select the Data Source Type as APM Query.</p> <p>This field list all the columns that contains number value. You can either select the value in these fields or provide the value in the Limit section.</p>

Field	Data Type	Description	Behavior and Usage
Time Level	N/A	The period for which you want to view a KPI result.	<p>This field appears in the Data Source Fields section when you select the Data Source Type as Analysis Services.</p> <p>This is a required field. You can select the Time Level list to select a time level, such as year, semester, quarter, month, week or day. The time level appears in the format: Dimension/Hierarchy/Level.</p>
Values	Number	Displays a text box where you can provide the actual values.	<p>This field appears in the Add Measures section when you select the Data Source Type as Manual.</p> <p>To delete a row, select .</p>
Worst Value	N/A	The output value that should be strictly avoided.	<p>This field appears in the Data Source Fields section when you select the Data Source Type as APM Query.</p> <p>This field list all the columns that contains number value. You can either select the value in these fields or provide the value in the Limit section. This value is used to calculate the normalized score that is assigned to the KPI when it is created.</p>

Schedule, Alerts, and Privileges

The [Schedule Alerts and Privileges](#) section contains fields that allows you to set the schedule, alerts, and privileges for the KPI. The following table provides information about the fields in this section.

Field	Data Type	Description	Behavior and Usage
Alerts	N/A	<p>The alert options for the KPI.</p> <p>Note: To receive the alerts, you must configure the smtp server.</p>	<p>The Alerts section contains the following fields:</p> <ul style="list-style-type: none"> • Alert Conditions: You can select desired alert conditions for a KPI. You can choose to send an alert when: <ul style="list-style-type: none"> ◦ The Actual value is worse than the critical value. ◦ The Actual value is better than the stretch value. ◦ The Actual value is worse than a specified value. Depending on the direction of the scale, the actual value must be either higher or lower than the specified value to trigger an alert. <p>For example, on a scale where the Stretch value is 25 and the Critical value is 100, higher values are worse than lower values. In this case, an alert will be generated when the Actual value is greater than the specified alert value. For example, if you set the alert value to 75, an alert will be triggered whenever the Actual value is greater than 75.</p> <p>On a scale where the Stretch value is 100 and the Critical value is 25, lower values are worse than higher values. In this case, an alert will be generated when the Actual value is less than the specified alert value. For example, if you set the alert value to 75, an alert will be triggered whenever the Actual value is less than 75.</p> ◦ The Actual value was not automatically updated as scheduled. <p>For example, if an Actual value is scheduled to be entered manually or populated automatically based on an Analysis Services query on January 25, 2006 at 1:00 p.m., and the KPI measures are updated after 1:00 p.m. on January 25, 2006, but the Actual value is not populated, an email message will be sent to the specified recipient(s).</p> <ul style="list-style-type: none"> • An alert will include the following information: You can write the alert message in the An alert will include the following information text box. To create a message with specific details, use the following syntax in the message: <ul style="list-style-type: none"> ◦ {KPI_NAME}: Indicates the name of the KPI. ◦ {MEASURE_DATE}: Indicates the measurement date on which the condition occurred. ◦ {ACTUAL_VALUE}: Indicates the actual value of the KPI on the specified measurement date. ◦ {TRIGGERED_CONDITIONS}: Indicates the alert condition that was met on the specified measurement date. <p>For example, a message could be formatted as follows:</p> <p>An alert has been triggered while updating KPI {KPI_NAME} for the period ending on {MEASURE_DATE}. The value of {ACTUAL_VALUE} meets the following criteria: {TRIGGERED_CONDITIONS}.</p> <p>When this message is received in an email message, it would read as follows:</p> <p>An alert has been triggered while updating Financial KPI for the period ending on 2/1/2005. The value of 0 meets the following criteria: The value was not automatically updated as scheduled.</p> • Add Recipient button (): You can add a list of email recipients by selecting the Add Recipient button. The Select the users window appears from which you can select the desired users.



Field	Data Type	Description	Behavior and Usage
Privileges	N/A	The privileges that you can grant to a user or group on accessing a KPI.	You can set privileges to a User or a Group to do the perform the following operations on a KPI: <ul style="list-style-type: none"> • View: Allows the user or the group to view the KPI. • Update: Allows the user or the group to edit the KPI • Delete: Allows the user or the group to delete the KPI.
Schedule	N/A	The time period for a KPI update. Note: If one of the KPIs you selected is part of a hierarchy, a message will appear stating that the schedule for the selected KPI is defined at the root level in the hierarchy of KPIs.	Note: You can add a schedule for a KPI only after saving the KPI. The summary of the KPI schedule that you have defined in the Edit Schedule window appears in the Schedule section. Note: You can view the schedule status log for a KPI in the Schedule Logs page of the Operations Manager. To create or edit a schedule for a KPI, you can select the  . The Edit Schedule window appears. Enter the values in the required fields. For more information on creating a schedule, see Schedule a Job .

Create a Copy of a KPI

About This Task

You can copy an existing KPI. You can use the copy to modify the values of the KPI as desired.

Procedure

1. [Access the KPI design page](#) of an existing KPI.
2. In the upper-right corner of the page, select . **Copy of <Label>** page appears, where <Label> is the name of the KPI that you have selected. If needed, modify the **Name** box, and then select .

View a KPI Score

Procedure

1. [Access the Key Performance Indicator design page](#).
2. Select the **Show Score Only** check box.

-or-

Select **Aggregate Score only**, in case of **Data Source Type** as Aggregate.

Note: On selecting **Aggregate Score only**, the **Show Score Only** check box is selected by default.

3. Select .
4. Select  to view the KPI.

The KPI is displayed on the KPI details page and only the score is displayed on the [trend-line chart](#), [tabular view](#), and [dial chart](#). Note that if the **Show Score Only** check box is not selected, the trend-line chart, tabular view, and dial display the actual values for the given time period.

Update the Measures of a KPI

You can manually update the KPI measures that are being displayed on the KPI details page.

Note: For better performance of KPI measure update, it is recommended to schedule KPI when the KPI data source is APM Query and the query result set contains records more than 5000 rows.

Before You Begin

- [Create a KPI](#).

Procedure

1. [Access the Key Performance Indicator details page](#) of an existing KPI.
2. In the upper-right corner of the page, select .
The KPI details page displays the updated measure for that KPI.

Export a KPI

About This Task

You can export a KPI in a PDF file format.

Procedure

1. [Access the KPI details page](#).
2. In the upper-right corner of the page, select  to export the KPI in .PDF file format.
The .PDF file appears.

Delete a KPI

Procedure

1. [Access the KPI design page](#).
2. In the upper-right corner of the page, select .
The **Delete KPI** dialog box appears.
3. Select **OK**.
A confirmation message appears, indicating that the KPI record is deleted. The KPI no longer appears in the **Key Performance Indicator** section of the **Metrics and Scorecards** page.

Chapter 6

Manage Metric Views

Topics:

- [Overview of Metric Views](#)
- [About Viewing a Metric View](#)
- [About the MDX Queries](#)
- [About Including Actions in a Metric View](#)
- [About the Drillthrough Feature](#)
- [About Drilldown and Drillup](#)
- [About Right and Left Y-Axis Scales in a Metric View](#)
- [Access the View Page of a Metric View](#)
- [Access the Metric Views Design Page](#)
- [Access an MDX Query](#)
- [Create a Metric View](#)
- [Create a Copy of a Metric View](#)
- [Sort the Table](#)
- [Create a Calculated Measure](#)
- [Basic Definitions of Calculations in Work History Cube](#)
- [Work History Cube Calculations](#)
- [Add Filters to a Metric View](#)
- [Modify the Filters Applied to a Metric View](#)
- [Modify the Graph Settings](#)
- [Zoom In and Out of the Graph in a Metric View](#)
- [Invoke Actions in a Graph for Metric Views](#)
- [Drill Down a Metric View](#)
- [Drill Down a Metric View in the Tabular View](#)

- [Drill Through a Metric View](#)
- [Export a Metric View](#)
- [Export a Drill Through Result](#)
- [Add Slicer Members When Viewing a Metric View](#)
- [Transpose a Metric View](#)
- [Delete a Metric View](#)

Overview of Metric Views

Metric View is a visual representation of analytical data (cube), either in graph or tabular format. You can slice and dice the data using the dimension members. You can filter the data that is displayed in the Metric View by adding slices.

For example, you might have a Metric View that contains failure and inventory data on all of the bearing types that exist in a particular facility. Using this Metric View, you can see:

- All the bearing types that exist in the facility.
- How many of each bearing type exists in the facility.
- How many bearing failures occurred last year in the facility.

Adding slices to this Metric View could allow you to view a more specific subset of data to determine:

- Which type of bearing fails most often.
- How much it cost last year to fix the bearings that failed most often.

A Metric View result appears in **Result** section. After you create a Metric View, you can:

- [Drill-down.](#)
- [Link a different Metric View to the current Metric View.](#)
- [Export a Metric View.](#)
- [Configure the Metric View graph.](#)

Note: Metric View is accessible to all users of the application depending upon the privileges assigned to the user on the [cube](#) and the Catalog folder.

About Viewing a Metric View

When you create a new Metric View or open an existing Metric View, the **Result** section displays the result for the Metric View. This section offers two views of the Metric View: Graph view and Table view.

Graph View

By default, the result appears in Graph View format. The Graph View in the **Result** section provides a visual representation of the Metric View. You can modify the default [graph settings](#) by selecting the  button available on the Metric View design page. You can use a mouse pointer to [zoom in](#) by dragging out a rectangle shape in the data point of the chart. When you zoom in to the graph, the **Reset Zoom** button appears. You can select the **Reset Zoom** button to go back to the previous view of the graph.

For example, the following graph shows the Event Count and Average Corrective Work Cost based on the criticality of the equipment.

Result

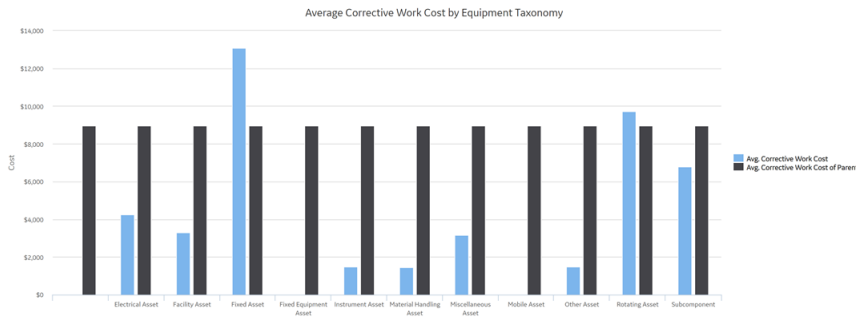



Table View

You can change the Graph View to Table View by selecting the  button in the **Result** section that is displayed in the Graph View. The Table View displays the same information that is displayed in the Graph View, but in a grid format.

Each row in the table corresponds to a value that appears along the x-axis of the graph. The columns in the table represent the values that are plotted on the y-axis of the graph. Using the Table View, you can easily view the actual values that have been plotted on the graph.

For example, the following table shows the Event Count and Average Corrective Work Cost based on the criticality of the equipment. These same values are represented graphically in the preceding image.

KPI Measure Update Log

KPI	LAST MEASURE UPDATE	LAST UPDATED BY	MESSAGE
PM Effectiveness % (Monthly)	9/23/2019 6:32:58 AM	MUJOB,	Success
Reactive Work Cost % (Monthly)	9/23/2019 6:33:08 AM	MUJOB,	Success
Reactive Work Count % (Monthly)	9/23/2019 6:32:58 AM	MUJOB,	Success
Corrective Work Cost % (Monthly)	9/23/2019 6:33:04 AM	MUJOB,	Success
Corrective Work Count % (Monthly)	9/23/2019 6:32:59 AM	MUJOB,	Success
Proactive Work Cost % (Monthly)	9/23/2019 6:33:02 AM	MUJOB,	Success
Proactive Work Count % (Monthly)	9/23/2019 6:33:00 AM	MUJOB,	Success
Average Corrective Work Cost (Monthly)	9/23/2019 6:33:01 AM	MUJOB,	Success
Corrective Work Cost (Monthly)	9/24/2019 6:50:16 AM	Super User, Baseline	Success
Critical Asset Mechanical Availability % (Monthly)	9/23/2019 6:33:07 AM	MUJOB,	Success
Critical Asset Mechanical Unavailability % (Monthly)	9/23/2019 6:33:02 AM	MUJOB,	Success
12M Rolling MTBF (Days)	9/23/2019 6:33:09 AM	MUJOB,	Success
12M Rolling MTBR (Days)	9/23/2019 6:33:06 AM	MUJOB,	Success

1 - 13 of 13 Results

Page 1 of 1

Close

About the MDX Queries

Multidimensional Expressions (MDX) allow you to query multidimensional objects such as cubes, and return the result set that contains the data from the cube.

In the **Metrics and Scorecards** module, you can examine the corresponding MDX query for a Metric View. The MDX Query button displays the **MDX Query** window that allows you to manipulate the MDX on which the data is generated. It is recommended that you do not use the **MDX Query** window without prior knowledge of how to manipulate MDX. Note that if you open the **MDX Query** window, it will contain an underlying expression for the currently selected Metric View.

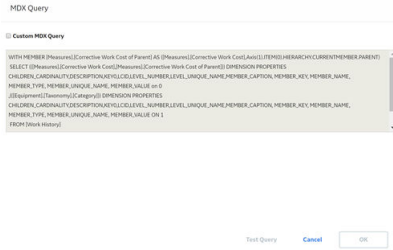

To specify a dataset, an MDX query must contain the following information:

- The number of axes.
- The members from each dimension to include on each axis of the MDX query.
- The name of the Cube that sets the context of the MDX query.
- The members from a slicer dimension on which data is sliced for members from axis dimensions.

The general syntax of an MDX statement is:

```
SELECT [<axis_specification>
[, <axis_specification>...]]
FROM [<Cube_specification>]
WHERE [<slicer_specification>]]
```

In the **MDX Query** window, the SELECT statement is used to specify a dataset containing a subset of multidimensional data. The SELECT clause determines the axis dimensions of an MDX SELECT statement. The FROM clause determines which Cube is to be used when extracting data to populate the result set of the MDX SELECT statement. The optional WHERE clause determines which dimension or member to use as a slicer dimension; this restricts the results to a specific dimension or member.

About Including Actions in a Metric View

You can configure SQL Server Analysis Services cubes to contain Actions, which can provide users with access to extended data and information. Actions that are defined in Analysis Services Cubes will be available in the Metrics and Scorecards module within the Metrics View that are built upon those cubes. When you select the Action, the GE Digital APM system will launch the URL behind that Action.

- If the URL is a GE Digital APM URL, the target will open within the GE Digital APM application. For example, an Action can be configured to open a record in the Record manager. When you select the Action, the **Record Manager** page will appear, displaying the record specified in the URL. You can also configure a URL in SQL Server Analysis Services (SSAS) to open a report from reporting services.
- If the URL specifies a target that is external to GE Digital APM, the external URL will appear in another tab of the same browser. For example, Actions can be configured to display your customer's website on each customer level member.

When a user selects the Target in the Metric View that is built on a cube containing Actions, those Actions appear as buttons in the Metric View's workspace. When a user selects an Action, the Action will be invoked, and the target data will appear. You can configure multiple Actions for a cube.

The available Actions and the information displayed is determined by how the cube is configured in Analysis Services.

- Actions are attached to Targets, which correspond to member levels in a Metric View.

Note: Actions can be attached to a Target at all member levels, including the cube level. Additionally, if an Action is configured on a member level, you will be able to see the Action only after you have drilled down to the associated level. For example, if an Action is configured for a member of Taxonomy Category level and you select the graph on All Taxonomy level, the Action will not appear in the workspace. You will be able to see the Action in the workspace only after you drill down to the Taxonomy Category and select a particular category (e.g., Fixed Asset).

- GE Digital APM supports the use of any Action for which a URL has been defined.

This documentation does not include details on configuring Actions in SQL Server Analysis Services (SSAS). Rather, we limit our discussion of Actions to how they can be invoked after they have been properly configured. For more information on defining Actions within Analysis Services cubes, refer to the SSAS documentation.

About the Drillthrough Feature

In a Metric View, you can drill through certain values in a table or a graph to view the underlying intersection data or source data. The intersection data displayed on the drill through is composed of data that is associated with the end value.

For example, suppose you have a Metric View that measures the total number of work orders over time. In this case, you could drill through the total number of work orders value for 2005 and view the underlying data that is associated with the work order, such as the equipment to which the work order was assigned, the department in which the equipment was located, and the manufacturer of the equipment to which the work order was assigned. Drill through data provides you with a more complete understanding of the Metric View.

The availability of the Drillthrough feature and the data that is displayed is determined by how the associated cube has been configured in Analysis Services.

About Drilldown and Drillup

By drilling down into a graph or a table view, you can view the details of each item represented in the graph. The items contain different levels, each with a greater amount of detail about a given category. For example, consider the following table.

▼ Reactive Work Count % by Equipment Taxonomy
Last Modified On 10/5/2016 9:46:06 AM Modified By Administrator, Meridium

Result /A Fixed Asset

	Reactive Work Count %	Reactive Work Count % of Parent
Boiler	25%	0.24
Fired Equipment	20%	0.24
Heat Exchanger	25%	0.24
Miscellaneous Fixed	13%	0.24
Pipe	25%	0.24
Tank/Material Storage	13%	0.24
Valve	35%	0.24
Vessel	22%	0.24

This following graph shows the Average Corrective Work Cost for all Equipment Taxonomy. You can see that across all Equipment Taxonomy, there are 12 Equipment Taxonomy. When you drill down into the All Equipment Taxonomy, you can see Average Corrective Work Cost per Equipment Taxonomy, as shown in the following image.

Result

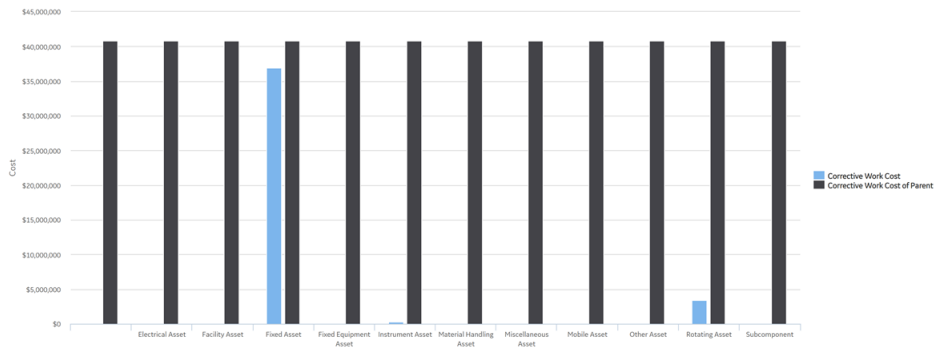

About Right and Left Y-Axis Scales in a Metric View

When you create a new Metric View, the y-axis label and scale appear by default on the left side of the graph. If the graph contains multiple measures for each x-axis category, all the measures initially use the same scale, which is determined automatically using the plotted minimum and maximum values. The default scale is not necessarily appropriate for all the plotted values.

When a single scale is not appropriate for plotting all the values on the y-axis, you can use two scales, one on the right and one on the left, and choose which values should use each scale.

Access the View Page of a Metric View

Before You Begin

- You must have View permission on the Catalog folder to view an existing Metric View.
- You must also have View permission on the cube to view the data of the Metric View.

Procedure

1. [Access the Metrics and Scorecards Overview Page](#) on page 3.
2. In the **Metric Views** list, select a Metric View.

Note: You can select  to search for an existing Metric View.

The page for the selected Metric View appears, displaying the result in graph view.

Note: You can select  to display the information in the **Result** section in tabular view.

Access the Metric Views Design Page

Procedure

1. [Access the view page of a Metric View.](#)
2. In the upper-right corner of the page, select .
The design page for the selected Metric View appears, displaying the dimension members.

On this page, you can modify the following settings of a Metric View:

- [Dimension members](#)
- [Graph settings](#)

Note: If you want to view a Metric View, then select .

Access an MDX Query

About This Task

The **MDX Query** allows you to modify the underlying MDX query or create a new MDX query.

Note: To edit an MDX Query, you must have the knowledge of how to modify an MDX Query code.

Procedure

1. [Access the design page of a Metric View.](#)
2. In the upper-right corner of the workspace, select , and then select **MDX Query**.
The **MDX Query** window appears, displaying the query.
3. Select the **Custom MDX Query** check box to modify the query.
The text box is enabled and the underlying query appears. The **Test Query** button is also enabled.
4. As needed, modify the query.
5. To validate the query, select **Test Query**.
Depending on the validation result, a message appears, indicating the success or failure of the query. If the query is incorrect, modify it as necessary.
6. When the query is validated, select **OK**.
The **MDX Query** window closes. The result of the query is displayed in the **Result** section of the workspace.



Create a Metric View



When you create a Metric View, you select measures and dimensions associated with a cube. The corresponding graph appears in the **Result** workspace of the page.

Before You Begin

- To create a Metric view, a user must first have at least View permission on the Cube.

Procedure



1. In the **Applications** menu, navigate to the **TOOLS** section, and then select **Metrics and Scorecards**.
2. In the **Metric View** list, select .
The design page for the Metric View appears.
3. In the left pane, provide the following values:
 - a) In the **Cube** drop-down list box, select the cube for which you want to create a Metric View.
Note: The **Cube** drop-down list box contains the cubes to which you have permission to access.
 - b) In the **Data/Measures** section, select .
The **Add to Measures** window appears.

- c) Select the check box next to each measure that you want to add to the Metric View, and then select **OK**.
The **Add to Measures** window closes and the graph for selected measures appears in the **Result** section.
 - d) In the **Rows/X-axis** section, select  .
The **Add to Rows** window appears.
 - e) Select the check box next to the dimension members to add to the X-axis, and then select **OK**.
The selected dimension members appear in the **Rows/X-axis** section.
 - f) In the **Columns/Legends** section, select  .
The **Add to Columns** window appears.
 - g) Select dimension members that you want to add to the columns, and then select **OK**.
The selected dimension member appears in the **Column/Legend** section.
 - h) In the **Slices** section, select  .
The **Add to Slicer** window appears.
 - i) Select the desired dimension members, and then select **OK**.
The **Add to Slicer** window closes and the results appear in the **Result** section of the workspace.

Note: You cannot add the same members from a dimension hierarchy that exist in the **Rows/X-axis** or **Slices** axes to the **Columns/Legend** axis and vice versa.
4. In the upper-right corner of the workspace, select.
The **Save Metric View : Select a folder** window appears.
 5. In the Catalog, navigate to the folder in which you want to save the Metric View, and then select **Done**.
The **Save Metric View** window appears.
 6. Provide the following values:
 - a) **ID:** Enter an ID for the Metric View.
 - b) **Caption:** Enter a caption for the Metric View.
 - c) **Description:** Enter a description of the Metric View.
 7. Select **OK**.
The Metric View is created and saved in the selected Catalog folder.

Create a Copy of a Metric View

Procedure

1. [Access a Metric View](#).
2. In the upper-right corner of the page, select  .
The left pane appears.
3. In the upper-right corner of the page, select  .
Copy of <Label> page appears, where <Label> is the name of the Metric View that you have selected.

Sort the Table

About This Task

When you sort a column, the rows in the table are arranged according to the contents of the column you choose to sort. You can sort any column either in ascending or descending order. When you use the Ascending option, the data in the column will be sorted in ascending alphanumeric order: 0-9, then A to Z.

When you use the Descending option, the data in the column will be sorted in descending alphanumeric order: 9 to 0, then Z to A. For example, to sort a list of repair costs in order from the highest cost to the lowest cost, sort the Repair Cost column using the Descending option.

Note: If there are multiple columns in the table, the rows will be sorted by the total amount of data in those columns.

Procedure

1. [Create a Metric View that contains dimension members.](#)

2. In the **Rows/X-axis** section, select .

-or-

In the **Columns/Legends** section, select .

The **Edit Sort** window appears.

3. Select the desired options. You can select from the following options:

- **Sort Type** : Select Ascending or Descending.
- **Measure** : Select the measurement for the sorting from the drop-down list box.

4. Select **Save**.

Your sort selections are applied to the table.

Create a Calculated Measure

About This Task

On the [Metric View design](#) page, you can make three types of calculations on existing Metric Views. Based on your selections, the expression will then become an additional column or row in the Metric View. After adding the expression to the Metric View, based on your preferences, it will be listed as a column, row, measure, or slice.

Note: To create or view calculated measure in SSAS, refer the SSAS documentation.

Procedure

1. [Access the Metrics and Scorecards Overview Page](#) on page 3.

2. In the **Metric View** list, select .

The design page for the Metric View appears.

3. In the **Cube** box, select the cube for which you want to create a Metric View.

Note: The **Cube** drop-down list box contains the cubes that you have permission to access.

4. Select .

The **Calculated Measure** window appears.

5. As needed, enter the values in the [available fields](#).

6. Select **OK**.

The **Calculated Measure** window closes, and the calculated measure name appears in the **Data/Measures** section.

Note: If you have performed a calculation on the Metric View, the **Drillthrough** button is disabled. You cannot drill through a calculated measure.

Calculated Measures

You can create calculated measure in two places; in cube (SSAS) and in Metric View design page. The calculated measure appears in Metric View design page in Data/Measures section.

You can create calculated measure by using the following functions:

- Contribution
- Difference
- MDX Query

Field	Data Type	Description	Behavior and Usage
Calculated measure type	N/A	Type of measure function that you want to perform.	<p>You can either create the calculated measure by using the existing functions, such as, Difference or Contribution in the interface, or write custom MDX by selecting the Custom function.</p> <ul style="list-style-type: none"> Contribution A calculation that determines the contribution per portion for different factors. For example, you can calculate the percentages from different categories from total cost, such as maintenance, repair, and lost opportunity. When using a contribution calculation, you can choose to evaluate the improvement opportunity for a particular family in comparison to all other families. An "improvement opportunity cost" means the potential for saving money if a particular factor is properly evaluated to prevent failures and downtime. On selecting the measure type Contribution, the following fields appear. <ul style="list-style-type: none"> Measure Dimension Hierarchy MDX Query You can create custom measures using the MDX query in the Expression box. Difference A calculation that involves the subtraction of one member from another to compute a value. A value expression can be used to evaluate overall repair cost and the costs within a site. For example, the difference in a repair cost can be compared between all repairs for a site and then all repairs for a particular piece of equipment. For this type of calculation, you would type in the [Measures] dimension and then the measure Cube, [Site Repair]. Note that when calculating the difference in a repair cost column, drilling down the hierarchy will automatically calculate the difference. On selecting the measure type Difference, the following fields appear. <ul style="list-style-type: none"> First measure Second measure
Dimension Hierarchy	N/A	The dimension member that you have added in Rows/X-Axis or Columns/Legend .	Select the dimension member from the Dimension Hierarchy box.
First measure	N/A	The first member for the calculation, Difference.	None
Measure	N/A	The measure for which you want to create the contribution.	Select the measure from the Measure drop-down list.

Field	Data Type	Description	Behavior and Usage
Name	Character	Name of the calculated measure	Appears in the Metrics View design page in the Data/Measures section and in the Result workspace as a new measure.
Second measure	N/A	The second member for the calculation, Difference.	None

Examples of Calculations

The following are some of the examples of creating calculated measures in a Metric View.

Example 1:

In the following example, a particular piece of equipment, in addition to its family and subfamilies, is being evaluated on its financial opportunity in comparison to all pieces of equipment. The user has chosen to work with the dimension Measures, and the Financial Opportunity within the dimension. This number has been divided by a sum based on the current member's ancestor and children, and its Financial Opportunity.

```
[Measures].[Opportunity_$$]/Sum({Ancestor([Equipment].CurrentMember, 1).Children}, [Measures].[Opportunity_$$])
```

Example 2:

You may choose to elaborate on a basic query to specify the results for null measurements. The following example builds on the previous example. This instance illustrates the opportunity cost divided by low-level children of a high-level parent. In the first line, the MDX query specifies that if the current member (the piece of equipment) does not have a parent family, the result for the calculation result will be 1. The bold section of the following code states that if the measure Opportunity Cost equals 0, then the results should return the calculation 0.

```
IIF(Ancestor([Equipment].CurrentMember, 1) IS NULL, 1, IIF([Measures].[Opportunity_$$]=0, 0, [Measures].[Opportunity_$$]/Sum({Ancestor([Equipment].CurrentMember, 1).Children}, [Measures].[Opportunity_$$])))
```

Example 3:

A value expression can be used to evaluate overall repair cost, and the costs within a site. The difference in a repair cost can be compared between all repairs for a site, and then all repairs for a particular piece of equipment. For this type of calculation, you would type in the [Measures] dimension, and then the measure Cube, [Site Repair] (see example).

Difference in repair cost

```
[Measures].[Site_Repair_Cost] - [Measures].[Company_Wide_Repair_Cost]
```

Example 4:

An MTBF calculation can be created with a fixed analysis period. For example, the percentage of repairs within a given time period can be calculated. In this case, we will limit the length of the fixed analysis period to 1748 days. As stated in the highlighted area, if the number of repairs equals 0, then the result of the calculation will be 0.

```
IIF([Measures].[N of Repair]= 0, 0, 1748 x [Measures].[N of Equipment]/[Measures].[N of Repair])
```

Example 5:

The example shows an MTBF calculation with a 12-month Moving analysis period (length 12 month). The calculation results will change depending on the current member (the current month). Figures are calculated dynamically. If there's no monthly data, a 0 will be calculated.

$12 \times ([\text{Measures}].[\text{Number of Equipment}], [\text{Failure Date}].[\text{All Failure Dates}]) /$

$\text{IIf}(\text{isempty}([\text{Failure Date}].\text{currentmember.lag}(11)), 0, \text{Sum}(\{[\text{Failure Date}].\text{currentmember.lag}(11): [\text{Failure Date}].\text{currentmember}\}, [\text{Measures}].[\text{Total Number of Failures}]))$

$\text{Sum}(\{\text{set: date from last 11 month to current month}\}, \text{measure})$

To specify that the system should check to see if there are a total of 12 months (11 back from the current month), type in the following code. If 12 months do not exist, the value is calculated as 0. Otherwise, the MTBF is calculated in the Month unit.

$\text{IIf}(\text{isempty}([\text{Failure Date}].\text{currentmember.lag}(11)), 0, \text{otherwise})$

Basic Definitions of Calculations in Work History Cube

The following table lists the basic calculations and the definitions of the measures provided in the Work History cube.

Measure	Definition
Corrective Work	Corrective Work Orders are repair work orders associated with restoring an asset after a breakdown or in response to performance degradation. It can also be the work to restore the asset to its prime condition as a result of a predictive maintenance (PdM) activity finding. Corrective Work = Breakdown Repairs + Degradation Repairs
Critical Assets	The assets with high criticality.
Failure Event	The repair events with breakdown.
Mechanical Downtime	The amount of time a piece of equipment is not operating due to a work event or failure. The calculation for this measure is: Maintenance Completion Date - Maintenance Start Date
Proactive Work	Proactive work is maintenance work that is completed to avoid failures or to identify defects that could lead to failures. It includes routine preventive and predictive maintenance activities and work tasks.
Reactive Work	Reactive work is maintenance work that breaks into the weekly schedule. Reactive work cost is calculated using the priority on the work order. Emergency Work Orders are considered to be breaking into the weekly schedule. Any order type except for miscellaneous can be included in this calculation.

Work History Cube Calculations

The following table displays the calculations that are used in Work History cube in the Metrics and Scorecards module.

Metric	Definitions	Metric Calculation	Units
Asset Count	Asset Count is the count of equipment or functional locations	Count of Equipment or Count of Functional Locations	Number
Average Corrective Work Cost	Average Corrective Work Cost is a financial indicator of the effort required to repair failing or failed assets expressed in dollars. This metric is determined by dividing the total corrective work costs related to an asset (or category, class, type or model of assets) for a given period by the number of events in that period.	Corrective Work Cost / Corrective Work Count	U.S. Dollars
CAMA% (Critical Asset Mechanical Availability Percentage)	The Critical Asset Mechanical Availability is an indicator of the time that a critical asset is available for service or can perform its intended function. This metric is a measurement of the time that a critical asset is available to perform its intended function. The calculation is expressed as a percentage of the total time under review.	1-CAMU%	Percentage
CAMD (Critical Asset Mechanical Downtime)	The Critical Asset Mechanical Downtime metric is an indicator of the days that a critical asset is unavailable for service; the time it is shutdown. This metric is expressed in total shutdown days. The calculation is expressed as the cumulative days of downtime under review.	Total Mechanical Downtime For Critical Assets / Critical Asset Count	Days

Metric	Definitions	Metric Calculation	Units
CAMU% (Critical Asset Mechanical Unavailability Percentage)	The Critical Asset Mechanical Unavailability metric is an indicator of the percentage of time that a critical asset is unavailable for service, or cannot perform its intended function. This metric is expressed in a percentage of the total time. The calculation is expressed as a percentage of the total time under review.	CAMD / Number of Days in Time Range	Percentage
Corrective Work Count	Count of events which can be classified as corrective work	Count of events which can be classified as corrective work	Number
Corrective Work Count %	The Corrective Work Count % is a numeric indicator of the number of corrective failure events as a percentage of the total work experienced by a maintenance group.	Corrective Work Count / Count of non-miscellaneous work	Percentage
Corrective Work Cost	The Corrective Work Costs are financial indicators of the effort required to repair failing or failed equipment. The calculation is expressed in dollars.	Total Maintenance Cost for All Corrective Work	U.S. Dollars
Corrective Work Cost %	Corrective Work Cost / Maintenance Cost for non-miscellaneous work	Corrective Work Cost / Maintenance Cost for non-miscellaneous work	Percentage
Critical Asset Count	Count of Assets with High Criticality	Count of Assets with High Criticality	Number
Event Count Non Misc	Count of non-miscellaneous events	Count of non-miscellaneous events	Days
Failure Event Count	Count of Event where Breakdown is equal to True	Count of Event where Breakdown is equal to True	Number
Failure Rate (FPMH)	Failure Rate is a numeric indicator of the frequency at which an asset fail for selected equipment types. This metric provides information on the expected failure per million hours of operational time.	1000000 / (MTBF x 24)	Number of failures per million hours
Maintenance Cost Non Misc	Maintenance cost for all the non miscellaneous work	Maintenance cost for all the non miscellaneous work	U.S. Dollars

Metric	Definitions	Metric Calculation	Units
MTBF(Days) (Mean time between Failures)	<p>The Mean time Between Failure (MTBF) is a numeric indicator of the average operating time between failures that are repaired for selected equipment types (assumes instant repairs). This metric is used to trend the time that assets are available for service. An increase in MTBF indicates improved asset reliability.</p> <p>SMRP Definition: Mean Time Between Failures is the average operating time between failures for an asset or component, where the failure means that an asset is unable to perform its required function. In GE Digital APM, a failure is indicated when the breakdown indicator is set to True.</p>	<p>(Asset Count x Total Calendar Time in Days) / (Failure Event Count)</p>	Days
MTBR(Days) (Mean Time Between Repairs)	<p>Mean Time Between Repairs (MTBR) is a numeric indicator of the average time between the completion of one repair to the beginning of the next. The MTBR addresses the time that an asset is not involved in a repair cycle. This metric is a numeric indicator of the average time between the completion of one repair to the beginning of the next.</p>	<p>(Asset Count x Total Calendar Time in Days) / (Corrective Work Count)</p>	Days

Metric	Definitions	Metric Calculation	Units
Preventative Maintenance Effectiveness %	<p>This metric indicates predictive maintenance effectiveness relating to the work generated by PdM programs. This metric is a useful measure of result generated from predictive activities, so the customers who include a Detection Method field in their data will be able to take advantage of it. In addition, if the work request references another work order of type PM or PdM, then we can calculate the PM effectiveness. The Preventative Maintenance Effectiveness metric is an indicator of the percentage of proactive work that is generated because of PM/PdM programs. Effective programs detect potential failures or degraded performance before plant operations are negatively affected.</p>	<p>Repair Count with PM or PdM detection / Corrective Work Count</p>	<p>Percentage</p>

Metric	Definitions	Metric Calculation	Units
PM Effectiveness%	<p>This metric indicates predictive maintenance effectiveness relating to the work generated by PdM programs. This metric is a very useful measure of results created from predictive activities, so those customers who include a Detection Method field in their data will be able to take advantage of it. In addition, if the work request references another work order of type PM or PdM then you can calculate the PM effectiveness.</p> <p>The Preventative Maintenance Effectiveness metric is an indicator of the percentage of proactive work that is generated because of PM/PdM programs. Effective programs detect potential failures or degraded performance before plant operations are negatively affected.</p>	(Repair Count with PM/PdM Detection) / (Corrective Work Count)	
Proactive Work Cost	Total Maintenance Cost for All Proactive Work	Total Maintenance Cost for All Proactive Work	U.S. Dollars
Proactive Work Cost %	The Proactive Work Cost % is a numeric indicator of the cost associated with proactive work events as a percentage of the total.	Proactive Work Cost / Maintenance Cost for non-miscellaneous work	Percentage

Metric	Definitions	Metric Calculation	Units
Proactive Work Count	Proactive work is maintenance work that is completed to avoid failures or to identify defects that could lead to failures. It includes routine preventive and predictive maintenance activities and work tasks identified from them. As maintenance groups prefers reliability, this percentage should rise. In organizations, proactive work will include the majority of plant repairs. All the organizations might not have notifications for predictive for preventive work, but will create preventive work orders from the preventive maintenance plan. Therefore, you need to compare the cost on the work orders.	Count of events which can be classified as Proactive Work	Number
Proactive Work Count %	The Proactive Work Count % is a numeric indicator of the number of proactive work events as a percentage of the total. This metric calculates a percentage of the PdM and PM events as a percentage of the total work.	Proactive Work Count / Count of non-miscellaneous work	Percentage
Reactive Work Cost	Reactive work is maintenance work or emergency work orders that occurs in the weekly schedule. Reactive work cost is calculated using the priority on the work order. Any order type except for miscellaneous can be included in this calculation.	Total Maintenance Cost for all Reactive Work	U.S. Dollars
Reactive Work Cost %	The Reactive Work Cost% is a numeric indicator of the costs associated with the reactive work experienced by a maintenance group. This calculation is expressed as a percentage of the work.	Reactive Work Cost / Maintenance Cost for Non-Miscellaneous Work	Percentage

Metric	Definitions	Metric Calculation	Units
Reactive Work Count	Reactive work is maintenance work or emergency work orders that occurs in the weekly schedule. Reactive work cost is calculated using the priority on the work order. Any order type except for miscellaneous can be included in this calculation.	Count of events which can be classified as Reactive Work	Number
Reactive Work Count %	The Reactive Work Count % is a numeric indicator of the costs associated with the reactive work taken by a maintenance group. This calculation is expressed as a percentage of the total work.	Reactive Work Count / Count of Non-Miscellaneous Work	Percentage
Repair Cost with PM/PdM Detection	Total Maintenance Cost for Corrective Work with PM/PdM detection.	Total Maintenance Cost for Corrective Work with PM/PdM detection.	U.S. Dollars
Repair Count with PM/PdM Detection	Count of Repair Events with PM/PdM Detection	Count of Repair Events with PM/PdM Detection	Number
Total Mechanical Downtime for Critical Assets	Sum of Mechanical Downtime for Critical Assets	Sum of Mechanical Downtime for Critical Assets	Days

Note: The Site dimension in the Work History cube will display only the data for the site to which the user is assigned.



Add Filters to a Metric View

By adding filters, you can view a subset of the results that are currently displayed in the **Results** workspace for a Metric View. By default, the top 20 count will be applied on the measure in the row and column. This is to avoid the browser to go into an unrecoverable state when the query result set is large. If you want to modify the filter, you need to manually edit the filter. In case of a drilldown too, the same top 20 count filter will be applied.

Before You Begin

- [Create a Metric View](#) and specify dimension members for the **Rows/X-axis** or **Columns/Legends**.

Procedure

1. [Access the Metric View](#).
2. In the upper-right corner of the page, select . The left pane appears, displaying the dimensions that you have set for the Metric View.
3. In the **Rows/X-axis** or **Columns/Legends** sections, select  to specify measures in which you want to add filters. Depending on the axis on which you want to add filters, the **Row Filters** or **Column Filters** window appears.

4. Select **+**.
The filter options appear.
5. As needed, enter the values in the [available fields](#).
6. As needed, repeat steps 4 through 5 to add more filters.
7. Select **OK**.
The **Row Filters** or **Column Filters** window closes and the **Result** section of the workspace is refreshed to reflect the changes.

Row and Column Filter Options

The [filter options that you select](#) on the **Row Filters** or **Column Filters** window function as a formulaic expression. This means that all of your selections work together to create a logical statement that tells the GE Digital APM system which columns or rows to exclude from the result displayed in the table and chart.

The following filter options are available on the **Edit Filter** window.

Field	Data Type	Description	Behavior and Usage
Function	N/A	Lets you choose the various functions.	<p>You can add multiple filters.</p> <p>When deleting the members from either Rows/X-axis or Column/Legend section, you must retain at least one member for the filter to appear correctly.</p> <p>Contains the following options:</p> <ul style="list-style-type: none"> • Non-Empty Lets you specify whether or not you want to display only those rows that contain values. • Top Count Displays the top X number of values that appear in the row or column that you specify in the Measure box, where X is the number that you specify in the Value box. • Top Percent Displays the top X percent of values that appear in the row or column that you specify in the Measure box, where X is the number (i.e., percentage) that you specify in the Value box. • Bottom Count Displays the lower X number of values that appear in the row or column that you specify in the Measure box, where X is the number that you specify in the Value box. • Bottom Percent Displays the lower X percent of values that appear in the row or column that you specify in the Measure box, where X is the number (i.e., percentage) that you specify in the Value box.

Field	Data Type	Description	Behavior and Usage
Measure	N/A	A list of available measures in the cube.	The filter will be applied on the measure selected from this list.
Value	Number	Lets you specify a numeric value.	The value specified in the Value box will be used as a filter criteria.

Modify the Filters Applied to a Metric View

Before You Begin

- [Add filters to a Metric View.](#)

About This Task

You can modify the filters that are applied to a Metric View and then save the Metric View in the Catalog folder. The list of filters that are currently applied to a cube appears in the **Rows/X-axis** or **Columns/Legend** of the Metric View.

Procedure

1. [Access the Metric View](#) whose filters you want to modify.
2. On the **Rows/X-axis** or **Columns/Legend**, select . The **Row Filters** or **Column Filters** window appears, displaying a list of filters.
3. Select the filter that you want to modify, and then modify the [filter options](#) as necessary.

Note: If you want to delete the filter, select  that appears next to the name of the filter.

4. Select **Save**. The **Row Filters** or **Column Filters** window closes, and the specified filter options are saved. The **Result** section of the workspace is refreshed to reflect the changes.

Modify the Graph Settings

About This Task

The graph on the **Results** workspace provides a visual representation of the Metric View. You can edit the various elements of the graph, such as, the graph type, title, legend placement, and so on.

Note: You can edit the graph settings only if you have the Update privilege on a Metric View.

Procedure

1. [Access the design page of a Metric View.](#)
2. In the upper-right corner of the workspace, select , and then select **Graph Settings**. The **Edit graph settings** window appears.
3. As needed, edit the [graph settings](#).
4. Select **OK**. The **Edit graph settings** window closes, and the updated graph appears in the **Result** section of the workspace.

5. Select .

A confirmation message appears, indicating that the graph has been modified.

Edit Graph Settings

Graph

Fields	Data Type	Description	Behavior and Usage
Graph Title	Character	A label that indicates the title of the graph displayed on the Results workspace.	Enter a title for the graph in the text box.
Graph Type	N/A	A property that identifies the type of graph that you want to view.	Displays a drop-down list of graph types. Select the type of graph that you want to be displayed on the Results workspace. The following graph types are supported: <ul style="list-style-type: none"> • Column • Bar • Scatter • Area • Pie • Pyramid • Combination • Spider Web
Show Legend	N/A	The legends indicates the meaning of each color in the graph.	Select the check box to display the legends on the graph and from the corresponding drop-down list, select the area where you want to display the chart legends.
Show Scroll Bar	N/A	An option that lets you control the number of data series that appear on the graph's x-axis within a chart area by using a scroll bar.	Select the check box if you want to allow x-axis panning on the graph. On selecting the check box, the Maximum amount of points to show box appears. In this box, you can specify the number of data series to be displayed on the graph at a time. This is a required field.

Series

Fields	Data Type	Description	Behavior and Usage
Color Palette	N/A	A property that allows you to select colors for data series.	Displays a list of color. Each color displays a drop-down list of color schemes from which you can select a color for a data series.
Graph Type	N/A	A property that identifies the type of graph that you want to plot for a measure.	This field is populated with available chart types when you select the Graph Type as Combination in the Graph section. This is useful if you have more than one measure.
Measure	N/A	Displays the measure name that you have selected Data/ Measures in the Metric View.	Populated automatically. The measures are used in plotting the graph based on the selected graph type.
Series settings	N/A	Allows you to configure a dual axis graph. For example, Y and Y1 axis.	Select the measure that should be plotted on the Y and Y1 axis for column chart and X and X1 for bar chart. This is recommended if you have two measures to be plotted.
Stacked	N/A	A property that allows you to present your data on the chart in stacked bar graph format.	Stacked chart compares data sets by placing one set of data on top of another. Each dataset is represented in a different color and each individual stacked column size represents the contribution proportionate to the total value. Select the check box, if you want the graph to appear stacked.
y Axis	N/A	A property that identifies the location for the measures to be plotted on the y Axis.	Select the y axis location from the drop-down list. This field allows you to configure measure in Y or Y1 axis using the values, Left or Right .

Axes

Fields	Data Type	Description	Behavior and Usage
Formatter	N/A	Lets you specify the type of numbers to appear on the axis and formats the scale accordingly.	You can select the format as Number, Currency (e.g., using dollar sign), Percentage and so on. You can also select the number of decimal places to which the values will be rounded when they are displayed on the axis by selecting Number with 0 precision, Number with 1 precision and so on.
Left	N/A	Lets you configure settings for a data set plotted on the of the y-axis.	You can configure the following settings, Format, Type, Title, Minimum, and Maximum for the Y-axis.
Minimum	Number	Lets you specify the minimum value that should be plotted on the y-axis of the graph.	This is an optional field. When you specify a minimum value, the graph is plotted from that value.
Maximum	Number	Lets you specify the maximum value points that should be plotted on the y-axis of the graph.	This is an optional field. When you specify a minimum value, the graph is plotted till that value.
Right	N/A	Lets you configure settings for a data set plotted on the of the y1-axis.	You can configure the following settings, Format, Type, Title, Minimum, and Maximum for the Y1-axis.
Title	Character	A label that will indicate the name for the values that are plotted on the y and y1 axis.	Enter the name in the Title box. The name provided for both Y and Y1 axis will overwrite the default label.

Fields	Data Type	Description	Behavior and Usage
Type	N/A	An option that lets you specify the scaling type for y and y1 axis.	<ul style="list-style-type: none"> • Linear: Select Linear to measure data that changes arithmetically (for example, sales growth or decline). • Logarithmic: Select Logarithmic to measure data that changes exponentially (for example, sound waves measured in decibels or earthquake magnitudes) <p>Note: By default, the charts are displayed in Linear type.</p>
X Axis Title	N/A	A label that indicates the name for the x-axis.	Enter the name in the X Axis Title box. The name will appear on the x-axis of the graph.
y Axis	N/A	A property that identifies the location for the measures to be plotted on the y Axis.	Select the y axis location from the drop-down list. This field allows you to configure measure in Y or Y1 axis using the values, Left or Right .
Y Axis Formatting	N/A	List of options that lets you define the format for the values that are plotted on the left and right sides of y-axis. For example, y-axis title, setting minimum and maximum value.	In this section, you can change the y-axis settings, such as Number format, Title and so on.

Zoom In and Out of the Graph in a Metric View

Procedure

1. [Access the Metric View](#).
2. To zoom in a graph, hover on any datapoint on the graph, hold the left mouse button, and then drag out a rectangle shape on the graph.
The **Reset Zoom** button appears.
3. To zoom out, select **Reset Zoom**.

Invoke Actions in a Graph for Metric Views

Before You Begin

- [Create a Metric View](#) using the cube on which the actions are defined.

About This Task

Actions defined in Analysis Services Cubes will be available within the Metric Views that are built on those cubes. When you select the target, the URL behind that action is launched or the **Drill through** action gets invoked.

The **Drill through** action is not invoked if:

- You have used **Calculated Measure** in the Metric View.
- If the Analysis Server is being cached at that moment.

Procedure

1. [Access the Metric View](#) on which you want to invoke actions.
The **Cube Action** button appears on the upper-right corner of the **Results** section of the workspace.
2. Select **Cube Action** to launch the URL configured for the cube.
3. In the Results section, select the data series on the graph for which you want to invoke the cell actions.
The **Cell Action** button appears on the upper-right corner of the **Results** section of the workspace.
4. Select the action that you want to invoke.
The result for the selected action appears.

Drill Down a Metric View

Procedure

1. [Access the Metric View](#) that you want to drill down.
2. Select the data series of the graph whose data you want to drill down to the next level in the hierarchy.
The **Drilldown** button appears on the upper-right corner of the **Result** workspace.
3. Select **Drilldown**.
The data series is drilled down to next level in the hierarchy. A link appears on the upper-left corner of the **Result** workspace, indicating the level to which you have drilled down.

Note: To drill up to a previously accessed hierarchy level, in the upper-left corner of the **Result** workspace, select the link that indicates the level to which you want to drill up.

Drill Down a Metric View in the Tabular View

Procedure

1. [Access the Metric View](#) that you want to drill down.
2. Select  to access the tabular view.
3. Select the dimension member header cell whose data you want to drill down.
The drill down result set (children of selected member) appears in the workspace. This operation is valid only if the selected member has a child member. The dimension member is drilled down to next

level in the hierarchy. A link appears on the upper-left corner of the workspace, indicating the level to which you have drilled down.

🔍 Reactive Work Count % by Equipment Taxonomy
Last Modified On 10/5/2016 9:46:06 AM Modified By Administrator, Meridium

Result / Fixed Asset

	Reactive Work Count %	Reactive Work Count % of Parent
Boiler	25%	0.24
Fired Equipment	20%	0.24
Heat Exchanger	25%	0.24
Miscellaneous Fixed	13%	0.24
Pipe	25%	0.24
Tank/Material Storage	13%	0.24
Valve	35%	0.24
Vessel	22%	0.24

Note: To drill up to a previously accessed hierarchy level, on the upper-left corner of the workspace, select the link that indicates the level to which you want to drill up.

Drill Through a Metric View

Note: You cannot drill through a calculated measure.

Before You Begin

- [Create a Metric View.](#)

Procedure

1. [Access the Metric View page](#) for the Metric View that you want to drill through.
2. In the graph view, select the data series on the graph that you want to drill through, and then select **Drillthrough**.

-or-

In the tabular view, in the grid, select the value to drill through.

The **Drillthrough Result** window appears.

Note: Interaction with the view or design page of a Metric View, such as drill through, is not available on the GE Digital APM mobile application.

Export a Metric View

You can export a Metric View (both graph view and tabular view) to a PDF.

Before You Begin

- [Create a Metric View.](#)

Procedure

1. [Access the Metric View that you want to export.](#)
2. In the upper-right corner of the **Result** workspace, select  to export the Metric View in PDF format.

A drop-down menu appears, displaying the options.

3. Select **Export as PDF** to export the Metric View in PDF format.
The PDF file appears.

Export a Drill Through Result

About This Task

By default, the **Drillthrough Result** window displays the first 100 records of the result. However, if you want to analyze the complete result set of the drill through action, you can export all the results to a .CSV file.

Note: The drill through export result depends on the maximum number of rows defined in DefaultDrillthroughMaxRows in the OLAP database. The default value for this property is 10000 (rows). For more information, see the MSDN documentation.

Procedure

1. Access the **Drillthrough Result** window .
2. Select .
The .CSV file appears.

Add Slicer Members When Viewing a Metric View

About This Task

You can add slicer members when viewing a Metric View. However, the selected slice members cannot be saved.

Procedure

1. Access the **Metric View** page.
2. Next to the Metric View name, select  .
The **Add to Slicer** window appears.
3. Select the desired slicer members, and then select **OK**.
The **Add to Slicer** window closes, and the results appear in the **Results** workspace.

Note: You cannot add the same members from a dimension hierarchy that exist in the **Rows/X-axis** or **Slices** axes to the **Columns/Legend** axis and vice versa.



Transpose a Metric View

About This Task

You can rearrange the members from columns to rows and vice versa by using the Transpose feature. The Transpose feature is available in the Metric View design page.

Note: If the rows or columns that you transpose contain **filters** or **sort**, then the filters and sort are also transposed along with the members.

Procedure

1. [Access the Metric View page](#), and then select .
2. In the upper right side of the page, select .
3. Select .
A confirmation message appears, indicating that the Metric View is updated.

Delete a Metric View

Procedure

1. [Access the details of the Metric View](#).
2. In the upper-right corner of the page for the selected Metric View, select .
The **Delete Metric View** dialog box appears.
3. Select **OK**.
A confirmation message appears, indicating that the Metric View is deleted. The Metric View no longer appears in the **Metric Views** section on the **Metrics and Scorecards** page.

Chapter 7

Manage Privileges

Topics:

- [About Security in Metrics and Scorecards](#)
- [About Cube Privileges](#)
- [About KPI Privileges](#)
- [About Scorecard Privileges](#)
- [Modify Access Rights to an Analysis Services Cube Record](#)
- [Modify Access Rights to a Scorecard](#)
- [Modify Access Rights to a KPI](#)

About Security in Metrics and Scorecards

Data permissions on Scorecard, KPI, and other related families are configured in **Data Permissions** in the **Security Manager**.

In GE Digital APM, you can manage privileges for specific:

- [KPIs](#)
- [Scorecards](#)
- [Analysis Services Cube records](#)

Note:

- Only Super Users and members of the MI Metrics Administrator Security Group can manage privileges for the Analysis Services Cube records. Members of the MI Metrics Administrator Security Group can manage the privileges for individual KPIs and Scorecards. Other users can manage privileges only for the KPIs and Scorecards that they created and for which they have been granted update privileges.
- If a Security User is assigned to multiple Security Groups, the user is granted the privileges of the Security Group with the most permissions. For example, if a Security User is assigned to both, the MI Metrics Viewer and the MI Metrics Admin Security Groups, the user is granted view, create, update and delete privileges.

About Cube Privileges

Cube privileges determine which Analysis Services Cube records are available for selection within Metric Views and KPIs. You can see the list of the users and groups that have access to any Analysis Services Cube record by [viewing its privileges](#).

You can grant access or revoke the access to a cube via [the Manage Cubes page](#). Only Super Users and members of the MI Metrics Administrator Security Group can [manage privileges](#) for the Analysis Services Cube records.

When users have been granted access to Analysis Services Cube records, they will be able to view the Metric Views, Scorecards, and reports that are based on the associated Analysis Services cubes.

Members of the MI Metrics Administrator Security Group can manage the entity-level privileges for all KPIs and Scorecards. Other users can manage privileges only for the KPIs and Scorecards that they have created and for which they have been granted entity-level update privileges.

About KPI Privileges

The KPI privileges that you set up in the GE Digital APM are applied in addition to family-level permissions defined for the KPI families.

By default, all the MI Metrics User are given the View, Insert, Update, and Delete permissions to the KPI family.

You can also manage privileges at entity-level by selecting the users and groups that should have access to a given KPI. Via the [Schedule, Alerts, and Privileges section](#), you can grant or revoke the privileges for the users and the groups.

The Super Users and members of the MI Metrics Administrator Security Group can, by default, manage privileges for all KPIs. Other users can manage the privileges for a KPI that they create, unless those

privileges are revoked by an administrative user. Non-administrative users can also manage privileges for KPIs to which they have been granted Update privilege.

About Scorecard Privileges

The Scorecard privileges that you set up in the GE Digital APM are applied in addition to family-level permissions defined for the Scorecard families. By default, all the MI Metrics User are given the View, Insert, Update, and Delete permissions to the Scorecard family.

You can also manage privileges at entity-level by selecting the users and groups that should have access to a given Scorecard. Via the [Privileges section](#), you can grant or revoke the privileges for users and groups.



The Super Users and members of the MI Metrics Administrator Security Group can manage privileges for all Scorecards. By default, other users can manage the privileges for any Scorecards that they create, unless those privileges are revoked by an administrative user. Non-administrative users can also manage privileges for Scorecards to which they have been granted Update privilege.

Modify Access Rights to an Analysis Services Cube Record

About This Task

When users are granted access to Analysis Services Cube records, they can view the Scorecards, KPIs, and Metric Views associated with those records. Administrative users can grant or revoke privileges to Security Groups and individual Security Users so that they can access Analysis Services Cube records. Cube privileges determine which Analysis Services Cube records are available for Metric Views and KPIs. You can see the list of users and groups that have access to any Analysis Services Cube record by viewing the **Privileges** section.

Procedure

1. Access the [Manage Cubes](#) page.
2. In the left pane, select the Analysis Services Cube record to which you want to modify access. In the workspace, in the **Privileges** section, the **User/Group** list appears.
Note: To revoke access from a user or group, in the **User/Group** list, next to the user or group whose privileges you want to revoke, select .
3. To grant access to users and groups, in the **User/Group** section, select the **Add User/Group** link. The **Select Users or Group** window appears, displaying the **User** section.
4. If you want to assign privileges to a group, then select the check box that appears next to each user name to whom you want to grant access to the cube.
5. If you want to assign privileges to a group, then select the **Group** tab. The **Group** section appears.
6. Select the check box that appears next to each group name.
Note: Inactive Security Groups may also appear in the list.
7. Select **OK**. The **Select Users or Group** window closes, and the new users or the groups appear in the **User/Group** list.
8. In the **User/Group** list, next to each user or group, select or clear the **View** check box for the user or group. The **View** privilege allows the user or group to use the cube for creating a Metric View or a KPI.
9. In the upper-right corner of the workspace, select .

Your changes are saved.

Modify Access Rights to a Scorecard

About This Task

To view a Scorecard, a user must be granted privileges to specific Scorecards via the GE Digital APM application. You can revoke privileges for users and groups that no longer need to access the Scorecard.

Note: Super Users and members of the MI Metrics Administrator Security Group can manage privileges for ALL Scorecards. Other users can, by default, manage the privileges for any Scorecard that they create, unless those privileges are revoked by an administrative user. Non-administrative users can also manage privileges for Scorecards to which they have been granted Update privileges.

Procedure

1. [Access the Scorecard design page.](#)
2. Select the **Privileges** tab.

The **Privileges** section appears, displaying the **User/Group** subsection.

Note: To revoke access from a user or group, in the **User/Group** list, next to the user or group whose privileges you want to revoke, select .

3. To grant access to users and groups, select the **User/Group** link.

The **Select Users or Groups** window appears, displaying the **User** section.

4. Next to each user to whom you want to grant access to the Scorecard, select the check box.
5. Select the **Group** tab.

The **Group** section appears.

6. Next to each group to which you want to grant access to the Scorecard, select the check box.

7. Select **OK**.

The **Select Users or Groups** window closes, and the new users or groups appears in the **User/Group** list.

8. In the **User/Group** list, next to each user or group, clear the check boxes for any privileges that you do not want the user or group to have:

- **View:** Allows the user or the group to view the Scorecard.
- **Update:** Allows the user or the group to edit the Scorecard.
- **Delete:** Allows the user or the group to delete the Scorecard.

9. In the upper-right corner of the page, select .
- Your changes are saved.

Modify Access Rights to a KPI



About This Task

To view a KPI, a user must be granted privileges to specific KPIs via the GE Digital APM application. By managing privileges, you select the users and groups that have access rights to a given KPI. You can also revoke privileges for users and groups that no longer need to access the KPI.

Note: Super Users and members of the MI Metrics Administrator Security Group can manage privileges for all KPIs. Other users can manage the privileges for any KPI that they create by default, unless those

privileges are revoked by an administrative user. Non-administrative users can also manage privileges for KPIs to which they have been granted Update privileges.

Procedure

1. [Access the KPI design page.](#)
2. In the upper-right corner of the page, select .
The KPI design page appears.
3. Select the **Schedule, Alerts, and Privileges** tab.
The **Schedule, Alerts, and Privileges** section appears, displaying the **Select Users or Group** list in the **Privileges** subsection.
Note: To revoke access from a user or group, in the **User/Group** list, next to the user or group whose privileges you want to revoke, select .
4. To grant access to users and groups, select the **User/Group** link.
The **Select User or Group** window appears displaying the **User** section.
5. Next to each user to whom you want to grant access to the KPI, select the check box.
6. Select the **Group** tab.
The **Group** section appears.
7. Next to each group to which you want to grant access to the KPI, select the check box.
8. Select **OK**.
The **Select Users or Group** window closes, and the new users and groups appear in the **User/Group** list.
9. In the **User/Group** list, next to each user or group, clear the check boxes for any privileges that you do not want the user or group to have:
 - **View:** Allows the user or the group to view the KPI.
 - **Update:** Allows the user or the group to edit the KPI
 - **Delete:** Allows the user or the group to delete the KPI.
10. In the upper-right corner of the page, select .
Your changes are saved.

Chapter 8

Deployment and Upgrade

Topics:

- [Deployment](#)
- [Upgrade](#)

Deployment

Deployment

Refer to the deployment information here [Deploy Metrics and Scorecards for the First Time](#).

Upgrade

Upgrade

Refer to the upgrade information here [Upgrade or Update Metrics and Scorecards to V5.0.2.0.0](#).

Chapter 9

Reference

Topics:

- [General Reference](#)
- [Family Field Descriptions](#)
- [Queries Folder](#)

General Reference

Metrics and Scorecards System Requirements

License Requirements

The Metrics Manager license is required to use the Metrics and Scorecards module.

Additional Components Required

In addition to the basic GE Digital APM system architecture, your system must also contain the following additional components:

- A SQL Server Analysis Services Server machine that will host the Microsoft SQL Server Analysis Services software. The following versions of SQL Server Analysis Services are supported in this version of GE Digital APM:
 - Microsoft SQL Server Analysis Services 2016
- If you are using an Oracle database, in order to process the Work History cube, you must install ODP.NET (Oracle Data Provider.NET), an Oracle Data Access Component, on the machine where the Work History cube is deployed.

System Architecture

Microsoft SQL Server Analysis Services provides the ability to analyze large amounts of data quickly and easily. Analysis Services provides the means to access warehouses of data by letting you create dimensional cubes from information in the database and dimension tables. Numeric measures can be summed into pre-aggregated values while cubes are being created. Cubes can contain data that is summarized, copied, or read directly from the data warehouse. Cubes, dimensions, and partitions can be processed (i.e., updated) to incorporate new or changed data from the data warehouse. Time, location, equipment type, or sizes are common dimensions against which measures are calculated and displayed in GE Digital APM. Note that the data warehouse can be created as a separate database, combining information from GE Digital APM and other data sources. Alternatively, dimensional cubes can be created by accessing the GE Digital APM database directly.

Together, Microsoft SQL Server Analysis Services and the Metrics and Scorecards module functionality provide GE Digital APM users with the ability to analyze data in the GE Digital APM database using the features of Analysis Services through the GE Digital APM interface. To use the Metrics and Scorecards functionality, you must incorporate SQL Server Analysis Services into your GE Digital APM system.

If you choose to implement the Metrics and Scorecards module within your system, we recommend using a configuration in which the Analysis Server exists on a machine that is separate from the GE Digital APM Server. This deployment scenario most accurately reflects the GE Digital APM testing environment. The following illustration shows how the SQL Server Analysis Services Server connects to the basic GE Digital APM System architecture.

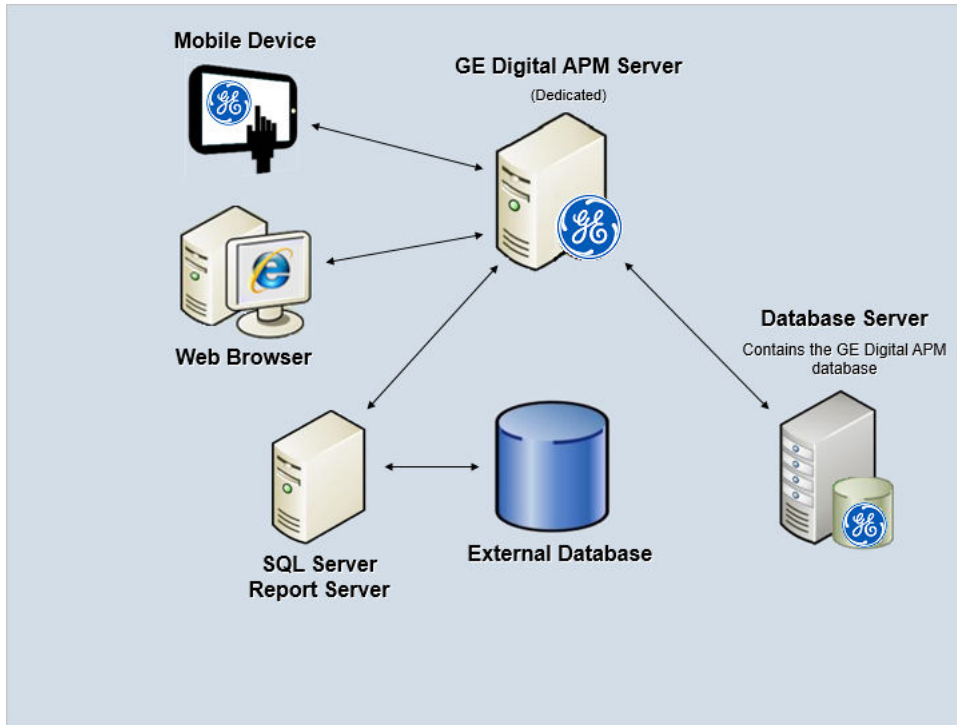

Note: While this image depicts only a single, dedicated GE Digital APM Server, your implementation may contain one or more of these machines. The purpose of this image is to depict the interaction of the SQL Server Analysis Server with the basic GE Digital APM components, not to provide details on the basic components themselves. While your GE Digital APM system may contain multiple dedicated GE Digital APM Servers, it will contain only a single SQL Server Analysis Server that all of those GE Digital APM Servers will access.

Deploying Metrics and Scorecards

After you have installed and configured the basic GE Digital APM system architecture, you will need to perform some configuration steps specifically for Metrics and Scorecards.

Note: For more information about performing the configuration steps, refer to the Deployment section of the Metrics and Scorecards documentation.

Metrics and Scorecards Security Groups

The following table lists the baseline Security Groups available for users within this module, as well as the baseline Roles to which those Security Groups are assigned.

Important: Assigning a Security User to a Role grants that user the privileges associated with all of the Security Groups that are assigned to that Role. To avoid granting a Security User unintended privileges, before assigning a Security User to a Role, be sure to review all of the privileges associated with the Security Groups assigned to that Role. Also, be aware that additional Roles, as well as Security Groups assigned to existing Roles, can be added via Security Manager.

Security Group	Roles
MI Metrics Administrator	MI Foundation Admin
MI Metrics User	MI Foundation Power MI Foundation User

Security Group	Roles
MI Metrics Viewer	MI APM Viewer
Everyone	MI Foundation Admin MI Foundation Power MI Foundation User

The baseline family-level privileges that exist for these Security Groups are summarized in the following table.

Family	MI Metrics Administrator	MI Metrics User	MI Metrics Viewer
Entity Families			
Analysis Services Cube	View, Update, Insert, Delete	View	View
KPI	View, Update, Insert, Delete	View, Update, Insert, Delete	View
KPI Measurement	View, Update, Insert, Delete	View, Update, Insert, Delete	View
Scorecard	View, Update, Insert, Delete	View, Update, Insert, Delete	View
Relationship Families			
Has KPI Measurement	View, Update, Insert, Delete	View, Update, Insert, Delete	View
Has Privileges	View, Update, Insert, Delete	View, Update, Insert, Delete	View
Has Sub Indicators	View, Update, Insert, Delete	View, Update, Insert, Delete	View
Is Used By Scorecard	View, Update, Insert, Delete	View, Update, Insert, Delete	View

In addition to performing functions associated with the family-level privileges described in this table, members of the MI Metrics Administrator Security Group:

- Can manage cube privileges by granting view access to the users.
- Has full access to all KPIs, Scorecards, and Cubes without needing to be granted additional privileges via the GE Digital APM.

Metrics and Scorecards Data Model

The following diagram illustrates how the entity and relationship families that are used in Metrics and Scorecards are related to one another. The shaded boxes represent entity families, and the arrows represent relationship families. You can determine the predecessor and successor in each relationship definition from the direction of the arrow head:

- The box from which the arrow originates is the predecessor in that relationship definition.
- The box to which the arrow head points is the successor in that relationship definition.

This family is not enabled for site filtering, which means that records in this family can be accessed by any user with the appropriate license and family privileges. For more information, refer to the [Sites](#) section of the documentation.

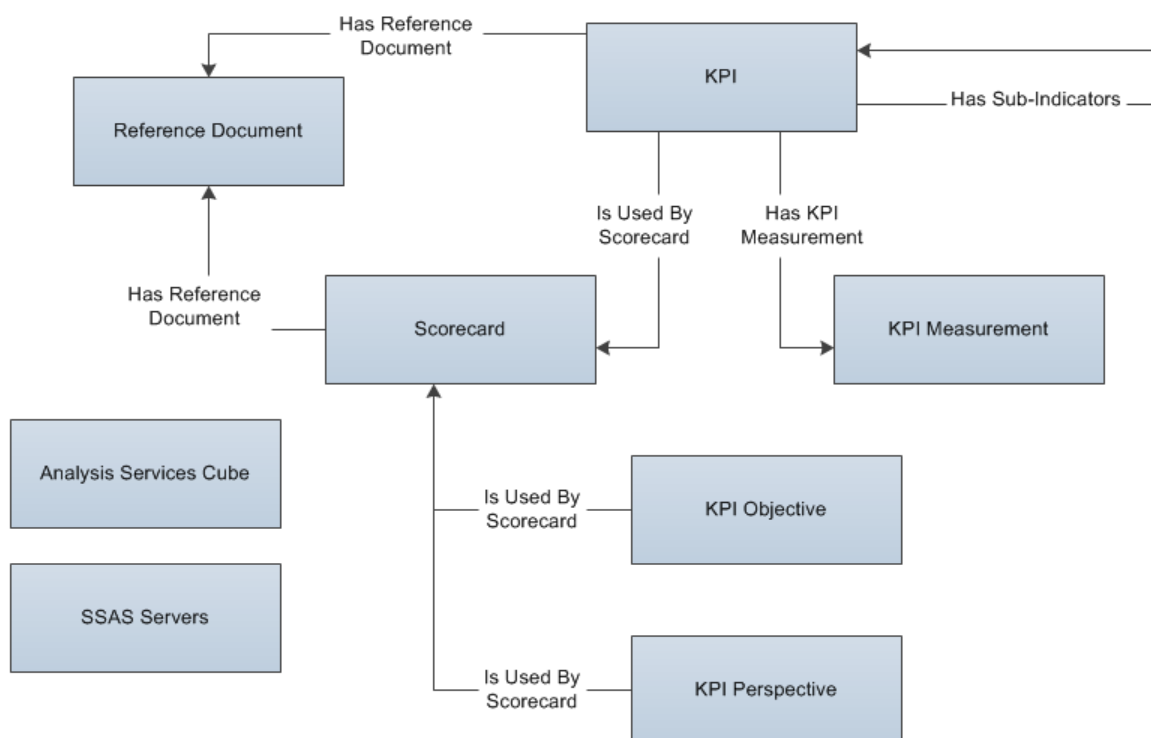

In this image, you can see that:

- KPI records can be related to other KPI records through the Has Sub-Indicators relationship.
- The SSAS Servers family is not related to any other families. SSAS Servers record support Metric Views.
- The Analysis Services Cube family is not linked to any other KPI families. Analysis Services Cube records support Metric Views.

Metrics and Scorecard Security Groups

The following baseline Security Groups are provided for the Metrics and Scorecards module:

- MI Metrics Administrator: Provides users with full access to all Metrics and Scorecards features and functions.
- MI Metrics User: Provides users with view-only access to Metrics and Scorecards functionality, provided that they have been granted the necessary entity-level permissions.

The baseline privileges for these Security Groups are summarized in the following table.

Family	MI Metrics Administrator	MI Metrics User
Analysis Services Cube	View, Update, Insert, Delete	View
KPI	View, Update, Insert, Delete	View, Update, Insert, Delete
KPI Measurement	View, Update, Insert, Delete	View, Update, Insert, Delete
Has KPI Measurement	View, Update, Insert, Delete	View, Update, Insert, Delete
Scorecard	View, Update, Insert, Delete	View, Update, Insert, Delete
Has Privileges	View, Update, Insert, Delete	View, Update, Insert, Delete

Family	MI Metrics Administrator	MI Metrics User
Has Sub Indicators	View, Update, Insert, Delete	View, Update, Insert, Delete
Is Used By Scorecard	View, Update, Insert, Delete	View, Update, Insert, Delete

In addition to performing functions associated with the family-level privileges described in the previous table, members of the MI Metrics Administrator Security Group:

- Can see the **Manage Cubes** button on the **Metrics and Scorecards** page in the GE Digital APM application.
- Can manage privileges for all KPIs in the GE Digital APM application.
- Can manage privileges for all Scorecards in the GE Digital APM application.
- Have full access to all KPIs, Scorecards, and Cubes without needing to be granted additional privileges via the GE Digital APM application.

Metrics and Scorecards URLs

There is one URL route associated with Metrics and Scorecards: metrics. The following table describes the various paths that build on the route, and the elements that you can specify for each.

Tip: For more information, refer to the URLs section of the documentation.

Element	Description	Accepted Value(s)	Notes
metrics/home: Opens the Metrics and Scorecards page, displaying the Scorecards, the Metric Views, and the KPIs.			
metrics/register-cube: Opens the Manage Cubes page.			
metrics/<WorkspaceName>/<EntityKey>: Opens the existing Scorecard, Metric Views, and the KPIs.			
<Workspace>	Specifies the workspace in which you want to open a Scorecard, Metric View, or a KPI.	scorecard-tile-view	The specified Scorecard will appear in the details workspace.
		kpi-viewer	The specified KPI will appear in the details page.
		kpi-designer	The specified KPI will appear in the design page.
		metric-view-designer	The details of the specified Metric Views will appear in the workspace.
<EntityKey>	Specifies the level of the asset hierarchy for which you want to view health information.	Any numeric Entity Key that corresponds to an existing Scorecard, Metric View, or a KPI.	N/A
		0	Opens a new design page for a Scorecard, Metric View, or a KPI.

Example URLs

Example URL	Destination
metrics/home	The Metrics and Scorecard page.
metrics/scorecard-designer/0	The design page for a new Scorecard.
metrics/kpi-designer/0	The design page for a new KPI.
metrics/metric-view-designer/0	The design page for a new Metric View.
metrics/scorecard-tile-view/64253576972	The Scorecard details page for the specified scorecard.
metrics/kpi-viewer/64253550109	The KPI details page for the specified KPI.
metrics/metric-view/64253518247	The Metric View details page for the specified Metric View.

Family Field Descriptions

KPI Records

KPI records store basic information about Key Performance Indicators. This topic provides an alphabetical list and description of the fields that exist for the KPI family. The information in the table reflects the baseline state and behavior of these fields. This list is not comprehensive.

This family is not enabled for site filtering, which means that records in this family can be accessed by any user with the appropriate license and family privileges. For more information, refer to the [Sites](#) section of the documentation.

Field	Data Type	Description	Behavior and Usage
Alert Distribution List	Text	The Security Users who have been designated to receive alerts from this KPI.	This field is populated automatically with the names of the recipients you defined when you created an alert in the Add Recipient of Alerts section.
Alert Message	Character	The text of the email message sent to a user when an alert is triggered.	This field is populated automatically with the text you defined in the Additional Notes box when you created an alert.
Alert Value	Number	The value that a KPI must meet in order to trigger an alert message.	This field is automatically populated with the number you defined in the Alert Configuration dialog box when creating an alert. When the KPI reaches this value, the text in the Alert Message field is sent in an email message to the users identified in the Alert Distribution List field.

Field	Data Type	Description	Behavior and Usage
Best value	Number	The optimal output level.	This field is automatically populated with the value you entered on the Limits section of the KPI Datasheet section. This value is used to calculate the normalized score that is assigned to the KPI when it is created.
Critical Value	Number	The output value that indicates that the KPI has reached a low performance level and is not reaching its potential target.	This field is populated automatically with the value you entered in the Limits section of the KPI Datasheet section.
Has Score Only	Logical	Indicates whether the Score is the only value displayed on the Trend Chart.	If this field is set to True, the KPI's Actual, Target, Critical and Stretch values are not displayed on the Trend Chart or Trend Data. Instead, only the score will be displayed for that KPI. There are formulas to calculate the score value .
KPI Schedule	Text	Information about the KPI schedule and how frequently to update measurements over a period of time.	This field stores the schedule information that you define via the Schedule section of the KPI design page.
Last Measure Update	Date	The date the KPI measurements were last updated.	If the KPI is successfully executed, this value is populated automatically with the current date.
Name	Character	The name of the KPI.	You can enter a name for the KPI into this field manually.
Schedule Last Run Date	Date	The most recent date that a KPI was updated by a scheduled update.	If the KPI is scheduled as a recurring item, after successful execution, this value is populated automatically with the current date. This field is not on a datasheet by default.

Field	Data Type	Description	Behavior and Usage
Schedule Next Run Date	Date	The next date that a KPI is scheduled to take place.	If the KPI is scheduled as a recurring item, after successful execution, this value is populated automatically with the next scheduled run date based on the KPI's schedule frequency. If the KPI is not scheduled as a recurring item, this field is not populated with a value. This field is not on a datasheet by default.
Stretch Value	Number	The output value that is much higher than a target value, demanding a breakthrough performance.	This field is automatically populated with the value you entered in the Limits section of the KPI Datasheet section.
Target Value	Number	The output value that is your aim for the KPI measurement at a given time.	This field is automatically populated with the value you entered in the Limits section of the KPI Datasheet section.
Worst Value	Number	The output value that should be strictly avoided.	This field is automatically populated with the value you entered in the Limits section of the KPI Datasheet section. This value is used to calculate the normalized score that is assigned to the KPI when it is created.

KPI Measurement Records

KPI Measurement records store information about the measurement values used in a KPI. This topic provides an alphabetical list and description of the fields that exist for the KPI Measurement family. The information in the table reflects the baseline state and behavior of these fields. This list is not comprehensive.

This family is not enabled for site filtering, which means that records in this family can be accessed by any user with the appropriate license and family privileges. For more information, refer to the [Sites](#) section of the documentation.

Field	Data Type	Description	Behavior and Usage
Actual	Number	The actual value for a KPI on a particular date.	Automatically populated from KPI data source.
Critical	Numeric	The critical value for a KPI on a particular date.	Automatically populated from a KPI or KPI datasource.
Event Start Date	Date	The KPI measurement date.	Populated automatically from KPI data source.

Field	Data Type	Description	Behavior and Usage
Stretch	Numeric	The stretch value for a KPI on a particular date.	Automatically populated from KPI or KPI data source. Not visible on KPI datasheet
Target	Numeric	The target value for a KPI on a particular date.	Automatically populated from KPI or KPI data source. Not visible on KPI datasheet.

KPI Objective, KPI Perspective, and Scorecard Records

KPI Objective, KPI Perspective, and Scorecard records store information about KPI Objective, KPI Perspective, and Scorecard families. This topic provides an alphabetical list and description of the fields that exist for the KPI Objective, KPI Perspective, and the Scorecard families. The information in the table reflects the baseline state and behavior of these fields. This list is not comprehensive.

The following families are not enabled for site filtering, which means that records in these families can be accessed by any user with the appropriate license and family privileges. For more information, refer the Site Filtering section of the documentation.

KPI Objective

Field	Data Type	Description	Behavior and Usage
Objective Name	Character	Name of the Objective.	None

KPI Perspective

Field	Data Type	Description	Behavior and Usage
Perspective Name	Character	Name of the Perspective.	None

Scorecard

Field	Data Type	Description	Behavior and Usage
Scorecard ID	Character	Name of the Scorecard.	None

Queries Folder

Queries Folder

The Catalog folder `\\Public\Meridium\Modules\Core\Queries` contains the following items:

Query Name	Behavior and Usage
AllKpis	Returns the list of all the KPIs that are displayed on the Metrics and Scorecards page.
AllScorecards	Returns the of all the Scorecards that are displayed on the Metrics and Scorecards page.