



Meridium APM Reliability Analytics

3.6.1.3.0



Meridium APM Reliability Analytics

3.6.1.3.0

Copyright © Meridium, Inc. 2017

All rights reserved. Printed in the U.S.A.

This software/documentation contains proprietary information of Meridium, Inc.; it is provided under a license agreement containing restrictions on use and disclosure. All rights including reproduction by photographic or electronic process and translation into other languages of this material are fully reserved under copyright laws. Reproduction or use of this material in whole or in part in any manner without written permission from Meridium, Inc. is strictly prohibited.

Meridium is a registered trademark of Meridium, Inc.

All trade names referenced are the service mark, trademark or registered trademark of the respective manufacturer.

About This Document

This file is provided so that you can easily print this section of the Meridium APM Help system.

You should, however, use the Help system instead of a printed document. This is because the Help system provides hyperlinks that will assist you in easily locating the related instructions that you need. Such links are not available in a print document format.

The Meridium APM Help system can be accessed within Meridium APM itself or via the Meridium APM Documentation Website (<https://www.meridium.com/documentation/WebHelp/WebHelpMaster.htm>).

Note: If you do not have access to the Meridium APM Documentation Website, contact [Meridium Global Support Services](#).

Table of Contents

Meridium APM Reliability Analytics	1
Copyright and Legal	2
About This Document	3
Table of Contents	4
What Is Reliability Analytics?	28
Reliability Analytics System Requirements	29
About the Reliability Analytics Data Model	30
Production Analysis Data Model	31
Spares Analysis Data Model	32
Reliability Growth Analysis Data Model	34
Reliability Distribution Analysis Data Model	35
Probability Distribution Analysis Data Model	36
System Reliability Data Model	37
Cost of Unreliability Data Model	40
What is Failure Data?	41
Supplying Failure Data to Meridium APM Reliability	42
The Importance of Failure Modes	44
About Failure Probability	45
Accessing Reliability Analytics in the Meridium APM Framework	46
Aspects of the Reliability Analytics Start Page	47
First-Time Deployment Workflow	49
Upgrade or Update Reliability Analytics to 3.6.1.3.0	51
Reliability Analytics Security	53
Modifying the Reliability List Queries	58
About Creating a Reliability Analysis from an Associated Page	59
About the Baseline Associated Page Queries	60
Modifying the Associated Page Queries	62
Creating Associated Pages That Can Be Used to Create Analyses	63

What Are Reliability Automation Rules?	66
Reliability Automation Rule Data Model	67
About Creating Queries for Use with the Rule Builder	68
Accessing the List of Reliability Automation Rules	70
Aspects of the Automation Rule List Screen Page	71
Rules List Tasks Menu	73
Common Tasks Menu	74
About Creating a New Reliability Automation Rule	75
Creating a Rule Based on a Query	76
Creating a Rule Based on Equipment/Location-Event Data Structure	82
Accessing an Existing Reliability Automation Rule	90
Aspects of the Reliability Automation Rule Summary Screen	91
Rule Tasks Menu	93
Common Tasks Menu	94
Displaying a Preview of the Analysis Failure Data	95
Merging Analyses	96
Undoing a Merge	98
Executing Reliability Automation Rules	99
Deleting Reliability Automation Rules	100
Parameters for the Reliability Automation Rules URL	101
Examples of Reliability Automation Rules URLs	102
About Navigating the Reliability Analytics Module	103
Using the Reliability Analytics Site Map	104
What is a Production Analysis?	105
Data Used in a Production Analysis	106
Production Analysis Workflow	108
Example of a Production Process	109
Using the Production Analysis Builder	110
Creating a Production Analysis from a Query or Dataset	111
Creating a Production Analysis from Manually Entered Data	117

Accessing the List of Production Analyses	122
Aspects of the List of Production Analyses	123
Plots Menu	125
Common Tasks Menu	126
Opening an Existing Production Analysis	127
Opening Multiple Existing Production Analyses	129
Aspects of the Production Analysis Page	131
Analysis Tasks Menu	132
Analysis Settings Menu	134
Common Tasks Menu	135
Associated Pages Menu	136
About the Production Analysis Plot	137
About the Process Reliability Line	139
Defining the Process Reliability Line	140
Types of Production Lines	141
About the Demonstrated Line	142
About the Nameplate Line	143
About the Custom Line	145
Using Regression Fit	147
Drawing a Line Manually	149
Selecting a Point and Specifying Beta	150
Specifying Beta and Eta Values	152
Grouping Production Data	154
What is a Breakpoint?	155
Creating a Breakpoint	157
Removing a Breakpoint	158
About the Edit Production Data Window	159
Data Mapped to the Edit Production Data Window	160
Accessing the Production Data	161
Aspects of the Edit Production Window	162

Changing the Minimum Production Output	164
Changing the Unit of Measure	165
Changing the Margin Value	166
Changing the Margin Currency	167
About the Production Loss Regions Window	168
About the Production Lines Window	170
Hiding and Displaying the Production Analysis Details	172
Ignoring Production Output Values	173
Overview of the Production Analysis Report	175
Running the Production Analysis Report	176
Analysis Summary Section	177
Production Lines Section	179
Production Loss Regions Section	180
Production Weibull Plot Section	181
Production Data Section	182
Results of a Production Analysis	183
What is a Spares Analysis?	185
Spares Analysis Workflow	186
Example of a Spares Analysis	187
Spares Analysis Example Data	188
Spare Analysis Record Data	189
Spare Record Data	190
Spare Application Record Data	192
Spare Application Population Record Data	196
Accessing the List of Spares Analyses	198
Aspects of the List of Spares Analyses	199
Common Tasks Menu	201
Opening an Existing Spares Analysis	202
Creating a New Spares Analysis	204
Aspects of the Spares Analysis Page	205

Tools Menu	206
Navigation Menu	207
Common Tasks Menu	209
Associated Pages Menu	210
About the Spares Analysis Workspace	211
Aspects of the Spares Analysis Tree	213
Copying and Pasting Records in the Spares Analysis Tree	214
Deleting a Record from the Spares Analysis Tree	215
Aspects of the Details Area	216
Aspects of the Details Area of a Spares Analysis Record	217
Aspects of the Details Area of a Spare Record	218
Aspects of the Details Area of a Spare Application Record	219
Creating a Spares Analysis Record	221
Analysis Section	223
Simulation Options Section	224
Deleting a Spares Analysis	225
Overview of Spare Records	226
Creating a Spare Record	227
Aspects of a Spare Record	228
Deleting a Spare Record	230
Overview of Spare Application Records	231
Creating a Spare Application Record	232
Application Section	234
Failure Distributions Section	235
Failure Consequence Section	238
Preventive Maintenance Section	240
About Defining Failure Distribution Information	242
Defining Failure Distribution Information Manually	243
Importing Failure Distribution Information	244
Refreshing Failure Distribution Information	247

Deleting a Spare Application Record	248
Overview of Spare Application Population Records	249
Creating a Spare Application Population Record	250
Aspects of Spare Application Population Records	251
Deleting a Spare Application Population Record	252
About Monte Carlo Simulations	253
Running a Monte Carlo Simulation	255
Interpreting Spares Analysis Results in the Dataset Editor	258
Exporting the Analysis Results to a File	260
Overview of the Event Log	262
Creating and Saving the Event Log	264
Specifying the Number of Iterations	265
Aspects of the Event Log	266
Time Column of the Event Log	268
Application Column of the Event Log	269
Event Column of the Event Log	270
Spares in Stock Column of the Event Log	271
Spares in Order Column of the Event Log	272
Overview of the Spares Analysis Report	273
Running the Spares Analysis Report	274
Analysis Properties Section	275
Spare Properties Section	276
About the Application Properties Section	278
Properties Grid	279
Failure Distribution Grid	280
Failure Consequence Grid	281
Preventative Maintenance Grid	282
Plots Section	283
Error Symbol in Spares Analyses	284
Interpreting the Spares Analysis Example	285

Interpreting the Spare Level Plots	286
Interpreting the Downtime Plots	289
Interpreting the Spare Usage Plots	293
Interpreting the Sensitivity Plots	296
Interpreting the Optimal Holding Plots	299
About the Spares Analysis Plots	302
Spare Level Plot	303
Downtime Plot	305
Spare Usage Plot	307
Sensitivity Plot	309
Optimal Holding Plot	311
What is a Reliability Growth Analysis?	313
Types of Reliability Growth Analyses	314
About Data Used in Reliability Growth Analyses	315
About Reliability Growth	318
Example of an Analysis Using Event Dates	319
Example of an Analysis Using Cumulative Operating Time	321
Example of an Analysis Using Grouped and Non-Event Data	323
Reliability Growth Analysis Workflow	325
Accessing the List of Growth Analyses	326
Aspects of the Growth Analysis List Page	327
Plots Menu	329
Common Tasks Menu	330
Opening an Existing Reliability Growth Analysis	331
Accessing the Reliability Growth Builder	333
Using the Reliability Growth Builder	334
Creating a Growth Analysis Derived from Failure Dates	335
Creating a Growth Analysis Derived From COT	339
Creating a Growth Analysis From Non-Event and Grouped Data (Cost)	343
Creating Reliability Growth Analyses from an Associated Page	347

Welcome Screen	349
Select Data Source Type Screen	350
Data Source Screen	351
Select Data Format Screen	352
Select Data Fields Screen	354
Provide Information for Downtime Screen	357
Analysis Start Time Screen	358
The <Measurement> Data Grid	359
Aspects of the Reliability Growth Analysis Page (Event-Based)	361
Aspects of the Reliability Growth Analysis Page (Non-Event)	364
Plots Menu	366
Current Analysis Menu	367
Common Tasks Menu	369
Specifying Time Units	370
Specifying the Analysis Period	372
Specifying the Data Format for a Reliability Growth Analysis	375
Accessing the AMSAA Detailed Results	377
AMSAA Detailed Results (Event-Based)	378
AMSAA Detailed Results (Non-Event)	380
About the Measurement Data Window	382
Data Mapped to the <Measurement> Grid	384
Accessing the Measurement Data Window	386
Failure Data Using Failure Dates	387
Failure Data Using COT	390
Cost Data	392
Assets Tab	393
What are the Results of a Reliability Growth Analysis?	395
Accessing the Cumulative <Measurement> Plot Page	397
Cumulative Failure Plot Using Failure Dates	398
Cumulative Failure Plot Using COT	400

Cumulative Cost Plot	401
Accessing the MTB<Measurement> Plot Page	403
MTBF Trend Graph Using Failure Dates	404
MTBF Trend Graph Using COT	405
MTBC Trend Graph	406
Accessing the <Measurement> Rate Plot Page	407
Failures Rate Trend Graph Using Failure Dates	408
Failures Rate Trend Graph Using COT	409
Cost Rate Trend Graph	410
Accessing the Multiple Growth Analyses Page	411
Aspects of the Multiple Growth Analyses Page	413
Plots Menu	415
Common Tasks Menu	416
Goodness of Fit Test for a Growth Analysis	417
About the Beta Value and MTBE	421
Splitting an Analysis Into Segments	422
Estimating Data in the Future	424
Interpreting Extrapolation Results Using Failure Dates	426
Interpreting Extrapolation Results Using COT	428
Interpreting Extrapolation Results for Cost	431
Overview of the Reliability Growth Report	433
Running the Reliability Growth Report	434
Analysis Summary Section	436
Growth Model Segments Section	439
Assets Section	442
<Measurement> Data Section	443
Plots Section	445
Overview of Reliability Distribution Analysis	446
Weibull Distribution	447
Weibull Analysis Information	448

Weibull Results Interpretation	451
Goodness of Fit (GOF) Tests for a Weibull Distribution	453
Normal Distribution	454
Lognormal Distribution	455
Exponential Distribution	456
Failure Data	457
Confidence Level and P-Value	458
Accessing the List of Reliability Distribution Analyses	460
Aspects of the Reliability Distribution Analysis List	461
Plots Menu	463
Common Tasks Menu	464
Opening an Existing Reliability Distribution Analysis	465
Opening Multiple Existing Distribution Analyses	467
Using the Reliability Distribution Builder	469
Creating a Distribution Analysis from a Query or Dataset	470
Creating a Distribution Analysis from Manually Entered Data	477
Creating Distribution Analyses from an Associated Page	482
Overview of the Reliability Distribution Summary Page	484
Analysis Information Section	486
Time to Failure Distribution Section	487
Time to Repair Distribution Section	488
Failure Data Section	489
Plots Menu	490
Tools Menu	491
Analysis Tasks Menu	492
Common Tasks Menu	494
Changing the Failure Type	495
Accessing the Time To Failure Distribution Page	496
Aspects of the Time To Failure Distribution Page	497
Accessing the Time To Repair Distribution Page	499

Aspects of the Time To Repair Distribution Page	500
Accessing the Failure History By Asset Timeline	502
Aspects of the Failure History By Asset Page	503
About the Failure Data Window	504
Data Mapped to the Failure Data Window	505
Accessing the Failure Data for a Distribution Analysis	506
Aspects of the Failure Data for a Distribution Analysis	507
About the Asset Data for a Distribution Analysis	509
Working with PM Optimization	511
Performing a Preventive Maintenance Optimization	512
Aspects of the Preventive Maintenance Optimization Page	514
About Failure Probability Calculations	515
Accessing the Failure Data for an Existing Analysis	516
Aspects of the Probability of Equipment Failure Page	518
Calculating the Probability of Failure at a Specified Age	520
Calculating the Age When a Certain Probability of Failure will be Reached	521
About the Distribution Analysis Plots	522
Probability Plot	523
Failure Rate Plot	525
PDF Plot	526
CDF Plot	528
Overview of the Reliability Distribution Report	530
Running the Reliability Distribution Report	531
Analysis Summary Section	533
Statistical Distribution Information Section	535
Distribution Subsection	536
Parameters Subsection	537
Goodness of Fit Subsection	540
Assets Section	541
Failure Data Section	542

Plots Section	543
What are the Results of a Reliability Distribution Analysis?	544
Time to Failure	545
What is a Probability Distribution Analysis?	547
Data Used in a Probability Distribution Analysis	548
Accessing the List of Probability Distribution Analyses	549
Aspects of the Probability Distribution Analyses List	550
Plots Menu	552
Common Tasks Menu	553
About the Multiple Distributions Plot Page for a Probability Distribution Analysis	554
Using the Distribution Builder	555
Creating a Probability Distribution from a Query or Dataset	556
Creating a Probability Distribution from Manually Entered Data	560
Opening an Existing Probability Distribution Analysis	564
Overview of the Probability Distribution Results Page	566
Analysis Information Section	567
Distribution Section	568
Calculated Parameters Section	569
Kolmogorov-Smirnov Goodness of Fit Test Section	570
Probability Density Function (PDF) Plot Section	571
Cumulative Density Function (CDF) Plot Section	572
Plots Menu	573
Distribution Options Menu	574
Analysis Tasks Menu	575
Common Tasks Menu	576
About the Distribution Data Window	577
Data Mapped to the Distribution Data Window	578
Accessing the Distribution Data Window	579
Aspects of the Distribution Data Window	580
Modifying the Random Variable and Specifying Units	582

About the Probability Distribution Analysis Plots	583
Failure Probability Plot	584
PDF Plot	586
CDF Plot	588
Overview of the Probability Distribution Report	589
Running the Probability Distribution Report	590
Analysis Summary Section	592
Overview of the Statistical Distribution Information Section	593
Distribution Subsection	594
Parameters Subsection	595
Goodness of Fit Test Subsection	598
Distribution Data Section	599
Plots Section	600
Overview of System Reliability Analysis	601
Monte Carlo Simulations: A Simple Example	602
Components in a System Reliability Analysis	604
System Reliability Analysis Workflow	606
About the System Reliability Analysis Example	607
Scenario A Diagram	608
Scenario A Risks	609
Scenario A Actions	610
Scenario B Diagram	611
Scenario B Risks	612
Scenario B Actions	613
Scenario C Diagram	614
Scenario C Risks	615
Scenario C Actions	616
What Conclusions Will We Be Able to Draw from Our Example?	617
About the System Reliability Analysis Example Data	618
Example System Analysis Record Data	619

Example System Scenario Record Data	620
Example System Subsystem Record Data	621
Example System Asset Record Data	623
Example System Buffer Record Data	625
Example System Link Record Data	626
Example System Sensor Record Data	627
Example Switch Element Data	628
Example Risk Data	629
Example Action Data	635
Example System Resource Record Data	637
Example System Resource Usage Record Data	638
Accessing the Select a System Reliability Analysis from the List Page	640
Aspects of the Select a System Reliability Analysis from the List Page	641
Common Tasks Menu	643
About Navigating System Reliability Features	644
Aspects of the System Reliability Summary Page	645
Aspects of the System Reliability Analysis Definition Page	647
Aspects of the System Reliability Scenarios - Diagram Page	649
Aspects of the System Reliability Scenarios - Actions Page	650
Aspects of the System Reliability Scenarios - Risks Page	651
Aspects of the System Reliability Scenarios - Global Events Page	652
Aspects of the System Reliability Scenarios - Grid Page	653
Aspects of the System Reliability Simulation Results Page	655
Tools Menu	657
Navigation Menu	658
Common Tasks Menu	659
Datasheets in System Reliability Analyses	660
About Saving System Reliability Analyses	661
About Deleting Components in System Reliability Analyses	662
Creating a New System Reliability Analysis	663

Defining Analysis Parameters	664
Workflow for Developing a Scenario	665
Creating System Scenario Records	666
Creating Copies of System Scenario Records	668
Modifying System Scenario Records	669
Deleting System Scenario Records	670
About Building Diagrams	671
Elements of a Diagram	672
Accessing the Diagram Associated with a Scenario	675
Options Available on the Diagram Canvas	676
Displaying an Overview of the Diagram	679
Overview of the Properties Pane	680
About Fields Displayed in the Properties Pane	685
Asset Fields	686
Buffer Fields	694
Link Fields	695
Sensor Fields	696
Subsystem Fields	697
Switch Fields	698
Using the Diagram Hierarchy	701
About the Diagram Palette	703
Hiding and Displaying Panes	704
About Adding Elements	706
Adding an Element from the Diagram Palette Pane	707
Importing Existing Assets	708
Fields Mapped From Equipment or Functional Location Records	711
Importing a Reliability Distribution Analysis	712
Fields Mapped From a Reliability Distribution Analysis	713
Importing a Reliability Growth Analysis	717
Fields Mapped From a Reliability Growth Analysis	718

Using the Import Subsystem Window	720
Importing a Subsystem	722
About Connecting Elements	724
Connecting Elements in a Diagram	725
Deleting Elements from a Diagram	726
Deleting Connections Between Elements	727
Performing Validation	728
Aspects of the Diagram Validation Results Dialog Box	730
Types of Errors	731
Not Reach End Error	732
Not Reach Start Error	733
Isolated Element(s) Error	734
Circular Error	735
About Risks	736
About Potential and Functional Failures	737
Diagram Hierarchy Pane	738
Risks Pane	739
Mitigating Actions Pane	741
Accessing the Properties Pane	743
About Fields Displayed on the Properties Pane	744
Risk Fields	745
About Actions and Risks	751
Creating Risks on the Risks Page	752
Creating Risks on the Actions Page	753
Assigning Existing Risks to Actions	755
Options for Modifying Risks	756
Modifying Risks on the Risks Page	757
Modifying Risks Using the Actions Page	758
About Resources for Risks	759
Assigning Resources to Risks	760

Modifying Resources Assigned To Risks	762
Removing Resources from Risks	763
About Defining Distribution Data for Risks	765
Defining Distributions Data Manually	766
About Associating Existing Distribution Data with Risks	767
Associating Existing Distribution Data with Risks	768
Opening Associated Analyses	770
Refreshing Distribution Data	771
Removing the Association Between a Risk and a Growth or Distribution Analysis	772
About Resetting Risks	774
Rules for Resetting Risks	776
Selecting Risks to Reset	777
Overview of the Risks to Reset Dialog Box	781
Using the Risks to Reset Dialog Box	783
The Shortcut Menu in the Risks Pane	786
Deleting Risks	787
About Actions	788
Diagram Hierarchy Pane	789
Actions Pane	790
Mitigated Risks Pane	791
Accessing the Properties Pane	793
About Fields Displayed on the Properties Pane	794
Action Fields	795
About Creating System Action Records	799
About the Select Action Type Dialog Box	800
Creating System Condition Monitor Records	802
Creating System Inspection Records	804
Creating System Preventative Maintenance Records	806
Creating System Special Action Records	808
Assigning Existing Actions to Risks	810

Overview of the <Special Action> Window	811
The Mitigated Risks Tab	813
Specifying Failure Consequence Values for the Simulation	816
Specifying TTF Distribution Values for the Simulation	818
Options for Modifying Actions	821
Modifying Actions Using the Actions Page	822
Modifying Actions Using the Risks Page	823
About Resources for Actions	824
Assigning Resources to Actions	825
Modifying Resource Assigned to Actions	827
Removing Resources from Actions	828
About Optimizing Actions	830
Optimizing a Single Action	831
Optimizing Multiple Actions	834
About Applying Optimal Action Intervals	837
Applying Optimal Intervals to Actions	838
Deleting Actions	839
About Global Events	840
About Action-Driven Global Events	841
About Date-Driven Global Events	842
Global Events Pane	843
Actions to Align Pane	844
About Creating Global Events	845
Creating System Global Event Records	846
About Assigning Actions to Global Events	847
Assigning Actions to Global Events	848
Removing Actions from Global Events	850
Modifying System Global Event Records	851
Deleting Global Events	852
Overview of the System Reliability Scenarios - Grid Page	853

By Action	855
By Asset	856
By Buffer	857
By Distribution	858
By Link	860
By Risk	861
By Subsystem	863
By Switch	864
About Resources	865
About Adding Resources to Analyses	866
Creating Resources from Scratch	867
Importing Existing Resources	869
Modifying Resources	871
Deleting Resources	873
About Running Simulations	874
Running Simulations	876
About Event Logs	878
Understanding the Content of the Event Log	879
Refreshing Multiple Distributions	882
About the System Reliability Report	883
Running the System Reliability Report	885
Summary Section	886
Simulation Result Summary	887
Plots Section	888
Simulation Results - Elements Section	889
Simulation Results - Actions Section	891
Simulation Results - Resources Section	892
What Can You Learn from a System Reliability Analysis?	893
Understanding the Analysis Results	894
What Is the Average Total?	896

What is the Simulation Period?	897
Show Total Check Box	900
Total Cost Tab	902
Total Cost Trend Tab	904
Annual Action Cost Tab	906
Action Cost Trend Tab	908
Resource Occurrence Tab	909
Resource Time Tab	911
Resource Cost Tab	913
Elements Grid	915
Actions Grid	916
Resources Grid	917
About the Histogram Plot	918
Trend Plot	921
Impact Plot	923
Interpreting Simulation Results That Include Source and Additional Risks	924
What is a Cost of Unreliability Analysis?	926
Data Used in a Cost of Unreliability Analysis	927
Accessing the List of Cost of Unreliability Analyses	928
Aspects of the Cost of Unreliability List Page	929
Common Tasks Menu	931
Using the Cost of Unreliability Builder	932
Creating a Cost of Unreliability Analysis from a Query or Dataset	933
Creating a Cost of Unreliability Analysis from Manually Entered Data	938
Accessing the Cost of Unreliability Analysis Summary Page	941
Overview of the Cost of Unreliability Analysis Summary	943
Analysis Information Section	944
Summary Results Section	945
Analysis Options Section	946
Plot Menu	947

Plot Options Menu	948
Analysis Tasks Menu	949
Common Tasks Menu	950
About the Failure Data Window	951
Data Mapped to the Failure Data Window	953
Accessing the Failure Data for a Cost of Unreliability Analysis	954
Aspects of the Failure Data	955
Aspects of the Asset Data	957
Specifying the Units of Measurement	959
Selecting MTBF Calculation Options	961
Total Cost Pareto	962
Mean Time Between Failures Pareto	963
Mean Time To Repair Pareto	964
Availability Pareto	965
Number of Failures Pareto	967
Downtime Pareto	968
Generating and Viewing a Trend Plot	969
Viewing Underlying Plot Data	974
Overview of the Cost of Unreliability Report	975
Running the Cost of Unreliability Report	976
Analysis Summary Section	978
Assets Section	980
Failure Data Section	981
Plots Section	982
Results of a Cost of Unreliability Analysis	983
Saving Changes to an Existing Analysis	984
Copying an Analysis	985
Renaming an Analysis	986
Setting the Confidence Level for an Analysis	987
Changing the Distribution Type	988

Modifying the Fit Method	989
Changing the Distribution Parameters	990
Modifying the Analysis Period	992
Choosing the Time Units for an Analysis	994
Modifying Analysis Data via the Failure Data Window	996
Reloading Analysis Data	998
Generating a Report for an Analysis	1000
About Publishing and Unpublishing Analyses	1002
Publishing Analyses	1003
Unpublishing Analyses	1004
Customizing the Display of Plots	1005
Working with Data Censoring in Analyses	1006
About Reliability Recommendations	1008
Accessing the Recommendations Page	1009
Aspects of the Recommendations Page	1010
About the Task Menus on the Recommendations Page	1011
Common Tasks Menu	1012
Aspects of the Recommendation Details Page	1013
About the Task Menus on the Recommendation Details Page	1015
Common Tasks Menu	1016
Creating a New Reliability Recommendation Record	1017
Fields in Reliability Recommendation Records	1019
Opening an Existing Reliability Recommendation Record	1023
Deleting an Analysis	1025
About the Reliability Analytics Catalog Folder Structure	1026
Analyses Folder	1027
Queries Folder	1030
Reports Folder	1031
SSRS Folder	1033
Production Analysis	1034

Production Losses	1038
Reliability Growth	1040
Growth Model	1048
Distribution	1051
About System Action Families	1057
System Condition Monitor	1058
System Inspection	1061
System Preventive Maintenance	1067
System Special Action	1072
System Analysis	1077
System Asset	1092
System Buffer	1095
System Global Event	1099
System Link	1109
System Resource	1112
System Resource Usage	1114
System Risk	1116
System Scenario	1123
System Sensor	1126
System Subsystem	1130
System Switch	1135
Unreliability Cost	1138
Parameters for the Reliability Production URL	1143
Examples of the Production Analysis URLs	1144
Parameters for the Spares Analysis URL	1145
Examples of the Spares Analysis URLs	1147
Parameters for the Reliability Growth URL	1148
Examples of Reliability Growth URLs	1158
Parameters for the Reliability Distribution URL	1159
Examples of Reliability Distribution URLs	1169

Parameters for the Probability Distribution URL	1171
Examples of Probability Distribution URLs	1175
Parameters for the System Reliability URL	1176
Examples of the System Reliability URL	1178
Parameters for the Cost of Unreliability Analysis URL	1179
Examples of Cost of Unreliability URLs	1182
Action	1183
Average Total	1184
Confidence Level	1185
Cumulative Operating Time (COT)	1186
Event Log	1187
Failure	1188
Global Event	1189
Goodness of Fit (GOF) Test	1190
Kolmogorov-Smirnov Test	1191
Least Squares	1192
Maximum Likelihood Estimators (MLE)	1193
Reliability	1194
Resources	1195

What Is Reliability Analytics?

The *Reliability Analytics* module is part of the Failure Elimination work process and provides a collection of tools that apply reliability engineering principles to help you make tactical (short term) and strategic (long term) decisions for maintenance and operational equipment management activities. It provides a means for analyzing historical failure data to identify trends and predict future failures, and it provides a mechanism for simulating *what if* scenarios regarding the reliability of a system to determine if a new or modified strategy will be effective.

The Reliability Analytics module provides the following types of Reliability analyses:

- [Production Analysis](#)
- [Spares Analysis](#)
- [Reliability Growth Analysis](#)
- [Reliability Distribution Analysis](#)
- [Probability Distribution Analysis](#)
- [System Reliability Analysis](#)
- [Cost of Unreliability Analysis](#)

Each analysis type provides a unique set of features and tools that allow you to analyze data to develop strategies to improve reliability.

Reliability Analytics System Requirements

The *Reliability Analytics* license is required to take advantage of Reliability Analytics functionality. In addition, your system must contain the basic Meridium APM system architecture.

CEHint: Details on the system requirements for the basic architecture and activating licenses can be found in the Installation, Upgrade, and System Administration section of the Meridium APM Help system.

After you have installed and configured the basic system architecture, you will need to perform some configuration tasks specifically for the Reliability Analytics feature.

About the Reliability Analytics Data Model

The Reliability Analytics module is unique compared to other Meridium APM modules in that you are not required to use all Reliability Analytics features to complete the Reliability Analytics workflow. Rather, each analysis type has its own workflow and can be used independently of all other analysis types. As such, this documentation does not include a comprehensive Reliability Analytics data model and instead includes a data model that is specific to each analysis type:

- [Production Analysis Data Model](#)
- [Spares Analysis Data Model](#)
- [Reliability Growth Analysis Data Model](#)
- [Reliability Distribution Analysis Data Model](#)
- [Probability Distribution Analysis Data Model](#)
- [System Reliability Data Model](#)
- [Cost of Unreliability Data Model](#)

Note: The separation of analysis types and their respective data models within this documentation is not meant to indicate that you would *not want* to use more than one analysis type but that you are *not required* to do so. In many cases, you may need to perform more than one type of analysis to get a complete understanding of the data (e.g., the results of a Growth Analysis may indicate that you should perform a Reliability Distribution Analysis).

Production Analysis Data Model

The following diagram shows the Production Analysis entity families and the relationships that exist between them. The shaded boxes represent entity families, and the arrows represent relationship families. You can determine the direction of the each relationship definition from the direction of the arrow head: the box *from* which the arrow originates is the predecessor, and the box *to* which the arrow heard points is the successor.

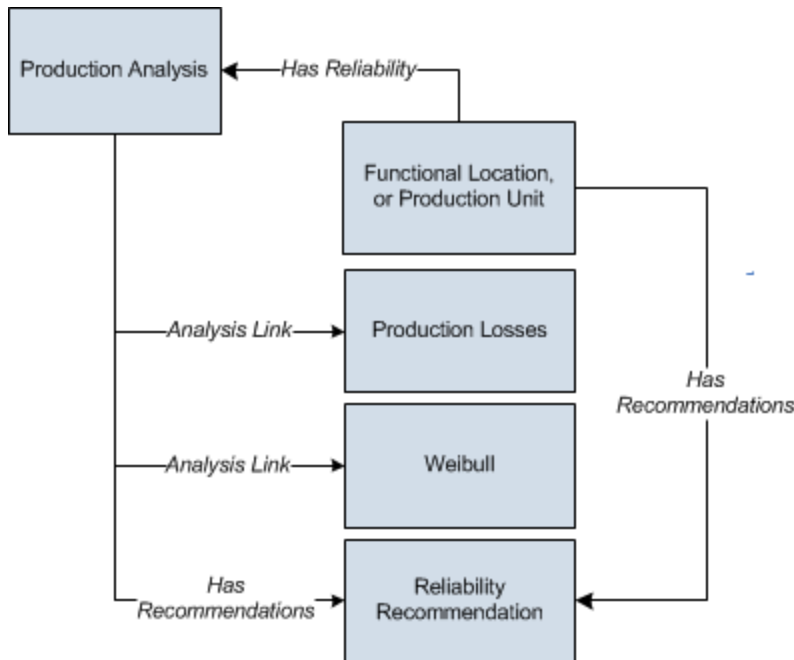

As you develop a Production Analysis, you will create records in these families and link them together, either manually or automatically via the options in the Meridium APM Framework. Throughout this documentation, we use the term *Production Analysis* to mean the combination of the Production Analysis record and all the records that are linked to it.

A Production Analysis is meant to be conducted at the *unit* level and can be linked to a Functional Location record representing a unit or a Production Unit record representing the same unit. The Production Unit family will be available *only* if the Production Loss Accounting (PLA) module is active.

Spares Analysis Data Model

The following diagram shows the Spares Analysis entity families and the relationships that exist between them. The shaded boxes represent entity families, and the arrows represent relationship families. You can determine the direction of the each relationship definition from the direction of the arrow head: the box *from* which the arrow originates is the predecessor, and the box *to* which the arrow heard points is the successor.

Spares Analysis Data Model

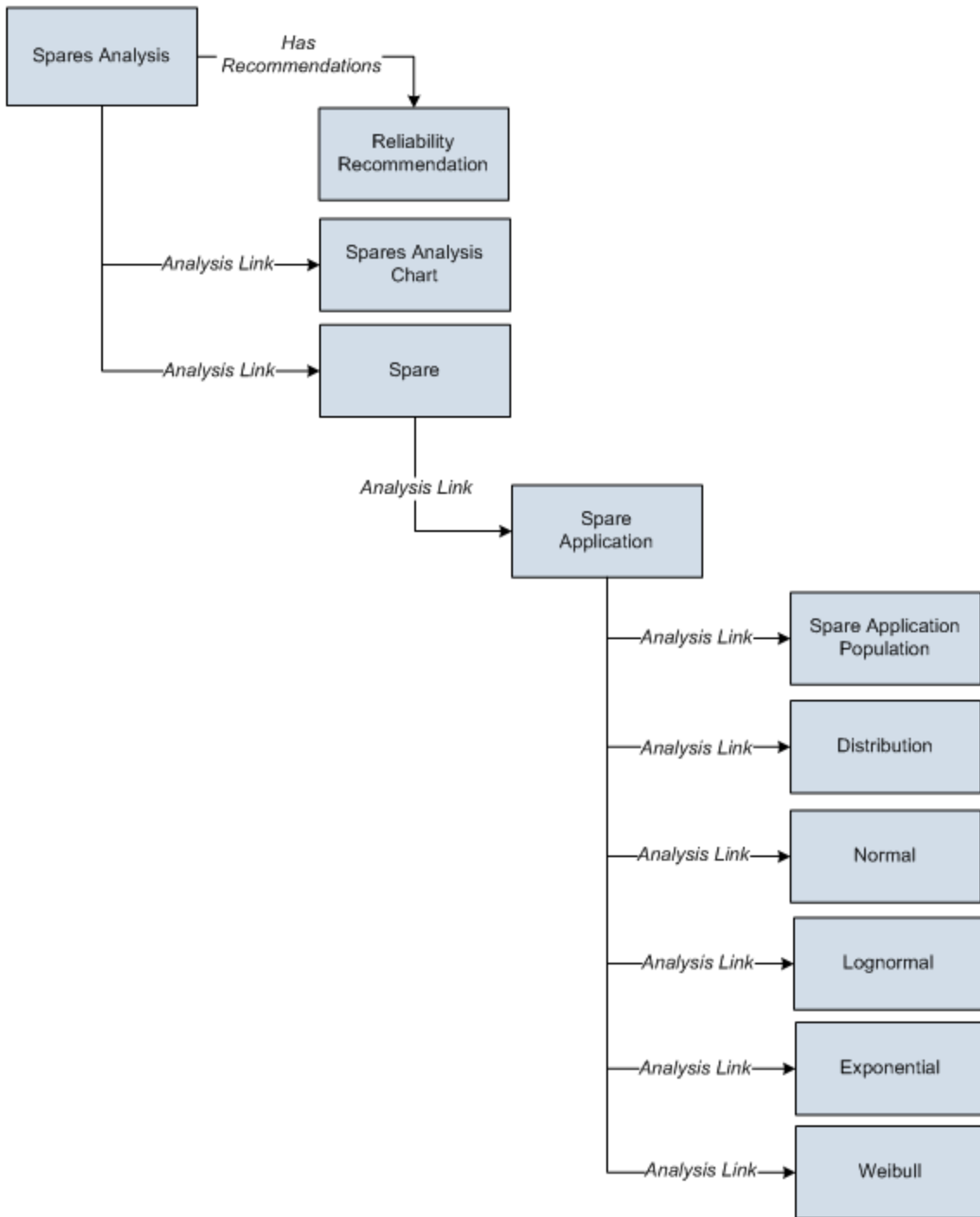

As you develop a Spares Analysis, you will create records in these families and link them together, either manually or automatically via the options in the Meridium APM Framework. Throughout this documentation, we use the term *SparesAnalysis* to mean the combination of the Spares Analysis record and all the records that are linked to it.

Reliability Growth Analysis Data Model

The following diagram shows the Reliability Growth Analysis entity families and the relationships that exist between them. The shaded boxes represent entity families, and the arrows represent relationship families. You can determine the direction of the each relationship definition from the direction of the arrow head: the box *from* which the arrow originates is the predecessor, and the box *to* which the arrow heard points is the successor.

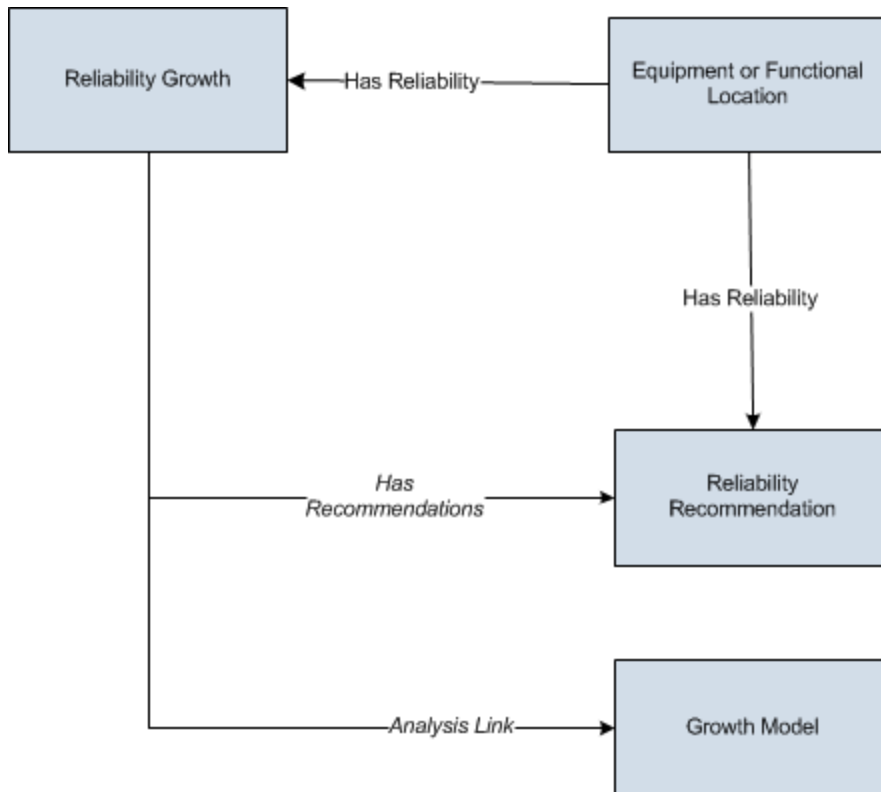

As you develop a Reliability Growth Analysis, you will create records in these families and link them together, either manually or automatically via the options in the Meridium APM Framework. Throughout this documentation, we use the term *Reliability Growth Analysis* to mean the combination of the Reliability Growth record and all the records that are linked to it.

Reliability Distribution Analysis Data Model

The following diagram shows the Reliability Distribution Analysis entity families and the relationships that exist between them. The shaded boxes represent entity families, and the arrows represent relationship families. You can determine the direction of the each relationship definition from the direction of the arrow head: the box *from* which the arrow originates is the predecessor, and the box *to* which the arrow head points is the successor.

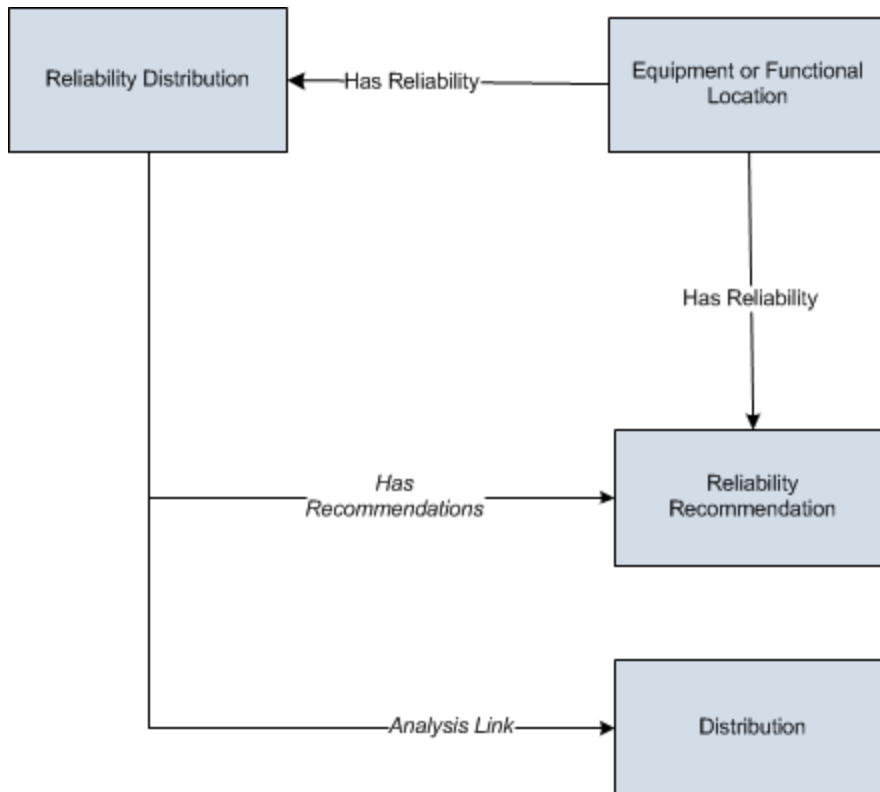

Note: In this image, the *Distribution* box represents one of four Distribution sub-families in which records can exist: Exponential, Lognormal, Normal, or Weibull. When you create a Distribution record using the Reliability Distribution Analysis workflow, the specific family to which that Distribution record will belong will depend upon the distribution type that is selected on the [Time To Failure Distribution](#) or [Time To Repair Distribution](#) page.

As you develop a Reliability Distribution Analysis, you will create records in these families and link them together, either manually or automatically via the options in the Meridium APM Framework. Throughout this documentation, we use the term *Reliability Distribution Analysis* to mean the combination of the Reliability Distribution record and all the records that are linked to it.

Probability Distribution Analysis Data Model

The following diagram shows the Probability Distribution Analysis entity families and the relationships that exist between them. The shaded boxes represent entity families, and the arrows represent relationship families. You can determine the direction of the each relationship definition from the direction of the arrow head: the box *from* which the arrow originates is the predecessor, and the box *to* which the arrow head points is the successor.

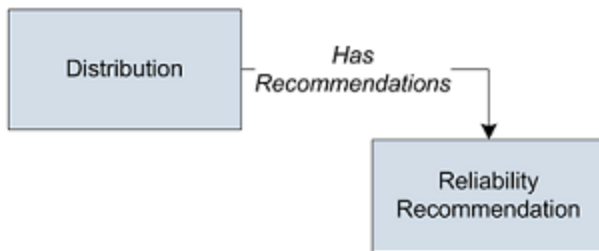

Note: In this image, the *Distribution* box represents one of four Distribution sub-families in which records can exist: Exponential, Lognormal, Normal, or Weibull.

As you develop a Probability Distribution Analysis, you will create records in these families and link them together, either manually or automatically via the options in the Meridium APM Framework. Throughout this documentation, we use the term *Probability Distribution Analysis* to mean the combination of the Distribution record and all the records that are linked to it.

System Reliability Data Model

The following diagram shows the entity and relationship families that are used in a System Reliability Analysis. Throughout this documentation, we use the term *System Reliability Analysis* to mean the combination of the root System Analysis record and all records that are linked to it. Note that in the following image:

- **Black arrows and boxes** represent entity families, relationship families, and associated relationship definitions that are configured in the baseline database and do not require customization for the baseline functionality to work.
- **Red arrows and boxes** represent entity families, relationship families, and associated relationship definitions that may require customization.

System Reliability Data Model

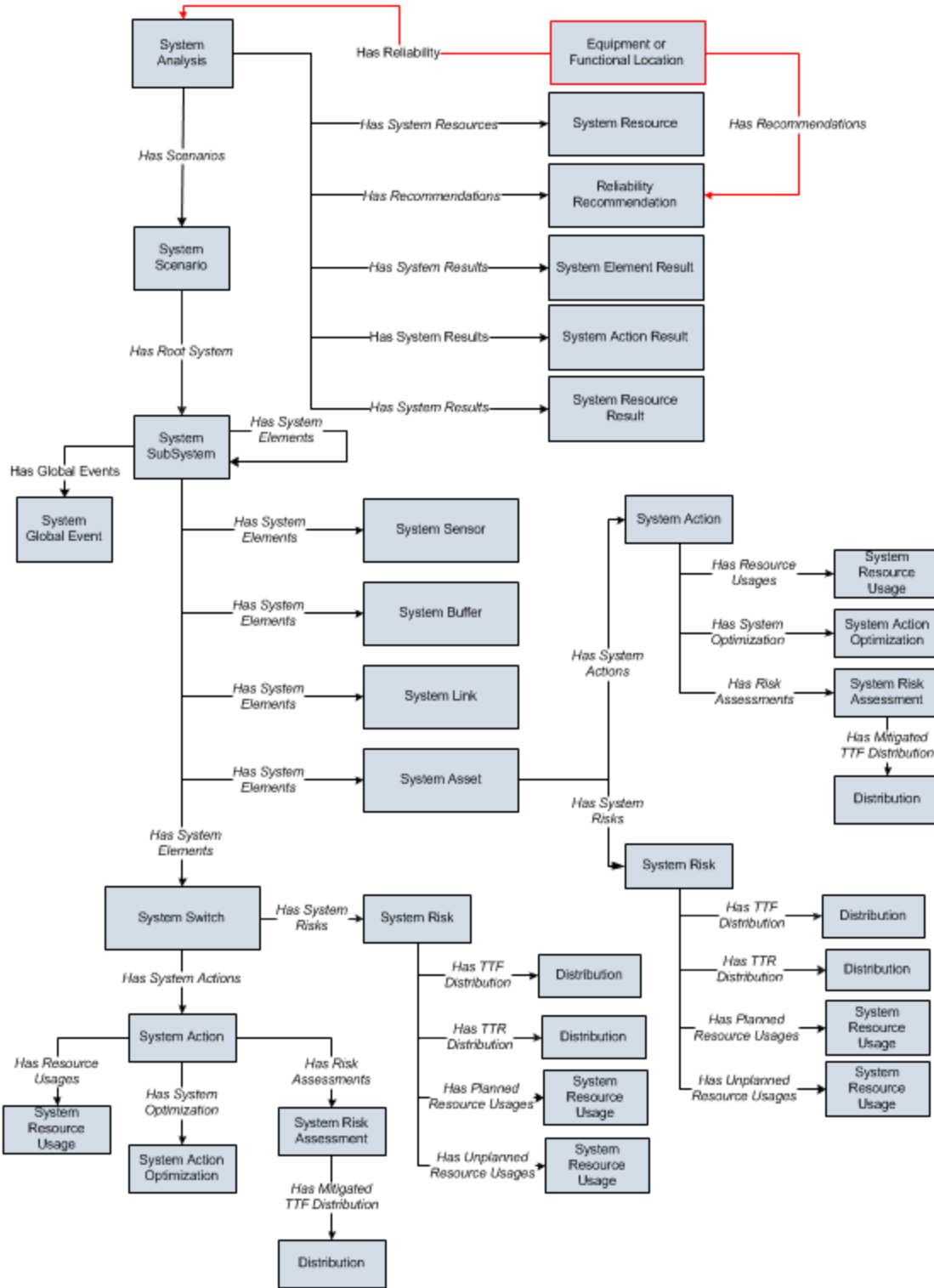

In this image:

- The *System Action* box represents one of four System Action subfamilies in which records can exist: System Condition Monitor, System Inspection, System Preventive Maintenance, or System Special Action. The specific family that is used will depend upon the type of Action that is created for a given Asset or Switch element.
- The *Distribution* box represents one of four Distribution subfamilies in which records can exist: Exponential, Lognormal, Normal, or Weibull record. The specific family that is used will depend upon the distribution type selected for the associated Risk.

Cost of Unreliability Data Model

The following diagram shows the Cost of Unreliability Analysis entity families and the relationships that exist between them. The shaded boxes represent entity families, and the arrows represent relationship families. You can determine the direction of the each relationship definition from the direction of the arrow head: the box *from* which the arrow originates is the predecessor, and the box *to* which the arrow heard points is the successor.

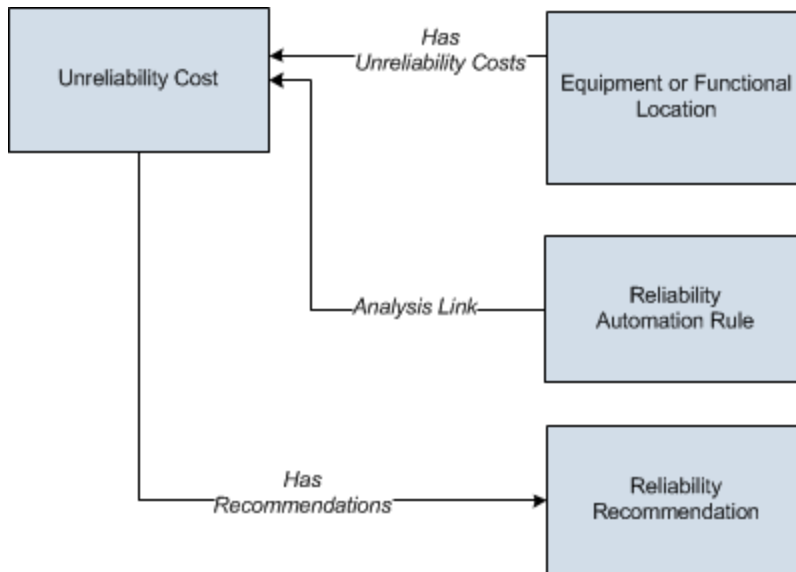

As you develop a Cost of Unreliability Analysis, you will create records in these families and link them together, either manually or automatically via the options in the Meridium APM Framework. Throughout this documentation, we use the term *Cost of Unreliability Analysis* to mean the combination of the Unreliability Cost record and all the records that are linked to it.

What is Failure Data?

A *failure* is the inability of a piece of equipment to perform its intended function. A failure may involve the complete loss of function, a partial loss of function, or the potential loss of function.

Reliability describes how likely it is that a piece of equipment will perform its intended function without failure for a given period of time. Reliability is expressed as a percentage and is expressed mathematically as $(1 - \text{The Probability of Failure})$.

The Meridium APM Reliability Analytics module allows you to analyze failure data so that you can draw conclusions and make predictions about the reliability of your equipment and locations. To perform an analysis in Reliability Analytics, you must first collect failure data and store it in Meridium APM. Examples of important data include:

- Equipment type and location.
- Failure modes.
- Failure type, class, repair actions, and cost.
- Design, process, diagnostic, and work order data.

After the data has been collected, you will need to gather the data, format it, and [supply it to the Meridium APM Reliability Analytics tools](#). Throughout this documentation, we assume that you are collecting and can access the data that is necessary to perform a Reliability analysis.

Supplying Failure Data to Meridium APM Reliability

When you create a new analysis in Reliability Analytics, you will need to select a query or dataset on which to base the analysis or manually enter the data that you want to analyze. One of the easiest and most efficient ways to conduct an analysis is to create one based upon a query. The advantage of using queries is that each time you view the analysis, Meridium APM will run the underlying query to retrieve the most current information from the database. Analyses based on datasets and manually entered data, on the other hand, require more manual intervention to reflect updates.

Note: Throughout this documentation, we assume you have entered all important data and will be creating analyses based on queries.

The specific data that you need in order to create an analysis will vary, depending on the type of analysis that you are creating, the specific information that is available, and the results that you want to see. The following information provides a basic example of a query that you might use for collecting data to perform most types of Reliability analyses.

Field	[Asset ID]	[Asset Installation D...	[Equipment Subunit]	[Failure Mode]	[Failure Date / Time]
Alias	Asset ID	Asset Installation Date	Equipment Subunit	Failure Mode	Failure Date / Time
Table	[Centrifugal Pump]	[Centrifugal Pump]	[Failure]	[Failure]	[Failure]
Sort					
Sort Index					
Include	<input checked="" type="checkbox"/>	<input checked="" type="checkbox"/>	<input checked="" type="checkbox"/>	<input checked="" type="checkbox"/>	<input checked="" type="checkbox"/>
Display	<input checked="" type="checkbox"/>	<input checked="" type="checkbox"/>	<input checked="" type="checkbox"/>	<input checked="" type="checkbox"/>	<input checked="" type="checkbox"/>
Hyperlink					
Criteria	'PMP-4543'		'Seals'	'Wear'	
Or					

This query returns failure data for Centrifugal Pump PMP-4543. The query results are limited to failures where the Equipment Subunit is *Seals* and the Failure Mode is *Wear*. Running this query will return the results shown in the following image.

Asset ID	Asset Installation Date	Equipment Subunit	Failure Mode	Failure Date / Time
PMP-4543	1/1/1963	Seals	Wear	11/26/1997
PMP-4543	1/1/1963	Seals	Wear	9/6/1998
PMP-4543	1/1/1963	Seals	Wear	5/29/1997
PMP-4543	1/1/1963	Seals	Wear	12/8/1998
PMP-4543	1/1/1963	Seals	Wear	3/4/1999
PMP-4543	1/1/1963	Seals	Wear	1/14/1999
PMP-4543	1/1/1963	Seals	Wear	8/28/1999
PMP-4543	1/1/1963	Seals	Wear	6/1/2000
PMP-4543	1/1/1963	Seals	Wear	9/17/1992
PMP-4543	1/1/1963	Seals	Wear	2/7/1993
PMP-4543	1/1/1963	Seals	Wear	7/10/1994
PMP-4543	1/1/1963	Seals	Wear	6/22/1994
PMP-4543	1/1/1963	Seals	Wear	8/30/1995
PMP-4543	1/1/1963	Seals	Wear	12/2/1995
PMP-4543	1/1/1963	Seals	Wear	12/31/1995
PMP-4543	1/1/1963	Seals	Wear	3/27/1996
PMP-4543	1/1/1963	Seals	Wear	4/30/1996
PMP-4543	1/1/1963	Seals	Wear	12/15/1996
PMP-4543	1/1/1963	Seals	Wear	12/3/1996

Note: The type of failure data you collect will influence the conclusions you can make about your equipment. If you have one pump or several pumps with a specific failure mode, then you can perform a very specific analysis. If you have many pumps with many different failure modes, then your analysis will be less specific.

The following columns of information are included in the results:

- Asset ID (from the Pump record)
- Asset Installation Date (from the Pump record)
- Equipment Subunit (from the Failure record)
- Failure Mode (from the Failure record)
- Failure Date/Time (from the Failure record)
- Total Downtime (from the Failure record)
- Lost Profit Opportunity (from the Failure record)
- Total Failure Cost (from the Failure record)

here

The Importance of Failure Modes

It is important that the type of failure data you collect will influence the conclusions you can make about your equipment. If you have one pump or several pumps with a specific failure mode, then you can perform a very specific analysis. If you have many pumps with many different failure modes, then your analysis will be less specific.

For example, if you want to know the chances of a certain part on the pump failing, and in your dataset you have several pumps that have failed in that way, then your analysis will be more accurate than using data with multiple failure modes. If you are analyzing all of the pumps at your site, and you have many different reasons for failure, you will be able to determine overall failure statistics. This analysis, however, will not be particularly useful in determining the probability of failure of a specific piece of equipment.

About Failure Probability

Conditional Reliability is used in Meridium APM's Failure Probability Calculator. The calculator is available for all distribution models and uses conditional probability to compute the probability of failure at time, t .

The concept of Conditional Reliability involves the following questions:

- What is the probability of failure given that the item has survived until today?
- or-
- How many days until I reach a certain % probability of failure?

The results of a failure probability calculation in Meridium APM can be a bit confusing. However, the results are correct. For example, the user may find the *current* probability of failure for a given element to be 90% or more after 3 years of operating time. If the user were to calculate the future probability of failure 10 days from the current date, the estimate of future failure probability might be around 1%. This is not incorrect. This often occurs when the future is small compared to the total life experienced by the elements under study.

Wear out, Beta > 1

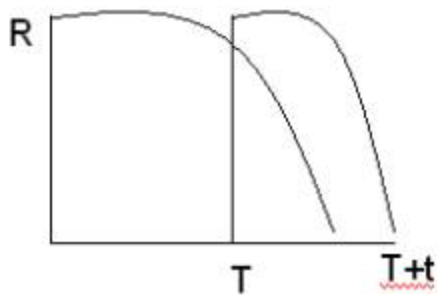

Infant Mortality, Beta < 1

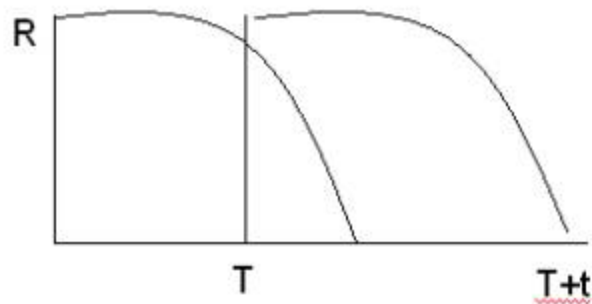

$$R(T,t) = R(T+t)/R(T)$$

The Probability of surviving $(T + t)$ days equals the Probability of surviving (T) days and then surviving additional (t) days.

Meridium APM Reliability allows you to specify the operating time and calculate the probability of equipment failure. Or you can choose to specify the probability of equipment failure and then calculate the future age when the specified probability will be reached.

Accessing Reliability Analytics in the Meridium APM Framework

To access Reliability Analytics in the Meridium APM Framework:

- On the Meridium APM Framework main menu, click **Go To**, point to **Failure Elimination**, and then click **Reliability Analytics**.

The **Reliability Analytics Start Page** appears.

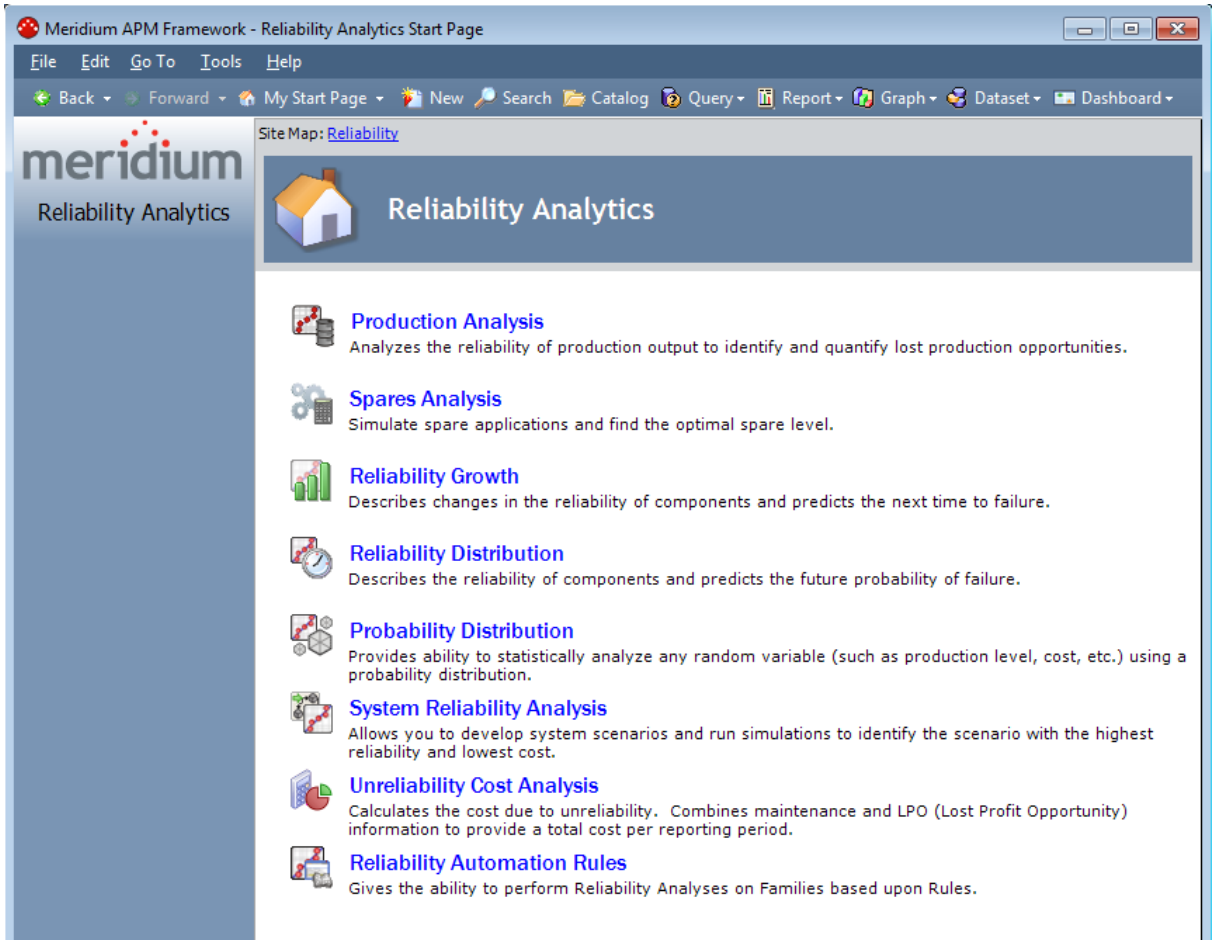

Aspects of the Reliability Analytics Start Page

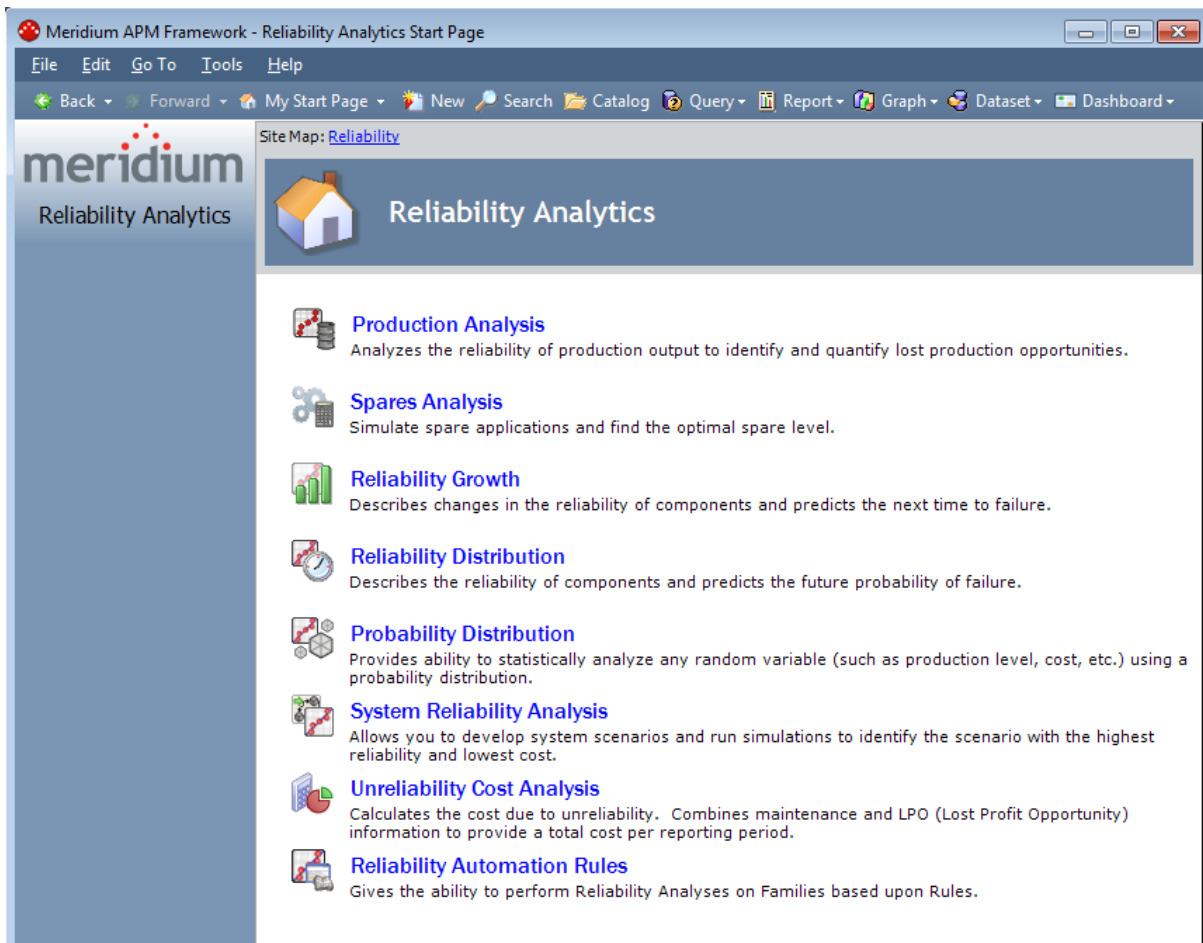

The following links appear on the **Reliability Analytics Start Page**:

- **Production Analysis**: Displays the [Select a Production Analysis from the List page](#), where you can view, create, edit, delete, and save Production Analyses. You can also define Reliability, Demonstrated lines, Nameplate lines, and Production lines. In addition, you can set the minimum production value, the unit of measure for production output, the margin value, and the unit of measure for the margin.
- **Spares Analysis**: Displays the [Select a Spares Analysis from the List page](#), where you can view, create, edit, delete, and save Spares Analyses. You can run a Monte Carlo simulation to view results on the Spare Level Plot, Downtime Plot, Spare Usage Plot, Sensitivity Plot, and Optimal Holding Plot. In addition, you can export the simulation results to a dataset, and save it within the Meridium APM Catalog for future reference.
- **Reliability Growth**: Displays the [Select a Growth Analysis from the List page](#), where you can view, create, edit, delete, and save Reliability Growth Analyses. You are able to track changes in Mean Time Between Failure (MTBF) over a specified period of time to determine strategies or repairs necessary to increase the

reliability of a product (i.e., element, system, or subsystem).

- **Reliability Distribution:** Displays the [Select a Distribution Analysis from the List page](#), where you can view, create, edit, delete, and save Reliability Distribution Analyses. You can also view Probability Plots, Failure Rate Plots, Probability Density Function Plots, Cumulative Distribution Function Plots, and Competing Failure Modes Plots. In addition, you can view failure data, calculate the future probability of failure, and calculate the future age when specified probability will be reached. Meridium APM Reliability supports four Distribution types: [Weibull](#), [Normal](#), [Lognormal](#), and [Exponential](#).
- **Probability Distribution:** Displays the [Probability Distribution List page](#), where you can view, create, edit, delete, and save Probability Distribution Analyses. You can also view Probability Plots, Probability Density Function Plots, Cumulative Distribution Function Plots, and Composite Plots. Meridium APM Probability supports four Distribution types: [Weibull](#), [Normal](#), [Lognormal](#), and [Exponential](#).
- **System Reliability Analysis:** Displays the [Select a System Reliability Analysis from the List page](#), from which you can open or delete an existing analysis or create a new analysis.
- **Unreliability Cost of Analysis:** Displays the [Select a Cost of Unreliability Analysis page](#), where you can view, create, edit, delete, and save Cost of Unreliability Analyses. You can also view Total Cost Plots, Mean Time Between Failures Plots, Mean Time to Repair Plots, Availability Plots, Failure Plots, Downtime Plots, and Trend Plots for Cost of Unreliability Analyses.
- **Reliability Automation Rules:** Displays the [Automation Rules List Screen](#), where you can search for existing [automation rules](#) and create new Reliability Automation Rules. You can also view a preview of the Analysis Failure Data, merge analyses, execute Reliability Automation Rules, and delete Reliability Automation Rules.

Note: You must be a member of the MI Reliability Administrator Security Group or a Super User in order to access the **Automation Rule List Screen** page. If you are not a member of one of these Security Groups, the **Reliability Automation Rules** link will not appear.

First-Time Deployment Workflow

Deploying and configuring Reliability Analytics for the first time includes completing multiple steps, which are outlined in the table in this topic. The steps in this section of the documentation provide all the information that you need to deploy and configure the Reliability Analytics module on top of the basic Meridium APM system architecture.

Whether a step is required or optional is indicated in the **Required/Optional** cell. Steps are marked as *Required* if you must perform the steps to take advantage of Reliability Analytics functionality.

The person responsible for completing each task may vary within your organization. We recommend, however, that the steps be performed in relatively the same order in which they are listed in the table.

Step	Task	Required/Optional	Notes
1	Review the Reliability Analytics data models to determine which relationship definitions you will need to modify to include your custom equipment and location families. Modify any relationship definitions as needed via Configuration Manager.	Optional	This task is necessary only if you store equipment and location information in families other than the baseline Equipment and Functional Location families.
2	Assign the desired Security Users to one or more Reliability Analytics Security Groups in Configuration Manager.	Required	Users will not be able to access Reliability Analytics unless they have permissions to the Reliability Analytics families.
3	Modify Reliability Analytics queries.	Optional	This task is necessary only if you want to change the behavior of the baseline list queries.

Step	Task	Required/Optional	Notes
4	Configure the ability for users to create Reliability Distribution and Reliability Growth Analyses from Associated Pages using URL Manager.	Optional	This task is necessary only if you want to implement this functionality.
5	Configure Reliability Automation Rules.	Optional	This task is necessary only if you want to use Reliability Automation Rules to create analyses automatically.

Upgrade or Update Reliability Analytics to 3.6.1.3.0

The following tables list the steps that are required to update or upgrade Reliability Analytics to 3.6.1.3.0. This step assumes that you have completed the steps for upgrading the components in the basic Meridium APM system architecture.

Update from any version V3.6.1.0.0 through V3.6.1.2.0

This module will be updated to 3.6.1.3.0 automatically when you update the components in the basic Meridium APM system architecture. No additional steps are required.

Upgrade from any version V3.6.0.0.0 through V3.6.0.12.6

Reliability Analytics will be upgraded to 3.6.1.3.0 automatically when you upgrade the components in the basic Meridium APM system architecture. No additional steps are required.

Upgrade from any version V3.5.1.0.0 through V3.5.1.12.0

Reliability Analytics will be upgraded to 3.6.1.3.0 automatically when you upgrade the components in the basic Meridium APM system architecture. No additional steps are required.

Upgrade from any version V3.5.0 SP1 LP through V3.5.0.1.9.0

Reliability Analytics will be upgraded to 3.6.1.3.0 automatically when you upgrade the components in the basic Meridium APM system architecture. No additional steps are required.

Upgrade from any version V3.5.0 through V3.5.0.0.7.1

Reliability Analytics will be upgraded to 3.6.1.3.0 automatically when you upgrade the components in the basic Meridium APM system architecture. No additional steps are required.

Upgrade from any version V3.4.5 through V3.4.5.0.1.4

Step	Task	Required/Optional	Notes
1	Configure the ability for users to Reliability Distribution and Reliability Growth Analyses from Associated Pages using URL Manager.	Optional	This feature is new in V3.5.0, so even if you have deployed Reliability Analytics in V3.4.5, you will not have completed this step. You need to complete this task, however, only if you want to implement this functionality.

Reliability Analytics Security

The following Security Groups are provided for Reliability Analytics.

- MI Reliability Viewer
- MI Reliability User
- MI Reliability Administrator

These Security Groups are provided as part of the baseline Meridium APM database. In addition to assigning Security Users to the appropriate Security Group, you must assign the appropriate family privileges to any Security User or Security Group who should be able to perform Reliability Analytics tasks. Specifically, you must set family privileges for any custom-defined families that will be used in Reliability Analytics.

The baseline privileges for the baseline Security Groups are listed in the following table.

Family	MI Reliability Viewer	MI Reliability User	MI Reliability Administrator
Analysis	View	View	View
Analysis Link	View	View, Update, Insert, Delete	View, Update, Insert, Delete
Distribution	View	View, Update, Insert, Delete	View, Update, Insert, Delete
Exponential	View	View, Update, Insert, Delete	View, Update, Insert, Delete
Growth Model	View	View, Update, Insert, Delete	View, Update, Insert, Delete
Has Mitigated TTF Distribution	View	View, Update, Insert, Delete	View, Update, Insert, Delete
Has Global Events	View	View, Update, Insert, Delete	View, Update, Insert, Delete
Has Planned Resource Usages	View	View, Update, Insert, Delete	View, Update, Insert, Delete
Has Recommendations	View	View, Update, Insert, Delete	View, Update, Insert, Delete
Has Reliability	View	View, Update, Insert, Delete	View, Update, Insert, Delete
Has Resource Usage	View	View, Update, Insert, Delete	View, Update, Insert, Delete

Family	MI Reliability Viewer	MI Reliability User	MI Reliability Administrator
Has Risk Assessments	View	View, Update, Insert, Delete	View, Update, Insert, Delete
Has Root System	View	View, Update, Insert, Delete	View, Update, Insert, Delete
Has Scenarios	View	View, Update, Insert, Delete	View, Update, Insert, Delete
Has System Actions	View	View, Update, Insert, Delete	View, Update, Insert, Delete
Has System Results	View	View, Update, Insert, Delete	View, Update, Insert, Delete
Has System Elements	View	View, Update, Insert, Delete	View, Update, Insert, Delete
Has System Optimization	View	View, Update, Insert, Delete	View, Update, Insert, Delete
Has System Resources	View	View, Update, Insert, Delete	View, Update, Insert, Delete
Has System Risks	View	View, Update, Insert, Delete	View, Update, Insert, Delete
Has TTF Distribution	View	View, Update, Insert, Delete	View, Update, Insert, Delete
Has Unplanned Resource Usages	View	View, Update, Insert, Delete	View, Update, Insert, Delete
Has Unreliability Cost	View	View, Update, Insert, Delete	View, Update, Insert, Delete
Lognormal	View	View, Update, Insert, Delete	View, Update, Insert, Delete
Normal	View	View, Update, Insert, Delete	View, Update, Insert, Delete
Production Analysis	View	View, Update, Insert, Delete	View, Update, Insert, Delete
Production Losses	View	View, Update, Insert, Delete	View, Update, Insert, Delete

Family	MI Reliability Viewer	MI Reliability User	MI Reliability Administrator
Reliability Automation Rule			View, Update, Insert, Delete
Reliability Distribution	View	View, Update, Insert, Delete	View, Update, Insert, Delete
Reliability Growth	View	View, Update, Insert, Delete	View, Update, Insert, Delete
Reliability Recommendation	View	View, Update, Insert, Delete	View, Update, Insert, Delete
Spare	View	View, Update, Insert, Delete	View, Update, Insert, Delete
Spares Analysis	View	View, Update, Insert, Delete	View, Update, Insert, Delete
Spare Analysis Chart	View	View, Update, Insert, Delete	View, Update, Insert, Delete
Spare Application	View	View, Update, Insert, Delete	View, Update, Insert, Delete
Spare Application Population	View	View, Update, Insert, Delete	View, Update, Insert, Delete
System Action	View	View, Update, Insert, Delete	View, Update, Insert, Delete
System Action Mapping	View	View, Update, Insert, Delete	View, Update, Insert, Delete
System Action Optimization	View	View, Update, Insert, Delete	View, Update, Insert, Delete
System Action Result	View	View, Update, Insert, Delete	View, Update, Insert, Delete
System Analysis	View	View, Update, Insert, Delete	View, Update, Insert, Delete
System Asset	View	View, Update, Insert, Delete	View, Update, Insert, Delete
System Buffer	View	View, Update, Insert, Delete	View, Update, Insert, Delete

Family	MI Reliability Viewer	MI Reliability User	MI Reliability Administrator
System Condition Monitor	View	View, Update, Insert, Delete	View, Update, Insert, Delete
System Element	View	View, Update, Insert, Delete	View, Update, Insert, Delete
System Element Result	View	View, Update, Insert, Delete	View, Update, Insert, Delete
System Global Event	View	View, Update, Insert, Delete	View, Update, Insert, Delete
System Inspection	View	View, Update, Insert, Delete	View, Update, Insert, Delete
System Link	View	View, Update, Insert, Delete	View, Update, Insert, Delete
System Preventative Maintenance	View	View, Update, Insert, Delete	View, Update, Insert, Delete
System Resource	View	View, Update, Insert, Delete	View, Update, Insert, Delete
System Resource Result	View	View, Update, Insert, Delete	View, Update, Insert, Delete
System Resource Usage	View	View, Update, Insert, Delete	View, Update, Insert, Delete
System Risk	View	View, Update, Insert, Delete	View, Update, Insert, Delete
System Risk Assessment	View	View, Update, Insert, Delete	View, Update, Insert, Delete
System Scenario	View	View, Update, Insert, Delete	View, Update, Insert, Delete
System Sensor	View	View, Update, Insert, Delete	View, Update, Insert, Delete
System Special Action	View	View, Update, Insert, Delete	View, Update, Insert, Delete
System Subsystem	View	View, Update, Insert, Delete	View, Update, Insert, Delete

Family	MI Reliability Viewer	MI Reliability User	MI Reliability Administrator
System Switch	View	View, Update, Insert, Delete	View, Update, Insert, Delete
Unreliability Cost	View	View, Update, Insert, Delete	View, Update, Insert, Delete
Weibull	View	View, Update, Insert, Delete	View, Update, Insert, Delete

Modifying the Reliability List Queries

The baseline Meridium APM database contains queries that are used to display results on the analysis list pages. If desired, you can modify these queries to customize the lists that are displayed. For example, you may want to customize these queries to add additional prompts or filters. Note that if you modify one of the baseline queries or create your own query to be used for one of the list pages, the query will be used by anyone who accesses the list of analyses.

Before you modify or create Reliability Analytics queries, note the following:

- Meridium APM is hard-coded to look for the Reliability Analytics queries in the folder \\Public\Meridium\Modules\Reliability Manager\Analyses. Any query that you want to use must exist in this location.
- Meridium APM is hard-coded to look for the query names as they are delivered. If you want to use a customized query, you must modify a query that Meridium APM delivers, or you can rename or delete a query we deliver and add your own query to the same folder using the *exact* name of the delivered query. For example, if you want a query to return a list of Reliability Growth Analyses filtered according to a specific value in the Analysis Start Date field, you would modify the delivered Reliability Growth query or rename or delete this query and add your own Reliability Growth query to the same folder.
- The analysis query source alias must be **analy**, and the automation rule query source alias must be **relrules**.
- The following fields must exist in all queries and must use the aliases as they appear in this list:
 - Analysis ID
 - Published
 - ENTY_KEY
 - LAST_UPBY_SEUS_KEY
 - LAST_UPDT_DT

Note: The Automation Rules query will not contain the Published field. It should contain all other fields in the preceding list.

About Creating a Reliability Analysis from an Associated Page

Within the Reliability Analytics module, you can create a Reliability Growth Analysis from the [Reliability Growth Builder](#), and you can create a Reliability Distribution Analysis from the [Reliability Distribution Builder](#). In addition to these standard features, which require no manual configuration, you also have the option of allowing users to create a [Reliability Growth Analysis](#) or [Reliability Distribution Analysis](#) from an Associated Page while they are viewing an Equipment or Functional Location record in the Record Manager. If you configure this functionality, when a user creates a new analysis in this way, certain values in the Equipment or Functional Location record will be mapped to the analysis using the parameter values that are defined in the Associated Page's underlying URL.

This feature is supported by two main components:

- The *AutoCreate* parameter value, which is available for the [Reliability Growth](#) and [Reliability Distribution](#) URLs.
- A query that is required by the AutoCreate parameter value and passes in values that will be used for creating the new analysis.

If you are following the Meridium APM Best Practice and are storing equipment and location data in the baseline Equipment and Functional Location families, in order to take advantage of this functionality, you will need to [create an Associated Page on these families manually](#). You can create this Associate Page using the [baseline query that is provided to support this functionality](#) and passing in values to the URL that will cause values returned by the query to be used in the new analysis.

This documentation assumes that you are following the Meridium APM Best Practice and will therefore:

- Use the baseline query.
- Construct your Associated Page URLs based upon the baseline query.

If your equipment and location information is stored in non-baseline families, to take advantage of this functionality, you will need to [modify the baseline queries](#) to work with your custom families and then create Associated Page URLs to accommodate those changes. The [Reliability Growth](#) and [Reliability Distribution URL documentation](#) provide basic information about this URL parameter that should allow you to customize the URLs to suit your needs. Note that even if you are following the Meridium APM Best Practice for storing equipment and location information, you may want to modify the baseline query to provide additional functionality (e.g., additional prompts).

About the Baseline Associated Page Queries

The baseline queries *Equipment - Work History* and *Functional Location - Work History*, which are stored in the Catalog folder \\Public\Meridium\Modules\Reliability Manager\Queries, can be used to [create an Associated Page](#) on the Equipment and Functional Location families that will allow users to create Reliability Growth and Reliability Distribution Analyses automatically from Equipment and Functional Location records.

The Equipment - Work History query includes the Equipment and Work History families and returns information about the Work History records that are linked to a given Equipment record. In this query:

- The following fields are included for the Equipment Family:
 - Equipment ID
 - Valid From Date
- The following fields are included from the Work History family:
 - Event Start Date
 - Time to Repair
- The following prompt is defined for the Equipment ID field:

```
((? :s :caption='Equipment ID' :id=EquipmentID :query='SELECT DISTINCT [MI_EQUIP000_EQUIP_ID_C] FROM [MI_EQUIP000] ORDER BY [MI_EQUIP000_EQUIP_ID_C]'))
```

When the query is run, the value that is passed into this prompt determines the Equipment record for which to return Work History records. Information from those Equipment and Work History records is used to create the analysis.

The Functional Location - Work History query includes the Functional Location and Work History families and returns information about the Work History records that are linked to a given Functional Location record. In this query:

- The following field is included for the Functional Location Family:
 - Location
- The following fields are included from the Work History family:
 - Event Start Date
 - Time to Repair
- The following prompt is defined for the Location field:

```
((? :s :caption='Functional Location' :id=FunctionalLocation :query='SELECT DISTINCT [MI_FNCLOC00_LOCAT_C] FROM [MI_FNCLOC00] ORDER BY [MI_FNCLOC00_LOCAT_C]'))
```

When the query is run, the value that is passed into this prompt determines the Functional Location record for which to return Work History records. Information

from those Functional Location and Work History records is used to create the analysis.

Modifying the Associated Page Queries

If you want to use this functionality but do not use the baseline Equipment and Functional Location families to store your equipment and location information or the Work History family to store your failure information, you will need to create your own custom queries or modify the following [baseline queries](#).

If you choose to modify the baseline queries, you will need to:

- Replace the sources families with your own custom families.
- Include the fields whose values you want to map to the analysis.
- Add a prompt to the desired field, similar to the prompt that is provided in the baseline queries.

If you decide to use different queries other than baseline queries or add additional fields to either baseline query, before doing so, you should review the parameters that are required to build a [Reliability Growth Analysis](#) or [Reliability Distribution Analysis](#) to determine what information you want to map from the query to the analysis. The values that you want to map to the analysis will need to be returned by the fields that you include in the query.

Creating Associated Pages That Can Be Used to Create Analyses

The following instructions provide details on creating an Associated Page link that will allow users to create a Reliability Growth or Reliability Distribution Analysis while viewing an Equipment or Functional Location record in Record Manager. You may need to repeat these steps multiple times, depending upon how many Associated Pages you want to create.

To create an Associated Page that will allow you to create a Reliability Growth or Reliability Distribution Analysis from an Equipment or Functional Location record:

1. In the Meridium APM URL Manager, on the **Associate Families with URLs** tab, select *Equipment* or *Functional Location* in list of available families.
2. Click the **New Menu Item** button.

The **Menu Item Information** dialog box appears.

3. In the **Caption** text box, type **New Growth Analysis** or **New Distribution Analysis**, depending upon the type of analysis that you want to create.
4. In the **URL** text box, type one of the following URLs, depending on which type of analysis you want to create. The syntax provided here assumes that you are using the [baseline queries provided to support this functionality](#).
 - **Reliability Growth Analysis for the Equipment Family:** meridium://Reliability/growth?Action=AutoCreate&QueryPath=Public\Meridium\Modules\Reliability Manager\Queries\Equipment - Work History&AssetIDField=Equipment ID&FailureDateField=Event Start Date&InstallationDateField=Valid From Date&DowntimeField=Time To Repair&EquipmentID=[MI_EQUIP000_EQUIP_ID_C]
 - **Reliability Distribution Analysis for the Equipment Family:** meridium://Reliability/Distribution?Action=AutoCreate&QueryPath=Public\Meridium\Modules\Reliability Manager\Queries\Equipment - Work History&AssetIDField=Equipment

ID&FailureDateField=Event Start Date&InstallationDateField=Valid From Date&DowntimeField=Time To Repair&EquipmentID=[MI_EQUIP000_EQUIP_ID_C]

- **Reliability Growth Analysis for the Functional Location family:** meridium://Reliability/growth?Action=AutoCreate&QueryPath=Public\Meridium\Modules\Reliability Manager\Queries\Functional Location - Work History&AssetIDField=Location&FailureDateField=Event Start Date&DowntimeField=Time To Repair&FunctionalLocation=[MI_FNCLOC00_LOCAT_C]
 - **Reliability Distribution Analysis for the Functional Location family:** meridium://Reliability/Distribution?Action=AutoCreate&QueryPath=Public\Meridium\Modules\Reliability Manager\Queries\Functional Location - Work History&AssetIDField=Location&FailureDateField=Event Start Date&DowntimeField=Time To Repair&FunctionalLocation=[MI_FNCLOC00_LOCAT_C]
5. Click the **Save** button.

The Associated Page is saved.

What Are Reliability Automation Rules?

Reliability Distribution, Reliability Growth, and Cost of Unreliability Analyses can be created interactively or through Reliability Automation Rules, which can generate multiple Reliability analyses for a hierarchy of equipment and location that have related events.

Using Reliability Automation Rules, you can analyze several families in a single step. Based on the parameters that you predefine for the analysis, the system will automatically execute the analysis calculations on the entire population that is valid for the parameters and generate the appropriate reliability document. The results of the analysis calculations are captured in the database against the identified population, providing quick reference to the current reliability.

Note: To generate a Reliability Analysis document, equipment and location families and failure data for the equipment and location must already be defined in the database.

To access the **Reliability Automation Rules** function, you must be a member of the MI Reliability Administrator Security Group or a Super User.

Reliability Automation Rule Data Model

The following diagram shows the entity and relationship families that are used by Reliability Automation Rules.

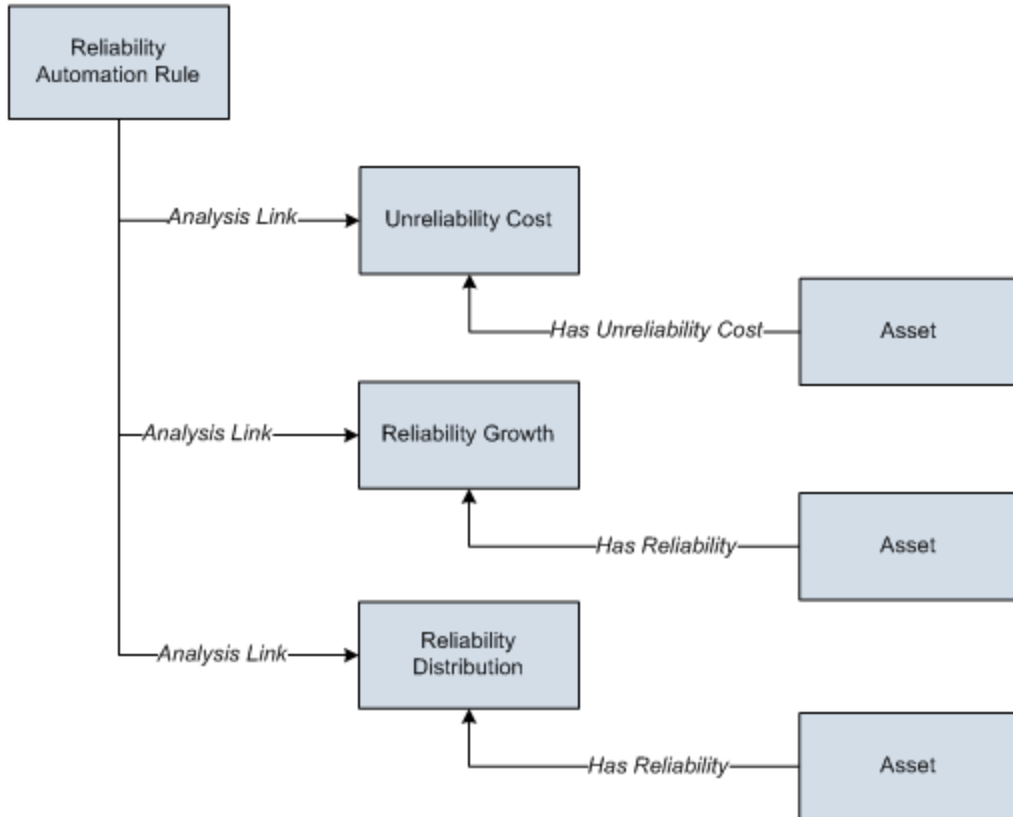

About Creating Queries for Use with the Rule Builder

On the **Source Data** page of the [Reliability Automation Rule Builder](#), you can select a pre-defined query to provide the data on which auto-generated Reliability Analyses will be built for a query-based Automation Rule. Before you can use the **Reliability Automation Rule Builder**, one or more appropriate queries must be defined. Ideally, these queries will be pre-defined by an administrative user before other users access the system.

Note: After these queries have been created and used to build rules, they should not be deleted. Without the queries, the Automation Rules that are based on them cannot update the analyses that they generated.

Automation Rule queries must contain:

- All of the fields required for mapping to the selected analysis type (Reliability Distribution, Reliability Growth, Cost of Unreliability). For all analysis types, the following fields should be selected:
 - Asset ID (required).
 - Asset Installation Date (optional).
 - Failure Date (required).
 - Downtime (optional).
 - Maintenance Cost (optional, for Cost of Unreliability Analysis only).
 - LPO (optional, for Cost of Unreliability Analysis only).
- The fields that will be used for grouping populations of events (including system fields such as Family ID and Family Key and the entity family caption)
- Filtering criteria.

Note: Filtering is disabled in the **Reliability Automation Rule Builder** if a query is used to build analyses.

We strongly recommended that you use a query that contains the metadata information in the Asset ID and Failure Date fields (which are required fields) and that these two fields are defined in two separate entity families. This precludes the use of **Group By** queries, complex (non metadata-based) queries in the SQL Editor, and system fields or calculated fields for Asset ID and Failure Date information.

The master query cannot contain parameters. The master query should be stored in a public directory in the Catalog and must not be deleted. We recommend that you store this query in the following Catalog folder: \\Public\Meridium\Modules\Reliability\Manager.

If you need additional fields for mapping or population grouping in the Reliability Automation Rule, you must change the master query. The master query should be accessible

to members of the MI Reliability Administrators Security Group who will be working with Reliability Automation Rules. When the Reliability Automation Rule is executed to generate the analyses, sub-queries will be created using the master query as the source. If the master query is deleted, the sub-queries will cease to operate.

Accessing the List of Reliability Automation Rules

To access the list of Reliability Automation rules:

- In the Meridium APM Framework application, on the [Reliability Analytics Start Page](#), click the **Reliability Automation Rules** link.

Note: You must be a member of the MI Reliability Administrator Security Group or a Super User in order to access the **Automation Rule List Screen** page. If you are not a member of one of these Security Groups, the **Reliability Automation Rules** link will not appear.

The **Automation Rule List Screen** page appears.

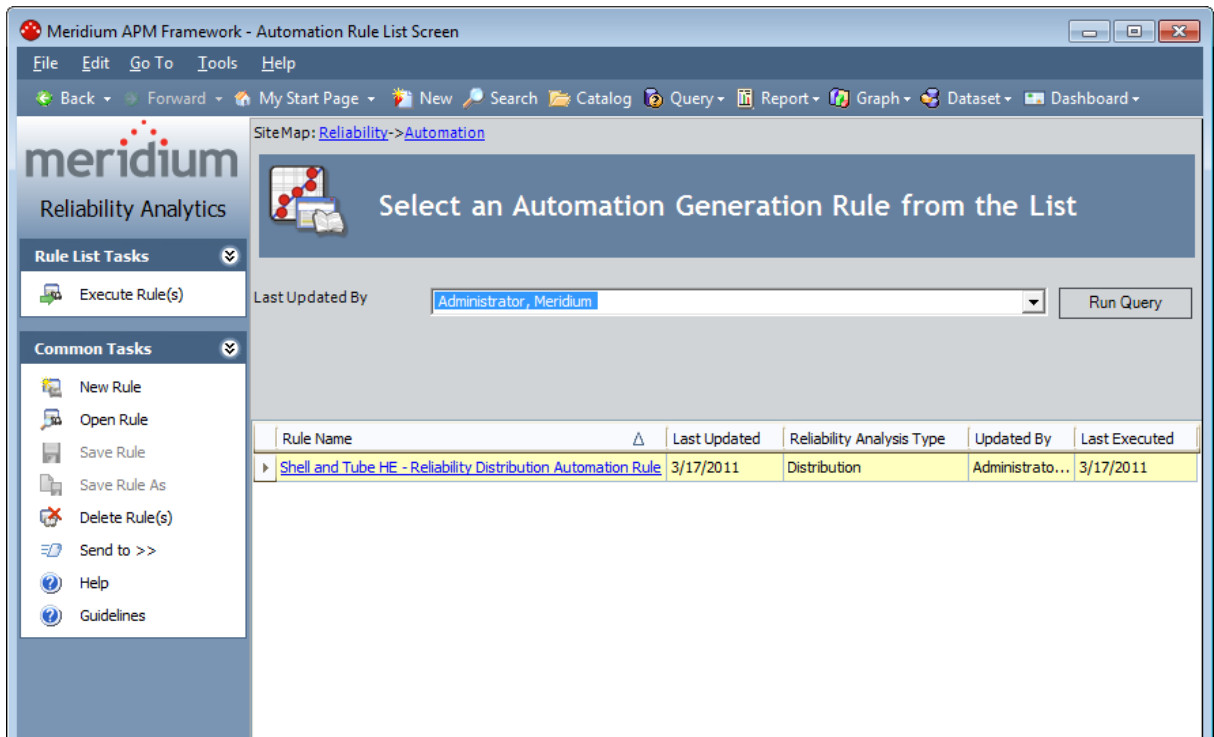

From the **Automation Rule List Screen** page, you can run the Reliability Automation Rule list query to access a list of existing Reliability Automation Rules and then [view a summary of any rule](#).

Aspects of the Automation Rule List Screen Page

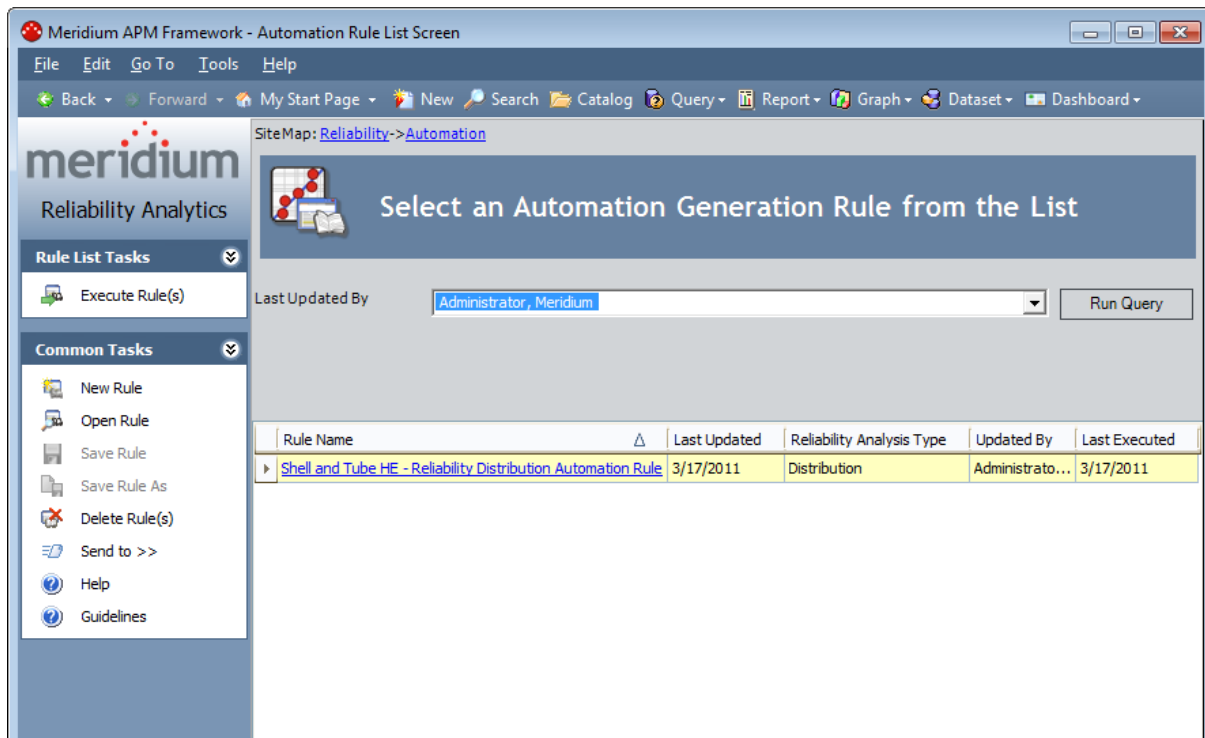

The [Automation Rule List Screen](#) page lets you run the Automation Rules query to access a list of existing Reliability Automation Rules that meet your query criteria. The Automation Rules query is stored in the Meridium APM Catalog folder \\Public\Meridium\Modules\Reliability Manager\Analyses. While the Automation Rules query can be [customized](#) for your specific implementation, the baseline Automation Rules query contains one prompt: **Last Updated By**. This prompt appears at the top of the page as a drop-down list that contains the following options:

- Your user name, which is selected by default.
- The user name of any user who last updated any Reliability Automation Rule.
- The **[All Users]** option, which lets you retrieve a list of Reliability Automation Rules updated by any user.

Selecting a value from the **Last Updated By** list will cause the list of Reliability Automation Rules to display only the rules that meet that criteria. For example, if you select your name, the query will return a list of all the Reliability Automation Rules that were last updated by you.

After you select the desired criteria, you can click the **Run Query** button, to run the Automation Rules query and display the results in a grid at the bottom of the page. The default Automation Rules query is configured to display the following columns of information: **Rule Name**, **Last Updated**, **Reliability Analysis Type**, **Updated By**, and **Last Executed**. You can click any hyperlinked **Rule Name** to [view the summary](#) of the selected rule.

CEHint: If desired, you can customize the column display.

In addition, the **Automation Rule List Screen** page contains two task menus, which you can use to perform functions associated with Reliability Automation Rules.

Rules List Tasks Menu

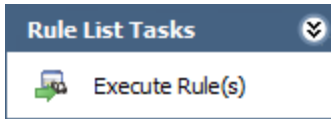

The **Rule List Tasks** menu on the **Automation Rule List Screen** page contains the following link:

- **Execute Rule(s)**: Executes the selected Reliability Automation Rule(s).

Common Tasks Menu

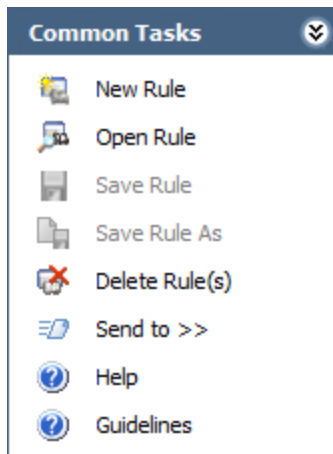

The **Common Tasks** menu on the **Automation Rule List Screen** page contains the following links:

- **New Rule:** Displays the **Reliability Automation Rule Builder**, which will guide you through the process of [creating a new rule](#).
- **Open Rule:** Displays the **Find a Reliability Automation Rule** window, which you can use to find and open an existing rule.
- **Delete Rule(s):** Deletes the current rule(s) from the database, after asking for confirmation.
- **Send To:** Displays a submenu with options that let you provide a link to the current page on your desktop (create shortcut), in an email message, or on a Home Page.
- **Help:** Displays the context-sensitive Help topic for the **Automation Rule List Screen** page.
- **Guidelines:** Displays the Reliability Concepts, which provide reliability workflows and descriptions of reliability concepts.

Note: The **Save Rule** and **Save Rule As** links are always disabled on the **Automation Rule List Screen** page.

About Creating a New Reliability Automation Rule

Using the **Reliability Automation Rule Builder**, you can create a new Reliability Automation Rule based either on:

- [A query](#).

Note: To create a Reliability Automation Rule based on a query, the [query must exist](#) in the Catalog.

- [Equipment, location, and event data](#).

Note: The equipment, location, and event families and any necessary relationships must already be defined.

Creating a Rule Based on a Query

To create a rule based on a query:

1. In the Meridium APM Framework application, on the [Automation Rule List Screen page](#) or the [Summary Screen of \[Automation Rule\] page](#), on the **Common Tasks** menu, click the **New Rule** link.

The **Reliability Automation Rule Builder** appears, displaying the Welcome screen.

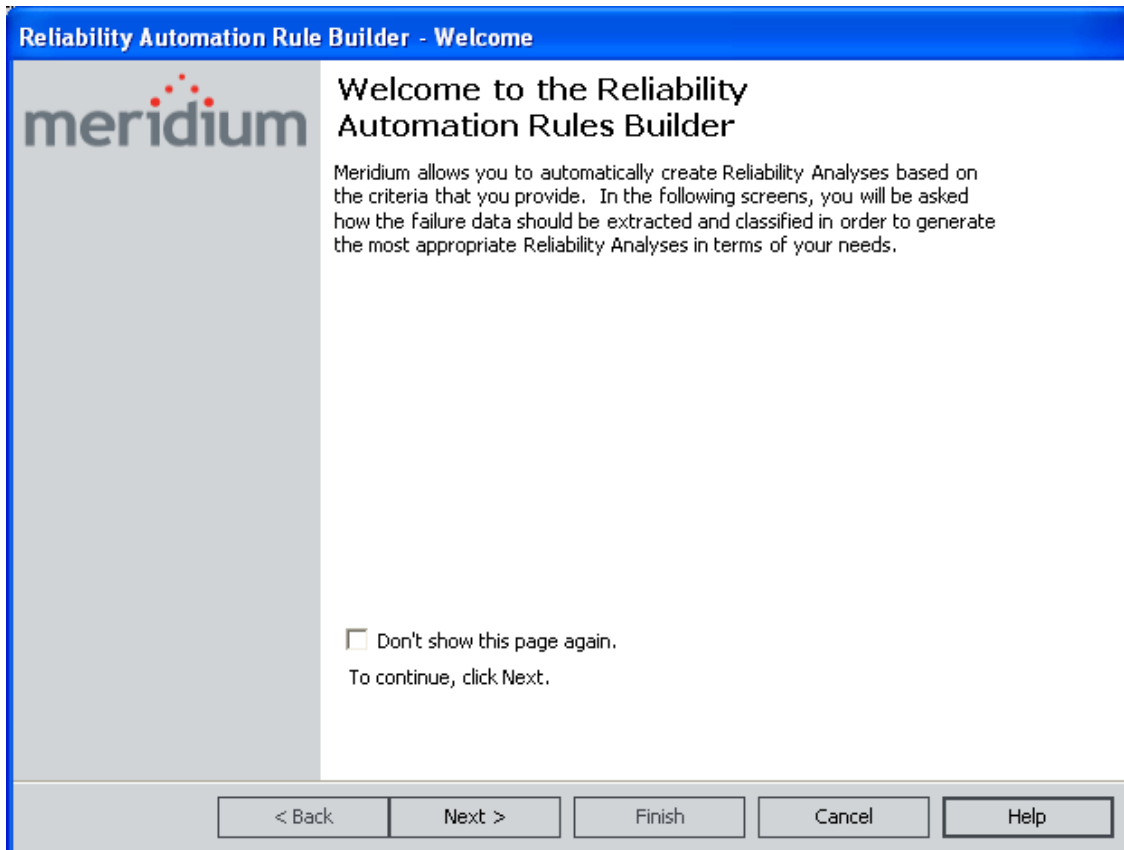

Hint: You can select the **Don't show this page again** check box if you prefer to bypass the Welcome screen in the future.

2. Click the **Next** button.

The **Choose Reliability Document Type** screen appears.

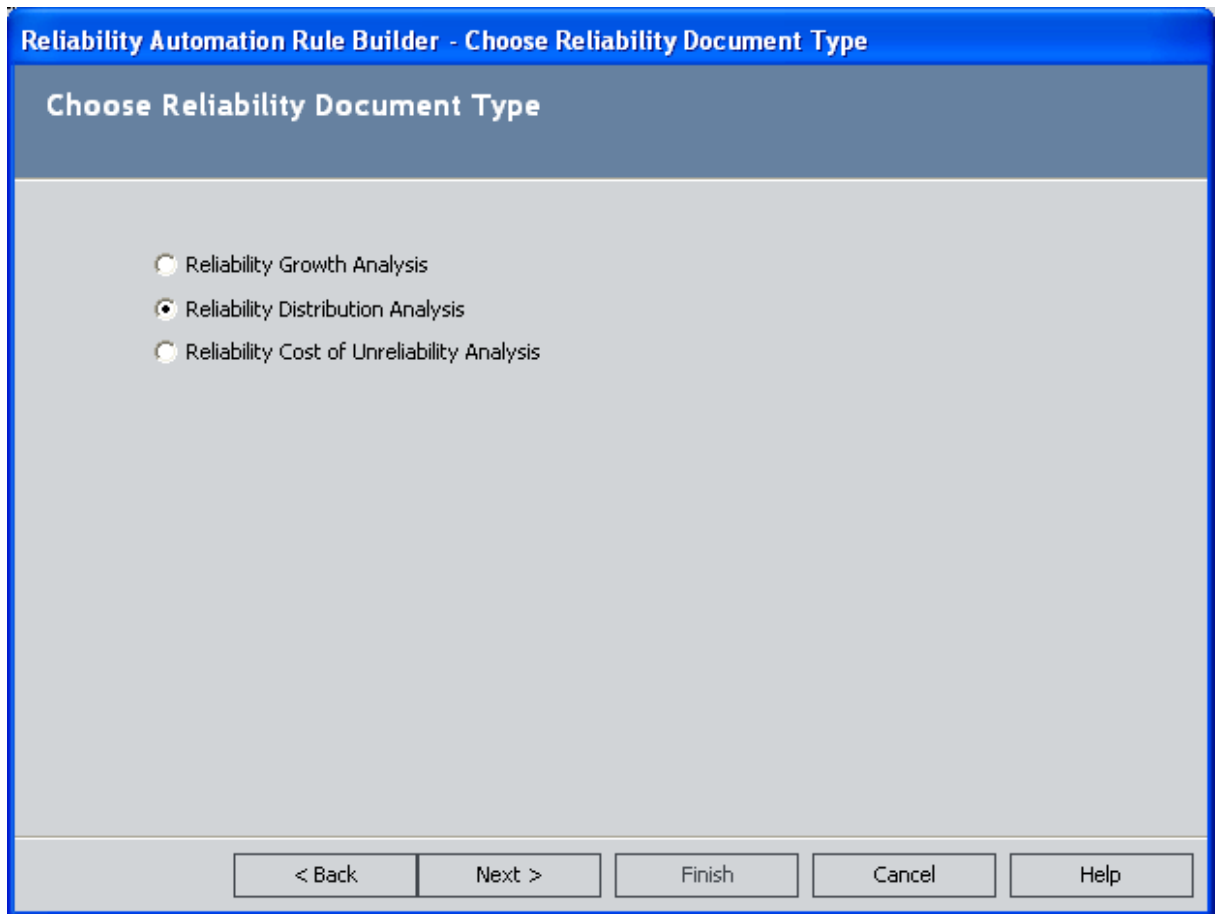

3. Select the option for the type of rule you want to create:
 - **Reliability Growth Analysis**
 - **Reliability Distribution Analysis**
 - **Reliability Cost of Unreliability Analysis**
 - The **Reliability Distribution Analysis** option is selected by default.
4. Click the **Next** button.

The **Source Data** screen appears.

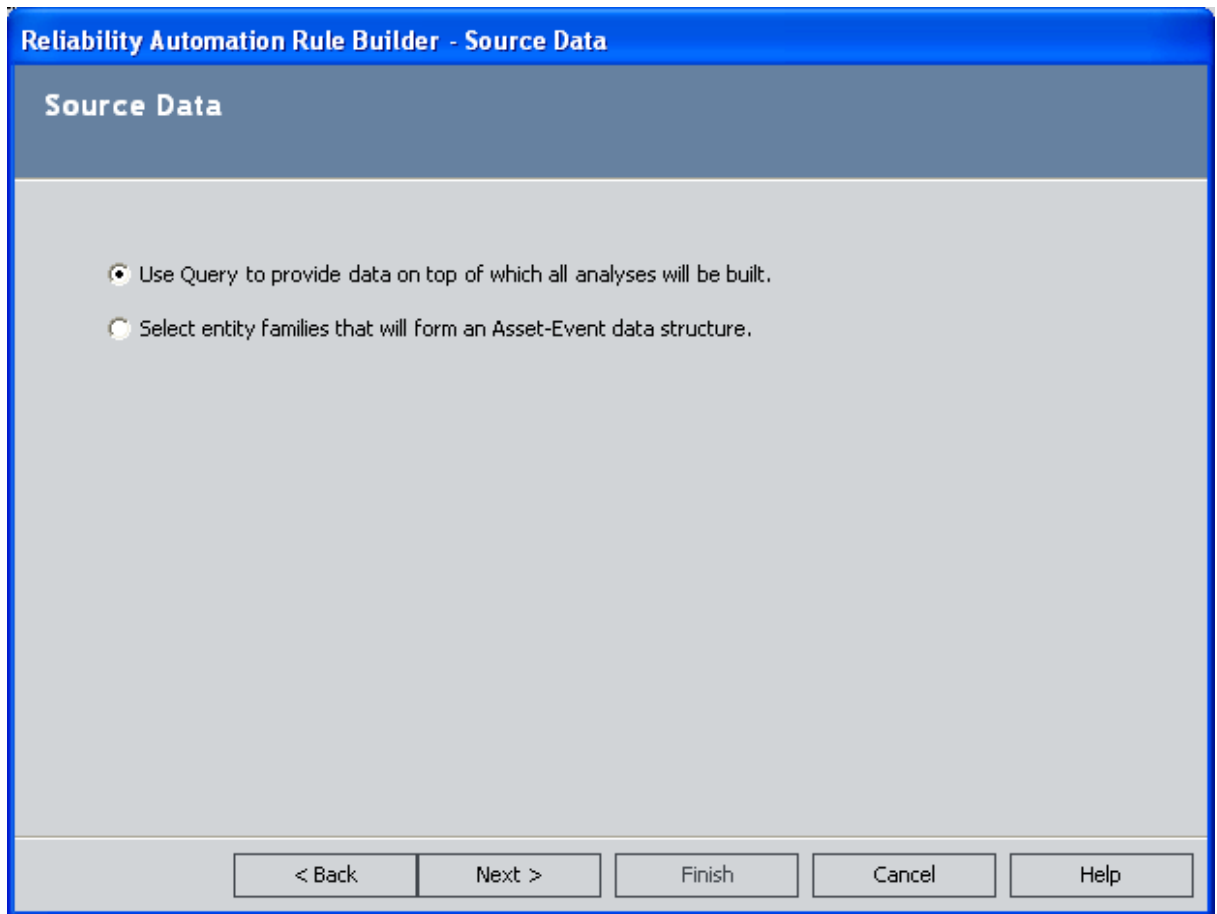

5. Accept the default selection: **Use a Query to provide data on which the analysis will be built.**
6. Click the **Next** button.
The **Select Query** screen appears.

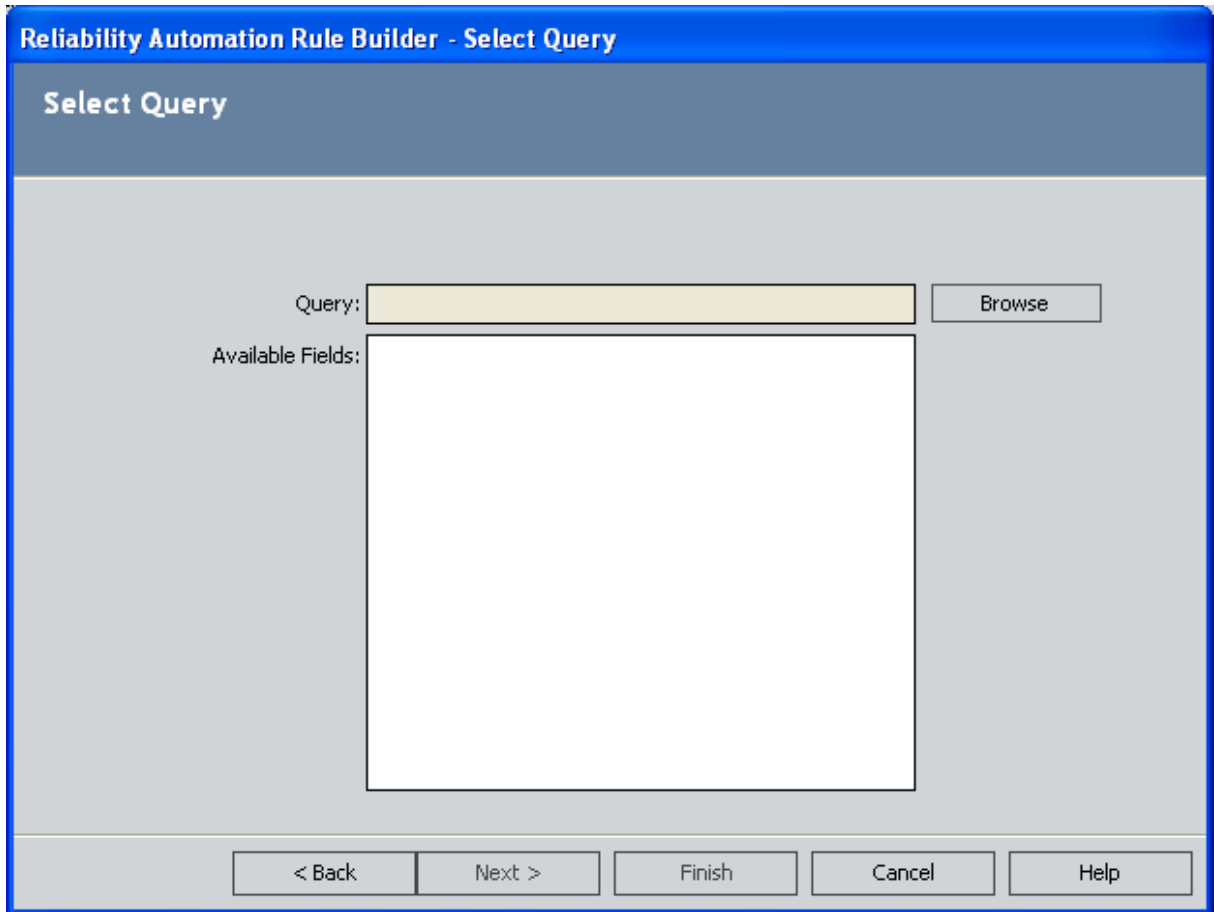

7. Click the **Browse** button to open the Catalog and locate an existing query.
8. Select the query, and click the **Open** button.

After you open the query, the **Select Query builder** screen will return to focus, and the name of the query that you selected will appear in the **Query** field. The **Available Fields** list will display the fields in the query.

Note: If you try to create a Reliability Automation Rule based on a query in which at least one field does not have an alias, an error message will appear, and the rule will not be created. Automation rules can be based only on queries that have an alias on every field that will be used in the rule. Otherwise, the fields cannot be properly mapped, and the rule cannot be created.

8. Click the **Next** button.

The **Identify the Fields that are Necessary for the Analysis** screen appears.

Reliability Automation Rule Builder - Identify the Fields that are Necessary for the Analysis

Identify the Fields that are Necessary for the Analysis

Asset ID [Dropdown]

Asset Installation Date [Dropdown]

Failure Date [Dropdown]

Downtime [Dropdown]

< Back Next > Finish Cancel Help

9. On the **Identify the fields that are necessary for the analysis** screen, select a value for each field. Required fields are labeled with bold text.
 - **Asset ID:** The field from your query that contains the Asset ID.
 - **Asset Installation Date:** The field from your query that contains the date when the piece of equipment was first installed.
 - **Failure Date:** The field from your query that contains the date when the piece of equipment or location failed.
 - **Downtime:** The field that contains the downtime. The downtime is the amount of time that an item is not available for any reason.
 - **Maintenance Cost:** The cost of fixing the equipment after a failure occurs. The Maintenance Cost represents both the labor and the material costs. This appears only if you selected **Reliability Cost of Unreliability Analysis** as the document type.
 - **Lost Profit Opportunity (LPO) Cost:** The field that contains the LPO Cost. The LPO cost is the profit that the company loses when the production fails in an oversold market. It represents the difference between the market price of the product and the cost of producing it. This appears only if you selected **Reliability Cost of Unreliability Analysis** as the document type.

10. Click the **Next** button.

The **Select Population Grouping** screen appears.

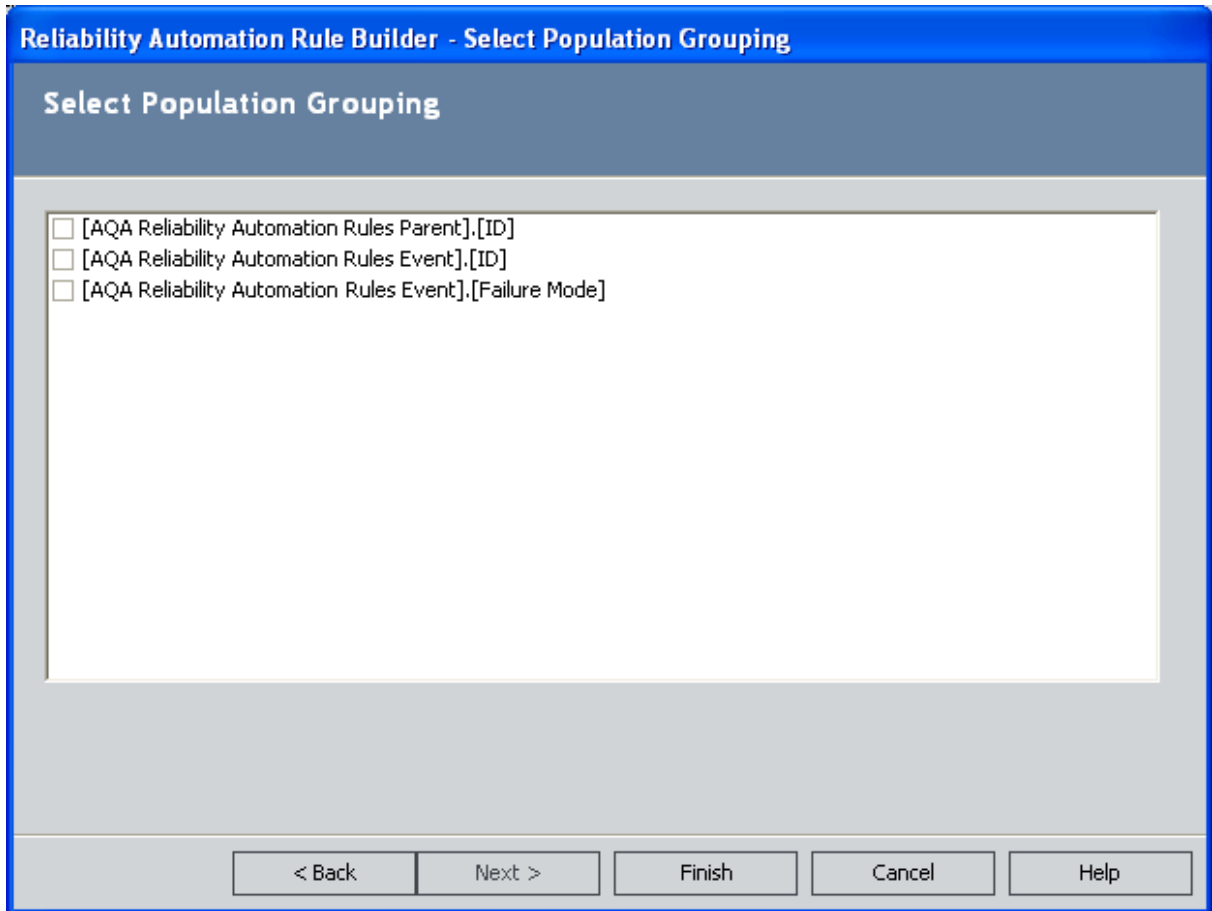

11. Select the check box(es) next to the fields that will allow you to create populations of events for analyses. Note that you are not required to select any population grouping(s). If you select a population grouping, the data will be filtered by that population into different groups. For example, if you select the Asset ID field to be a population field, a potential analysis will be generated on the **Automation Rule Information** page for every piece of equipment and location. The fields listed on the **Select Population Grouping** screen consist of fields from the equipment/location family, relationship family, and event family selected in the query.

12. Click the **Finish** button.

The [Summary Screen of \[Automation Rule\]page](#) appears, displaying a list of failure mode definitions (i.e., the analyses) that will be generated when the rule is saved and executed.

13. To save the rule, on the **Common Tasks** menu, click the **Save Rule** link.

Creating a Rule Based on Equipment/Location-Event Data Structure

To create a rule based on equipment/location-event data:

1. In the Meridium APM Framework application, on the [Automation Rule List Screen page](#) or the [Summary Screen of \[Automation Rule\] page](#), click the **New Rule** link on the **Common Tasks** menu.

The **Reliability Automation Rule Builder** appears, displaying the Welcome screen.

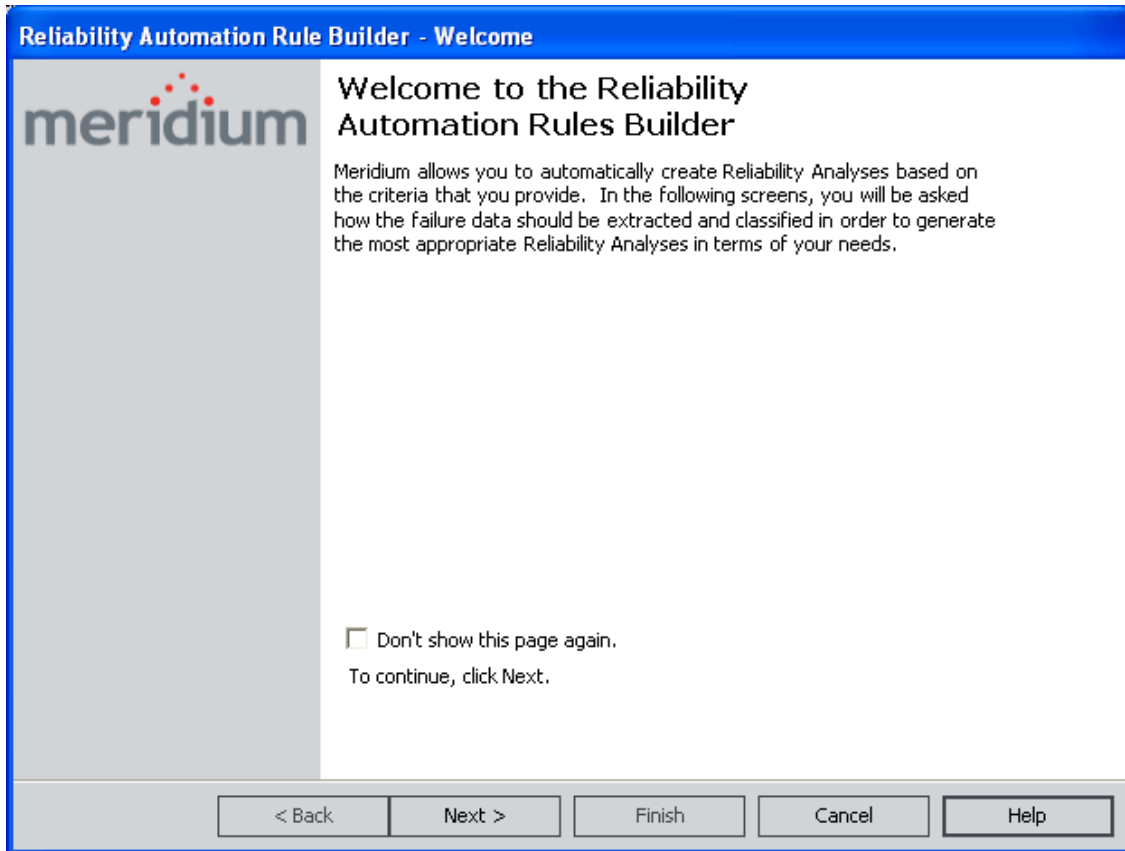

OE Hint: You can select the **Don't show this page again** check box if you prefer to bypass the Welcome screen in the future.

2. Click the **Next** button.

The **Choose Reliability Document Type** screen appears.

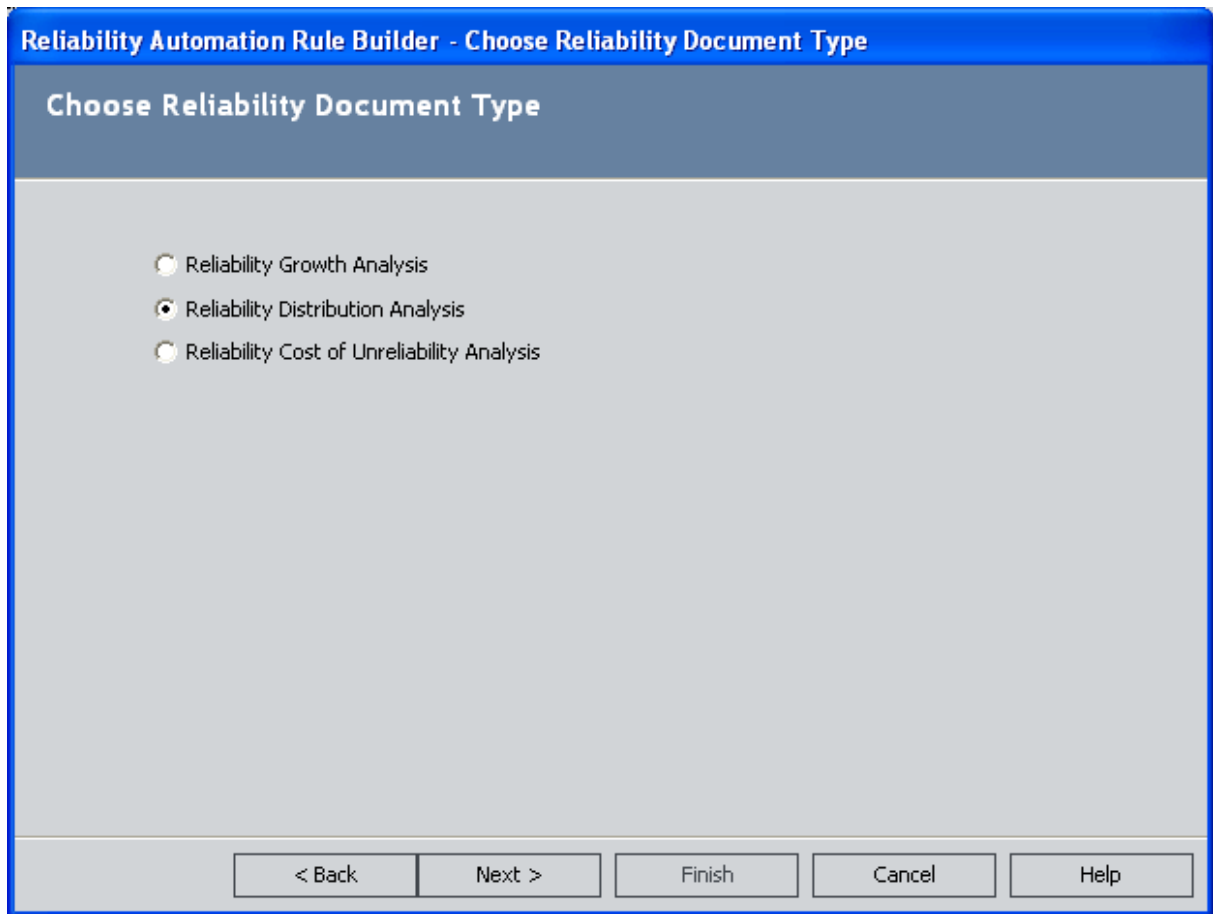

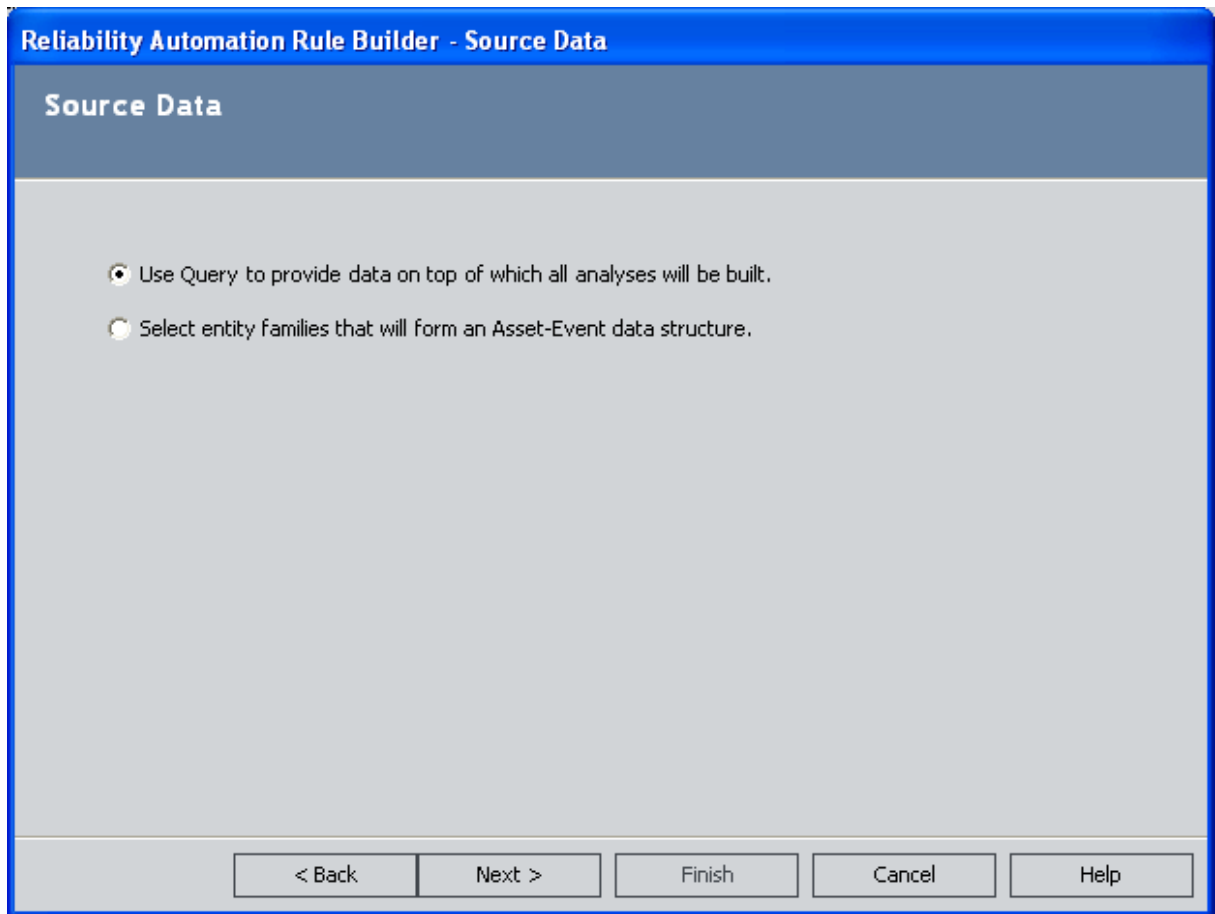

3. Select the option for the type of rule you want to create:
 - Reliability Growth Analysis
 - Reliability Distribution Analysis
 - Reliability Cost of Unreliability Analysis
 - The Reliability Distribution Analysis option is selected by default.
 3. Click the **Next** button.
- The **Source Data** screen appears.

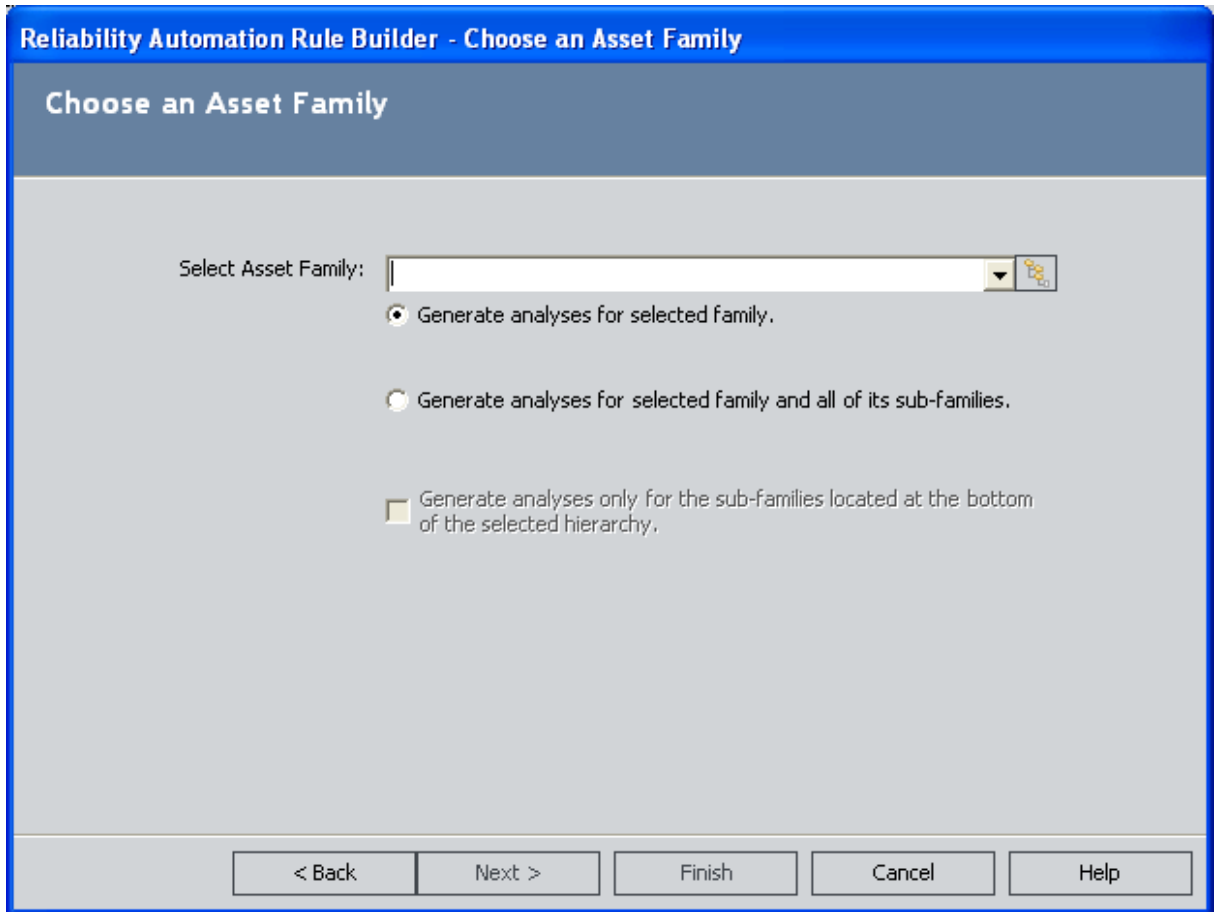

5. Select the **Select entity families that will form an Asset-Event data structure** option.
6. Click the **Next** button.

The **Choose an Asset Family** screen appears.



7. In the **Select Asset Family** list, select the desired family. Alternatively, you can click the  button to select a family from the hierarchy or simply type a family name in the text box.
8. Determine the level at which to perform the analysis:
 - To generate an analysis only for the selected family, accept the default selection, **Generate analyses for selected family**.
 - To include all of the subfamilies of the selected family in the analysis, select the **Generate analyses for selected family and all of its sub-families** option. Note that if you choose to include subfamilies, the check box below this option will become enabled. Select the check box if you want to generate analyses *only* for the sub-families that are located at the bottom of the hierarchy for the selected family.

Note: If you choose this option and then choose to add filters or grouping to the Reliability Automation Rule later in the builder, Meridium APM may incorrectly group or filter data, resulting in analyses based on data that did not match the desired criteria. If this happens, you may need to create automation rules individually for families at the bottom of a family hierarchy.

9. Click the **Next** button.

The **Choose Relationship and Event Families** screen appears.

Reliability Automation Rule Builder - Choose Relationship and Event Families

Choose Relationship and Event Families

Select Relationship Family: [Dropdown]

Select Event Family: [Dropdown]

Include assets even if they do not include event data

< Back Next > Finish Cancel Help

10. In the **Select Relationship Family** list, select the relationship family that identifies the relationship that should exist between the family that you selected on the previous screen and the Event family that you will select on this screen.
11. In the **Select Event Family** list, select the desired family. You can choose to include equipment and location in the analysis that do not include event data by selecting the **Include assets even if they do not include event data** check box. Note that the **Select Event Family** list is disabled until you select a relationship family in the **Select Relationship Family** list.
12. Click the **Next** button.

The **Identify the Fields that are Necessary for the Analysis** screen appears.

Reliability Automation Rule Builder - Identify the Fields that are Necessary for the Analysis

Identify the Fields that are Necessary for the Analysis

Asset ID [Dropdown]

Asset Installation Date [Dropdown]

Failure Date [Dropdown]

Downtime [Dropdown]

< Back Next > Finish Cancel Help

13. On the **Identify the fields that are necessary for the analysis** screen, select a value for each field. Required fields are labeled with bold text.
 - **Asset ID:** The field from your query that contains the Asset ID.
 - **Asset Installation Date:** The field from your query that contains the date when the piece of equipment was first installed.
 - **Failure Date:** The field from your query that contains the date when the piece of equipment or location failed.
 - **Downtime:** The field that contains the downtime. The downtime is the amount of time that an item is not available for any reason.
 - **Maintenance Cost:** The cost of fixing the equipment after a failure occurs. The Maintenance Cost represents both the labor and the material costs. This appears only if you selected **Reliability Cost of Unreliability Analysis** as the document type.
 - **Lost Profit Opportunity (LPO) Cost:** The field that contains the LPO Cost. The LPO cost is the profit that the company loses when the production fails in an oversold market. It represents the difference between the market price of the product and the cost of producing it. This appears only if you selected **Reliability Cost of Unreliability Analysis** as the document type.

Note: You can click the **Finish** button on the **Identify the Fields that are Necessary for the Analysis** screen if you prefer not to define filters.

- Click the **Next** button.

The **Apply any Desired Filters** screen appears.

The screenshot shows a software window titled "Reliability Automation Rule Builder - Apply any Desired Filters". The window contains a form with the following elements:

- Define Filters:** A section with three input fields labeled "Field", "Condition", and "Value". The "Field" field has a dropdown arrow. Below these fields is a checkbox labeled "Match Case?". To the right of this section is an "Add Filter" button.
- Filter Conditions:** A large, empty rectangular text area. To its right is a "Remove Filter" button.
- Match:** A section with two radio buttons: "All conditions" (which is selected) and "Any condition".
- Navigation:** At the bottom of the window are five buttons: "< Back", "Next >", "Finish", "Cancel", and "Help".

- In the **Field** list, click the  button to select a field.
- In the **Condition** list, select one of the field condition operators. The field conditions that you can select are the same as those that are available in the Advanced search. The list of operators will change depending on the type of field that you select (i.e., numeric, character, date, or logical).
- Type the value that should meet the condition in the **Value** text box. When typing dates or a number in this field, insert single quotes around the value.
- Click the **Add Filter** button. The filter criteria will appear in the pane.
- To apply multiple filters, repeat the previous steps. Remember to click the **Add Filter** button each time you specify new filter criteria.

20. In the **Match** section, select either the **All conditions (And operator)** option or the **Any condition (Or operator)** option to apply to the filter results.
21. Click the **Next** button.

The **Select Population Grouping** screen appears.

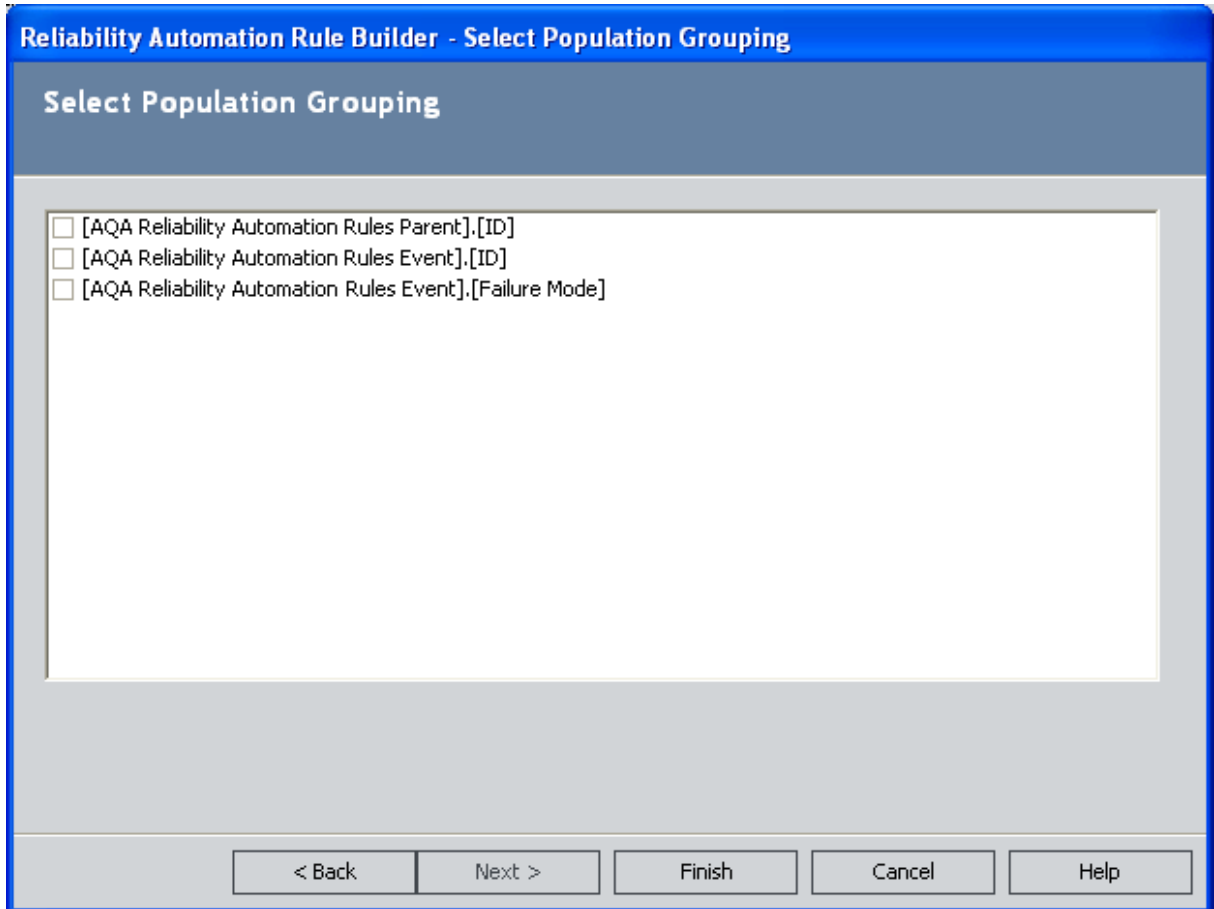

Reliability Automation Rule Builder - Select Population Grouping

Select Population Grouping

[AQA Reliability Automation Rules Parent].[ID]
 [AQA Reliability Automation Rules Event].[ID]
 [AQA Reliability Automation Rules Event].[Failure Mode]

< Back Next > Finish Cancel Help

22. Select the check box(es) next to the fields that will allow you to create populations of events for analyses. You are not required to select any population grouping(s). If you select a population grouping, the data will be filtered by that population into different groups. For example, if you select the Asset ID field to be a population field, a potential analysis will be generated on the **Automation Rule Information** page for every piece of equipment and location. The fields listed on the **Select Population Grouping** screen consist of fields from the equipment/location family, relationship family, and event family that you selected.
23. Click the **Finish** button.

The [Summary Screen of \[Automation Rule\] page](#) appears, displaying a list of failure mode definitions (i.e., the analyses) that will be generated when the rule is saved and executed.

24. To save the rule, on the **Common Tasks** menu, click the **Save Rule** link.

Accessing an Existing Reliability Automation Rule

To open an existing Reliability Automation Rule:

1. In the Meridium APM Framework application, on the [Automation Rule List Screen page](#), in the **Last Updated By** list, select the criteria that you want to use for limiting the list of automation rules. The available criteria will vary, depending on how the automation rules list query has been configured.
2. Click the **Run Query** button.

The Meridium APM system runs the Reliability Automation Rules list query and displays the results in the grid at the bottom of the page.

3. In the **Rule Name** column, click the hyperlinked name of the rule that you want to open.

The [Summary Screen of \[Automation Rule\] page](#) appears.

The screenshot shows the 'Summary Screen of [Automation Rule] page' in the Meridium APM Framework application. The window title is 'Meridium APM Framework - Summary Screen of '3.0.2 SP1 Automation Rule' Automation Rule'. The interface includes a menu bar (File, Edit, Go To, Tools, Help), a toolbar with navigation and action buttons, and a sidebar with 'Rule Tasks' and 'Common Tasks'. The main content area displays the 'Reliability Automation Rules' summary for the rule '3.0.2 SP1 Automation Rule'. It includes a description, criteria, and a table of potential analyses.

Reliability Automation Rules

Rule Name: **3.0.2 SP1 Automation Rule**

Rule Description:

Automation Rule Criteria

[Update Rule Information...](#)

This Automation Rule will be used to create Distribution analyses. The Rule will analyze the 'Fan' family only using the 'Work Order' family for events based upon the 'Asset Has Maintenance' relationship. There are groupings being applied in this rule.

Automation Rule Information

This Automation Rule has never been executed. Below is a list of potential analyses based upon the filters and grouping specified. 5 analyses will be created the next time this rule is executed. 0 analyses have less than 2 failure events and will not be created. You can select one and view its details or you can select multiple analyses and merge them.

Analysis Name	Number of Assets	Number of Failure Events
Fan Bearing Failure	10	80
Fan Misalignment	10	10
Fan Motor Failure	10	10
Fan PM - No Failure	10	52
Fan Unbalance	10	20

5 records found

Aspects of the Reliability Automation Rule Summary Screen

The Summary Screen of [Automation Rule]page displays information about the selected Reliability Automation Rule. You can access the summary screen from the [Automation Rules List Screen page](#). This screen also appears when you [create a new Reliability Automation Rule](#).

The screenshot shows the Meridium APM Framework interface for the '3.4.0 Automation Rule'. The main content area includes the following sections:

- Reliability Automation Rules**: Rule Name: 3.4.0 Automation Rule; Rule Description: Description for 3.4.0 Automation Rule.
- Automation Rule Criteria**: This Automation Rule will be used to create Distribution analyses. The Rule will analyze the 'Fan' leaf-level families only using the 'Work Order' family for events based upon the 'Asset Has Maintenance' relationship. There are groupings being applied in this rule.
- Automation Rule Information**: This Automation Rule has never been executed. Below is a list of potential analyses based upon the filters and grouping specified. 30 analyses will be created the next time this rule is executed. 20 analyses have less than 2 failure events and will not be created. You can select one and view its details or you can select multiple analyses and merge them.

Analysis Name	Number of Assets	Number of Failure Events
Fan FDF 101 Bearing Failure	1	8
Fan FDF 101 Misalignment	1	1
Fan FDF 101 Motor Failure	1	1
Fan FDF 101 PM - No Failure	1	6
Fan FDF 101 Unbalance	1	2
Fan FDF 102 Bearing Failure	1	8
Fan FDF 102 Misalignment	1	1
Fan FDF 102 Motor Failure	1	1
Fan FDF 102 PM - No Failure	1	5
Fan FDF 102 Unbalance	1	2
Fan FDF 103 Bearing Failure	1	8

50 records found

The Summary Screen of [Automation Rule]page contains the following items, which provide details about the Reliability Automation Rule:

- **Rule Name:** The name of the rule that you selected.
- **Rule Description:** A short description of the rule that you selected.
- **Automation Rule Criteria** section: Displays a description of the criteria that identify the rule, including the type of analysis that will be generated from the rule. In addition, this section contains the name of the family to which the analyzed events belong, along with the relationship between the family and events. If filters or groupings have been applied to the rule, they will be noted in this section. You can click the **Update Rule Information** link to display the **Reliability Automation Rule Builder**, which will be populated with the information you entered when you created the rule. You can modify the rule by making different selections in the

builder.

- **Automation Rule Information** section: Lists the potential analyses that are based upon the filters and groupings specified. A Reliability Analysis will be created for each potential analysis that contains at least the [minimum number of failure events](#) required for the analysis the next time you execute the rule. You can click any name in the list to [view a preview](#) of the data that will be included in the analysis.
 - For Reliability Automation Rules based on an Equipment/Location-Event data structure, the name of the analysis is populated automatically by the Meridium APM system based on the name of the equipment/location family that you selected on the **Choose an Asset Family** builder screen.
 - If you made no selections on the **Select Population Grouping** screen, the Meridium APM system will use only the equipment/location family name as the name of the analysis.
 - If you make Group By selections on the **Select Population Grouping** screen, the Meridium APM system will append the name of each member of the selected population group(s) on this screen to the name of the analysis.
 - For Reliability Automation Rules based on a query, the name of the analysis is populated automatically using values that correspond to the fields you selected on the **Select Population Grouping** screen. If you did not select any groupings, the new analysis will be named *New Analysis*.

For example, suppose that *Equipment* is the name of the selected equipment/location family. If you selected the Manufacturer field for population grouping, the name of each manufacturer is listed next to the Equipment family name.

In addition, the **Summary Screen of [Automation Rule]** page also contains two task menus: [Rule Tasks](#) and [Common Tasks](#).

Rule Tasks Menu

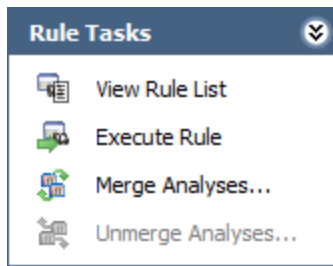

The **Rule Tasks** menu on the **Summary Screen** of **[Automation Rule]** page contains the following links:

- **View Rule List:** Displays the [Automation Rule List Screen page](#).
- **Execute Rule:** Executes the rule that is currently displayed.
- **Merge Analyses:** [Merges](#) the selected analyses. This link is enabled only when more than one analysis is selected in the **Automation Rule Information** list.
- **Unmerge Analyses:** Displays the **Unmerge Analyses** dialog box, where you can select the merged analyses that you want to [unmerge](#). This link is enabled only when one or more merged analyses exist.

Note: You can merge only analyses that share similar characteristics.

Common Tasks Menu

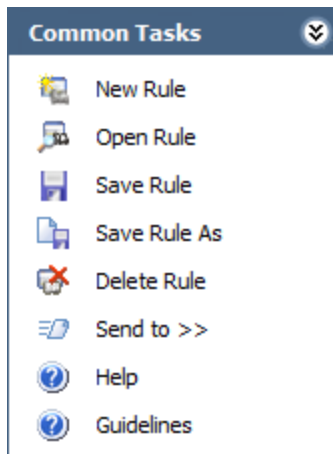

The **Common Tasks** menu on the **Summary Screen of [Automation Rule]** page contains the following links:

- **New Rule:** Displays the **Reliability Automation Rule Builder**, which lets you [create a new Reliability Automation Rule](#).
- **Open Rule:** Displays the **Find a Reliability Automation Rule** window, which you can use to find and open an existing rule.
- **Save Rule:** Saves the currently displayed Reliability Automation Rule.
- **Save Rule As:** Saves the currently saved analysis with a different name.
- **Delete Rule:** Deletes the current rule(s), after asking for confirmation.
- **Send To:** Displays a submenu with options that let you provide a link to the current page on your desktop (create shortcut), in an email message, or on a Home Page.
- **Help:** Displays the context-sensitive Help topic for the **Summary Screen of [Automation Rule]** page.
- **Guidelines:** Displays the Reliability Concepts, which provide reliability workflows and descriptions of reliability concepts.

Displaying a Preview of the Analysis Failure Data

Based on the selections that you choose in the [Reliability Automation Rule Builder](#), a query is generated for analysis. From the [Summary Screen of \[Automation Rule\] page](#), you can access the query containing the failure data for the analysis that will be generated when the Reliability Automation Rule is executed.

To display a preview of the analysis failure data:

- In the Meridium APM Framework application, in the **Automation Rule Information** section, click the name of the desired analysis in the **Analysis Name** column.

The **Analysis Failure Data Details** dialog box appears.

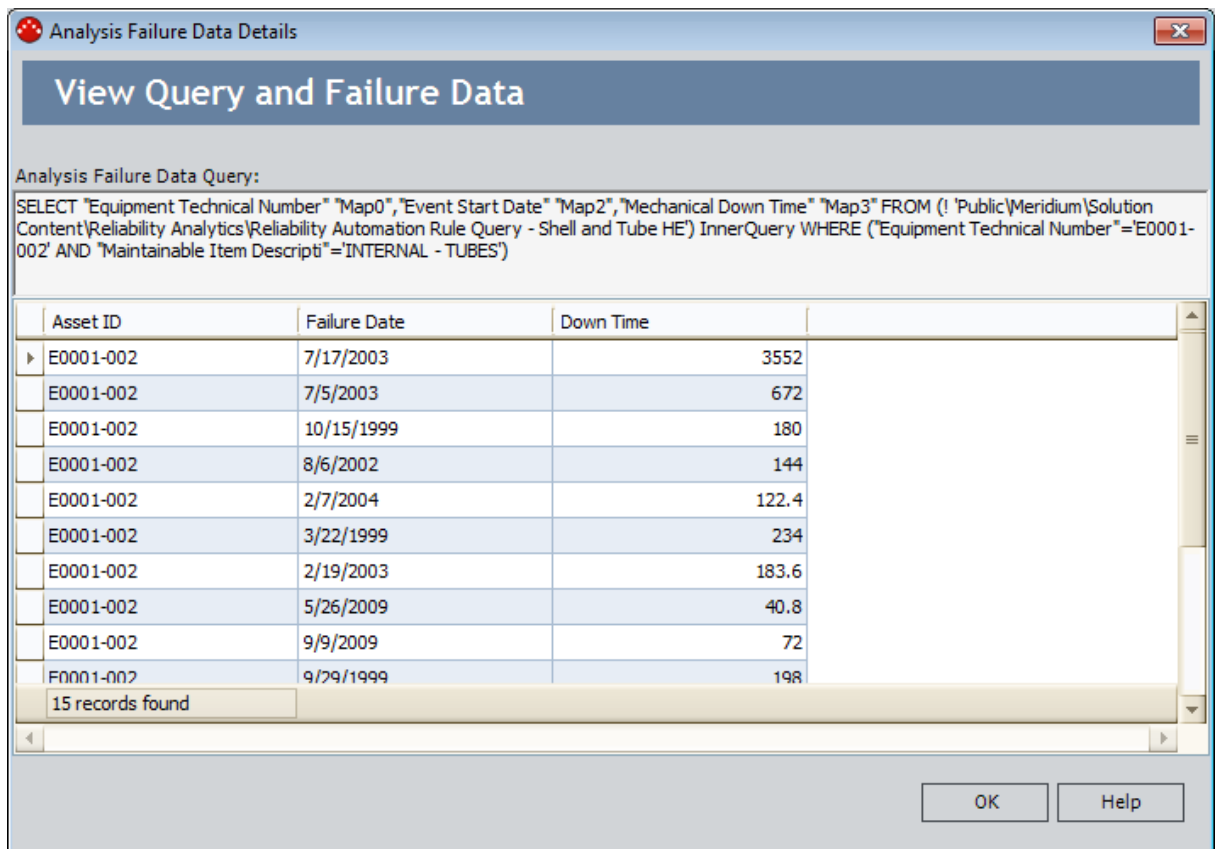

The **Analysis Failure Data Details** dialog box displays the query that is being used to retrieve the failure data for the selected analysis, and a grid displays the result set of the query based on the mapping fields you selected in the **Reliability Automation Rule Builder**.

Note: You cannot edit the fields listed in the query results.

Merging Analyses

If two or more analyses share similar characteristics, you may find it useful to merge them and produce one analysis instead of separate analyses. Also, if an analysis does not have the minimum number of failure events required in order to create an analysis, you can merge it with another analysis.

Note: You can merge analyses only if they contain the same equipment and population groupings.

To merge two analyses:

1. In the Meridium APM Framework application, on the [Summary Screen of \[Automation Rule\] page](#), in the **Automation Rule Information** section, select the rows containing the analyses that you want to merge.

When you select more than one analysis, the **Merge Analyses** link becomes enabled on the **Rule Tasks** menu.

2. Click the **Merge Analyses** link.

The **Merge Analysis Grouping Fields** dialog box appears.

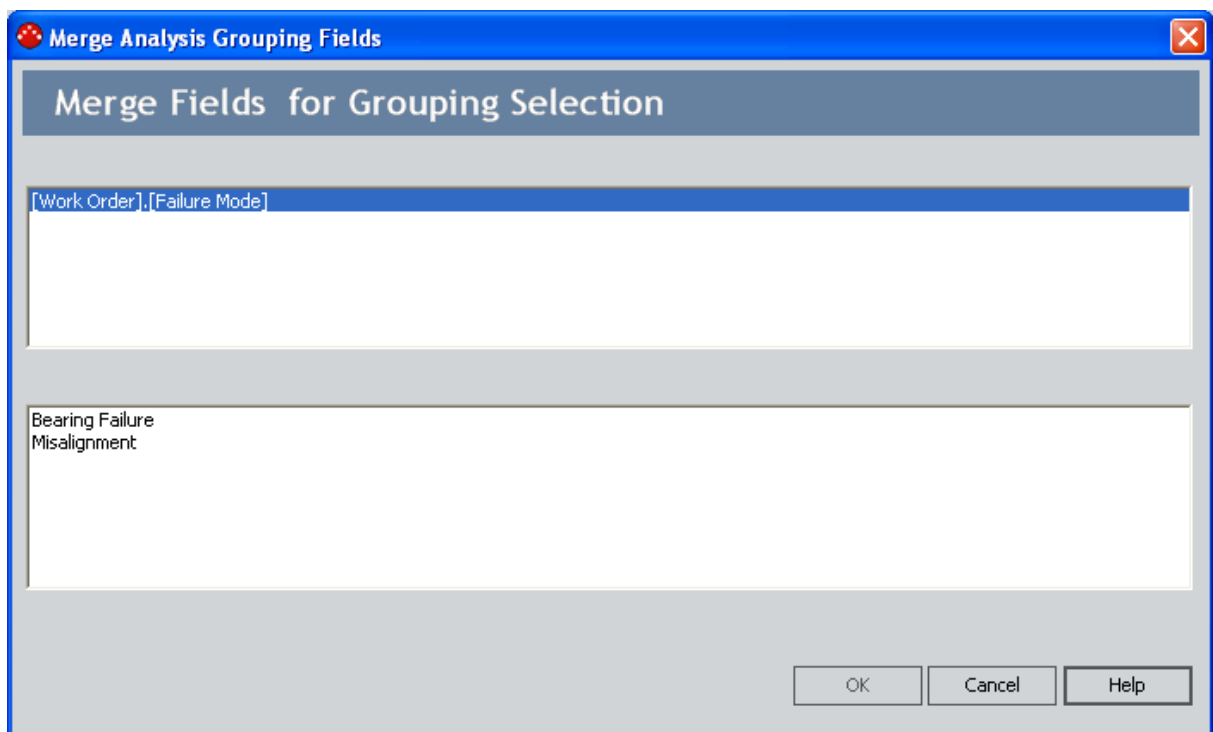

The groupings for the selected analyses are listed in the list at the top of the dialog box.

3. Click a grouping in the first list to select it.

The lower list is populated with the fields belonging to that grouping.

Merging Analyses

4. Click a field in the second list to select it as the reference field. The field(s) that you do not select are the alternate field(s).
5. Click **OK**.

The reference field now contains the values for the alternate field, and one analysis will be generated based on the reference field when the rule is executed. The system updates the list of analyses in the **Automation Rule Information** section.

Undoing a Merge

To undo the merge of two or more analyses to create separate analyses:

1. In the Meridium APM Framework application, on the [Summary Screen of \[Automation Rule\] page](#), in the **Automation Rule Information** section, select the desired analysis.
2. On the **Rule Tasks** menu, click the **Unmerge Analyses** link. Note that this link is enabled only if the selected analysis has been merged.

The **Unmerge Analyses** dialog box displays a list of existing merge conditions.

3. Select the desired merge condition(s), and click **OK**.

A prompt appears, asking if you really want to delete the selected merge condition (s).

4. Click the **Yes** button.

The merge conditions are deleted, and the system updates the list of analyses in the grid in the **Automation Rule Information** section. The separate analyses appear in the list.

Executing Reliability Automation Rules

You can execute Reliability Automation Rules either from the [Summary Screen of \[Automation Rule\] page](#) (to execute the currently displayed rule) or from the [Automation Rules List Screenpage](#) (to execute one or more selected rules). Either procedure produces the same results.

When a rule is executed, only the potential analyses that contain the minimum number of failure points for an analysis will be created or updated. The following number of failure points is required for each analysis that can be created from a Reliability Automation Rule.

- Reliability Growth Analysis: 3 failure points
- Reliability Distribution Analysis: 2 failure points
- Cost of Unreliability Analysis: 1 failure point

If the potential analysis does not contain the corresponding number of failures or more, when the rule is executed, the analysis will not be created.

Note: Before you use a rule to create an analysis, you should review the data required for the type of analysis you are creating. If you use invalid data, the analysis will still be created, but the results will not be valid.

To execute a Reliability Automation Rule:

- On the [Summary Screen of \[Automation Rule\] page](#), on the **Rule Tasks** menu, click the **Execute Rule** link.

-or-

On the [Automation Rules List Screen page](#), in the list of rules, select one or more rules that you want to execute. Then, on the **Rule Tasks List** menu, click the **Execute Rule(s)** link.

The system executes the rule(s) and generates the resulting analysis.

Deleting Reliability Automation Rules

To delete one or more Reliability Automation Rules:

1. On the [Summary Screen of \[Automation Rule\] page](#), on the **Common Tasks** menu, click the **Delete Rule** link.

-or-

On the [Automation Rules List Screen page](#), in the list of rules, select one or more rules that you want to delete. Then, on the **Common Tasks** menu, click the **Delete Rule** link.

A confirmation message appears, asking if you really want to delete the rule.

2. Click the **Yes** button.

The rule is deleted from the database.

Parameters for the Reliability Automation Rules URL

The URL for accessing Reliability Automation rules, **meridium://Reliability/Automation**, accepts the parameters described in the following table. Note that to create a functional URL, you must define at least the Page parameter.

Note: Some parameter values for the Reliability Automation Rules URL are case sensitive. When constructing URLs for Reliability Automation Rules, use the exact case that appears in the following table.

Parameter Name	Description	Accepted Value(s)	Notes
EntyKey	Specifies which automation rule you want to view.	The Entity Key of the desired automation rule.	You can use this parameter in conjunction with the Summary, ParetoPlot, or PlotData parameter.
Page	Specifies whether to display the list of existing rules or a specific rule.	List Summary	<ul style="list-style-type: none"> • List: Displays the Automation Rule List Screen page. • Summary: Displays the Summary Screen for [Automation Rule] page for the automation rule specified by the EntyKey parameter.

Examples of Reliability Automation Rules URLs

- <meridium://Reliability/Automation?Page=List>
Displays the **Automation Rule List Screen** page.
- <meridium://Reliability/Automation?Page=Summary&EntyKey=1234567>
Displays the **Summary Screen for [Automation Rule]** page for the automation rule with the Entity Key 1234567.

About Navigating the Reliability Analytics Module

Within the Meridium APM Framework application, the Reliability Analytics module provides the following navigational tools:

- A [start page](#) with links that provide access to the Reliability analyses and their various features and tools.
- [A Site Map that you can use to navigate within the Reliability Analytics module](#). The Site Map indicates your current location and shows the typical path for arriving there. To access a previous page, you can click its hyperlinked name in the Site Map.

Using the Reliability Analytics Site Map

The Site Map in Reliability Analytics allows you to navigate from the current page to other pages in Reliability Analytics. The **Reliability** link, which provides access to the **Reliability Analytics Start Page**, will always be available. Links to other pages may also be available depending upon your location in the application. You can click any link that is available to access the corresponding page.

The following image shows an example of what the Site Map looks like on the **Production Analytics** page. A red outline has been added to the image to highlight the Site Map.

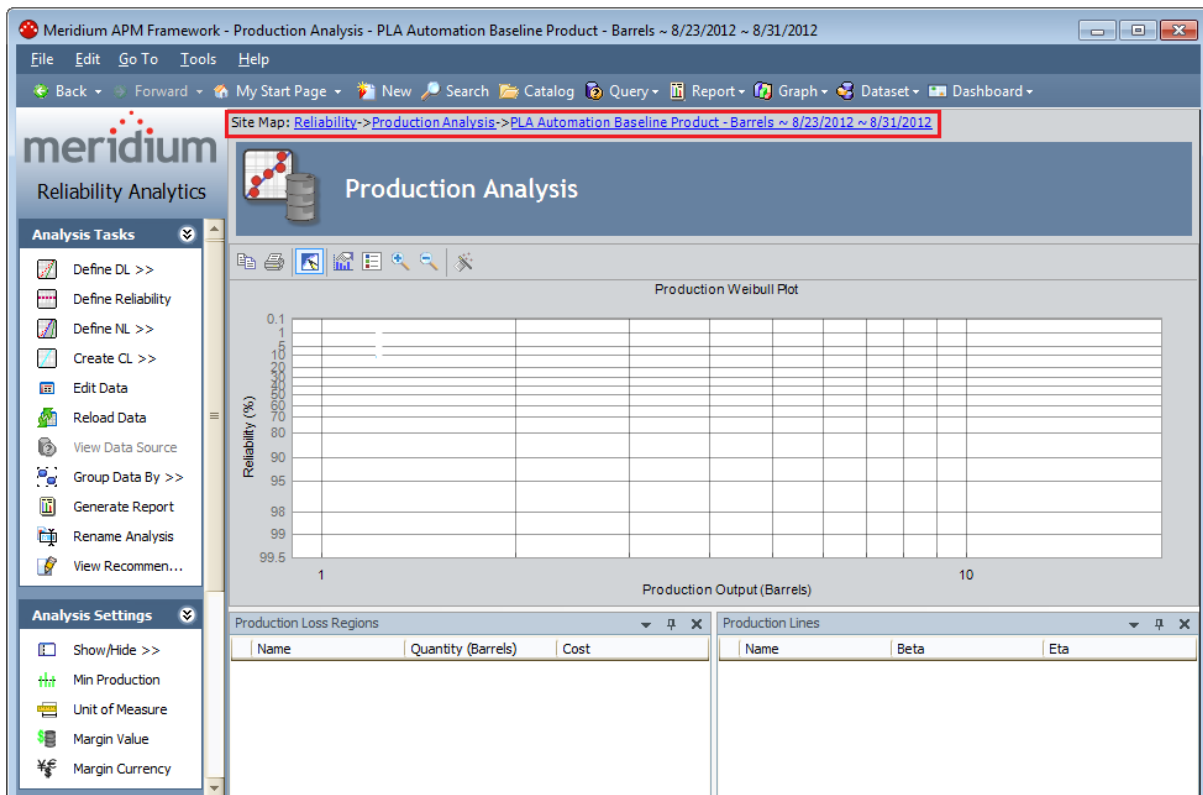

What is a Production Analysis?

Meridium APM Reliability Analytics offers various tools that help you analyze the reliability of your equipment and locations so that you can make decisions about when to repair and replace those pieces of equipment and locations. For example, a Reliability Distribution Analysis lets you analyze historical failure data to help predict future failures. Based upon those predictions, you can make plans for replacing equipment and making repairs to prevent future failures. Predicting failures and replacing equipment will ensure profitability, however, only if equipment failures are primarily responsible for your lost profit opportunities.

Often, a large amount of profit is lost due to production problems, rather than equipment or location problems. Therefore, analyzing losses due to operational problems is necessary for conducting a comprehensive analysis of production losses. To quantify losses due to operational problems, in addition to analyzing individual equipment and locations, you must also analyze the process in which they are involved. To do this, you can use a *Production Analysis*.

Production Analyses allow you to evaluate the reliability of the process in which individual pieces of equipment and locations are involved. Instead of analyzing the failure data, Meridium APM Production Analyses analyze production output data to help you see patterns in the output and determine the reliability of the process as a whole. Production Analyses provide a visual representation of production output and allow you to quantify production losses and the cost associated with them. With regular use of Production Analyses, your company can determine where you are losing the most money and then take corrective actions that will help yield higher production and earn larger profits.

Within a Production Analysis, you can plot production output data and then:

- Define the *observed* production rate with a [Demonstrated Line](#).
- Determine the reliability of the production process by defining a [Process Reliability Line](#).
- Define the *ideal* production output capacity with a [Nameplate Line](#).
- Compare the expected output to the ideal output to [calculate the efficiency and utilization costs](#).
- Draw one or more [Custom Lines](#) to exhibit losses and gains compared to other observed production output or based upon theoretical scenarios.

Data Used in a Production Analysis

To create a Production Analysis, you must collect production output information, which consists of numeric values representing the output of a process over some period of time. How you collect the output data and how often you collect it is up to you and may be determined based upon a variety of factors, including the type of process, how often the process produces measurable output, and how often you want to record it. While the amount of time between output readings is up to you, note that to create a meaningful analysis, the output data must be collected at *regular* intervals (e.g., hourly, daily, weekly, or monthly) so that the output values can be compared to one another.

When you create a Production Analysis from within the Production Analysis module, you can supply data to the analysis using a [Meridium APM query or dataset](#), or [you can enter data manually using a grid](#) provided for that purpose. To use a query as the basis for your analysis, the production output data must be stored in the Meridium APM database so that it can be queried. For example, you might store production data in custom Production Output records that you create and associate with the systems for which you record regular output readings.

You can also create a Production Analysis from within the Production Loss Accounting (PLA) module. PLA allows you to create production plans and then record daily production output against the plan. If desired, you can use these production output values as the starting point for a Production Analysis.

Note: If you are using PLA to collect production data, Meridium provides the *Production Data* family to store the output readings.

Keep in mind that production output data is collected for a [process](#), not for individual pieces of equipment. A single process may involve one or more pieces of equipment. Throughout this documentation and in the Meridium APM Production Analysis tool, we refer to this collection of equipment as the production *unit*. The term *unit* is simply a way for us to refer to the process and all the pieces of equipment involved in it. It does not imply a Meridium APM family or a specific record in the database.

Note: If you are using PLA to collect production data, Meridium provides the *Production Unit* family for use within the PLA workflow.

If you are using a query or dataset to store production output data, the following table lists the fields whose values you can provide to the analysis (through the [Production Analysis Builder](#)). The source data *must* include *at least* production output values.

Data	Description	Notes
Production Output	Values representing the amount of output produced by the unit during the specified period of time (e.g., hourly, daily, weekly, or monthly).	These values must be numeric. You can define the units of measure for the output values after you create the analysis. Production output values are required for creating a Production Analysis.
Production Date	The date on which the production output value was recorded. If you have a date field within your query or dataset and you choose not to map it to the Production Analysis Builder , you can see the dates used to build the analysis in the Edit Production Data grid .	Production Dates are optional.
Unit ID	A value that describes the production unit, which consists of the individual pieces of equipment that work together to produce the production output. You may have more than one Unit ID value within the Production Analysis and may group your datapoints by that specific value .	Units are optional.

Production Analysis Workflow

After you gather production output data and use it to create a Production Analysis, you will need to perform a number of tasks within the analysis in order to analyze the data. You are not required to perform these tasks in any particular order. In this topic, however, we provide a workflow that we recommend you use for conducting a complete Production Analysis the first time. Following this workflow will ensure that you complete all the tasks that are necessary to conduct a complete analysis and will give you an overview of the analysis process. After you have learned how to perform a full analysis using this recommended workflow, you can adjust the order of the steps, omit steps, or repeat steps to suit your specific needs.

Performing a Production Analysis consists of completing the following main steps:

1. **Collect production output data.** Before you can create a Production Analysis, you first must [collect production output data](#), which are numeric values representing the output of a process over some period of time.
2. **Use the data to create a new Production Analysis.** You can create a new Production Analysis from a Meridium APM [query or dataset](#) or from [manually entered data](#).
3. **Define the unit of measure for your output data.** Unit of measure is not taken into account when you first create the analysis, even if a unit of measure is associated with your production output values. After the analysis has been created, however, you can label the production output data with the appropriate unit by [setting the unit of measure](#) for the analysis.
4. **Adjust the cost value for your unit of measure.** To calculate the cost of your production losses, you will need to [define the cost associated with each unit of output](#).
5. **Draw the [Demonstrated Line](#),** which represents the production output when the unit is operating at its observed rate of capability.
6. **Draw the [Process Reliability Line](#),** which is the first point at which output suddenly changes and the datapoints begin to deviate significantly from the Demonstrated Line.
7. **Draw the [Nameplate Line](#),** which represents the ideal production output of the unit under ideal conditions.
8. **Draw one or more [Custom Lines](#),** which let you make a visual comparison between your demonstrated production rate and other observed or theoretical production rates.
9. **Evaluate the results** by viewing the calculations on the [Production Loss Regions pane](#).

Example of a Production Process

To make this documentation easier to follow and to help explain how Production Analyses can be used to evaluate production processes, in this topic, we provide an example of a simple production process. We will refer to this example throughout the Production Analysis documentation as necessary.

Consider the process of manufacturing bottled water, which might consist of the following steps:

1. Collect water from spring.
2. Fill bottles.
3. Attach labels.
4. Attach caps.
5. Sort bottles, discard any that fail quality inspection, and package for shipping.

All of these steps must be completed in order to produce a finished product. In our example, the production unit consists of the individual pieces of equipment that together perform the steps in the process. The production output of this unit is a bottle of water ready to be sold.

For our example, we will assume that we collect production output as the number of bottles produced per day. We will also assume that we began producing bottled water on January 1, 2000. Once a year we generate a Production Analysis to evaluate the actual production output, to calculate losses compared to the [ideal production output](#), and to [establish goals for improving production the following year](#).

Note: This example is extended in the Production Loss Accounting (PLA) documentation. The PLA documentation assumes that a separate facility has production units that create bottles, labels, and caps and distributes them to the facility that performs the process described above.

Using the Production Analysis Builder

Using the **Production Analysis Builder**, you can create a new Production Analysis:

- [Based on a new or existing query or dataset.](#)

-or-

- [From manually entered data.](#)

You can access the **Production Analysis Builder** from the [Select a Production Analysis from the List page](#) or the **Production Analysis** page.

Creating a Production Analysis from a Query or Dataset

To create a new Production Analysis based on a new or existing query or dataset:

1. On the [Reliability Analytics Start Page](#), click the **Production Analysis** link.

The [Select a Production Analysis from the List](#) page appears.

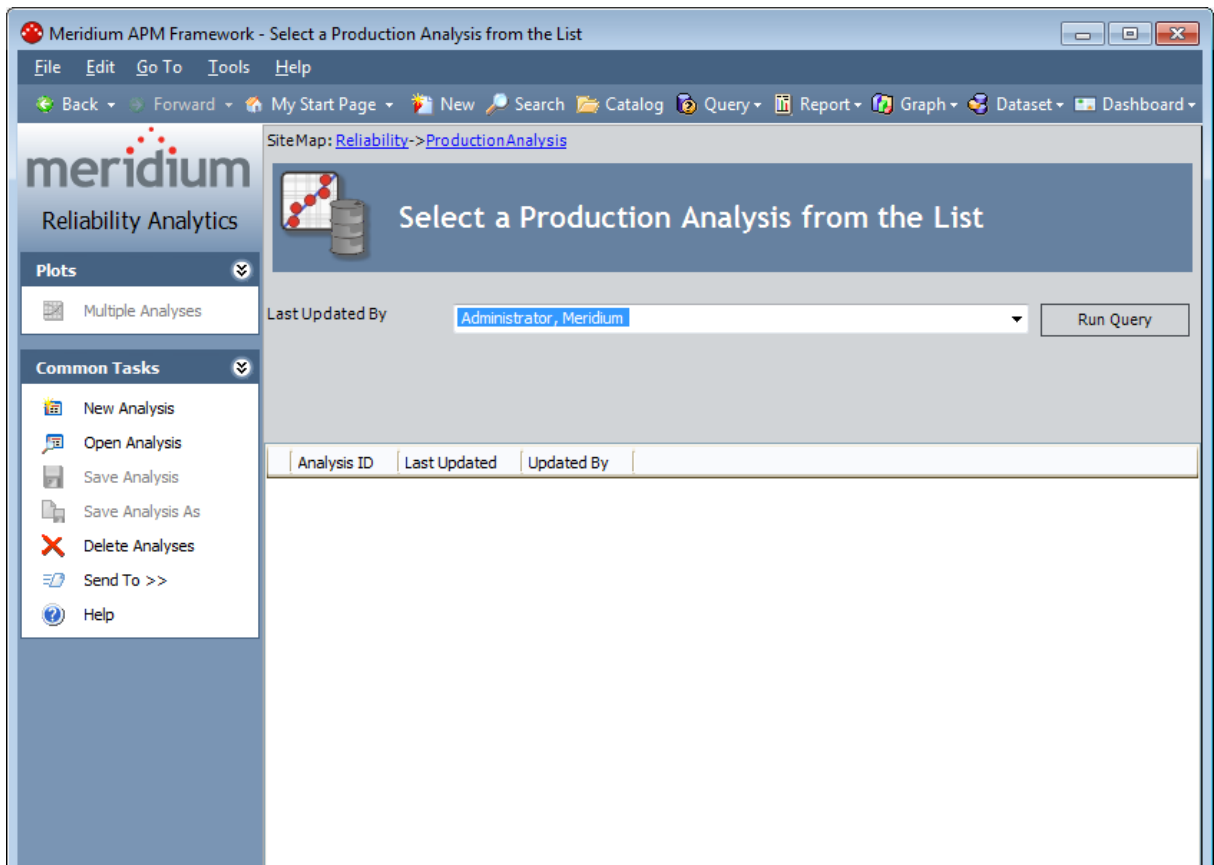

2. On the [Common Tasks menu](#), click the **New Analysis** link.

The **Production Analysis Builder** appears, displaying the Welcome screen.

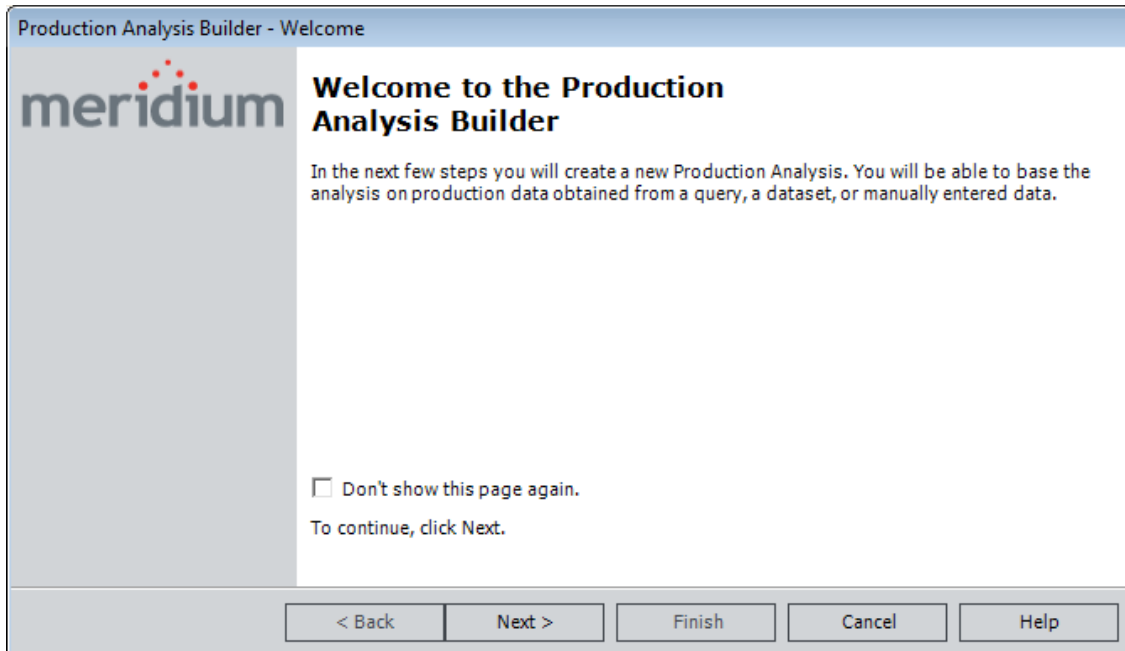

Hint: If you do not want to view this screen the next time you access the builder, select the **Don't show this page again** check box.

3. Click the **Next** button.

The **Select Data Source Type** screen appears.

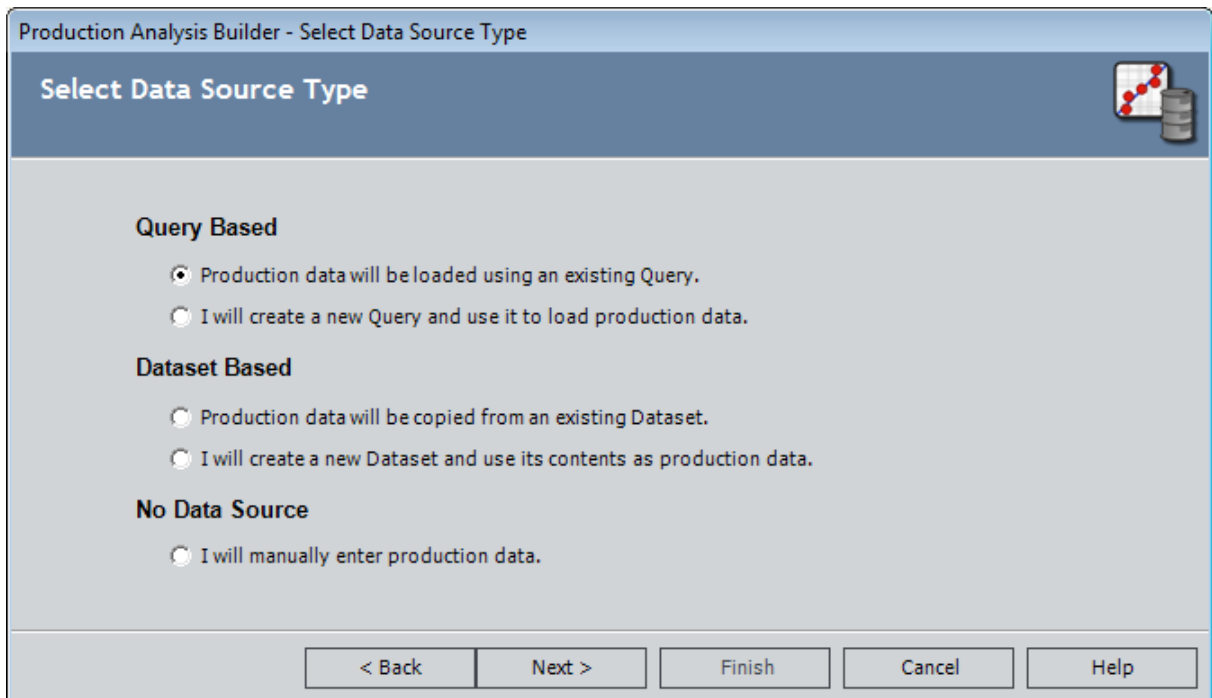

4. Select one of the following options:

- **Production data will be loaded using an existing Query.** If you select this option, when you click the **Next** button, you will be asked to find and select the desired query in the Catalog.
- **I will create a new Query and use it to load the production data.** If you select this option, when you click the **Next** button, the Query Builder will appear so that you can design a new query. Click the **Help** button in the Query Builder for details on building a new query.
- **Production data will be copied from an existing Dataset.** If you select this option, when you click the **Next** button, you will be asked to find and select the desired dataset in the Catalog.
- **I will create a new Dataset and use its contents as production data.** If you select this option, when you click the **Next** button, the Dataset Builder will appear so that you can design a new dataset. Click the **Help** button in the Dataset Builder for details on building a new dataset.

After you have selected or created the desired query or dataset and clicked the **Next** button, it appears on the **Select** screen of the **Production Analysis Builder**.

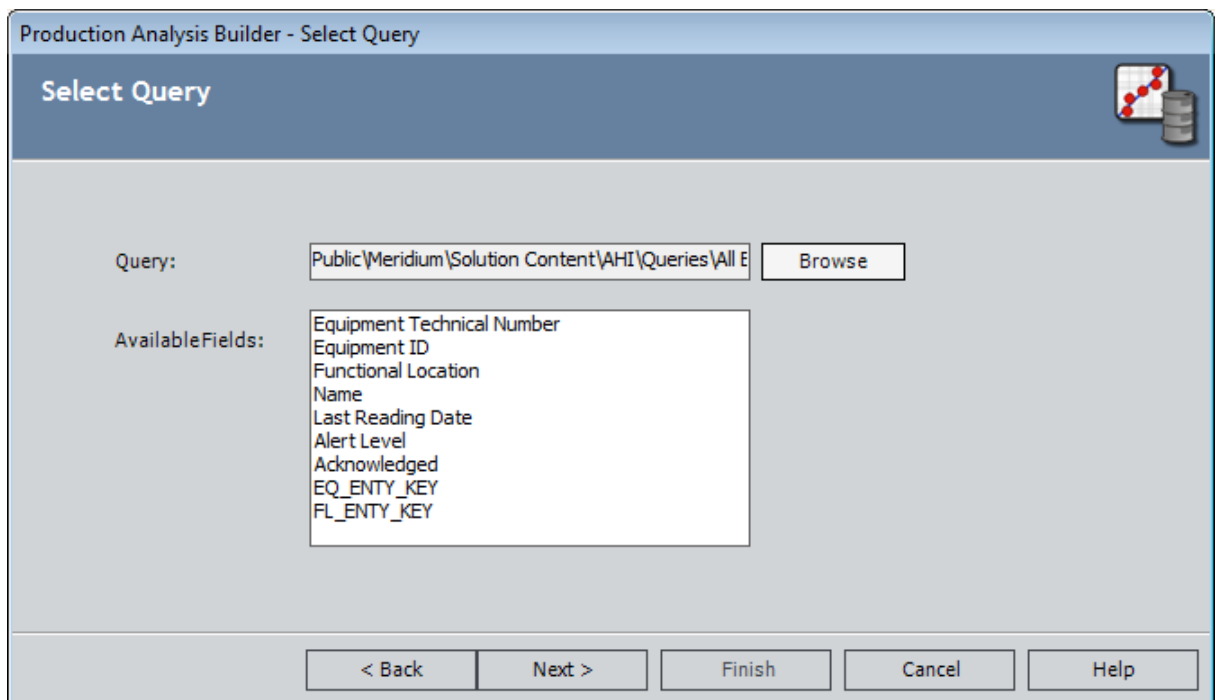

5. Click the **Next** button.

The **Select Production Fields** screen appears. The **Production Output** list and the **Production Date** list are populated automatically.

Production Analysis Builder - Select Production Fields

Select Production Fields

Production Output: EQ_ENTY_KEY

Production Date: Last Reading Date

Unit ID:

< Back Next > Finish Cancel Help

6. In the **Production Output** list, select the field that stores values representing the production amount that you want to use in your analysis. The list displays all the numeric fields that exist in your query or dataset; the first numeric field is selected by default. This field is required.
7. In the **Production Date** list, select the field that will be used as the date of production for the analysis. The list displays all date fields that exist in your query or dataset, the first date field is selected by default. This field is optional.
8. In the **Unit ID** field, select the field that stores values identifying the production unit for which the production data has been recorded. The list displays all character fields but is not populated automatically. This field is optional.
9. Click the **Finish** button.

Note: If the query returns or the dataset contains any null production values, a warning message appears, notifying you that all null production values will be converted to a value of zero within the analysis. Click **OK**.

If Meridium APM finds zeros or negative numbers for the **Production Output** value in the dataset or the query results, the **Minimum Production Output** dialog box appears.

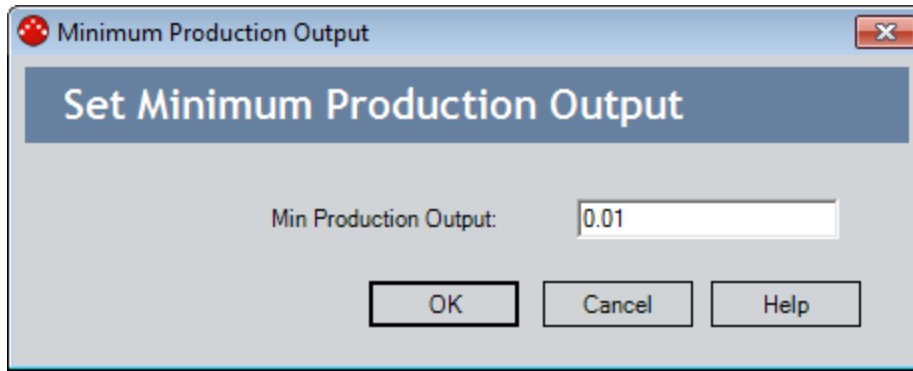

10. In the **Min Production Output** text box, type the value that you want to use to replace zero and negative production output values. The suggested value is calculated based on the highest production output value. Zero and negative values cannot be plotted and will instead be plotted using the value specified here. You can also [change the Minimum Production value](#) after the Production Analysis has been created.

Note: To determine the suggested value, **0.00001** is multiplied by the highest production output value and then rounded down. For example, if the highest production output value is **823**, that value is multiplied by **.00001** to equal **.00823**. That value is then rounded down to one at the first non-zero decimal place, or **.001** in this example, to become the default value in the **Minimum Production Output** dialog box.

11. Click **OK**.

The **Production Analysis** page appears, displaying the results of the analysis.

Creating a Production Analysis from a Query or Dataset

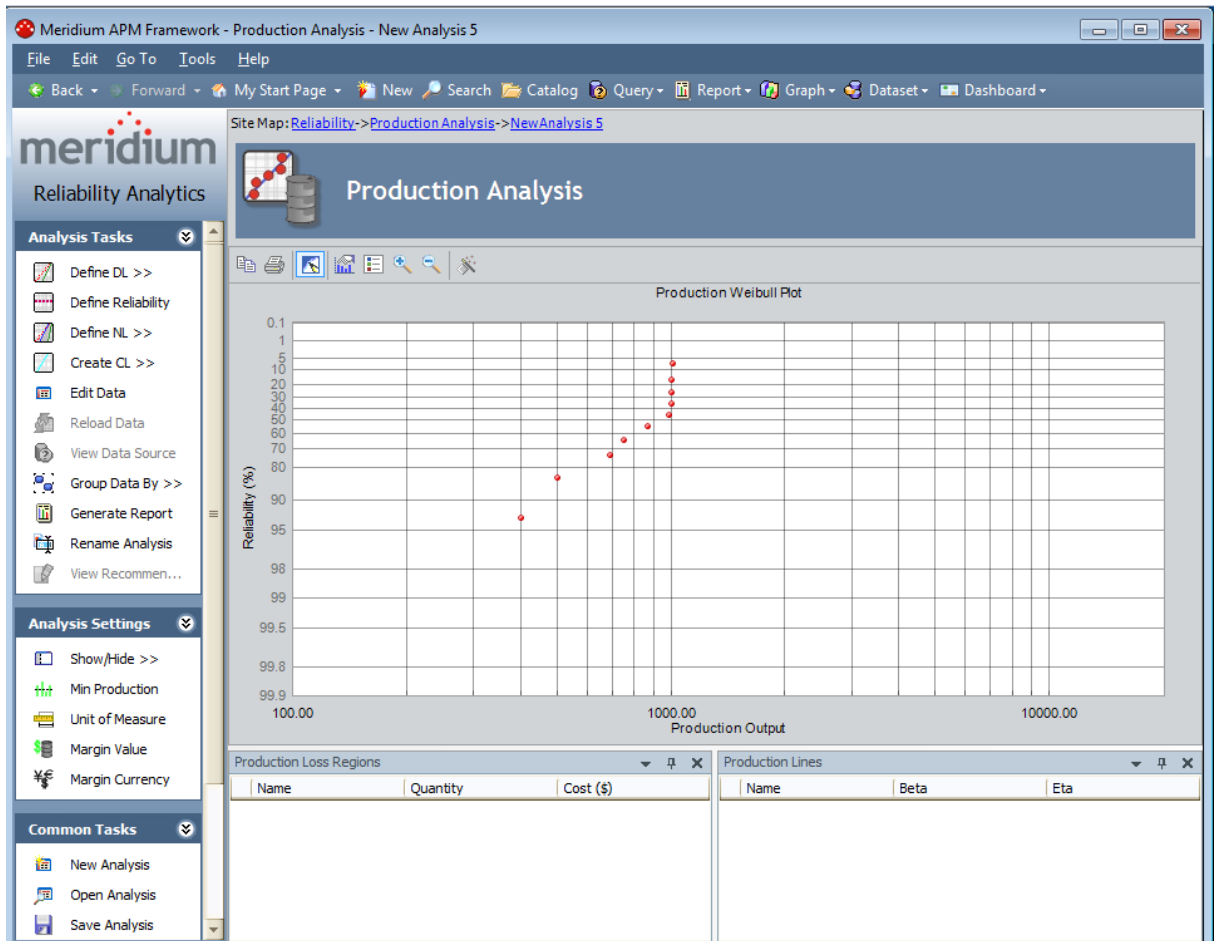

12. Click the **Save Analysis** link on the [Common Tasks menu](#) to save the analysis results. After you have created a new analysis, our first step will be to [draw the Demonstrated Line](#).

Creating a Production Analysis from Manually Entered Data

To create a new Production Analysis based on manually entered data:

1. On the [Reliability Analytics Start Page](#), click the **Production Analysis** link.

The [Select a Production Analysis from the List](#) page appears.

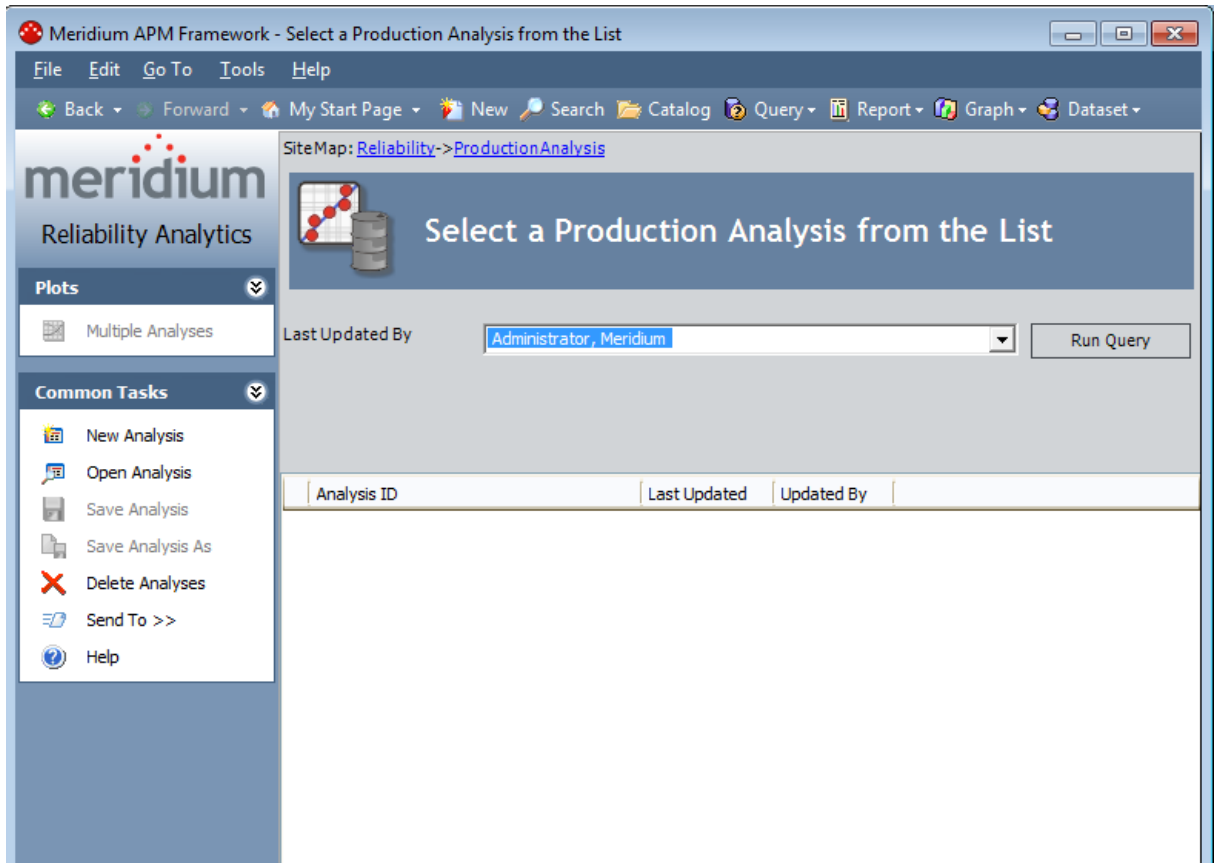

2. On the [Common Tasks menu](#), click the **New Analysis** link

The **Production Analysis Builder** appears, displaying the **Welcome** screen.

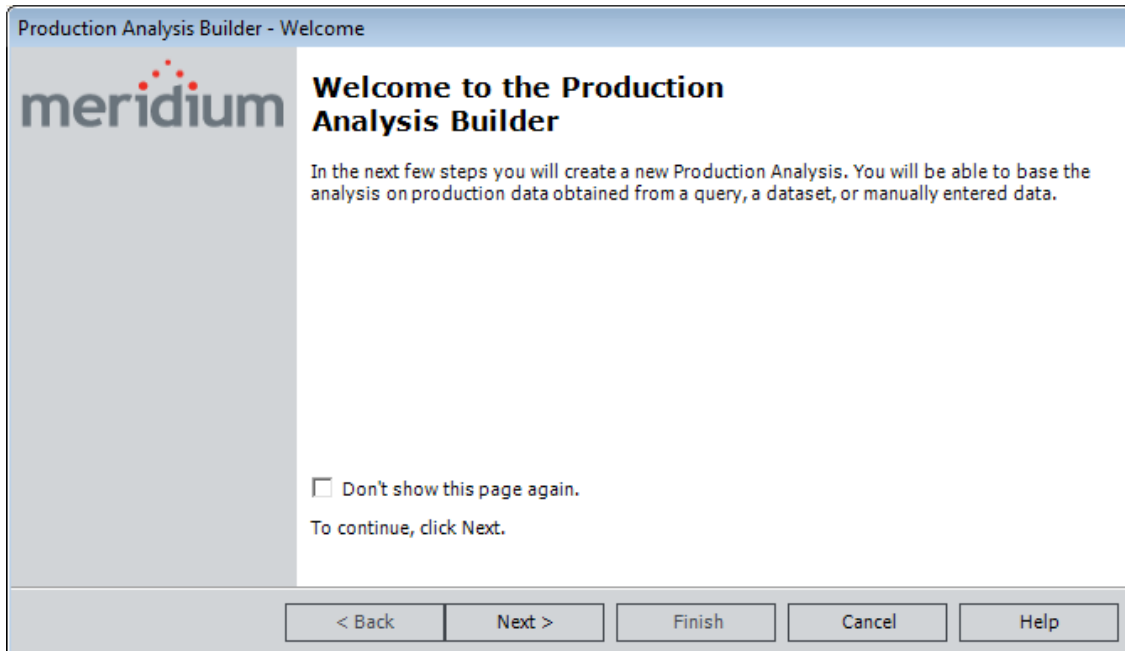

OE Hint: If you do not want to view this screen the next time you access the builder, select the **Don't show this page again** check box.

3. Click the **Next** button.

The **Select the Data Source Type** screen appears.

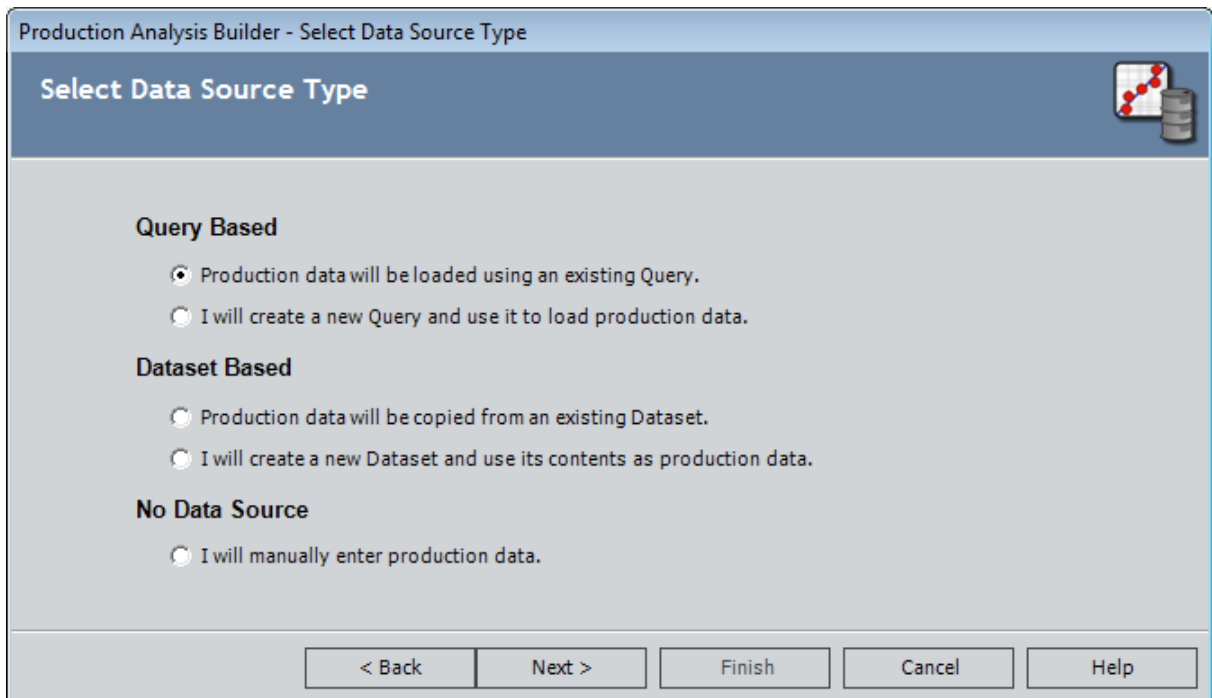

4. Select the **I will manually enter production data** option.
5. Click the **Finish** button

The **Edit Production Data** grid appears, displaying a single empty row.

Production Output	Date	Ignore	Product	Production Comments
		<input type="checkbox"/>		

OK Cancel Help

Total Rows: 0 Ignored Rows: 0 Total Production: 0.00

6. In the **Production Output** cell of the first row, type the first production output value. This field is required.

Note: If you do not have any data for a given date, you must type 0 (zero). Null values are not allowed.

7. In the **Date** cell of the first row, if you want to enter a date:
 - Click the button, and use the Calendar to select a date associated with the first production output value.

-or-

 - Type the first production date.

The date is optional.
8. In the **Ignore** cell of the first row, select the check box if you want to exclude this output value from calculations performed by the Production Analysis. The

datapoint will be plotted but will be displayed as an X.

9. In the **Product** cell of the first row, type the name of the product. This field is optional.
10. In the **Production Comments** cell of the first row, type any additional comments. This field is optional.
11. Repeat steps 6-10 until all production data has been entered.
12. Click **OK**.

The **Edit Production Data** grid closes. If you entered zeros or negative numbers for the production output values, the [Minimum Production Output dialog box](#) appears.

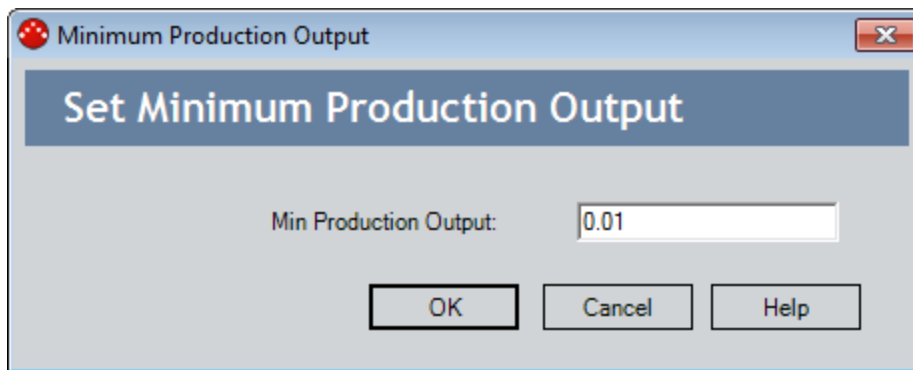

13. In the **Min Production Output** text box, type the value that you want to use to replace zero and negative production output values. The suggest value is **0.00001**, but is calculated based on the highest production output. Zero and negative values cannot be plotted and will instead be plotted using the value specified here. You can also [change the Minimum Production value](#) after the Production Analysis has been created.

Note: Note: The value **.00001** is multiplied by the highest production output value and then rounded down. For example, if the highest production output value is **823**, that value is multiplied by **.00001** to equal **.00823**. That value is then rounded down to the nearest tenth decimal place, or **.001** in this example, to become the suggested value in the **Minimum Production Output** dialog box.

14. Click **OK**.

The **Production Analysis** page appears, displaying the results of the analysis.

Creating a Production Analysis from Manually Entered Data

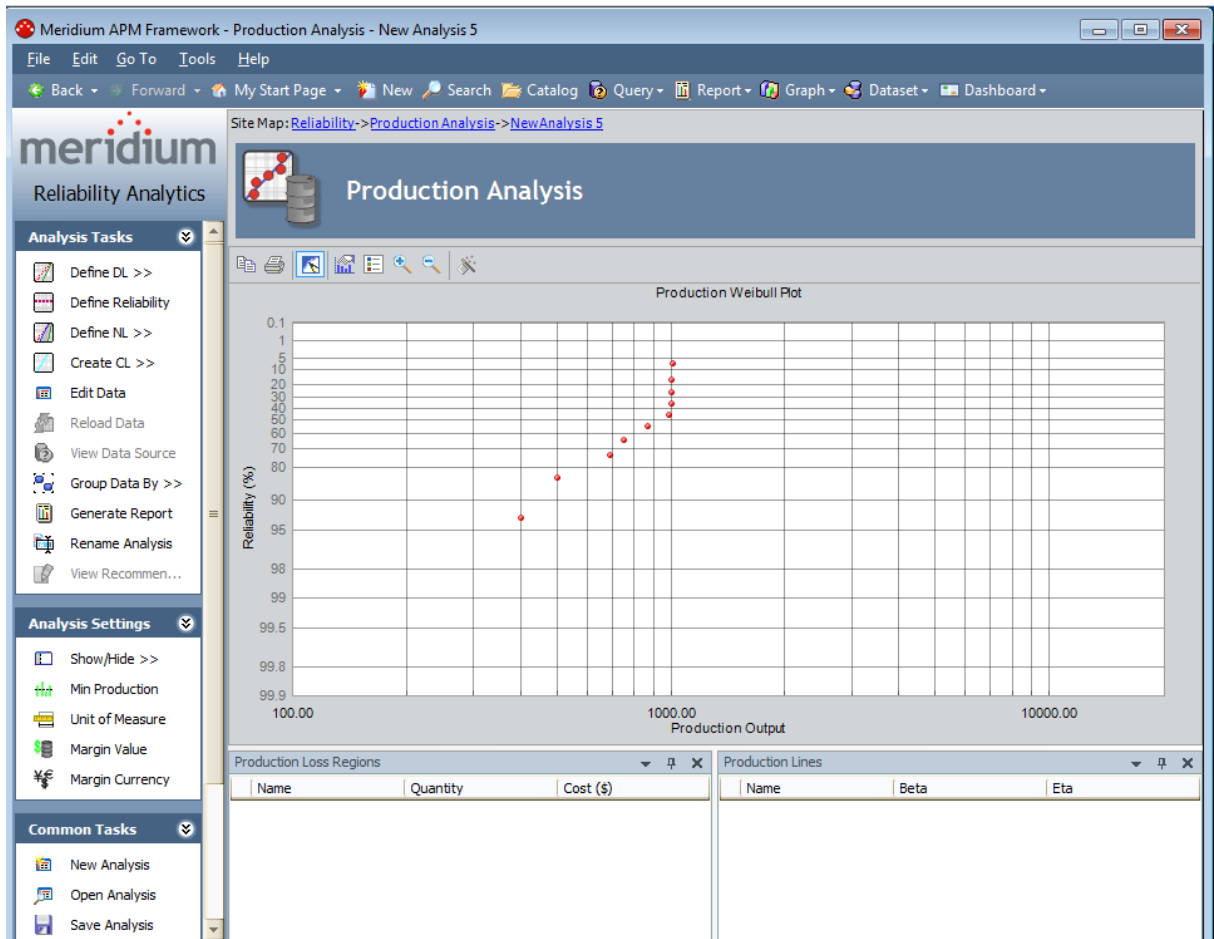

15. Click the **Save Analysis** link on the [Common Tasks menu](#) to save the analysis results. After you have created a new analysis, our first step will be to [draw the Demonstrated Line](#).

Accessing the List of Production Analyses

To display the list of existing Production Analyses:

- On the [Reliability Analytics Start Page](#), click the **Production Analysis** link.

The **Select a Production Analysis from the List** page appears.

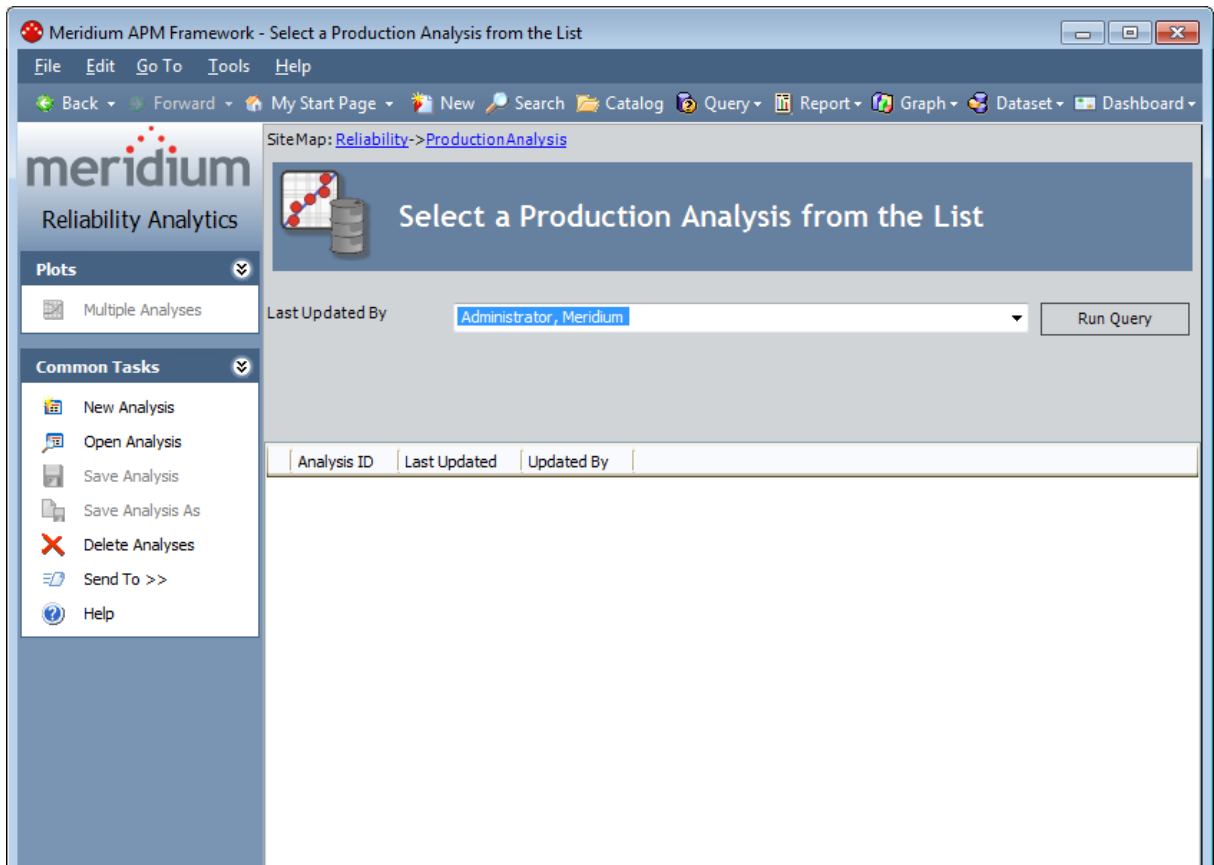

When you first access the **Select a Production Analysis from the List** page, Meridium APM runs the Production Weibull query to display all the Production Analyses that were updated by the Meridium APM user who is currently logged in. From the **Select a Production Analysis from the List** page, you can:

- Click any hyperlinked analysis in the results list to access that analysis. Note that you can also select more than one analysis, and click the **Multiple Analyses** link on the **Plots** menu to view multiple Production Analyses on the Multiple Production Analyses Plot.
- Select different criteria and rerun the **Production Weibull** query to view a different list of Production Analyses and then access any analysis in that list.
- Click the **New Analysis** link on the [Common Tasks menu](#) to begin the process of creating a new Reliability Production Analysis.

Aspects of the List of Production Analyses

The **Select a Production Analysis from the List** page lets you run the Production Weibull query to view a list of existing Production Analyses that meet your query criteria.

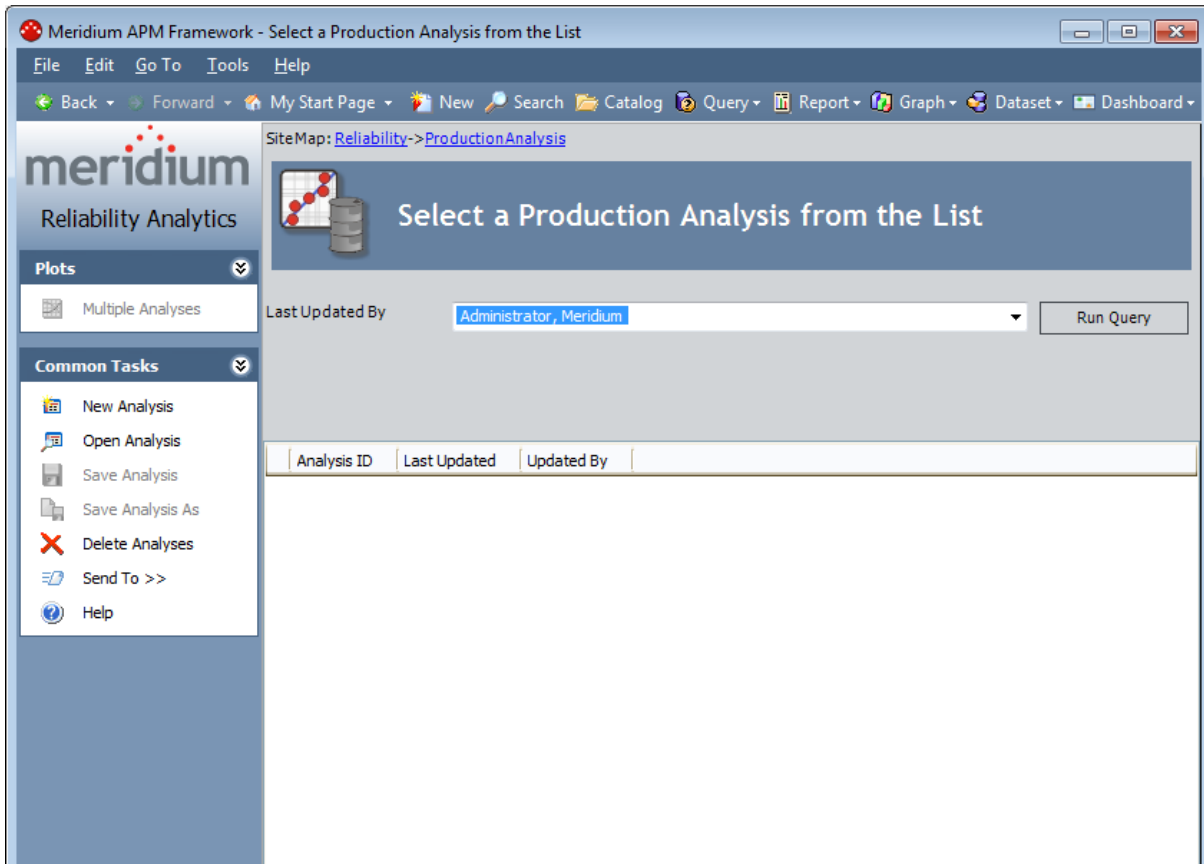

The Production Weibull query is stored in the Meridium APM Catalog in the folder \\Public\Meridium\Modules\Reliability Manager\Analyses. The baseline Production Weibull query contains one prompt: **Last Updated By**. This prompt appears at the top of the page as a drop-down list that contains the list of users.

The **Last Updated By** list contains the following options:

- Your user name, which is selected by default and will cause the query to return only the Production Analyses that were last updated by you.
- The user name of any user who last updated any Production Analysis, which will cause the query to return only the Production Analyses that were last updated by that user.
- The **[All Users]** option, which will cause the query to return a list of Production Analyses updated by any user.

Each time you access the [Select a Production Analysis from the List page](#), the value that appears by default in the prompt will be used to filter the list. After you select different

criteria, you can click the **Run Query** button to run the Production Weibull query and display the results in a grid at the bottom of the page.

Note: Although the results are returned by the Production Weibull query, query page size is ignored. The entire list of analyses is displayed at once.

The default Production Weibull query is configured to display the following columns of information: **Analysis ID**, **Last Updated**, and **Updated By**. You can click any hyperlinked Analysis ID to view the associated Production Analysis summary. In addition, you can use the options on the [Common Tasks menu](#) to perform various tasks for the analyses in the list.

Plots Menu

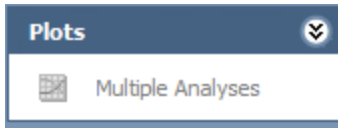

The **Plots** menu on the **Select a Production Analysis from the List** page contains the following link:

- **Multiple Analyses:** Displays the datapoints of [multiple existing Production Analyses](#) on the Multiple Production Analyses Plot.

Common Tasks Menu

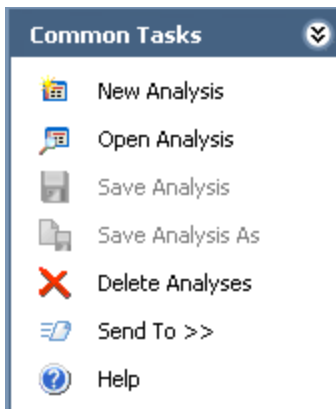

The **Common Tasks** menu on the **Select a Production Analysis from the List** page contains the following links:

- **New Analysis:** Displays the [Production Analysis Builder](#), which will guide you through the process of creating a new Production Analysis.
- **Open Analysis:** Opens the **Find Items** window, which lets you search for an existing Production Analysis.
- **Delete Analyses:** Deletes the currently displayed analysis.
- **Send To:** Displays a submenu with options that let you provide a link to the current page on your desktop (create shortcut), in an email message, or on a Home Page.
- **Help:** Displays the context-sensitive Help topic for the **Select a Production Analysis from the List** page.

Note: The **Save Analysis** and **Save Analysis As** links are always disabled on the **Select a Production Analysis from the List** page.

Opening an Existing Production Analysis

To open a Production Analysis:

1. On the **Select a Production Analysis from the List** page, in the **Last Updated By** list, select the user for which you want to return a list of Production Analyses.

Note: Additional fields may appear if the baseline query has been modified. If additional fields are available, use them to limit the query results as desired.

2. Click the **Run Query** button.

Meridium APM runs the Production Weibull query and displays the results in the grid in the main display area.

SiteMap: [Reliability](#)->[ProductionAnalysis](#)

Select a Production Analysis from the List

Last Updated By:

Analysis ID	Last Updated	Updated By
2006 Unit 1...	6/24/2010	Demo, Joe
Gasoline - B...	9/7/2010	Demo, Joe

3. In the **Analysis ID** column, click the analysis ID of the analysis that you want to open.

The **Production Analysis** page appears.

Opening an Existing Production Analysis

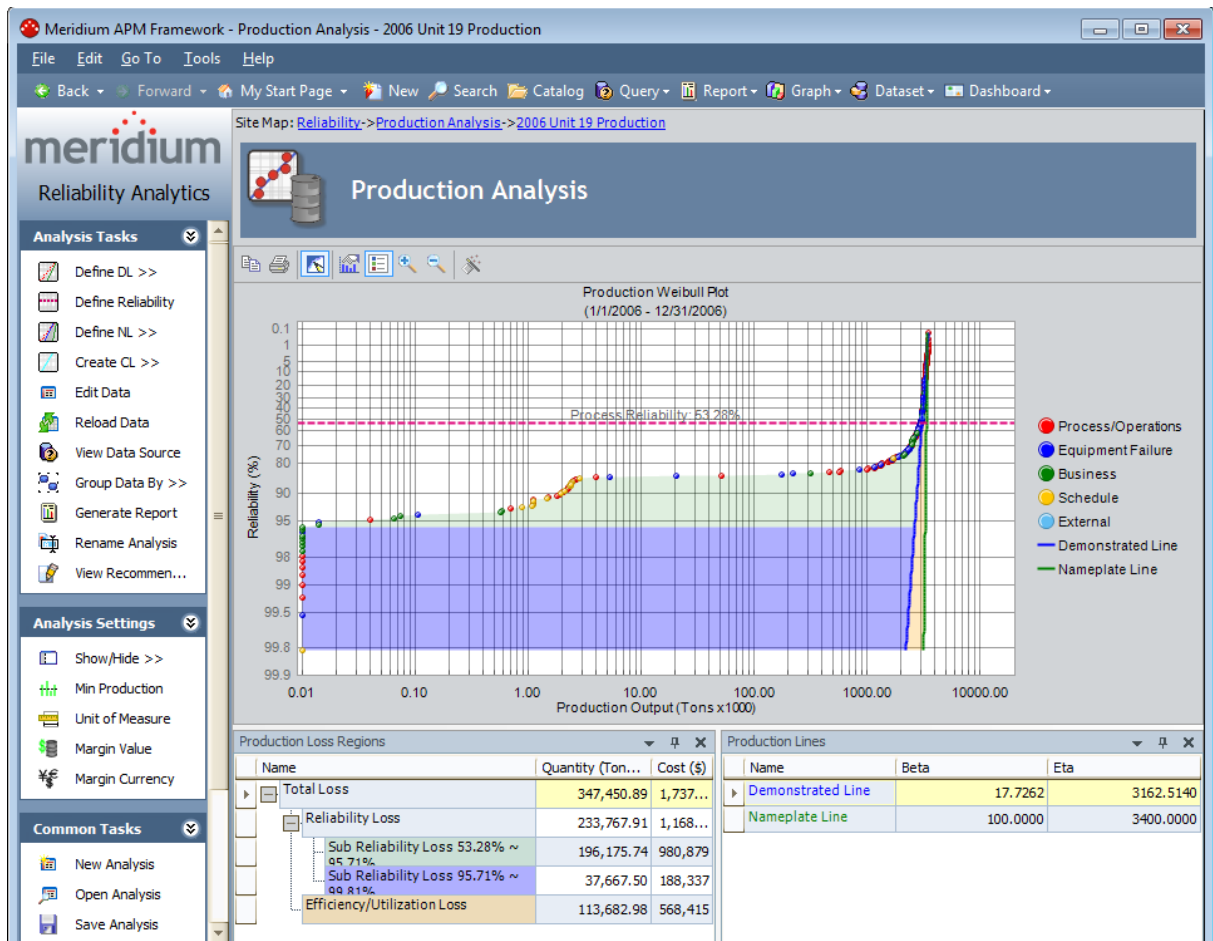

When you open an existing analysis, the analysis will display the data and calculations that were last saved with the analysis. If you want to reload the underlying query or dataset and update calculations based on any changes to the underlying data, you must [reload the analysis](#) after opening it.

Opening Multiple Existing Production Analyses

To open multiple existing Production Analyses:

1. On the [Select a Production Analysis from the List](#) page, in the **Last Updated By** list, select the user for which you want to return a list of Production Analyses.

Note: Additional fields may appear if the baseline query has been modified. If additional fields are available, use them to limit the query results as desired.

2. Click the **Run Query** button.

Meridium APM runs the Production Weibull query and displays the results in the grid in the main display area.

Analysis ID	Last Updated	Updated By
▶ 2006 Unit 1...	6/24/2010	Demo, Joe
Gasoline - B...	9/7/2010	Demo, Joe

3. Select the rows containing the Production Analyses that you want to open.
4. On the [Plots menu](#), click the **Multiple Analyses** link.

The selected analyses appear on the **Multiple Production Analyses Plot** page, displaying the datapoints, [Process Reliability Lines](#), and [Production Lines](#) for each analyses. Each separate analysis and the lines associated with it appear in coordinating colors. The legend appears to the right of the plot by default to display which colors represent what for the different analyses.

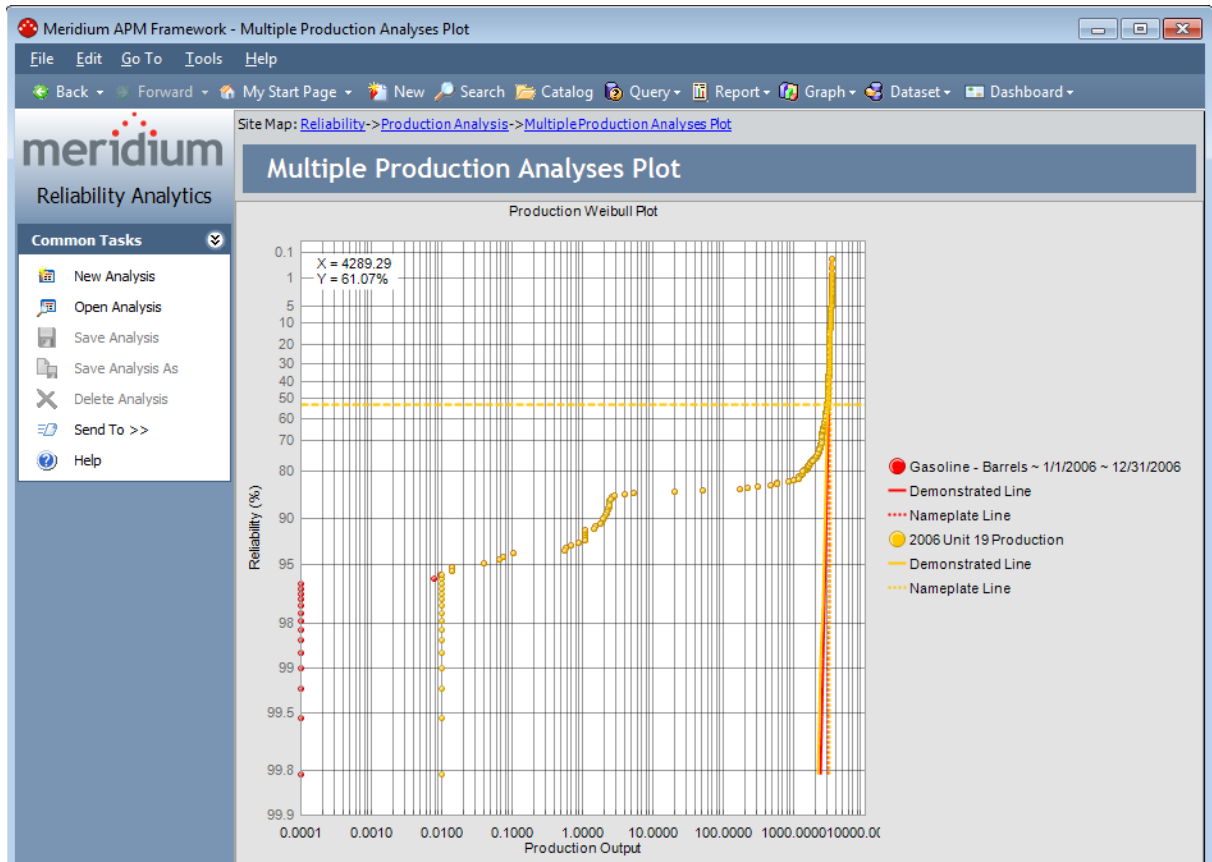

Note that even though the Process Reliability Lines are represented as a dotted, horizontal line on the **Multiple Production Analyses Plot**, they are not represented in the legend.

From the **Multiple Production Analyses Plot** page, you can:

- Pause on a defined analysis or Production Line in the legend to highlight the associating analysis or Production Line in the plot area.
- View the details of a specific analysis by clicking a datapoint, reliability line, or production line to open *that* analysis on the **Production Analysis** page.
- View the details of a datapoint, reliability line, or production line by pausing on a datapoint, reliability line, or production line.
- Customize the **Multiple Production Analysis Plot** using the standard graph toolbar or the annotation toolbar.
- Click the **New Analysis**, **Open Analysis**, **Send To**, or the **Help** links on the [Common Tasks menu](#).

Aspects of the Production Analysis Page

The **Production Analysis** page displays the [Production Analysis Plot](#) as datapoints on a graph. The dates for which the datapoints represent are displayed as a subtitle above the graph. There are two windows that appear below the analysis by default and display the values from defining the [Process Reliability line](#), the [Demonstrated Line](#), the [Nameplate Line](#), and the [Production Line](#):

- [Production Loss Regions pane](#)

Production Loss Regions		
Name	Quantity (Tons x1000)	Cost (\$)
Total Loss	338,226.07	1,691,130
Reliability Loss	224,543.09	1,122,715
Sub Reliability Loss 65.60% ~ 95.71%	186,875.59	934,378
Sub Reliability Loss 95.71% ~ 99.81%	37,667.50	188,337
Efficiency/Utilization Loss	113,682.98	568,415

- [Production Lines pane](#)

Production Lines		
Name	Beta	Eta
Demonstrated Line	17.7262	3162.5140
Nameplate Line	100.0000	3400.0000

The **Production Analysis** page contains the following task menus: [Analysis Tasks](#), [Analysis Settings](#), [Common Tasks](#), and [Associated Pages](#). These task menus give you quick access to common tasks associated with Production Analyses.

The **Production Analysis** page provides a standard graph toolbar, where only some of standard toolbar options are available. The standard graph toolbar for a Production Analysis contains an additional **Zoom in** feature, which allows you to zoom in on any selected area. A **Zoom out** feature is also available to let you revert to the original view of the Production Analysis. The annotation toolbar for a Production Analysis allows you to customize the plot with features such as shapes and text boxes.

Analysis Tasks Menu

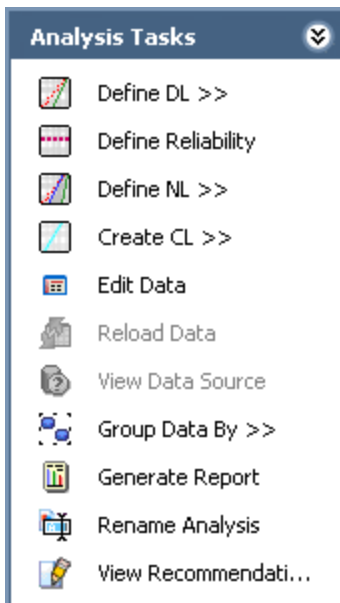

The **Analysis Tasks** menu on the **Production Analysis** page contains the following links:

- **Define DL:** Displays a submenu that lets you define the [Demonstrated Line](#) using the following options: Regression Fit, Draw Line, Select Point and Specify Beta, or Specify Beta and Eta.
- **Define Reliability:** Allows you to draw the [Process Reliability Line](#), which defines the reliability of the process as a percentage.
- **Define NL:** Displays a submenu that lets you define the [Nameplate Line](#) using the following options: Regression Fit, Draw Line, Select Point and Specify Beta, or Specify Beta and Eta.
- **Create CL:** Displays a submenu that lets you define a [Custom Line](#) using the following options: Regression Fit, , Draw Line, Select Point and Specify Beta, or Specify Beta and Eta.
- **Edit Data:** Displays the [Edit Production Data window](#), where you can view and edit the production data.
- **Reload Data:** [Reloads the data](#) stored in the database after asking for confirmation to overwrite any existing data. This link appears only if the analysis is based on a query or a dataset.
- **View Data Source:** Displays the data that serves as the source of the analysis. This link appears only if the analysis is based on a query or a dataset.
 - If the analysis is based on a query, this link will open the query results.
 - If the analysis is based on a dataset, this link will open the dataset.
- **Group Data By:** Displays a submenu that allows you to [separate datapoints into groups](#) using the values in a selected field. Each group will be identified on the

Production Analysis with a different color.

- **Generate Report:** Displays the **Report Options** dialog box, where you can [select the elements of the analysis](#) that you want to include in a report.
- **Rename Analysis:** Displays the **Rename Analysis** dialog box, where you can [change the name and description of the analysis](#). Note that changes to the name and description take effect immediately, but you must save the analysis to save the changes.
- **View Recommendations:** Allows you to [view and edit recommendations](#) related to the current analysis. This link is enabled only if you are viewing a saved analysis.

Analysis Settings Menu

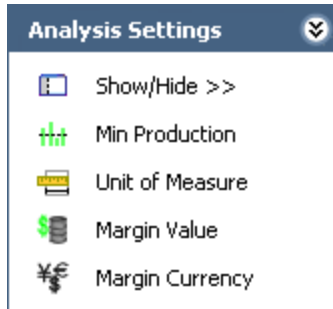

The **Analysis Settings** menu on the **Production Analysis** page contains the following links:

- **Show/Hide:** Displays a submenu, where you can choose to show or hide the [Production Lines pane](#) and the [Production Loss Regions pane](#).
- **Min Production:** Displays the **Minimum Production Output** dialog box, where you can [change the minimum value used by the current analysis](#).
- **Unit of Measure:** Displays the **Unit of Measure** dialog box, where you can [change the units of measure](#) for the production output.
- **Margin Value:** Displays the **Margin Value** dialog box, where you can [define the cost associated with each unit of output](#).
- **Margin Currency:** Displays the **Margin Currency** dialog box, where you can [change the cost currency of the analysis](#).

Common Tasks Menu

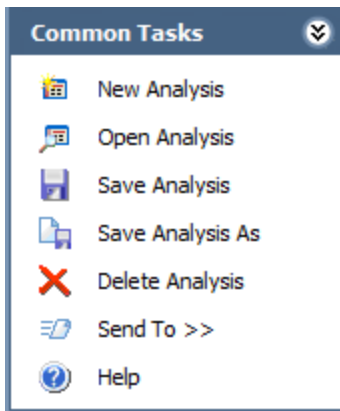

The **Common Tasks** menu on the **Production Analysis** page contains the following links:

- **New Analysis:** Displays the [Production Analysis Builder](#), which will guide you through the process of creating a new Production Analysis.
- **Open Analysis:** Displays the **Find Items** window, which you can use to locate and open an existing Production Analysis.
- **Save Analysis:** Saves the currently displayed analysis. If you are viewing a brand new analysis that has not yet been saved, this link will display the **Save Analysis** dialog box, where you can [save the analysis](#). If you are viewing an existing analysis, when you click this link, Meridium APM will save any changes that you made to the analysis since it was last saved.
- **Save Analysis As:** Displays the **Save this Analysis** dialog box, where you can choose to [save it with a different name](#).
- **Delete Analysis:** Deletes the currently displayed analysis.
- **Send To:** Displays a submenu with options that let you provide a link to the current page on your desktop (create shortcut), in an email message, on a Home Page.
- **Help:** Displays the context-sensitive Help topic for the [Production Analysis page](#).

Associated Pages Menu

The **Associated Pages** menu on the **Production Analysis** page displays only links that have been configured for the Production Analysis family. For details on configuring items to appear on the **Associated Pages** menu, see the URL Manager Help.

About the Production Analysis Plot

When you create a Production Analysis, Meridium APM plots the production output values. The output values themselves are plotted along the x-axis, and the Reliability Percentage values for each datapoint are plotted along the y-axis. The Reliability Percentage is calculated by first determining the median rank of each output value and then using the median rank in a second equation that converts it to the Reliability Percentage. The following simplified equation can be used to determine an approximated median rank for each output value:

$$\text{Median Rank} = 1 - (i - .3) / (N + .4)$$

...where:

- **i** = The order of each datapoint with respect to other datapoints. To determine the **i** value of each datapoint, the output values are sorted from highest to lowest. The highest output value is assigned a value of **i=1**. The second-highest value is assigned **i=2**, and so on until all the output values have been numbered.
- **N** = The number of output values. For example, if your Production Analysis has a year's worth of datapoints, then **N=365**. If your Production Analysis has only a month's worth of datapoints, then **N=31** or **N=30**, depending on what month you are using.

After the median rank has been calculated, the Reliability Percentage is calculated using the following equation and then plotted along the y-axis:

$$\text{Reliability Percentage} = 100 - (\text{Median Rank} * 100)$$

The general shape of the plot can provide you with basic information about your production process:

- Ideally, the datapoints will be plotted to form a vertical line at the highest possible X-value. This would mean that your process is producing the highest rate of output at all times, with no variation, and that you have no reliability or process problems. While this scenario is not realistic, visualizing the ideal plot compared to your actual plot can be useful in understanding how far your actual data deviates from ideal data.
- If the datapoints are plotted in a straight, diagonal line that slopes downward from right to left with no sharp change in production rate, then any variation in output is due to process problems; you have no equipment/location reliability problems.
- If the datapoints show a sharp change in production, then you have both process problems and equipment/location reliability problems. You will [draw your Process Reliability](#) where you notice this sharp change in production output.
- Within the [reliability loss region](#), you may notice distinct areas where the production output varies greatly from the rest of the datapoints in the region. These variations may be due to different types of reliability problems, such as system shutdowns, intentional cutbacks, and equipment/location failures. You can [create](#)

[breakpoints](#) to divide the reliability loss region into separate areas where you notice these changes.

About the Process Reliability Line

An ideal process will produce the maximum possible output at all times, but actual processes demonstrate variation in output over time. The variation in output can be caused by various factors, including process problems, equipment and location problems, shut-downs, and cutbacks.

The Process Reliability Line marks the location at which datapoints begin to trend away from the [Demonstrated Line](#). This is the location at which variation in output shifts from being attributed to production losses to being attributed to reliability losses and defines the reliability of the process, expressed as a percentage. It is the point at which the process shifts from being fairly reliable to being unreliable.

For example, in the following Production Analysis, notice the Process Reliability Line for the [bottled water production process](#).

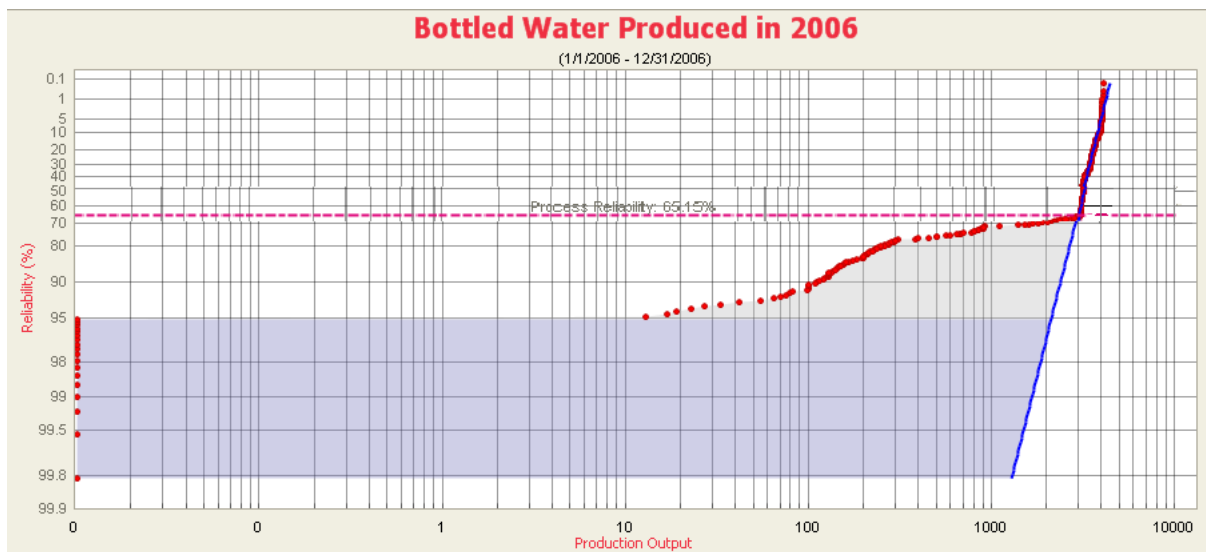

Reading the analysis from *right to left*, notice that the output closely follows the Demonstrated Line until the production output is around 3000 bottles per day. The output then decreases and begins to trend away from the Demonstrated Line toward a lower Reliability rate. We have [drawn the Process Reliability Line](#) where we observed this distinct change.

Notice that the line is labeled **Process Reliability: 65.15%**. This means that our process is reliable 65.15% of the time. The other 34.85% of the time, production loss is due to equipment/location failures, downtime, or intentional cutbacks in production.

The decision of where to draw the Process Reliability Line is somewhat subjective and will be determined by how your datapoints look after they have been plotted and how you interpret the plot. If your datapoints do not exhibit a distinct trend away from the Demonstrated Line, and are plotted in a fairly, straight, diagonal line, it may not be appropriate to draw the Process Reliability Line at all.

Defining the Process Reliability Line

To create a Process Reliability line on a Production Analysis:

1. On the [Production Analysis page](#), on the [Analysis Tasks menu](#), click the **Define Reliability** link.
2. Select the point on the analysis at which datapoints begin to trend away from the Demonstrated Line.

A dotted line appears and is labeled **Process Reliability: [Percentage]**, where **[Percentage]** indicates the reliability of the process, represented as a percentage.

3. On the [Common Tasks menu](#), click the **Save Analysis** link to save the changes.

Note: To delete the Process Reliability Line, right-click the line, and then click **Delete Reliability Line**.

Types of Production Lines

When viewing the results of a Production Analysis, you can define the following types of lines:

- **Demonstrated Line:** Represents the production output when the unit is operating at its observed rate of its capability. The region between the Demonstrated Line and the Nameplate Line is represented as the **Efficiency/Utilization Loss** region on the **Production Loss Regions** pane.
- **Nameplate Line:** Represents the most ideal production output of the unit.
- **Custom Line:** Provides a visual comparison between the Demonstrated Line and other observed or theoretical production rates. You can have more than one Custom Line per analysis.

All of these lines can be drawn by:

- Using [Regression Fit](#).
- [Selecting a point and specifying the Beta value](#).
- [Drawing the line](#) manually.
- [Specifying Beta and Eta](#) values.

Note: To delete any of the lines, right-click the line, and then click **Delete Line**.

About the Demonstrated Line

Somewhere on the Production Analysis you should be able to identify a group of datapoints that represent your typical output. Consider again our example of the [bottled water production process](#). In the Production Analysis plot, notice the group of datapoints between 3000 and 4000 bottles per day. Within this range, the variation in number of bottles produced is relatively small. This is the *demonstrated* production output of our production process, where the production unit produces the same amount on a regular basis. Therefore, we have defined the Demonstrate Line along these datapoints.

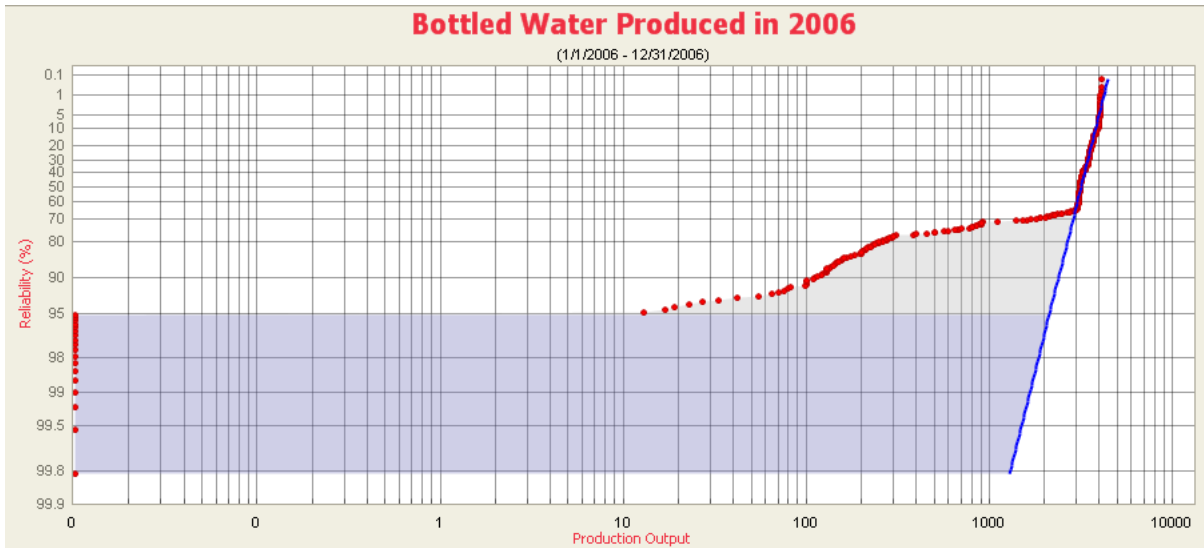

The Demonstrated Line extends beyond the plotted datapoint to show what the production would have been if the production rate had not started to drop off due to reliability problems, such as equipment and location failures, cutbacks, and downtime.

CEHint: Drawing the Demonstrated Line *first* can help you determine where to draw the Process Reliability Line. You will want to draw the Process Reliability Line where the datapoints begin to deviate from the Demonstrated Line.

About the Nameplate Line

Every process will have both *ideal* output value and *actual* output values. Ideally, a process should always produce the maximum possible output. The maximum possible output is determined by a variety of factors and is often influenced most significantly by manufacturer specifications. Many manufacturers specify a *nameplate* value for their equipment to indicate the highest capacity of a given piece of equipment under ideal operating conditions. Together, the nameplate values for the individual pieces of equipment can help you determine the nameplate value for the entire unit, which is the maximum production output for the process under ideal operating conditions.

After you have plotted your production data, you will want to draw a Nameplate Line on the Production Analysis Plot to indicate the ideal output. Meridium APM will calculate the difference between the ideal output and your [observed output values](#) (represented by the Demonstrated Line) to determine your Efficiency/Utilization Losses.

Note that it may not always be appropriate to use the manufacturers' nameplate value as the nameplate value for your process. The maximum production capacity based upon manufacturers' specifications may be unrealistic if you intentionally operate under conditions that do not meet those specifications. For example, you may operate at a lower temperature due to environmental constraints. If you calculate your production losses based upon an impossible goal, your losses may appear inflated. In this case, you may want to consider these factors into account to determine a more realistic nameplate value: one that actually can be achieved.

Consider again our example of the [bottled water production process](#). On the Production Analysis Plot, notice that on October 18, 2006, the bottled water production process produced 4100 bottles of water, the highest observed value all year. In this example, we have drawn the Nameplate Line (green) through the highest *actual* production value, which we consider our ideal value. This will help us determine the efficiency and utilization losses by comparing the ideal production output to the [observed production output](#).

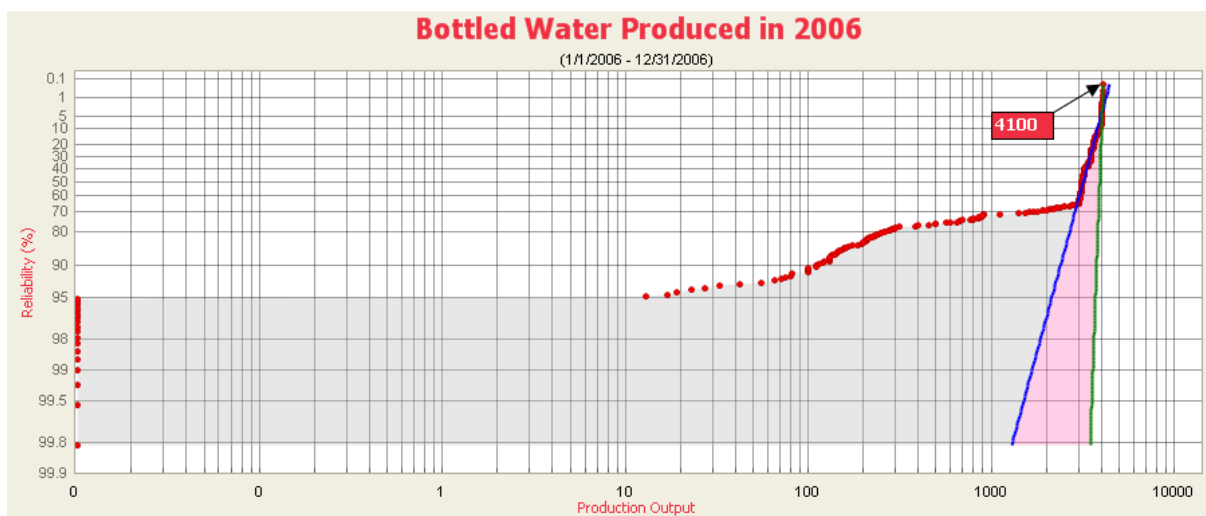

About the Nameplate Line

Alternatively, your process may be operating precisely according to the manufacturers' specifications. In this case, you may want to draw your Nameplate Line at a location determined by the manufacturers' nameplate values. In this case, the location of the Nameplate Line may or may not correspond to any actual output values that have been plotted. Even though the manufacturers' specifications are being followed, the process may still be operating well below its maximum capacity, in which case the Nameplate Line may be drawn above your first observed output value.

About the Custom Line

After you have drawn the Demonstrated Line, the Process Reliability Line, and the Nameplate Line, you can optionally draw one or more additional Custom Lines to compare historical or projected production rates to the observed production rate. For example, you might draw a Custom Line:

- To compare the current year's production to the previous year's production.
- To compare your company's production rates with the production rates of another company that is using the same process.
- To project how much more you could produce the next year if you improved your process to achieve a projected production rate.

Again, consider our example of the [bottled water production process](#). To increase our profits, we want to have a higher rate of production in 2007 than we did in 2006. To set a stretch goal for 2007, we have drawn a Custom Line using the Beta and Eta values that we want to achieve for 2007.

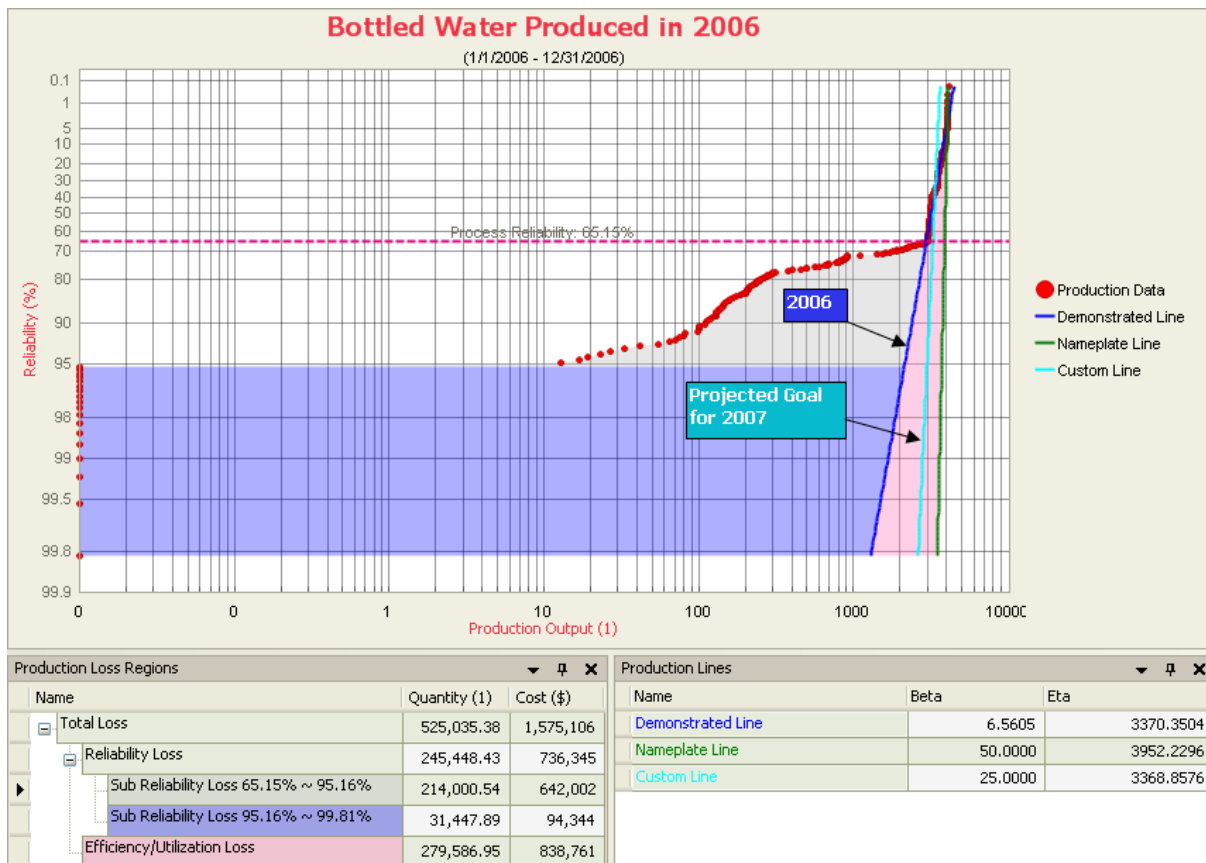

To draw the line, we used the [Specify Beta and Eta](#) option and chose the Eta value of **3368.8576**, which is the same as the Demonstrated Line for 2006, and a Beta value of **25** to project *less* production variation than shown by the Demonstrated Line. After we have evaluated the differences in the current 2006 production rate and the anticipated

About the Custom Line

2007 production rate, we can begin determining what actions we need to take to achieve that goal for the following year.

Using Regression Fit

The **Regression Fit** option lets you select a group of datapoints and then calculates the best-fit method to draw a line for that set of datapoints. For the following example, we will draw a Demonstrated Line using the **Regression Fit** option.

To draw a line using the Regression Fit:

1. On the [Production Analysis page](#), on the [Analysis Tasks menu](#), click the **Define DL** link.

A submenu appears.

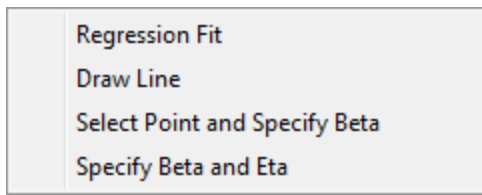

2. Click **Regression Fit**.

The pointer changes to a cross \oplus , indicating that you can begin selecting a group of datapoints.

3. Click and drag the pointer to create a box around at least two datapoints.

Note: If you attempt to draw a regression fit around datapoints where the Beta value will be close to zero and Eta will be too large, an error message appears, explaining that Eta is out of range.

Meridium APM draws the line through the area of selected datapoints using the best-fit method, and the pointer reverts back to an arrow. The following image shows a magnified example of a line drawn using the Regression Fit method.

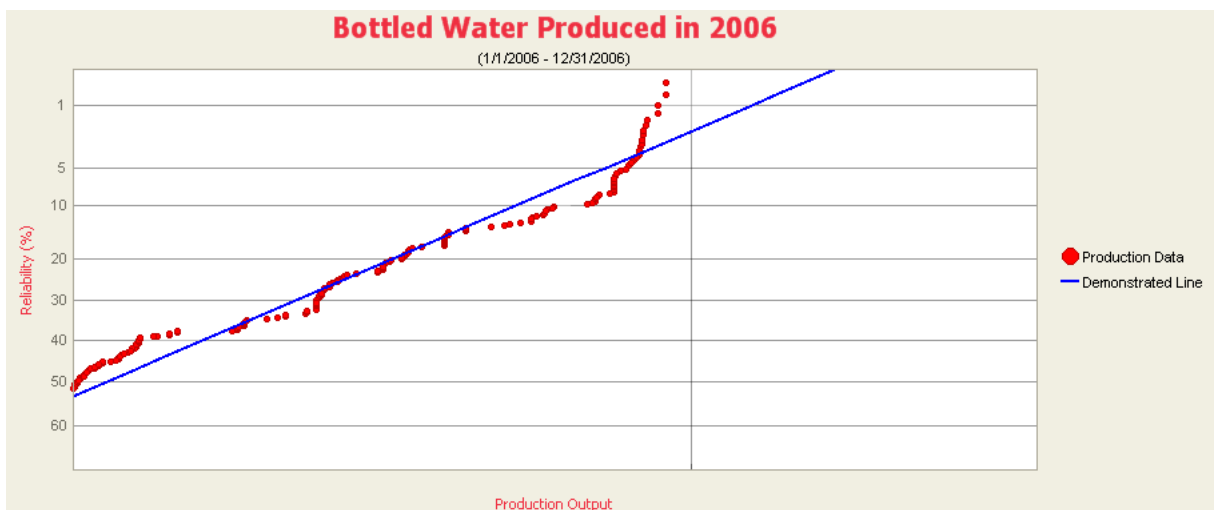

4. On the [Common Tasks menu](#), click the **Save Analysis** or **Save Analysis As** link to save all changes.

Drawing a Line Manually

The **Draw Line** option allows you to draw a line manually anywhere on the current analysis. For example, we will show you how to draw a Nameplate Line using the Draw option.

To draw a line manually:

1. On the [Production Analysis page](#), on the [Analysis Tasks menu](#), click the **Define NL** link.

A submenu appears.

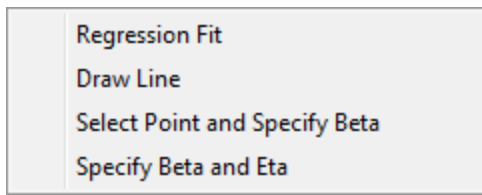

2. Click **Draw Line**.

The pointer changes to a pencil  , indicating that you can draw the line manually anywhere on the Production Analysis.

3. Click and drag the pointer where you want the line to appear.

The line appears, and the pointer reverts back to an arrow. In the following image, we show an example of a Nameplate Line drawn using the Draw Line option.

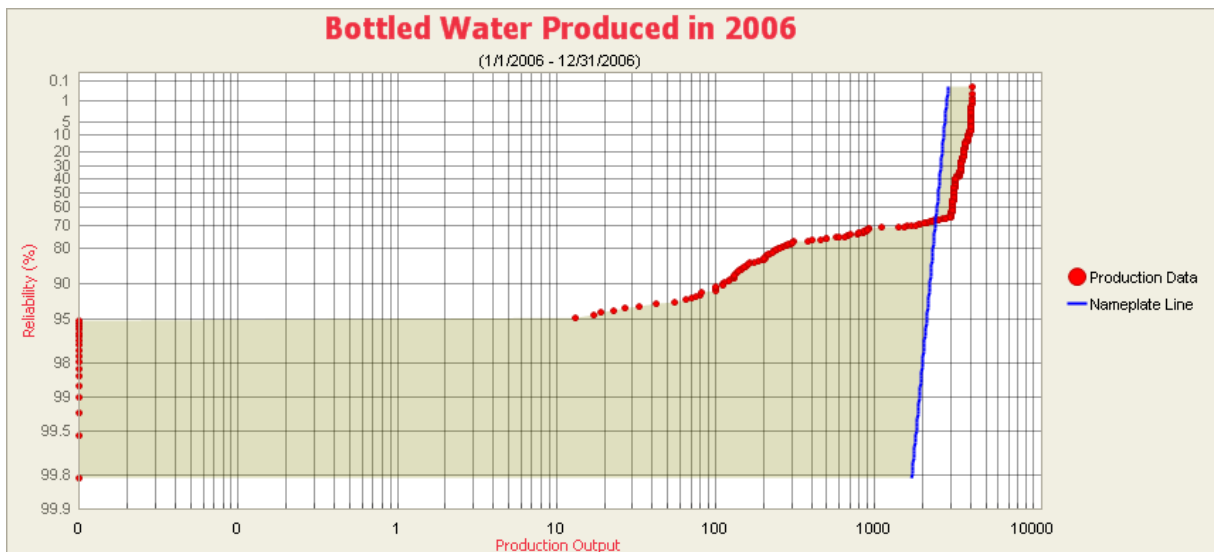

4. On the [Common Tasks menu](#), click the **Save Analysis** or **Save Analysis As** link to save all changes.

Selecting a Point and Specifying Beta

The **Select Point and Specify Beta** option allows you to select a datapoint for a line to pass through and [enter the Beta value](#) to determine the slope of the line. For the following example, we will draw a Nameplate Line using the **Select Point and Specify Beta** option.

To draw a line by selecting a point and specifying the Beta value:

1. On the [Production Analysis page](#), on the [Analysis Tasks menu](#), click the **Define NL** link.

A submenu appears.

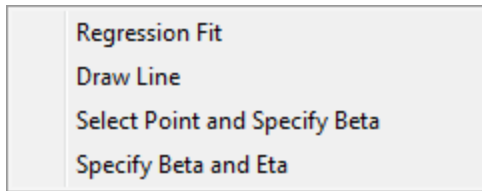

2. Click **Select Point and Specify Beta**.
3. Click the datapoint through which you want the line to pass.

The **Define Nameplate Line** dialog box appears.

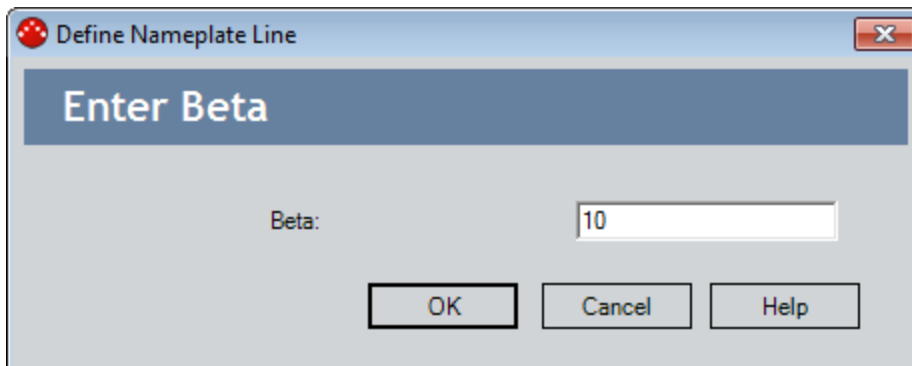

4. In the **Beta** text box, type the desired Beta value. If a Nameplate Line does not currently exist, the value for Beta is set by default to **10** but can be changed to any number between .001 and 1000. If a Nameplate Line does exist, the value for Beta is set to the value of that line but can be changed to any number between .001 and 1000. Keep in mind that the higher the Beta value, the more vertical the line will be.
5. Click **OK**.

The line is drawn through the selected datapoint with the slope designated by the specified Beta value. The following image shows a magnified view of a line that was drawn using a Beta value of **50**.

Selecting a Point and Specifying Beta

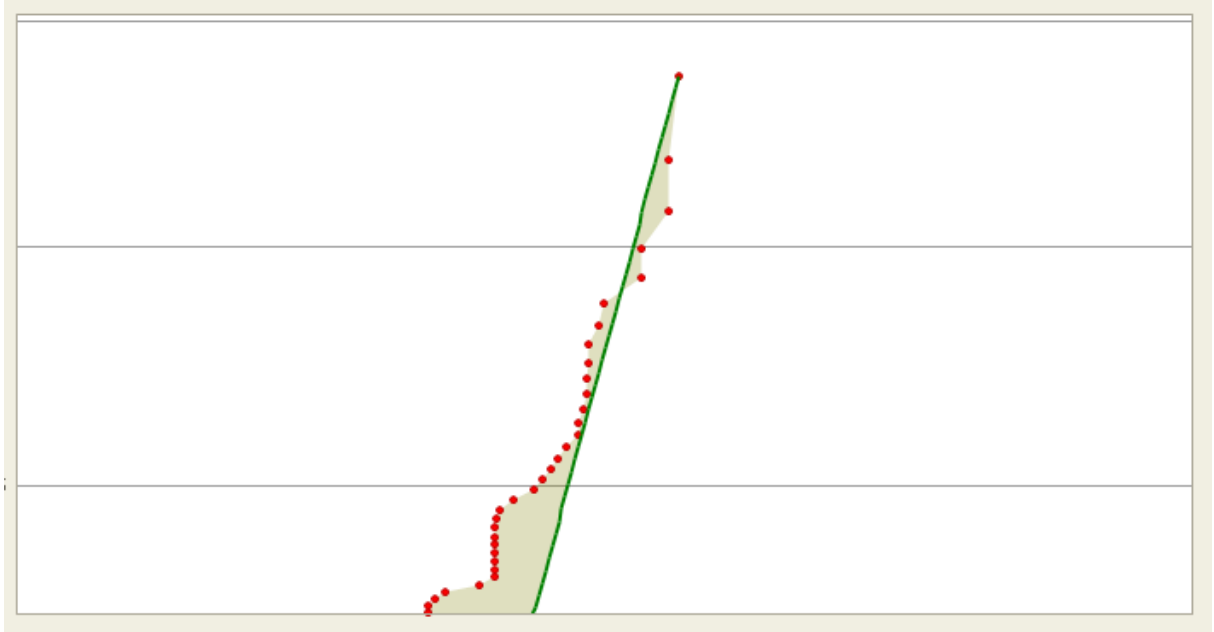

6. On the [Common Tasks menu](#), click the **Save Analysis** or **Save Analysis As** link to save changes.

Specifying Beta and Eta Values

The **Specify Beta and Eta** option allows you to draw a line by entering both the Beta and Eta values. This tool may be useful when you create a Custom Line to indicate the production rate of output used in another Production Analysis. Simply copy the Beta and Eta values for the Demonstrated Line from that analysis and then provide them when using this option. In the following example, we will create a Custom Line.

To draw a Custom Line by specifying Beta and Eta values:

1. On the [Production Analysis page](#), on the [Analysis Tasks menu](#), click the **Create CL** link.

A submenu appears.

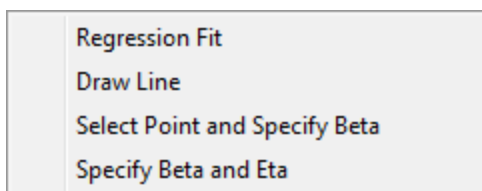

2. Click **Specify Beta and Eta**.

The **Create Custom Line** dialog box appears.

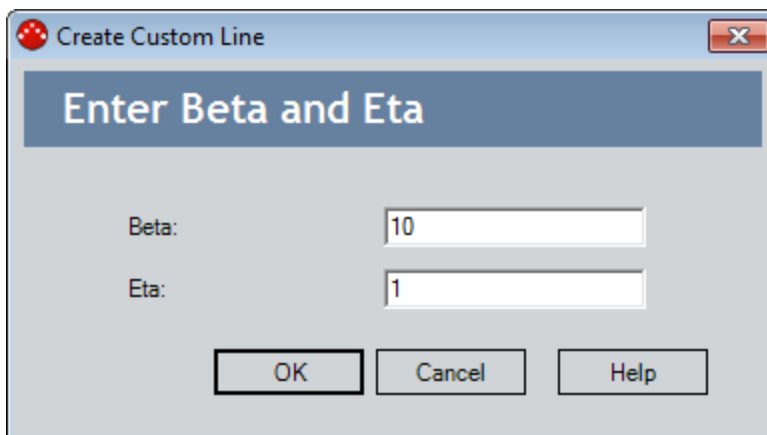

3. In the **Beta** text box, type the desired Beta value. The Beta value is set to **10** by default but can be changed to any number between .001 and 1000.
4. In the **Eta** text box, type the desired Eta value. The Eta value is set to **1** by default but can be changed to any number less than 1000000000.
5. Click **OK**.

The line appears and intersects the production output where the Reliability Percentage is 36.8% with a slope designated by the specified Beta value. The Beta and Eta values specified appear on the [Production Lines pane](#). In the following example, the Beta value is set to **25** and the Eta value is set to **3368.8576**. These

are the values we chose to use for the [Custom Line](#) in our [bottled water production process example](#).

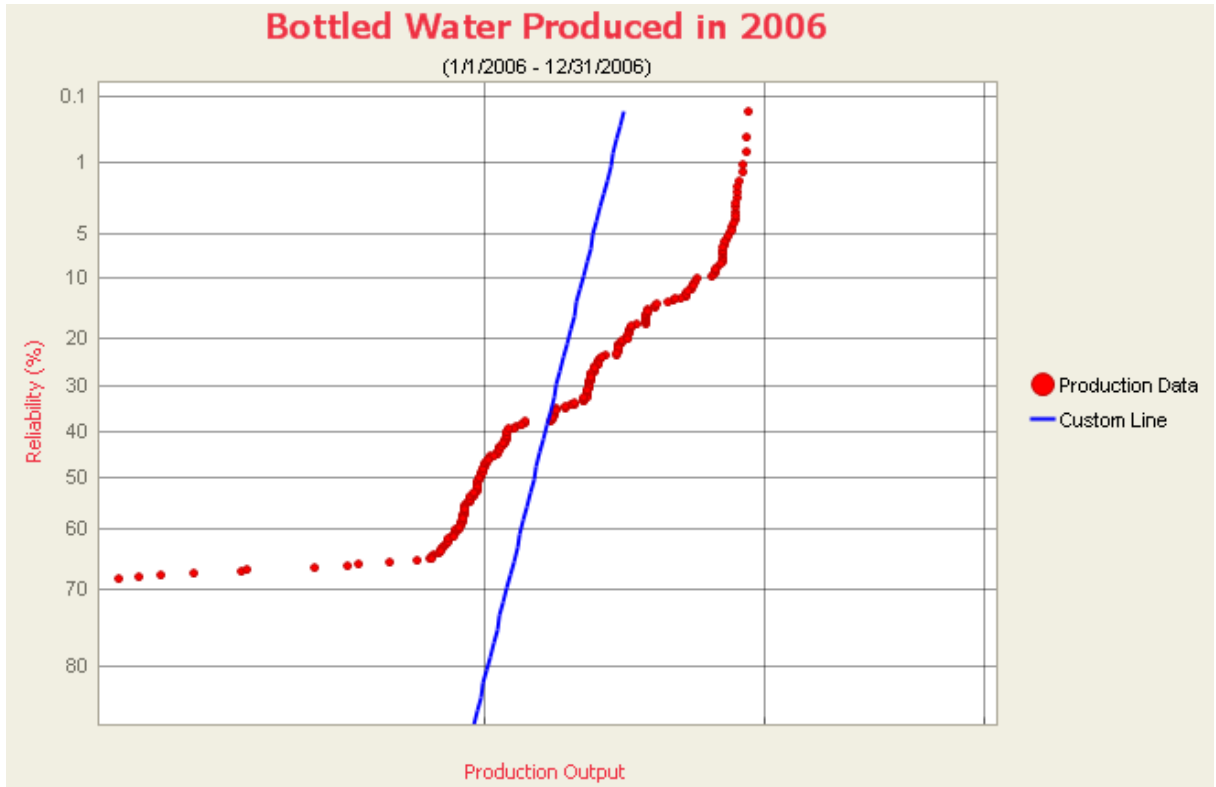

6. On the [Common Tasks menu](#), click the **Save Analysis** or **Save Analysis As** link to save all changes.

Grouping Production Data

When a Production Analysis has been created using fields in addition to Production Output and Date, you can color code the datapoints according to the values in any of those fields.

Consider again our example of the bottled water production process. The dataset used to create our Bottled Water Production Analysis contains three columns: Date, Production, and Category. We used the Category field to record the reasons for the Production Output on a given day, such as Equipment Failure, Process Variability, Budgeted Maintenance, and so on. We can use the Group By feature to color code our datapoints for each of these categories.

To group the data by a field:

1. On the [Analysis Tasks menu](#), click the **Group By** link.

A submenu appears with the fields available in the query or dataset.

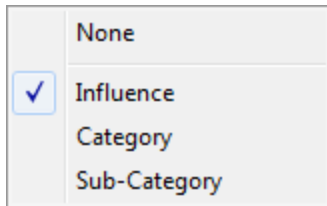

2. Select the field that you want to use for color coding.

The datapoints within the Production Analysis change color to correspond to the values in the field. A different color is assigned automatically to each unique value.

Note: The legend will not appear automatically. You can enable the legend using the standard graph toolbar.

By grouping our example analysis by the **Category** field, we can see which datapoints are associated with each category.

CE Hint: You can hover over a datapoint on the Production Analysis to highlight all the datapoints in the same group.

What is a Breakpoint?

On a Production Analysis Plot, you will draw the Process Reliability Line to identify your Reliability Loss Region. Datapoints below the Process Reliability Line help make up the Reliability Loss Region.

Typically, the Reliability Loss Region will show large variations in output that can be attributed to problems that impact the production process significantly, such as equipment and location failures, system shutdowns, and intentional cutbacks. For example, if you collect production output data daily and the system is shut down completely for five days during your collection period, then five datapoints will have near-zero values. These values should be easily distinguishable from the rest of the values in the Reliability Loss Region.

To calculate your Reliability Losses accurately, you may want to separate the datapoints associated with shutdowns from the datapoints where losses are attributed to actual equipment slowdowns or intentional cutbacks. You can use the breakpoint tool to separate the Reliability Loss Region into these categories. The breakpoints will be taken into account in calculations so that your Reliability Losses represent losses due to actual equipment and location problems. Breakpoints also can be used to identify areas of distinct change in output when you do not know the reason for the change.

Consider again our example of a [bottled water production process](#). In the following example, we have circled the datapoints associated with unplanned shutdowns due to uncontrollable issues (e.g., lack of raw material), where the production output is near zero.

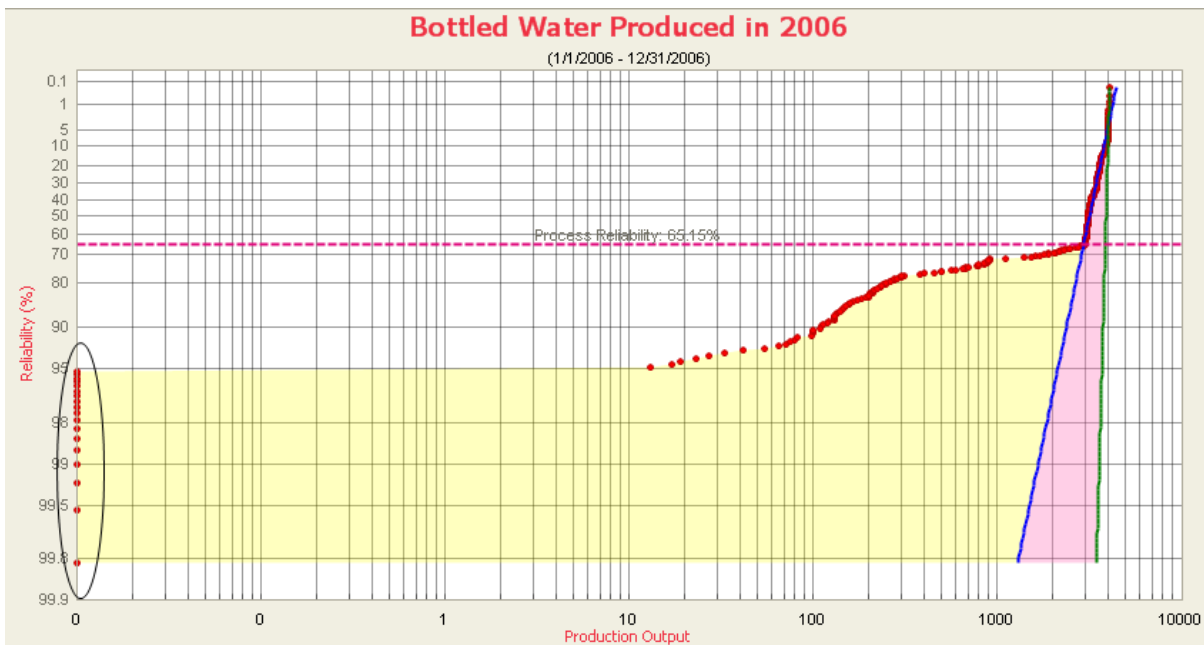

To separate this region from the rest of the reliability losses, we can [create a breakpoint](#) on the highest Reliability value within that distinct region. After the breakpoint has been

What is a Breakpoint?

created, Meridium APM automatically shades the different regions of production output.

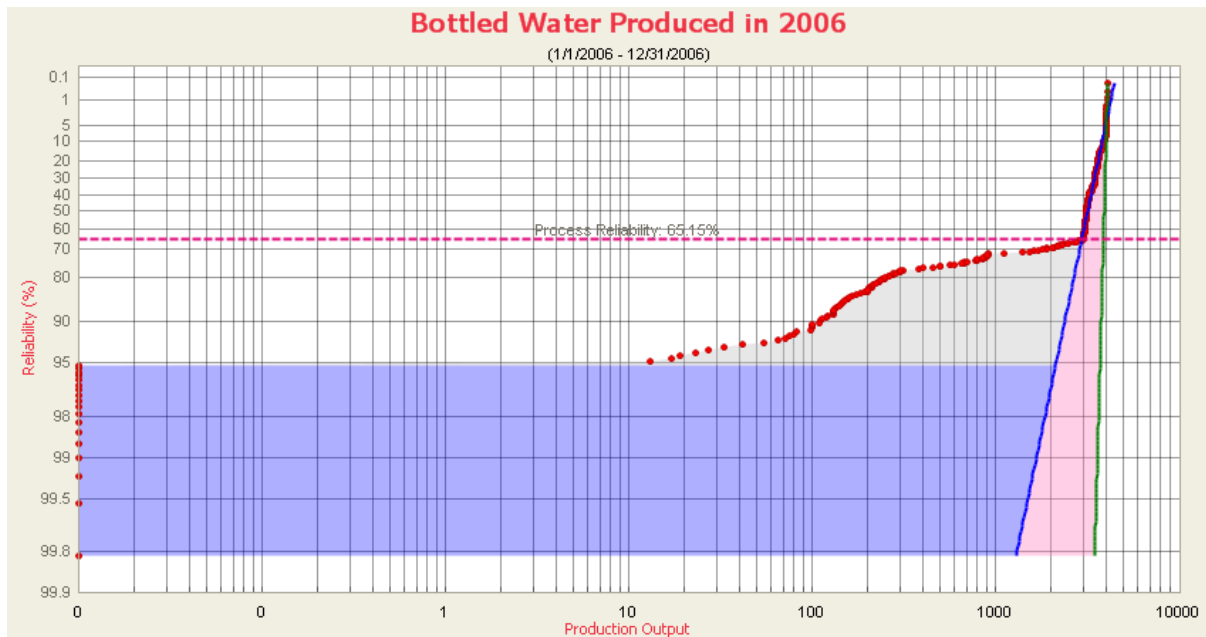

CE Hint: You can change the color of any region by right-clicking the shaded region and clicking **Set Region Color**. A color template window will appear where you can select the desired region color.

Now two shaded Reliability Loss regions are visible on the Production Analysis Plot. The gray area represents losses associated with unplanned and planned shutdowns, and the purple area represents the losses due to equipment and location failures and intentional cutbacks. All reliability losses will be calculated for *each* region and will appear as Sub Reliability Loss regions on the [Production Loss Regions](#) pane.

Note: You can [create more than one breakpoint](#) when your production output displays more than two regions of shutdowns, equipment and location failures, intentional cutbacks, or other unknown variations.

Creating a Breakpoint

To create a breakpoint for a Production Analysis:

1. On the [Production Analysis page](#), right-click the datapoint where you want to insert the breakpoint.

A shortcut menu appears.

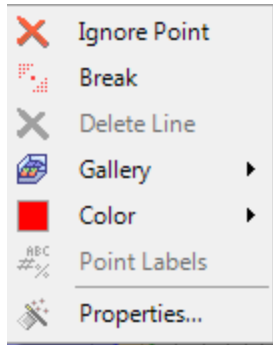

2. Click **Break**.

Meridium APM separates the **Reliability Loss** region into two shaded regions. The [Production Loss Regions pane](#) includes the values for the **Sub Reliability Loss** regions and the total **Reliability Loss** region.

3. Repeat steps 1 and 2 until all desired breakpoints have been created.

CEHint: If the datapoints are close together, you may need to zoom in before creating a breakpoint.

Removing a Breakpoint

To remove a breakpoint and the associated region:

1. On the [Production Analysis page](#), right-click the desired region.

A shortcut menu appears.

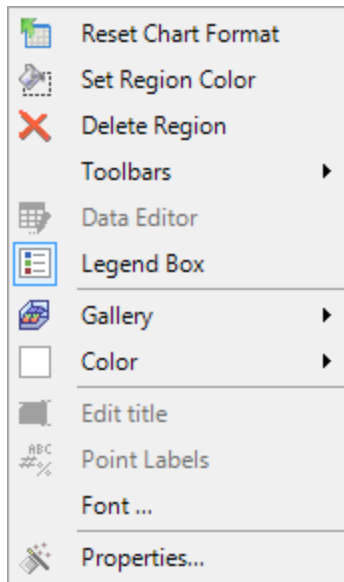

2. Click **Delete Region**.

The region is removed, along with the associated breakpoint.

CEHint: You can also delete a breakpoint by right-clicking on the desired datapoint and clicking **Break**. A box around the **Break** icon indicates that this is a breakpoint.

About the Edit Production Data Window

The [Edit Production Data window](#) allows you to view the data associated with a Production Analysis. Some of the fields on the **Edit Production Data** window correspond to [values that were used to create the analysis](#). For input fields:

- For an analysis based upon a query, the **Edit Production Data** window displays the information returned by the query.
- For an analysis based upon a dataset, the **Edit Production Data** window displays the information stored in the dataset.
- For an analysis based upon manually-entered data, the **Edit Production Data** window displays the information that you entered when you create the analysis.

Other fields show values that are calculated by the Meridium APM system and are read-only. All values in the **Edit Production Data** window are stored in the Production Data field in the Production Analysis record.

You can modify certain values via this window in order to update data. In most cases, however, you would not want to change the data unless there was an error in the original data source. Some values are calculated by the Meridium APM system and cannot be modified.

The following image shows an example of the **Edit Production Data** window.

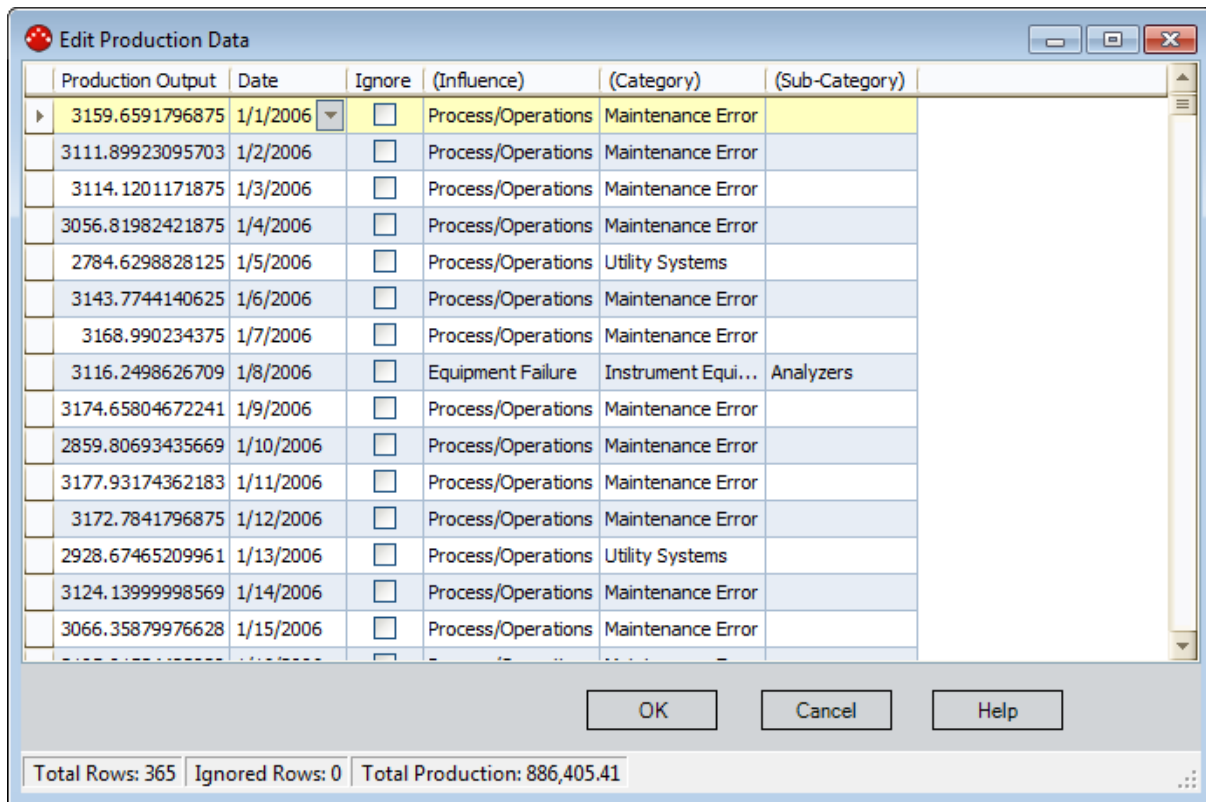

Data Mapped to the Edit Production Data Window

When you create a Production Analysis from a query or dataset, the **Production Analysis Builder** will prompt you to map values from columns in the query or dataset to certain values in the Production Analysis. The values that you select to map on the **Select Production Fields** screen in the **Production Analysis Builder** will then appear in the associated columns in the **Edit Production Data** window.

Note: If the analysis is based on a query or a dataset and contains additional columns that are not mapped to columns in the analysis dataset, those columns will appear in the **Edit Production Data** window with the column name in parentheses.

The following chart displays which columns are mapped from fields in the **Production Analysis Builder** to columns in the **Edit Production Data** window.

Production Analysis Builder Screen	Production Analysis Builder Field	Edit Production Data Window Column
Select Production Fields	Production Output	Production Output
Select Production Fields	Production Date	Date

Accessing the Production Data

To view and modify the production data:

- On the [Production Analysis page](#), click the **Edit Data** link on the [Analysis Tasks menu](#).

The **Edit Production Data** window appears.

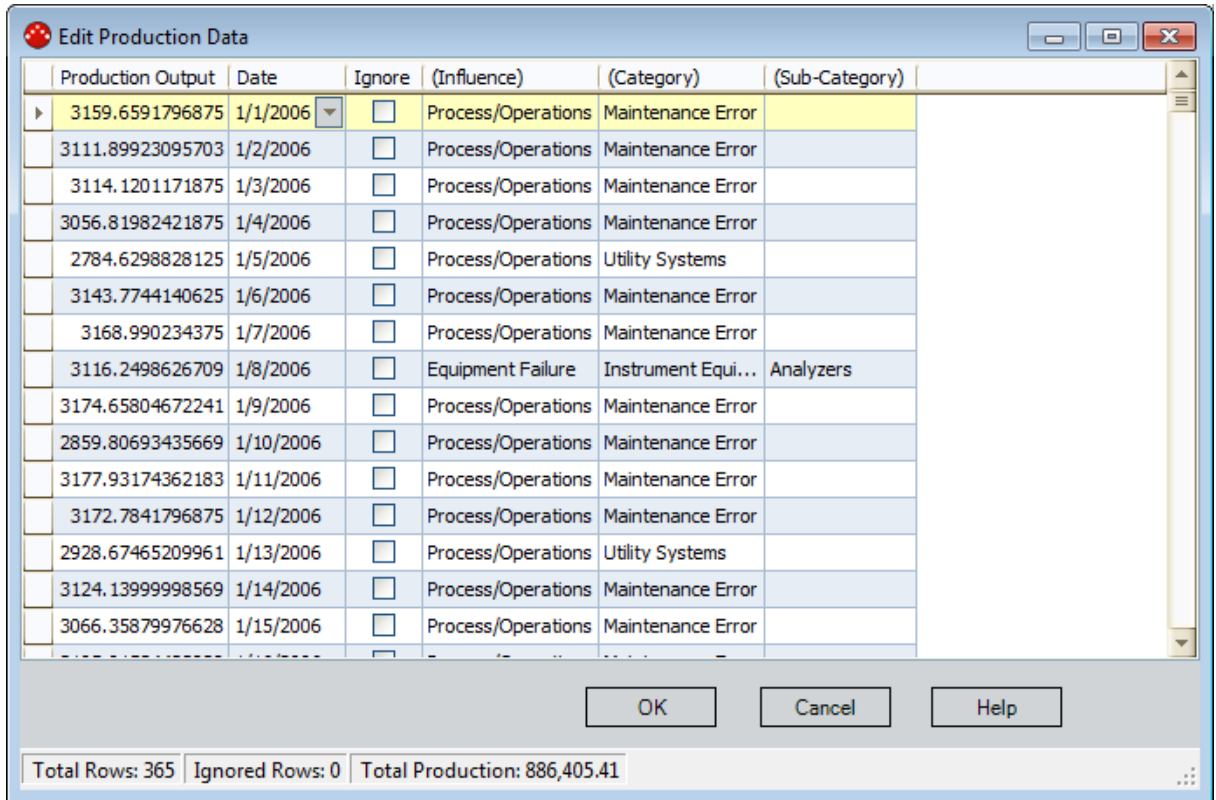

Aspects of the Edit Production Window

The **Edit Production Data** window displays columns that are specific to the fields in the query or the dataset. If there are any additional values that are not mapped to either the **Production Output** or **Date** column, they will appear in parentheses along the top of the grid.

Production Output	Date	Ignore	(Influence)	(Category)	(Sub-Category)
3159.6591796875	1/1/2006	<input type="checkbox"/>	Process/Operations	Maintenance Error	
3111.89923095703	1/2/2006	<input type="checkbox"/>	Process/Operations	Maintenance Error	
3114.1201171875	1/3/2006	<input type="checkbox"/>	Process/Operations	Maintenance Error	
3056.81982421875	1/4/2006	<input type="checkbox"/>	Process/Operations	Maintenance Error	
2784.6298828125	1/5/2006	<input type="checkbox"/>	Process/Operations	Utility Systems	
3143.7744140625	1/6/2006	<input type="checkbox"/>	Process/Operations	Maintenance Error	
3168.990234375	1/7/2006	<input type="checkbox"/>	Process/Operations	Maintenance Error	
3116.2498626709	1/8/2006	<input type="checkbox"/>	Equipment Failure	Instrument Equi...	Analyzers
3174.65804672241	1/9/2006	<input type="checkbox"/>	Process/Operations	Maintenance Error	
2859.80693435669	1/10/2006	<input type="checkbox"/>	Process/Operations	Maintenance Error	
3177.93174362183	1/11/2006	<input type="checkbox"/>	Process/Operations	Maintenance Error	
3172.7841796875	1/12/2006	<input type="checkbox"/>	Process/Operations	Maintenance Error	
2928.67465209961	1/13/2006	<input type="checkbox"/>	Process/Operations	Utility Systems	
3124.13999998569	1/14/2006	<input type="checkbox"/>	Process/Operations	Maintenance Error	
3066.35879976628	1/15/2006	<input type="checkbox"/>	Process/Operations	Maintenance Error	

OK Cancel Help

Total Rows: 365 Ignored Rows: 0 Total Production: 886,405.41

CEHint: You can sort the data on the **Edit Production Data** grid.

The following columns of information are displayed in the grid on the **Edit Production Data** window:

- **Production Output:** The production amounts you are using to create the analysis. This value is mapped from a query or dataset or manually entered when you create the analysis.
- **Date:** The date the corresponding production amount was record. This value is mapped from a query or dataset or manually entered when you create the analysis.
- **Ignore:** A value that indicates whether or not the data on the selected row is *ignored*, meaning excluded from the analysis calculations and plots. When *selected*, the data in the associated row will be excluded from the analysis. When *cleared*, data in the selected row will be included in the analysis. You can modify this value manually.

- **Total Rows:** The total number of rows in the **Edit Production Data** window.
- **Ignored Rows:** The total number of rows in the **Edit Production Data** window in which the **Ignore** check box is selected.
- **Total Production:** The sum of the values in the **Production Output** column.

Note: If you change any values in the **Edit Production Data** window, after you click **OK**, the changes will be reflected in your Production Analysis but will not be saved until you click the **Save** link on the **Common Tasks** menu. Also, if you change any values in the **Edit Production Data** window to 0 or negative values, after you click **OK**, if there were no prior 0 or negative values then the [Minimum Production Output dialog box](#) will appear.

Changing the Minimum Production Output

The Minimum Production Output is the value used to replace all zeros and negative numbers in the Production Analysis. When you create a new analysis, if the source data contains zeros or negative numbers, you will be prompted to specify a Minimum Production Output value. You will also be prompted to set the Minimum Production Output value if you modify or reload the data to contain zeros and negative numbers in an existing analysis that did not previously contain zeros or negative numbers. You can use the following instructions to modify the value that currently is saved with the analysis.

To change the Minimum Production Output:

1. On the [Production Analysis page](#), on the [Analysis Settings menu](#), click the **Min Production** link.

The **Minimum Production Output** dialog box appears. The **Min Production Output** value is set by default to the value that was selected when the analysis was last saved.

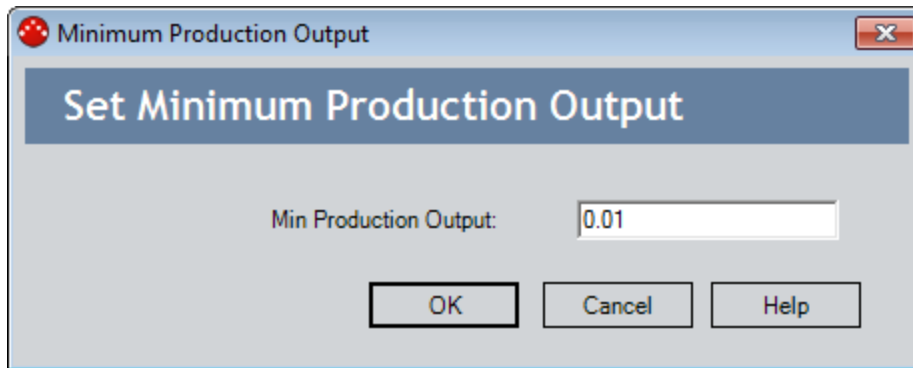

2. In the **Min Production Output** text box, type the value that you want to use to replace zeros and negative numbers.
3. Click **OK**.

The Production Analysis is generated with the new Minimum Production Output value.

4. On the [Common Tasks menu](#), click the **Save Analysis** or **Save Analysis As** link to save all changes.

Note: The **Min Production** link is always enabled, regardless of whether or not the production output data includes zero or negative values.

Changing the Unit of Measure

When viewing the results of a Production Analysis, the Production Output is characterized along the x-axis and in the **Production Loss Regions** pane. The unit of measure is taken into account for production data when the analysis is first created if the data is from a query. If the data is from a dataset or manually entered data, then there is no unit of measure associated with the Production Analysis and it has to be set. After the analysis exists, you can label the output for the production data with the appropriate unit by setting the unit of measure.

To set a unit of measure:

1. On the [Production Analysis page](#), on the [Analysis Settings menu](#), click the **Unit of Measure** link.

The **Unit of Measure** dialog box appears.

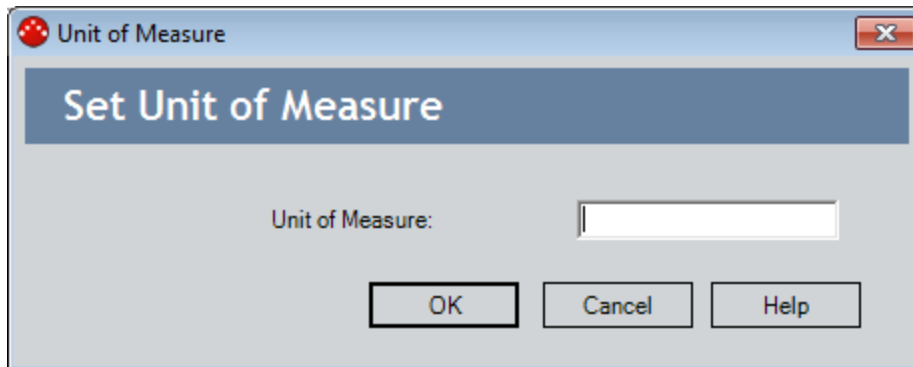

2. In the **Unit of Measure** text box, type the value that characterizes the unit of measure used to collect the data for the Production Analysis.
3. Click **OK**.

The Production Analysis is generated, and the unit of measure is displayed on the x-axis and on the [Production Loss Region pane](#) on the **Quantity** column header. Note that the values in the **Quantity** column change appropriately.

4. On the [Common Tasks menu](#), click the **Save Analysis** or **Save Analysis As** link to save all changes.

Changing the Margin Value

On the **Production Loss Regions** pane, the **Cost** column is displayed. The **Cost** represents the expense associated with the production loss. By default, Meridium APM assumes a one-to-one ratio of lost production to cost. For example, if your production loss data is recorded in tons, then Meridium APM assumes one dollar of cost for every ton of lost production. To make the Cost value accurate, you may want to change the default loss-to-cost ratio.

To change the Margin Value:

1. On the [Production Analysis page](#), on the [Analysis Settings menu](#), click the **Margin Value** link.

The **Margin Value** dialog box appears.

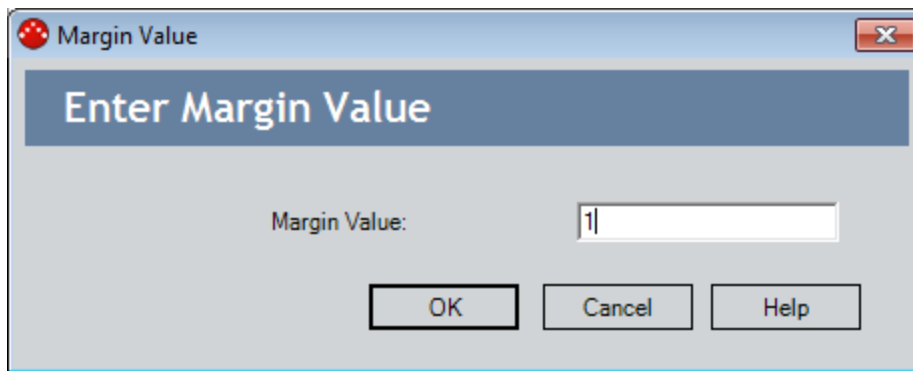

2. In the **Margin Value** text box, type the value by which Meridium APM will multiply the production loss to determine the cost. For example, if each ton of lost production costs two dollars, type **2** in the **Margin Value** text box.
3. Click **OK**.

The [Production Loss Regions pane](#) displays the new calculations for the Cost values.

4. On the [Common Tasks menu](#), click the **Save Analysis** or **Save Analysis As** link to save all changes.

Changing the Margin Currency

On the [Production Loss Regions pane](#), the **Cost** column that is displayed and represents the cost associated with the calculated production losses. For the cost calculations to be accurate, they must be displayed in the correct currency. If you want to modify the currency that is currently saved with the analysis, you can change it on the **Margin Currency** dialog box.

Note: When you create a new Production Analysis, if you are logged in as a user with a Meridium APM Culture setting that has an associated currency, the Margin Currency will be set by default to that currency and saved with the analysis. If you have no Meridium APM Culture setting defined, or if your Meridium APM Culture setting has no currency associated with it, the Margin Currency will be set by default to the currency associated with your Window Regional and Language Options. Other users will see the currency that was last saved with the analysis, regardless of their Meridium APM Culture or Windows Regional and Language Options settings.

To change the margin currency:

1. On the [Production Analysis page](#), on the [Analysis Settings menu](#), click the **Margin Currency** link.

The **Margin Currency** dialog box appears.

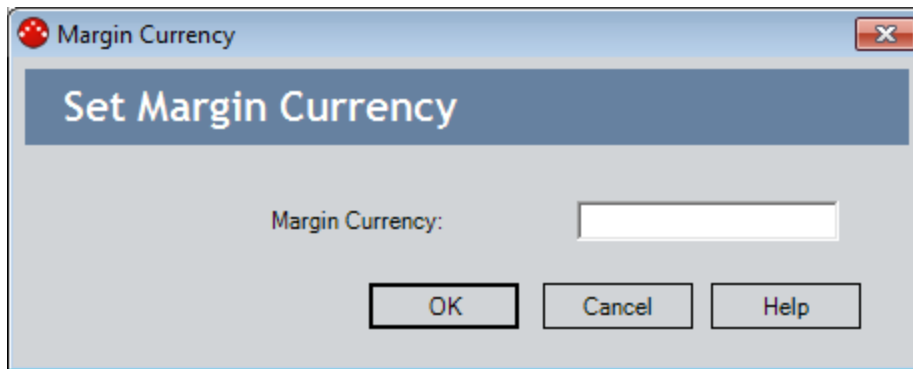

2. In the **Margin Currency** text box, type the desired currency code.
3. Click **OK**.

The [Production Loss Regions pane](#) displays the new currency code in the **Cost** column header.

4. On the [Common Tasks menu](#), click the **Save Analysis** or **Save Analysis As** link to save all changes.

About the Production Loss Regions Window

The [Production Loss Regions](#) pane can optionally appear on the Production Analysis page.

Name	Quantity (Tons x1000)	Cost (\$)
Total Loss	338,226.07	1,691,130
Reliability Loss	224,543.09	1,122,715
Sub Reliability Loss 65.60% ~ 95.71%	186,875.59	934,378
Sub Reliability Loss 95.71% ~ 99.81%	37,667.50	188,337
Efficiency/Utilization Loss	113,682.98	568,415

The **Production Loss Regions** pane displays the calculations that summarize your Reliability Losses and your Efficiency and Utilization Losses. The **Production Loss Regions** pane contains various rows, depending on which lines have been created on the analysis.

- **Total Loss:** The sum of the **Reliability Loss** and the **Efficiency/Utilization Loss**.
- **Reliability Loss:** The sum of the production loss is the region that lies between the Minimum Production Output value and the [Demonstrated Line](#), below the Process Reliability Line. If breakpoints exist, then the **Reliability Loss** is also the sum of all the **Sub Reliability Loss** regions.
- **Sub Reliability Loss:** For the first **Sub Reliability Loss** row, the sum of the losses between the Demonstrated Line and the first breakpoint, below the Process Reliability Line. For subsequent **Sub Reliability Loss** rows, the sum of the losses between the previous breakpoint and the next breakpoint, below the Process Reliability Line.

Note: **Sub Reliability Loss** rows will appear only if [breakpoints exist on the Production Analysis](#). The number of **Sub Reliability Loss** rows will correspond to the number of breakpoints that have been inserted.

Because all Reliability Losses are calculated below the Process Reliability Line, the values for the **Quantity** and **Cost** will change if you change the location of the Process Reliability Line.

- **Efficiency/Utilization Loss:** The sum of the production losses between the Demonstrated Line and the Nameplate Line.

For each row on the **Production Loss Regions** pane, the following columns are displayed:

- **Name:** The name of the production loss region.
- **Quantity:** A value representing the total production loss for each region. To specify the units used to calculate these losses, you can [change the unit of measure](#).

- **Cost:** A value representing the amount of profit that was lost due to the production loss in each region. This value is always rounded up to the nearest dollar. To specify the currency, you can [change the margin currency](#).

CEHint: To export the data from the **Production Loss Regions** pane, right-click the window and click **Copy Production Loss Regions Data**. After the values have been copied, they can be pasted into other applications, such as Microsoft Excel.

About the Production Lines Window

The [Production Lines pane can optionally appear](#) on the **Production Analysis** page.

Name	Beta	Eta
Demonstrated Line	17.7262	3162.5140
Nameplate Line	100.0000	3400.0000
Custom Line	50.0000	3160.0000

The **Production lines** pane contains various rows, depending on how many lines have been created. The color of each label corresponds to the color of the line on the analysis. For example, our [bottled water production process](#) has the following lines specified on the analysis, therefore:

- **Demonstrated:** The Demonstrated Line for the current analysis.
- **Custom:** The Custom Line that represents the projected goal in 2007 for the current analysis.
- **Nameplate:** The Nameplate Line for the current analysis.

For each row, the **Production Lines** pane provides the following columns:

- **Name:** The names of the production lines that exist in the analysis.
- **Beta:** The Beta value for the line. In a Production Analysis, the Beta value indicates how reliable the production process is. The closer the line is to vertical, the higher the Beta value. *A higher Beta value indicates less variation in the production process (more reliable); a lower Beta value indicates more variation in the production process (less reliable).* You can use the following general guidelines to evaluate the production process according to the Beta value.
 - **Beta = 5:** Large variation in production output; a very poor production process.
 - **Beta = 10:** Moderate variation in production output; a fair production process.
 - **Beta = 25:** Some variation in production output; a good production process.
 - **Beta = 50:** Minimal variation in production output; a very good production process.
 - **Beta = 100:** Only minor variations in production output; an excellent production process.
 - **Beta = 200:** Almost no variation in production output; an outstanding production process.

- **Eta:** The Eta value for the line. In a Production Analysis, the Eta value represents where the line crosses the y-axis at 36.8% Reliability.

You can manually change the Beta and Eta values by clicking in any Beta and Eta value field, deleting the current value, and defining a different one.

CEHint: To export the data from the **Production Lines** pane, right-click the window and click **Copy Production Lines Data**. After the values have been copied, they can be pasted into other applications, such as Microsoft Excel.

Hiding and Displaying the Production Analysis Details

The Production Analysis details appear automatically below the analysis after you [create a new Production Analysis](#). The analysis details are separated into the [Production Loss Regions pane](#) and [Production Lines pane](#).

To hide the Production Analysis details if they are currently displayed:

1. On the [Production Analysis page](#), on the **Analysis Settings** menu, click the **Show/Hide** link.

A submenu appears, displaying two options: [Production Lines](#) and [Production Regions](#). If a window is displayed, a check mark appears next to the window name.
2. Click the name of the window that you want to hide.

The submenu closes and the specified window is hidden. When the **Show/Hide** submenu is opened again, that option will not be selected.

To display the Production Analysis details when they are hidden:

1. On the [Production Analysis page](#), on the **Analysis Settings** menu, click the **Show/Hide** link.

A submenu appears, displaying two options: [Production Lines](#) and [Production Regions](#). If a window is displayed, a check mark appears next to the window name.
2. Click the name of the window that you want to show.

The submenu closes and the specified window appears. When the **Show/Hide** submenu is opened again, that option will be selected.

To move the Production Lines or Production Loss Regions pane:

- On the [Production Analysis page](#), click and drag the menu bar of the desired window to the area you want the window to be placed.

If you are [opening an existing Production Analysis](#), the details may or may not appear in another area of the analysis, depending on the last saved changes.

Ignoring Production Output Values

Certain production output may be inaccurate or invalid for your Production Analysis. For example, if there is a planned shutdown for three days, there will be three near-zero production output values that you will not want to include in the production loss calculations. You may want to include this data in your production data for record purposes, but you may not want it to affect the calculations of the reliability losses. In this case, you can ignore individual production output datapoints from the analysis.

You can ignore any datapoints for any reason. Keep in mind, however, that the goal is to ignore datapoints that would inaccurately skew your Reliability Loss calculations. For instance, you may want to ignore datapoints associated with planned shutdowns because they represent planned, intentional losses. You would not, however, want to ignore datapoints associated with unplanned shutdowns, which represent unplanned, reliability losses due to equipment and location problems.

To ignore datapoints from the analysis calculations:

1. On the [Production Analysis page](#), on the [Analysis Tasks menu](#), click the **Edit Data** link.

The [Edit Production Data grid](#) appears.

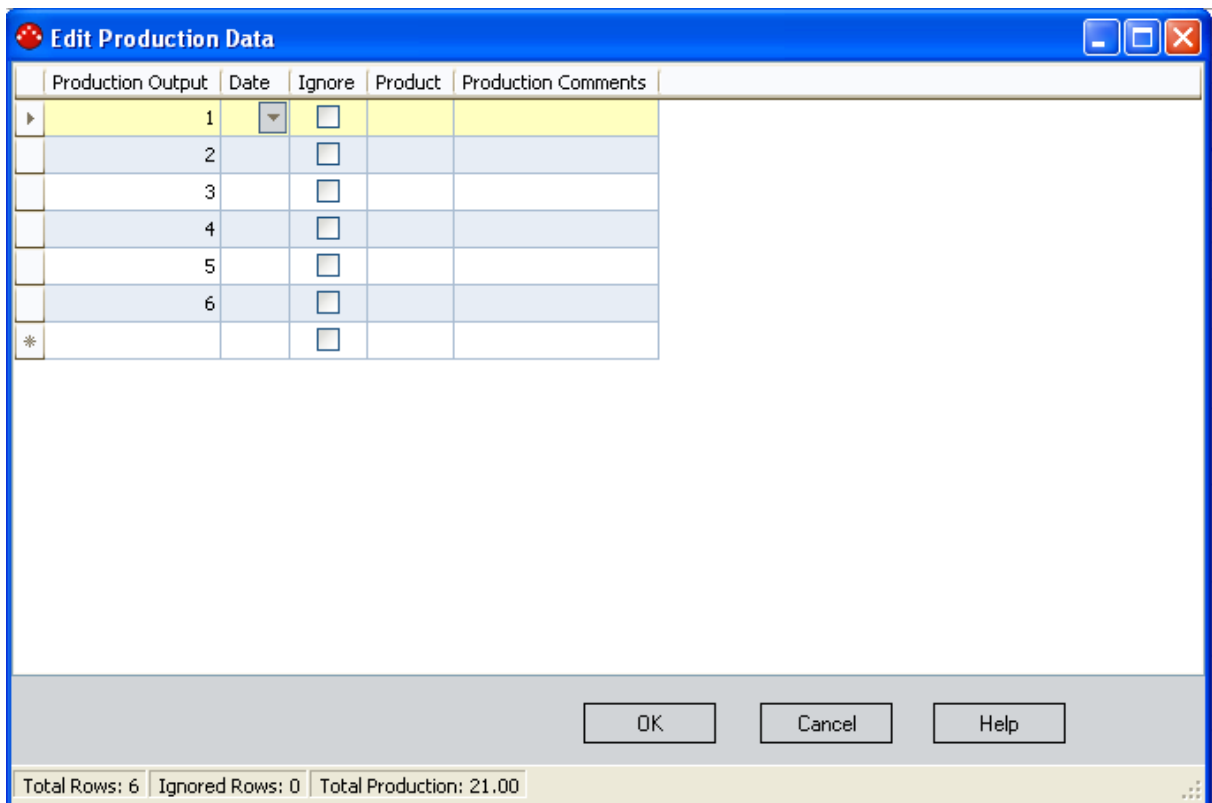

2. Locate the row containing the production data that you want to ignore.
3. In the **Ignore** cell of that row, select the check box.
4. Repeat these steps for any additional datapoints that you want to ignore.

Note: To include a datapoint for which the **Ignore** flag has been selected, clear the check box.

5. Click **OK**.

Meridium APM recalculates the losses on the [Production Loss Regions pane](#), taking the ignored datapoints into account. The ignored datapoints are still plotted on the analysis but are represented by an X.

CEHint: You can also right-click any datapoint and click **Ignore Point** to omit that datapoint from calculations.

Overview of the Production Analysis Report

The baseline Meridium APM database includes the Production Analysis Report, which you can use to view a summary of the results of a Production Analysis. When you run the Production Analysis Report, it will appear on the **Report Viewer** page.

The Production Analysis Report is built from the following Catalog items:

- The main report, *ProductionAnalysisReport*, which is stored in the Catalog folder \\Public\Meridium\Modules\Reliability Manager\SSRS.
- The subreport, *SubreportProductionAnalysis*, which is stored in the Catalog folder \\Public\Meridium\Modules\Reliability Manager\Reports.
- The supporting queries that supply data in the main report and subreport, which are stored in the Catalog folder \\Public\Meridium\Modules\Reliability Manager\Reports. The following supporting queries are available:
 - Production Analysis Query
 - *Production Analysis Query Lines*: Provides the information that is displayed in the [Analysis Summary](#), [Production Lines](#), [Production Weibull Plot](#), and [Production Data](#) sections of the Production Analysis Report.
 - *Production Analysis Query Regions*: Provides the information that is displayed in the [Production Loss Regions section](#) of the Production Analysis Report.

Throughout this documentation, we refer to the main report, the subreport, and the supporting queries collectively as the *Production Analysis Report*.

The Production Analysis Report contains a prompt on the ENTY_KEY field in the Production Analysis family. When you run the Production Analysis Report via the Production Analysis module, the ENTY_KEY of the Production Analysis record associated with the current analysis is passed automatically to the prompt, and the results for the current Production Analysis are displayed. If you run the main report or any of the queries in the preceding list directly from the Catalog, however, you will need to supply the ENTY_KEY of a Production Analysis record manually to retrieve results. The subreport (i.e., Catalog item *SubreportProductionAnalysis*) cannot be run directly from the Catalog.

The Production Analysis Report contains the following sections:

- [Analysis Summary](#)
- [Production Lines](#)
- [Production Loss Regions](#)
- [Production Weibull Plot](#)
- [Production Data](#)

Running the Production Analysis Report

You can run the Production Analysis Report to view a summary of the results of a Production Analysis.

To run the Production Analysis Report:

1. On the [Production Analysis page](#), on the **Analysis Tasks** menu, click the **Generate Report** link.

The **Report Options** dialog box appears. The following image shows what the **Report Options** dialog box looks like by default.

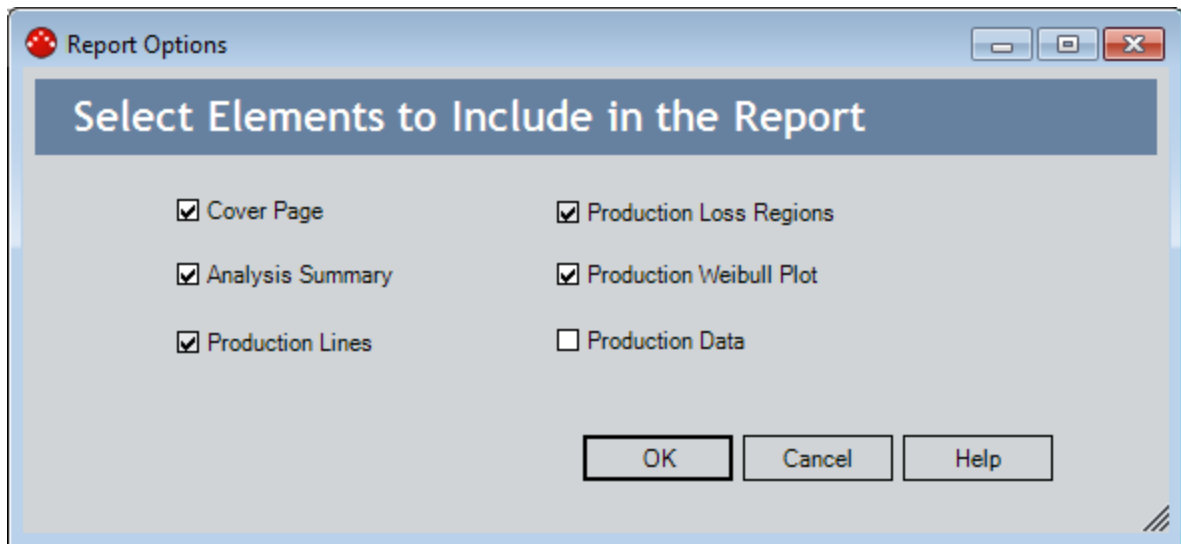

2. Select the desired elements to be included in the report, and click **OK**.
The Production Analysis Report appears on the **Report Viewer** page.

Analysis Summary Section

The **Analysis Summary** section of the Production Analysis Report displays information that is stored in the Production Analysis record.

Analysis Summary	
Analysis Name:	2006 Unit 19 Production
Analysis Description:	Production Analysis for Unit 19
Analysis Start Date:	1/1/2006
Analysis End Date:	12/31/2006
Process Reliability:	53.28%
Total Data Points:	365
Ignored Data Points:	0
Min Production:	0.01
Unit of Measure:	Tons x1000
Margin:	\$ 5
Last Modified:	11/3/2011
Modified By:	Administrator,Meridium

The following table lists each item in the **Analysis Summary** section and the corresponding Production Analysis record field whose data is displayed in the report.

Report Item	Production Analysis Field
Analysis Name	Analysis ID
Analysis Description	Short Description
Analysis Start Date	Analysis Start Date
Analysis End Date	Analysis End Date
Process Reliability	Pro Reliability
Total Data Points	Total Points
Ignored Data Points	Ignored Points
Min Production	Min Production
Unit of Measure	Unit of Measure

Report Item	Production Analysis Field
Margin	Margin Value
Last Modified	LAST_UPDT_DT
Modified By	LAST_UPBY_SEUS_KEY <div data-bbox="683 453 1341 579" style="border: 1px solid black; background-color: #ffffcc; padding: 5px;">Note: The name of the Security User associated with this value is displayed in the report.</div>

Production Lines Section

The **Production Lines** section of the Production Analysis Report contains a grid that displays information that is stored in the Weibull records that are linked to the Production Analysis record. Each row in the grid represents one Weibull record that is linked to the Production Analysis record.

Production Lines				
Name	Beta	Eta	R ²	Goodness of Fit
Demonstrated Line	2.80	4.52	1.00	True
Nameplate Line	7.14	5.92		

The following table lists each column in the grid in the **Production Lines** section and the corresponding Weibull record field whose data is displayed in the report.

Column	Weibull Field
Name	Analysis ID
Beta	Beta
Eta	Eta
R ²	R-Squared
Goodness of Fit	Passed

Production Loss Regions Section

The **Production Loss Regions** section of the Production Analysis Report contains a grid that displays information that is stored in the Production Losses records that are linked to the Production Analysis record. Each row in the grid represents one Production Losses record that is linked to the Production Analysis record.

Production Loss Regions				
Name	Region Start	Region End	Quantity	Cost
Total Loss			1,365,881.22	1,365,881
Reliability Loss	55.65%		172,266.65	172,267
Sub Reliability Loss	55.65%	82.57%	52,511.37	52,511
Sub Reliability Loss	82.57%	91.61%	63,589.09	63,589
Sub Reliability Loss	91.61%	93.80%	15,530.59	15,531
Sub Reliability Loss	93.80%	97.63%	26,475.09	26,475
Sub Reliability Loss	97.63%	99.81%	14,160.51	14,161
Efficiency/Utilization Loss			1,193,614.58	1,193,615

The following table lists each column in the grid in the **Production Loss Regions** section and the corresponding Production Losses record field whose data is displayed in the report.

Column	Production Losses Field
Name	Losses Type
Region Start	Area Start
Region End	Area End
Quantity	Production Losses
Cost	Losses Cost

Production Weibull Plot Section

The **Production Weibull Plot** section of the Production Analysis Report displays the Production Weibull Plot that is displayed on the [Production Analysis page](#).

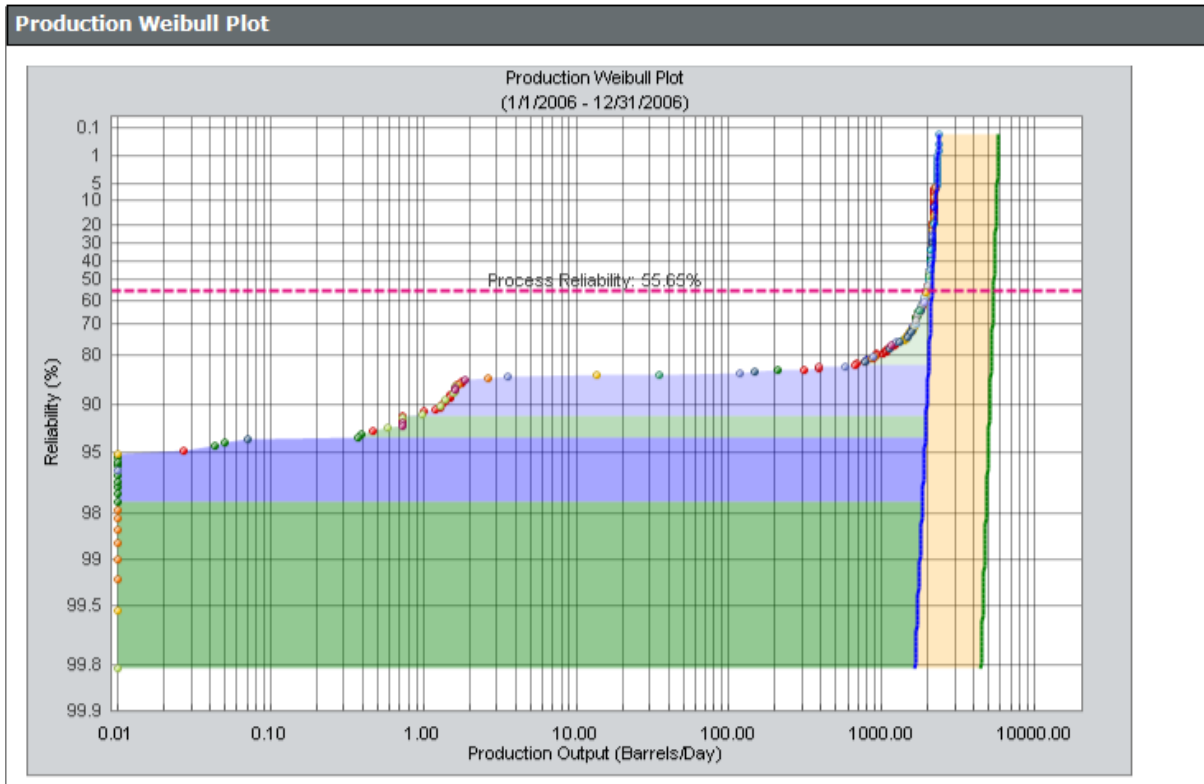

Production Data Section

The **Production Data** section of the Production Analysis Report contains a grid that displays information that is stored in the Production Data field in the Production Analysis record.

Production Data		
Production Output	Date	Ignored
2106.44	1/1/2006	False
2074.60	1/2/2006	False
2076.08	1/3/2006	False
2037.88	1/4/2006	False
1856.42	1/5/2006	False
2095.85	1/6/2006	False
2112.66	1/7/2006	False
2077.50	1/8/2006	False
2116.44	1/9/2006	False
1906.54	1/10/2006	False
2118.62	1/11/2006	False
2115.19	1/12/2006	False
1952.45	1/13/2006	False
2082.76	1/14/2006	False

The following columns of information are displayed in the grid in the **Production Data** section. The values displayed in these columns are stored in the Production Data field in the Production Analysis record:

- **Production Output**
- **Date**
- **Ignored**

Results of a Production Analysis

After you have [created your Production Analysis](#), defined your [production lines](#), defined a [Process Reliability Line](#), created any desired [breakpoints](#), and customized the analysis to your liking, you can interpret the results to determine where to take corrective actions. Consider the following completed Production Analysis for our [bottled water process](#).

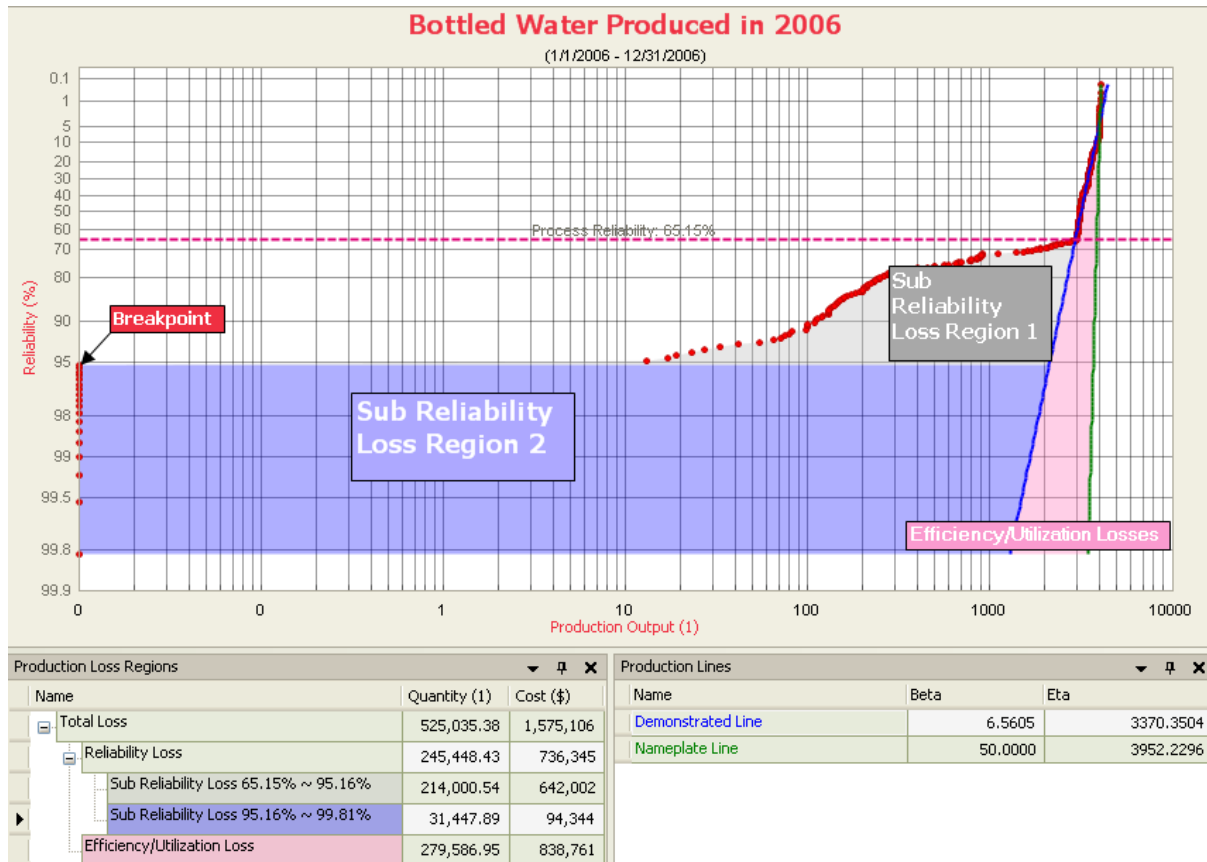

In the previous image, we have labeled three shaded regions:

- **Sub Reliability Loss Region 1** (gray): The area between the first datapoint *above* the breakpoint datapoint and the Demonstrated Line, below the Process Reliability Line. This represents the production from all unintentional equipment slowdowns and intentional cutbacks.
- **Sub Reliability Loss Region 2** (purple): The area between the breakpoint datapoint *below* the breakpoint datapoint and the Demonstrated Line, below the Process Reliability Line. This represents the production from all intentional and unintentional shutdowns.
- **Efficiency/Utilization Losses** (pink): The area between the Demonstrated Line (blue) and the Nameplate Line (green).

Each area represents the production losses associated with the corresponding set of datapoints. The losses are calculated and appear on the [Production Loss Regions pane](#). In the following table, we list our losses from *least* to *greatest*.

Region	Quantity Lost	Cost
Efficiency/Utilization Losses	279,586.89	\$838,762
Sub Reliability Loss Region 1	214,000.54	\$642,002
Sub Reliability Loss Region 2	31,447.89	\$94,344

Note: The shaded regions in the plot can sometimes be misleading. For example, in this case the **Sub Reliability Loss Region 2** is the largest region on the graph. If you look at the loss calculations, however, this region is associated with the second *least* amount of loss. You should always refer to the loss calculations to determine which region is responsible for the highest loss.

The loss calculations can help you determine where to focus your attention to make improvements. You should focus *first* on the area that is responsible for the *greatest* amount of loss.

Many companies automatically focus their attention on equipment and location failures. In this example, however, equipment and location reliability problems account for *less* loss than process problems. Therefore, in this case, we should focus on improving the process before we focus on improving equipment and location reliability. The analysis indicates that even if we repair the equipment, we will probably still experience losses due to process problems.

If, as in our example, your analysis indicates that you should focus on correcting process problems, the steps you take will vary, depending upon the process itself and what you suspect the problems to be. For example, if we suspect that poor employee performance is the cause of our process problems, attempts at lowering the process problems for our bottled water process example might begin with monitoring the employees and possibly creating individual Production Analyses with production output for each employee every month. Also, we might ask a manager to monitor the work of our employees and report any observed problems. Employees might need to be replaced based on production numbers and observations. This would be the first step in helping us achieve our stretch goal for the end of 2007.

If, on the other hand, the analysis indicated that equipment and location problems were responsible for the *greatest* production loss, then conducting a Reliability Distribution Analysis on the piece of equipment or location may be useful to predict the next Time to Failure and make repairs or replacements before failures occur.

What is a Spares Analysis?

Meridium APM Reliability Analytics offers various tools that help you analyze the reliability of your equipment and locations so that you can make decisions about when to repair and replace those pieces of equipment and locations. For example, a Reliability Distribution Analysis lets you analyze historical failure data to help predict future failures. Based upon those predictions, you can make plans for replacing equipment and making repairs to prevent future failures. As part of making plans to replace equipment in the future, you will want to make sure that you have an adequate number of spare parts available. Having spare parts on hand will help reduce the amount of downtime associated with unplanned failures.

The key to a successful spares program is maintaining a balance between:

- Optimizing the spares level so that you have enough spare parts to handle unplanned failures.
- Not having a surplus of parts that are not actually needed.

To help you maintain the optimal number of spare parts, Meridium APM provides Spares Analysis, which is a tool that uses delivery time and cost, downtime, lost production costs, and failure and repair data to calculate how many spare parts should be kept on hand at any given time.

You can modify the input data for a Spares Analysis to evaluate the potential savings or losses associated with changing the spares level. For example, if you currently keep three spare seals for a pump, you could use a Spares Analysis to determine whether it would benefit your company financially to store either more or fewer spare seals instead.

After [creating a Spares Analysis](#), you can:

- [Run a Monte Carlo simulation](#).
- View the cost differences between spare levels on the [Spares Analysis plots](#).
- View the results of the Monte Carlo simulation in a dataset.
- [Export a log of events](#) from the Monte Carlo simulation to a text file.

Spares Analysis Workflow

To create a full Spares Analysis, you need to complete each step in the following workflow:

1. [Create a Spares Analysis record](#). The Spares Analysis record contains data about the analysis.
2. [Create a Spare record](#). The Spare record contains data about the spare part that you want to analyze.
3. [Create a Spare Application record](#). The Spare Application record contains the failure and repair data for the spare part that you want to analyze.
4. [Create a Spare Application Population record](#). The Spare Application Population record contains age data for the equipment that contains the spare part that you are analyzing.
5. [Run the Monte Carlo simulation](#) to calculate analysis results.
6. [View the results of the Monte Carlo simulation](#).

After these initial steps have been performed, you can modify existing records, add additional records, rerun the Monte Carlo simulation, and view the updated results as needed.





















Example of a Spares Analysis

To make this documentation easier to follow and to help explain how Spares Analyses can be used to evaluate spare parts, in this topic, we provide an example of a Spares Analysis that analyzes the spare parts associated with a group of equipment. We will refer to this example throughout the Spares Analysis documentation as necessary.

For our example, we will create a Spares Analysis for a group of pumps, which contain seals, bearings, and impellers, each of which can fail. Because we may need to replace seals, bearings, and impellers on the pumps when they fail, we want to use a Spares Analysis to determine the optimal level for each spare part. Currently, one spare seal, one spare bearing, and no spare impellers are stored in the warehouse. By conducting a Spares Analysis, we can determine if this number of spare parts is appropriate.

In the Spares Analysis, we will include failure data for each part of the pump, run the Monte Carlo simulation, and then view the plots to see the optimal level of each spare part. By implementing the recommended spare level, we will be able to limit the amount of downtime and reduce failure costs.

The following records will be defined for our Spares Analysis example. Note that data that exists within each record in the Spares Analysis example can be found in the [Spares Analysis Example Data](#) tables.

-  **Spares Analysis Example** (Spares Analysis record)
-  **Seals** (Spare record)
-  **Indoor Application** (Spare Application record)
-  **Indoor Population 1** (Spare Application Population record)
-  **Indoor Population 2** (Spare Application Population record)
-  **Outdoor Application** (Spare Application record)
-  **Outdoor Population 1** (Spare Application Population record)
-  **Bearings** (Spare record)
-  **Outdoor Population 2** (Spare Application Population record)
-  **Outdoor Population 3** (Spare Application Population record)
-  **Indoor Population 2** (Spare Application Population record)
-  **Outdoor Application** (Spare Application record)
-  **Outdoor Population 1** (Spare Application Population record)
-  **Impellers** (Spare record)
-  **Outdoor Population 2** (Spare Application Population record)
-  **Outdoor Population 1** (Spare Application Population record)
-  **Outdoor Population 3** (Spare Application Population record)
-  **Pump Population 2** (Spare Application Population record)
-  **Pump Population 3** (Spare Application Population record)
-  **Pump Population 4** (Spare Application Population record)

Spares Analysis Example Data

The following topics contain details on the specific data that is used in our Spares Analysis example:

- [Spare Analysis Record Data](#)
- [Spare Record Data](#)
- [Spare Application Record Data](#)
- [Spare Application Population Record Data](#)

Spare Analysis Record Data

The following table shows the data stored in the Spares Analysis record for our Spares Analysis example.

Record	Section	Values Specified
Spares Analysis Example	Analysis	Name: Spares Analysis Example Description: This is a sample Spares Analysis example. Simulation Start Date: 1/1/2008 Simulation End Date: 1/1/2018 Currency: \$
Spares Analysis Example	Simulation Options	Number of Iterations: 100 Random Seed: No Enable Event Log: No

Spare Record Data

The following table shows the data stored in the Spare records that are included in our Spares Analysis example.

Record	Section	Values Specified
Seals	Spare	Name: Seals On-Site Delivery Time: 4 Hours Normal Order Time: 25 Days Normal Cost: 100 Expedited Order Time: 3 Days Expedited Cost: 300 Holding Cost Rate: 20 per Year Min Inventory Level: 0 Max Inventory Level: 10 Current Holding Level: 1
Bearings	Spare	Name: Bearings On-Site Delivery Time: 4 Hours Normal Order Time: 25 Days Normal Cost: 100 ExpeditedOrderTime: 3 Days Expedited Cost: 300 Holding Cost Rate: 20 per Year Min Inventory Level: 0 Max Inventory Level: 10 Current Holding Level: 1

Spare Record Data

Record	Section	Values Specified
Impellers	Spare	<p>Name: Impellers</p> <p>On-Site Delivery Time: 4 Hours</p> <p>Normal Order Time: 25 Days</p> <p>Normal Cost: 100</p> <p>Expedited Order Time: 3 Days</p> <p>Expedited Cost: 300</p> <p>Holding Cost Rate: 20 per Year</p> <p>Min Inventory Level: 0</p> <p>Max Inventory Level: 10</p> <p>Current Holding Level: 0</p>

Spare Application Record Data

The following table shows the data stored in the Spare Application record that are included in our Spares Analysis example.

Section	Values Specified
Seals - Indoor Application	
Application	Name: Indoor Application
Failure Distribution	Distribution Name: Failure Distribution Distribution Description: Manually entered based on manufacturer data. Units: Months Distribution Type: Exponential MTBF: 60
Failure Consequence	Preparation Time: 4 Hours Repair Time: 8 Hours Total Correction Time: 12 Hours Labor Cost: 1000 Fixed Lost Production Cost: 0 Variable: Lost Production Cost Rate: 100000 per Day # of Required Spares: 1
Preventive Maintenance	Enable Preventive Maintenance: No Time-based Replacement Interval: No Labor Cost: No Downtime: No
Seals - Outdoor Application	
Application	Name: Outdoor Application

Section	Values Specified
Failure Distribution	<p>Distribution Name: Failure Distribution</p> <p>Distribution Description: Manually entered based on manufacturer data.</p> <p>Units: Months</p> <p>Distribution Type: Exponential</p> <p>MTBF: 48</p>
Failure Consequence	<p>Preparation Time: 4 Hours</p> <p>Repair Time: 8 Hours</p> <p>Total Correction Time: 12Hours</p> <p>Labor Cost: 1000</p> <p>Fixed Lost Production Cost: 0</p> <p>Variable: Lost Production Cost Rate: 100000perDay</p> <p># of Required Spares: 1</p>
Preventive Maintenance	<p>Enable Preventive Maintenance: No</p> <p>Time-based Replacement Interval: No</p> <p>Labor Cost: No</p> <p>Downtime: No</p>
Bearings - Indoor Application	
Application	<p>Name: IndoorApplication</p>
Failure Distribution	<p>Distribution Name: FailureDistribution</p> <p>Distribution Description: Manuallyentered based on manufacturer data.</p> <p>Units: Months</p> <p>Distribution Type: Exponential</p> <p>MTBF: 60</p>

Section	Values Specified
Failure Consequence	Preparation Time: 4Hours Repair Time: 4 Hours Total Correction Time: 8Hours Labor Cost: 500 Fixed Lost Production Cost: 0 Variable: Lost Production Cost Rate: 100000perDay # of Required Spares: 1
Preventive Maintenance	Enable Preventive Maintenance: No Time-based Replacement Interval: No Labor Cost: No Downtime: No
Bearings - Outdoor Application	
Application	Name: OutdoorApplication
Failure Distribution	Distribution Name: FailureDistribution Distribution Description: Manually entered based on manufacturer data. Units: Months Distribution Type: Exponential MTBF: 48
Failure Consequence	Preparation Time: 4Hours Repair Time: 4Hours Total Correction Time: 8Hours Labor Cost: 500 Fixed Lost Production Cost: 0 Variable: Lost Production Cost Rate: 100000perDay # of Required Spares: 1

Section	Values Specified
Preventive Maintenance	Enable Preventive Maintenance: No Time-based Replacement Interval: No Labor Cost: No Downtime: No
Impellers - All Applications	
Application	Name: AllApplications
Failure Distribution	Distribution Name: FailureDistribution Distribution Description: Manually entered based on manufacturer data. Units: Months Distribution Type: Exponential MTBF: 72
Failure Consequence	Preparation Time: 4Hours Repair Time: 4Hours Total Correction Time: 8Hours Labor Cost: 500 Fixed Lost Production Cost: 0 Variable: Lost Production Cost Rate: 100000perDay # of Required Spares: 1
Preventive Maintenance	Enable Preventive Maintenance: No Time-based Replacement Interval: No Labor Cost: No Downtime: No

Spare Application Population Record Data

The following table shows the data stored in the Spare Application Population records that are included in our Spares Analysis example.

Population Name	Values Specified
Seals - Indoor Application	
Indoor Population 1	Population Size: 2 Age Value: 2 Years
Indoor Population 2	Population Size: 1 Age Value: 4 Years
Seals - Outdoor Application	
Outdoor Population 1	Population Size: 4 Age Value: 2Years
Outdoor Population 2	Population Size: 2 Age Value: 3Years
Outdoor Population 3	Population Size: 1 Age Value: 5Years
Bearings - Indoor Application	
Indoor Population 1	Population Size: 2 Age Value: 2Years
Indoor Population 2	Population Size: 1 Age Value: 4Years
Bearings - Outdoor Application	
Outdoor Population 1	Population Size: 4 Age Value: 2Years
Outdoor Population 2	Population Size: 2 Age Value: 3Years
Outdoor Population 3	Population Size: 1 Age Value: 5Years

Spare Application Population Record Data

Population Name	Values Specified
Impellers - All Applications	
Pump Population 1	Population Size: 6 Age Value: 2Years
Pump Population 2	Population Size: 1 Age Value: 4Years
Pump Population 3	Population Size: 2 Age Value: 3Years
Pump Population 4	Population Size: 1 Age Value: 5Years

Accessing the List of Spares Analyses

To access the list of existing Spares Analyses:

- On the [Reliability Analytics Start Page](#), click the **Spares Analysis** link.

Meridium APM runs the Spares query and displays the results on the **Select a Spares Analysis from the List** page.

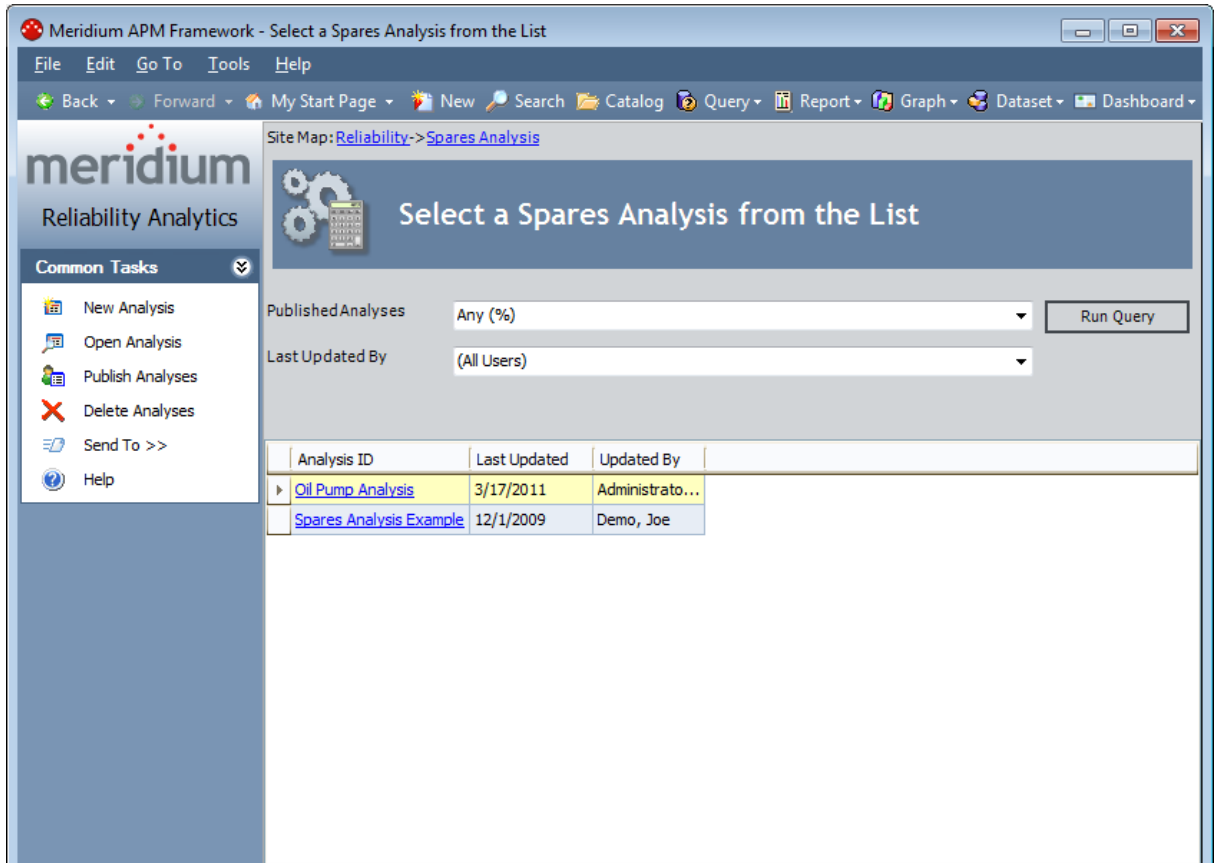

Aspects of the List of Spares Analyses

The **Select a Spares Analysis from the List** page lets you run the Spares query to view a list of existing Spares Analyses that meet your query criteria.

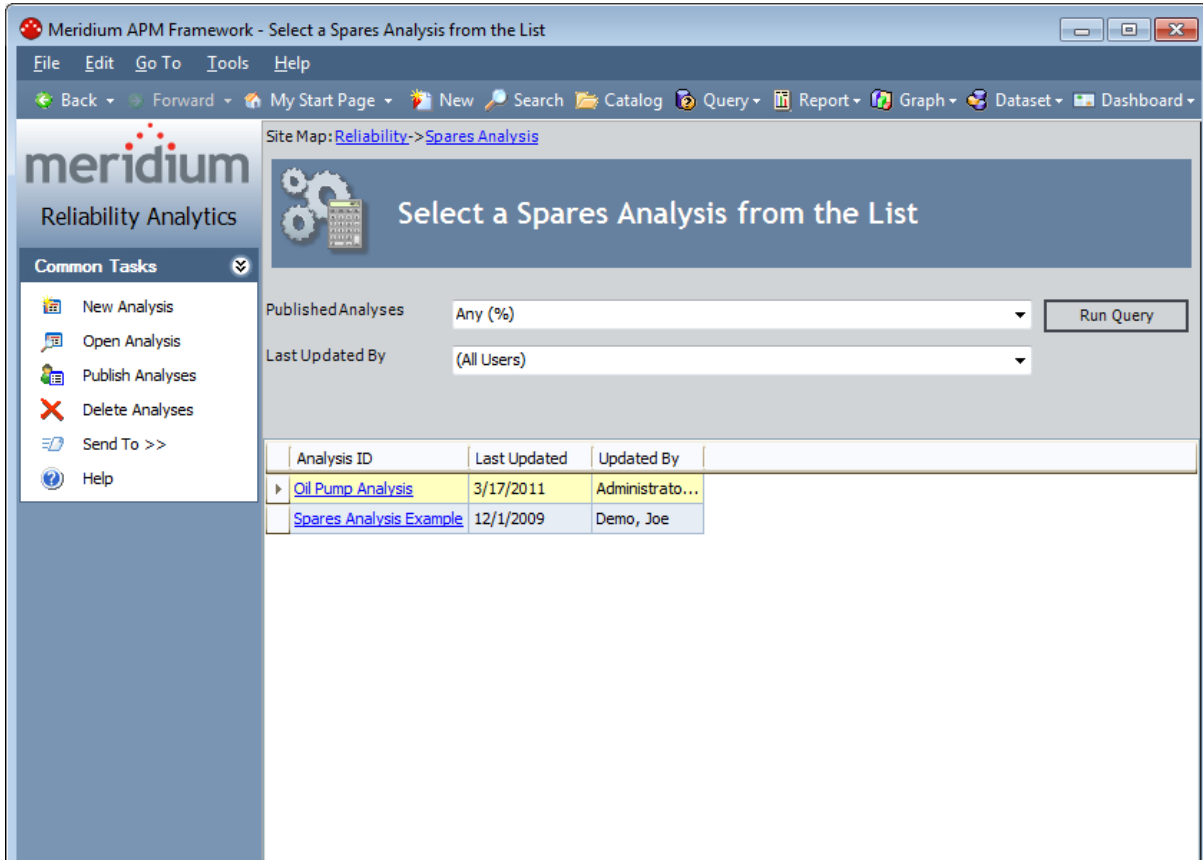

Analysis ID	Last Updated	Updated By
Oil Pump Analysis	3/17/2011	Administrato...
Spares Analysis Example	12/1/2009	Demo, Joe

The Spares query is stored in the following Catalog folder: \\Public\Meridium\Modules\Reliability Manager\Analyses. The baseline Spares query contains two prompts: **Published Analyses** and **Last Updated By**. These prompts appear at the top of the page as drop-down lists that contain various options.

The **Published Analyses** list contains the following options:

- **Any (%):** Will cause the query to return all Spares Analyses, either published or unpublished.
- **Yes (Y):** Will cause the query to return only published Spares Analyses.
- **No (N):** Will cause the query to return only unpublished Spares Analyses.

The **Last Updated By** list contains the following options:

- Your user name, which is selected by default and will cause the query to return only the Spares Analyses that were last updated by you.
- The user name of any user who last updated any Spares Analysis, which will cause

the query to return only the Spares Analyses that were last updated by that user.

- The **[All Users]** option, which will cause the query to return a list of Spares Analyses updated by any user.

Each time you access the **Select a Spares Analysis from the List** page, the values that appear by default in the prompts will be used to filter the list. After you select different criteria, you can click the **Run Query** button to run the Spares query and display the results in a grid at the bottom of the page.

Note: Although the results are returned by the Spares query, query page size is ignored. The entire list of analyses is displayed at once.

The default Spares query is configured to display the following columns of information: **Analysis ID**, **Last Updated**, and **Updated By**. You can click any hyperlinked analysis ID to view the **Spares Analysis** page.

CEHint: If desired, you can customize the column display.

Common Tasks Menu

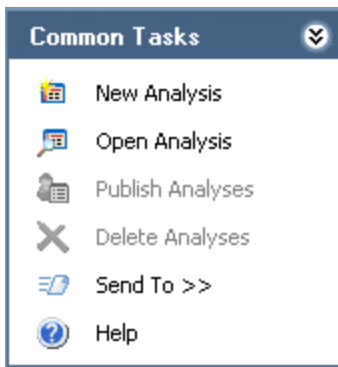

The **Common Tasks** menu on the **Select a Spares Analysis from the List** page contains the following links:

- **New Analysis:** Displays the **Spares Analysis** page, where you can begin [creating a new Spares Analysis](#).
- **Open Analysis:** Opens the **Find Items** window, which lets you search for an existing Spares Analysis and open it on the **Spares Analysis** page.
- **Publish Analyses:** [Publishes](#) the selected analysis or analyses. If you select one or more analyses that are already published, this link will read **Unpublish Analyses** and will [unpublish](#) the selected analyses.
- **Delete Analyses:** Deletes the analysis that is currently displayed.
- **Send To:** Displays a submenu with options that let you provide a link to the current page on your desktop (create shortcut), in an email message, or on a Home Page.
- **Help:** Displays the context-sensitive Help topic for the **Select a Spares Analysis from the List** page.

Opening an Existing Spares Analysis

To open an existing Spares Analysis:

1. On the [Select a Spares Analysis from the List page](#), in the **Published Analyses** list, select one of the following options:
 - **Any(%)**: Will cause the query to return all Spares Analyses, either published or unpublished.
 - **Yes(Y)**: Will cause the query to return only published Spares Analyses.
 - **No(N)**: Will cause the query to return only unpublished Spares Analyses.
2. In the **Last Updated By** list, select the user who last modified the Spares Analysis that you want to open. Note that you can select the **(All Users)** option, which will cause the query to return a list of Spares Analyses that were updated by any user.
3. Click the **Run Query** button.

The Meridium APM system runs the Spares query and displays the results in the grid in the main display area.

Site Map: [Reliability](#)->[Spares Analysis](#)



Select a Spares Analysis from the List

PublishedAnalyses:

Last Updated By:

Analysis ID	Last Updated	Updated By
Oil Pump Analysis	3/17/2011	Administrator, Meridium
Spares Analysis Example	12/1/2009	Demo, Joe

4. In the **Analysis ID** column, click the hyperlinked analysis ID of the analysis that you want to open.

The [Spares Analysis page](#) appears.

Opening an Existing Spares Analysis

Meridium APM Framework - Spares Analysis - Spares Analysis Example

File Edit Go To Tools Help

Back Forward My Start Page New Search Catalog Query Report Graph Dataset Dashboard

meridium Reliability Analytics

Spares Analysis

Tools

- Run Simulation
- Export Results
- Generate Report
- View Recommen...

Navigation

- Analysis Definition
- Spare Level Plot
- Downtime Plot
- Spare Usage Plot
- Sensitivity Plot
- Optimal Holding ...

Common Tasks

- New Analysis
- Open Analysis
- Save Analysis
- Save Analysis As
- Publish Analysis
- Delete Analysis
- Send To >>
- Help

Site Map: Reliability->SparesAnalysis->Spares Analysis Example

Spares Analysis Example

- SEALS
 - Indoor Application
 - Outdoor Application
- BEARINGS
 - Indoor Application
 - Outdoor Application
- IMPELLER
 - All Applications

Analysis

Name: Spares Analysis Example

Description: This is a sample Spares Analysis example made by SE Meridium, Juan Garcia

Simulation Start Date: 1/1/2009 Simulation End Date: 1/1/2019

Currency: \$

Simulation Options

Spares

Name	Current Level	Min Inventory Level	Max Inventory Level
SEALS	1	1	10
BEARINGS	1	1	10
IMPELLER	1	1	10

Add Spare Remove Selected Spare(s)

Creating a New Spares Analysis

To create a new Spares Analysis you must complete the following steps:

1. [Create a Spares Analysis record.](#)
2. [Create one or more Spare records.](#)
3. [Create one or more Spare Application records.](#)
4. [Create one or more Spare Application Population records.](#)

Note that before you can [run a Monte Carlo simulation](#), a Spares Analysis must contain at least one Spare record, one Spare Application record, and one Spare Application Population record. If the analysis does not meet this minimum requirement, when you attempt to run the Monte Carlo simulation, an error message appears, explaining which record(s) are missing.

Additionally, most fields in each record within a Spares Analysis are required. Note that each field that is required contains a default value when you first create the record. You can modify the default values, but if you delete the value completely, the  [symbol](#) appears to the left of the field. If you do not want to specify a value for a field that contains a default value of 0 (zero), make sure to at least leave the default value in the field.

Aspects of the Spares Analysis Page

The Spares Analysis page appears when you [create a new Spares Analysis](#) or [open an existing Spares Analysis](#).

The screenshot displays the Meridium APM Framework Spares Analysis page. The interface is divided into several sections:

- Navigation Menu (Left):**
 - Tools:** Run Simulation, Export Results, Generate Report, View Recommen...
 - Navigation:** Analysis Definition, Spare Level Plot, Downtime Plot, Spare Usage Plot, Sensitivity Plot, Optimal Holding ...
 - Common Tasks:** New Analysis, Open Analysis, Save Analysis, Save Analysis As, Publish Analysis, Delete Analysis, Send To >>
- Analysis Section (Right):**
 - Name:** Spares Analysis Example
 - Description:** This is a sample Spares Analysis example made by SE Meridium, Juan Garcia
 - Simulation Start Date:** 1/1/2009
 - Simulation End Date:** 1/1/2019
 - Currency:** \$
- Spares Section (Right):**

Name	Current Level	Min Inventory Level	Max Inventory Level
SEALS	1	0	10
BEARINGS	1	0	10
IMPELLER	1	0	10

The Spares Analysis page is divided in two sections:

- **Task Menu:** Displays the [Tools menu](#), [Navigation menu](#), [Common Tasks menu](#), and the [Associated Pages menu](#), which you can use to navigate throughout Spares Analysis and to perform various tasks.
- **Workspace:** Displays the main display area for the link that is selected in the [Navigation menu](#). For example, if you click the [Spare Level Plot](#) link, the Spares Analysis page will display the [Spare Level Plot workspace](#). If you click the [Analysis Definition](#) link, the Spares Analysis page will display the [Spares Analysis workspace](#). Note that a green arrow will appear next to the link that is currently selected on the [Navigation menu](#).

Tools Menu

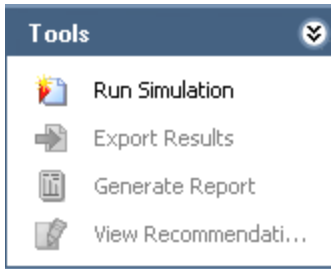

The **Tools** menu on the **Spares Analysis** page contains the following links:

- **Refresh Distributions:** After prompting you for confirmation, refreshes all the distribution data associated with the Spares Analysis by replacing the current TTF and TTR distributions with the most recently saved TTF and TTR distributions from the source distribution.
- **Run Simulation:** Displays the **Simulation Progress** window while Meridium APM runs a Monte Carlo simulation for the current analysis. Note that when the simulation is complete, the **Spares Analysis** page will appear, displaying the last record or plot that you were viewing prior to running the simulation.
- **Export Results:** Displays the **Export Analysis Results** dialog box, where you can save the results of the Monte Carlo simulation to a MS Excel, text, or XML file. This link becomes enabled *after* you run a Monte Carlo simulation.
- **Generate Report:** Displays the **Report Viewer** page, where you can view the [report for the current Spares Analysis](#). This link becomes enabled *after* you save the Spares Analysis. If you have not saved the Spares Analysis, a message appears, asking you to save the changes before generating a report.
- **View Recommendations:** Displays the [Recommendations page](#), where you can [view](#) and [create](#) Recommendation records that are linked to the current Spares Analysis record. This link becomes enabled *after* you save the Spares Analysis.

Navigation Menu

Using the links on the **Navigation** menu, you can navigate between various workspaces that appear on the **Spares Analysis** page, including the plots that Meridium APM provides for viewing the results of the Monte Carlo simulation. Note that a green arrow appears next to the link that is associated with the page or plot that you are currently viewing.

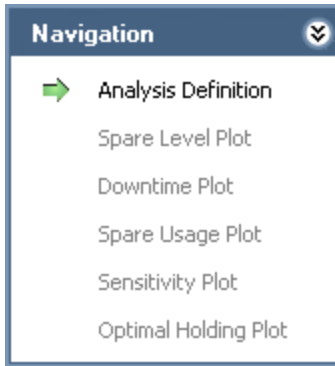

The **Navigation** menu on the **Spares Analysis** page contains the following links:

- **Analysis Definition:** Displays the analysis summary in the [Spares Analysis](#) workspace, where you can create, view, and modify any record for a Spares Analysis.
- **Spare Level Plot:** Displays the [Spare Level Plot](#) workspace, where you can view the costs associated with each possible spare level included in the inventory range, which is specified in the **Spares** section of the appropriate Spare record (specified in the **Min Inventory Level** and **Max Inventory Level** text boxes in the [Analysis section](#)). This link is enabled *after* you run a Monte Carlo simulation.
- **Downtime Plot:** Displays the [Downtime Plot](#) workspace, where you can view the downtime for the analysis period associated with each number of spares. This link is enabled *after* you run a Monte Carlo simulation.
- **Spare Usage Plot:** Displays the [Spare Usage Plot](#) workspace, where you can view the projected yearly spare usage assuming that you store the recommended number of spares. This link is enabled *after* you run a Monte Carlo simulation.
- **Sensitivity Plot:** Displays the [Sensitivity Plot](#) workspace, where you can compare the cost effects of maintaining the recommended number of spares, one spare less than the recommended number of spares, and one spare more than the recommended number of spares. This link is enabled *after* you run a Monte Carlo simulation.
- **Optimal Holding Plot:** Displays the [Optimal Holding Plot](#) workspace, where you can view the recommended level of spares for each year in the analysis period. This link is enabled *after* you run a Monte Carlo simulation.

Note: The **Spare Level Plot**, **Downtime Plot**, **Spare Usage Plot**, **Sensitivity Plot**, and **Optimal Holding Plot** workspaces will always display the results of the simulation that was *last* run. If you modify data in the Spares Analysis that will affect the simulation

results, a message will appear at the top of any plot that you are viewing, indicating that you need to re-run the Monte Carlo simulation to update the plots.

Common Tasks Menu

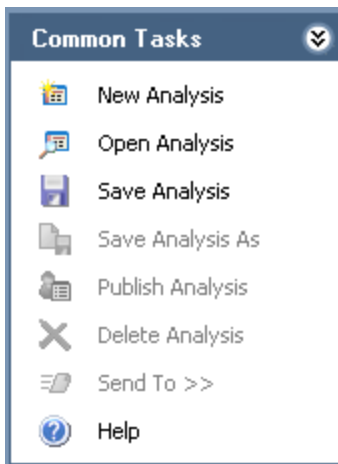

The **Common Tasks** menu on the **Spares Analysis** page contains the following links:

- **New Analysis:** Displays a new Spares Analysis record in the [Spares Analysis workspace](#).
- **Open Analysis:** Displays the **Find Items** window, which you can use to locate and open an existing Spares Analysis.
- **Save Analysis:** Saves the currently displayed analysis. If you are viewing an analysis that has not yet been saved, this link will display the **Save Analysis** dialog box, where you can [save the analysis](#). If you are viewing an existing analysis, when you click this link, Meridium APM will save any changes that you made to the analysis since it was last saved.
- **Save Analysis As:** Displays the **Save this Analysis** dialog box, where you can choose to [save the current Spares Analysis with a different name](#). This link is enabled only when you are viewing a *saved* analysis.
- **Delete Analysis:** Deletes the analysis that is currently displayed. This link is enabled only when you are viewing a *saved* analysis.
- **Send To:** Displays a submenu with options that let you provide a link on the current page to your desktop (create shortcut), in an email message, or on a Home Page. This link will become enabled whenever you are viewing a saved analysis.
- **Help:** Displays the context-sensitive Help topic for the **Spares Analysis** page.

Associated Pages Menu

The **Associated Pages** menu on the **Spares Analysis** page displays Associated Pages that have been configured for the Spares Analysis family via the URL Manager. This menu always displays Associated Pages that are configured for the *Spares Analysis* family, regardless of which record is selected in the Spares Analysis tree. For details on configuring Associated Pages, see the URL Manager Help.

About the Spares Analysis Workspace

The Spares Analysis workspace of the Spares Analysis page is divided in two sections:

- [Spares Analysis tree](#): Displays a hierarchical view of a single Spares Analysis and all the Spare and Spare Application records that are linked to that analysis.

SiteMap: [Reliability](#)->[Spares Analysis](#)->[Spares Analysis Example](#)

Spares Analysis

Spares Analysis Example

- SEALS
 - Indoor Application
 - Outdoor Application
- BEARINGS
 - Indoor Application
 - Outdoor Application
- IMPELLER
 - All Applications

Analysis

Name: Spares Analysis Example

Description: This is a sample Spares Analysis example made by SE Meridium, Juan Garcia

Simulation Start Date: 1/1/2009 Simulation End Date: 1/1/2019

Currency: \$

Simulation Options

Spares

Name	Current Level	Min Inventory Level	Max Inventory Level
SEALS	1	0	10
BEARINGS	1	0	10
IMPELLER	1	0	10

Add Spare Remove Selected Spare(s)

- [Details area](#): Displays the details of the record that is selected in the Spares Analysis tree, where you specify or modify values for the Spares Analysis.

About the Spares Analysis Workspace

SiteMap: [Reliability](#)->[Spares Analysis](#)->[Spares Analysis Example](#)

Spares Analysis

Spares Analysis Example

- SEALS
 - Indoor Application
 - Outdoor Application
- BEARINGS
 - Indoor Application
 - Outdoor Application
- IMPELLER
 - All Applications

Analysis

Name: Spares Analysis Example

Description: This is a sample Spares Analysis example made by SE Meridium, Juan Garcia

Simulation Start Date: 1/1/2009 Simulation End Date: 1/1/2019

Currency: \$

Simulation Options

Spares

Name	Current Level	Min Inventory Level	Max Inventory Level
SEALS	1	0	10
BEARINGS	1	0	10
IMPELLER	1	0	10

Add Spare Remove Selected Spare(s)

Note that when you are viewing the **Spares Analysis** workspace, a green arrow will appear next to the **Analysis Definition** link on the [Navigation menu](#).

Aspects of the Spares Analysis Tree

The Spares Analysis tree displays a hierarchical view of a single Spares Analysis and all the Spare and Spare Application records that are involved in that analysis.

- The Spares Analysis record is always the root record in the Spares Analysis tree.
- The Spare records are always the second level of the Spares Analysis tree.
- The Spare Application records are always the third level of the Spares Analysis tree.

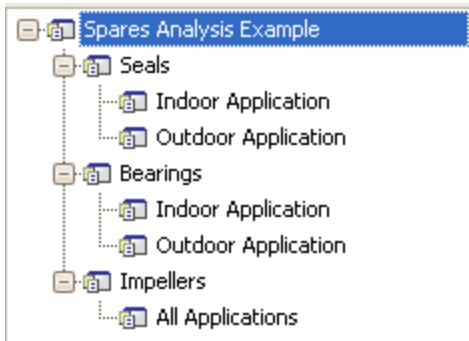

Note that the Spare Application Population records are not displayed in the Spares Analysis tree. When you select a Spare Application record, the Spare Application Population records appear in the details area to the right of the analysis tree.

You can click any record within the Spares Analysis tree to display the details of the record in the details area. If you right-click any of the records in the Spares Analysis tree, a shortcut menu will appear with options that let you:

- [Create a record](#).
- [Copy and paste existing records](#) within the Spares Analysis.
- [Delete an existing record](#).

Copying and Pasting Records in the Spares Analysis Tree

To copy and paste records in the Spares Analysis tree:

1. Open the desired Spares Analysis.
2. Right-click the record in the Spares Analysis tree that you want to copy, and click **Copy**. Note that if the record that you copy is linked to any other records, the linked records will also be copied.
3. Navigate to the record where you want to paste the copied record. Note that if you copied a Spare record, you can paste it *only* to a Spares Analysis record. If you copied a Spare Application record, you can paste it *only* to a Spare record.
4. Right-click the record to which you want to paste the copied record, and click **Add Copied <Node>**.

The copied record and any linked records appear under the selected record.

Deleting a Record from the Spares Analysis Tree

In the Spares Analysis tree, you can delete a Spare record or a Spare Application record. When you delete a Spare record, Meridium APM will delete the Spare record, and also any associated Spare Application records and Spare Application Population records. When you delete a Spare Application record, Meridium APM will delete the Spare Application record, and also any associated Spare Application Population records.

Note: Spares Analysis records cannot be deleted via the Spares Analysis tree. To delete a Spares Analysis record, use the **Delete Analysis** link on the [Common Tasks menu](#).

To delete a record from the Spares Analysis tree:

1. Open the desired Spares Analysis.
2. Right-click the record that you want to delete, and click **Delete**.

The selected record and all associated records are deleted.

Aspects of the Details Area

Within the **Spares Analysis** workspace, the area to the right of the Spares Analysis tree displays the details of the record that is selected in the Spares Analysis tree and is referred to as the *details area* throughout this documentation.

Analysis

Name: Spares Analysis Example

Description: This is a sample Spares Analysis example made by SE Meridium, Juan Garcia

Simulation Start Date: 1/1/2009 Simulation End Date: 1/1/2019

Currency: \$

Simulation Options

Spares

Name	Current Level	Min Inventory Level	Max Inventory Level
▶ SEALS	1	0	10
BEARINGS	1	0	10
IMPELLER	1	0	10

Add Spare Remove Selected Spare(s)

Note that the content of the details area will change depending on the record that is selected in the Spares Analysis tree. The following details areas may appear in the **Spares Analysis** workspace:

- [Details area of a Spares Analysis record](#)
- [Details area of a Spare record](#)
- [Details area of a Spare Application record](#)

Note: The details of a Spare Application Population record appears in the **Populations** section of the [details area of the linked Spare Application record](#).

Aspects of the Details Area of a Spares Analysis Record

When you select a Spares Analysis record in the Spares Analysis tree, the following sections appear in the details area of the **Spares Analysis** workspace for the selected Spares Analysis record: **Analysis**, **SimulationOptions**, and **Spares**.

The screenshot displays the details area for a Spares Analysis record, organized into three main sections:

- Analysis:** Contains a text field for the Name ("Spares Analysis Example"), a text area for the Description ("This is a sample Spares Analysis example made by SE Meridium, Juan Garcia"), two date pickers for Simulation Start Date (1/1/2009) and Simulation End Date (1/1/2019), and a currency field set to "\$".
- Simulation Options:** This section is currently empty.
- Spares:** Contains a table with the following data:

Name	Current Level	Min Inventory Level	Max Inventory Level
SEALS	1	0	10
BEARINGS	1	0	10
IMPELLER	1	0	10

 Below the table are two buttons: "Add Spare" and "Remove Selected Spare(s)".

The [Analysis](#) section and [Simulation Options](#) section lets you view and modify values for the Spares Analysis record.

The **Spares** section displays a list of any Spare records that are included in the Spares Analysis. The **Spares** section will be empty until you have [created a Spare record](#).

Using the buttons at the bottom of the details area for the Spares Analysis record, you can either [create a new Spare record](#) that will be linked to the current Spares Analysis record or [delete a Spare record](#) from the list in the **Spares** section.

Aspects of the Details Area of a Spare Record

When you select a Spare record in the Spares Analysis tree, the following sections appear in the details area of the **Spares Analysis** workspace for the selected Spare record: **Spare** and **Applications**.

The screenshot shows two main sections: 'Spare' and 'Applications'.

Spare Section:

- Name: SEALS
- On-site Delivery Time: 4 Hours
- Normal Order Time: 25 Days
- Expedited Order Time: 3 Days
- Holding Cost Rate (\$): 20 Per Year
- Min Inventory Level: 0
- Current Holding Level: 1
- Normal Cost (\$): 100
- Expedited Cost (\$): 300
- Max Inventory Level: 10

Applications Section:

Application Name	Population Size
Indoor Application	3
Outdoor Application	7

Buttons at the bottom: Add Application, Remove Selected Application(s)

The [Spare section](#) lets you view and modify values for the selected Spare record.

The **Applications** section displays a list of any Spare Application records that are linked to the currently displayed Spare record. The **Application** section will be empty until you have [created a Spare Application record](#).

Using the buttons at the bottom of the details area for the Spare record, you can either [create a new Spare Application record](#) that will be linked to the current Spare record or [delete a Spare Application record](#) from the list in the **Spares** section.

Aspects of the Details Area of a Spare Application Record

When you select a Spare Application record in the Spares Analysis tree, the following sections appear in the details area of the **Spares Analysis** workspace for the selected Spare record:

- Application
- Populations
- FailureDistributions
- FailureConsequence
- Preventive Maintenance

The screenshot displays the details area of the Spares Analysis workspace for a selected Spare Application record. The interface is organized into several sections:

- Application:** A text field labeled "Name" contains the value "Indoor Application".
- Populations:** A table with columns: Population Name, Population Size, Age Value, and Age Unit.

Population Name	Population Size	Age Value	Age Unit
Population 1		2	2 Years
Population 2		1	4 Years

 Below the table are buttons for "Add Population" and "Remove Selected Population(s)".
- Failure Distributions:** A table with columns: Name, Distribution Type, Time Unit, Parameter 1, Parameter 2, and Parameter 3.

Name	Distribution Type	Time Unit	Parameter 1	Parameter 2	Parameter 3
Failure Distribution	Exponential	Months	60 (MTBF)		

 Below the table are buttons for "Refresh All Distributions", "Add From Analysis", "Add New", and "Remove Selected".
- Failure Consequence:** A form with several input fields and dropdown menus:
 - Preparation Time: 4, Hours
 - Repair Time: 8, Hours
 - Total Correction Time: 12, Hours
 - Labor Cost (\$): 1000
 - Fixed Lost Production Cost (\$): 0
 - Variable Lost Production Cost Rate (\$): 100000, Per Day
 - # of Required Spares: 1
- Preventive Maintenance:** A section with a checkbox "Enable Preventive Maintenance" (unchecked) and input fields:
 - Time-based Replacement Interval: 1, Days
 - Labor Cost (\$): 0

The [Application](#), [Failure Distributions](#), [Failure Consequence](#), and [Preventive Maintenance](#) sections let you view and modify values for the Spare Application record.

The **Populations** section displays a list of any Spare Application Population records that are linked to the selected Spare Application record. The **Populations** section will be empty until you have [created a Spare Application Population record](#).

Using the buttons in the **Populations** section of the details area for the Spare Application record, you can either [create a new Spare Application Population record](#) that will be linked to the current Spare Application record or [delete a Spare Application Population record](#).

Creating a Spares Analysis Record

To create a Spares Analysis record:

1. On the [Reliability Analytics Start Page](#), click the **Spares Analysis** link.

The [Select a Spares Analysis from the List](#) page appears.

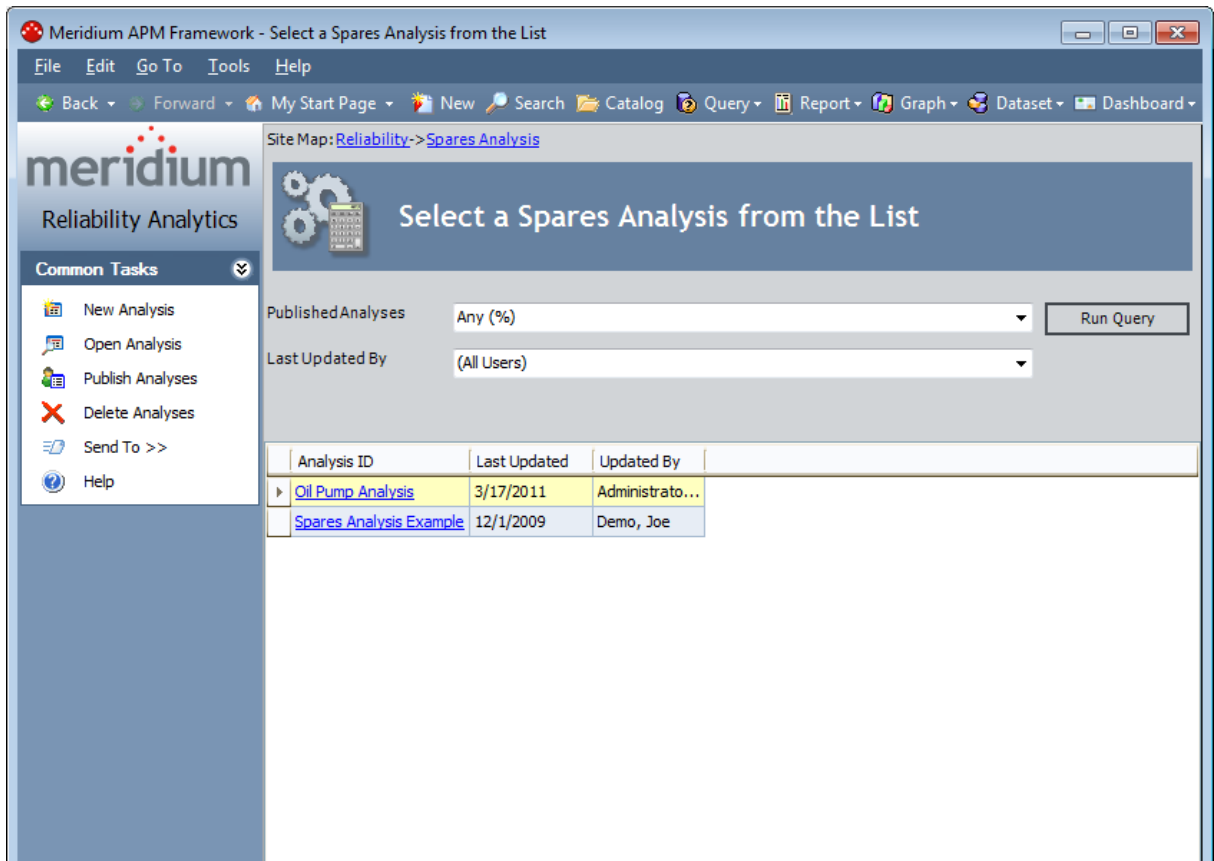

2. On the [Common Tasks menu](#), click the **New Analysis** link.

The **Spares Analysis** page appears, displaying the [details area of a new Spares Analysis record](#) in the **Spares Analysis** workspace.

Creating a Spares Analysis Record

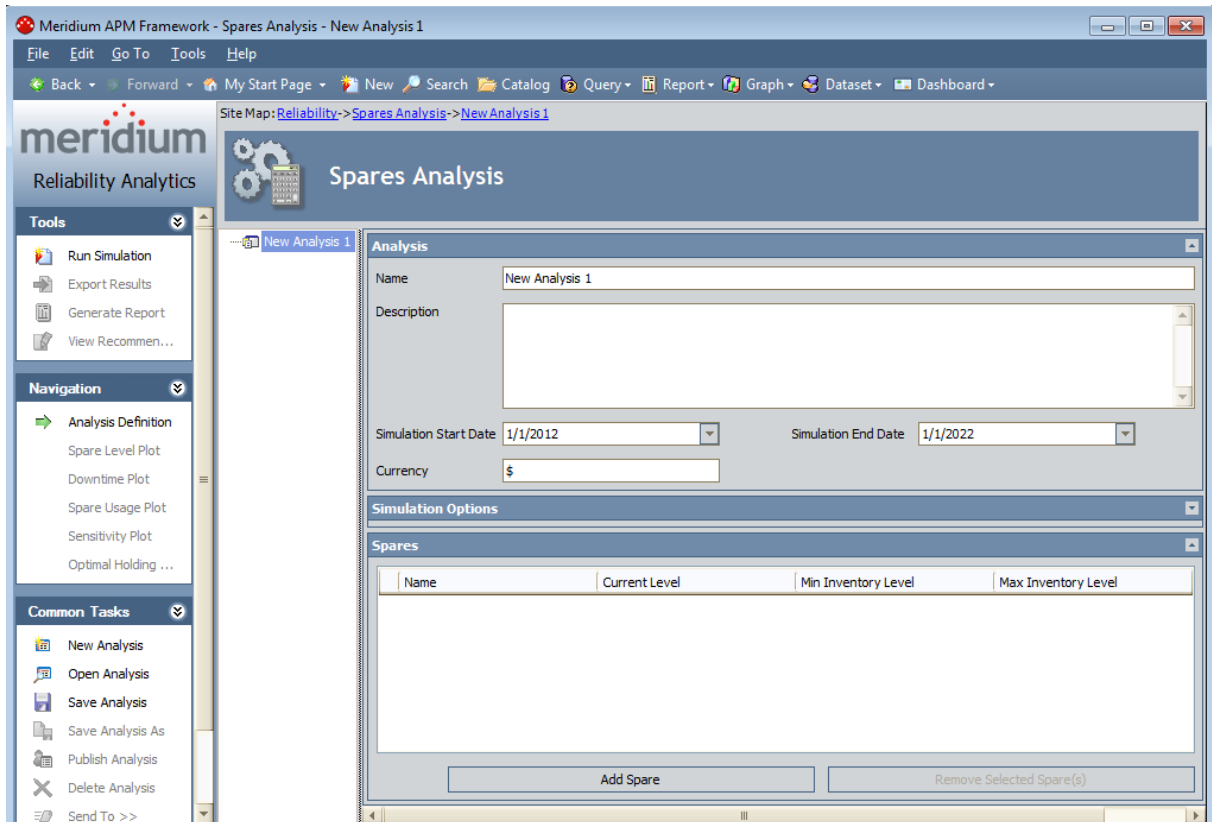

3. Specify the properties in the [Analysis section](#).
4. Note that the **Simulation Options** section is collapsed by default. If you want to modify any information in the **Simulation Options** section, click the  button to the right of the section. If you do not want to modify any information in the **Simulation Options** section, proceed to step 6.

The **Simulation Options** section is expanded.

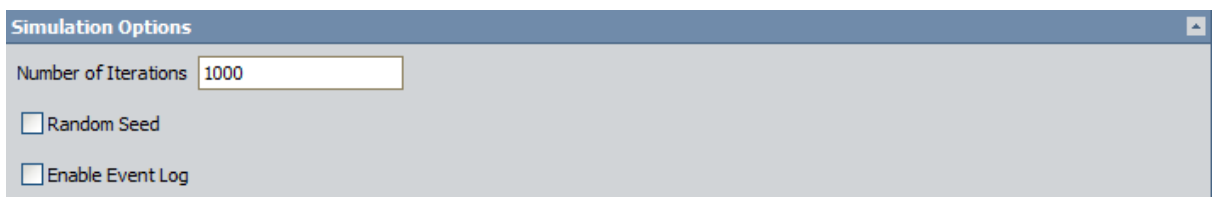

5. Specify the properties in the [Simulation Options section](#).
6. On the [Common Tasks menu](#), click the **Save Analysis** link.

The Spares Analysis record is saved. At this point, you need to [add a Spare record](#) to the Spares Analysis. Note that after you [create a Spare record](#), the name of that Spare record will appear in the **Spares** section of the linked Spares Analysis record.

Analysis Section

The screenshot shows a software window titled "Analysis". Inside the window, there are four input fields:

- Name:** A text box containing "New Analysis 1".
- Description:** A large, empty text area.
- Simulation Start Date:** A date picker dropdown menu showing "1/1/2011".
- Simulation End Date:** A date picker dropdown menu showing "1/1/2021".
- Currency:** A dropdown menu showing the dollar sign "\$".

In the **Analysis** section in the [details area of a Spares Analysis record](#), you can insert or modify the following values:

- **Name:** The name of the Spares Analysis. When you create a new analysis, **New Analysis 1** appears in the **Name** text box by default. You can modify the value in this text box to change the name of the existing analysis.
- **Description:** Any additional information about the Spares Analysis.
- **Simulation Start Date:** A date that defines the beginning of the analysis period. When you create a new analysis, the start date is set by default to the first day of the current year. For example, for the analyses created in the year 2010, the start date will be set to **1/1/2010** by default. If desired, you can type or select a different start date. Note that if the start date is *after* the specified end date, an error message appears when you attempt to save the analysis.
- **Simulation End Date:** A date that defines the end of the analysis period. When you create a new analysis, the end date of the analysis is set by default to the first day of the year that is 10 years after the current date. For example, if the start date is **1/1/2010** by default, then the end date will be set to **1/1/2020** by default. If desired, you can type or select a different end date. The end date must be after the start date. If the end date is *before* the specified start date, an error message appears when you attempt to save the analysis.
- **Currency:** The currency that will be used as a label throughout the Spares Analysis for all cost text boxes and in the plots. You can type symbols and text in the **Currency** text box. For example, you can type the symbol for U.S. currency, **\$**, or you can type text for U.S. currency, **US Dollars**. Note that any data that you type in the cost text boxes throughout the analysis must be appropriate for the type of currency that you type in the **Currency** text box.

Simulation Options Section

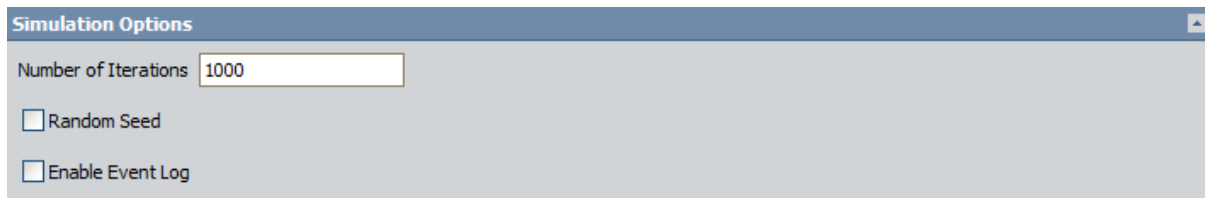

The screenshot shows a window titled "Simulation Options" with a close button in the top right corner. Inside the window, there is a text input field labeled "Number of Iterations" containing the value "1000". Below this field are two unchecked checkboxes: "Random Seed" and "Enable Event Log".

In the **Simulation Options** section in the [details area of a Spares Analysis record](#), you can insert or modify the following values:

- **Number of Iterations:** A number that represents the number of times that Meridium APM will perform calculations on the Spares Analysis data when you run the Monte Carlo simulation. When you create a new Spares Analysis record, the Number of Iterations is set to **1000** by default. If desired, you can type a different number of iterations. Note that the larger the number of iterations, the longer it will take for the simulation to run and the more accurate the Monte Carlo results will be.
- **Random Seed:** Specifies whether or not you want to run the Monte Carlo simulation for random results. Note that if you select the **Random Seed** check box, you will generate *different* results each time that you run the Monte Carlo simulation.
- **Enabled Event Log:** Specifies whether or not you want a [log of the events](#) determined by the Monte Carlo simulation to be saved. When this check box is selected, the **Save Simulation As** dialog box will appear after the Monte Carlo simulation is complete, where you can navigate to the location where you want to [save the Event Log](#).

Deleting a Spares Analysis

When you delete a Spares Analysis, Meridium APM will delete the Spares Analysis record, and all associated Spare, Spare Application, and Spare Application Population records.

To delete a Spares Analysis:

1. Open the Spares Analysis that you want to delete.
2. On the [Common Tasks menu](#), click the **Delete Analysis** link.
A confirmation message appears, asking if you really want to delete the analysis.
3. Click the **Yes** button.

The Spares Analysis record and all associated Spare, Spare Application, and Spare Application Population records are deleted.

Overview of Spare Records

A Spare record is used to define delivery time, cost, and spare level data for the spare part that you are analyzing. There might be more than one Spare record to represent each spare part involved in a piece of equipment.

For the [Spares Analysis example](#) that is presented in this documentation, we will create the following Spare records:

- Seal Spare record
- Bearing Spare record
- Impeller Spare record

Creating a Spare Record

To create a Spare record:

1. Open a Spares Analysis, and select the Spares Analysis record in the analysis tree.
2. At the bottom of the details area, click the **Add Spare** button.

A new [Spare record appears in the details area](#) of the **Spares Analysis** workspace.

The screenshot shows the 'Spares Analysis' workspace. On the left is a tree view with 'Spares Analysis Example' expanded to show 'SEALS', 'BEARINGS', and 'IMPELLER', each with 'Indoor Application' and 'Outdoor Application' sub-items. 'Spare 1' is selected under 'IMPELLER'. The main area is divided into two sections: 'Spare' and 'Applications'. The 'Spare' section contains fields for Name (Spare 1), On-site Delivery Time (0 Days), Normal Order Time (0 Days), Expedited Order Time (0 Days), Holding Cost Rate (\$0 Per Year), Min Inventory Level (0), and Current Holding Level (0). It also has fields for Normal Cost (\$0) and Expedited Cost (\$0), and a Max Inventory Level (0). The 'Applications' section is empty with columns for Application Name and Population Size, and buttons for 'Add Application' and 'Remove Selected Application(s)'.

3. Specify the properties in the [Spare section](#).
4. On the [Common Tasks menu](#), click the **Save Analysis** link.

The Spare record is saved. At this point, you can:

- Repeat these steps to create another Spare record.
- or-
- [Create a Spare Application record](#) for the Spare record that you just created. Note that after you [create a Spares Application record](#), the name of that Spare Application record will appear in the **Applications** section of the linked Spare record.

Aspects of a Spare Record

In the **Spare** section in the [details area of a Spare record](#), you can insert or modify the following values:

- **Name:** The name of the Spare record. When you create a new Spare record, **Spare n** appears in the **Name** text box by default, where **n** represents the sequential order of the new Spare record. For example, the name of the first Spare record that you create for a Spares Analysis will be *Spare 1*, the name of the second Spare record that you create will be *Spare 2*, and so on. If desired, you can type a different name for the Spare record. Note that the name of each Spare record must be unique to the root Spares Analysis. If you type a name that already exists for another Spare record associated with the current Spares Analysis, the  [symbol](#) appears to the left of the text box, and you will not be able to navigate out of the text box until you have specified a unique name for the record.
- **On-site Delivery Time:** The amount of time that it takes to have the spare part transferred from where it is stored on-site (e.g., warehouse) to the repair location. The list to the right of the **On-site Delivery Time** text box lets you define the unit of measure for the specified period of time.
- **Normal Order Time:** The amount of time that it takes to order the spare part from the manufacturer and receive it at the location where it is stored on-site (i.e., warehouse). The list to the right of the **Normal Order Time** text box lets you define the unit of measure for the specified period of time.
- **Normal Cost(\$):** The cost associated with a standard (i.e., not expedited) order for the spare part. The normal cost must be less than or equal to the expedited cost. If you type a value in the **Normal Cost (\$)** text box that is *greater* than the value in the **Expedited Cost (\$)** text box, the **Expedited Cost (\$)** text box will be updated automatically with the value in the **Normal Cost (\$)** text box.

For example, if the **Expedited Cost (\$)** text box contains the value *1000* and you type *1500* in the **Normal Cost (\$)** text box, the value in the **Expedited Cost (\$)** text box will be set automatically to *1500*.

- **Expedited Order Time:** The amount of time it will take to place a rush order for the part and receive it at the location where it is stored on-site (i.e., warehouse). The list to the right of the **Expedited Order Time** text box lets you define the unit

of measure for the specified period of time.

- **Expedited Cost(\$):** The cost associated with placing a rush order for the spare part. The expedited cost must be greater than the normal cost. If you type a value in the **Expedited Cost (\$)** text box that is *less* than the value in the **Normal Cost (\$)** text box, an error message will appear, and the value in the **Expedited Cost (\$)** text box will revert back to the value that existed before you modified it.
- **Holding Cost Rate(\$):**The cost of storing the spare part for the amount of time selected in the **Per** list.
- **Per:** The unit of measure that applies to the value in the **Holding Cost Rate** text box.
- **Min Inventory Level:** The *minimum* number of spare parts that you want to analyze using the Spares Analysis. The minimum inventory level must be less than or equal to the maximum inventory level. If you type a value in the **Min Inventory Level** text box that is *greater* than the value in the **Max Inventory Level** text box, the **Max Inventory Level** text box will be updated automatically with the value in the **Min Inventory Level** text box.

For example, if the **Max Inventory Level** text box contains the value 3 and you type 4 in the **Min Inventory Level** text box, the value in the **Max Inventory Level** text box will be set automatically to 4.

- **Max Inventory Level:** The *maximum* number of spare parts that you want to analyze using the Spares Analysis. The maximum inventory level must be greater than the minimum inventory level. If you type a value in the **Max Inventory Level** text box that is *less* than the value in the **Min Inventory Level** text box, an error message will appear, and the value in the **Max Inventory Level** text box will revert back to the value that existed before you modified it.
- **Current Holding Level:** The *actual* number of spare parts that you are currently storing. The current holding level must be greater than or equal to the minimum inventory level but less than or equal to the maximum inventory level. If you type a value in the **Current Holding Level** text box that is *less* than the value in the **Min Inventory Level** text box or *greater* than the value in the **Min Inventory Level** text box, an error message appears and the value in the **Current Holding Level** text box reverts back to the original value.

Deleting a Spare Record

Deleting a Spare record will cause Meridium APM to delete that Spare record, and any associated Spare Application records and Spare Application Population records.

To delete a Spare record:

1. Open the Spares Analysis from which you want to delete a Spare record.
2. If it is not already selected, select the Spares Analysis record in the Spares Analysis tree.
3. In the [details area of the Spares Analysis record](#), locate the **Spares** section, which displays a list of all existing Spare records.

Name	Current Level	Min Inventory Level	Max Inventory Level
SEALS	1	0	10
BEARINGS	1	0	10
IMPELLER	1	0	10
Spare_1	0	0	0

Buttons: Add Spare, Remove Selected Spare(s)

4. Select the row(s) containing the Spare record(s) that you want to delete.
5. Click the **Remove Selected Spare(s)** button.

The selected Spare record(s) and any associated Spare Application records and Spare Application Population records are deleted.

Overview of Spare Application Records

A Spare Application record stores failure and repair data for the spare part that you are analyzing. You might have more than one Spare Application record for each Spare record. For example, a spare part might be used in a piece of equipment that is located in an indoor environment, and the same type of spare part might be used in another piece of equipment located in an outdoor environment. The failure data and repair data might be different for both spare parts. Therefore, you would want to create one Spare Application record for the spare part that is used in the indoor environment and another Spare Application record for the spare part that is used in the outdoor environment.

Creating a Spare Application Record

To create a Spare Application record:

1. On the [Spares Analysis page](#), in the analysis tree, select the Spare record for which you want to create a new Spare Application record.
2. In the [Applications section](#), click the **Add Application** button.

The [details area of the Spare Application record](#) appears in the **Spares Analysis** workspace.

The screenshot shows a software interface for creating a Spare Application record. It consists of several stacked panels:

- Application:** A text input field labeled 'Name' containing 'Application 1'.
- Populations:** A table with columns: Population Name, Population Size, Age Value, Age Unit. Below the table are buttons for 'Add Population' and 'Remove Selected Population(s)'. The table is currently empty.
- Failure Distributions:** A table with columns: Name, Distribution Type, Time Unit, Parameter 1, Parameter 2, Parameter 3. Below the table are buttons for 'Refresh All Distributions', 'Add From Analysis', 'Add New', and 'Remove Selected'. The table is currently empty.
- Failure Consequence:** A series of input fields with unit dropdowns:
 - Preparation Time: 0 Days
 - Repair Time: 0 Days
 - Total Correction Time: 0 Days
 - Labor Cost (\$): 0
 - Fixed Lost Production Cost (\$): 0
 - Variable Lost Production Cost Rate (\$): 0 Per Day
 - # of Required Spares: 1
- Preventive Maintenance:**
 - Enable Preventive Maintenance
 - Time-based Replacement Interval: 1 Days
 - Labor Cost (\$): 0

3. Specify the properties in the [Application section](#).
4. Specify the properties in the [Failure Distributions section](#).
5. Specify the properties in the [Failure Consequences section](#).

6. If desired, specify the properties in the [Preventive Maintenance section](#).
7. On the [Common Tasks menu](#), click the **Save Analysis** link.

A new Spare Application record is created and linked to the Spare record. At this point, you can:

- Repeat these steps to create another Spare Application record.
- or-
- [Create a Spare Application Population record](#) for the Spare Application record that you created.

Application Section

In the **Application** section in the [details area of a Spare Application record](#), you can specify the name of the Spare Application record. In the following image, you can see that the name of the Spare Application record is *Spare Application 1*.

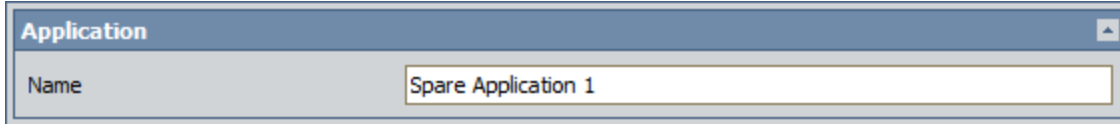

The image shows a screenshot of a software interface. At the top, there is a blue header bar with the word "Application" in white text. Below this header, there is a form with a label "Name" on the left and a text input field on the right. The text input field contains the text "Spare Application 1".

When you create a new Spare Application record, *Application n* appears in the **Name** text box by default, where *n* represents the sequential order of the new Spare Application record. For example, the name of the first Spare Application record that you create for a Spares Analysis will be *Application 1*, the name of the second Spare Application record that you create will be *Application 2*, and so on. If desired, you can type a different name for the Spare Application record. The name of each Spare Application record must be unique to the root Spare record, and if you type a name that already exists for another Spare Application record that is linked to the same Spare record, the  [symbol](#) appears to the left of the text box. You will not be able to navigate out of that text box until you have specified a unique name for the record.

Failure Distributions Section

In the **Failure Distributions** section in the [details area of a Spare Application record](#), you can [specify failure distribution information](#) for a Spare Application record. The following image shows an example of the **Failure Distributions** section.

Name	Distribution Type	Time Unit	Parameter 1	Parameter 2	Parameter 3
Manually Entered TTF Distribution	Exponential	Days	1 (MTBF)		
1041828 Exchanger U-Bend - Internal Tubes	Weibull	Days	0.8576 (Beta)	1523.5244 (Eta)	0 (Gamma)
E0004-090 INTERNAL - TUBES	Weibull	Days	1 (Beta)	1 (Eta)	0 (Gamma)

Buttons: Refresh Distributions, Add From Analysis, Add New, Remove Selected

The grid in the **Failure Distributions** section contains the following columns:

- **Name:** Displays the name of the failure distribution, according to the following guidelines:
 - For [failure distribution information that you have imported](#), displays the hyperlinked value that is stored in the Analysis ID field in the Reliability Distribution or Reliability Growth record from which you imported failure distribution information. You can click the hyperlink to open the analysis.
 - For [failure distribution information that you want to define manually](#), you can type a name in the **Name** cell. *New TTF Distribution* is displayed in the **Name** cell by default.
- **Distribution Type:** Displays the distribution type, according to the following guidelines:
 - For [failure distribution information that you have imported](#), this column displays the read-only distribution type of the analysis from which you have imported failure distribution information.
 - For [failure distribution information that you want to define manually](#), a list appears, where you can select the desired value. The value is set to *Exponential* by default, but you can select any of the following additional distribution types:
 - **Weibull**
 - **Normal**
 - **Lognormal**
- **Time Unit:** Displays the unit of measure that applies to the distribution type that appears in the **Distribution Type** column, according to the following guidelines:
 - For [failure distribution information that you have imported](#), this column displays the read-only unit of measure used in the analysis from which you have imported failure distribution information.
 - For [failure distribution information that you want to define manually](#), a list appears, where you can select the desired value. The value is set to *Days* by

default, but you can select any of the following additional units of measure:

- **Hours**
- **Weeks**
- **Months**
- **Years**
- **Parameter 1:** Displays one of the following parameters, depending upon the distribution type:
 - For a Weibull distribution, displays the Beta value.
 - For an Exponential distribution, displays the MTBF value.
 - For a Normal distribution, displays the Mean value.
 - For a Logonormal distribution, displays the Mu value.

By default, *up to* four decimal places are displayed for values in the **Parameter 1** column. If you select a cell in the **Parameter 1** column for a parameter that can be modified, all decimal places for the value will be displayed.

- **Parameter 2:** Displays one of the following parameters, depending upon the distribution type:
 - For a Weibull distribution, displays the Eta value.
 - For an Exponential distribution, nothing is displayed. The MTBF value that is displayed in the **Parameter 1** column is the only parameter in an Exponential distribution
 - For a Normal distribution, displays the Standard Deviation value.
 - For a Logonormal distribution, displays the Sigma value.

By default, *up to* four decimal places are displayed for values in the **Parameter 2** column. If you select a cell in the **Parameter 2** column for a parameter that can be modified, all decimal places for the value will be displayed.

- **Parameter 3:** Displays one of the following parameters, depending upon the distribution type:
 - For a Weibull distribution, displays the Gamma value.
 - For an Exponential distribution, nothing is displayed. The MTBF value displayed in the **Parameter 1** column is the only parameter in an Exponential distribution.
 - For a Normal distribution, nothing is displayed. The Mean and Standard Deviation values that are displayed in the **Parameter 1** and **Parameter 2** columns are the only parameters in a Normal distribution.
 - For a Logonormal distribution, displays the Gamma value.

By default, *up to* four decimal places are displayed for values in the **Parameter 3** column. If you select a cell in the **Parameter 3** column for a parameter that can be modified, all decimal places for the value will be displayed.

The following buttons appear below the grid in the **Failure Distributions** section:

- **Refresh Distributions:** After displaying a confirmation message, refreshes all the failure distribution information that you have imported from Reliability Growth and Reliability Distribution Analyses for the Spare Application record that is currently selected in the Spares Analysis tree.
- **Add From Analysis:** Displays the **Find Items** window, where you can search for a Reliability Growth or Reliability Distribution Analyses from which you want to [import failure distribution information](#) for the Spare Application record that is currently selected in the Spares Analysis tree.
- **Add New:** Creates an additional row in the grid, where you can [enter failure distribution information manually](#) for the Spare Application record that is currently selected in the Spares Analysis tree.
- **Remove Selected:** Deletes the selected row of failure distribution information from the Spare Application record that is currently selected in the Spares Analysis tree.

When you right-click a row in the grid, a short cut menu appears, containing various options, depending upon the source of the failure distribution information in that row:

- If the row contains [manually defined failure distribution information](#), the shortcut menu contains the following option:
 - **Replace with Analysis:** Opens the **Find Items** window, where you can search for an existing Reliability Growth or Reliability Distribution Analysis whose failure distribution information you want to use to replace the data for the selected row.
- If the row contains [imported failure distribution information](#), the shortcut menu contains the following options:
 - **Refresh Distribution:** Refreshes the failure distribution information that was imported from a Reliability Growth or Reliability Distribution Analyses and was used to create the values for the selected row.
 - **Replace with Analysis:** Opens the **Find Items** window, where you can search for an existing Reliability Growth or Reliability Distribution Analysis whose failure distribution information you want to use to replace the data in the selected row.
 - **Remove Association:** Removes the connection between the following records:
 - The Distribution record to which the Spare Application record is linked.
 - and-
 - The Reliability Growth or Reliability Distribution record from which you [imported failure distribution information](#).

When you select this option, you can modify the failure distribution information.

Failure Consequence Section

In the **Failure Consequence** section in the [details area of a Spare Application record](#), you can enter and modify failure consequence information for the Spare Application record.

Failure Consequence		
Preparation Time	<input type="text" value="0"/>	Days
Repair Time	<input type="text" value="0"/>	Days
Total Correction Time	<input type="text" value="0"/>	Days
Labor Cost (\$)	<input type="text" value="0"/>	
Fixed Lost Production Cost (\$)	<input type="text" value="0"/>	
Variable Lost Production Cost Rate (\$)	<input type="text" value="0"/>	Per Day
# of Required Spares	<input type="text" value="1"/>	

The **Failure Consequence** section contains the:

- **Preparation Time text box:** The amount of time it takes to prepare for a repair of the part. Preparation tasks might include setting up equipment that may be used for the repair or disassembling any equipment. Note that spare parts are not required to be in stock for preparation tasks to occur. This value is stored in the Preparation Time Value field in the Spare Application record.
- **Preparation Time list:** A list containing units of measure. In the list, you can select the unit of measure that corresponds to the value in the **Preparation Time** text box. The unit of measure *Days* is selected by default. This value is stored in the Preparation Time Unit field in the Spare Application record.
- **Repair Time text box:** The amount of time it takes to complete the actual repair of the part. This value is stored in the Repair Time Value field in the Spare Application record.
- **Repair Time list:** A list containing units of measure. In the list, you can select the unit of measure that corresponds to the value in the **Repair Time** text box. The *Days* unit of measure is selected by default. This value is stored in the Repair Time Unit field in the Spare Application record.
- **Total Correction Time text box:** The sum of the values in the **Preparation Time** and **Repair Time** text boxes. This text box is populated automatically after you enter values in the **Preparation Time** and **Repair Time** text boxes. This value is not stored in the Spare Application record; it appears only in the **Failure Consequence** section of the [details area of the Spare Application record](#).
- **Total Correction Time list:** A list containing units of measure. The list is populated automatically with the unit of measure that is the *largest* between the selections in

the **Preparation Time** and **Repair Time** lists. If the units of measure that are selected in the **Preparation Time** and **Repair Time** lists are the *same*, that unit of measure will appear in the **Total Correction Time** list. This value is not stored in the Spare Application record; it appears only in the **Failure Consequence** section of the [details area of the Spare Application record](#).

- **Labor Cost(\$)** text box: The cost of the labor associated with the value in the **Total Correction Time** text box. This value is stored in the Repair Labor Cost field in the Spare Application record.
- **Fixed Lost Production Cost(\$)** text box: The lost production cost that is incurred each time the piece of equipment fails, regardless of the length of downtime. For example, when the piece of equipment fails, there might be incomplete products that must be thrown away, therefore costing your organization a total of \$20,000 each time the piece of equipment fails. This value is stored in the Fixed Lost Production Cost field in a Spare Application record.
- **Variable Lost Production Cost Rate(\$)** text box: For a piece of equipment failure, the lost production cost per unit of downtime. For example, your organization might lose \$100,000 per day that the piece of equipment is down. This value is stored in the Variable Lost Production Cost field in the Spare Application Record.
- **Variable Lost Production Cost Rate(\$)** list: A list containing units of measure. In the list, you can select the unit of measure that corresponds to the value in the **Variable Lost Production Cost Rate (\$)** text box. The unit of measure *Day* is selected by default. This value is stored in the Variable Lost Production Unit field in the Spare Application record.
- **# of Required Spares**: The number of spare parts that will be used for this particular repair. This value is stored in the Required Spares field in the Spare Application record.

Preventive Maintenance Section

In the **Preventive Maintenance** section in the [details area of a Spare Application record](#), you can specify preventive maintenance information for the Spare Application Record. The following image shows the **Preventive Maintenance** section.

The **Preventive Maintenance** section contains the following fields:

- **Enable Preventive Maintenance:** A check box that indicates whether or not you want to include any preventive maintenance work that is done for the spare part(s) in the calculations of the Monte Carlo simulation. When you select this check box, the analysis results will include a calculation of the preventive maintenance cost based upon the values that you specify in the **Preventive Maintenance** section. This selection is stored in the Enable Preventive Maintenance field in the Spare Application record.
- **Time-based Replacement Interval text box:** The operational time between subsequent planned maintenance activities. This text box becomes enabled *only* if you selected the **Enable Preventive Maintenance** check box. This value is stored in the PM Interval Value field in the Spare Application record.
- **Time-based Replacement Interval list:** A list containing units of measure. In this list, you can select the unit of measure that corresponds to the value in the **Time-based Replacement Interval** text box. The unit of measure *Days* is selected by default. This value is stored in the PM Interval Unit field in the Spare Application record.
- **Labor Cost(\$):** The cost of labor for each time the maintenance work is performed on the spare part(s). This option becomes enabled *only* if you selected the **Enable Preventive Maintenance** check box. This value is stored in the PM Labor Cost field in the Spare Application record.
- **Downtime text box:** The amount of time that the piece of equipment is not functional during the preventive maintenance work. This value is stored in the PM Downtime Value field in the Spare Application record. When you run the Monte Carlo simulation, the Meridium APM system will use this value and the values that you specify in the **Variable Lost Production Cost Rate** and **# of Required Spares** text boxes in the **Failure Consequence** section to calculate the cost of the preventive maintenance activity.
- **Downtime list:** A list containing units of measure. In this list, you can select the unit of measure that corresponds to the value in the **Downtime** text box. The unit

of measure *Days* is selected by default. This value is stored in the PM Downtime Unit field in the Spare Application record.

About Defining Failure Distribution Information

When you define failure distribution information for a Spare Application record, you are defining the ways in which a spare part can fail, requiring a replacement (or repaired to as good as new) spare part. You can define one or multiple failure distributions for a Spare Application record, and you can [define the failure distribution manually](#) or by [importing the information from an existing Reliability Distribution or Reliability Growth Analysis](#).

When you define multiple failure distributions for a Spare Application record:

- After a failure occurs and a replacement (or repaired to as good as new) spare part is put into service, the time in-service for the spare part is reset to zero (0) for ALL the failure distributions defined for that Spare Application record to reflect that a replacement (or repaired to as good as new) spare part is placed into service.
- After you complete preventive maintenance on a spare part to mitigate one failure, the time in service for the spare part is reset to zero (0) for ALL the failure distributions defined for that Spare Application record to reflect that conducting preventive maintenance on a spare part is equivalent to replacing (or repairing to as good as new) the spare part.

Defining Failure Distribution Information Manually

The following instructions assume that you are viewing the Spares Analysis containing the Spare Application record for which you want to define failure distribution information.

To define failure distribution information manually:

1. On the **Spares Analysis** page, in the Spares Analysis tree, select the Spare Application record for which you want to define failure distribution information.
2. In the [details area of the Spares Application record](#), in the grid in the **Failure Distributions** section, click the **Add New** button.

A new row is added to the grid in the **Failure Distributions** section. The row outlined in red in the following image shows what the new row looks like, by default.

The screenshot shows a window titled "Failure Distributions" containing a table with the following data:

Name	Distribution Type	Time Unit	Parameter 1	Parameter 2	Parameter 3
1041828 Exchanger U-Bend - Internal Tubes	Weibull	Days	0.8576 (Beta)	1523.5244 (Eta)	0 (Gamma)
1041828 Exchanger U-Bend Growth Analysis	Exponential	Days	542.1817 (MTBF)		
New TTF Distribution	Exponential	Days	1 (MTBF)		

Below the table are four buttons: "Refresh All Distributions", "Add From Analysis", "Add New" (highlighted with a dashed border), and "Remove Selected".

3. In the **Name** cell, type the desired name.
4. In the **Distribution Type** cell, select the desired distribution type from the list.
5. In the **Time Unit** cell, in the list, select the desired unit of measure to be applied to the distribution.
6. In the following cells, type the [parameters that are used for the distribution type](#) that you selected:
 - **Parameter 1**
 - **Parameter 2**
 - **Parameter 3**
7. On the **Common Tasks** menu, click the **Save Analysis** link.

A Distribution record containing the information you defined is created and linked to the Spare Application record. The Distribution record is created in a subfamily of the Distribution family, where the subfamily is determined by the value that you select in the **Distribution Type** cell.

Importing Failure Distribution Information

If an existing Reliability Distribution or Reliability Growth Analysis contains failure distribution information for the piece of equipment that you are analyzing in a Spares Analysis, you can import that failure distribution information into the Spare Application record. Note that for our [Spares Analysis example](#), we [enter failure distribution information manually](#).

The following instructions assume that you are viewing the Spares Analysis containing the Spare Application record for which you want to import failure distribution information.

Note: You cannot import an analysis that uses the unit of measure *Quarters*.

To import failure distribution information from an existing Reliability Distribution or Reliability Growth Analysis:

1. On the **Spares Analysis** page, in the Spares Analysis tree, select the Spare Application record for which you want to import failure distribution information.
2. In the [details area of the Spares Application record](#), in the [Failure Distributions section](#), click the **Add From Analysis** button.

The **Find Items** window appears.

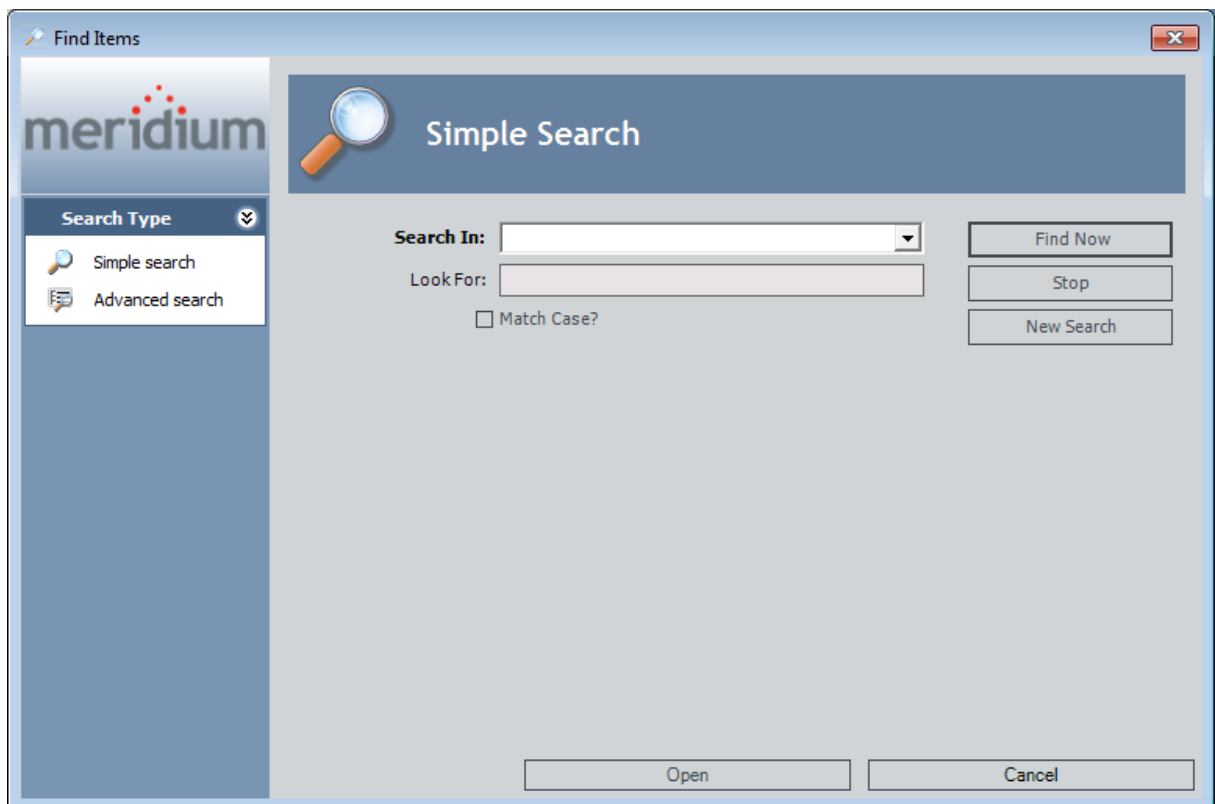

- Specify the search criteria that will return the Reliability Distribution or Reliability Growth Analysis containing the failure distribution information that you want to import, and click the **Find Now** button.

The search results appear in the grid below the search criteria.

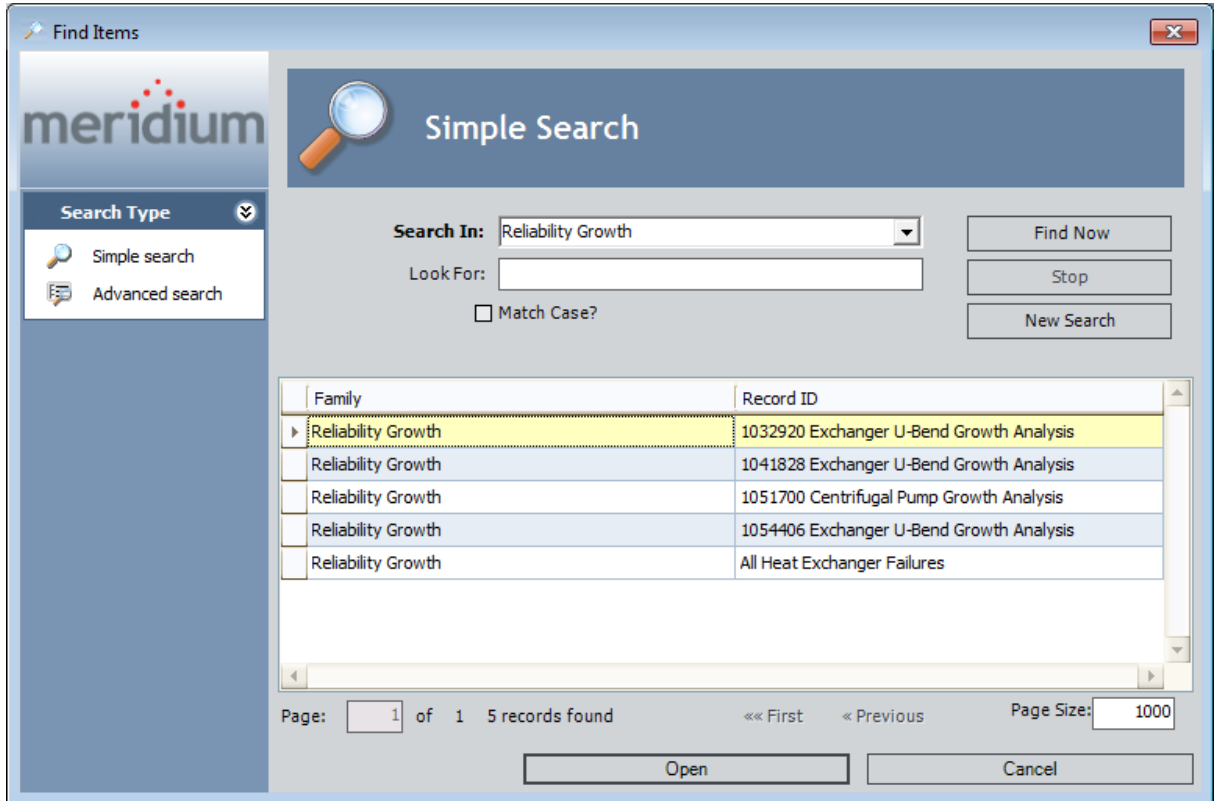

- Select the row containing the analysis with the failure distribution information that you want to import into the Spares Analysis, and click the **Open** button.

The failure distribution information from the selected analysis appears automatically in the [Failure Distributions section](#) in the [details area of the Spare Application record](#).

Note: If you selected a row containing an analysis that uses the unit of measure *Quarters*, an error message appears, indicating that the unit of measure *Quarters* is not supported in Spares Analysis, and the failure distribution information for that Analysis is not added to the **Failure Distributions** section in the details area of the Spare Application record.

- On the [Common Tasks menu](#), click the **Save Analysis** link.

A Distribution record is created and linked to the Spare Application record. The Distribution record is created in a subfamily of the Distribution record, where the subfamily is determined by the distribution type that was selected when the Reli-

Importing Failure Distribution Information

ability Distribution or Reliability Growth Analysis from which you imported the failure distribution information was created.

Refreshing Failure Distribution Information

After you have imported failure distribution information from an existing Reliability Distribution or Reliability Growth Analysis, if the source analysis is modified, you can refresh the distributions in order to retrieve the latest data. If you are viewing a Spare Application record on the **Spares Analysis** page, you can refresh the failure distribution information for that record only using the **Refresh Distributions** button in the [Failure Distributions section](#). The following instructions assume that you want to refresh the distributions for *all* Spare Application records in a Spares Analysis.

To refresh failure distribution information in all Spare Application records in a Spares Analysis:

1. On the **Spares Analysis** page, on the [Tools menu](#), select the **Refresh Distributions** link.

A confirmation message appears, asking if you really want to refresh all distributions in the current analysis.

2. Click **OK**.

The failure distribution information is refreshed.

Deleting a Spare Application Record

When you delete a Spare Application record, any Spare Application Population records to which it is linked will also be deleted.

The following instructions assume that you are viewing the Spares Analysis containing the Spare Application record that you want to delete.

To delete a Spare Application record:

1. On the **Spares Analysis** page, in the Spares Analysis tree, select the Spare record containing the Spare Application record that you want to delete.
2. In the [details area of the Spare record](#), in the [Applications section](#), select the row containing the Spare Application record that you want to delete.
3. Click the **Remove Selected Application(s)** button.

The selected Spare Application record and any Spare Application Population records to which it is linked are deleted.

Overview of Spare Application Population Records

A Spare Application Population record is used to record the *population age* of a group of equipment that together use the data in the Spare Application record to which it is linked. An analysis might have more than one group of equipment with different ages using the same failure and repair data from the linked Spare Application record.

Consider the [age data for our Spares Analysis example](#):

- One pump is four years old.
- Two pumps are three years old.
- Six pumps are two years old.
- One pump is five years old.

Note: The population age is an *operational* age rather than a *Calendar* age.

Note that a Spare Application Population record does not have an associated details area on the **Spares Analysis** page. All Spare Application Population records in a Spares Analysis are located in the **Populations** section of the linked Spare Application record.

Creating a Spare Application Population Record

To create a Spare Application Population record:

1. Open a Spares Analysis.
2. In the analysis tree, select the Spare Application record for which you want to create a new Spare Application Population record.
3. In the **Populations** section of the [details area](#), click the **Add Population** button.

A new Spare Application Population record appears in the **Populations** section of the [details area of the Spare Application record](#).

Population Name	Population Size	Age Value	Age Unit
Population 1	2	2	2 Years
Population 2	1	1	4 Years
Population 3	1	1	0 Years

4. Specify values for the properties in the [Populations section](#).
5. On the [Common Tasks menu](#), click the **Save Analysis** link.

The Spare Application Population record is saved. At this point, you can:

- Repeat these steps to create another Spare Application Population record.
- OR-
- [Run a Monte Carlo simulation](#).

Aspects of Spare Application Population Records

Population Name	Population Size	Age Value	Age Unit
Population 1		4	2 Years
Population 2		2	3 Years
Population 3		1	5 Years

Buttons: Add Population, Remove Selected Population(s)

The following columns are located in the **Populations** section on a Spare Application Population record:

- **Population Name:** The name of the Spare Application Population record. When you create a new Spare Application Population record, **Population n** appears in the **Population Name** cell by default, where **n** represents the sequential order of the new Spare Application Population record. For example, the name of the first Spare Application Population record that you create for a Spares Analysis will be Population 1, the name of the second Spare Application Population record that you create will be Population 2, and so on.

If desired, you can type a different name for the Spare Application Population record. Note that the name of each Spare Application Population record must be unique to the root Spare Application record. Note that if you type a name that already exists for another Spares Application Population record that is linked to the same Spare Application record, the  [symbol](#) appears to the left of the **Population Name** text box. Note that you will not be able to navigate out of the text box until you have specified a unique name for the record.

- **Population Size:** The number of pieces of equipment that share the same age.
- **Age Value:** The operational age of the population of equipment that is associated with the data in the linked Spare Application record and Spare record. In other words, the amount of time that the population has been in use.
- **Age Unit:** The unit of measure associated with the Age Value. The **Age Unit** list is set to **Years** by default. If desired, you can change the value by using the  button.

Deleting a Spare Application Population Record

To delete a Spare Application Population record:

1. Open the Spares Analysis from which you want to delete a Spare Application Population record.
2. If it is not already selected, select the Spare Application record in the Spares Analysis tree.

In the [details area of the Spare Application record](#), locate the **Populations** section, which displays a list of all existing Spare Application Population records.

Population Name	Population Size	Age Value	Age Unit
Population 1		4	2 Years
Population 2		2	3 Years
Population 3		1	5 Years

3. Select the row(s) containing the Spare Application Population record(s) that you want to delete.
4. Click the **Remove Selected Population(s)** button.

The selected Spare Application Population record(s) are deleted.

About Monte Carlo Simulations

There are some instances in which conditions are too complex to use the typical analytical methods to answer certain questions. Monte Carlo simulations can be used to predict results in these situations. Consider the following simple questions with seemingly unpredictable answers:

- How many people will be in the check-out line at the grocery store at 7 P.M. on Wednesday?
- How many cars will be on Main Street at 9 P.M. on Friday?
- When will the next power outage occur in our neighborhood?

The answers to these questions vary based on a number of factors, including:

- The probability of previous occurrences in these situations.
- Actual conditions leading up to the event.
- Variable values that provide inputs to calculated outputs.

Now, consider the following more complex questions:

- How long will the piece of equipment continue to operate before the next failure?
- How many spare parts should be stored to handle unplanned failures but not result in a surplus of parts that are not needed?

When these types of questions arise, a Monte Carlo simulation can be run to look at the random variables and probability for a complex piece of equipment to calculate the most predictable results. A number of iterations can be specified to indicate the amount of times that you want the Monte Carlo simulation to run. Note that the larger the number of iterations, the more accurate the Monte Carlo results will be.

For example, suppose you want to determine the probability of rolling a seven using two dice with values one through six. There are 36 possible combinations for the two dice, six of which will total seven, which means that mathematical probability of rolling a seven is six in 36, or 16.67 percent.

But is the mathematical probability the same as the *actual* probability? Or are there other factors that might affect the mathematical probability, such as the design of the dice themselves, the surface on which they are thrown, and the technique that is used to roll them?

To determine the *actual* probability of rolling a seven, you might physically roll the dice 100 times and record the outcome each time. Assume that you did this and rolled a seven 17 out of 100 times, or 17 percent of the time. Although this result would represent an actual, physical result, it would still represent an *approximate* result. If you continued to roll the dice again and again, the result would become less and less approximate.

A Monte Carlo simulation is the mathematical representation of this process. It allows you to simulate the act of physically rolling the dice and lets you specify how many

times to roll them. Each roll of the dice represents a single iteration in the overall simulation; as you increase the number of iterations, the simulation results become more and more accurate. For each iteration, variable inputs are generated at random to simulate conditions such as dice design, rolling surface, and throwing technique. The results of the simulation would provide a statistical representation of the physical experiment described above.

Running a Monte Carlo Simulation

When you run a Monte Carlo simulation, calculations are performed on the delivery time, downtime, lost production costs, and failure and repair data to determine how many spare parts should be kept on hand at any given time. A Monte Carlo simulation performs these calculations for every spare part many times. The exact number of times the calculations are performed is determined by the value in the **Number of Iterations** text box in the [Simulation Options section](#) of the **Spares Analysis** workspace. After a Monte Carlo simulation has been run, you can view its results on any of the [Spares Analysis plots](#).

Note that the plots will contain results from the last time the Monte Carlo simulation was run. Therefore, if you edit any data on any record that might affect the results of the Monte Carlo simulation, you should re-run the simulation before viewing the plots. Otherwise, the plots might contain results that do not match the most current data. A message will appear at the top of the plots indicating if the simulations need to be rerun.

You can run only one simulation at a time. While a simulation is running, however, you can continue working in other areas of the Meridium APM Framework by:

- Clicking anywhere on the Meridium APM Framework main window outside the **Run Simulation** dialog box. When you do so, the simulation will continue to run in the background, and the dialog box will be hidden behind the Meridium APM Framework window. When the simulation finishes, the dialog box will be returned to focus automatically.

-or-

- Clicking either the minimize or the close button on the **Run Simulation** dialog box. When you do so, the simulation will continue to run in the background, and the minimized dialog box will appear on your Windows taskbar. When the simulation finishes, the dialog box will be maximized and returned to focus automatically.

To run a Monte Carlo simulation:

1. After you have [created a Spares Analysis](#), on the [Tools menu](#), click the **Run Simulation** link.
2. The **Browse For Folder** window appears, where you can select or create a folder in which to store the Event Logs.

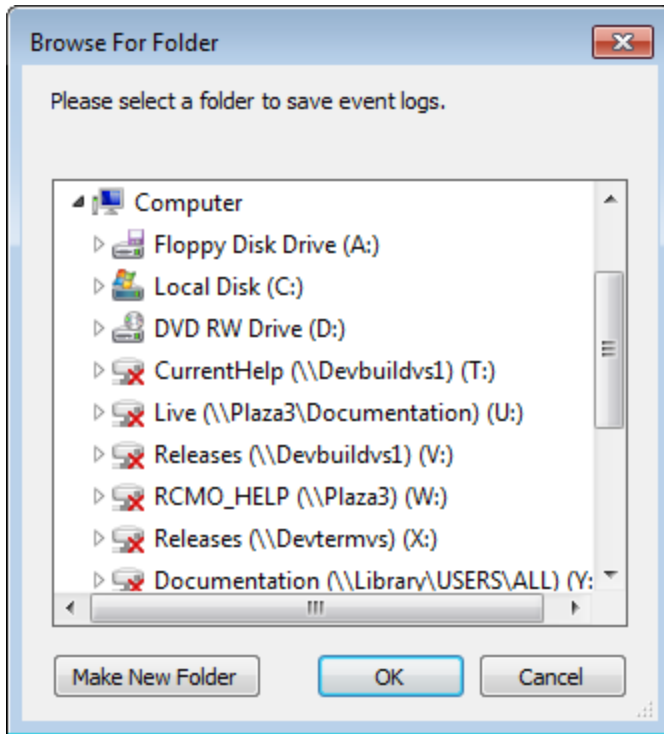

Note: If the **Enable Event Log** check box is cleared in the Simulation Options section of the Spares Analysis, the **Browse For Folder** dialog box will not appear.

3. Navigate to the location where you want to save the Event Logs.
4. Click **OK**.

The **Run Simulation** dialog box appears, displaying a progress bar that indicates the progress of the simulation.

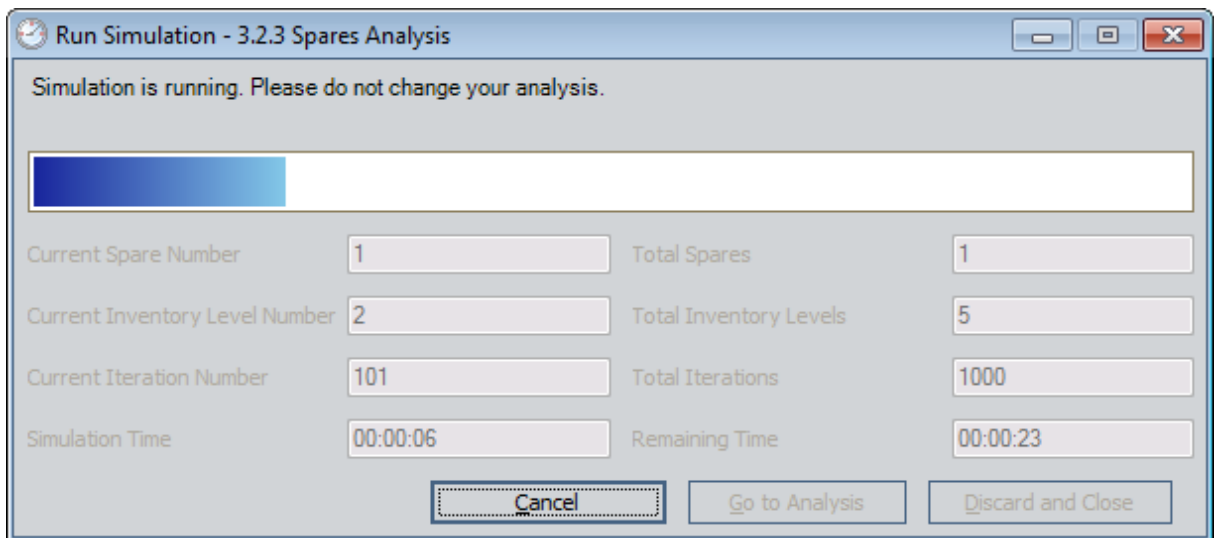

Note: If there are already Event Logs files in the folder that you select, a warning message will appear, indicating that any existing Event Log files may be overwritten.

5. After the progress bar reaches the end, the **Go to Analysis** and **Discard and Close** buttons become enabled. If you do not want to view the results, you can click the **Discard and Close** button to close the **Run Simulation** dialog box. These instructions assume that you want to view the results.
6. Click the **Go to Analysis** button.

The **Run Simulation** window closes, and the links on the [Navigation menu](#) become enabled.

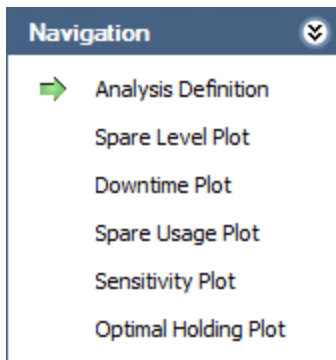

6. Click the link on the [Navigation menu](#) for the plot whose results you want to see.

The workspace for the selected plot appears on the **Spares Analysis** page, and the green arrow appears next to the corresponding link on the **Navigation** menu.

Interpreting Spares Analysis Results in the Dataset Editor

Consider the following image of the exported results of our [Spares Analysis example](#) in a dataset. Note the [values that were specified for the following fields within our Spares Analysis](#):

- Simulation Start Date
- Simulation End Date
- Min Inventory Level
- Max Inventory Level

Spare Name	Minimum Holding Level	Year	Labor Cost	Normal Order Cost	Lost Production Cost	Ware Housing Cost	Total Cost	PM Spare Usage	Unplanr
Seals	0	1/1/2008 12:00 AM	2500	0	605000	7.78434463881032	607987.784344639	0	
Seals	0	1/1/2009 12:00 AM	2150	0	722500	0.401805517703349	725265.401805518	0	
Seals	0	1/1/2010 12:00 AM	2510	0	878500	0.0231021682451892	881763.023102168	0	
Seals	0	1/1/2011 12:00 AM	2550	0	892500	0.0231963470319743	895815.023196347	0	
Seals	0	1/1/2012 12:00 AM	2310	0	808500	0.0213696630137087	811503.021369663	0	
Seals	0	1/1/2013 12:00 AM	2460	0	861000	0.0221917808219151	864198.022191781	0	
Seals	0	1/1/2014 12:00 AM	2300	0	805000	0.0211872146118525	807990.021187215	0	
Seals	0	1/1/2015 12:00 AM	2510	0	878500	0.0227397260273762	881763.022739726	0	
Seals	0	1/1/2016 12:00 AM	2390	0	836500	0.021461187214592	839607.021461187	0	
Seals	0	1/1/2017 12:00 AM	2400	0	840000	0.0222739156131147	843120.022273916	0	
Seals	0	1/1/2018 12:00 AM	2370	0	829500	0.0219269976288536	832587.021926998	0	
Seals	1	1/1/2008 12:00 AM	2580	224	241436.148080753	17.1306288443994	244359.278709597	0	
Seals	1	1/1/2009 12:00 AM	2180	196	178575.169993852	17.3538311466578	181034.523824999	0	
Seals	1	1/1/2010 12:00 AM	2450	213	223568.43736817	17.0978057532293	226344.535173923	0	
Seals	1	1/1/2011 12:00 AM	2550	223	226860.891163288	16.9806154809339	229746.871778769	0	
Seals	1	1/1/2012 12:00 AM	2350	201	229031.802534199	17.3026189198615	231702.105153118	0	
Seals	1	1/1/2013 12:00 AM	2490	212	236602.961611792	17.1887015345028	239433.150313326	0	
Seals	1	1/1/2014 12:00 AM	2370	204	228605.276879527	17.1515163449757	231295.428395872	0	
Seals	1	1/1/2015 12:00 AM	2410	210	216215.213505287	17.1554924847696	218945.368997772	0	
Seals	1	1/1/2016 12:00 AM	2490	218	226070.399065419	17.180813165922	228888.579878585	0	
Seals	1	1/1/2017 12:00 AM	2270	205	194097.485292169	16.9625353091388	196655.447827479	0	
Seals	1	1/1/2018 12:00 AM	2310	194	234684.678831355	14.8608543773691	237314.539685732	0	
Seals	2	1/1/2008 12:00 AM	2580	356	135247.538992613	35.3828599783752	138224.921852591	0	
Seals	2	1/1/2009 12:00 AM	2190	217	115500	37.0536325962022	117950.053632596	0	
Seals	2	1/1/2010 12:00 AM	2460	243	132000	36.7030004364061	134748.703000436	0	
Seals	2	1/1/2011 12:00 AM	2540	251	136000	36.5940347114306	138836.594034711	0	
Seals	2	1/1/2012 12:00 AM	2350	233	127359.556060422	36.938514155753	129985.494574578	0	
Seals	2	1/1/2013 12:00 AM	2500	246	137000	36.6912861109415	139794.691286111	0	
Seals	2	1/1/2014 12:00 AM	2350	232	131466.318819328	36.7474965698244	134094.066315897	0	
Seals	2	1/1/2015 12:00 AM	2430	239	134614.208188264	36.7800794292094	137331.988267694	0	
Seals	2	1/1/2016 12:00 AM	2470	246	126500	36.84237459635	129255.842374596	0	
Seals	2	1/1/2017 12:00 AM	2290	227	125793.92336126	36.4778876899476	128353.40124895	0	
Seals	2	1/1/2018 12:00 AM	2290	221	141428.572945091	32.0266373639549	143995.599582455	0	
Seals	3	1/1/2008 12:00 AM	2580	457	132114.547296128	54.0474406077717	135208.594736736	0	
Seals	3	1/1/2009 12:00 AM	2170	217	108500	57.0292214530934	110944.029221453	0	
Seals	3	1/1/2010 12:00 AM	2470	247	123500	56.6583789933117	126273.658378993	0	

Note that since the analysis period of our Spares Analysis example is 10 years, the first 10 rows of the results display data that corresponds to an inventory level of 0 (zero) for the Seals Spare record, meaning that no spare seals are in stock. The next 10 rows display data that corresponds to an inventory level of 1 for the Seals Spare record, and so on for each of the 11 inventory levels for each year in the analysis period. Note that

since the inventory range specified was **0** to **10**, there are 11 inventory levels because it counts **0** as an inventory level.

After each of the 11 inventory levels for each of the 10 years are indicated for the Seals Spare record in the dataset, you can scroll down to see this repeated for each of the 11 inventory levels for each of the 10 years for the Bearings Spare record. And, it will be repeated for each of the 11 inventory levels for each of the 10 years for the Impellers Spare record.

Exporting the Analysis Results to a File

After a Monte Carlo simulation has been run, results are created from calculations for each Spare record for every year included in the analysis period of the Spares Analysis. These results can be saved as an MS Excel, text, or XML file.

To save the results of the Monte Carlo simulation as a file:

1. After the Monte Carlo simulation is complete, on the [Tools menu](#), click the **Export Result** link.

The **Export Analysis Results** dialog box appears.

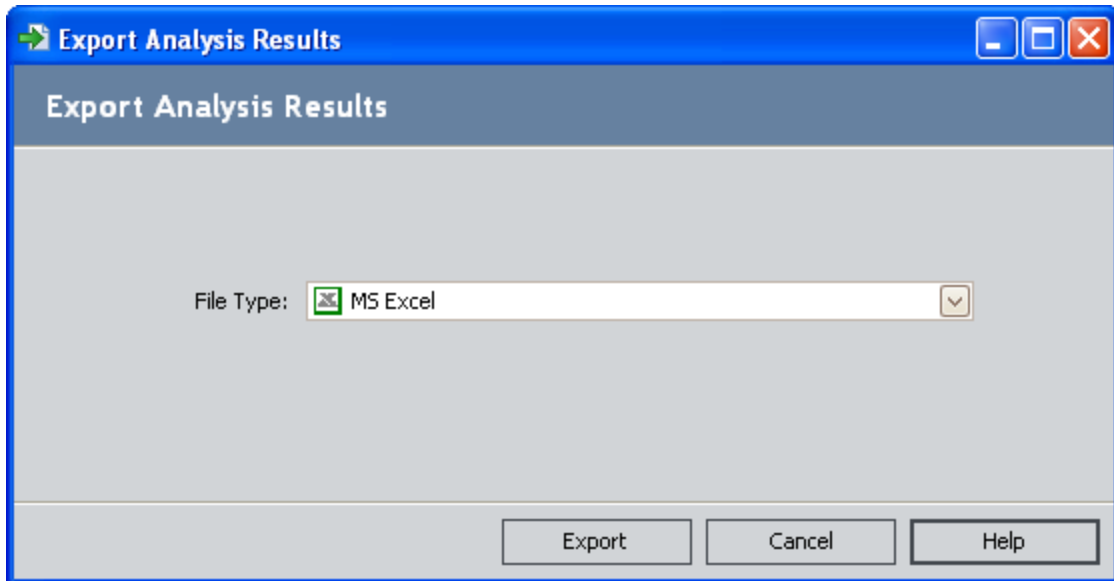

2. In the **File Type** list, select **MS Excel**, **Text**, or **XML**.
3. Click the **Export** button.

The **Export to File** dialog box appears.

Exporting the Analysis Results to a File

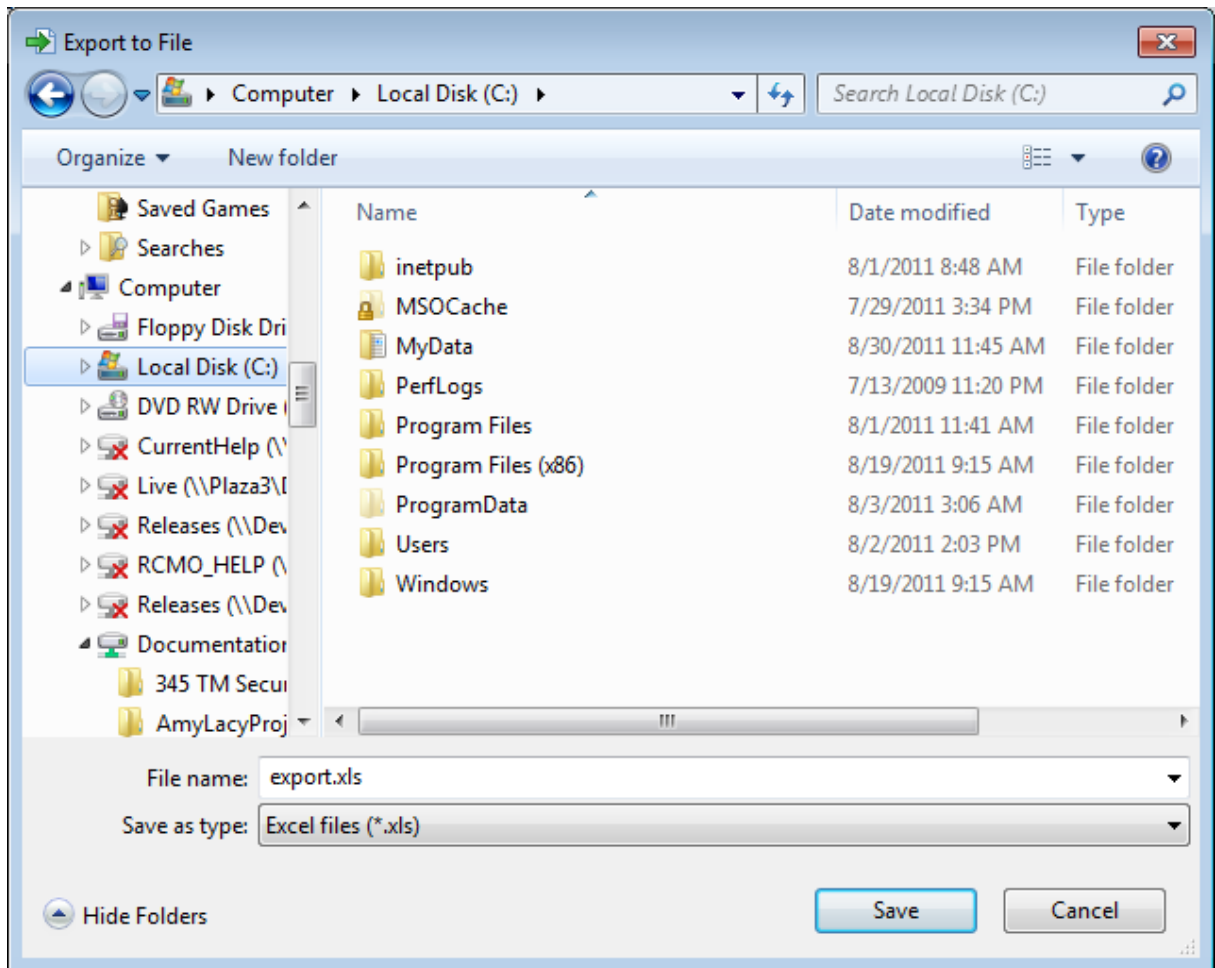

4. Navigate to the location where you want to save the file, type a unique name in the **Filename** text box, and click the **Save** button.

The file is saved to the specified location.

Overview of the Event Log

When you [run a Monte Carlo simulation](#), the failure predictions and hypothetical repair scenarios can be [saved as text files](#) for later reference. These text files are referred to as the *Event Logs*.

Event Logs are optional for Spares Analyses. If you enable Event Logs for a Spares Analysis with a large number of iterations, a large number of Event Logs will be created, and the simulation will take a long time to complete. Therefore, when you enable Event Logs for a Spares Analysis, we recommend lowering the number of iterations so that only a few Event Logs are created at a time. If you do not enable Event Logs for a Spares Analysis, you can continue to run the simulation with a high number of iterations.

For each holding level for every Spare in each iteration in the Spares Analysis, one Event Log file will be created that records every event that happens in that iteration. Each file is named **<Spare Name>-<Current Holding Level>-<Iteration Number>.txt** where:

- **<Spare Name>** is the name of the Spare in the Spares Analysis.
- **<Current Holding Level>** is the number of spare parts that you are storing.
- **<Iteration number>** is the number of the iteration that is detailed in the file.

Each Event Log displays hypothetical scenarios that you can expect to occur based on the information included in the analysis, including but not limited to:

- The analysis period.
- The spare parts inventory range.
- The number of pieces of equipment in the analysis population and the age of each of those pieces of equipment.
- The failure data for each piece of equipment in the population, such as MTBF.
- The correction time for each piece of equipment in the population.
- The data associated with ordering and receiving spare parts.

For each piece of equipment in the analysis population, the Event Log includes a prediction about when you can expect:

- The piece of equipment to operate at normal capacity.
- The piece of equipment to fail.
- The preparation for the repair to begin.
- The actual repairs to begin.
- The spare part to be ordered.
- The spare part to be received.
- The spare part to be used.
- The maintenance work to begin.

Overview of the Event Log

- The maintenance work to be completed.
- The repairs to be completed.

To understand the Event Logs, you will need to understand how the [scenarios are displayed in the text file](#).

CEHint: Although the Event Logs are saved as text files, you may want to open them in Microsoft Excel so that they are easier to read and interpret.

Creating and Saving the Event Log

The following instructions provide details on enabling the creation of Event Logs and saving them to the location of your choice when you run the simulation.

To create the Event Log:

1. Open the desired Spares Analysis, and navigate to the Spares Analysis record.
In the [Simulation Options section](#) in the Spares Analysis record, select the **Enable Event Log** check box.
2. If the **Number of Iterations** text box has a value greater than one, when you select the **Enable Event Log** check box, a message will appear stating that due to the amount of data that will be logged, the number of iterations will be changed to one. If you click **OK**, the **Number of Iterations** text box will be populated automatically with the value 1. If you click **Cancel**, the value in the **Number of Iterations** text box will stay the same and the **Enable Event Log** check box remains selected, but if there is too much data the simulation may not complete.
3. [Run the Monte Carlo simulation.](#)

The **Browse for Folder** dialog box appears.

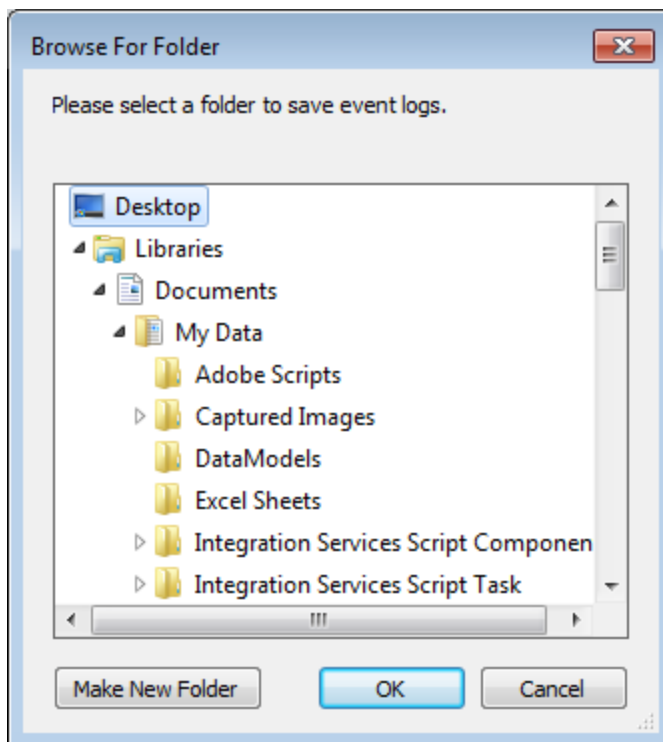

4. Navigate to the location where you want to save the Event Log files, and click **OK**.
An Event Log is created for each holding level for every Spare for each iteration and is saved to the location that you specified.

Specifying the Number of Iterations

An Event Log is created for each holding level for every Spare for each iteration in a Spares Analysis. If you enable Event Logs for a Spares Analysis with a large number of iterations, a large number of Event Logs will be created, and the simulation will take longer to complete. When you enable Event Logs, you should change the number of iterations to a small number (i.e., one) so a small number of Event Log files will be created and the simulation will run in the shortest amount of time. The following instructions assume that the **Enable Event Log** check box is already selected.

To specify the number of iterations for a simulation with Event Logs:

1. In the [Simulation Options section](#) in the Spares Analysis record, in the **Number of Iterations** text box, type the number of iterations you want the simulation to run for the Spares Analysis.
2. If you change the value in the **Number of Iterations** text box to a number greater than 1, a message will appear stating that due to the amount of data that will be logged, the number of iterations will be changed to one. If you click **OK**, the **Number of Iterations** text box will be populated automatically with the value 1. If you click **Cancel**, the value in the **Number of Iterations** text box will stay the same and the **Enable Event Log** check box remains selected, but if there is too much data the simulation may not complete.

-or-

If you change the value in the **Number of Iterations** text box to 1, when you run the simulation, one Event Log will be created and the simulation will complete in the shortest amount of time possible.

Aspects of the Event Log

Consider the following images from our Spares Analysis example. Note that the following images of the Event Log have been opened in Microsoft Excel and contain only a piece of the whole log.

Spare Name: Seals, Minimum Holding Level: 0, Iteration Index: 55				
Time	Application	Event	Spares in Stock	Spares in Order
0		None	1	0
290.638251	Outdoor Application - Pump Population 4 - 1	Fail	1	0
290.638251	Outdoor Application - Pump Population 4 - 1	BeginUnplannedCorrection	1	0
290.804918	Outdoor Application - Pump Population 4 - 1	ConsumeUnplannedCorrectionSpare	0	0
291.138251	Outdoor Application - Pump Population 4 - 1	EndUnplannedCorrection	0	0
310.6149	Outdoor Application - Pump Population 5 - 0	Fail	0	0
310.6149	Outdoor Application - Pump Population 5 - 0	BeginUnplannedCorrection	0	1
313.6149		None	1	0
313.781567	Outdoor Application - Pump Population 5 - 0	ConsumeUnplannedCorrectionSpare	0	0
314.1149	Outdoor Application - Pump Population 5 - 0	EndUnplannedCorrection	0	0

Spare Name: Seals, Minimum Holding Level: 0, Iteration Index: 56				
Time	Application	Event	Spares in Stock	Spares in Order
0		None	1	0
116.02159	Outdoor Application - Pump Population 3 - 1	Fail	1	0
116.02159	Outdoor Application - Pump Population 3 - 1	BeginUnplannedCorrection	1	0
116.188257	Outdoor Application - Pump Population 3 - 1	ConsumeUnplannedCorrectionSpare	0	0
116.52159	Outdoor Application - Pump Population 3 - 1	EndUnplannedCorrection	0	0
146.442973	Outdoor Application - Pump Population 3 - 3	Fail	0	0
146.442973	Outdoor Application - Pump Population 3 - 3	BeginUnplannedCorrection	0	1
149.442973		None	1	0
149.60964	Outdoor Application - Pump Population 3 - 3	ConsumeUnplannedCorrectionSpare	0	0
149.942973	Outdoor Application - Pump Population 3 - 3	EndUnplannedCorrection	0	0

Spare Name: Seals, Minimum Holding Level: 0, Iteration Index: 57				
Time	Application	Event	Spares in Stock	Spares in Order
0		None	1	0
174.770689	Outdoor Application - Pump Population 4 - 1	Fail	1	0
174.770689	Outdoor Application - Pump Population 4 - 1	BeginUnplannedCorrection	1	0
174.937356	Outdoor Application - Pump Population 4 - 1	ConsumeUnplannedCorrectionSpare	0	0
175.270689	Outdoor Application - Pump Population 4 - 1	EndUnplannedCorrection	0	0
507.232746	Indoor Application - Pump Population 2 - 0	Fail	0	0
507.232746	Indoor Application - Pump Population 2 - 0	BeginUnplannedCorrection	0	1
510.232746		None	1	0
510.399413	Indoor Application - Pump Population 2 - 0	ConsumeUnplannedCorrectionSpare	0	0
510.732746	Indoor Application - Pump Population 2 - 0	EndUnplannedCorrection	0	0

The Event Log is divided into numerous groups and columns, which will be highlighted in red in the later examples to make the event log easier to explain. Each group contains a set of values for each unique combination of:

- A spare part included in the Spares Analysis. For example, if an analysis contains three Spare records, then each group within the Event Log will contain values for only one of those Spare records (e.g., Spare record 1).
- An inventory level within the analysis inventory range (determined by the values in the **Min Inventory Level** and **Max Inventory Level** text boxes in the [Spare section](#)) for each spare part. For example, if the inventory range is from 0 to 3, each group

within the Event Log will contain values for only one of those inventory levels (e.g., 0 spare parts).

- An iteration number less than or equal to the value specified in the **Number of Iterations** text box in the [Simulation Options section](#). For example, if the Number of Iterations is 5, each group in the Event Log will contain a set of values that resulted from only one iteration. The Event Log as a whole represents all iterations included in the analysis.

If an analysis is based on only one spare part, one inventory level, and one iteration number, then the Event Log will contain only one group of values. If an analysis is based on more than one spare part, inventory level, or iteration number, then the Event Log will contain more than one group.

In the following example, the first row of a group indicates that the values below the heading corresponds to the Seals spare part, an inventory level of 0 (zero), and an iteration of 0 (zero).

Spare Name: Seals, Minimum Holding Level: 0, Iteration Index: 0

After the information for this scenario appears, another group will appear, corresponding to the Seals spare part, an inventory level of 0 (zero), and an iteration of 1, and so on until values associated with all spare parts, inventory levels, and iteration numbers appear.

Note: There is an additional row after the last event with the value **None** in the **Event** column, and the number of days associated with that event is always past the Simulation End Date. The simulation stops at the first event *after* the Simulation End Date, and this additional event indicates when the simulation actually stopped but is not included in the Monte Carlo simulation results.

Additionally, each group in the Event Log contains the following columns of data:

- [Time](#)
- [Application](#)
- [Event](#)
- [Spares in Stock](#)
- [Spares in Order](#)

Time Column of the Event Log

The value in the **Time** column indicates the number of days that have passed since the piece of equipment began operating. You can think of the Time value as the analysis period. For example, if the Simulation Start Date is **1/1/2008** and the Simulation End Date is **1/1/2018**, then the analysis period, or Time, would be 10 years, or 3,650 days.

As you proceed down the **Time** column, the value will begin to increase. Where the value in the **Time** column exists in the same row as an event, you can infer that the event will occur n number of days after the piece of equipment began operating, where n is the value in the **Time** cell.

For example, in the following image, you can see that a failure will occur approximately 175 days after the piece of equipment begins operating, as indicated by the value **174.770689**.

Spare Name: Seals, Minimum Holding Level: 0, Iteration Index: 57				
Time	Application	Event	Spares in Stock	Spares in Order
0		None	1	0
174.770689	Outdoor Application - Pump Population 4 - 1	Fail	1	0

Application Column of the Event Log

The text in the **Application** column indicates the Spares Application associated with the piece of equipment that failed. For example, in the following image, **Outdoor Application - Pump Population 4 - 1** appears in the **Application** column for the first failure in the first group of scenarios.

Spare Name: Seals, Minimum Holding Level: 0, Iteration Index: 57				
Time	Application	Event	Spares in Stock	Spares in Order
0		None	1	0
174.770689	Outdoor Application - Pump Population 4 - 1	Fail	1	0
174.770689	Outdoor Application - Pump Population 4 - 1	BeginUnplannedCorrection	1	0
174.937356	Outdoor Application - Pump Population 4 - 1	ConsumeUnplannedCorrectionSpare	0	0
175.270689	Outdoor Application - Pump Population 4 - 1	EndUnplannedCorrection	0	0
507.232746	Indoor Application - Pump Population 2 - 0	Fail	0	0
507.232746	Indoor Application - Pump Population 2 - 0	BeginUnplannedCorrection	0	1
510.232746		None	1	0
510.399413	Indoor Application - Pump Population 2 - 0	ConsumeUnplannedCorrectionSpare	0	0
510.732746	Indoor Application - Pump Population 2 - 0	EndUnplannedCorrection	0	0
533.744839	Indoor Application - Pump Population 1 - 0	Fail	0	0
533.744839	Indoor Application - Pump Population 1 - 0	BeginUnplannedCorrection	0	1
536.744839		None	1	0

The first part of the example value, **Outdoor Application**, is the name of the Spare Application record that is associated with the failure that occurred (specified in the **Name** text box in the [Application section](#)).

The second part of the example value, **Pump Population 4 - 1**, represents the piece of equipment that failed that exists within the population that is associated with the Spare Application. **Pump Population 4** is the name of the Spare Application Population record (specified in the **Population** cell in the [Populations section](#)), and **1** is the actual piece of equipment that failed. Note that the pieces of equipment are numbered beginning with zero (e.g., 0,1,2,3). For example, the value for the *second* piece of equipment will be **1**.

For example, since our Spares Analysis example contains the Spare Application Population record Pump Population 4 with a Population Size of 2 (specified in the **Population Size** cell in the [Populations section](#)), two pieces of equipment exist in that population. So, when a failure occurs on the first piece of equipment in Pump Population 4, then the value in the **Application** column of the Event Log will be **Outdoor Application - Population 4 - 0**, where **0** represents the first piece of equipment.

Event Column of the Event Log

The text in the **Event** column indicates the type of event that will occur. The following list explains the event names that can appear within an Event Log:

- **None:** Indicates that the piece of equipment is operating at normal capacity. Note that when this value appears in the **Event** column, it could indicate any of the following options:
 - The simulation begins.
 - The simulation ends.
 - A spare part is ordered.
 - An order for a spare part is received.
- **Fail:** Indicates that the piece of equipment fails.
- **BeginUnplannedCorrection:** Indicates that the preparation work to repair the failed piece of equipment begins.
- **ConsumeUnplannedCorrectionSpare:** Indicates that the repair work to repair the failed piece of equipment begins.
- **EndUnplannedCorrection:** Indicates that the preparation work and repair work is completed, and the piece of equipment is operating normally again.
- **BeginPreventiveMaintenance:** Indicates that the maintenance work begins.
- **ConsumePreventiveMaintenanceSpare:** Indicates that the maintenance work is completed.

Consider the following image.

Spare Name: Seals, Minimum Holding Level: 0, Iteration Index: 57				
Time	Application	Event	Spares in Stock	Spares in Order
0		None	1	0
174.770689	Outdoor Application - Pump Population 4 - 1	Fail	1	0
174.770689	Outdoor Application - Pump Population 4 - 1	BeginUnplannedCorrection	1	0
174.937356	Outdoor Application - Pump Population 4 - 1	ConsumeUnplannedCorrectionSpare	0	0
175.270689	Outdoor Application - Pump Population 4 - 1	EndUnplannedCorrection	0	0

In this example:

- The piece of equipment is operating at normal capacity until almost the 175th day, at which it fails.
- The moment that the piece of equipment fails, preparation to repair the failure begins, as indicated in the **Event** column by the text **BeginUnplannedCorrection**.
- A little more than an hour later, the spare part that is indicated in the **Spares in Stock** column is used to repair the failure, as indicated in the **Event** column by the text **ConsumeUnplannedCorrectionSpare**.
- About three hours later, the repair is complete, as indicated in the **Event** column by the text **EndUnplannedCorrection**.

Spares in Stock Column of the Event Log

The value in the **Spares in Stock** column indicates the number of spare parts that are being stored during each type of event within the Event Log.

In the following image, you can see that one spare seal is being stored until the piece of equipment fails. After the piece of equipment fails, when the repair begins, the spare part is used for the repair, meaning that no spare seals are being stored any longer.

Spare Name: Seals, Minimum Holding Level: 0, Iteration Index: 57				
Time	Application	Event	Spares in Stock	Spares in Order
0		None	1	0
174.770689	Outdoor Application - Pump Population 4 - 1	Fail	1	0
174.770689	Outdoor Application - Pump Population 4 - 1	BeginUnplannedCorrection	1	0
174.937356	Outdoor Application - Pump Population 4 - 1	ConsumeUnplannedCorrectionSpare	0	0
175.270689	Outdoor Application - Pump Population 4 - 1	EndUnplannedCorrection	0	0

Spares in Order Column of the Event Log

The value in the **Spares in Order** column indicates the number of spare parts that have been ordered and that you are waiting to receive in the storage location (i.e., warehouse) before beginning the necessary repairs on the piece of equipment.

In the following image, a spare seal is not ordered until the second failure occurs. Since no spare seals are in stock at the time of the second failure, one is ordered to repair that failure.

Spare Name: Seals, Minimum Holding Level: 0, Iteration Index: 57

Time	Application	Event	Spares in Stock	Spares in Order
0		None	1	0
174.770689	Outdoor Application - Pump Population 4 - 1	Fail	1	0
174.770689	Outdoor Application - Pump Population 4 - 1	BeginUnplannedCorrection	1	0
174.937356	Outdoor Application - Pump Population 4 - 1	ConsumeUnplannedCorrectionSpare	0	0
175.270689	Outdoor Application - Pump Population 4 - 1	EndUnplannedCorrection	0	0
507.232746	Indoor Application - Pump Population 2 - 0	Fail	0	0
507.232746	Indoor Application - Pump Population 2 - 0	BeginUnplannedCorrection	0	1
510.232746		None	1	0
510.399413	Indoor Application - Pump Population 2 - 0	ConsumeUnplannedCorrectionSpare	0	0
510.732746	Indoor Application - Pump Population 2 - 0	EndUnplannedCorrection	0	0
533.744839	Indoor Application - Pump Population 1 - 0	Fail	0	0

Overview of the Spares Analysis Report

The baseline Meridium APM database includes the Spares Analysis Report, which you can use to view a summary of the results of a Spares Analysis. When you run the Spares Analysis report, it will appear on the **Report Viewer** page.

The Spares Analysis Report is built from the following Catalog items:

- The main report, *SparesAnalysis*, which is stored in the Catalog folder \\Public\Meridium\Modules\Reliability Manager\Reports.
- The subreport, *Spares*, which is stored in the Catalog folder \\Public\Meridium\Modules\Reliability Manager\Reports.
- The subreport, *SparesApplication*, which is stored in the Catalog folder \\Public\Meridium\Modules\Reliability Manager\Reports.
- The subreport, *SparesChart*, which is stored in the Catalog folder \\Public\Meridium\Modules\Reliability Manager\Reports.
- The supporting queries that supply data in the main report and subreports, which are stored in the Catalog folder \\Public\Meridium\Modules\Reliability Manager\Reports. The following supporting queries are available:
 - *Spares Analysis - Applications*
 - *Spares Analysis - Charts*
 - *Spares Analysis - ChartsMain*
 - *Spares Analysis - Main*
 - *Spares Analysis - Spares*
 - *Spares Analysis - SparesMain*

Throughout this documentation, we refer to the main report, the subreports, and the supporting queries collectively as the *Spares Analysis Report*.

The Spares Analysis Report contains the following sections:

- [Analysis Properties](#)
- [Spare Properties](#)
- [Application Properties](#)
- [Plots](#)

Running the Spares Analysis Report

Note: You cannot run a Spares Analysis report directly from the Meridium APM Catalog. To generate a report successfully, you must use the **Generate Report** link on the [Tools menu](#) on the **Spares Analysis** page.

To run the Spares Analysis Report:

- On the **Spares Analysis** page, on the [Tools menu](#), click the **Generate Report** link.

The Spares Analysis Report appears on the **Report Viewer** page.

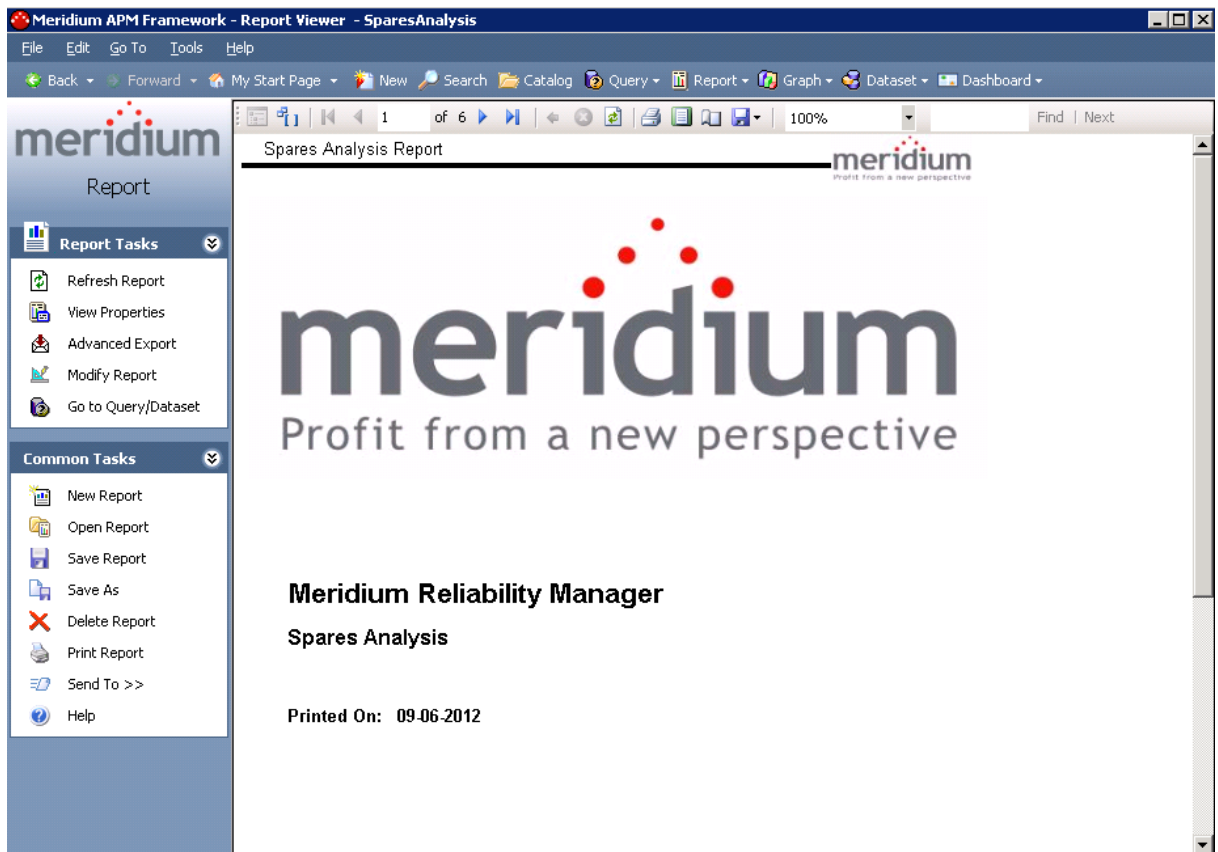

Analysis Properties Section

The **Analysis Properties** section of the Spares Analysis Report displays information that is stored in the Spares Analysis record. The name of the analysis, which is stored in the Analysis ID field of the Spares Analysis record, is displayed in blue at the top of the **Analysis Properties** section.

Spares Analysis Example

Analysis Properties	
Description	This is a sample Spares Analysis Example.
Start Date	1/1/2008 12:00:00 AM
End Date	1/1/2018 12:00:00 AM
Currency	\$
Simulation Options	
Iteration #	100
Random Seed	False
Events logged	False

The following table lists each item in the **Analysis Properties** section and the corresponding Spares Analysis record field whose data is displayed in the report.

Report Item	Record field(s)
Analysis Properties	
Description	Short Description
Start Date	Analysis Start Date
End Date	Analysis End Date
Currency	Currency
Simulation Options	
Iteration	Iteration Number
Random Seed	Random Seed
Events Logged	Enable Event Log

Spare Properties Section

Each Spare Analysis record can be linked to multiple Spare records. In the Spares Analysis report, a **Spare Properties** section will appear for each Spare record that is linked to the Spare Analysis record. The name of the spare, which is stored in the Spare ID field of the Spare record, is displayed in blue at the top of each **Spare Properties** section.

Spare 1

Spare Properties	
On-site delivery time	2 Hours
Normal order time	5 Days
Expedited order time	3 Days
Normal cost	\$ 2500
Expedited cost	\$ 5000
Holding cost rate	\$ 250 / Year
Inventory level range	1 to 5
Current holding level	2

The following table lists each item in the **Spare Properties** section and the corresponding Spares Analysis record field whose data is displayed in the report.

Report Item	Record field(s)
On-site deliver time	Onsite Delivery Time Value Onsite Delivery Time Unit
Normal order time	Normal Order Time Value Normal Order Time Unit
Expedited order time	Expedited Order Time Value Expedited Order Time Unit
Normal cost	Normal Cost
Expedited cost	Expedited Cost
Holding cost rate	Holding Cost Rate Holding Cost Unit
Inventory level range	Min Inventory Level Max Inventory Level

Spare Properties Section

Report Item	Record field(s)
Current holding level	Current Holding Level

About the Application Properties Section

Spare records can be linked to multiple Spare Application records. For each Spare record in the Spares Analysis report, there can be multiple **Application Properties** sections. The **Application Properties** section contains the following grids:

- [Populations](#)
- [Failure Distribution](#)
- [Failure Consequence](#)
- [Preventative Maintenance](#)

The name of the corresponding Application, which is stored in the Application ID field of each Spare Application record, is displayed at the beginning of each **Application Properties** section.

Properties Grid

The **Properties** grid displays information stored in Spare Application Population records. There can be multiple Spare Application Population records linked to each Spare Application record. For each Spare Application Population record, one row exists in the **Populations** grid.

Application 1

<i>Populations</i>		
Population Name	Population Size	Population Age
Population 1	5	0 Years
Population 2	5	250 Days

The following table lists each item in the **Properties** grid and the corresponding Spare Application Population record field whose data is displayed in the report.

Report Item	Record field(s)
Population Name	Name
Population Size	Population Size
Population Age	Age Age Time Unit

Failure Distribution Grid

The **Failure Distribution** grid displays information that is stored in Distribution records that are linked to the Spare Application record. There can be multiple Distribution records linked to each Spare Application record. For each Distribution record, one row exists in the **Failure Distribution** grid.

<i>Failure Distribution</i>					
Name	Distribution Type	Time Unit	Parameter1	Parameter2	Parameter3
TTF Distribution for Spares Analysis	Exponential	Days	375 (MTBF)		

The following table lists each item in the **Failure Distribution** grid and the corresponding Distribution record field whose data is displayed in the report. The values in the **Parameter 1**, **Parameter 2**, and **Parameter 3** columns will be different depending on whether the Distribution record is a Exponential, Lognormal, Normal, or Weibull distribution.

Report Item	Family	Record field(s)	Notes
Name	Distribution	Short Description	None
Distribution Type	Distribution	Distribution Type	None
Time Unit	Distribution	Units	None
Parameter 1	Exponential Lognormal Normal Weibuill	MTBF Mu Fix Mean Beta	None
Parameter 2	Lognormal Normal Weibuill	Sigma Fix Standard Deviation Eta	If the Distribution Type is Exponential, no value is displayed.
Parameter 3	Lognormal Weibull	Gamma Gamma	If the Distribution Type is Exponential or Normal, no value is displayed.

Failure Consequence Grid

The **Failure Consequence** grid displays information stored in the Spare Application record.

<i>Failure Consequence</i>	
Preparation Time	4 Hours
Repair Time	1 Days
Labor Cost	\$ 1200
Fixed Lost Production Cost	\$ 3000
Variable Lost Production Cost Rate	\$ 5000/Day
# of Required Spaces	1

The following table lists each item in the **Failure Consequence** grid and the corresponding Spare Application record field whose data is displayed in the report.

Report Item	Record field(s)
Preparation Time	Preparation Time Value Preparation Time Unit
Repair Time	Repair Time Value Repair Time Unit
Labor Cost	Repair Labor Cost
Fixed Lost Production Cost	Fixed Lost Production Cost
Variable Lost Production Cost Rate	Variable Lost Production Cost Variable Lost Production Unit
# of Required Spaces	Required Spares

Preventative Maintenance Grid

The **Preventative Maintenance** grid displays information stored in the Spare Application record.

<i>Preventive Maintenance</i>	
Time-based Replacement Interval	400 Days
Labor Cost	\$ 1200
Downtime	1 Days

The following table lists each item in the **Preventative Maintenance** grid and the corresponding Spare Application record field whose data is displayed in the report.

Report Item	Record field(s)
Time-based Replacement Interval	PM Interval Value PM Interval Unit
Labor Cost	PM Labor Cost
Downtime	PM Downtime Value PM Downtime Unit

Plots Section

If you have [run a Monte Carlo simulation](#), the [Spares Analysis plots](#) will appear in the Spares Analysis report with the results from the last simulation that was run. The following image displays an example of the **Spares Level Plot** graph.

SparesLevel - Spare 1

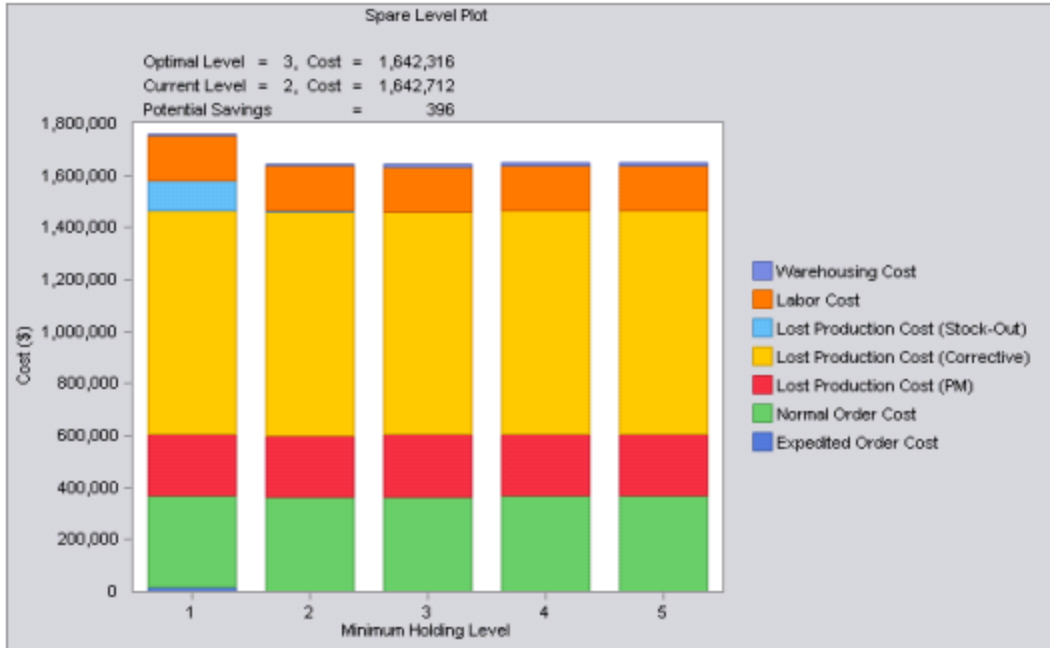

Error Symbol in Spares Analyses

Rather than displaying a pop-up error message, to the left of any text box where an error occurred, the  symbol appears to the left of the text box where the error occurred in the following circumstances:

- You try to type a name for a Spare, Spare Application, or Spare Application Population record that is not unique to the root record.
- You delete a value from a required text box. If you do not want to type a value in a text box, you must at least leave the default value of 0 (zero) in the text box.
- You type an invalid value in any field. For example, if you type **abc** in the **Number of Iterations** text box, the  symbol will appear.

You can then pause on the  symbol to display a detailed error message.

For example, if you type the name of an existing Spares Application record in the **Name** text box of a new Spares Application record that is linked to the same Spares record, then you will see this:



If you pause on the  symbol, then the following error message will appear: *Invalid value.*

The error message displays the error that occurred on that particular text box, and you will not be able to navigate out of that text box until you have specified a unique name for the record.

Interpreting the Spares Analysis Example

After you have [created a Spares Analysis](#) and [run a Monte Carlo simulation](#), you can interpret the results to determine if the current storing level of spare parts is appropriate. Consider the completed Spares Analysis from our [example](#).

Currently, one spare seal, one spare bearing, and no spare impellers are stored in the warehouse. After completing a Spares Analysis, we can view the results of the Monte Carlo simulation in the following [Spares Analysis plots](#) for *each* spare part to determine if any changes need to be made to the current holding level of seals, bearings, or impellers to avoid excessive costs and downtime:

- [Spare Level Plot](#)
- [Downtime Plot](#)
- [Spare Usage Plot](#)
- [Sensitivity Plot](#)
- [Optimal Holding Plot](#)

Interpreting the Spare Level Plots

The following Spare Level Plots display the optimal level of each spare part included in the Spares Analysis example and the cost difference between what we are currently storing and what is recommended that we store. The Spare Level Plot displays the cost of each spare level within the inventory range (determined by the values in the **Min Inventory Level** and **Max Inventory Level** text boxes in the [Spare section](#)) for the analysis period (determined by the values in the **Simulation Start Date** and **Simulation End Date** boxes in the [Analysis section](#)).

- **Seals**

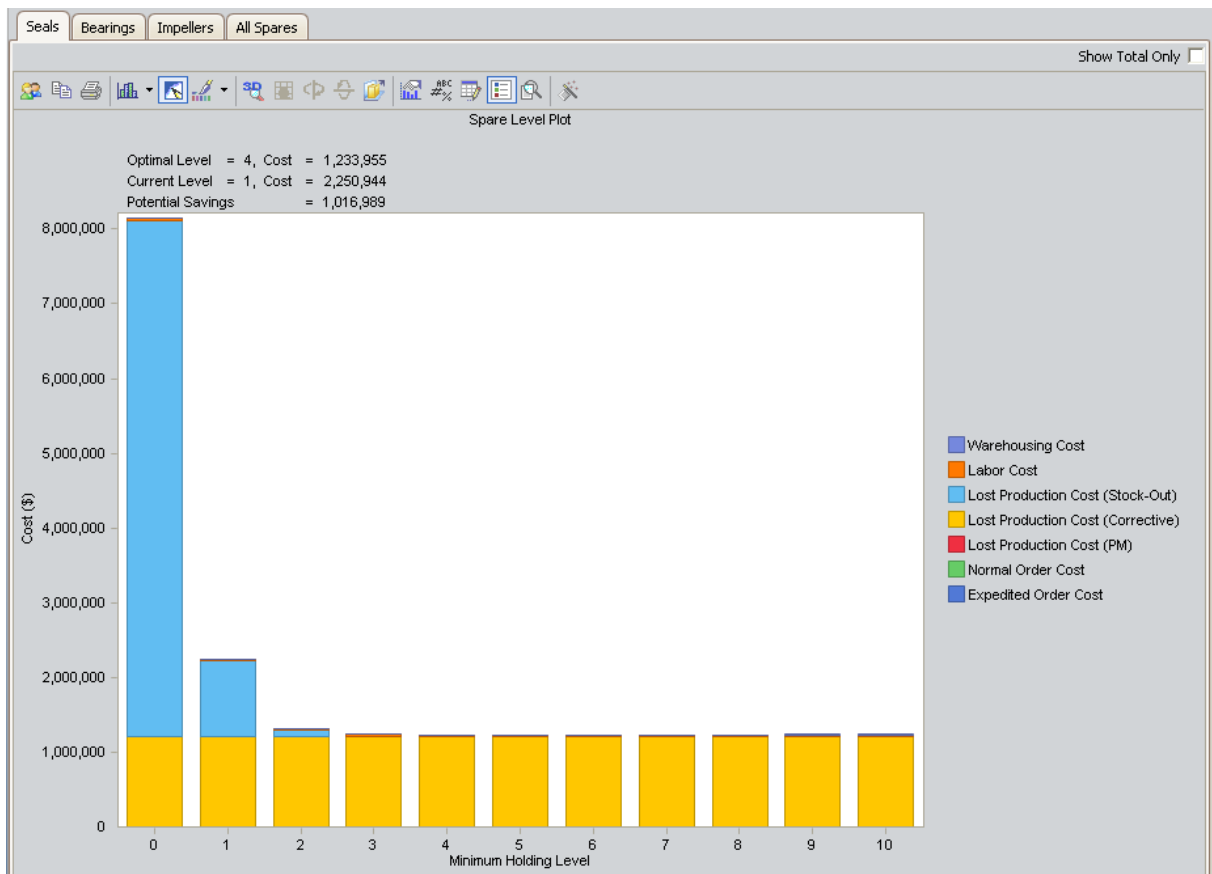

By comparing the current holding level of one seal and the optimal level of four spare seals, we can determine how much money our organization is losing every 10 years by not storing more spare seals. The benefit of storing more spare seals is calculated using the following equation:

$$\text{Benefit} = \text{Current Level} - \text{Optimal Level}$$

Consider the following values from our example:

- Current Level = 2,250,944
- Optimal Level = 1,233,955

Given these values:

$$\text{Benefit} = 2,250,944 - 1,233,955$$

$$\text{Benefit} = 1,106,989$$

- **Bearings**

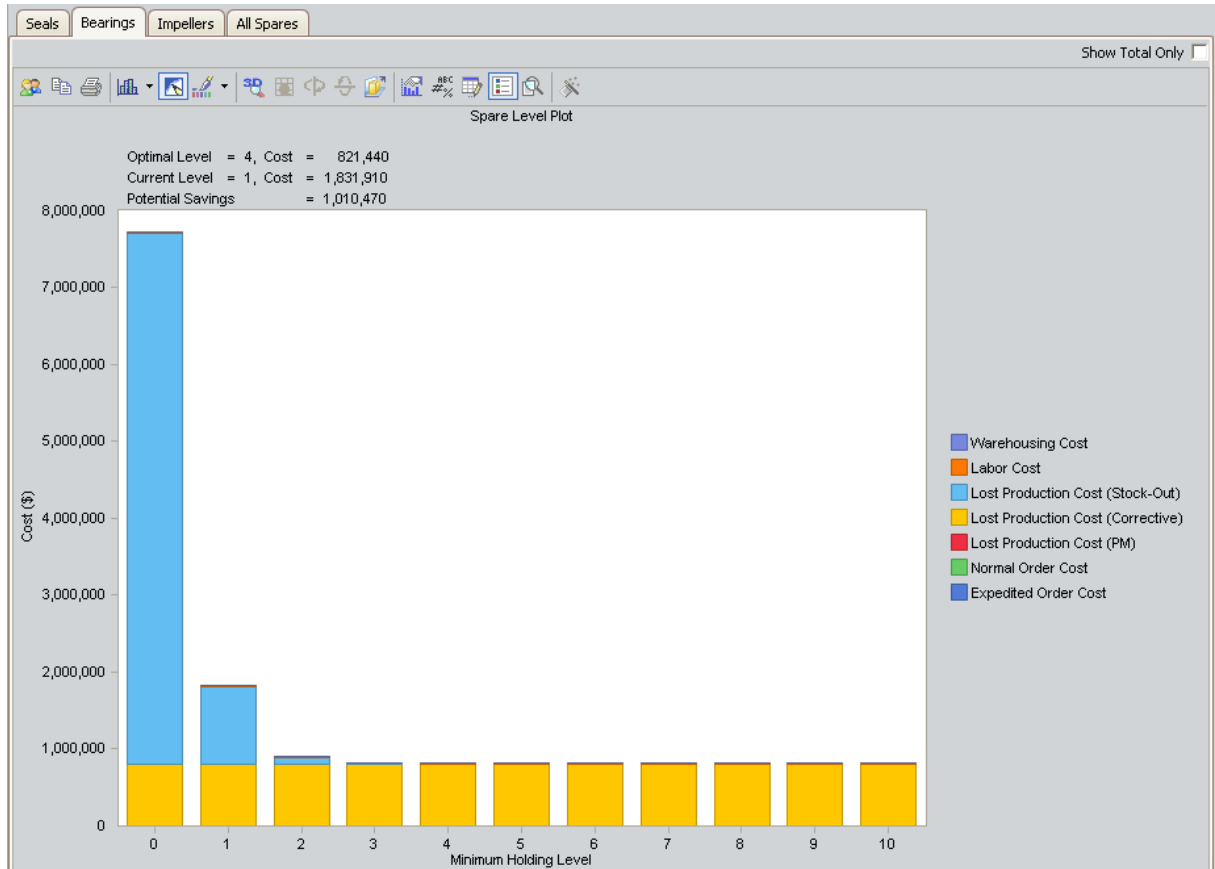

By comparing the current holding level of one bearing and the optimal level of three spare bearings, we can determine how much money our organization is losing every ten years by not storing more spare bearings. The benefit of storing more bearings is calculated using the following equation:

$$\text{Benefit} = \text{Current Level} - \text{Optimal Level}$$

Consider the following values from our example:

- Current Level = 1,831,910
- Optimal Level = 821,440

Given these values:

$$\text{Benefit} = 1,831,910 - 821,440$$

Benefit = 1,010,470

- **Impellers**

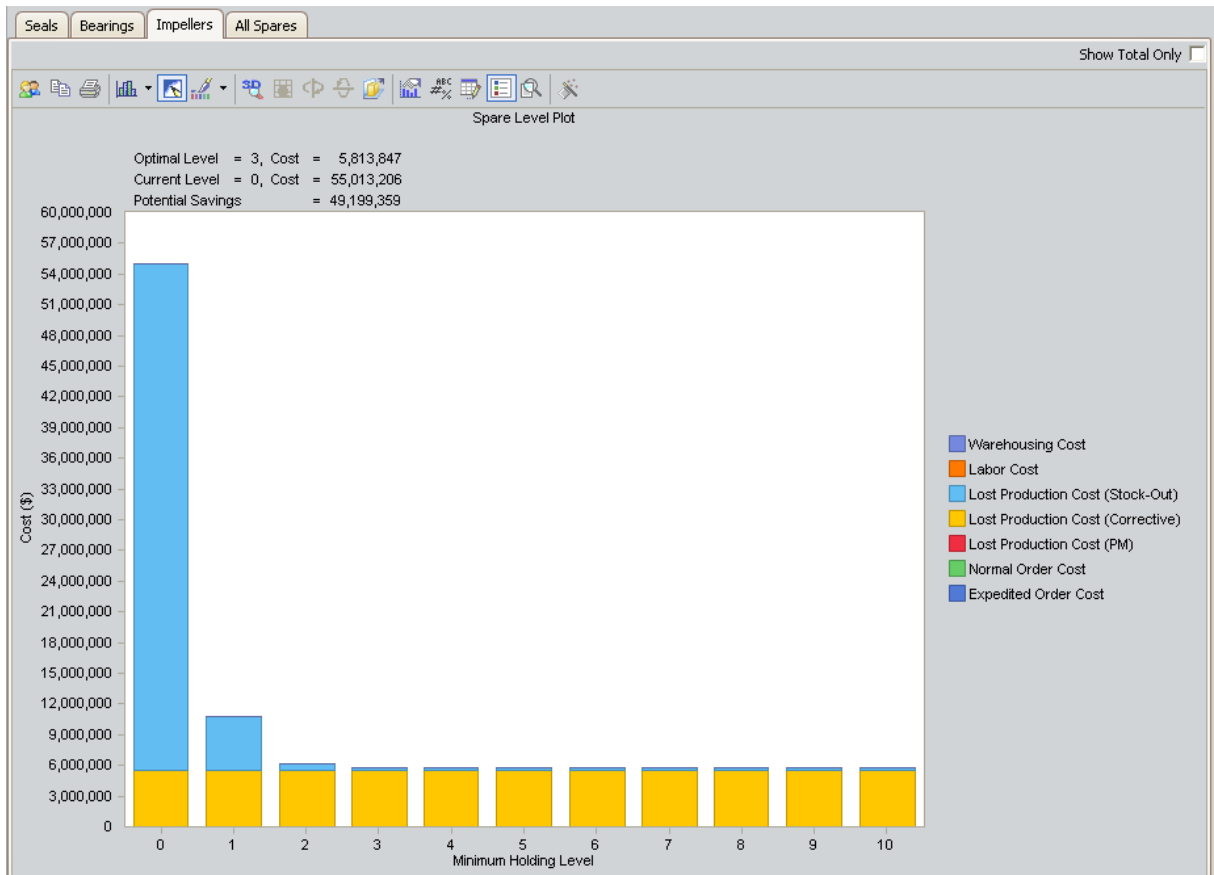

By comparing the current holding level of no impellers and the optimal level of two spare impellers, we can determine how much money our organization is losing every ten years by not storing more spare impellers. The benefit of storing more impellers is calculated using the following equation:

Benefit = Current Level – Optimal Level

Consider the following values from our example:

- Current Level = 5,513,206
- Optimal Level = 591,089

Given these values:

Benefit = 5,513,206 – 591,089

Benefit = 4,922,117

Interpreting the Downtime Plots

The following Downtime Plots display the specific downtime associated with each spare part included in the Spares Analysis example:

- **Seals**

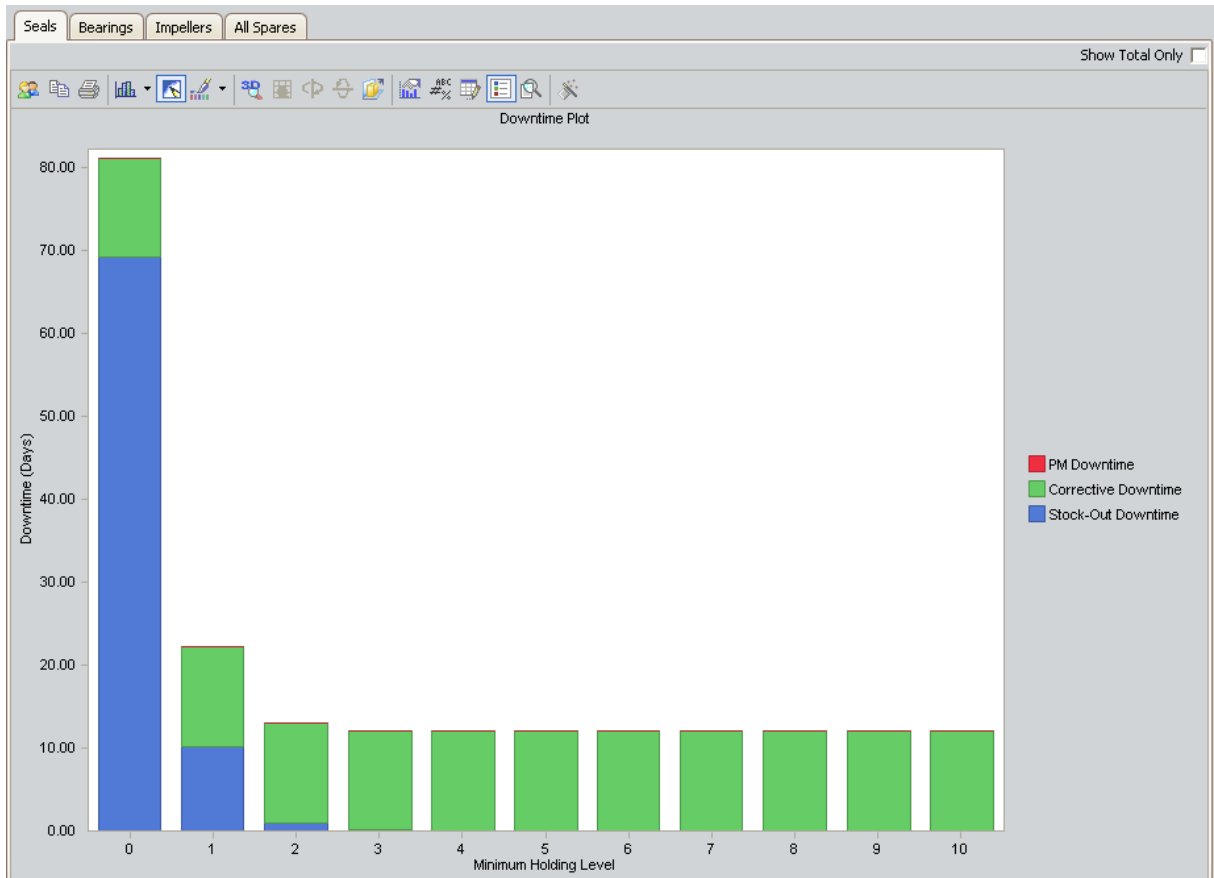

In this image, we can determine that the downtime associated with our current holding level of one spare seal has a total of about 22 days. If we store the optimal spare level (specified in the [Spare Level Plot](#)) of four seals, we can determine that there will be a total of only about 12 days of downtime.

- **Bearings**

Interpreting the Downtime Plots

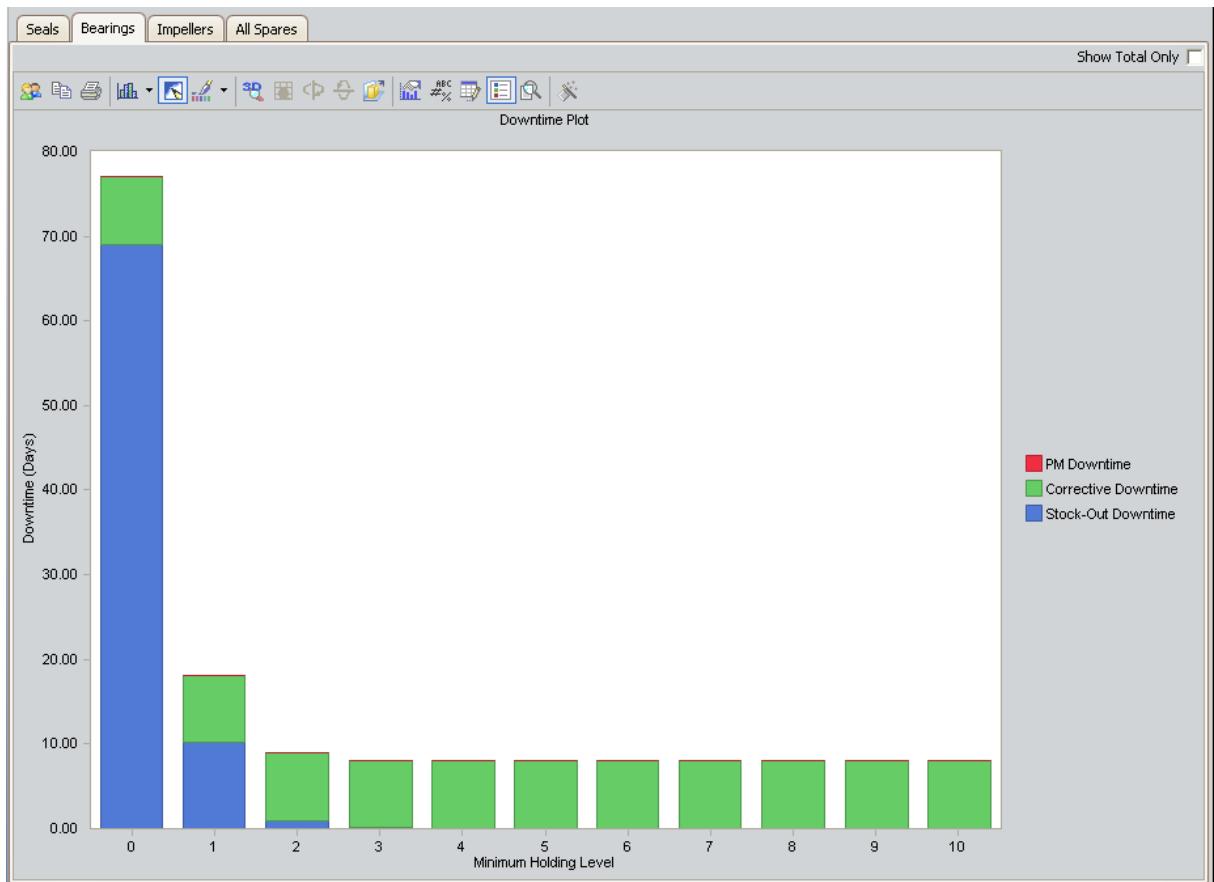

In this image, we can determine that the downtime associated with our current holding level of one spare bearing has a total of about 18 days. If we store the optimal spare level (specified in the [Spare Level Plot](#)) of four bearings, we can determine that there will be a total of only about eight days of downtime.

- **Impellers**

Interpreting the Downtime Plots

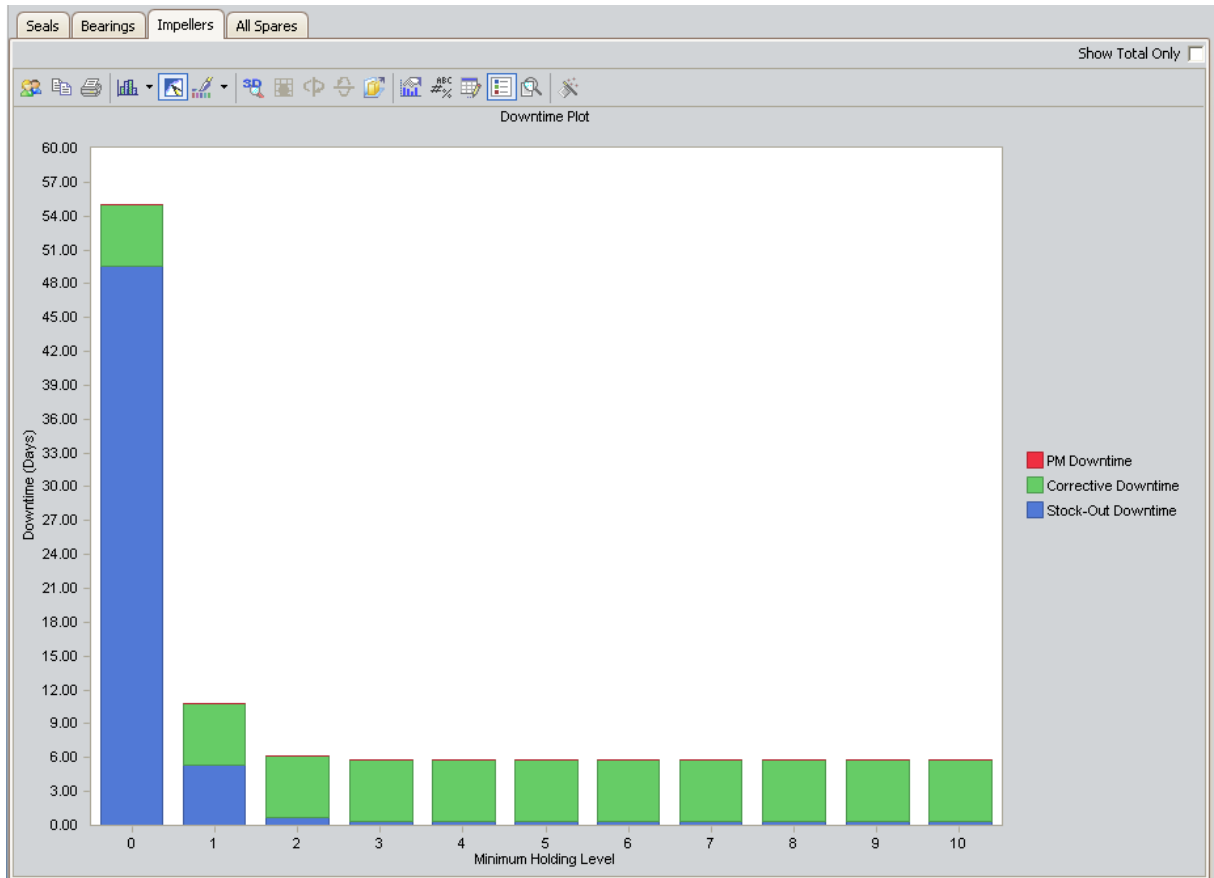

In this image, we can determine that the downtime associated with our current holding level of 0 (zero) spare impellers has a total of 72 days. If we store the optimal spare level (specified in the [Spare Level Plot](#)) of three impellers, we can determine that there will be a total of only about eight days of downtime.

Based on the results for the seals, bearings, and impellers in the Downtime Plots shown above, we can use the following equation to determine the optimal amount of downtime:

$$\text{Current Holding Level} = \sum \text{Current Holding Level Downtime for All Spares}$$

Consider the following values from our example:

- Total Seals Downtime (current holding level) = 22 days
- Total Bearings Downtime (current holding level) = 18 days
- Total Impellers Downtime (current holding level) = 72 days

Given these values:

$$\text{Current Holding Level Downtime} = 22 + 18 + 72$$

$$\text{Current Holding Level Downtime} = 112 \text{ days}$$

Optimal Holding Level = Σ Optimal Holding Level Downtime for All Spares

Consider the following values from our example:

- Total Seals Downtime (optimal holding level) = 12 days
- Total Bearings Downtime (optimal holding level) = 8 days
- Total Impellers Downtime (optimal holding level) = 8 days

Given these values:

Optimal Holding Level Downtime = $12 + 8 + 8$

Optimal Holding Level Downtime = 28 days

Overall Downtime (optimal) = Σ Current Holding Level Downtime – Σ Optimal Holding Level Downtime

Consider the following values from our example:

- Current Holding Level Downtime = 112 days
- Optimal Holding Level Downtime = 28 days

Given these values:

Overall Downtime (optimal) = $112 - 28$

Overall Downtime (optimal) = 84 days

Interpreting the Spare Usage Plots

The following Spare Usage Plots display the annual spare usage for each year within the analysis period, assuming that we are storing the optimal level of spare parts.

- **Seals**

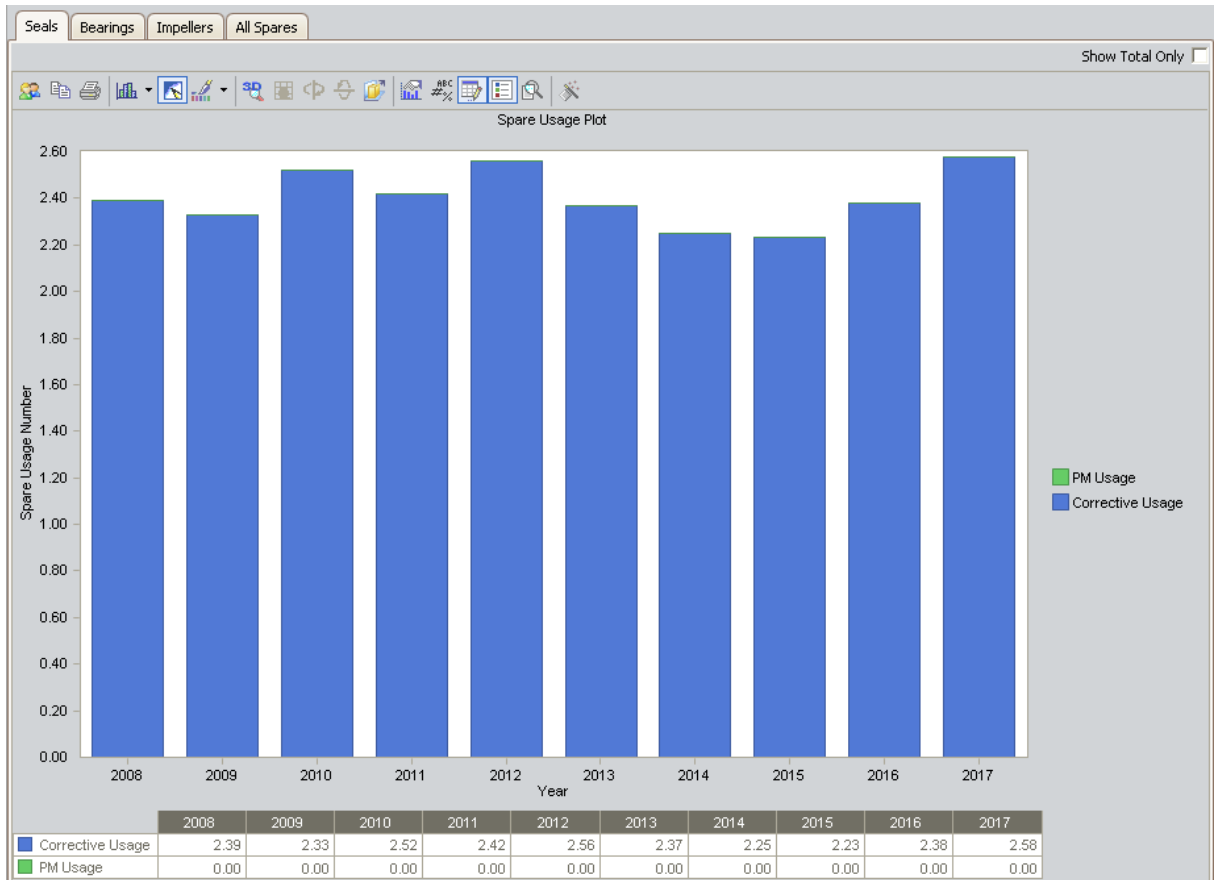

The Spare Usage Plot shows the number of spare parts that will be used for each year within the analysis period. Using the preceding image, if we add the spare usage for each year, we can determine that a total of about 24 spare seals will be used during the entire analysis period.

- **Bearings**

Interpreting the Spare Usage Plots

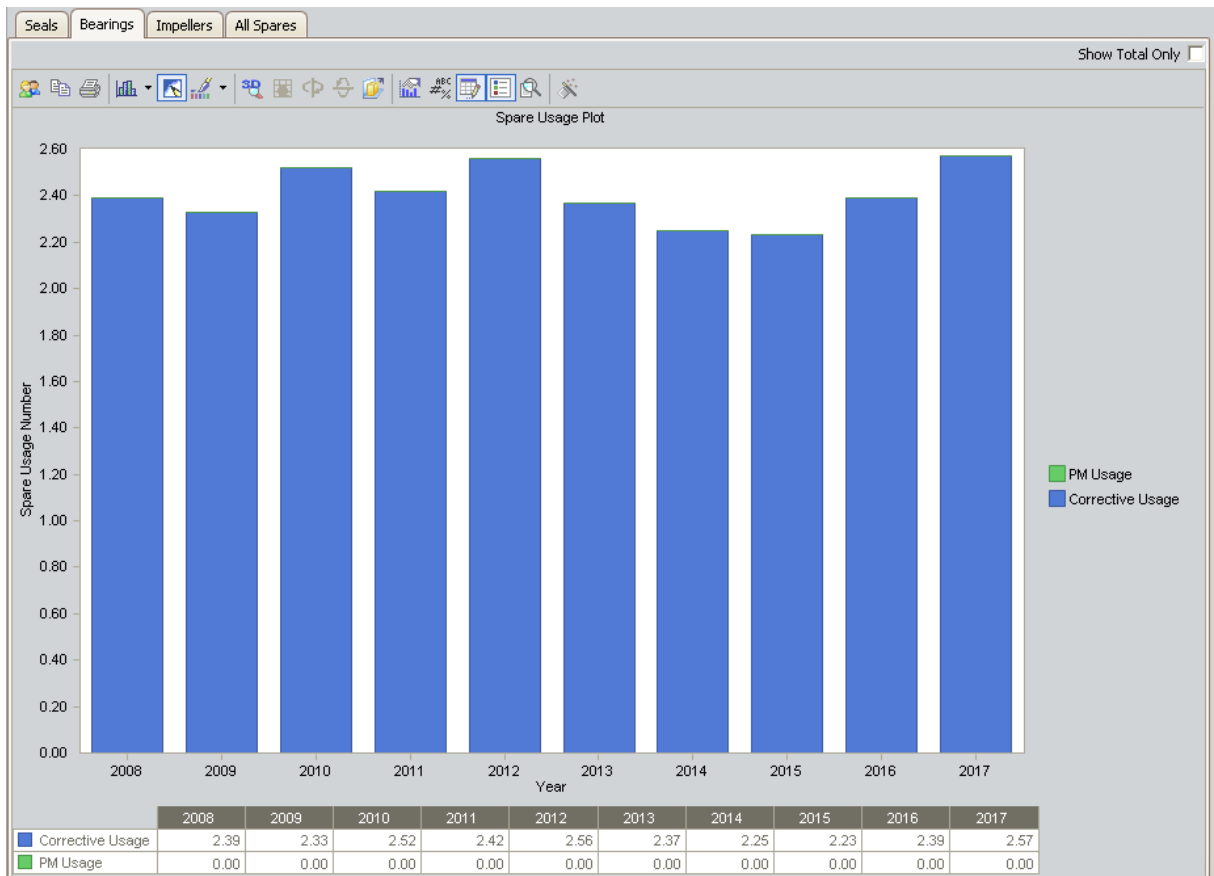

The Spare Usage Plot shows the number of spare parts that will be used for each year within the analysis period. Using the preceding image, if we add the spare usage for each year, we can determine that a total of about 24 spare seals will be used during the entire analysis period.

- **Impellers**

Interpreting the Spare Usage Plots

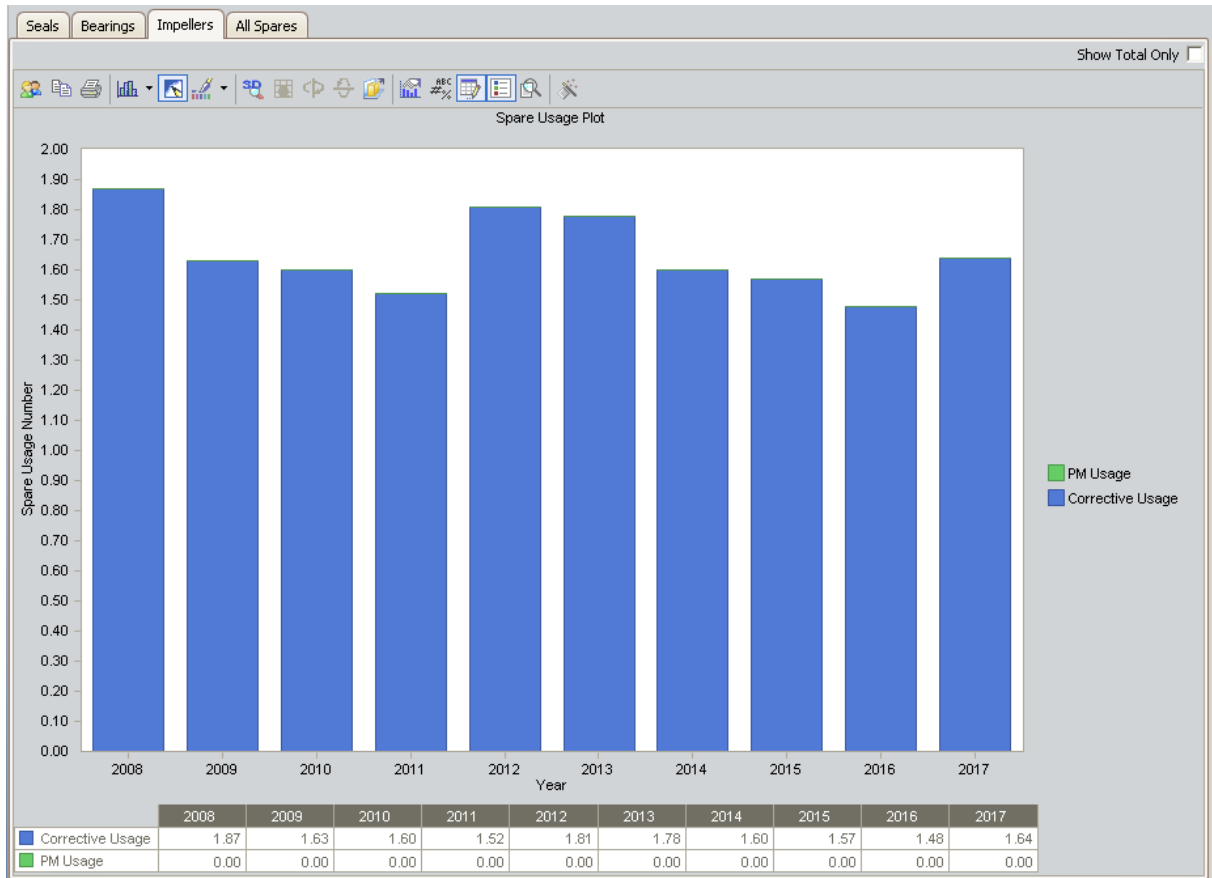

The Spare Usage Plot shows the number of spare parts that will be used for each year within the analysis period. Using the preceding image, if we add the spare usage for each year, we can determine that a total of about 21 spare seals will be used during the entire analysis period.

Based on the results for the seals, bearings, and impellers in the Spare Usage Plots shown above, we can use the following equation to how many spares we will use during the 10-year analysis period if we store the optimal level of each spare part:

Total Spares Used = Spare Seals + Spare Bearings + Spare Impellers

Consider the following values from our example:

- Spare Seals = 24
- Spare Bearings = 24
- Spare Impellers = 21

Given these values:

Total Spares Used = 24 + 24 + 21

Total Spares Used = 69 spare parts

Interpreting the Sensitivity Plots

The following Sensitivity Plots display the cost associated with holding the optimal number of spare parts, the cost of holding one less spare part than the optimal number, and the cost of holding one more spare part than the optimal number during each year within the analysis period.

- **Seals**

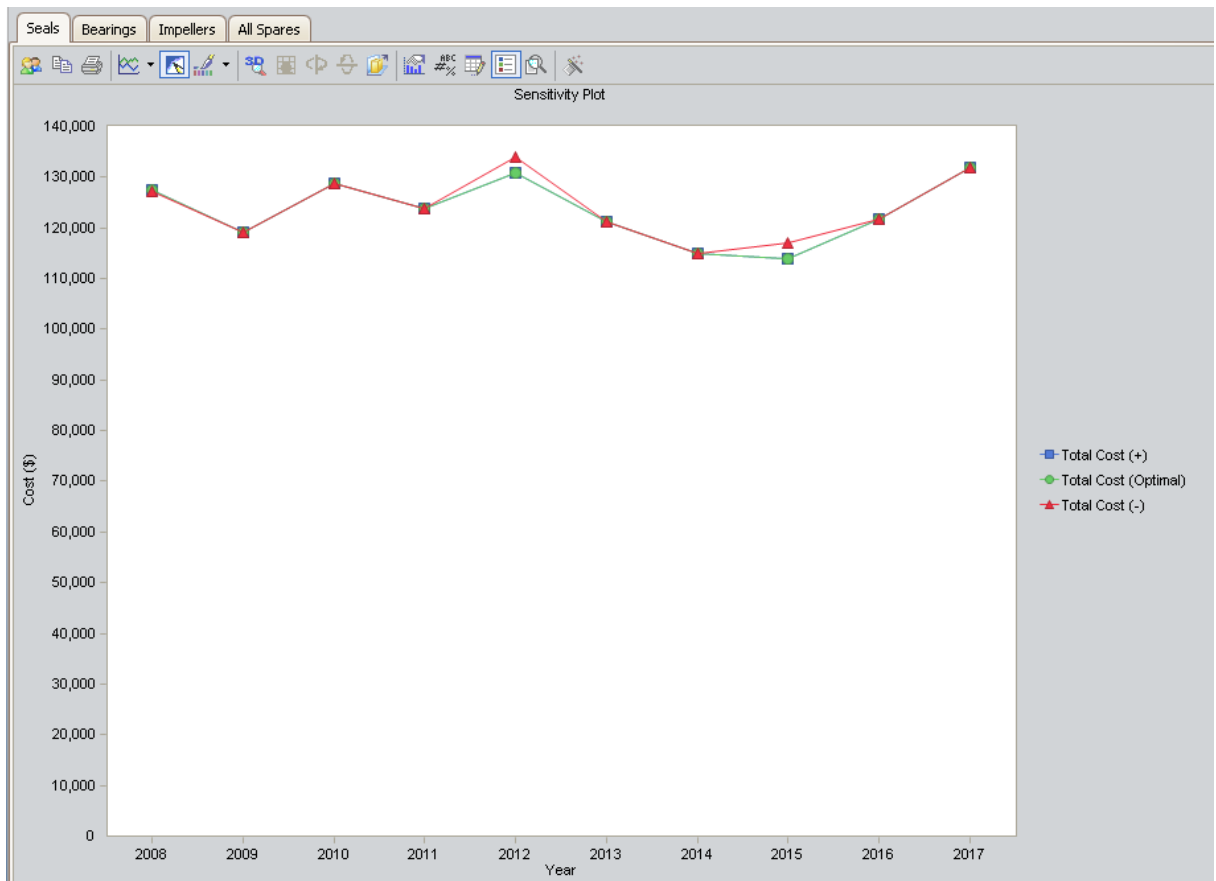

In this image, we can determine that there is a minimal cost difference between storing the optimal level of four spare seals (specified in the [Spare Level Plot](#)) and either five spare seals or only three spare seals within the 10-year analysis period.

- **Bearings**

Interpreting the Sensitivity Plots

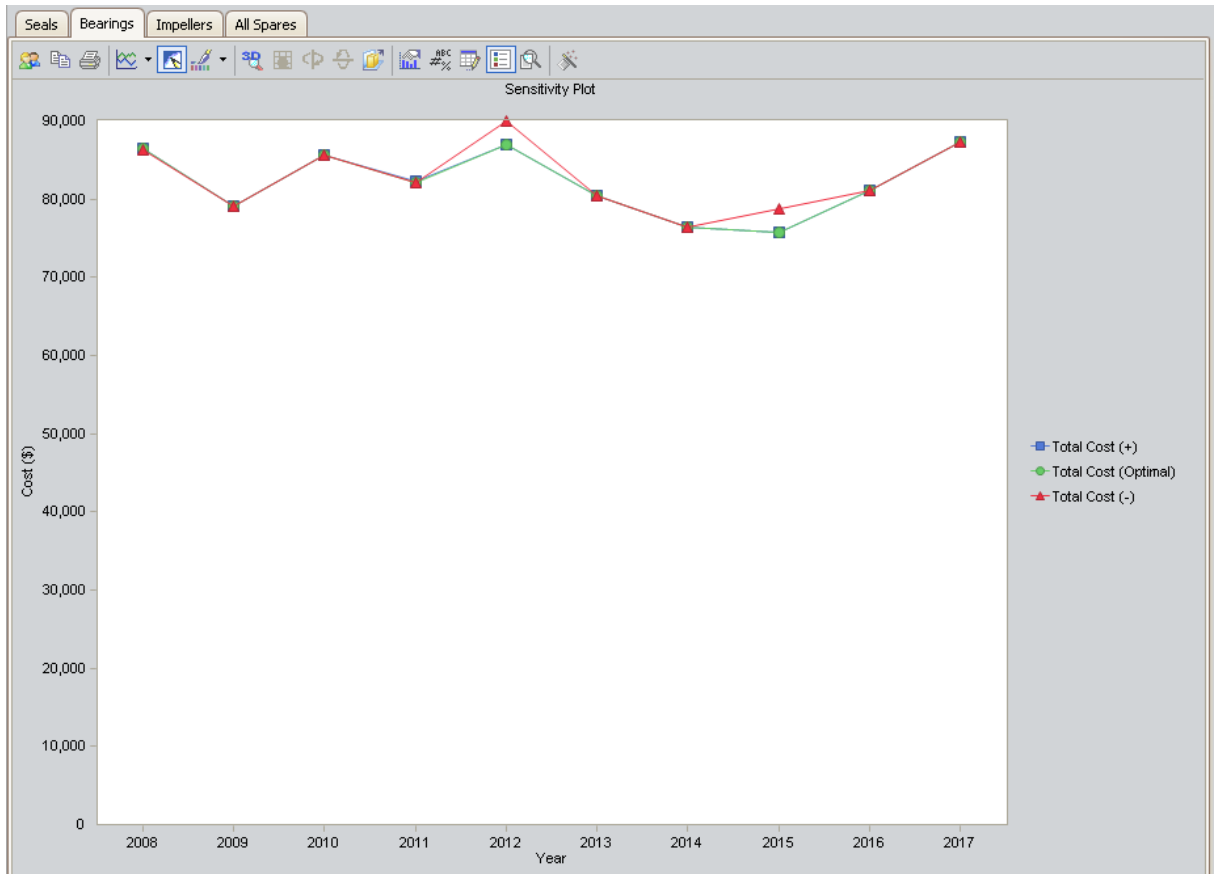

In this image, we can determine that there is a minimal cost difference between storing the optimal level of four spare bearings (specified in the [Spare Level Plot](#)) and five spare bearings or three spare bearings within the 10-year analysis period.

- **Impellers**

Interpreting the Sensitivity Plots

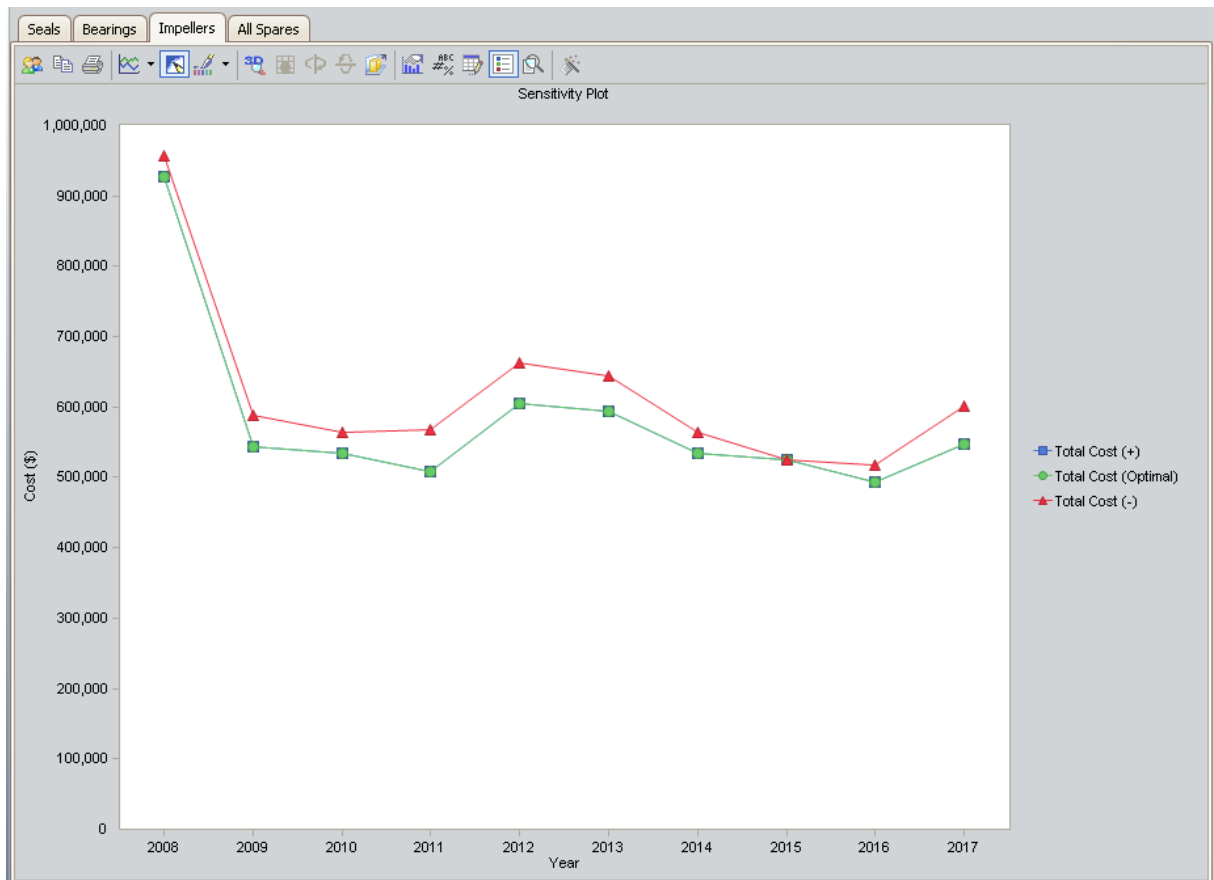

In this image, we can determine that there is a minimal cost difference between storing the optimal level of three spare impellers (specified in the Spare Level Plot) and either four spare impellers and a slightly greater cost difference with storing only two spare impellers. Additionally, we can determine that in 2008, there is a greater cost to hold spare impellers.

Based on the results for the seals, bearings, and impellers in the Sensitivity Plots shown above, we can estimate that, if desired, we can store one less or one more of each spare part with only a minimal cost effect.

Interpreting the Optimal Holding Plots

The following Optimal Holding Plots display the best possible spare level for each year within the analysis period.

- **Seals**

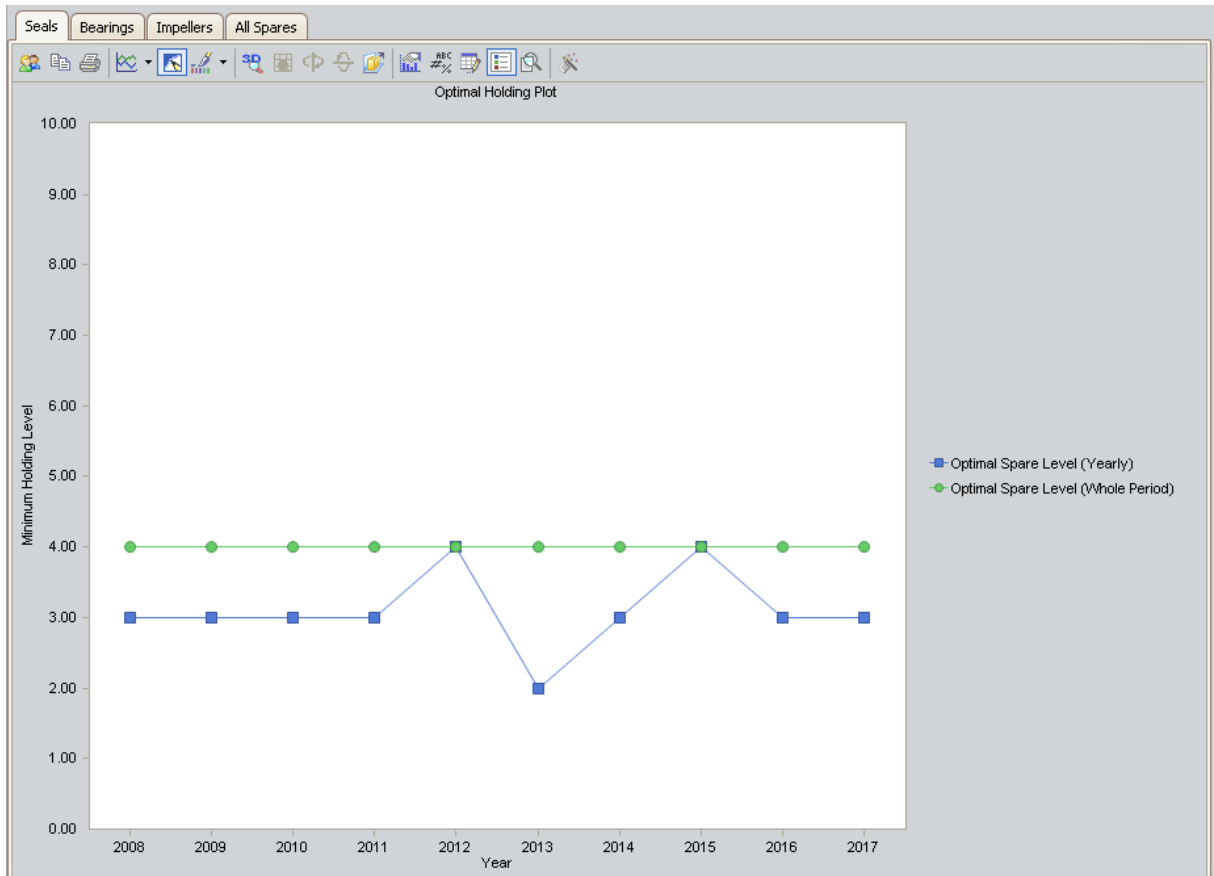

The optimal spare level of four seals was shown in the Spare Level Plot. From the Optimal Holding Plot we can determine that although the most conservative optimal holding level for the whole period is four, we can store three seals until 2012.

- **Bearings**

Interpreting the Optimal Holding Plots

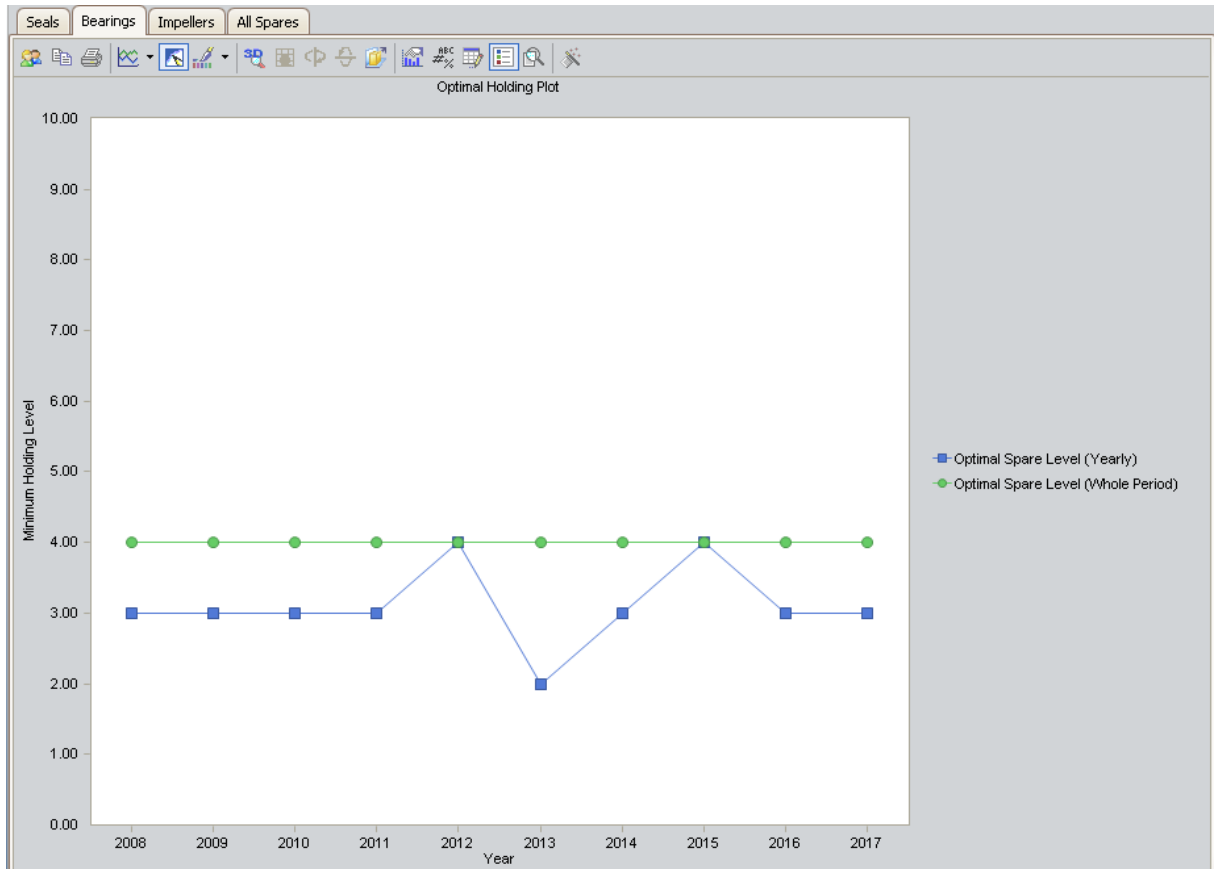

The optimal spare level of four seals was shown in the Spare Level Plot. From the Optimal Holding Plot we can determine that although the most conservative optimal holding level for the whole period is four, we can store three seals until 2012.

- Impellers

Interpreting the Optimal Holding Plots

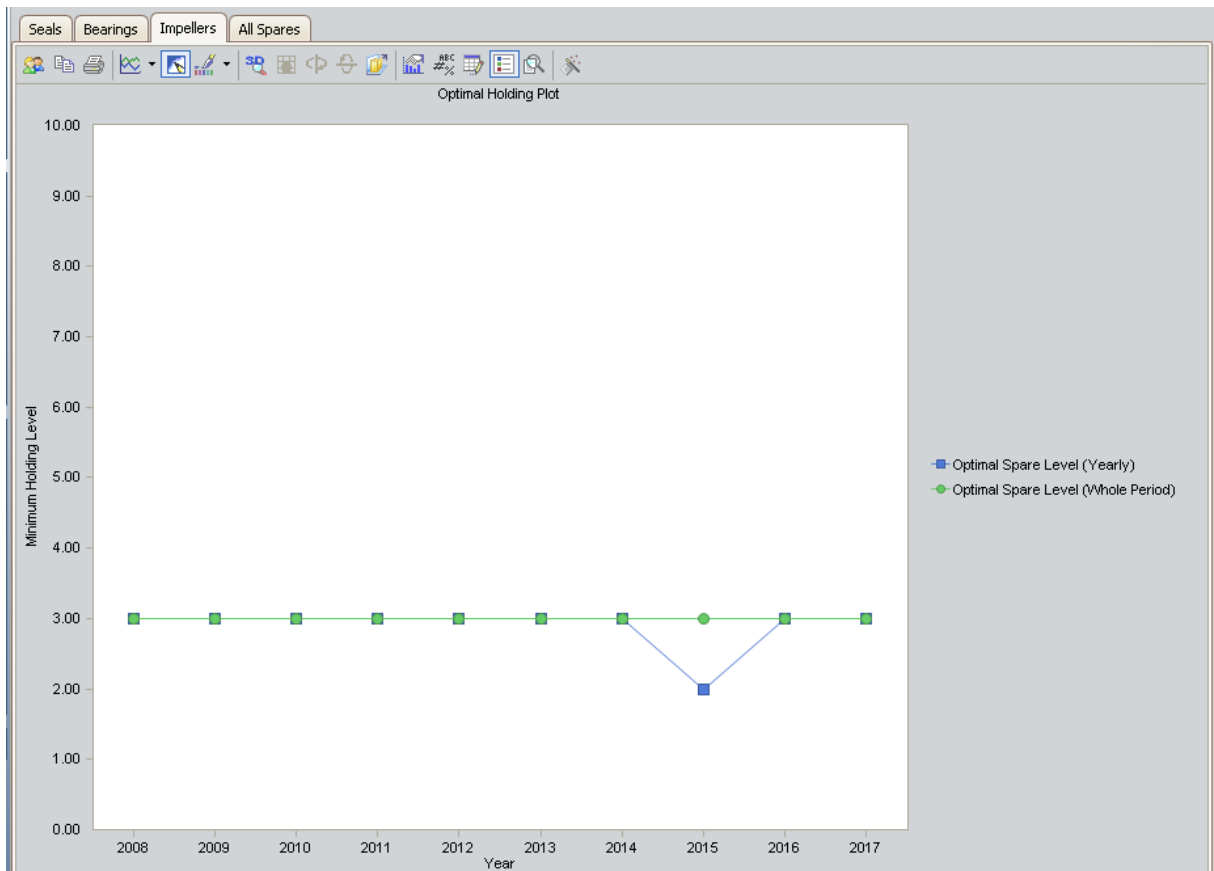

The optimal spare level of four seals was shown in the Spare Level Plot. From the Optimal Holding Plot we can determine that although the most conservative optimal holding level for the whole period is four, we can store three seals until 2011.

Based on the results for the seals, bearings, and impellers in the Optimal Holding Plots shown above, we can determine that the most conservative optimal holding level for the whole analysis period is four spares. However, around 2011 it is important to refer back to the graphs to determine the optimal level for that year.

About the Spares Analysis Plots

While viewing the **Spares Analysis** page, you can access any of the following plots from the links on the [Navigation menu](#):

- [Spare Level Plot](#)
- [Downtime Plot](#)
- [Spare Usage Plot](#)
- [Sensitivity Plot](#)
- [Optimal Holding Plot](#)

When you run the Monte Carlo simulation for a Spares Analysis, each of the plots will be generated for each Spare record in the analysis. If more than one Spare record exists in the Spares Analysis, each plot will be generated multiple times, according to the number of Spare records in the analysis. When you are viewing any one plot type (e.g., Downtime Plot), the plot for each Spare record will be displayed on a separate tab.

Consider our [Spares Analysis example](#) that contains three Spare records that represent three spare parts: Seals, Bearings, and Impellers. When you click the **Spare Level Plot** link, four tabs will appear, one for each Spare record and one for all Spare records, as shown in the following image.

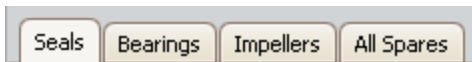

Each plot displays a standard graph toolbar by default, where some standard options are available. The annotation toolbar for a Spares Analysis allows you to customize the plot with features such as shapes and text boxes. Note that the annotation toolbar does not appear by default. To display the annotation toolbar, right-click the plot, point to the **Toolbars** option, and click **Annotation Toolbar**.

The green arrow in the [Navigation menu](#) appears next to the plot that you are currently viewing. To return to the **Spares Analysis** workspace from a plot, you can click the **Analysis Definition** link on the **Navigation** menu at any time.

Spare Level Plot

The Spare Level Plot is a bar graph that displays the cost associated with each possible spare level included in the range between the Min Inventory Level and Max Inventory Level values, which were specified in the [Spares section](#) of the appropriate Spare record.

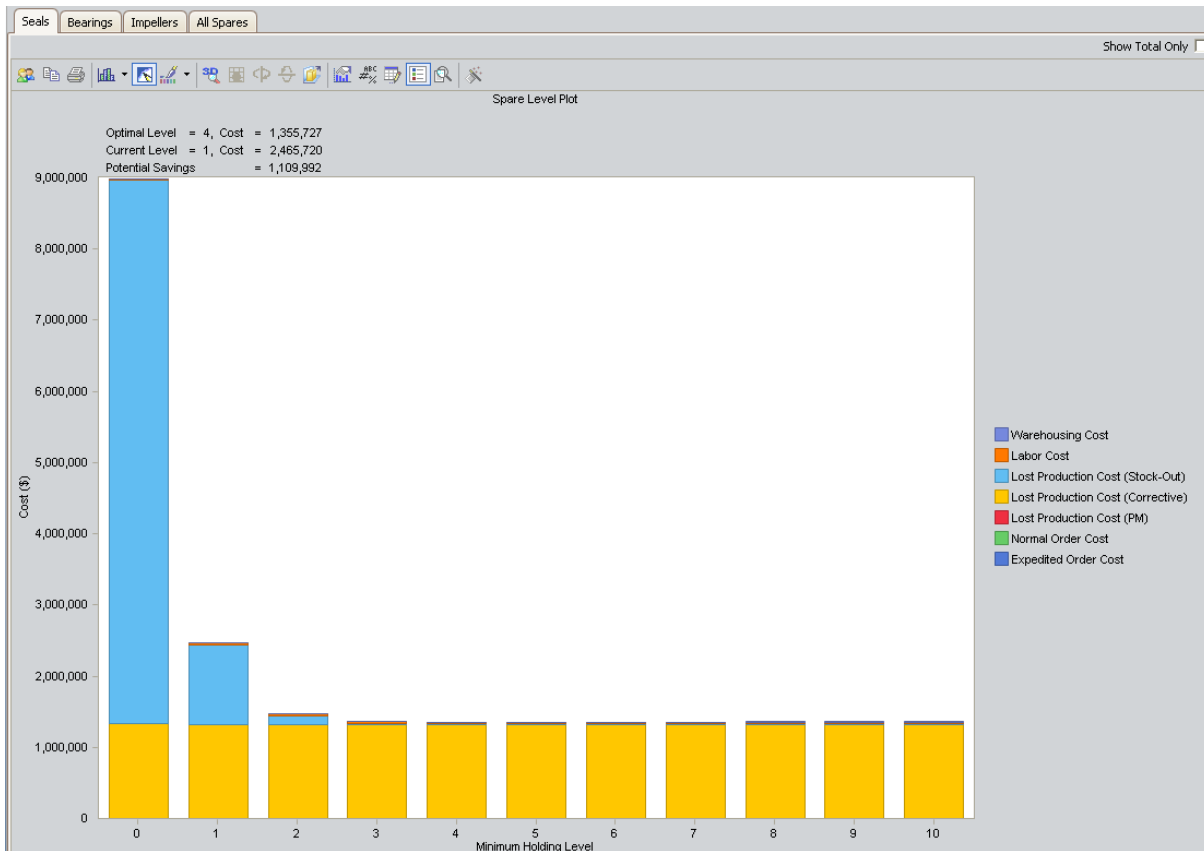

For this image, the Min Inventory Level is **0** (zero) and the Max Inventory Level is **10**. The x-axis displays the number of spare levels, and the y-axis displays the cost associated with each spare level. Additionally, the current holding level, the optimal spares level, and the potential savings amounts are displayed above the Spares Level Plot.

By default, each bar in the Spares Level Plot is divided into the following cost categories, which are shaded with different colors that are represented in the legend to the right of the plot:

- **Warehousing Cost:** The cost of storing the spare parts between failures.
- **Labor Cost:** The total cost of labor associated with every spare level.
- **Lost Production Cost (Stock-Out):** The total lost production cost accrued as a result of waiting for the spare to arrive when one must be ordered.
- **Lost Production Cost (Corrective):** The total lost production cost accrued as a result of the downtime due to preparation and repair after a failure.

Spare Level Plot

- **Lost Production Cost (PM):** The total cost of lost production cost accrued as a result of the preventive maintenance activities. Note that if the **Enable Preventive Maintenance** check box is selected in the **Preventive Maintenance** section, values from the **Preventive Maintenance** section will be included in this cost category.
- **Normal Order Cost:** The total cost of all normal orders placed for the spare parts.
- **Expedited Order Cost:** The total cost of all rushed orders placed for the spare parts.

CE Hint: If you select the **Show Total Only** check box in the upper-right corner of the plot, you can view the *total* costs associated with each spare level.

In addition to providing a Spare Level Plot for each Spare record in the analysis, Meridium APM also displays the **AllSpares** tab, which compares all Spare records according to the cost associated with each possible spare level. By looking at the **AllSpares** tab, you can estimate how much money your company might lose by not storing the optimal level of spare parts. The following image shows an example of the Spare Level Plot for All Spares.

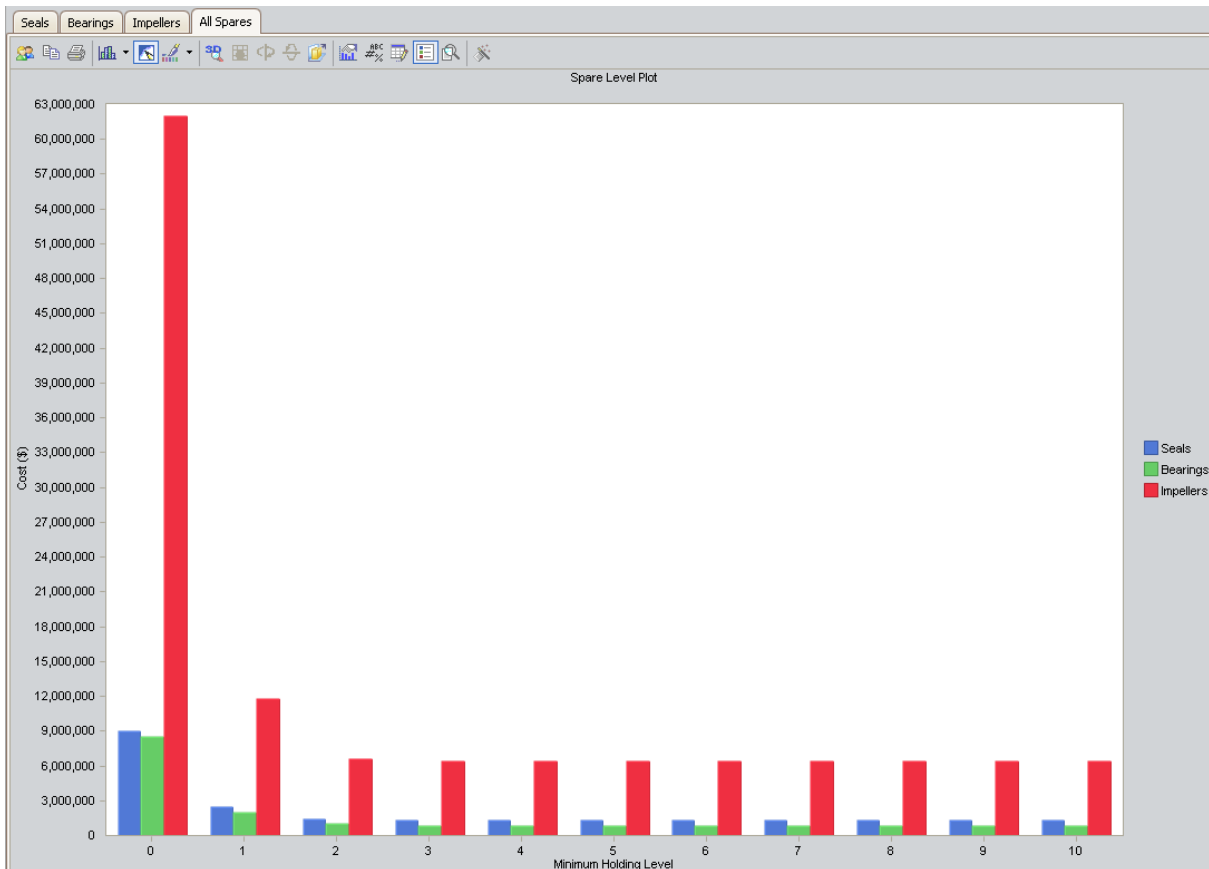

Downtime Plot

The Downtime Plot is a bar graph that displays the specific downtime during which the piece of equipment is not operating during the analysis period. The Downtime Plot displays the specific downtime associated with each spare level in the range indicated in the [Spares section](#) of the appropriate Spare record.

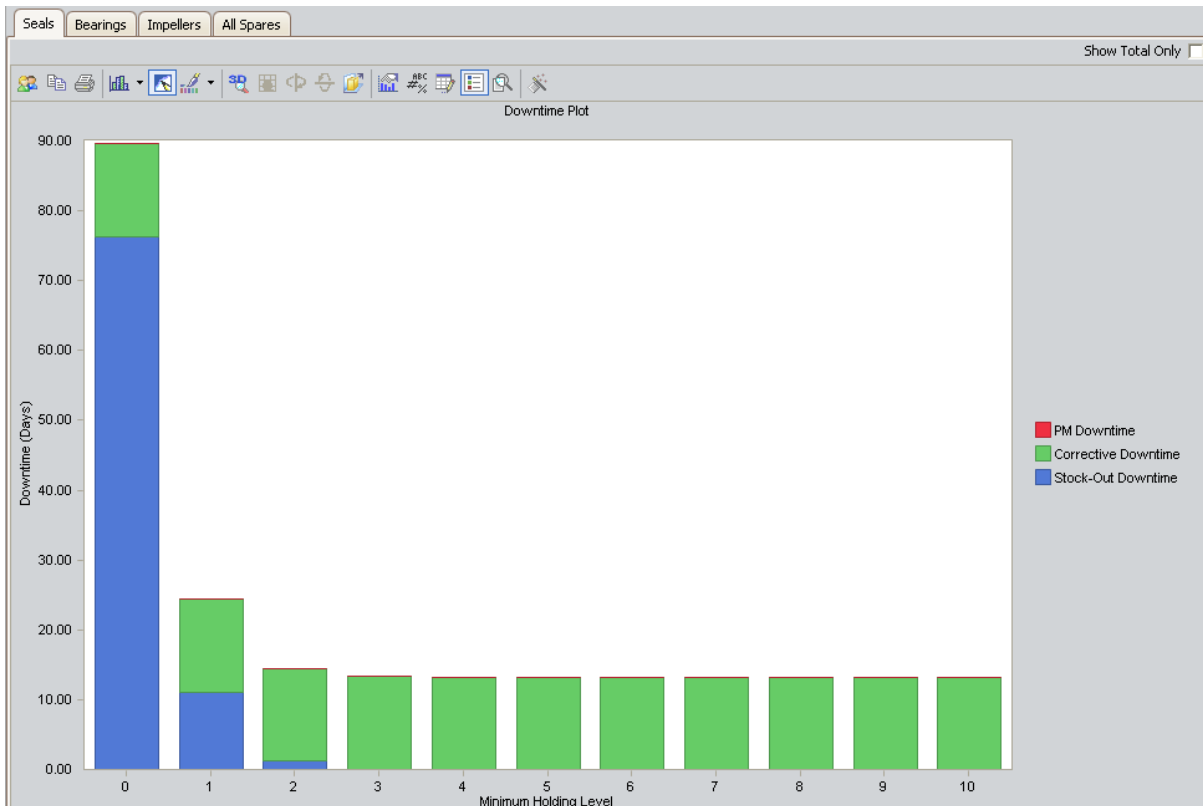

This image is based on a Min Inventory Level of **0** (zero) and a Max Inventory Level of **10**. The x-axis displays the number of spare levels, and the y-axis displays the downtime in days for each spare level.

By default, each bar in the Downtime Plot is divided into the following downtime categories, which are shaded with different colors that are represented in the legend to the right of the plot:

- **PM Downtime:** The downtime that results from performing preventive maintenance. PM Downtime is calculated only if the **Enable Preventive Maintenance** check box is selected in the [Preventive Maintenance section](#). If the **Enable Preventive Maintenance** check box is not selected, PM Downtime will always be zero.
- **Corrective Downtime:** The sum of the time spent preparing for the repair of the piece of equipment and actually repairing the piece of equipment (specified in the **Preparation Time, Repair Time, and Total Correction Time** cells in the [Failure Consequence section](#)).
- **Stock-Out Downtime:** The time period during which there was no spare part

Downtime Plot

available for the necessary repair. For example, if you do not have any spare parts stored when a piece of equipment fails, you will need to order a spare part. If the sum of the Normal Order Time and the On-site Delivery Time (both specified in the [Spare section](#)) takes longer than the Preparation Time (specified in the [Failure Consequence section](#)), then there will be a period of *stock-out* downtime while you wait for the spare part(s) to arrive at the repair site.

CE Hint: If you select the **Show Total Only** check box in the upper-right corner of the plot, you can view the *total* downtime associated with each spare level.

In addition to providing a Downtime Plot for each Spare record in the analysis, Meridium APM also displays the **AllSpares** tab, which compares all Spare records according to the amount of downtime associated with each possible spare level. By looking at the **AllSpares** tab, you can estimate how many days of downtime you might have per possible spare level for each piece of equipment. The following image shows an example of the Downtime Plot for All Spares.

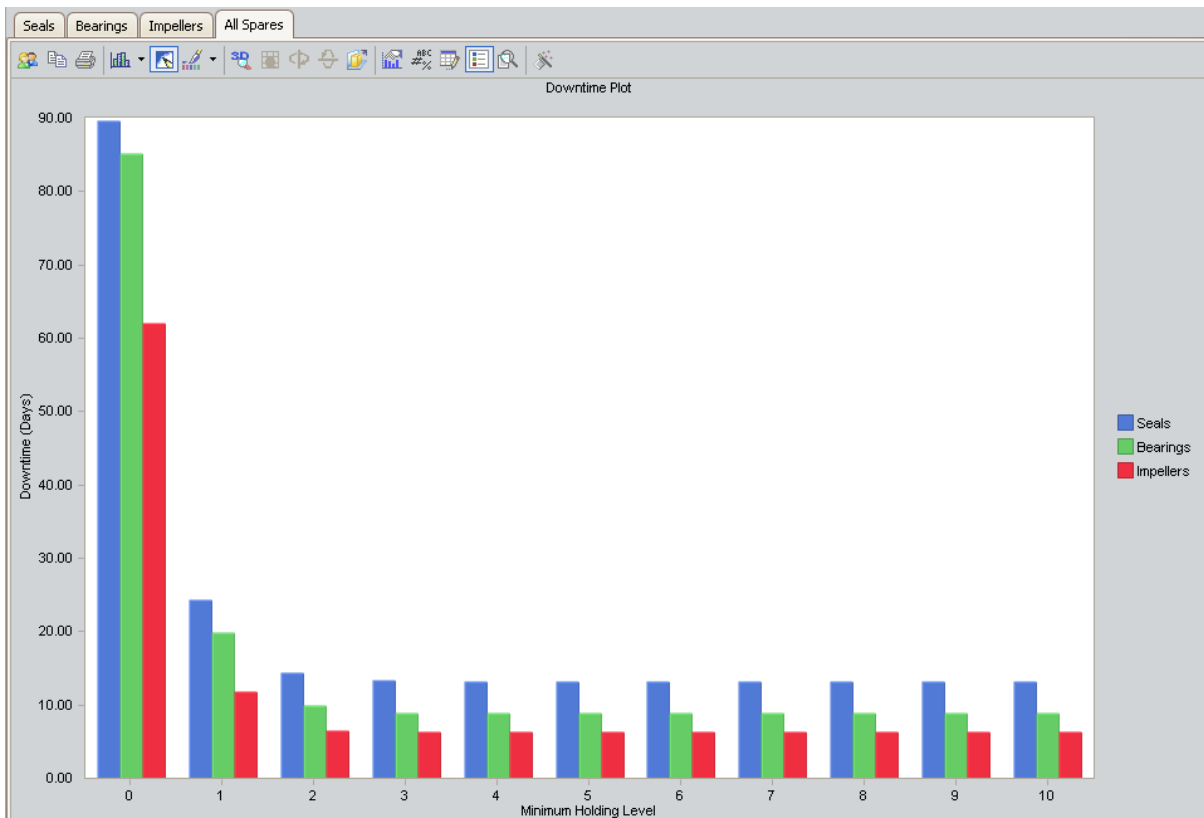

Spare Usage Plot

The Spare Usage Plot is a bar graph that displays the spare usage for each year in the analysis period, assuming that you store the optimal level of spare parts.

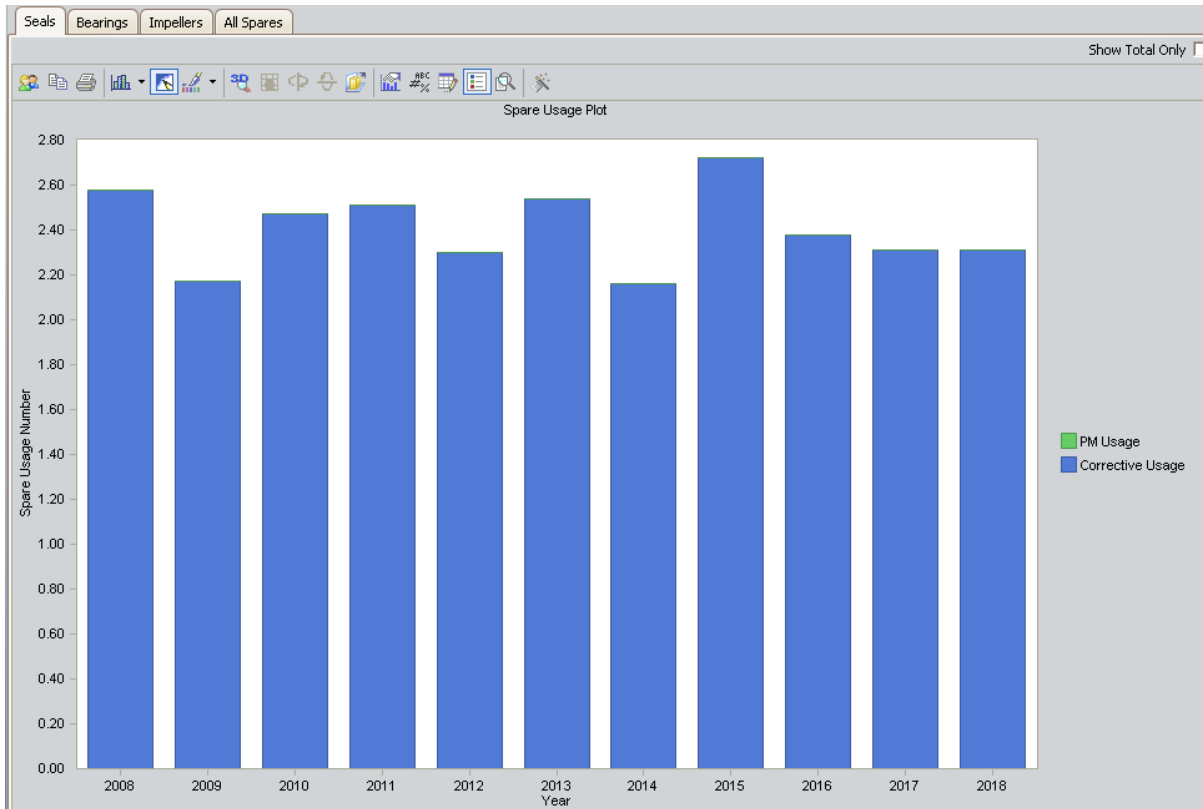

In this image, the Simulation Start Date is **1/1/2008**, and the Simulation End Date is **1/1/2018**. The x-axis displays the years for the analysis period, and the y-axis displays the number of spares used in that year when you store the optimal spare level.

By default, each bar in the Spare Usage Plot is divided into the following spare usage categories, which are shaded with different colors that are represented in the legend to the right of the plot:

- **PM Usage:** The total number of spare parts used for Preventive Maintenance (specified in the **# of Required Spares** cell in the [Failure Consequence section](#)). Note that if the **Enabled Preventive Maintenance** check box in the [Preventive Maintenance section](#) is not selected, PM Usage will not be included in this graph.
- **Corrective Usage:** The total number of spare parts used for repairing equipment failures (specified in the [Failure Distribution section](#)).

OE Hint: If you select the **Show Total Only** check box in the upper-right corner of the plot, you can view the *total* usage associated with each year in the analysis period.

Spare Usage Plot

In addition to providing a Spare Usage Plot for each Spare record in the Analysis, Meridium APM displays the **AllSpares** tab, which compares all Spare records according to the spare usage for each year. Assuming that you are storing the optimal level of each spare part, by looking at the Spare Usage Plot for All Spares, you can estimate how many of each spare part you might need each year.

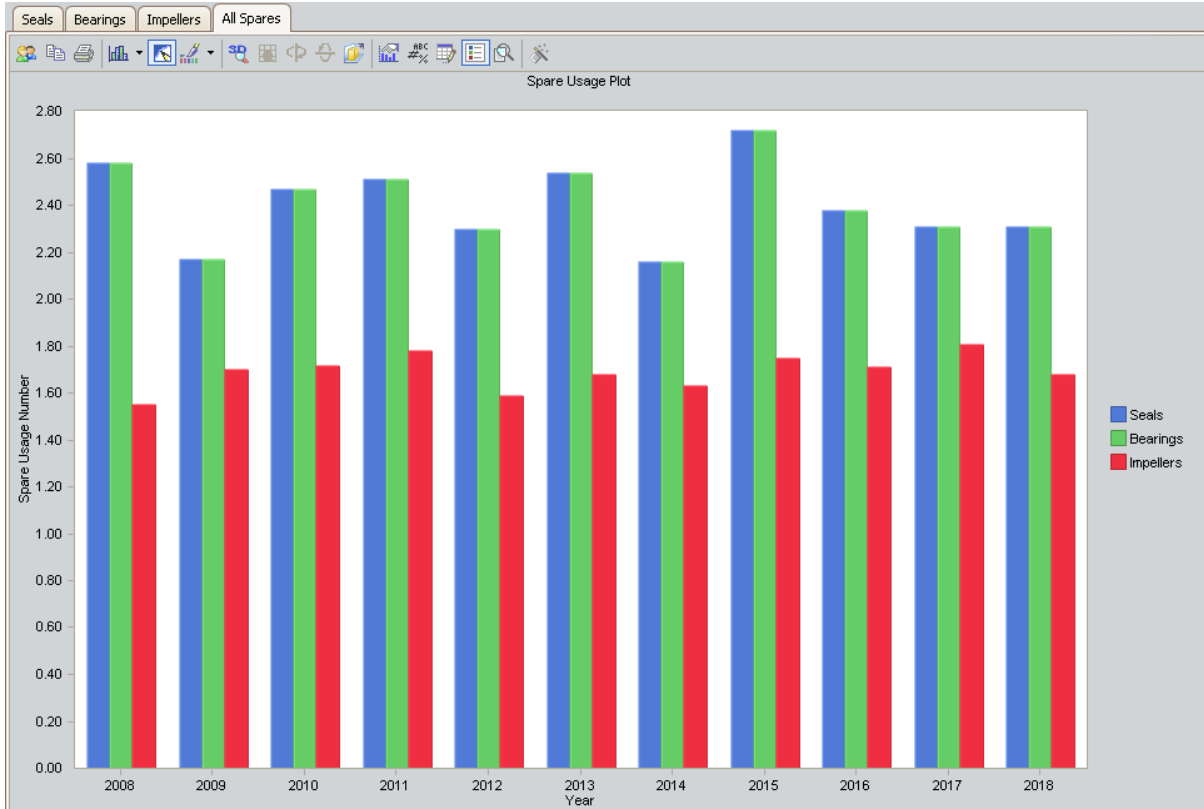

Sensitivity Plot

The Sensitivity Plot is a line graph that displays for each year in the analysis period:

- The cost associated with holding the optimal number of spare parts.
- The cost of holding one less spare part than the optimal number.
- The cost of holding one more spare part than the optimal number.

For example, if the optimal level determined by the Monte Carlo simulation is three, then the Sensitivity Plot will display the cost associated with holding three spare parts, two spare parts, and four spare parts.

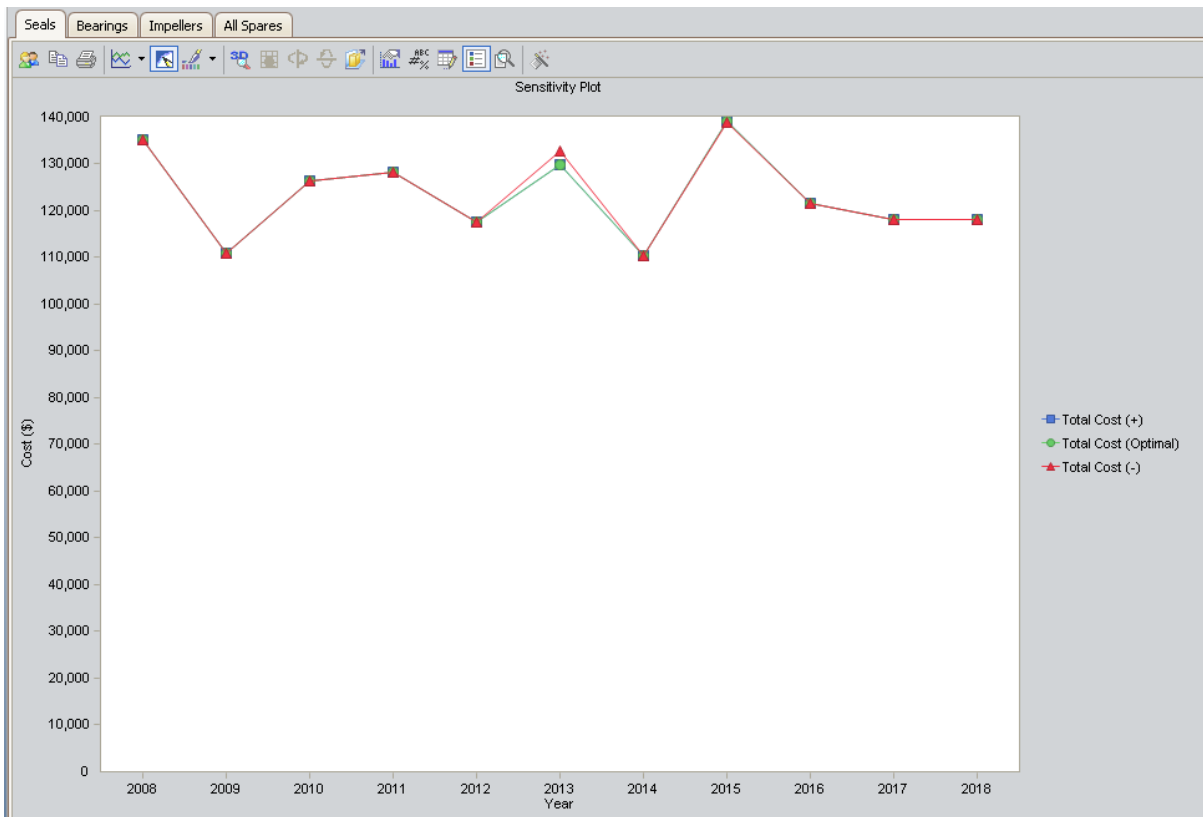

In this image, the Simulation Start Date is **1/1/2008**, and the Simulation End Date is **1/1/2018**. The x-axis displays the years for the analysis period, and the y-axis displays the costs that you can expect to incur in each year.

By default, each line in the Sensitivity Plot is divided into the following cost categories, which are shaded with different colors that are represented in the legend to the right of the plot:

- **Total Cost (+):** The total cost when storing one spare part *more* than the recommended number of spare parts.
- **Total Cost (Optimal):** The total cost when storing the recommended number of

Sensitivity Plot

spare parts. Note that the Optimal Spare Level, or recommended number of spare parts, is located at the top of the [Spare Level Plot](#).

- **Total Cost (-):** The total cost when storing one spare part *less* than the recommended number of spare parts.

Note: If the Min Inventory Level is 0 (zero), the Max Inventory Level is 1, and the Optimal Spare Level is 1, then the **Total Cost (+)** line will not appear on the Sensitivity Plot. With this inventory range specified on the Spare record, the Total Cost (+) line would represent the holding level of two spare parts, and that value is not within the inventory range.

In addition to providing a Sensitivity **Plot** for each Spare record in the analysis, Meridium APM displays the **AllSpares** tab, which compares all Spare records according to the cost of storing the optimal amount of the spare part, one spare part more than the optimal amount, and one spare part less than the optimal amount. By looking at the **AllSpares** tab, you can estimate the cost of storing the optimal amount, one more than the optimal amount, and one less than the optimal amount of each spare part during analysis period. The following image shows an example of the Sensitivity Plot for All Spares.

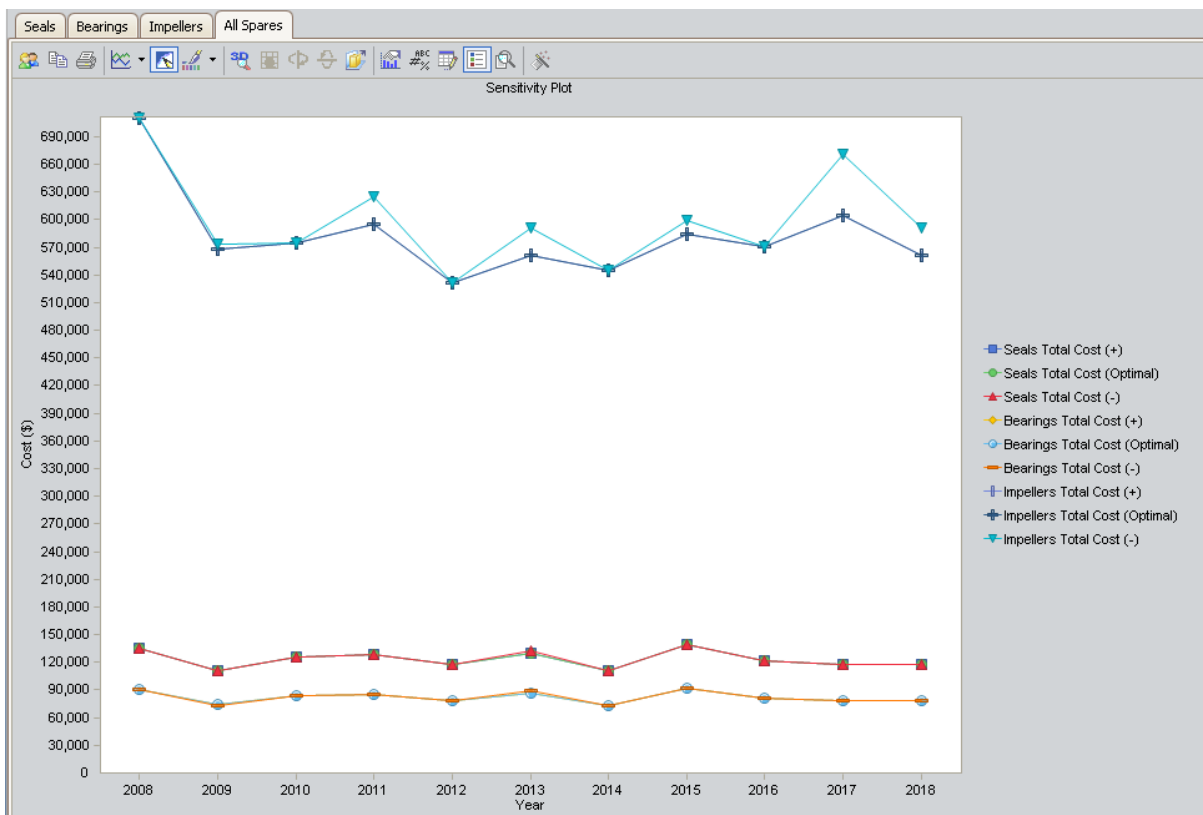

Optimal Holding Plot

The optimal spare level is determined as the most conservative value over the entire analysis period. Because failure data might change each year, the optimal inventory level might change for each year within the analysis period. The Optimal Holding Plot displays the optimal spare level for the whole period and for each individual year of the analysis period.

Consider the following Optimal Holding Plot from the data used in the [Spares Analysis example](#).

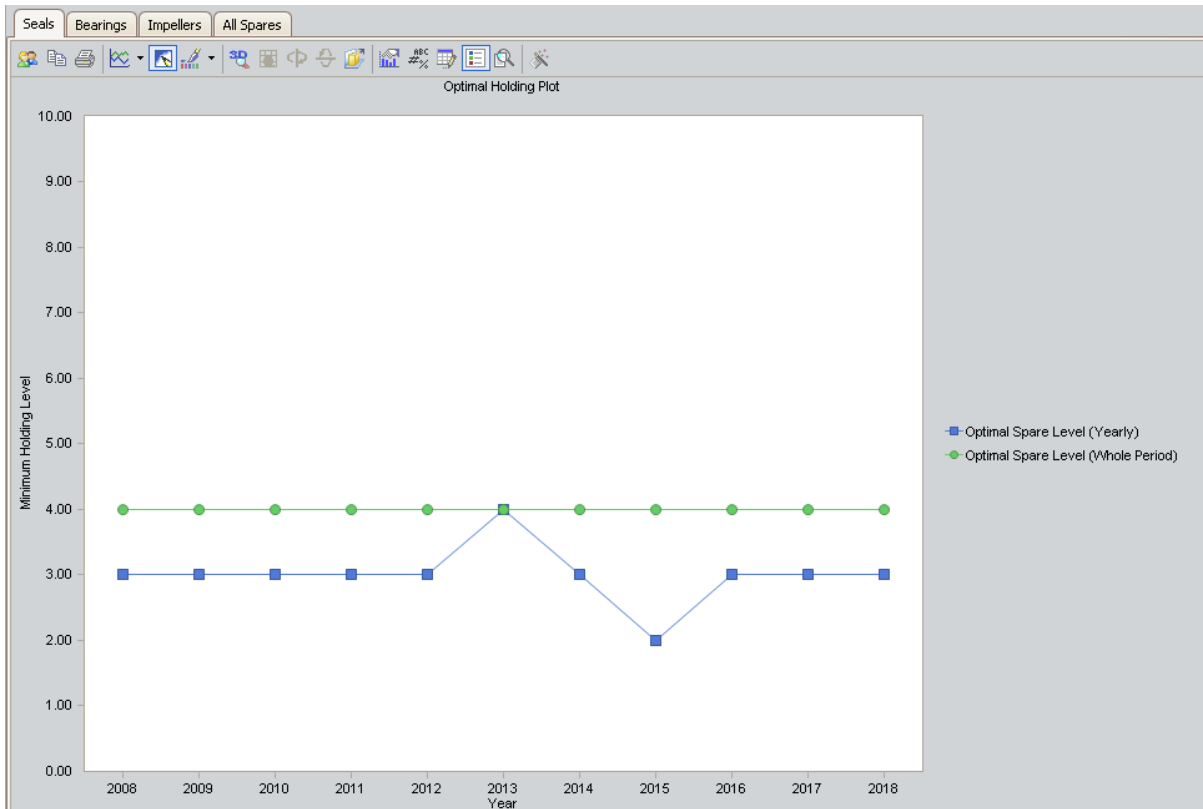

In this image, the Simulation Start Date is set to **1/1/2008**, and the Simulation End Date is set to **1/1/2018** in the [Analysis section](#) of the Spares Analysis record. The x-axis displays the years included in the analysis period, and the y-axis displays the inventory level associated with the lowest cost of spares levels for each year.

By default, each bar in the Optimal Holding Plot is divided into the following cost categories, which are shaded with different colors that are represented in the legend to the right of the plot:

- **Optimal Spare Level (Yearly):** The lowest cost of spare levels associated with each year included in the analysis period.
- **Optimal Spare Level (Whole Period):** The recommended number of spare parts associated with the *entire* analysis period.

Optimal Holding Plot

In addition to providing an Optimal Holding Plot for each Spare record in the analysis, Meridium APM displays the **AllSpares** tab, which compares all Spare records according to the optimal holding level for the whole period and for each individual year during the analysis period. The following image shows an example of the Optimal Holding Plot for All Spares, which you can use to compare the optimal holding levels for each piece of equipment.

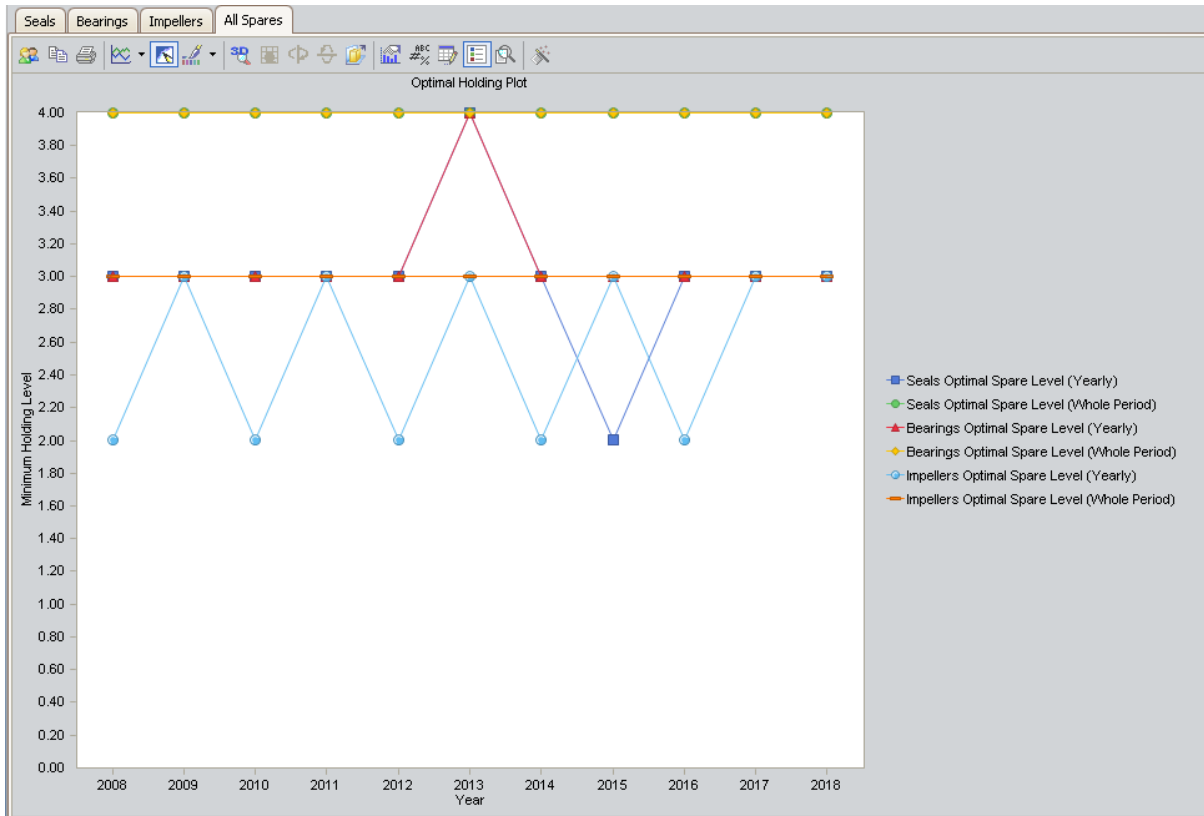

What is a Reliability Growth Analysis?

A Reliability Growth Analysis can help you make strategic decisions by indicating whether your data measurements are random or if they follow a trend. The graphs produced by a Reliability Growth Analysis will show any time-dependent trends, allowing you to make decisions based on past behavior and predict how your data will behave in the future.

When you view the results of a Reliability Growth Analysis, if you see the data is trending in one direction until a certain point in time and then begins trending in another direction, you can examine what changed at the point in time when the trend shifted to determine the impact of those changes. In addition, if you make a strategy change and then examine whether the data worsens or begins to improve at that point, you can determine the impact of the strategy change. For example, a distinct change in a Mean Time Between Failures (MTBF) plot can identify the point at which improved maintenance strategies were put into place for a piece of equipment.

Similarly, when you observe data that is trending at the same rate over time without distinct changes, you can use those trends to predict the data's future behavior. For example, if you are tracking the cost associated with running a piece of equipment over a certain period of time, and the cost is consistently higher during winter months, you can predict how much more it will cost to run the piece of equipment in December than it will in July.

Trend charts generated by Reliability Growth Analyses can also show outlying events that may have had significant effects on the overall trend of strategy effectiveness. For example, a thunderstorm that results in a two-day power outage at a plant should not reflect poorly on a piece of equipment's reliability. Reliability Growth Analyses allow you to ignore these types of events.

You can perform a Reliability Growth Analysis and examine trend charts for one piece of equipment or location a group of similar pieces of equipment or locations. For example, you may want to examine trends for one pump that is constantly breaking down, or you may want to examine trends for a set of pumps to detect any improvement after you installed a new maintenance strategy.

Types of Reliability Growth Analyses

Before you can perform a Reliability Growth Analysis, you first must collect data, or numeric values representing some variable's performance, over some period of time. All data that you collect will be:

- Based on an event (e.g., a failure).
- or-
- [not based on an event](#) (e.g., repair cost).

Both data that is event-based and not event-based will also be:

- [Grouped](#) (i.e., datapoints represent multiple measurements or an amount).
- or-
- Non-grouped (i.e., datapoints represent a single measurement).

By default, the Meridium APM system assumes that your data is not grouped. You can specify that your analysis includes grouped data by including the amount of data per datapoint on the [Select Data Fields screen](#) in the **Reliability Growth Analysis Builder**. Data that is not event-based typically measures an amount (e.g., repair cost) and is grouped data.

Event-based data can be derived from:

- [Failure Dates](#): specific dates on which failures occurred. (e.g., 1/3/2012)
- [Cumulative Operating Time](#): An amount of time that has passed since the piece of equipment was put into service (e.g., 10 days).

Data that is not event-based is usually derived from cumulative operating time.

About Data Used in Reliability Growth Analyses

The following table lists the data you need to collect in order to conduct a Reliability Growth Analysis.

Data Needed	Description	Notes
Asset ID	An ID that uniquely describes a piece of equipment or location, such as Asset ID or Tag ID . Reliability Growth Analyses can be conducted on any number of equipment or locations.	This field is required and must be a character field. If the value in this field is blank, a blank Asset ID will be assigned to the data.
Cumulative Operating Time	The total amount of time that has passed since the piece of equipment or location was placed into service.	This field is required for an analysis based on cumulative operating time.
Downtime	The amount of time the piece of equipment or location is not in operation. You can use the date a piece of equipment or location is repaired or the day it returns to service to help estimate downtime. If this information is available, it can be used to make the analysis more accurate.	This field is optional for an analysis based on failure dates. Downtime is not used by analyses based on cumulative operating time.
Downtime Units	The downtime units.	This field is used only by analyses based on failure dates that are using downtime. This field must be in calendar time.

Data Needed	Description	Notes
Failure Date	The date on which the piece of equipment or location failed. This data can have many different descriptions such as Out of Service Date, Shutdown Date, or Failure Date.	<p>This field is required for an analysis based on failure dates and optional for an analysis based on cumulative operating time. For an analysis based on cumulative operating time:</p> <ul style="list-style-type: none"> ■ All failures must have a failure date, or no dates will appear in the analysis. ■ Failure dates should be in the same order as cumulative operating time.
Installation Date	The date on which the piece of equipment or location was installed.	This field is optional.
Operating Time Units	The operating time units.	<p>For an analysis based on failure dates, this field must be in calendar time.</p> <p>For an analysis based on cumulative operating time, you can use custom time units, such as miles.</p>
Measurement Name	The type of the measurements you are collecting (e.g., failures, safety events, or cost). Throughout the documentation, we use the term <i>measurement</i> to represent the pieces of data that are being collected.	This value is required for all analyses.

Data Needed	Description	Notes
Number of Failures	The number of failures or amount of data that is recorded at each measurement.	This field is optional. If no data is provided for this field, the Meridium APM system will assume there is one failure for each datapoint. If you are using grouped data , this field is required.

About Reliability Growth

To make this documentation easier to follow and to help explain how Reliability Growth Analyses can be used as an evaluation tool in different scenarios, we provide some examples that could benefit from a Reliability Growth Analysis.

- [Example 1](#): Demonstrates a scenario where you would create a Reliability Growth Analysis with event-based data that is measured using failure dates.
- [Example 2](#): Demonstrates a scenario where you would create a Reliability Growth Analysis with event-based data that is measured using cumulative operating time.
- [Example 3](#): Demonstrates a scenario where you would create a Reliability Growth Analysis with grouped data that is not event-based that is measured using cumulative operating time.

Example of an Analysis Using Event Dates

If you track events (e.g., safety events or failures) by specific date, then you can create a Reliability Growth Analysis using event-based data that is measured using failure dates.

Example 1: Failure Dates

Centrifugal Pump 1051700 was installed at the Springfield plant on July 20, 1998. Since its installation, the pump has failed several times, and each time the pump fails it is repaired immediately without any significant downtime. You have collected data noting which days the pump failed. You want to use the following data to perform a Reliability Growth Analysis to determine the mean time between pump failures.

Failure Dates	Number of Failures
12/14/1998	1
2/7/1999	1
6/26/1999	1
8/1/1999	1
9/5/1999	1
1/1/2001	1
1/2/2001	1
2/7/2002	1
7/11/2002	1
12/10/2002	1
5/12/2003	1
7/2/2003	1
11/28/2005	1
1/30/2006	1

In this case, you would use event-based data derived from failure dates to determine:

- The date that the pump will fail next.
- How many times the pump will fail by a certain date.
- If the number of failures increased or decreased as a result of a strategy change

Example of an Analysis Using Event Dates

(e.g., a new preventative maintenance schedule), which was implemented after the failure on September 5, 1999.

Example of an Analysis Using Cumulative Operating Time

Sometimes the specific days on which a piece of equipment or location fails may not be available, or the piece of equipment or location may not operate for the same amount of time every day. In these cases, it would be more valuable to determine future failures using cumulative operating time (COT), or the amount of time the piece of equipment or location has been in operation.

Example 2: Cumulative Operating Time

Haul Truck 1 was purchased for a shipping firm as a used vehicle with 11,028 miles. The truck now runs varied routes depending on the number of shipments to which it is assigned. Because the truck does not always travel the same number of miles each day, you collect the data representing the mileage points at which the truck broke down. You want to use the following data to perform a Reliability Growth Analysis to determine the mean operating time (i.e., number of miles) between failures.

Cumulative Operating Time (Miles)	Number of Failures
27,393	1
41,675	1
60,400	1
66,128	1
72,132	1
77,314	1
113,888	1
146,671	1
205,424	1
224,624	1
243,841	1
260,828	1
279,951	1
303,156	1

Example of an Analysis Using Cumulative Operating Time

In this case, you would use event-based data derived from cumulative operating time to determine:

- The mileage point at which the next failure will occur.
- How many failures will occur by a certain point (e.g., five failures will have occurred after 1,000 miles).
- If the number of failures increased or decreased as a result of a strategy change (e.g., more routine oil changes), which was implemented after the failure at 77,314 miles.

Example of an Analysis Using Grouped and Non-Event Data

In Examples 1 and 2, each datapoint represents a single measurement or failure. In some datasets, each datapoint may represent *more than one* measurement, or an *amount* of data. Throughout this documentation, this type of data is referred to as *grouped data*. To perform Reliability Growth Analyses on grouped data, when you create a dataset, you must use datapoints that represent multiple measurements or an amount of data. Datasets containing grouped data can be based on either failure dates or cumulative operating time.

For example, if you want to analyze a pump for which you record data every six months and every time you record data you record multiple failures (one datapoint represents multiple failures), you would create a Reliability Growth Analysis based on event-based, grouped data that is derived from cumulative operating time.

In Examples 1 and 2, each datapoint was also based on an event. Examples of event-based failures include equipment or location failures, safety incidents, or equipment or location repairs. Sometimes, you may want to perform a Growth Analysis on a variable that does not measure a specific event (e.g., an amount). For the correct labels to appear throughout the analysis, these datasets should be entered as non-event data. Datasets containing non-event data can be based on either failure dates or cumulative operating time.

Using a Reliability Growth Analysis to measure cost is the most common examples of evaluating grouped data and non-event data.

Example 3: A Reliability Growth Analysis Using Cost

You want to measure the cost of equipment failures at the Springfield plant in order to determine how you should plan a budget for that plant in the future. Individual pieces of equipment fail at different rates, so you measure the total cost of replacement parts and mechanic labor for the entire plant every few months. You want to use the following data to perform a Reliability Growth Analysis to view the cost trends at this plant.

Cumulative Operating Time (Months)	Cost
6.5	1,120
13	996
17	1,052
23	1,085
37	1,075
49.5	1,096

Example of an Analysis Using Grouped and Non-Event Data

Cumulative Operating Time (Months)	Cost
62	1,001

In this case, you would use non-event, grouped data that is derived from cumulative operating time to determine:

- The repair costs that the plant will incur by some point in the future.
- If the repair costs have increased or decreased as a result of a strategy change (e.g., changing the mechanic who replaces parts), which was implemented after 23 months.

Reliability Growth Analysis Workflow

After you gather data for a Reliability Growth Analysis, you must perform a number of tasks to analyze the data. Following this workflow will ensure that you complete all the tasks that are necessary to conduct a complete analysis and will give you an overview of the analysis process.

1. **Collect data.** Before you can create a Reliability Growth Analysis, you first must [collect data](#) for the elements you wish to analyze.
2. **Create a new Reliability Growth Analysis.** You can create a new Reliability Growth Analysis from a query, dataset, or manually entered data.
3. **Evaluate the results in the following ways using the features of the Reliability Growth Analysis tool.**
 - Determine whether the data follows a trend using the [Goodness of Fit test](#).
 - Predict how the data will look in the future by [using the extrapolation tool](#).
 - Determine at what point in time trends in the data changed in the data by [using the segment tool](#).

Accessing the List of Growth Analyses

To display a list of the Reliability Growth Analyses that currently exist in the database:

- On the [Reliability Analytics Start Page](#), click the Reliability Growth link.

The Select a Growth Analysis from the List page appears.

The screenshot shows the 'Select a Growth Analysis from the List' page in the Meridium APM Framework. The page includes a navigation menu on the left with options like 'Plots' (MTBE Plot, Cumulative Plot, Rate Plot) and 'Common Tasks' (New Analysis, Open Analysis, Save Analysis, etc.). The main content area features a search filter for 'PublishedAnalyses' set to 'Any (%)' and 'Last Updated By' set to '(All Users)'. Below the filters is a table of growth analyses.

Analysis ID	Last Updated	Updated By	Final MTBF
v3.4.4 Growth Analysis from ma...	1/6/2012	Clingenpeel,...	619.224045082268
v3.4.3 Growth Analysis from ma...	7/1/2011	Clingenpeel,...	619.224045082268
v3.4.2 Growth Analysis from ma...	4/27/2011	Clingenpeel,...	619.224045082268
v3.4.1 Growth Analysis from ma...	12/2/2010	Clingenpeel,...	619.224045082268
v3.4.0 Growth Analysis from ma...	5/13/2010	Clingenpeel,...	619.224045082268
v3.3.3 Growth Analysis from ma...	4/7/2010	Clingenpeel,...	619.224045082268
v3.3.2 SP2 Growth Analysis fro...	11/13/2009	Clingenpeel,...	619.224045082268
v3.3.2 Growth Analysis from ma...	7/17/2009	Clingenpeel,...	619.224045082268
v3.3.1 Growth Analysis from ma...	2/6/2009	Clingenpeel,...	619.224045082268
v3.3.0 Growth Analysis from ma...	11/7/2008	Clingenpeel,...	619.224045082268
v3.2.3 Growth Analysis from ma...	5/22/2008	Clingenpeel,...	619.224045082268
v3.2.2 Growth Analysis from ma...	1/23/2008	Clingenpeel,...	619.224045082268
v3.2.1 Growth Analysis from ma...	1/29/2007	Clingenpeel,...	619.224045082268
v3.2.0 Growth Analysis from ma...	10/17/2006	Clingenpeel,...	619.224045082268
v3.1.0 Growth Analysis from ma...	2/8/2006	Clingenpeel,...	619.224045082268
v3.0.2 SP3 Growth Analysis fro...	1/25/2005	Clingenpeel,...	619.224045082268
v3.0.2 SP1 Growth Analysis fro...	8/5/2004	Clingenpeel,...	619.224045082268

Aspects of the Growth Analysis List Page

You can use the [Select a Growth Analysis from the List page](#) to select a Reliability Growth Analysis to open on the Reliability Growth Analysis page.

Meridium APM Framework - Select a Growth Analysis from the List

File Edit Go To Tools Help

Back Forward My Start Page New Search Catalog Query Report Graph Dataset Dashboard

meridium Reliability Analytics

Plots

- MTBE Plot
- Cumulative Plot
- Rate Plot

Common Tasks

- New Analysis
- Open Analysis
- Save Analysis
- Save Analysis As
- Publish Analyses
- Delete Analyses
- Send To >>
- Help
- Guidelines

Site Map: Reliability->Growth

Select a Growth Analysis from the List

PublishedAnalyses: Any (%) Run Query

Last Updated By: (All Users)

Analysis ID	Last Updated	Updated By	Final MTBF
v3.4.4 Growth Analysis from ma...	1/6/2012	Clingenpeel,...	619.224045082268
v3.4.3 Growth Analysis from ma...	7/1/2011	Clingenpeel,...	619.224045082268
v3.4.2 Growth Analysis from ma...	4/27/2011	Clingenpeel,...	619.224045082268
v3.4.1 Growth Analysis from ma...	12/2/2010	Clingenpeel,...	619.224045082268
v3.4.0 Growth Analysis from ma...	5/13/2010	Clingenpeel,...	619.224045082268
v3.3.3 Growth Analysis from ma...	4/7/2010	Clingenpeel,...	619.224045082268
v3.3.2 SP2 Growth Analysis fro...	11/13/2009	Clingenpeel,...	619.224045082268
v3.3.2 Growth Analysis from ma...	7/17/2009	Clingenpeel,...	619.224045082268
v3.3.1 Growth Analysis from ma...	2/6/2009	Clingenpeel,...	619.224045082268
v3.3.0 Growth Analysis from ma...	11/7/2008	Clingenpeel,...	619.224045082268
v3.2.3 Growth Analysis from ma...	5/22/2008	Clingenpeel,...	619.224045082268
v3.2.2 Growth Analysis from ma...	1/23/2008	Clingenpeel,...	619.224045082268
v3.2.1 Growth Analysis from ma...	1/29/2007	Clingenpeel,...	619.224045082268
v3.2.0 Growth Analysis from ma...	10/17/2006	Clingenpeel,...	619.224045082268
v3.1.0 Growth Analysis from ma...	2/8/2006	Clingenpeel,...	619.224045082268
v3.0.2 SP3 Growth Analysis fro...	1/25/2005	Clingenpeel,...	619.224045082268
v3.0.2 SP1 Growth Analysis fro...	8/5/2004	Clingenpeel,...	619.224045082268

The Select a Growth Analysis from the List page contains the following items:

- **Published Analyseslist:** Displays the following values:
 - **Yes (Y):** Will cause the query to return only published Reliability Growth Analyses.
 - **No (N):** Will cause the query to return only unpublished Reliability Growth Analyses.
 - **Any (%):** Will cause the query to return all Reliability Growth Analyses, both published and unpublished.
- **Last Updated By list:** Displays the following values:
 - **The last and first name associated with your Security User account:** This value is selected by default. When you select this value, the query will return Reliability Growth Analysis records that were last updated by you.

- **The last and first name of any Security user who last updated any Reliability Growth Analysis record:** When you select one of these values, the query will return Reliability Growth Analysis records that were last updated by the selected Security User.
- **[All Users]:** When you select this value, the query will return all Reliability Growth Analysis records in the database.
- **Run Query button:** Runs the Reliability Growth query and populates the results area based upon your selections in the **Published Analyses** and **Last Updated By** lists.
- **Query results grid:** This grid is populated when you click the **Run Query** button. The grid contains the following columns that displays Reliability Growth Analysis values:
 - **Analysis ID**
 - **Last Updated**
 - **Updated By**
 - **Final MTBF**
- **Task Menus:** Menus that provide access to specific functionality. The following menus are available: **Plots** and **Common Tasks**.

Plots Menu

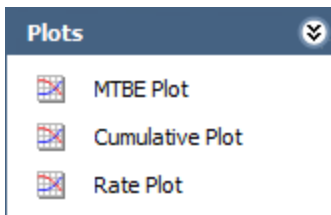

The **Plots** menu on the **Select a Growth Analysis from the List** page contains the following links:

- **MTBE Plot:** Displays the [MTBE Trend Plot](#) page for the selected analyses.
- **Cumulative Plot:** Displays the [Cumulative Plot](#) page for the selected analyses.
- **Rate Plot:** Displays the [Rate Trend Plot](#) page for the selected analyses.

Note:The links on the **Plots** menu are enabled when one or more records are selected in the query results grid on the **Select a Growth Analysis from the List** page.

Common Tasks Menu

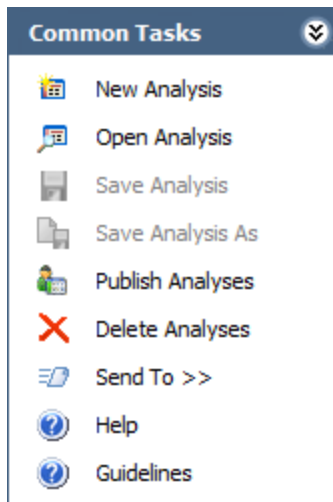

The **Common Tasks** menu on the **Select a Growth Analysis from the List** page contains the following links:

- **New Analysis:** Displays the [Reliability Growth Builder](#), which you can use to create a new Reliability Growth Analysis record.
- **Open Analysis:** Opens the **Find Reliability Growth Analysis** window, which you can use to search for an existing **Reliability Growth Analysis** record.
- **Save Analysis:** This link is always disabled.
- **Save Analysis As:** This link is always disabled.
- **Publish Analyses:** [Publishes](#) the selected Reliability Growth Analysis record(s). If you select one or more records that are already published, this link will be labeled **Unpublish Analyses** and will [unpublish](#) the selected records.
- **Delete Analyses:** After asking for confirmation, deletes the selected Reliability Growth Analysis record(s) from the list.
- **Send To:** Displays a submenu with options that let you provide a link to the current page on your desktop (create shortcut), in an email message, or on a Home Page.
- **Help:** Displays the context-sensitive Help topic for the **Select a Growth Analysis from the List** page.
- **Guidelines:** Displays overview information about the Reliability Analytics module.

Opening an Existing Reliability Growth Analysis

To open an existing Reliability Growth Analysis:

1. On the [Reliability Analytics Start Page](#), click the **Reliability Growth** link.

The [Select a Growth Analysis from the List](#) page appears.

The screenshot shows the 'Select a Growth Analysis from the List' page in the Meridium APM Framework. The page includes a navigation menu on the left with options like 'Plots' (MTBE Plot, Cumulative Plot, Rate Plot) and 'Common Tasks' (New Analysis, Open Analysis, Save Analysis, etc.). The main content area features a 'Published Analyses' dropdown menu set to 'Any (%)' and a 'Last Updated By' dropdown menu set to '(All Users)'. A 'Run Query' button is located to the right of these dropdowns. Below the filters is a table of published analyses.

Analysis ID	Last Updated	Updated By	Final MTBF
v3.4.4 Growth Analysis from ma...	1/6/2012	Clingenpeel,...	619.224045082268
v3.4.3 Growth Analysis from ma...	7/1/2011	Clingenpeel,...	619.224045082268
v3.4.2 Growth Analysis from ma...	4/27/2011	Clingenpeel,...	619.224045082268
v3.4.1 Growth Analysis from ma...	12/2/2010	Clingenpeel,...	619.224045082268
v3.4.0 Growth Analysis from ma...	5/13/2010	Clingenpeel,...	619.224045082268
v3.3.3 Growth Analysis from ma...	4/7/2010	Clingenpeel,...	619.224045082268
v3.3.2 SP2 Growth Analysis fro...	11/13/2009	Clingenpeel,...	619.224045082268
v3.3.2 Growth Analysis from ma...	7/17/2009	Clingenpeel,...	619.224045082268
v3.3.1 Growth Analysis from ma...	2/6/2009	Clingenpeel,...	619.224045082268
v3.3.0 Growth Analysis from ma...	11/7/2008	Clingenpeel,...	619.224045082268
v3.2.3 Growth Analysis from ma...	5/22/2008	Clingenpeel,...	619.224045082268
v3.2.2 Growth Analysis from ma...	1/23/2008	Clingenpeel,...	619.224045082268
v3.2.1 Growth Analysis from ma...	1/29/2007	Clingenpeel,...	619.224045082268
v3.2.0 Growth Analysis from ma...	10/17/2006	Clingenpeel,...	619.224045082268
v3.1.0 Growth Analysis from ma...	2/8/2006	Clingenpeel,...	619.224045082268
v3.0.2 SP3 Growth Analysis fro...	1/25/2005	Clingenpeel,...	619.224045082268
v3.0.2 SP1 Growth Analysis fro...	8/5/2004	Clingenpeel,...	619.224045082268

2. [In the Published Analyses list, select a value.](#)
3. [In the Last Updated By list, select a value.](#)
4. Click the **Run Query** button.

The Meridium APM system runs the Reliability Growth query and the results are displayed in the query results grid.

5. In the **Analysis ID** column, click the analysis ID of the analysis that you want to open.

The [Reliability Growth Analysis page](#) appears, displaying a summary of the analysis.

Opening an Existing Reliability Growth Analysis

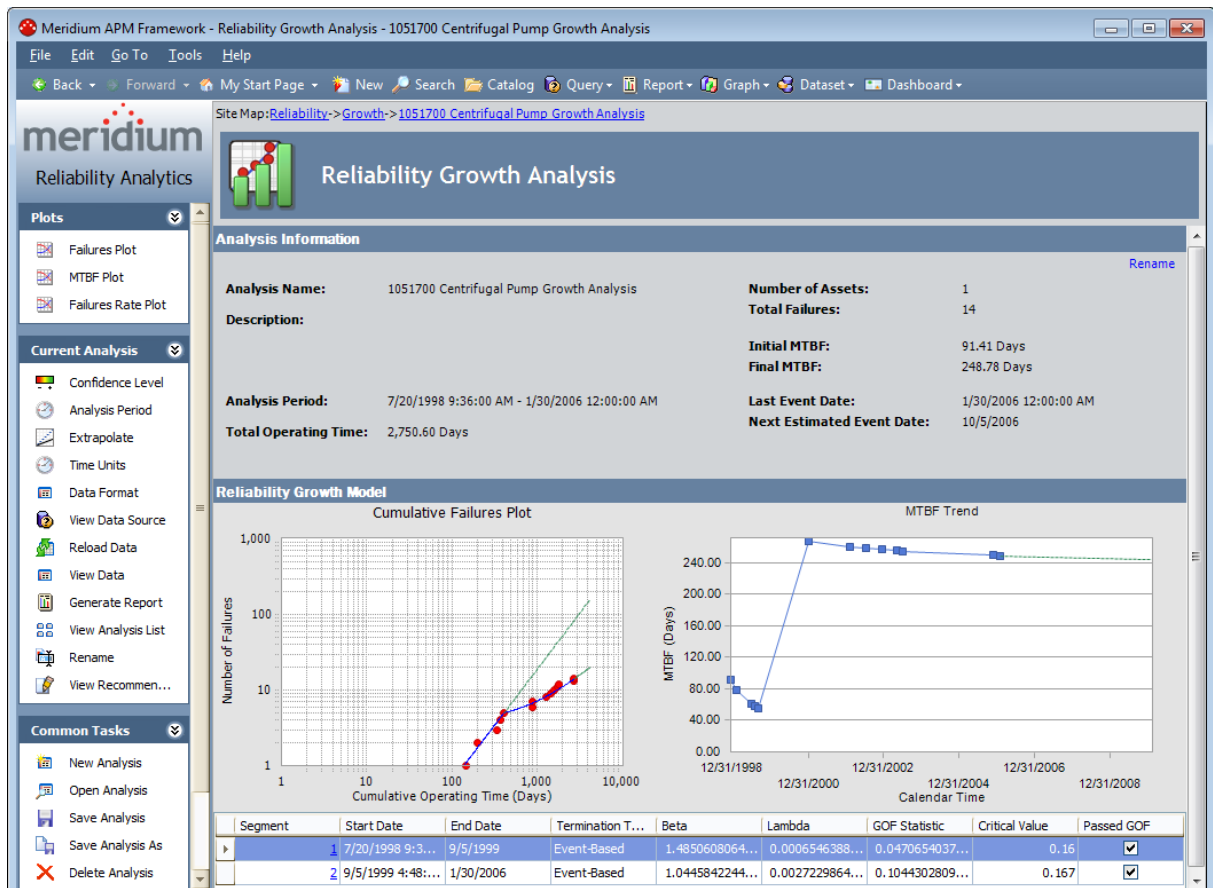

Note that when you open an existing analysis, the analysis will use the data and calculations that were last [saved](#) with the analysis. If you want to reload the underlying query or dataset and update calculations based on any changes to the underlying data, you must [reload the data](#) after opening the analysis.

Accessing the Reliability Growth Builder

To access the Reliability Growth Builder:

1. Access one of the following pages:
 - [Select a Growth Analysis from the List page](#)
 - [Reliability Growth Analysis page](#)
 - [AMSAA Reliability Growth Model page](#)
2. On the **Common Tasks** menu, click the **New Analysis** link.

The **Reliability Growth Builder** appears, displaying the **Welcome** screen.

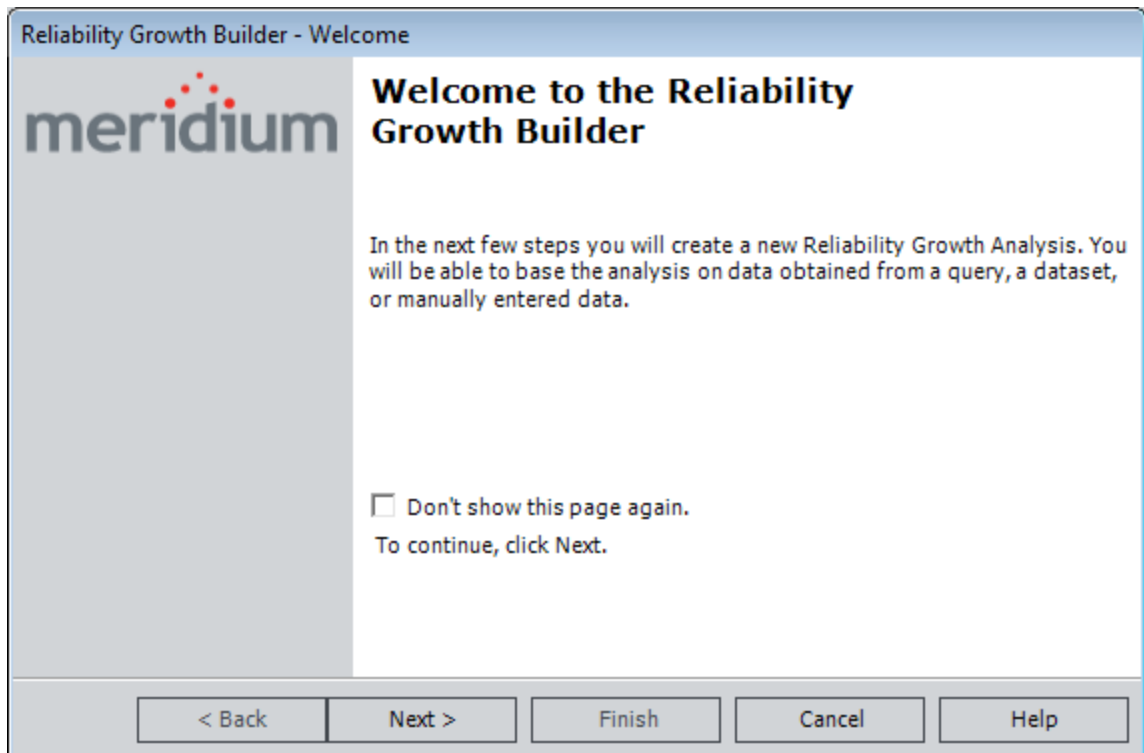

Using the Reliability Growth Builder

You can use the **Reliability Growth Builder** to create a Reliability Growth Analysis from data that is manually entered or contained in queries or datasets. This data can be:

- Based on an event (e.g., a failure).
- or-
- not based on an event (e.g., repair cost). In [Example 3](#), we create an analysis using non-event, grouped data.

In addition, event or non-event data can be measured using:

- Failure dates. In [Example 1](#), we will create an analysis using event-based data derived from failure dates.
- or-
- Cumulative operating time. In [Example 2](#), we will create an analysis using event-based data derived from cumulative operating time.

The **Reliability Growth Builder** displays various screens containing various options that you can use to create a Reliability Growth Analysis. This section of the documentation provides details on each of these screens and how you can use them to create a Reliability Growth Analysis.

- [Welcome screen](#)
- [Select Data Source Type screen](#)
- [Select Data Source screen](#)
- [Select Data Format screen](#)
- [Select Data Fields screen](#)
- [Provide Information for Downtime screen](#)
- [Analysis Start Time screen](#)

Creating a Growth Analysis Derived from Failure Dates

If you record event-based data that uses failure dates (e.g., a failure was recorded on 5/5/10), then you can create a Reliability Growth Analysis using event-based data and data containing dates.

To create a Reliability Growth Analysis based on a query or dataset:

1. [Access the Reliability Growth Builder.](#)
2. On the [Welcome screen](#), click the **Next** button.

The **Select Data Source Type** screen appears.

Reliability Growth Builder - Select Data Source Type

Select Data Source Type

Query Based

- Data will be loaded using an existing Query.
- I will create a new Query and use it to load data.

Dataset Based

- Data will be copied from an existing Dataset.
- I will create a new Dataset and use its contents as data.

No Data Source

- I will manually enter data.

< Back Next > Finish Cancel Help

3. On the [Select Data Source Type screen](#), specify the source of the data for your analysis, and click the **Next** button. These instructions assume that you have selected one of the **Query Based** or **Dataset Based** options. If you selected the **I will manually enter data** option, after the **Select Data Format** screen, click the **Finish** button, and the [<Measurement> Data](#) grid appears.

The **Select Data Sources** screen appears.

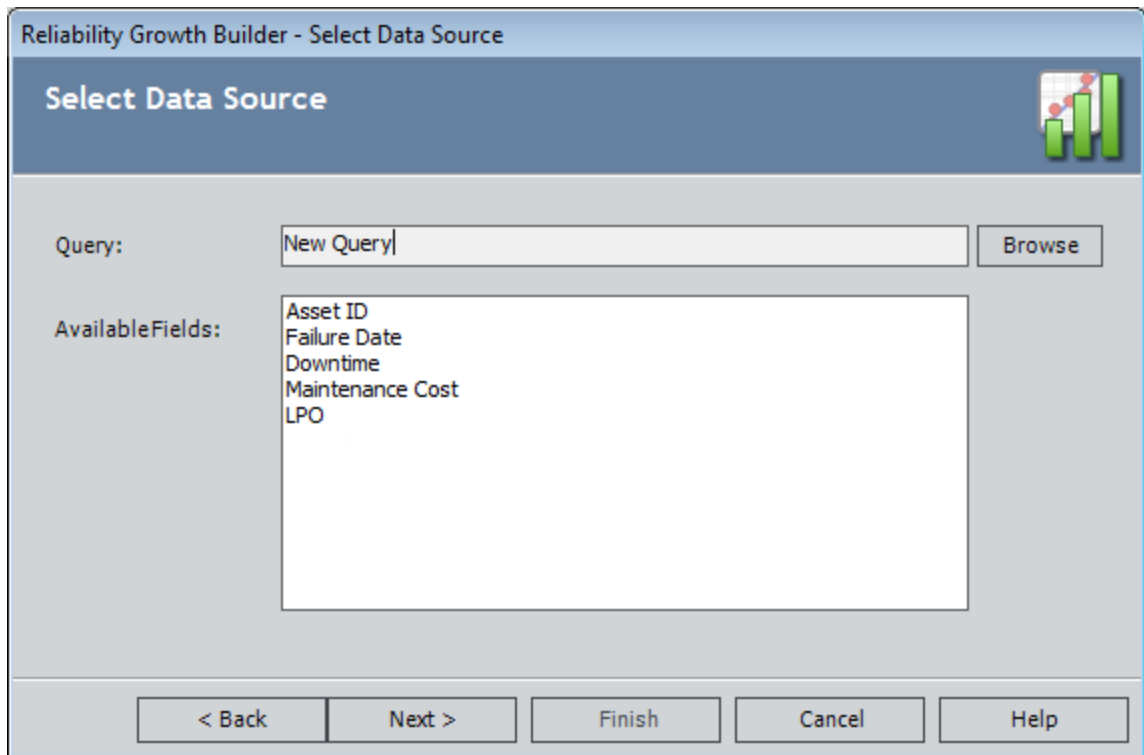

4. On the [Select Data Source](#) screen, select the query or dataset you will use for the Reliability Growth Analysis, and click the **Next** button.

The **Select Data Format** screen appears.

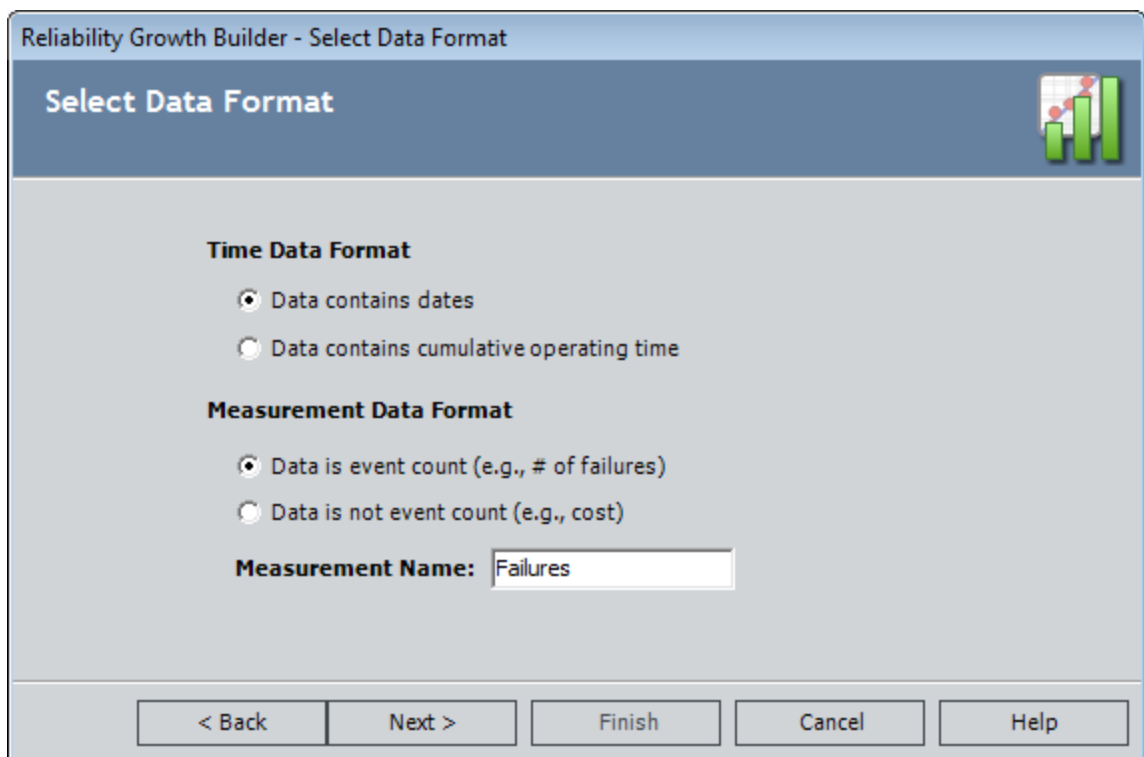

5. On the [Select Data Format screen](#), specify the time data format, the measurement data format, and the name of the measurement you will use throughout the Reliability Growth Analysis, and click the **Next** button. These instructions assume you are creating an analysis similar to [Example 1](#), and will select the **Data contains dates** option and the **Data is event count** option, and leave the **Measurement Name** text box with the default value *Failures*.

The **Select Data Fields** screen appears.

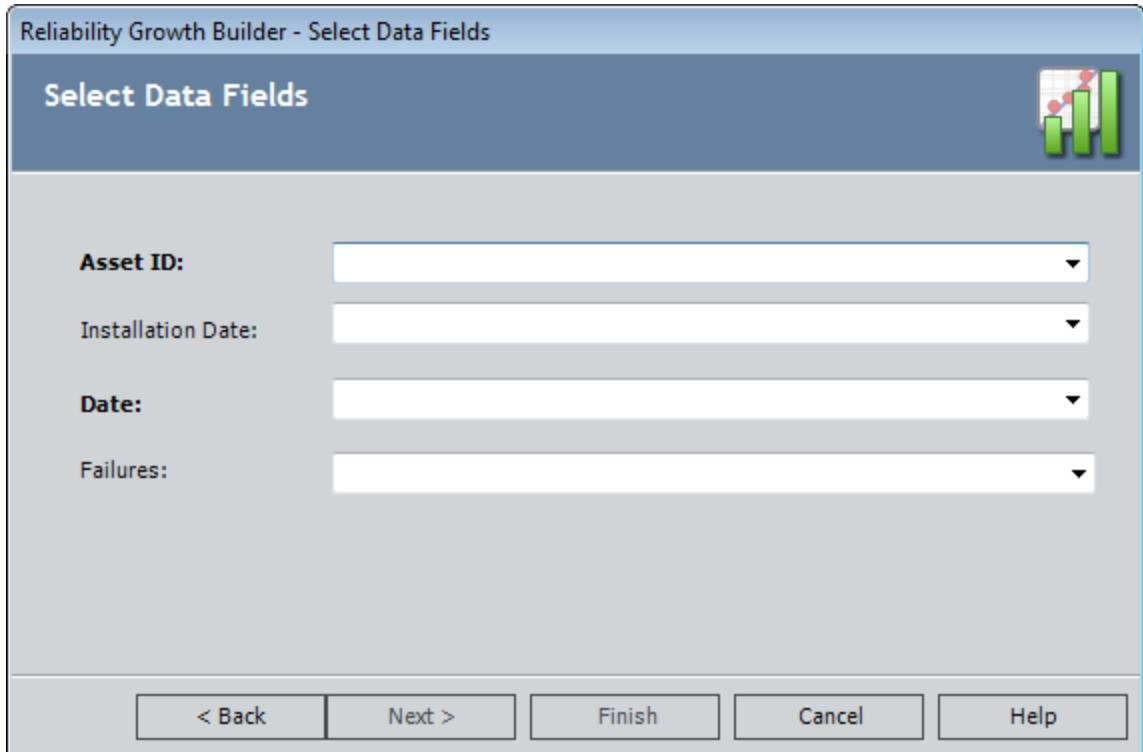

Reliability Growth Builder - Select Data Fields

Select Data Fields

Asset ID:

Installation Date:

Date:

Failures:

< Back Next > Finish Cancel Help

On the [Select Data Fields screen](#), select the query or dataset columns that you want to map for the Reliability Growth Analysis, and click the **Next** button.

6. The **Provide Information for Downtime** screen appears.

Reliability Growth Builder - Provide Information for Downtime

Provide Information for Downtime

Downtime Field: [Dropdown Menu]

Time Units: [Days] [Dropdown Menu]

< Back Next > Finish Cancel Help

7. On the [Provide Information for Downtime screen](#), in the **Downtime Field** list, select the query or dataset column that contains downtime values.
8. In the **Time Units** list, select the time units associated with downtime from the following options:
 - Hours
 - Days
 - Weeks
 - Months
 - Quarters
 - Years
9. Click the **Finish** button.

The Meridium APM system generates the analysis, and the **Reliability Growth Analysis** page appears, displaying the analysis results.

10. On the **Common Tasks** menu, click the **Save Analysis** link to [save the analysis](#).

Creating a Growth Analysis Derived From COT

If you record event-based data using operating time instead of failure dates (e.g., a failure occurred after the piece of equipment was running for 10 days), then you can create a Reliability Growth Analysis using event-based data and cumulative operating time (COT).

To create a Reliability Growth Analysis based on a query or dataset:

1. [Access the Reliability Growth Builder.](#)
2. On the [Welcome screen](#), click the **Next** button.

The **Select Data Source Type** screen appears.

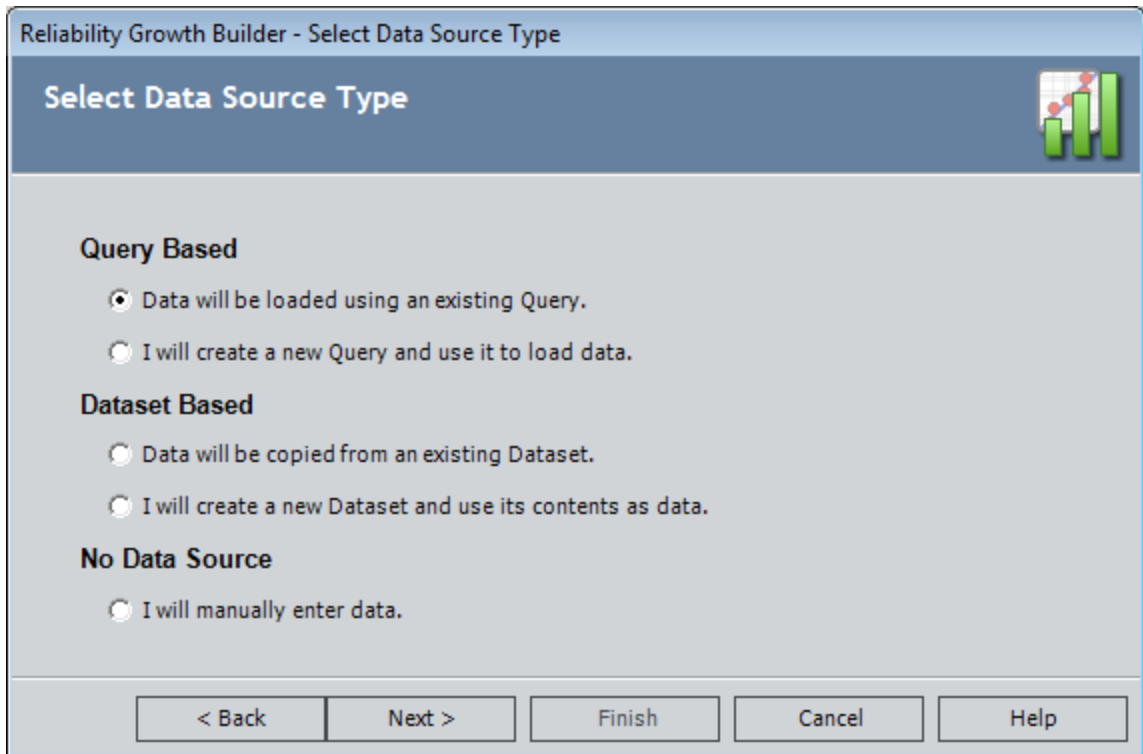

The screenshot shows a dialog box titled "Reliability Growth Builder - Select Data Source Type". The main heading is "Select Data Source Type". There are three sections of radio button options:

- Query Based**
 - Data will be loaded using an existing Query.
 - I will create a new Query and use it to load data.
- Dataset Based**
 - Data will be copied from an existing Dataset.
 - I will create a new Dataset and use its contents as data.
- No Data Source**
 - I will manually enter data.

At the bottom, there are five buttons: "< Back", "Next >", "Finish", "Cancel", and "Help".

3. On the [Select Data Source Type screen](#), specify the source of the data for your analysis, and click the **Next** button. These instructions assume that you have selected one of the **Query Based** or **Dataset Based** options. If you selected the **I will manually enter data** option, after the **Select Data Format** screen, click the **Finish** button, and the [<Measurement> Data](#) grid appears.

The **Select Data Source** screen appears.

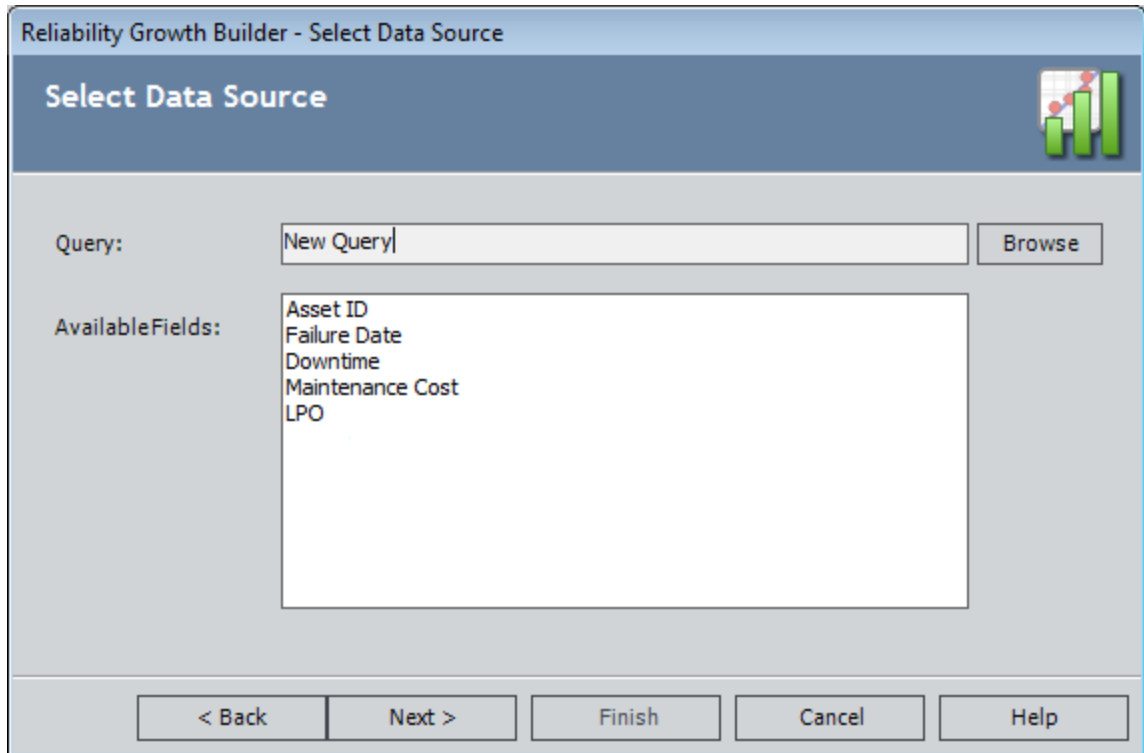

4. On the [Select Data Source](#) screen, select the query or dataset you will use for the Reliability Growth Analysis, and click the **Next** button.

The **Select Data Format** screen appears.

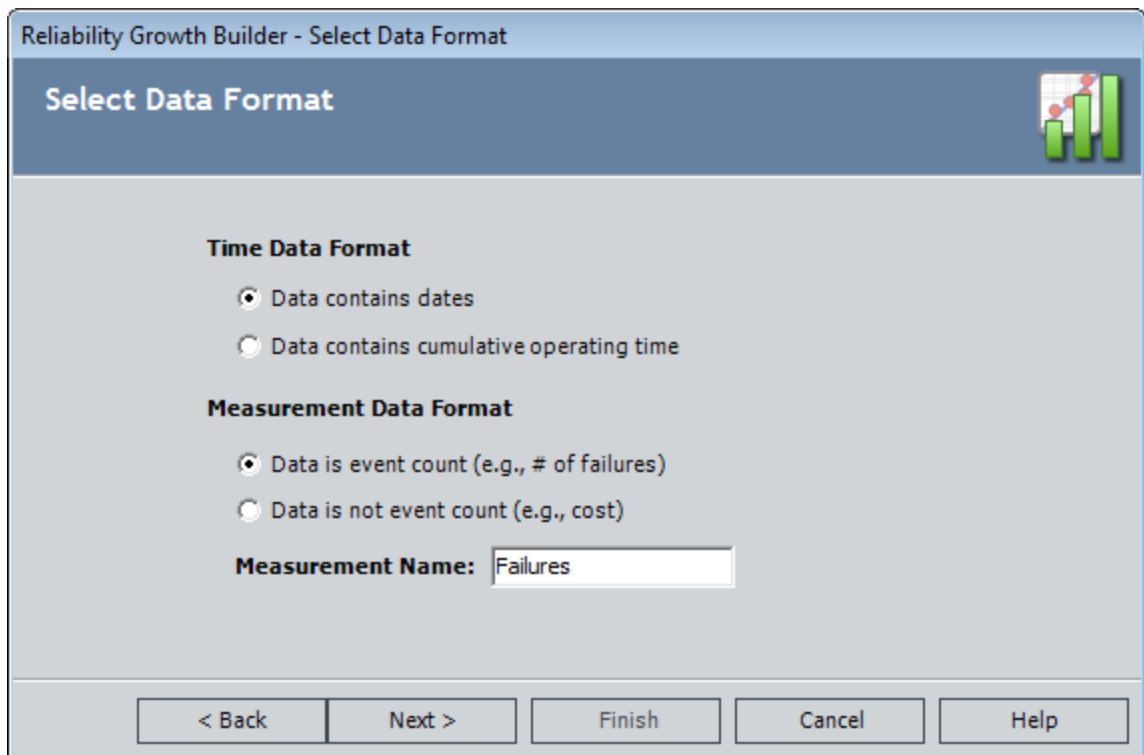

5. On the [Select Data Format screen](#), specify the time data format, the measurement data format, and the name of the measurement you will use throughout the Reliability Growth Analysis, and click the **Next** button. These instructions assume you are creating an analysis similar to [Example 2](#), and will select the **Data contains cumulative operating time** option, and the **Data is event count** option, and leave the **Measurement Name** text box with the default value *Failures*.

The **Select Data Fields** screen appears.

Reliability Growth Builder - Select Data Fields

Select Data Fields

Cumulative Operating Time: [Dropdown]

Time Units: Days [Dropdown] [Text Box]

Asset ID: [Dropdown]

Date: [Dropdown]

Failures: [Dropdown]

< Back Next > Finish Cancel Help

6. On the [Select Data Fields screen](#), select the query or dataset columns that you want to map for the Reliability Growth Analysis, and click the **Next** button.

The **Analysis Start Time** screen appears.

Reliability Growth Builder - Analysis Start Time

Analysis Start Time

Start Time

I want to use the time of the first data point as the start time for this analysis.

Days

< Back Next > Finish Cancel Help

7. On the [Analysis Start Time screen](#), specify the start time of the analysis, and click the **Finish** button.

Note: If you did not select a field in the **Date** list on the **Select Data Fields** screen or if you selected a field that did not contain a date in every row, a message will appear, stating that one or more failure dates are missing and that dates will not be estimated in the analysis.

The Meridium APM system generates the analysis, and the **Reliability Growth Analysis** page appears, displaying the analysis results.

8. On the **Common Tasks** menu, click the **Save Analysis** link to [save the analysis](#).

Creating a Growth Analysis From Non-Event and Grouped Data (Cost)

If you record data that is not associated with an event (e.g., repair cost) you would create a Reliability Growth Analysis from data that is not event-based. If you record more than one measurement per datapoint or record an amount of data, you should create a Reliability Growth Analysis using grouped data.

Using a Reliability Growth Analysis to measure cost is the most common example of evaluating grouped data and non-event data.

To create a Reliability Growth Analysis based on a query or dataset:

1. [Access the Reliability Growth Builder.](#)
2. On the [Welcome screen](#), click the **Next** button.

The **Select Data Source Type** screen appears.

Reliability Growth Builder - Select Data Source Type

Select Data Source Type

Query Based

- Data will be loaded using an existing Query.
- I will create a new Query and use it to load data.

Dataset Based

- Data will be copied from an existing Dataset.
- I will create a new Dataset and use its contents as data.

No Data Source

- I will manually enter data.

< Back Next > Finish Cancel Help

3. On the [Select Data Source Type screen](#), specify the source of the data for your analysis, and click the **Next** button. These instructions assume that you have selected one of the **Query Based** or **Dataset Based** options. If you selected the **I will manually enter data** option, after the **Select Data Format** screen, click the **Finish** button, and the [<Measurement> Data](#) grid appears.

The **Select Data Source** screen appears.

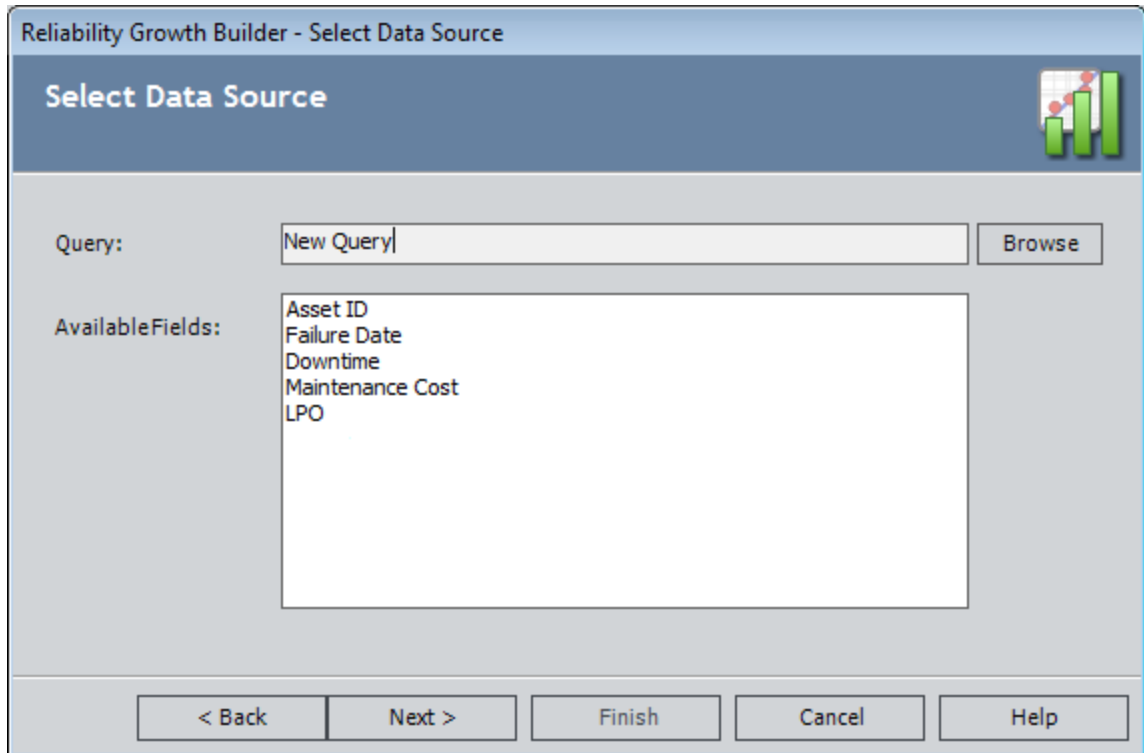

4. On the [Select Data Source](#) screen, select the query or dataset you will use for the Reliability Growth Analysis, and click the **Next** button.

The **Select Data Format** screen appears.

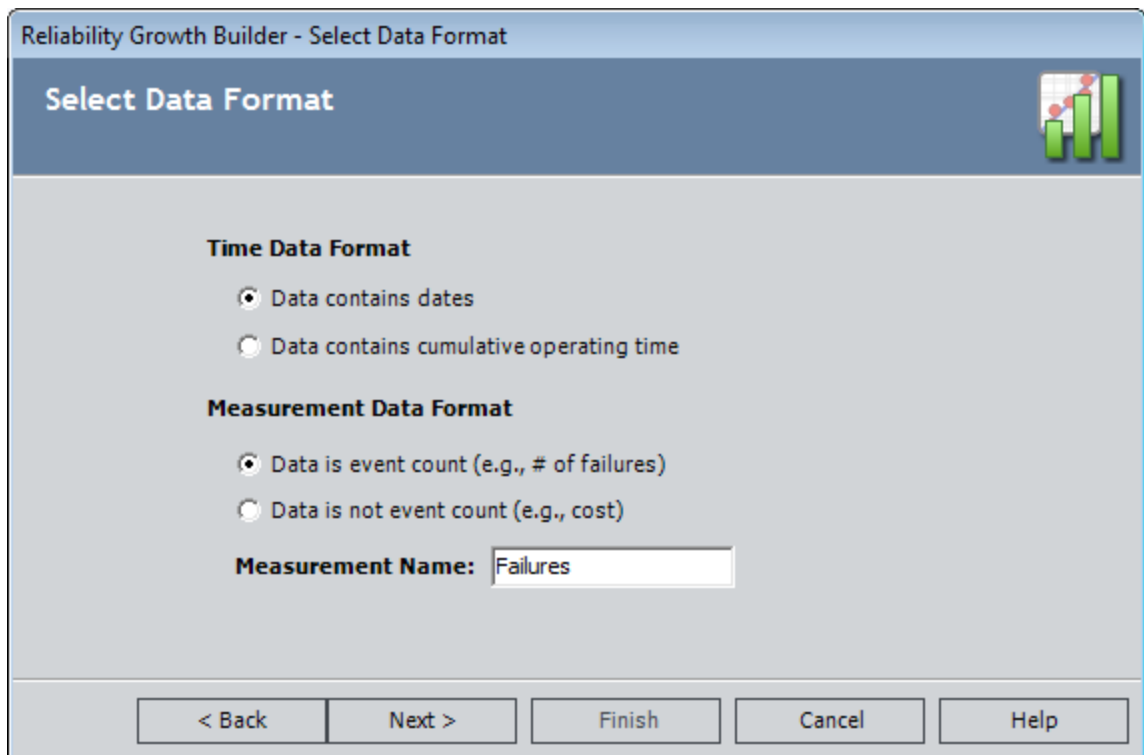

5. On the [Select Data Format screen](#), specify the time data format, the measurement data format, and the name of the measurement you will use throughout the Reliability Growth Analysis, and click the **Next** button. These instructions assume you are creating an analysis similar to [Example 3](#), and will select the **Data contains cumulative operating time** option and the **Data is not event count** option, and enter *Cost* in the **Measurement Name** text box.

The **Select Data Fields** screen appears.

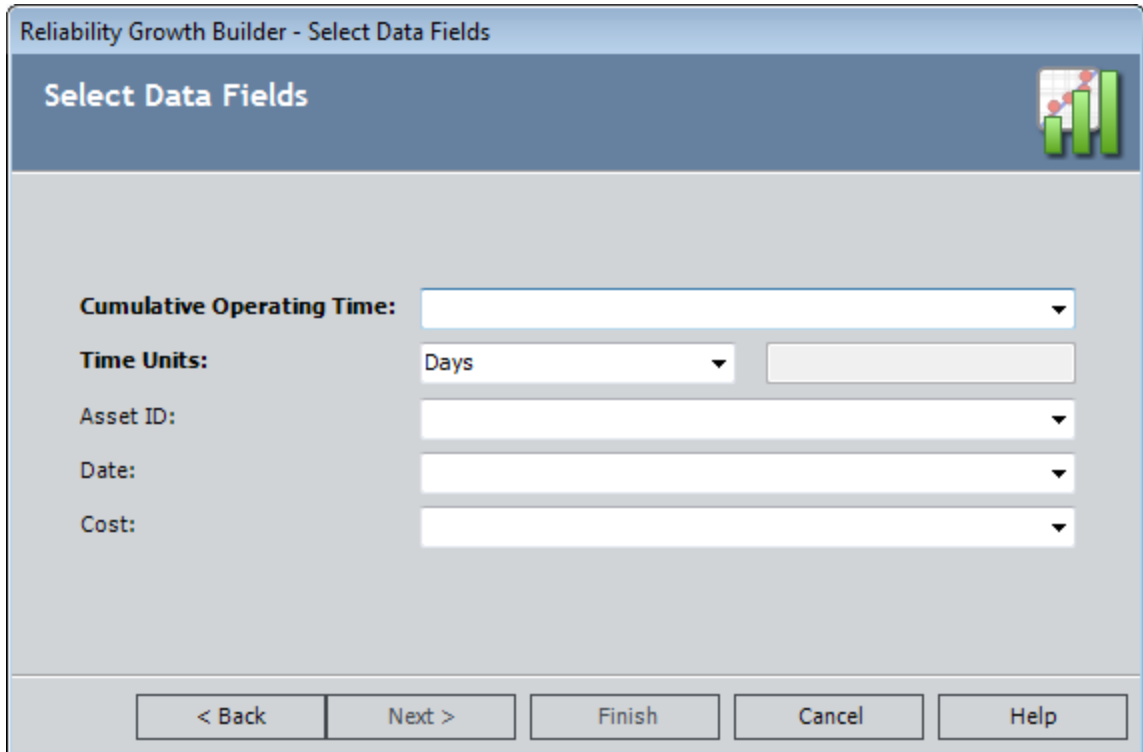

Reliability Growth Builder - Select Data Fields

Select Data Fields

Cumulative Operating Time: [Dropdown]

Time Units: Days [Dropdown] [Text Box]

Asset ID: [Dropdown]

Date: [Dropdown]

Cost: [Dropdown]

< Back Next > Finish Cancel Help

6. On the [Select Data Fields screen](#), select the query or dataset columns that you want to map for the Reliability Growth Analysis, and click the **Next** button. To ensure that your analysis includes grouped data, you must map a column to the **Cost** field.

The **Analysis Start Time** screen appears.

Reliability Growth Builder - Analysis Start Time

Analysis Start Time

Start Time

I want to use the time of the first data point as the start time for this analysis.

Months

< Back Next > Finish Cancel Help

7. On the [Analysis Start Time screen](#), specify the start time of the analysis, and click the **Finish** button.

Note: If you did not select a field in the **Date** list on the **Select Data Fields** screen, or if you selected a field that did not contain a date in every row, a message will appear stating that one or more failure dates are missing and dates will not be estimated in the analysis.

The Meridium APM system generates the analysis, and the **Reliability Growth Analysis** page appears, displaying the analysis results.

8. On the **Common Tasks** menu, click the **Save Analysis** link to [save the analysis](#).

Creating Reliability Growth Analyses from an Associated Page

The following instructions assume that an administrative user has already [created an Associated Page](#) that can be used to create a Reliability Growth Analysis from an Equipment or Functional Location record.

To create a Reliability Growth Analysis from an Associated Page:

1. In the Meridium APM Framework, open an Equipment or Functional Location record in the Record Manager.
2. On the **Associated Pages** menu, click the **New Growth Analysis** link.

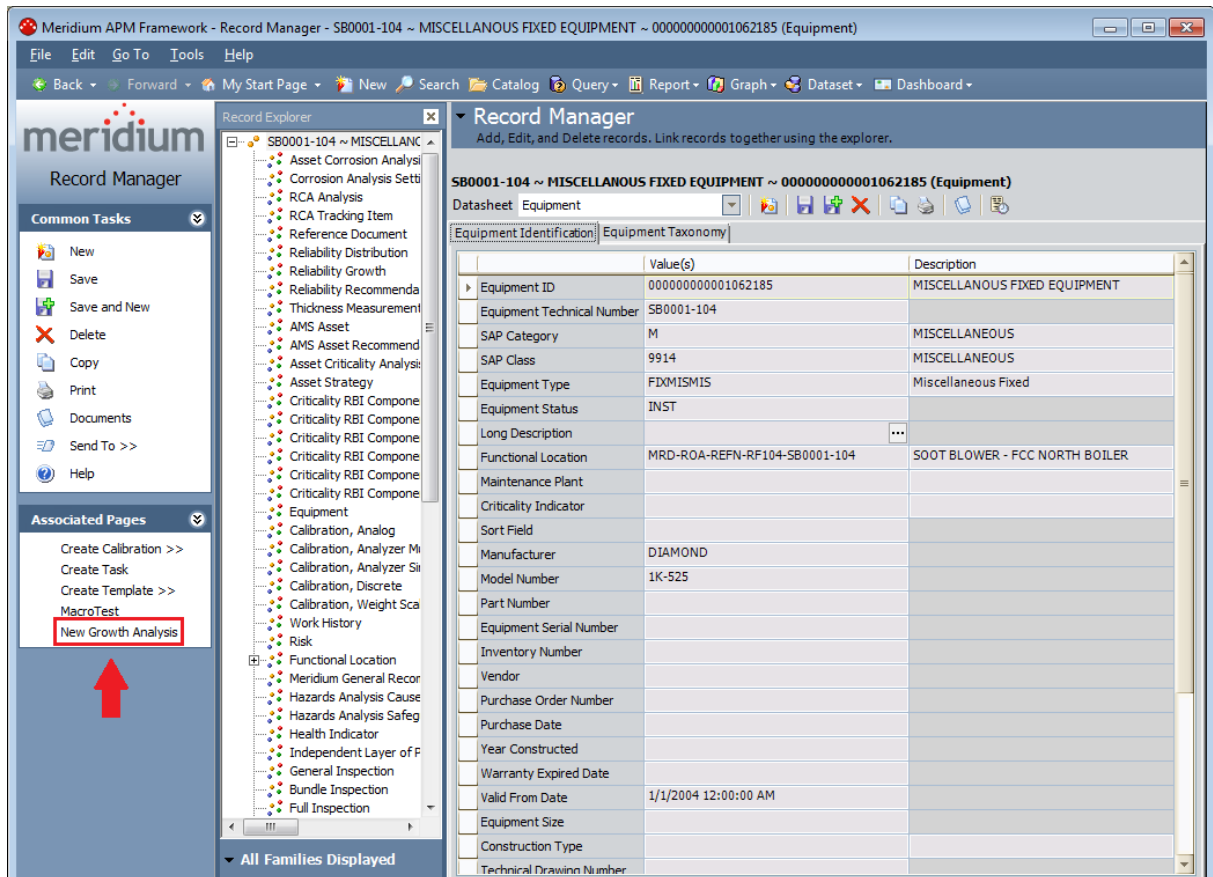

The **Enter parameter values** dialog box appears. If you are viewing an Equipment record, the **Enter parameter values** dialog box displays the value in the Equipment ID field of the current record. If you are viewing a Functional Location record, the **Enter Parameter values** dialog box displays the value in the Location field of the current record.

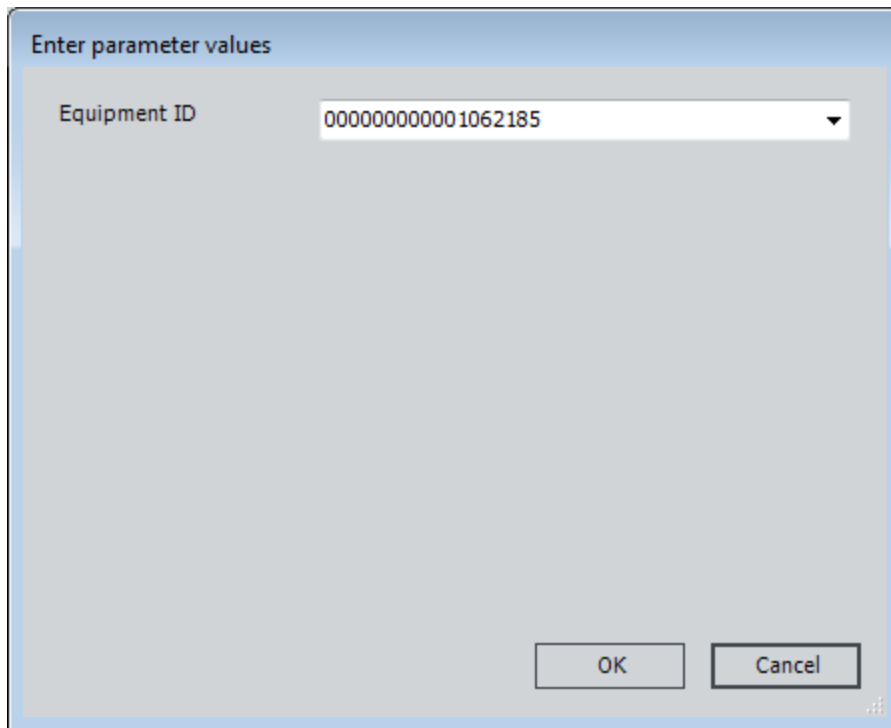

The image shows a dialog box with a light blue title bar that reads "Enter parameter values". Inside the dialog, there is a label "Equipment ID" followed by a dropdown menu. The dropdown menu is currently open, showing the value "00000000001062185" and a small downward-pointing arrow on the right side. At the bottom right of the dialog, there are two buttons: "OK" and "Cancel".

3. Click **OK**.

The Reliability Growth Analysis is created, and the **Reliability Growth Analysis** page appears.

Welcome Screen

When you access the **Reliability Growth Builder**, the **Welcome** screen is displayed.

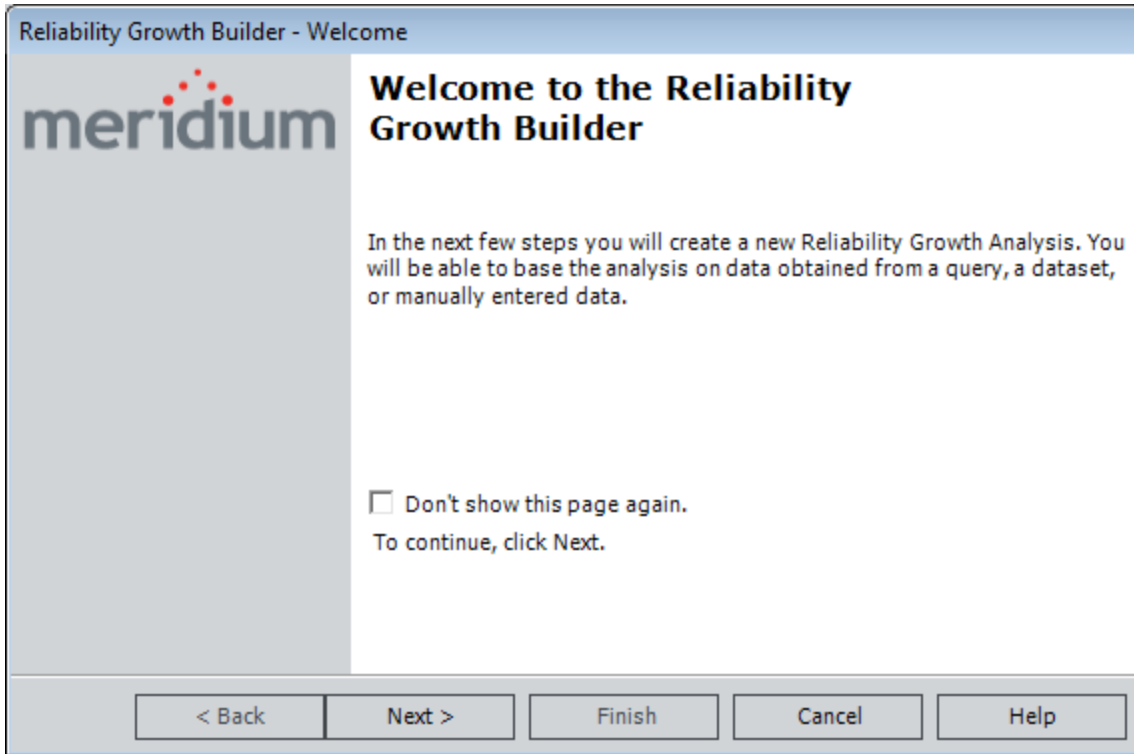

The **Don't show this page again** check box is displayed on the **Welcome** screen. When this check box is selected, the **Welcome** screen will not be displayed the next time you access the builder. When this check box is clear, the **Welcome** screen will be displayed the next time you access the builder.

Select Data Source Type Screen

Your selection on the **Select Data Source Type** screen determines the source of the data for your analysis.

Reliability Growth Builder - Select Data Source Type

Select Data Source Type

Query Based

- Data will be loaded using an existing Query.
- I will create a new Query and use it to load data.

Dataset Based

- Data will be copied from an existing Dataset.
- I will create a new Dataset and use its contents as data.

No Data Source

- I will manually enter data.

< Back Next > Finish Cancel Help

Choose from the following options that are displayed on the **Select Data Source Type** screen:

- **Data will be loaded using an existing Query:** If you select this option, when you click the **Next** button, you will be asked to find and select the desired query in the Meridium APM Catalog.
- **I will create a new Query and use it to load data:** If you select this option, when you click the **Next** button, the Query Builder will appear so that you can design a new query.
- **Data will be copied from an existing Dataset:** If you select this option, when you click the **Next** button, you will be asked to find and select the desired dataset in the Meridium APM Catalog.
- **I will create a new Dataset and use its contents as data:** If you select this option, when you click the **Next** button, the Dataset Builder will appear so that you can design a new dataset.
- **I will manually enter data:** If you select this option, when you click the **Next** button, the **Select Data Format** screen will appear. After you click the **Finish** button on the **Select Data Format** screen, the [<Measurement> Data grid](#) will appear, in which you can enter your data manually.

Data Source Screen

The **Select Data Source** screen allows you to choose the query or dataset you will use for the Reliability Growth Analysis. This screen appears only if you selected one of the following options on the **Select Data Source Type** screen:

- Data will be loaded using an existing Query
- Data will be copied from an existing Dataset

The following image shows an example of the screen where a query has been selected as the datasource.

Reliability Growth Builder - Select Data Source

Select Data Source

Query: New Query| Browse

AvailableFields: Asset ID
Failure Date
Downtime
Maintenance Cost
LPO

< Back Next > Finish Cancel Help

Click the **Browse** button to search for an existing query or dataset in the Meridium APM Catalog. After you select the desired datasource from the Catalog:

- If you are using an existing query as your datasource, the name of the query will be displayed in the **Query** text box.

-or-

If you are using an existing dataset as your datasource, the name of the query will be displayed in the **Dataset** text box.

- The fields that exist for the selected query or dataset appear in the **Available Fields** list.

Select Data Format Screen

The **Select Data Format** screen allows you to specify the time data format, the measurement data format, and the name of the measurement you will use throughout the Reliability Growth Analysis.

Reliability Growth Builder - Select Data Format

Select Data Format

Time Data Format

- Data contains dates
- Data contains cumulative operating time

Measurement Data Format

- Data is event count (e.g., # of failures)
- Data is not event count (e.g., cost)

Measurement Name: Failures

< Back Next > Finish Cancel Help

You can choose from the following options on the **Select Data Format** screen:

- **Time Data Format**
 - **Data contains dates:** Indicates that the datasource contains [data that contains specific event dates](#) (e.g., 5/5/2012).
-or-
 - **Data contains cumulative operating time:** Indicates that the datasource contains [data the contains operation time values](#) (e.g., 10 days).
- **Measurement Data Format**
 - **Data is event count:** Indicates that the datasource contains data that contains event counts, such as number of equipment failures, safety incidents, or equipment repairs.
-or-
 - **Data is not event count:** Indicates that the datasource contains data that does [not contain event counts](#) but contains an amount, such as cost or hours.

- **Measurement Name:** The name of the data you are measuring throughout the analysis (e.g., cost, events). This value is required. By default, this value is *Failures*. The measurement name that you select will be displayed throughout the analysis results.

Select Data Fields Screen

The **Select Data Fields** screen allows you to select columns from your query or dataset to map to the Reliability Growth Analysis. This screen will look different, depending on whether your analysis contains failure dates or cumulative operating time.

The following image displays the **Select Data Fields** screen for an analysis containing failure dates.

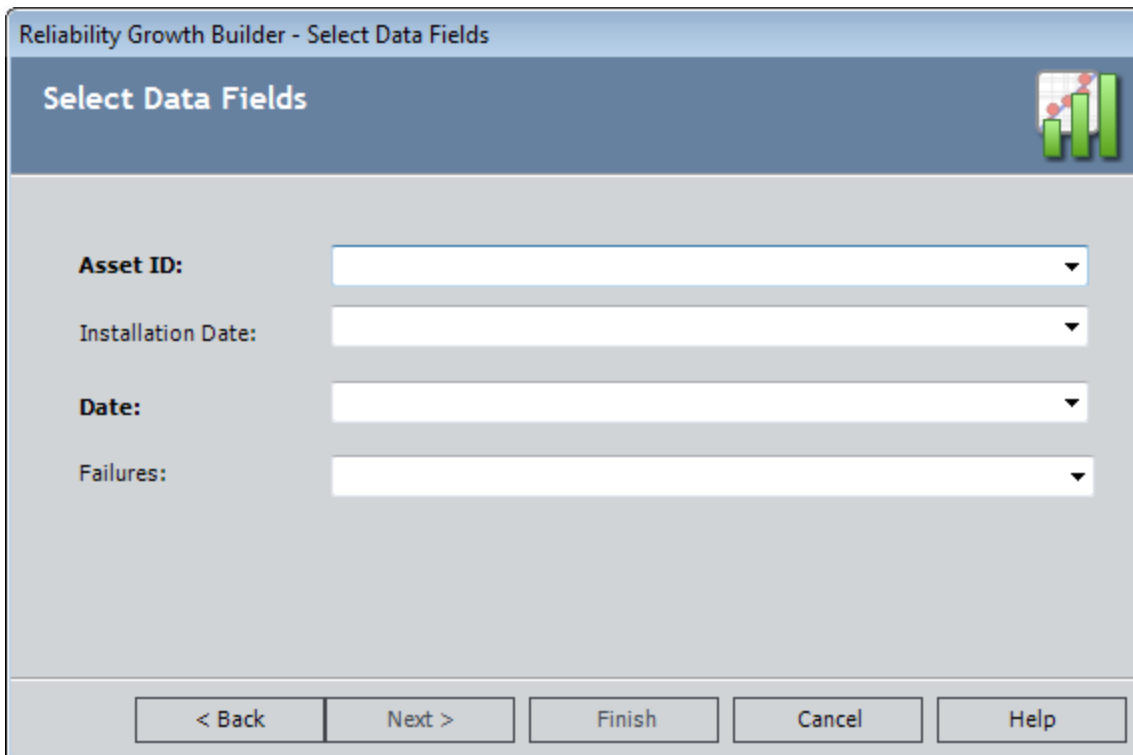

The screenshot shows a software window titled "Reliability Growth Builder - Select Data Fields". The window has a dark blue header with the title "Select Data Fields" and a small icon of a bar chart with a red line graph. Below the header, there are four dropdown menus labeled "Asset ID:", "Installation Date:", "Date:", and "Failures:". At the bottom of the window, there are five buttons: "< Back", "Next >", "Finish", "Cancel", and "Help".

Select a column from your query or dataset containing dates to map to the following fields on the **Select Data Fields** screen:

- **Asset ID:** Select the query or dataset column that contains the IDs of the failed equipment or locations. This value is required, and you must select a column that contains alphanumeric values.
- **Installation Date:** Select the query or dataset column that contains the installation dates of the equipment or locations. This field appears only for an analysis based on failure dates, and the value is optional.
- **Date:** Select the query or dataset column that contains the failure date of the equipment or locations. This value is required.
- **<Measurement>:** Select the query or dataset column that contains the number of failures recorded at each measurement. If you do not select a value from the list, the Meridium APM system will assume that one failure exists for each datapoint. If the number of failures is *1*, the calculation will be based on an event-terminated or time-terminated analysis. If the number of failures is more than 1, the

calculation will be based on a grouped-data analysis. For [Example 3](#), we are using grouped data and need to define a column for this field.

Note: The name of the last list is dependent on the value you chose in the **Measurement Name** text box on the **Select Data Format** screen. In [Example 1](#) and [Example 2](#), we accepted the default value *Failures*, so the last list is named *Failures*. In [Example 3](#), we entered the value *Cost*, so this list would be named *Cost*.

The following image displays the **Select Data Fields** screen for an analysis containing cumulative operating time:

Select a column from your query or dataset containing cumulative operating time to map to the following fields on the **Select Data Fields** screen:

- **Cumulative Operating Time:** Select the query or dataset column that contains the piece of equipment's or location's cumulative operating time, or the time that has passed since it was placed into service. This field appears only for an analysis based on cumulative operating time, and the value is required.
- **Time Units:** Select the units for cumulative operating time from the following options: **Hours, Days, Weeks, Months, Quarters, Years, or Custom**. If you select *Custom*, the second text box is enabled and you can specify any units you desire (e.g., miles). This field appears only for an analysis based on cumulative operating time, and the value is required.
- **Asset ID:** Select the query or dataset column that contains the IDs of the failed equipment or locations. This value is optional.

- **Date:** Select the query or dataset column that contains the failure date of the equipment or locations. This value is optional, but if you do not select a field in the **Date** list, all labels in the Reliability Growth Analysis will display cumulative operating time only, and you will be able to extrapolate based on time only, not date.
- **<Measurement>:** Select the query or dataset column that contains the number of failures recorded at each measurement. If you do not select a value from the list, the Meridium APM system will assume that one failure exists for each datapoint. If the number of failures is *1*, the calculation will be based on an event-terminated or time-terminated analysis. If the number of failures is more than 1, the calculation will be based on a grouped-data analysis. For [Example 3](#), we are using grouped data and need to define a column for this field.

Note: The name of the last list is dependent on the value you chose in the **Measurement Name** text box on the **Select Data Format** screen. In [Example 1](#) and [Example 2](#), we accepted the default value *Failures*, so the last list is named *Failures*. In [Example 3](#), we entered the value *Cost*, so this list would be named *Cost*.

Provide Information for Downtime Screen

The **Provide Information for Downtime** screen allows you to selected the desired query or dataset columns that you want to map for downtime for failed equipment or locations. This screen appears in the **Reliability Growth Builder** only when you select the **Data contains dates** option on the [Data Format screen](#).

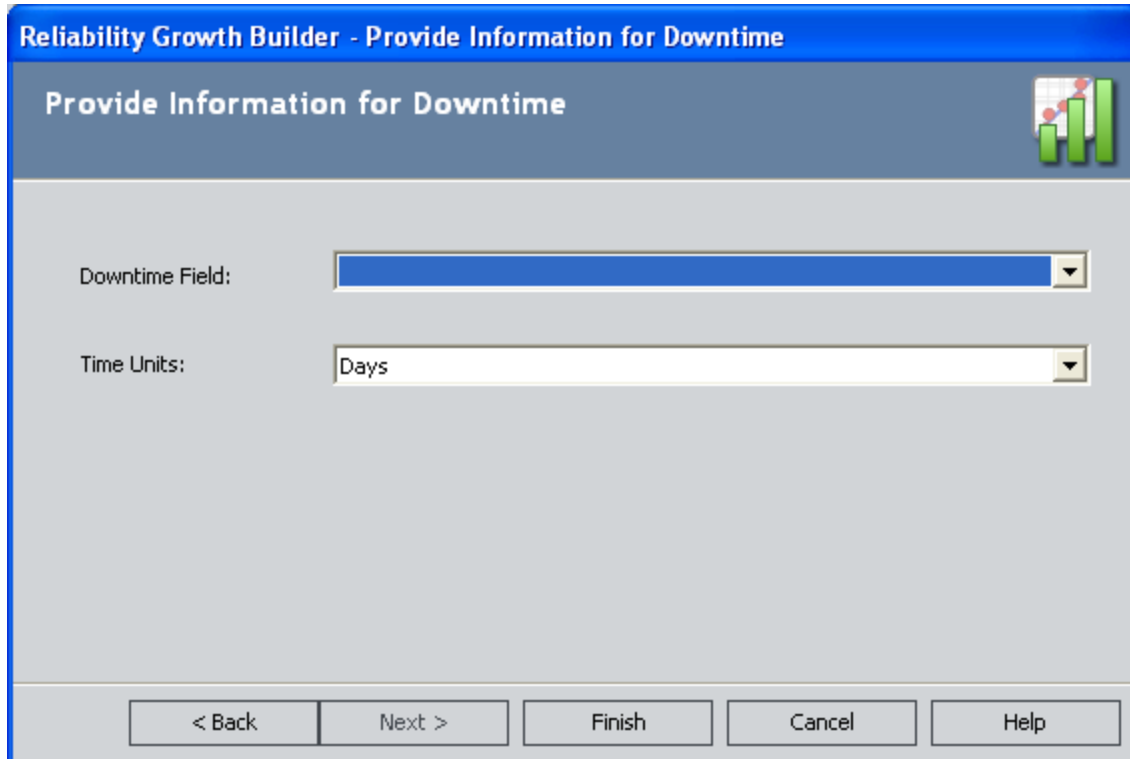

The screenshot shows a software window titled "Reliability Growth Builder - Provide Information for Downtime". The window has a blue header bar with the title and a sub-header "Provide Information for Downtime" on the left, and a small bar chart icon on the right. Below the header, there are two dropdown menus. The first is labeled "Downtime Field:" and is currently empty. The second is labeled "Time Units:" and is currently set to "Days". At the bottom of the window, there are five buttons: "< Back", "Next >", "Finish", "Cancel", and "Help".

Select a column from your query or dataset to map to the following fields on the **Provide Information for Downtime Screen**:

- **Downtime Field list:** Select the query or dataset column that contains downtime values for the failed equipment or locations (e.g., Total Time to Repair). This value is optional but must be numeric.
- **Time Units list:** Select the time units associated with the selected downtime (i.e., Hours, Weeks, Months, Quarters, or Years). The value *Days* is selected by default.

Analysis Start Time Screen

The **Analysis Start Time** screen allows you to specify the start time for the analysis. This screen appears only when you are creating a Reliability Growth Analysis that is based on cumulative operating time.

Reliability Growth Builder - Analysis Start Time

Analysis Start Time

Start Time

I want to use the time of the first data point as the start time for this analysis.

0 Days

< Back Next > Finish Cancel Help

On this screen:

- Select the **I want to use the time of the first data point as the start time for the analysis** check box if you want to treat the first failure datapoint as the start time for the analysis. If you choose this option, the cumulative time for all other rows will be calculated by subtracting this value.
- or-
- If you want to specify a different cumulative operating time as the start time for the analysis, clear the check box and type a value in the text box. The cumulative time of all rows will be calculated by subtracting this value from cumulative operating time. The units for this text box are populated automatically with the time units that you selected on the **Select Data Fields** screen.

The <Measurement> Data Grid

If you choose to enter failure data manually, at the end of the **Reliability Growth Builder**, the <Measurement> Data grid will appear, where you can enter data. The <Measurement> Data grid will look different depending on whether your analysis is using [failure dates](#) or [cumulative operating time](#). The following images show examples of the <Measurement> tab and **Assets** tab for an analysis based on failure dates.

Note: The name of the window is dependent on the value you chose in the **Measurement Name** text box on the **Select Data Format** screen. In [Example 1](#) and [Example 2](#), we accepted the default value *Failures*, so the window is named *Failures Data*. In [Example 3](#), we entered the value *Cost*, so the window is named *Cost Data*.

The <Measurement>tab:

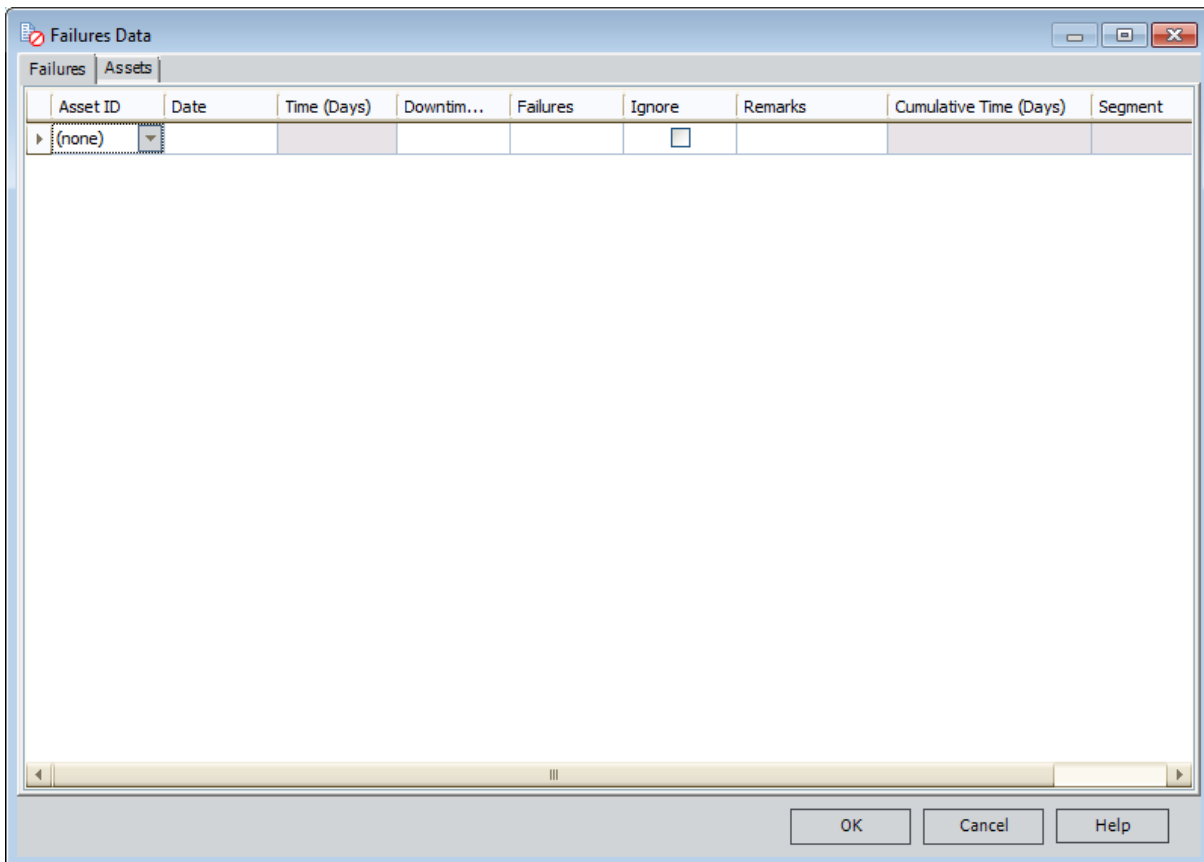

The **Assets** tab:

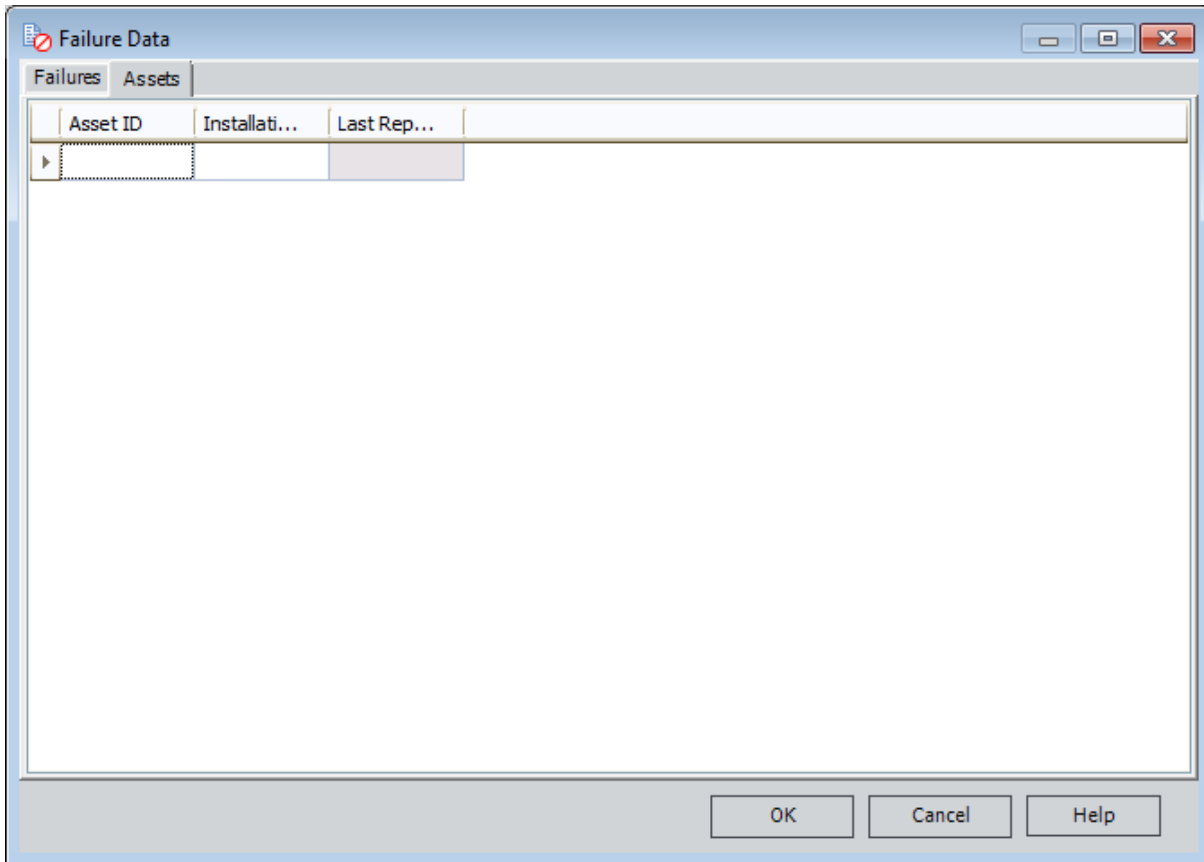

The <Measurement> Data grid allows you to enter the information about the equipment, locations, and failures that you want to include in the analysis. To enter data, you can manually type the data in the cells, or you can use the cut, copy, and paste functions to transfer data to the grid from other applications. A minimum of three failure data-points is required to perform a calculation.

Note: If you enter any downtime values that exceed the next failure date, the Meridium APM system will highlight the downtime values on the <Measurement> Data window. The cumulative time between failures will be calculated assuming that the downtime is not accurate and that the failure dates are accurate. When you close the <Measurement> Data window, an error message will appear. The same error message will also appear in the Analysis Information section.

Aspects of the Reliability Growth Analysis Page (Event-Based)

The Reliability Growth Analysis page is divided into two sections: **Analysis Information** and **Reliability Growth Model**. This page will look different depending on the type of data that you use for your analysis. The following image shows the **Reliability Growth Analysis** page for [Example 1](#), an analysis that is created from event-based data that is derived from failure dates:

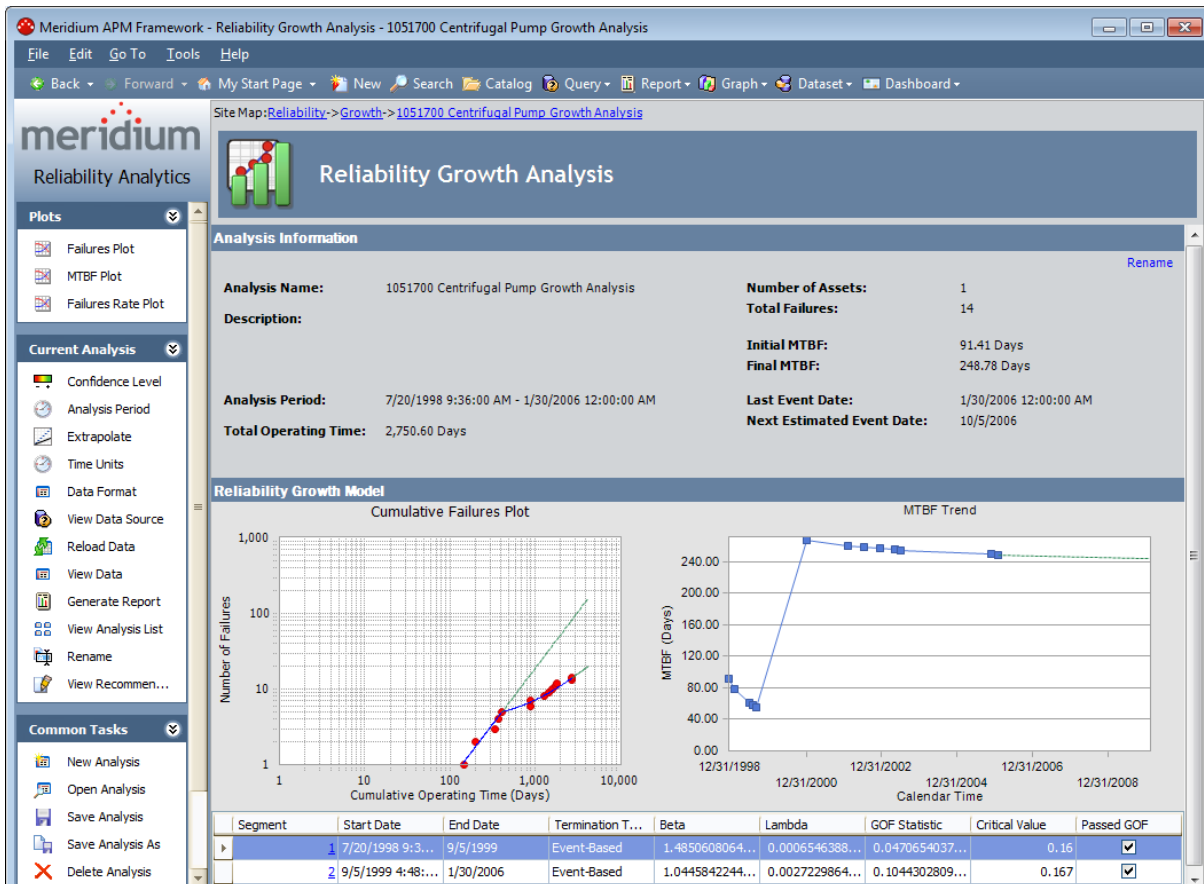

The **Analysis Information** section contains the following items:

- **Analysis Name:** The ID of the selected Reliability Growth Analysis. You can click the **Rename** link in this section or on the **Current Analysis** menu if you want to change either the name or the description of the analysis.
- **Description:** A description of the analysis, as defined when the analysis was saved. You can click the **Rename** link in this section or on the **Current Analysis** menu if you want to [change either the name or the description of the analysis](#).
- **Analysis Period:** The start and end dates of the analysis. If the analysis is based on [cumulative operating time](#), it will be the start and end times of the analysis (e.g., 11,000 miles - 303,000 miles).

- **Total Operating Time:** The total amount of cumulative time that the equipment or locations are in operation during the specified analysis period. For example, if you run one piece of equipment for 10 days, the total operating time is 10 days. If multiple pieces of equipment or locations are included in the analysis, their operating time will be added together. So two pieces of equipment running for 10 days would have a total operating time of 20 days.
- **Number of Assets:** The number of pieces of equipment or locations included in the analysis.
- **Total <Measurement>:** The total number of measurements (e.g., failures, cost) for all pieces of equipment and locations in the analysis. The caption of this item will change depending on the [measurement name](#).
- **Initial MTBF:** The Mean Time Between Failures at the beginning of the analysis. This item is displayed only for analyses using event-based data.
- **Final MTBF:** The Mean Time Between Failures at the end of the analysis. This item is displayed only for analyses using event-based data.
- **Last Event Date:** The last failure date in the analysis. This item appears only for an analysis using event-based data.
- **Next Estimated Event Date:** The next estimated failure date, calculated by the Meridium APM system. This item only appears for an analysis using on event-based data.
- **Rename:** A link that displays the **Rename Analysis** dialog box, where you can [rename the analysis](#).

The **Reliability Growth Model** section displays the following items:

- **Preview of the Cumulative Failures Plot:** A read-only view of the [Cumulative Failures Plot](#). You can click on the graph or click the **Failures Plot** link on the **Plots** menu to display the **Cumulative Failures Plot** page.
- **Preview of the MTBF Trend Plot:** A read-only view of the [MTBF Trend graph](#). You can click on the graph or click the **MTBF Plot** link on the **Plots** menu to display the **MTBF Plot** page. This plot is displayed only for analyses using event-based data.
- **Grid:** A grid containing detailed information for the segments that are included in the analysis. One row is displayed for each segment in the analysis. The grid displays the following columns of information:
 - **Segment:** Displays a hyperlinked segment number, which you can click to view the [details for the AMSAA model](#) on the **AMSAA Reliability Growth Model** page, which describes how the calculations were performed to generate the model and lists calculated analysis values.
 - **Start Date:** The start date for the segment. For the first segment, this is the same as the analysis start date. For subsequent segments, this is the end date of the previous segment.
 - **End Date:** The end date for the segment. For the last segment, this date is the same as the analysis end date. For multi-segment analyses, the end date of one segment is always the start date of the next segment.

Note: For a Reliability Growth Analysis based on cumulative operating time, the **Start Date** and **End Date** columns will be **Start Time <units>** and **End Time <units>**.

- **Termination Type:** A value that indicates whether the end date is event-based, time-based or grouped data. If you select the **Time-Based** option on the **Analysis Period** dialog box, the value in the **Termination Type** column will be *Time-Based*. Likewise, if you select the **Event-Based** option on the **Analysis Period** dialog box, the value in the **Termination Type** column will be *Event-Based*. If the analysis contains grouped data, the value in the **Termination Type** column will be *Grouped-Data*.

Note: If the **Cumulative Failures Plot** graph contains more than one segment, the termination type may vary between segments. If the analysis is *Event-Based*, all segments will be event-based. If the analysis is *Time-Based*, however, the last segment will be *Time-Based*, but the termination type for all other segments will be *Event-Based*.

- **Beta:** A value representing the slope of the line in the [Cumulative Failures Plot](#). The [Beta value](#) helps serve as an indicator of whether the MTBF is increasing, decreasing, or staying the same.
- **Lambda:** A scale parameter that equals the Y-intercept of the [Cumulative Failures Plot](#) at time $t= 1$.
- **GOF Statistic:** A value calculated by a Cramer-von Mises or Chi-squared test that [indicates the preciseness of the fit](#).
- **Critical Value:** A standard value used to determine whether the analysis [passes the goodness of fit \(GOF\) test](#).
- **Passed GOF:** A value that indicates [whether the segment passes the GOF test](#).
 - The analysis *passes* the GOF test (i.e., the **Passed GOF** check box is selected) when the GOF Statistic is lower than the Critical Value.
 - The analysis *fails* the GOF test (i.e., the **Passed GOF** check box is cleared) when the GOF Statistic is *higher* than the Critical Value.

Aspects of the Reliability Growth Analysis Page (Non-Event)

The Reliability Growth Analysis page is divided into two sections: Analysis Information and Reliability Growth Model. This page will look different depending on whether or not your analysis data is event-based and the [value you enter in the Measurement Name dialog box](#). The following image shows the Reliability Growth Analysis page for [Example 3](#), an analysis using grouped data that is not based on events, is derived from cumulative operating time, and has the measurement name *Cost*.

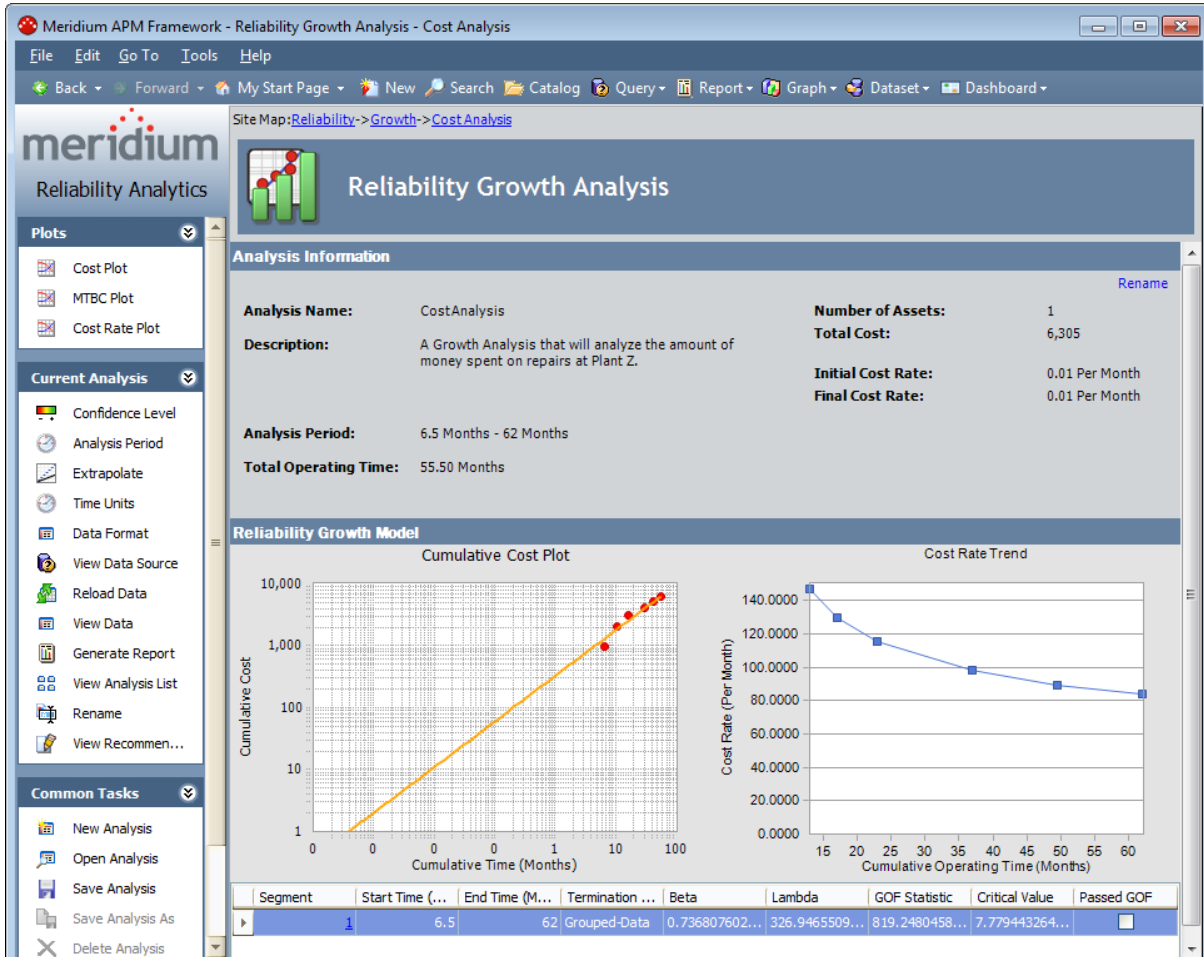

The Reliability Growth Analysis page for an analysis that is not event-based will appear mostly the same as the [Reliability Growth Analysis page for an event-based analysis](#), with the following exceptions.

The Analysis Information section contains the following items:

- **Initial Cost Rate:** The cost rate at the beginning of the analysis, per day. This item appears only for an analysis using non-event data.

- **Final Cost Rate:** The cost rate at the end of the analysis, per day. This item appears only for an analysis using non-event data.

The **Reliability Growth Model** section displays the following items:

- **Preview of the Cost Rate Trend Plot:** A read-only view of the **Cost Rate Trend** plot. You can click on the graph or click the **Cost Rate Plot** link on the **Plots** menu to display the actual **Cost Rate Plot** page. This plot is displayed only for analyses that are not using event-based data.

The following items are not displayed:

- **Initial MTBF**
- **Final MTBF**
- **Last Event Date**
- **Next Estimated Event Date**
- **Preview of the MTBF Trend Plot**

Plots Menu

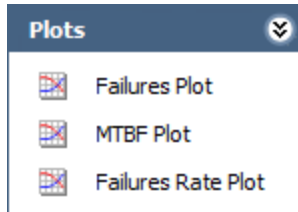

The **Plots** menu on the **Reliability Growth Analysis** page contains the following links:

- **<Measurement> Plot:** Displays the [Cumulative <Measurement> Plot graph](#), where <measurement> corresponds with the value specified in the **Measurement Name** text box on the **Data Format** dialog box for the analysis. In the above image, the link is labeled *Failures Plot*.
- **MTB<Measurement> Plot:** Displays the [MTB<Measurement> Trend graph](#), where <measurement> corresponds with the first letter of the value specified in the **Measurement Name** text box on the **Data Format** dialog box for the analysis. In the above image, the link is labeled *MTBF Plot*.
- **<Measurement> Rate Plot:** Displays the [<Measurement> Rate Trend graph](#), where <measurement> corresponds with the value specified in the **Measurement Name** text box on the **Data Format** dialog box for the analysis. In the above image, the link is labeled *Failures Rate Plot*.

Current Analysis Menu

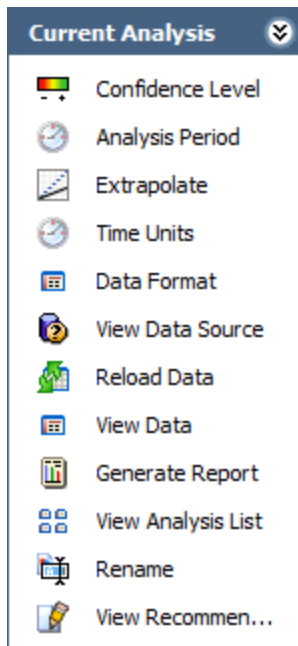

The **Current Analysis** menu on the **Reliability Growth Analysis** page contains the following links:

- **Confidence Level:** Displays the **Confidence Level** dialog box, which you can use to [specify the confidence level](#).
- **Analysis Period:** Displays the **Analysis Period** dialog box, where you can [modify the start date, start time, end date, and end time of the analysis period](#).
- **Extrapolate:** Displays the **Extrapolation** dialog box, where you can [specify how you want to estimate the number of measurements \(e.g., failures, cost\) that will have occurred by a future date or after a certain amount of time](#).
- **Time Units:** Displays the **Time Units** dialog box, where you can [specify the operating time](#). If the analysis is based on dates, you can also use this dialog box to specify downtime units.
- **Data Format:** Displays the **Data Format** dialog box, where you can [specify whether or not the analysis uses event-based data and the measurement name](#) that will be used throughout the analysis.
- **View Data Source:** Displays the data that serves as the source of the analysis. This link is displayed only if the analysis is based on a query or a dataset.
 - If the analysis is based on a query, this link will open the query results.
 - If the analysis is based on a dataset, this link will open the dataset.
- **Reload Data:** After asking for confirmation, [reloads the analysis data](#) that is stored in the database. This link is displayed only if the data source for the analysis is a query or dataset.

- **View Data:** Displays the [<Measurement> Data window](#), where <Measurement> corresponds with the value specified in the **Measurement Name** text box on the **Data Format** dialog box for the analysis, which you can use to view the analysis data.
- **Generate Report:** Displays the **Report Options** dialog box, where you can select the elements of the analysis that you want to include in a report.
- **View Analysis List:** Displays the [Select a Growth Analysis from the List page](#), which displays a list of the existing Reliability Growth Analyses.
- **Rename:** Displays the **Rename Analysis** dialog box, where you can [modify the name and description of the analysis](#). Changes to the name and description of an analysis are applied immediately, but are not saved until you save the analysis.
- **View Recommendations:** Displays the [Recommendations page](#), where you can view and manage the Recommendation records associated with the analysis.

Common Tasks Menu

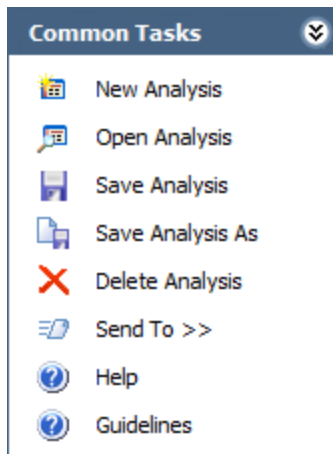

The **Common Tasks** menu on the **Reliability Growth Analysis** page contains the following links:

- **New Analysis:** Displays the **Reliability Growth Builder**, which guides you through the process of creating a new Reliability Growth Analysis.
- **Open Analysis:** Displays the **Find Reliability Growth Analysis** window, where you can search for an existing Reliability Growth Analysis to open on the **Reliability Growth Analysis** page.
- **Save Analysis:** Saves the analysis. If you are viewing an analysis that has not yet been saved, when you click this link, the **Save Analysis** dialog box appears, where you can [specify a name and description for the analysis](#). If you are viewing an existing analysis, when you click this link, the Meridium APM system will save any changes that you made to the analysis since it was last saved.
- **Save Analysis As:** Displays the **Save this Analysis** dialog box, where you can [save the analysis with a different name](#).
- **Delete Analysis:** After asking for confirmation, deletes the analysis.
- **Send To:** Displays a submenu with options that let you provide a link to the current page on your desktop (create shortcut), in an email message, or on a Home Page.
- **Help:** Displays the context-sensitive Help topic for the **Reliability Growth Analysis** page.
- **Guidelines:** Displays overview information about the Reliability Analytics module.

Specifying Time Units

Time units are used in Reliability Growth Analysis calculations and on the plots that display the results of the analysis. You will initially specify time units in the **New Analysis Builder** when you create the analysis, but you can later change them via the **Time Units** dialog box.

To change the time units for an analysis:

1. On the **Reliability Growth Analysis** page, on the **Current Analysis** menu, click the **Time Units** link.

The **Time Units** dialog box appears. If your analysis is based on dates, the **Time Units** dialog box will look like the following image.

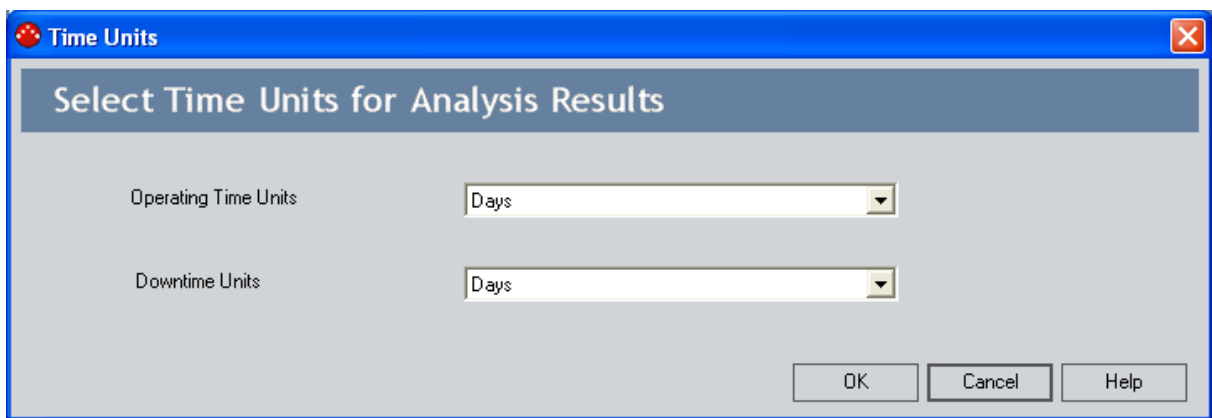

If your analysis is based on [cumulative operating time](#), the **Time Units** dialog box will look different.

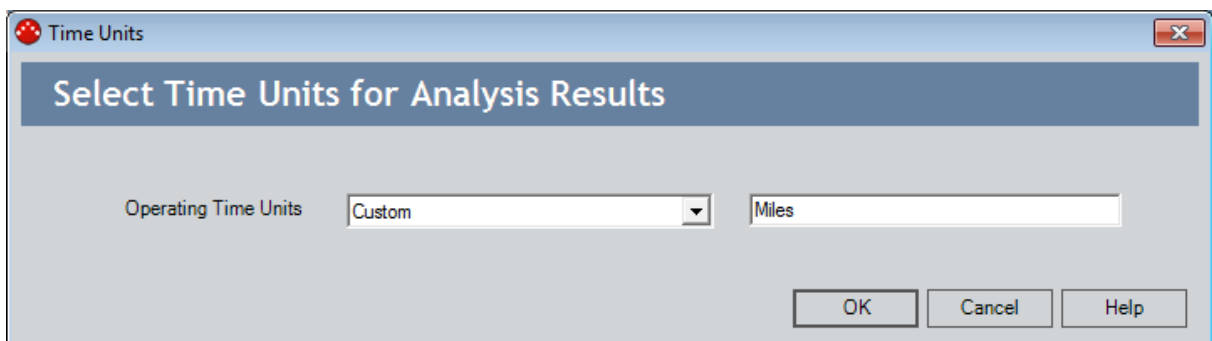

The **Time Units** dialog box for an analysis that based on cumulative operating time contains a **Custom** option in the **Operating Time Units** list. If you select the **Custom** option, in the second text box, type the value that represents the units that you want to use for the analysis. The units do not have to be time-based. In [Example 2](#), we used the custom time units of miles.

2. In the **Operating Time Units** list, select **Days**, **Years**, **Quarters**, **Months**, **Weeks**, or **Hours**.

3. In the **Downtime Units** list, select **Days, Years, Quarters, Months, Weeks,** or **Hours**. This list only appears for analyses that are based on dates.
4. Click **OK**.

The Meridium APM system recalculates the analysis automatically based on the new time units and displays the new units on the plot pages and the summary page.

Specifying the Analysis Period

When you create an analysis, by default, the start date is set to the earliest date in the failure data and the end date is set to the last failure date. You can adjust the analysis period to focus the analysis on a specific period of time. Note that failures that are outside the analysis period will be ignored in the analysis.

To specify the analysis period for a Reliability Growth Analysis:

1. On the [Reliability Growth Analysis page](#), on the **Current Analysis** menu, click the **Analysis Period** link.

The **Analysis Period** dialog box appears. The following images displays an example of the **Analysis Period** dialog box for an analysis that contains dates. If your analysis **does not contain dates**, the **Analysis Period** dialog box will look different.

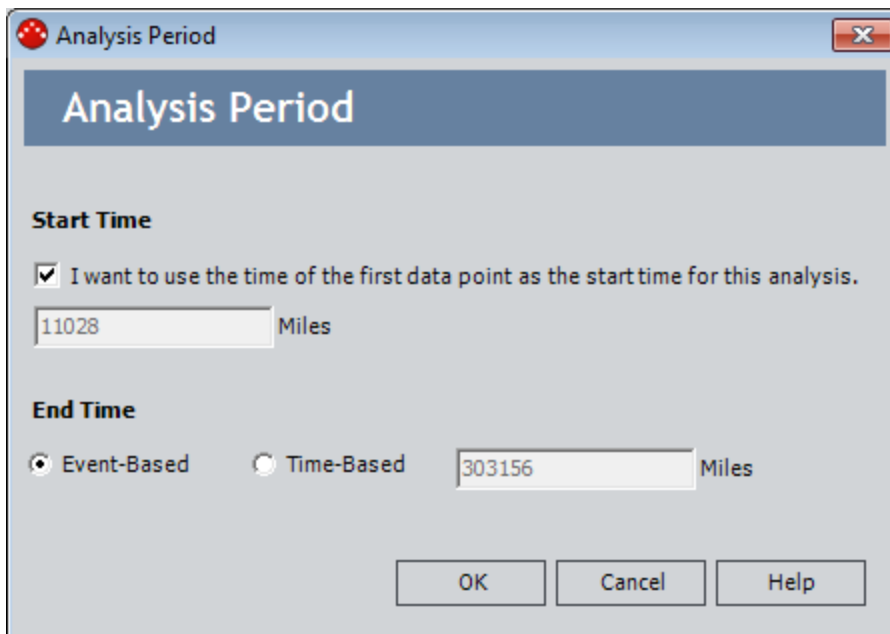

The screenshot shows a dialog box titled "Analysis Period" with a close button (X) in the top right corner. The dialog has a blue header bar with the title "Analysis Period". Below the header, there are two sections: "Start Time" and "End Time".

Start Time

I want to use the time of the first data point as the start time for this analysis.

Miles

End Time

Event-Based Time-Based Miles

At the bottom of the dialog, there are three buttons: "OK", "Cancel", and "Help".

Instead of a date field, the **Analysis Period** dialog box for an analysis that does not contain dates displays a text box in which you can enter a start or end time instead of a start or end date. In Example 2, the analysis date contains cumulative operating time with the units of miles, so you can enter the mileage at which the analysis will start and end.

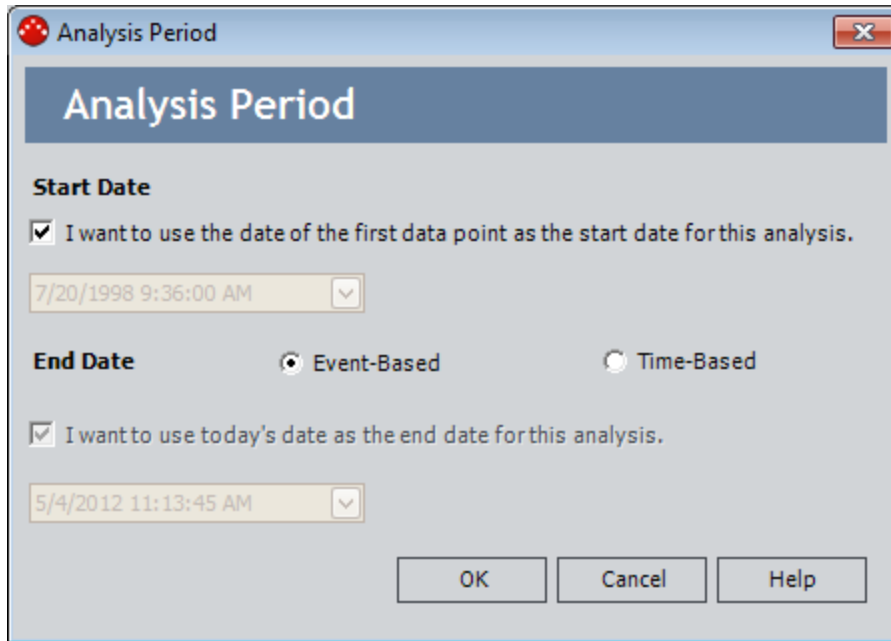

2. If you want the start date to be the first datapoint, select the **I want to use the first data point as the start date for this analysis** check box. When this check box is selected, the corresponding date field is disabled automatically and displays the date on which the first event occurred.

-or-

If you want the start date to be different than the first datapoint, clear the check box, and then type or select the desired date and time.

Note: To ensure that all failure dates appear on the plots, make sure the start date is *before* the date associated with of the first datapoint. Only failures that occur *after* the start date will appear on the plots.

3. If you want the end date to correspond with the last event (i.e., datapoint) in the analysis, select the **Event-Based** option. When this option is selected, the **I want to use today's date as the end date for the analysis** check box is selected and disabled automatically. The corresponding date field is also disabled automatically and displays the date on which the last event occurred.

-or-

If you want the end date to correspond with a certain time, select the **Time-Based** option. If you do not want today's date to be the end date, clear the **I want to use today's date as the end date for this analysis** check box, and then type or select the desired date and time.

Note: An Event-Based end time occurs when the last event and the end of the observation period (i.e., the end date) are the same. Note that if some time has accumulated since the last event, this time is not included in the reliability

model. If you want to include that time in the reliability model, you should select a Time-Based end time and enter the latest time in the observation period.

4. Click **OK**.

The Meridium APM system recalculates the analysis using the dates that you selected for the analysis period.

Note: If you have not included enough failures to calculate the results, a warning message will appear. A minimum of three failures must exist for each segment in the specified analysis period.

Specifying the Data Format for a Reliability Growth Analysis

When you create an analysis, you will choose whether or not your data is event-based and select the measurement name that will be used throughout the analysis via the **Select Data Format** screen in the **Reliability Growth Builder**. By default, the **Measurement Name** will be set to *Failures*.

Via the **Data Format** dialog box, you can change whether or not your measurement data is event-based, and you can change the value that corresponds with the type of data that is used in the analysis.

To specify the data format for a Reliability Growth Analysis:

1. On the [Reliability Growth Analysis page](#), on the **Current Analysis** menu, click the **Data Format** link.
2. The **Data Format** dialog box appears.

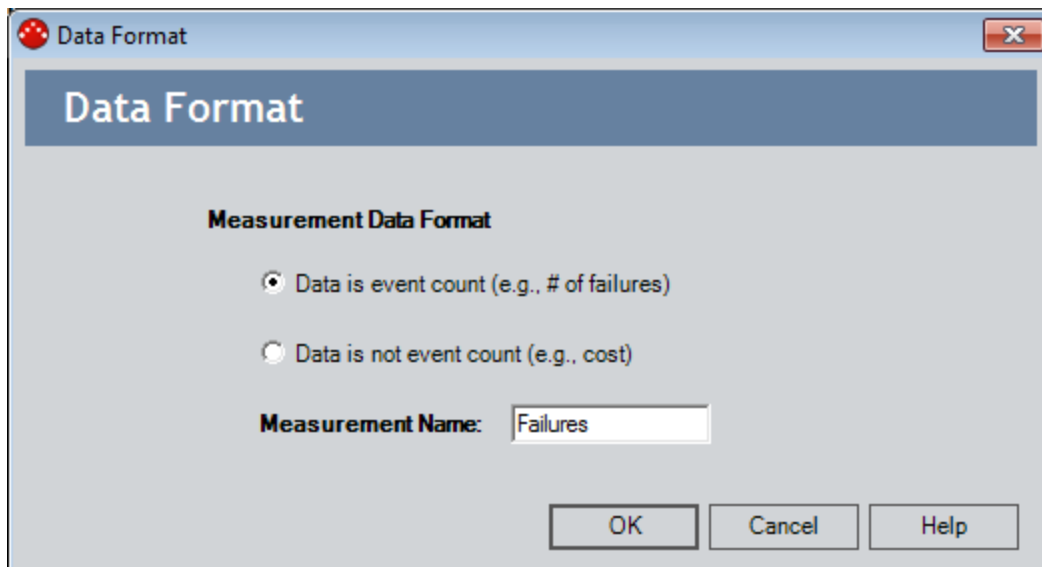

3. If desired, select a different data format from one of the following options:
 - **Data is event count:** The data you are measuring is based on events, such as failures, safety incidents, or equipment repairs.
 - **Data is not event count:** The data you are measuring is [not an event](#), but an amount, such as cost or hours.
4. In the **Measurement Name** text box, type a value that corresponds with the type of data used in the analysis (e.g., cost, events). By default, this text box contains the measurement value you entered on the **Select Data Format** screen in the **Reliability Growth Builder** when you created the analysis. If you modify this value, labels

throughout the analysis will change automatically (e.g., the name of the **<Measurement> Data** window).

5. Click **OK**.

The **Reliability Growth Analysis** page appears, displaying the Reliability Growth Analysis with updated data or measurement labels, as appropriate.

Accessing the AMSAA Detailed Results

To display the details of the AMSAA Growth model:

- On the [Reliability Growth Analysis page](#), in the grid in the **Reliability Growth Model** section, in the **Segment** column, click a hyperlinked segment number.

The AMSAA Reliability Growth Model page appears.

Meridium APM Framework - AMSAA Reliability Growth Model - 1051700 Centrifugal Pump Growth Analysis

File Edit Go To Tools Help

Back Forward My Start Page New Search Catalog Query Report Graph Dataset Dashboard

meridium
Reliability Analytics

Plots

- Failures Plot
- MTBF Plot
- Failures Rate Plot

Current Analysis

- Confidence Level
- Analysis Period
- Extrapolate
- Time Units
- Data Format
- View Data Source
- Reload Data
- View Data
- Generate Report
- View Analysis List
- Rename
- View Recommen...

Common Tasks

- New Analysis
- Open Analysis
- Save Analysis
- Save Analysis As

Site Map: Reliability -> Growth -> 1051700 Centrifugal Pump Growth Analysis -> Detailed Results

AMSAA Reliability Growth Model

The AMSAA Model assumes the following instantaneous failure rate equation:

$$\rho(t) = \lambda \beta (t - t_0)^{\beta - 1}$$

Based on this assumption, the expected number of failures is:

$$\theta(t) = \theta_0 + \lambda (t - t_0)^\beta$$

The instantaneous Mean Time Between Failures (MTBF) is represented by:

$$m(t) = \frac{1}{\lambda \beta (t - t_0)^{\beta - 1}}$$

Where,

t	Cumulative Operating Time
t_0	0.00
β	1.485061
λ	0.000655
θ_0	0

This model was calculated using Failures that occurred in the period between 7/20/1998 9:36:00 AM and 9/5/1999 4:48:00 AM. The total Failures is 5.

At 147.00 Days (first data point of the current segment), the MTBF is 91.41 Days .

At 411.80 Days (end of the current segment), the MTBF is 55.46 Days .

AMSAA Detailed Results (Event-Based)

The **AMSAA Reliability Growth Model** page displays the formulas and results of the Reliability Growth Analysis calculations. If the Reliability Growth Analysis has been split into multiple segments, a separate set of results will be displayed for each segment. The labels on the **AMSAA Reliability Growth Model** page will look different depending on whether or not the analysis contains event-based data. If the data is event-based, certain labels will also look different depending on whether or not the data contains dates.

The following image displays [Example 1](#), an analysis that uses event-based data containing failure dates.

The screenshot shows the Meridium APM Framework interface for the AMSAA Reliability Growth Model. The browser title is "Meridium APM Framework - AMSAA Reliability Growth Model - 1051700 Centrifugal Pump Growth Analysis". The site map indicates the path: Reliability -> Growth -> 1051700 Centrifugal Pump Growth Analysis -> Detailed Results.

The main content area displays the following information:

The AMSAA Model assumes the following instantaneous failure rate equation:

$$\rho(t) = \lambda\beta(t-t_0)^{\beta-1}$$

Based on this assumption, the expected number of failures is:

$$\theta(t) = \theta_0 + \lambda(t-t_0)^\beta$$

The instantaneous Mean Time Between Failures (MTBF) is represented by:

$$m(t) = \frac{1}{\lambda\beta(t-t_0)^{\beta-1}}$$

Where,

$t =$	Cumulative Operating Time
$t_0 =$	0.00
$\beta =$	1.485061
$\lambda =$	0.000655
$\theta_0 =$	0

This model was calculated using Failures that occurred in the period between 7/20/1998 9:36:00 AM and 9/5/1999 4:48:00 AM. The total Failures is 5.

At 147.00 Days (first data point of the current segment), the MTBF is 91.41 Days .

At 411.80 Days (end of the current segment), the MTBF is 55.46 Days .

The **AMSAA Reliability Growth Model** page displays the following information:

- **Beta (β):** A value representing the slope of the line in the [Cumulative Failures Plot](#). The [Beta value](#) helps serve as an indicator of whether the MTBF is increasing, decreasing, or staying the same.
- **Lambda (λ):** A scale parameter that equals the Y-intercept of the [Cumulative Failures Plot](#) at time $t = 1$. This value is used to calculate the time to next measurement (e.g., failure, cost).
- **Initial MTBF:** The mean time between failures that was calculated at the beginning of the analysis, or the beginning of the segment.

- **Final MTBF:** The mean time between failures that was calculated at the end of the analysis, or end of the segment.

Additionally, for analyses based upon event-based data that do not include dates, references to dates will be displayed as the [time units you chose for your analysis](#) (e.g., At 303,156.00 Miles, the MTBF is 20,757.81 Miles).

AMSAA Detailed Results (Non-Event)

The **AMSAA Reliability Growth Model** page displays the formulas and results of the Growth Analysis calculations. If the Reliability Growth Analysis has been split into multiple segments, a separate set of results will be displayed for each segment. If the analysis contains grouped data, the formulas used to calculate Beta (β) and Lambda (λ) are different than the formulas used for non-grouped data.

The following image shows the **AMSAA Reliability Growth Model** page for [Example 3](#), an analysis based upon grouped, non-event data.

The **AMSAA Reliability Growth Model** page for an analysis based upon non-event data will look mostly the same as the [AMSAA Reliability Growth Model page for an event-based analysis](#). Instead of showing the Initial MTBF and Final MTBF, however, the following items will be displayed:

- **Initial Cost Rate:** The cost rate, calculated from when the first datapoint is recorded for the segment.
- **Final Cost Rate:** The cost rate at the end of the segment.

Additionally, for an analysis that is based upon data that includes cumulative operating time and does not include dates, references to dates will be displayed as the [time units you chose for your analysis](#) (e.g., At 62 Months, the Cost Rate is 83.7040 Per Month).

About the Measurement Data Window

The [<Measurement> Data window](#) allows you to view the data associated with a Reliability Growth Analysis. Most of the fields on the **<Measurement> Data** window correspond to [values that were used to create the analysis](#). For input fields:

- For an analysis based upon a query, the **<Measurement> Data** window displays the information returned by the query.
- For an analysis based upon a dataset, the **<Measurement> Data** window displays the information stored in the dataset.
- For an analysis based upon manually-entered data, the **<Measurement> Data** window displays the information that you entered when you create the analysis.

Other fields show values that are calculated by the Meridium APM system and are read-only. All values in the **<Measurement> Data** window are stored in the [Failures field](#) in the Reliability Growth record.

[You can modify certain values on this window](#) in order to update data. In most cases, however, you would not want to change the data unless there was an error in the original data source. Some values are calculated by the Meridium APM system and cannot be modified.

The name of the **<Measurement> Data** window will vary, depending upon how the analysis has been configured. **<Measurement>** will be replaced with the value that you specified in the **Measurement Name** text box on the **Data Format** window. The following image shows an example where this window is labeled **Failures Data**.

About the Measurement Data Window

Failures Data

Failures | Assets

	Datasheet	Asset ID	Date	Time (Da...	Downtim...	Failures	Ignore	Remarks	Cumulati...	Segment
▶	view	000000000...	9/2/1992	0	0	1	<input checked="" type="checkbox"/>		0	
	view	000000000...	2/26/1995	0	0	1	<input checked="" type="checkbox"/>		0	
	view	000000000...	7/20/1998	0	0	1	<input type="checkbox"/>		0	
	view	000000000...	12/14/1998	147	0	1	<input type="checkbox"/>		147	
	view	000000000...	2/7/1999	202	0	1	<input type="checkbox"/>		202	
	view	000000000...	6/26/1999	341	0	1	<input type="checkbox"/>		341	
	view	000000000...	8/1/1999	376.7	0	1	<input type="checkbox"/>		376.7	
	view	000000000...	9/5/1999	411.8	0	1	<input type="checkbox"/>		411.8	
	view	000000000...	1/1/2001	895.8	0	1	<input type="checkbox"/>		895.8	
	view	000000000...	1/2/2001	896.6	0	1	<input type="checkbox"/>		896.6	
	view	000000000...	2/7/2002	1297.6	0	1	<input type="checkbox"/>		1297.6	
	view	000000000...	7/11/2002	1451.9	0	1	<input type="checkbox"/>		1451.9	
	view	000000000...	12/10/2002	1603.6	0	1	<input type="checkbox"/>		1603.6	
	view	000000000...	5/12/2003	1756.6	0	1	<input type="checkbox"/>		1756.6	
	view	000000000...	7/2/2003	1807.6	0	1	<input type="checkbox"/>		1807.6	
	view	000000000...	11/28/2005	2687.6	0	1	<input type="checkbox"/>		2687.6	
	view	000000000...	1/30/2006	2750.6	0	1	<input type="checkbox"/>		2750.6	
*	view	(none)					<input type="checkbox"/>			

OK Cancel Help

Data Mapped to the <Measurement> Grid

When you create a Reliability Growth Analysis from a query or dataset, the **Reliability Growth Builder** will prompt you to map values from columns in the query or dataset to certain values in the Reliability Growth Analysis. The values that you select to map on the **Select Data Fields** and **Provide Information For Downtime** screens in the **Reliability Growth Builder** will then appear in the associated columns in the <Measurement> Data window.

Note: If the analysis is based on a query or a dataset and contains additional columns that are not mapped to columns in the analysis dataset, those columns will appear in the <Measurement> Data window with the column name in parentheses.

The following chart displays which columns are mapped from fields in the **Reliability Growth Builder** to columns in the <Measurement> Data window:

Reliability Growth Builder Screen	Reliability Growth Builder Field	<Measurement> Data Window Tab	<Measurement> Data Window Column
Select Data Fields	Asset ID	<Measurement>	Asset ID
Select Data Fields	Date	<Measurement>	Date
Select Data Fields	Cumulative Operating Time	<Measurement>	COT (units)
Provide Information for Downtime	Downtime Field	<Measurement>	Downtime

Data Mapped to the <Measurement> Grid

Reliability Growth Builder Screen	Reliability Growth Builder Field	<Measurement> Data Window Tab	<Measurement> Data Window Column
Select Data Fields	<Measurement>	<Measurement>	<Measurement>
Select Data Fields	Installation Date	Assets	Installation Date

Accessing the Measurement Data Window

To access the measurement data for a Reliability Growth Analysis:

- On the [Reliability Growth Analysis page](#), on the **Current Analysis** menu, click the **View Data** link.

The **<Measurement> Data** window appears, where **<Measurement>** is the value specified in the **Measurement Name** text box on the **Data Format** window for the analysis. The following image shows an example where this window is labeled **Failures Data**.

Datasheet	Asset ID	Date	Time (Da...	Downtim...	Failures	Ignore	Remarks	Cumulati...	Segment
view	000000000...	9/2/1992	0	0	1	<input checked="" type="checkbox"/>		0	
view	000000000...	2/26/1995	0	0	1	<input checked="" type="checkbox"/>		0	
view	000000000...	7/20/1998	0	0	1	<input type="checkbox"/>		0	
view	000000000...	12/14/1998	147	0	1	<input type="checkbox"/>		147	
view	000000000...	2/7/1999	202	0	1	<input type="checkbox"/>		202	
view	000000000...	6/26/1999	341	0	1	<input type="checkbox"/>		341	
view	000000000...	8/1/1999	376.7	0	1	<input type="checkbox"/>		376.7	
view	000000000...	9/5/1999	411.8	0	1	<input type="checkbox"/>		411.8	
view	000000000...	1/1/2001	895.8	0	1	<input type="checkbox"/>		895.8	
view	000000000...	1/2/2001	896.6	0	1	<input type="checkbox"/>		896.6	
view	000000000...	2/7/2002	1297.6	0	1	<input type="checkbox"/>		1297.6	
view	000000000...	7/11/2002	1451.9	0	1	<input type="checkbox"/>		1451.9	
view	000000000...	12/10/2002	1603.6	0	1	<input type="checkbox"/>		1603.6	
view	000000000...	5/12/2003	1756.6	0	1	<input type="checkbox"/>		1756.6	
view	000000000...	7/2/2003	1807.6	0	1	<input type="checkbox"/>		1807.6	
view	000000000...	11/28/2005	2687.6	0	1	<input type="checkbox"/>		2687.6	
view	000000000...	1/30/2006	2750.6	0	1	<input type="checkbox"/>		2750.6	
* view	(none)					<input type="checkbox"/>			

The **<Measurement> Data** window contains two tabs: **<Measurement>** and **Assets**. The **<Measurement> tab** provides information about the event data. The **Assets tab** provides information about the equipment or locations that are included in the analysis.

Failure Data Using Failure Dates

The following image displays data for [Example 1](#), an analysis using data that is event-based and contains failure dates.

Datasheet	Asset ID	Date	Time (Da...	Downtim...	Failures	Ignore	Remarks	Cumulati...	Segment
view	000000000...	9/2/1992	0	0	1	<input checked="" type="checkbox"/>		0	
view	000000000...	2/26/1995	0	0	1	<input checked="" type="checkbox"/>		0	
view	000000000...	7/20/1998	0	0	1	<input type="checkbox"/>		0	
view	000000000...	12/14/1998	147	0	1	<input type="checkbox"/>		147	
view	000000000...	2/7/1999	202	0	1	<input type="checkbox"/>		202	
view	000000000...	6/26/1999	341	0	1	<input type="checkbox"/>		341	
view	000000000...	8/1/1999	376.7	0	1	<input type="checkbox"/>		376.7	
view	000000000...	9/5/1999	411.8	0	1	<input type="checkbox"/>		411.8	
view	000000000...	1/1/2001	895.8	0	1	<input type="checkbox"/>		895.8	
view	000000000...	1/2/2001	896.6	0	1	<input type="checkbox"/>		896.6	
view	000000000...	2/7/2002	1297.6	0	1	<input type="checkbox"/>		1297.6	
view	000000000...	7/11/2002	1451.9	0	1	<input type="checkbox"/>		1451.9	
view	000000000...	12/10/2002	1603.6	0	1	<input type="checkbox"/>		1603.6	
view	000000000...	5/12/2003	1756.6	0	1	<input type="checkbox"/>		1756.6	
view	000000000...	7/2/2003	1807.6	0	1	<input type="checkbox"/>		1807.6	
view	000000000...	11/28/2005	2687.6	0	1	<input type="checkbox"/>		2687.6	
view	000000000...	1/30/2006	2750.6	0	1	<input type="checkbox"/>		2750.6	
* view	(none)					<input type="checkbox"/>			

The following columns of information are displayed in the grid on the **Failures Data** window:

- **Datasheet:** The text *view*, which appears as a hyperlink that displays the datasheet associated with the event (e.g., a Work History record). This column only appears when a query is the data source for the analysis.
- **Asset ID:** The ID of the piece of equipment or location that failed. This value is mapped from a query or dataset or manually entered when you create the analysis.
- **Date:** The date on which the failure occurred. This value is mapped from a query or dataset or manually entered when you create the analysis and is required. If you delete a value in the **Date** column for an event-based analysis that is based on dates, when you click **OK**, an error message will appear.
- **Time <units>:** The Time to Failure, which is the amount of time between the date the piece of equipment or location was put into service until the date that it failed.

If the data includes an installation date for the piece of equipment or location, this value is calculated from the installation date. If the data does not include an installation date, this value is calculated from the first failure. **<Units>** corresponds with the value selected in the **Operating Time Units** list on the **Time Units** dialog box for the analysis. Values in this column are calculated by the Meridium APM system and are read-only.

The pump in Example 1 was placed into service on July 20, 1998. In the above image, the value in the **Time** column for each subsequent failure date is the number of days that have passed since the installation date (July 20, 1998). The first failure was on December 14, 1998, 147 days after the pump was placed into service, so the Time value for that failure is 147.

- **Downtime <units>**: The amount of time that passed from the time the piece of equipment or location failed until it was returned to service. This information helps determine the total operating time of a piece of equipment or location. **<Units>** corresponds with the value selected in the **Downtime Units** list on the **Time Units** dialog box for the analysis. In Example 1, the pump was returned to service immediately, and no downtime occurred. This value is mapped from a query or dataset or manually entered when you create the analysis.
- **Failures**: The number of failures represented by each datapoint. Cells in this column will contain the value 1 (one) by default, which indicates that the analysis data is not grouped, and one datapoint represents one failure. A value that is not equal to 1 (one) indicates that the analysis data is grouped, and each datapoint represents more than one failure or an amount of data. This value can optionally be mapped from a query or dataset or manually entered when you create the analysis.

Note: The name of this column depends on the [measurement name](#) you are using for your analysis.

- **Ignore check box**: A value that indicates whether or not the data on the selected row is *ignored*, meaning excluded from the analysis calculations and plots. When *selected*, the data in the associated row will be excluded from the analysis. When *cleared*, data in the selected row will be included in the analysis. You can modify this value manually.
- **Remarks**: Comments about the failure. You can enter a value in this column manually.
- **Cumulative Time**: The Cumulative Time to Failure, which is the total runtime for a population of equipment or locations at the moment that a failure occurs in one of them. Values in this column are calculated by the Meridium APM system and are read-only.

Note: If your analysis includes multiple pieces of equipment or locations, the Cumulative Time will be the sum of the runtime for all pieces of equipment or locations. For example, if at the time of failure *Pump 1* has run for 30 days and *Pump 2* has run for 30 days, the Cumulative Time would be 60 days.

- **Segment:** The segment to which the data belongs. In Example 1, the analysis has been [split into two segments](#) to point out a change in the data trend. Values displayed in this column are read-only.

Failure Data Using COT

The **Failures** tab on the **Failures Data** window for an event-based analysis containing cumulative operating time looks mostly the same as the [Failures tab for an event-based analysis derived from failure dates](#), with a few exceptions. The following image displays data for [Example 2](#), an analysis using data that is event-based and derived from cumulative operating time.

Asset ID	Date	COT (Miles)	Failures	Ignore	Remarks	Cumulative Time (Miles)	Segment
Haul Tru...		11028	1	<input type="checkbox"/>		0	1
Haul Truck ...		27393	1	<input type="checkbox"/>		16365	1
Haul Truck ...		41675	1	<input type="checkbox"/>		30647	1
Haul Truck ...		60400	1	<input type="checkbox"/>		49372	1
Haul Truck ...		66128	1	<input type="checkbox"/>		55100	1
Haul Truck ...		72132	1	<input type="checkbox"/>		61104	1
Haul Truck ...		77314	1	<input type="checkbox"/>		66286	1
Haul Truck ...		113888	1	<input type="checkbox"/>		102860	1
Haul Truck ...		146671	1	<input type="checkbox"/>		135643	1
Haul Truck ...		163669	1	<input type="checkbox"/>		152641	1
Haul Truck ...		165105	1	<input type="checkbox"/>		154077	1
Haul Truck ...		205424	1	<input type="checkbox"/>		194396	1
Haul Truck ...		224634	1	<input type="checkbox"/>		213606	1
Haul Truck ...		243841	1	<input type="checkbox"/>		232813	1
Haul Truck ...		260828	1	<input type="checkbox"/>		249800	1
Haul Truck ...		279951	1	<input type="checkbox"/>		268923	1
Haul Truck ...		303156	1	<input type="checkbox"/>		292128	1
* (none)				<input type="checkbox"/>			

The following columns of information behave differently for an analysis based on cumulative operating time:

- **Date:** The date on which the failure occurred. This value is optional, but in order for dates to be displayed throughout the analysis, ALL failures must have a failure date. If one or more failure dates are missing, then no dates will be shown in the analysis; only cumulative operating time will be shown. For instance, in [Example 2](#), the data does not include dates on which the haul truck broke down, so the analysis results will be able to predict the next failure in cumulative operating times only (e.g., the next failure will occur at 324,001 miles).

- **COT <units>**: The Cumulative Operating Time, which is the total amount of time that has passed since the piece of equipment or location was placed into service. <Units> corresponds with the value selected in the **Operating Time Units** list on the **Time Units** dialog box for the analysis. This column is sorted in ascending order by default. This value is mapped from a query or dataset or manually entered when you create the analysis, and is required.

Note: For analyses based on cumulative operating time, if the values in the **Failure Date** column are not in the same order as the values in the **COT (units)** column (e.g., if the Failure Date 1/1/2012 has a COT of 1000 and the Failure date 1/2/2012 has a COT of 990), when you click **OK**, a message will appear, stating that sorting cumulative operating time values from smallest to largest will result in failure dates that are not in order from earliest to latest. As a result, no dates will be shown in the analysis results; only cumulative operating time will be shown.

- **Downtime <units>**: This column is not displayed for an analysis based on cumulative operating time.
- **Cumulative Time <units>**: The Cumulative Time to Failure, which is the total runtime for a population of equipment and locations at the moment that a failure occurs in one of them. Values in this column are calculated by the Meridium APM system and are read-only.

Note: The Cumulative Time is the total runtime for a piece of equipment or location after the analysis has started. This may be different from the COT, which is the total runtime of the piece of equipment or location since it was created. In our example, the haul truck has a mileage of 11,028 before the analysis starts, and fails at a mileage of 27,393. The COT is the total mileage on the truck, 27,293. The Cumulative Time is the mileage the truck has run since the analysis started (27,393-11,028=16,365). If the piece of equipment or location is brand new (i.e., the truck has a mileage of 0), the Cumulative Time and the COT will be the same.

Cost Data

The **Cost** tab on the **Cost Data** window displays a grid containing information about costs associated with equipment and locations in the analysis. The grid appears mostly the same as the [Failures tab for an event-based analysis derived from cumulative operating time](#), with a few exceptions. The following image displays data for [Example 3](#), an analysis using grouped data that is not event-based and derived from cumulative operating time.

Asset ID	Date	COT (Mo...)	Cost	Ignore	Remarks	Cumulati...	Segment
		6.5	1120	<input type="checkbox"/>		0	1
		13	996	<input type="checkbox"/>		6.5	1
		17	1052	<input type="checkbox"/>		10.5	1
		23	1085	<input type="checkbox"/>		16.5	1
		37	1075	<input type="checkbox"/>		30.5	2
		49.5	1096	<input type="checkbox"/>		43	2
		62	1001	<input type="checkbox"/>		55.5	2
(none)				<input type="checkbox"/>			

The following column of information behaves differently for an analysis that is not based on events and uses grouped data:

- **Cost:** The cost measured at each datapoint. For grouped data, values in this column represent the amount of data (e.g., cost) recorded between that datapoint and the previous datapoint. For non-grouped data, which is used in Examples 1 and 2, the values in this field are always 1 (one). For grouped data, the values can be greater than or less than 1 (one) but must be greater than 0 (zero). This value is mapped from a query or dataset or manually entered when you create the analysis.

Note: The name of this column depends on the [measurement name](#) you are using for your analysis.

Assets Tab

The **Assets** tab of the <Measurement> **Data** window displays a grid containing information about each piece of equipment or location that is related to a measurement. In the following example, the Reliability Growth Analysis was performed for one piece of equipment only, so only one piece of equipment appears on the **Assets** tab.

Datasheet	Asset ID	Installation Date	Last Replacement
view	000000000001051700		1/30/2006 12:00:00 AM
* view			

The following columns of information are displayed in the grid on the **Assets** tab:

- **Datasheet:** The text *view*, which appears as a hyperlink that displays the datasheet associated with the piece of equipment or location. This link is displayed only when a query is the data source for the analysis.
- **Asset ID:** The Record ID of the piece of equipment or location that is being analyzed. This value is mapped from a query or dataset or manually entered when you create the analysis.
- **Installation Date:** The date on which the piece of equipment or location was installed. This column appears only for analyses based on failure dates. This value is mapped from a query or dataset or manually entered when you create the analysis.
- **Last Replacement:** The last date or time at which the piece of equipment or

location failed. Values in this column are calculated by the Meridium APM system and are read-only. For data that contains cumulative operating time, this column is **Last Replacement <Measurement>**.

What are the Results of a Reliability Growth Analysis?

Reliability Growth Analysis results are made up of a multiple parts that together demonstrate an overall picture of your data. You can view the results in graphical form, use calculated values to interpret the results, and perform additional tasks to help you determine the trends in your data and whether they are getting better or worse.

Viewing the Data Trends

The following list gives a brief description of the graphs that display the data:

- [Cumulative <Measurement> Plot graph](#): Displays the number of measurements recorded for the piece of equipment or location as a function of time. Since the log (cumulative measurement) versus the log (cumulative time) is linear, the plot line is a straight line. You can use this plot to see how your data is trending over time.
- [Mean Time Between <Measurement> Trend graph](#): Reflects how frequently measurements are being record for pieces of equipment or locations (e.g., failures, cost) as a function of time (cumulative operating time). If the trend in this plot is:
 - *Increasing*, measurements are being recorded less often (e.g., if a measurement is taken every time the piece of equipment or location fails, the piece of equipment or location is failing less often). This indicates that the pieceof equipment or location is becoming *more reliable*.
 - *Decreasing*, measurements are being recorded more frequently (e.g., if a measurement is taken every time the piece of equipment or location fails, the piece of equipment or location is failing more often). This indicates that the piece of equipment or location is becoming *less reliable*.
- [<Measurement> Rate Trend graph](#): Reflects the rate of your measurements (e.g., failures, cost). This plot can tell you a measurement per time unit, so that you can see per day or per month when measurements increase or decrease.

Interpreting the Data Trends

The following list gives a brief description of the values calculated by the Meridium APM system that you can use to interpret trends within your data:

- [Goodness of Fit](#): Helps you determine if the measurements are following a pattern or occurring at random.
- **Confidence**: Indicates the percentage of uncertainty of the Goodness of Fit method. The [confidence level you select for your data](#) helps determine whether or not the data will pass the Goodness of Fit test.
- **The Beta Value**: Helps you [interpret the MTB<Measurement> Trend plot](#). This value is displayed on the [Reliability Growth Analysis page](#).

What are the Results of a Reliability Growth Analysis?

- **Next Estimated Event Date:** Provides an estimate of the amount of time you can expect to pass before the next event will occur for the piece of equipment or location. The value is calculated using the last datapoint and the MTBF or measurement rate. The approximate date (or time) when the next event will occur is displayed on the [Reliability Growth Analysis page](#).
- **Initial and Final MTBF or Initial or Final <Measurement> Rate:** Helps you compare how the piece of equipment or location is behaving at the beginning of the analysis versus the end of the analysis. Using these values, you can determine if the piece of equipment's or location's measurement rate has improved or gotten worse over the analysis period. These values are displayed on the [Reliability Growth Analysis page](#).

Additionally, you can view the **AMSAA Reliability Growth Model** page for an overview of the formulas used by the Meridium APM system to calculate the model results.

Using Tools to Enhance Results

The following tools can further assist you in interpreting and applying analysis results:

- **Splitting an analysis:** Allows you to [divide an analysis](#) into multiple parts so that you can see multiple trends in the data (e.g., data before and after a strategy change).
- **Extrapolation:** Allows you to estimate the number of measurements (e.g., failures, amount of cost) that will have occurred by some point in the future.

Based on the analysis results, you can generate recommendations for the maintenance and reliability activities that should be executed in the future to maintain best practices in your organization.

Accessing the Cumulative <Measurement> Plot Page

To access the Cumulative <Measurement> Plot Page:

1. [Access the Reliability Growth Analysis page.](#)
2. On the **Plots** menu, click the <Measurement> Plot link.

-or-

In the **Reliability Growth Model** section, click the preview of the **Cumulative <Measurement> Plotgraph.**

The **Cumulative <Measurement> Plot** page appears, displaying the **Cumulative <Measurement> Plotgraph.** The following image displays the **Cumulative <Measurement> Plotpage** for Example 1.

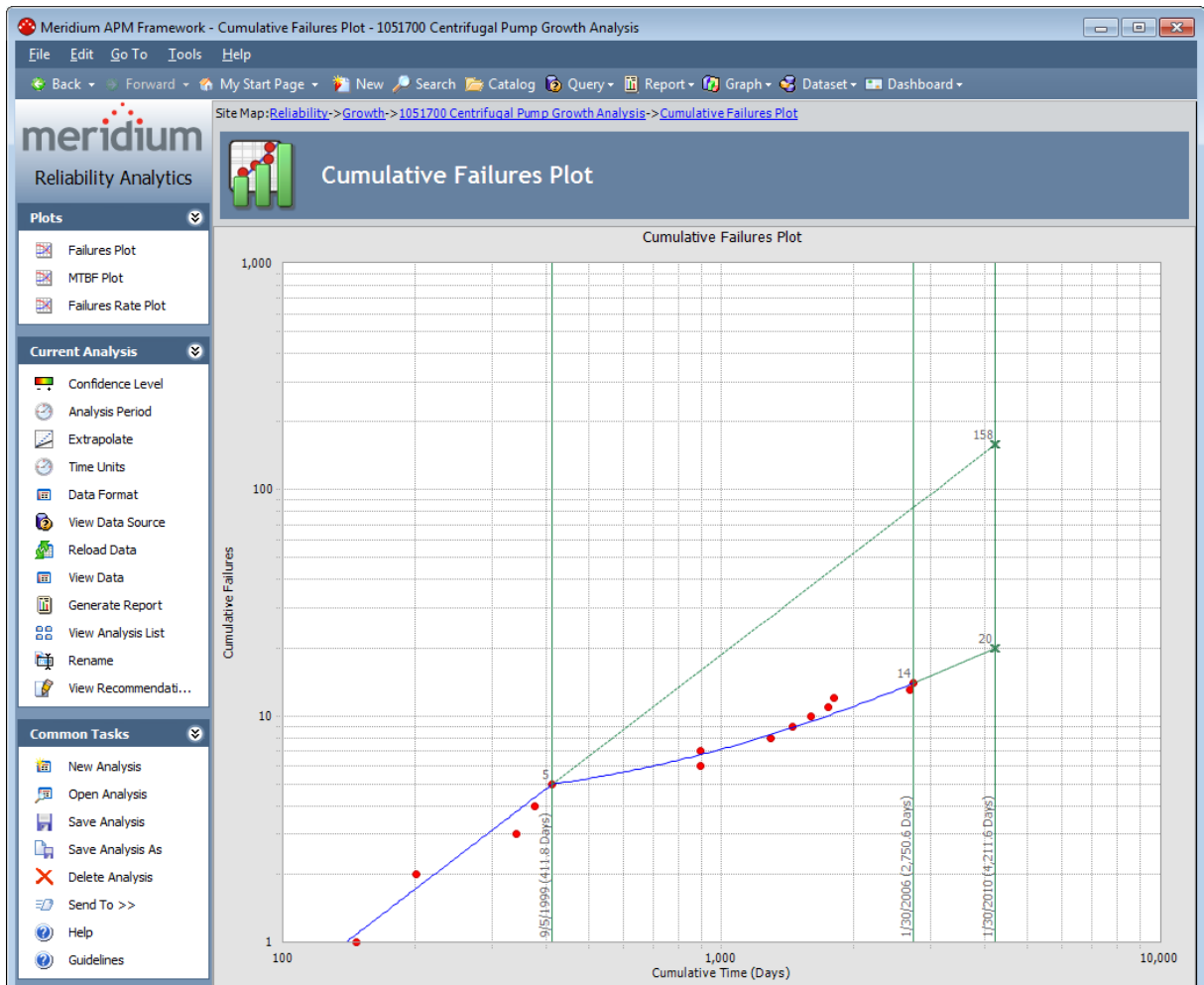

Cumulative Failure Plot Using Failure Dates

The **Cumulative Failures Plot** page contains a graph with a log-log plot with data overlay, which means it uses logarithmic scales on both the horizontal and vertical axes. The graph represents the cumulative failures as a function of the cumulative time (Cumulative Failures vs. Cumulative Operating Time), which is the total amount of time the piece of equipment or location has been in operation since the start of the analysis.

The following image shows the **Cumulative Failures Plot** graph for [Example 1](#).

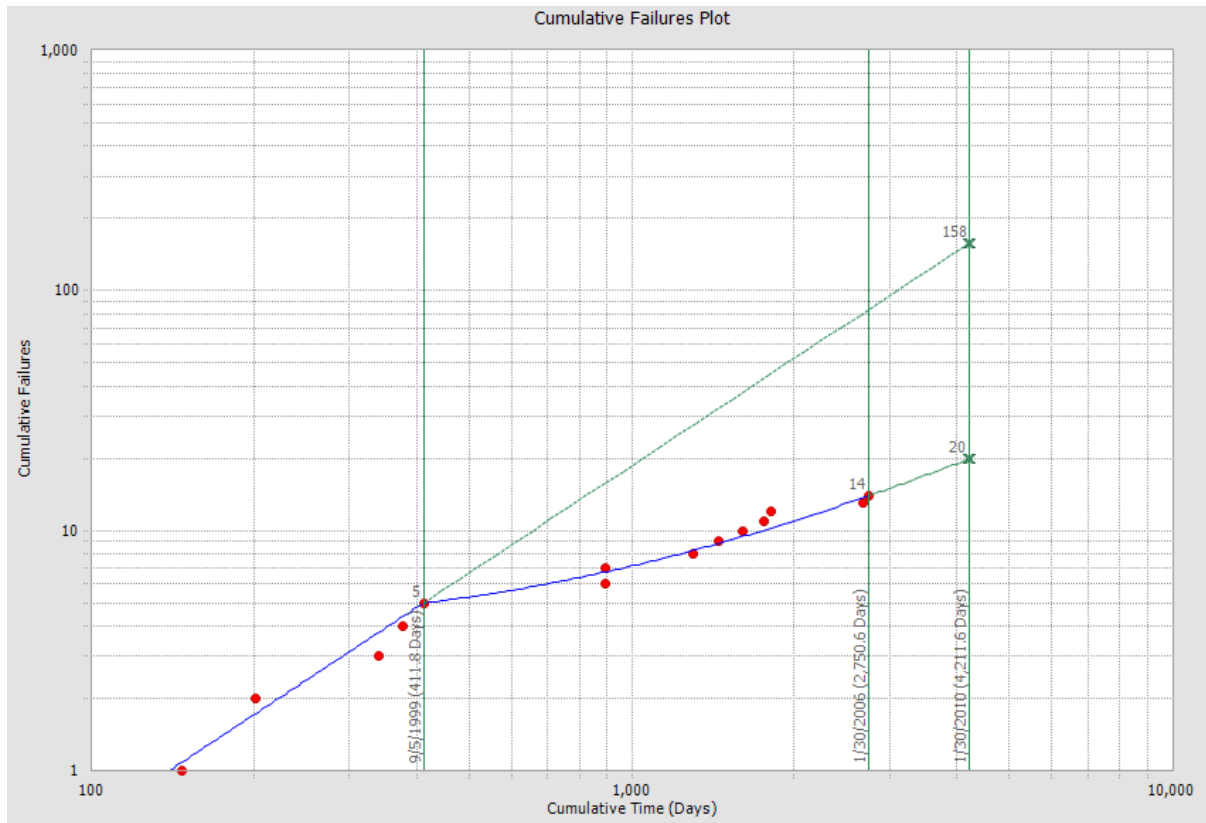

On the **Cumulative Failures Plot** graph, the x-axis shows the cumulative operating time, and the y-axis shows the total number of failures. For a single piece of equipment or location operating continuously, cumulative operating time is simply the total amount of time the piece of equipment or location has been in operation. For a group of equipment or locations, the cumulative operating time is the total amount of operating time multiplied by the number of pieces of equipment or locations. For example, ten pieces of equipment operating for a time period of one year results in ten years of cumulative operating time. The units for the x-axis can be changed.

While viewing the graph, you can:

- Click the plot line to display the [AMSAA Reliability Growth Model page](#).
- Click any datapoint to view the failure data.

Cumulative Failure Plot Using Failure Dates

- Determine whether the analysis passed the GOF test by the color of the plot line. If the plot line is blue, it passed the GOF test. If the plot line is orange, it failed the GOF test.
- [Split the analysis into segments.](#)
- [Estimate how many failures will have occurred at some date in the future.](#)

Cumulative Failure Plot Using COT

The **Cumulative Failures Plot** page for an analysis containing cumulative operating time contains a graph that is a log-log plot with data overlay, which means it uses logarithmic scales on both the horizontal and vertical axes. It is used in the same way as the **Cumulative Failures Plot** containing failure dates, except that the x-axis is measured in cumulative operating time instead of dates.

The following image shows the **Cumulative Failures Plot** graph for [Example 2](#).

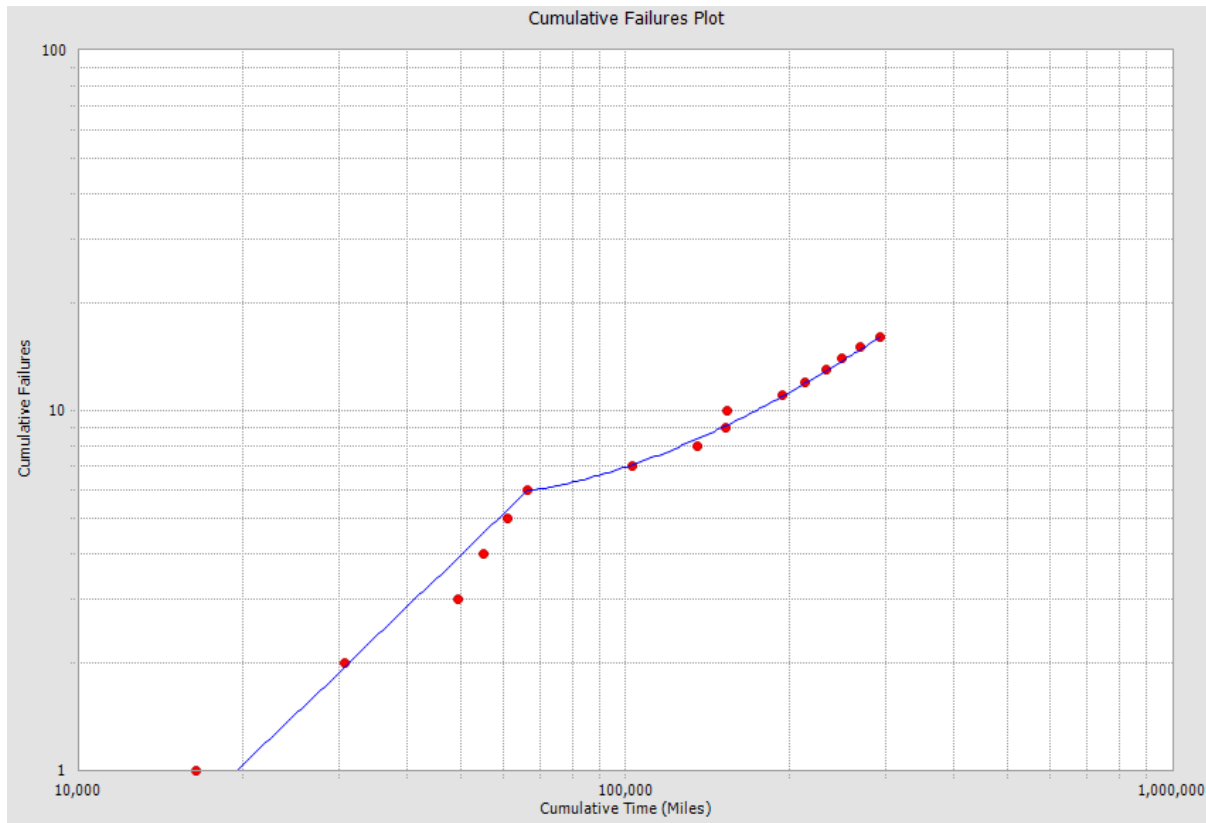

On the **Cumulative Failures Plot** graph, the x-axis shows cumulative time to failure, and the y-axis shows the total number of failures. The cumulative time to failure represents the total amount of time that a piece of equipment or location had been in operation when a failure occurred.

The same options are available while viewing the **Cumulative Failures Plot** page for an analysis based on cumulative operating time as for an [analysis based on failure dates](#). Instead of displaying the number of failures over calendar time, however, the plot displays the number of failures over the [time units you specified for your analysis](#). In Example 2, we used the custom units of *miles*, so failures are displayed at the mileage point they occurred instead of the date they occurred.

Cumulative Cost Plot

The **Cumulative Cost Plot** page contains a graph with a log-log plot with data overlay, which means it uses logarithmic scales on both the horizontal and vertical axes. When the cost data is based on cumulative operating time, the graph represents the cumulative cost as a function of the cumulative time. In Example 3, the **Cumulative Cost Plot** displays how much money is spent to repair a piece of equipment or location over time.

The following image shows an example of the **Cumulative Cost Plot** graph for [Example 3](#), which contains grouped data that is not based on events.

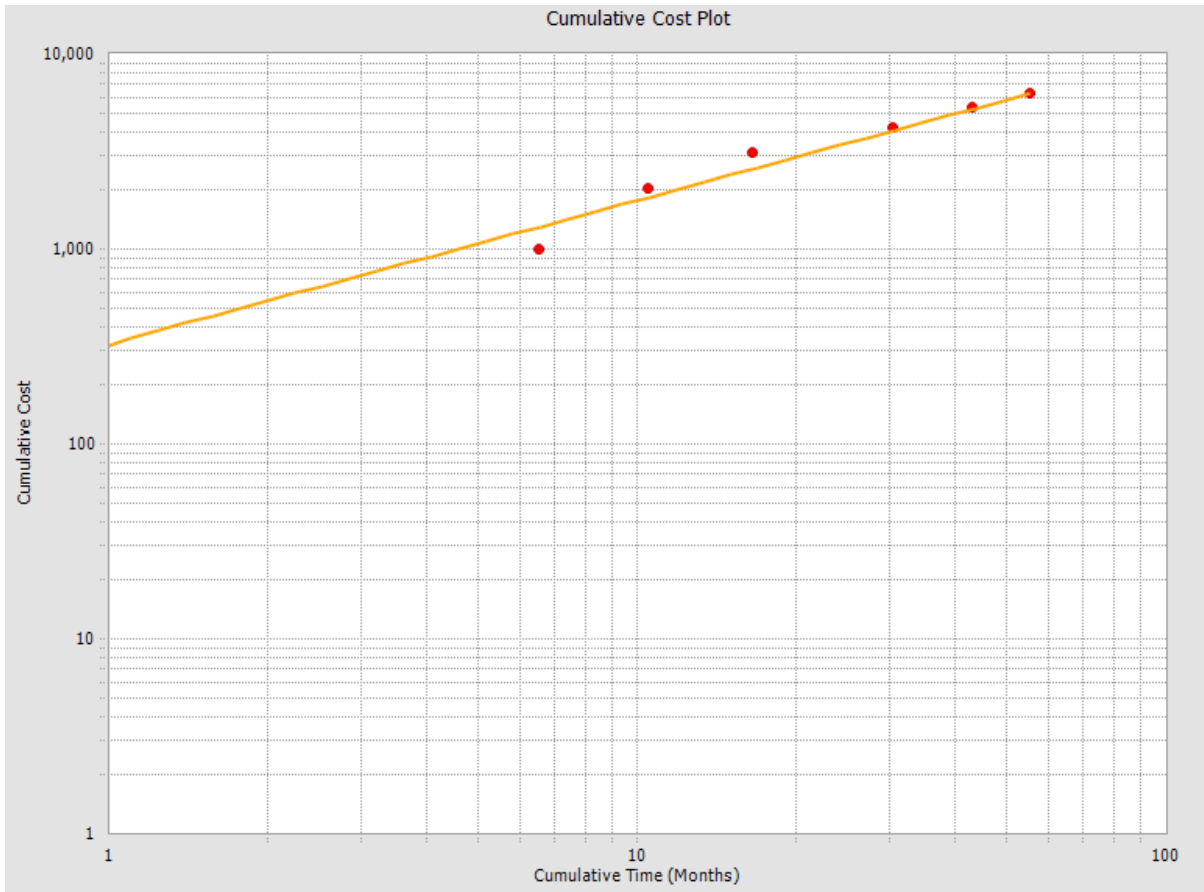

On the **Cumulative Cost Plot** graph, the x-axis shows cumulative time, and the y-axis shows cumulative cost. For a single piece of equipment or location, cumulative time is the total amount of time the piece of equipment or location has been in operation.

The same options are available while viewing the **Cumulative Failures Plot** page for an analysis with grouped data that is not based on events and derived from cumulative operating time the same way you can for [an event-based analysis derived from cumulative operating time](#). For grouped data, however, each datapoint will represent an amount of data or multiple failures instead of just one failure point. In addition, because the data is not event-based, the datapoints represent your custom meas-

Cumulative Cost Plot

urement instead of the [default event-based measurement of failures](#). In Example 3, the first datapoint represents a cost of 1,000 dollars instead of 1,000 failures.

Accessing the MTB<Measurement> Plot Page

To access the MTB<Measurement> Plot Page:

1. [Access the Reliability Growth Analysis page.](#)
2. On the **Plots** menu, click the **MTB<Measurement> Plot** link.

-or-

In the **Reliability Growth Model** section, click the preview of the **MTB<Measurement> Trend** graph.

Note: A preview of the **MTB<Measurement> Trend** graph appears in the **Reliability Growth Model** section *only* if the analysis is based on event count data. Otherwise, a preview of the **<Measurement> Rate Trend** graph appears.

The **MTB<Measurement> Plot** page appears, displaying the **MTBF Trend** graph. The following image displays the **MTB<Measurement> Plot** page for Example 1:

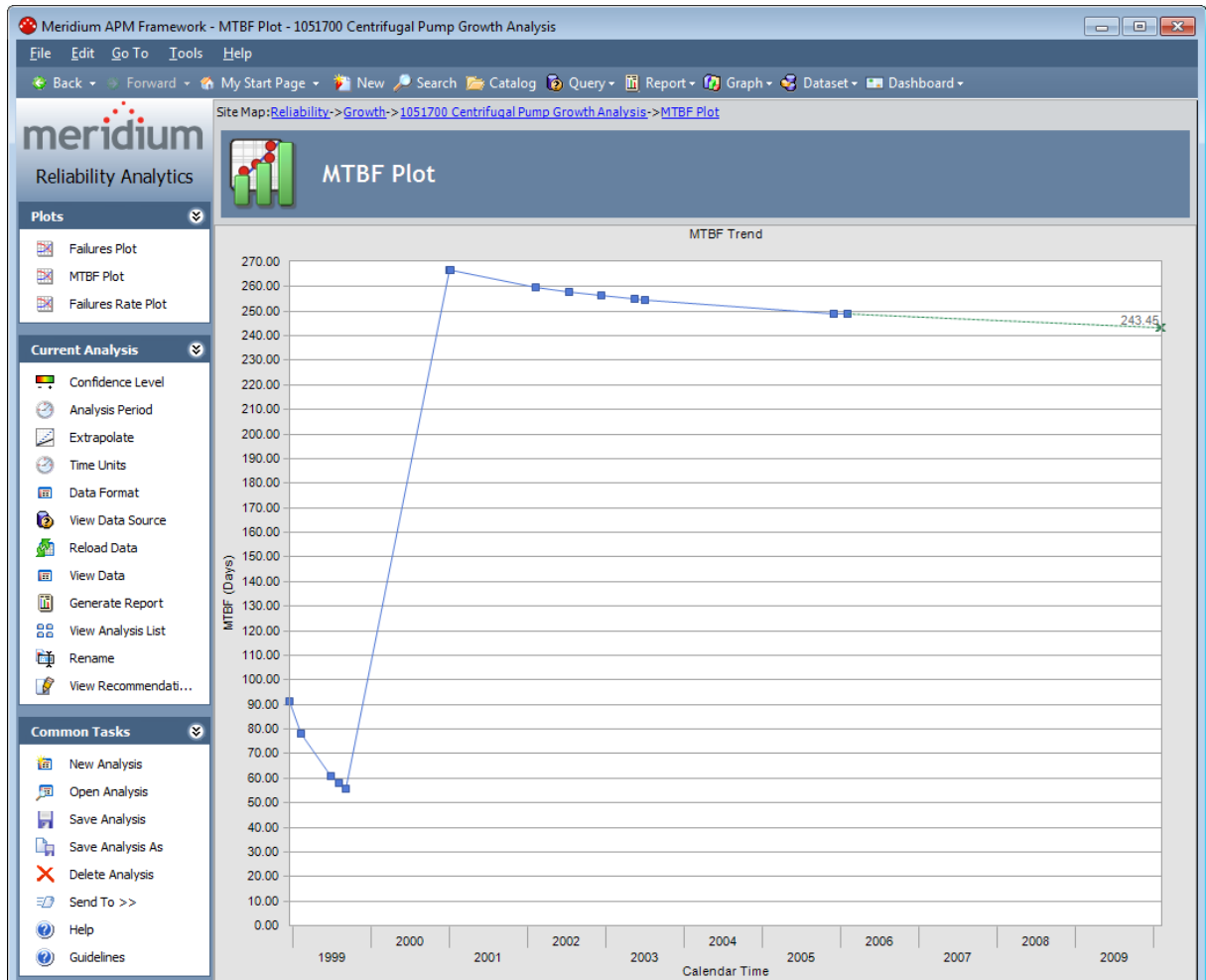

MTBF Trend Graph Using Failure Dates

The **MTBF Trend** graph shows how the Mean Time Between Failures (MTBF) changes over time. MTBF is calculated from the distribution of the failures over time. The datapoints represent observed failure dates included in the analysis.

The following image shows the **MTBF Trend** graph for [Example 1](#).

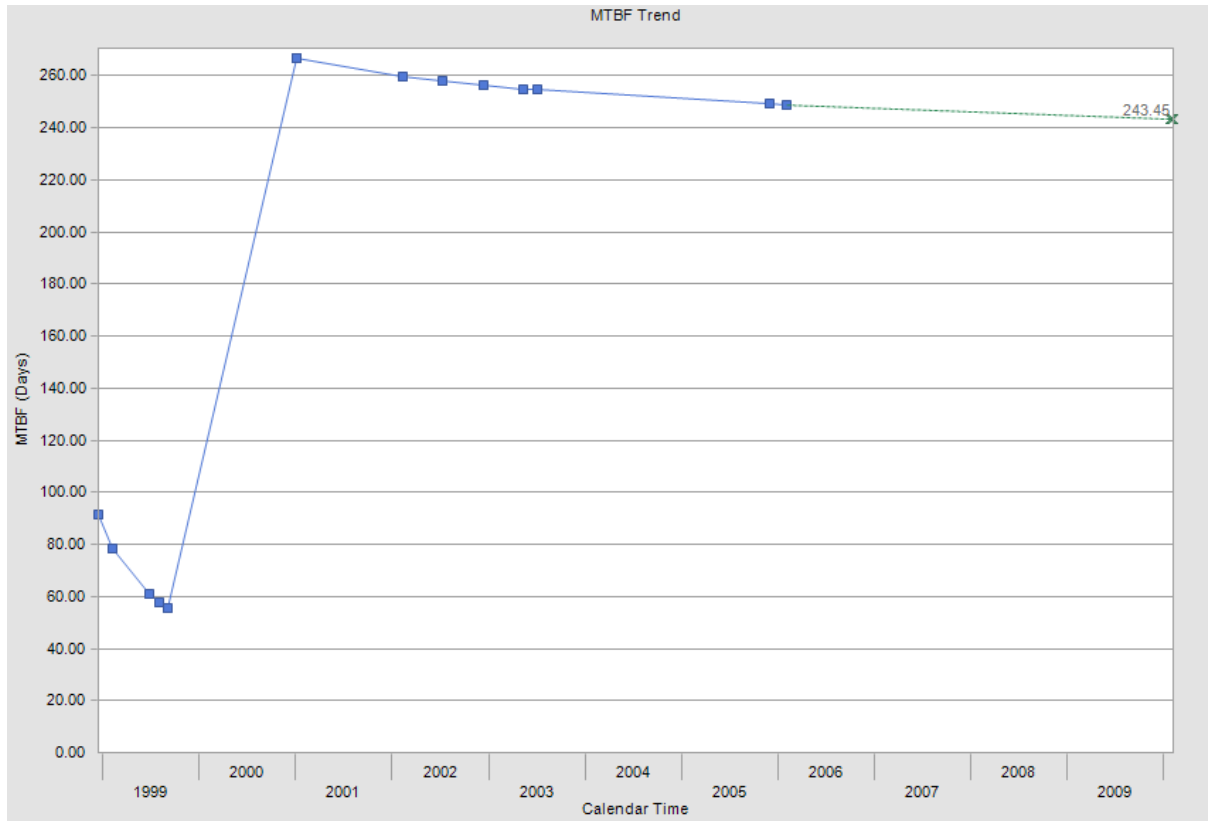

On the **MTBF Plot** page, the x-axis displays the calendar time, and the y-axis displays the MTBF and its units. The datapoints represent observed failure dates included in the analysis.

MTBF Trend graphs are used in the following ways:

- To show how MTBF has decreased or increased over time.
- To show that strategy changes have improved MTBF. In [Example 1](#), notice that the MTBF is decreasing until the fifth failure. At that point in time, a strategy change was made to increase inspection rounds, resulting in an increase in MTBF.

While viewing the graph, you can:

- Click any datapoint to [view the failure data](#).
- [Estimate how many failures will have occurred \(and what the MTBF would be\) at some date in the future.](#)

MTBF Trend Graph Using COT

The **MTBF Trend** graph shows how the Mean Time Between Failures (MTBF) changes over time. MTBF is calculated from the distribution of the failures over time. The data-points represent observed failure times included in the analysis.

The following image shows the **MTBF Trend** graph for [Example 2](#).

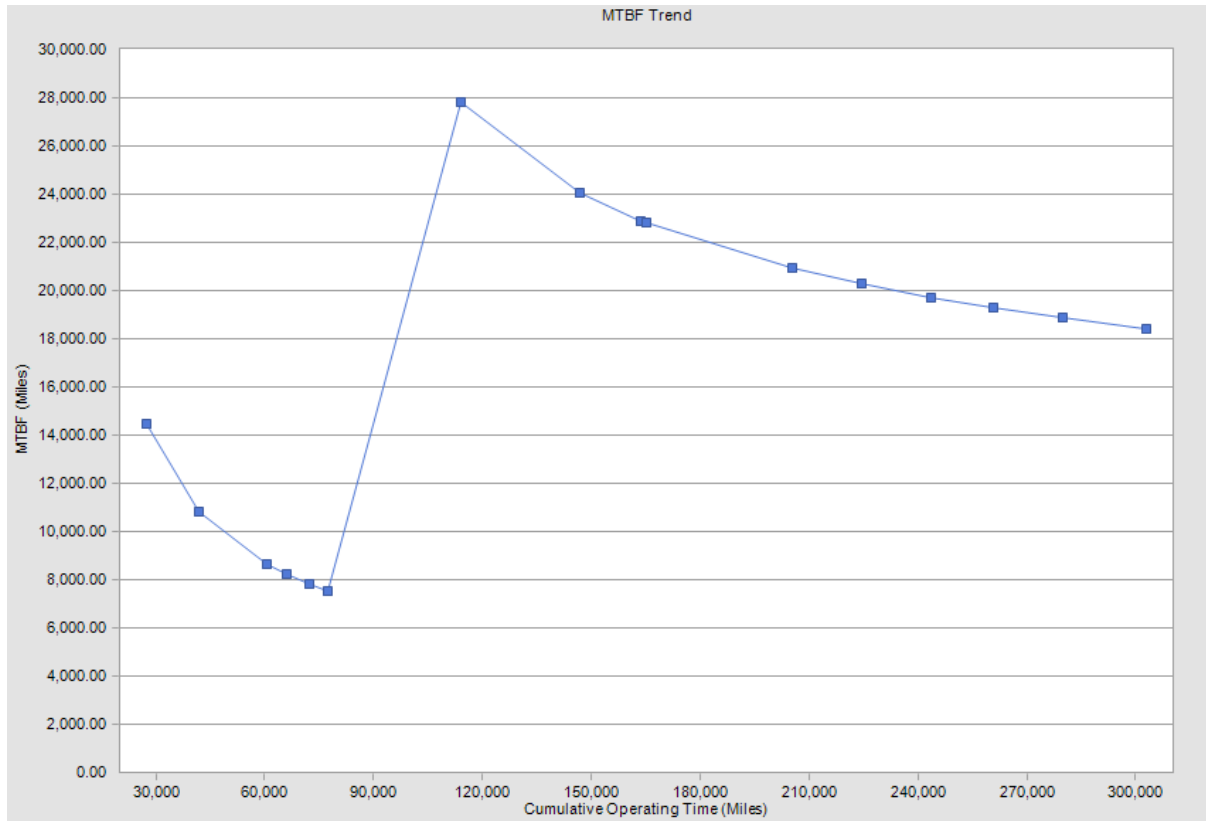

On the **MTBF Plot** page, the x-axis displays cumulative operating time if the analysis does not contain dates and displays calendar time if the analysis does contain dates. In this example, the analysis does not contain dates, so cumulative operating time is displayed. The y-axis displays the MTBF and its units. The datapoints represent observed failures included in the analysis.

The same options are available while viewing the **MTBF Trend** graph for an analysis based on cumulative operating time as for an [analysis based on failure dates](#). Instead of displaying the mean time between failures using calendar time, however, the graph displays the mean time between failures using the [time units you specified for your analysis](#). In Example 2, we used the custom units of *miles*, so the average number of miles between each failure is displayed on the **MTBF Plot** page.

MTBC Trend Graph

The **MTBC Trend** graph shows how the Mean Time Between Cost (MTBC) changes over time. MTBC is calculated from the distribution of cost over time. The datapoints represent cost measurements included in the analysis.

The following image shows the **MTBC Trend** graph for [Example 3](#).

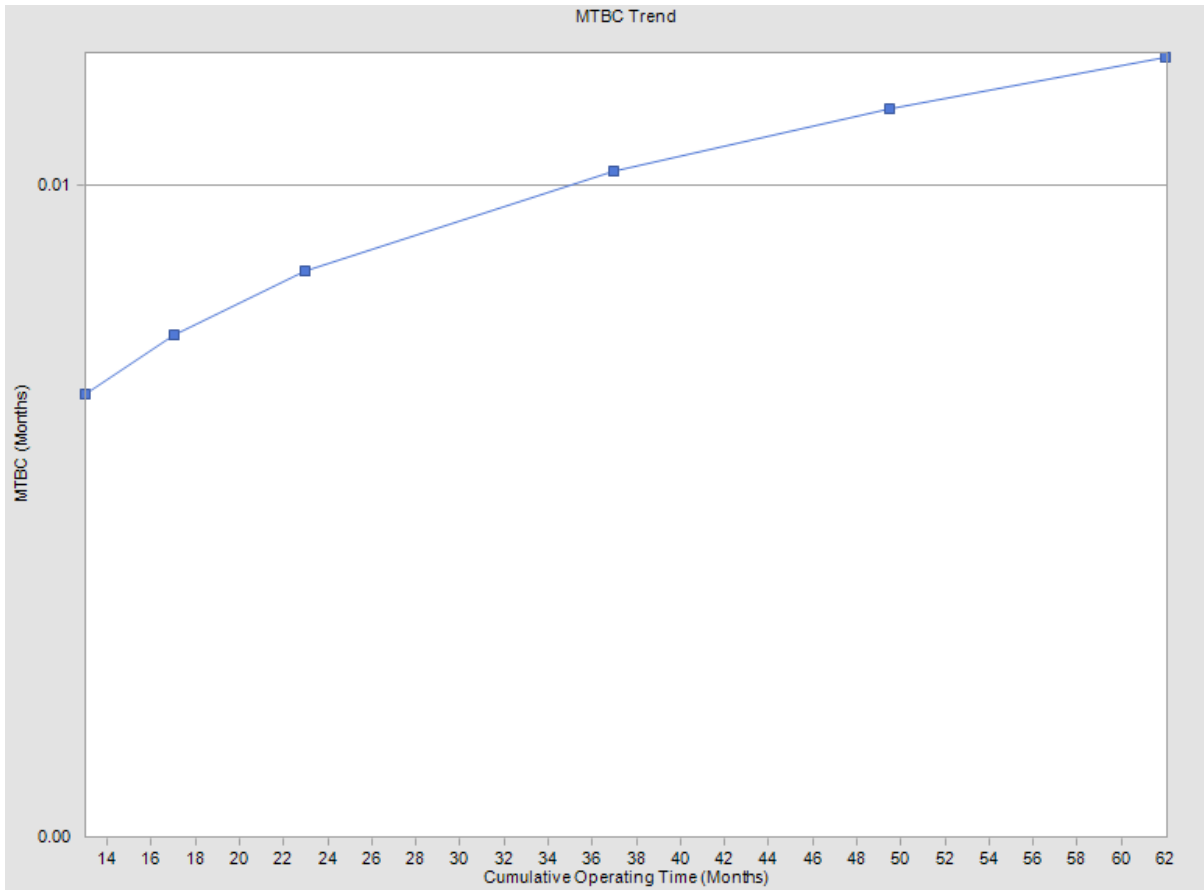

On the **MTBC Plot** page, the x-axis displays the cumulative operating time, and the y-axis displays the MTBC.

For Example 3 and other analyses using cost, the MTBC trend displays how much time lapses between spending. If cost is directly tied to failures, this plot may be useful to see the amount of time between failures of a piece of equipment or location. But if the cost measurements are not necessarily tied to failures (e.g., general maintenance, miscellaneous costs), then this plot only shows you the amount of time in between expenditures, which is not necessarily patterned behavior. In this case, it might be more helpful to view data using the [Cost Rate Trend graph](#).

In general, MTBC plots are used to show how MTBC has changed over time. As with an MTBF plot, you can click any datapoint to view the [cost data](#) and [estimate the amount of cost incurred at some time in the future](#).

Accessing the <Measurement> Rate Plot Page

To access the <Measurement> Rate Plot Page:

1. [Access the Reliability Growth Analysis page.](#)
2. On the **Plots** menu, click the <Measurement> Rate Plot link.

-or-

In the **Reliability Growth Model** section, click the preview of the <Measurement> Rate Trend graph.

Note:A preview of the<Measurement> Rate Trend graph appears in the **Reliability Growth Model** section *only* if the analysis is based on non-event count data. Otherwise, a preview of the **MTB<Measurement> Trend** graph appears.

The <Measurement> Rate Plot page appears, displaying the <Measurement> Rate Trend graph. The following image displays the <Measurement> Rate Plot page for Example 1:

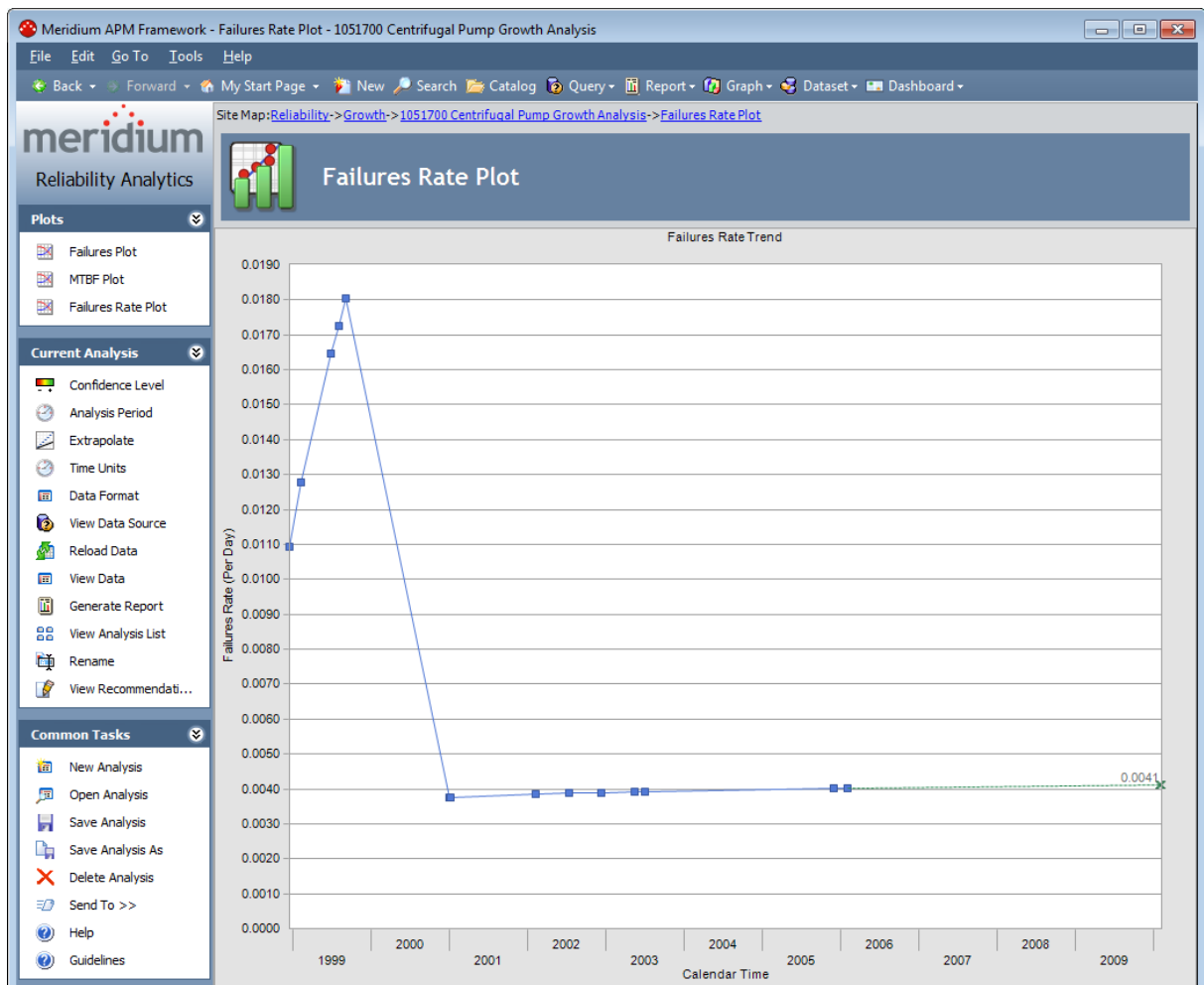

Failures Rate Trend Graph Using Failure Dates

The **Failures Rate Trend** graph shows how the failure rate of a piece of equipment or location changes over time. This graph is the inverse of the **MTBF Trend** graph. The datapoints represent observed failure dates included in the analysis.

The following image shows the Failures Rate Trend graph for [Example 1](#).

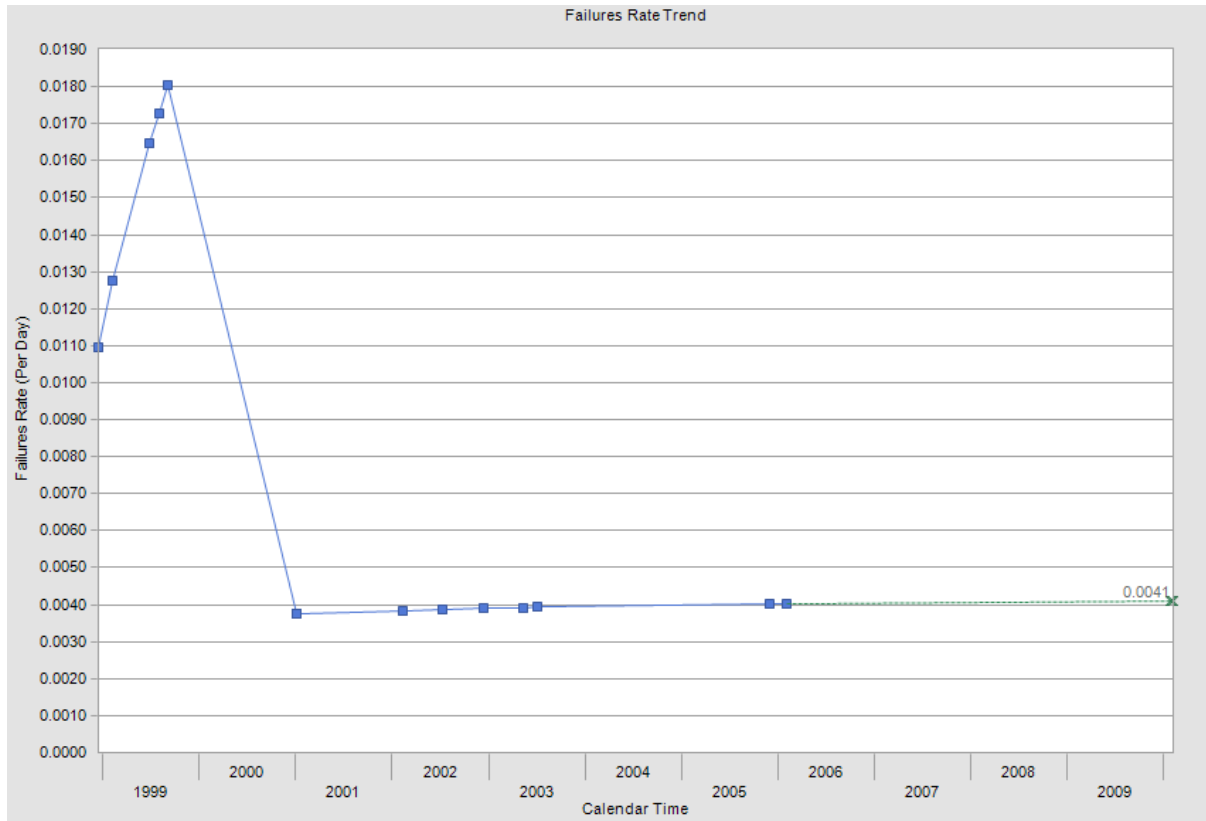

On the **Failures Rate Trend** graph, the x-axis displays the calendar time, and the y-axis displays the failure rate and its units. The datapoints represent observed failure dates in the analysis.

You can use the **Failure Rate Trend** graph to:

- View changes in the rate that failures are occurring.
- View the number of failures occurring per day, rather than the number of days between failures.

While viewing the graph, you can:

- Click any datapoint to [view the failure data](#).
- [Estimate how many failures will have occurred at some date in the future.](#)

Failures Rate Trend Graph Using COT

The **Failures Rate Trend** graph shows how the failure rate of a piece of equipment or location changes over time. This graph is the inverse of the **MTBF Trend** graph. The datapoints represent observed failures included in the analysis.

The following image shows the Failures Rate Trend graph for [Example 2](#).

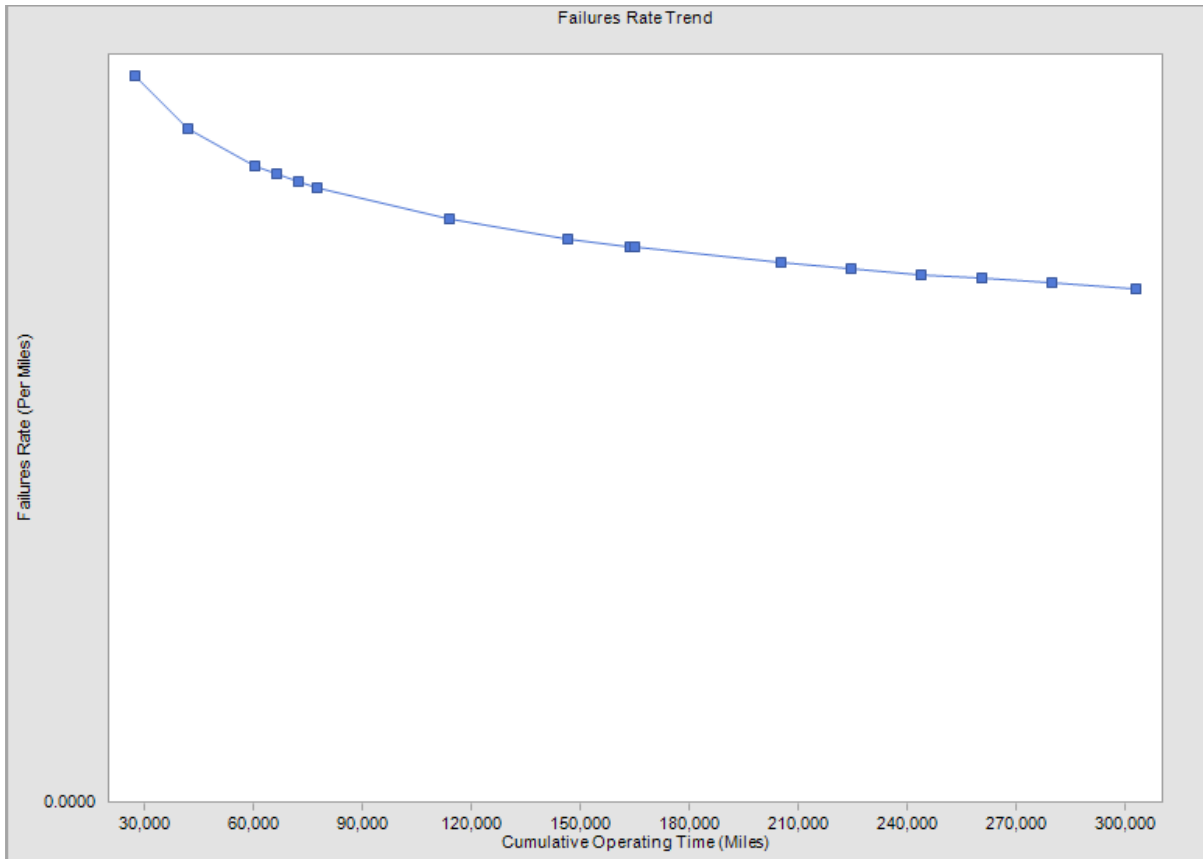

On the **Failures Rate Trend** graph, the x-axis displays cumulative operating time, and the y-axis displays the Failure Rate and its units. The datapoints represent observed failure times in the analysis.

The same options are available while viewing the **Failures Rate Trend** graph for an analysis based on cumulative operating time as for an [analysis based on failure dates](#). Instead of displaying the failure rate using calendar time (per day), however, the plot displays the failure rate using the [time units you specified for your analysis](#). In Example 2, we used the custom units of *miles*, so failures are displayed per mile.

Cost Rate Trend Graph

The **Cost Rate Trend** graph shows how the cost rate of a piece of equipment or location changes over time. This graph is the inverse of the **MTBC Trend** graph. The datapoints represent cost amounts included in the analysis.

The following image shows the **Cost Rate Trend** graph for [Example 3](#).

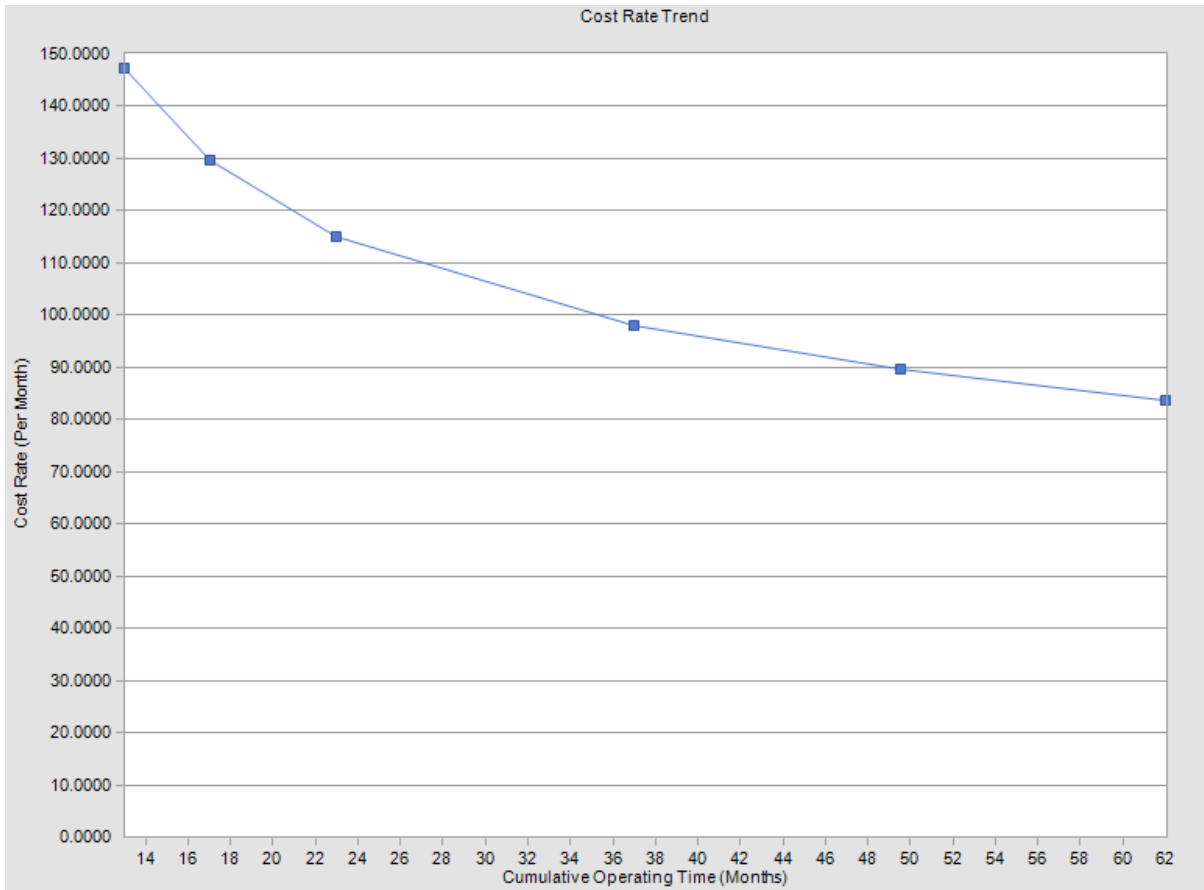

On the **Cost Rate Trend** graph, the x-axis displays cumulative operating time, and the y-axis displays the cost rate and its units. The datapoints represent times when cost was incurred.

You can use the **Cost Rate Trend** graph to:

- View changes in the rate that money is being spent.
- Determine if strategy changes have changed the amount of money being spent over time.
- Estimate how much money is being spent per time unit (e.g., month).

As with a **Failure Rate Trend** graph, you can click any datapoint to view the [cost data](#) and [estimate the amount of cost incurred at some time in the future](#).

Accessing the Multiple Growth Analyses Page

You can view multiple analyses on the same plot by displaying them on the **Multiple Growth Analyses** page.

To access the **Multiple Growth Analyses** page:

1. On the **Select a Growth Analyses from the List** page, select the analyses that you want to view on one plot.
2. On the **Plots** menu, click one of the following links, depending upon the plot that you want to view:
 - **MTBE Plot** link.
 - **Cumulative Plot** link.
 - **Rate Plot** link.

Note: If you selected more than 20 analyses to be shown on the **Multiple Growth Analyses** page, a warning message appears, indicating that the plot may take a long time to load and that interpretation will be difficult. You can click the **Yes** button to continue or the **No** button to return to the **Select a Growth Analysis from the List** page.

The [Multiple Growth Analyses page](#) appears, displaying the selected analyses on one plot.

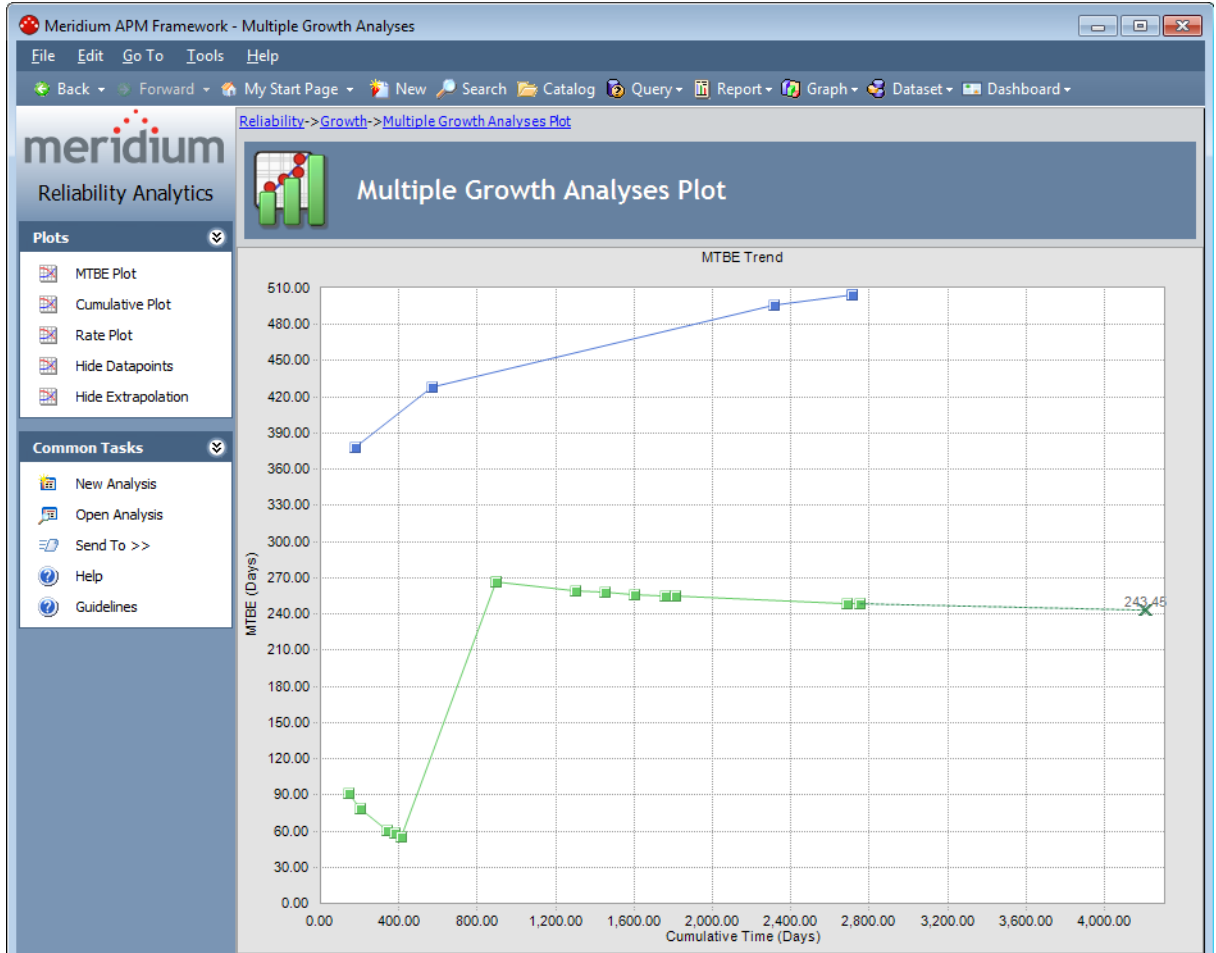

Aspects of the Multiple Growth Analyses Page

The **Multiple Growth Analyses** page allows you to view the MTBE Trend, Cumulative, or Rate Trend graphs for more than one Reliability Growth Analysis at once. The following image displays an example of the **Multiple Growth Analyses** page displaying the **MTBE Trend** graph.

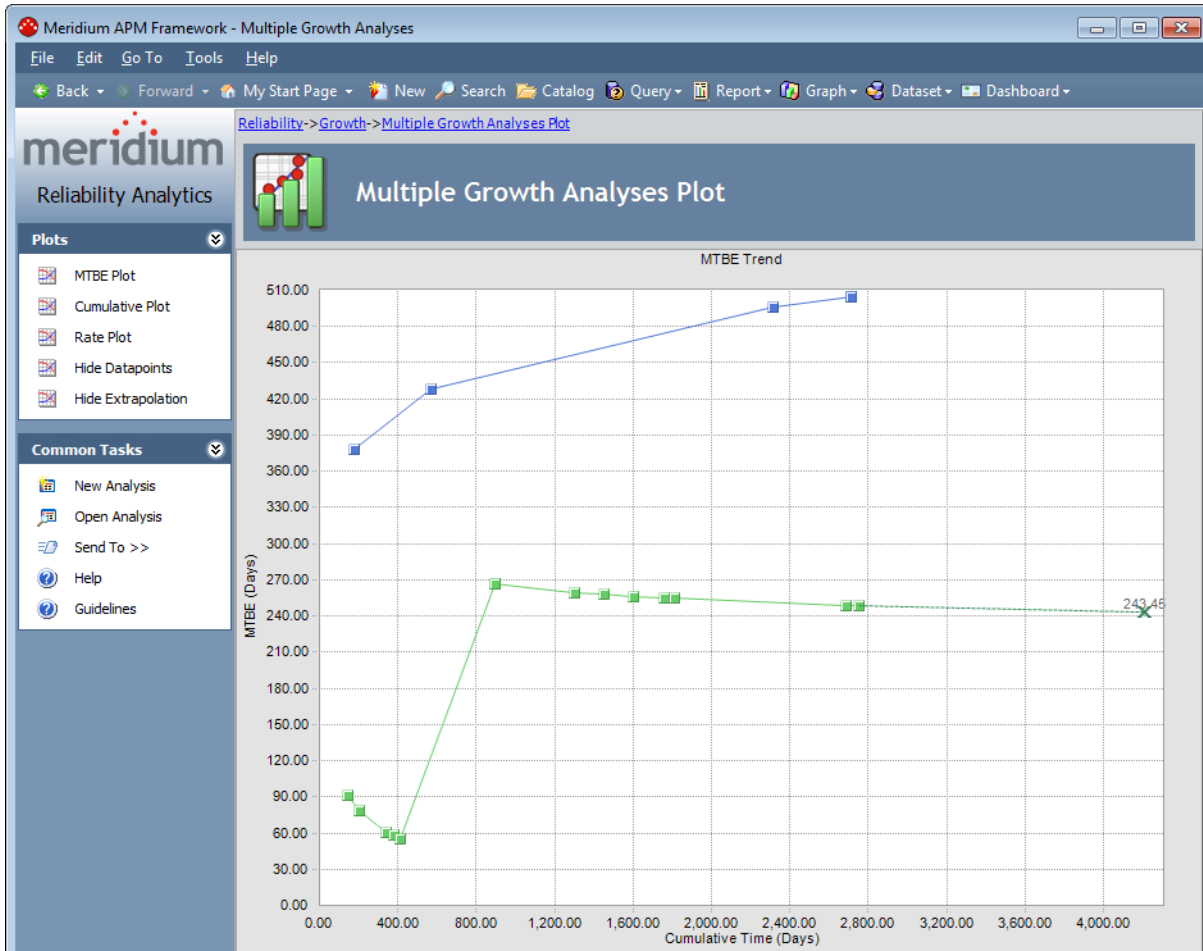

A plot displaying multiple analyses looks similar to a plot that displays a single analysis. Because the analyses may not be in the same units, however, some conversions must be made to allow the data to be compared more easily. When you are viewing multiple analyses on a single graph:

- On the **MTBE Trend** graph the y-axis label is *MTBE* if the analyses use different time units or *MTBE <units>* if all analyses use the same time unit.
- On the **Rate Trend** graph, the y-axis label is *Rate* if the analyses use different time units and *Rate <unit>* if all analyses use the same time unit.
- On the **Cumulative** graph, the y-axis label is *Cumulative*.
- On all graphs, the x-axis label is *Cumulative Time* if the analyses use different time

units and *Cumulative Time* <units> if all analyses use same time unit.

- If the analyses use different time units, the data is converted to the *smallest* unit. For example, if one analysis uses weeks and another uses days, the units for the former analysis are converted to days.
- If one or more analyses use custom units, no conversion is made, and the x-axis and y-axis have no units.
- If one or more analyses use custom units and one or more analyses use non-custom units on the same graph, the x-axis and y-axis have no units, and the data for the analyses with non-custom units will be converted to the *smallest* unit.
- You can hide datapoints and extrapolation on all graphs.
- If you pause on one of the analysis plot lines, that line is highlighted while the other plot lines are dimmed. If you click one of the analysis plot lines, the **Reliability Growth Analyses** page appears for that analysis.

Plots Menu

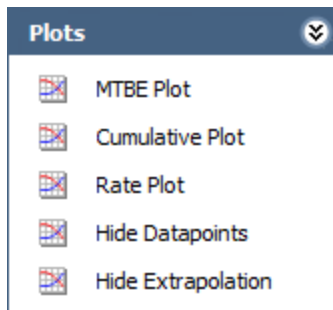

The **Plots** menu on the **Multiple Growth Analyses** page contains the following links:

- **MTBE Plot:** Displays the [MTBE Trend graph](#) for the analyses you accessed on the **Multiple Growth Analyses** page.
- **Cumulative Plot:** Displays the [Cumulative graph](#) for the analyses you accessed on the **Multiple Growth Analyses** page.
- **Rate Plot:** Displays the [Rate Trend graph](#) for the analyses you accessed on the **Multiple Growth Analyses** page.

Note: If you click the link that corresponds with the plot that you are currently viewing on the **Multiple Growth Analyses** page, nothing will happen, and the plot that you are currently viewing will continue to be displayed.

- **Hide Datapoints:** Hides datapoints if they are currently displayed. If datapoints are currently hidden, this link will be labeled **Show Datapoints**, and clicking it will cause the datapoints to reappear.
- **Hide Extrapolation:** Hides extrapolation if it is currently displayed. If extrapolation is hidden, this link will be labeled **Show Extrapolation**, and clicking it will cause the extrapolation to reappear.

Common Tasks Menu

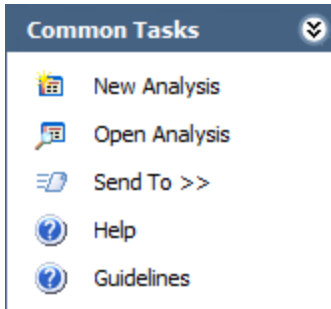

The **Common Tasks** menu on the **Multiple Growth Analyses** page contains the following links:

- **New Analysis:** Displays the **Reliability Growth Builder**, which guides you through the process of creating a new Reliability Growth Analysis.
- **Open Analysis:** Displays the **Find Reliability Growth Analysis** window, which you can use to search for existing Reliability Growth Analysis records.
- **Send To:** Displays a submenu with options that let you provide a link to the current page on your desktop (create shortcut), in an email message, or on a Home Page.
- **Help:** Displays the context-sensitive Help topic for the **Multiple Growth Analyses** page.
- **Guidelines:** Displays overview information about the Reliability Analytics module.

Goodness of Fit Test for a Growth Analysis

A *Goodness of Fit* (GOF) test determines how well your analysis data fits the calculated data model.

- If your data *passes* the GOF test, your data follows the data model closely, and you can rely on the predictions made by model.
- If your data *fails* the GOF test, it may not follow the model closely enough to confidently rely on model predictions.

On the **Reliability Growth Analysis** page, in the **Segment** grid, the [Passed GOF check box](#) is selected when your data passes the test and cleared when your data fails the test.

To determine whether the data passes the GOF test, the Meridium APM system uses the following values:

- **GOF Statistic:** Determines how precisely the data fits the model. This value is calculated from a Cramer-von Mises or Chi-squared test and is displayed in the [GOF Statistic](#) column in the **Segment** grid on the **Reliability Growth Analysis** page.
- **Alpha Value:** Determines what critical value to use for the GOF test. This value depends on the [Confidence Level](#) you select for the analysis.
- **Critical Value:** Determines whether the data passes the GOF test. This standard value depends on the number of datapoints included in the analysis and the alpha value. It is displayed in the [Critical Value](#) column in the **Segment** grid on the **Reliability Growth Analysis** page.

Test Statistic

Two different methods are used for calculating GOF for Reliability Growth Analyses, depending upon whether or not the analyses use grouped data.

Goodness of Fit (GOF) for a Reliability Growth Analyses based on data that is not grouped is calculated using the Cramer-von Mises test.

- For analyses whose [end date is time-based](#), Cramer-von Mises test uses the following formula to calculate the GOF Statistic:

$$C_M^2 = \frac{1}{12N} + \sum_{i=1}^N \left[\left(\frac{t_i}{T} \right)^{\hat{\beta}} - \frac{2i-1}{2N} \right]^2$$

- For analyses whose [end date is event-based](#), Cramer-von Mises test uses the following formula to calculate the GOF statistic:

$$C_M^2 = \frac{1}{12(N-1)} + \sum_{i=1}^{N-1} \left[\left(\frac{t_i}{t_N} \right)^{\hat{\beta}} - \frac{2i-1}{2(N-1)} \right]^2$$

Goodness of Fit for a Reliability Growth Analysis based on grouped data is calculated using a Chi-squared test. This test uses the following formula to calculate a test statistic:

$$\chi^2 = \sum_{i=1}^k \frac{(n_i - \hat{\theta}_i)^2}{\hat{\theta}_i}$$

Critical Value: Cramer-Von Mises Test

For non-grouped data, the Cramer-von Mises test is used to determine whether the data passes the GOF test. This test compares the GOF Statistic to a Critical Value. The Critical Value depends on two values:

- **Alpha** = 1- Confidence Level
- **N** = The number of datapoints in the population.

Alpha is determined using the Confidence Level, which [you can define manually for each analysis](#). The Confidence Level indicates the percentage of uncertainty of the Goodness of Fit method. This percentage is usually determined by experience or an industry standard and limits how closely the data must fit the model in order for it to pass the Goodness of Fit test. The higher the Confidence Level, the easier it will be for your data to pass the Goodness of Fit test. The lower the Confidence Level, the harder it will be for your data to pass the Goodness of Fit test. If the data does pass, however, the data will be a very close fit to the model.

Note: When you [select a Confidence Level](#), you must specify 80, 90, 95, or 98 percent. If you do not modify the confidence level, alpha is automatically set to 0.1 (i.e., a confidence level of 90%).

After a Confidence Level has been determined, the Meridium APM system uses the following *Critical Values for Cramer-von Mises Test* chart to find the Critical Value. The chart displays critical values at four confidence levels (80%, 90%, 95% and 98%) which in turn calculate 4 alpha values (0.2, 0.1, 0.05, 0.02).

$N \backslash \alpha$	0.2	0.15	0.1	0.05	0.01
2	0.138	0.149	0.162	0.175	0.186
3	0.121	0.135	0.154	0.184	0.23
4	0.121	0.134	0.155	0.191	0.28
5	0.121	0.137	0.16	0.199	0.3
6	0.123	0.139	0.162	0.204	0.31
7	0.124	0.14	0.165	0.208	0.32
8	0.124	0.141	0.165	0.21	0.32
9	0.125	0.142	0.167	0.212	0.32
10	0.125	0.142	0.167	0.212	0.32
11	0.126	0.143	0.169	0.214	0.32
12	0.126	0.144	0.169	0.214	0.32
13	0.126	0.144	0.169	0.214	0.33
14	0.126	0.144	0.169	0.214	0.33
15	0.126	0.144	0.169	0.215	0.33
16	0.127	0.145	0.171	0.216	0.33
17	0.127	0.145	0.171	0.217	0.33
18	0.127	0.146	0.171	0.217	0.33
19	0.127	0.146	0.171	0.217	0.33
20	0.128	0.146	0.172	0.217	0.33
30	0.128	0.146	0.172	0.218	0.33
60	0.128	0.147	0.173	0.22	0.33
100	0.129	0.147	0.173	0.22	0.34

Note: If the number of datapoints in your analysis is between two rows in the chart (e.g., 22), the smaller value (e.g., 20) is used. If the number of datapoints is greater than 100, 100 is used.

Critical Value: Chi-squared Test

For grouped data, the Chi-squared test is used to determine whether the analysis passed the GOF test. This test uses Degrees of Freedom (i.e., the number of datapoints - 2) and the [Confidence Level](#) to calculate a Critical Value, which is then compared to the GOF Statistic to determine whether the analysis passed the GOF test. The Confidence Level is defined the same way it is in the Cramer-von Mises test (i.e., it indicates the percentage of uncertainty of the Goodness of Fit method).

The following formula is used to calculate the Chi-squared distribution.

$$F(x; k) = \frac{\gamma\left(\frac{k}{2}, \frac{x}{2}\right)}{\Gamma\left(\frac{k}{2}\right)} = P\left(\frac{k}{2}, \frac{x}{2}\right)$$

In the formula, k is degrees of freedom and $F(x;k)$ is the Confidence Level. These values are used to find the Critical Value, x .

Determining the Results

For both the Cramer-von Mises test and the Chi-squared test, if the GOF statistic is greater than the Critical Value at the chosen Confidence Level, the data fails the GOF test. This means the data does not follow the analysis pattern closely enough to confidently predict future measurements. If the GOF Statistic is lower than the Critical Value, the population passes the test, which means data is more likely to occur in a pattern and therefore is more predictable.

For example, if you run a Reliability Growth Analysis on a set of failure data, and the data fails the GOF test, it may mean that the piece of equipment or location does not fail in a predictable pattern (i.e., the piece of equipment or location fails at random). If this is the case, any predictions you make based on this data will not be as reliable as predictions made against data that has passed the GOF test.

If the analysis fails a GOF test, it does not necessarily mean that you cannot use the data model. The Reliability Growth Analysis might fail a GOF test because there is more than one trend within the data. If you suspect this is the case, you can [split the analysis into segments](#) at the points where it looks like a change occurred. Afterwards, the separate segments may individually pass the GOF test because they have been split up into multiple failure patterns.

Additionally, if the analysis fails the GOF test, you should also check for a visual goodness of fit. Models can sometimes still be used even if the analysis does not pass the GOF test.

About the Beta Value and MTBE

The **Reliability Growth Analysis** page displays the Beta and Lambda values as calculated by the application based on your data. The Beta value indicates whether MTBE is increasing, decreasing, or remaining constant.

Beta Value	MTBF	Equipment Reliability
$\beta = 1$	Unchanging MTBE (predictable failures)	If the Beta value is equal to or close to one (1), then the reliability is <i>constant</i> , and time is not a major factor.
$\beta < 1$	Increasing MTBE (improving reliability)	If the value of Beta is <i>less than</i> one, the reliability of the equipment is <i>improving</i> over time.
$\beta > 1$	Decreasing MTBE (deteriorating reliability)	If the value of Beta is <i>greater than</i> one (1), then the reliability of the equipment is <i>deteriorating</i> over time.

If the Beta value indicates that the MTBE is increasing or decreasing, you can try splitting the failure data up by time, failure mode, operating time, or some other appropriate value to create a set of data where the Beta value is closer to one. If you choose to split the data into time periods, you might try using the feature that lets you [split a single analysis into multiple segments](#).

Splitting an Analysis Into Segments

In some cases, a Reliability Growth Analysis may indicate that your data is trending in an undesirable direction (e.g., failures are occurring very often, costs are too high). In these cases, you will probably decide to make significant adjustments to your work process in order to improve the results. You can create a Reliability Growth Analysis that is split into segments to represent periods of time before and after you made changes to improve the reliability of your equipment and locations.

When you generate a report for an analysis that has been split into segments, the report will contain information about each segment and the analysis as a whole.

To split an analysis into segments:

1. Access the **Reliability Growth Analysis** page for an existing Reliability Growth Analysis.
2. On the **Plots** menu, click the **<Measurement> Plot** link.
3. On the [Cumulative <Measurement> Plot page](#), locate the datapoint that represents the *last* measurement recorded before you made a significant change to your work process.
4. Right-click the datapoint, and click **Split** on the shortcut menu.

Note: The **Split** option is enabled only if there are at least three datapoints to the left and to the right of the datapoint you selected.

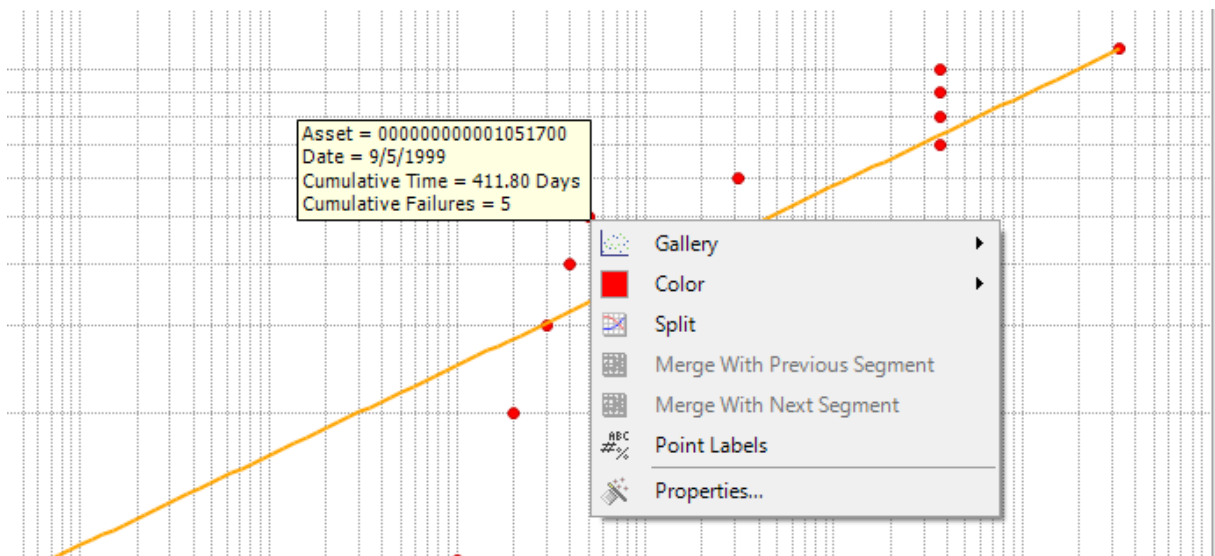

The plot line bends at the datapoint you selected, representing two segments instead of one.

Splitting an Analysis Into Segments

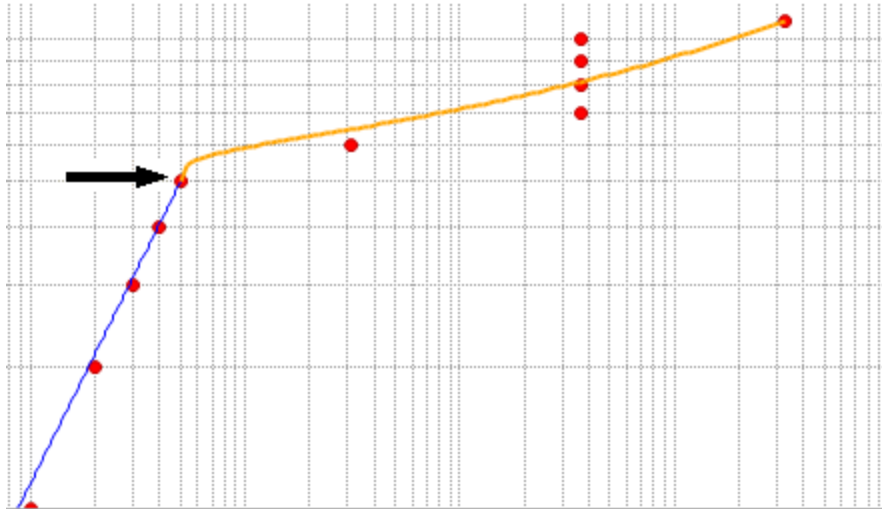

Although the analysis still has an overall Initial and Final MTBF, each individual segment now also has its own Initial and Final MTBF. The **AMSAA Reliability Growth Model** page will also display different information for each segment. Each segment is colored according to whether it passed the GOF test. If the segment is blue, it passed the GOF Test. If the segment is orange, it failed the GOF test.

If desired, you can merge the segments back into one by right-clicking on a segment and clicking **Merge With Previous Segment** on the shortcut menu.

Note: When you split the analysis manually via the **Cumulative <Measurement>** plot, the **MTBE Trend** plot and the **<Measurement> Rate** plot will also reflect the split.



Estimating Data in the Future

You might want to estimate the number of events that will have occurred or the amount of non-event data (e.g., cost) that has been incurred at some point in the future. This estimation assumes that you do not plan to make any additional changes in your piece of equipment, location, or work process.

To estimate data measurements in the future:

1. On the **Cumulative <Measurement> Plot**, the **MTB<Measurement> Plot**, or the **<Measurement> Rate Plot** pages, on the **Current Analysis** menu, click the **Extrapolate** link.

The **Extrapolation** dialog box appears.

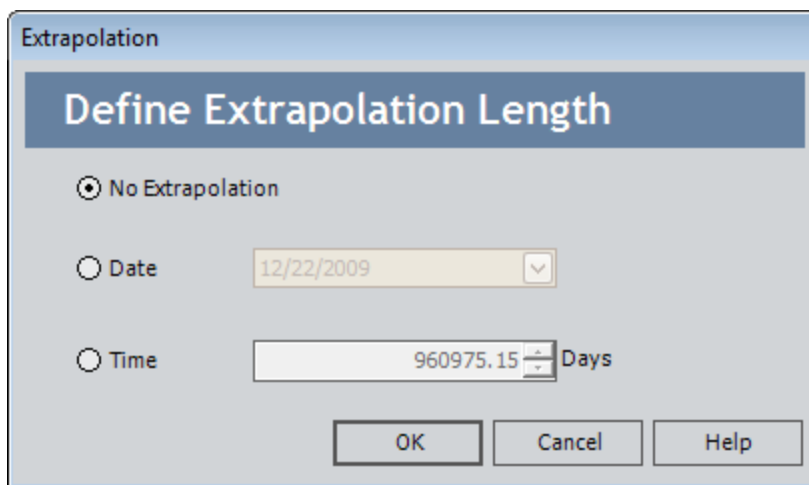

If you have not yet extrapolated the analysis, the **No Extrapolation** option is selected by default.

2. To estimate the number of failures that will have occurred:
 - By a specific date, select the **Date** option. In the list to the right of the **Date** option, select the date on which you want to know how many failures will have occurred.

Note: You can extrapolate by date only if your analysis data contains dates. If the analysis does not contain dates, the **Date** option will not appear, and you will not be able to extrapolate based on dates.

- After a certain amount of time, select the **Time** option. In the text box to the right of the **Time** option, specify the number of time units at which you want to know how many failures will have occurred. The unit of measure to the right of the text box corresponds with the value that you selected in the [Time Units dialog box](#).

Note: The date or time that you specify must be greater than the default date or time, which is the analysis end date or time.

3. Click **OK**.

The plot returns to focus, and [several lines have been added](#) based on the extrapolation specification.

Interpreting Extrapolation Results Using Failure Dates

After you select an extrapolation method (by date or by amount of time), for each segment in the analysis, a dotted green line extends from the last failure date for that segment to the specified date in the future. The future date is calculated based on the date or time units you provided in the **Extrapolation** dialog box. At the end of the dotted green line, a number appears, representing the estimated number of failures that would have occurred at that point in time.

A solid green line also intersects the end date for each segment, and the cumulative operating time at the end of that segment appears on the solid green line.

For [Example 1](#), suppose you suggested to increase inspections rounds for a pump in order to slow the growing failure rate. This strategy was implemented on September 5, 1999. Several years later, you create a graph using the extrapolation tool to display to management the number of failures that have been prevented and will continue to be prevented as a result of the strategy.

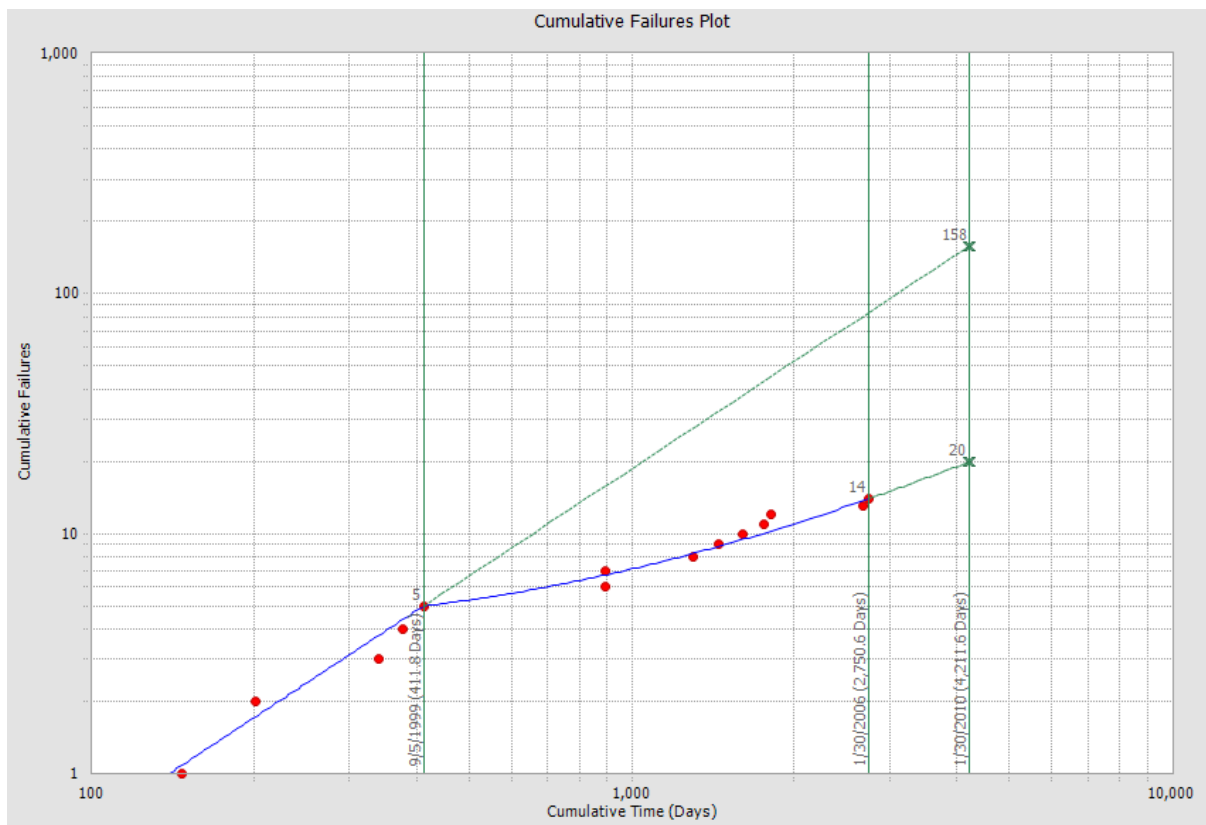

In this example, the analysis is [split into two segments](#) at the fifth failure, which took place on 9/5/1999, the day on which the strategy was implemented. The first segment represents the data without the strategy change, and the second segment represents the date with the strategy change. The dotted green extrapolation lines display the

future data trend of each segment until the extrapolation date *1/30/2010*, which was specified using the **Extrapolation** dialog box.

The solid green lines display the date and cumulative time at the end of each segment and at the extrapolation date. In this example, these lines represent the date of the strategy change, the current date, and the future date, respectively.

The following chart displays the number of failures at each solid green line, which are represented in the graph by a gray number where the solid green line intersects a segment or extrapolation line.

Strategy	# of Failures on 9/5/1999 (date of strategy change)	# of Failures on 1/30/2006 (current date)	# of Failures on 1/30/2010 (extrapolation date)
Segment 1 (Without Strategy Change)	5	Not Displayed	158
Segment 2 (With Strategy Change)	5	14	20

At the extrapolation date for the first segment the number *158* is displayed, which means that if you had not made the strategy change, you could have expected 158 failures by January 30, 2010.

At the extrapolation date for the second segment the number *20* is displayed, which means that if you do not make any changes from your last failure date (January 30, 2006) until the future date (January 30, 2010), you can expect 20 failures by that date.

Assuming the failure trend continues as expected, an observation can be made that a strategy change introduced on September 5, 1999 allowed you to prevent *138* failures between September 5, 1999 and January 30, 2010 (i.e., $158 - 20$).

Interpreting Extrapolation Results Using COT

After you select an Extrapolation method (by date or by time period), for each segment in the analysis, a dotted green line extends from the last failure date for that segment to the specified date in the future (calculated based on the date or time units you provided in the **Extrapolation** dialog box). At the end of the dotted green line, a number appears, representing the estimated number of failures that would have occurred at that point in time.

A solid green line also intersects the end date for each segment, and the cumulative operating time at the end of that segment appears on the solid green line.

For [Example 2](#), suppose you began changing a haul truck's oil more frequently in order to slow its growing failure rate. This strategy was implemented after the truck had traveled 77,314 miles. After the truck has logged some miles using the new strategy, you create a graph to display to management the number of failures you will have prevented after the haul truck has logged 750,000 miles.

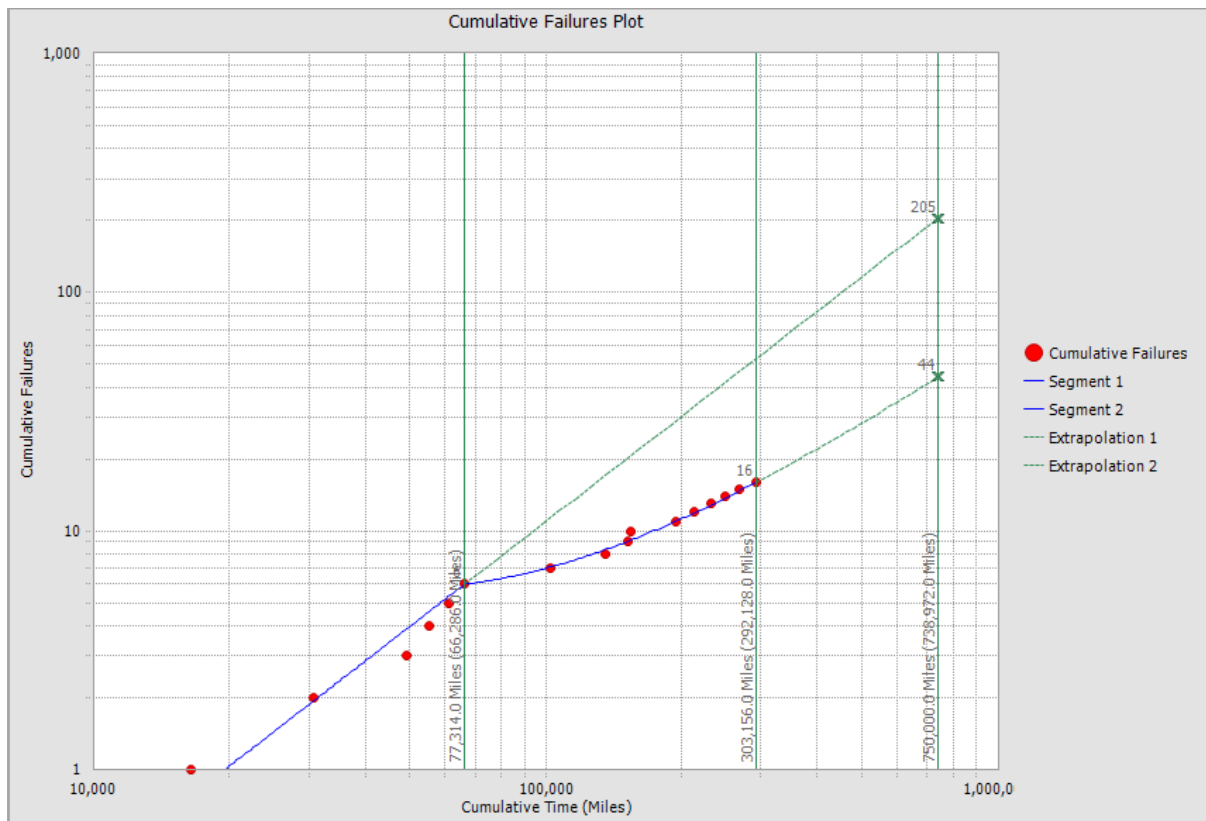

This image represents the extrapolation results for [Example 2](#), where we extrapolated using time. The x-axis represents the cumulative time, or the total runtime for a piece of equipment or location after the analysis has started, using the units of miles.

The analysis is [split into two segments](#) at the sixth failure, which took place on 77,314 miles, the mileage at which the strategy was implemented. The first segment represents the data without the strategy change, and the second segment represents the date with the strategy change. The dotted green extrapolation lines display the future data trend of each segment until the extrapolation time of 750,000 miles, which was specified using the **Extrapolation** dialog box.

The solid green lines display the cumulative operating time (i.e., the total mileage for the truck) and the cumulative time (i.e., the truck's mileage since the analysis has started) at the end of each segment and the at extrapolation date. In this example, these lines represent the mileage of the truck at the strategy change, the current mileage, and the future mileage, respectively.

Note: In our example, the haul truck has a mileage of 11,028 before the analysis started. Therefore, the cumulative time and the cumulative operating time will always be 11,028 miles apart. If the piece of equipment or location is brand new (i.e., the truck has a mileage of 0 when the analysis started), the cumulative time and the cumulative operating time will be the same.

The following chart displays the number of failures at each solid green line, which are represented in the graph by a gray number where a solid green line intersects a segment or extrapolation line.

Strategy	# of Failures at 77,314 miles (time of strategy change)	# of Failures at 303,156 miles (current mileage)	# of Failures at 750,000 miles (extrapolation mileage)
Segment 1 (Without Strategy Change)	6	Not Displayed	205
Segment 2 (With Strategy Change)	6	16	44

At the extrapolation time for the first segment the number 205 is displayed, which means that if you had not made the strategy change, you could have expected 206 failures by the time the truck traveled 750,000 miles.

At the extrapolation time for the second segment the number *44*s displayed, which means that if you do not make any changes from your last failure time (303,156 miles) until the future failure time (750,000 miles), you can expect 44 failures by that time.

Finally, an observation can be made that the change introduced at 77,314 miles allowed you to prevent *161* failures between a mileage of 77,314 and 750,000 (i.e., 205 - 44).

Interpreting Extrapolation Results for Cost

After you select an Extrapolation method, for each segment in the analysis, a dotted green line extends from the last failure date for that segment to the specified date in the future (calculated based on the date or time units you provided in the **Extrapolation** dialog box). At the end of the dotted green line, a number appears, representing the estimated number of failures that would have occurred at that point in time.

A solid green line also intersects the end date for each segment, and the cumulative operating time at the end of that segment appears on the solid green line.

For [Example 3](#), suppose you changed mechanics to try to curb the growing cost of repairing equipment. This strategy was implemented after 23 months. After a few years have passed, you want to create a graph using the extrapolation tool to display to management the amount of money you have saved using this strategy after a period of 10 years.

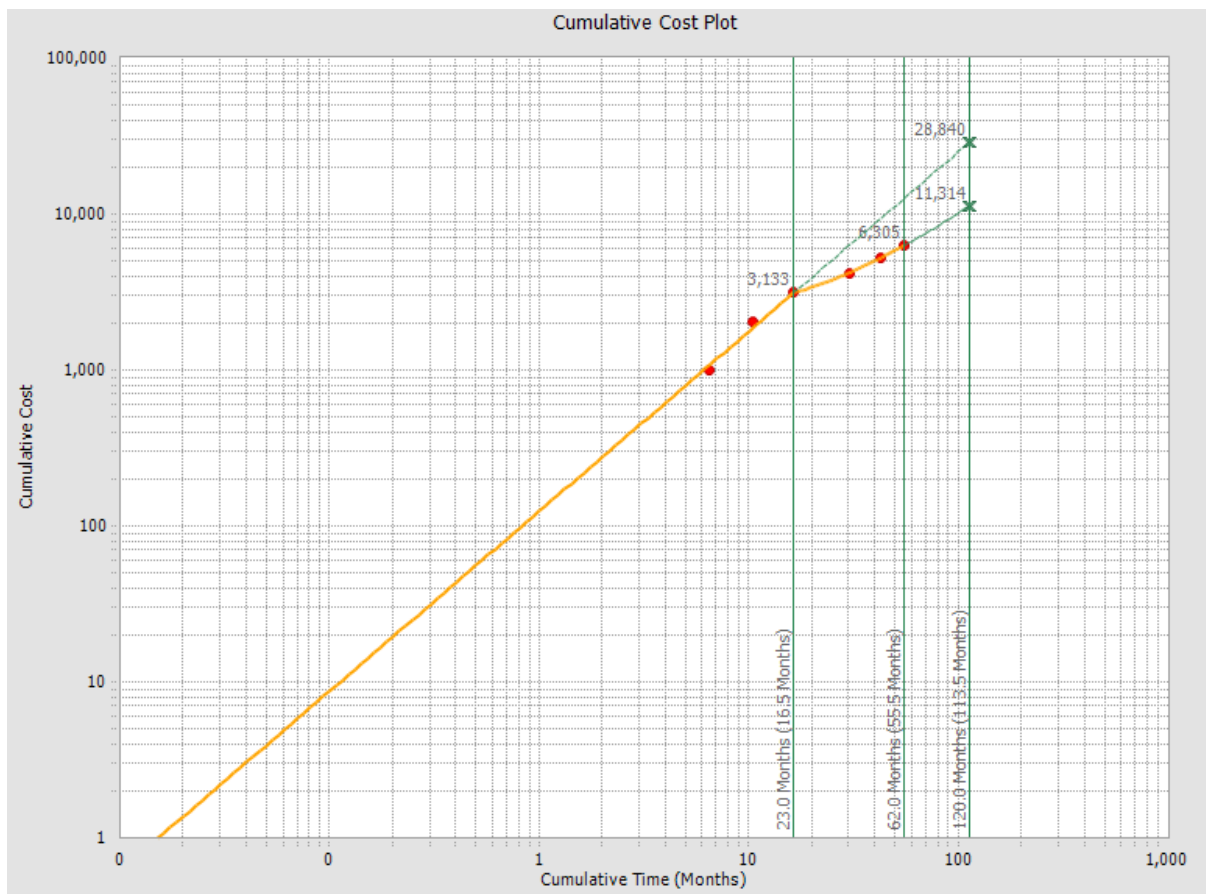

This image represents the extrapolation results for [Example 3](#), where we extrapolated using time. The x-axis represents the cumulative time, or the amount of time cost has been measured, using the units of months.

In this example, the analysis is [split into two segments](#) at the third failure, which occurred at 23 months, the time at which the strategy was implemented. The first segment represents the data without the strategy change, and the second segment represents the data with the strategy change. The dotted green extrapolation lines display the future data trend of each segment until the extrapolation time of 120 months, which was specified using the **Extrapolation** dialog box.

The solid green lines display the cumulative operating time (i.e., the total amount of time that cost has been measured) and the cumulative time (i.e., the amount of time that has passed since the analysis started) at the end of each segment and the extrapolation date. In this example, these lines represent the cost that had been incurred at the strategy change, the current amount of cost that has been incurred, and the future cost, respectively.

The following chart displays the amount of cost at each solid green line, which is represented in the graph by a gray number where a solid green line intersects a segment or extrapolation line.

Strategy	Cost at 23 months (time of strategy change)	Cost at 62 months (current time)	Cost at 120 months (extrapolation time)
Segment 1 (Without Strategy Change)	\$3,133	Not Displayed	\$28,840
Segment 2 (With Strategy Change)	\$3,133	\$6,305	\$11,314

At the extrapolation time for the first segment the number 28,840 is displayed, which means that if you had not made any changes after 23 months, you could have expected repairs to cost 28,840 dollars by the time 120 months had passed.

At the extrapolation time for the second segment the number 11,314 is displayed, which means that if you do not make any changes from your last cost measurement (62 months) until the future time (120 months), you can expect 11,314 dollars in cost to accumulate by that date.

Finally, an observation can be made that the change introduced at 23 months saved you 17,526 dollars between the time of 23 months and 120 months (i.e., 28,840 - 11,314).

Overview of the Reliability Growth Report

The baseline Meridium APM database includes the Reliability Growth Report, which you can use to view a summary of the results of a Reliability Growth Analysis. When you run the Reliability Growth Report, it will appear on the **Report Viewer** page.

The Reliability Growth Report is built from the following Catalog items:

- The main report, *GrowthAnalysisReport*, which is stored in the Catalog folder \\Public\Meridium\Modules\Reliability Manager\Reports.
- The subreport, *AssetsubreportGrowth*, which is stored in the Catalog folder \\Public\Meridium\Modules\Reliability Manager\Reports.
- The subreport, *FailuresubreportGrowth*, which is stored in the Catalog folder \\Public\Meridium\Modules\Reliability Manager\Reports.
- The supporting query that supplies data in the main report and subreports, *GrowthAnalysisQuery*, which is stored in the Catalog folder \\Public\Meridium\Modules\Reliability Manager\Reports.

Throughout this documentation, we refer to the main report, the subreports, and the supporting query collectively as the *Reliability Growth Report*.

The Reliability Growth Report contains a prompt on the ENTY_KEY field in the Reliability Growth family. When you run the Reliability Growth Report while viewing a Reliability Growth Analysis, the ENTY_KEY of the Reliability Growth record associated with the current analysis is passed automatically to the prompt, and the results for the current Reliability Growth Analysis are displayed. If you run the main report (i.e., *GrowthAnalysisReport*) or the supporting query (i.e., *GrowthAnalysisQuery*) directly from the Catalog, however, you will need to supply the ENTY_KEY of a Reliability Growth record manually to retrieve results. The subreports (i.e., Catalog items *AssetsubreportGrowth* and *FailuresubreportGrowth*) cannot be run directly from the Catalog.

The Reliability Growth Report contains the following sections:

- [Analysis Summary](#)
- [Growth Model Segments](#)
- [Assets](#)
- [<Measurement> Data](#)
- [Plots](#)

Running the Reliability Growth Report

You can run the Reliability Growth Report to view a summary of the results of a Reliability Growth Analysis.

To run the Reliability Growth Report:

1. On the **Reliability Growth Analysis** page, on the **Current Analysis** menu, click the **Generate Report** link.

The **Report Options** dialog box appears. The following image shows what the **Report Options** dialog box looks like by default.

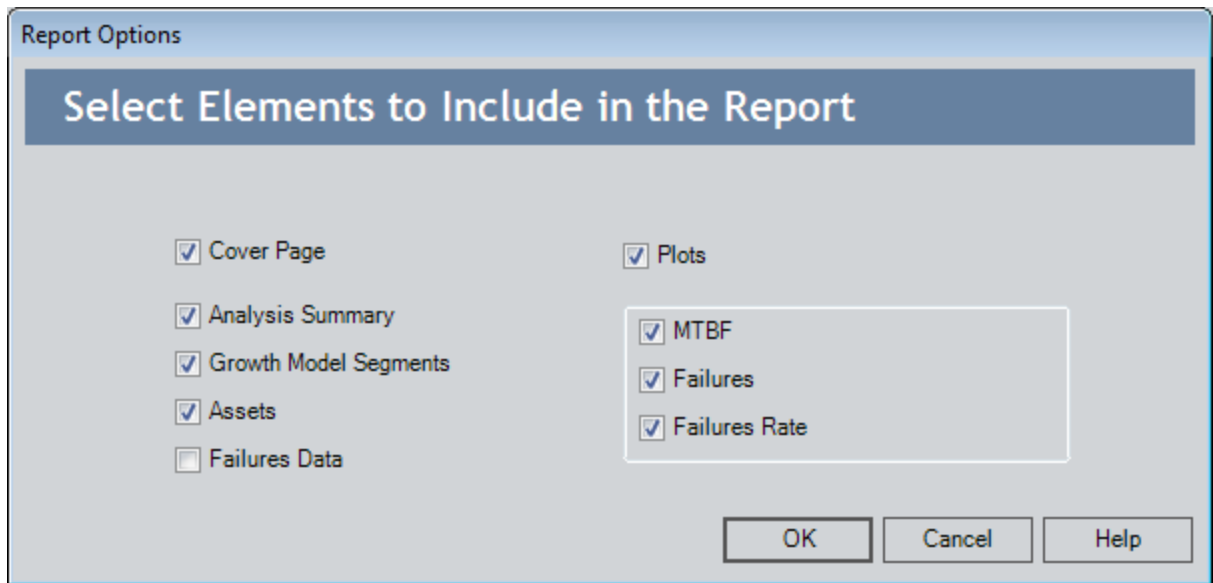

Note:The option labels displayed on this window may look different from this image, depending on the measurement name you selected on the **Select Data Format** screen of the **Reliability Growth Builder**.

2. Select the elements that you want to include in the report, and click **OK**.

The Reliability Growth Report appears on the **Report Viewer** page.

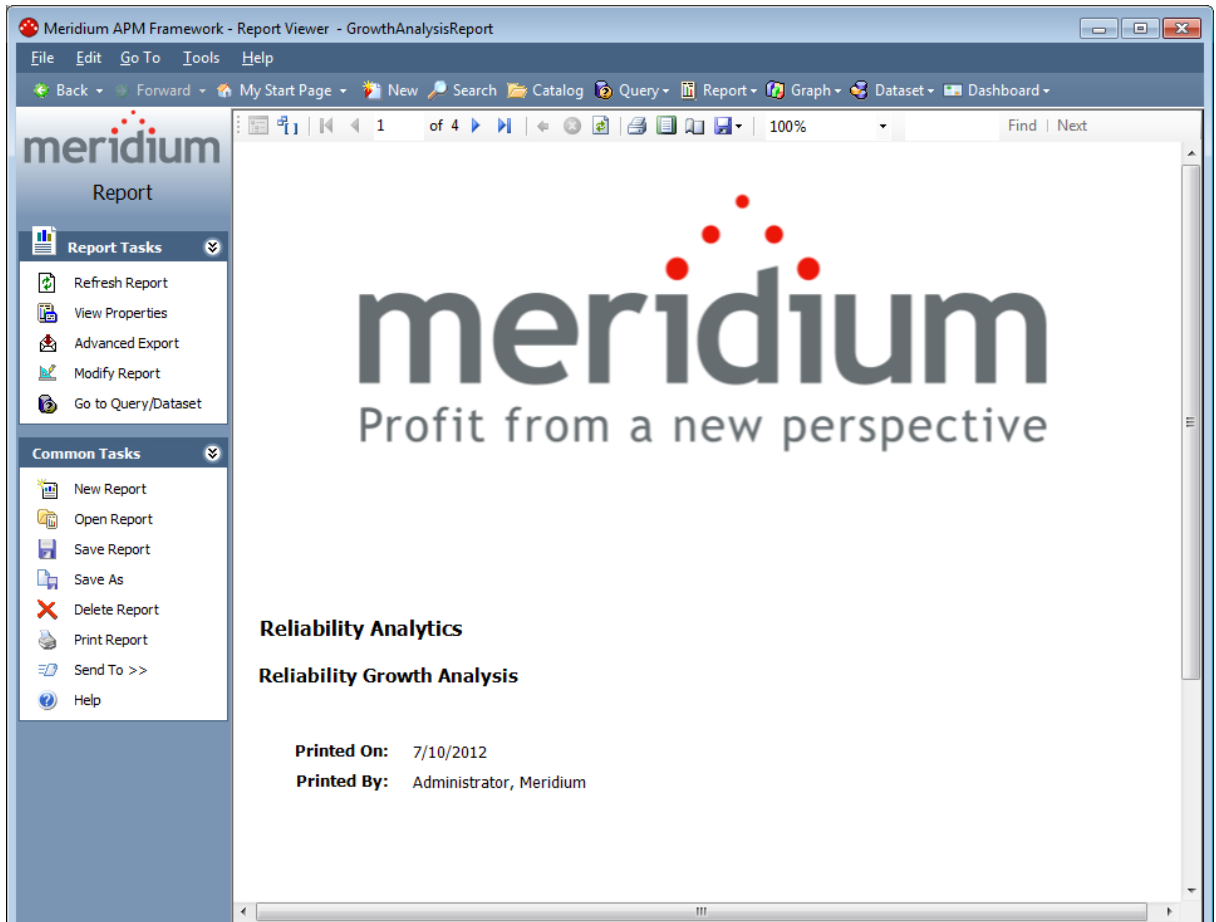

Analysis Summary Section

The **Analysis Summary** section of the Reliability Growth Report displays information that is stored in the Reliability Growth record and the Growth Model record that is linked to the Reliability Growth record. The **Analysis Summary** section will look different depending on whether or not your analysis data is event-based and the [value you enter in the Measurement Name dialog box](#). Also, the values in the **Analysis Summary** section will come from different fields in the Reliability Growth and Growth Model records depending on whether the analysis is based on dates or cumulative operating time.

The following image displays the **Analysis Summary** section for [Example 1](#), an analysis based on dates that contains event-based data.

Analysis Summary	
Analysis Name:	1051700 Centrifugal Pump Growth Analysis
Analysis Description:	
Analysis Start:	7/20/1998 9:36:00 AM
Analysis End:	1/30/2006
Number of Assets:	1
Total Failures:	14
Time Units:	Days
Observation Time:	2750.60 Days
Initial MTBF:	91.41 Days
Final MTBF:	248.78 Days
Next Estimated Event Date:	10/5/2006
Use Confidence	False
Confidence:	
Last Modified:	3/17/2011
Modified By:	Administrator, Meridium

The following table lists each item in the **Analysis Summary** section for an analysis based on dates that contains event-based data and the corresponding Reliability Growth or Growth Model record field whose data is displayed in the report.

Report Item	Reliability Growth or Growth Model record	Record field(s)	Notes
Analysis Name	Reliability Growth	Analysis ID	None

Report Item	Reliability Growth or Growth Model record	Record field(s)	Notes
Analysis Description	Reliability Growth	Short Description	None
Analysis Start	Reliability Growth	Analysis Start Date	If the analysis is based on cumulative operating time, the report will use the value in the field Analysis Start Time.
Analysis End	Reliability Growth	Analysis End Date	If the analysis is based on cumulative operating time, the report will use the value in the field Analysis End Time.
Number of Assets	Reliability Growth	Assets	None
Total <Measurement>	Growth Model	Number of Failures	None
Time Units	Reliability Growth	Time Units	None
Observation Time	Growth Model Reliability Growth	Total Observation Time Time Units	None
Initial MTBF	Reliability Growth	Initial MTBF Time Units	None
Final MTBF	Reliability Growth	Final MTBF Time Units	None
Next Estimated Event Date	Reliability Growth	TTNF Time Units	None
Use Confidence	Reliability Growth	Use Confidence	None
Confidence	Reliability Growth	Confidence Level	None

Report Item	Reliability Growth or Growth Model record	Record field(s)	Notes
Last Modified	Reliability Growth	LAST_UPDT_DT	None
Modified By	Reliability Growth	LAST_UPBY_SEUS_KEY	The name of the Security User associated with this value is displayed in the report.

The **Analysis Summary** section for an analysis that is not event-based will appear mostly the same as the **Analysis Summary** section for an analysis that is event-based, with the following exceptions.

- The Next Estimated Event Date field will not be displayed in the **Analysis Summary** section.
- The Initial MTBF and Final MTBF fields will be labeled *Initial <Measurement> Rate* and *Final Measurement Rate*, respectively.

Note: Although the values used in the report are stored in Reliability Growth or Growth Model records, the report contains additional logic in order to display the values in this format. In other words, the values in the records are not in the exact form in which they appear in the report.

Growth Model Segments Section

The **Growth Model Segments** section of the Reliability Growth Report displays information that is stored in the Reliability Growth record or the Growth Model record that is linked to the Reliability Growth record. The **Growth Model Segments** section will look different depending on whether the analysis is based on dates or cumulative operating time. The following image displays the **Growth Model Segments** section for [Example 1](#), an analysis based on dates.

Growth Model Segments								
Segment	Start Date	End Date	Termination Type	Beta	Lambda	Statistic	Critical Value	Passed
1	7/20/1998 9:36:00 AM	9/5/1999 4:48:00 AM	Event-Based	1.49	0.00	0.05	0.16	True
2	9/5/1999 4:48:00 AM	1/30/2006	Event-Based	1.04	0.00	0.10	0.17	True

The following table lists each item in the **Growth Model Segments** section for an analysis based on dates and the corresponding Reliability Growth or Growth Model record field whose data is displayed in the report.

Report Item	Reliability Growth or Growth Model record	Record field(s)	Notes
Segment	Growth Model	Sequence	None
Start Date	Growth Model	Model Start Date	None
End Date	Reliability Growth	Analysis End Date	None

Report Item	Reliability Growth or Growth Model record	Record field(s)	Notes
Termination Type	Reliability Growth	Is Grouped Data Time Terminated	<p>If the value in the Is Grouped Data field is <i>True</i>, the Termination Type is Grouped-Data. If the value is <i>False</i>, the Termination Type depends on the value in the Time Terminated field.</p> <p>If the value in the Time Terminated field is <i>False</i>, the Termination Type is Event-Based. If the value in this field is <i>True</i>, the Termination Type is Time-Based.</p>
Beta	Growth Model	Beta	None
Lambda	Growth Model	Lambda	None
Statistic	Growth Model	GOF Statistic	None
Critical Value	Growth Model	GOF P-Value	None
Passed	Growth Model	Passed GOF	None

The **Growth Model Segments** section for an analysis that contains cumulative operating time will appear mostly the same as the **Growth Model Segments** section for an analysis that contains dates, with the following exceptions.

- The Start Date and End Date fields will not be displayed in the **Growth Model Segments** section.
- The **Growth Model Segments** section will display the following fields.

Growth Model Segments Section

Report Item	Reliability Growth or Growth Model record	Record field(s)
Start Time	Reliability Growth	Analysis Start Time
End Time	Reliability Growth	Analysis End Time

Assets Section

The **Assets** section of the Reliability Growth Report displays values that are stored in the Failures field in the Reliability Growth record. The **Assets** section will look different depending on whether the analysis is based on dates or cumulative operating time. The following image displays the **Assets** section for [Example 1](#), an analysis based on dates.

Assets		
Asset ID	Installation Date	Last Replacement
000000000001051700		1/30/2006

The following columns in the **Assets** section contain data that is stored in the [Failures field](#) in the Reliability Growth record:

- Asset ID
- Installation Date

Note: The **Installation Date** column appears only for analyses based on dates.

- Last Replacement

<Measurement> Data Section

The <Measurement> Data section of the Reliability Growth Report displays information that is stored in the Failures field of the Reliability Growth record. The <Measurement> Data section will look different depending on whether the analysis is based on dates or cumulative operating time. It will also look different depending on the [value you enter in the Measurement Name dialog box](#). The following image displays the <Measurement> Data section for [Example 1](#), an analysis based on dates that has a measurement name of *Failures*.

Failures Data							
Asset ID	Date	Time	Downtime	Failures	Ignore	Remarks	Cumulative Time
0000000000 01051700							
	9/2/1992 2:24:00 AM	0.00	0.00	1	true		0
	2/26/1995 4:48:00 AM	0.00	0.00	1	true		0
	7/20/1998 9:36:00 AM	0.00	0.00	1	false		0
	12/14/1998 9:36:00 AM	147.00	0.00	1	false		147
	2/7/1999 9:36:00 AM	202.00	0.00	1	false		202
	6/26/1999 9:36:00 AM	341.00	0.00	1	false		341
	8/1/1999 2:24:00 AM	376.70	0.00	1	false		376.7
	9/5/1999 4:48:00 AM	411.80	0.00	1	false		411.8
	1/1/2001 4:48:00 AM	895.80	0.00	1	false		895.8
	1/2/2001	896.60	0.00	1	false		896.6
	2/7/2002	1297.60	0.00	1	false		1297.6
	7/11/2002 7:12:00 AM	1451.90	0.00	1	false		1451.9
	12/10/2002	1603.60	0.00	1	false		1603.6
	5/12/2003	1756.60	0.00	1	false		1756.6
	7/2/2003	1807.60	0.00	1	false		1807.6
	11/28/2005	2687.60	0.00	1	false		2687.6
	1/30/2006	2750.60	0.00	1	false		2750.6

The following columns in the <Measurement> Data section contain data that is stored in the [Failures field](#) in the Reliability Growth record:

- Asset ID
- Date
- Time

Note: The Time column appears only for analyses based on dates.

- Downtime

Note: The Downtime column appears only for analyses based on dates.

- COT

Note: The COT column appears only for analyses based on cumulative operating time.

- <Measurement>
- Ignore
- Remarks
- Cumulative Time

Plots Section

The **Plots** section of the Reliability Growth Report displays the graphs that are accessed via the **Plots** menu on the [Reliability Growth Analysis page](#). The following image displays an example of the **MTBF Trend** graph.

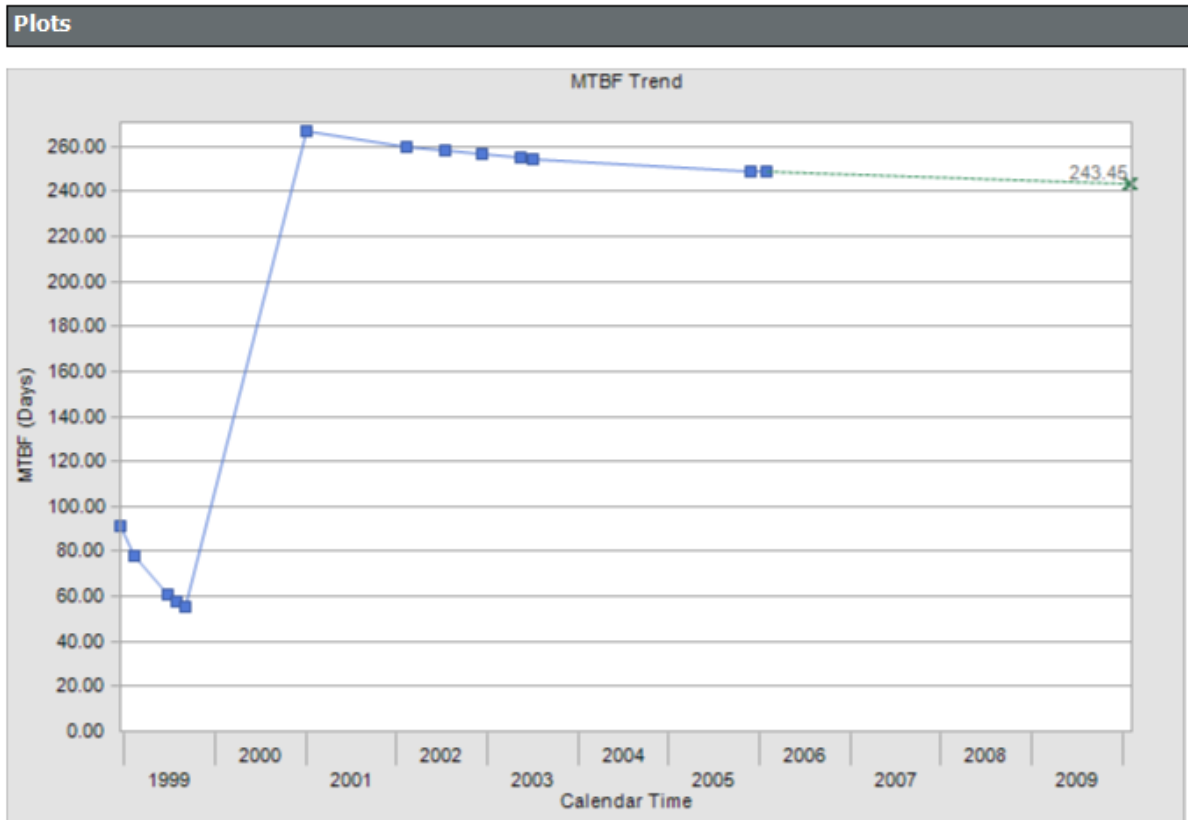

The **Plots** section contains the following graphs:

- [MTB<Measurement> Trend](#)
- [Cumulative <Measurement> Plot](#)
- [<Measurement> Rate Trend](#)

Overview of Reliability Distribution Analysis

A Reliability Distribution Analysis allows you to describe the Time to Failure (TTF) as a statistical distribution, which is usually characterized by a specific pattern. Four distribution types are supported: [Weibull](#), [Normal](#), [LogNormal](#), and [Exponential](#).

The Distribution Analysis characterizes how failures are distributed over the life of equipment. Analyzing the distribution of failures means examining a particular failure mode over one or multiple pieces of equipment. Generating a Distribution Analysis will help you find the answers to the following questions:

- Do most of the equipment failures occur early on?
- Does the equipment fail more at the end of its span of service?
- Are the failures fairly evenly distributed throughout the life of the equipment or randomly occurring?

In a Distribution Analysis, you are trying to determine the probability of failure at a certain point in time. The model assumes that the shape of the distribution is not changing over time. A Distribution Analysis can help you determine the pattern of failures, and the results can be compared to industry data.

If Time to Repair (TTR) information is available, a Distribution Analysis also will be calculated to describe the maintainability of the piece of equipment. PM Optimization and Failure Probability calculations can be performed on any piece of equipment that has a valid Time to Failure (TTF) distribution.

Weibull Distribution

A Weibull Distribution describes the type of failure mode experienced by the population (infant mortality, early wear out, random failures, rapid wear-out). Estimates are given for Beta (shape factor) and Eta (scale). MTBF (Mean Time Between Failures) is based on characteristic life curve, not straight arithmetic average.

A Weibull Distribution uses the following parameters:

- **Beta:** Beta, also called the shape factor, controls the type of failure of the element (infant mortality, wear-out, or random).
- **Eta:** Eta is the scale factor, representing the time when 63.2 % of the total population is failed.
- **Gamma:** Gamma is the location parameter that allows offsetting the Weibull distribution in time. The Gamma parameter should be used if the datapoints on the Weibull plot do not fall on a straight line.

If the value of Beta is greater than one (1), you can perform Preventative Maintenance (PM) Optimizations. A Gamma different from a value zero (0) means that the distribution is shifted in order to fit the datapoints more closely.

Note: This is an advanced feature and should be used in the proper context and with a good understanding of how to apply a three-parameter Weibull distribution.

Weibull Analysis Information

You can use the following information to compare the results of individual Weibull analyses. The following results are for *good* populations of equipment.

Beta Values Weibull Shape Factor						
Components	Low	Typical	High	Low (days)	Typical (days)	High (days)
Ball bearing	0.7	1.3	3.5	583	1667	10417
Roller bearings	0.7	1.3	3.5	375	2083	5208
Sleeve bearing	0.7	1	3	417	2083	5958
Belts drive	0.5	1.2	2.8	375	1250	3792
Bellows hydraulic	0.5	1.3	3	583	2083	4167
Bolts	0.5	3	10	5208	12500	4166667
Clutches friction	0.5	1.4	3	2792	4167	20833
Clutches magnetic	0.8	1	1.6	4167	6250	13875
Couplings	0.8	2	6	1042	3125	13875
Couplings gear	0.8	2.5	4	1042	3125	52083
Cylinders hydraulic	1	2	3.8	375000	37500	8333333
Diaphragm metal	0.5	3	6	2083	2708	20833
Diaphragm rubber	0.5	1.1	1.4	2083	2500	12500
Gaskets hydraulics	0.5	1.1	1.4	29167	3125	137500
Filter oil	0.5	1.1	1.4	833	1042	5208
Gears	0.5	2	6	1375	3125	20833
Impellers pumps	0.5	2.5	6	5208	6250	58333
Joints mechanical	0.5	1.2	6	58333	6250	416667
Knife edges fulcrum	0.5	1	6	70833	83333	695833
Liner recip. comp. cyl.	0.5	1.8	3	833	2083	12500
Nuts	0.5	1.1	1.4	583	2083	20833
"O"-rings elastomeric	0.5	1.1	1.4	208	833	1375
Packings recip. comp. rod	0.5	1.1	1.4	208	833	1375
Pins	0.5	1.4	5	708	2083	7083
Pivots	0.5	1.4	5	12500	16667	58333
Pistons engines	0.5	1.4	3	833	3125	7083
Pumps lubricators	0.5	1.1	1.4	542	2083	5208
Seals mechanical	0.8	1.4	4	125	1042	2083
Shafts cent. pumps	0.8	1.2	3	2083	2083	12500
Springs	0.5	1.1	3	583	1042	208333

Beta Values Weibull Shape Factor						
Vibration mounts	0.5	1.1	2.2	708	2083	8333
Wear rings cent. pumps	0.5	1.1	4	417	2083	3750
Valves recip comp.	0.5	1.4	4	125	1667	3333
Equipment Assemblies	Low	Typical	High	Low (days)	Typical (days)	High (days)
Circuit breakers	0.5	1.5	3	2792	4167	58333
Compressors centrifugal	0.5	1.9	3	833	2500	5000
Compressor blades	0.5	2.5	3	16667	33333	62500
Compressor vanes	0.5	3	4	20833	41667	83333
Diaphragm couplings	0.5	2	4	5208	12500	25000
Gas turb. comp. blades/vanes	1.2	2.5	6.6	417	10417	12500
Gas turb. blades/vanes	0.9	1.6	2.7	417	5208	6667
Motors AC	0.5	1.2	3	42	4167	8333
Motors DC	0.5	1.2	3	4	2083	4167
Pumps centrifugal	0.5	1.2	3	42	1458	5208
Steam turbines	0.5	1.7	3	458	2708	7083
Steam turbine blades	0.5	2.5	3	16667	33333	62500
Steam turbine vanes	0.5	3	3	20833	37500	75000
Transformers	0.5	1.1	3	583	8333	591667
Instrumentation	Low	Typical	High	Low (days)	Typical (days)	High (days)
Controllers pneumatic	0.5	1.1	2	42	1042	41667
Controllers solid state	0.5	0.7	1.1	833	4167	8333
Control valves	0.5	1	2	583	4167	13875
Motorized valves	0.5	1.1	3	708	1042	41667
Solenoid valves	0.5	1.1	3	2083	3125	41667
Transducers	0.5	1	3	458	833	3750
Transmitters	0.5	1	2	4167	6250	45833
Temperature indicators	0.5	1	2	5833	6250	137500
Pressure indicators	0.5	1.2	3	4583	5208	137500
Flow instrumentation	0.5	1	3	4167	5208	416667
Level instrumentation	0.5	1	3	583	1042	20833
Electro-mechanical parts	0.5	1	3	542	1042	41667
Static Equipment	Low	Typical	High	Low (days)	Typical (days)	High (days)
Boilers condensers	0.5	1.2	3	458	2083	137500
Pressure vessels	0.5	1.5	6	52083	83333	1375000
Filters strainers	0.5	1	3	208333	208333	8333333

Beta Values Weibull Shape Factor						
Check valves	0.5	1	3	4167	4167	52083
Relief valves	0.5	1	3	4167	4167	41667
Service Liquids	Low	Typical	High	Low (days)	Typical (days)	High (days)
Coolants	0.5	1.1	2	458	625	1375
Lubricants screw compr.	0.5	1.1	3	458	625	1667
Lube oils mineral	0.5	1.1	3	125	417	1042
Lube oils synthetic	0.5	1.1	3	1375	2083	10417
Greases	0.5	1.1	3	292	417	1375

Weibull Results Interpretation

Meridium APM Reliability shows the failure pattern of a single piece of equipment or groups of like equipment using Weibull analysis methods. This helps the user to determine the appropriate repair strategy to improve reliability.

Is the Probability Plot a good fit?

Follow these steps to determine whether or not the plot is a good fit:

- Identify Beta (slope) and its associated failure pattern
- Compare Eta (characteristic life) to standard values
- Check [goodness of fit](#), compare with Weibull database
- Make a decision about the nature of the failure and its prevention

The following chart demonstrates how to interpret the Weibull analysis data using the Beta parameter, Eta parameter and typical failure mode to postulate a failure cause.

Weibull Results			Interpretation
Beta	Eta	Typical Failure Mode	Failure Cause
Greater than 4	Low compared with standard values for failed parts (less than 20%)	Old age, rapid wear out (systematic, regular)	Poor machine design
Greater than 4	Low compared with standard values for failed parts (less than 20%)	Old age, rapid wear out (systematic, regular)	Poor material selection
Between 1 and 4	Low compared with standard values for failed parts (less than 20%)	Early wear out	Poor system design
Between 1 and 4	Low	Early wear out	Construction problem
Less than 1	Low	Infant Mortality	Inadequate maintenance procedure

Weibull Results Interpretation

Weibull Results			Interpretation
Between 1 and 4	Between 1 and 4	Less than manufacturer recommended PM cycle	Inadequate PM schedule
Around 1	Much less than	Random failures with definable causes	Inadequate operating procedure

Goodness of Fit (GOF) Tests for a Weibull Distribution

A Goodness of Fit test is a statistical test that determines whether the analysis data follows the distribution model.

- If the data passes the Goodness of Fit test, it means that it follows the model pattern closely enough that predictions can be made based on that model.
- If the data fails the Goodness of Fit test, it means that the data does not follow the model closely enough to confidently make predictions and that the data does not appear to follow a specific pattern.

Weibull results are valid if Goodness of Fit (GOF) tests are satisfied. Goodness of Fit tests for a Weibull distribution include the following types:

- **R²Linear regression (least squares):** An R-Squared test statistic greater than 0.9 is considered a good fit for linear regression.
- **Kolmogorov-Smirnov:** The Meridium APM system uses confidence level and P-Value to determine if the data is considered a good fit. If the P-Value is greater than 1 minus the confidence level, the test passes.

Note:The R-Squared test statistic is calculated only for reference. The Meridium APM system uses the Kolmogorov-Smirnov test as the Goodness of Fit test.

Normal Distribution

A Normal Distribution describes the spread of data values through the calculation of two parameters: mean and standard deviation. When using the Normal Distribution on time to failure data, the mean exactly equals MTBF and is a straight arithmetic average of failure data. Standard deviation (denoted by sigma) gives estimate of data spread or variance.

A Normal Distribution uses the following parameters:

- **Mean:** The mean is the arithmetic average of the datapoints.
- **Standard Deviation:** The Standard Deviation value represents the scatter (how tightly the datapoints are clustered around the mean).

Lognormal Distribution

In Lognormal Distributions of failure data, two parameters are calculated: Mu and Sigma. These do not represent mean and standard deviation, but are used to calculate MTBF. In Lognormal analysis, the median (antilog of mu) is often used as the MTBF. The standard deviation factor (antilog of sigma) gives the degree of variance in the data.

A Lognormal Distribution uses the following parameters:

- **Mu:** Mu presents the logarithmic average for the Distribution function.
- **Sigma:** Sigma represents the scatter.
- **Gamma:** Gamma is a location parameter.

Exponential Distribution

An Exponential Distribution is a mathematical distribution that describes a purely random process. It is a single parameter distribution where the mean value describes MTBF (Mean Time Between Failures). It is simulated by the Weibull distribution for value of Beta = 1. When applied to failure data, the Exponential distribution exhibits a constant failure rate, independent of time in service. The Exponential Distribution is often used in reliability modeling, when the failure rate is known but the failure pattern is not.

An Exponential Distribution uses the following parameter:

- **MTBF:** The Exponential Distribution is a single parameter distribution where the mean value describes MTBF.

Failure Data

The following table shows the typical data required for building a Reliability Distribution Analysis in Meridium APM.

Data Needed	Description	Notes
Asset ID	Select a field that uniquely describes a piece of equipment, such as <i>Equipment ID</i> . Reliability analysis can be conducted on any number of equipment.	Select a text field. This is a required field.
Installation Date	Select the field that contains the date on which the piece of equipment was installed.	This field is optional. Select a date field.
Failure Date	Select the field that contains the last date on which the piece of equipment failed. This data can have many different descriptions (e.g., Out of Service Date, Shutdown Date, or Failure Date).	Select a text field. This is a required field.
Failure Mode	Sometimes users put failed parts in this field, or even a description like "worn out" or "broke down". These descriptions can be very useful when deciding to include or not include a particular failure in the failure history for purposes of censoring.	Needed for Distribution analysis only.
Downtime	If this information is available, it can be used to make the estimation more accurate. Fields like "return to service date" or "date repaired" can be used to estimate downtime.	This field is optional.
Time Units	Select the Downtime time units.	

Confidence Level and P-Value

In a Distribution Analysis, the Confidence Level and the P-Value are used to determine whether the data passes the Goodness of Fit test.

The Confidence Level indicates the percentage of uncertainty of the Goodness of Fit method. This percentage is usually determined by experience or an industry standard and limits how closely the data must fit the model in order for it to pass the Goodness of Fit test. The higher the Confidence Level, the farther apart your confidence bounds will be, and the easier it will be for your data to pass the Goodness of Fit test. The lower the Confidence Level and the closer together the bounds are, the harder it will be for your data to pass the Goodness of Fit test. If the data does pass, however, the data will be a very close fit to the model.

Note: When you [enter a Confidence Level](#), you must specify a value that is greater than one (1) but less than one hundred (100).

The following images show examples of the same graph with a Confidence Level of 90% and 10%, with the confidence bounds represented by green lines. At a 90% confidence level the confidence bounds are farther apart, most of the data falls inside the bounds, and the GOF test is passed. At a 10% confidence level, the confidence bounds are closer together, most of the data falls outside the bounds, and the GOF test is failed.

Confidence Level = 90%

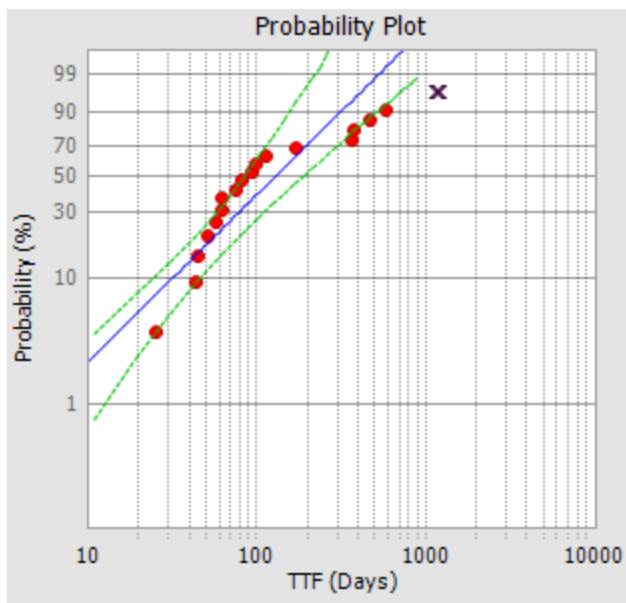

Confidence Level = 10%

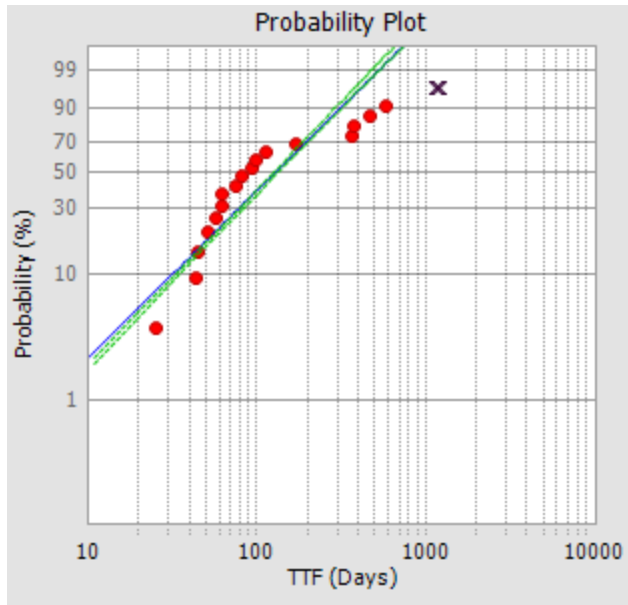

The P-value indicates the probability that the data fits the selected model. If you have a P-value of 0.01 , then there is a 1% probability that the data is compatible with the model, or conversely, that there is a 99% probability that the model is not in agreement with the data. If you have a P-value of 0.95 , there is a 95% probability that the model is appropriate.

To calculate whether the Goodness of Fit test has passed or failed, you need both the confidence level and the P-value. If the P-value is less than or equal to 1 minus the confidence level, the fit test has failed and you should reject the distribution model at the chosen confidence level. Otherwise, the fit is successful and you should accept the distribution model at the chosen confidence level.

For example, suppose you have a P-Value of 99% (i.e., 0.99) and a confidence level of 90% (i.e., 0.90). The following equation demonstrates that the Goodness of Fitness test is passed.

$$\text{P-Value} > 1 - \text{confidence level}$$

$$0.99 > 1 - 0.90$$

$$.99 > 0.10$$

Accessing the List of Reliability Distribution Analyses

To display the list of existing Reliability Distribution Analyses:

- On the [Reliability Analytics Start Page](#), click the **Reliability Distribution** link.

The **Select a Distribution Analysis from the List** page appears.

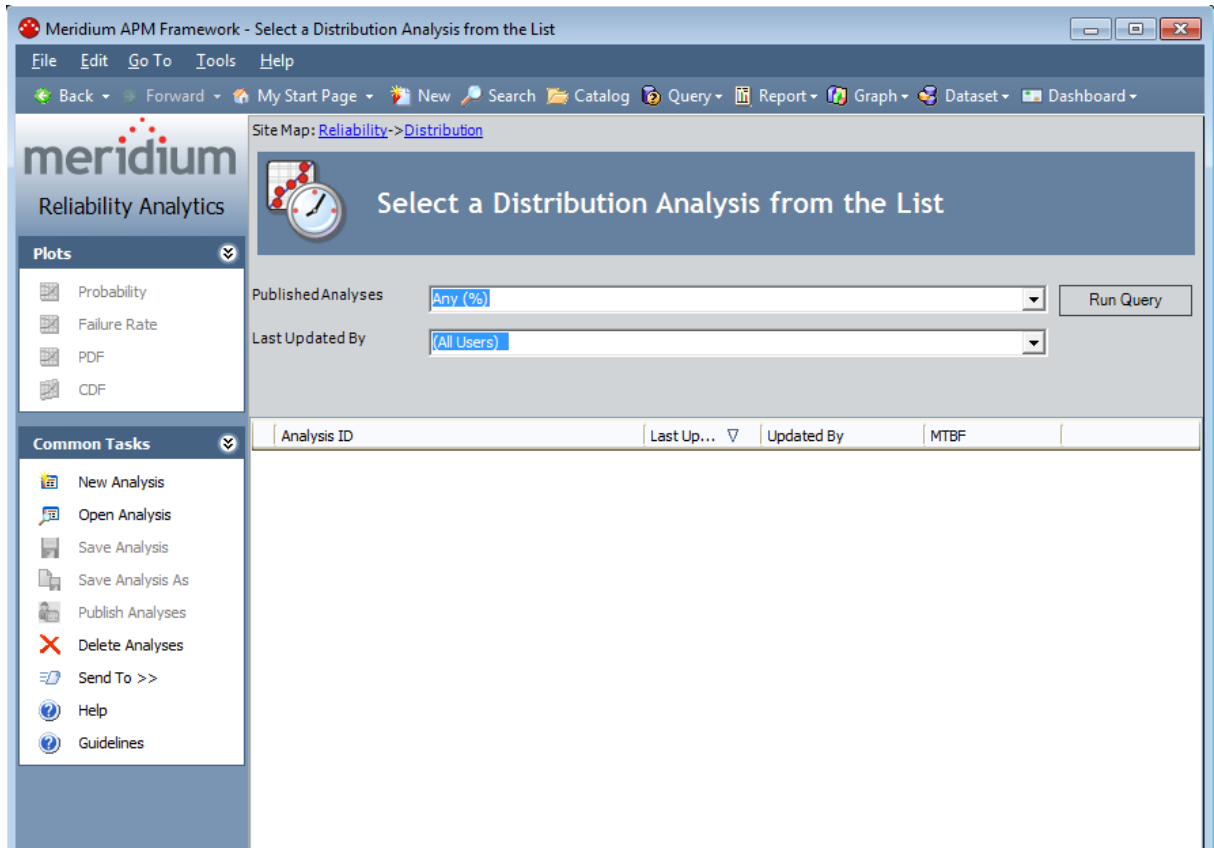

From the **Select a Distribution Analysis from the List** page, you can run the Reliability Distribution query to view a list of existing Reliability Distribution Analyses and then access the summary for any analysis. Alternatively, you can click the **New Analysis** link on the [Common Tasks](#) menu to begin the process of [creating a new Reliability Distribution Analysis](#).

Aspects of the Reliability Distribution Analysis List

The [Select a Distribution Analysis from the List page](#) lets you run the Reliability Distribution query to access a list of existing Reliability Distribution Analyses that meet your query criteria.

The screenshot shows the Meridium APM Framework interface. The main content area is titled "Select a Distribution Analysis from the List". Below the title, there are two drop-down menus: "Published Analyses" set to "Any (%)" and "Last Updated By" set to "(All Users)". A "Run Query" button is located to the right of these menus. Below the filters is a table with the following columns: Analysis ID, Last Up..., Updated By, and MTBF. The table contains 15 rows of data, all with a "Last Up..." date of 3/17/2011 and an "Updated By" of "Administrator, Meridium".

Analysis ID	Last Up...	Updated By	MTBF
G0014-037 Seal Failures	3/17/2011	Administrator, Meridium	727.298793498901
E0035-023 INTERNAL - TUBES	3/17/2011	Administrator, Meridium	227.274685240284
E0321-094 INTERNAL - TUBES	3/17/2011	Administrator, Meridium	2582.2307891736
E0319-094 INTERNAL - TUBES	3/17/2011	Administrator, Meridium	0
E0317-094 INTERNAL - TUBES	3/17/2011	Administrator, Meridium	0
E0315-094 INTERNAL - TUBES	3/17/2011	Administrator, Meridium	0
E0313-094 INTERNAL - TUBES	3/17/2011	Administrator, Meridium	1543.97211501119
E0201-094 INTERNAL - TUBES	3/17/2011	Administrator, Meridium	0
E0139-094 INTERNAL - TUBES	3/17/2011	Administrator, Meridium	0
E0136-094 INTERNAL - TUBES	3/17/2011	Administrator, Meridium	0
E0135-094 INTERNAL - TUBES	3/17/2011	Administrator, Meridium	0
E0124-050 INTERNAL - TUBES	3/17/2011	Administrator, Meridium	0
E0124-050 EXTERNAL - CHANNEL	3/17/2011	Administrator, Meridium	0
E0122-050 INTERNAL - TUBES	3/17/2011	Administrator, Meridium	0

The Reliability Distribution query is stored in the Meridium APM Catalog folder \\Public\Meridium\Modules\Reliability Manager\Analyses. While the Reliability Distribution query can be [customized](#) for your specific implementation, the baseline Reliability Distribution query contains two prompts: **Published Analyses** and **Last Updated By**. These prompts appear at the top of the page as drop-down lists that contain the various options.

The **Published Analyses** list contains the following options:

- **Any (%):** Will cause the query to return all Reliability Distribution Analyses, either published or unpublished.
- **Yes (Y):** Will cause the query to return only published Reliability Distribution Analyses.
- **No (N):** Will cause the query to return only unpublished Reliability Distribution Analyses.

The **Last Updated By** list contains the following options:

- Your user name, which is selected by default and will cause the query to return only the Reliability Distribution Analyses that were last updated by you.
- The user name of any user who last updated any Reliability Distribution Analysis, which will cause the query to return only the Reliability Distribution Analyses that were last updated by that user.
- The **[All Users]** option, which will cause the query to return a list of Reliability Distribution Analyses updated by any user.

Each time you access the **Select a Distribution Analysis from the List** page, the values that appear by default in the prompts will be used to filter the list. After you select different criteria, you can click the **Run Query** button to run the Reliability Distribution query and display the results in a grid at the bottom of the page.

Note: Although the results are returned by the Reliability Distribution query, query page size is ignored. The entire list of analyses is displayed at once.

The default Reliability Distribution query is configured to display the following columns of information: **Analysis ID**, **Last Updated**, **Updated By**, and **MTBF**. You can click any hyperlinked analysis ID to [view the associated analysis summary](#). In addition, you can use the option on the [Plots menu](#) and the **Common Tasks** menu to perform various tasks for the analyses in the list.

CE Hint: If desired, you can customize the column display.

Plots Menu

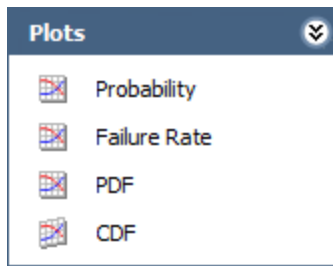

The **Plots** menu on the **Select a Distribution Analysis from the List** page contains the following links:

- **Probability:** If you select a single analysis, this link displays the [Probability Plot](#) of that analysis on the **Probability Plot** page. If you selected multiple analyses, this link displays the Probability Plots of those analyses on the **Multiple Distributions Plot** page.
- **Failure Rate:** If you select a single analysis, this link displays the [Failure Rate Plot](#) of that analysis on the **Probability Density Function** page. If you selected multiple analyses, this link displays the Failure Rate Plots of those analyses on the **Multiple Distributions Plot** page.
- **PDF:** If you select a single analysis, this link displays the [Probability Density Function Plot](#) of that analysis on the **Probability Density Function** page. If you selected multiple analyses, this link displays the Probability Density Function Plots of those analyses on the **Multiple Distributions Plot** page.
- **CDF:** If you select a single analysis, this link displays the [Cumulative Density Function Plot](#) of that analysis on the **Probability Density Function** page. If you selected multiple analyses, this link displays the Cumulative Density Function Plots of those analyses on the **Multiple Distributions Plot** page.

Common Tasks Menu

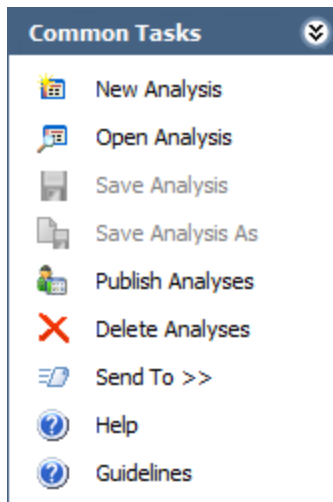

The **Common Tasks** menu on the **Select a Distribution Analysis from the List** page contains the following links:

- **New Analysis:** Displays the **Reliability Distribution Builder**, which guides you through the process of [creating a new Reliability Distribution Analysis](#).
- **Open Analysis:** Lets you [locate an existing Reliability Distribution analysis](#) using the **Find a Reliability Distribution Analysis** window.
- **Publish Analyses:** [Publishes](#) the selected analysis or analyses. If you select one or more analyses that are already published, this link reads **Unpublish Analyses** and will [unpublish](#) the selected analysis.
- **Delete Analyses:** Deletes the currently displayed analysis.
- **Send To:** Displays a submenu with options that let you provide a link to the current page on your desktop (create shortcut), in an email message, or on a Home Page.
- **Help:** Displays the context-sensitive Help topic for the **Select a Distribution Analysis from the List** page.
- **Guidelines:** Displays the Reliability Concepts, which provide reliability workflows and descriptions of reliability concepts.

Note: The **Save Analysis** and **Save Analysis As** links are always disabled.

Opening an Existing Reliability Distribution Analysis

To open a Reliability Distribution Analysis summary:

1. On the [Reliability Analytics Start Page](#), click the **Reliability Distribution** link.

The [Select a Distribution Analysis from the List](#) page appears.

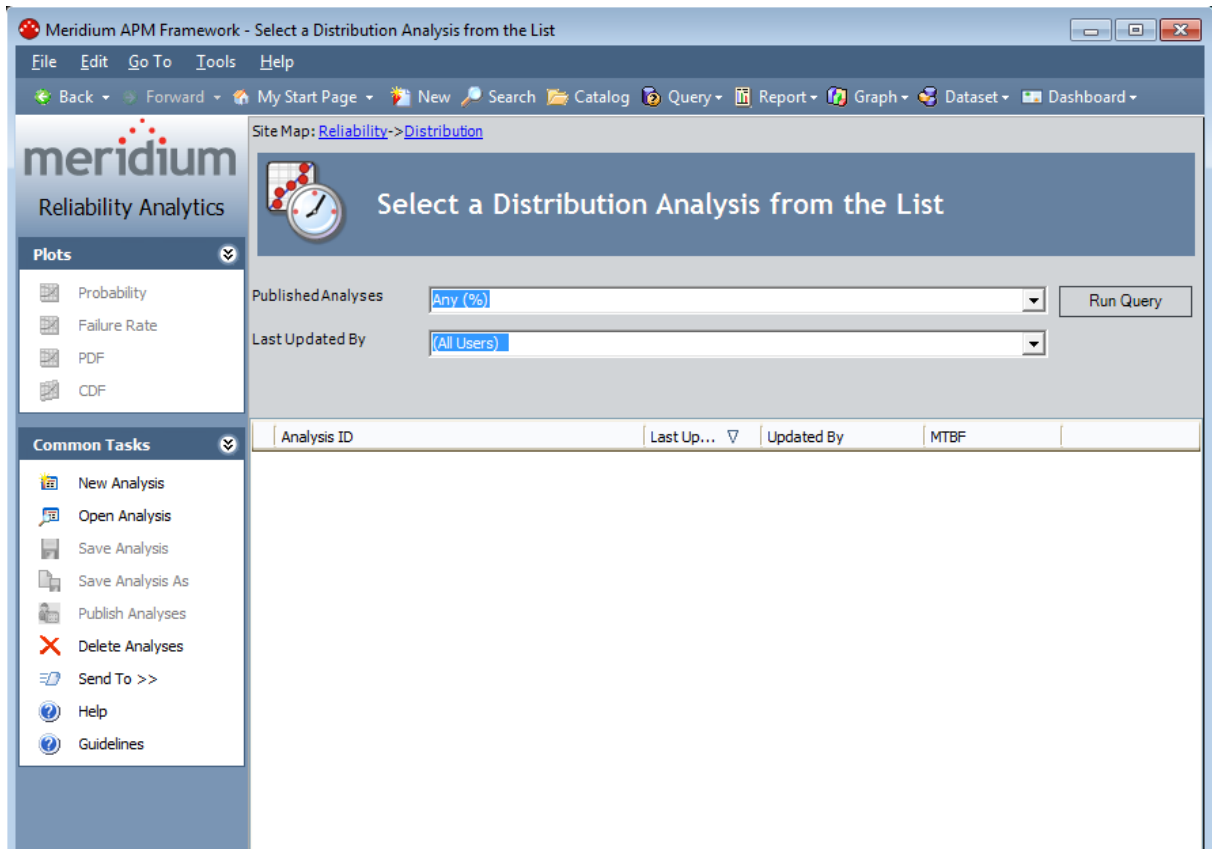

2. At the top of the page, in the fields provided, select the criteria that you want to use for limiting the list of Distribution Analyses. The available criteria will vary, depending on how the Reliability Distribution query has been configured.

3. Click the **Run Query** button.

Meridium APM runs the Reliability Distribution query and displays the results in the grid at the bottom of the page.

4. In the **Analysis ID** column, click the analysis ID of the analysis that you want to open.

The **Reliability Distribution Summary** page appears.

Opening an Existing Reliability Distribution Analysis

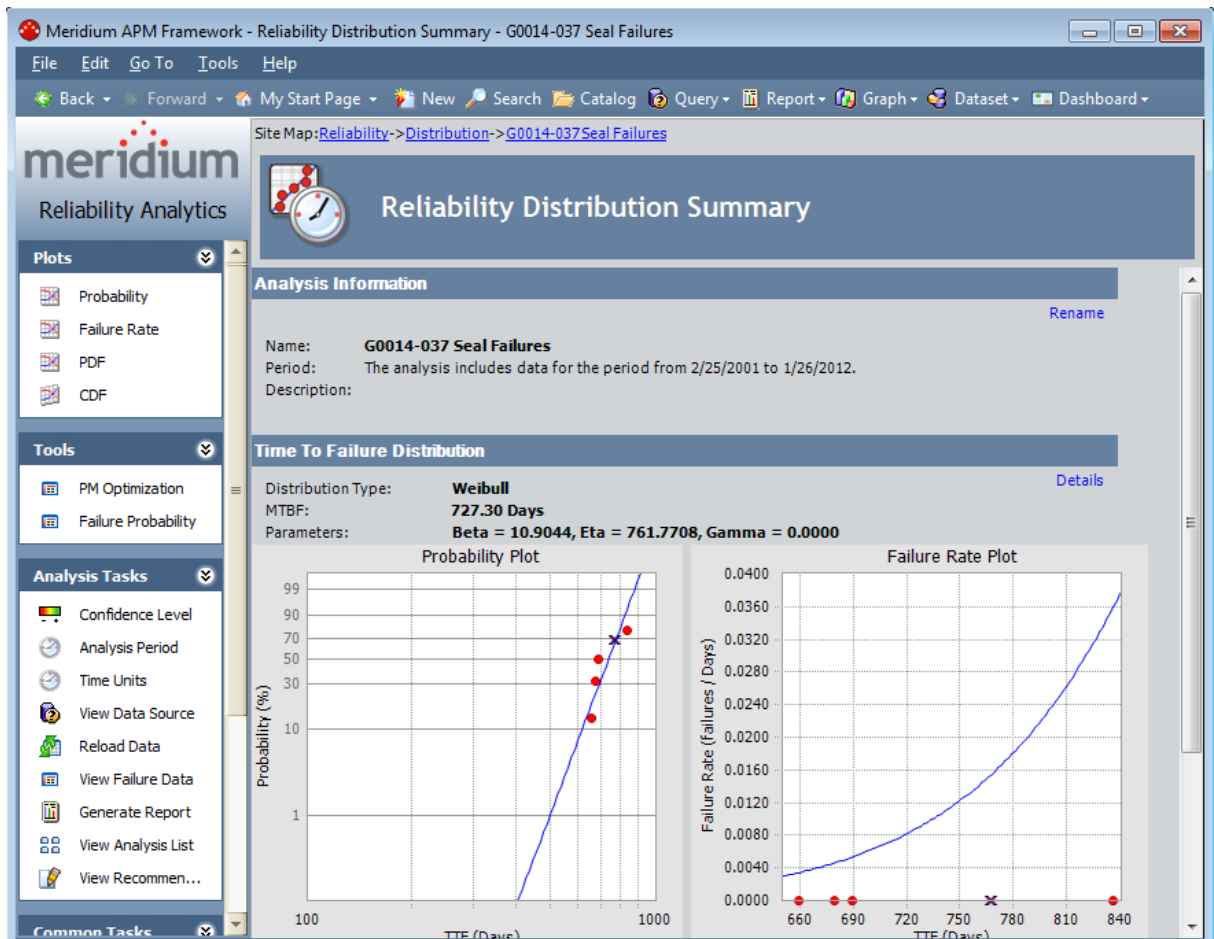

When you open an existing analysis, the analysis will display the data and calculations that were last [saved](#) with the analysis. If you want to reload the underlying query or dataset and update calculations based on any changes to the underlying data, you must [reload the analysis](#) after opening it.

Opening Multiple Existing Distribution Analyses

To open multiple existing Distribution Analyses:

1. On the [Select a Distribution Analysis from the List page](#), at the top of the page, in the **Last Updated By** list, select the user for which you want to return a list of Production Analyses.

Note: Additional fields may appear if the baseline query has been modified. If additional fields are available, use them to limit the query results as desired.

2. Click the **Run Query** button.

Meridium APM runs the **Reliability Distribution** query and displays the results in the grid in the main display area.

3. Select the rows containing the Distribution Analyses that you want to open.
4. On the **Plots** menu, click the link for the desired graph for which you want to view the selected analyses:
 - [Probability plot](#)
 - [Failure Rate plot](#)
 - [PDF plot](#)
 - [CDF plot](#)

The selected analyses appear on the **Multiple Distributions Plot** page, displaying the corresponding plot for which you selected.

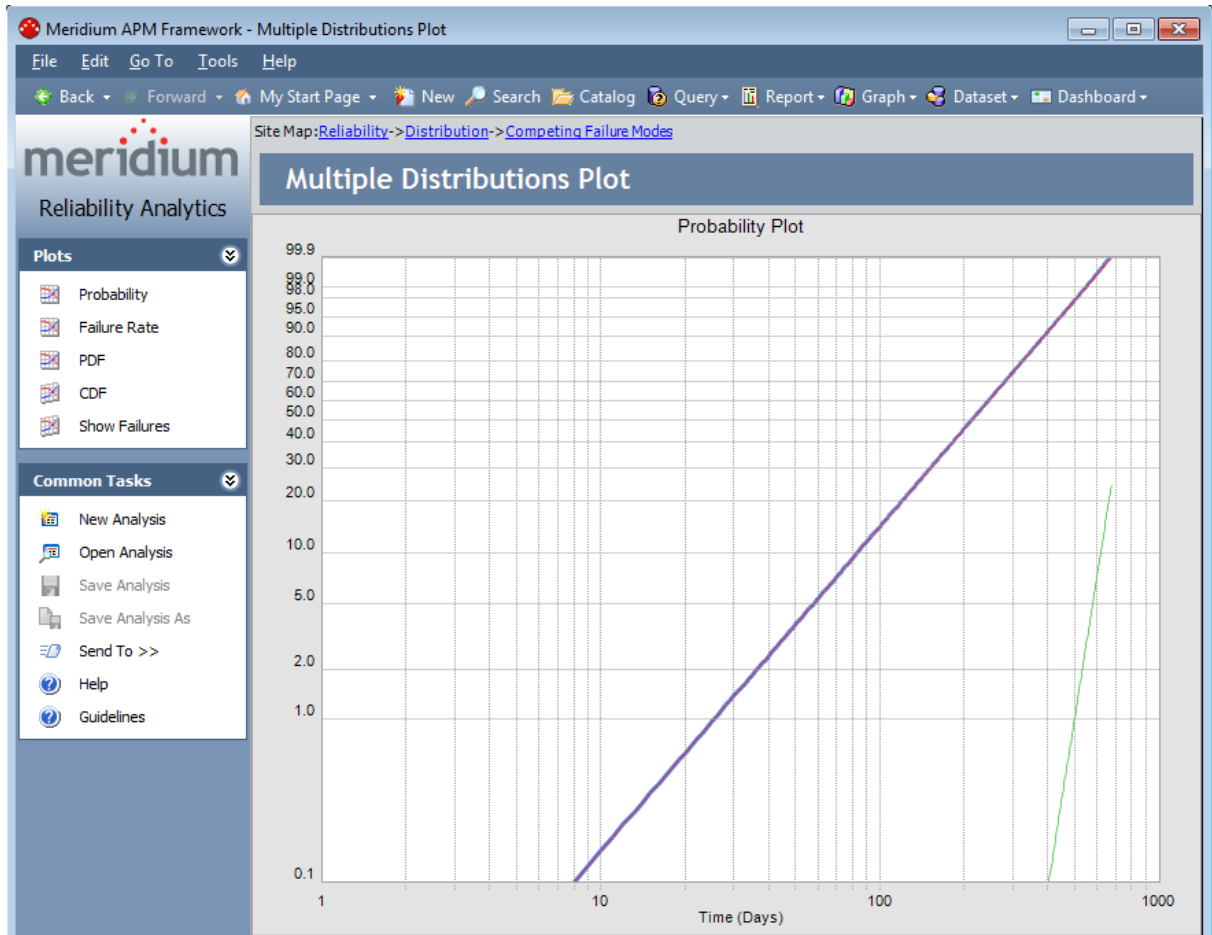

From the **Multiple Distributions Plot** page, you can:

- View the details of a specific analysis by clicking the desired plot and *that* analysis will open on the [Reliability Distribution Summary page](#).
- Point to a plot to display the name of the analysis that the plot represents, the distribution type, MTBF, Beta, Eta, gamma, and R2.
- Customize the **Multiple Distributions Plot** page using the standard graph toolbar or the annotation toolbar.
- Click the link to another corresponding plot on the **Plots** menu for which you want to view the same highlighted Distribution analyses.
- Click the **Show Failures** link on the **Plots** menu to view the failure dates for each analysis. You can then pause on a failure datapoint to view the name of the analysis, name of the piece of equipment, date of the failure, and the TTF.
- Click the **New Analysis**, **Open Analysis**, **Send To**, **Help**, or the **Guidelines** links on the [Common Tasks menu](#).

Using the Reliability Distribution Builder

Using the **Reliability Distribution Builder**, you can create a new Distribution Analysis:

- [Based on a new or existing query or dataset.](#)
- [From manually entered data.](#)

You can access the **Reliability Distribution Builder** from the [Select a Distribution Analysis from the List](#) page or the [Reliability Distribution Summary page](#).

Creating a Distribution Analysis from a Query or Dataset

To create a new Distribution analysis based on a new or existing query or dataset:

1. On the [Reliability Distribution Summary page](#) or the [Select a Distribution Analysis from the List](#) page, on the **Common Tasks** menu, click the **New Analysis** link.

The **Reliability Distribution Builder** appears, displaying the Welcome screen.

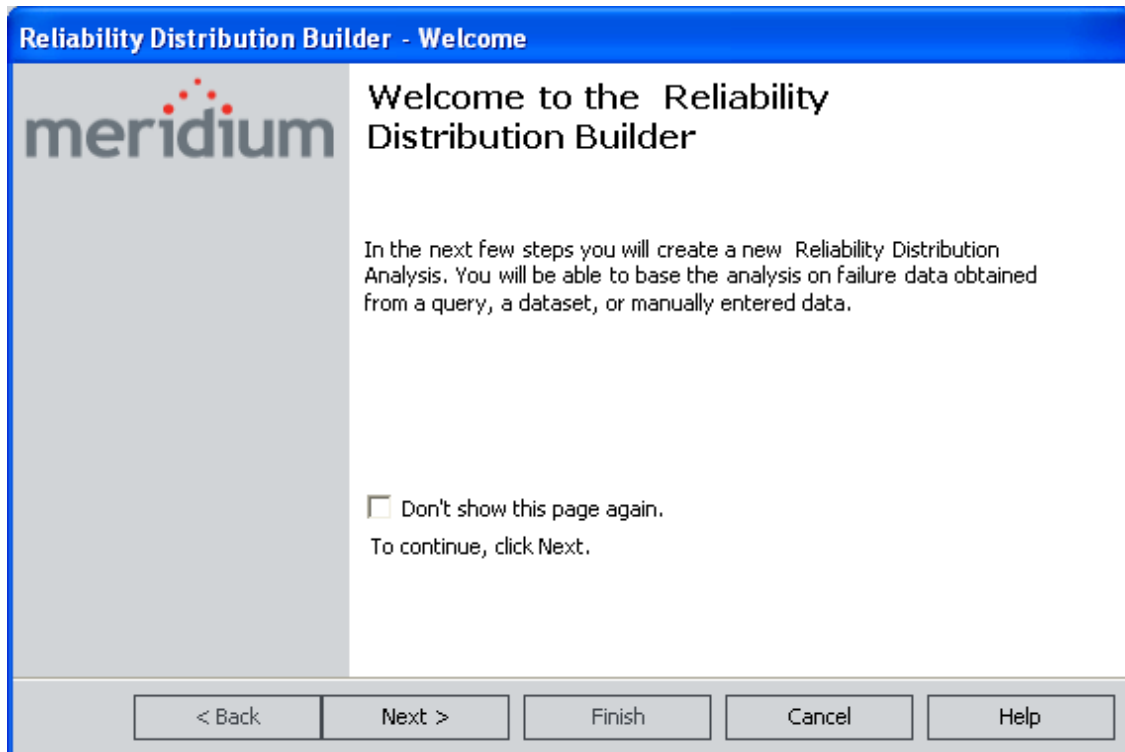

CEHint: If you do not want to view this screen the next time that you access the builder, select the **Don't show this page again** check box.

2. Click the **Next** button.

The **Select Data Source Type** screen appears.

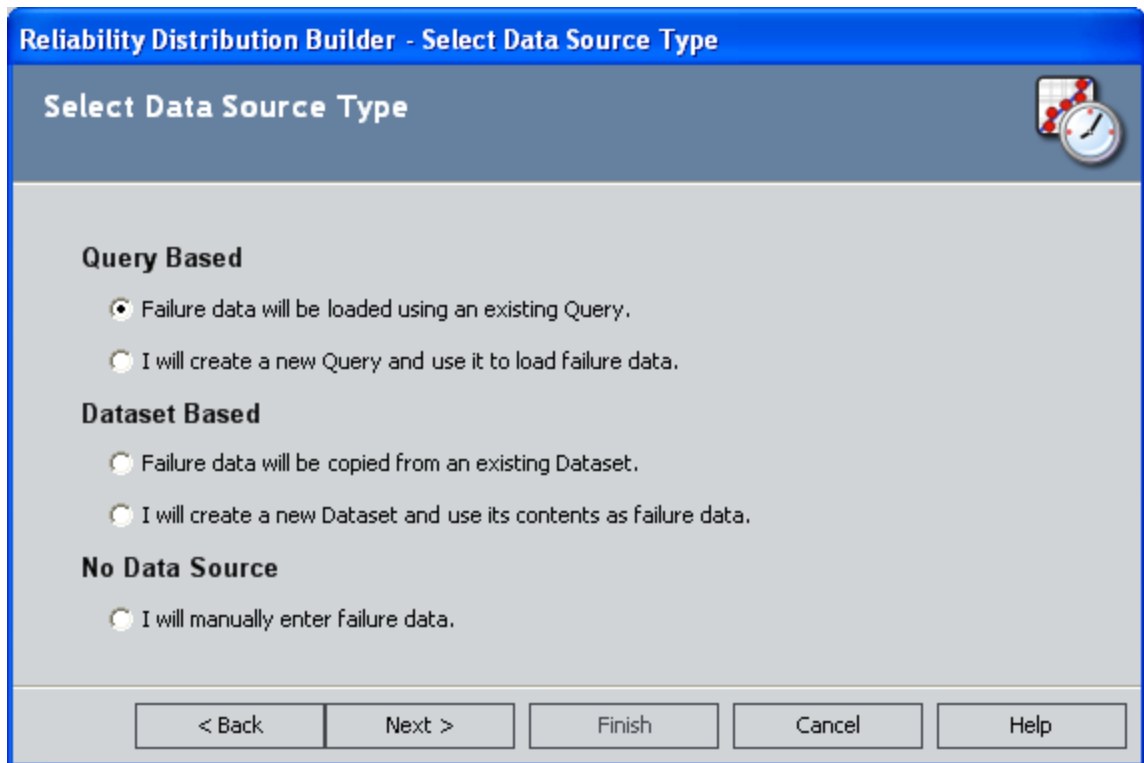

3. Select one of the following options:

- **Failure data will be loaded using an existing Query.** If you select this option, when you click the **Next** button, you will be asked to find and select the desired query in the Catalog.
- **I will create a new Query and use it to load the failure data.** If you select this option, when you click the **Next** button, the Query Builder will appear so that you can design a new query. Click the **Help** button in the Query Builder for details on building a new query.
- **Failure data will be copied from an existing Dataset.** If you select this option, when you click the **Next** button, you will be asked to find and select the desired dataset in the Catalog. Note that if the dataset you choose was created from a query that included installation, failure dates, or TTF data you will not be able to select either of those columns in the analysis. To avoid this problem, run the query in unformatted mode and then export to a dataset.
- **I will create a new Dataset and use it to load the failure data.** If you select this option, when you click the **Next** button, the Dataset Builder will appear so that you can design a new dataset. Click the **Help** button in the Dataset Builder for details on building a new dataset.

After you have selected or created the desired query or dataset, it appears on the **Select** screen of the **Reliability Distribution Builder**.

4. Click the **Next** button.

The **Select Data Format** screen appears.

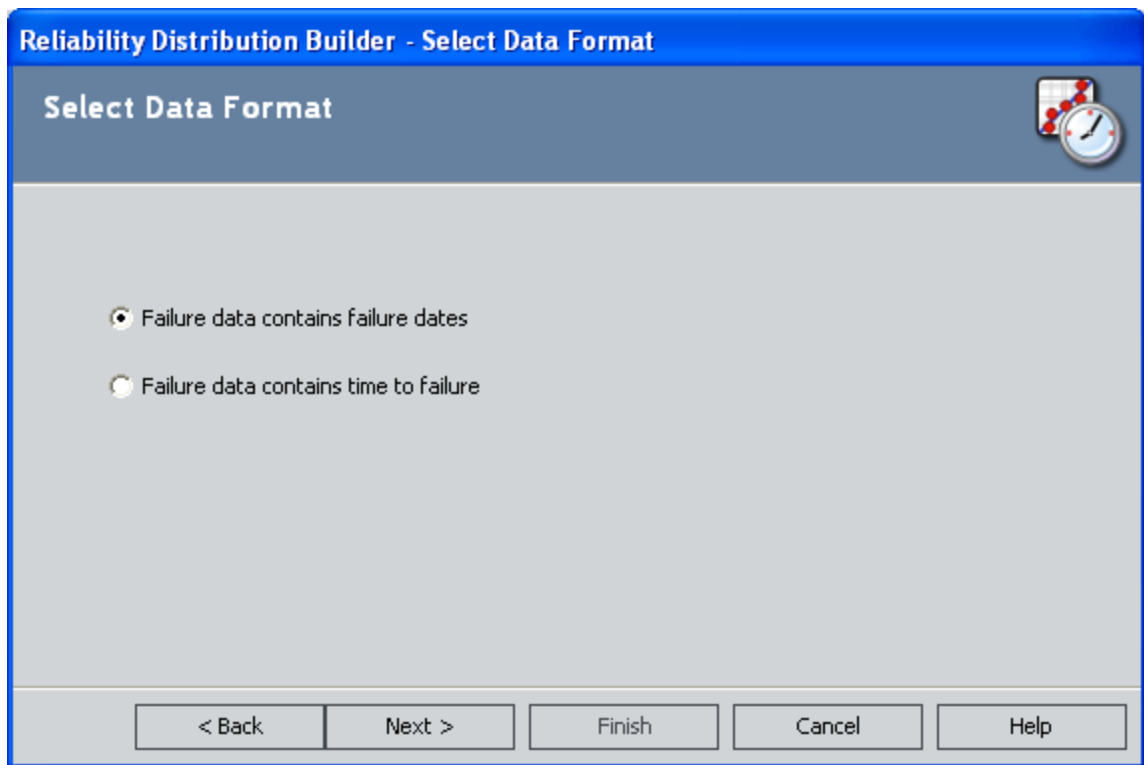

5. If the failure data contains failure dates, select the **Failure data contains failure dates** option.

-or-

If the failure data contains numbers representing the time to failure, select the **Failure data contains time to failure** option.

6. Click the **Next** button.

The **Failure Type** screen appears.

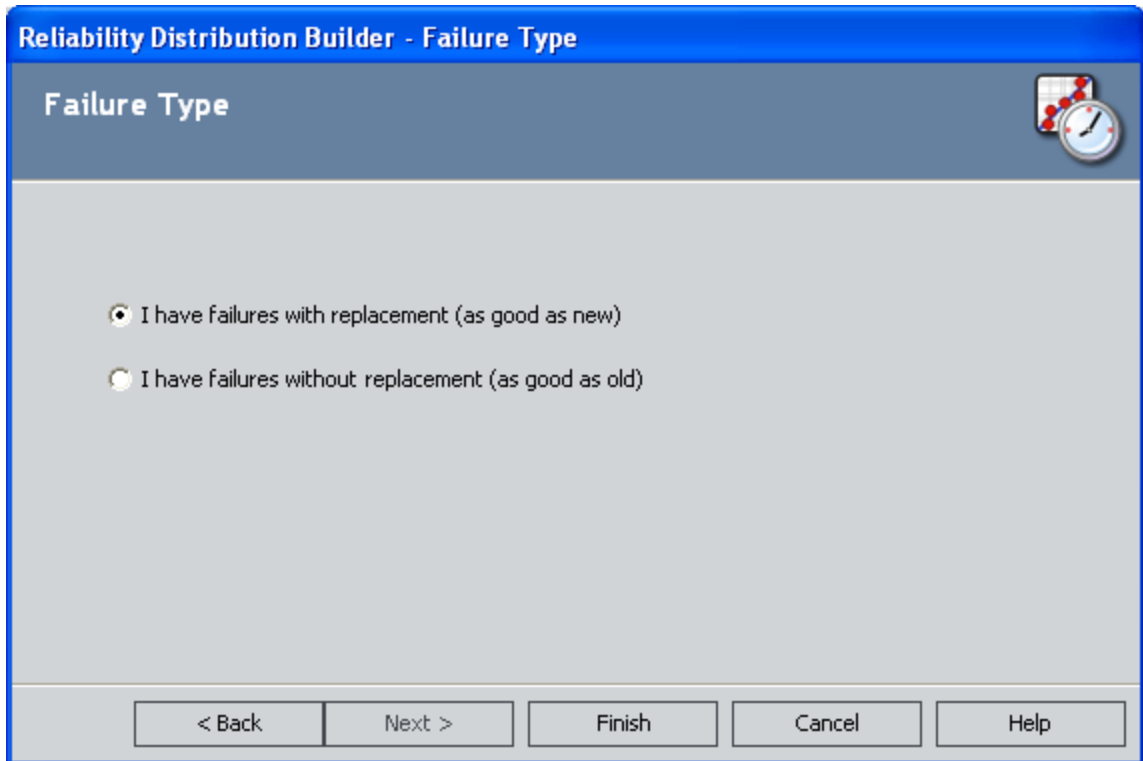

7. If the piece of equipment is replaced after each failure, select the **I have failures with replacement (as good as new)** option.

-or-

If the piece of equipment is not replaced after each failure, select the **I have failures without replacement (as good as old)** option. In other words, select this option if a failure does not require replacement of the entire unit (e.g., for heat exchangers, boiler tubes, or piping).

8. Click the **Next** button.

The **Select Failure Fields** screen appears. Note that this screen will look different depending on the option that you selected on the previous screen.

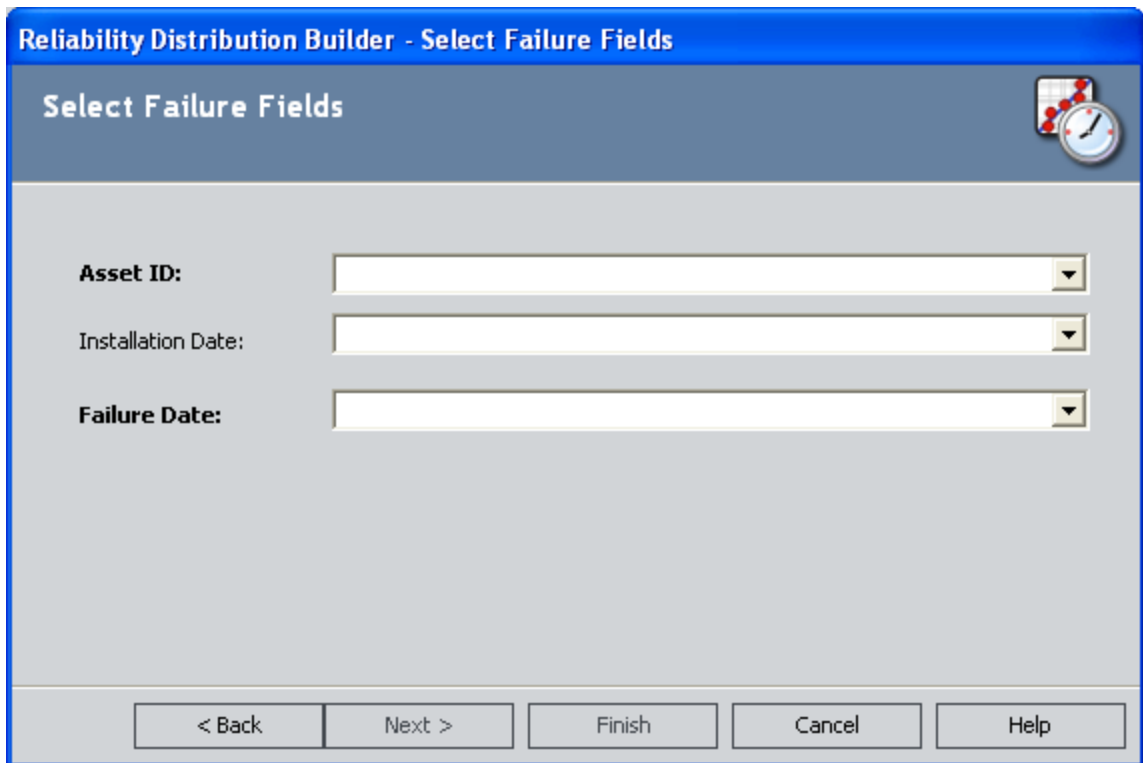

Reliability Distribution Builder - Select Failure Fields

Select Failure Fields

Asset ID: [Dropdown]

Installation Date: [Dropdown]

Failure Date: [Dropdown]

< Back Next > Finish Cancel Help

9. In the **Asset ID** list, select the name of the field that contains the IDs of the failed entities. This is required and must be a character field.
10. In the **Installation Date** list, select the field that contains the Installation Date, which is the date when the piece of equipment was installed. This field is optional.
11. In the **Failure Date** list, select the field that contains the Failure Date, which is the date on which the failure events occurred (e.g., the Out of Service date). This field is required.
12. If you selected the **I have failures without replacement (as good as old)**, complete the following additional fields, which appear only when you have made this selection:
 - **Number of Subcomponents:** The name of the field that contains the number of subcomponents contained by the piece of equipment that you selected in the **Asset ID** field.

Note: If this field is not mapped, you will receive a warning message notifying you that the number of subcomponents must be entered for every analyzed piece of equipment. You must enter those values in the **Asset** tab of the **Failure Data** grid in order to take into account non-failed elements. Moreover, failure probability cannot be calculated if this value is left blank.

- **Number of Failures:** The name of the field that contains the number of failed elements at each failure event.

- **Replacement?:** The field that indicates whether replacement is made following each equipment failure. It needs to be mapped to a field of type **Logical**. A replacement causes the entire piece of equipment to be renewed, thus resetting calculation of the time to failure.

13. Click the **Next** button.

-or-

If the selected query or dataset does not include downtime data, click the **Finish** button and skip to the end of these instructions.

The **Provide Information for Downtime** screen appears.

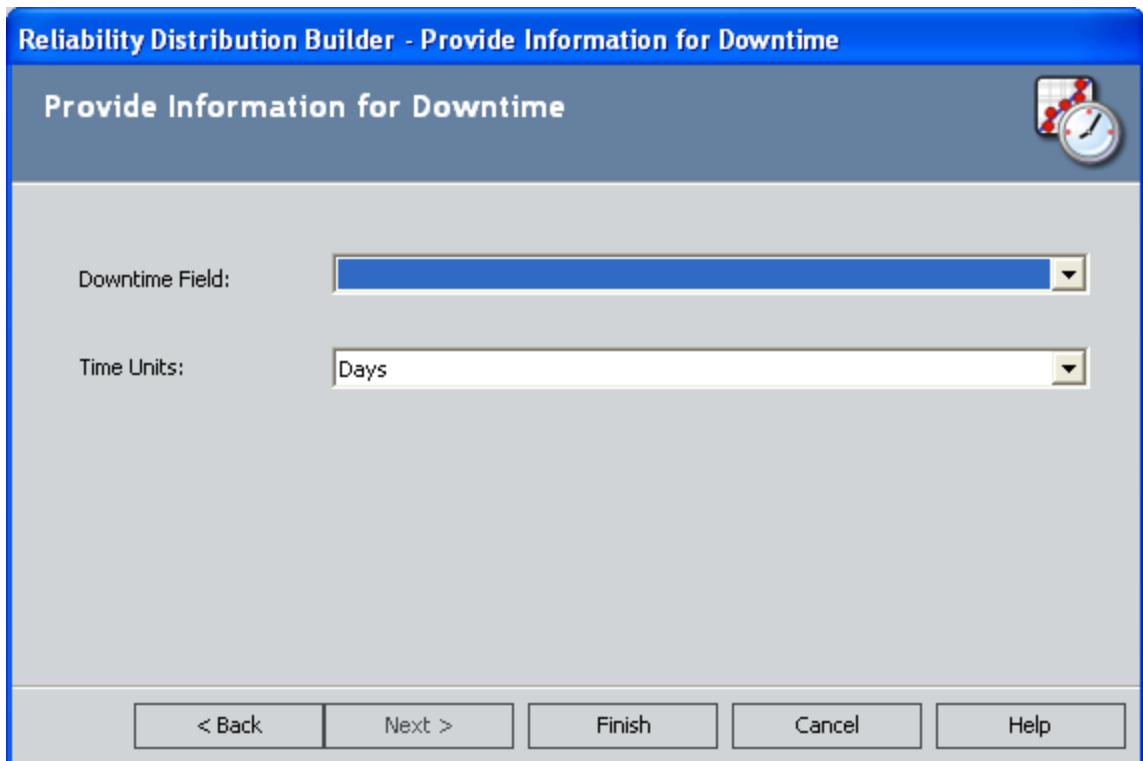

14. In the **Downtime Field** list, select the desired field (e.g., Total Time to Repair). This field is optional but must be numeric.
15. In the **Time Units** list, select the time units associated with the selected the downtime (Hours, Weeks, Months, Quarters, or Years).

Note: The time units that you select here will apply to *downtime* only. Operating time will be set by default to *days*. After the analysis has been created, you can change the units for both downtime and operating time [via the Time Units dialog box](#).

16. Click the **Finish** button.

The system validates the field mappings and generates the analysis. The summary page displays the results of the analysis.

17. On the **Common Tasks** menu, click the **Save Analysis** link to save the analysis results.

Creating a Distribution Analysis from Manually Entered Data

To create a new Distribution analysis by entering failure data manually:

1. On the [Reliability Distribution Summary page](#) or the [Select a Distribution Analysis from the List](#) page, on the **Common Tasks** menu, click the **New Analysis** link.

The **Reliability Distribution Builder** appears, displaying the Welcome screen.

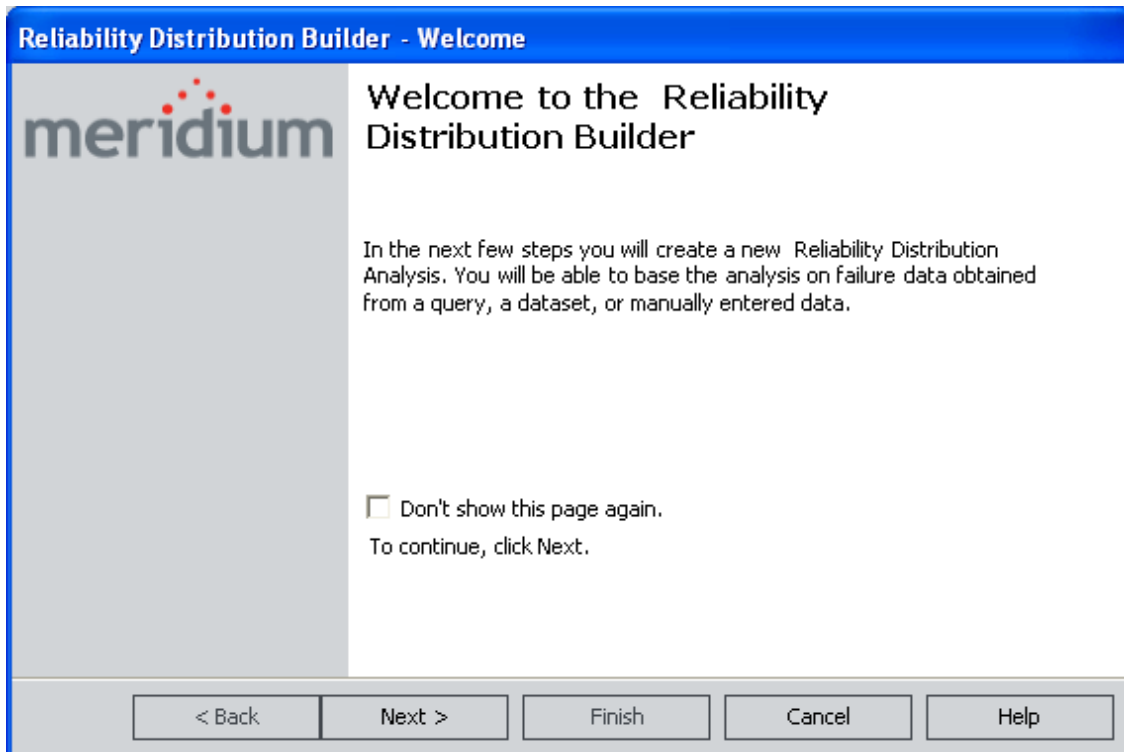

CEHint: If you do not want to view this screen the next time that you access the builder, select the **Don't show this page again** check box.

2. Click the **Next** button.

The **Select Data Source Type** screen appears.

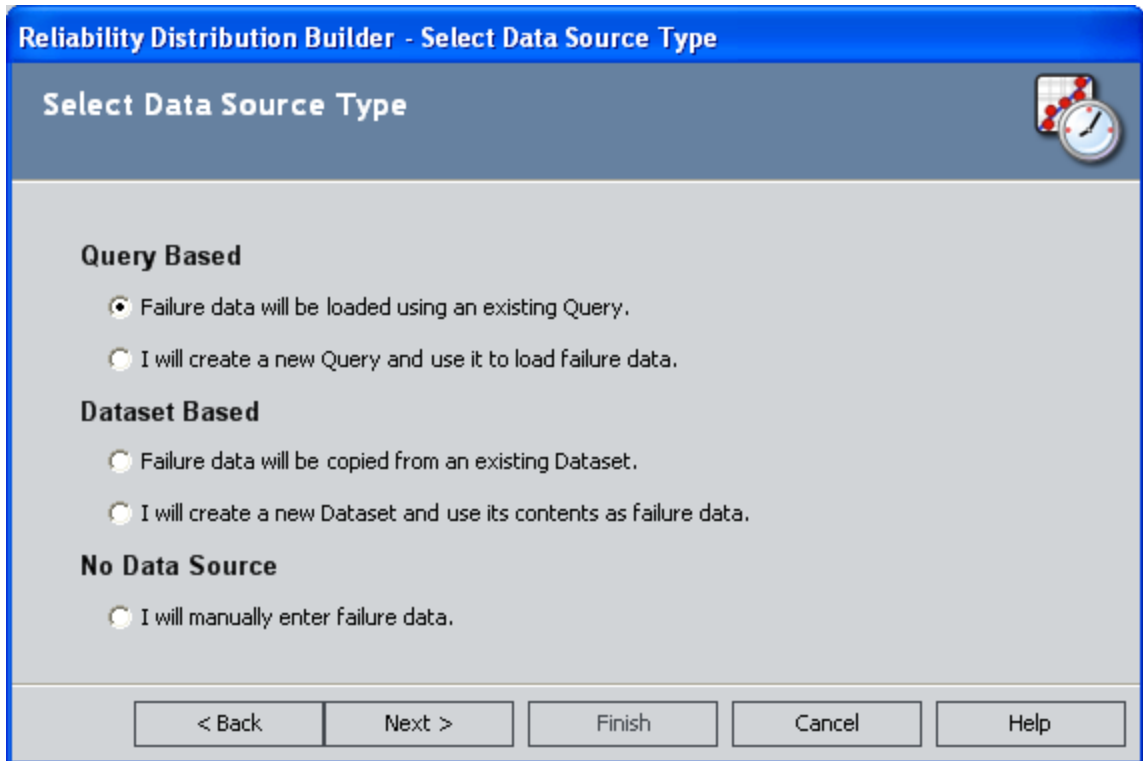

3. Select the **I will manually enter failure data** option.

The **Select Data Format** screen appears.

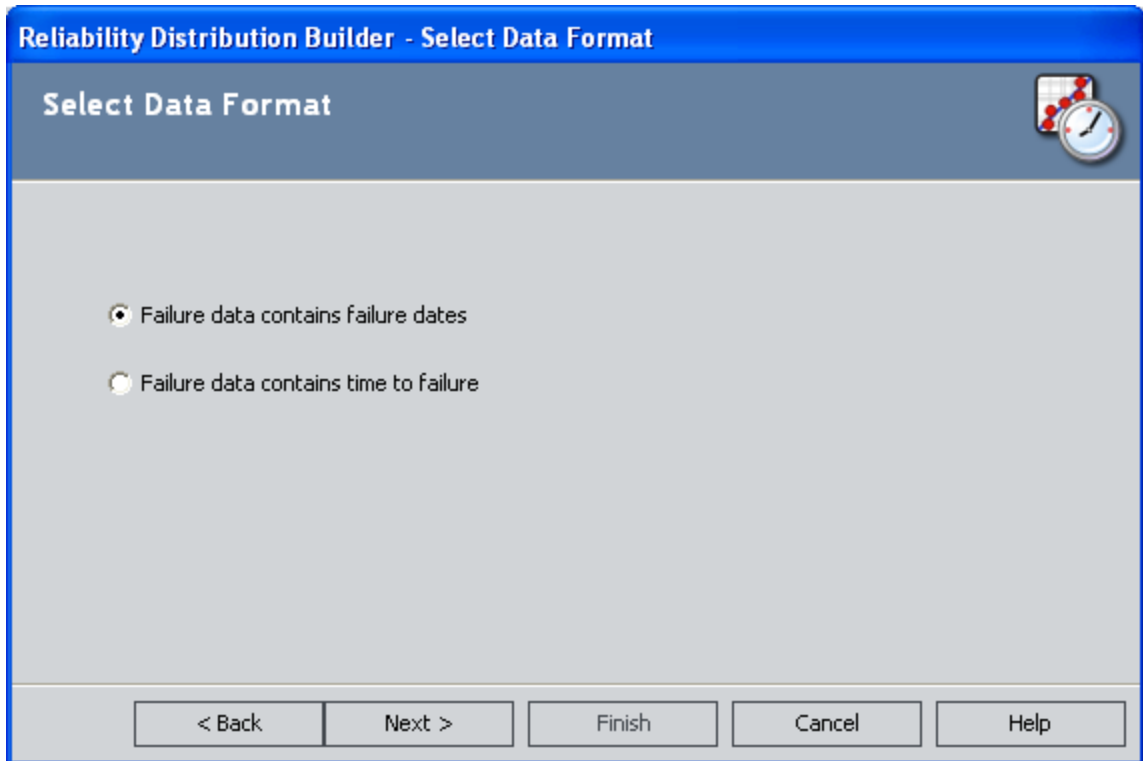

4. If the failure data contains failure dates, select the first option on the **Select Data Format** screen.

-or-

If the failure data contains Time to Failure values, select the second option on the **Select Data Format** screen.

5. Click the **Next** button.

The **Failure Type** screen appears.

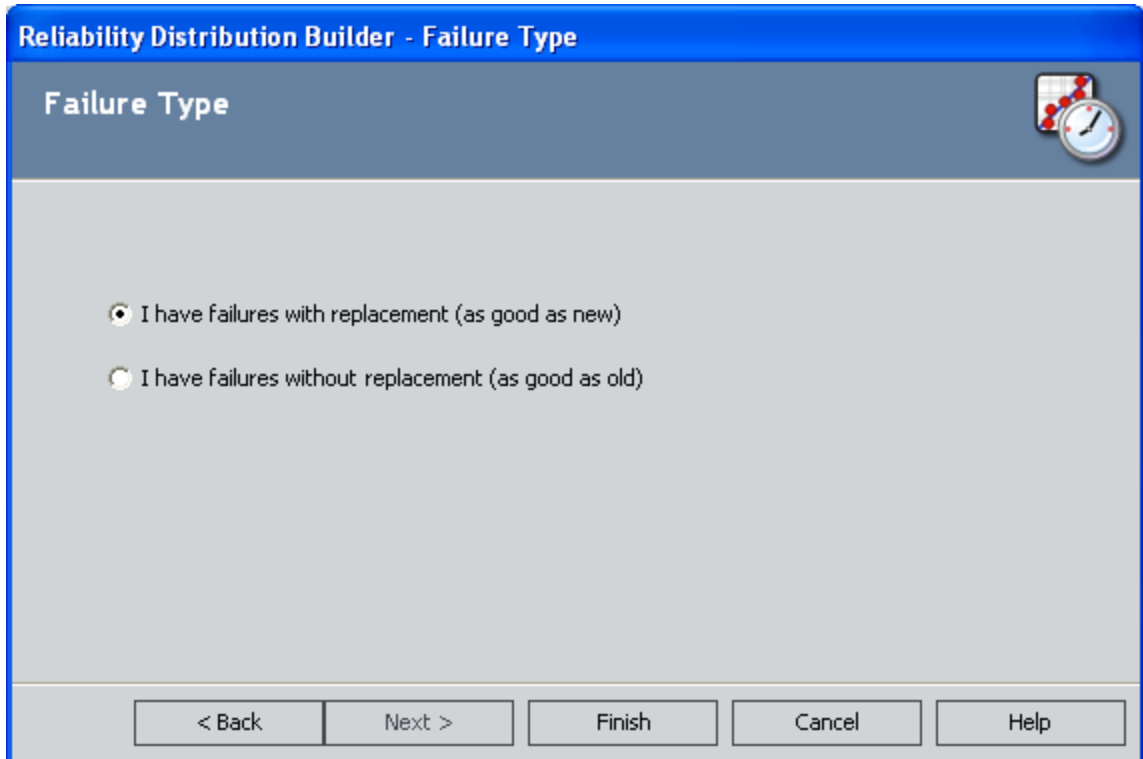

The screenshot shows a software dialog box titled "Reliability Distribution Builder - Failure Type". The main area of the dialog is titled "Failure Type" and contains two radio button options. The first option, "I have failures with replacement (as good as new)", is selected. The second option is "I have failures without replacement (as good as old)". At the bottom of the dialog, there are five buttons: "< Back", "Next >", "Finish", "Cancel", and "Help".

6. If a replacement is made following each failure, select the **I have failures with replacement(as good as new)** option.

-or-

If no replacement is made following each failure select the **I have failures without replacement (as good as old)** option.

7. Click the **Finish** button.

A blank **Failure Data** grid appears. To enter data, you can manually type the data in the cells or you can use the clipboard operations (cut, copy, paste) to transfer data to the grid from other applications.

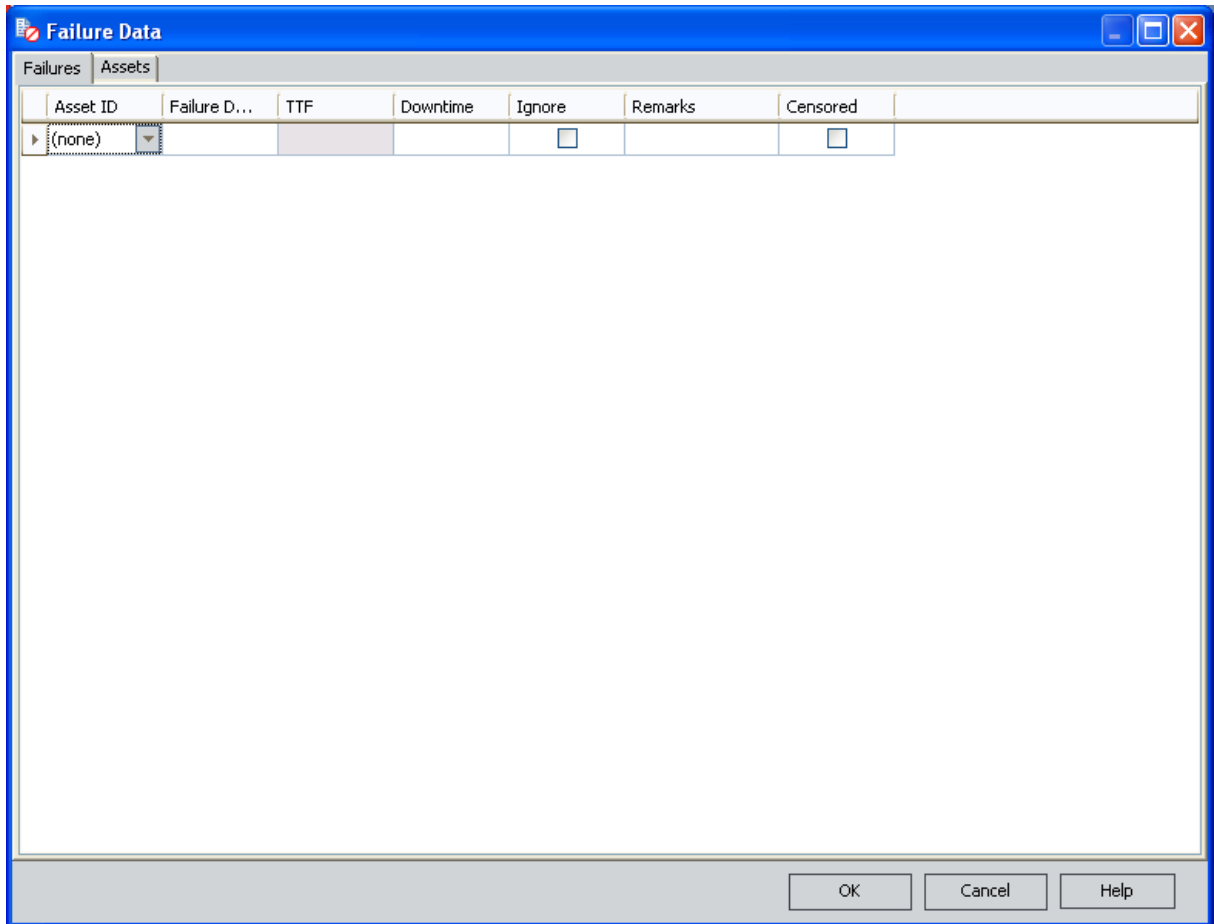

8. Enter the information about the failures and equipment that you want to include in the analysis. Note that:
 - A minimum of three failure datapoints is required to perform a calculation.
 - If you enter downtime values that exceed the next failure date, the Meridium APM system will highlight the downtime values in the **Failure Data** window. When you close the **Failure Data** window, an error message appears in the **Analysis Information** section.
 - The units of days will be assumed for both downtime and operating time for the data that you enter. After you create the analysis, you can change the time units via the **Time Units** dialog box.

10. Click **OK**.

Note: A minimum of three failure datapoints is required to perform a calculation or a warning message will be displayed.

The system generates the analysis. The **Failure Data** grid closes and the system displays a summary of the analysis.

11. On the **Common Tasks** menu, click the **Save Analysis** link to save the analysis results.

Creating Distribution Analyses from an Associated Page

The following instructions assume that an administrative user has already [created an Associated Page](#) that can be used to create a Reliability Distribution Analysis from an Equipment or Functional Location record.

To create a Reliability Distribution analysis from an Associated Page:

1. In the Meridium APM Framework, open an Equipment or Functional Location record in the Record Manager.
2. On the **Associated Pages** menu, click the **New Distribution Analysis** link.

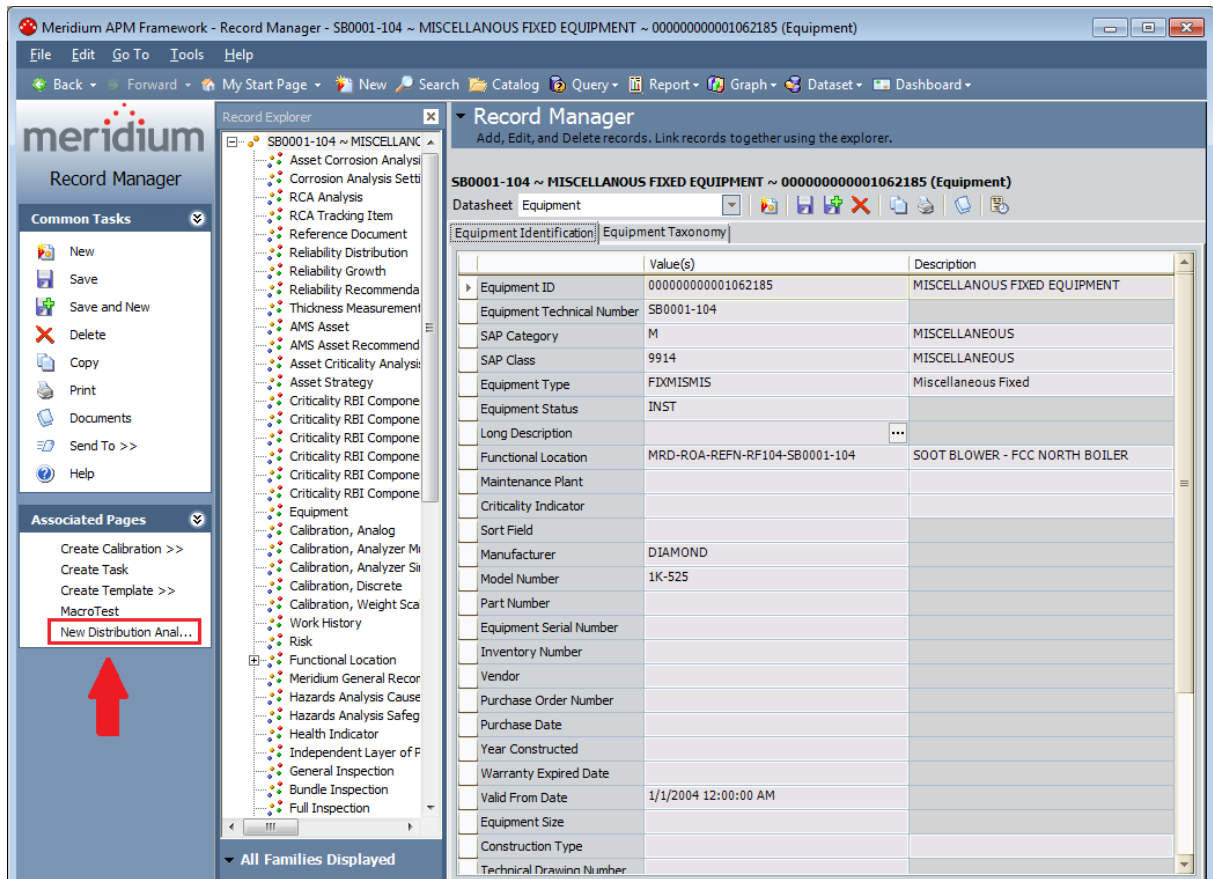

The **Enter parameter values** dialog box appears. If you are viewing an Equipment record, the **Enter parameter values** dialog box displays the value in the Equipment ID field of the current record. If you are viewing a Functional Location record, the **Enter Parameter values** dialog box displays the value in the Location field of the current record.

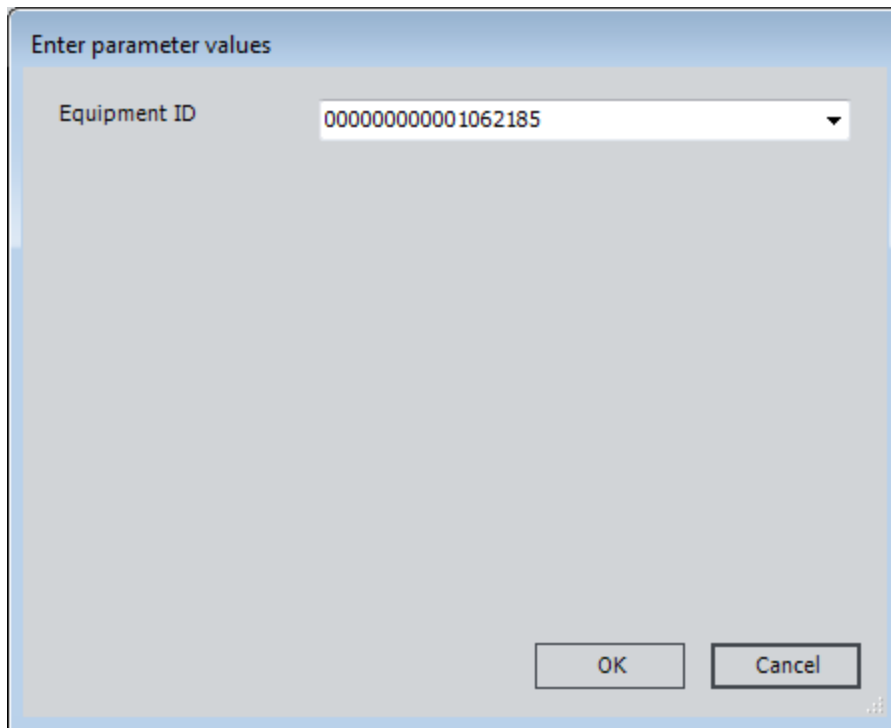

The image shows a dialog box with a light blue title bar that reads "Enter parameter values". Inside the dialog, there is a label "Equipment ID" followed by a dropdown menu. The dropdown menu is currently open, showing the value "00000000001062185" and a small downward-pointing arrow. At the bottom right of the dialog, there are two buttons: "OK" and "Cancel".

3. Click **OK**.

The Reliability Distribution Analysis is created, and the **Reliability Distribution Summary** page appears.

Overview of the Reliability Distribution Summary Page

The **Reliability Distribution Summary** page contains a summary of the selected Distribution Analysis. The summary information is divided into four sections, which appear in the main display area:

- [Analysis Information](#)
- [Time to Failure Distribution](#)
- [Time to Repair Distribution](#)
- [Failure Data](#)

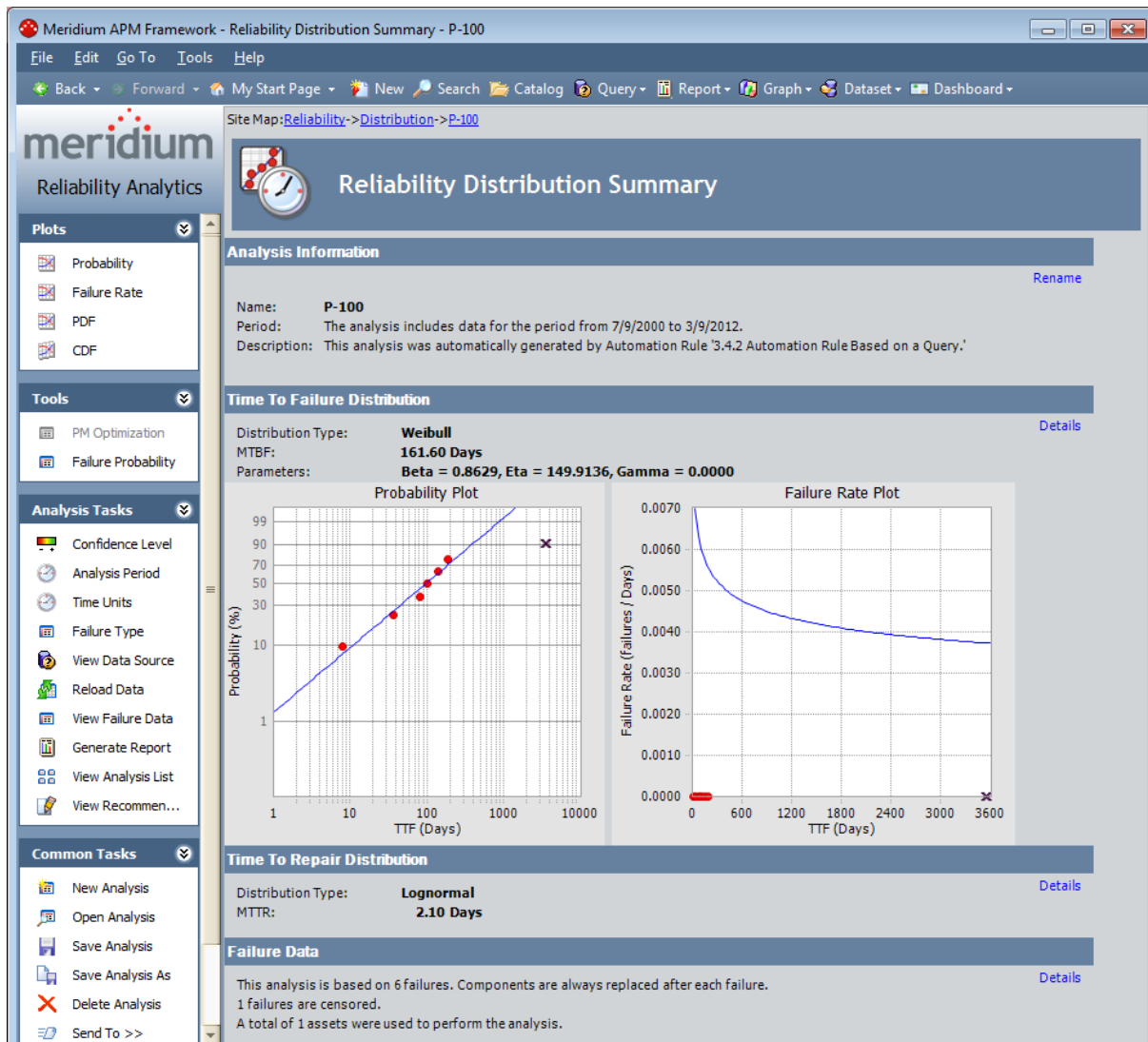

The **Reliability Distribution Summary** page also contains four task menus: [Plots](#), [Tools](#), [Analysis Tasks](#), and [Common Tasks](#). These task menus give you quick access to common tasks associated with Distribution analyses.

Analysis Information Section

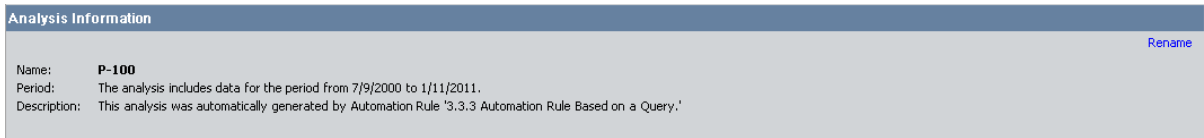

Analysis Information Rename

Name: **P-100**
Period: The analysis includes data for the period from 7/9/2000 to 1/11/2011.
Description: This analysis was automatically generated by Automation Rule '3.3.3 Automation Rule Based on a Query.'

The **Analysis Information** section contains information that identifies the current analysis, including the following information:

- **Analysis Name:** The ID of the selected Reliability Distribution Analysis.
- **Analysis Period:** The start and end dates and times for the analysis. The **Analysis Period** description also includes the total operating time, the number of observed failures, and the number of pieces of equipment used in the analysis. The total (or cumulative) operating time is the total amount of time that the pieces of equipment are in operation during the specified analysis period.
- **Description:** The description of the analysis as defined when the analysis was saved. Click the **Rename** link located in this section or the **Current Analysis** menu if you want to change either the name or the description of the analysis.
- **Rename:** A link that displays the **Rename Analysis** dialog box, where you can [rename the analysis](#).

Time to Failure Distribution Section

The **Time to Failure Distribution** section provides a summary of details for the Time to Failure (TTF) distribution, which calculates the time from when an item was placed into service until it fails.

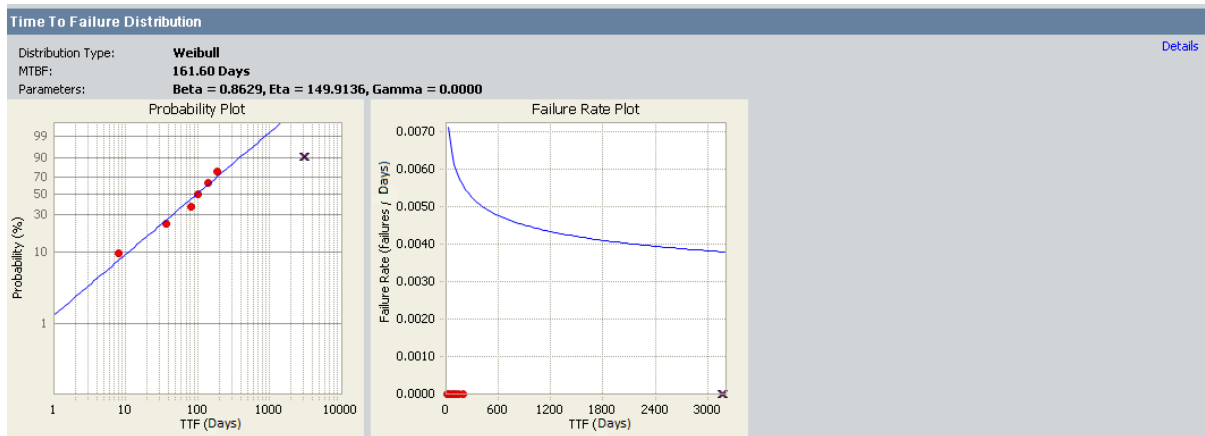

TTF may be expressed as days, hours, cycles, units processed, and so on. This section includes the following information:

- **Distribution Type:** The type of distribution used in the analysis.
- **MTBF:** Mean Time Between Failures defined for the analysis.

Note: MTBF is not applicable, and therefore not calculated, if the failure type is **Failures Without Replacement**. Click the **Details** link to view the detailed results of the TTF Distribution.

- **Parameters:** The parameters defined for the analysis.

Note: You will receive an error message in the **Distribution Parameters** section on this screen if the distribution parameters could not be calculated. There must be a minimum of two datapoints in the failure data in order for the system to fit a distribution.

You can click the **Details** link in the Time to Failure Distribution section to [view additional information](#) about the distribution parameters, the distribution properties, and the results of the Goodness of Fit (GOF) tests.

This section also displays a small image of the Probability Plot and Failure Rate Pot. You can click the images to view the plots on a separate screen.

Time to Repair Distribution Section

The **Time to Repair Distribution** section provides a summary of the details for the Time to Repair (TTR) distribution, which calculates the average amount of time that passes before an element must have some type of maintenance performed on it.

Time To Repair Distribution		Details
Distribution Type:	Lognormal	
MTTR:	2.10 Days	

This time is generally referred to as the time from when an item fails to when it is returned to productive service. This section includes the following information:

- **Distribution Type:** The type of distribution used in the analysis.
- **MTTR:** Mean Time to Repair defined for the analysis.

The **Time to Repair Distribution** section also contains a **Details** link, which you can click to [view additional information](#) about the Time to Repair Distribution.

Failure Data Section

The **Failure Data** section lists the number of failures contained in the Failure Data that were used to generate MTBF, the number of the failures from the data that were censored when the calculations were last performed, and the number of pieces of equipment contained in the Failure Data.

Failure Data	Details
This analysis is based on 6 failures. Components are always replaced after each failure. 1 failures are censored. A total of 1 assets were used to perform the analysis.	

The failure type that was selected upon the creation of the analysis is also listed in this section.

- If the analysis is based on the **Failures With Replacements** failure type, the following information is displayed: **Components are always replaced after each failure.**
- If the analysis is based on the **Failures Without Replacements** failure type, the following information is displayed: **Components are not automatically replaced after each failure.**

In this section, you can click the **Details** link to [view the Failure History By Asset Timeline](#).

Plots Menu

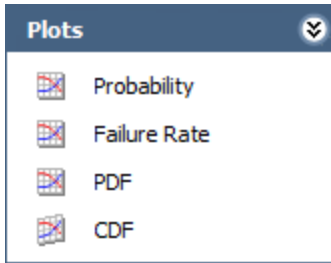

The **Plots** menu on the **Reliability Distribution Summary** page contains the following links:

- **Probability:** Displays the [Probability plot](#).
- **Failure Rate:** Displays the [Failure Rate plot](#).
- **PDF:** Displays the [Probability Density Function plot](#).
- **CDF:** Displays the [Cumulative Distribution Function plot](#).

Tools Menu

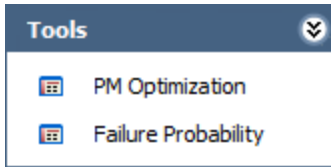

The **Tools** menu on the **Reliability Distribution Summary** page contains the following links:

- **PM Optimization:** Displays the optimal preventive maintenance interval and a graphical plot of the Planned Cost, Unplanned Cost, and Total Cost if a PM Optimization has been previously performed. Or, displays the [Preventive Maintenance Optimization dialog box](#), which will prompt you to enter the cost data. The Optimal Value inflection point is identified on the total cost curve.
- **Failure Probability:** Takes you to the [Probability of Equipment Failure page](#) for the current analysis.

Analysis Tasks Menu

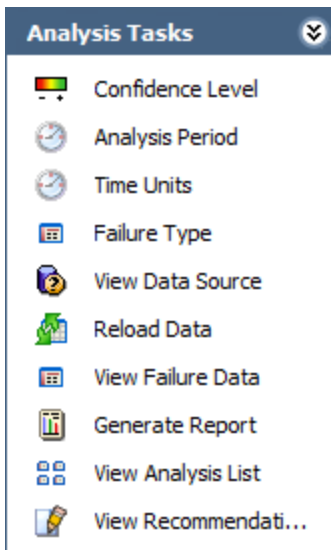

The **Analysis Tasks** menu on the **Reliability Distribution Summary** page contains the following links:

- **Confidence Level:** Displays the **Confidence Level** dialog box, which lets you select to use confidence and [specify the confidence level](#).
- **Analysis Period:** Displays the **Analysis Period** dialog box, where you can [change the Start Date and End Date of the analysis period](#).

Note: The **Analysis Period** link is not available if you entered raw Time to Failure (TTF) values on the **Failure Data** grid to create the analysis.

- **Time Units:** Displays the **Time Units** dialog box, where you can [specify the operating time units and the downtime units](#).
- **Failure Type:** Displays the **Select the Failure Type** dialog box, where you can [specify whether or not the piece of equipment is replaced after each failure](#).
- **View Data Source:** Displays the data that serves as the source of the analysis. This link appears only if the analysis is based on a query or a dataset.
 - If the analysis is based on a query, this link will open the query results.
 - If the analysis is based on a dataset, this link will open the dataset.
- **Reload Data:** [Reloads the data](#) stored in the database. This link appears only if the analysis is based on a query or a dataset.
- **View Failure Data:** Displays the [Failure Data](#) grid.
- **Generate Report:** Displays the **Report Options** dialog box, where you can select the elements of the analysis that you want to include in a report.

Note: You must save the analysis before you can generate a report.

- **View Analysis List:** Displays the [Select a Distribution Analysis from the List page](#), which displays a list of the existing Reliability Distribution analyses.
- **View Recommendations:** Displays the [Recommendations page](#), where you can view and manage the Recommendation records associated with the analysis.

Common Tasks Menu

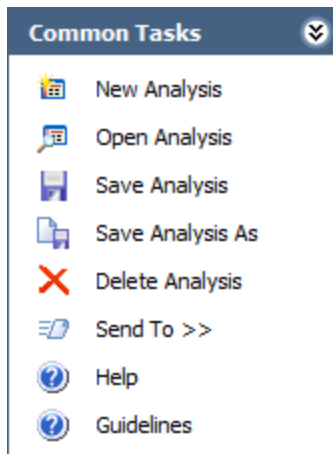

The **Common Tasks** menu on the **Reliability Distribution Summary** page contains the following links:

- **New Analysis:** Displays the **Reliability Distribution Builder**, which guides you through the process of [creating a new Reliability Distribution Analysis](#).
- **Open Analysis:** Lets you [locate an existing Reliability Distribution Analysis](#) using the **Find a Reliability Distribution Analysis** window.
- **Save Analysis:** Save the currently displayed analysis. If you are viewing a new analysis that has not yet been saved, this link will display the **Save Analysis** dialog box, where you can [save the analysis](#). If you are viewing an existing analysis, when you click this link, Meridium APM will save any changes that you made to the analysis since it was last saved.
- **Save Analysis As:** Displays the **Save this Analysis** dialog box, where you can choose to [save it with a different name](#).
- **Delete Analysis:** Deletes the currently displayed analysis.
- **Send To:** Displays a submenu with options that let you provide a link to the current page on your desktop (create shortcut), in an email message, or on a Home Page.
- **Help:** Displays the context-sensitive Help topic for the **Reliability Distribution Summary** page.
- **Guidelines:** Displays the Reliability Concepts, which provide reliability workflows and descriptions of reliability concepts.

Changing the Failure Type

When you create a Reliability Distribution Analysis, you establish the failure type in the **Reliability Distribution Builder**. After the analysis is created, if you forgot which option you chose or accidentally chose the wrong option and want to change it, you can do so via the **Failure Type** dialog box.

To change the failure type:

1. On the **Reliability Distribution Summary** page, on the **Analysis Tasks** menu, click the **Failure Type** link.

The **Failure Type** dialog box appears.

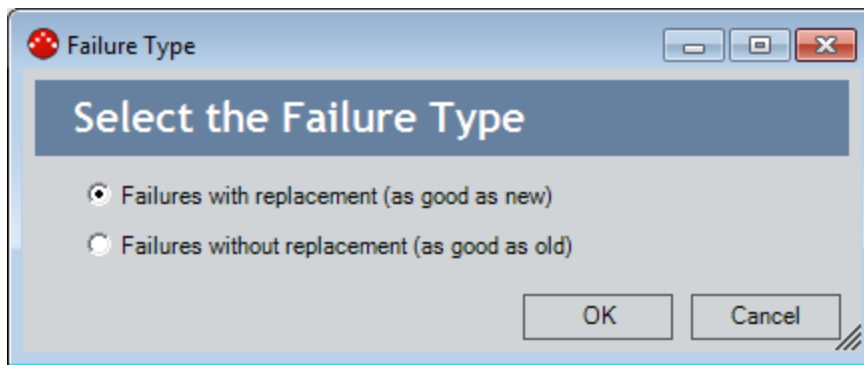

2. If the piece of equipment is replaced after each failure, select the **Failures with replacement (as good as new)** option.

-or-

If the piece of equipment is not replaced after each failure, select the **Failures without replacement (as good as old)** option. In other words, select this option if a failure does not require replacement of the entire piece of equipment (e.g., for heat exchangers, boiler tubes, or piping).

3. Click **OK**.

The analysis is recalculated based on the selected failure type.

Note: If you are viewing the **Preventive Maintenance Optimization** page and you change the failure type to the **Failures without replacement (as good as old)** option, a red label appears on the page warning you that PM Optimization calculations are not supported for failures without replacement and that the results are not valid.

Accessing the Time To Failure Distribution Page

To access the Time To Failure Distribution page:

- On the [Reliability Distribution Summary page](#), in the Time to Failure Distribution section, click the **Details** link.

The Time To Failure Distribution page appears.

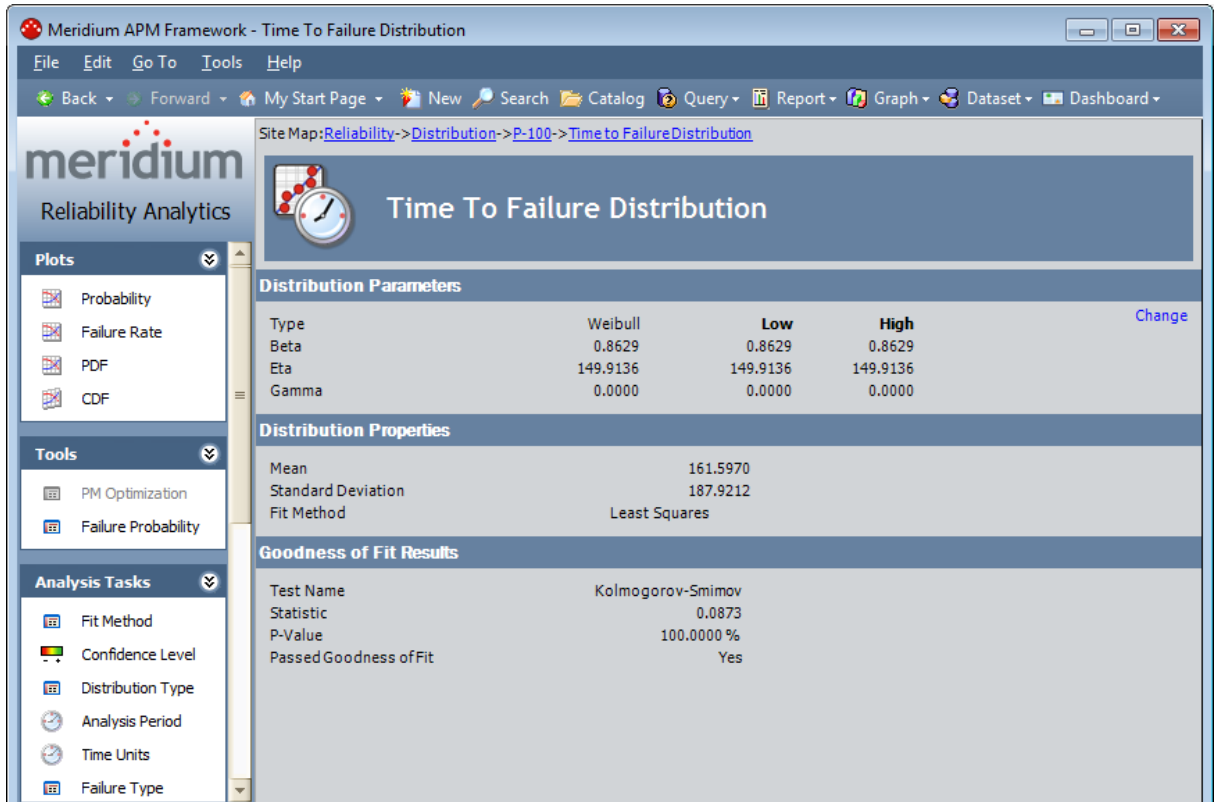

Aspects of the Time To Failure Distribution Page

The following information is displayed on the **Time To Failure Distribution** page:

Distribution Parameters

Distribution Parameters				
Type	Weibull	Low	High	Change
Beta	10.9044	10.9044	10.9044	
Eta	761.7708	761.7708	761.7708	
Gamma	0.0000	0.0000	0.0000	

- **Type:** The distribution type, which affects the distribution parameters. You can [change the distribution type](#) by clicking the **Distribution Type** link on the **Analysis Tasks** menu.
- **Parameters:** The distribution parameters, which are determined by the distribution type. You can [change the distribution parameters](#) by clicking the **Change** link in the upper, right corner of this section.

Distribution Properties

Distribution Properties	
Mean	727.2988
Standard Deviation	80.6207
Fit Method	Least Squares

- **Mean:** The average point of distribution. This value is calculated using parameters in the **Distribution Parameters** section, which vary depending on the distribution type. For example, the following formula is used to calculate the mean for a Weibull Distribution:

$$Mean = Eta \times Gamma \left(1 + \frac{1}{Beta}\right)$$

- **Standard Deviation:** Indicates how tightly the datapoints are clustered around the mean in a set of failure data.
- **Fit Method:** The curve-fitting estimation method used to estimate the parameters for the distribution. The method of fit for a Distribution Analysis can be either **Least Squares** or **Maximum Likelihood Estimators (MLE)**.

Goodness of Fit Results

Goodness of Fit Results	
Test Name	Kolmogorov-Smirnov
Statistic	0.2139
P-Value	99.3069 %
Passed Goodness of Fit	Yes

- **Test Name:** The name of the fit test that was performed on the data.
- **Statistic:** A value that indicates how exact the fit is. Typically, the lower the number is, the better the fit.
- **P-Value:** A value that is calculated by the Meridium APM system. The P-value is interpreted as the probability that the test statistic is due to random error.

Typically, the higher the P-value, the more likely the model is appropriate and the more likely that the fit will pass the test.

- **Passed Goodness of Fit:** A value of *Yes* or *No* that indicates if the fit test (listed next to the **Test Name**) was successful (the distribution fits the data based on the test performed). If the [P-value is less than or equal to 1 minus the confidence level](#), the fit test has failed and you should reject the distribution at the chosen significance level. Otherwise, the fit is successful and you should accept the distribution at the chosen significance level.

Accessing the Time To Repair Distribution Page

To access the Time To Repair Distribution page:

- On the [Reliability Distribution Summary page](#), in the Time to Repair Distribution section, click the **Details** link.

The Time To Repair Distribution page appears.

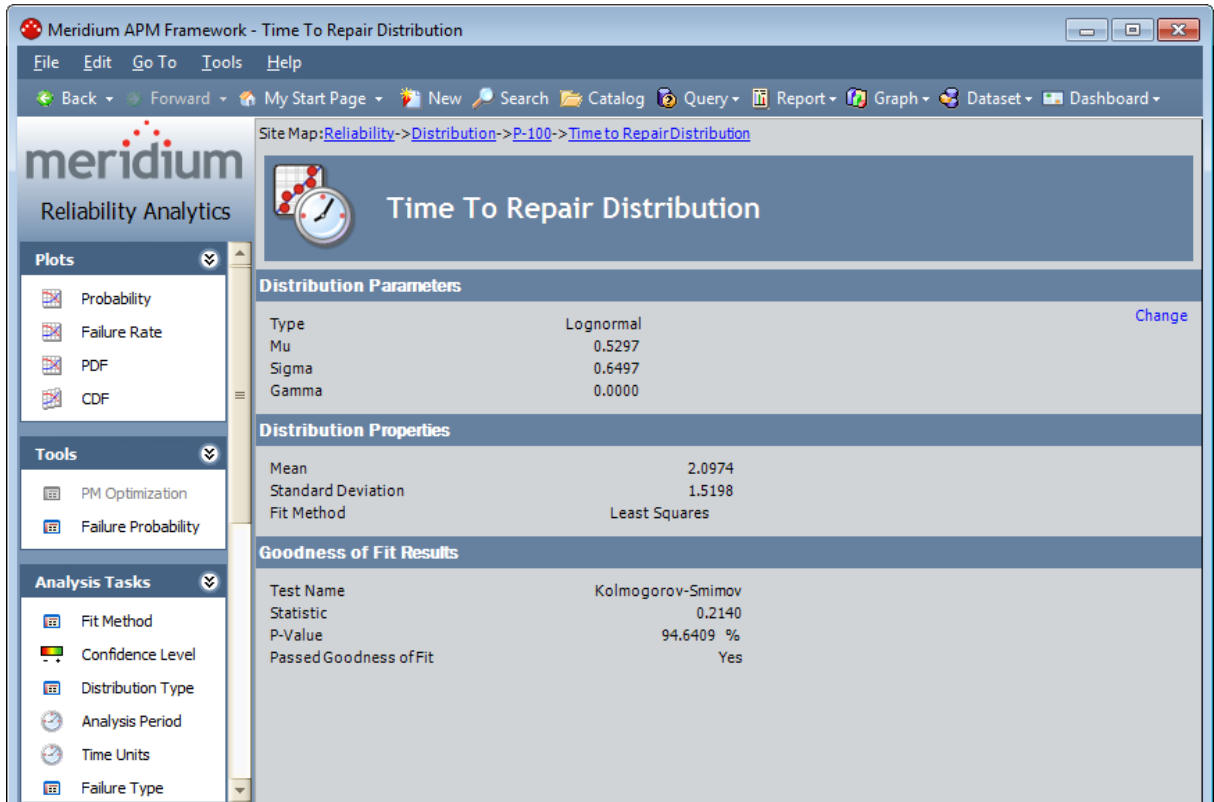

Aspects of the Time To Repair Distribution Page

The following information is displayed on the **Time to Repair Distribution** page for the Time to Repair Distribution:

Distribution Parameters

Distribution Parameters		Change
Type	Weibull	
Beta	0.9494	
Eta	230.3154	
Gamma	0.0000	

- **Type:** The distribution type, which affects the distribution parameters. You can [change the distribution type](#) by clicking the **Distribution Type** link on the **Analysis Tasks** menu.
- **Parameters:** The distribution parameters, which are determined by the distribution type. You can [change the distribution parameters](#) by clicking the **Change** link in the upper, right corner of this section.

Distribution Properties

Distribution Properties	
Mean	235.7761
Standard Deviation	248.4394
Fit Method	Least Squares

- **Mean:** The average point of distribution. This value is calculated using parameters in the **Distribution Parameters** section, which vary depending on the distribution type. For example, the following formula is used to calculate the mean for a Weibull Distribution:

$$Mean = Eta \times Gamma \left(1 + \frac{1}{Beta} \right)$$

- **Standard Deviation:** The scatter (i.e., how tightly the datapoints are clustered around the mean).
- **Fit Method:** The curve-fitting estimation method used to estimate the parameters for the distribution. The method of fit for a Distribution Analysis can be either **Least Squares** or **Maximum Likelihood Estimators(MLE)**.

Goodness of Fit Results

Goodness of Fit Results	
Test Name	Kolmogorov-Smirnov
Statistic	0.1173
P-Value	100.0000 %
Passed Goodness of Fit	Yes

- **Test Name:** The name of the fit test that was performed on the data.
- **Statistic:** A value that indicates how exact the fit is. Typically, the lower the number is, the better the fit.
- **P-Value:** A value that is calculated by the Meridium APM system. The P-value is

interpreted as the probability that the test statistic is due to random error. Typically, the higher the P-value, the more likely the model is appropriate and the more likely that the fit will pass the test.

- **Passed Goodness of Fit:** A value of *Yes* or *No* that indicates if the fit test (listed next to the **Test Name**) was successful (the distribution fits the data based on the test performed). If the [P-value is less than or equal to 1 minus the confidence level](#), the fit test has failed and you should reject the distribution at the chosen significance level. Otherwise, the fit is successful and you should accept the distribution at the chosen significance level.

Aspects of the Failure History By Asset Page

For each piece of equipment included in your analysis, the **Failure History by Asset** timeline shows when each failure occurred. The pieces of equipment are listed along the y-axis of the timeline. Dates are listed along the x-axis. The timeline is intended to illustrate the general distribution of failures over time for the pieces of equipment included in the analysis. It can also be used as a tool for identifying which pieces of equipment do not fit the normal failure distribution pattern. The timeline is not intended to provide specific information about failures and dates.

The range of dates displayed along the x-axis is determined by the failure dates that exist. The timeline will always include *all* failure dates, including those that occurred outside the [Analysis Period](#). For example, in the following figure, the Analysis Period ends in February 1996, but failures that occurred after February 1996 are still shown on the timeline.

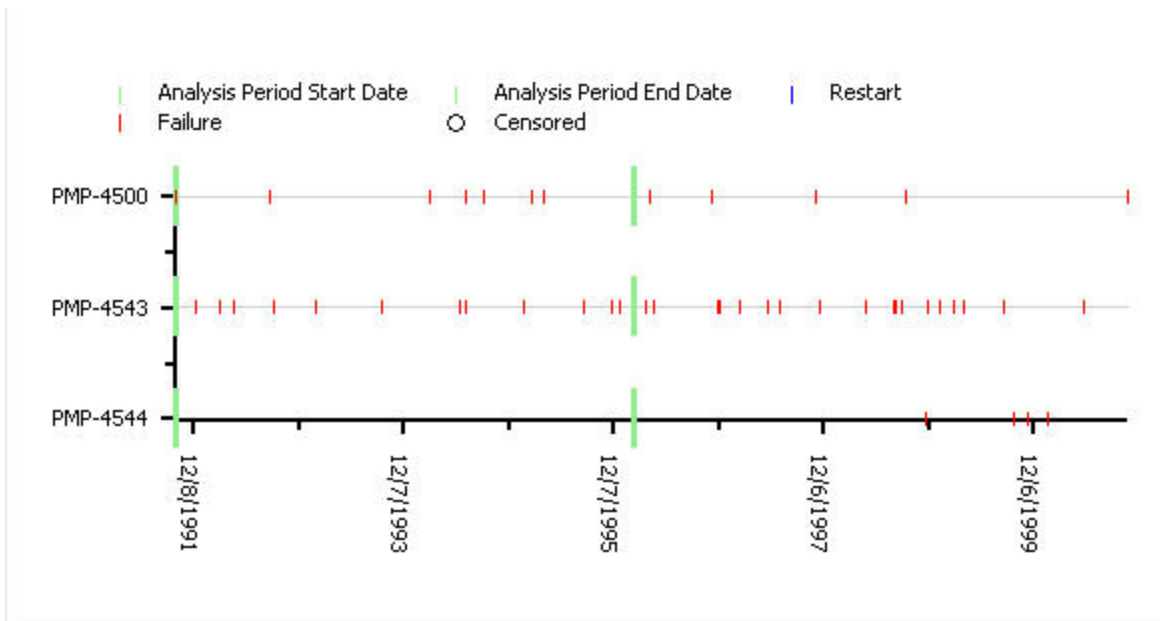

The start date of the analysis period is always designated on the timeline by a green line. If the start date is the same as the first failure date, the green mark will appear directly on the y-axis, as shown in the figure above. The end date of the analysis period is indicated on the timeline by a green line if it is set to a specific date. The end date is not shown on the timeline if you have selected the option **I want to use today's date as the end date for this analysis**.

About the Failure Data Window

The [Failure Data window](#) allows you to view the data associated with a Reliability Distribution Analysis. Most of the fields on the **Failure Data** window correspond to [values that were used to create the analysis](#). For input fields:

- For an analysis based upon a query, the **Failure Data** window displays the information returned by the query.
- For an analysis based upon a dataset, the **Failure Data** window displays the information stored in the dataset.
- For an analysis based upon manually-entered data, the **Failure Data** window displays the information that you entered when you create the analysis.

Other fields show values that are calculated by the Meridium APM system and are read-only. All values in the **Failure Data** window are stored in the Failure Data field in the Production Analysis record.

You can modify certain values on this window in order to update data. In most cases, however, you would not want to change the data unless there was an error in the original data source. Some values are calculated by the Meridium APM system and cannot be modified.

The following image shows an example of the **Failure Data** window.

Datasheet	Asset ID	Failure D...	TTF	Downtime	Ignore	Remarks	Censored	(Taxono...	(Maintai...
view	G0014-037	2/25/2001	0	126	<input type="checkbox"/>		<input checked="" type="checkbox"/>	Centrifugal ...	SEALS - RO...
view	G0014-037	5/18/2001	0	270	<input checked="" type="checkbox"/>		<input type="checkbox"/>	Centrifugal ...	SEALS - RO...
view	G0014-037	7/19/2001	0	40.8	<input checked="" type="checkbox"/>		<input type="checkbox"/>	Centrifugal ...	SEALS - RO...
view	G0014-037	9/3/2001	0	216	<input checked="" type="checkbox"/>		<input type="checkbox"/>	Centrifugal ...	SEALS - RO...
view	G0014-037	1/3/2002	0	54	<input checked="" type="checkbox"/>		<input type="checkbox"/>	Centrifugal ...	SEALS - RO...
view	G0014-037	4/16/2002	0	456	<input checked="" type="checkbox"/>		<input type="checkbox"/>	Centrifugal ...	SEALS - ME...
view	G0014-037	7/7/2002	0	0	<input checked="" type="checkbox"/>		<input type="checkbox"/>	Centrifugal ...	SEALS - ME...
view	G0014-037	8/1/2002	0	40.8	<input checked="" type="checkbox"/>		<input type="checkbox"/>	Centrifugal ...	SEALS - CA...
view	G0014-037	1/21/2003	689.45	20.4	<input type="checkbox"/>		<input type="checkbox"/>	Centrifugal ...	SEALS - CA...
view	G0014-037	3/21/2003	0	270	<input checked="" type="checkbox"/>		<input type="checkbox"/>	Centrifugal ...	SEALS - CA...
view	G0014-037	6/3/2003	0	244.8	<input checked="" type="checkbox"/>		<input type="checkbox"/>	Centrifugal ...	SEALS - CA...
view	G0014-037	7/27/2003	0	285.6	<input checked="" type="checkbox"/>		<input type="checkbox"/>	Centrifugal ...	SEALS - CA...
view	G0014-037	10/29/2003	0	72	<input checked="" type="checkbox"/>		<input type="checkbox"/>	Centrifugal ...	SEALS - CA...
view	G0014-037	11/11/2004	659.05	336	<input type="checkbox"/>		<input type="checkbox"/>	Centrifugal ...	SEALS - CA...
view	G0014-037	2/26/2005	0	144	<input checked="" type="checkbox"/>		<input type="checkbox"/>	Centrifugal ...	SEALS - CA...
view	G0014-037	10/5/2006	679	168	<input type="checkbox"/>		<input type="checkbox"/>	Centrifugal ...	SEALS - CA...
view	G0014-037	10/11/2007	0	162	<input checked="" type="checkbox"/>		<input type="checkbox"/>	Centrifugal ...	SEALS - FU...
view	G0014-037	1/25/2009	836	336	<input type="checkbox"/>		<input type="checkbox"/>	Centrifugal ...	SEALS - FU...
* view	(none)				<input type="checkbox"/>		<input type="checkbox"/>		

Data Mapped to the Failure Data Window

When you create a Reliability Distribution Analysis from a query or dataset, the **Reliability Distribution Builder** will prompt you to map values from columns in the query or dataset to certain values in the Reliability Distribution Analysis. The values that you select to map on the **Select Failure Fields** and **Provide Information For Downtime** screens in the **Reliability Distribution Builder** will then appear in the associated columns in the **Failure Data** window.

Note: If the analysis is based on a query or a dataset and contains additional columns that are not mapped to columns in the analysis dataset, those columns will appear in the **Failure Data** window with the column name in parentheses.

The following chart displays which columns are mapped from fields in the **Reliability Distribution Builder** to columns in the **Failure Data** window:

Reliability Distribution Builder Screen	Reliability Distribution Builder Field	Failure Data Window Tab	Failure Data Window Column
Select Failure Fields	Asset ID	Failures	Asset ID
Select Failure Fields	Failure Date	Failures	Failure Date
Provide Information for Downtime	Downtime Field	Failures	Downtime
Select Failure Fields	Number of Failures	Failures	Number of Failures
Select Failure Fields	Replacement?	Failures	Replaced
Select Failure Fields	Installation Date	Assets	Installation Date
Select Failure Fields	Number of Sub-components	Assets	Number of Sub-components

Accessing the Failure Data for a Distribution Analysis

To view the failure data on the Failure Data window:

- On the [Reliability Distribution Summary page](#), on the Analysis Tasks menu, click the **View Failure Data** link.

The **Failure Data** window appears.

	Datasheet	Asset ID	Failure D...	TTF	Downtime	Ignore	Remarks	Censored	(Taxono...	(Maintal...
▶	view	G0014-037	2/25/2001		0 126	<input type="checkbox"/>		<input checked="" type="checkbox"/>	Centrifugal ...	SEALS - RO...
	view	G0014-037	5/18/2001		0 270	<input checked="" type="checkbox"/>		<input type="checkbox"/>	Centrifugal ...	SEALS - RO...
	view	G0014-037	7/19/2001		0 40.8	<input checked="" type="checkbox"/>		<input type="checkbox"/>	Centrifugal ...	SEALS - RO...
	view	G0014-037	9/3/2001		0 216	<input checked="" type="checkbox"/>		<input type="checkbox"/>	Centrifugal ...	SEALS - RO...
	view	G0014-037	1/3/2002		0 54	<input checked="" type="checkbox"/>		<input type="checkbox"/>	Centrifugal ...	SEALS - RO...
	view	G0014-037	4/16/2002		0 456	<input checked="" type="checkbox"/>		<input type="checkbox"/>	Centrifugal ...	SEALS - ME...
	view	G0014-037	7/7/2002		0 0	<input checked="" type="checkbox"/>		<input type="checkbox"/>	Centrifugal ...	SEALS - ME...
	view	G0014-037	8/1/2002		0 40.8	<input checked="" type="checkbox"/>		<input type="checkbox"/>	Centrifugal ...	SEALS - CA...
	view	G0014-037	1/21/2003	689.45	20.4	<input type="checkbox"/>		<input type="checkbox"/>	Centrifugal ...	SEALS - CA...
	view	G0014-037	3/21/2003		0 270	<input checked="" type="checkbox"/>		<input type="checkbox"/>	Centrifugal ...	SEALS - CA...
	view	G0014-037	6/3/2003		0 244.8	<input checked="" type="checkbox"/>		<input type="checkbox"/>	Centrifugal ...	SEALS - CA...
	view	G0014-037	7/27/2003		0 285.6	<input checked="" type="checkbox"/>		<input type="checkbox"/>	Centrifugal ...	SEALS - CA...
	view	G0014-037	10/29/2003		0 72	<input checked="" type="checkbox"/>		<input type="checkbox"/>	Centrifugal ...	SEALS - CA...
	view	G0014-037	11/11/2004	659.05	336	<input type="checkbox"/>		<input type="checkbox"/>	Centrifugal ...	SEALS - CA...
	view	G0014-037	2/26/2005		0 144	<input checked="" type="checkbox"/>		<input type="checkbox"/>	Centrifugal ...	SEALS - CA...
	view	G0014-037	10/5/2006	679	168	<input type="checkbox"/>		<input type="checkbox"/>	Centrifugal ...	SEALS - CA...
	view	G0014-037	10/11/2007		0 162	<input checked="" type="checkbox"/>		<input type="checkbox"/>	Centrifugal ...	SEALS - FU...
	view	G0014-037	1/25/2009	836	336	<input type="checkbox"/>		<input type="checkbox"/>	Centrifugal ...	SEALS - FU...
*	view	(none)				<input type="checkbox"/>		<input type="checkbox"/>		

The failure data is divided into two tabs: **Failures** and **Assets**. The [Failures tab](#) provides information about the failures. The [Assets tab](#) provides information about the pieces of equipment that are involved in the failures.

Aspects of the Failure Data for a Distribution Analysis

	Datasheet	Asset ID	Failure D...	TTF	Downtime	Ignore	Remarks	Censored	(Taxono...	(Maintai...
▶	view	G0014-037	2/25/2001	0	126	<input type="checkbox"/>		<input checked="" type="checkbox"/>	Centrifugal ...	SEALS - RO...
	view	G0014-037	5/18/2001	0	270	<input checked="" type="checkbox"/>		<input type="checkbox"/>	Centrifugal ...	SEALS - RO...
	view	G0014-037	7/19/2001	0	40.8	<input checked="" type="checkbox"/>		<input type="checkbox"/>	Centrifugal ...	SEALS - RO...
	view	G0014-037	9/3/2001	0	216	<input checked="" type="checkbox"/>		<input type="checkbox"/>	Centrifugal ...	SEALS - RO...
	view	G0014-037	1/3/2002	0	54	<input checked="" type="checkbox"/>		<input type="checkbox"/>	Centrifugal ...	SEALS - RO...
	view	G0014-037	4/16/2002	0	456	<input checked="" type="checkbox"/>		<input type="checkbox"/>	Centrifugal ...	SEALS - ME...
	view	G0014-037	7/7/2002	0	0	<input checked="" type="checkbox"/>		<input type="checkbox"/>	Centrifugal ...	SEALS - ME...
	view	G0014-037	8/1/2002	0	40.8	<input checked="" type="checkbox"/>		<input type="checkbox"/>	Centrifugal ...	SEALS - CA...
	view	G0014-037	1/21/2003	689.45	20.4	<input type="checkbox"/>		<input type="checkbox"/>	Centrifugal ...	SEALS - CA...
	view	G0014-037	3/21/2003	0	270	<input checked="" type="checkbox"/>		<input type="checkbox"/>	Centrifugal ...	SEALS - CA...
	view	G0014-037	6/3/2003	0	244.8	<input checked="" type="checkbox"/>		<input type="checkbox"/>	Centrifugal ...	SEALS - CA...
	view	G0014-037	7/27/2003	0	285.6	<input checked="" type="checkbox"/>		<input type="checkbox"/>	Centrifugal ...	SEALS - CA...
	view	G0014-037	10/29/2003	0	72	<input checked="" type="checkbox"/>		<input type="checkbox"/>	Centrifugal ...	SEALS - CA...
	view	G0014-037	11/11/2004	659.05	336	<input type="checkbox"/>		<input type="checkbox"/>	Centrifugal ...	SEALS - CA...
	view	G0014-037	2/26/2005	0	144	<input checked="" type="checkbox"/>		<input type="checkbox"/>	Centrifugal ...	SEALS - CA...
	view	G0014-037	10/5/2006	679	168	<input type="checkbox"/>		<input type="checkbox"/>	Centrifugal ...	SEALS - CA...
	view	G0014-037	10/11/2007	0	162	<input checked="" type="checkbox"/>		<input type="checkbox"/>	Centrifugal ...	SEALS - FU...
	view	G0014-037	1/25/2009	836	336	<input type="checkbox"/>		<input type="checkbox"/>	Centrifugal ...	SEALS - FU...
*	view	(none)				<input type="checkbox"/>		<input type="checkbox"/>		

CEHint: You can group, filter, and sort the data on the Failure Data window.

By default, the following information is provided for each failure belonging to a Reliability Distribution Analysis on the **Failures** tab of the **Failure Data** window:

- **Datasheet:** A link that displays the datasheet associated with the failure event. This column appears only when a query is the data source for the analysis.
- **Asset ID:** The ID of the piece of equipment that failed. This value is mapped from a query or dataset. For manually entered data, you can click the first cell in the column and select the Asset ID belonging to the piece of equipment that you added on the [Assets tab](#) or type the ID in the cell.
- **Failure Date:** The date on which the failure of the piece of equipment occurred. This value is mapped from a query or dataset or manually entered when you create the analysis and is required.
- **TTF:** The Time to Failure is the duration of time from when the piece of equipment is placed into service until it fails. TTF may be expressed in terms of days, hours, cycles, units processed, etc. TTF values are calculated by the Meridium APM system based on the failure dates and are shown in gray to indicate that they are read-only.

- **Downtime:** The amount of corrective maintenance time for the piece of equipment after the failure occurs. This value is mapped from a query or dataset or manually entered when you create the analysis.
- **Ignore check box:** When selected, excludes the data in the associated row from the analysis calculations and plots. When cleared, includes the data in the associated row in the analysis calculations. You can modify this value manually.
- **Remarks:** Additional comments about the failure. You can enter a value in this column manually.
- **Censored check box:** A value that indicates whether or not the data point is *censored*, meaning the datapoint is excluded as a failure but included in the operating time of the piece of equipment. Select the check box if you want to [censor the data](#) in the selected row. When you create a Reliability Distribution Analysis using a query or dataset as the data source, the Meridium APM system automatically censors time values from the beginning of the Analysis Period to the first event and the time value from the last event to the end of the analysis. After the calculations for the analysis have been performed, each time that the query or dataset is refreshed, the censoring settings will be reset using the default criteria. Therefore, note that if you select a check box and refresh the page, the check boxes will no longer be selected.

Regardless of the data source you use, you can censor any failure data. Note that:

- For Maximum Likelihood Estimators (MLE), the maximum number of censored datapoints is one (1) less than the total number of datapoints.
- For Least Squares estimation, the maximum number of censored datapoints is two (2) less than the total number of datapoints.
- **Number of Failures:** The number of failed elements at each failure event. This column appears only when the failure type is **Failures Without Replacements**. This value is mapped from a query or dataset or manually entered when you create the analysis.
- **Replaced:** A value that indicates whether replacements were made following each equipment failure. A replacement causes the entire piece of equipment to be renewed, thus resetting calculation of the time to failure. This column appears only when the failure type is **Failures Without Replacements**. This value is mapped from a logical field in a query or dataset or manually entered when you create the analysis.

About the Asset Data for a Distribution Analysis

Datasheet	Asset ID	Installati...	Last Rep...	Present ...	Future Age	Present ...	Future F...
view	G0014-037		1/25/2009 ...	0	0	0	0
* view							

By default, the following information is provided on the **Assets** tab of the **Failure Data** window for each piece of equipment belonging to a Reliability Distribution Analysis:

- **Datasheet:** A link that displays the datasheet associated with the failure event. This column appears only when a query is the data source for the analysis.
- **Asset ID:** The ID of the piece of equipment that failed. This value is mapped from a query or dataset or manually entered when you create the analysis and is required.
- **Installation Date:** The date on which the piece of equipment was installed. This value is mapped from a query or dataset or manually entered when you create the analysis and is optional.
- **Last Replacement:** The last date on which the failed piece of equipment was replaced. This field is calculated by the Meridium APM system and values are read-only.
- **Number of Subcomponents:** This field is displayed on the grid only when the failure type is **Failures Without Replacements**. A piece of equipment can contain multiple subcomponents, such as tubes in a heat exchanger bundle. The **Number of**

Subcomponents column contains the number of subcomponents contained by the piece of equipment that is selected in the **Asset ID** column. This value is mapped from a query or dataset or manually entered when you create the analysis.

- **Present Age:** The current age of the piece of equipment. This field is calculated by the Meridium APM system and values are read-only.
- **Future Age:** The future age of the piece of equipment. This field is calculated by the Meridium APM system by adding the specified operating time to the current age of the piece of equipment. Values in this field are read-only.
- **Present Failure Probability:** The current probability of failure for each piece of equipment. This field is calculated by the Meridium APM system based on the present age of the piece of equipment and is read-only.
- **Future Failure Probability:** The future probability of equipment failure. This field is calculated by the Meridium APM system using the specified operating time. Values in this field are read-only.

Note that you can [specify the future time to calculate the future probability of failure](#).

Working with PM Optimization

Preventative Maintenance (PM) Optimization uses the results of a Distribution Analysis to measure the optimum time to perform a Planned (Restorative) Maintenance (PM) procedure on a piece of equipment. PM Optimization does not calculate minor maintenance schedules, but determines the optimal time to perform major repairs or replace a piece of equipment to there is a minimal amount of cost and risk. PM Optimization is only valid for *wear-out* failure modes and will not give accurate results for a Weibull analysis where Beta is less than 1.

A PM Optimization is composed of the following steps:

1. The calculation model is configured to acquire the necessary parameters, including Mean Time Between Failures (MTBF). MTBF is used to determine the probability that a piece of equipment will fail.
2. The cost ratio is determined. This ratio is the cost of planned Preventative Maintenance (PM) events versus the cost of unplanned maintenance events. You can manually enter the cost or select an existing query as the source of the cost data.
3. Based upon the MTBF and the calculation of the ratios, the Meridium APM system estimates the optimum time (interval) to maintain equipment. The cost per piece of equipment based on the Optimized Preventative Maintenance Interval is also displayed.
4. The Meridium APM system creates optimization graphs, which gives the analyst the optimum time to conduct a repair or overhaul based upon the ratio of planned to unplanned repair costs. This ensures that repairs are conducted in a cost-effective manner, minimizing risk while maximizing time in service.

The limitation to using a PM Optimization is it will always give a result for the statistical distribution on which it is based. This does not mean that it will always make sense to do a PM at the interval specified. In particular, design flaws that manifest themselves as poor reliability can more effectively be addressed through redesign rather than PM.

Performing a Preventive Maintenance Optimization

A [PM Optimization](#) involves several steps. Based upon the MTBF and the calculation of the ratios, the system estimates the optimum time interval to maintain equipment.

Note: This option is available only if **Failures With Replacements** was selected as the failure type via the **Reliability Distribution Analysis Builder** or the **Failure Type** dialog box. PM Optimization is not available when Beta is less than or equal to one ($\text{Beta} \leq 1$).

To perform a PM Optimization:

1. From the [Reliability Distribution Summary page](#), on the **Tools** menu, click the **PM Optimization** link.

The **Preventative Maintenance Optimization** dialog box appears.

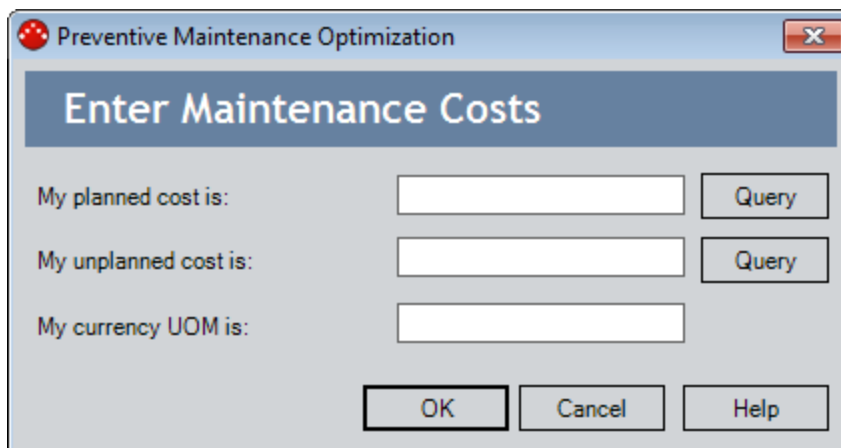

Note: If a PM Optimization has been performed previously, the **Preventive Maintenance Optimization** dialog box displays the results of the previous calculation.

2. Enter the planned maintenance cost and the unplanned maintenance cost. You can manually enter the cost or you can select a query and use it to populate a cost box.

To select an existing query stored in the catalog that contains the data that you want to use to populate a cost field:

- a. Click the **Query** button located next to the cost box.

The **Find Query** dialog box appears.

- b. Navigate to the desired query and select it.

Note: If you attempt to select a query that does not have any numeric fields, you will receive an error message.

Performing a Preventive Maintenance Optimization

The cost box on the **Preventive Maintenance Optimization** dialog box is populated with the name of the query you selected.

3. If desired, repeat steps a and b to select a query for the second cost field.
4. If desired, specify a currency UOM in the **My currency UOM is** text box to display values in a currency *other than* the default UOM.
5. Click **OK** to perform the calculations for the first time or to recalculate the PM Optimization to include the new data you just entered.

The system validates the data, and the **Preventive Maintenance Optimization** page displays the [results](#).

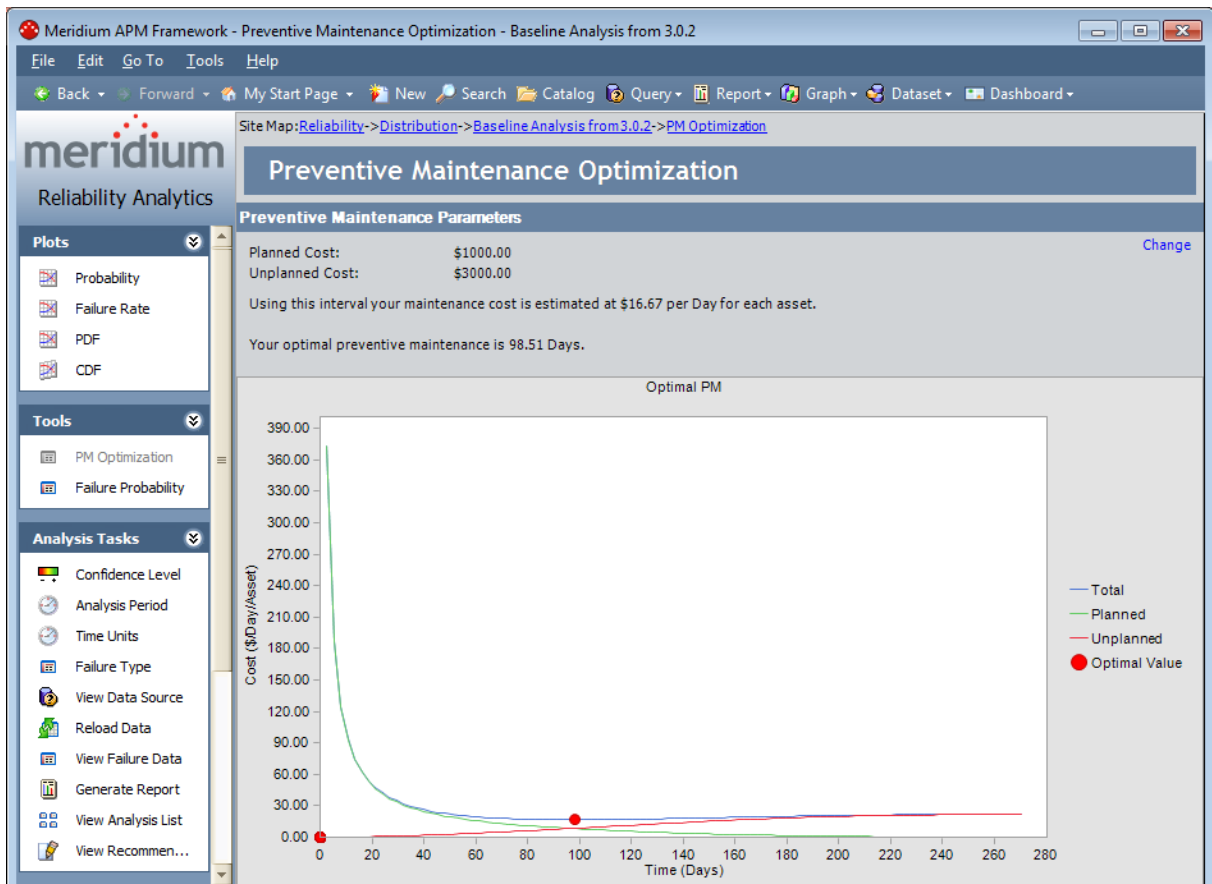

Aspects of the Preventive Maintenance Optimization Page

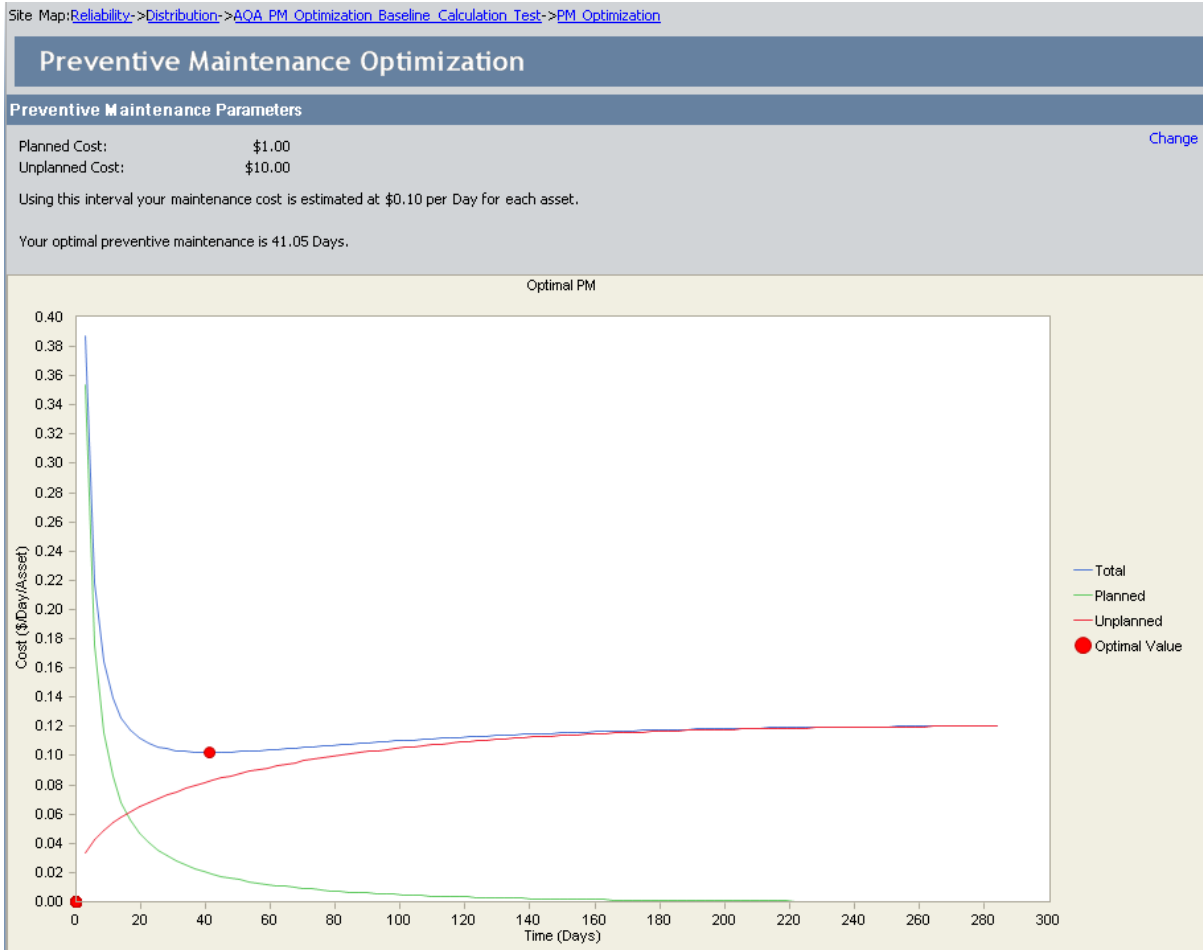

The following information appears on the **Preventive Maintenance Optimization** results screen:

- **Planned Cost:** The planned maintenance cost you entered on the **Preventative Maintenance Optimization** dialog box.
- **Unplanned Cost:** The unplanned maintenance cost you entered on the **Preventative Maintenance Optimization** dialog box.
- **Optimal Preventative Maintenance Interval:** The optimum interval during which you should perform maintenance on the piece of equipment you are analyzing.
- **Estimated Maintenance Cost:** The estimated maintenance cost per day for each piece of equipment during the optimal PM interval.
- **Optimal Value inflection point:** A value identified on the total cost curve.

About Failure Probability Calculations

The Meridium APM system can perform calculations on the data used in a Reliability Distribution Analysis to estimate how likely it is that a piece of equipment will fail today. Then, using future values that you supply, the Meridium APM system can calculate how likely it is that a piece of equipment will fail at some point in the future.

- The *current* failure probability is based on the current age of the piece of equipment, which is the amount of time that has passed between the last replacement date (i.e., the last failure date) and the End Date of the [Analysis Period](#).
- Two options are available for calculating *future* failure probability calculations:
 - You can [specify an operating time](#) to define a future age for the piece of equipment, and then the Meridium APM system will determine how likely it is that a piece of equipment will fail when it has reached that age.
 - You can [specify a failure probability](#), and the Meridium APM system will determine the age at which the piece of equipment will reach that likelihood of failing.

Failure probability calculations can be performed on the [Probability of Equipment Failure page](#). Probability of failure can be calculated for all Distribution models. The Meridium APM system uses the following formula to determine failure probability:

$$P(t1|t0) = 1 - \frac{(1 - D(t1))^n}{(1 - D(t0))^n}$$

Where:

- $P(t1|t0)$ is the failure probability at any given time assuming that the equipment has not yet failed at the current age. If you [specify a failure probability](#), the Meridium APM system will use this value to calculate the future age of the equipment.
- $D(t)$ is the cumulative distribution function, or the failure probability at time t for a new piece of equipment. The curve in the [CDF plot](#) represents this function.
- $t0$ is the current age of the piece of equipment.
- $t1$ is the future age of the piece of equipment. If you specify an operating time, this value is determined by adding the [that time](#) to the current age of the piece of equipment, and the resulting value is then used to calculate the failure probability.
- n is the number of subcomponents the piece of equipment contains (e.g., tubes in a heat exchanger bundle). If the failure type of the Reliability Distribution Analysis is *Failure with replacement*, the number of subcomponents is *1*. If the failure type is *Failure without replacement*, this value is mapped from a query or dataset or manually entered when you create the Reliability Distribution Analysis. The number of subcomponents appears in the **Number of Subcomponents** column on the [Assets tab of the Failure Data window](#).

Accessing the Failure Data for an Existing Analysis

When you access the **Probability of Equipment Failure** page for an analysis for the first time, the system will require you to specify an operating time that will be used for performing calculations. The operating time that you specify will be added to the Analysis Period to determine Future Age for which to calculate the probability of failure. After you access the **Probability of Equipment Failure** page, you will have the option of [changing the operating time](#) or [specifying a future probability](#).

The following instructions assume that you are accessing the **Probability of Equipment Failure** page for a new analysis *for the first time*. If you have accessed the **Probability of Equipment Failure** page previously, you will not be prompted to supply an operating time, as described in the instructions. Instead, the [Probability of Equipment Failure page](#) will appear immediately after you click the **Failure Probability** link and will display the results of the last calculation.

To access the **Probability of Equipment Failure** page for an analysis:

1. On the [Reliability Distribution Summary page](#), on the **Tools** menu, click the **Failure Probability** link.

The **Failure Probability Calculation** dialog box appears.

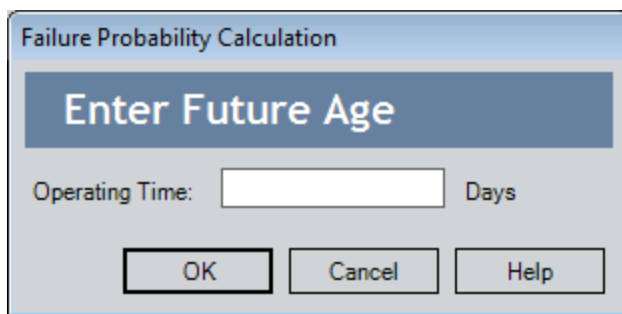

2. In the **Operating Time** text box, type a value that indicates the desired operating time. The value that you specify here will be added to the Present Age of the piece of equipment to determine the [Future Age for calculating the failure probability](#). For example, if the Present Age of the piece of equipment is 365 days, if you specify an operating time of 365 days, Meridium APM will determine how likely it is that the piece of equipment will fail when it has reached an age of 730 days, or two years.

Note: The unit of time corresponds to the [Time Units](#) that you have defined for the Operating Time in the analysis.

3. Click **OK**.

The system performs calculations and displays them on the **Probability of Equipment Failure** page.

Accessing the Failure Data for an Existing Analysis

Meridium APM Framework - Probability of Equipment Failure - P-100

File Edit Go To Tools Help

Back Forward My Start Page New Search Catalog Query Report Graph Dataset Dashboard

Site Map: Reliability -> Distribution -> P-100 -> Failure Probability

Probability of Equipment Failure

Specified Option: **Operating Time**
Value: **365.00 Days**

Asset ID	Installation Date	Last Replacement	Present Age	Future Age	Present Failure Probability	Future Failure Probability
P-100	1/1/2000	7/27/2001	3878.66671474856	4243.66671474856	99.9999935960386	73.7278951029573

PM Optimization
Failure Probability
Specify Time
Specify Probability

Confidence Level
Analysis Period
Time Units

Recalculate

Aspects of the Probability of Equipment Failure Page

The **Probability of Equipment Failure** page displays the probability of equipment failure, which is calculated by the system using the Future Age that you specify and the information available for the Distribution Analysis. The upper portion of the window displays two values, as shown in the following image.

Specified Option:	Operating Time
Value:	100.00 Days

- **Specified Option:** Indicates the selected option, either **Operating Time** or **Future Probability**.
- **Value:** Displays the value that you specified on the **Failure Probability Calculation** dialog box for the Specified Option.

Below these two values, a grid appears, displaying the following columns of information.

Asset ID	Installation Date	Last Replacement	Present Age	Future Age	Present Failure Probability	Future Failure Probability △
▶ Baseline-101	1/1/1990	1/24/1999	4383.58304398148	4483.58304398148	100	100
Asset-202	1/1/2000	11/27/2000	3710.58304398148	3810.58304398148	100	100
HX-123	1/1/2003	8/27/2003	2707.58304398148	2807.58304398148	100	100

- **Asset ID:** The Asset ID for each piece of equipment included in the analysis.
- **Installation Date:** The initial date that the piece of equipment was installed.
- **Last Replacement:** The date the piece of equipment last failed and, as a result, was replaced.
- **Present Age:** The current age of the piece of equipment. The value in the **Present Age** column represents the amount of time between the date in the **Last Replacement** column and the end date of the [Analysis Period](#), expressed in the [Time Units](#) selected for the analysis.
- **Future Age:** The age that is used for determining the value in the **Future Failure Probability** column. The value in the **Future Age** column is determined by adding the [Operating Time you specified](#) to the Present Age of the piece of equipment.
- **Present Failure Probability:** The current probability of failure for each piece of equipment based on the present age of the piece of equipment.
- **Future Failure Probability:** The probability that the piece of equipment will fail between the present time and the value in the **Future Age** column. The Future Failure Probability is based on the assumption that at the Present Age the piece of equipment has not failed.

A **Recalculate** button appears below the grid in the bottom, right corner of the page. You can click this button to recalculate values in the grid based on changes you make to any editable field. Note that when you [change the Time Units](#), [change the operating time](#) via the **Failure Probability Calculation** dialog box, or [change the probability](#) via the **Failure Probability Calculation** dialog box, the values in the grid are recalculated automatically.

Note: Since pieces of equipment contain multiple sub-elements, probability of failure calculations will be affected when the failure type is *Failures Without Replacements*.

Calculating the Probability of Failure at a Specified Age

After you have [accessed the Probability of Equipment Failure page](#), you can change the operating time to modify the Future Age and then recalculate the future probability of failure based on those changes.

Note: The following instructions provide details on changing the Future Age for *all* equipment in the analysis. You can recalculate failure probability for one or more pieces of equipment individually by modifying the Future Age in the grid and then clicking the **Update** button.

To change the future age and recalculate the future probability of failure:

1. On the **Probability of Equipment Failure** page, on the **Tools** menu, click the **Specify Time** link.

The **Failure Probability Calculation** dialog box appears. The **Operating Time** field displays the value that was last used to perform the calculation. The unit of time corresponds to the [Time Units](#) that you have defined for the Operating Time in the analysis. The Operating Time that you specify is how much time that will be added to the Present Age in order to determine the Future Age for which the failure probability will be calculated.

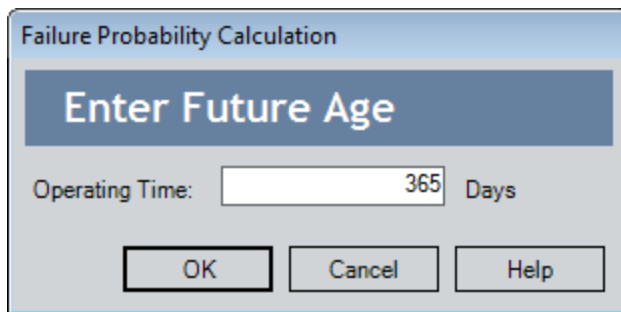

2. Modify the value in the **Operating Time** text box. For example, if you want to calculate the failure probability of a piece of equipment when it is two years older than its Present Age, you would set the operating time to **2 years**.
3. Click **OK**.

The system recalculates the future probability of failure values and displays them for each piece of equipment in the grid on the **Probability of Equipment Failure** page.

Calculating the Age When a Certain Probability of Failure will be Reached

After you have [accessed the Probability of Equipment Failure page](#), you can choose a specific probability of failure, and the system will calculate the future age at which that probability of failure will be reached.

Note: The following instructions provide details on changing the failure probability for *all* equipment in the analysis. You can recalculate failure probability for one or more pieces of equipment individually by modifying the probability in the grid and then clicking the **Update** button.

To calculate the future age when the specified probability will be reached:

1. On the **Probability of Equipment Failure** page, on the **Tools** menu, click the **Specify Probability** link.

The **Failure Probability Calculation** dialog box appears.

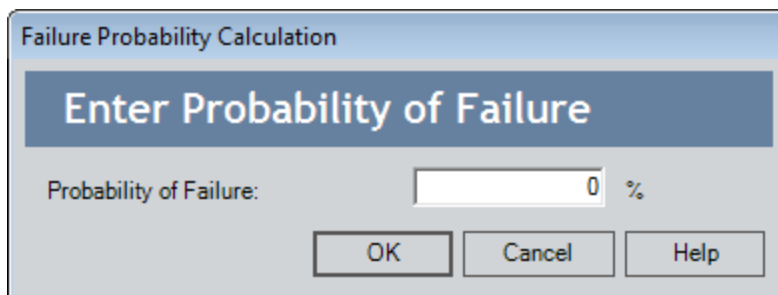

2. In the **Probability of Failure** text box, type a value that represents the desired probability of failure. For example, type **50** to calculate the age at which a piece of equipment has a 50 percent chance of failing.
3. Click **OK**.

The system recalculates the future probability of failure values and displays them for each piece of equipment in the grid on the **Probability of Equipment Failure** page.

Note: When using the **Failures Without Replacements** failure type, *Present Failure Probability* and *Future Failure Probability* will only be calculated for pieces of equipment that have a value greater than zero defined for the number of sub-elements. A value of 1 is assumed for the number of sub-elements for each piece of equipment when using the **Failures With Replacement** failure type.

About the Distribution Analysis Plots

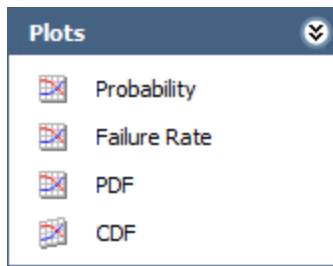

On the [Plots menu](#) on the **Reliability Distribution Summary** page, you can view any of the following plots by clicking the associating link:

- [Probability Plot](#)
- [Failure Rate Plot](#)
- [PDF Plot](#)
- [CDF Plot](#)

Note that when you view any of the plots, Meridium APM displays automatically-censored datapoints that represent the analysis End Dates for the defined piece of equipment.

While viewing any of the plots, you can:

- Click any datapoint to view the failure data.
- [Censor a datapoint](#) by right-clicking it and then clicking **Censored**.
- Customize the appearance of the plot by using standard graph features.
- Pause on the distribution plot line to view summary details about the Distribution Analysis, including the type of distribution and the distribution parameters. The value of R² is also listed. This value indicates the strength of a linear model. R² measures how closely the points fall to the least squares line, providing an indication of how confident one can be of predictions made with the line.

Probability Plot

The Probability plot is a log-log with data overlay and confidence limits. It displays the probability (expressed as a percentage) that a failure will occur over a certain time period (CDF Occurrence % vs. time). CDF Occurrence % used here is numerically equal to the value from the cumulative distribution. Time used here refers to life data, not Calendar data.

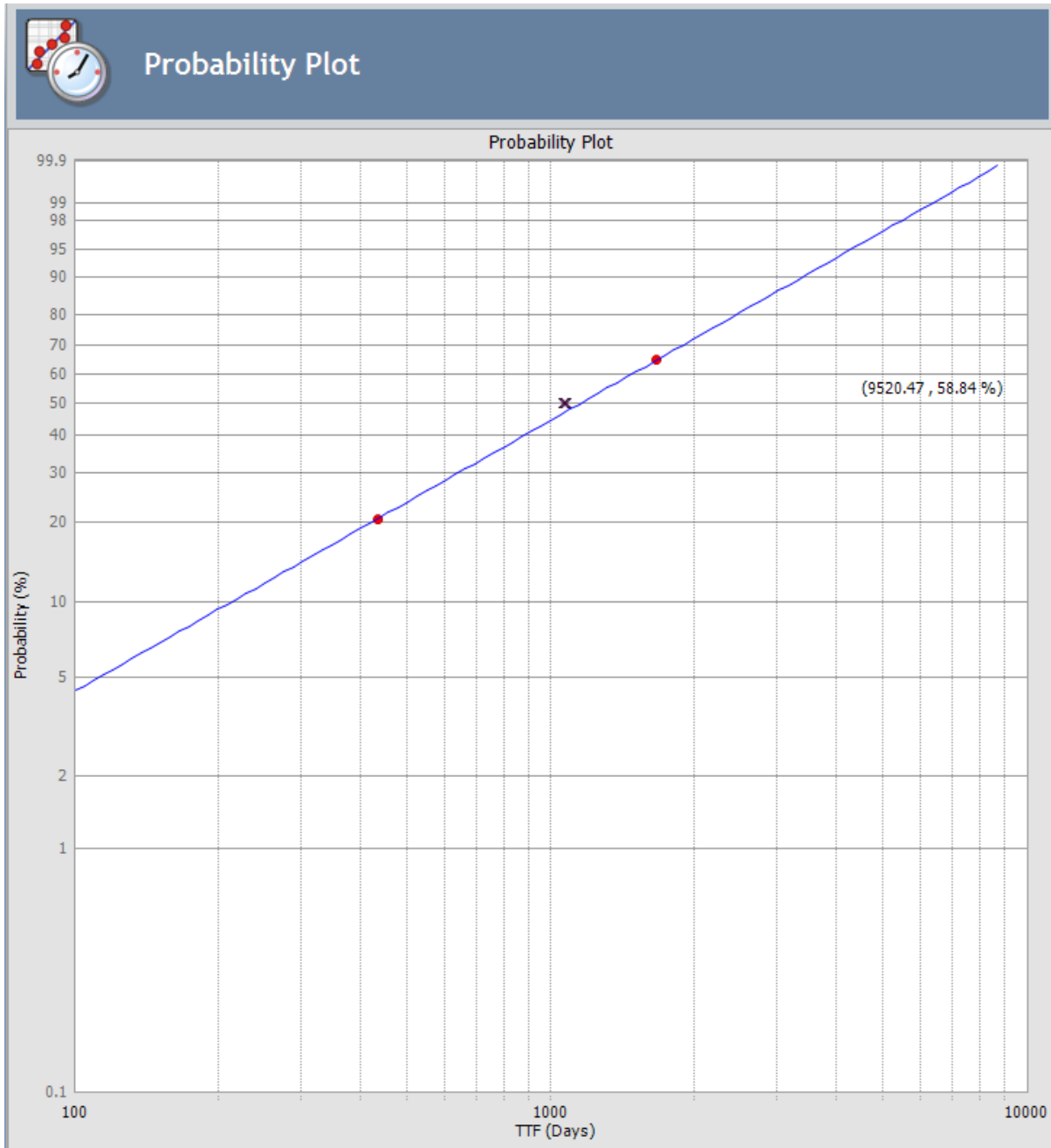

Probability Plot

The Probability plot provides the same data as the [CDF plot](#), just represented in a log-log format. It reflects the standard technique for representing Weibull Distribution. Log-log format Data overlay gives a visual estimate of goodness of fit. Data overlay also gives clues to the presence of multiple failure modes. If a single or multiple inflection points exist in the data, then there is a possibility of multiple failure modes.

Note: If you selected to use a [Confidence Level](#), confidence intervals are included in the analysis calculations and the upper and lower limits appear on the plot.

Failure Rate Plot

The Failure Rate plot shows the instantaneous failure rate of the population.

- If the function is increasing, the equipment is wearing out.
- If the function is decreasing, the equipment is subject to infant mortality.

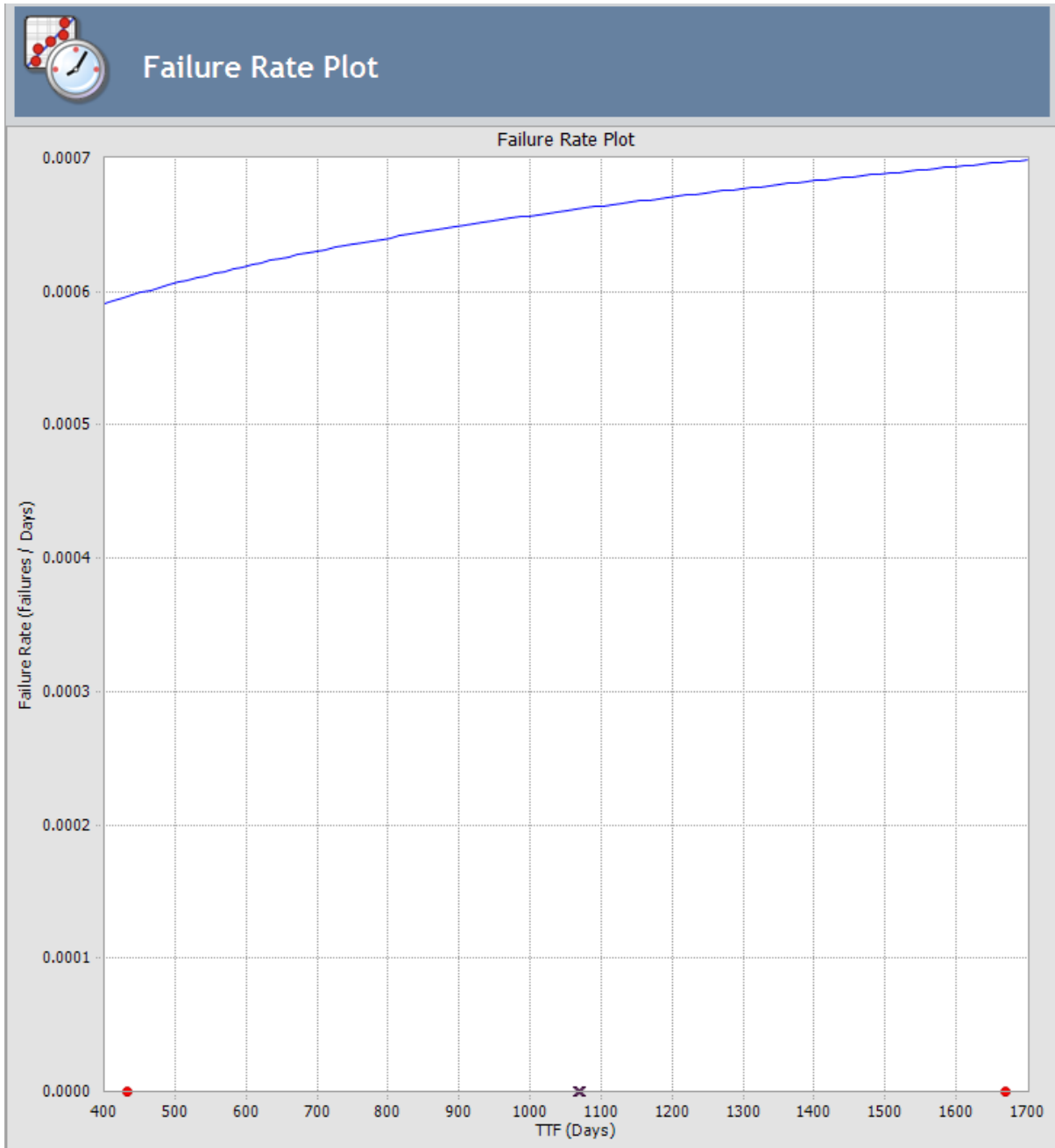

PDF Plot

The Probability Density Function (PDF) plot is a log-log plot that counts the number of failures between certain time periods, creating a curve that estimates how many failures you can expect to occur at a given number of time units. This plot shows Probability vs. time. The term *Probability* is used here to describe the percent of the population that failed at the particular value of time (t). A PDF plot helps you to answer a question such as, "What is the chance of a member of the population failing at exactly the time in question?"

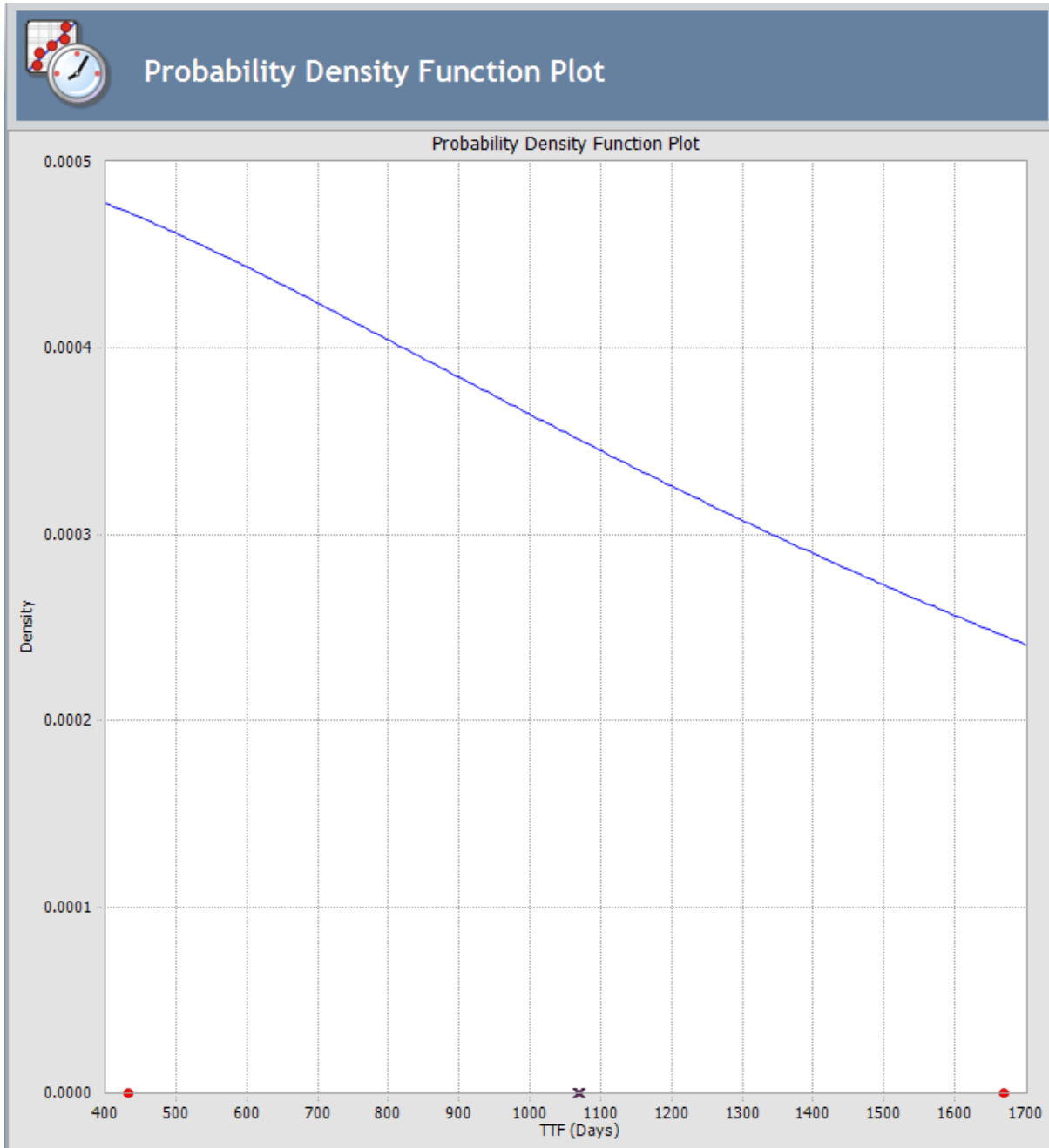

PDF Plot

PDF shows the curve fit of the data. It answers the question, "Based on the curve fit, what is the probability that failure will occur below or above a certain value?" The chart is a graphical representation of the data. It shows the variance or spread of the data, but it is not used often for analysis.

CDF Plot

The Cumulative Distribution Function (CDF) Plot shows the probability of a piece of equipment failing over time, as shown in the following figure. The dotted line illustrates that at a given time, you can determine the probability of failure or unreliability.

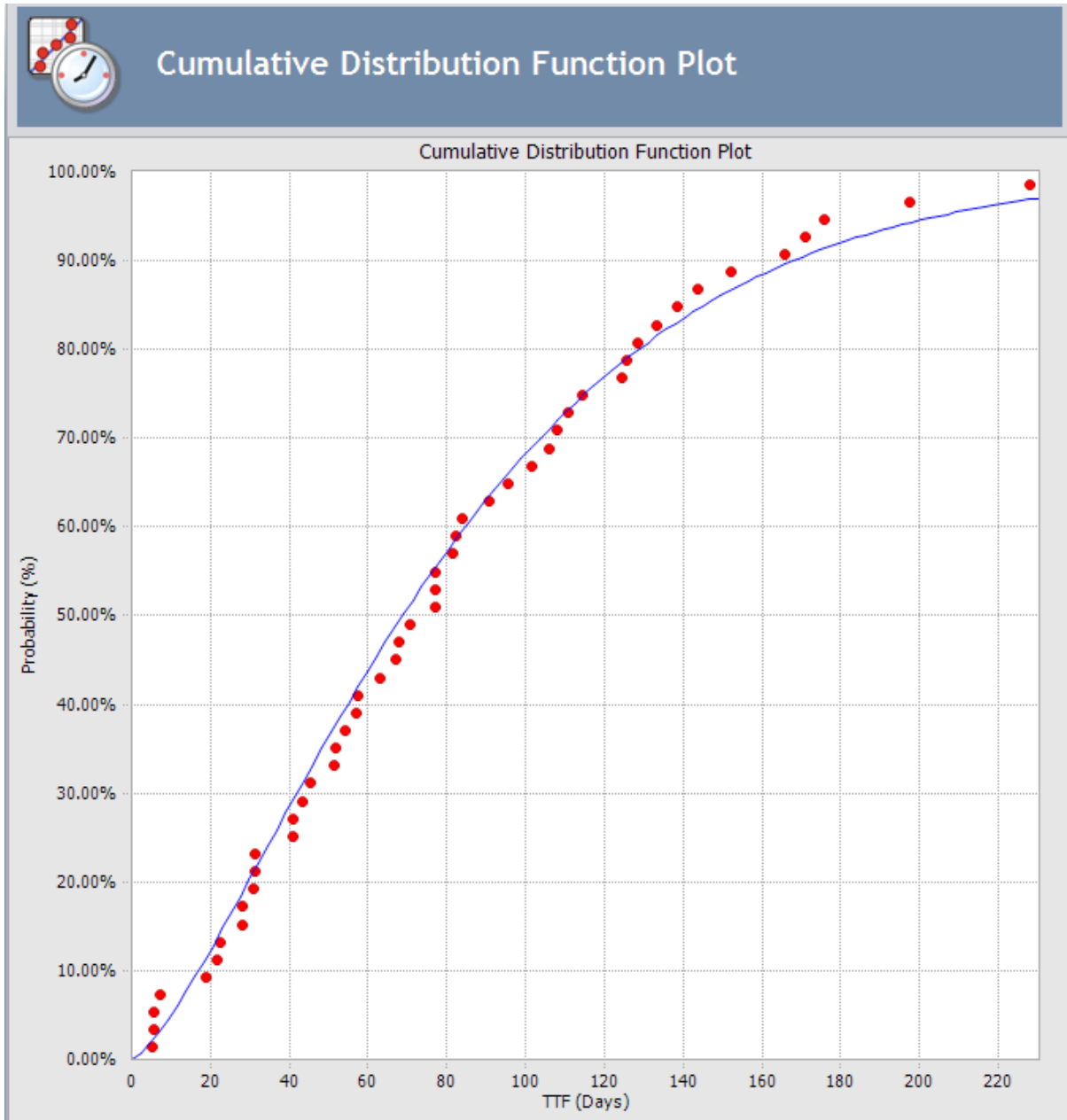

Here, the term *Probability* is used in this instance to describe the percent of the total population that will fail by time (t). *Time* used here refers to life data, not Calendar data. The plot type is lin-lin with data overlay and confidence limits.

The reliability of a piece of equipment can be evaluated by subtracting the Probability of Failure from 1 ($R = 1 - P$). The Probability of Failure Plot shows the probability that the unit will survive up to a given age. The Failure Rate Plot displays the Failure Rate for a given system based on the System Reliability calculations.

Cumulative Distribution Plot answers the question, "What is the probability of failure at time(t)?" The CDF curve is the area under the PDF curve. The CDF accumulates all probability of failure up to the point in time in question. Since the number of failures increases with increasing time, the slope of the curve is always positive, always increasing.

In addition, you can select one or more Reliability Distribution Analyses from the list of analyses and generate a composite plot in order to compare the competing failure modes. Competing failure modes occur when the failure pattern, due to one type of fault, dominates the survivor population from another type of fault. If the failure patterns overlap like this, then they are said to be competing failure modes.

Note: If you selected to use a [Confidence Level](#), confidence intervals are included in the analysis calculations and the upper and lower limits appear on the plot.

Overview of the Reliability Distribution Report

The baseline Meridium APM database includes the Reliability Distribution Report, which you can use to view a summary of the results of a Reliability Distribution Analysis. When you run the Reliability Distribution Report, it will appear on the **Report Viewer** page.

The Reliability Distribution Report is built from the following Catalog items:

- The main report, *DistributionAnalysisReport*, which is stored in the Catalog folder \\Public\Meridium\Modules\Reliability Manager\SSRS.
- The subreport, *SubreportDistributionAnalysis*, which is stored in the Catalog folder \\Public\Meridium\Modules\Reliability Manager\Reports.
- The subreport, *assetSubreportDistribution*, which is stored in the Catalog folder \\Public\Meridium\Modules\Reliability Manager\Reports.
- The supporting queries that supply data in the main report and subreports, which are stored in the Catalog folder \\Public\Meridium\Modules\Reliability Manager\Reports. The following supporting queries are available:
 - *ReliabilityDistributionQuery*
 - *ReliabilityDistributionTTR*
 - *ReliabilityExponentialTTF*
 - *ReliabilityExponentialTTR*
 - *ReliabilityLognormalTTF*
 - *ReliabilityLognormalTTR*
 - *ReliabilityNormalTTF*
 - *ReliabilityNormalTTR*
 - *ReliabilityWeibullTTF*
 - *ReliabilityWeibullTTR*

Throughout this documentation, we refer to the main report, the subreports, and the supporting queries collectively as the *Reliability Distribution Report*.

The Probability Distribution Report contains the following sections:

- Analysis Summary
- Statistical Distribution Information
- Assets
- Failure Data
- Plots

Running the Reliability Distribution Report

To run the Reliability Distribution Report:

1. While viewing the desired Reliability Distribution Analysis on any page, on the **Analysis Tasks** menu, click the **Generate Report** link.

The **Report Options** dialog box appears. The following image shows what the **Report Options** dialog box looks like by default.

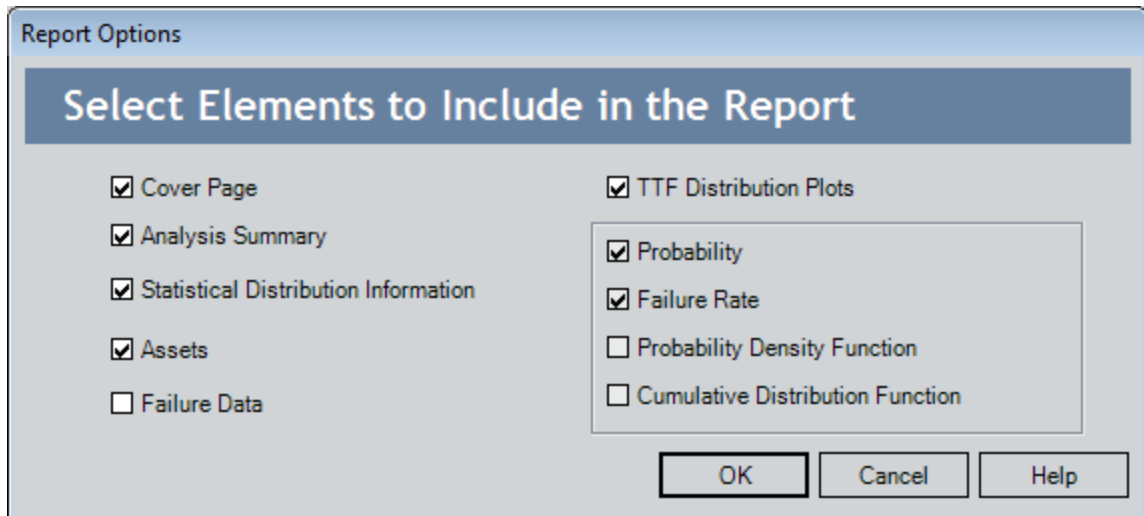

2. Select the desired elements to be included in the report, and click **OK**.

The Reliability Distribution Report appears on the **Report Viewer** page.



Analysis Summary Section

The **Analysis Summary** section of the Reliability Distribution Report displays information that is stored in the Reliability Distribution record and Distribution records that are linked to the Reliability Distribution record.

Analysis Summary	
Analysis Name:	1041828 Exchanger U-Bend - Internal Tubes
Analysis Description:	1041828 Exchanger U-Bend Distribution Analysis
Analysis Start:	3/3/2005 4:48:00 AM
Analysis End:	8/15/2012 10:27:58 AM
Number of Assets:	1
Number of Failures:	3
Censored Failures:	1
MTBF:	1,648.41 Days
MTRR:	5.00 Days
Use Confidence:	False
Confidence Level:	
Last Modified:	10/29/2009
Modified By:	Demo, Joe

The following table lists each item in the **Analysis Summary** section and the corresponding Reliability Distribution or Distribution record field whose data is displayed in the report.

Report Item	Reliability Distribution or Distribution record	Record Field	Notes
Analysis Name	Reliability Distribution	Analysis ID	None
Analysis Description	Reliability Distribution	Short Description	None
Analysis Start	Reliability Distribution	Analysis Start Date	None

Report Item	Reliability Distribution or Distribution record	Record Field	Notes
Analysis End	Reliability Distribution	Analysis End Date	None
Number of Assets	Reliability Distribution	Assets	None
Number of Failures	Reliability Distribution	Number of Failures	None
Censored Failures	Reliability Distribution	Censored Failures	None
MTBF	Reliability Distribution	MTBF	None
MTTR	Reliability Distribution	MTTR	None
Use Confidence	Reliability Distribution	Use Confidence	None
Confidence Level	Distribution	Confidence Level	None
Last Modified	Reliability Distribution	LAST_UPDT_DT	None
Modified By	Reliability Distribution	LAST_UPBY_SEUS_KEY	The name of the Security User associated with this value is displayed in the report.

Statistical Distribution Information Section

The **Statistical Distribution Information** section of the Reliability Distribution Report displays information that is stored in each Distribution record that is linked to the Reliability Distribution record. Each Distribution record is a member of one of four Distribution subfamilies in which records can exist: Exponential, Lognormal, Normal, or Weibull. The following image displays the statistical distribution information for a Weibull record.

Statistical Distribution Information				
Time To Failure Distribution				
Distribution Type:	Weibull			
Operating Time Units:	Days			
Fit Method:	Least Squares			
R²:	1.00			
Mean:	1648.41			
Standard Deviation:	1929.37			
Median:	993.69			
Parameters				
Name	Value	Low	High	Calculated
Beta	0.86	0.86	0.86	Yes
Eta	1523.52	1523.52	1523.52	Yes
Gamma	0.00	0.00	0.00	No
Goodness of Fit Test				
Name	Statistic	P-Value	Passed	
Kolmogorov-Smirnov Test	0.03	0.00	True	

The following subsections are displayed for *each* Distribution record that is linked to the Reliability Distribution:

- [Distribution](#)
- [Parameters](#)
- [Goodness of Fit](#)

Distribution Subsection

The **Statistical Distribution Information** section contains the **<Variable>Distribution** subsection, where **<Variable>** is the value that is stored in the Variable field in the Distribution record that is linked to the Reliability Distribution record. Throughout the documentation, we will refer to this subsection as the **Distribution** subsection.

Time To Failure Distribution	
Distribution Type:	Weibull
Operating Time Units:	Days
Fit Method:	Least Squares
R²:	1.00
Mean:	1648.41
Standard Deviation:	1929.37
Median:	993.69

The following table lists each item in the **Distributions** subsection and the corresponding Distribution record field whose data is displayed in the report.

Report Item	Distribution Field
Distribution Type	Distribution Type
Operating Time Units	Units
Fit Method	Fit Method
R ²	R-Squared
Mean	Mean
Standard Deviation	Standard Deviation
Median	Median

Parameters Subsection

The **Statistical Distribution** section contains the **Parameters** subsection, which contains information stored in a Distribution record (i.e., Weibull, Lognormal, Exponential, or Normal record). The Weibull, Lognormal, Exponential, or Normal record is linked to the Reliability Distribution record. The items that appear in the **Parameters** subsection will be different, depending on the type of Distribution record. The following image displays an example of the **Parameters** subsection for a Weibull record.

Parameters

Name	Value	Low	High	Calculated
Beta	0.86	0.86	0.86	Yes
Eta	1523.52	1523.52	1523.52	Yes
Gamma	0.00	0.00	0.00	No

The following table lists each item in the **Parameters** subsection for a Weibull record whose data is displayed in the report. For a Weibull record, one row is displayed for each of the following field captions: Beta, Eta, and Gamma.

Report Item	Weibull Field
Beta	
Value	Beta
Low	Beta Low
High	Beta High
Calculated	Beta Fixed
Eta	
Value	Eta
Low	Eta Low
High	Eta High
Calculated	Eta Fixed
Gamma	
Value	Gamma
Low	Gamma Low
High	Gamma High
Calculated	Gamma Fixed

The following table lists each item in the **Parameters** subsection for a Lognormal record whose data is displayed in the report. For a Lognormal record, one row is displayed for each of the following field captions: Mu, Sigma, and Gamma.

Report Item	Lognormal Field
Mu	
Value	Mu
Low	Mu Low
High	Mu High
Calculated	Mu Fixed
Sigma	
Value	Sigma
Low	Sigma Low
High	Sigma High
Calculated	Sigma Fixed
Gamma	
Value	Gamma
Low	Gamma Low
High	Gamma High
Calculated	Gamma Fixed

The following table lists each item in the **Parameters** subsection for an Exponential record whose data is displayed in the report. For an Exponential record, one row is displayed for the field caption MTBF.

Report Item	Exponential Field
MTBF	
Value	MTBF
Low	MTBF Low
High	MTBF High
Calculated	MTBF Fixed

The following table lists each item in the **Parameters** subsection for a Normal record whose data is displayed in the report. For a Normal record, one row is displayed for each of the following field captions: Mean, Standard Deviation.

Report Item	Normal Field
Mean	
Value	Mean
Low	Mean Low
High	Mean High
Calculated	Fix Mean
Standard Deviation	
Value	Standard Deviation
Low	Standard Deviation Low
High	Standard Deviation High
Calculated	Fix Standard Deviation

Goodness of Fit Subsection

The **Statistical Distribution Information** section contains the **Goodness of Fit Test** subsection, which displays information from the corresponding Distribution record.

Goodness of Fit Test

Name	Statistic	P-Value	Passed
Kolmogorov-Smirnov Test	0.03	0.00	True

The Kolmogorov-Smirnov test is the only test used to measure goodness of fit, so the **Name** column in the report is populated automatically with the value *Kolmogorov-Smirnov Test*. The following table lists each remaining item in the **Goodness of Fit Test** subsection and the corresponding Distribution record field whose data is displayed in the report.

Report Item	Distribution Field
Statistic	GOF Statistic
P-Value	GOF P-Value
Passed	Passed

Assets Section

The **Assets** section of the Reliability Distribution Report displays information that is stored in the Failure Data field in the Reliability Distribution record.

Assets						
Asset ID	Installation Date	Last Replacement	Present Age	Future Age	Present Future Probability	Future Failure Probability
00000000 00010418 28		11/30/2007	697.69	1062.69	40.06%	19.94%

The following values are displayed in the **Assets** section, and they are stored in the Failure Data field in the Reliability Distribution record:

- **Asset ID**
- **Installation Date**
- **Last Replacement**
- **Present Age**
- **Future Age**
- **Present Future Probability**
- **Future Failure Probability**

Failure Data Section

The **Failure Data** section of the Reliability Distribution Report displays information that is stored in the Failure Data field in the Reliability Distribution record.

Failure Data						
Asset ID	Failure Date	TTF	Downtime	Ignore	Censored	Remarks
00000000 00010418 28						
	4/24/1998	0	6	False	True	
	3/3/2005 4:48:00 AM	2499.2	2.4	False	False	
	5/3/2007 7:12:00 PM	789.2	4.8	False	False	
	11/30/2007	205.4	6	False	False	

The following values are displayed in the **Failure Data** section, and they are stored in the Failure Data field in the Reliability Distribution record:

- Asset ID
- Failure Date
- TTF
- Downtime
- Ignore
- Censored
- Remarks

Plots Section

The **Plots** section of the Reliability Distribution Report displays the graphs that are displayed on the [Reliability Distribution Summary page](#) or accessed via the **Plots** menu on the [Reliability Distribution Summary page](#). The following image shows an example of the Probability Plot.

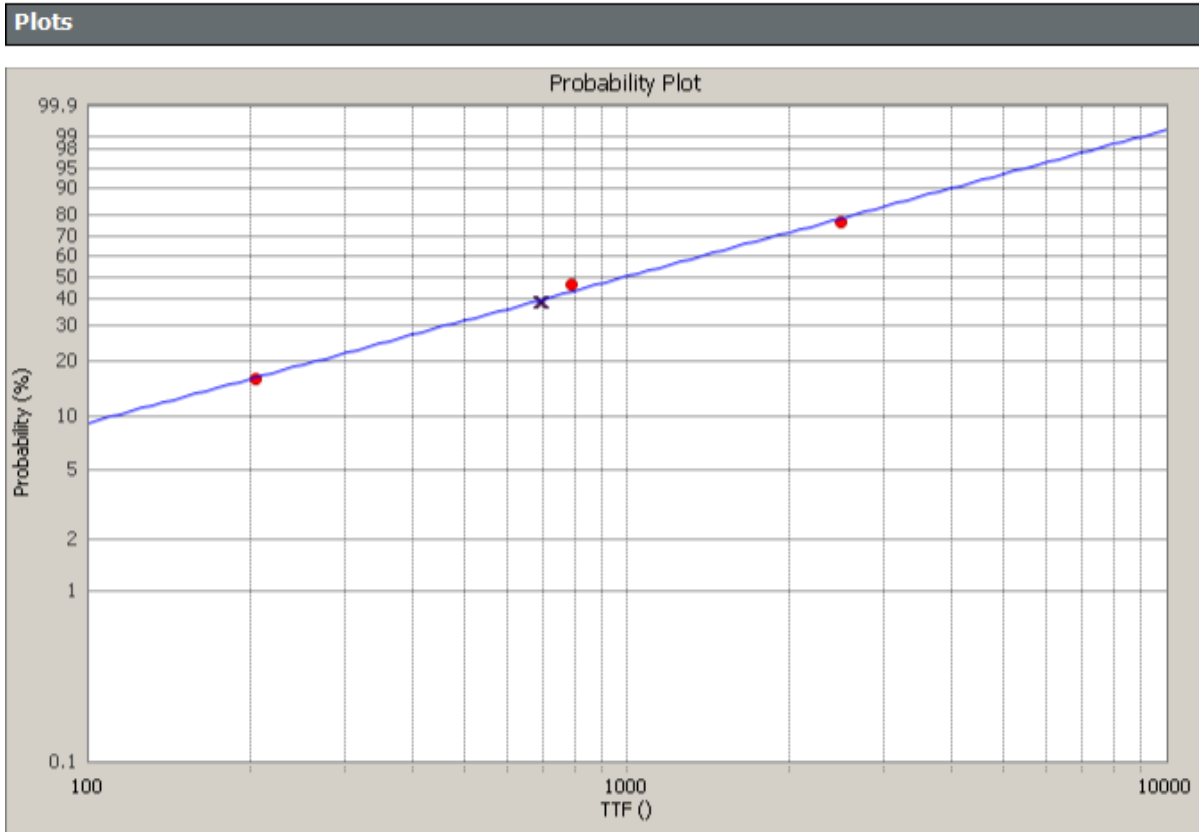

The **Plots** section displays the following graphs:

- [Probability Plot](#)
- [Failure Rate Plot](#)
- [Probability Density Function Plot](#)
- [Cumulative Distribution Function Plot](#)

What are the Results of a Reliability Distribution Analysis?

After you have created a Reliability Distribution Analysis, the following options are available:

- Analysis results can include confidence intervals and parameters for the selected Distribution and goodness of fit measures.
- Distribution fitting can be done by Least Squares or Maximum Likelihood (MLE).
- The four different types of Reliability plots (Probability of Failure, Failure Rate, Probability Density Function, and Cumulative Distribution Function) can be displayed. In addition, you can select between 2 and 10 Distribution analyses and choose to view and compare all four of the plot types for the selected analyses using the Competing Failure Plots feature.
- Reliability Distribution Analyses can support Failures without Replacement, which are needed to calculate reliability for heat exchangers, boiler tubes, piping, and other pieces of equipment where a repair does not necessarily involve changing the whole unit.
- The Preventive Maintenance Optimization calculator can utilize the results of the Distribution analysis and allow you to input the estimated costs of an unplanned repair versus a planned repair. Based on the MTBF and the ratio of unplanned cost to planned cost, the system calculates the optimal time to maintain equipment.
- A Failure Probability calculator can utilize the results of a Distribution Analysis; based upon MTBF, Beta, and the last Failure Date, the system calculates the probability of equipment failure at the time in the future that you specify. The system also provides the capability to calculate future life based upon a failure probability that the user specifies.
- Based on the analysis results, you can generate recommendations for the maintenance and reliability activities that should be executed in the future to maintain best practices in your organization.

Time to Failure

The most important piece of data for distributions is Time to Failure (TTF), which is also sometimes known as Time to Event (TTE) or Time Between Failures (TBF).

Suppose that you have the following timeline, where each number represents the amount of time that passes between failures.

Installation	5	11	23	38	16	22	44	32	Out of Service
--------------	---	----	----	----	----	----	----	----	----------------

You could fit a Weibull Distribution to this data. A Probability Density Function (PDF) is similar to a histogram of the raw TTF data:

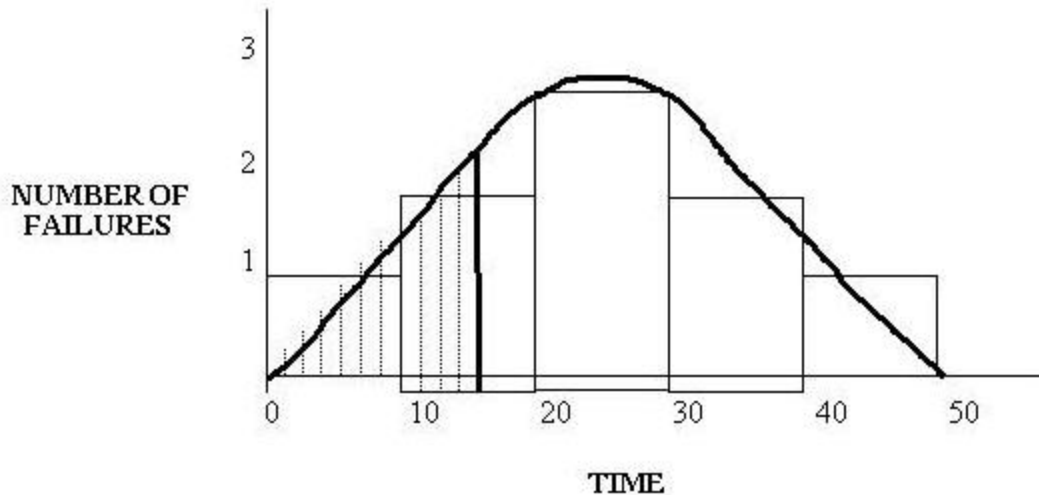

The distribution shows:

- One failure occurring between time 0 & 10.
- Two failures occurring between time 11 & 20.
- Three failures occurring between time 21 & 30.
- Two failures occurring between time 31 & 40.
- One failure occurring between time 41 & 50 (Out of service).

This type of graph counts the number of failures between certain periods. This creates a curve, which you can examine and ask: At 15 time units, how many failures can I expect to have? The answer: Between two and three failures. You are distributing the failures over the life of the equipment so that at any given point in that life, you can calculate the probability that the equipment will fail. This calculation is generated based on the area under the curve, as shown in the previous graphic. In practice, the PDF is adjusted in such a way that the area under the curve is exactly one, and the number on the y-axis represents the number of failures per time unit.

You select your historical data: other pieces of equipment by the same manufacturer, other pieces of equipment in the same location, other pieces of equipment of the same type, etc. For example, suppose that you want to buy a new pump. You could perform a Distribution Analysis on the other pumps of the same model to predict the reliability of the new pump.

What is a Probability Distribution Analysis?

Based on a query, dataset, or data that you manually enter, you can pull in an independent variable to generate a Probability Distribution analysis. This type of analysis allows you to describe the Time to Failure (TTF) as a statistical distribution, which usually is characterized by a specific pattern. Meridium APM Reliability supports four Distribution types: [Weibull](#), [Normal](#), [Lognormal](#), and [Exponential](#).

Data Used in a Probability Distribution Analysis

The following table shows the typical data required for building and analyzing Reliability Distribution documents in Meridium APM.

Data Needed	Description	Notes
Value	Select the field that contains the value you want to analyze.	Select a numeric field. This is a required field.
Censored	If desired, select a field provides censoring information. Select the field from the data source that contains a value that indicates censored values, i.e. not included in the Probability Distribution analysis calculations.	Select a logical field. This field is optional.
Random Variable	If the data source is a query, the name of the random variable and the units of measure will be pre-populated based on the selection you made in the Value field on the previous screen. If you selected a different data source, type the name of the random variable in the Random Variable field and the units of measure for the random variable in the Units field.	This field is optional.
Units	Select the units of measure for the random variable.	This field is optional.

Accessing the List of Probability Distribution Analyses

To load a list of existing Probability Distribution Analyses:

- On the **Reliability Start Screen**, click the **Probability Distribution** link.

The **Probability Distribution List** page appears.

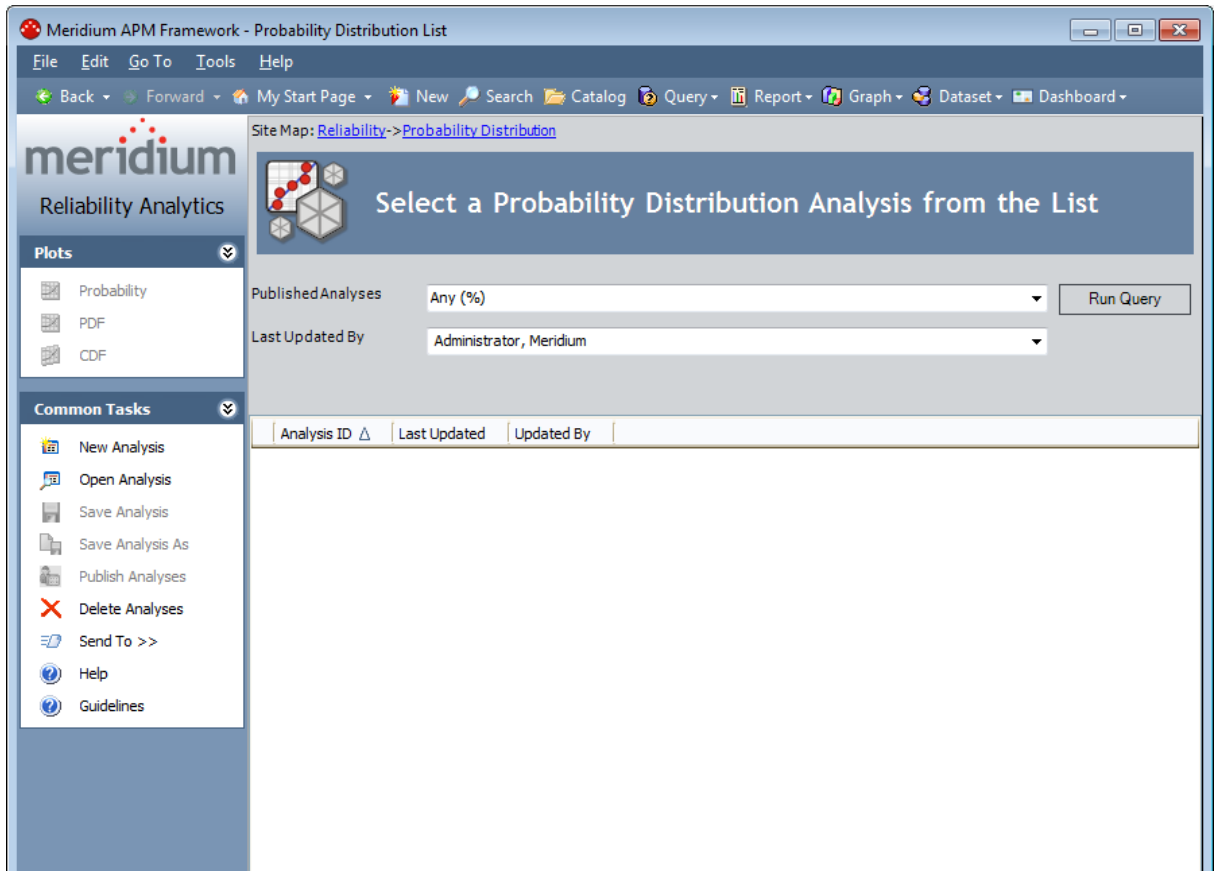

From the **Probability Distribution List** page, you can run the Probability Distribution query to retrieve a list of Probability Distribution Analyses that exist in the database. From the list of analyses, you can access the analysis summary for any analysis. Alternatively, you can click the **New Analysis** link on the [Common Tasks menu](#) to begin the process of [creating a new Probability Distribution analysis](#).

Aspects of the Probability Distribution Analyses List

The [Probability Distribution List page](#) lets you run the Probability Distribution query to access a list of existing Probability Distribution Analyses that meet your query criteria.

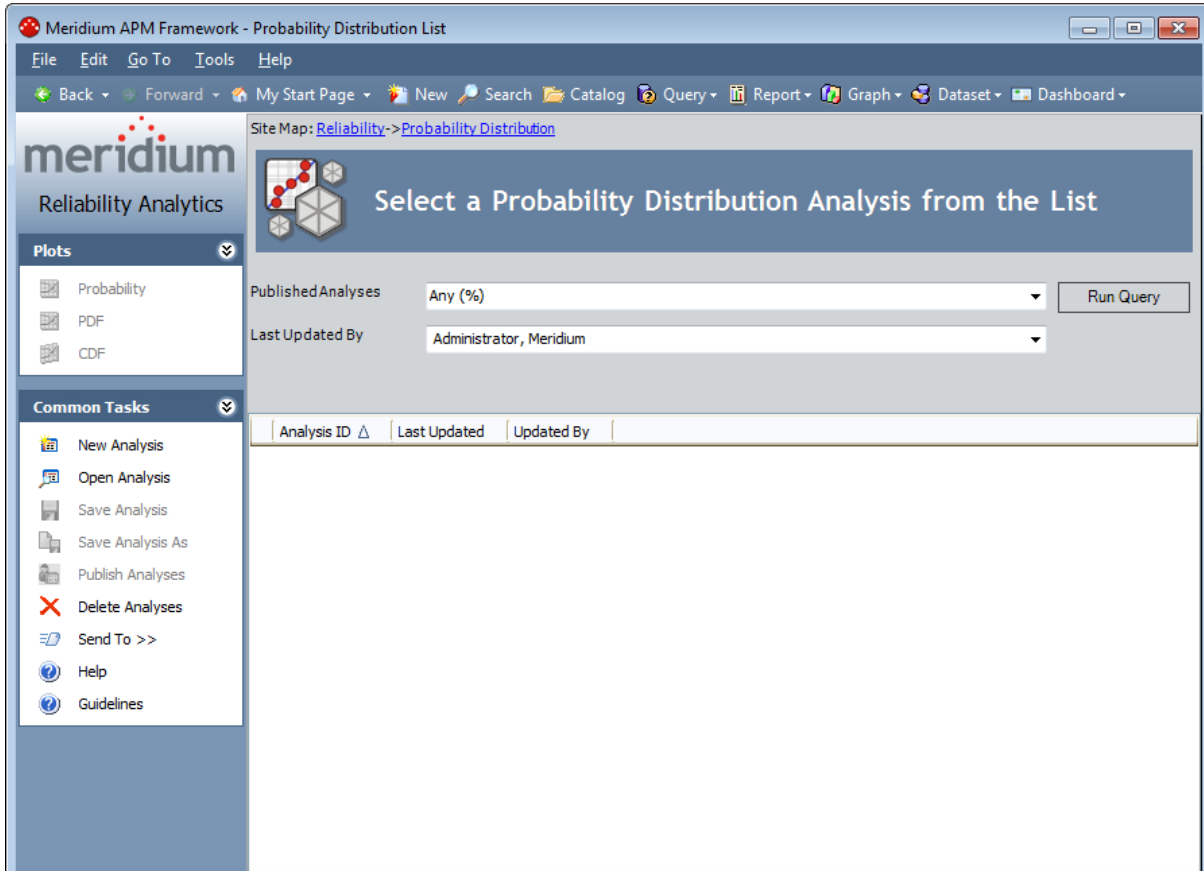

The Probability Distribution query is stored in the Meridium APM Catalog folder \\Public\Meridium\Modules\Reliability Manager\Analyses. While the Probability Distribution query can be [customized](#) for your specific implementation, the baseline Probability Distribution query contains two prompts: **Published Analyses** and **Last Updated By**. These prompts appear at the top of the page as drop-down lists that contain the various options.

The **Published Analyses** list contains the following options:

- **Any (%):** Will cause the query to return all Probability Distribution Analyses, either published or unpublished.
- **Yes (Y):** Will cause the query to return only published Probability Distribution Analyses.
- **No (N):** Will cause the query to return only unpublished Probability Distribution Analyses.

The **Last Updated By** list contains the following options:

- Your user name, which is selected by default and will cause the query to return only the Probability Distribution Analyses that were last updated by you.
- The user name of any user who last updated any Probability Distribution Analysis, which will cause the query to return only the Probability Distribution Analyses that were last updated by that user.
- The **[All Users]** option, which will cause the query to return a list of Probability Distribution Analyses updated by any user.

Each time you access the **Probability Distribution List** page, the values that appear by default in the prompts will be used to filter the list. After you select different criteria, you can click the **Run Query** button to run the Probability Distribution query and display the results in a grid at the bottom of the page.

Note: Although the results are returned by the Probability Distribution query, query page size is ignored. The entire list of analyses is displayed at once.

The default Probability Distribution query is configured to display the following columns of information: **Analysis ID**, **Last Updated**, and **Updated By**. You can click any hyper-linked analysis ID to view the associated [Probability Distribution Analysis summary](#). In addition, you can use the options on the [Plots](#) and [Common Tasks](#) menus to perform various tasks for the analyses in the list.

CE Hint: If desired, you can customize the column display.

Plots Menu



The **Plots** menu on the **Probability Distribution List** page contains the following links:

- **Probability:** Displays a [Probability Plot](#) for the selected analysis.
- **PDF:** Displays a [Probability Density Function Plot](#) for the selected analysis.
- **CDF:** Displays a [Cumulative Distribution Function Plot](#) for the selected analysis.

Common Tasks Menu

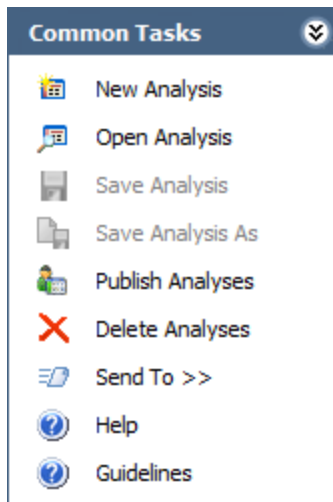

The **Common Tasks** menu on the **Probability Distribution List** page contains the following links:

- **New Analysis:** Displays the [Distribution Builder](#), which will guide you through the process of creating a new Probability Distribution Analysis.
- **Open Analysis:** Lets you locate an existing Probability Distribution Analysis using the **Find a Reliability Distribution Analysis** window.
- **Publish Analyses:** [Publishes](#) the selected analysis or analyses. If you select one or more analyses that are already published, this link reads **Unpublish Analyses** and will [unpublish](#) the selected analysis.
- **Delete Analysis:** Deletes the currently displayed analysis.
- **Send To:** Displays a submenu with options that let you provide a link to the current page on your desktop (create shortcut), in an email message, or on a Home Page.
- **Help:** Displays the context-sensitive Help topic for the **Probability Distribution List** page.
- **Guidelines:** Displays the Reliability Concepts, which provide reliability workflows and descriptions of reliability concepts.

Note: The **Save Analysis** and **Save Analysis As** links are always disabled.

About the Multiple Distributions Plot Page for a Probability Distribution Analysis

You can select one or more Probability Distribution Analyses (a minimum of 2 analyses and a maximum of 10 analyses) from the list of existing analyses, select the desired plot type on the [Plots menu](#), and generate a composite plot in order to compare the distribution curves. The composite plot appears on the **Multiple Distributions Plot** page.

From this page, you can do the following:

- To display the selected Distribution Analyses as datapoints on the plot, click the **Show Failures** link on the **Plots** menu. A **Hide Datapoints** link now appears on the **Plots** menu.
- Pause on the distribution plot line to display a tool tip that shows summary details about the Distribution Analysis, including the type of distribution and the distribution parameters.
- Click the distribution plot line to access the **Probability Distribution Results** page for a distribution.
- To return to the list of Distribution Analyses, click the **Back** button.

Using the Distribution Builder

Using the **Distribution Builder**, you can create a new Probability Distribution Analysis:

- Based on a [new or existing query or dataset](#).
- By [manually entering failure data](#).

You can access the Distribution Builder either from the [Probability Distribution List page](#) or from the [Probability Distribution Results page](#).

Creating a Probability Distribution from a Query or Dataset

To create a new Probability Distribution Analysis based on a new or existing query or dataset:

1. On the [Probability Distribution List](#) page or on the [Probability Distribution Results](#) page, on the **Common Tasks** menu, click the **New Analysis** link.

The **Distribution Builder** appears, displaying the Welcome screen.

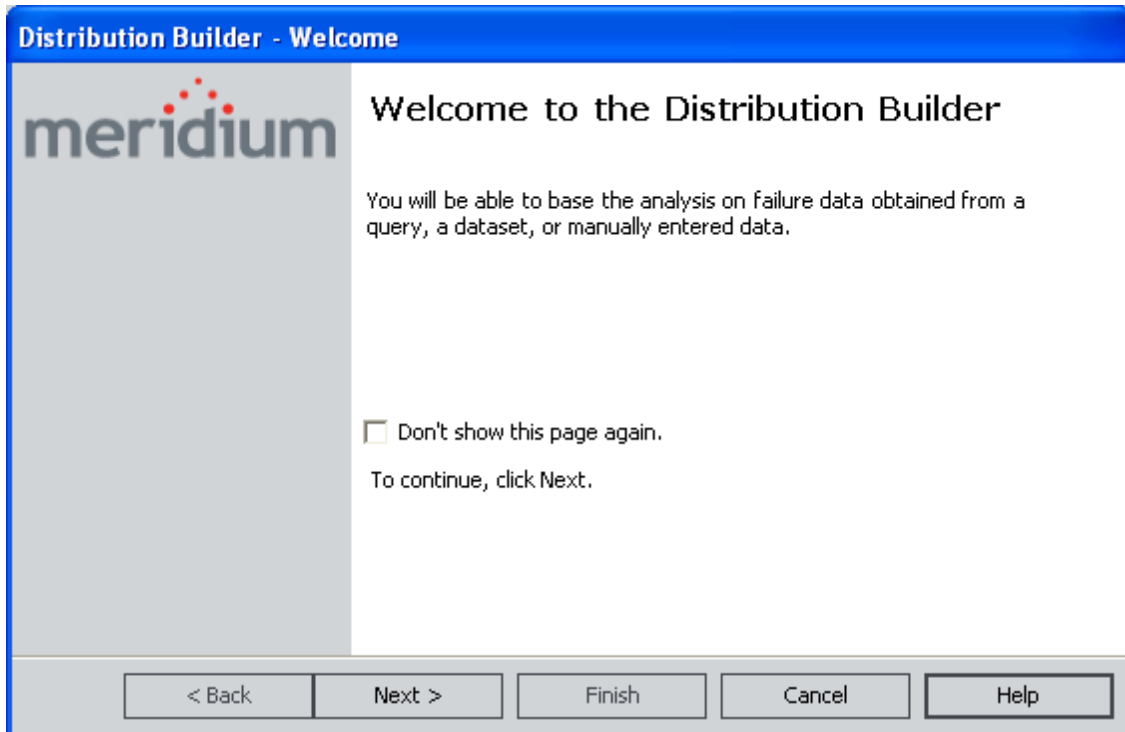

CEHint: If you do not want to view this screen the next time that you access the builder, select the **Don't show this page again** check box.

2. Click the **Next** button.

The **Select Data Source Type** screen appears, displaying the options that are available for entering the data for analysis in the Reliability Manager application.

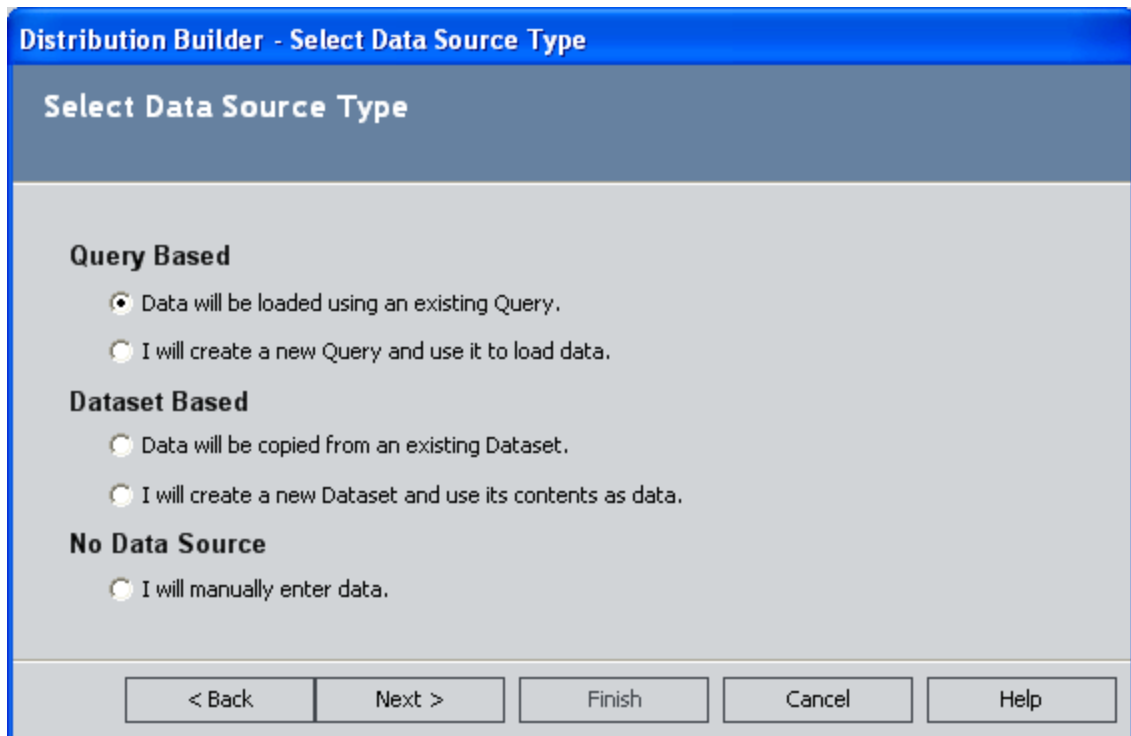

3. Select one of the following options:

- **Failure data will be loaded using an existing Query.** If you select this option, when you click the **Next** button, you will be asked to find and select the desired query in the Catalog.
- **I will create a new Query and use it to load the failure data.** If you select this option, when you click the **Next** button, the Query Builder will appear so that you can design a new query. Click the **Help** button in the Query Builder for details on building a new query.
- **Failure data will be copied from an existing Dataset.** If you select this option, when you click the **Next** button, you will be asked to find and select the desired dataset in the Catalog. Note that if the dataset you choose was created from a query that included installation or failure dates you will not be able to select either of those columns in the analysis. To avoid this problem, run the query in unformatted mode and then export to a dataset.
- **I will create a new Dataset and use it to load the failure data.** If you select this option, when you click the **Next** button, the Dataset Builder will appear so that you can design a new dataset. Click the **Help** button in the Dataset Builder for details on building a new dataset.

After you have selected or created the desired query or dataset, it appears on the **Select** screen of the **Distribution Builder**.

4. Click the **Next** button.

The **Select Data Fields** screen appears.

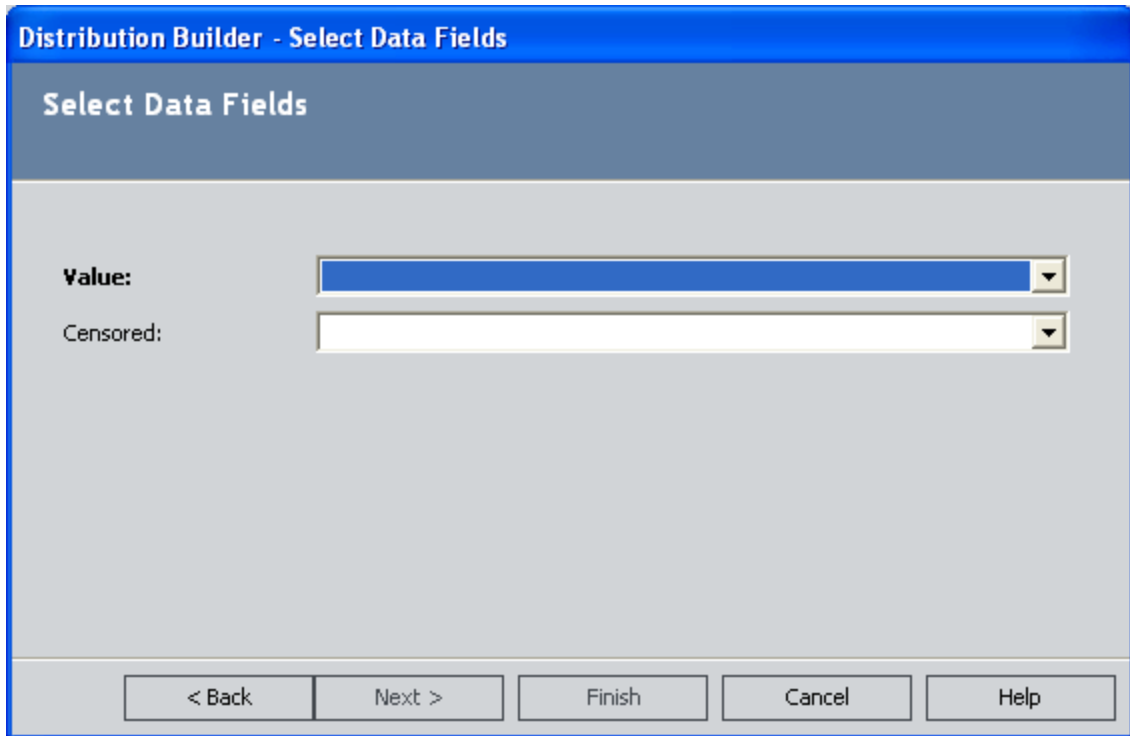

5. In the **Value** list, select a numeric value from the list. This is a required field. A random variable associates a numerical value with every event. It describes a (possibly infinite) set of different events having a related probabilistic structure. The probability distribution of the random variable is a function that maps each possible value of the random variable to a particular probability.
6. If desired, in the **Censored** list, select a field that indicates censored values (i.e., not included in the Probability Distribution Analysis calculations). The selected field must be a logical field.
7. Click the **Next** button.

The **Specify Random Variable and Its Units** screen appears.

The screenshot shows a software dialog box titled "Distribution Builder - Specify Random Variable and Its Units". The main area of the dialog is grey and contains two text input fields. The first field is labeled "Random Variable:" and the second is labeled "Units:". Below these fields is a row of five buttons: "< Back", "Next >", "Finish", "Cancel", and "Help".

Note that the name of the random variable and the units of measure are pre-populated based on the selection you made in the **Value** selection box on the previous screen.

8. Click the **Finish** button.

The system validates the field mappings and generates the analysis. The **Probability Distribution Results** page displays the results of the analysis.

9. On the [Common Tasks menu](#), click the **Save Analysis** link to save the analysis results.

Creating a Probability Distribution from Manually Entered Data

To manually enter the data for a Probability Distribution Analysis:

1. On the [Probability Distribution List](#) page or on the [Probability Distribution Results](#) page, on the **Common Tasks** menu, click the **New Analysis** link.

The **Distribution Builder** appears, displaying the Welcome screen.

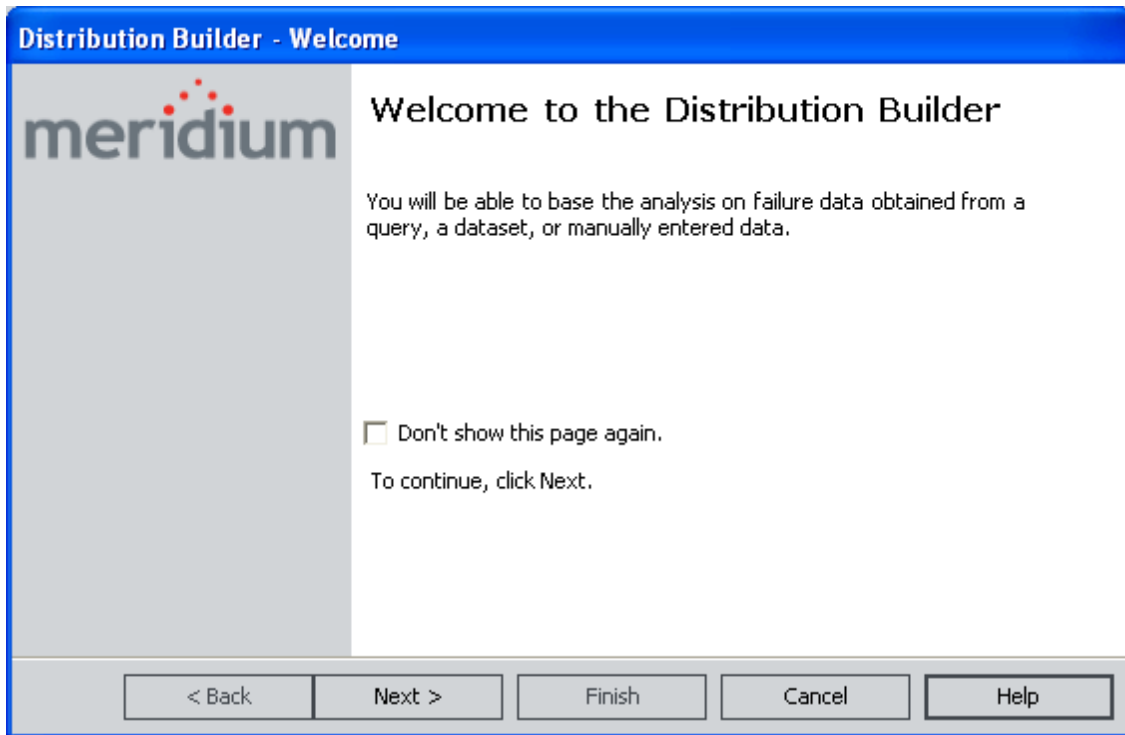

CEHint: If you do not want to view this screen the next time that you access the builder, select the **Don't show this page again** check box.

2. Click the **Next** button.

The **Select Data Source Type** screen appears, displaying the options that are available for entering the data for analysis in the Reliability Manager application.

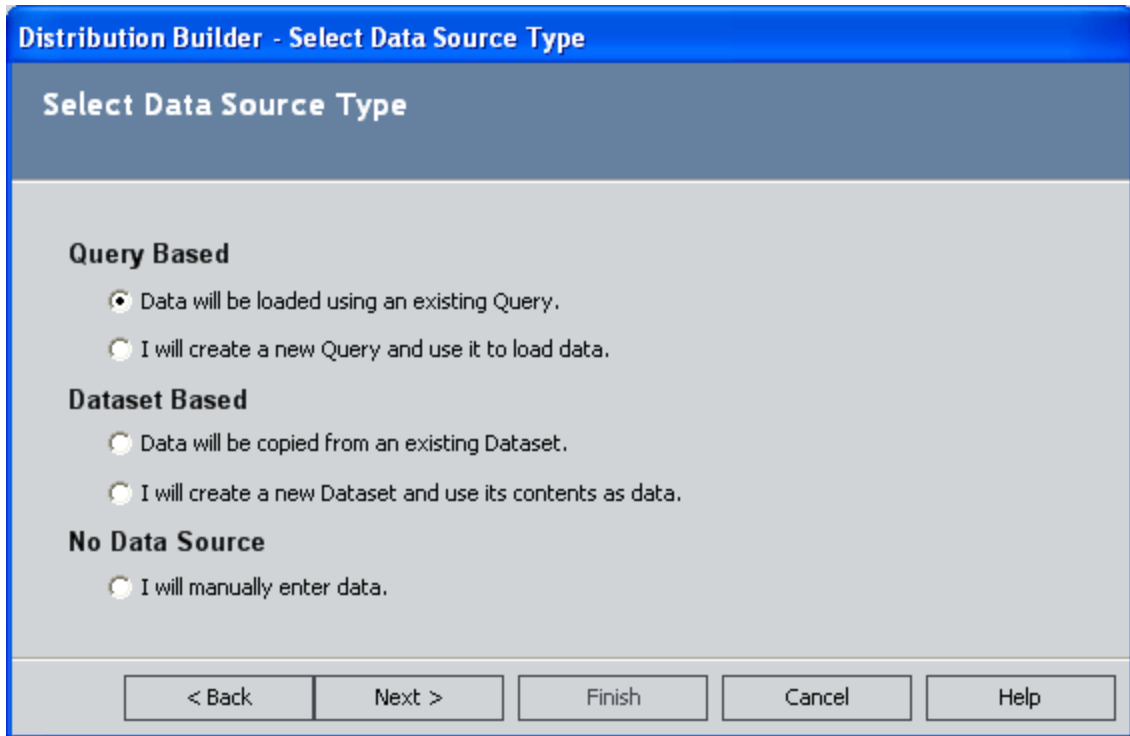

3. Select the **I will manually enter data** option, and click the **Finish** button.
The **Distribution Builder** closes, and a blank **Distribution Data** grid appears.

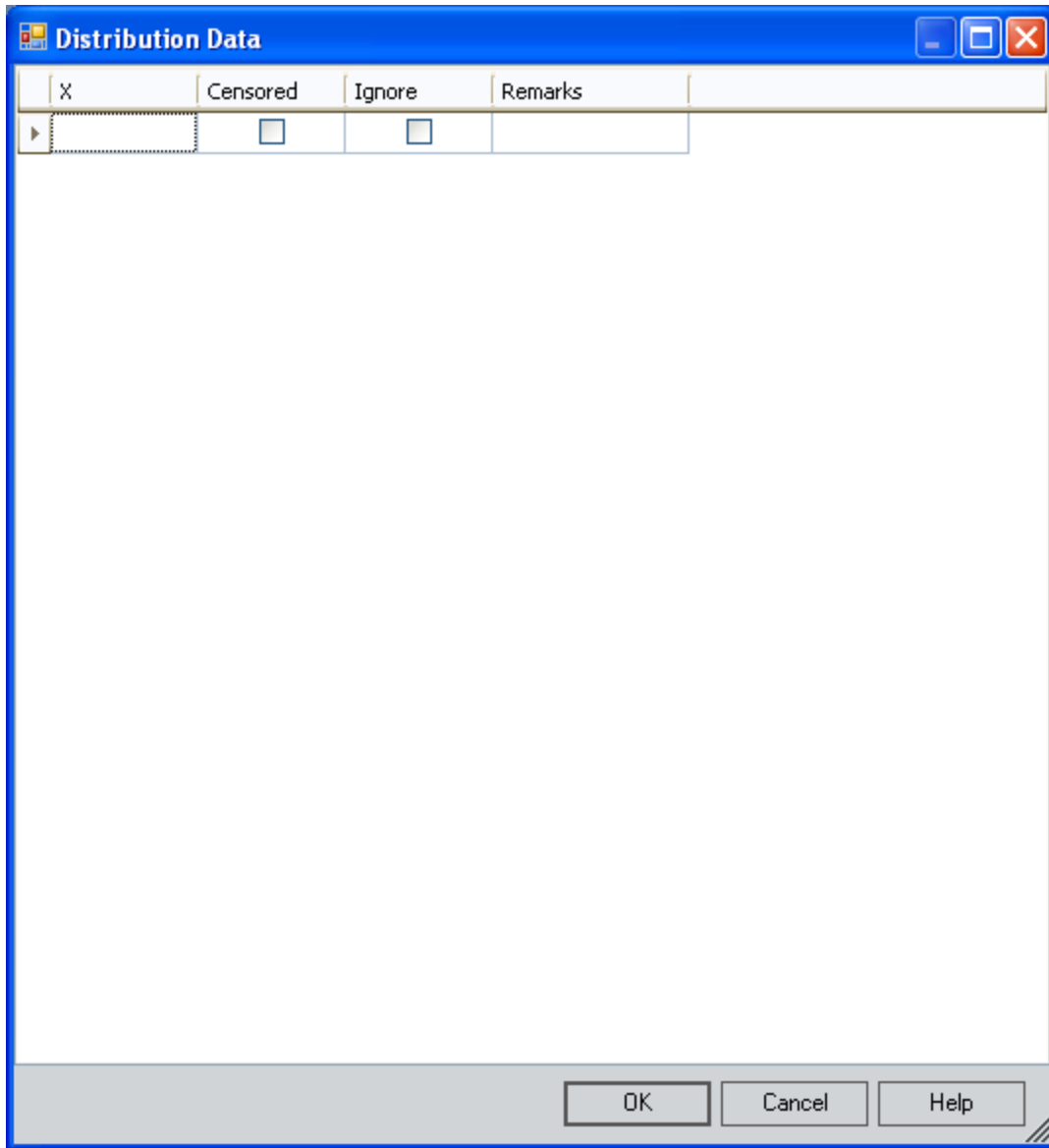

4. Enter the information about the random variables that you want to include in the analysis. By default, the following properties are listed on the grid:
 - **X:** The value of the random variable.
 - **Censored:** Select the check box to censor data.
 - **Ignore:** Select the check box if you do not want to include the data on the selected row in the calculations.
 - **Remarks:** Comments about the event.

To enter data, you can manually type the data in the cells or you can use the clipboard operations (cut, copy, paste) to transfer data to the grid from other applications.

5. Click **OK** to save the data and generate the analysis. Note that a minimum of three failure data points is required to perform a calculation or you will receive a warning message and the analysis will not be generated.

The **Distribution Data** grid closes, and the system generates the analysis and displays the summary page.

6. On the [Common Tasks menu](#), click the **Save Analysis** link to save the analysis results.

Opening an Existing Probability Distribution Analysis

To open an existing Probability Distribution analysis:

1. On the **Reliability Start Screen**, click the **Probability Distribution** link.

The [Probability Distribution List page](#) appears.

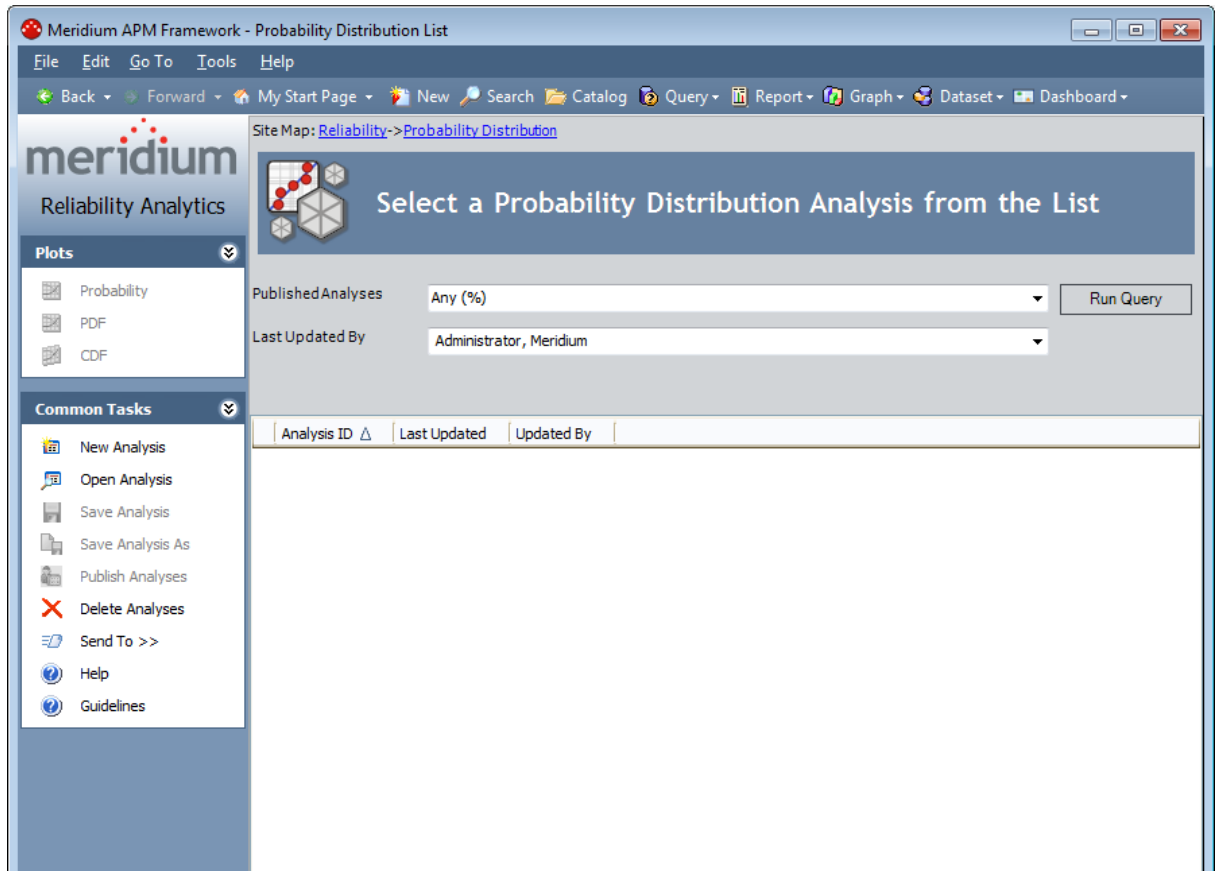

2. At the top of the page, in the fields provided, select the criteria that you want to use for limiting the list of Probability Distribution Analyses. The available criteria will vary, depending on how the Probability Distribution query has been configured.

3. Click the **Run Query** button.

Meridium APM runs the Probability Distribution query and displays the results in the grid at the bottom of the page.

4. In the **Analysis ID** column, click the analysis ID of the analysis that you want to open.

The **Probability Distribution Results** page appears, displaying the selected analysis.

Note that when you open an existing analysis, the analysis will display the data and calculations that were last [saved](#) with the analysis. If you want to reload the underlying query or dataset and update calculations based on any changes to the underlying data, you must [reload the analysis](#) after opening it.

Overview of the Probability Distribution Results Page

Note: Depending on the type of Distribution Analysis that is selected, different types of information will be available on the **Probability Distribution Results** page.

The **Probability Distribution Results** page contains the following sections of information:

- [Analysis Information](#)
- [Distribution](#)
- [Calculated Parameters](#)
- [Kolmogorov-Smirnov Goodness of Fit Test](#)
- [Probability Density Function \(PDF\) Plot](#)
- [Cumulative Density Function \(CDF\) plot](#)

In addition, the **Probability Distribution Results** page provides the following task menus: [Plots](#), [Distribution Options](#), [Analysis Tasks](#), and [Common Tasks](#).

Analysis Information Section

Analysis Information	
Name	temp test for 3.2.0 upgrade - SAVE - with units
Description	temp test for 3.2.0 upgrade - SAVE - with units
Random Variable	Downtime
Units	TWC Units

The **Analysis Information** section contains information that identifies the current analysis, including the following:

- **Analysis Name:** The ID of the selected Probability Distribution Analysis.
- **Description:** The description of the analysis as defined when the analysis was saved.
- **Random Variable:** The name of the random variable, which associates a numerical value with every event and describes a (possibly infinite) set of different events having a related probabilistic structure. You can [change the random variable and specify units](#).
- **Units:** The units that are used to measure the random variable. You can [change the random variable and specify units](#).
- **Rename:** Displays the **Rename Analysis** dialog box, where you can [rename the analysis](#).

Distribution Section

Distribution	
Type	Weibull
Fit Method	Least Squares
Confidence Level	90.00 %
Mean	9.2958
Standard Deviation	6.0884
Median	8.1768
R ²	0.7747

The **Distribution** section contains details about the selected distribution type. It includes the following information:

- **Type:** The type of Distribution.
- **Fit Method:** The curve-fitting estimation method used to estimate the parameters for the distribution. The method of fit for a Probability Distribution Analysis can be either Least Squares or Maximum Likelihood Estimators.
- **Confidence Level:** If you selected to use confidence, the selected confidence level percentage is listed here. The confidence level is used to indicate that you want the model to fit with a particular level of certainty.
- **Mean:** The average point of the distribution. This value is calculated using parameters in the **Calculated Parameters** section, which vary depending on the distribution type. For example, the following formula is used to calculate the mean for a Weibull Distribution:

$$\text{Mean} = \text{Eta} \times \text{Gamma}\left(1 + \frac{1}{\text{Beta}}\right)$$

- **Standard Deviation:** The variability of the random variable around the mean.
- **Median:** The middle point of the distribution. This value is calculated using parameters in the **Calculated Parameters** section, which vary depending on the Distribution Type. For example, the following formula is used to calculate the Median for a Weibull Distribution:

$$\text{Median} = \text{Eta} \times (\text{Ln}(2))^{\frac{1}{\text{Beta}}}$$

- **R2:** The R-Squared Correlation Coefficient, which describes the strength of a linear model. It measures how closely the points fall to the least squares line, providing an indication of how confident one can be of predictions made with the line.

Calculated Parameters Section

The **Calculated Parameters** section contains the parameters that correspond to the selected distribution type.

Calculated Parameters				Change
		Low	High	
Beta	1.5599	1.3916	10.7160	
Eta	10.3425	4.9762	13.7657	
Gamma	0.0000	0.0000	0.0000	

If confidence was selected, the upper and lower bounds are listed for each parameter.

Kolmogorov-Smirnov Goodness of Fit Test Section

Kolmogorov-Smirnov Goodness of Fit Test

Statistic	0.1025
P-Value	0.0000 %
Passed	Yes

The **Kolmogorov-Smirnov Goodness of Fit Test** section contains the results of the Goodness of Fit (GOF) test.

- **Statistic:** A value that indicates how exact the fit is. Typically, the lower the number is, the better the fit.
- **P-Value:** A value that is calculated by the Meridium APM system. The P-value is interpreted as the probability that the test statistic is due to random error. Typically, the higher the P-value, the more likely the model is appropriate and the more likely that the fit will pass the test.
- **Passed Goodness of Fit:** A value of *Yes* or *No* that indicates if the fit test (listed next to the **Test Name**) was successful (the distribution fits the data based on the test performed). If the [P-value is less than or equal to 1 minus the confidence level](#), the fit test has failed and you should reject the distribution at the chosen significance level. Otherwise, the fit is successful and you should accept the distribution at the chosen significance level.

Probability Density Function (PDF) Plot Section

The **Probability Density Function (PDF) Plot** section contains a preview of the Probability Density Function (PDF) plot.

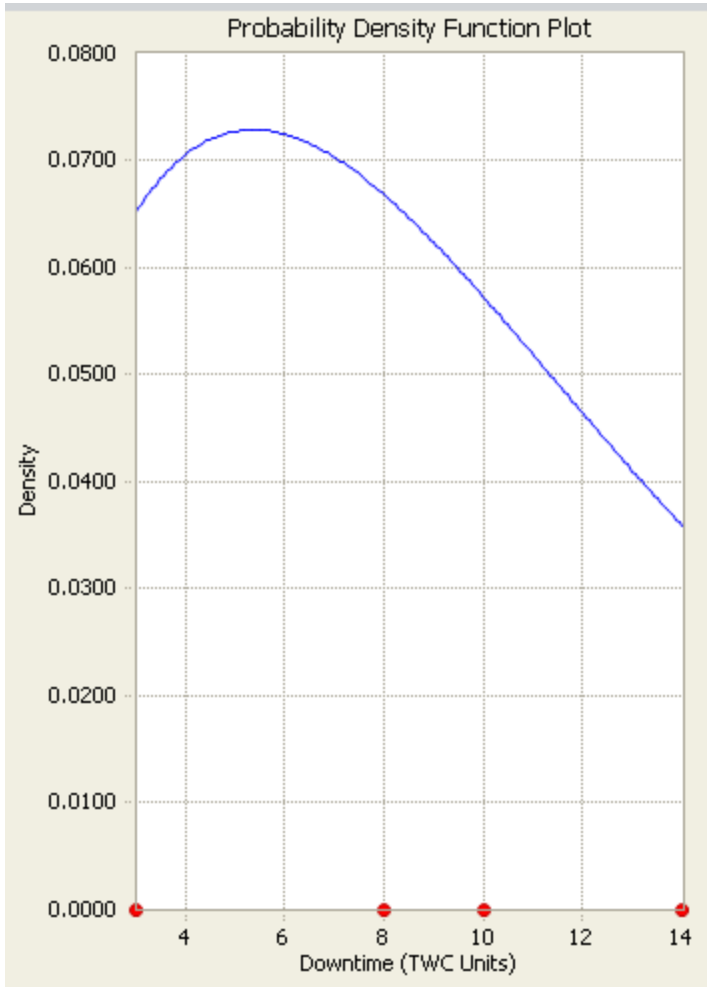

To view the actual PDF plot:

- Click the plot, or on the [Plots menu](#), click the **PDF** link.

Cumulative Density Function (CDF) Plot Section

The **Cumulative Density Function (CDF)** plot section contains a preview of the Cumulative Density Function (CDF) plot.

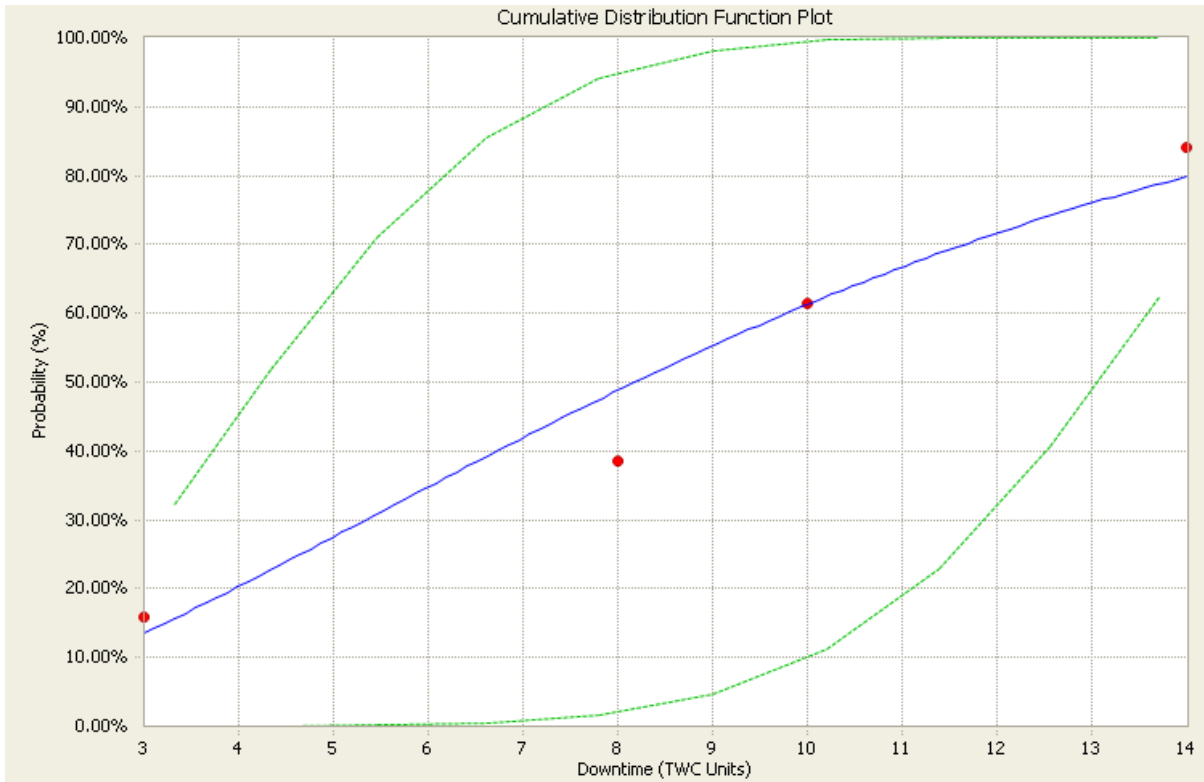

To view the actual CDF plot:

- Click the plot, or on the [Plots menu](#), click the **CDF** link.

Plots Menu

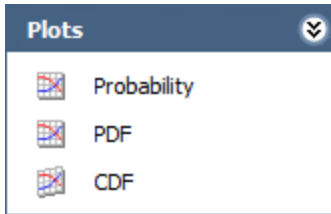

The **Plots** menu on the **Probability Distribution Results** page contains the following links:

- **Probability:** Displays the [Probability plot](#).
- **PDF:** Displays the [Probability Density Function plot](#).
- **CDF:** Displays the [Cumulative Distribution Function plot](#).

Note: You can also [select multiple distributions from the list and generate a composite plot](#).

Distribution Options Menu

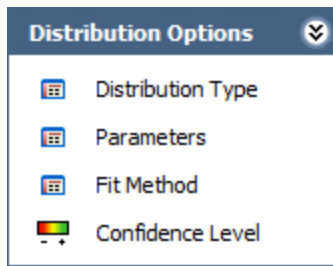

The **Distribution Options** menu on the **Probability Distribution Results** page contains the following links:

- **Distribution Type:** Displays the **Distribution Type** dialog box, where you can [select a distribution type](#).
- **Parameters:** Displays the **Distribution Parameters** dialog box, where you can [select the distribution parameters](#).
- **Fit Method:** Displays the **Fit Method** dialog box, where you can [select the Fit Method](#).
- **Confidence Level:** Displays the **Confidence Level** dialog box, where you can [select to use confidence and specify the confidence level](#).

Analysis Tasks Menu

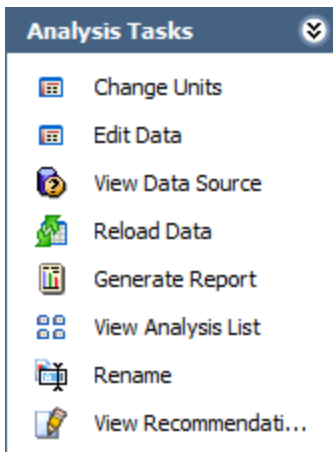

The **Analysis Tasks** menu on the **Probability Distribution Results** page contains the following links:

- **Change Units:** Displays the [Random Variable dialog box](#), where you can specify the name of the random variable that is being analyzed and the units used to measure it.
- **Edit Data:** Displays the [Distribution Data grid](#).
- **Generate Report:** Displays the **Report Options** dialog box, where you can select the elements of the analysis that you want to include in a report.

Note: You must save the analysis before you can generate a report.

- **Create Task:** Displays the **New Task Builder**, where you can create a new task for the current analysis.
- **View Tasks:** Displays the Task List page in Task Management, which shows a list of all the Task records that exist for the current Equipment record.
- **View Analysis List:** Displays the [list of all existing analyses](#).
- **Rename:** Displays the **Rename Analysis** dialog box, where you can [enter a new name and description for the analysis](#).
- **View Recommendations:** Displays the [Recommendations page](#), where you can view and manage the Recommendation records associated with the analysis.

Common Tasks Menu

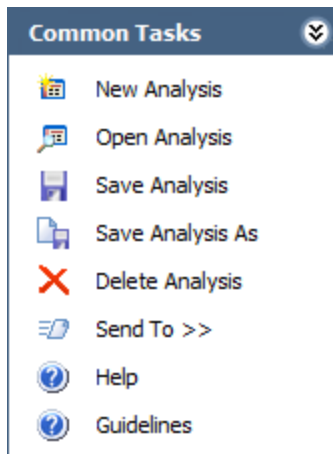

The **Common Tasks** menu on the **Probability Distribution Results** page contains the following links:

- **New Analysis:** Displays the [Distribution Builder](#), which will guide you through the process of creating a new Probability Distribution Analysis.

Note: If you create a new Probability Distribution Analysis from the summary page of an existing Probability Distribution Analysis that has not been saved, the charts and data on the summary page that appears for the new analysis will contain the data from the existing analysis. To avoid this problem, save the existing analysis before creating a new analysis.

- **Open Analysis:** Lets you locate an existing Probability Distribution Analysis using the **Find a Reliability Distribution Analysis** window.
- **Save Analysis:** Saves the currently displayed analysis. If you are viewing a brand new analysis that has not yet been saved, this link will display the **Save Analysis** dialog box, where you can [save the analysis](#). If you are viewing an existing analysis, when you click this link, Meridium APM will save any changes that you made to the analysis since it was last saved.
- **Save Analysis As:** Displays the **Save this Analysis** dialog box, where you can choose to [save it with a different name](#).
- **Delete Analysis:** Deletes the currently displayed analysis.
- **Send To:** Displays a submenu with options that let you provide a link to the current page on your desktop (create shortcut), in an email message, or a Home Page.
- **Help:** Displays the context-sensitive Help topic for the **Probability Distribution Results** page.
- **Guidelines:** Displays the Reliability Concepts, which provide reliability workflows and descriptions of reliability concepts.

About the Distribution Data Window

The [Distribution Data window](#) allows you to view the data associated with a Probability Distribution Analysis. Some of the fields on the **Distribution Data** window correspond to [values that were used to create the analysis](#). For input fields:

- For an analysis based upon a query, the **Distribution Data** window displays the information returned by the query.
- For an analysis based upon a dataset, the **Distribution Data** window displays the information stored in the dataset.
- For an analysis based upon manually-entered data, the **Distribution Data** window displays the information that you entered when you create the analysis.

Other fields show values that are calculated by the Meridium APM system and are read-only. All values in the **Distribution Data** window are stored in the Data field in the Distribution record.

You can modify certain values on this window in order to update data. In most cases, however, you would not want to change the data unless there was an error in the original data source. Some values are calculated by the Meridium APM system and cannot be modified.

The following image shows an example of the **Distribution Data** window.

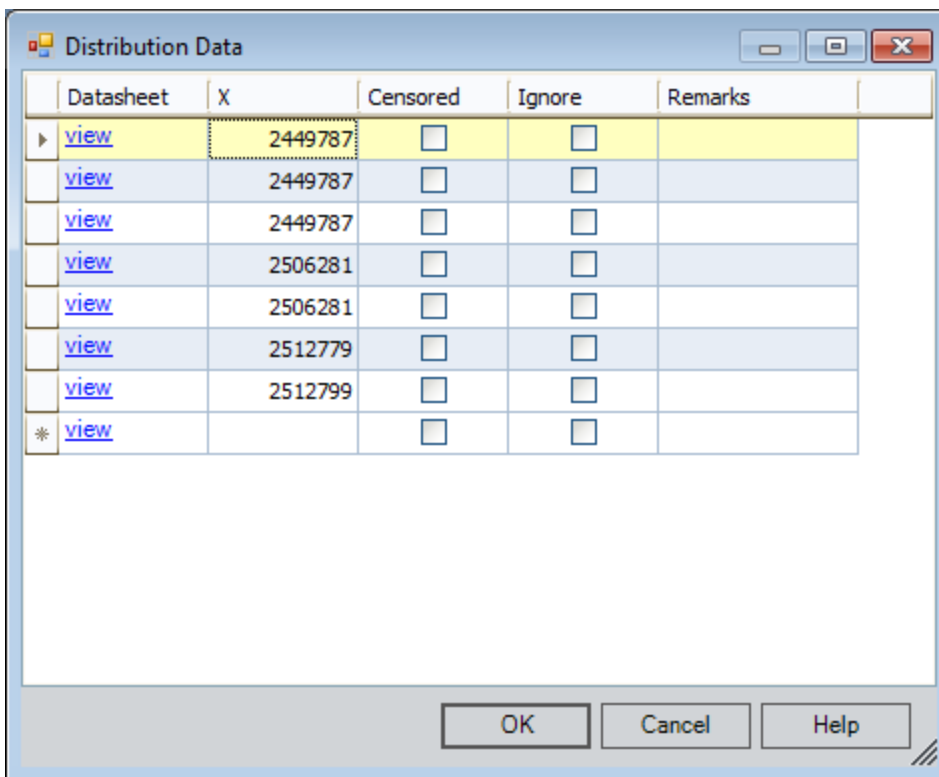

Data Mapped to the Distribution Data Window

When you create a Probability Distribution Analysis from a query or dataset, the **Distribution Builder** will prompt you to map values from columns in the query or dataset to certain values in the Probability Distribution Analysis. The values that you select to map on the **Select Data Fields** screen in the **Distribution Builder** will then appear in the associated columns in the **Distribution Data** window.

Note: If the analysis is based on a query or a dataset and contains additional columns that are not mapped to columns in the analysis dataset, those columns will appear in the **Distribution Data** window with the column name in parentheses.

The following chart displays which columns are mapped from fields in the **Distribution Builder** to columns in the **Distribution Data** window.

Distribution Builder Screen	Distribution Builder Field	Distribution Data Window Column
Select Data Fields	Value	X
Select Data Fields	Censored	Censored

Accessing the Distribution Data Window

To access the Distribution Data window:

- On the **Probability Distribution Results** page, on the **Analysis Tasks** menu, click the **Edit Data** link.

The [Distribution Data window](#) appears.

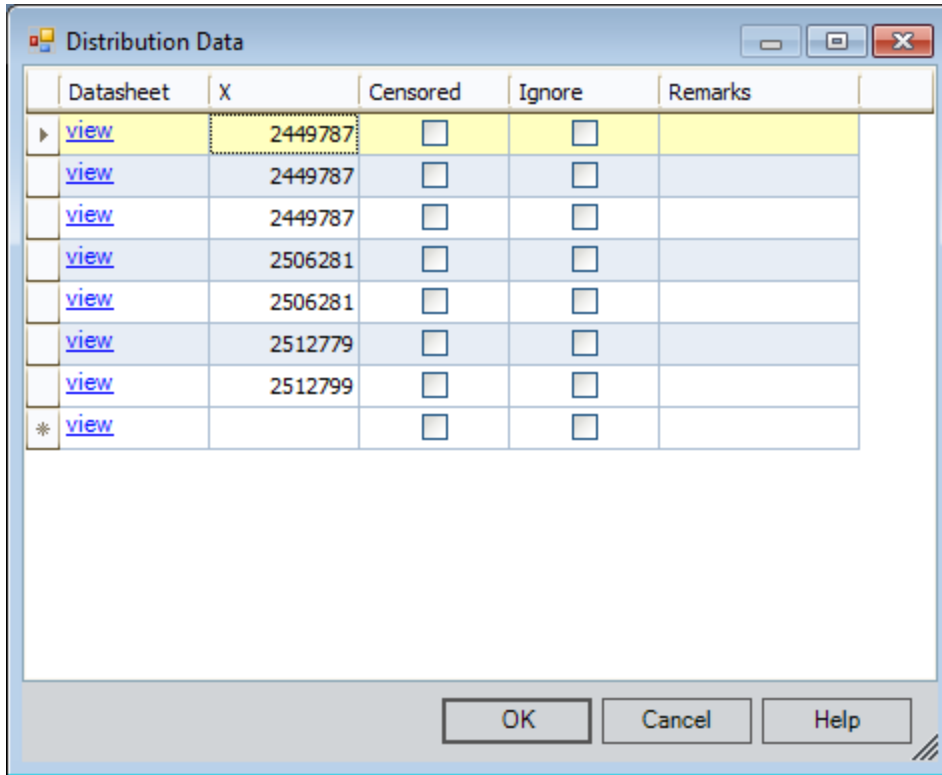

Aspects of the Distribution Data Window

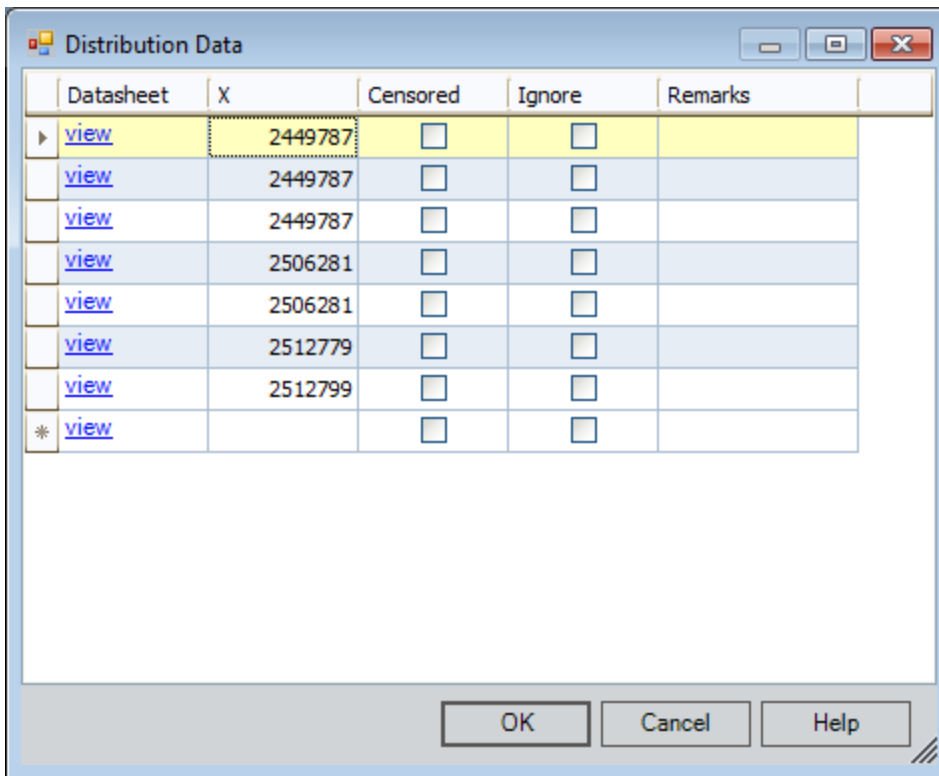

Datasheet	X	Censored	Ignore	Remarks
view	2449787	<input type="checkbox"/>	<input type="checkbox"/>	
view	2449787	<input type="checkbox"/>	<input type="checkbox"/>	
view	2449787	<input type="checkbox"/>	<input type="checkbox"/>	
view	2506281	<input type="checkbox"/>	<input type="checkbox"/>	
view	2506281	<input type="checkbox"/>	<input type="checkbox"/>	
view	2512779	<input type="checkbox"/>	<input type="checkbox"/>	
view	2512799	<input type="checkbox"/>	<input type="checkbox"/>	
* view		<input type="checkbox"/>	<input type="checkbox"/>	

Note: You can group, filter, and sort the data on the Distribution Data window.

By default, the following information is provided for a Probability Distribution Analysis on the **Distribution Data** window:

- **Datasheet:** The text *view*, which appears as a hyperlink that displays the datasheet associated with the event (e.g., a Work History record). If you have the appropriate privileges, after you click the **View** link, you can edit the data and click the **Save** button to save any changes. This column only appears when a query is the data source for the analysis.
- **X:** The value of the random variable. This value can be mapped from a query or dataset using the or manually entered when you create the analysis.
- **Censored:** A value that indicates whether or not the data on the selected row is *censored*, meaning the datapoint is excluded as a failure but included in the operating time of the piece of equipment or location. *Select* the check box if you want to [censor the data](#) on the selected row. When you create a Probability Distribution Analysis using a query or dataset as the data source, the system automatically censors time values from the beginning of the Analysis Period to the first event and the time value from the last event to the end of the analysis. After the calculations for the analysis have been performed, each time that the query or dataset is refreshed, the failure data will be automatically censored.

Regardless of the data source you use, you can censor any event. Note that:

- For MLE (Maximum Likelihood Estimators), the maximum number of censored datapoints is one (1) less than the total number of datapoints.
- For Least Squares estimation, the maximum number of censored datapoints is two (2) less than the total number of datapoints.
- **Ignore:** A value that indicates whether or not the data on the selected row is *ignored*, meaning excluded from the analysis calculations and plots. When *selected*, the data in the associated row will be excluded from the analysis. When *cleared*, data in the selected row will be included in the analysis. You can modify this value manually.

Note: A minimum of three datapoints is required to perform a calculation. If you exceed the maximum number of ignored datapoints, the application will display a warning message after you click **OK**. The events marked as ignored will not appear on the plots.

- **Remarks:** Comments about the event. You can click the **Remarks** cell to enter a value manually via the text editor.

Modifying the Random Variable and Specifying Units

To change the random variable and specify the appropriate units:

1. On the **Probability Distribution Results** page, on the [Analysis Tasks menu](#), click the **Change Units** link.

The **Random Variable** dialog box appears.

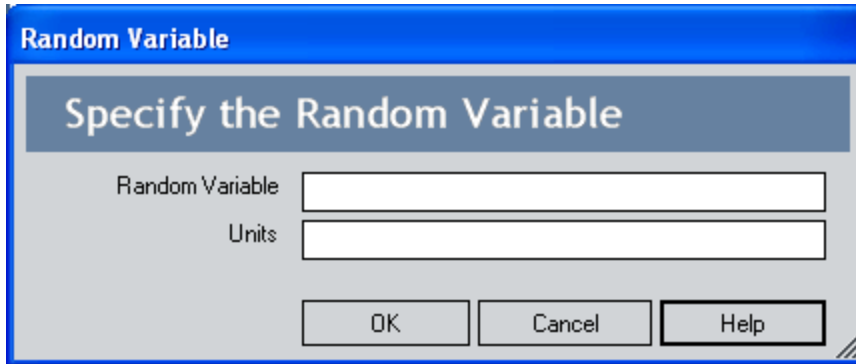

The image shows a dialog box titled "Random Variable" with a blue header. Below the header is a grey bar with the text "Specify the Random Variable". The main area of the dialog box is light grey and contains two text input fields. The first field is labeled "Random Variable" and the second is labeled "Units". At the bottom of the dialog box, there are three buttons: "OK", "Cancel", and "Help".

2. Type the name of the random variable in the **Random Variable** text box.
3. Type the corresponding units in the **Units** text box.
4. Click **OK**.

The system recalculates the Probability Distribution using the new random variable.

About the Probability Distribution Analysis Plots



On the [Plots menu](#) on the **Probability Distribution Results** page, you can view any of the following plots by clicking the associating link:

- [Failure Probability Plot](#)
- [PDF Plot](#)
- [CDF Plot](#)

While viewing any of the plots, you can:

- Click any datapoint to view the failure data.
- Censor a datapoint by right-clicking it and then clicking **Censored**.
- Customize the appearance of the plot by using standard graph features.
- Pause on the distribution plot line to view summary details about the Distribution Analysis, including the type of distribution and the distribution parameters. The value of R^2 is listed also. This value indicates the strength of a linear model. R^2 measures how closely the points fall to the least squares line, providing an indication of how confident one can be of predictions made with the line.

Failure Probability Plot

The Probability plot is a log-log with data overlay and confidence limits that graphically displays the probability (expressed as a percentage) of each possible value of the random variable (CDF Occurrence % vs. time). *CDF Occurrence %* used here is numerically equal to the value from the cumulative distribution. *Time* used here refers to life data, not Calendar data.

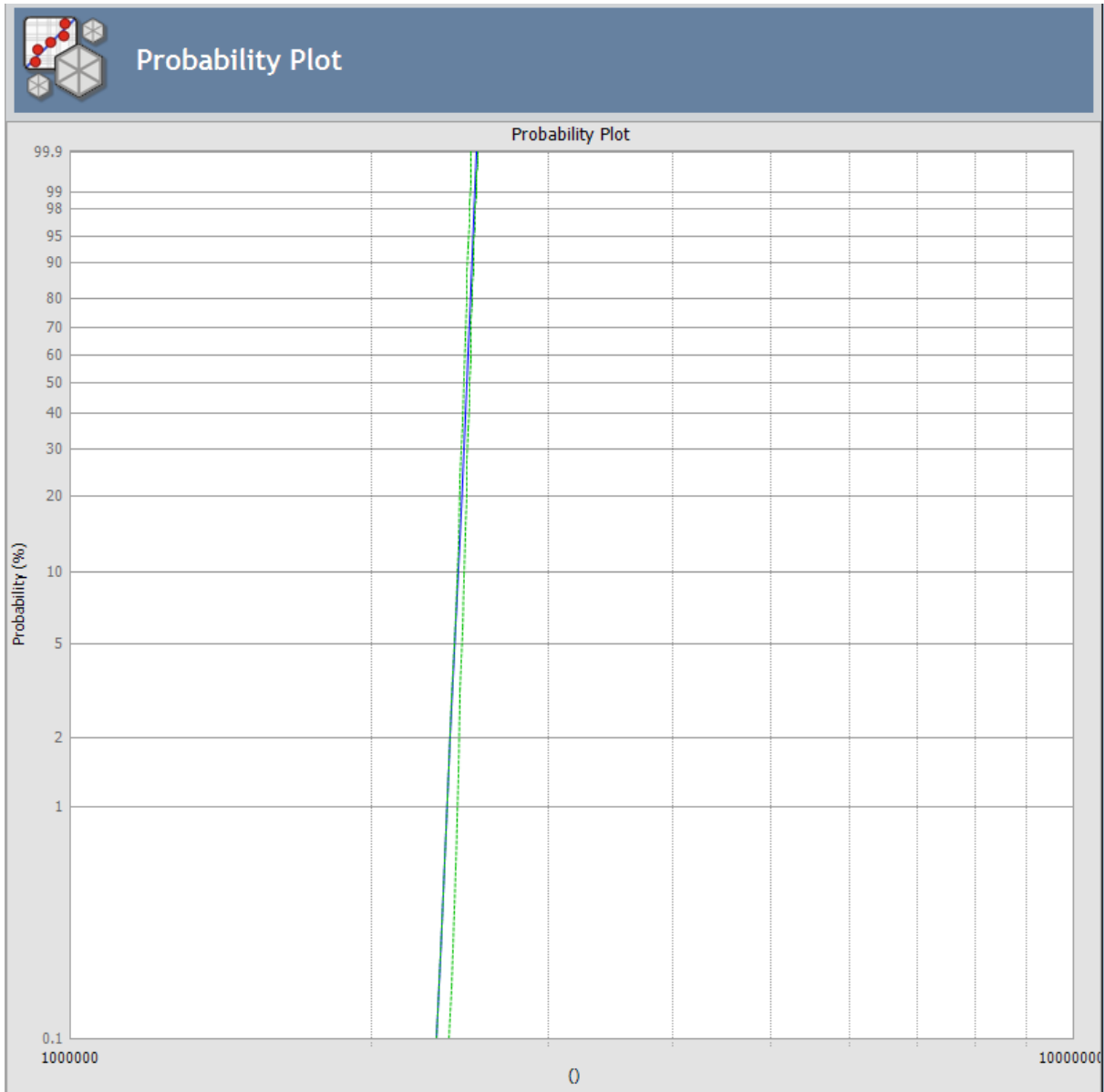

This plot shows the same data as CDF, just represented in a log-log format, which is the standard technique for representing Weibull Distribution. Log-log format Data overlay gives a visual estimate of goodness of fit (GOF). Data overlay also gives clues to the pres-

Failure Probability Plot

ence of multiple failure modes. If a single or multiple inflection points exist in the data, then there is a possibility of multiple failure modes.

PDF Plot

The Probability Density Function (PDF) plot is a lin-lin plot that counts the number of failures between certain time periods, creating a curve that estimates how many failures you can expect to occur at a given number of time units. This plot shows Probability vs. time. The term *Probability* is used here to describe the percent of the population that failed at the particular value of time (t). A PDF plot helps you to answer a question such as, "What is the chance of a member of the population failing at exactly the time in question?"

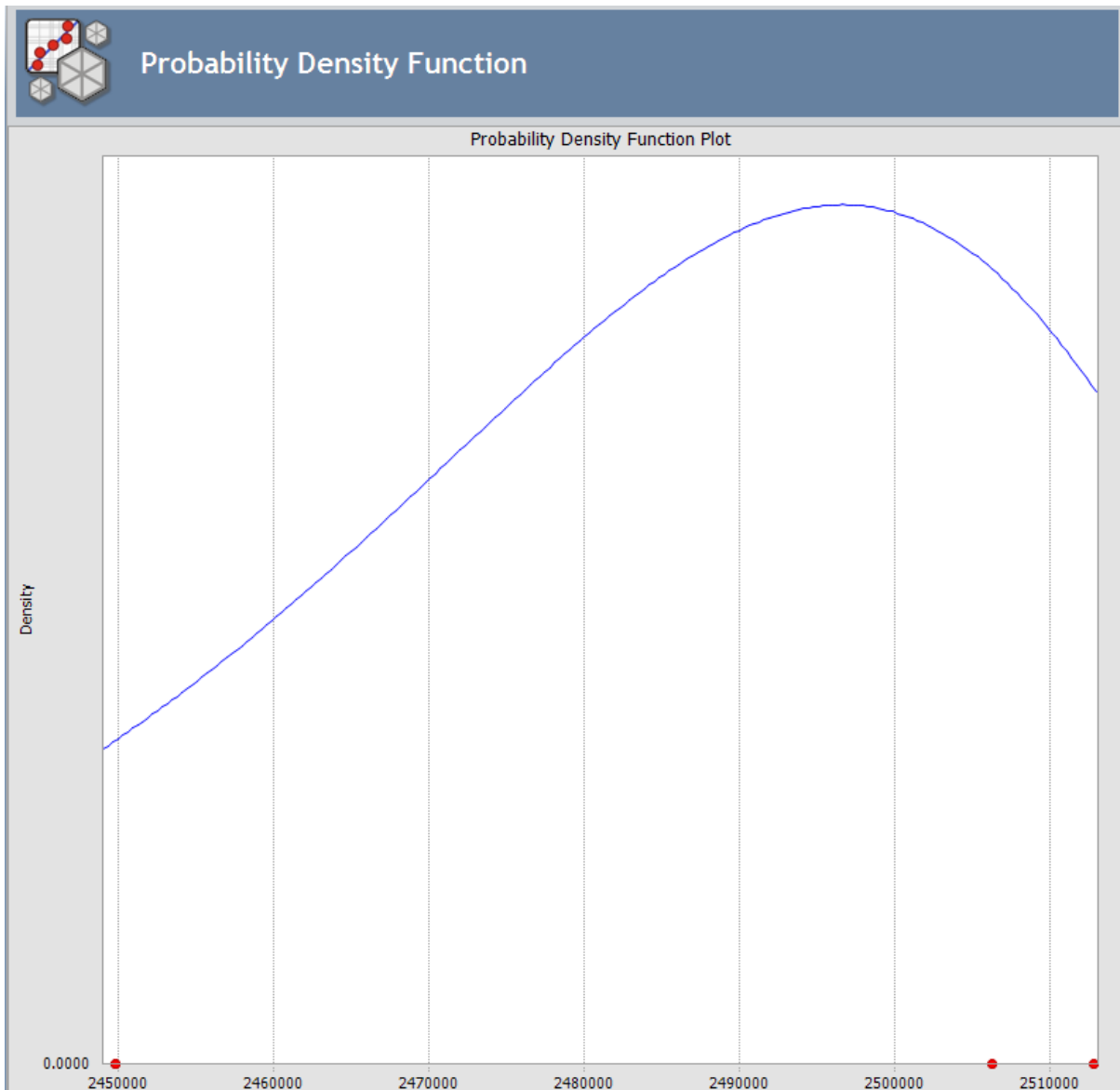

PDF shows the curve fit of the data. It answers the question "Based on the curve fit, what is the probability that failure will occur below or above a certain value?" The chart

is a graphical representation of the data. It shows the variance or spread of the data, but it often is not used for analysis.

CDF Plot

The CDF plot is a lin-lin plot with data overlay and confidence limits. It shows Probability vs. time. The term *Probability* is used in this instance to describe the percent of the total population that will fail by time (t). *Time* refers to life data, not Calendar data.

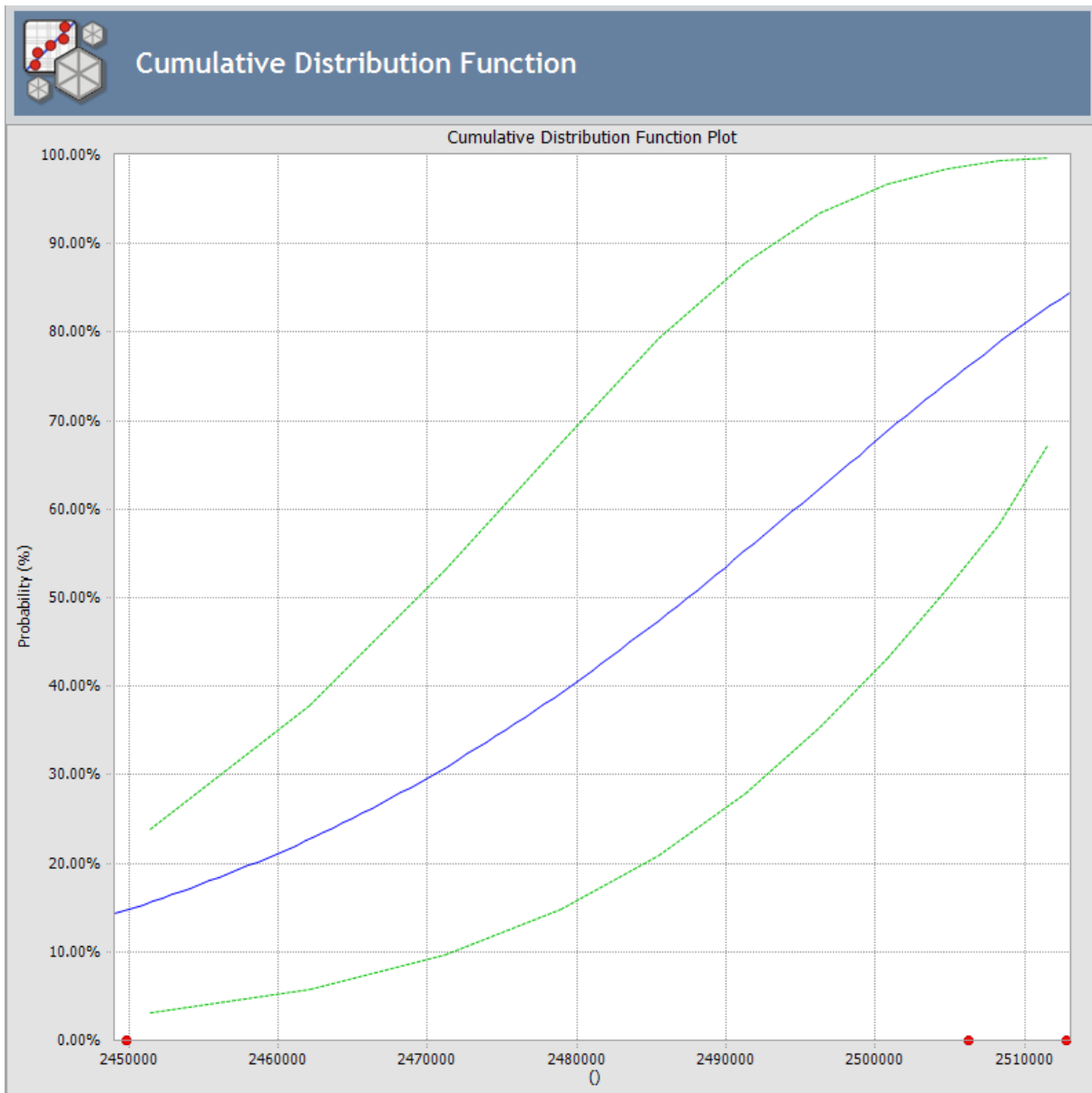

Cumulative Distribution Function answers a different question than PDF: "What is the probability of failure at time(t)?" The CDF curve is the area under the PDF curve. The CDF accumulates all probability of failure up to the point in time in question. Since the number of failures increases with increasing time, the slope of the curve is always positive, always increasing.

Overview of the Probability Distribution Report

The baseline Meridium APM database includes the Probability Distribution Report, which you can use to view a summary of the results of a Probability Distribution Analysis. When you run the Probability Distribution Report, it will appear on the **Report Viewer** page.

The Probability Distribution Report is built from the following Catalog items:

- The main report, *ProbDistReport*, which is stored in the Catalog folder \\Public\Meridium\Modules\Reliability Manager\SSRS.
- The subreport, *SubReportProbDist*, which is stored in the Catalog folder \\Public\Meridium\Modules\Reliability Manager\Reports.
- The supporting queries that supply data in the main report and subreport, which are stored in the Catalog folder \\Public\Meridium\Modules\Reliability Manager\Reports. The following supporting queries are available:
 - *ProbabilityDistributionQuery*
 - *Weibull Distribution Query*
 - *Lognormal Distribution Query*
 - *Normal Distribution Query*
 - *Exponential Distribution Query*

Throughout this documentation, we refer to the main report, the subreport, and the supporting queries collectively as the *Probability Distribution Report*.

The Probability Distribution Report contains a prompt on the ENTY_KEY and Distribution Type fields in the Distribution family. When you run the Probability Distribution Report via the Probability Distribution module, the ENTY_KEY and Distribution Type of the Distribution record associated with the current analysis is passed automatically to the prompt, and the results for the current Probability Distribution Analysis are displayed. If you run the main report or any of the queries in the preceding list directly from the Catalog, however, you will need to supply the ENTY_KEY and Distribution Type of a Distribution record manually to retrieve results. The subreport (i.e., Catalog item *SubReportProbDist*) cannot be run directly from the Catalog.

The Probability Distribution Report contains the following sections:

- Analysis Summary
- Statistical Distribution Information
- Distribution Data
- Plots

Running the Probability Distribution Report

You can run the Probability Distribution Report to view a summary of the results of a Probability Distribution Analysis.

To run the Probability Distribution Report:

1. On the **Probability Distribution Results** page, on the **Analysis Tasks** menu, click the **Generate Report** link.

The **Report Options** dialog box appears. The following image shows what the **Report Options** dialog box looks like by default.

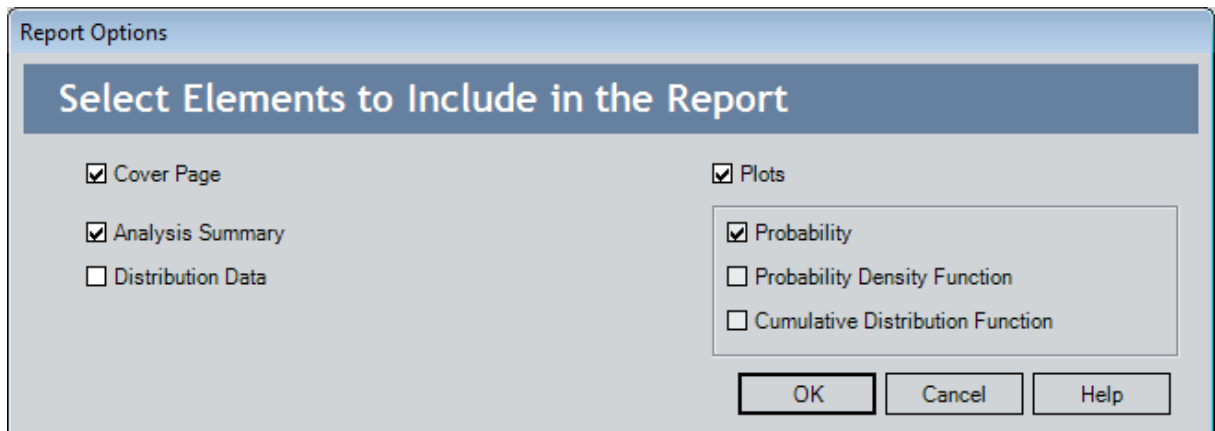

2. Select the desired elements to be included in the report, and click **OK**.

The Probability Distribution Report appears on the **Report Viewer** page.

Running the Probability Distribution Report

The screenshot displays the Meridium APM Framework Report Viewer interface. The window title is "Meridium APM Framework - Report Viewer - ProbDistReport". The interface includes a menu bar (File, Edit, Go To, Tools, Help) and a toolbar with navigation and action icons. A sidebar on the left contains "Report Tasks" (Refresh Report, View Properties, Advanced Export, Modify Report, Go to Query/Dataset) and "Common Tasks" (New Report, Open Report, Save Report, Save As, Delete Report, Print Report, Send To >>, Help). The main content area shows the Meridium logo with the tagline "Profit from a new perspective". Below the logo, the report title "Reliability Analytics" is followed by the subtitle "Probability Distribution Analysis". At the bottom, it indicates "Printed On: 8/15/2012" and "Printed By: Administrator, Meridium".

Meridium
Report

Report Tasks

- Refresh Report
- View Properties
- Advanced Export
- Modify Report
- Go to Query/Dataset

Common Tasks

- New Report
- Open Report
- Save Report
- Save As
- Delete Report
- Print Report
- Send To >>
- Help

meridium
Profit from a new perspective

Reliability Analytics
Probability Distribution Analysis

Printed On: 8/15/2012
Printed By: Administrator, Meridium

Analysis Summary Section

The **Analysis Summary** section of the Probability Distribution Report displays information that is stored in a Distribution record. Distribution records are categorized into one of four Distribution subfamilies: Exponential, Lognormal, Normal, or Weibull.

Analysis Summary	
Analysis Name:	Prob. Dist. Analysis 44
Analysis Description:	Distribution using the Variable X.
Random Variable:	Downtime
Units:	Days
Last Modified:	8/15/2012
Modified By:	Administrator, Meridium

The following table lists each item in the **Analysis Summary** section and the corresponding Distribution record field whose data is displayed in the report.

Report Item	Distribution Field	Notes
Analysis Name	Analysis ID	None
Analysis Description	Short Description	None
Random Variable	Random Variable Field	None
Units	Units	None
Last Modified	LAST_UPDT_DT	None
Modified By	LAST_UPBY_SEUS_KEY	The name of the Security User associated with this value is displayed in the report.

Overview of the Statistical Distribution Information Section

The **Statistical Distribution Information** section of the Probability Distribution Report displays information that is stored in the Distribution record (i.e., Exponential, Lognormal, Normal, or Weibull record). The following image displays an example of the statistical distribution information for a Weibull record.

Statistical Distribution Information				
Distribution Type:	Weibull			
Fit Method:	Least Squares			
Use Confidence:	True			
Confidence Level:	90.00%			
Mean:	9.30			
Standard Deviation:	6.09			
Median:	8.18			
R²:	0.84			
Parameters				
Name	Value	Low	High	Calculated
Beta	1.56	1.31	10.72	Yes
Eta	10.34	4.53	13.61	Yes
Gamma	0.00	0.00	0.00	No
Goodness of Fit Test				
Name	Statistic	P-Value	Passed	
Kolmogorov-Smirnov Test	0.10	0.00	True	

The following subsections are displayed within the **Statistical Distribution Information** section:

- [Distribution](#)
- [Parameters](#)
- [Goodness of Fit](#)

Distribution Subsection

The **Statistical Distribution Information** section contains the **DistributionType** subsection, which displays information that is stored in the Distribution record. Throughout the documentation, we will refer to this subsection as the **Distribution** subsection. The following image displays an example of the **Distribution** subsection for a Weibull record.

Statistical Distribution Information	
Distribution Type:	Weibull
Fit Method:	Least Squares
Use Confidence:	True
Confidence Level:	90.00%
Mean:	9.30
Standard Deviation:	6.09
Median:	8.18
R²:	0.84

The following table lists each item in the **Distribution** section and the corresponding Distribution record field whose data is displayed in the report.

Report Item	Distribution Field
Distribution Type	Distribution Type
Fit Method	Fit Method
Use Confidence	Use Confidence
Confidence Level	Confidence Level
Mean	Mean
Standard Deviation	Standard Deviation
Median	Median
R ²	R-Squared

Parameters Subsection

The **Statistical Distribution** section contains the **Parameters** subsection, which contains information stored in the Distribution record. The type of information that appears in the **Parameters** subsection depends on the [distribution type](#) (i.e., Weibull, Lognormal, Exponential, or Normal). The following image displays an example of the **Parameters** section for a Weibull record.

Parameters

Name	Value	Low	High	Calculated
Beta	1.56	1.31	10.72	Yes
Eta	10.34	4.53	13.61	Yes
Gamma	0.00	0.00	0.00	No

The following table lists each item in the **Parameters** subsection for a Weibull record whose data is displayed in the report. One row is displayed for each of the following field captions: Beta, Eta, and Gamma.

Report Item	Weibull Field
Beta	
Value	Beta
Low	Beta Low
High	Beta High
Calculated	Beta Fixed
Eta	
Value	Eta
Low	Eta Low
High	Eta High
Calculated	Eta Fixed
Gamma	
Value	Gamma
Low	Gamma Low
High	Gamma High
Calculated	Gamma Fixed

The following table lists each item in the **Parameters** subsection for a Lognormal record whose data is displayed in the report. For a Lognormal record, one row is displayed for each of the following field captions: Mu, Sigma, and Gamma.

Report Item	Lognormal Field
Mu	
Value	Mu
Low	Mu Low
High	Mu High
Calculated	Mu Fixed
Sigma	
Value	Sigma
Low	Sigma Low
High	Sigma High
Calculated	Sigma Fixed
Gamma	
Value	Gamma
Low	Gamma Low
High	Gamma High
Calculated	Gamma Fixed

The following table lists each item in the **Parameters** subsection for an Exponential record whose data is displayed in the report. For an Exponential record, one row is displayed for the field caption MTBF.

Report Item	Exponential Field
MTBF	
Value	MTBF
Low	MTBF Low
High	MTBF High
Calculated	MTBF Fixed

The following table lists each item in the **Parameters** subsection for a Normal record whose data is displayed in the report. For a Normal record, one row is displayed for each of the following field captions: Mean, Standard Deviation.

Report Item	Normal Field
Mean	
Value	Mean
Low	Mean Low
High	Mean High
Calculated	Fix Mean
Standard Deviation	
Value	Standard Deviation
Low	Standard Deviation Low
High	Standard Deviation High
Calculated	Fix Standard Deviation

Goodness of Fit Test Subsection

The **Statistical Distribution Information** section contains the **Goodness of Fit Test** subsection, which displays information from the Distribution record.

Goodness of Fit Test

Name	Statistic	P-Value	Passed
Kolmogorov-Smirnov Test	0.10	0.00	True

The Kolmogorov-Smirnov test is the only test used to measure goodness of fit, so the **Name** column in the report is populated automatically with the value *Kolmogorov-Smirnov Test*. The following table lists each remaining item in the **Goodness of Fit Test** subsection and the Distribution record field whose data is displayed in the report.

Report Item	Weibull Field
Statistic	GOF Statistic
P-Value	GOF P-Value
Passed	Passed

Distribution Data Section

The **Distribution Data** section of the Probability Distribution Report displays information that is stored in the Data field in the Distribution record.

Distribution Data				
X	Median Rank	Censored	Ignored	Remarks
10.0	0.61	False	False	
3.0	0.16	False	False	
8.0	0.39	False	False	
14.0	0.84	False	False	

The following values are displayed in the **Distribution Data** section, and they are stored in the Data field in the Reliability Distribution record:

- X (i.e., the Random Variable)
- Median Rank
- Censored
- Ignored
- Remarks

Plots Section

The **Plots** section of the Probability Distribution Report displays the graphs that are displayed on the [Probability Distribution Results page](#) or accessed via the [Plots menu](#) on the **Probability Distribution Results** page. The following image shows an example of the Probability Plot graph.

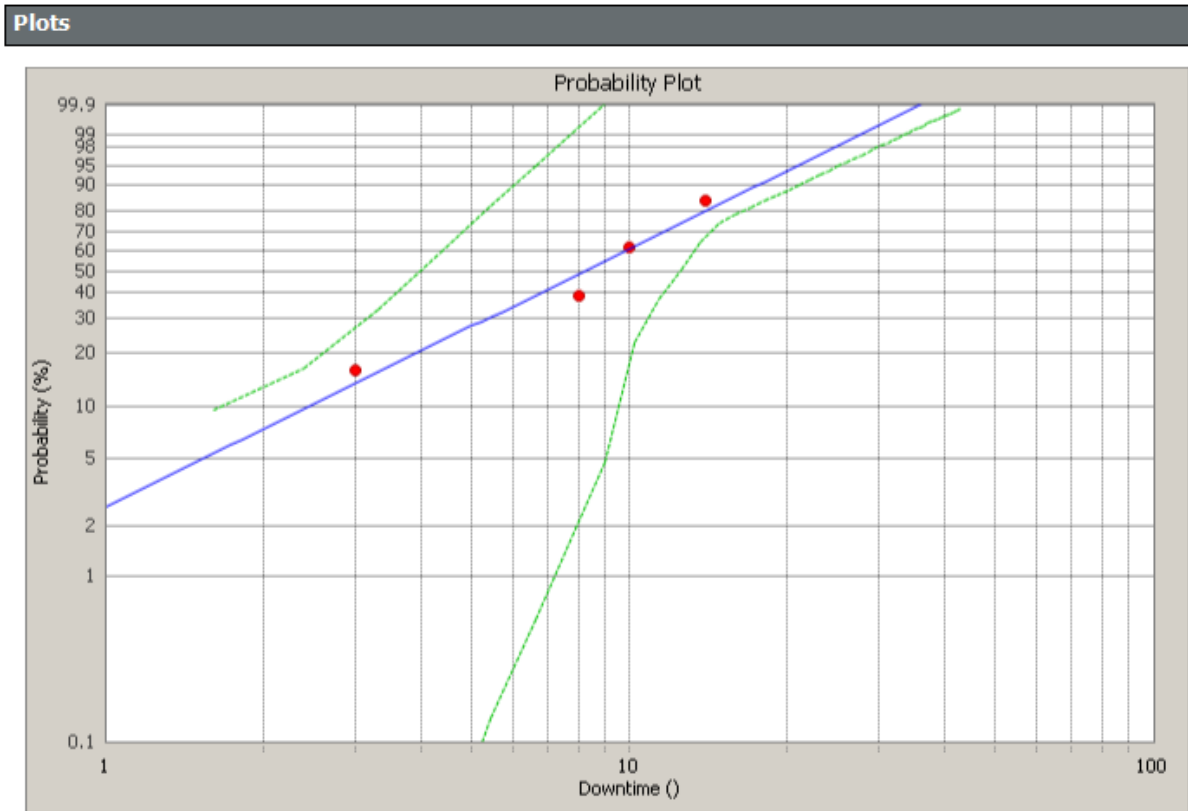

The **Plots** section displays the following graphs:

- [Probability Plot](#)
- [Probability Density Function Plot](#)
- [Cumulative Distribution Function Plot](#)

Overview of System Reliability Analysis

System Reliability is a feature of Meridium APM Reliability Analytics that allows you to [model different system scenarios](#) and then run [Monte Carlo simulations](#) to simulate the behavior of the system so that you can predict the cost and reliability of the system and its elements.

System Reliability can be a useful tool in various situations:

- When you are constructing a new system from scratch, you can use a System Reliability Analysis to model various options for the construction of the system and then choose the option that is the most reliable and cost-effective.
- For existing systems, you can use a System Reliability Analysis to evaluate how the system could be modified to increase reliability and production output.

Using a System Reliability Analysis, you can:

- Estimate the overall reliability and cost of a system, including the estimated reliability for each of the included equipment and locations.
- Use equipment and location information that is already stored in the database or create new equipment and locations to use in the analysis.
- Add maintenance and downtime to the system and recalculate the effects of additions.
- View a graphical summary of the cost and reliability predictions for a system.
- Model different scenarios to compare reliability and cost across multiple systems.

Monte Carlo Simulations: A Simple Example

Meridium APM System Reliability Analysis uses Monte Carlo simulations to predict the reliability of a system. Monte Carlo methods offer a common statistical model for simulating physical systems and are especially useful for modeling systems with variable and uncertain inputs. When you create a System Reliability Analysis, you will specify certain values that will serve as inputs to the simulation. Other inputs will be generated at random to simulate possible conditions. Outputs will be generated based upon the inputs and combined to provide a summary the projected system reliability.

Consider a simple example of rolling dice. Assume that you want to determine the probability of rolling a seven using two dice with values one through six. There are 36 possible combinations for the two dice, six of which will total seven, as shown in the following image.

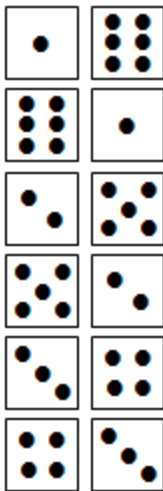

This means that mathematical probability of rolling a seven is six in 36, or 16.67 percent.

But is the mathematical probability the same as the *actual* probability? Or are there other factors that might affect the mathematical probability, such as the design of the dice themselves, the surface on which they are thrown, and the technique that is used to roll them?

To determine the *actual* probability of rolling a seven, you might physically roll the dice 100 times and record the outcome each time. Assume that you did this and rolled a seven 17 out of 100 times, or 17 percent of the time. Although this result would represent an actual, physical result, it would still represent an *approximate* result. If you continued to roll the dice again and again, the result would become less and less approximate.

A Monte Carlo simulation is the mathematical representation of this process. It allows you to simulate the act of physically rolling the dice and lets you specify how many times to roll them. Each roll of the dice represents a single iteration in the overall simulation; as you increase the number of iterations, the simulation results become more and more accurate. For each iteration, variable inputs are generated at random to

simulate conditions such as dice design, rolling surface, and throwing technique. The results of the simulation would provide a statistical representation of the physical experiment described above.

Components in a System Reliability Analysis

A System Reliability Analysis is made up of records and links as defined by the [System Reliability data model](#). But beyond understanding a System Reliability Analysis at the entity level, it is helpful to visualize it at a conceptual level, where groups of records and links make up the main elements of the analysis, as defined in the following list:

- **System Reliability Analysis:** A collection of Scenarios, Resources, and simulation results that make up a given analysis. A System Reliability Analysis is represented by a [System Analysis record](#), which stores identifying information about the analysis and is linked to other records that make up the analysis.
- **Scenario:** A representation of one design option for a given system. A Scenario is represented by a [System Scenario record](#), which contains all the identifying information for the Scenario and is linked to other records that help define the Scenario. Each Scenario can contain the following components:
 - **Diagram:** A logical, visual representation of the physical structure of a system, including all the elements in the system and the connections between them. A Diagram might be the representation of a system as it physically exists at your work site, or it might represent a variation of a physical system developed for the purpose of analyzing how changes to the system could impact maintenance and production costs. Each Scenario contains one Diagram.

A Diagram is represented by a [System Subsystem record](#), which can be linked to [System Subsystem](#), [System Sensor](#), [System Buffer](#), [System Link](#), [System Asset](#), and [System Switch](#) records. The items that these records represent are referred to as *elements*, which are simply the components that make up the Diagram itself.
 - **Risk:** A component that identifies a specific way that a piece of equipment or location can fail and specifies the consequences of the failure and includes Time to Failure (TTF) and Time to Repair (TTR) distribution data. A Risk is represented by a System Risk record, which contains all of the identifying information for the Risk.
 - **Action:** A component that identifies a specific operation that can be performed against a piece of equipment or location. Actions include condition-based maintenance, procedures, redesigns, time-based maintenance, and training, and may or may not mitigate Risks. Actions are represented by records in the [System Condition Monitor](#), [System Inspection](#), [System Preventive Maintenance](#), or [System Special Action](#) families, which contain all the identifying information for the Action.
 - **Global Event:** A component that groups together Actions that require a system shutdown. Scheduling a Global Event can make a system more efficient by providing more time in which to run the system while still allowing maintenance and other Actions to take place. A Global Event is represented by a [System Global Event record](#), which contains all the identifying information for the Global Event.
- **Resource:** A component of a System Reliability Analysis that associates a cost with an occurrence of an Action or Risk. Resources are defined for a System Reliability Analysis and are represented by a [System Resource record](#).

- **Simulation Results:** The outcome of running a simulation against all Scenarios included in a given System Reliability Analysis. Simulation results are stored in System Element Result, System Action Result, or System Resource Result records, which are linked to the root System Analysis record.

System Reliability Analysis Workflow

To develop a System Reliability Analysis, you will need to complete the following steps:

1. [Develop Scenarios](#).

To develop a Scenario, you must [create a System Scenario record](#) and then [build a Diagram](#) for the Scenario. You can create multiple Scenarios to model different design options for a single system. For each Scenario, you can define [Risks](#), [Actions](#), and [Global Events](#).

2. [Run simulations](#).

You can perform a [Monte Carlo simulation](#) of a System Scenario to calculate the availability and cost of failure for an entire system and the individual elements included in each Scenario.

3. [Evaluate results](#).

Running the simulation will result in the generation of various calculations and plots. By evaluating the results, you will be able to determine the cost and reliability of each Scenario relative to other Scenarios in the analysis.

4. [Modify Scenarios](#) and [rerun simulations](#).

By modifying Scenarios and rerunning the simulation, you can determine the impact of those changes to the overall cost and reliability of the system. You can complete this step as many times as needed until you feel that the analysis cannot be refined any further.

5. [Make recommendations](#).

After you have modified the Scenarios and have rerun the simulation various times, you should be able to identify the conditions that will result in the lowest cost and the highest reliability. You can then make recommendations about measures that should be implemented based upon the analysis results.

About the System Reliability Analysis Example

To make this documentation easier to follow and to help explain how System Reliability Analyses can be created and used, in this area of the documentation, we provide an example of a System Reliability Analysis. We will refer to this example as necessary throughout the System Reliability Analysis documentation.

Our System Reliability Analysis Example involves a water bottling facility, which contains a system that performs the following steps in the water bottling process:

1. Collects water from a source via a pump.
2. Runs the water through a bottling subsystem, which fills bottles and attaches caps and labels to the bottles.

Note: In this example, we assume that the bottles, labels, and caps are produced at a separate facility and utilized in this process.

For our example, we will use three different Scenarios to evaluate the reliability and cost associated with three different models for this system:

- [Scenario A](#).
- [Scenario B](#).
- [Scenario C](#).

In addition to these Scenarios, we will define the following Resources for our System Reliability Analysis Example:

- **Bearing:** A replacement bearing.
- **Seal:** A replacement seal.
- **Mechanic:** A mechanic who will perform needed maintenance.
- **Vibration Technician:** A professional who will perform vibration analysis.

Scenario A Diagram

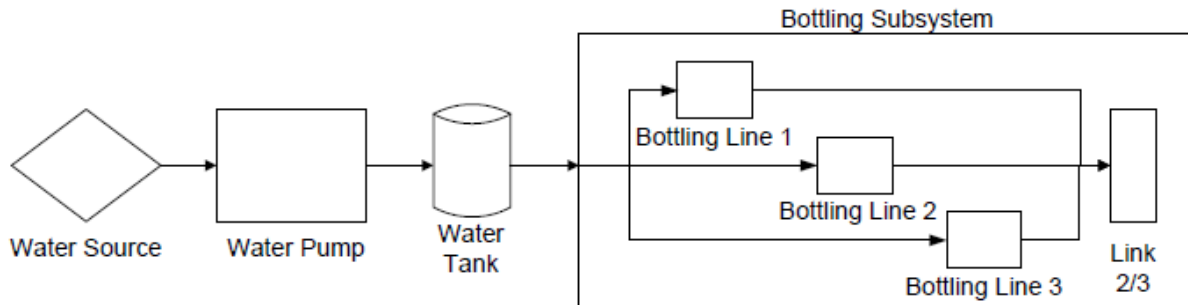

Scenario A represents the current structure of the system as shown in this image. The physical model for Scenario A includes the following components:

- **Water Source:** Produces water that can be used in the water bottling process. For our example, we will assume that the Water Source is a naturally occurring spring. This component is represented by an Asset element in the Diagram for Scenario A.
- **Water Pump:** Pulls water from the Water Source and into the Buffer. This component is represented by an Asset element in the Diagram for Scenario A.
- **Water Tank:** Stores water and feeds it into the Bottling Subsystem. This component is represented by a Buffer element in the Diagram for Scenario A.
- **Bottling Subsystem:** Fills bottles and attaches labels and caps. This subsystem is comprised of three Asset elements (Bottling Line 1, Bottling Line 2, and Bottling Line 3) and a Link. This component is represented by a Subsystem element in the Diagram for Scenario A.
- **Link:** Combines and manages the production of the Bottling Lines within the Bottling Subsystem. The Link specifies that two of the three Bottling Lines must be running for the entire Subsystem to run. This component is represented by a Link in the Diagram for Scenario A.

Scenario A Risks

When the Water Pump element fails due to a Risk, the entire system will fail and accrue lost production costs. The following Risks are assigned to the Water Pump element in Scenario A:

- Seal Failure.
- Bearing Failure.
- Impeller Failure.

Every time the Water Pump experiences an *unplanned* Bearing Failure, the correction will require the use of the Bearing, Mechanic, and Seal Resources. If the Water Pump requires a bearing replacement as the result of a *planned* correction, only the Bearing and Mechanic Resources will be needed. Therefore, the following Resources have been assigned to the Bearing Failure Risk:

- **Unplanned Resources:** Mechanic, Bearings, and Seal.
- **Planned Resources:** Mechanic and Bearings.

Scenario A Actions

There are no Actions defined for Scenario A.

Scenario B Diagram

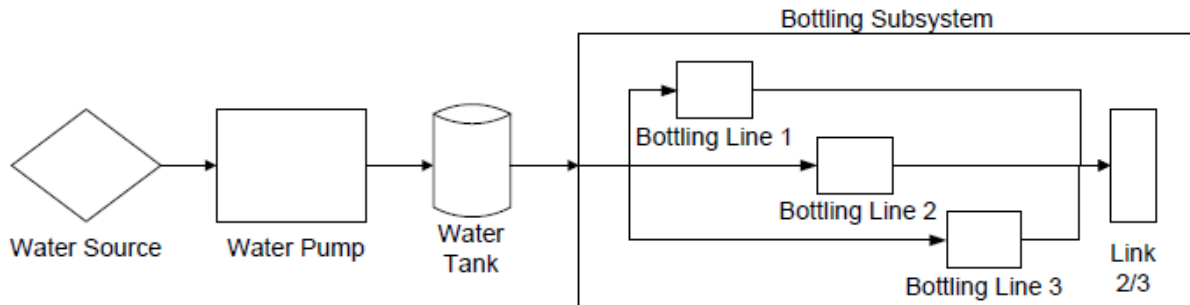

The physical model for Scenario B is shown in this image. It is identical to Scenario A, but Actions and additional Resources have been assigned to the Water Pump in this Scenario to mitigate Risks.

Scenario B Risks

The same Risks are defined for Scenario B as are defined for Scenario A. The same Resources are assigned to these Risks.

Scenario B Actions

For Scenario B, the following Actions have been defined for the Water Pump:

- **Replace Seal:** A time-based maintenance Action that mitigates the Seal Failure Risk.
- **Vibration Analysis:** An inspection or periodic condition-based maintenance Action that mitigates the Bearing Failure Risk. The Vibration Technician Resource has been assigned to the Vibration Analysis Action.
- **Redesign Impeller:** A redesign Action that mitigates the Impeller Failure Risk.

Scenario C Diagram

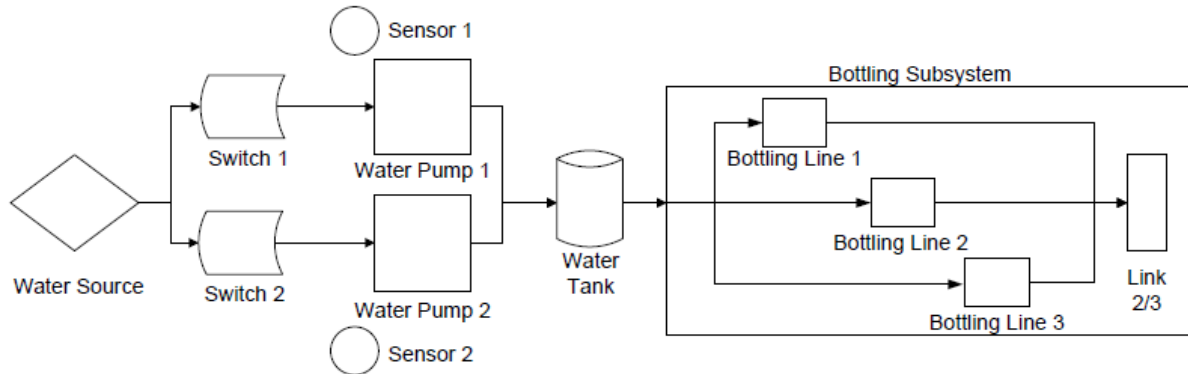

The physical model for Scenario C is shown in this image. It is similar to Scenario A but contains the following additional components:

- **Water Pump 2:** Pulls water from the Water Source and into the Water Tank. Water Pump 2 serves as a backup or standby for Water Pump 1 and is represented by an Asset element in the Diagram for Scenario C.
- **Sensor 1:** Monitors Water Pump 1 for failure. When Water Pump 1 fails, Sensor 1 activates Switch 2, indicating that Water Pump 2 will start running, and deactivates Switch 1 to indicate that Water Pump 1 has stopped running. Sensor 1 is represented by a Sensor element in the Diagram for Scenario C.
- **Sensor 2:** Monitors Water Pump 2 for failure. When Water Pump 1 fails, Water Pump 2 will start running and will continue to run until it fails. When Water Pump 2 fails, Sensor 2 will activate Switch 1, indicating that Pump 1 is running, and will deactivate Switch 2 to indicate that Water Pump 2 has stopped running. Sensor 2 is represented by a Sensor element in the Diagram for Scenario C.
- **Switch 1:** Is initially set to *On*, indicating that Water Pump 1 is initially running. When *activated* by Sensor 1, *connects* the Water Source and Water Pump 1 so that Pump 1 will feed water into the Water Tank. When *deactivated* by Sensor 1, Switch 1 *disconnects* Water Source and Water Pump 1. Switch 1 is represented by a Switch element in the Diagram for Scenario C.
- **Switch 2:** Is initially set to *Off*, indicating that Pump 2 is not running initially. When *activated* by Sensor 2, *connects* the Water Source and Water Pump 2 so that Pump 2 will feed water into the Water Tank. When *deactivated* by Sensor 2, Switch 2 *disconnects* Water Source and Water Pump 2. Switch 2 is represented by a Switch element in the Diagram for Scenario C.

Scenario C Risks

The same Risks are defined for Scenario C as are defined for Scenarios A and B. The same Resources are assigned to these Risks.

Scenario C Actions

There are no Actions defined for Scenario C.

What Conclusions Will We Be Able to Draw from Our Example?

By comparing Scenario A, Scenario B, and Scenario C, we will be able to view each Scenario's reliability and cost and identify the Scenario that has the highest reliability and lowest cost associated with it. Scenario A represents the current design, and both Scenario B and Scenario C represent modifications to the original design. These modifications support different hypotheses about modifying our current system:

- Scenario B proposes that by implementing certain Actions that mitigate Risks associated with the Water Pump, we may be able to increase the reliability and decrease the cost of the system.
- Scenario C proposes that by introducing an additional Water Pump, which will prevent a full system failure when Water Pump 1 fails, we may be able to increase the reliability and decrease the cost of the system.

By modeling and comparing the three different Scenarios, we should be able to draw conclusions and make recommendations about changes that should be implemented to improve the reliability of the system.

Note that this example is fairly simple and is limited to three Scenarios. As you develop a System Reliability Analysis, you may want to develop additional Scenarios that model other variations to the system. As we continue to use this example throughout the System Reliability documentation, we will provide suggestions for where you might modify or extend our example to take advantage of the System Reliability features to create a more complex, in-depth analysis.

About the System Reliability Analysis Example Data

In this area of the documentation, we list the specific data used in our [System Reliability Analysis Example](#). This information is provided for your reference. As we use our example throughout the System Reliability Analysis documentation, you may need to refer to the data that we have used to fully understand the effect that certain inputs have on the analysis results.

Note: In these topics, we list only the fields that contain a value. In the case of numeric fields, this includes fields that contain a value of zero (0). Fields that contain NO value are not listed here.

The following topics contain details on the specific data in our System Reliability Analysis Example:

- [Example System Analysis Record Data.](#)
- [Example System Scenario Record Data.](#)
- [Example System Subsystem Record Data.](#)
- [Example System Asset Record Data.](#)
- [Example System Buffer Record Data.](#)
- [Example System Link Record Data.](#)
- [Example System Sensor Record Data.](#)
- [Example Switch Element Data.](#)
- [Example Risk Data.](#)
- [Example Action Data.](#)
- [Example System Resource Record Data.](#)
- [Example System Resource Usage Record Data.](#)

Example System Analysis Record Data

Like all System Reliability Analyses, our [System Reliability Analysis Example](#) contains one root System Analysis record. The following values exist in the fields of that record:

- **Name:** System Reliability Analysis Example
- **Currency:** \$
- **Start Date:** 1/1/2010 12:00:00 AM
- **Period:** 7 Years
- **Iterations:** 1000
- **Time Analysis Type:** Yearly
- **Confidence (%):** 90
- **Histogram Bins:** 20
- **Enable Event Log:** False
- **Random Seed:** True

Example System Scenario Record Data

The following table shows the data stored in the System Scenario records in our [System Reliability Analysis Example](#).

Scenario	Values Specified
Scenario A	Name: Scenario A Description: Current Structure
Scenario B	Name: Scenario B Description: Current Structure With Actions
Scenario C	Name: Scenario C Description: Redesigned Structure With Backup Pump

Example System Subsystem Record Data

Each Scenario in our [System Reliability Analysis Example](#) contains two System Subsystem records. One System Subsystem record contains the Diagram structure for each Scenario, and the other System Subsystem record contains the Bottling Lines, which are used in all three Scenarios. The following table lists the data that exist in each record.

Subsystem	Values specified
Diagram for Scenario A	Name: Diagram for Scenario A Production Contribution: 100 Fixed Cost: 0 Variable Cost: 0 Variable Cost Units: Per Day Lost Production Cost: 100000 Lost Production Cost Units: Per Day
Diagram for Scenario B	Name: Diagram for Scenario B Production Contribution: 100 Fixed Cost: 0 Variable Cost: 0 Variable Cost Units: Per Day Lost Production Cost: 100000 Lost Production Cost Units: Per Day
Diagram for Scenario C	Name: Diagram for Scenario C Production Contribution: 100 Fixed Cost: 0 Variable Cost: 0 Variable Cost Units: Per Day Lost Production Cost: 100000 Lost Production Cost Units: Per Day

Example System Subsystem Record Data

Subsystem	Values specified
Bottling Sub-system	Name: Bottling Subsystem Production Contribution: 100 Fixed Cost: 0 Variable Cost: 0 Variable Cost Units: Per Day Lost Production Cost: 0 Lost Production Cost Units: Per Day

Example System Asset Record Data

The following table shows the data stored in the System Asset records in our [System Reliability Analysis Example](#). The light blue row identifies the Scenario(s) in which each Asset element is used.

Asset	Values Specified
All Scenarios	
Water Source	Name: Water Source Production Contribution: 100 Fixed Cost: 0 Variable Cost: 0 Variable Cost Units: Per Day Lost Production Cost: 0 Lost Production Cost Units: Per Day
Bottling Line	Name: <Bottling Line 1, Bottling Line 2, or Bottling Line 3> ¹ Production Contribution: 40 Fixed Cost: 0 Variable Cost: 0 Variable Cost Units: Per Day Lost Production Cost: 0 Lost Production Cost Units: Per Day
Scenario A	
Water Pump	Name: Water Pump Production Contribution: 100 Fixed Cost: 5000 Variable Cost: 50 Variable Cost Units: Per Hour Lost Production Cost: 0 Lost Production Cost Units: Per Day
Scenario B	

Asset	Values Specified
Water Pump	Name: Water Pump Production Contribution: 100 Fixed Cost: 5000 Variable Cost: 50 Variable Cost Units: Per Hour Lost Production Cost: 0 Lost Production Cost Units: Per Day
Scenario C	
Water Pump 1	Name: Water Pump 1 Production Contribution: 100 Fixed Cost: 5000 Variable Cost: 50 Variable Cost Units: Per Hour Lost Production Cost: 0 Lost Production Cost Units: Per Day
Water Pump 2	Name: Water Pump 2 Production Contribution: 100 Fixed Cost: 5000 Variable Cost: 50 Variable Cost Units: Per Hour Lost Production Cost: 0 Lost Production Cost Units: Per Day

Example System Buffer Record Data

The following data is stored in the System Buffer record for our [System Reliability Analysis Example](#):

- **Name:** Water Tank
- **Production Contribution:** 100
- **Initial Quantity in Percentage:**50
- **Time to Empty:** 0.5
- **Time to Empty Units:** Days
- **Time to Refill:** 5
- **Time to Refill Units:** Days

Example System Link Record Data

The following data is stored in the System Link record for our [System Reliability Analysis Example](#).

- **Name:** Link
- **Minimum Predecessors:** 2

Example System Sensor Record Data

The following table shows the data stored in the System Sensor records for our [System Reliability Analysis Example](#).

Sensor	Values Specified
Sensor 1	<p>Name: Sensor 1</p> <p>Monitored Elements: Water Pump 1</p> <p>Activated Switches: Switch 2</p> <p>Deactivated Switches: Switch 1</p>
Sensor 2	<p>Name: Sensor 2</p> <p>Monitored Elements: Water Pump 2</p> <p>Activated Switches: Switch 1</p> <p>Deactivated Switches: Switch 2</p>

Example Switch Element Data

The following table shows the data stored in the System Switch records in our [System Reliability Analysis Example](#).

Element	Values Specified
Switch 1	<p>Name: Switch 1</p> <p>Is Initially On: Yes</p> <p>Product Contribution: 100</p> <p>Fixed Cost: 0</p> <p>Variable Cost: 0</p> <p>Variable Cost Units: Per Day</p> <p>Lost Production Cost: 0</p> <p>Lost Production Cost Units: Per Day</p>
Switch 2	<p>Name: Switch 2</p> <p>Is Initially On: No</p> <p>Product Contribution: 100</p> <p>Fixed Cost: 0</p> <p>Variable Cost: 0</p> <p>Variable Cost Units: Per Day</p> <p>Lost Production Cost: 0</p> <p>Lost Production Cost Units: Per Day</p>

Example Risk Data

The following table shows the data for the Risks used in our [System Reliability Analysis Example](#).

Note: The Source column identifies the entity family name of the record in which the associated data is stored. The data from all source records is combined to create the comprehensive Risk data.

Risk	Assigned To	Source	Values Specified
Water Source Failure	Water Source Asset in all Scenarios	System Risk Record	Name: Water Source Failure Last Failure: 1/1/1999 12:00:00 AM Fixed Unplanned Correction Cost: 0 Variable Unplanned Correction Cost: 0 Per Day Planned Correction Cost: 0 Planned Correction Duration: 0 Hours Is Active: True Is Latent: False Failure Without Replacement: False Number of Subcomponents: 1 PF Interval: 0 Days Repair Immediately: True Percentage of PF Interval to Wait (%): 0
		Exponential	Name: TTF Distribution Distribution Type: Exponential Time Unit: Years MTBF: 20 Enable Distribution Association: No
		Exponential	Name: TTR Distribution Distribution Type: Exponential Time Unit: Weeks MTBF: 2 Enable Distribution Association: No

Risk	Assigned To	Source	Values Specified
Bottling Line Failure	Bottling Line Asset in all Scenarios	System Risk Record	Name: Bottling Line Failure Last Failure: 1/1/1999 12:00:00 AM Fixed Unplanned Correction Cost: 0 Variable Unplanned Correction Cost: 0 Per Day Planned Correction Cost: 0 Planned Correction Duration: 0 Hours Is Active: True Is Latent: False Failure Without Replacement: False Number of Subcomponents: 1 PF Interval: 0 Days Repair Immediately: True Percentage of PF Interval to Wait (%): 0
		Exponential	Name: TTF Distribution Distribution Type: Exponential Time Unit: Months MTBF: 12 Enable Distribution Association: No
		Normal	Name: TTR Distribution Distribution Type: Exponential Time Unit: Days MTRR: 1 Enable Distribution Association: No

Risk	Assigned To	Source	Values Specified
Seal Failure	<ul style="list-style-type: none"> • Water Pump Asset in Scenario A and B • Water Pump 1 and Water Pump 2 Assets in Scenario C 	System Risk Record	Name: Seal Failure Last Failure: 1/1/1999 12:00:00 AM Fixed Unplanned Correction Cost: 1500 Variable Unplanned Correction Cost: 1000 Per Day Planned Correction Cost: 1000 Planned Correction Duration: 4 Hours Is Active: True Is Latent: False Failure Without Replacement: No Number of Subcomponents: 1 PF Interval: 30 Days Repair Immediately: True Percentage of PF Interval to Wait (%): 0
		Weibull	Name: TTF Distribution Distribution Type: Weibull Time Unit: Years Beta: 4 Eta: 3 Gamma: 0 Enable Distribution Association: No
		Normal	Name: TTR Distribution Distribution Type: SingleValue Time Unit: Hours Value: 12 Enable Distribution Association: No

Risk	Assigned To	Source	Values Specified
Bearing Failure	<ul style="list-style-type: none"> • Water Pump Asset in Scenario A and B • Water Pump 1 and Water Pump 2 Assets in Scenario C 	System Risk Record	Name: Bearing Failure Last Failure: 1/1/1999 12:00:00 AM Fixed Unplanned Correction Cost: 2000 Variable Unplanned Correction Cost: 1000 Per Day Planned Correction Cost: 1000 Planned Correction Duration: 4 Hours Is Active: True Is Latent: False Failure Without Replacement: False Number of Subcomponents: 1 PF Interval: 6 Weeks Repair Immediately: True Percentage of PF Interval to Wait (%): 0
		Exponential	Name: TTF Distribution Distribution Type: Exponential Time Unit: Months MTBF: 60 Enable Distribution Association: No
		Exponential	Name: TTR Distribution Distribution Type: Exponential Time Unit: Hours MTR: 8 Enable Distribution Association: No

Risk	Assigned To	Source	Values Specified
Impeller Failure	<ul style="list-style-type: none"> • Water Pump Asset in Scenario A and B • Water Pump 1 and Water Pump 2 Assets in Scenario C 	System Risk Record	Name: Impeller Failure Last Failure: 1/1/1999 12:00:00 A.M. Fixed Unplanned Correction Cost: 1500 Variable Unplanned Correction Cost: 1000 Per Day Planned Correction Cost: 1000 Planned Correction Duration: 4 Hours Is Active: True Is Latent: False Failure Without Replacement: False Number of Subcomponents: 1 PF Interval: 0 Days Repair Immediately: True Percentage of PF Interval to Wait (%): 0
		Exponential	Name: TTF Distribution Distribution Type: Exponential Time Unit: Months MTBF: 24 Enable Distribution Association: No
		Normal	Name: TTR Distribution Distribution Type: Single Value Time Unit: Hours Value: 12 Enable Distribution Association: No

Example Action Data

The following table shows the data used in the Actions in our System Reliability Analysis Example. This information defines the properties of the Actions associated with the Water Pump element in Scenario B.

Note: The Source column identifies the entity family name of the record in which the associated data is stored. The data from all source records is combined to create comprehensive Action data.

Action	Mitigated Risk	Source	Value Specified
Redesign Impellers	Impeller Failure	System Special Action Record	Name: Redesign Impellers Action Cost: 1600 Interval: 2 Years Duration: 2 Days Shutdown Required: True One Time Action: True Replace Failure Consequence: True Replace TTF Distribution: True
		System Risk Assessment	Mitigated Unplanned Correction Cost: 1000 ¹
		Weibull	Name: New TTF Distribution Distribution Type: Weibull Time Unit: Months Beta: 4 Eta: 48 Gamma: 0

Example Action Data

Action	Mitigated Risk	Source	Value Specified
Replace Seals	Seal Failure	System Preventive Maintenance Record	Name: Replace Seals Action Type: Time-Based Maintenance (Preventive) (PM) Action Cost: 2000 Interval: 2 Years Duration: 4 Hours Shutdown Required: True One Time Action: False
Vibration Analysis	Bearing Failure	System Inspection Record	Name: Vibration Analysis Action Type: Condition-Based Maintenance (Predictive) (CM) Condition Monitoring Type: Periodic Action Cost: 0 Interval: 3 Weeks Duration: 1 Hours Shutdown Required: False One Time Action: False Detection Probability (%): 90

Example System Resource Record Data

The following table shows the data stored in the System Resource records in our [System Reliability Analysis Example](#).

Resource	Values Specified
Bearing	Name: Bearing Fixed Cost: 200 Variable Cost: 0 Per Day Count Occurrences: True
Mechanic	Name: Mechanic Fixed Cost: 0 Variable Cost: 100 Per Hour Count Occurrences: False
Seal	Name: Seal Fixed Cost: 250 Variable Cost: 0 Per Day Count Occurrences: True
Vibration Technician	Name: Vibration Technician Fixed Cost: 0 Variable Cost: 100 Per Hour Count Occurrences: False

Example System Resource Usage Record Data

The following table shows the data stored in the System Resource Usage records in our [System Reliability Analysis Example](#):

Resource	Linked To	Values Specified
Vibration Technician	Vibration Analysis Action	Resource: Vibration Technician Quantity: 1 Duration: 1 Duration Units: Hours
Mechanic	Bearing Failure Risk	Planned Resource Usage Resource: Mechanic Quantity: 1 Duration: 4 Duration Units: Hours Unplanned Resource Usage Resource: Mechanic Quantity: 1 Duration: 8 Duration Units: Hours

Example System Resource Usage Record Data

Resource	Linked To	Values Specified
Bearing	Bearing Failure Risk	<p>Planned Resource Usage</p> <p>Resource: Bearing</p> <p>Quantity: 2</p> <p>Duration: 0</p> <p>Duration Units: Hours</p> <p>Unplanned Resource Usage</p> <p>Resource: Bearing</p> <p>Quantity: 2</p> <p>Duration: 0</p> <p>Duration Units: Hours</p>
Seal	Bearing Failure Risk	<p>Unplanned Resource Usage</p> <p>Resource: Seal</p> <p>Quantity: 1</p> <p>Duration: 0</p> <p>Duration Units: Hours</p>

Accessing the Select a System Reliability Analysis from the List Page

The **Select a System Reliability Analysis from the List** page provides access to all existing System Reliability Analyses.

To access the list of existing System Reliability Analyses:

- On the [Reliability Analytics Start page](#), click the **System Reliability Analysis** link.

The **Select a System Reliability Analysis from the List** page appears.

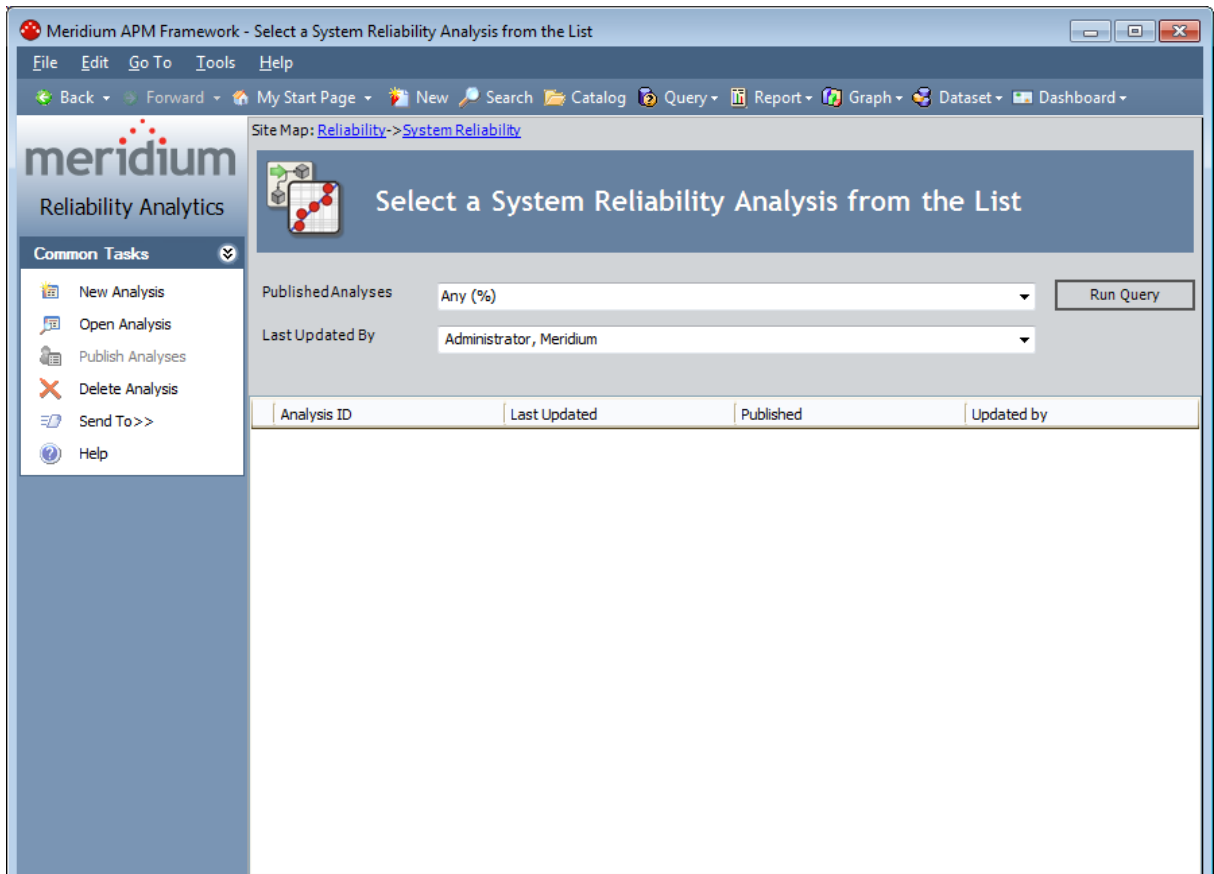

Aspects of the Select a System Reliability Analysis from the List Page

The [Select a System Reliability Analysis from the List page](#) lets you run the System Reliability query to access a list of existing Reliability System Analyses that meet your query criteria.

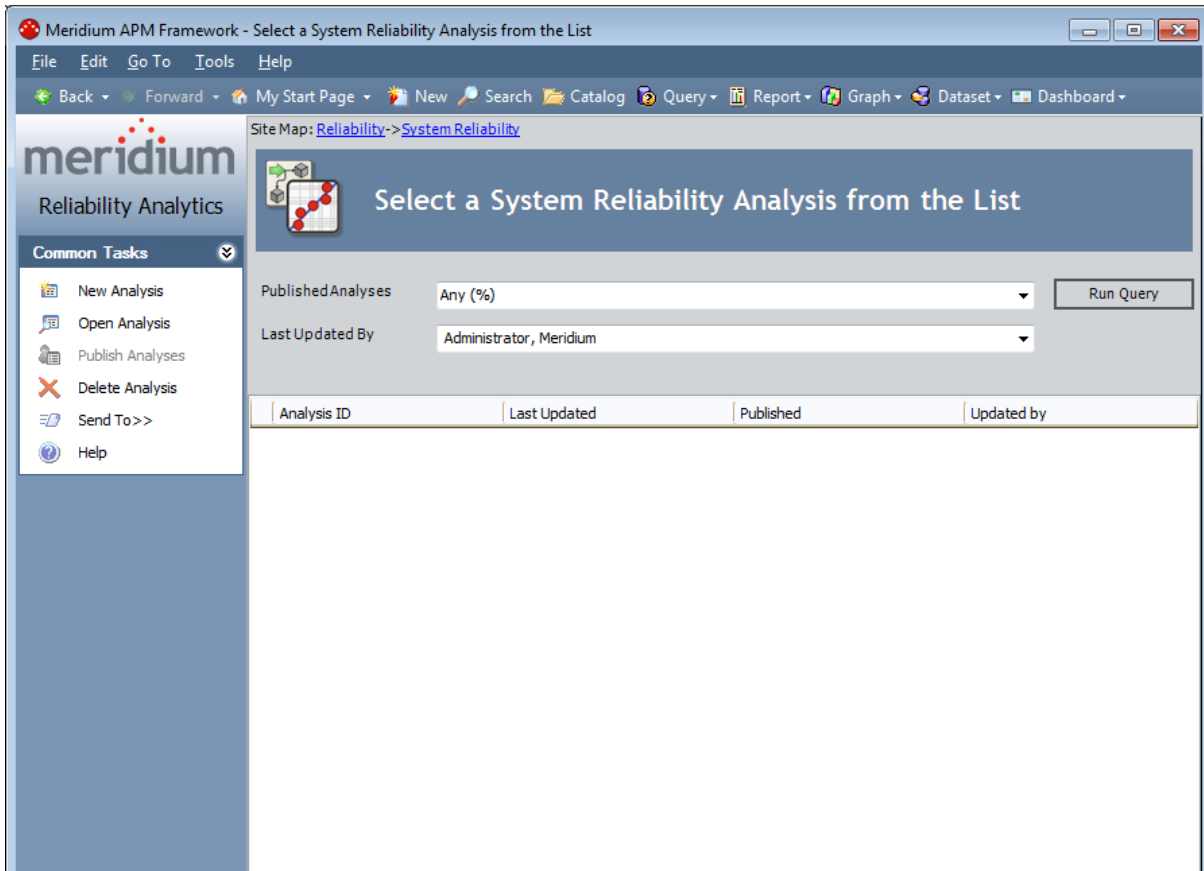

The System Reliability query is stored in the Catalog folder \\Public\Meridium\Modules\Reliability Manager\Analyses. While the System Reliability query can be [customized](#) for your specific implementation, the baseline System Reliability query contains two prompts: **Published Analyses** and **Last Updated By**. These prompts appear at the top of the page as drop-down lists that contain various options.

The **Published Analyses** list contains the following options:

- **Any (%):** Will cause the query to return ALL analyses, either published or unpublished.
- **Yes (Y):** Will cause the query to return *only* published analyses.
- **No (N):** Will cause the query to return *only* unpublished analyses.

The **Last Updated By** list contains the following options:

- Your user name, which will cause the query to return only the Reliability System Analyses that were last updated by you.
- The user name of any user who last updated any System Reliability Analysis, which will cause the query to return only the Reliability System Analyses that were last updated by that user.
- The **(All Users)** option, which will cause the query to return a list of Reliability System Analyses updated by ANY user.

Each time you access the **Select a System Reliability Analysis from the List** page, the values that appear by default in the prompts will be used to filter the list. After you select different criteria, you can click the **Run Query** button to run the Systems Reliability query and display the results in a grid at the bottom of the page.

Note: Although the results are returned by the System Reliability query, query page size is ignored. The entire list of analyses is displayed at once.

The default Systems Reliability query is configured to display the **Analysis ID, Last Updated, Published, and Updated By** columns. After you run the query, you can click any hyperlinked Analysis ID to view the associated [System Reliability Analysis summary](#). In addition, you can use the options on the [Common Tasks menu](#) to perform tasks associated with the analyses in the list.

CE Hint: If desired, you can customize the column display of the results grid.

Common Tasks Menu

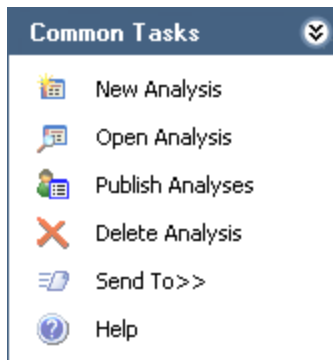

The **Common Tasks** menu on the **Select a System Reliability Analysis from the List** page contains the following links:

- **New Analysis:** Displays the **System Reliability Analysis Definition** page, where you can begin the process of creating a new System Reliability Analysis.
- **Open Analysis:** Displays the **Find Items** window, which you can use to find and open an existing System Reliability Analysis. Note that you can also open an existing System Reliability Analysis by clicking any hyperlinked value in the Analysis ID column.
- **Publish Analyses:** After asking for confirmation, [publishes the selected analysis or analyses](#).

Note: If you have selected a published Analysis, this link will become **Unpublish Analyses**. After asking for confirmation, this link [unpublishes the selected analysis or analyses](#). If you select a combination of published and unpublished analyses, the name of the link will be appropriate for the last analysis in the list. Clicking the link will perform that action for all the analyses. For example, to publish multiple analyses, you should select only unpublished analyses.

- **Delete Analyses:** After asking for confirmation, deletes the selected analysis or analyses.
- **Send To:** Displays a submenu with options that let you provide a link to the current page on your desktop (create shortcut), in an email message, or on a Home Page.
- **Help:** Displays the context-sensitive Help topic for the current page.

About Navigating System Reliability Features

From the **Select a System Reliability Analysis from the List** page, you can open an existing System Reliability Analysis or create a new one. When you do so:

- If you are creating a new analysis or opening an existing analysis for which the simulation results have not yet been saved, the [System Reliability Analysis Definition page](#) will be displayed.
- If you are opening an existing analysis for which the simulation results have been saved, the [System Reliability Summary page](#) will be displayed.

In either case, after you have accessed an analysis, you can use the task menus to perform tasks and access additional pages and features related to that analysis. This section of the documentation provides an overview of those tasks, pages, and features.

Note: Each page title is prefixed with the text *System Reliability* and appended with the name of the System Reliability Analysis. For example, if you are viewing the [System Reliability Analysis Example](#) on the **System Reliability Summary** page, the full page title would be **System Reliability Summary - System Reliability Analysis Example**. Throughout the documentation, we refer to the page names *without* the text *System Reliability* or the analysis name. Continuing with the example, we would refer to this page simply as the **System Reliability Summary**page.

Aspects of the System Reliability Summary Page

The **System Reliability Summary** page displays a summary of the simulation results that currently exist for a given System Reliability Analysis.

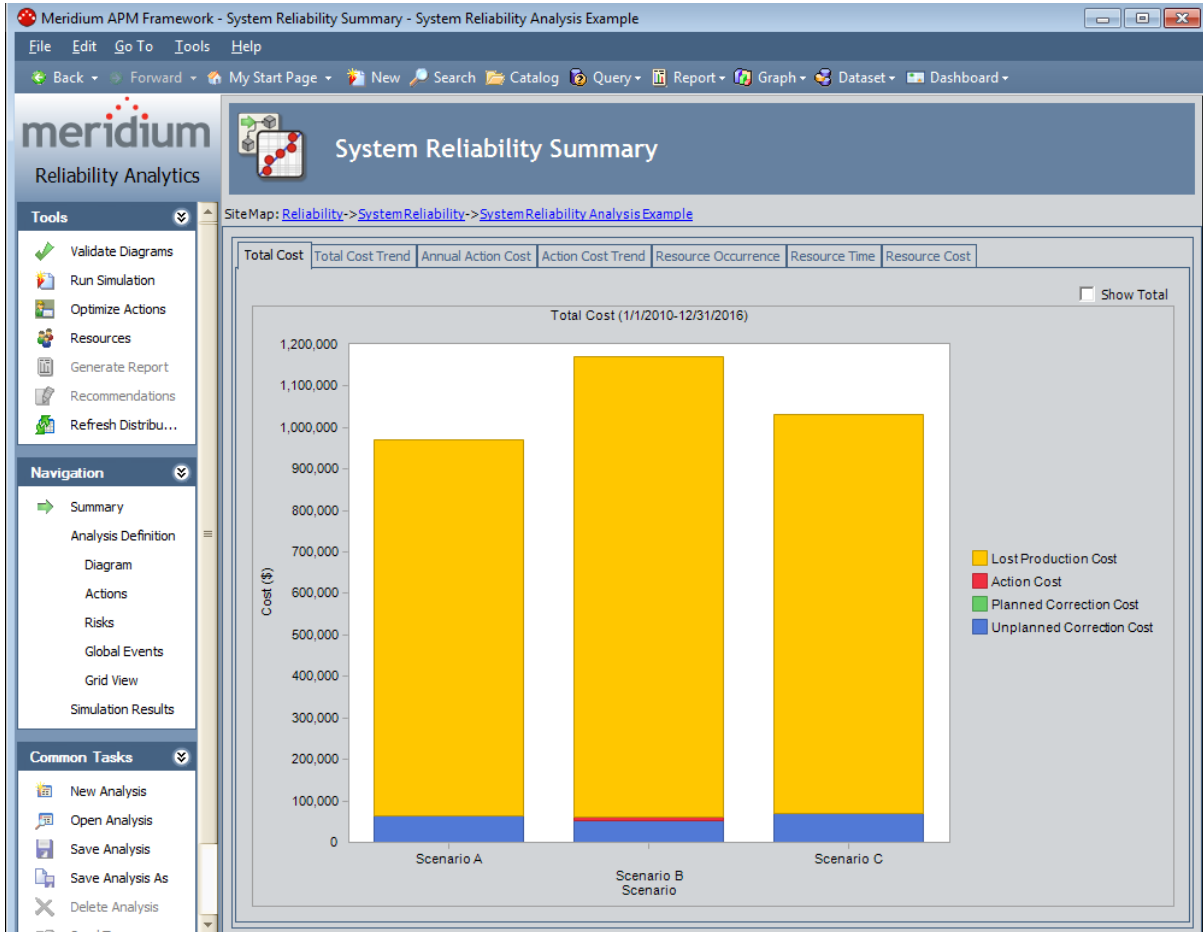

The **System Reliability Summary** page contains the following features:

- **Task menus:** Displays the task menus that are common to most pages in System Reliability: [Tools](#), [Navigation](#), and [Common Tasks](#).
- **System Reliability Summary workspace:** Displays the simulation results on seven tabs:
 - [Total Cost](#): Displays the Total Cost graph that exists for the System Reliability Analysis.
 - [Total Cost Trend](#): Displays the Total Cost Trend graph that exists for the System Reliability Analysis.
 - [Annual Action Cost](#): Displays the Annual Action Cost graph that exists for the System Reliability Analysis.
 - [Action Cost Trend](#): Displays the Action Cost Trend graph that exists for the

System Reliability Analysis.

- **Resource Occurrence:** Displays the Resource Occurrence graph that exists for the System Reliability Analysis.
- **Resource Time:** Displays the Resource Time graph that exists for the System Reliability Analysis.
- **Resource Cost:** Displays the Resource Cost graph that exists for the System Reliability Analysis.

You can right-click a graph to display a submenu of options that you can use to customize the graph.

Note: If values that will affect the simulation results have been modified since the simulation was last run, a message will be displayed at the top of the page indicating that the simulation must be rerun. Whenever this message appears, we recommend that you rerun the simulation to ensure that valid results are displayed.

Aspects of the System Reliability Analysis Definition Page

The **System Reliability Analysis System Definition** page contains features that allow you to [define basic properties of a given System Reliability Analysis](#) and manage Scenarios associated with it.

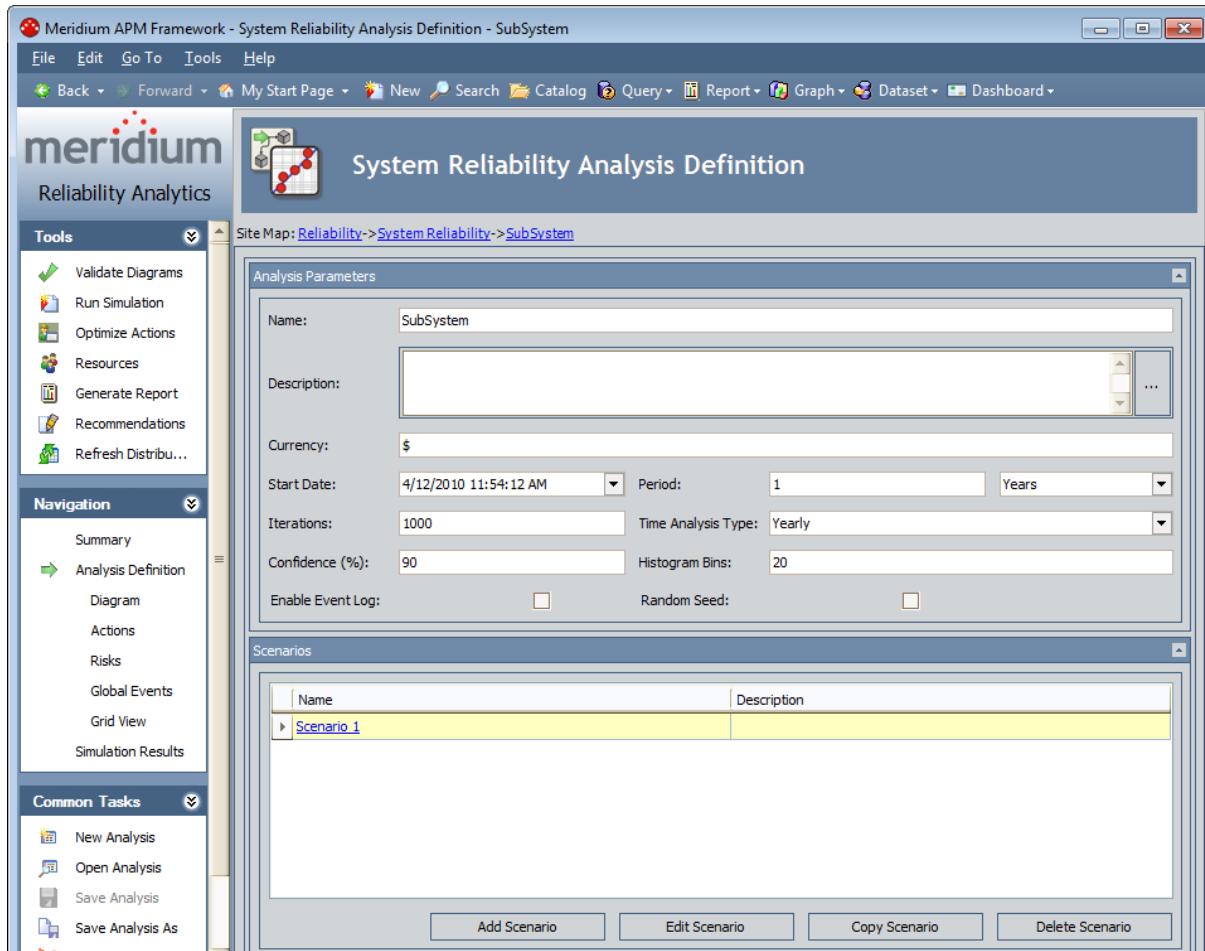

The **System Reliability Analysis Definition** page is divided into the following areas:



- **Task menus:** Displays the task menus that are common to most pages in System Reliability: [Tools](#), [Navigation](#), and [Common Tasks](#).
- **Analysis Parameters section:** Displays [fields that you can use to define the properties of a System Reliability Analysis](#). The content of this pane is controlled by the default datasheet that is defined for the System Analysis family.
- **Scenarios section:** Contains a grid and buttons that you can use to [manage the Scenarios](#) associated with a System Reliability Analysis. The grid displays the following columns of information, which display values from the following fields in System Scenario records:

- Name
- Description

Note: The **Name** and **Description** columns are the only fields of the [System Scenario record](#) that are available to view in the **Scenarios** grid. Additional fields exist in the [System Scenario record](#) but cannot be added to the **Scenarios** grid.

Below the **Scenarios** grid, the following buttons appear:

- **Add Scenario:** Displays the **Add New Scenario** dialog box, where you can [create a new System Scenario record](#) to link to the current System Analysis record.
- **Edit Scenario:** Displays a dialog box where you can [modify the properties of the System Scenario record](#) that is currently selected in the **Scenarios** grid.
- **Copy Scenario:** [Creates a copy of the System Scenario record](#) that is currently selected in the **Scenarios** grid. The copy includes the System Scenario record itself and the System Subsystem records that are linked to it.
- **Delete Scenario:** After asking for confirmation, [deletes the System Scenario record](#) that is currently selected in the **Scenarios** grid.

Note that if you want to collapse the **Analysis Parameters** or **Scenarios** section, you can click the  button in the section header. To expand the section again, click the  button.

Aspects of the System Reliability Scenarios - Diagram Page

The **System Reliability Scenarios - Diagram** page displays the Diagram that is associated with a given Scenario.

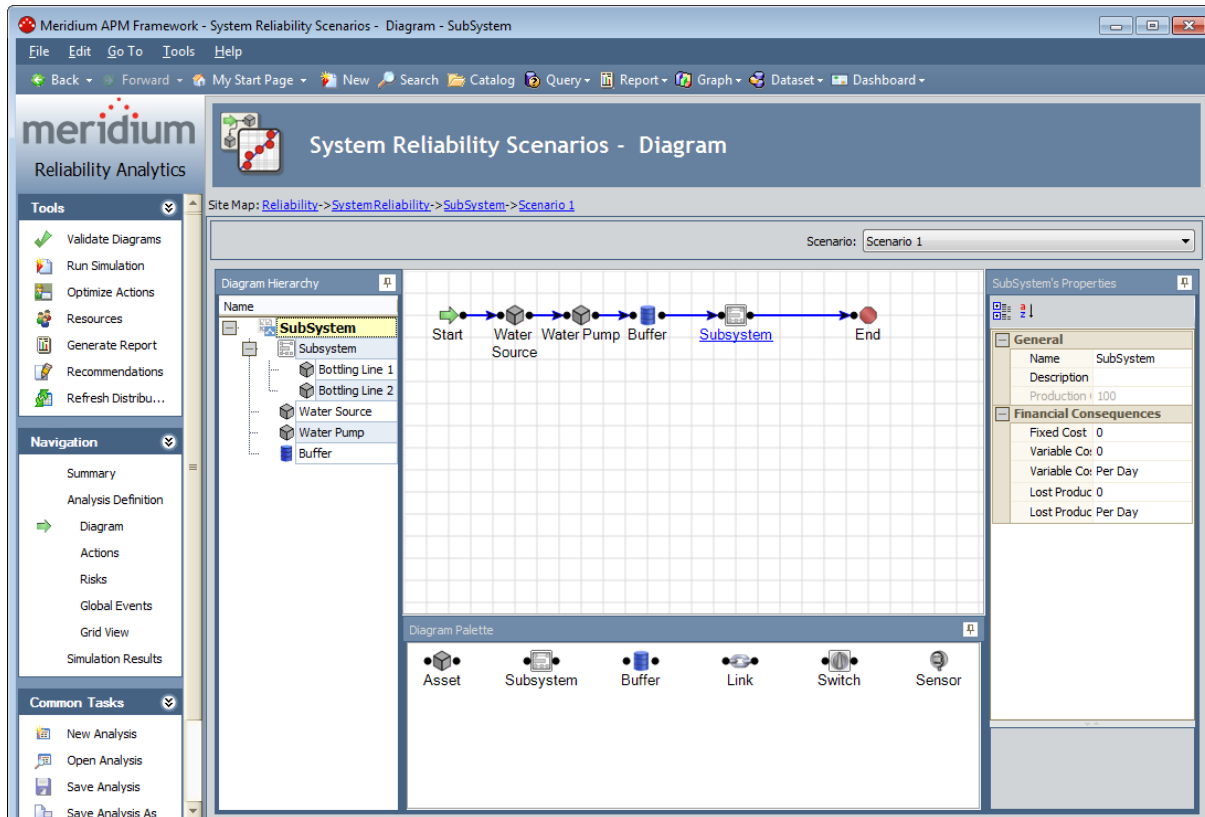

The **System Reliability Scenarios - Diagram** page contains the following features:

- **Task menus:** Displays the task menus that are common to most pages in System Reliability: [Tools](#), [Navigation](#), and [Common Tasks](#).
- **System Reliability Scenarios - Diagram workspace:** Serves as the main display area and contains the following features:
 - **Scenario list:** Contains the names of the System Scenario records that are associated with the current System Reliability Analysis. You can select any name in the list to view the Diagram associated with that Scenario.
 - **Diagram Hierarchy pane:** Provides a hierarchical view of the elements included in the Diagram.
 - **Diagram Canvas:** Serves as an interactive drawing interface where you can build a Diagram. You can drag elements from the **Diagram Palette** pane to the Diagram Canvas to display the elements and their links within the Diagram. You can then rearrange the elements by dragging them to different locations on the Diagram Canvas.
 - **Diagram Palette pane:** Displays the available Diagram elements that you can drag onto the Diagram Canvas to include in the Diagram.
 - **Properties pane:** Displays the information associated either with the entire Diagram or a selected element.

Aspects of the System Reliability Scenarios - Actions Page

The **System Reliability Scenarios - Actions** page lets you view and [manage the Actions](#) that exist for a given Scenario in a System Reliability Analysis.

The screenshot shows the Meridium APM Framework interface for System Reliability Scenarios - Actions - SubSystem. The main workspace is divided into three panes:

- Diagram Hierarchy:** A tree view showing the structure of the system. The selected element is 'Water Pump'.
- Actions:** A table listing actions associated with the selected element. The table has columns for Name, Description, and Resource Usages.

Name	Description	Resource Usages
Redesign Impellers		Resource Usages
Replace Seals		Resource Usages
Vibration Analysis		Resource Usages
- Mitigated Risks:** A table listing risks mitigated by the selected action. The table has columns for Name, Description, TTF, TTR, Planned R..., Unplanned..., and Risks to Reset.

Name	Description	TTF	TTR	Planned R...	Unplanned...	Risks to Reset
Impeller Failure		TTF Distribution	TTR Distribution	Planned Reso...	Unplanned Re...	0

The **System Reliability Scenarios - Actions** page contains the following features:

- **Task menus:** Displays the task menus that are common to most pages in System Reliability: [Tools](#), [Navigation](#), and [Common Tasks](#).
- **System Reliability Scenarios - Actions workspace:** Displays the following sections:
 - **Scenario list:** Contains the names of the System Scenario records that are associated with the current System Reliability Analysis. You can select any name in the list to view the Actions associated with that Scenario.
 - **Diagram Hierarchy pane:** Displays the elements that can have Actions associated with them.
 - **Actions pane:** Displays a grid that you can use to view Actions associated with the selected element in the **Diagram Hierarchy** pane and buttons that you can use to perform various operations against those Actions.
 - **Mitigated Risks pane:** Displays a grid that you can use to view Risks that have been mitigated by the selected Action in the Actions pane and buttons that you can use to perform various operations against those Risks.

Aspects of the System Reliability Scenarios - Risks Page

The **System Reliability Scenarios - Risks** page lets you view and [manage the Risks](#) that exist for a given Scenario in a System Reliability Analysis.

The screenshot displays the Meridium APM Framework interface for System Reliability Scenarios - Risks. The main workspace is titled "System Reliability Scenarios - Risks" and shows a "Scenario for Diagram B" selected. The interface is divided into several sections:

- Diagram Hierarchy:** A tree view on the left showing the structure of the analysis, including "Scenario for Diagram B", "Bottling Subsystem", "Bottling Line 1", "Bottling Line 2", "Bottling Line 3", "Water Pump", and "Water Tank".
- Risks Table:** A table listing risks associated with the selected scenario. The table has columns for Name, Description, TTF, TTR, Planned Resource Usages, Unplanned Resource Usages, and Risks to Reset.

Name	Description	TTF	TTR	Planned Resource Usages	Unplanned Resource Usages	Risks to Reset
Bearing Failure		TTF Distribution	TTR Distribution	Planned Resource Usages	Unplanned Resource Usages	0
Impeller Failure		TTF Distribution	TTR Distribution	Planned Resource Usages	Unplanned Resource Usages	0
Seal Failure		TTF Distribution	TTR Distribution	Planned Resource Usages	Unplanned Resource Usages	0
- Mitigating Actions Table:** A table at the bottom for defining actions to mitigate risks, with columns for Name, Description, and Resource Usages.

The System Reliability Scenarios - Risks page contains the following features:

- **Task menus:** Displays the task menus that are common to most pages in System Reliability: [Tools](#), [Navigation](#), and [Common Tasks](#).
- **System Reliability Scenarios - Risks workspace:** Displays the following sections:
 - **Scenario list:** Contains the names of the System Scenario records that are associated with the current System Reliability Analysis. You can select any name in the list to view the Risks associated with that Scenario.
 - **Diagram Hierarchy pane:** Displays the elements that can have Risks associated with them.
 - **Risks pane:** Displays a grid that you can use to view Risks associated with the selected element in the **Diagram Hierarchy** pane and buttons that you can use to perform various operations against those Risks.
 - **Mitigating Actions pane:** Displays a grid that you can use to view Actions that will mitigate the Risk selected in the **Risks** pane and buttons that you can use to perform various operations against those Actions.

Aspects of the System Reliability Scenarios - Global Events Page

The System Reliability Scenarios - Global Events page lets you view and [manage the Global Events](#) that exist for a given Scenario in a System Reliability Analysis.

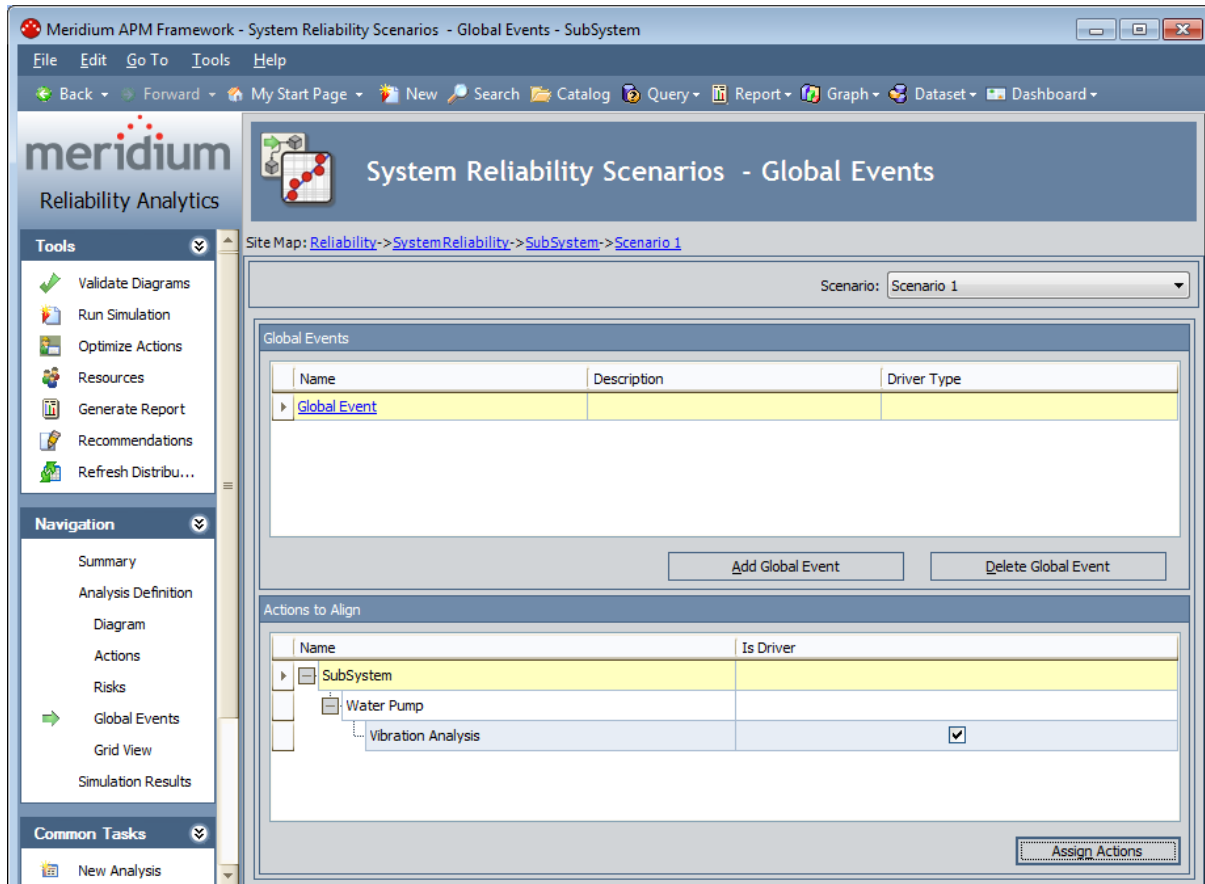

The System Reliability Scenarios - Global Events page contains the following features:

- **Task menus:** Displays the task menus that are common to most pages in System Reliability: [Tools](#), [Navigation](#), and [Common Tasks](#).
- **System Reliability Scenarios - Global Events workspace:** Displays the following sections:
 - **Scenario list:** Contains the names of the System Scenario records that are associated with the current System Reliability Analysis. You can select any name in the list to view the Global Events associated with that Scenario.
 - **Actions to Align pane:** Displays a grid that you can use to view Actions to align with the Global Event and buttons that you can use to perform various operations against those Actions.
 - **Global Events pane:** Displays a grid that you can use to view Global Events associated with the selected Scenario and buttons that you can use to perform actions related to Global Events.

Aspects of the System Reliability Scenarios - Grid Page

The **System Reliability Scenarios - Grid** page displays the *grid view* of a given Scenario. The grid view facilitates a global view of the entire Scenario and its properties.

Note: The **System Reliability Scenarios - Grid** page displays Assets, Buffers, Distributions, Links, Risks, Subsystems, and Switches. Sensors can be viewed only on the [System Reliability Scenarios - Diagram page](#). Global Events can be viewed only on the [System Reliability Scenarios - Global Events page](#).

The **System Reliability Scenarios - Grid** page contains the following features:

- **Task menus:** Displays the task menus that are common to most pages in System Reliability: [Tools](#), [Navigation](#), and [Common Tasks](#).
- [System Reliability Scenarios - Grid workspace](#): Serves as the main display area and contains the following features:
 - **Scenario list:** Contains the names of the System Scenario records that are associated with the current System Reliability Analysis. You can select any name in the list to view the grid associated with that Scenario.
 - **Filter list:** Contains a list of Scenario elements that you can select and view a specialized display of the Diagram that focuses on detailed information related to the selected Filter option in the [grid view](#). You can select any of the following **Filter** options:
 - [Action](#)
 - [Asset](#)
 - [Buffer](#)

- [Subsystem](#)
- [Switch](#)
- **Grid:** Provides a [grid view](#) of the Scenario.

Aspects of the System Reliability Simulation Results Page

The **System Reliability Simulation Results** page displays the simulation results that currently exist for a given System Reliability Analysis.

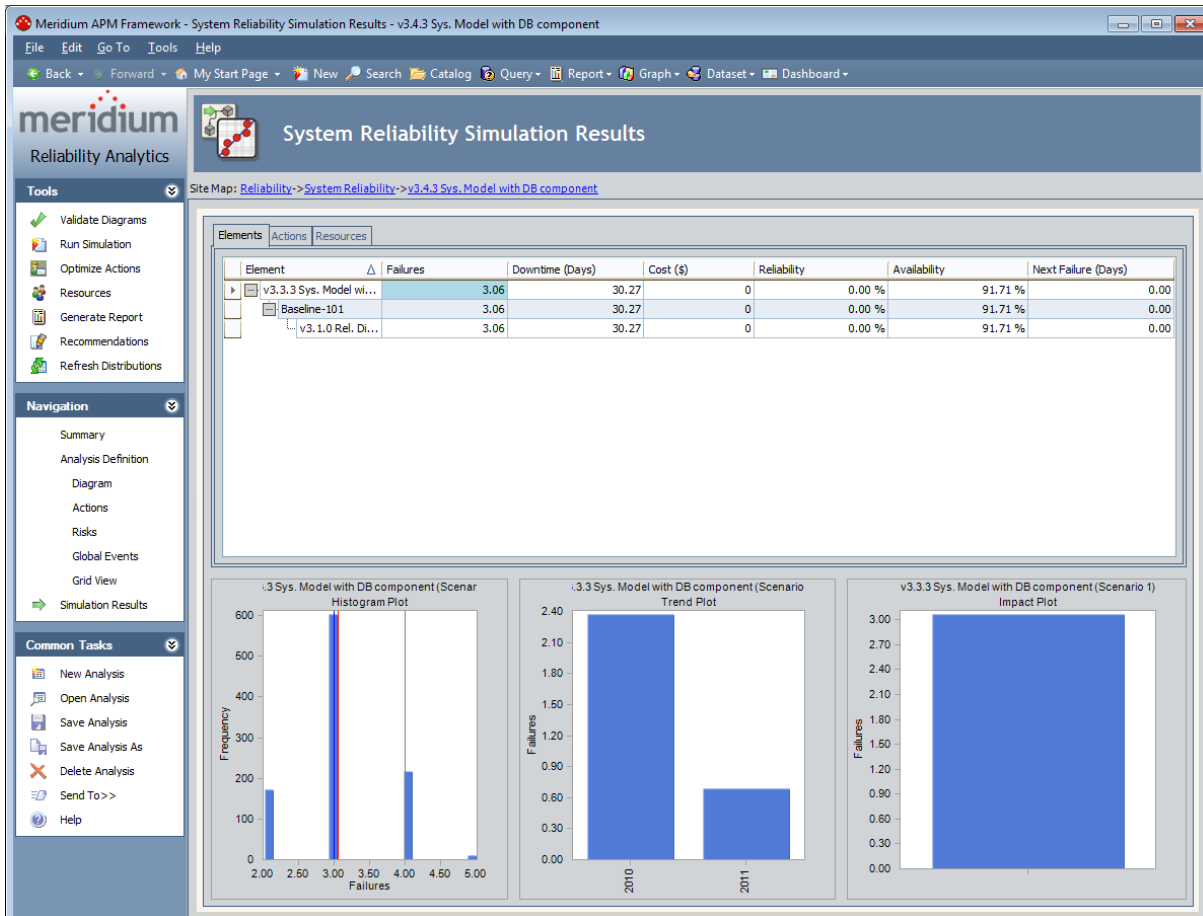

The **System Reliability Simulation Results** page contains the following features:

- **Task menus:** Displays the task menus that are common to most pages in System Reliability: [Tools](#), [Navigation](#), and [Common Tasks](#).
- **Tabbed grid:** Appears at the top of the System Reliability Simulation Results workspace and contains detailed simulation results on three tabs:
 - **Elements grid:** Displays detailed simulation results for the components in the System Reliability Analysis.
 - **Actions grid:** Displays detailed simulation results for the Actions associated with the System Reliability Analysis.
 - **Resources grid:** Displays detailed simulation results for the Resources associated with the System Reliability Analysis.

- **Plots area:** Displays plots for the Scenario that is currently selected in the grid at the top of the workspace. As you select different cells in the grid, the plots will be updated to display information that is specific to that element. The following plots are displayed.
 - **[Histogram Plot](#):** Provides a visual representation of the frequency distribution of the result that appears in the grid.
 - **[Trend Plot](#):** Provides the average value for each analysis time interval, as defined by the value in the Time Analysis Type field in the root [System Analysis record](#), of the result that appears in the grid.
 - **[Impact Plot](#):** Provides the average values that are combined to make up the average value of the result that appears in the grid.

Note: If values that will affect the simulation results have been modified since the simulation was last run, a message will be displayed at the top of the page indicating that the simulation must be rerun. Whenever this message appears, we recommend that you rerun the simulation to ensure that valid results are displayed.

Tools Menu

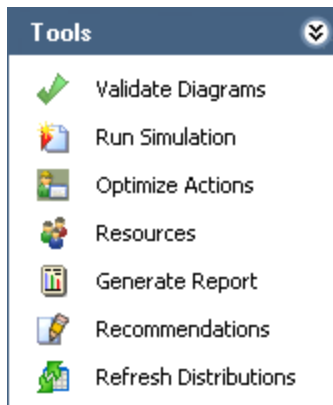

The **Tools** menu contains the following links:

- **Validate Diagrams:** [Evaluates the Diagrams](#) in the System Reliability Analysis and provides feedback on whether or not the Diagrams are valid. If any of the Diagrams are invalid, [detailed results](#) will be displayed on the **Diagram Validation Results** dialog box.
- **Run Simulation:** Validates the Diagrams in the System Reliability Analysis and, if the models are valid, shows the progress of the simulation and then displays the results on the [System Reliability Summary page](#). If the Diagram for any Scenario is invalid, detailed results will be displayed on the **Diagram Validation Results** dialog box and the simulation cannot run.
- **Optimize Actions:** Displays the **Multiple Action Interval Optimization** window, where you can [run a simulation to find the optimal interval to perform Actions](#) that have been assigned to a Scenario.
- **Resources:** Displays the **Resources** window, where you can [define Resources](#) for the System Reliability Analysis.
- **Generate Report:** Runs a report and displays the results on the **Report Viewer** page. If changes have been made to the System Reliability Analysis, you will be prompted to save your changes before the report results can be generated.
- **Recommendations:** Displays the **Recommendations** page, which shows the Reliability Recommendation records that are associated with the current System Reliability Analysis. If changes have been made to the System Reliability Analysis, you will be prompted to save your changes before the **Recommendations** page will be displayed.
- **Refresh Distributions:** After prompting you for confirmation, refreshes all the distribution data associated with the System Reliability Analysis by replacing the current TTF and TTR distributions with the most recently saved TTF and TTR distributions from the source distribution.

Navigation Menu

The **Navigation** menu contains links that allow you to navigate throughout the various views and elements of a System Reliability Analysis.

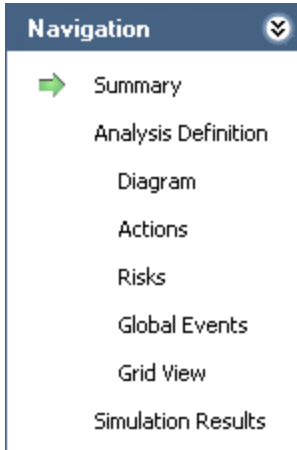

The **Navigation** menu contains the following links:

- **Summary:** Displays the [System Reliability Summary page](#).
- **Analysis Definition:** Displays the [System Reliability Analysis Definition page](#).
 - **Diagram:** Displays the [System Reliability Scenarios - Diagram page](#).
 - **Actions:** Displays the [System Reliability Scenarios - Actions page](#).
 - **Risks:** Displays the [System Reliability Scenarios - Risks page](#).
 - **Global Events:** Displays the [System Reliability Scenarios - Global Events page](#).
 - **Grid View:** Displays the [System Reliability Scenarios - Grid page](#).
- **Simulation Results:** Displays the [System Reliability Simulation Results page](#).

Note: As you navigate through pages that are accessible from the **Navigation** menu, keep in mind that clicking the **Back** button will take you to the page you were on immediately before you accessed the current System Reliability Analysis. For example, if you open a System Reliability Analysis from the **Select a System Reliability Analysis from the List** page, causing the **System Reliability Summary** page to be displayed, if you then navigate to the **System Reliability Analysis Definition** page and then click the **Back** button, the **Select a System Reliability Analysis from the List** page will be displayed, not the **System Reliability Summary** page.

Common Tasks Menu

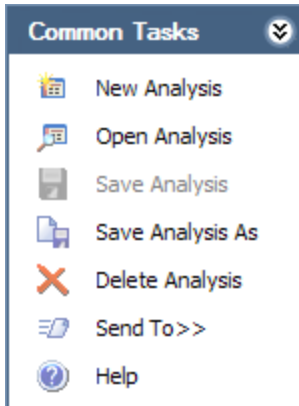

The **Common Tasks** menu contains the following links:

- **New Analysis:** Displays the **System Reliability Analysis Definition** page, where you can begin the [process of creating a new System Reliability Analysis](#).
- **Open Analysis:** Displays the **Find Items** window, which you can use to find and open an existing System Reliability Analysis.
- **Save Analysis:** Saves all changes that you have made to the current System Reliability Analysis. This link is enabled only if the analysis contains unsaved changes.
- **Save Analysis As:** Displays the **Save Analysis As** dialog box, where you can choose to [save the current analysis with a different name](#). This will create a copy of the current analysis with the new name.
- **Delete Analysis:** After asking for confirmation, deletes the current analysis and then displays the **Select a System Reliability Analysis from the List** page.
- **Send To:** Displays a submenu with options that let you provide a link to the current page on your desktop (create shortcut), in an email message, or on a Home Page.
- **Help:** Displays the context-sensitive Help topic for the current page.

Datasheets in System Reliability Analyses

In a System Reliability Analysis, the content of many of the windows and panes is driven by custom-layout datasheets. In most cases, however, the datasheet toolbar is not displayed, so it is not obvious which datasheet you are viewing.

The following table, therefore, lists the items whose content is controlled by a custom-layout datasheet, the datasheet that controls the content, and the family for which the datasheet is defined.

Item	Datasheet	Family
Analysis Parameters pane	System Analysis	System Analysis
Add New Scenario window	System Scenario	System Scenario
New Inspection window	System Inspection	System Inspection
New Preventive Maintenance window	System Preventive Maintenance	System Preventive Maintenance
New Condition Monitor window	System Condition Monitor	System Condition Monitor
New Special Action window	System Special Action	System Special Action
Add New Risk window	System Risk	System Risk
New Global Event window	System Global Event	System Global Event
Add New Resource window	System Resource	System Resource

About Saving System Reliability Analyses

A System Reliability Analysis consists of multiple records that are linked together to make up the entire analysis. As you navigate through the pages in System Reliability, you will add and modify records belonging to the analysis. Rather than saving these records individually, you will need to save the entire analysis in order to retain the changes that you have made to individual records.

You can save a System Reliability Analysis by clicking the **Save Analysis** link on the [Common Tasks menu](#) on any page in System Reliability. Clicking this link will save the root System Analysis record and ALL records that are linked to it, either directly or indirectly. In other words, when you save a System Reliability Analysis, the following analysis components will also be saved:

- Scenarios
- Diagrams
- Resources
- Risks
- Actions
- Global Events
- Simulation Results

If you make changes to any of the components in the preceding list and do not save the analysis, your changes will be discarded. You will know that the analysis contains unsaved changes if the **Save Analysis** link is enabled on the [Common Tasks menu](#). Additionally, when you navigate away from System Reliability, if the analysis contains unsaved changes, you will be prompted to save those changes.

About Deleting Components in System Reliability Analyses

A System Reliability Analysis consists of multiple records that are linked together to make up the entire analysis. These records represent components in the analysis. As you navigate through the pages in System Reliability, you can manage the components that belong to an analysis, including adding, modifying, and deleting components.

Note: If you delete a Scenario, any components or elements that are linked to that Scenario will be deleted. If you delete an Asset or Switch element, the Actions and Risks that are associated with that element are deleted as well. If you delete a Resource, any linked System Resource Usage records will be deleted as well.

Any of the following components can be deleted from an analysis:

- Scenarios
- Elements
- Resources
- Risks
- Actions
- Global Events

When you delete a component from a System Reliability Analysis, that component will be *removed* from the grid or pane in which it is displayed, but the record that stores the information about the component will not be deleted from the database until you save the analysis. In other words, when you delete a component from an analysis, it is considered an unsaved change. The record that represents the component in the analysis will only be deleted if you save the change. If you delete a component and do not save the analysis, your deletion will be discarded.

Note: You will know that the analysis contains unsaved changes, which may include deletions, if the **Save Analysis** link is enabled on the [Common Tasks menu](#). Additionally, when you navigate away from System Reliability, if the analysis contains unsaved changes, you will be prompted to save those changes.

Creating a New System Reliability Analysis

Developing a System Reliability Analysis consists of multiple steps, as defined in the System Reliability Analysis workflow. In this topic, we provide details on performing the first step in the process.

To begin the process of creating a new System Reliability Analysis:

- On the **Select a System Reliability Analysis from the List** page, on the **Common Tasks** menu, click the **New Analysis** link.

The [System Reliability Analysis Definition page](#) appears, displaying a new analysis. From here, you can complete the process of building a new analysis.

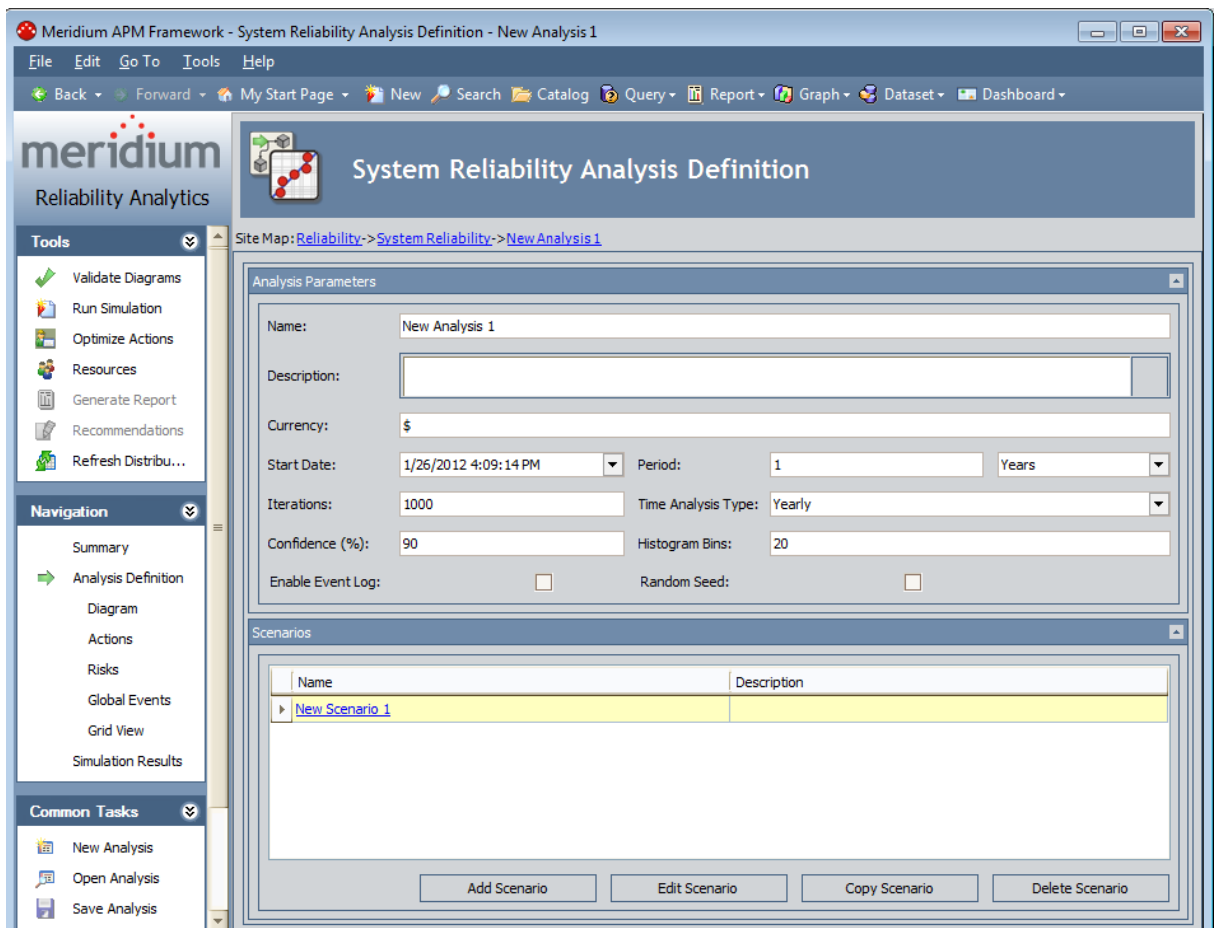

Defining Analysis Parameters

The parameters of a System Reliability Analysis are defined in a [System Analysis record](#), which is the root record in the analysis. The values that you define for the analysis parameters will serve as inputs to the simulation and will affect the simulation results. You can modify the analysis parameters and rerun the simulation to see the effect that they have on the results.

To define the analysis properties:

- On the **System Reliability Analysis Definition** page, in the **Analysis Parameters** pane, specify the desired values for the available fields.

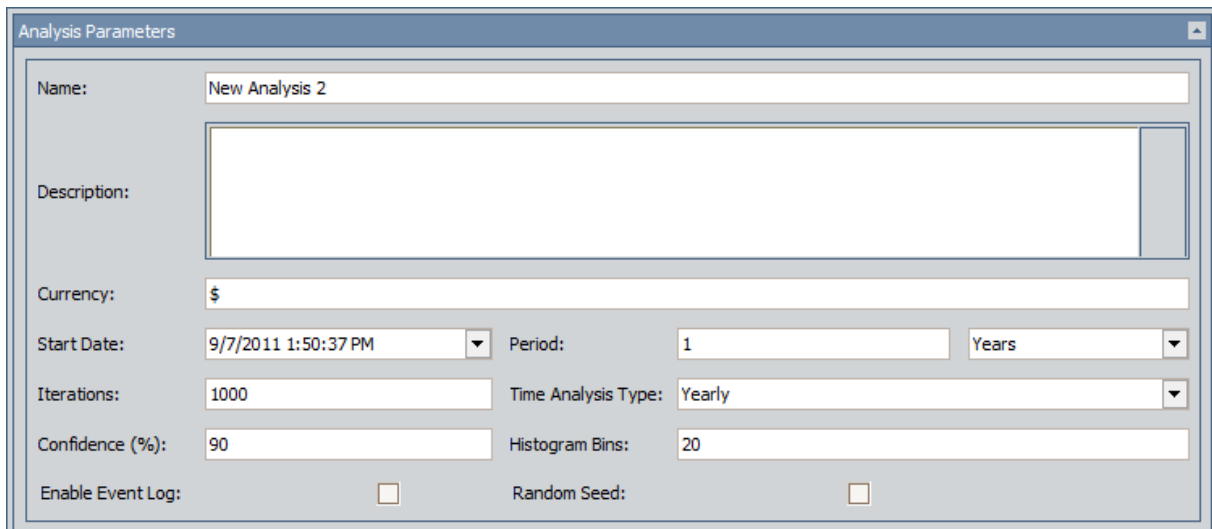

The screenshot shows a dialog box titled "Analysis Parameters" with the following fields and values:

Name:	New Analysis 2		
Description:			
Currency:	\$		
Start Date:	9/7/2011 1:50:37 PM	Period:	1 Years
Iterations:	1000	Time Analysis Type:	Yearly
Confidence (%):	90	Histogram Bins:	20
Enable Event Log:	<input type="checkbox"/>	Random Seed:	<input type="checkbox"/>

After you have defined the desired parameters, you can [save your changes](#) or [run the simulation](#) to see the effect of the changes you made.

Workflow for Developing a Scenario

To develop a Scenario, you must complete the following steps:

1. [Create a System Scenario record](#).
2. [Develop a Diagram for the Scenario](#).

After you have created the Diagram, you can [add Risks](#), [Actions](#), and [Global Events](#) to the Scenario, if desired.

Creating System Scenario Records

Creating a [System Scenario record](#) is the first step in the process of [developing a Scenario](#).

Note: When you create a new System Reliability Analysis, one System Scenario record will be created automatically and identified by the value *New Scenario 1* in the Name field. You can [modify the Scenario](#) and include it in your System Reliability Analysis, or you can [delete the Scenario](#) and create a new one. Each System Reliability Analysis must contain at least one Scenario.

To create a new System Scenario record:

1. [Access the System Reliability Analysis Definition page](#) for the System Reliability Analysis for which you want to create a new Scenario.
2. In the **Scenarios** section, below the grid, click the **Add Scenario** button.

The **Add New Scenario** dialog box appears.

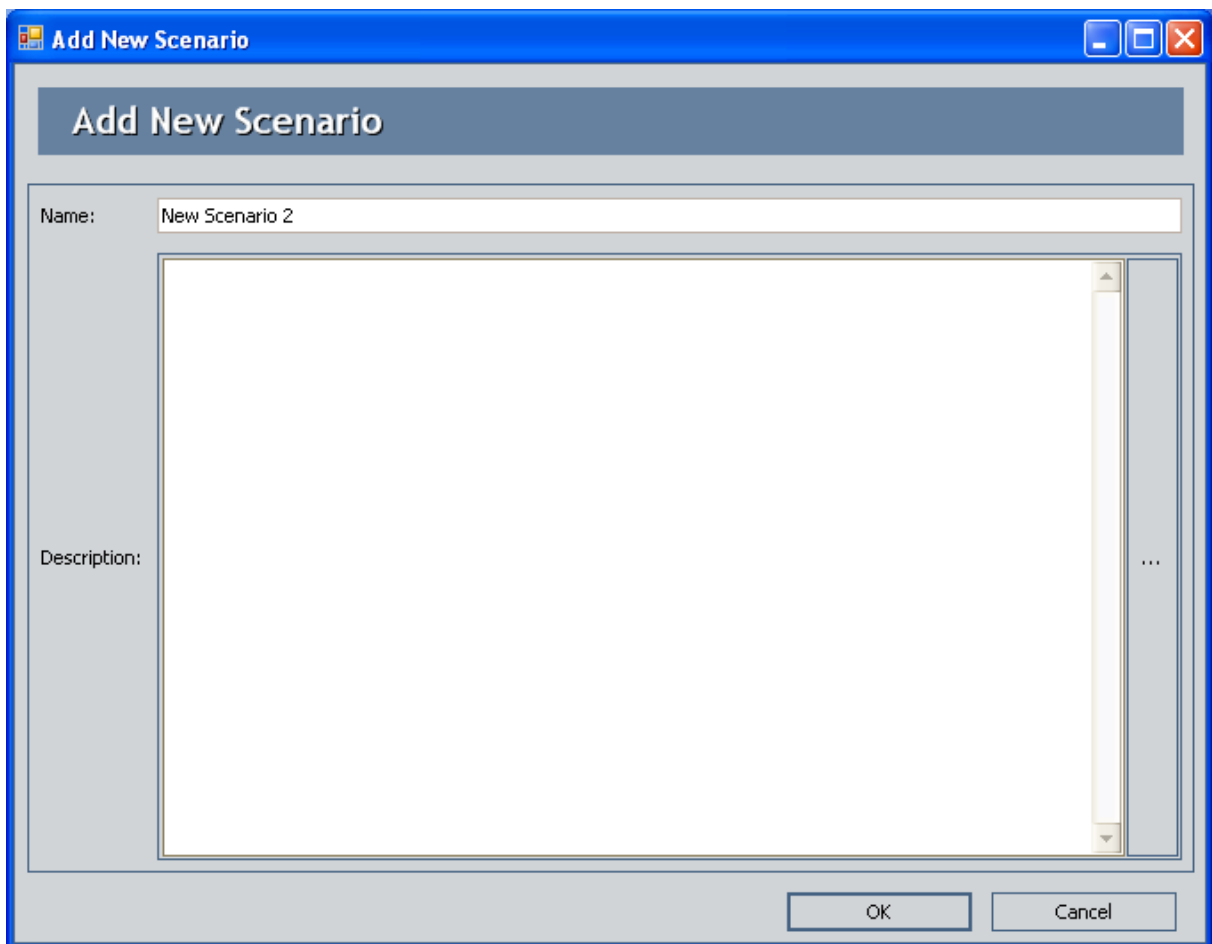

The screenshot shows a standard Windows-style dialog box titled "Add New Scenario". The dialog has a blue title bar with the text "Add New Scenario" and standard window control buttons (minimize, maximize, close). The main content area has a dark blue header with the text "Add New Scenario" in white. Below the header, there is a "Name:" label followed by a text input field containing the text "New Scenario 2". Below the name field is a large, empty text area for the "Description:". At the bottom of the dialog, there are two buttons: "OK" and "Cancel".

Creating System Scenario Records

The content of the **Add New Scenario** dialog box is controlled by the default data-sheet defined for the System Scenario family.

3. [Define the properties of the System Scenario record as desired.](#)
4. Click **OK**.

The System Scenario record is created, and the [System Reliability Scenarios - Diagram page](#) appears so that you can begin building a Diagram for the Scenario.

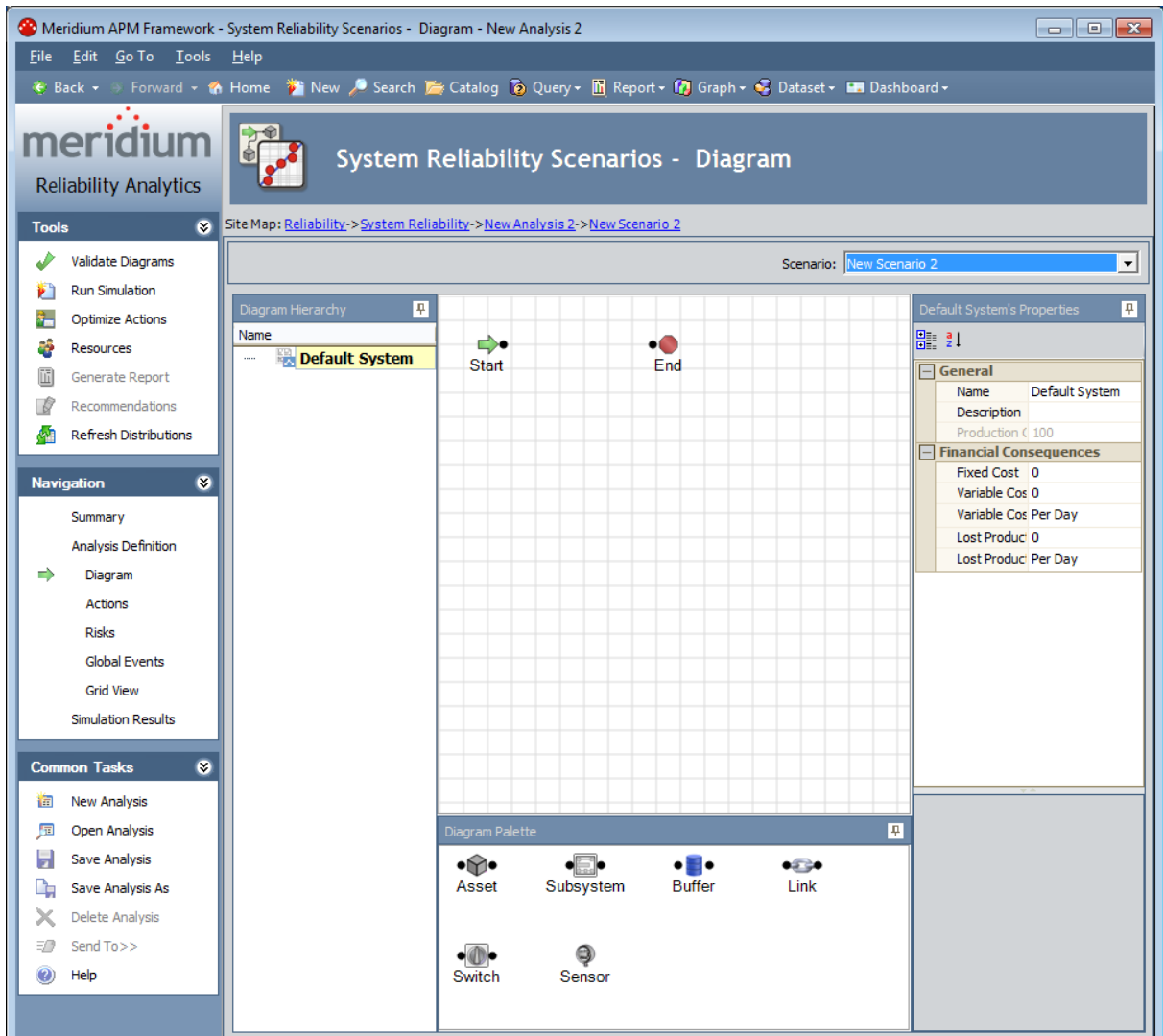

Creating Copies of System Scenario Records

When you create a copy of a Scenario, you are copying the System Scenario record itself and all the components that are included in that Scenario (e.g., all Sensor elements, Switch elements, and Asset elements).

To copy a Scenario:

1. [Access the System Reliability Analysis Definition page](#) for the System Reliability Analysis containing the Scenario that you want to copy.
2. In the grid within the **Scenarios** section, select the row containing the System Scenario record that you want to copy.
3. Click the **Copy Scenario** button.

The Scenario is copied and appears in the grid in the **Scenarios** section with the value **Copy of <Scenario Name>** in the Name column, where **<Scenario Name>** is the name of the System Scenario record that you copied.

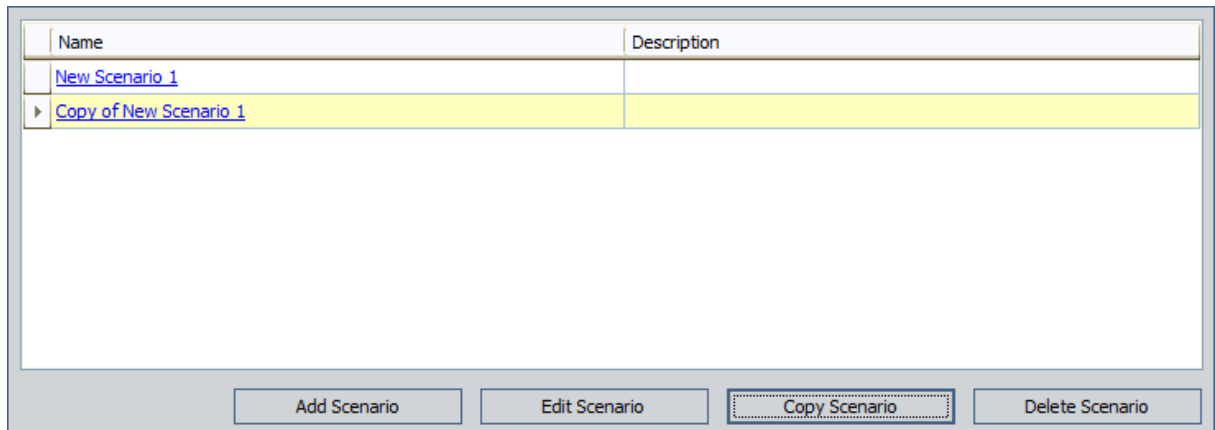

Modifying System Scenario Records

To modify a System Scenario record:

1. [Access the System Reliability Analysis Definition page](#) for the System Reliability Analysis containing a Scenario that you want to modify.
2. In the grid within the **Scenarios** section, select the row containing the System Scenario record that you want to modify.
3. Click the **Edit Scenario** button.

The **<Scenario Name>** dialog box appears, where **<Scenario Name>** is the value in the Name field of the System Scenario record that you selected. The content of this dialog box is controlled by the default datasheet defined for the System Scenario family.

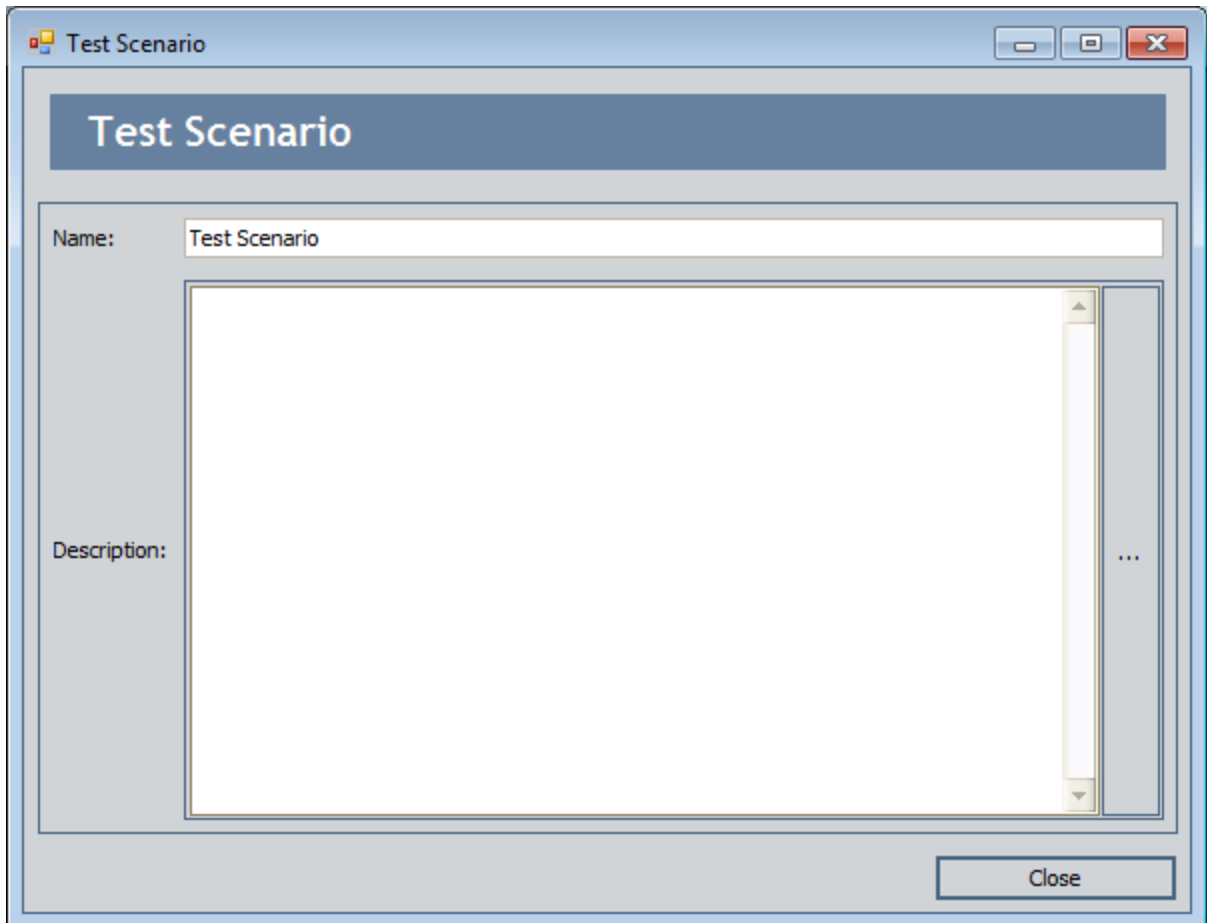

The screenshot shows a dialog box titled "Test Scenario". The dialog has a header bar with the text "Test Scenario". Below the header, there is a "Name:" label followed by a text input field containing "Test Scenario". Below the name field, there is a "Description:" label followed by a large, empty text area with a vertical scrollbar on the right side. At the bottom right of the dialog, there is a "Close" button.

4. [Modify the properties of the System Scenario record as desired.](#)
5. Click **OK**.

Your changes are applied.

Deleting System Scenario Records

Deleting a Scenario from a System Reliability Analysis will delete the System Scenario record and all Diagrams that are associated with it.

To delete a Scenario from a System Reliability Analysis:

1. [Access the System Reliability Analysis Definition page](#) for the System Reliability Analysis containing a Scenario that you want to delete.
2. In the grid within the **Scenarios** section, select the row containing the scenario that you want to delete.
3. Click the **Delete Scenario** button.
A confirmation message appears, asking if you really want to delete the Scenario.
4. Click the **Yes** button.
The Scenario is removed from the grid in the **Scenarios** section.

About Building Diagrams



A Diagram represents one option for the physical layout and construction of a system. A Diagram consists of a root System Subsystem record, which is linked to System Subsystem, System Sensor, System Buffer, System Link, System Asset, and System Switch records that together make up the Diagram.



When you create a System Scenario record, a System Subsystem record is created automatically and linked to the System Scenario record. Therefore, after you have created a Scenario, there is no manual step required for *creating* a Scenario Diagram. You simply must *build* out the Scenario Diagram by adding the necessary elements and connections.







You can view and build a Diagram on the [System Reliability Scenarios - Diagram page](#). You can also view the elements of a Diagram on the [System Reliability Scenarios - Grid page](#).

Elements of a Diagram

The following table lists the elements that are available in a Diagram and the associated records that are created automatically in the Meridium APM database when you add each element to the Diagram.

Icon	Element	Record	Description
	Start	None	Represents the starting point for all paths in the Diagram. This element is created by default when you create a new Diagram. You cannot enter data for this element in the Properties grid because no record is associated with this element.
	End	None	Represents the ending point for all paths in the Diagram. This element is created by default when you create a new Diagram. You cannot enter data for this element in the Properties grid because no record is associated with this element.
	Asset	System Asset	Represents a piece of equipment or location in the system. An Asset element can either be imported from an Equipment or Functional Location record that exists within the Meridium APM database, or it can be created from scratch .

Icon	Element	Record	Description
	Buffer	System Buffer	<p>Represents an intermediate storage container between two other elements. For example, consider Scenario A in our System Reliability Analysis Example <i>without</i> a Water Tank element. The Water Pump produces output (water) that is fed into the Bottling Subsystem. If the Water Pump were to fail, the Bottling Subsystem would not receive any input (water) and the entire system would fail. Similarly, if the Bottling Subsystem were to fail, then the output of the Water Tank would have nowhere to go, and the entire system would fail.</p> <p>Alternatively, and as is constructed in the Scenarios in our System Reliability Analysis Example, a Buffer element (Water Tank) is inserted between the Water Pump and the Bottling Subsystem. If the Water Pump were to fail, the Bottling Subsystem could continue to function as long as input (water) was available from the Water Tank. If the Bottling Subsystem were to fail, the Water Tank could serve as storage for output (water) until the Bottling Subsystem could be restored or until the Water Tank could accept no more additional output. In either case, a failure of the entire system could be avoided or minimized.</p>
	Link	System Link	<p>Connects other elements that work together to produce output. For example, consider the Bottling Subsystem in our System Reliability Analysis Example. Each of the three Bottling Lines produces bottles filled with water. In the Link element, the Bottling Lines combine their respective outputs into one stream of output for further use beyond our example. A Link represents the "hub" where the outputs of equipment and locations meet before connecting to the rest of the Diagram.</p>

Icon	Element	Record	Description
	Sensor	System Sensor	<p>Detects the failure of a piece of equipment or location and notifies Switches of the failure. A Sensor cannot be connected to any other elements in the Diagram. If an Asset element in the Diagram fails, the Sensor that is monitoring that element will activate designated Switches to start elements running and deactivate other Switches to put other elements in standby. If the Asset element is deleted from the Diagram, then the connection between the Asset element and the Sensor will be deleted as well.</p> <p>For example, consider Scenario C in our System Reliability Analysis Example. Sensor 1 monitors Water Tank 1 for failures. When a failure is detected, Sensor 1 deactivates Switch 1, which deactivates the failed Water Tank 1, and activates Switch 2, which activates the available Water Tank 2.</p>
	Switch	System Switch	<p>Represents a component that is activated or deactivated by a Sensor when a failure occurs. Switches allow you to connect or disconnect an entire branch of the Diagram when failures are detected.</p> <p>For example, consider Scenario C in our System Reliability Analysis Example. Switch 1 is deactivated by Sensor 1 when a failure of Water Pump 1 is detected.</p>
 	Subsystem	System Subsystem	<p>Represents an entire system of equipment and locations. You can build Subsystems within other Subsystems within the main Diagram to model production units. For each Diagram:</p> <ul style="list-style-type: none"> The root Subsystem, like <i>Diagram for Scenario A</i> in Scenario A, is represented by this icon:  Other Subsystem elements, like the Bottling Line in all of the scenarios in the System Reliability Analysis Example, are represented by this icon: 

Accessing the Diagram Associated with a Scenario

To access the Diagram associated with a Scenario:

1. [Access the System Reliability Analysis Definition page](#) for the System Reliability Analysis containing the Scenario whose Diagram you want to access.
2. In the grid in the **Scenarios** section, click the hyperlinked name of the Scenario whose Diagram you want to access.

The [System Reliability Scenarios - Diagram page](#) appears.

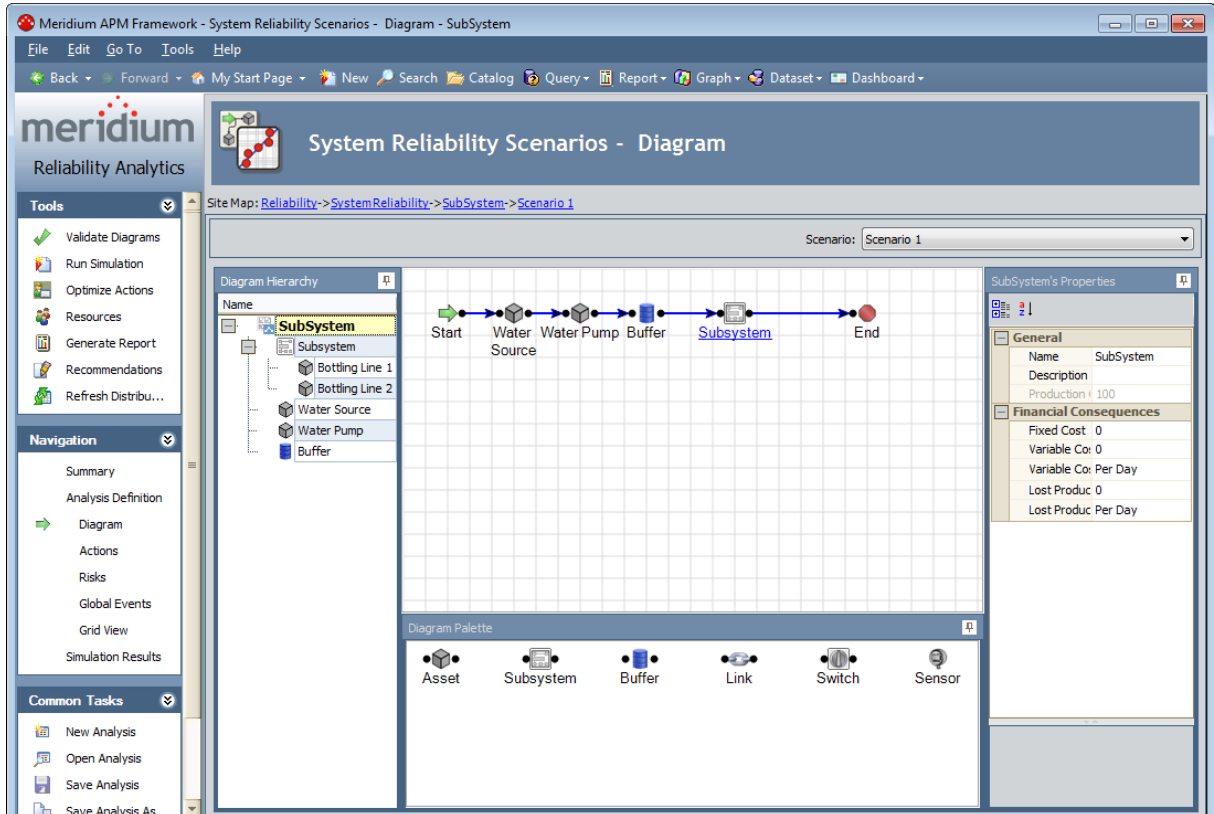

Options Available on the Diagram Canvas

The Diagram Canvas on the **System Reliability Scenarios - Diagram** page is the main area that you will use for building a Diagram. When the Diagram is complete, the Diagram Canvas will contain a visual representation of the elements and connections in the physical system. The Diagram is interactive and can be modified using tools that are available on the Diagram Canvas itself, including the following features.

Drag-and-Drop

Click any element on the Diagram Canvas to make a green box appear around it, then hold your mouse button down, and drag the element to the desired location.

Shortcut Menu

Right-click any blank area on the Diagram Canvas to see the following menu:

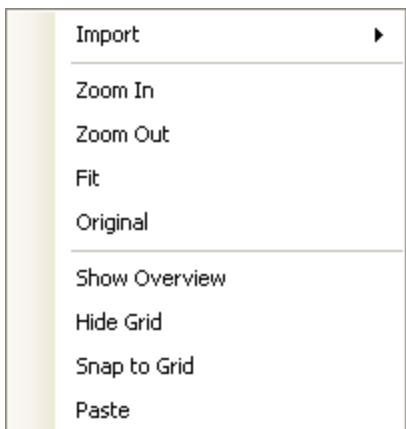

The shortcut menu contains the following options:

- **Import:** Displays a submenu with the following options:
 - **Reliability Growth:** Displays the **Find Items** window, which you can use to search for a Reliability Growth Analysis to import into the Diagram.
 - **Reliability Distribution:** Displays the **Find Items** window, which you can use to search for a Reliability Distribution Analysis to import into the Diagram.
 - **Asset:** Displays the **Find Items** window, which you can use to search for an existing record to import into the Diagram.
 - **Subsystem:** Displays the **Find Items** window, which you can use to search for a System Subsystem record to import into the Diagram.
- **Zoom In:** Zooms in on the Diagram by 10 percent of the current zoom level.
- **Zoom Out:** Zooms out from the Diagram by 10 percent of the current zoom level.
- **Fit:** Fits the entire Diagram within the space available on the Diagram Canvas.
- **Original:** Returns the Diagram to the original zoom level, which is the zoom level

that is shown when you first access the [System Reliability Scenarios - Diagram page](#).

- **Show Overview:** Opens the [Overview](#) window.
- **Hide Grid:** Removes the grid lines from the Diagram Canvas. This option appears on the menu only when the grid lines are displayed.

Note: When the grid lines are hidden, the **Hide Grid** option is replaced by the **Show Grid** option. This option will display the grid lines on the Diagram Canvas.

- **Snap to Grid:** Allows you to position elements only at intersections. In other words, you will not be able to position elements between lines. This option appears on the menu only when the grid lines are displayed.
- **Paste:** Pastes the element that was last copied. This option appears on the menu only when an element has been copied.

Right-click any element on the Diagram Canvas to see options available for that element:

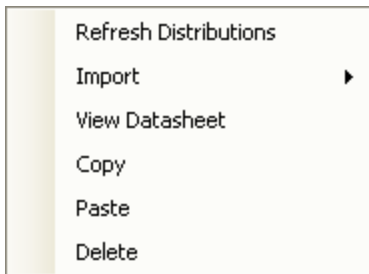

The shortcut menu contains the following options:

- **Refresh Distributions:** Refreshes the distribution data for the selected element by importing the most current information from the associated Reliability Distribution Analysis or Reliability Growth Analysis.
- **Import:** Displays a submenu with the following options:
 - **Reliability Growth:** Displays the **Find Items** window, which you can use to search for a Reliability Growth Analysis to import.
 - **Reliability Distribution:** Displays the **Find Items** window, which you can use to search for a Reliability Distribution Analysis to import.

Note: The **Import** option appears on the shortcut menu only when you select an Asset or Subsystem element.

- **View Datasheet:** Displays the datasheet associated with the currently selected record. This menu option appears only when you right-click an imported element.
- **Copy (Ctrl+C):** Creates a copy of the selected element.
- **Paste (Ctrl+V):** Pastes the element that was last copied.
- **Delete (Delete):** Deletes the selected element from the Diagram.

Note: When you select a connection, **Delete** is the only available option. When you select the Start or End element, NO options will appear on the shortcut menu.

Displaying an Overview of the Diagram

If the Diagram you are currently viewing exceeds the size of the Diagram Canvas on the **System Reliability Scenarios - Diagram** page, you can use the overview feature to display a more compact view of the Diagram.

To display an overview of a Diagram:

1. Right-click any blank space on the Diagram Canvas.
2. Click **Show Overview**.

The **Overview** window appears, displaying a blue locator box that highlights the section of the Diagram that is currently shown on the Diagram Canvas.

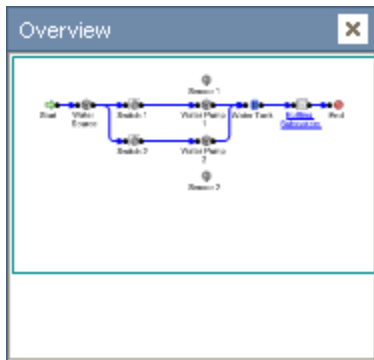

You can click another location within the **Overview** window to move the locator box to that location. As you do so, the view on the Diagram Canvas will change to reflect your location within the Diagram on the **Overview** window.

Overview of the Properties Pane

The **Properties** pane lets you view and modify the properties of the element that is currently selected on the [Diagram Canvas](#). The header text of the **Properties** pane will indicate which element is selected by showing **<Name>'s Properties**, where **<Name>** is the value in the Name field of the record that is associated with the selected element. For example, in the following image, the value in the Name field is *Asset*, so the **Properties** pane is titled *Asset's Properties*. Throughout this documentation, we refer to this area of the screen generically as the **Properties** pane.

The screenshot shows the 'Asset's Properties' pane with the following sections and data:

General	
Name	Asset
Description	
Production Contribution	100

Financial Consequences	
Fixed Cost	0
Variable Cost	0
Variable Cost Units	Per Day
Lost Production Cost	0
Lost Production Cost Un	Per Day

Actions	
Number of Actions	0

Risks	
Number of Risks	1

Distributions	
[-] TTF Distribution TTF Distribution	
Name	TTF Distribution
Description	
Distribution Type	Exponential
Time Unit	Days
MTBF	Infinity
[-] TTR Distribution TTR Distribution	
Name	TTR Distribution
Description	
Distribution Type	Exponential
Time Unit	Days
MTRR	0

Reference Data	
Equipment Type	

Description
Description of the currently selected element.

The **Properties** pane contains multiple rows, where most of the rows represent fields in the record that is associated with the selected element. For each row, you will see a label on the left and a text box on the right. The label on the left is the field caption, and the value in the text box is the value in that field.

For example, in the following image, you can see that in this row, the label is *Name*, and the value in the text box is *Asset*.

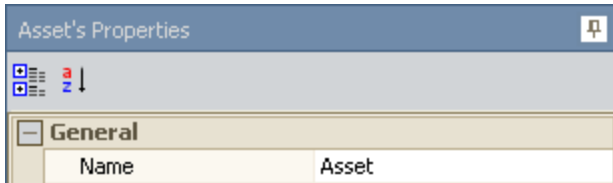

You can conclude, therefore, that in the record that is associated with the selected element, the value in the *Name* field is *Asset*.

You can view the fields in the **Properties** pane in one of two ways:

- Alphabetically, where the fields are listed in ascending alphabetic order according to the text box label. To view the fields alphabetically, you can click the  button. The following image shows the **Properties** pane where the fields are listed alphabetically.

Overview of the Properties Pane

Asset's Properties	
Description	
Equipment Type	
Fixed Cost	0
Lost Production Cost	0
Lost Production Cost Units	Per Day
Name	Asset
Number of Actions	0
Number of Risks	1
Production Contribution	100
<input type="checkbox"/> TTF Distribution	TTF Distribution
Name	TTF Distribution
Description	
Distribution Type	Exponential
Time Unit	Days
MTBF	Infinity
<input type="checkbox"/> TTR Distribution	TTR Distribution
Name	TTR Distribution
Description	
Distribution Type	Exponential
Time Unit	Days
MTTR	0
Variable Cost	0
Variable Cost Units	Per Day

Description
Description of the currently selected element.

- Categorically, where the fields are listed under category headings. To view the fields categorically, you can click the  button. Each category can be collapsed by clicking the minus sign (-) or expanded by clicking the plus sign (+). The following image shows the **Properties** pane where the fields are listed categorically.

Overview of the Properties Pane

The screenshot shows the 'Asset's Properties' pane with the following sections:

- General**
 - Name: Asset
 - Description: (highlighted)
 - Production Contribution: 100
- Financial Consequences**
 - Fixed Cost: 0
 - Variable Cost: 0
 - Variable Cost Units: Per Day
 - Lost Production Cost: 0
 - Lost Production Cost Un: Per Day
- Actions**
 - Number of Actions: 0
- Risks**
 - Number of Risks: 1
- Distributions**
 - TTF Distribution**
 - Name: TTF Distribution
 - Description:
 - Distribution Type: Exponential
 - Time Unit: Days
 - MTBF: Infinity
 - TTR Distribution**
 - Name: TTR Distribution
 - Description:
 - Distribution Type: Exponential
 - Time Unit: Days
 - MTTR: 0
- Reference Data**
 - Equipment Type:

Description
Description of the currently selected element.

Note: If you select an Asset in the Diagram Canvas that has more than one System Risk or System Action record associated with it, the **Distributions** category does not appear.

The **Properties** pane works much like a standard datasheet, where you can place your cursor in a text box and then modify the value in the associated field. If a value already exists in a field, it will be displayed in the appropriate text box. At the bottom of the **Properties** pane, any help text that is defined for the selected field will be displayed. For

example, in the following image, the help text that is defined for the Description field is *Description of the currently selected element.*

The screenshot shows a software interface titled "Asset's Properties". It contains several expandable sections:

- General**: Name (Asset), Description (highlighted), Production Contribution (100).
- Financial Consequences**: Fixed Cost (0), Variable Cost (0), Variable Cost Units (Per Day), Lost Production Cost (0), Lost Production Cost Un (Per Day).
- Actions**: Number of Actions (0).
- Risks**: Number of Risks (1).
- Distributions**:
 - TTF Distribution**: Name (TTF Distribution), Description, Distribution Type (Exponential), Time Unit (Days), MTBF (Infinity).
 - TTR Distribution**: Name (TTR Distribution), Description, Distribution Type (Exponential), Time Unit (Days), MTRR (0).
- Reference Data**: Equipment Type.

Below the main pane, a separate box displays the help text for the "Description" field: **Description**
Description of the currently selected element.

About Fields Displayed in the Properties Pane

Different fields are displayed in the **Properties** pane depending upon the element that is selected on the Diagram Canvas. When you select an element, the **Properties** pane will display the fields that belong to the record that is associated with the selected element. You can select any of the following elements to view the fields in the associated record in the **Properties** pane:

- [Asset](#)
- [Buffer](#)
- [Link](#)
- [Sensor](#)
- [Subsystem](#)
- [Switch](#)

Asset Fields

When you select an Asset on the Diagram Canvas, the **Properties** pane displays information related to that Asset. The following table lists:

- The row labels that are displayed in the **Properties** pane when you select an Asset on the Diagram Canvas. The table is organized by the categories that are displayed when you view the **Properties** pane in a *categorized* view.

Note: In the table, the **Distributions** category displays in alphabetical order ALL of the fields that can be displayed in the **Distributions** category in the **Properties** pane. In some cases, depending upon which Asset you select on the Diagram Canvas, not all of these fields will appear in the **Properties** pane. You can use the **Notes** column in the table to view any exceptions.

- The family caption of the family containing the record whose value is displayed in that row. Note that if the value in a row is not stored in a record, the table contains the following text: *This row does not display values from a record.*
- The field caption of the field whose value is displayed in that row. Note that if the value in a row is not stored in a field, the table contains the following text: *This row does not display any values from a field.*
- Notes that provide more information about the value in a row.

Row Label	Record	Field	Notes
General			
Name	System Asset	Name	None
Description	System Asset	Description	None
Production Contribution	System Asset	Production Contribution	None
Financial Consequences			
Fixed Cost	System Asset	Fixed Cost	None
Variable Cost	System Asset	Variable Cost	None
Variable Cost Units	System Asset	Variable Cost Units	None
Lost Production Cost	System Asset	Lost Production Cost	None
Lost Production Cost Units	System Asset	Lost Production Cost Units	None

Row Label	Record	Field	Notes
Actions			
Number of Actions	This row does not display values from a record.	This row does not display values from a field.	This row displays the number of System Action records that are linked to the selected System Asset record. When you click inside the Number of Actions cell, the  button appears, which you can click to display the Action Editor window , where you can create, modify, or delete System Action records that are linked to the System Asset record.
Risks			

Row Label	Record	Field	Notes
Number of Risks	This row does not display values from a record.	This row does not display values from a field.	This row displays the number of System Risk records that are linked to the selected System Asset record. When you click inside the Number of Risks cell, the  button appears, which you can click to display the Risk Editor window , where you can create, modify, or delete System Risk records that are linked to the System Asset record.
Distributions 1			
Beta	Weibull	Beta	This row appears only when the selected System Asset record is linked to a System Risk record that is linked to a Distribution record whose Distribution Type is Weibull.

Row Label	Record	Field	Notes
Distribution Type	Distribution	Distribution Type	The row displays a list containing the available selections for the distribution types for the Distribution record that is linked to the selected System Asset record. The list contains the following values: Exponential, Lognormal, Normal, SingleValue, and Weibull.
Eta	Weibull	Eta	This row appears only when the selected System Asset record is linked to a System Risk record that is linked to a Distribution record whose Distribution Type is Weibull.
Gamma	Lognormal	Gamma	This row appears only when the selected System Asset record is linked to a System Risk record that is linked to a Distribution record whose Distribution Type is Lognormal.

Row Label	Record	Field	Notes
Gamma	Weibull	Gamma	This row appears only when the selected System Asset record is linked to a System Risk record that is linked to a Distribution record whose Distribution Type is Weibull.
Mean	Normal	Mean	This row appears only when the selected System Asset record is linked to a System Risk record that is linked to a Distribution record whose Distribution Type is Normal.
MTBF	Exponential	MTBF	This row appears only when the selected System Asset record is linked to a System Risk record that is linked to a Distribution record whose Distribution Type is Exponential.

Row Label	Record	Field	Notes
MTTR	Exponential	MTBF	This row appears only when the selected System Asset record is linked to a System Risk record that is linked to a Distribution record whose Distribution Type is Exponential.
Mu	Lognormal	Mu	This row appears only when the selected System Asset record is linked to a System Risk record that is linked to a Distribution record whose Distribution Type is Lognormal.
Name	Exponential, Lognormal, Normal, SingleValue, or Weibull	Name	None
Sigma	Lognormal	Sigma	This row appears only when the selected System Asset record is linked to a System Risk record that is linked to a Distribution record whose Distribution Type is Lognormal.

Row Label	Record	Field	Notes
Standard Deviation	Normal	Standard Deviation	This row appears only when the selected System Asset record is linked to a System Risk record that is linked to a Distribution record whose Distribution Type is Normal.
Time Unit	Exponential, Lognormal, Normal, SingleValue, or Weibull	Units	None
Value	Normal	Value	This row appears only when the selected System Asset record is linked to a System Risk record that is linked to a Distribution record whose Distribution Type is SingleValue, whose distribution data is stored in a Normal record.
Reference Data			
Equipment Type	System Asset	Equipment Type	None

The following image shows the categorized view of the **Properties** pane that would be displayed if you selected the Water Source element in Scenario A.

Water Source's Properties	
General	
Name	Water Source
Description	
Production Contribution	100
Financial Consequences	
Fixed Cost	0
Variable Cost	0
Variable Cost Units	Per Day
Lost Production Cost	0
Lost Production Cost Units	Per Day
Actions	
Number of Actions	0
Risks	
Number of Risks	1
Distributions	
TTF Distribution	
Name	TTF Distribution
Description	
Distribution Type	Exponential
Time Unit	Years
MTBF	20
TTR Distribution	
Name	TTR Distribution
Description	
Distribution Type	Exponential
Time Unit	Weeks
MTTR	2
Reference Data	
Equipment Type	

Buffer Fields

When you select a Buffer on the Diagram Canvas, the **Properties** pane displays information related to that Buffer. The following table lists:

- The row labels that are displayed in the **Properties** pane when you select a Buffer on the Diagram Canvas. The table is organized by the categories that are displayed when you view the **Properties** pane in a *categorized* view.
- The field caption of the field in the associated System Buffer record whose value is displayed in that row.

Row Label	System Buffer Field
General	
Name	Name
Description	Description
Production Contribution	Production Contribution
Buffer	
Initial Quantity in Percentage	Initial Quantity in Percentage
Time to Empty	Time to Empty
Time to Empty Units	Time to Empty Units
Time to Refill	Time to Refill
Time to Refill Units	Time to Refill Units

The following image shows the categorized view of the **Properties** pane that would be displayed if you selected the Water Tank element in Scenario A.

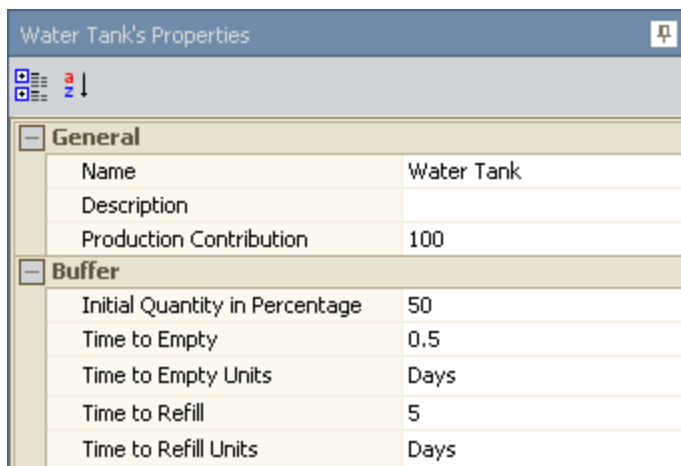

Link Fields

When you select a Link on the Diagram Canvas, the **Properties** pane displays information related to that Link. The following table lists:

- The row labels that are displayed in the **Properties** pane when you select a Link on the Diagram Canvas. The table is organized by the categories that are displayed when you view the **Properties** pane in a *categorized* view.
- The field caption of the field in the associated record whose value is displayed in that row.

Row Label	System Link Field
General	
Name	Name
Description	Description
Minimum Predecessors	Minimum Predecessors

The following image shows the categorized view of the **Properties** pane that would be displayed if you selected the Link element in Scenario A.

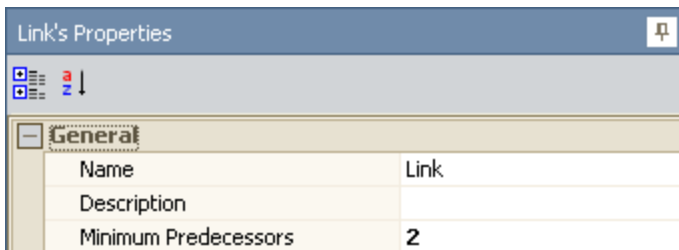

Sensor Fields

When you select a Sensor on the Diagram Canvas, the **Properties** pane displays information related to that Sensor. The following table lists:

- The row labels that are displayed in the **Properties** pane when you select a Sensor on the Diagram Canvas. The table is organized by the categories that are displayed when you view the **Properties** pane in a *categorized* view.
- The field caption of the field in the associated System Sensor record whose value is displayed in that row.

Row Label	System Sensor Field
General	
Name	Name
Description	Description
Detail	
Monitored Elements	Monitored Elements
Deactivated Switches	Deactivated Switches
Activated Switches	Activated Switches

The following image shows the categorized view of the **Properties** pane that would be displayed if you selected the Sensor 1 element in Scenario C.

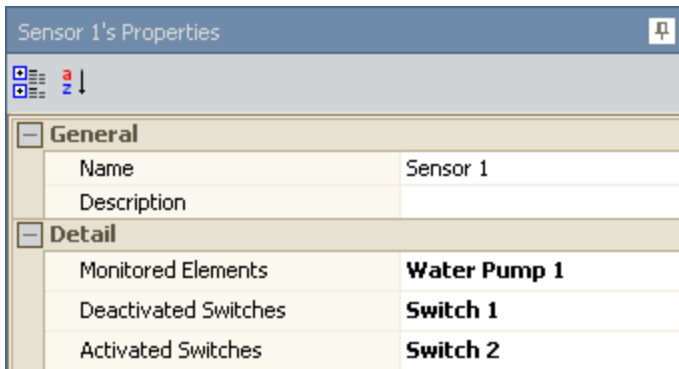

Subsystem Fields

When you select a Subsystem on the Diagram Canvas, the **Properties** pane displays information related to that Subsystem. The following table lists:

- The row labels that are displayed in the **Properties** pane when you select a Subsystem on the Diagram Canvas. The table is organized by the categories that are displayed when you view the **Properties** pane in a *categorized* view.
- The field caption of the field in the associated System Subsystem record whose value is displayed in that row.

Row Label	System Subsystem Field
General	
Name	Name
Description	Description
Production Contribution	Production Contribution
Financial Consequences	
Fixed Cost	Fixed Cost
Variable Cost	Variable Cost
Variable Cost Units	Variable Cost Units
Lost Production Cost	Lost Production Cost
Lost Production Cost Units	Lost Production Cost Units

The following image shows the categorized view of the **Properties** pane that would be displayed if you selected the Diagram for Scenario A subsystem in Scenario A.

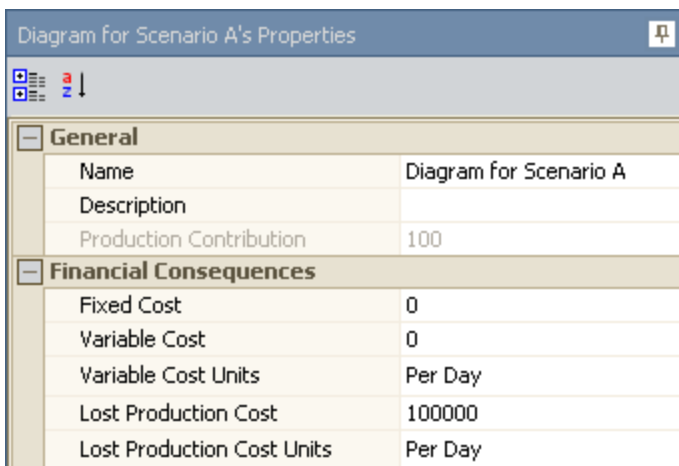



Switch Fields

When you select a Switch on the Diagram Canvas, the **Properties** pane displays information related to that Switch. The following table lists:

- The row labels that are displayed in the **Properties** pane when you select a Switch on the Diagram Canvas. The table is organized by the categories that are displayed when you view the **Properties** pane in a categorized view.
- The name of the record whose value is displayed in that row. Note that if the value in that row is not stored in a record, the table displays the following text: *This row does not display values from a record.*
- The field caption of the field whose value is displayed in that row. Note that if the value in a row is not stored in a field, the table displays the following information: *This row does not display values from a field.*
- Notes that provide more information about the value in that row.

Row Label	System Record	System Field	Notes
General			
Name	System Switch	Name	None
Description	System Switch	Description	None
Is Initially On	System Switch	Is Initially On	None
Production Contribution	System Switch	Production Contribution	None
Financial Consequences			
Fixed Cost	System Switch	Fixed Cost	None
Variable Cost	System Switch	Variable Cost	None
Variable Cost Units	System Switch	Variable Cost Units	None
Lost Production Cost	System Switch	Lost Production Cost	None
Lost Production Cost Units	System Switch	Lost Production Cost Units	None
Actions			

Row Label	System Record	System Field	Notes
<p>Number of Actions</p>	<p>This row does not display values from a record.</p>	<p>This row does not display values from a field.</p>	<p>This row displays the number of System Action records that are linked to the selected Switch record. When you click inside the Number of Actions cell, the  button appears, which you can click to display the Action Editor window, where you can create, modify, or delete System Action records that are linked to the selected Switch record.</p>
<p>Risks</p>			
<p>Number of Risks</p>	<p>This row does not display values from a record.</p>	<p>This row does not display values from a field.</p>	<p>This row displays the number of System Risk records that are linked to the selected Switch record. When you click inside the Number of Risks cell, the  button appears, which you can click to display the Risk Editor window, where you can create, modify, or delete System Risk records that are linked to the selected Switch record.</p>

Switch Fields

Row Label	System Record	System Field	Notes
Reference Data			
Equipment Type	System Switch	Equipment Type	None

The following image shows the **Properties** pane that would be displayed if you selected the Switch 1 element in Scenario A.

Switch 1's Properties ⌵

☰ ☱ ☲ ☳

General	
Name	Switch 1
Description	
Is Initially On	<input checked="" type="checkbox"/>
Production Contribution	100
Financial Consequences	
Fixed Cost	0
Variable Cost	0
Variable Cost Units	Per Day
Lost Production Cost	0
Lost Production Cost Units	Per Day
Actions	
Number of Actions	0
Risks	
Number of Risks	0
Reference Data	
Equipment Type	

Using the Diagram Hierarchy

The **Diagram Hierarchy** pane on the **System Reliability Scenarios - Diagram** page provides a hierarchical view of the elements in a Diagram. This view is especially useful when you are viewing a complex system containing multiple subsystems.

Consider [Scenario C](#) in our [System Reliability Analysis Example](#). In this case, the **Diagram Hierarchy** pane would look like this:

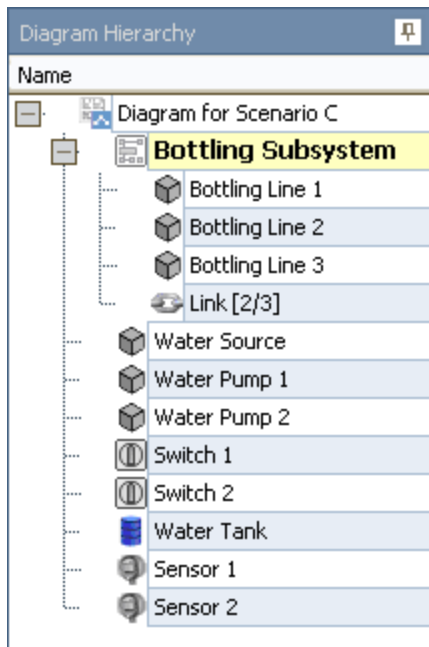





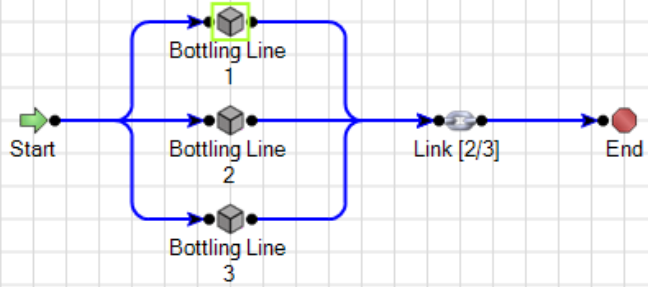
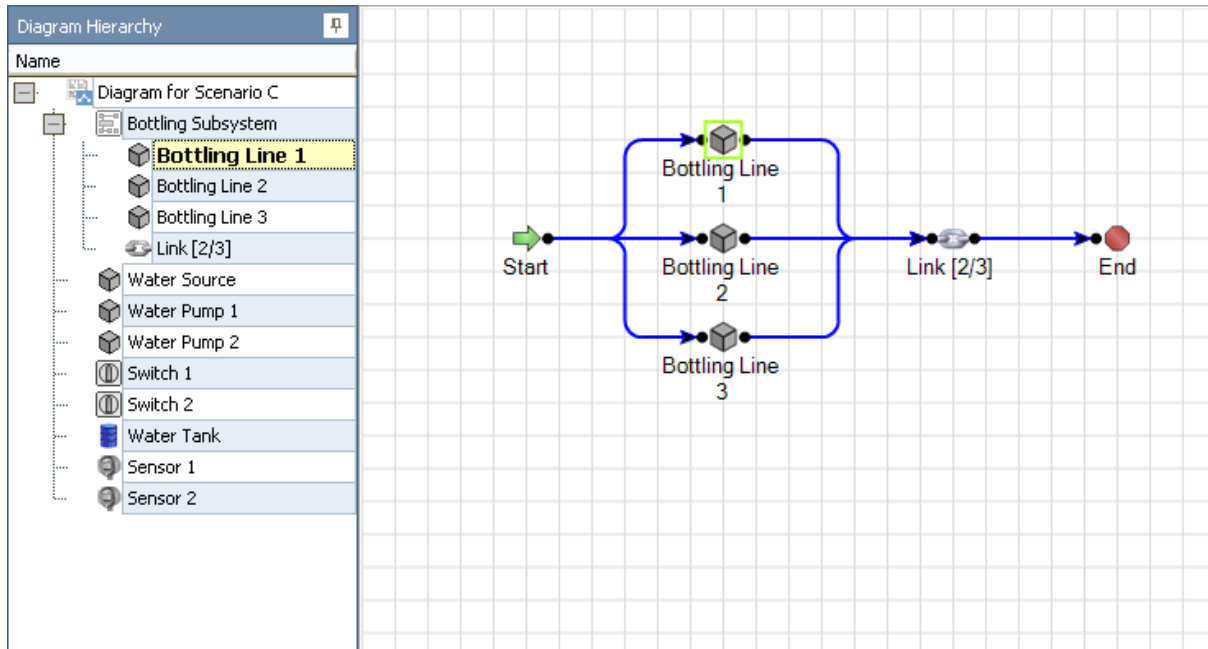

You can click any element in the **Diagram Hierarchy** pane to display that element on the Diagram Canvas. For example, if you clicked **Bottling Line 1**, the element that represents Bottling Line 1 would be displayed on the Diagram Canvas as shown in the following image.

Using the Diagram Hierarchy



About the Diagram Palette

On the **System Reliability Scenarios - Diagram** page, the **Diagram Palette** pane contains icons that represent the physical [elements](#) of the Diagram. You can select an element from the palette and drag it onto the Diagram Canvas to define its properties and include it in the Diagram. The following icons are available.

-  • Asset
-  • Subsystem
-  • Buffer
-  • Link
-  • Switch
-  • Sensor

Hiding and Displaying Panes

If you are working with a large Diagram, you may want to increase the display area of the Diagram Canvas. You can do so by hiding the **Diagram Hierarchy**, **Diagram Palette**, and **Properties** panes.

To hide a pane:

- In the upper, right corner of the pane header, click the  button.

The pane closes and is identified by a tab that appears in the pane's original position. For example, the following image shows the **Diagram Hierarchy** pane after it has been hidden. Note the **Diagram Hierarchy** tab that appears on the left side of the screen.

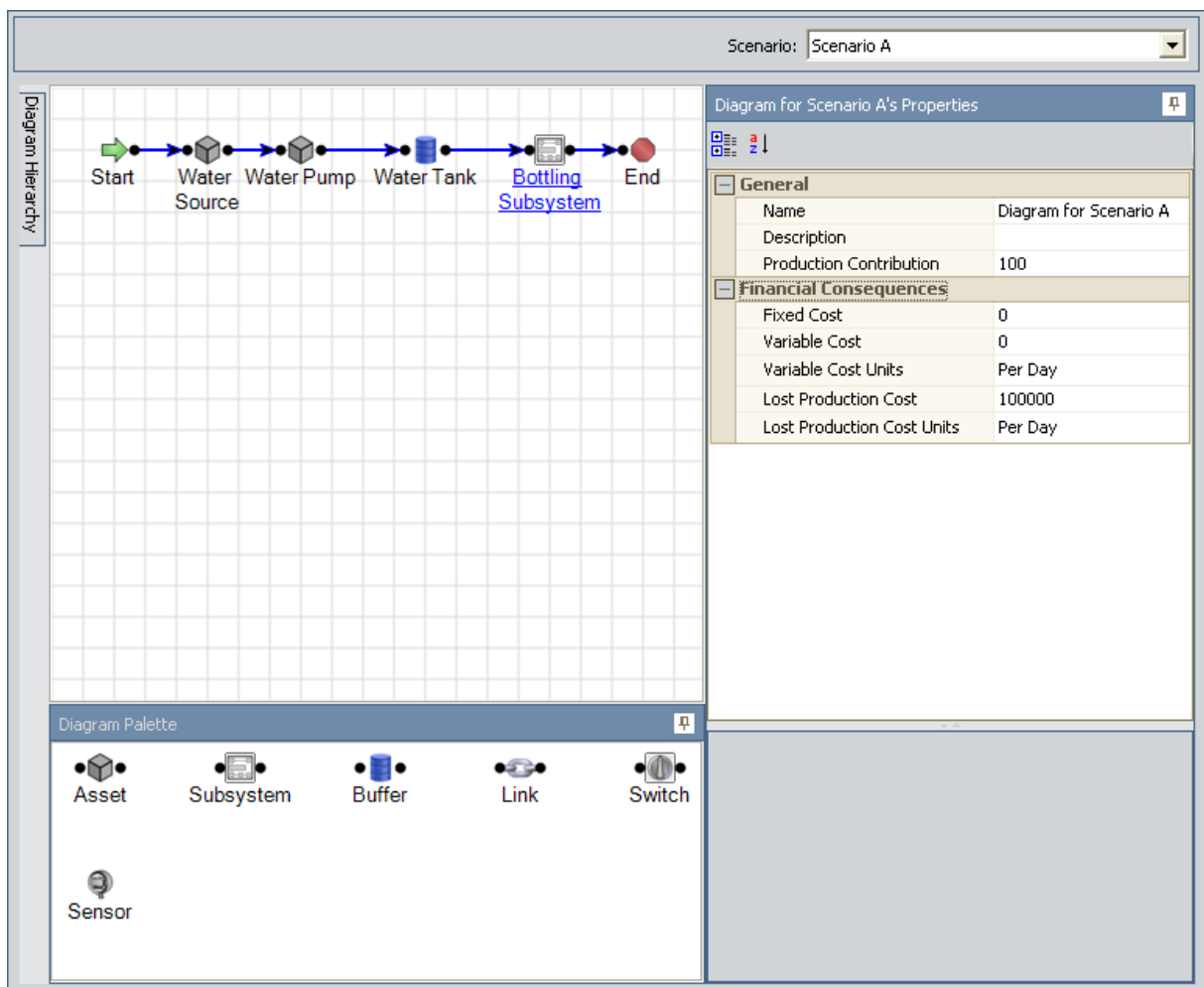

To display a hidden pane:

- Place your pointer over the tab that identifies the pane you want to display.

Hiding and Displaying Panes

The pane reappears. If you move your pointer off the pane, the pane will disappear again. You can lock the pane back into the display position by clicking the  button again.

About Adding Elements

After a Scenario has been created, you can build the Diagram by adding [elements](#) and [connections](#). You have two options for adding elements to a Diagram:

- You can [create new elements from scratch](#) by using the Diagram Palette pane. When you add an element in this way, the Meridium APM system will create a new record to store information for that element. The new record will be linked to the System Subsystem that represents the Diagram.
- You can [create new elements by importing records that already exist in the Meridium APM database](#). When you add an element in this way, the Meridium APM system will use the information in the existing record to populate information in a new record to represent the appropriate Diagram element. The original record will continue to exist in the Meridium APM database. The new record will be linked to the System Subsystem record that represents the Diagram.

After you add elements to a Diagram, you can [create connections](#) between them to indicate their relationship to one another and their physical arrangement within the system.

Adding an Element from the Diagram Palette Pane

To add a new element to the Diagram from the Diagram Palette pane:

1. Click the desired element in the [Diagram Palette](#) pane.

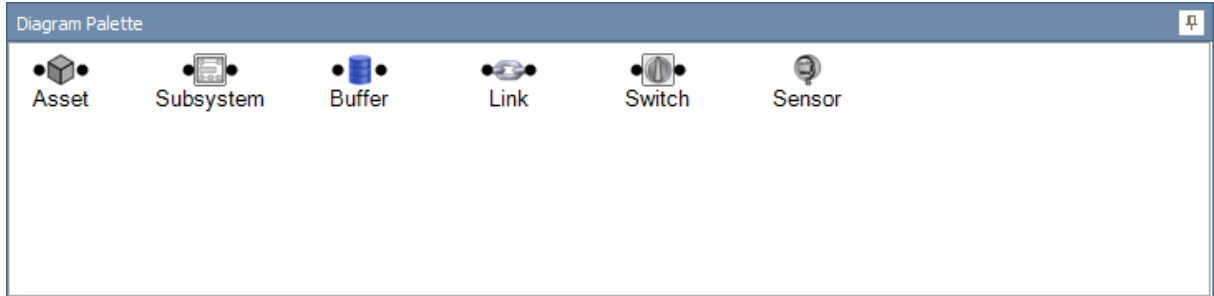

2. Hold your mouse button down, drag the element to the Diagram Canvas, and then release your mouse button to drop it in the desired location.

The element appears on the Diagram Canvas. It is selected automatically, so the **Properties** pane displays the properties of the new element. When you save the System Reliability Analysis, the appropriate record will be created in the Meridium APM database to store information for that element.

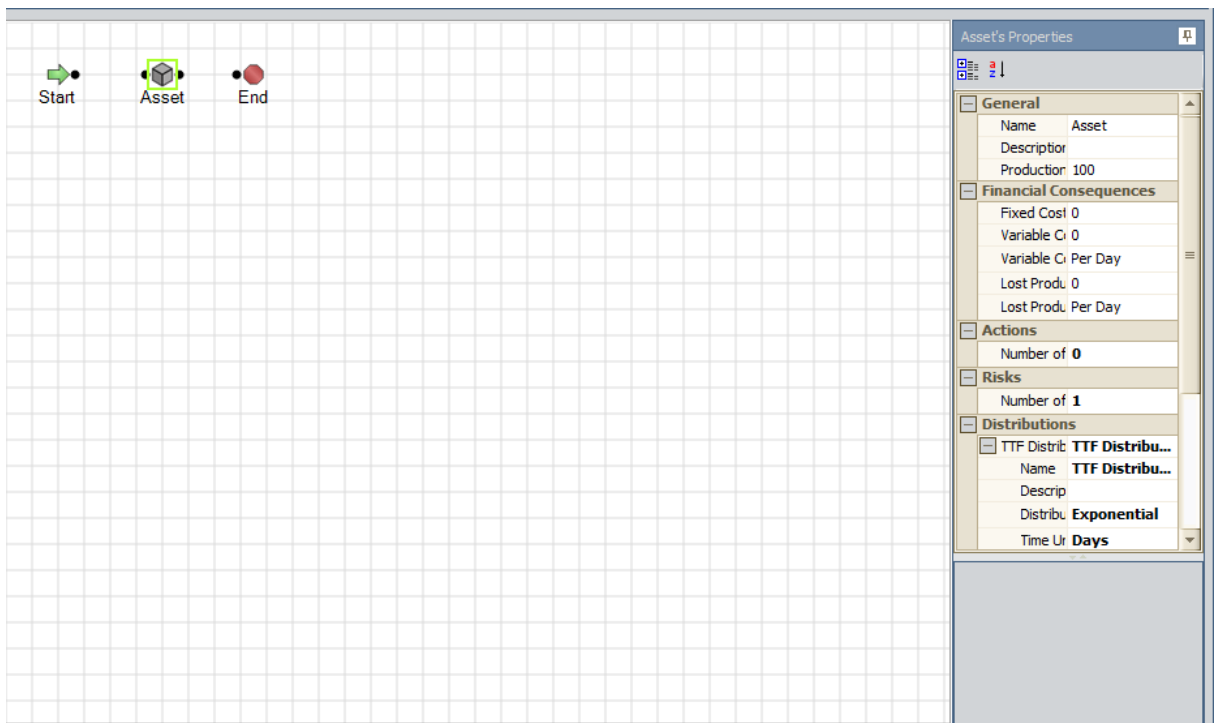

Importing Existing Assets

You can create new Asset elements by importing existing Equipment and Functional Location records into a Diagram. You can import one or more records in a single operation. One Asset element will be created for each record that you import, and a new System Asset record will be created to store information for that element. Fields from the Equipment or Functional Location record will be [mapped to the System Asset record](#).

You can also choose to import the Reliability Distribution Analysis or Reliability Growth Analysis associated with the Equipment or Functional Location record that you selected. Values from fields in the Reliability Growth or Reliability Distribution record will be mapped to System Risk and Distribution records, which are created when the corresponding record is imported and linked to the System Asset record.

To create Asset elements by importing data from existing records:

1. Right-click the Diagram Canvas, point to **Import**, and then click **Asset**.

The **Find Items** window appears.

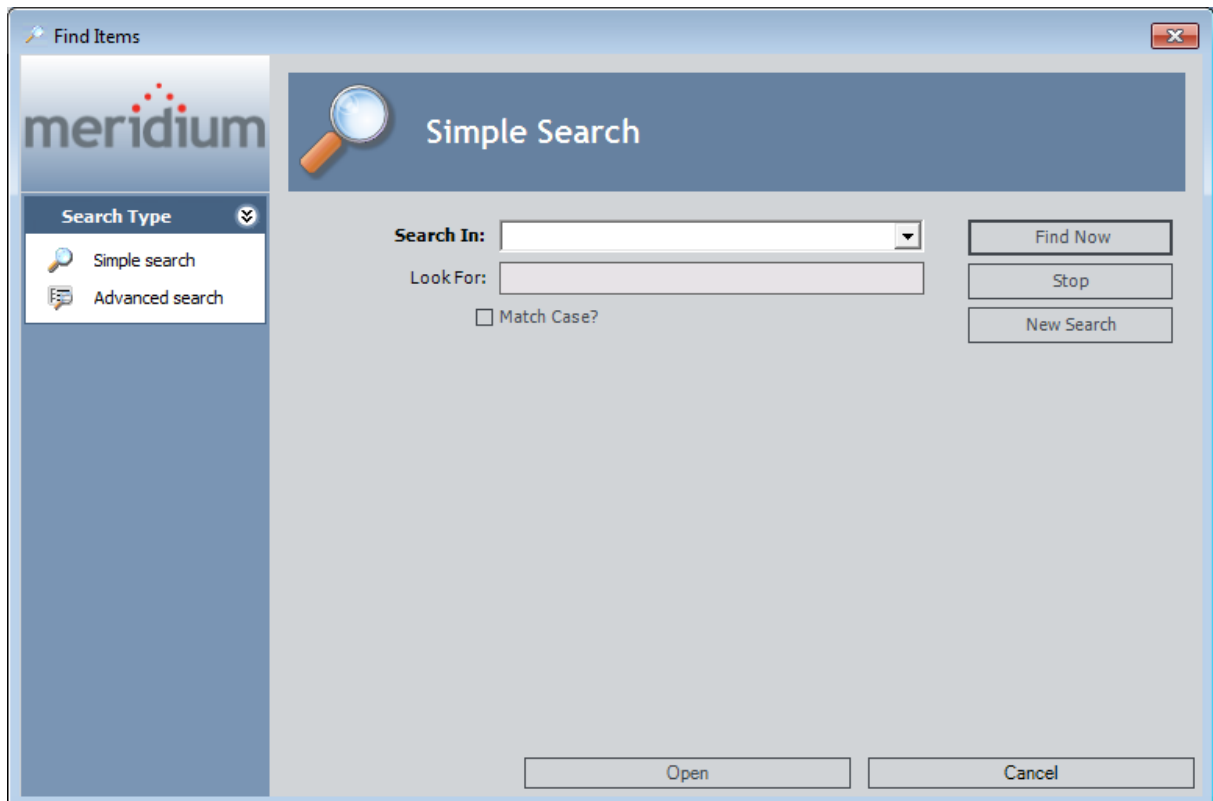

2. In the **Search In** list, select *Equipment* or *Functional Location*.
3. Click the **Find Now** button.

The search results appear at the bottom of the **Find Items** window.

Importing Existing Assets

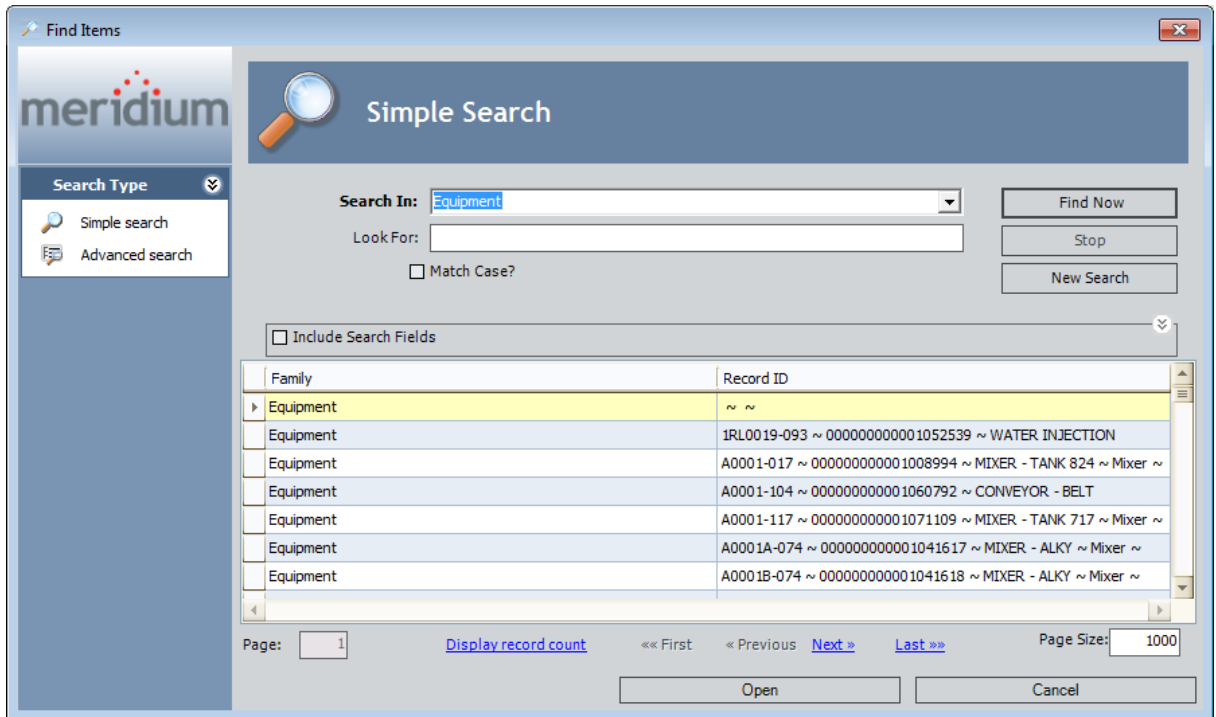

4. Select the record(s) that you want to import.
5. Click the **Open** button.

The **Import Asset** window appears.

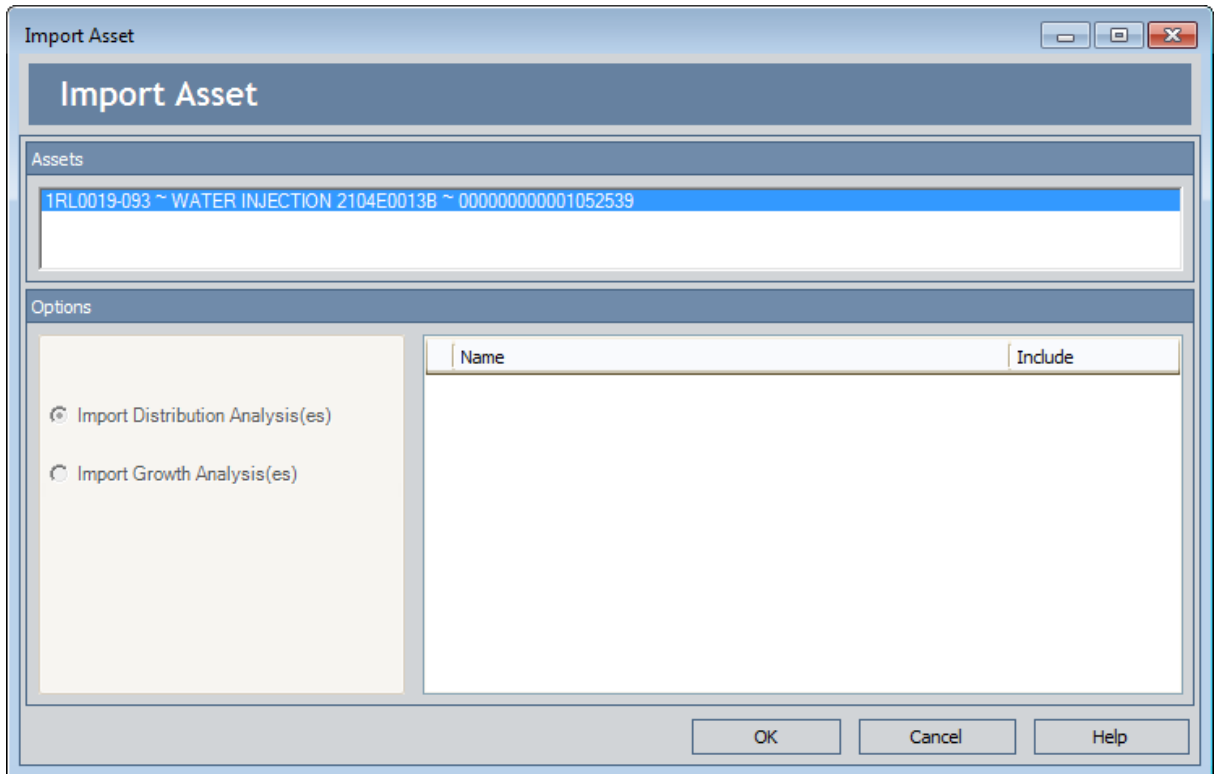

The **Assets** pane displays a list of records that you selected from the search results. The **Options** pane allows you to import the Reliability Distribution Analyses or Reliability Growth Analyses associated with the Equipment or Functional Location records that you selected, if desired.

Note: If no Reliability Distribution Analyses or Reliability Growth Analyses are associated with the selected Equipment or Functional Location records, the **Options** pane will be disabled.

6. Select the desired import options.
7. Click **OK**.

A new Asset element is added to the Diagram for each selected Equipment or Functional Location record.

Fields Mapped From Equipment or Functional Location Records

When you import an existing Equipment or Functional Location record into the Diagram, a new [System Asset record](#) is created, and information from the imported record is mapped to the System Asset record.

The following chart displays the values that are imported from fields in Equipment or Functional Location records and the System Analysis record and field to which they are mapped. All other values in System Analysis records are populated automatically with default values.

Equipment or Functional Location Record Field	System Analysis Record	System Analysis Record Field	Notes
ID	System Asset	Name	None

When you are importing an Equipment or Functional Location record, if you choose to import the Reliability Distribution Analysis or Reliability Growth Analysis associated with the Equipment or Functional Location record that you selected, values from records in Reliability Distribution Analyses or Reliability Growth Analyses will also be mapped to records in the System Reliability Analysis.

The values that will be mapped are the *same values* that are mapped when a [Reliability Distribution Analyses](#) or [Reliability Growth Analyses](#) is imported *without* an Equipment or Functional Location record, with the following exception:

- The value in the ID field of the Equipment or Functional Location record will be mapped to the Name field in the System Asset record. The values in the Analysis ID field in the Reliability Growth or Reliability Distribution record will *not* be mapped to the System Asset record.

Importing a Reliability Distribution Analysis

You can create new Asset elements by importing existing Reliability Distribution Analyses into a Diagram. You can import one or more analyses in a single operation. One Asset element will be created for each record that you import, and a new System Asset record will be created to store information for that element. Fields from the Reliability Distribution record will be [mapped to the System Asset record](#).

To import a Reliability Distribution Analysis into a Diagram:

1. Right-click the Diagram Canvas, point to **Import**, and then click **Reliability Distribution**.

The **Find Items** window appears, displaying the Reliability Distribution family in the **Search In** list.

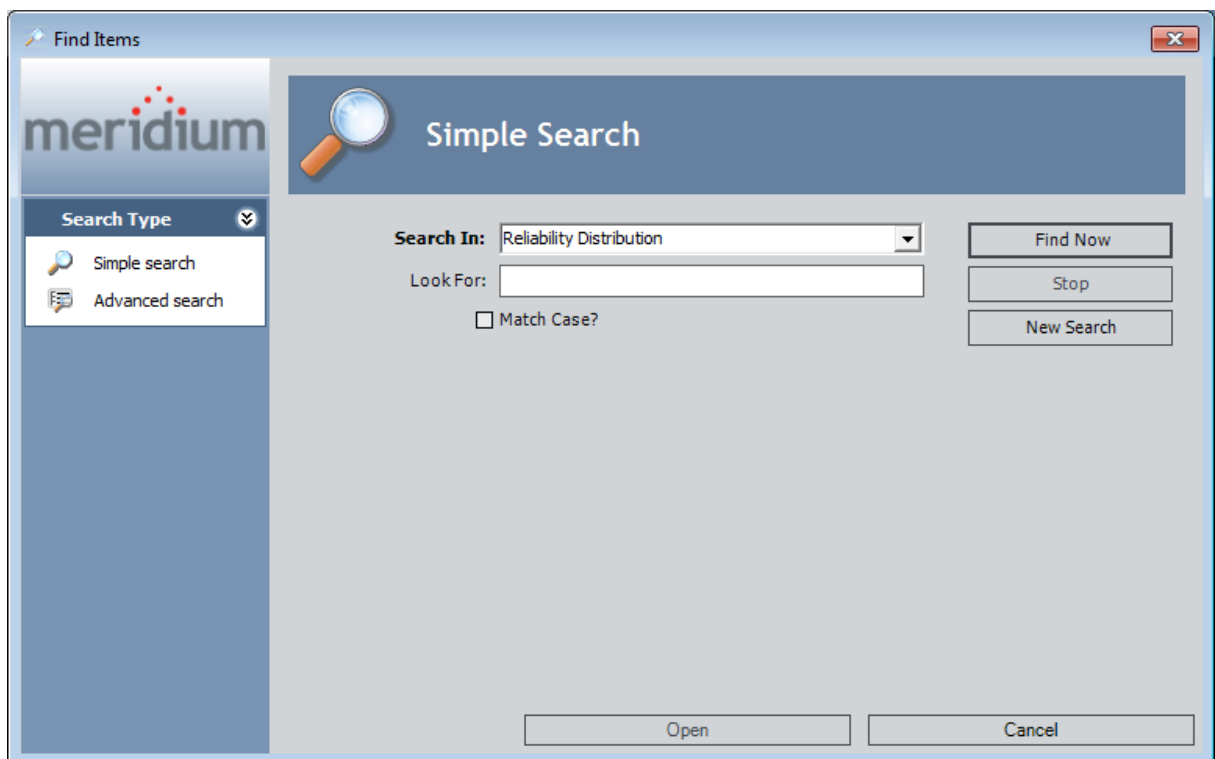

2. Click the **Find Now** button.

The search results appear at the bottom of the **Find Items** window.

3. Select the Reliability Distribution Analysis that you want to import. You can select multiple Reliability Distribution Analyses, if desired.
4. Click the **Open** button.

A new Asset element is added to the Diagram for each selected Reliability Distribution Analysis.

Fields Mapped From a Reliability Distribution Analysis

When you import an existing Reliability Distribution record into the Diagram, a new [System Asset record](#) is created, and information from the imported record is mapped to the System Asset record. Information is also mapped to System Risk and Distribution records, which are created when a record is imported and linked to the System Asset record.

The following chart displays the values that are imported from fields in records from a Distribution Analysis and the System Analysis record and field to which they are mapped. All other values in System Analysis records are populated automatically with default values.

Note: If you [import an Equipment or Functional Location record](#) and import the Reliability Distribution Analysis associated with that record, all of the fields in the following chart will be mapped *except* the Analysis ID field will not be mapped to the Name field in the System Asset record.

Reliability Distribution Analysis Record	Reliability Distribution Analysis Record Field	System Analysis Record	System Analysis Record Field	Notes
Reliability Distribution	Analysis ID	System Asset	Name	None
Reliability Distribution	Analysis ID	System Risk	Name	None
Reliability Distribution	Failures Without Replacement	System Risk	Failure Without Replacement	None
Distribution	Short Description	Distribution	Short Description	This value is mapped from the TTF and TTR Distribution records that are linked to the Reliability Distribution record to the corresponding TTF and TTR Distribution records that are linked to the System Risk records.

Fields Mapped From a Reliability Distribution Analysis

Reliability Distribution Analysis Record	Reliability Distribution Analysis Record Field	System Analysis Record	System Analysis Record Field	Notes
Distribution	Distribution Type	Distribution	Distribution Type	This value is mapped from the TTF and TTR Distribution records that are linked to the Reliability Distribution record to the corresponding TTF and TTR Distribution records that are linked to the System Risk records.
Distribution	Units	Distribution	Units	This value is mapped from the TTF and TTR Distribution records that are linked to the Reliability Distribution record to the corresponding TTF and TTR Distribution records that are linked to the System Risk records.

Fields Mapped From a Reliability Distribution Analysis

Reliability Distribution Analysis Record	Reliability Distribution Analysis Record Field	System Analysis Record	System Analysis Record Field	Notes
Exponential	MTBF	Exponential	MTBF	This value is mapped from the TTF and TTR Distribution records with a Distribution Type of <i>Exponential</i> that are linked to the Reliability Distribution record to the TTF and TTR Distribution records with a Distribution Type of <i>Exponential</i> that are linked to the System Risk records.
Lognormal	Mu Sigma Gamma	Lognormal	Mu Sigma Gamma	This value is mapped from the TTF and TTR Distribution records with a Distribution Type of <i>Lognormal</i> that are linked to the Reliability Distribution record to the TTF and TTR Distribution records with a Distribution Type of <i>Lognormal</i> that are linked to the System Risk records.

Fields Mapped From a Reliability Distribution Analysis

Reliability Distribution Analysis Record	Reliability Distribution Analysis Record Field	System Analysis Record	System Analysis Record Field	Notes
Normal	Mean Standard Deviation	Normal	Mean Standard Deviation	This value is mapped from the TTF and TTR Distribution records with a Distribution Type of <i>Normal</i> that are linked to the Reliability Distribution record to the TTF and TTR Distribution records with a Distribution Type of <i>Normal</i> that are linked to the System Risk records.
Weibull	Beta Eta Gamma	Weibull	Beta Eta Gamma	This value is mapped from the TTF and TTR Distribution records with a Distribution Type of <i>Weibull</i> that are linked to the Reliability Distribution record to the TTF and TTR Distribution records with a Distribution Type of <i>Weibull</i> that are linked to the System Risk records.

Importing a Reliability Growth Analysis

You can create new Asset elements by importing existing Reliability Growth Analyses into a Diagram. You can import one or multiple analyses in a single operation. One Asset element will be created for each record that you import, and a new System Asset record will be created to store information for that element. Fields from the Reliability Growth record will be [mapped to the System Asset record](#).

To import a Reliability Growth Analysis into a Diagram:

1. Right-click the Diagram Canvas, point to **Import**, and then click **Reliability Growth**.

The **Find Items** window appears, displaying the Reliability Growth family in the **Search In** list.

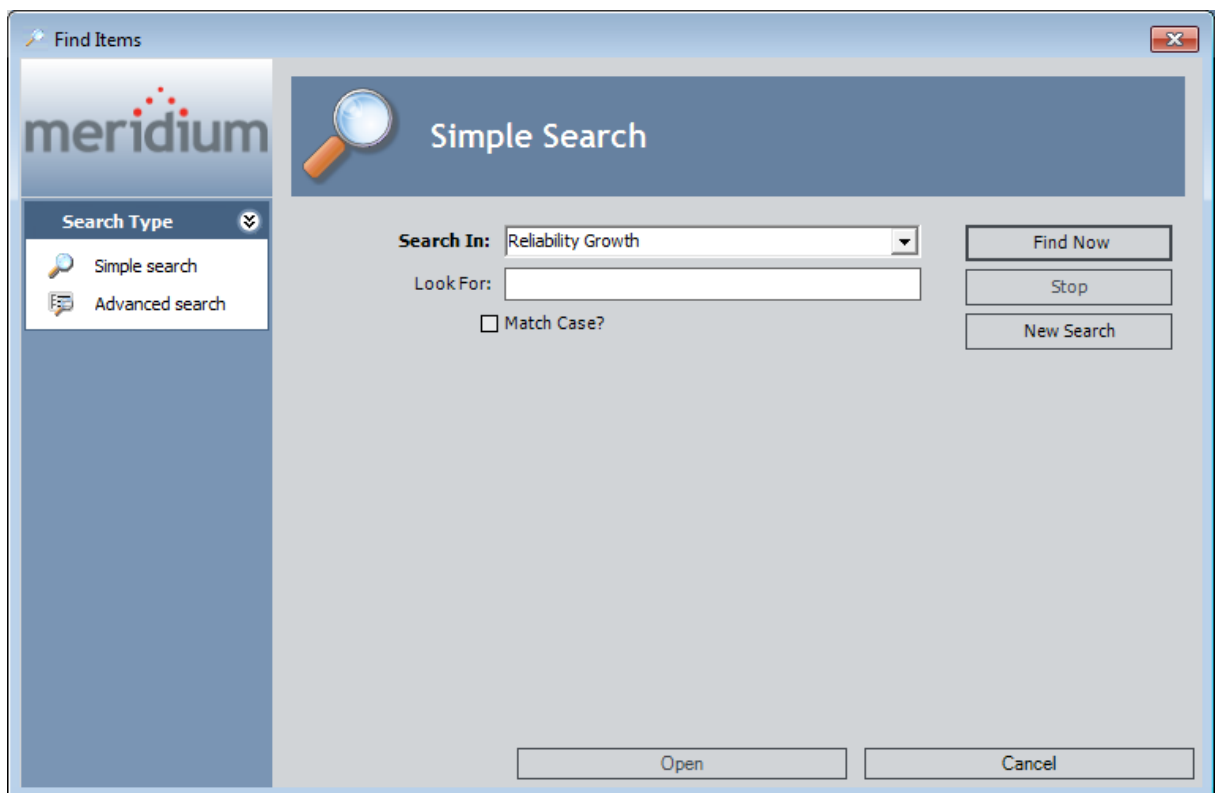

2. Click the **Find Now** button.

The search results appear at the bottom of the **Find Items** window.

3. Select the Reliability Growth Analysis that you want to import. You can select multiple Reliability Growth Analyses, if desired.
4. Click the **Open** button.

A new Asset element is added to the Diagram for each selected Reliability Growth Analysis.

Fields Mapped From a Reliability Growth Analysis

When you import an existing Reliability Growth record into the Diagram, a new [System Asset record](#) is created, and information from the imported record is mapped to the System Asset record. Information is also mapped to System Risk and Distribution records, which are created when a record is imported and linked to the System Asset record.

The following chart displays the values that are imported from fields in a Reliability Growth record and the System Analysis record and field to which they are mapped. All other values in System Analysis records are populated automatically with default values.

Note: If you [import an Equipment or Functional Location record](#) and import the Reliability Growth Analysis associated with that record, all of the fields in the following chart will be mapped *except* the Analysis ID field will not be mapped to the Name field in the System Asset record.

Reliability Growth Record Field	System Analysis Record	System Analysis Record Field	Notes
Analysis ID	System Asset	Name	None
Analysis ID	System Risk	Name	None
Short Description	Distribution	Short Description	This value is mapped to the TTF Distribution record that is linked to the System Risk record and appears in the TTF column on the System Reliability Scenarios - Risks page.
Final MTBF	Exponential	MTBF	This value is mapped to the TTF Distribution record that is linked to the System Risk record and appears in the TTF column on the System Reliability Scenarios - Risks page.

Fields Mapped From a Reliability Growth Analysis

Reliability Growth Record Field	System Analysis Record	System Analysis Record Field	Notes
Time Units	Distribution	Units	This value is mapped to the TTF Distribution record that is linked to the System Risk record and appears in the TTF column on the System Reliability Scenarios - Risks page.

Using the Import Subsystem Window

The [Import Subsystem window](#) contains a grid that displays a list of all records belonging to the System Subsystem family. These records can be imported into the Diagram to create a new Subsystem element.

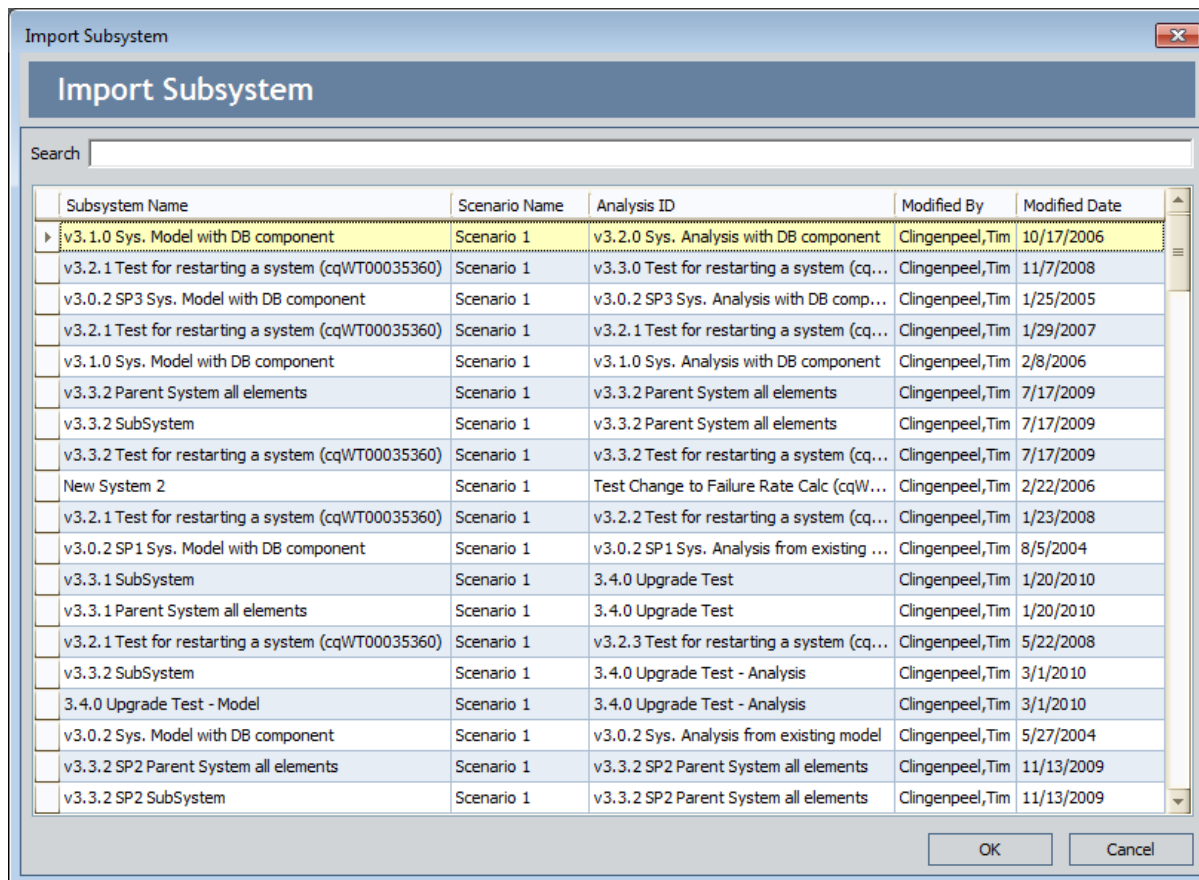

Subsystem Name	Scenario Name	Analysis ID	Modified By	Modified Date
v3.1.0 Sys. Model with DB component	Scenario 1	v3.2.0 Sys. Analysis with DB component	Clingenpeel,Tim	10/17/2006
v3.2.1 Test for restarting a system (cqWT00035360)	Scenario 1	v3.3.0 Test for restarting a system (cq...	Clingenpeel,Tim	11/7/2008
v3.0.2 SP3 Sys. Model with DB component	Scenario 1	v3.0.2 SP3 Sys. Analysis with DB comp...	Clingenpeel,Tim	1/25/2005
v3.2.1 Test for restarting a system (cqWT00035360)	Scenario 1	v3.2.1 Test for restarting a system (cq...	Clingenpeel,Tim	1/29/2007
v3.1.0 Sys. Model with DB component	Scenario 1	v3.1.0 Sys. Analysis with DB component	Clingenpeel,Tim	2/8/2006
v3.3.2 Parent System all elements	Scenario 1	v3.3.2 Parent System all elements	Clingenpeel,Tim	7/17/2009
v3.3.2 SubSystem	Scenario 1	v3.3.2 Parent System all elements	Clingenpeel,Tim	7/17/2009
v3.3.2 Test for restarting a system (cqWT00035360)	Scenario 1	v3.3.2 Test for restarting a system (cq...	Clingenpeel,Tim	7/17/2009
New System 2	Scenario 1	Test Change to Failure Rate Calc (cqW...	Clingenpeel,Tim	2/22/2006
v3.2.1 Test for restarting a system (cqWT00035360)	Scenario 1	v3.2.2 Test for restarting a system (cq...	Clingenpeel,Tim	1/23/2008
v3.0.2 SP1 Sys. Model with DB component	Scenario 1	v3.0.2 SP1 Sys. Analysis from existing ...	Clingenpeel,Tim	8/5/2004
v3.3.1 SubSystem	Scenario 1	3.4.0 Upgrade Test	Clingenpeel,Tim	1/20/2010
v3.3.1 Parent System all elements	Scenario 1	3.4.0 Upgrade Test	Clingenpeel,Tim	1/20/2010
v3.2.1 Test for restarting a system (cqWT00035360)	Scenario 1	v3.2.3 Test for restarting a system (cq...	Clingenpeel,Tim	5/22/2008
v3.3.2 SubSystem	Scenario 1	3.4.0 Upgrade Test - Analysis	Clingenpeel,Tim	3/1/2010
3.4.0 Upgrade Test - Model	Scenario 1	3.4.0 Upgrade Test - Analysis	Clingenpeel,Tim	3/1/2010
v3.0.2 Sys. Model with DB component	Scenario 1	v3.0.2 Sys. Analysis from existing model	Clingenpeel,Tim	5/27/2004
v3.3.2 SP2 Parent System all elements	Scenario 1	v3.3.2 SP2 Parent System all elements	Clingenpeel,Tim	11/13/2009
v3.3.2 SP2 SubSystem	Scenario 1	v3.3.2 SP2 Parent System all elements	Clingenpeel,Tim	11/13/2009

The grid displays the following columns:

- **Subsystem Name:** The value stored in the Name field of the System Subsystem record.
- **Scenario Name:** The value stored in the Name field of the System Scenario record to which the System Subsystem record is linked.
- **Analysis ID:** The value stored in the Analysis ID field of the System Analysis record to which the System Subsystem record is linked.
- **Modified By:** Displays the name of the Security User who last modified the System Analysis record to which the System Subsystem record is linked, as identified by the value in the LAST_UPBY_SEUS_KEY field in the System Analysis record.
- **Modified Date:** Displays the date when the analysis was last modified, as identified by the value stored in the LAST_UPDT_DT field in the System Analysis record to which the System Subsystem record is linked.

Using the Import Subsystem Window

You can type a keyword or phrase in the **Search** text box to filter the list of System Subsystem records that is displayed.

Importing a Subsystem

You can create new Subsystem elements by importing existing System Subsystem records into the Diagram. You can import one or multiple records in a single operation. For each System Subsystem record:

- An element will be created in the diagram.
- A copy of the record will be created and linked to the System Analysis record.
- All related records within the subsystem (e.g., System Asset records) will also be imported. An element and copy of each record will be created for each related record.

To import a Subsystem into the Diagram:

1. Right-click the Diagram Canvas, point to **Import**, and then click **Subsystem**.

The [Import Subsystem window](#) appears, displaying a list of all records belonging to the System Subsystem family.

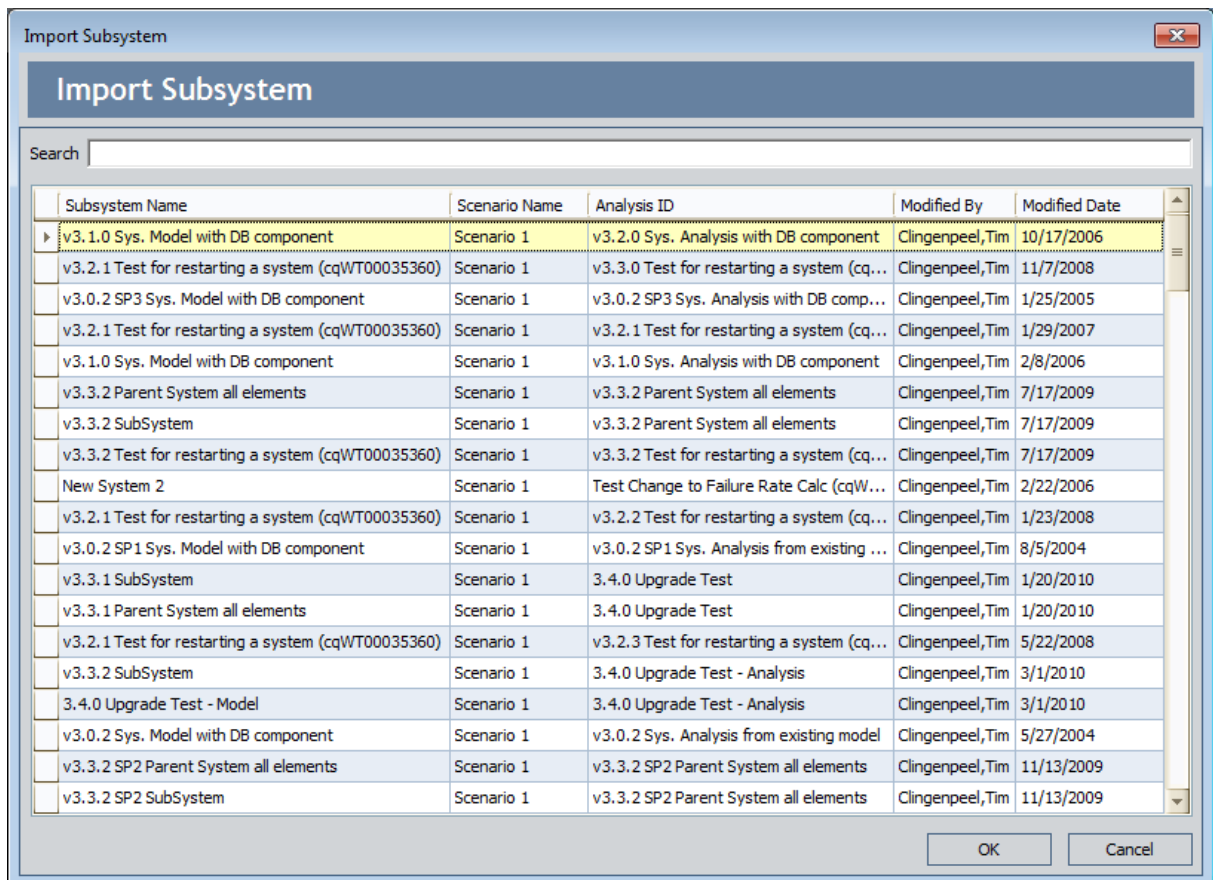

2. In the **Search** text box, type a keyword or phrase to filter the list of System Subsystem records displayed, if desired.

Importing a Subsystem

3. Select the row containing the System Subsystem record that you want to import. You can select multiple records, if desired.
4. Click **OK**.

The **Import Subsystem** window closes and a new Subsystem element is added to the Diagram for each selected System Subsystem record.

About Connecting Elements

After you add elements to a Diagram, you must connect the elements to create the Diagram. Depending on the structure of the system for which you are creating a Diagram, you will want to connect elements to each other *in a series* or *parallel* to one another.

Elements Connected in a Series

When you connect elements to each other in a series, every element has one preceding connection and one succeeding connection, with only one path from the Start element to the End element. For example, in the following image of [Scenario A](#) in the [System Reliability Analysis Example](#), the elements in the Diagram for Scenario A root subsystem are connected in a series: every element between the Start and End elements has one connection from an element and one connection to an element, and you can reach the End element from the Start element in only one way.

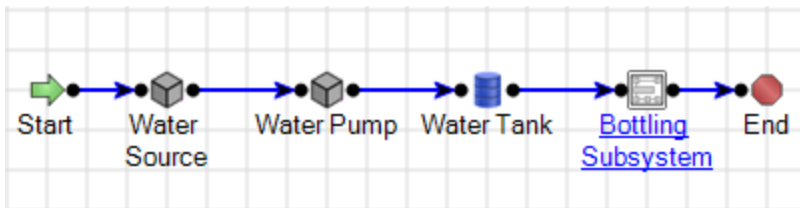

Elements Connected in Parallel

When you connect elements in parallel to one another, one or more elements will be connected to multiple elements, and there will be multiple paths from the Start element to the End element. For example, in the [System Reliability Analysis Example](#), the Bottling Line elements in the Bottling Subsystem root subsystem are connected in parallel. In this case, the Start element and the Link element are connected to three Subsystem elements: Bottling Line 1, Bottling Line 2, and Bottling Line 3. Therefore, there are three different paths from the Start element to the End element, depending on which of the three Bottling Lines that you pass through.

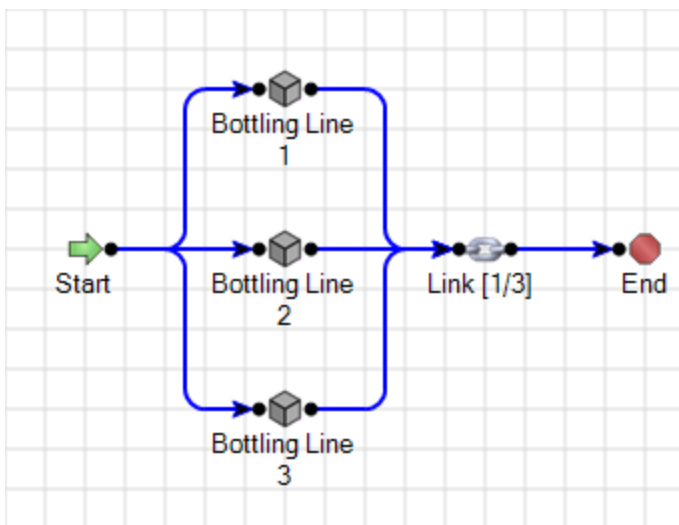

Connecting Elements in a Diagram

To connect two elements in a Diagram:

1. Using your pointer, for the desired element, point to the black circle on the side from which you want to start the connection.



2. Click the port and drag your pointer in the direction that you want to create the connection.

An arrow will be drawn automatically in the direction that you drag your pointer.

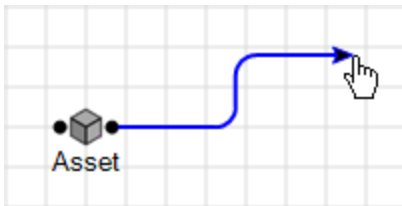

3. Continue dragging your pointer until the arrow reaches the desired destination (i.e., the circle on the element that will serve as the end of the connection). The connection will be completed automatically.

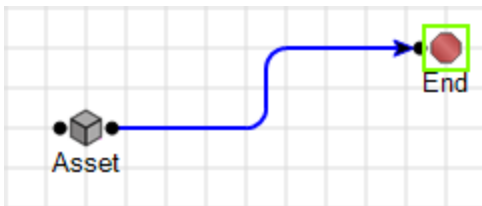

4. Release your mouse button to set the connection.

Deleting Elements from a Diagram

If desired, you can delete any element from a Diagram. As you delete elements from a Diagram, note that:

- If you delete an Asset element that was created by importing an Equipment or Functional Location record, when you delete the Asset element, *only* the Asset element will be deleted. The source record will not be deleted. Additionally, if the source record is linked to the System Analysis record, the link will ALSO be deleted.
- You cannot delete the Start or the End node.

To delete an element from a Diagram:

1. Right-click the element that you want to delete, and then click **Delete**.

-or-

Select the element that you want to delete, and press the Delete key on your keyboard.

A confirmation message appears, asking if you really want to delete the element.

2. Click the **Yes** button.

The element is deleted from the Diagram.

Deleting Connections Between Elements

To delete a connector between two elements in the Diagram:

1. Click the connector to select it.

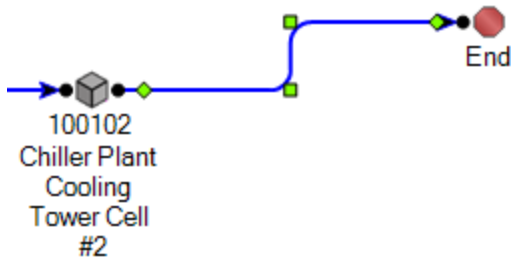

Note: This image shows the Canvas Diagram with [Hide Grid](#) option selected.

2. Right-click the connection, and then click **Delete**.

-or-

Press the Delete key on your keyboard.

A confirmation message appears, asking if you really want to delete the connection.

3. Click the **Yes** button.

The connection is deleted from the Diagram.

Performing Validation

For the Meridium APM system to run simulations, the elements within Diagrams must be connected correctly. Problems within a Diagram, such as isolated elements, broken connections, and circular connections will cause a Diagram to fail validation. When you perform a validation, the Meridium APM system will validate ALL Diagrams associated with any Scenario in a given System Reliability Analysis.

The validation process evaluates each Diagram in two directions:

- From the Start element to the End element.
- From the End element to the Start element.

If an error is found along either path, it will be reported in the validation results. An error that is found along *both* paths will be reported twice.

To validate the Diagrams within an analysis:

- While viewing a System Reliability Analysis on any page, on the [Tools menu](#), click the **Validate Diagrams** link.
- If all Diagrams are valid, the [Diagram Validation Results dialog box](#) will display a message that all diagrams are valid.

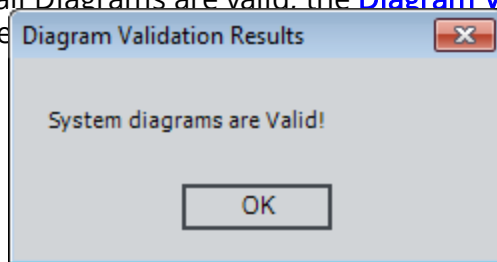

- If any Diagrams are invalid, the [Diagram Validation Results dialog box](#) will be displayed, where you can view the [results of the validation](#).

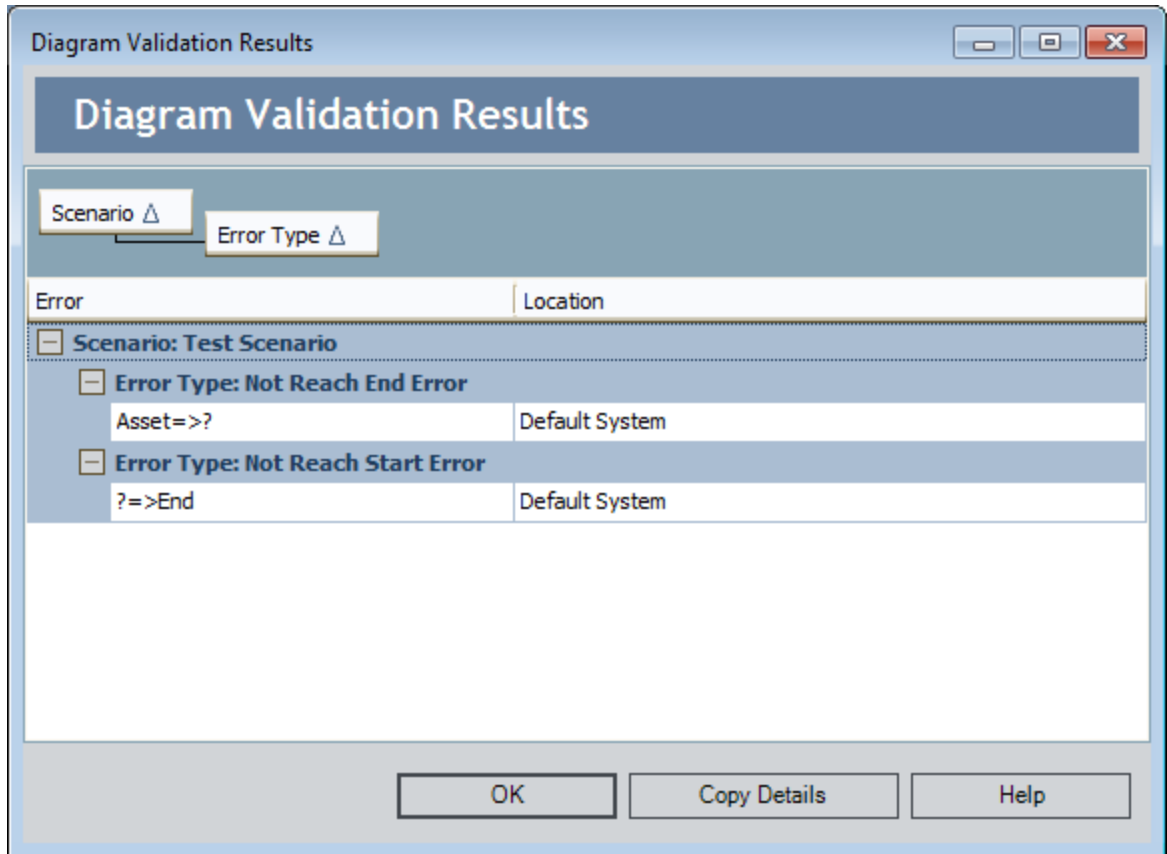

Aspects of the Diagram Validation Results Dialog Box

The **Diagram Validation Results** dialog box displays all the errors that exist in any of the Diagrams within a System Reliability Analysis.

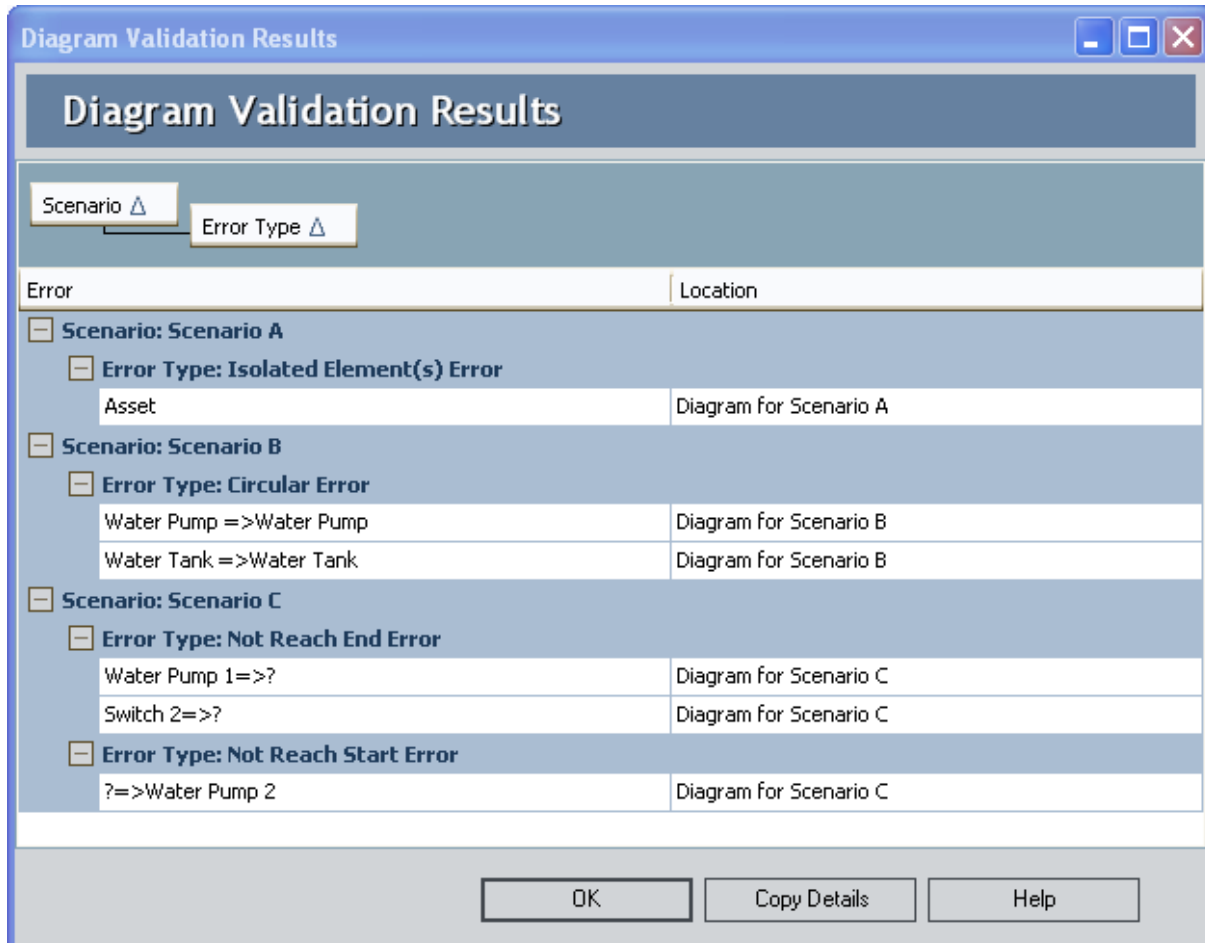

The **Diagram Validation Results** dialog box displays the **Error** grid, which displays error information, organized first by Scenario and then by error type.

Below the **Error** grid, the following buttons appear:

- **OK:** Closes the **Diagram Validation Results** dialog box.
- **Copy Details:** Copies the content of the **Error** grid so that you can paste the error information into another application or file, such as a Microsoft Word or Microsoft Excel document. You can use this method to view the Diagram Canvas and error information simultaneously while you correct the errors.
- **Help:** Displays the context-sensitive Help topic for the **Diagram Validation Results** dialog box.

Types of Errors

If you validate System Reliability Analysis Diagrams and Meridium APM indicates that any Diagram is invalid, the [Diagram Validation Results dialog box](#) will be displayed, where you can view the results of the validation.

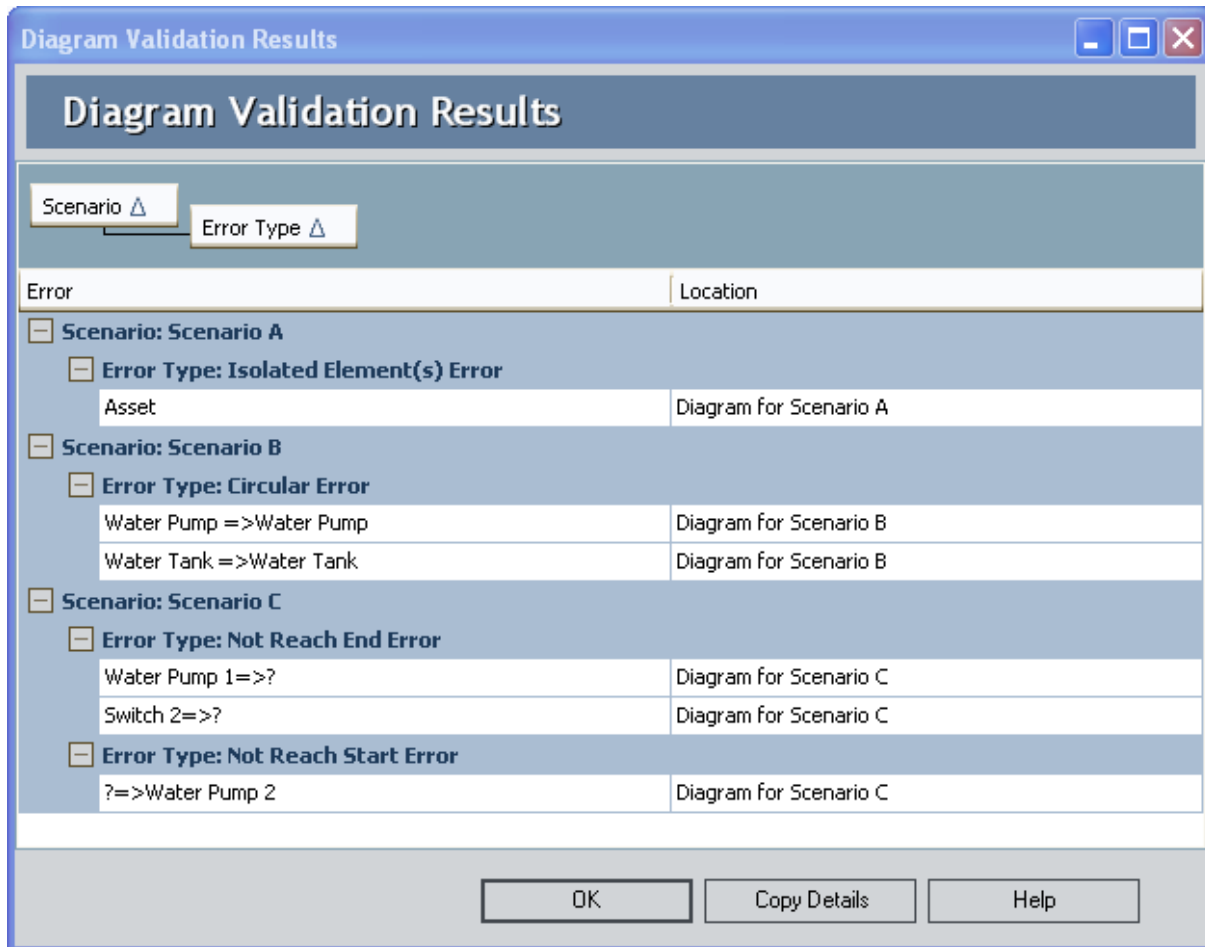

The **Diagram Validation Results** dialog box can display any of the following error messages, depending upon the conditions that are found within the Diagram:

- [Not Reach End Error](#).
- [Not Reach Start Error](#).
- [Isolated Element\(s\) Error](#).
- [Circular Error](#).

Not Reach End Error

A *Not Reach End Error* in a System Reliability Analysis Diagram results from a Diagram configuration where the End element cannot be reached from the Start element when following connections in the Diagram. Each Diagram must be connected such that a path exists from the Start element to the End element. If this path does not exist, the simulation will not run. You must correct this error before you can run the simulation.

The following images show a Not Reach End Error in [Scenario C](#) and the corresponding error message in the [Diagram Validation Results dialog box](#).

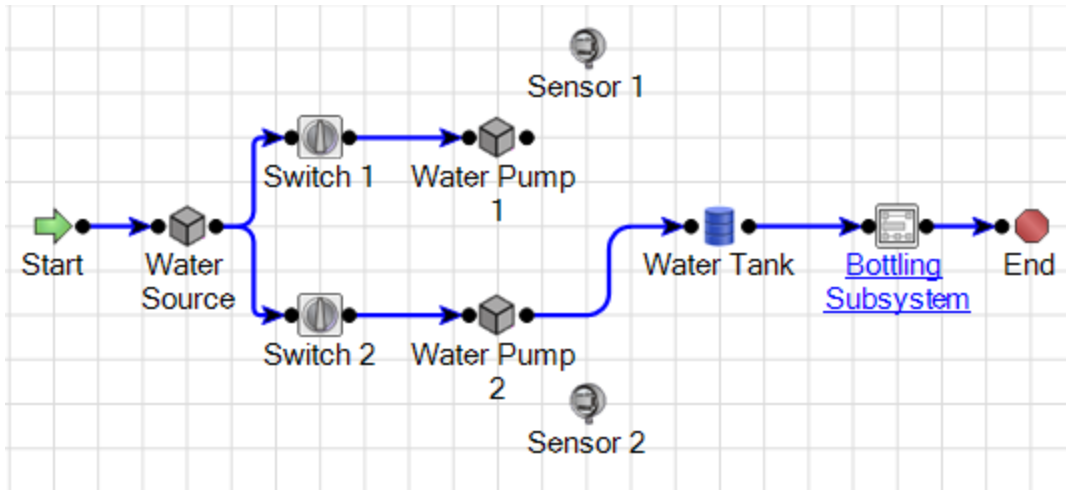

Scenario: Scenario C	
Error Type: Not Reach End Error	
Water Pump 1=>?	Diagram for Scenario C

Not Reach Start Error

A *Not Reach Start Error* in a System Reliability Analysis results from a Diagram configuration where the Start element cannot be reached from the End element by following connections in the Diagram. Each Diagram must be connected such that a path exists from the End element to the Start element. If this path does not exist, the simulation will not run. You must correct this error before you can run the simulation.

The following images show a Not Reach Start Error in [Scenario C](#) and the corresponding error message in the [Diagram Validation Results dialog box](#).

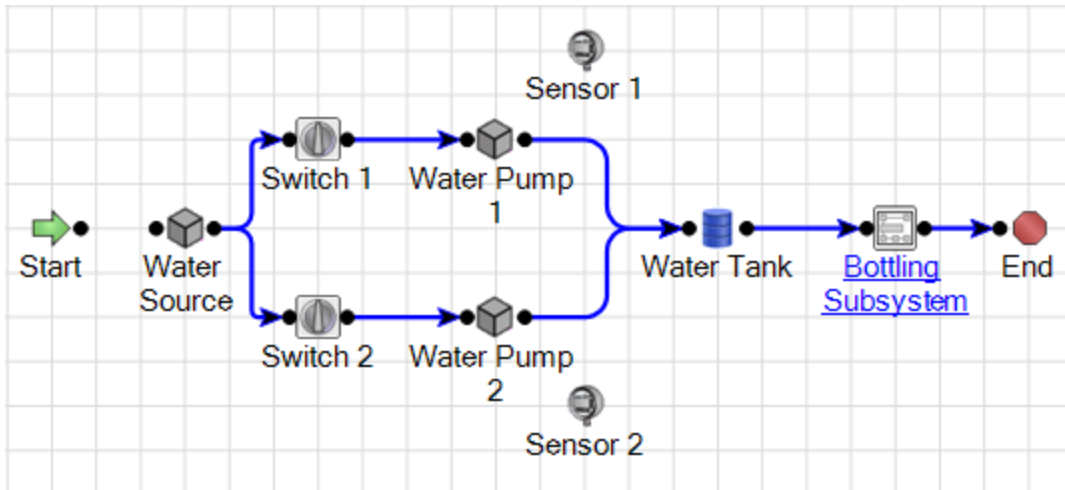

[-] Scenario: Scenario C	
[-] Error Type: Not Reach End Error	
Start=>?	Diagram for Scenario C
[-] Error Type: Not Reach Start Error	
?=>Water Source	Diagram for Scenario C

Note: This broken connection produced both a [Not Reach End Error](#) and a Not Reach Start Error because there is not a complete connection anywhere in the Diagram.

Isolated Element(s) Error

An *Isolated Element(s) Error* in System Reliability Analysis results from a Diagram configuration where an element is not connected, on one or both sides, to the elements that run from the Start element to the End element in the Diagram. This type of error will not prevent the simulation from running, but the element that is missing the connection(s) will be ignored by the simulation.

The following images show an isolated element error in [Scenario A](#) and the corresponding error message in the [Diagram Validation Results dialog box](#).

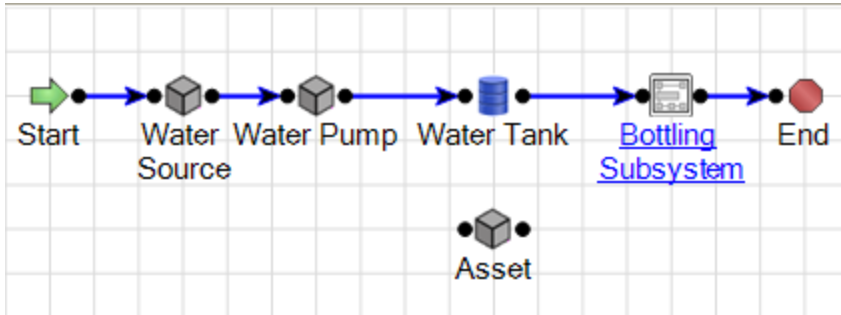

[-] Scenario: Scenario A	
[-] Error Type: Isolated Element(s) Error	
Asset	Diagram for Scenario A

Circular Error

A *Circular Error* in a System Reliability Analysis Diagram results from a Diagram configuration where an element in the series has a connection to an earlier element in the series in the Diagram. This will prevent the simulation from running and you must repair the connection so that it starts at the Start element and ends at the End element.

The following images show a circular error in [Scenario B](#) and its corresponding error message in the [Diagram Validation Results dialog box](#).

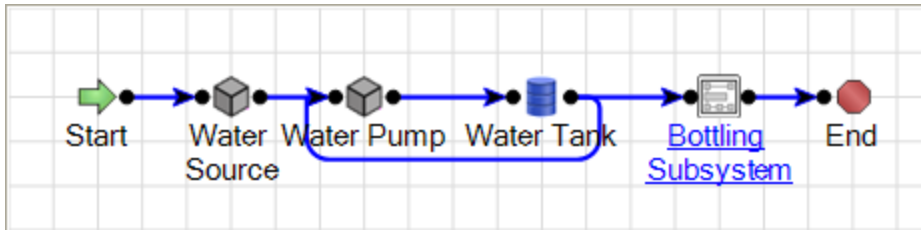

[-] Scenario: Scenario B	
[-] Error Type: Circular Error	
Water Pump =>Water Pump	Diagram for Scenario B
Water Tank =>Water Tank	Diagram for Scenario B

About Risks

In System Reliability, a Risk identifies one way in which a piece of equipment or location can fail. If the Risk occurs, then the piece of equipment or location will fail, and the system cannot run. In System Reliability Analyses, Risks are stored in System Risk records, which can be linked to [System Asset](#) and [System Switch records](#).

A piece of equipment or location may have multiple Risks to represent multiple ways in which that piece of equipment or location can fail. As such, System Asset and System Switch records can be linked to multiple System Risk records.

Each Risk has a characteristic pattern of causing a piece of equipment or location to fail as defined by its TTF distribution data or maximum operating time. Risks also have TTR distribution data, which characterizes the time required to correct the failure that occurs as the result of the Risk and get the system running again. This distribution data is stored in Distribution records, which are linked to Risk records.

About Potential and Functional Failures

A Risk identifies a way in which a piece of equipment or location can fail but does not necessarily indicate that a failure will absolutely occur or will occur immediately. For example, a piece of equipment might fail if a bearing wears out. Through an inspection, we may notice that the bearing is beginning to wear thin and determine that it will last only about two more months before it wears out completely and causes the piece of equipment to shut down. In this scenario:

- The *Risk* is a bearing failure.
- The *potential failure* is identified when an inspection detects a thin bearing.
- The *functional failure* occurs when the bearing completely wears out, causing the piece of equipment to shut down.

The time between when a potential failure is detected and when a functional failure occurs is the *P-F Interval*. In this example, the P-F Interval is two months. Before the P-F Interval, defects are small and are unlikely to be detected. After the P-F Interval is reached, defects can be found using proper inspection techniques. The following image demonstrates how the P-F Interval is connected to the piece of equipment failure.

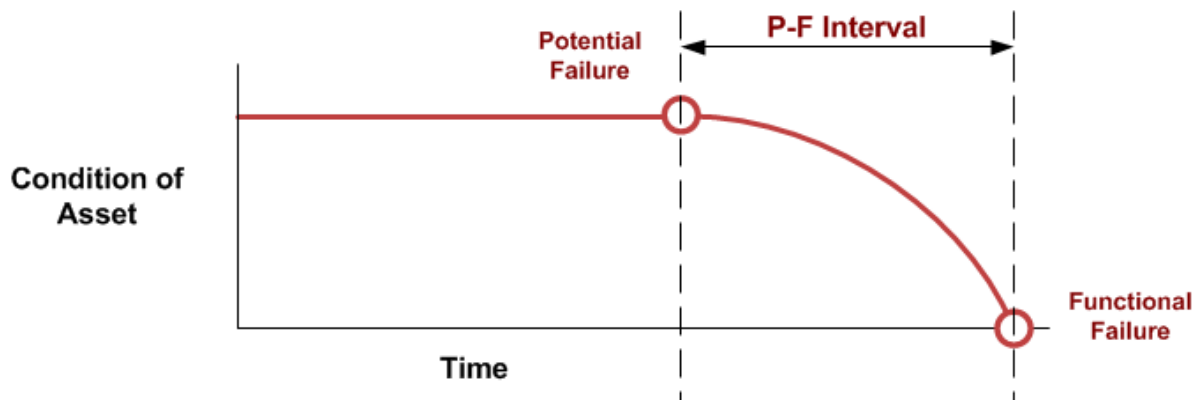

Using this information, we can determine a repair strategy for our example. If inspections were not properly conducted and we did not find the bearing defect, potential failures would not have been detected, and a functional failure would eventually occur, requiring the immediate replacement of the defective bearing. But in this case, the inspection identified a potential failure, so instead of replacing the bearing immediately, we can determine a percentage of the P-F interval at which to replace the bearing sometime before the piece of equipment fails while still preventing the eventual equipment failure.

Diagram Hierarchy Pane

The **Diagram Hierarchy** pane on the [System Reliability Scenarios - Risks](#) page displays the elements in the Diagram that you have defined on the [System Reliability Scenarios - Diagram](#) page. In the following image, the **Diagram Hierarchy** pane is outlined in red.

The screenshot shows the 'System Reliability Scenarios - Risks' interface. The 'Diagram Hierarchy' pane on the left is outlined in red and shows a tree structure with 'Water Pump' selected. The 'Risks' pane on the right displays a table with three rows of risks. The 'Mitigating Actions' pane is empty.

Name	Description	TTF	TTR	Planned Resource Usages	Unplanned Resource Usages	Risks to Reset
Bearing Failure		TTF Distribution	TTR Distribution	Planned Resource Usages	Unplanned Resource Usages	0
Impeller Failure		TTF Distribution	TTR Distribution	Planned Resource Usages	Unplanned Resource Usages	0
Seal Failure		TTF Distribution	TTR Distribution	Planned Resource Usages	Unplanned Resource Usages	0

When you select an element in the **Diagram Hierarchy** pane, the associated Risks for that element are displayed in the **Risks** pane. For example, in the preceding image, the selected *Water Pump* has three associated Risks:

- Bearing Failure.
- Impeller Failure.
- Seal Failure.

Risks Pane

The Risks pane is displayed on the [System Reliability Scenarios - Risks page](#) and on the Risks Editor window. The Risks pane displays the Risks associated with the Asset or Switch element selected in the [Diagram Hierarchy](#). In the following image, the Risks pane is outlined in red.

System Reliability Scenarios - Risks

Site Map: [Reliability](#)->[System Reliability](#)->[System Reliability Analysis Example](#)->[Scenario for Diagram B](#)

Scenario: Scenario for Diagram B

Diagram Hierarchy

Name

Scenario for Diagram B

- Botting Subsystem
 - Botting Line 1
 - Botting Line 2
 - Botting Line 3
 - Water Pump**
 - Water Tank

Risks

Name	Description	TTF	TTR	Planned Resource Usages	Unplanned Resource Usages	Risks to Reset
Bearing Failure		TTF Distribution	TTR Distribution	Planned Resource Usages	Unplanned Resource Usages	0
Impeller Failure		TTF Distribution	TTR Distribution	Planned Resource Usages	Unplanned Resource Usages	0
Seal Failure		TTF Distribution	TTR Distribution	Planned Resource Usages	Unplanned Resource Usages	0

Add Risk Associate Distribution Open Analysis Refresh Distribution Delete Risk

Mitigating Actions

Name	Description	Resource Usages
------	-------------	-----------------

Assign New Action Assign Existing Actions

The grid in the Risks pane contains the following columns of information:

- **Name:** Displays the value in the Name field in the System Risk record.
- **Description:** Displays the value in the Description field in the System Risk record.
- **TTF:** Displays the **TTF Distribution** link, which you can click to open the **TTF Distribution** window and view the [Time to Failure \(TTF\) distribution data for the associated System Risk record](#).
- **TTR:** Displays the **TTR Distribution** link, which you can click to open the **TTR Distribution** window and view the [Time to Repair \(TTR\) distribution data for the associated System Risk record](#).
- **Planned Resource Usages:** Displays the **Planned Resource Usages** link, which you can click to open the **Planned Resource Usages** window and view any [planned Resource usages that have been assigned to the Risk](#).
- **Unplanned Resource Usages:** Displays the **Unplanned Resource Usages** link,

which you can click to open the **Unplanned Resource Usages** window and view any [unplanned Resource usages that have been assigned to the Risk](#).

- **Risks to Reset:** Displays a number representing the number of [additional Risks that will be reset following the planned or unplanned correction of the Risk in that row](#). This number appears as a hyperlink, which you can click to access the [Risks to Reset dialog box](#), where you can manage the additional Risks that will be reset in the simulation following the planned or unplanned correction of the source Risk.

When you right-click any cell in the grid in the **Risks** pane, a [shortcut menu appears containing options that you can use to manage the Risks that you want to reset](#) following the planned or unplanned correction for the Risk in that row.

Below the grid in the **Risks** pane, the following buttons appear:

- **Add Risk:** Displays the **Add New Risk** window, where you create a new System Risk record to link to the currently selected System Asset or System Switch record.
- **Associate Distribution:** Displays the **Find Items** window, where you can [search for a Reliability Distribution or Reliability Growth Analysis to associate with the selected Risk](#).
- **Open Analysis:** Displays the **Reliability Distribution Summary** page or the **Reliability Growth Analysis** page for Reliability Distribution Analysis or Reliability Growth Analysis that is associated with the selected Risk. This button is enabled only when the selected Risk is associated with a Reliability Distribution Analysis or a Reliability Growth Analysis.
- **Refresh Distribution:** Refreshes the associated distributions by replacing the TTF and TTR distribution information with the most current information from the associated Reliability Distribution Analysis or Reliability Growth Analysis. This link is enabled only when the selected Risk is associated with a Reliability Distribution Analysis or a Reliability Growth Analysis.
- **Delete Risk:** After asking for confirmation, deletes the System Risk record that is currently selected in the **Risks** pane.

Mitigating Actions Pane

The **Mitigating Actions** pane is displayed on the [System Reliability Scenarios - Risks page](#) and on the **Risks Editor** window. It displays the Mitigating Actions associated with the Risk selected in the [Risks pane](#). In the following image, the **Mitigating Actions** pane is outlined in red.

System Reliability Scenarios - Risks

Site Map: [Reliability](#)->[System Reliability](#)->[System Reliability Analysis Example](#)->[Scenario for Diagram B](#)

Scenario: Scenario for Diagram B

Diagram Hierarchy

- Scenario for Diagram B
 - Bottling Subsystem
 - Bottling Line 1
 - Bottling Line 2
 - Bottling Line 3
 - Water Pump**
 - Water Tank

Risks

Name	Description	TTF	TTR	Planned Resource Usages	Unplanned Resource Usages	Risks to Reset
Bearing Failure		TTF Distribution	TTR Distribution	Planned Resource Usages	Unplanned Resource Usages	0
Impeller Failure		TTF Distribution	TTR Distribution	Planned Resource Usages	Unplanned Resource Usages	0
Seal Failure		TTF Distribution	TTR Distribution	Planned Resource Usages	Unplanned Resource Usages	0

Buttons: Add Risk, Associate Distribution, Open Analysis, Refresh Distribution, Delete Risk

Mitigating Actions

Name	Description	Resource Usages
Redesign Impellers		Resource Usages

Buttons: Assign New Action, Assign Existing Actions

When you select a Risk in the **Risks** pane, the associated Mitigating Actions for that Risk are displayed in the **Mitigating Actions** pane. For example, in the preceding image, the *Impeller Failure* Risk has one associated Mitigating Action, *Redesign Impellers*.

The grid in the **Mitigating Actions** pane contains the following columns of information:

- **Name:** Displays the value in the Name field in the [System Action record](#).
- **Description:** Displays the value in the Description field in the [System Action record](#).
- **Resource Usages:** Displays the **Resources Usages** link, which you can click to open the **Resource Usages** window to view and manage the Resources that have been assigned to the Action.

Below the grid in the **Actions** pane, the following buttons appear:

- **Assign New Action:** Displays the **Select Action Type** dialog box, where you can [create a new System Action record](#) to link to the currently selected System Asset or System Switch record. When you create a new Action by using the **Assign New Action** button, the Action will be assigned to mitigate the Risk currently selected in the [Risks pane](#).
- **Assign Existing Actions:** Displays the **Assign Actions** window, where you can [assign an existing Action to mitigate the Risk currently selected in the Risks pane](#) or remove an existing Action from mitigating the Risk currently selected in the **Risks** pane.

Accessing the Properties Pane

The [Properties pane](#) on the [System Reliability Scenarios - Risks page](#) lets you view and modify the [properties of the element that is currently selected](#) in the **Diagram Hierarchy** pane, **Risks** pane, or **Mitigating Actions** pane.

To access the Properties pane:

1. Select the element on the **System Reliability Scenarios - Risks** page for which you want to view or modify properties.
2. Pause on the **<Name>'s Properties** tab on the right side of the page.

The **<Name>'s Properties** pane appears. When you move your pointer away from the **<Name>'s Properties** tab, the **<Name>'s Properties** pane will collapse.

Note: If you want the **<Name>'s Properties** pane to remain on the page after you move your pointer away from the **<Name>'s Properties** tab, click the  button.

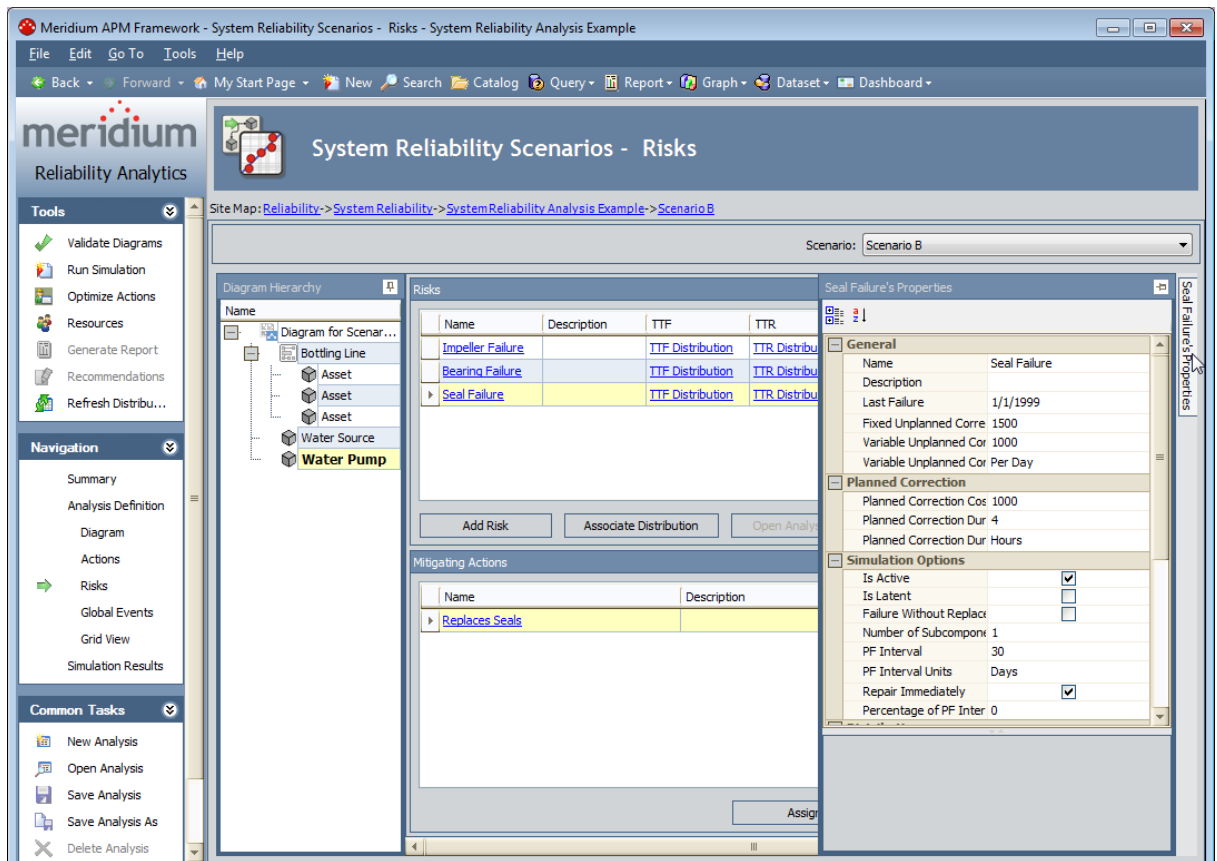

About Fields Displayed on the Properties Pane

Different fields are displayed in the **Properties** pane depending upon the element that is selected on the **System Reliability Scenarios - Risks** page. When you select an element, the **Properties** pane will display the fields that belong to the record that is associated with the selected element. You can select any of the following elements to view the fields in the associated record in the **Properties** pane:

- [Actions](#)
- [Assets](#)
- [Risks](#)
- [Switches](#)

Risk Fields

When you select a Risk in the **Risks** pane on the **System Reliability Scenarios - Risks** page, the **Properties** pane displays information related to that Risk. The following table lists:

- The row labels that are displayed in the **Properties** pane when you select a Risk in the **Risks** pane. The table is organized by the categories that are displayed when you view the **Properties** pane in a *categorized* view.

Note: In the table, the **Distributions** category displays in alphabetical order ALL of the fields that can be displayed in the **Distributions** category in the **Properties** pane. In some cases, depending upon which Risk you select in the **Risks** pane, not all of these fields will appear in the **Properties** pane. The **Notes** column contains information about any exceptions.

- The family caption of the family containing the record whose value is displayed in that row.
- The field caption of the field whose value is displayed in that row.
- Notes that provide more information about the value in a row.

Row Label	Record	Field	Notes
General			
Name	System Risk	Name	None
Description	System Risk	Description	None
Last Failure	System Risk	Last Failure	None
Fixed Unplanned Correction Cost	System Risk	Fixed Unplanned Correction Cost	None
Variable Unplanned Correction Cost	System Risk	Variable Unplanned Correction Cost	None
Variable Unplanned Correction Cost Units	System Risk	Variable Unplanned Correction Cost Units	None
Planned Correction			

Row Label	Record	Field	Notes
Planned Correction Cost	System Risk	Planned Correction Cost	None
Planned Correction Duration	System Risk	Planned Correction Duration	None
Planned Correction Duration Units	System Risk	Planned Correction Duration Units	None
Simulation Options			
Is Active	System Risk	Is Active	None
Is Latent	System Risk	Is Latent	None
Failure Without Replacement	System Risk	Failure Without Replacement	None
Number of Sub-components	System Risk	Number of Sub-components	None
PF Interval	System Risk	PF Interval	None
PF Interval Units	System Risk	PF Interval Units	None
Repair Immediately	System Risk	Repair Immediately	None
Percentage of PF Interval to Wait	System Risk	Percentage of PF Interval to Wait	None
Distributions			

Row Label	Record	Field	Notes
Beta	Weibull	Beta	This row appears only when the selected System Risk record is linked to a Distribution record whose Distribution Type is Weibull.
Description	Distribution	Short Description	None
Distribution Type	Distribution	Distribution Type	This row displays a list containing the available selections for the distribution types for the Distribution record that is linked to the selected System Risk record. The list contains the following values: Exponential, Lognormal, Normal, SingleValue, and Weibull.
Eta	Weibull	Eta	This row appears only when the selected System Risk record is linked to a Distribution record whose Distribution Type is Weibull.
Gamma	Weibull	Gamma	This row appears only when the selected System Risk record is linked to a Distribution record whose Distribution Type is Weibull.
Gamma	Lognormal	Gamma	This row appears only when the selected System Risk record is linked to a Distribution record whose Distribution Type is Lognormal.

Row Label	Record	Field	Notes
Mean	Normal	Mean	This row appears only when the selected System Risk record is linked to a Distribution record whose Distribution Type is Normal.
MTBF	Exponential	MTBF	This row appears only when the selected System Risk record is linked to a Distribution record whose Distribution Type is Exponential.
MTTR	Exponential	MTBF	This row appears only when the selected System Asset record is linked to a System Risk record that is linked to a Distribution record whose Distribution Type is Exponential.
Mu	Lognormal	Mu	This row appears only when the selected System Risk record is linked to a Distribution record whose Distribution Type is Lognormal.
Name	Exponential, Lognormal, Normal, SingleValue, or Weibull	Name	None
Sigma	Lognormal	Sigma	This row appears only when the selected System Risk record is linked to a Distribution record whose Distribution Type is Lognormal.

Row Label	Record	Field	Notes
Standard Deviation	Normal	Standard Deviation	This row appears only when the selected System Risk record is linked to a Distribution record whose Distribution Type is Normal.
Time Unit	Exponential, Lognormal, Normal, SingleValue, or Weibull	Units	None
Value	Normal	Value	This row appears only when the selected System Risk record is linked to a Distribution record whose Distribution Type is SingleValue, whose distribution data is stored in a Normal record.

The following image shows the categorized view of the **Properties** pane that would be displayed if you selected the Seal Failure Risk in Scenario B.

Seal Failure's Properties

General

Name	Seal Failure
Description	
Last Failure	1/1/1999
Fixed Unplanned Correction	1500
Variable Unplanned Correcti	1000
Variable Unplanned Correcti	Per Day

Planned Correction

Planned Correction Cost	1000
Planned Correction Duration	4
Planned Correction Duration	Hours

Simulation Options

Is Active	<input checked="" type="checkbox"/>
Is Latent	<input type="checkbox"/>
Failure Without Replacemer	<input type="checkbox"/>
Number of Subcomponents	1
PF Interval	30
PF Interval Units	Days
Repair Immediately	<input checked="" type="checkbox"/>
Percentage of PF Interval to	0

Distributions

TTF Distribution

Name	TTF Distribution
Description	
Distribution Type	Weibull
Time Unit	Years
Beta	4
Eta	3
Gamma	0

TTR Distribution

Name	TTR Distribution
Description	
Distribution Type	Single Value
Time Unit	Hours
Value	12

About Actions and Risks

After you create an Action in a System Reliability Analysis, you can assign a single Risk or multiple Risks to that Action. When you assign a Risk to an Action, a link is created between a System Risk Assessment record, which stores the GUID of the mitigated Risk in the Risk GUID field, and the Action. This allows the Action to *mitigate* the Risk. An Action may mitigate a Risk by changing certain properties, such as failure consequences or the failure distribution, of the Risk.

Actions mitigate Risks in different ways depending upon the type of Action that is assigned to the Risk. The different types of Actions mitigate Risks in the following ways:

- **Preventive Maintenance Action:** Can mitigate the Time to Fail (TTF) distribution of the Risk by increasing the maximum operating time of the Risk, as defined by the fields in the Distribution record that defines the TTF distribution associated with the Risk. For example the Replace Seal Action in [Scenario B](#) of the [System Reliability Analysis Example](#) mitigates the Seal Failure Risk by creating more operating time by replacing the existing seals, which have a smaller amount of operating time, with new seals that have a larger amount of operating time.
- **Condition Monitor or Inspection Action:** Can mitigate the consequences of failure by fixing potential failures before they occur. This allows proactive repairs, or [planned corrections](#), to be made to the system instead of reactively fixing a failure using an [unplanned correction](#). Planned corrections can consume less Resources and lower the costs of a Scenario. For example, the Vibration Analysis Action in [Scenario B](#) of the [System Reliability Analysis Example](#) mitigates the Bearing Failure Risk by identifying a potential Bearing Failure and executing a planned correction, which requires less Resources and less Resource usage than executing an unplanned correction.
- **Special Action:** Can mitigate the failure consequences of the Risk, as defined in the Fixed Unplanned Correction Cost field of the System Risk record, and the TTF distribution, as defined by the Distribution record that represents the TTF distribution associated with the Risk. For example, the occurrence of the Redesign Impeller Action in [Scenario B](#) of the [System Reliability Analysis Example](#) mitigates the Impeller Failure by reducing the fixed unplanned correction cost and extending the TTF distribution of the Impeller Failure Risk.

Note: An Action does not have to mitigate a Risk, but associating an Action with a Risk and mitigating the Risk creates a more reliable system.

Creating Risks on the Risks Page

The following instructions provide details on creating Risk records and simultaneously assigning them to Actions via the [System Reliability Scenarios - Risks](#) page. You can also complete this workflow using the [System Reliability Scenarios - Actions](#) page.

To add a Risk to an Asset or Switch element in a Scenario:

1. While viewing the desired non-Active Scenario on the **System Reliability Scenarios - Risks** page, in the **Diagram Hierarchy** pane, select the element to which you want to add a Risk.
2. Below the grid in the **Risks** pane, click the **Add Risk** button.

The **Add New Risk** window appears, displaying the default datasheet for the System Risk family.

The screenshot shows the 'Add New Risk' dialog box with the following fields and values:

- Name: New Risk
- Description: (empty text area)
- Last Failure: (empty dropdown)
- Fixed Unplanned Correction Cost: 0
- Variable Unplanned Correction Cost: 0 Per Day
- Planned Correction Cost: 0
- Planned Correction Duration: 0 Days
- Is Active:
- Is Latent:
- Failure Without Replacement:
- Number of Subcomponents: 1
- PF Interval: 0 Days
- Repair Immediately:
- Percentage of PF Interval to Wait (%): 0

3. In the fields on the **Add New Risk** window, [define the properties of the System Risk record as desired](#).
4. Click **OK**.

The System Risk record appears in the Risks pane.

Creating Risks on the Actions Page

The following instructions provide details on creating a Risk record and simultaneously assigning it to an Action using the **System Reliability Scenarios - Actions** page. You can also [complete this workflow using the System Reliability Scenarios - Risks page](#).

To assign a new Risk to an Action:

1. While viewing the desired non-Active Scenario on the **System Reliability Scenarios - Actions** page, in the **Diagram Hierarchy** pane, select the element that contains the Action to which you want to assign a Risk.
2. In the grid in the **Actions** pane, select the Action to which you want to assign a Risk.
3. Below the grid in the **Mitigated Risks** pane, click the **Assign New Risk** button.

The **New Risk** window appears, displaying the default datasheet for the System Risk family.

The screenshot shows the 'New Risk' dialog box with the following fields and values:

- Name: New Risk
- Description: (empty)
- Last Failure: (empty)
- Fixed Unplanned Correction Cost: 0
- Variable Unplanned Correction Cost: 0 Per Day
- Planned Correction Cost: 0
- Planned Correction Duration: 0 Days
- Is Active:
- Is Latent:
- Failure Without Replacement:
- Number of Subcomponents: 1
- PF Interval: 0 Days
- Repair Immediately:
- Percentage of PF Interval to Wait (%): 0

4. In the fields on the **New Risk** window, [define the properties of the System Risk record as desired](#).
5. Click **OK**.

The new Risk is created, linked to the selected element, assigned to the Action, and it appears in the grid in the **Mitigated Risks** pane.

Assigning Existing Risks to Actions

To assign existing Risks to an Action:

1. While viewing the desired Scenario on the [System Reliability Scenarios - Actions page](#), in the [Diagram Hierarchy pane](#), select the element that contains the Action to which you want to assign a Risk.
2. In the grid in the **Actions** pane, select the Action to which you want to assign a Risk.
3. Below the grid in the **Mitigated Risks** pane, click the **Assign Existing Risks** button.

The **Assign Risk** window appears, which shows the Risks that exist in the Scenario to which the Action belongs.

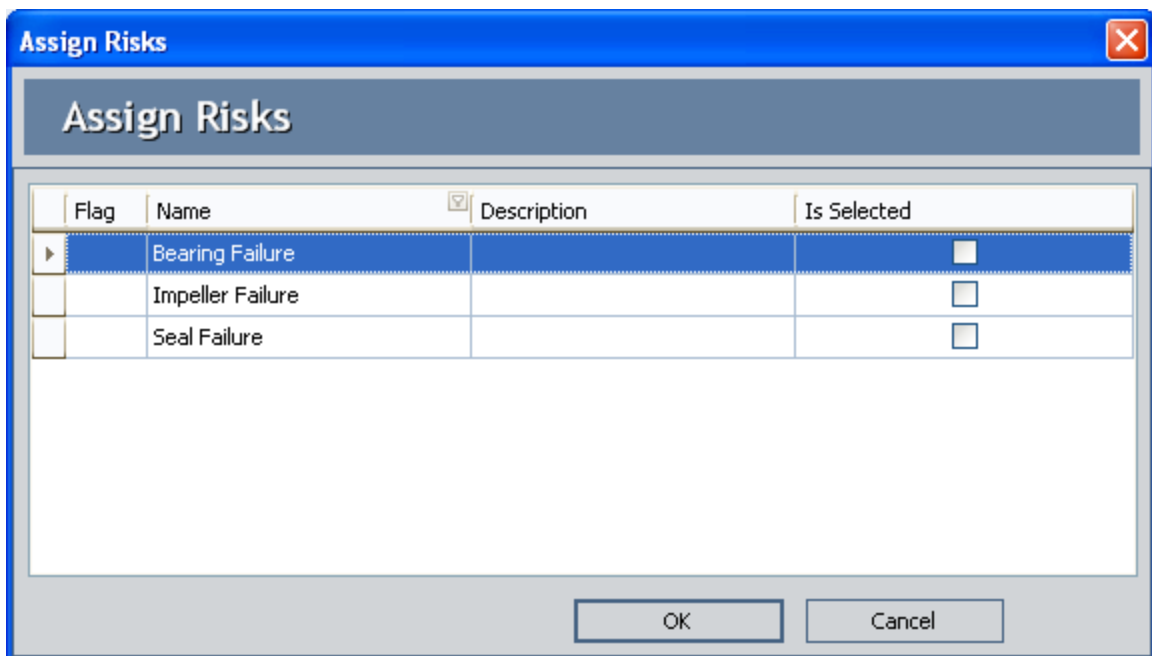

In this image, the **Assign Risks** window displays some of the Risks that exist in our [System Reliability Analysis Example](#).

4. On the **Assign Risks** window, in the **Is Selected** column of the grid, select the check box for the Risk(s) that you want to assign to the Action.

Hint: You can remove any Risk that is currently assigned to the Action by clearing the **Is Selected** check box.

5. Click **OK**.

The Risk(s) are assigned to the selected Action in the **Actions** pane and appear in the grid in the **Mitigated Risks** pane.

Options for Modifying Risks

You can modify the values in a System Risk record using either of the following pages:

- [System Reliability Scenarios - Risks](#)
- [System Reliability Scenarios - Actions](#)

Modifying Risks on the Risks Page

To modify a Risk using the System Reliability Scenarios - Risks page:

1. While viewing the desired Scenario on the **System Reliability Scenarios - Risks** page, in the **Diagram Hierarchy** pane, select the row that contains the Risk you want to modify.
2. In the **Name** column of the grid in the **Risks** pane, click the hyperlinked name of the Risk that you want to modify.

The **<Risk Name>** dialog box appears, where **<Risk Name>** is the name of the System Risk record that you selected.

The screenshot shows a dialog box titled "v3.1.0 Rel. Dist. Analysis from a query". The dialog box contains the following fields and controls:

- Name:** v3.1.0 Rel. Dist. Analysis from a query
- Description:** Description for v3.1.0 Rel. Dist. Analysis from a query
- Last Failure:** (empty dropdown menu)
- Fixed Unplanned Correction Cost:** 1000
- Variable Unplanned Correction Cost:** 10000, Per Day
- Planned Correction Cost:** 0
- Planned Correction Duration:** 0, Days
- Is Active:**
- Is Latent:**
- Failure Without Replacement:**
- Number of Subcomponents:** 1
- PF Interval:** 0, Days
- Repair Immediately:**
- Percentage of PF Interval to Wait (%):** 0

Buttons: OK, Cancel

3. Modify the properties of the System Risk record as desired.
4. Click **OK**.

Your changes to the System Risk record are saved.

Modifying Risks Using the Actions Page

To modify a Risk using the System Reliability Scenarios - Actions page:

1. While viewing the desired Scenario on the **System Reliability Scenarios - Actions** page, in the **Diagram Hierarchy** pane, select the row that contains the Risk you want to modify.
2. In the **Name** column of the grid in the **Mitigated Risks** pane, click the hyperlinked name of the Risk that you want to modify.

The **<Risk Name>** dialog box appears, where **<Risk Name>** is the name of the System Risk record that you selected.

The screenshot shows a dialog box titled "v3.1.0 Rel. Dist. Analysis from a query". The dialog box contains the following fields and controls:

- Name:** v3.1.0 Rel. Dist. Analysis from a query
- Description:** Description for v3.1.0 Rel. Dist. Analysis from a query
- Last Failure:** (empty dropdown menu)
- Fixed Unplanned Correction Cost:** 1000
- Variable Unplanned Correction Cost:** 10000, Per Day
- Planned Correction Cost:** 0
- Planned Correction Duration:** 0, Days
- Is Active:**
- Is Latent:**
- Failure Without Replacement:**
- Number of Subcomponents:** 1
- PF Interval:** 0, Days
- Repair Immediately:**
- Percentage of PF Interval to Wait (%):** 0

Buttons: OK, Cancel

3. Modify the properties of the System Risk record as desired.
4. Click **OK**.

Your changes to the System Risk record are saved.

About Resources for Risks

After Resources exist for a System Reliability Analysis, you can assign them to Risks. When you do so, you associate the cost of that Resource with each failure that occurs as a result of that Risk. This allows you to assign a realistic, financial cost to the consequences of the Risk that can be included in the simulation results.

When you assign a Resource to a Risk, a System Resource Usage record will be created and will store information that specifies how the Resource will be used (e.g., the quantity and duration). There are two ways to assign Resources to Risks:

- Planned Resource Usage.
- Unplanned Resource Usage.

Assigning Resources to Risks

To assign a Resource to a Risk:

1. On the [System Reliability Scenarios - Risks page](#), in the [Diagram Hierarchy pane](#), select the element that contains the Risk to which you want to assign a Resource.
2. In the grid in the **Risks** pane, in the row containing the Risk to which you want to assign a Resource, click the **Planned Resource Usages** link.

-or-

In the grid in the **Risks** pane, in the row containing the Risk to which you want to assign a Resource, click the **Unplanned Resource Usages** link.

The **<Resource Usages> - <Risk>** window appears, where **<Resource Usages>** is the type of Resource Usage that you selected and **<Risk>** is the name of the Risk that you selected.

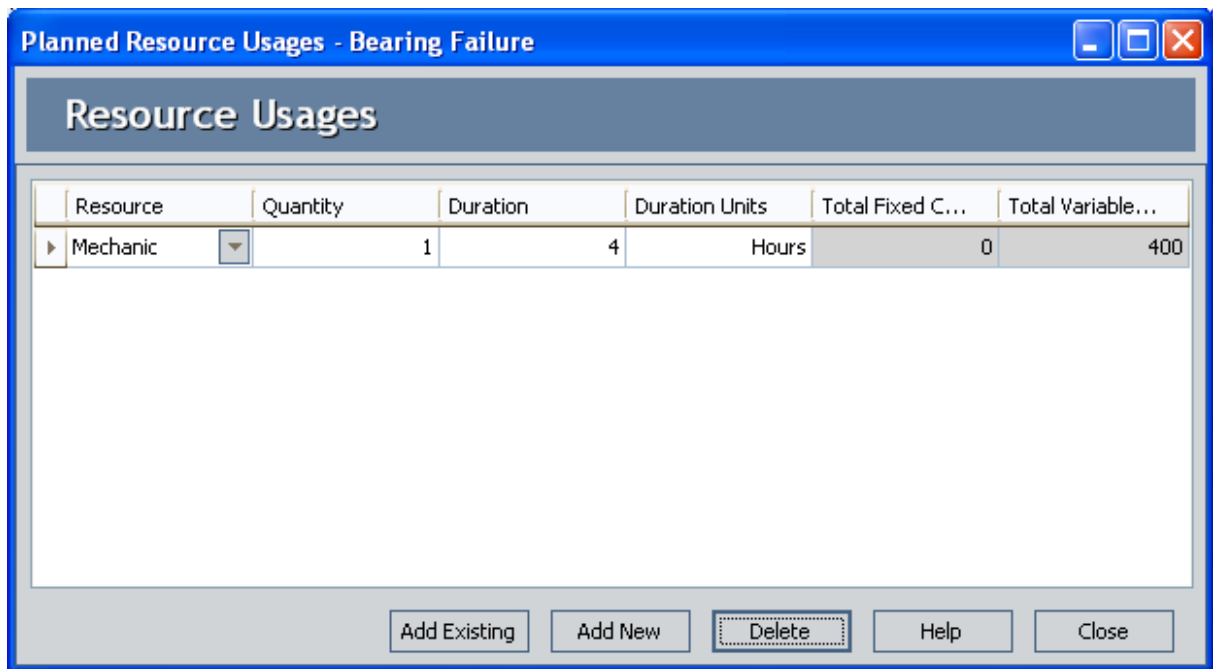

In this image, the **Planned Resource Usages - Bearing Failure** window displays the Resources that are assigned to the current Risk.

3. Click the **Add Existing** button. This button will be enabled only if one or more Resources already exist for the analysis.

A new row appears in the grid.

CE Hint: Alternatively, you can click the **Add New** button to [create a Resource from scratch](#) and assign it to a Risk. After you have created the Resource, you can skip to step 5.

4. In the **Resource** cell of the first row, click the  button, and select the Resource you want to assign to the Risk.
5. Type the desired values in the **Quantity**, **Duration**, and **Duration Units** cells. These values will be used to populate the corresponding fields in the [System Resource Usage record](#).

Note: The Total Fixed Cost and Total Variable Cost columns display the actual value that will be incurred when the System Resource Usage is added to the simulation results. Since this value is a product of the values you enter on the **Resource** dialog box and **Resource Usage** window, the cells are disabled and you cannot type values in these cells.

6. Click the **Close** button.

The <**Resource Usages**> - <**Risk**> window closes and your choices are applied.

Modifying Resources Assigned To Risks

When you modify a Resource that is assigned to a Risk, you modify the *System Resource Usage record*. The actual System Resource record is not changed.

To modify a Resource assigned to a Risk:

1. While viewing the desired System Reliability Analysis and Scenario on the [System Reliability Scenarios - Risks page](#), in the [Diagram Hierarchy pane](#), select the element whose Risk has Resources you want to modify.
2. In the grid in the **Risks** pane, in the row containing the Risk whose Resources you want to modify, click the **Planned Resource Usages** link.

-or-

In the grid in the **Risks** pane, in the row containing the Risk whose Resources you want to modify, click the **Unplanned Resource Usages** link.

The **<Resource Usages> - <Risk>** window appears, where **<Resource Usages>** is the type of Resource Usage that you selected and **<Risk>** is the name of the Risk that you selected.

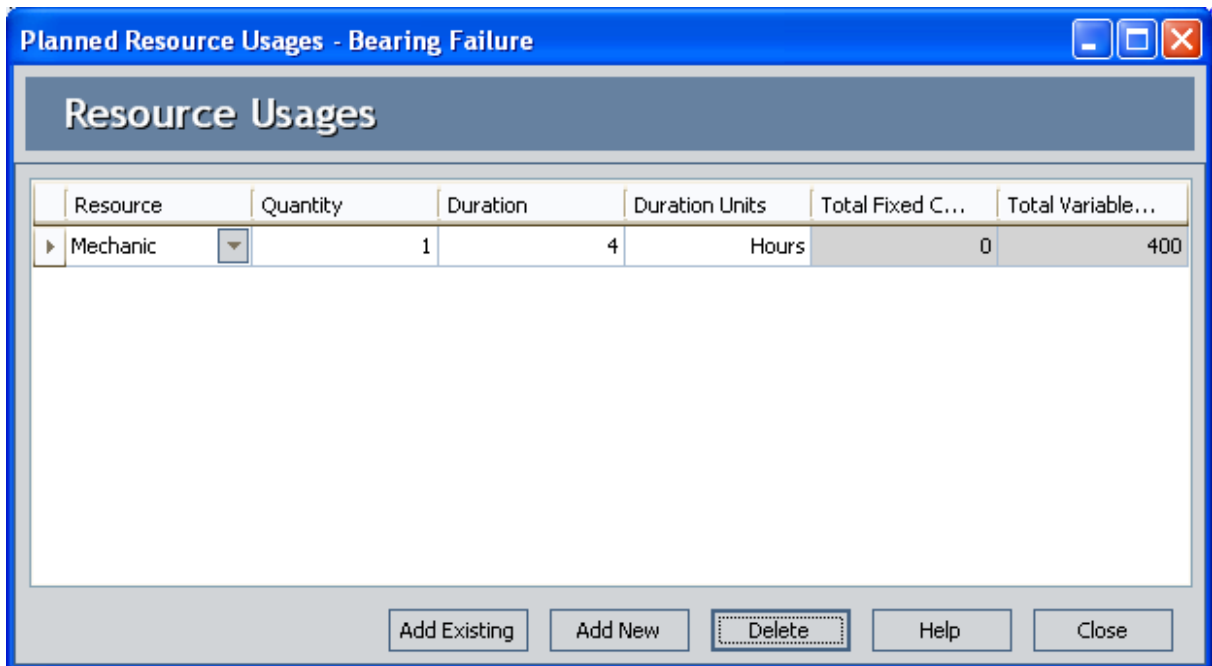

3. In the **Resource Usages** grid, [modify the properties of the Resource Usage record as desired](#).
4. Click the **Close** button.

Your changes are saved.

Removing Resources from Risks

When you remove a Resource from a Risk, you delete the System Resource Usage record so that the Resource is no longer used by the selected Risk. The actual System Resource record is still available for the System Reliability Analysis and can be used if needed.

To delete a Resource assigned to Risk:

1. While viewing the desired System Reliability Analysis and Scenario on the [System Reliability Scenarios - Risks page](#), in the [Diagram Hierarchy pane](#), select the Risk whose Resource you want to remove.
2. In the grid in the **Risks** pane, in the row containing the Risk whose Resources you want to remove, click the **Planned Resource Usages** link.

-or-

In the grid in the **Risks** pane, in the row containing the Risk whose Resources you want to remove, click the **Unplanned Resource Usages** link.

The **<Resource Usages> - <Risk>** window appears, where **<Resource Usages>** is the type of Resource Usage that you selected and **<Risk>** is the name of the Risk that you selected.

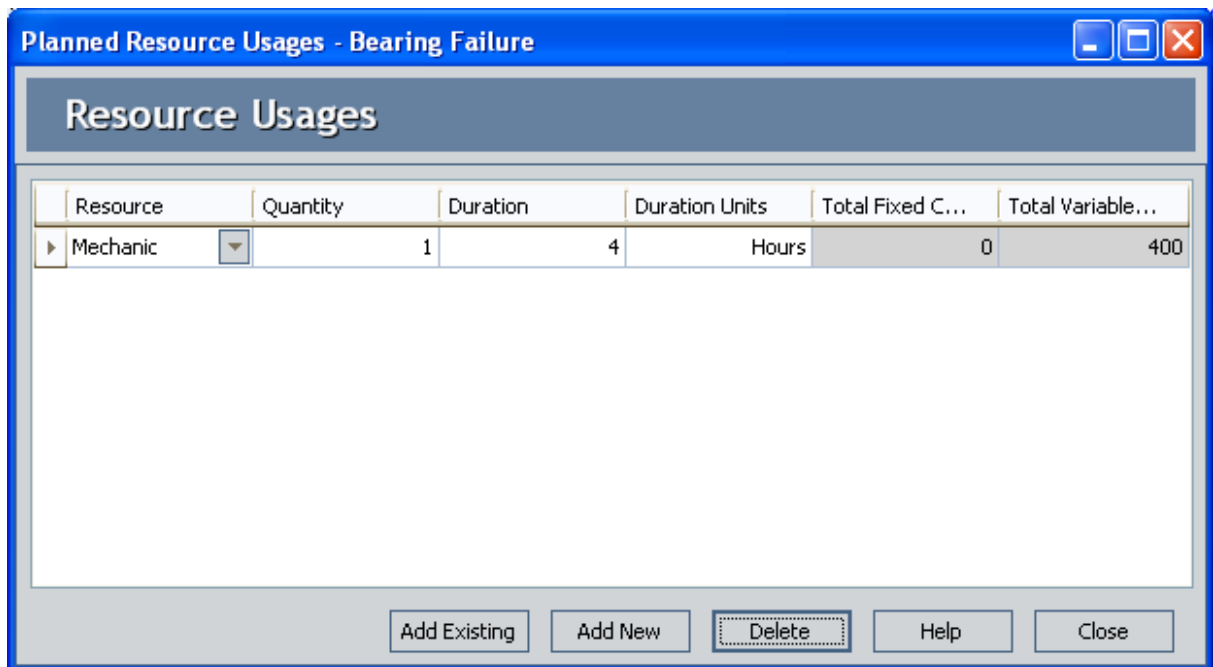

3. In the **Resource Usages** grid, select the Resource that you want to remove.
4. Click the **Delete** button.

A confirmation message appears, asking if you really want to delete the selected item(s).

5. Click the **Yes** button.

The Resource Usage is removed from the Risk.

About Defining Distribution Data for Risks

You have two options for defining distribution data for Risks. You can:

- [Enter distribution data manually.](#)
- [Associate distribution data from existing Reliability Distribution Analyses and Reliability Growth Analyses.](#)

Defining Distributions Data Manually

To define TTF or TTR distribution data manually:

1. While viewing the desired System Reliability Analysis and Scenario on the [System Reliability Scenarios - Risks page](#), in the [Diagram Hierarchy pane](#), select the element whose Risk distribution you want to define.
2. In the grid in the **Risks** pane, in the row containing the Risk whose distribution data you want to define...
 - In the **TTF** column, click the **TTF Distribution** link.
 - or-
 - In the **TTR** column, click the **TTR Distribution** link.

The **TTR Distribution** or **TTR Distribution** window appears, depending on which link you clicked.

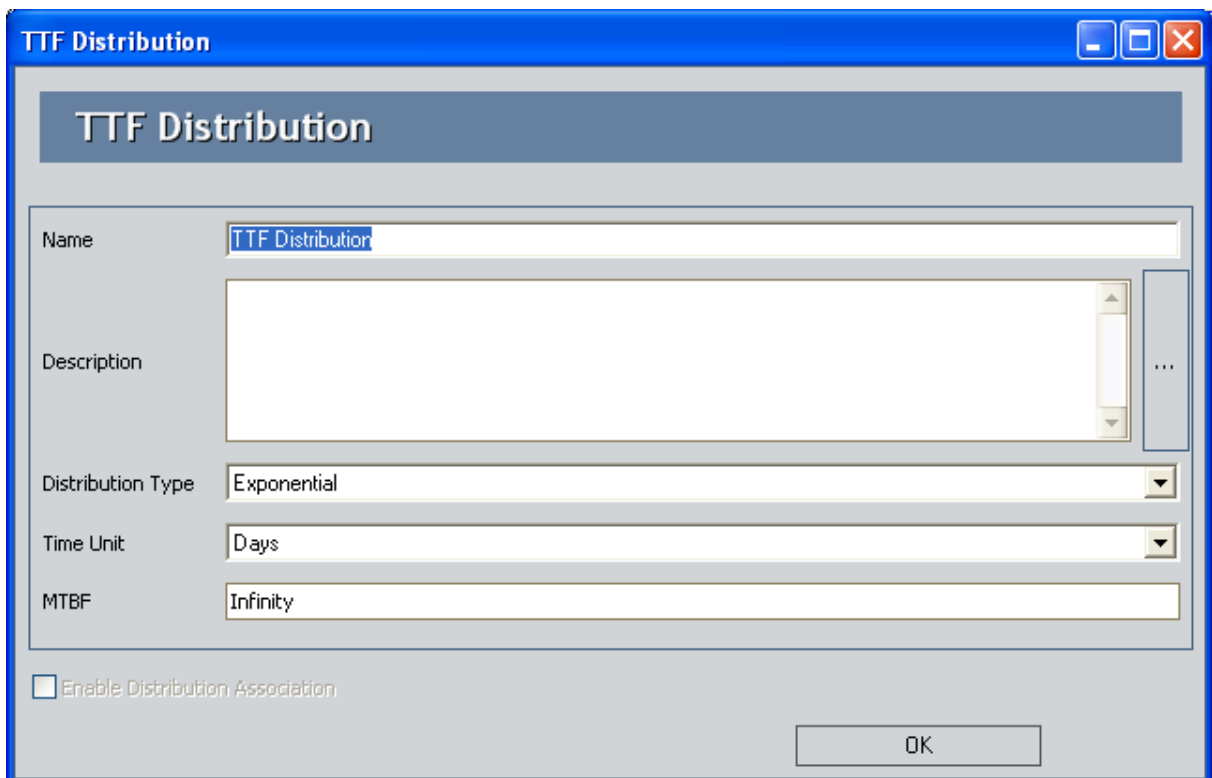

The screenshot shows a dialog box titled "TTF Distribution". The dialog has a header area with the text "TTF Distribution". Below the header, there are several input fields:

- Name:** A text box containing "TTF Distribution".
- Description:** A large empty text area.
- Distribution Type:** A dropdown menu showing "Exponential".
- Time Unit:** A dropdown menu showing "Days".
- MTBF:** A text box containing "Infinity".

At the bottom left, there is a checkbox labeled "Enable Distribution Association" which is currently unchecked. At the bottom right, there is an "OK" button.

3. Define the properties of the Distribution record as desired.
4. Click **OK**.

Your new distribution data is saved.

About Associating Existing Distribution Data with Risks

As an alternative to entering distribution data manually for Risks, you can associate distribution data from existing Reliability Growth Analyses and Reliability Distribution Analyses. When you enter data manually, you can choose any values that you desire for your distribution data, but when you associate existing distribution data with Risks, you use data stored in actual Reliability Growth or Reliability Distribution Analyses in a system.

After existing distribution data has been associated with a Risk, you can update the information periodically. When you associate the distribution data, the Entity Key and Family Key of the Reliability Distribution and Reliability Growth Analysis are stored in the System Risk record, thereby establishing a connection between the two records that allows for future updates. This way your System Reliability Analysis uses the most current information available to calculate the simulation results.

Associating Existing Distribution Data with Risks

To associate an existing Reliability Distribution Analysis or Reliability Growth Analysis with a Risk:

1. While viewing the desired System Reliability Analysis and Scenario on the [System Reliability Scenarios - Risks page](#), in the [Diagram Hierarchy pane](#), select the element that contains the Risk with which you want to associate distribution data.
2. In the grid in the **Risks** pane, select the Risk with which you want to associate a distribution data.
3. Below the grid in the **Risks** pane, click the **Associate Distribution** button.

The **Find Items** window appears, where you can search for a Reliability Growth Analysis or Reliability Distribution Analysis whose distribution data you want to associate with a Risk.

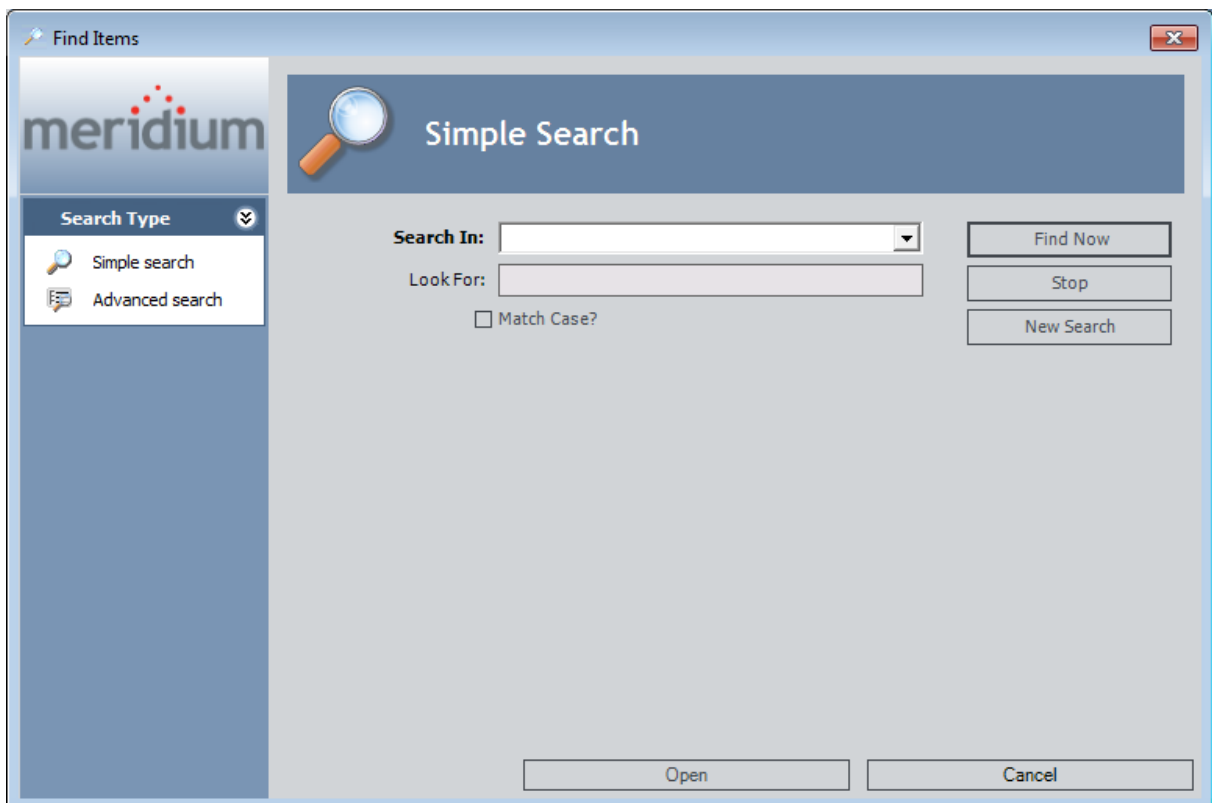

4. In the **Find Items** window, perform a search to locate your desired analysis.
The search results appear at the bottom of the window.
5. In the search results, select the desired record.
6. Click the **Open** button.

The distribution data from the selected record is imported, and a connection is established between the Risk and the selected Reliability Growth Analysis or Reliability Distribution Analysis.

Opening Associated Analyses

You can open the Reliability Growth or Reliability Distribution Analysis that is associated with the Risk selected in the in the [Diagram Hierarchy pane](#).

To open an associated analysis:

1. While viewing the desired System Reliability Analysis and Scenario on the [System Reliability Scenarios - Risks page](#), in the [Diagram Hierarchy pane](#), select the element that contains the Risk whose associated Reliability Growth or Reliability Distribution Analysis you want to view.
2. In the grid in the **Risks** pane, select the Risk whose associated Reliability Growth or Reliability Distribution Analysis you want to view.
3. Below the grid in the **Risks** pane, click the **Open Analysis** button.

Note: If your System Reliability Analysis has any unsaved changes, you will be prompted to save them.

The System Reliability Analysis is closed, and the Reliability Growth or Reliability Distribution Analysis is opened.

Refreshing Distribution Data

To refresh the distribution data associated with a Risk:

1. While viewing the desired System Reliability Analysis and Scenario on the [System Reliability Scenarios - Risks page](#), in the [Diagram Hierarchy pane](#), select the element that contains the Risk whose distribution data you want to refresh.
2. In the grid in the **Risks** pane, select the Risk whose distribution data you want to refresh.
3. Below the grid in the **Risks** pane, click the **Refresh Distribution** button.

A confirmation message appears, asking if you really want to refresh all distribution data for this Risk.

4. Click **OK**.

The distribution data is refreshed.

Removing the Association Between a Risk and a Growth or Distribution Analysis

To remove the association between a Risk and a Reliability Growth or Reliability Distribution Analysis:

1. While viewing the desired System Reliability Analysis and Scenario on the [System Reliability Scenarios - Risks page](#), in the [Diagram Hierarchy pane](#), select the element that contains the Risk for which you want to remove an analysis association.
2. In the grid in the **Risks** pane, select the hyperlink that represents the analysis association that you want to remove.

The **<Distribution>** window appears, where **<Distribution>** is the TTF or TTR distribution that you selected.

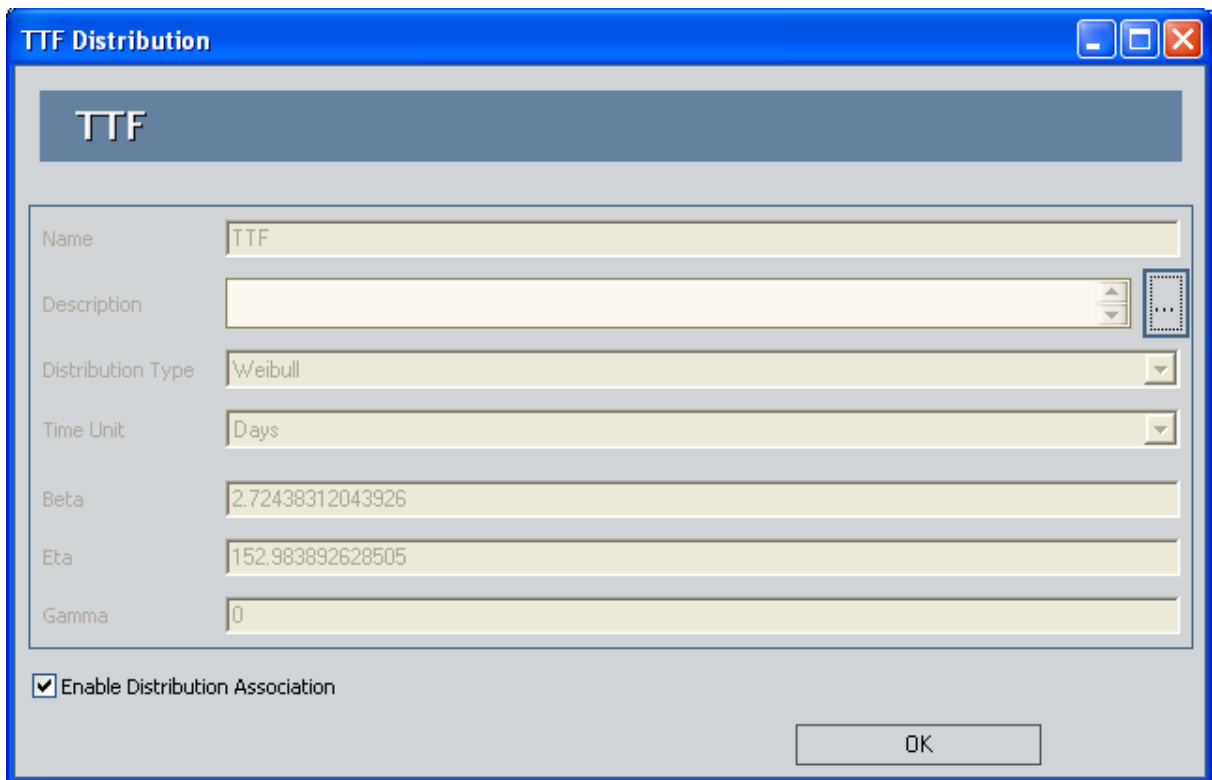

The screenshot shows a software window titled "TTF Distribution". The window has a blue title bar with standard minimize, maximize, and close buttons. The main content area has a dark blue header with the text "TTF". Below the header, there are several input fields arranged vertically. The "Name" field contains the text "TTF". The "Description" field is empty. The "Distribution Type" field is a dropdown menu currently showing "Weibull". The "Time Unit" field is a dropdown menu currently showing "Days". The "Beta" field contains the numerical value "2.72438312043926". The "Eta" field contains the numerical value "152.983892628505". The "Gamma" field contains the numerical value "0". At the bottom of the window, there is a checkbox labeled "Enable Distribution Association" which is checked. To the right of the checkbox is an "OK" button.

3. In the bottom of the **[Distribution]** window, clear the **Enable Distribution Association** check box.

The fields in the **TTF Distribution** window are enabled.

Note: You can keep the last values that have been imported from the associated analysis or you can enter new distribution data manually.

4. Click **OK**.

Your changes are saved.

About Resetting Risks

When a simulation is run, the occurrence of the Risks that are defined for a piece of equipment, location, or switch are simulated, based upon the TTF Distribution associated with that Risk. After a Risk occurs or after actions are performed that mitigate the occurrence of that Risk in the simulation, that Risk will be reset automatically. This means that the time in-service for the component associated with the Risk will be changed to zero (0), indicating that the component was replaced (or repaired to as good as new).

When a Risk will be reset automatically is determined by the failure type of that Risk. A Risk whose failure type is *Failure With Replacement* will be reset automatically when any of the following scenarios occurs:

- An unplanned correction takes place following the occurrence of a Risk.
- A planned correction takes place to mitigate the occurrence of a Risk.
- [Preventive Maintenance](#) is performed against a piece of equipment to mitigate the occurrence of a Risk.
- A [Special Action](#) with a [TTF replacement](#) is performed against a piece of equipment to mitigate the occurrence of a Risk.

A Risk whose failure type is *Failure Without Replacement* will be reset automatically when any of the following scenarios occurs:

- [Preventive Maintenance](#) is performed against a piece of equipment to mitigate the occurrence of a Risk.
- A [Special Action](#) with a [TTF replacement](#) is performed against a piece of equipment to mitigate the occurrence of a Risk.

For example, suppose that the following Risks with a failure type of *Failure With Replacement* are defined in your simulation for a *Water Pump*:

- Bearing Failure
- Impeller Failure
- Seal Failure

In the simulation, after unplanned correction is completed following the occurrence of the *Bearing Failure* Risk, the time in-service for the Bearing will be reset automatically to zero (0) to indicate that you will replace the Bearing after it fails so that the *Bearing Failure* Risk will not occur again until the defined TTF Distribution is reached.

In addition to Risks being reset automatically as described in the preceding scenarios, you can specify that *additional* Risks be reset following the planned or unplanned correction of a given Risk. In other words, you can specify a Risk as a *source* Risk, whose planned or unplanned correction triggers additional Risks to be reset at that time. This means that the time in-service for the components associated with the additional Risks will be changed to zero (0), indicating that the additional components were also

replaced (or repaired to as good as new) following the planned or unplanned correction of the source Risk.

Throughout the documentation we will use the term *source Risk* to refer to a Risk whose planned or unplanned correction triggers the resetting of additional Risks. We will use the term *additional Risk* to refer to Risks that are reset by the planned or unplanned correction of a source Risk.

You can specify that additional Risks should be reset *only* when:

- An unplanned correction takes place following the occurrence of a source Risk.
- or-
- A planned correction takes place to mitigate the occurrence of a source Risk.

It is important to note that source Risks that are mitigated as a result of Special Action with a TTF replacement or Preventive Maintenance will not trigger any additional Risks to be reset.

Continuing with the previous example, suppose that:

- You will replace the Seal, *in addition to* the Bearing, when the *Bearing Failure* Risk occurs.
- or-
- The planned correction that you perform to mitigate the occurrence of the *Bearing Failure* Risk will *also* mitigate the occurrence of the *Seal Failure* Risk.

In this case, you want to indicate in your simulation that the *Bearing Failure* Risk (i.e., the source Risk) should reset the *Seal Failure* Risk (i.e., the additional Risk). In other words, the time that the Seal has been in-service will *also* be changed to zero (0) to reflect that the Seal will be replaced (or repaired to as good as new) following the planned or unplanned correction of the *Bearing Failure* Risk.

You can manage the additional Risks that should be reset by a source Risk via the **Risks to Reset** dialog box or the shortcut menu in the **Risks** pane on the **System Reliability Scenarios - Risks** page. You can specify *any* Risk that is defined for a piece of equipment or location as a source Risk or an additional Risk, with a few [exceptions](#).

Rules for Resetting Risks

When you set up a simulation to include source Risks and additional Risks, it is important to keep in mind the following rules:

- You can specify a Risk as a source Risk if the failure type for that Risk is:
 - Failure Without Replacement
 - or-
 - Failure With Replacement
- You can specify a Risk as an additional Risk *only* if the failure type for that Risk is *Failure With Replacement*.

Keep in mind that in the simulation, only Risks whose failure type is *Failure With Replacement* are reset following a planned or unplanned correction. Risks whose failure type is *Failure Without Replacement* are not reset following planned or unplanned correction because the components associated with these Risks are not replaced (or repaired to as good as new). Specifically, this means that a Risk whose failure type is *Failure Without Replacement*...

- can be specified as a *source* Risk. In other words, the planned or unplanned correction of these Risks can trigger additional Risks to be reset, if the failure type of the additional Risks is *Failure With Replacement*.
- *Cannot* be specified as additional Risks. In the **Risks to Reset** grid on the **Risks to Reset** dialog box, rows containing Risks whose failure type is *Failure Without Replacement* are disabled.

For example, suppose that the following Risks with the following failure types are defined for a *Shell and Tube Heat Exchanger*:

- A Tube Bundle Failure Risk whose failure type is *Failure Without Replacement*
- A Shell Head Failure Risk whose failure type is *Failure With Replacement*
- A Seals (gaskets) Failure Risk whose failure type is *Failure With Replacement*

Now suppose that when you complete planned or unplanned correction for the *Tube Bundle Failure* Risk, though you will not replace (or repair to as good as new) the Tube Bundle, you *will* replace (or repair to as good as new) the Seals (gaskets). In this case, you want to indicate in your simulation that the *Tube Bundle Failure* Risk is a source Risk that should trigger the resetting of the *Seals (gaskets) Failure* Risk (i.e., an additional Risk). In other words, the time that the Seals (gaskets) has been in service will be changed to zero (0) to reflect that the Seals (gaskets) will be replaced (or repaired to as good as new) following the planned or unplanned correction of the *Tube Bundle Failure* Risk.

Selecting Risks to Reset

The following instructions provide details on specifying which additional Risks should be reset by a source Risk, using the [Risks to Reset dialog box](#). When you specify that an additional Risk should be reset, the time in-service for the component associated with the Risk will be changed to zero (0) in the simulation, following the planned or unplanned correction of the source Risk.

These instructions assume that you are viewing the desired scenario on the [System Reliability Scenarios - Risks page](#).

To select Risks to reset:

1. In the [Diagram Hierarchy pane](#), select the element whose Risks you want to manage.

The Risks defined for the piece of equipment or location represented by that element appear in the **Risks** pane.

Name	Description	TTF	TTR	Planned Resource...	Unplanned Resou...	Risks to Reset
Impeller Failure		TTF Distribution	TTR Distribution	Planned Resource U...	Unplanned Resource...	0
Bearing Failure		TTF Distribution	TTR Distribution	Planned Resource U...	Unplanned Resource...	0
Seal Failure		TTF Distribution	TTR Distribution	Planned Resource U...	Unplanned Resource...	0

2. In the grid in the [Risks pane](#), select the row containing the desired source Risk.
3. In the **Risks to Reset** cell, click the hyperlinked number.

The [Risks to Reset dialog box](#) appears.

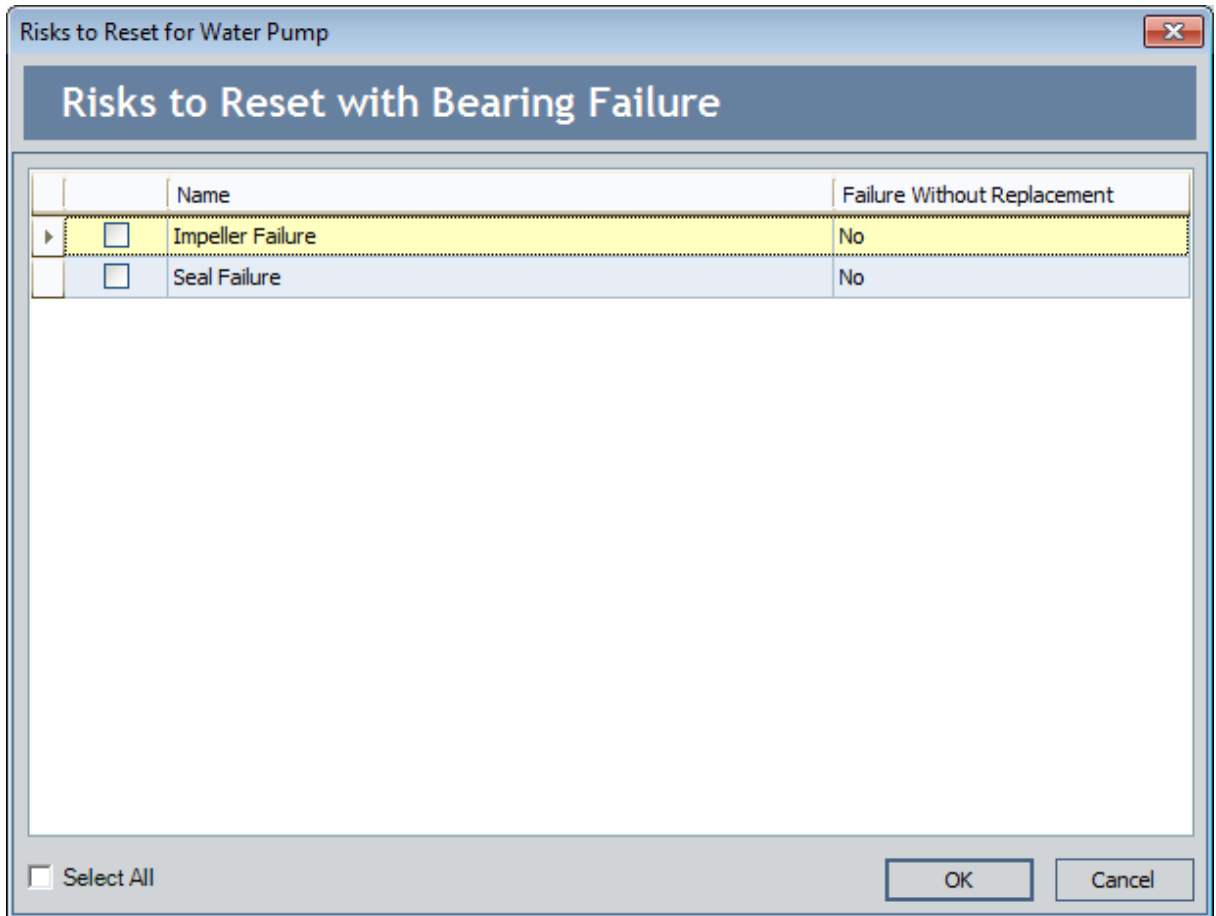

4. In the **Risks to Reset** grid, select the check box in the row containing each additional Risk that you want to be reset by the source Risk.

In the following image, the *Seal Failure* Risk is selected to be reset by the *Bearing Failure* Risk.

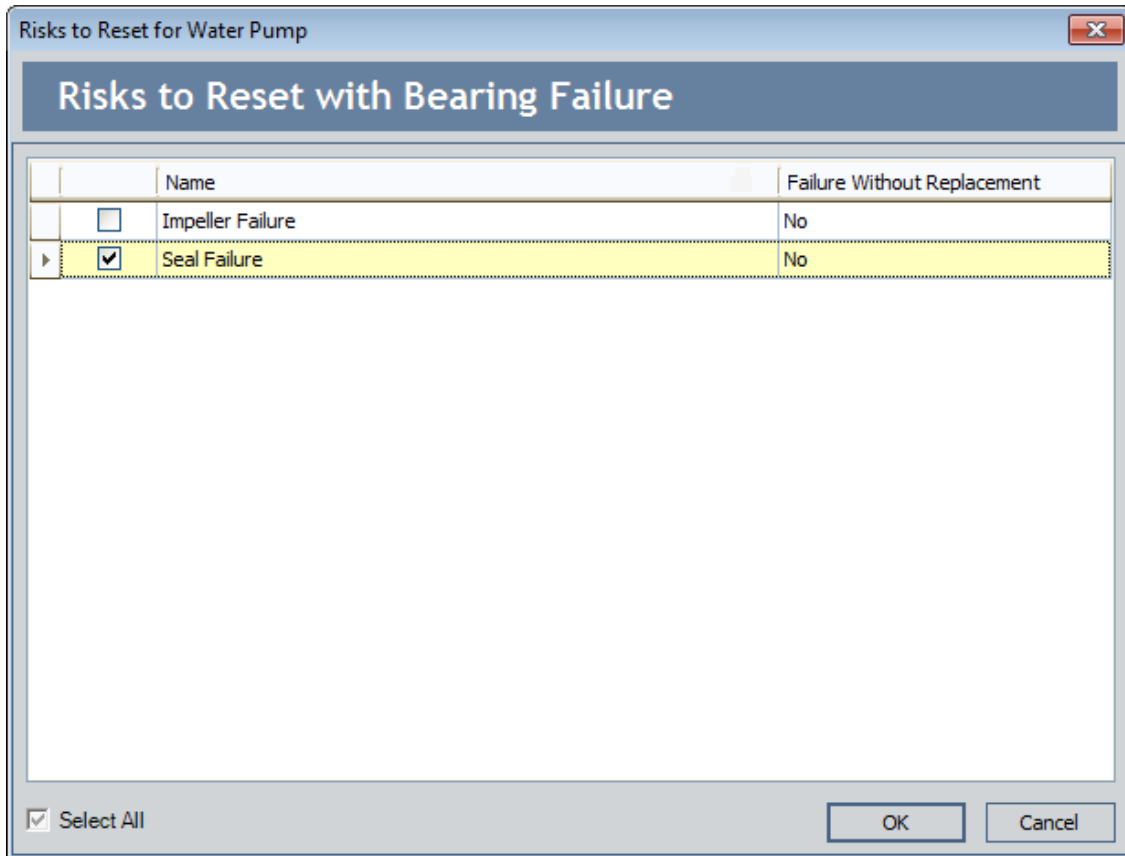

Hint: You can use the **Select All** check box to select *all* the Risks.

5. Click **OK**.

The **Risks to Reset** dialog box closes, and the hyperlinked number in the **Risks to Reset** cell for the source System Risk record changes to reflect the number of additional Risks you selected. When you run the simulation, the time in-service for the components associated with the additional Risks will be changed to zero (0), following the planned or unplanned correction of the source Risk.

In the following image, you can see that the hyperlinked number in the **Risks to Reset** cell for the *Bearing Failure* Risk is *1*, indicating that the *Bearing failure* Risk resets one additional Risk.

Selecting Risks to Reset

Name ▾	Description	TTF	TTR	Planned Resource Usages	Unplanned Resource Usages	Risks to Reset
Seal Failure		TTF Distribution	TTR Distribution	Planned Resource Usages	Unplanned Resource Usages	0
Impeller Failure		TTF Distribution	TTR Distribution	Planned Resource Usages	Unplanned Resource Usages	0
▶ Bearing Failure		TTF Distribution	TTR Distribution	Planned Resource Usages	Unplanned Resource Usages	1

Buttons: Add Risk, Associate Distribution, Open Analysis, Refresh Distribution, Delete Risk

In the example used in these instructions, when you run the simulation, the time that the Seal has been in service will be changed to zero (0) following the planned or unplanned correction of the *Bearing Failure* Risk to reflect that a the Seal was replaced (or repaired to as good as new).

Overview of the Risks to Reset Dialog Box

Using the **Risks to Reset** dialog box, you can specify per source Risk the additional Risks that should be reset following the planned or unplanned correction of that Risk.

The **Risks to Reset for <Asset ID>** dialog box contains the **Risks to Reset <Risk ID>** grid, where:

- **<Asset ID>** is the Entity ID of the record represented by the Asset element and to which the System Risk record for the source Risk is linked. Remember that Asset elements can represent records in one of the following families:
 - **System Asset:** This is the family that is used by default when an [Asset element is created from scratch](#).
 - **Equipment:** This is the family that is used by default when an [Asset element is imported](#) for a piece of equipment.
 - **Functional Location:** This is the family that is used by default when an [Asset element is imported](#) for a location.
- **<Risk ID>** is the value stored in the Name field in the System Risk record of the source Risk for which you are specifying additional Risks to be reset.

Throughout this documentation, we refer to the **Risks to Reset for <Asset ID>** dialog box as the **Risks to Reset** dialog box, and we refer to the **Risks to Reset with <Risk ID>** grid as the **Risks to Reset** grid.

Consider the following image, which shows an example of what the **Risks to Reset** dialog box looks like when you access it from the *Bearing Failure* Risk that is defined for the *Water Pump*.

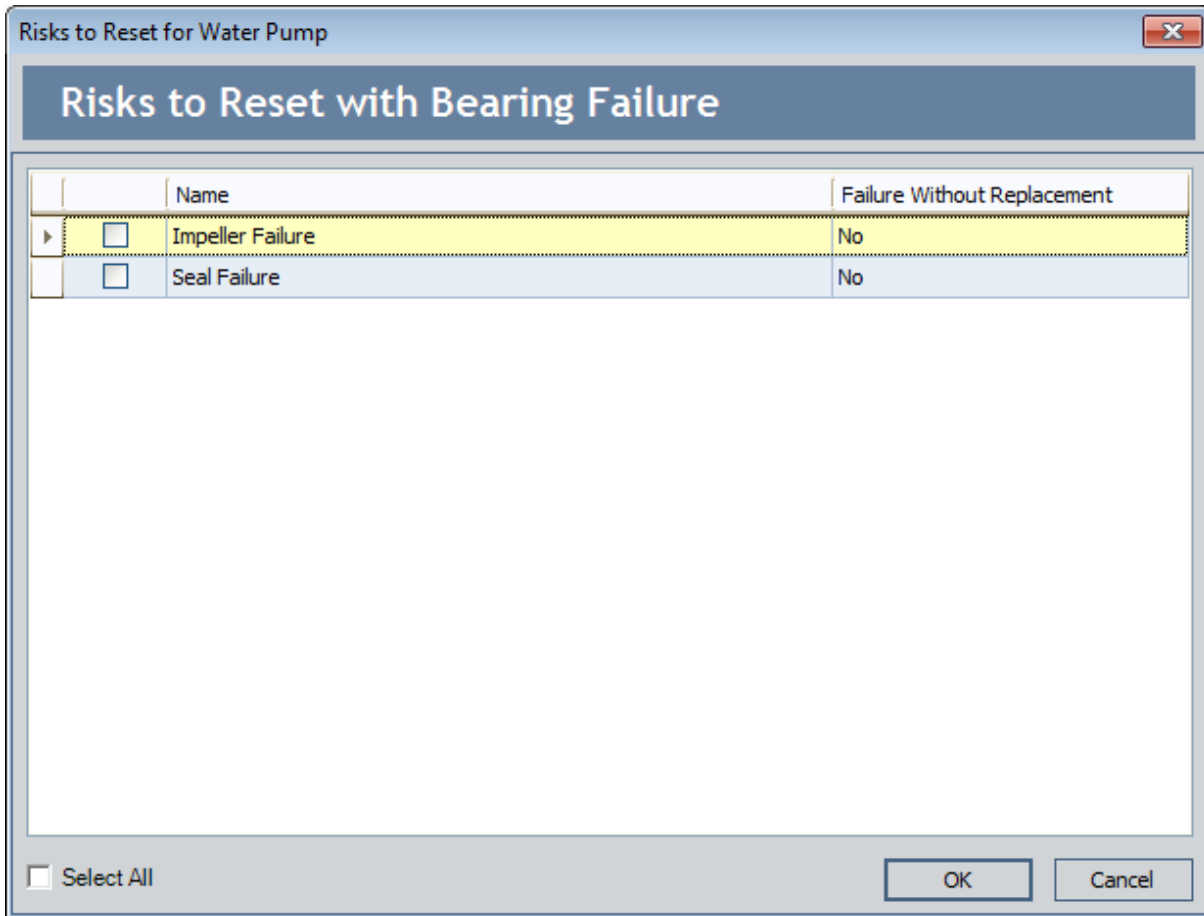

In this image, you can see that the **Risks to Reset** grid displays the Risks that are defined for the *Water Pump*, except for the currently selected Risk, whose ID appears in the title above the grid. In the **Risks to Reset** grid, you can select additional Risks that should be reset in the simulation following a planned or unplanned correction of the *Bearing Failure* Risk (i.e., the source Risk).

Using the Risks to Reset Dialog Box

You can use the **Risks to Reset** dialog box to select the additional Risks that a source Risk should reset. You can access the **Risks to Reset** dialog box, via the following locations:

- [System Reliability Scenarios - Risks page](#).
- [System Reliability Scenarios - Actions page](#).
- **Actions Editor** window.
- **Risks Editor** window.

You can modify selections on the **Risks to Reset** dialog box only when it is accessed via the **System Reliability Scenarios - Risks** page or the **Risks Editor** window. If you access the **Risks to Reset** dialog box using other methods, all the options will be disabled. The following image shows the **Risks to Reset** dialog box as it appears when you access it from the **System Reliability Scenarios - Risks** page or the **Risks Editor** window.

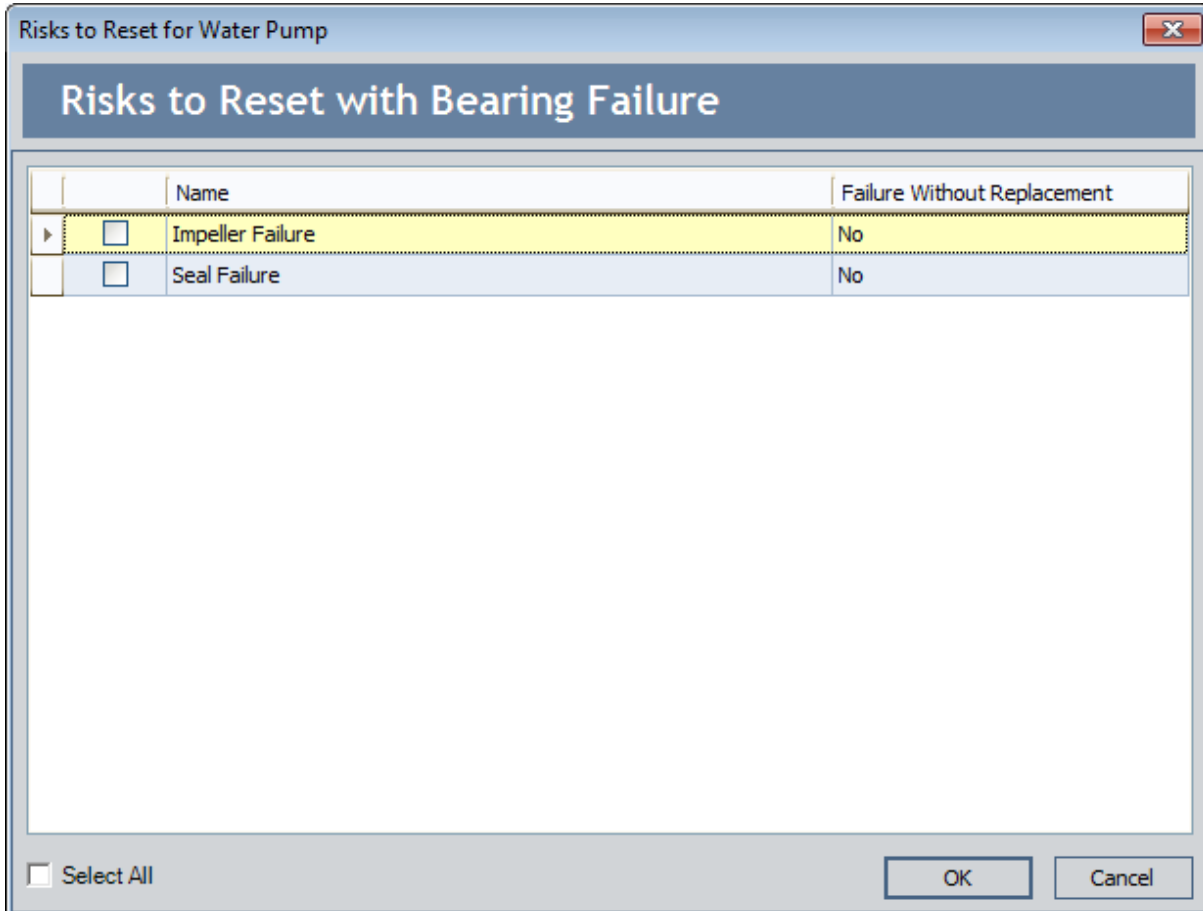

The **Risks to Reset** dialog box contains the **Risks to Reset** grid, which displays all the Risks that are defined for the selected Asset element, except for the currently selected Risk, whose ID appears in the title above the grid. This is the source Risk.

Each row in the **Risks to Reset** grid represents one Risk. For each Risk that is displayed in the grid, the following columns appear and contain values from the underlying System Risk record:

- **Name:** Displays the value stored in the Name field in the System Risk record.
- **Failure Without Replacement:** Displays one of the following read-only selections that is stored in the Failure Without Replacement field in the System Risk record:
 - **No:** Indicates that the failure type for the Risk in that row is *Failure With Replacement*. Risks with this failure type can be selected as an additional Risk to be reset.
 - **Yes:** Indicates that the failure type for the Risk in that row is *Failure Without Replacement*. Risks with this failure type *cannot* be selected as an additional Risk to be reset, and rows in the grid for these Risks will be disabled.

An additional, unlabeled column containing a check box appears to the left of the **Name** column and lets you select the Risks that should be reset by the source Risk.

Below the grid, the **Select All** check box appears, which you can use to:

- Select *all* the Risks defined for the piece of equipment or location.
- or-
- Clear *all* the currently selected Risks.

If one or more check boxes are selected in the grid (but not all), the **Select All** check box will be selected and colored gray. For example, the following image shows how the **Select All** check box appears in this case. A red outline has been added to the image to highlight this check box. You can clear the gray **Select All** check box to clear ALL the currently selected check boxes.

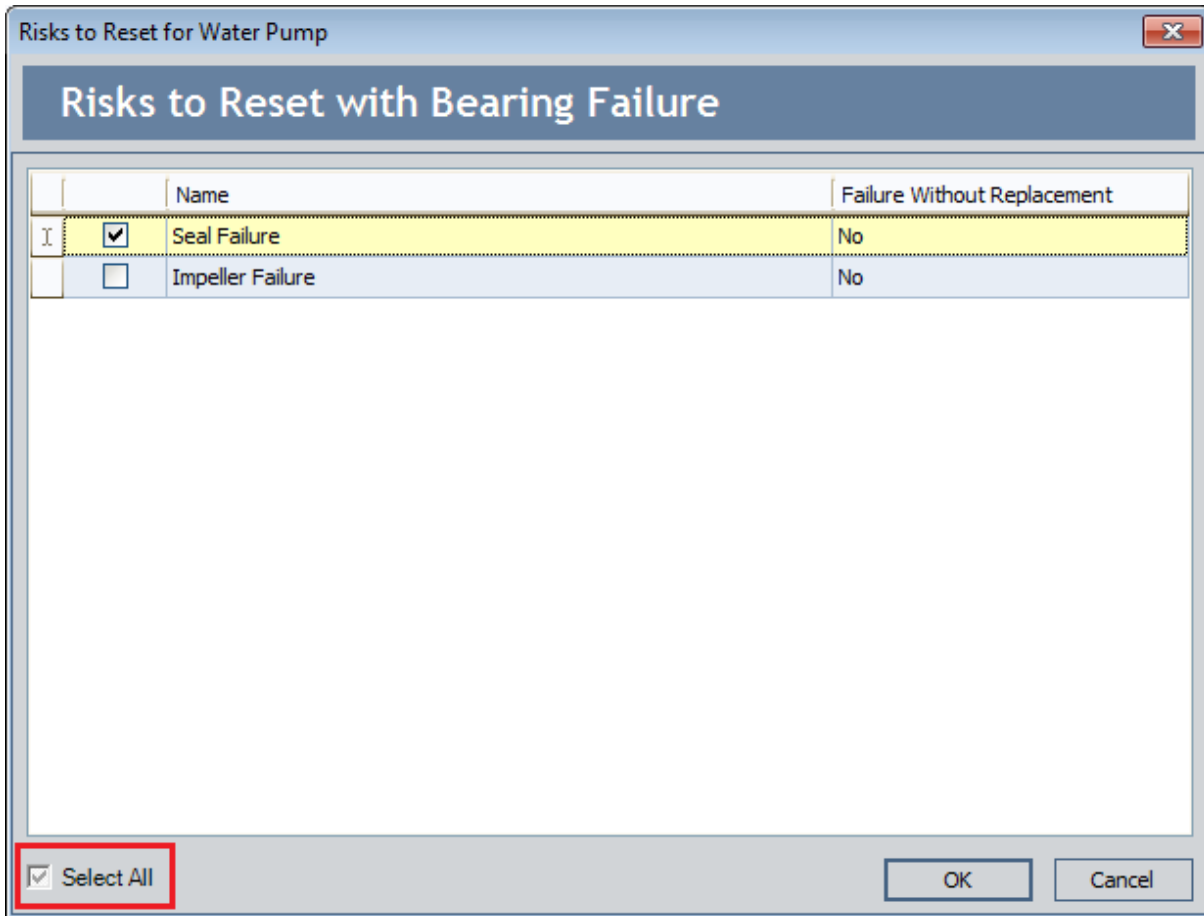

In addition, the following buttons are available on the **Risks to Reset** dialog box:

- **OK:** Saves your changes and closes the **Risks to Reset** dialog box.
- **Cancel:** Closes the **Risks to Reset** dialog box and discards your changes.

The Shortcut Menu in the Risks Pane

When you right-click any cell in the [Risks pane](#) on the **System Reliability Scenarios - Risks** page, a shortcut menu appears, as shown in the following image. This menu contains options that you can use to manage the additional Risks that you want to be reset by a source Risk. The source Risk is determined by the row from which you access the shortcut menu.

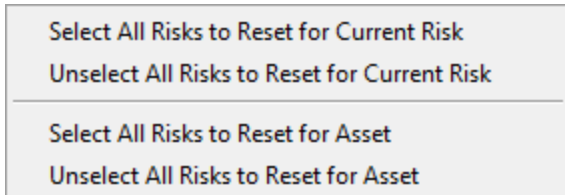

The shortcut menu contains the following options:

- **Select All Risks to Reset for the Current Risk:** Specifies that *all* the Risks defined for the piece of equipment or location should be reset by the selected source Risk.
- **Unselect All Risks to Reset for Current Risk:** Specifies that *none* of the Risks defined for the piece of equipment or location should be reset by the selected source Risk.
- **Select All Risks to Reset for Asset:** Specifies that *any* Risk defined for the piece of equipment or location should reset *all* the remaining Risks defined for the piece of equipment or location.
- **Unselect All Risks to Rest for Asset:** Specifies that *none* of the Risks defined for the piece of equipment or location should be reset by any other Risk defined for the piece of equipment or location.

Deleting Risks

To delete a Risk:

1. On the [System Reliability Scenarios - Risks page](#), in the [Diagram Hierarchy pane](#), select the element whose Risk you want to delete.
2. In the grid in the **Risks** pane, select the Risk that you want to delete.
3. Below the grid in the **Risks** pane, click the **Delete Risk** button.
A confirmation message appears, asking if you really want to delete the Risk.
4. Click the **Yes** button.
The System Risk record is removed from the grid in the **Risks** pane.

About Actions

In a System Reliability Analysis, an *Action* represents an operation that can be performed against a piece of equipment, location, or a switch. Actions can represent inspections, general maintenance, or specific events that mitigate Risks, such as training or procedures.

Actions can be unique events that happen only once during a simulation period, or they can be repeated at certain times during the simulation period. You can optionally assign Resources to Actions to associate a specific cost with the Action. When you assign Resources to Actions, a [System Resource Usage record](#) will be created.

Actions in System Reliability Analyses are stored in the following records, which can be linked to System Asset and System Switch records:

- [System Condition Monitor Records](#): Store information about continuous, condition-based maintenance Actions. An example of this type of Action would be an Action that continuously monitors the level of fluid in a gauge.
- [System Inspection Records](#): Store information about periodic, condition-based maintenance Actions. An example of this type of Action is the Vibration Analysis Action in [Scenario B](#) of our [System Reliability Analysis Example](#).
- [System Preventive Maintenance Records](#): Store information about time-based maintenance Actions. An example of this type of Action is the Replace Seals Action in [Scenario B](#) of our [System Reliability Analysis Example](#).
- [System Special Action Records](#): Store information about procedural, redesign, or training Actions. An example of this type of Action is the Redesign Impeller Action in [Scenario B](#) of our [System Reliability Analysis Example](#).

Diagram Hierarchy Pane

The **Diagram Hierarchy** pane on the [System Reliability Scenarios - Actions page](#) displays the elements in the Diagram that can have Actions associated with them. In the following image, the **Diagram Hierarchy** pane is outlined in red.

System Reliability Scenarios - Actions

Site Map: [Reliability](#)->[System Reliability](#)->[System Reliability Analysis Example](#)->[Scenario for Diagram B](#)

Scenario: Scenario for Diagram B

Diagram Hierarchy

- Default System
 - Bottling Subsystem
 - Bottling Line 1
 - Bottling Line 2
 - Bottling Line 3
 - Water Pump**
 - Water Tank

Actions

Name	Description	Resource Usages
Redesign Impellers		Resource Usages
Replace Seals		Resource Usages
Vibration Analysis		Resource Usages

Add Action Delete Action Optimize

Mitigated Risks

Name	Description	TTF	TTR	Planned Resource Usages	Unplanned Resource Usages	Risks to Reset
Bearing Failure		TTF Distribution	TTR Distribution	Planned Resource Usages	Unplanned Resource Usages	0

Assign New Risk Assign Existing Risks

When you select an element in the **Diagram Hierarchy** pane, the Actions that are currently defined for that element are displayed in the **Actions** pane. For example, in the preceding image, the selected *Water Pump* has three associated Actions:

- Redesign Impellers.
- Replace Seals.
- Vibration Analysis.

Actions Pane

The **Actions** pane is displayed on the [System Reliability Scenarios - Actions page](#) and on the **Actions Editor** window. It displays the Actions associated with the selected Asset or Switch element in the [Diagram Hierarchy pane](#). In the following image, the **Actions** pane is outlined in red.

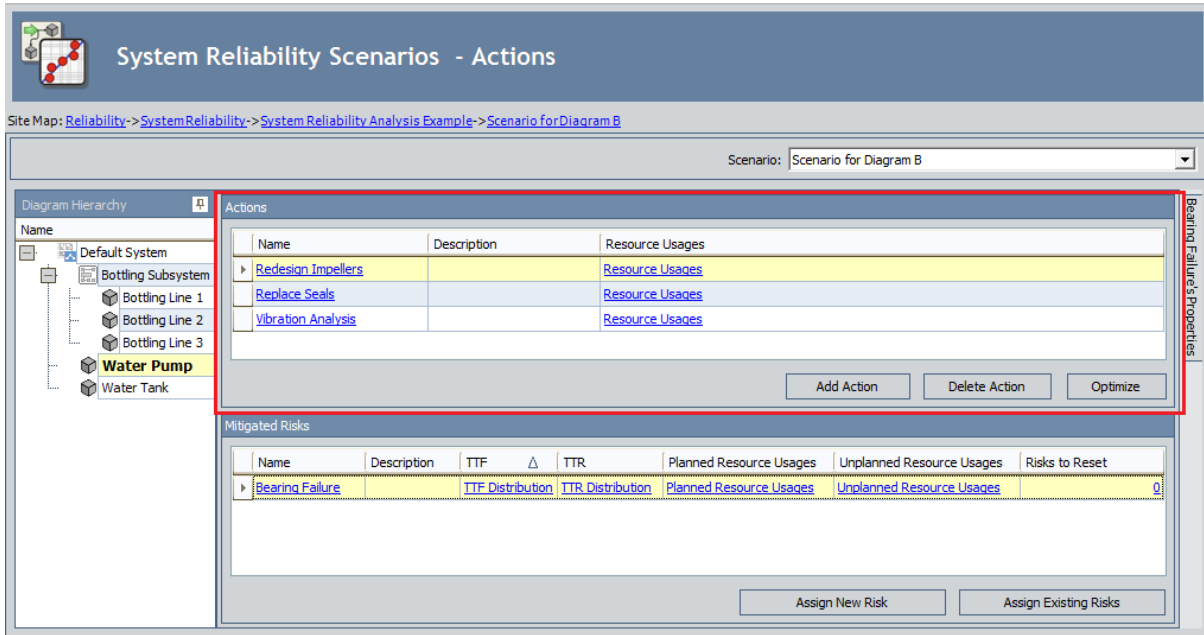

The grid in the **Actions** pane contains the following columns of information:

- **Name:** Displays the value in the Name field in the [System Action record](#).
- **Description:** Displays the value in the Description field in the [System Action record](#).
- **Resource Usages:** Displays the **Resource Usages** link, which provides access to any Resources that have been assigned to the Action.

Below the grid in the **Actions** pane, the following buttons appear:

- **Add Action:** Displays the **Select Action Type** dialog box, where you can [create a new System Action record](#) to link to the current [System Asset](#) or [System Switch record](#).
- **Delete Action:** After asking for confirmation, [deletes the System Action record](#) that is currently selected in the **Actions** pane.
- **Optimize:** Displays the **Action Interval Optimization** window, where you can [find the optimal interval](#) at which to implement an Action.

Mitigated Risks Pane

The **Mitigated Risks** pane is displayed on the [System Reliability Scenarios - Actions page](#) and on the **Actions Editor** window. It displays the Risks mitigated by the Action selected in the [Actions pane](#). In the following image, the **Mitigated Risks** pane is outlined in red.

The screenshot shows the 'System Reliability Scenarios - Actions' window. On the left is a 'Diagram Hierarchy' tree with 'Water Pump' selected. The main area is divided into 'Actions' and 'Mitigated Risks' panes. The 'Mitigated Risks' pane is highlighted with a red border and contains the following table:

Name	Description	TTF	TTR	Planned Resource Usages	Unplanned Resource Usages	Risks to Reset
> Bearing Failure		TTF Distribution	TTR Distribution	Planned Resource Usages	Unplanned Resource Usages	0

The **Mitigated Risks** pane contains the following columns of information:

- **Name:** Displays the value in the Name field in the System Risk record.
- **Description:** Displays the value in the Description field in the System Risk record.
- **TTF:** Displays the **TTF Distribution** link, which you can click to open the **TTF Distribution** window and view the Time to Failure (TTF) distribution data for the associated System Risk record.
- **TTR:** Displays the **TTR Distribution** link, which you can click to open the **TTR Distribution** window where and view the Time to Repair (TTR) distribution data for the associated System Risk record.
- **Planned Resource Usages:** Displays the **Planned Resource Usages** link, which you can click to open the **Planned Resource Usages** window and view any planned Resources that have been assigned to the Risk.
- **Unplanned Resource Usages:** Displays the **Unplanned Resource Usages** link, which you can click to open the **Unplanned Resource Usages** window and view any unplanned Resources that have been assigned to the Risk.
- **Risks to Reset:** Displays a number representing the number of [additional Risks that will be reset if the Risk in that row occurs or is mitigated as a result of planned correction](#). This number appears as a hyperlink, which you can click to access the [Risks to Reset dialog box](#), where you can view the additional Risks that

will be reset in the simulation if the source Risk occurs or is mitigated as a result of planned correction.

Below the **Mitigated Risks** grid, the following buttons appear:

- **Assign New Risk:** Displays the **New Risk** window, where you can create a new Risk that will be mitigated by the Action that is currently selected in the **Actions** pane.
- **Assign Existing Risks:** Displays the **Assign Risks** window, where you can assign an existing Risk to be mitigated by the Action that is currently selected in the **Actions** pane or remove an existing Risk from being mitigated by the Action that is currently selected in the **Actions** pane.

Accessing the Properties Pane

The [Properties pane](#) on the [System Reliability Scenarios - Actions page](#) lets you view and modify the [properties of the element that is currently selected](#) in the **Diagram Hierarchy** pane, **Mitigated Risks** pane, or **Actions** pane.

To access the Properties pane:

1. Select the element on the **System Reliability Scenarios - Actions** page for which you want to view or modify properties.
2. Pause on the **<Name>'s Properties** tab on the right side of the page.

The **<Name>'s Properties** pane appears. When you move your pointer away from the **<Name>'s Properties** tab, the **<Name>'s Properties** pane will collapse.

Note: If you want the **<Name>'s Properties** pane to remain on the page after you move your pointer away from the **<Name>'s Properties** tab, click the  button.

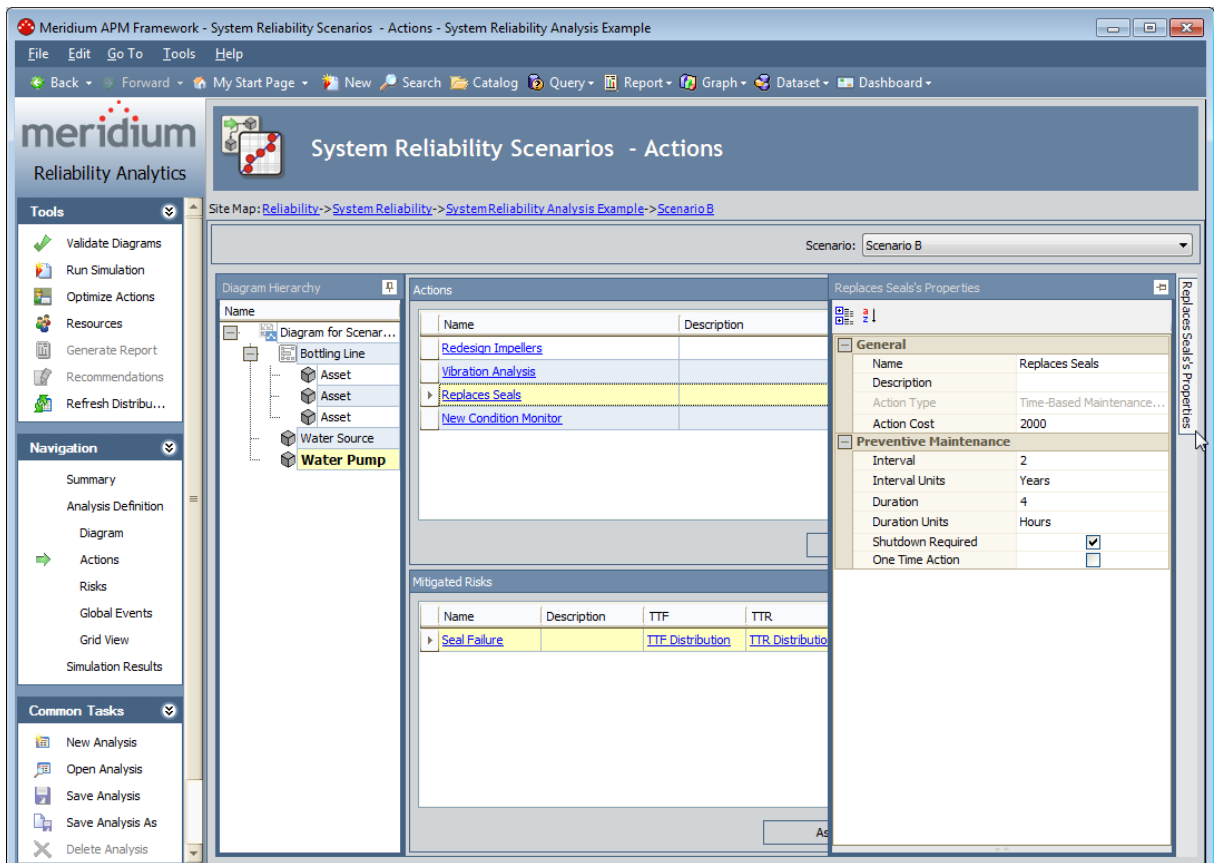

About Fields Displayed on the Properties Pane

Different fields are displayed in the **Properties** pane depending upon the element that is selected on the **System Reliability Scenarios - Actions** page. When you select an element, the **Properties** pane will display the fields that belong to the record that is associated with the selected element. You can select any of the following elements to view the fields in the associated record in the **Properties** pane:

- [Actions](#)
- [Assets](#)
- [Risks](#)
- [Switches](#)

Action Fields

When you select an Action from the **Actions** pane on the **System Reliability Scenarios - Actions** page, the **Properties** pane displays information related to that Action. The following table lists:

- The row labels that are displayed in the **Properties** pane when you select an Action in the **Actions** pane. The table is organized by the categories that are displayed when you view the **Properties** pane in a categorized view.
- The name of the record whose value is displayed in that row. Note that there are several subfamilies of [System Action records](#): System Condition Monitor records, System Inspection records, System Preventative Maintenance records, and System Special Action records.
- The field caption of the field whose value is displayed in that row.
- Notes that provide more information about the value in that row.

Row Label	System Record	System Field	Notes
General			
Name	System Action	Name	None
Description	System Action	Description	None
Action Type	System Action	Action Type	<p>This row is disabled and populated automatically with the category of System Action record to which it belongs. For System Condition Monitor and System Inspection records, this value is <i>Condition-Based Maintenance (Predictive)</i>. For System Preventative Maintenance records, this value is <i>Time-Based Maintenance (Preventative)</i>. For System Special Action records, this value is one of the following:</p> <ul style="list-style-type: none"> • Procedure (PROC) • Redesign (DSN) • Training (TRN)

Row Label	System Record	System Field	Notes
Conditioning Monitoring Type	System Action	Condition Monitoring Type	This row appears only when the selected System Action record is classified as a System Inspection or System Condition Monitor record.
Action Cost	System Action	Action Cost	None
Condition Monitor			This section and its corresponding rows appear only when the selected System Action record is a Condition Monitor record.
Detection Probability	System Condition Monitor	Detection probability	None
Inspection			This section and its corresponding rows appear only when the selected System Action record is a System Inspection record.
Interval	System Inspection	Interval	None
Interval Units	System Inspection	Interval Units	None
Duration	System Inspection	Duration	None
Duration Units	System Inspection	Duration Units	None
Shutdown Required	System Inspection	Shutdown Required	None
One Time Action	System Inspection	One Time Action	None
Detection Probability	System Inspection	Detection Probability	None

Row Label	System Record	System Field	Notes
Preventative Maintenance			This section and its corresponding rows appear only when the selected System Action record is a System Preventative Maintenance record.
Interval	System Preventative Maintenance	Interval	None
Interval Units	System Preventative Maintenance	Interval Units	None
Duration	System Preventative Maintenance	Duration	None
Duration Units	System Preventative Maintenance	Duration Units	None
Shutdown Required	System Preventative Maintenance	Shutdown Required	None
One Time Action	System Preventative Maintenance	One Time Action	None
Special Action			This section and its corresponding rows appear only when the selected System Action record is a Special Action record.
Interval	System Special Action	Interval	None
Interval Units	System Special Action	Interval Units	None
Duration	System Special Action	Duration	None
Duration Units	System Special Action	Duration Units	None

Action Fields

Row Label	System Record	System Field	Notes
Shutdown Required	System Special Action	Shutdown Required	None
One Time Action	System Special Action	One Time Action	None

The following image shows the categorized view of the **Properties** pane that would be displayed if you selected the Replace Seal Action in Scenario B.

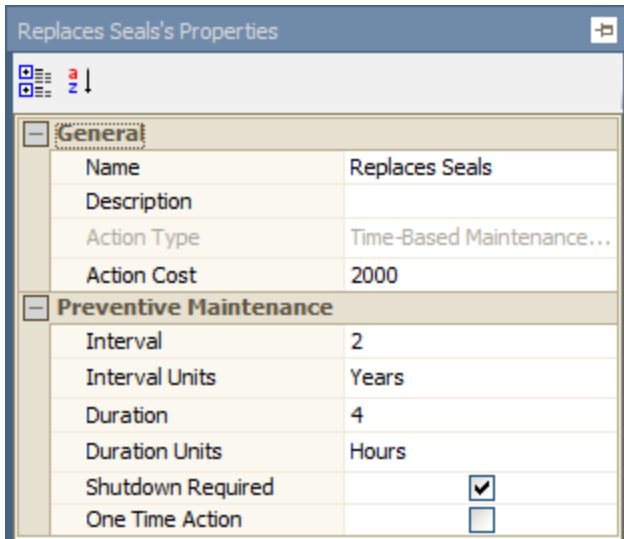

About Creating System Action Records

When you create an Action in a System Reliability Analysis, a record is created in a [sub-family of the System Action family](#). The Meridium APM system determines the specific family in which to create the record based upon the following factors:

- Your selections in the **Action Type** and **Condition Monitoring Type** lists on the [Select Action Type dialog box](#).
- and-
- The values that exist in System Action Mapping records.

After you select values on the **Select Action Type** dialog box, the Meridium APM system searches all System Action Mapping records for a record with identical values in the Action Type and Condition Monitoring fields, respectively. When it finds a record with matching values, the Meridium APM system creates a System Action record in the family whose caption appears in the ASO Action Type field in that System Action Mapping record.

About the Select Action Type Dialog Box

The **Select Action Type** dialog box lets you specify the type of Action that you want to create, using the combination of values that you select in the **Action Type** and **Condition Monitoring Type** lists. For more information, see the following table.

Before you can create an Action, you will need to access the **Select Action Type** dialog box. You can do so using the following methods:

- If you want to create a new Action and assign it to an Asset or Switch element without assigning it to a Risk, on the [System Reliability Scenarios - Actions page](#), in the **Diagram Hierarchy** pane, select the element to which you want to add an Action, and then click the **Add Action** button below the grid in the **Actions** pane.
- or-
- If you want to create a new Action and assign it to an Asset or Switch element and a risk, on the [System Reliability Scenarios - Risks page](#), in the **Diagram Hierarchy** pane, select the element that contains the Risk to which you want to assign an Action, and then click the **Assign New Action** button below the grid in the **Mitigating Actions** pane.

The following table shows the values that you can select in the **Action Type** list and **Condition Monitoring Type** list and the System Action subfamily in which the record for your action will be created.

Note: The **Condition Monitoring Type** list appears only if you select *Condition-Based Maintenance (Predictive) (CM)* in the **Action Type** list.

Action Type	Condition Monitoring Type	System Action Subfamily
Condition-Based Maintenance (Predictive) (CM)	Periodic	System Inspection record
Condition-Based Maintenance (Predictive) (CM)	Continuous	System Condition Monitor record
Procedure (PROC)	n/a	System Special Action record
Redesign (DSN)	n/a	System Special Action record
Time-Based Maintenance (Preventive) (PM)	n/a	System Preventive Maintenance record
Training (TRN)	n/a	System Special Action record

About the Select Action Type Dialog Box

For example, if you create an Action by selecting Condition-Based Maintenance (Predictive) (CM) in the Action Type list and Continuous in the Condition Monitoring Type list, a [System Condition Monitor record](#) will be created.

Creating System Condition Monitor Records

To create a new System Condition Monitor record:

1. Using the desired method, access the **Select Action Type** dialog box.

The **Select Action Type** dialog box appears.

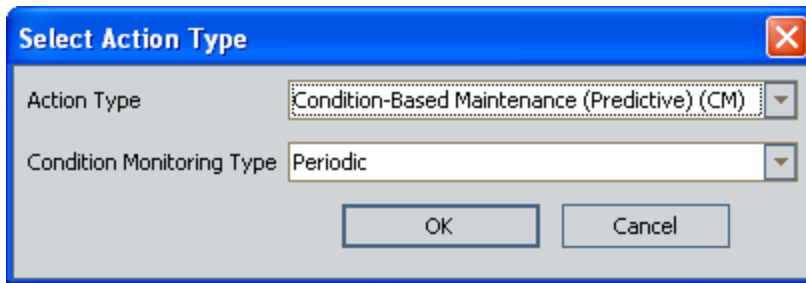

2. In the **Action Type** list, select **Condition-Based Maintenance (Predictive) (CM)**.
3. In the **Condition Monitoring Type** list, select **Continuous**.
4. Click **OK**.

The **New Condition Monitor** window appears.

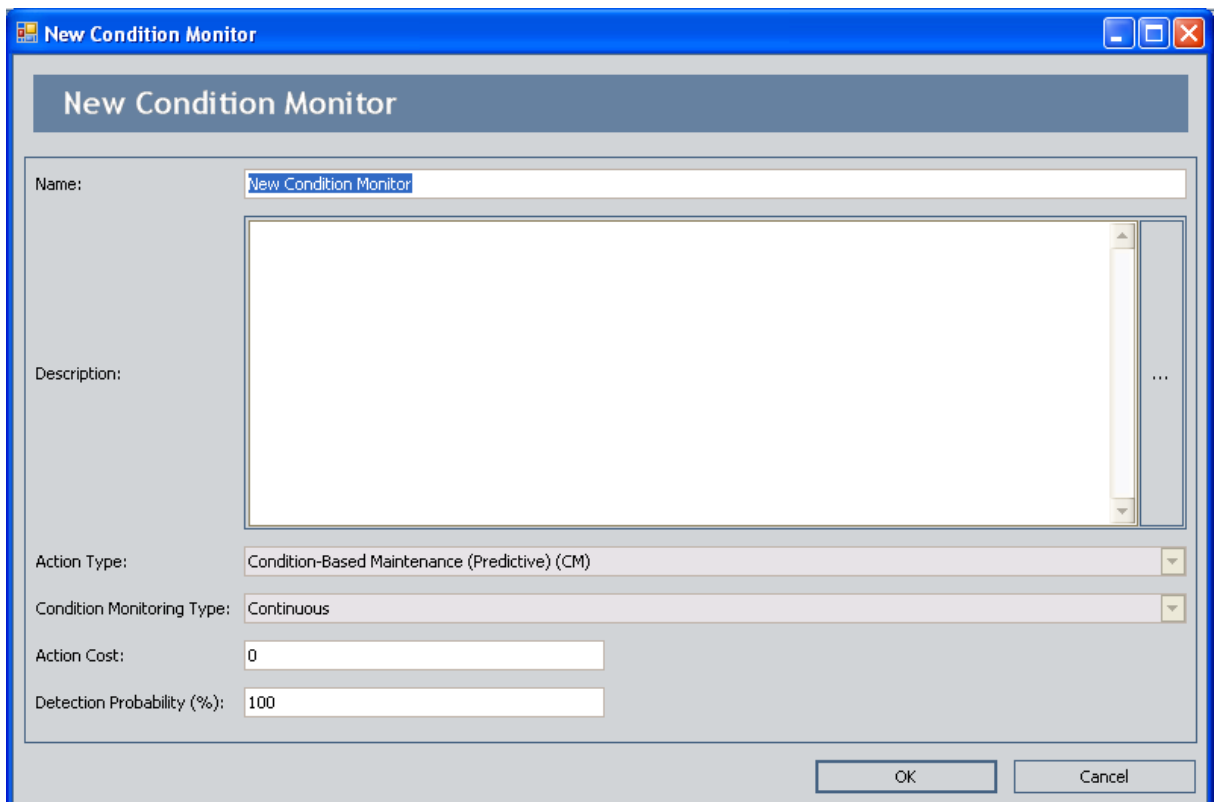

5. In the fields on the **New Condition Monitor** window, define the values of the System Condition Monitor record as desired.
6. Click **OK**.

The System Condition Monitor record is saved, and the new Action appears in the **Actions** grid.

CEHint: If desired, in the grid in the **Actions** pane, you can click the **Resource Usages** hyperlink to [assign Resources to the Action](#).

Creating System Inspection Records

To create a new System Inspection record:

1. Using the desired method, [access the Select Action Type dialog box](#).

The **Select Action Type** dialog box appears.

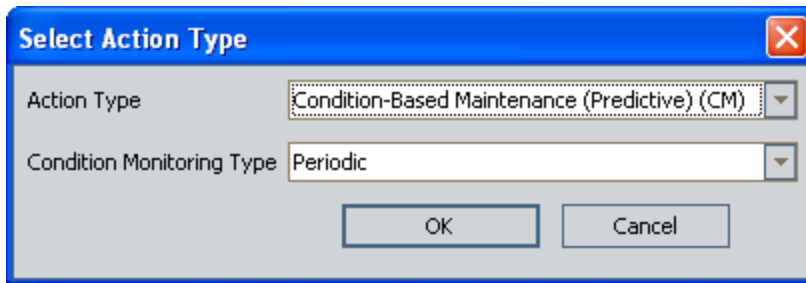

3. In the **Action Type** list, select **Condition-Based Maintenance (Predictive) (CM)**.
4. In the **Condition Monitoring Type** list, select **Periodic**.
5. Click **OK**.

The **New Inspection** window appears.

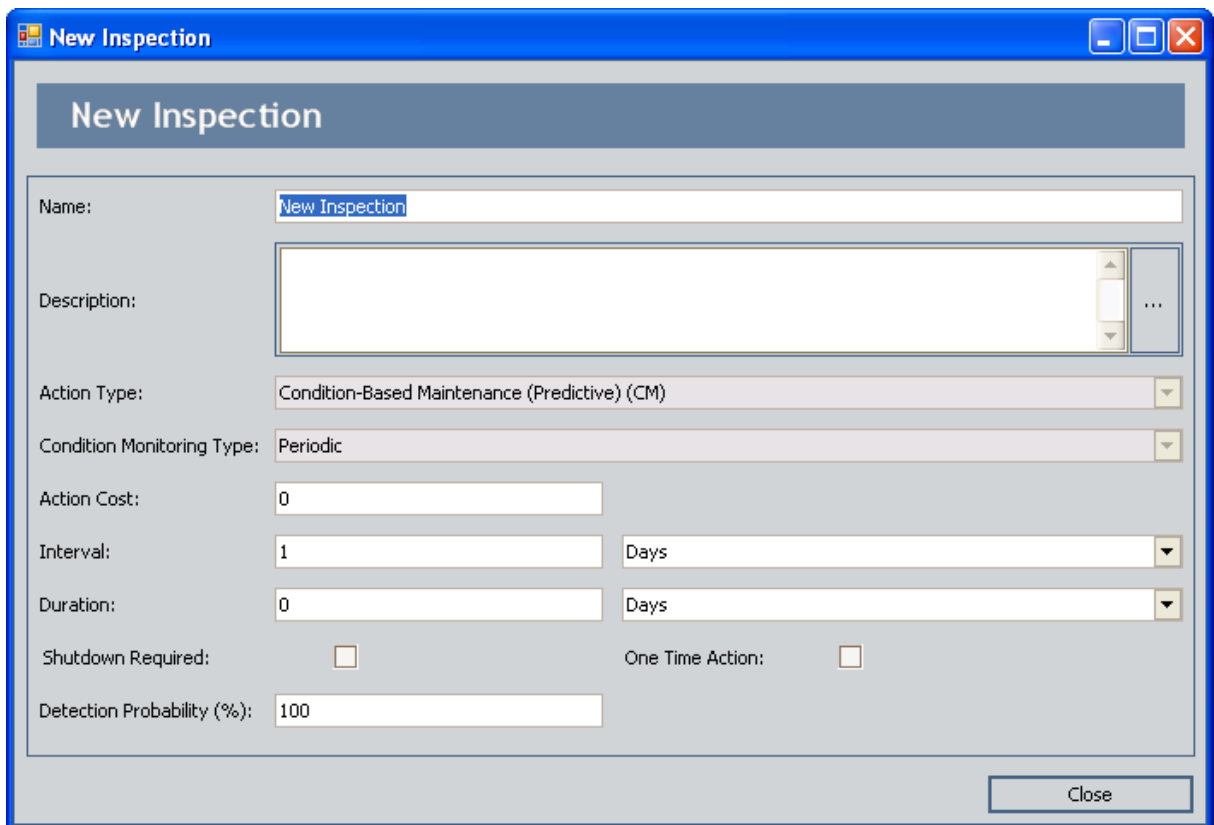

6. In the fields on the **New Inspection** window, [define the values of the System Inspection record as desired](#).
7. Click **OK**.

The System Inspection record is saved, and the new Action appears in the **Actions** grid.

CEHint: If desired, in the grid in the **Actions** pane, you can click the **Resource Usages** hyperlink to [assign Resources to the Action](#).

Creating System Preventative Maintenance Records

To create a new System Preventative Maintenance record:

1. Using the desired method, [access the Select Action Type dialog box](#).

The **Select Action Type** dialog box appears.

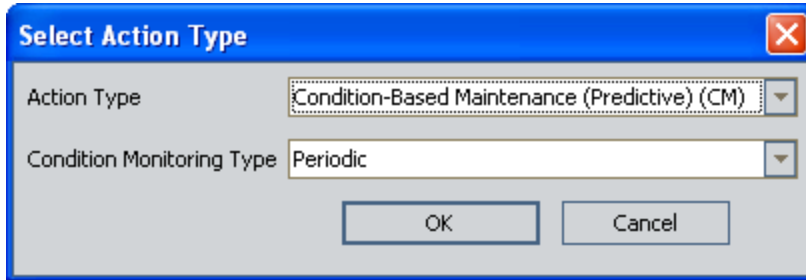

The **Select Action Type** dialog box is shown. It has a blue title bar with a close button. The main area is light gray. There are two dropdown menus: 'Action Type' is set to 'Condition-Based Maintenance (Predictive) (CM)' and 'Condition Monitoring Type' is set to 'Periodic'. At the bottom, there are 'OK' and 'Cancel' buttons.

2. In the **Action Type** list, select **Time-Based Maintenance (Preventative) (PM)**.

The **Condition Monitoring Type** list is hidden.

3. Click **OK**.

The **New Preventative Maintenance** window appears.

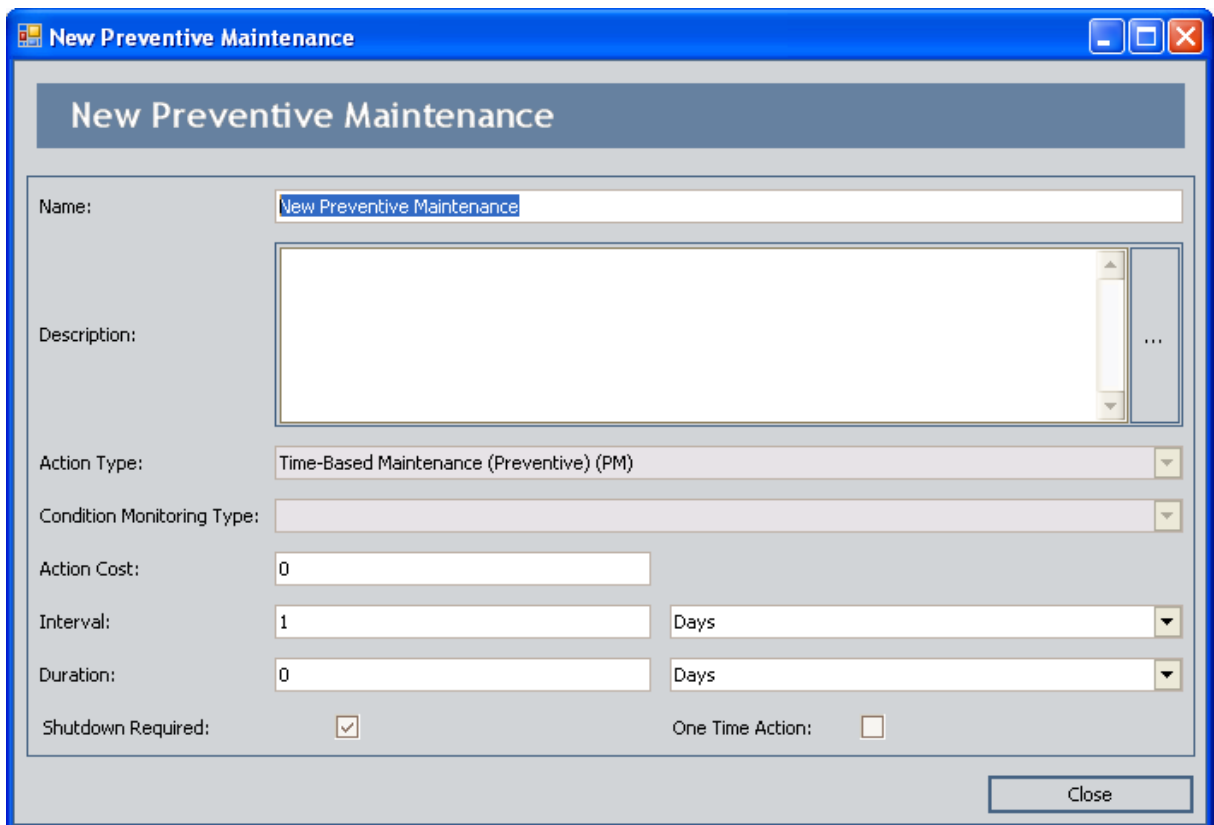

The **New Preventative Maintenance** window is shown. It has a blue title bar with standard window controls. The main area is light gray. At the top, there is a header 'New Preventative Maintenance'. Below that, there are several fields: 'Name' is 'New Preventative Maintenance', 'Description' is an empty text area with a scroll bar and a help icon, 'Action Type' is 'Time-Based Maintenance (Preventative) (PM)', 'Condition Monitoring Type' is empty, 'Action Cost' is '0', 'Interval' is '1' with a 'Days' dropdown, 'Duration' is '0' with a 'Days' dropdown, 'Shutdown Required' is checked, and 'One Time Action' is unchecked. A 'Close' button is at the bottom right.

4. In the fields on the **New Preventative Maintenance** window, [define the values of the System Preventative Maintenance record as desired](#).
5. Click **OK**.

The System Preventative Maintenance record is saved, and the new Action appears in the **Actions** grid.

CEHint: If desired, in the grid in the **Actions** pane, you can click the **Resource Usages** hyperlink to [assign Resources to the Action](#).

Creating System Special Action Records

To create a new System Special Action record:

1. Using the desired method, access the [Select Action Type dialog box](#).

The **Select Action Type** dialog box appears.

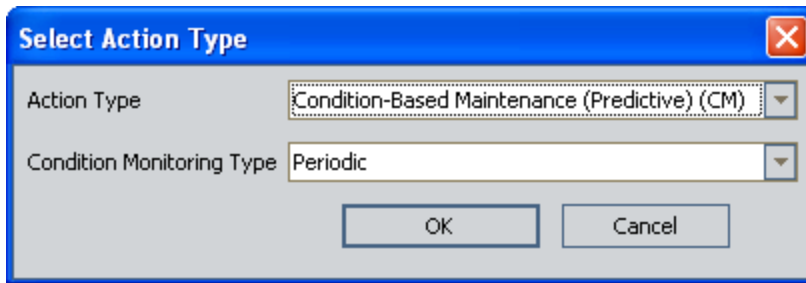

2. In the **Action Type** list, select one of the following values:
 - Procedure (PROC)
 - Redesign (DSN)
 - Training (TRN)

The **Condition Monitor Type** list is hidden.

3. Click **OK**.

The [New Special Action window](#) appears.

New Special Action

New Special Action

Action Properties | Mitigated Risks

Name: New Special Action

Description:

Action Type: Training (TRN)

Condition Monitoring Type:

Action Cost: 0

Interval: 1 Days

Duration: 0 Days

Shutdown Required: One Time Action:

Close

4. In the fields on the **New Special Action** window, [define the values of the New Special Action Record as desired](#).
5. Click **OK**.

The System Special Action record is saved, and the new Action appears in the **Actions** grid.

CEHint: If desired, in the grid in the [Actions pane](#), you can click the **Resource Usages** hyperlink to [assign Resources to the Action](#).

Assigning Existing Actions to Risks

To assign one or more existing Actions to Risks:

1. While viewing the desired Scenario on the [System Reliability Scenarios - Risks](#) page, in the [Diagram Hierarchy](#) pane, select the element that contains the Risk to which you want to assign an Action.
2. Below the grid in the **Mitigating Actions** pane, click the **Assign Existing Actions** button.

The **Assign Actions** window appears.

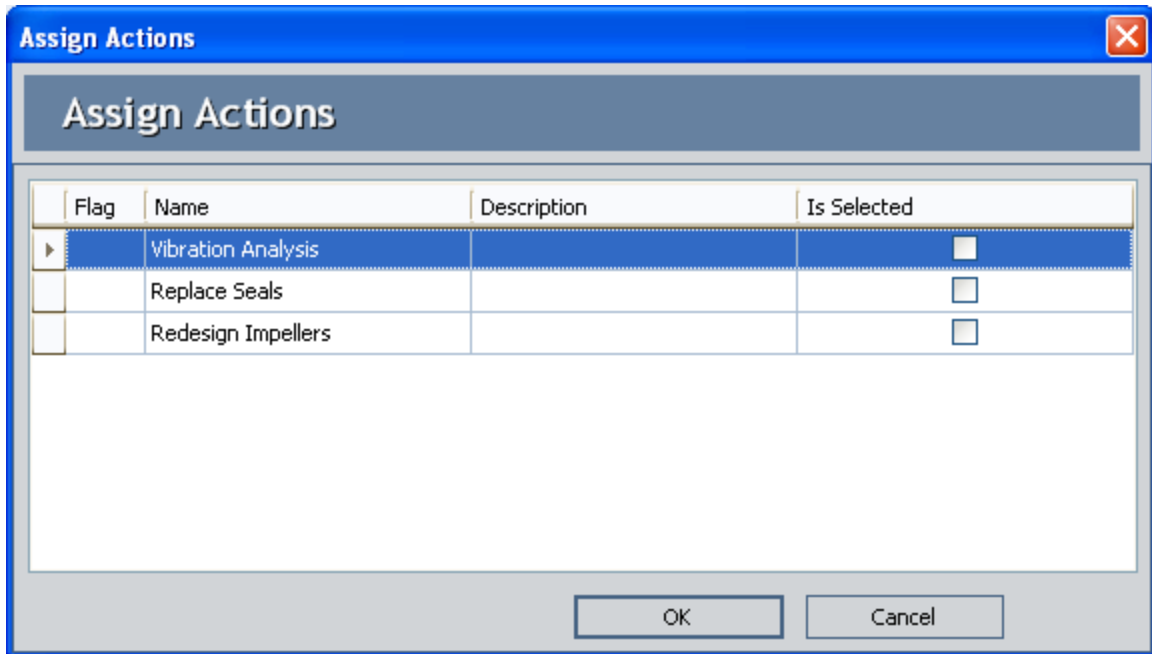

This image displays the Actions that are available to be assigned to Risks in the [System Reliability Analysis Example](#).

3. On the **Assign Actions** window, in the **Is Selected** column, select the check box for the Action(s) that you want to assign.

Note: You can remove any Action that is currently assigned to the Risk by clearing the **Is Selected** check box.

4. Click **OK**.

The Action(s) are assigned and appear in the grid in the **Mitigating Actions** pane.

Overview of the <Special Action> Window

When you view an existing System Special Action record, it appears in the <Special Action> window, where <Special Action> is the name of the Action as it appears in the Name field in the System Special Action record.

The screenshot shows a window titled "New Special Action" with a blue header bar. Below the header, there are two tabs: "Action Properties" (which is selected and highlighted) and "Mitigated Risks". The "Action Properties" tab contains several input fields and checkboxes. The "Name" field is filled with "New Special Action". The "Description" field is a large, empty text area. The "Action Type" dropdown menu is set to "Training (TRN)". The "Condition Monitoring Type" dropdown menu is empty. The "Action Cost" field is filled with "0". The "Interval" field is filled with "1" and the unit is "Days". The "Duration" field is filled with "0" and the unit is "Days". The "Shutdown Required" checkbox is checked. The "One Time Action" checkbox is also checked. A "Close" button is located at the bottom right of the window.

Using the <Special Action> window, you can perform the following tasks:

- View and modify the System Special Action record.
- View a list of System Risk Assessment records that are linked to the System Special Action record.

Additionally, for each System Risk Assessment record, you can specify the failure consequence and TTF Distribution values that you want to use in the simulation.

The <Special Action> window contains the following tabs:

- [Actions Properties](#): Displays the System Special Action datasheet.
- [Mitigated Risks](#): Displays the list of System Risk Assessment records that are linked to the Action and provides options that you can use to specify the failure consequence and TTF Distribution values that you want to be used in the

simulation when a Special Action is completed to mitigate the occurrence of a given Risk.

The Mitigated Risks Tab

You can use the **Mitigated Risks** tab on the [<Special Action> window](#) to specify for each Mitigated Risk that is associated with the Special Action the Failure Consequence and TTF Distribution values that you want to be used in the simulation when the Special Action is completed to mitigate the occurrence of the given Risk.

On the left, the **Mitigated Risks** tab displays the list of Mitigated Risks that are associated with the Special Action. Each Mitigated Risk represents one System Risk Assessment record that is linked to the System Special Action record. For each Mitigated Risk that appears in the list to the left, the following items are displayed to the right.

- **New Failure Consequence tab:** Contains the following items:
 - **Replace Failure Consequence check box:** Indicates that when the Special Action for the selected Mitigated Risk is completed, you want the simulation to use the value that you specify in the Fixed Unplanned Correction Cost field.
 - **Fixed Unplanned Correction Cost text box:** Stores the values that you want the simulation to use in place of the one that currently exists in the Fixed Unplanned Correction Cost field in the selected System Risk Assessment record. This text box is enabled only if the **Replace Failure Consequence** check box is selected.

The following image shows these items as they appear on the **New Failure Consequence** tab. A red outline has been added to the image to highlight this tab.

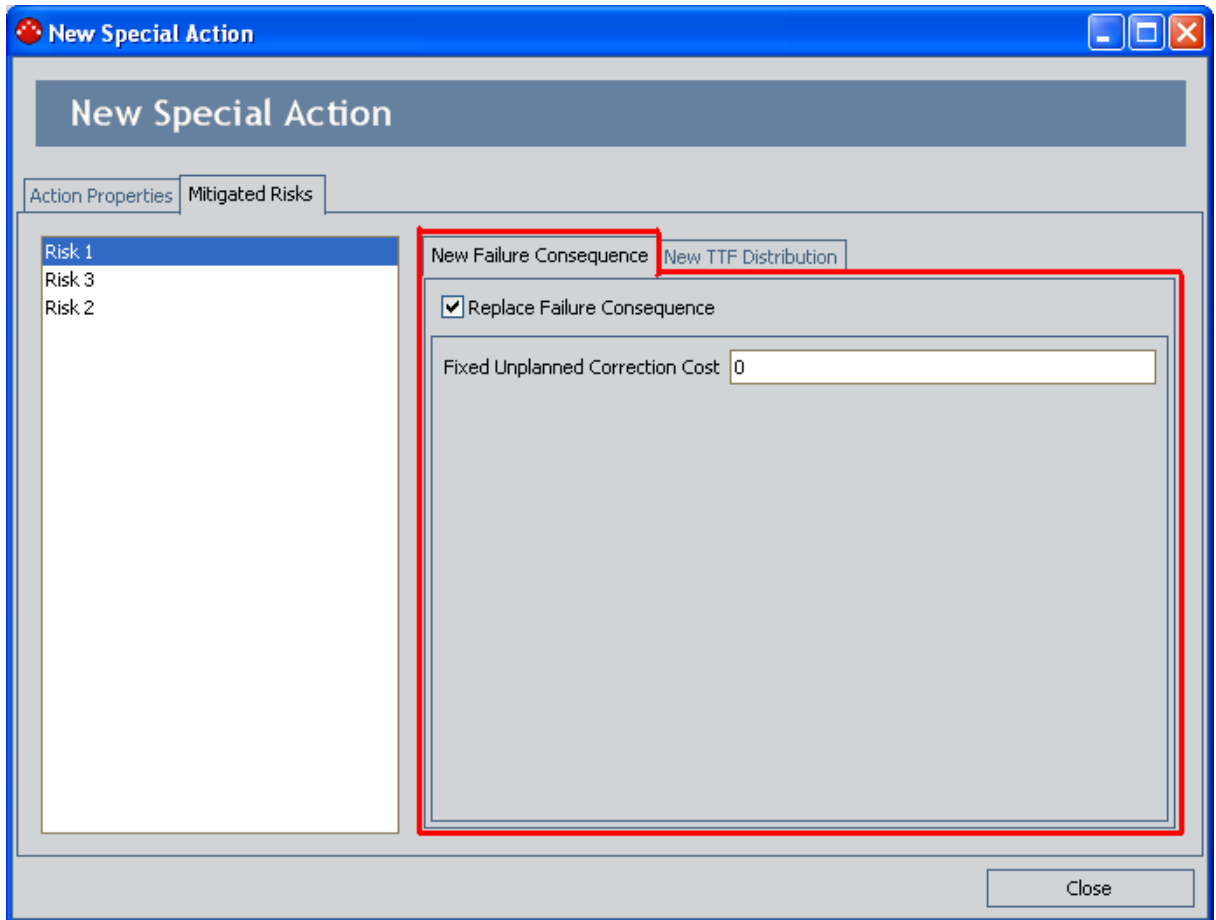

- **New TTF Distribution tab:** Contains the following items:
 - **Replace TTF Distribution check box:** Indicates that when the Special Action for the selected Mitigated Risk is completed, you want the simulation to use the values that you specify in the Distribution fields.
 - **Distribution datasheet:** Contains the fields that appear in the Distribution record that is linked to the System Risk Assessment record. The fields on the datasheet are enabled only if the **Replace TTF Distribution** check box is selected.

The following image shows these items as they appear on the **New TTF Distribution** tab. A red outline has been added to the image to highlight this tab.

The Mitigated Risks Tab

The image shows a software dialog box titled "New Special Action". It has two tabs: "Action Properties" and "Mitigated Risks". The "Mitigated Risks" tab is active and contains a list of risks: "Risk 1", "Risk 3", and "Risk 2". Within this tab, there are two sub-tabs: "New Failure Consequence" and "New TTF Distribution". The "New TTF Distribution" sub-tab is selected and highlighted with a red border. It contains a checkbox labeled "Replace TTF Distribution" which is unchecked. Below this are several input fields: "Name" (empty), "Description" (empty text area), "Distribution Type" (dropdown menu set to "Exponential"), "Time Unit" (dropdown menu set to "Days"), and "MTBF" (text field set to "Infinity"). A "Close" button is located at the bottom right of the dialog box.

Specifying Failure Consequence Values for the Simulation

If desired, you can use the [<Special Action> window](#) to specify for each Mitigated Risk that is associated with the Special Action the Failure Consequence values that you want to be used in the simulation when the Special Action is completed to mitigate the occurrence of the given Risk.

To specify Failure Consequence values for the simulation:

1. On the **System Reliability Scenarios - Actions** page, in the **Actions** pane, locate the row containing the desired Special Action.
2. In the **Name** cell, click the hyperlinked name of the Special Action.

The [<Special Action> window](#) appears, where **<Special Action>** is the value that appears in the Name field in the System Special Action record.

The screenshot shows a software window titled "New Special Action". It has a blue title bar with standard window controls. Below the title bar is a header area with the text "New Special Action". There are two tabs: "Action Properties" (which is active) and "Mitigated Risks". The "Action Properties" tab contains the following fields:

- Name: New Special Action
- Description: A large empty text area.
- Action Type: Training (TRN) (dropdown menu)
- Condition Monitoring Type: (empty dropdown menu)
- Action Cost: 0
- Interval: 1 Days (dropdown menu)
- Duration: 0 Days (dropdown menu)
- Shutdown Required:
- One Time Action:

A "Close" button is located at the bottom right of the dialog.

3. Click the **Mitigated Risks** tab.

The **Mitigated Risks** tab appears.

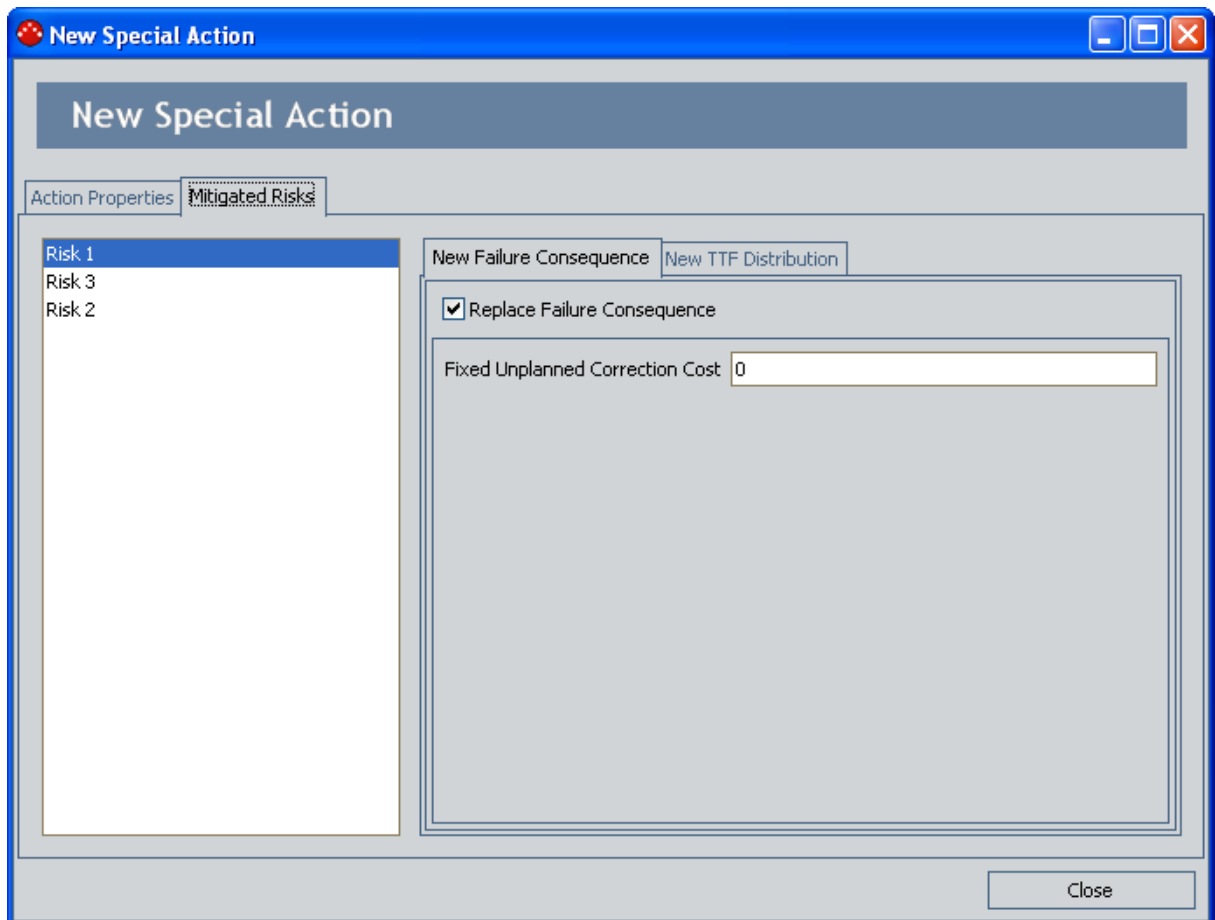

4. In the list to the left, selected the Mitigated Risk whose Failure Consequence values you want to specify for the simulation.
5. On the **New Failure Consequence** tab, select the **Replaced Failure Consequence** check box.
6. In the **Fixed Unplanned Correction Cost** text box, modify the value as desired.
7. Repeat these steps for each Mitigated Risk whose failure consequence values you want to specify for the simulation, and then click the **Close** button.

Your changes are saved, and the values that you specified will be used the next time the simulation is run.

Specifying TTF Distribution Values for the Simulation

If desired, you can use the [<Special Action> window](#) to specify for each Mitigated Risk that is associated with the Special Action the TTF Distribution values that you want to be used in the simulation when the Special Action is completed to mitigate the occurrence of the given Risk.

To specify TTF Distribution values for the simulation:

1. On the **System Reliability Scenarios - Actions** page, in the **Actions** pane, locate the row containing the desired Special Action.
2. In the **Name** cell, click the hyperlinked name of the Special Action.

The [<Special Action> window](#) appears, where **<Special Action>** is the value that appears in the Name field in the System Special Action record.

The screenshot shows a window titled "New Special Action" with two tabs: "Action Properties" and "Mitigated Risks". The "Action Properties" tab is active and contains the following fields:

- Name: New Special Action
- Description: (empty text area)
- Action Type: Training (TRN)
- Condition Monitoring Type: (empty dropdown)
- Action Cost: 0
- Interval: 1 Days
- Duration: 0 Days
- Shutdown Required:
- One Time Action:

A "Close" button is located at the bottom right of the window.

3. Click the **Mitigated Risks** tab.

The **Mitigated Risks** tab appears.

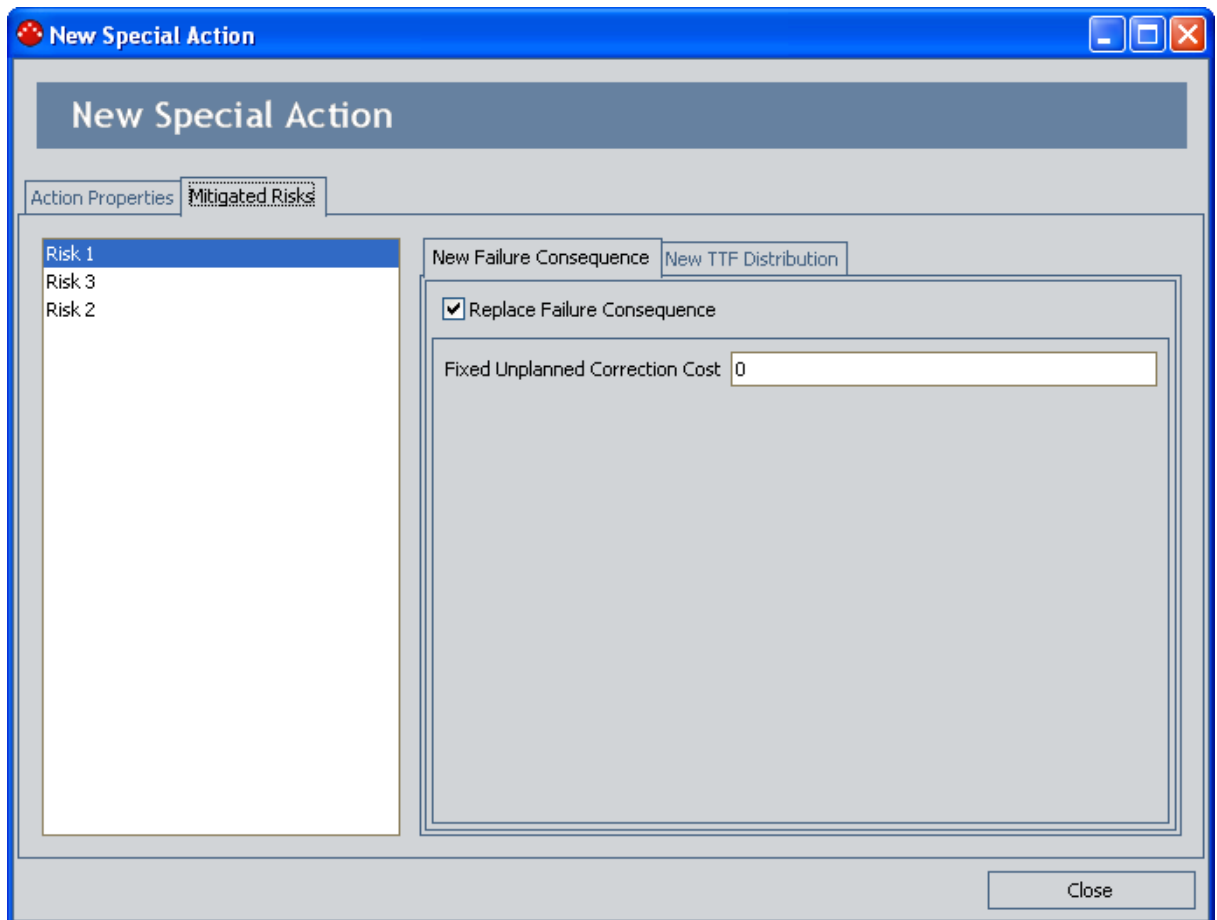

4. To the right, click the **New TTF Distribution** tab.
The **New TTF Distribution** tab appears.

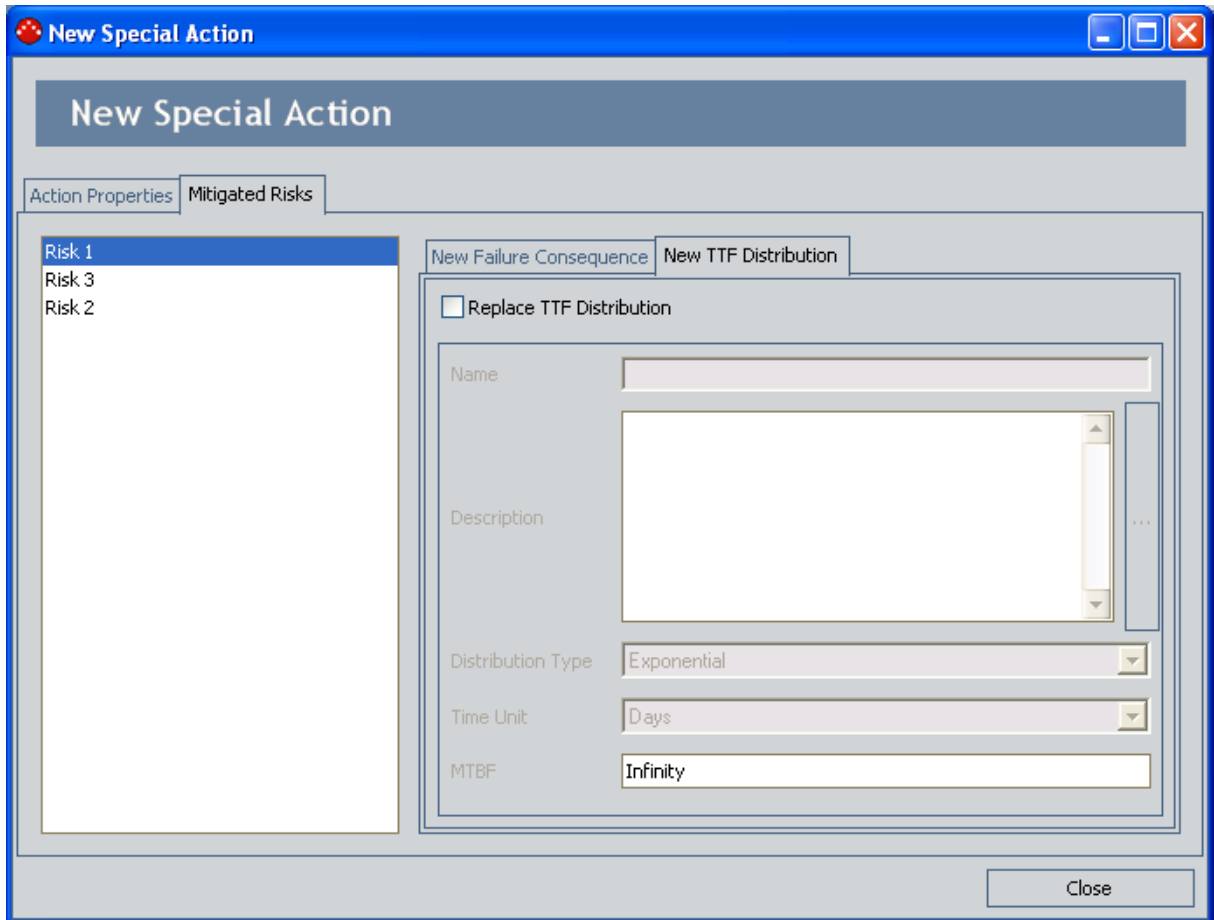

5. In the list to the left, select the Mitigated Risk whose TTF Distribution values you want to specify for the simulation
6. On the **New TTF Distribution** tab, select the **Replaced TTF Distribution** check box. The fields in the Distribution datasheet section are enabled.
7. In the remaining fields, modify the values as desired.
8. Repeat these steps for each Mitigated Risk whose TTF Distribution values you want to specify for the simulation, and then click the **Close** button.

Your changes are saved, and the values that you specified will be used the next time the simulation is run.

Options for Modifying Actions

You can modify the values in a System Action record from either of the following pages:

- [System Reliability Scenarios - Actions](#)
- [System Reliability Scenarios - Risks](#)

Modifying Actions Using the Actions Page

To modify an existing Action using the System Reliability Scenarios - Actions page:

1. While viewing the desired Scenario on the **System Reliability Scenarios - Actions** page, in the **Diagram Hierarchy** pane, select the element that contains the Action that you want to modify.
2. In the grid in the **Actions** pane, click the hyperlinked name of the Action that you want to modify.

The **<Action Name>** window appears, where **<Action Name>** is the name of the Action that you selected.

The screenshot shows a dialog box titled "Vibration Analysis". The "Name" field contains "Vibration Analysis". The "Description" field is empty. The "Action Type" is set to "Condition-Based Maintenance (Predictive) (CM)". The "Condition Monitoring Type" is set to "Periodic". The "Action Cost" is 0. The "Interval" is 1, with a unit dropdown set to "Days". The "Duration" is 0, with a unit dropdown set to "Days". There are two checkboxes: "Shutdown Required" and "One Time Action", both of which are unchecked. The "Detection Probability (%)" is 100. At the bottom right, there are "OK" and "Cancel" buttons.

The content of the **Vibration Analysis** window is controlled by the default data-sheet for the System Inspection family.

3. [Modify the fields in the System Action record as desired.](#)
4. Click **OK**.

Your changes to the System Action record are saved.

Modifying Actions Using the Risks Page

To modify an existing Action using the System Reliability Scenarios - Risks page:

1. While viewing the desired Scenario on the **System Reliability Scenarios - Risks** page, in the **Diagram Hierarchy** pane, select the element that contains the Action that you want to modify.
2. In the grid in the **Mitigating Actions** pane, click the hyperlinked name of the Action that you want to modify.

The **<Action Name>** window appears, where **<Action Name>** is the name of the Action that you selected.

The screenshot shows a dialog box titled "Vibration Analysis". The "Name" field contains "Vibration Analysis". The "Description" field is empty. The "Action Type" is set to "Condition-Based Maintenance (Predictive) (CM)". The "Condition Monitoring Type" is set to "Periodic". The "Action Cost" is 0. The "Interval" is 1, with a dropdown menu set to "Days". The "Duration" is 0, with a dropdown menu set to "Days". There are two checkboxes: "Shutdown Required" and "One Time Action", both of which are unchecked. The "Detection Probability (%)" is 100. At the bottom right, there are "OK" and "Cancel" buttons.

The content of the **Vibration Analysis** window is controlled by the default data-sheet for the System Inspection family.

3. [Modify the fields in the System Action record as desired.](#)
4. Click **OK**.

Your changes to the System Action record are saved.

About Resources for Actions

After Resources exist for a System Reliability Analysis, you can assign them to Actions. When you do so, you associate the cost of that Resource with each occurrence of the Action. This allows you to assign a realistic cost to the Action that can be included in the simulation results.

When you assign a Resource to an Action, a System Resource Usage record will be created and will store information that specifies how the Resource will be used (e.g., the quantity and duration).

Assigning Resources to Actions

To assign a Resource to an Action:

1. While viewing the desired System Reliability Analysis and Scenario on the [System Reliability Scenarios - Actions page](#), in the [Diagram Hierarchy pane](#), select the element that contains the Action to which you want to assign a Resource.
2. In the grid in the **Actions** pane, in the row containing the Action to which you want to assign a Resource, click the **Resources Usages** link.

The **Resource Usages - <Action>** window appears, where **<Action>** is the name of the Action that you selected, displaying any Resources that are assigned to the Action.

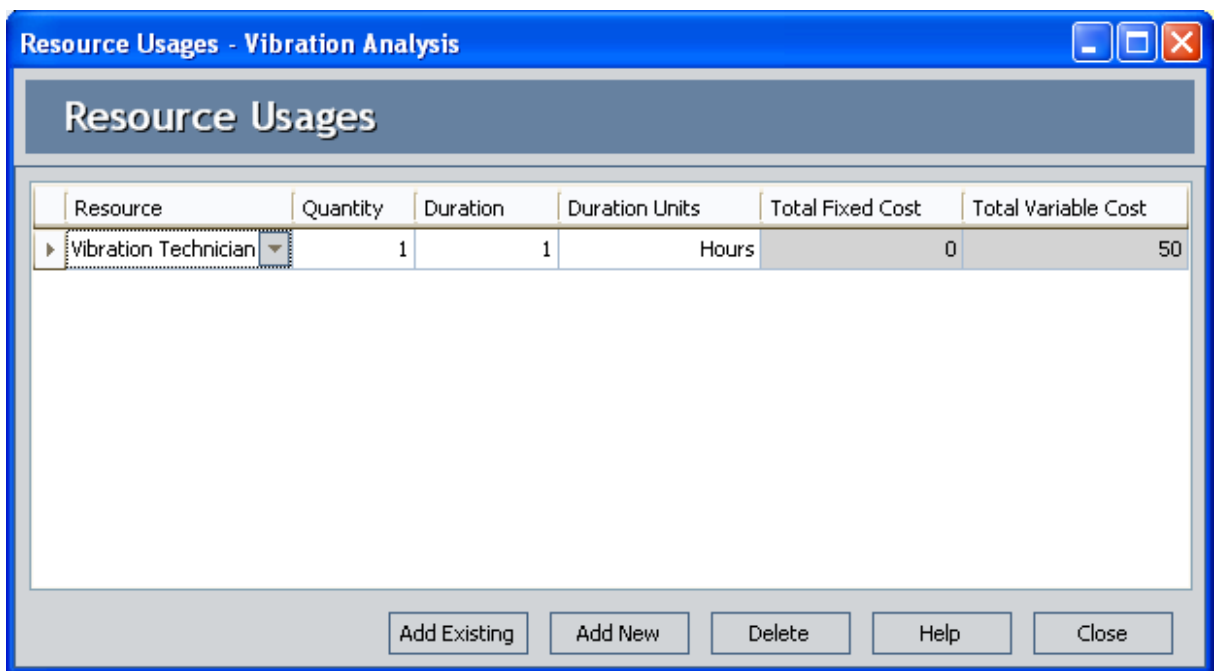

In this image, the **Resource Usages - Vibration Analysis** window displays the Resources that are assigned to the Vibration Analysis Action.

3. Click the **Add Existing** button. This button will be enabled only if one or more Resources already exist for the analysis.

A new row appears in the grid.

Note: You can click the **Add New** button to [create a Resource from scratch](#) and assign it to an Action. After you have created the Resource, you can skip to step 5.

4. In the **Resource** cell of the first row, click the  button, and select the Resource you want to assign to the Action.
5. Type the desired values in the **Quantity**, **Duration**, and **Duration Units** cells. These values will be used to populate the corresponding fields in the [System Resource Usage record](#).

Note: The Total Fixed Cost and Total Variable Cost columns display the actual values that will be incurred when the System Resource Usage is added to the simulation results. The Total Fixed Cost is calculated in the following equation: [Fixed Cost of the Resource](#) *Quantity. The Total Variable Cost is calculated by the following calculation: [Variable Cost of the Resource](#) *Quantity* Duration. Since these values are a product of the values you enter in the **Resource** dialog box and **Resource Usage** window, the cells are disabled and you cannot type values in these cells.

6. Click the **Close** button.

The **Resource Usages - [Action]** window closes, and the selected Resources are assigned to the Action.

Modifying Resource Assigned to Actions

When you modify a Resource assignment, you are modifying the *System Resource Usage record*. The actual System Resource record is not changed.

To modify a Resource assigned to an Action:

1. While viewing the desired System Reliability Analysis and Scenario on the [System Reliability Scenarios - Actions page](#), select the element whose Action has Resources you want to modify.
2. In the grid in the **Actions** pane, in the row containing the Action whose Resources you want to modify, click the **Resource Usages** link.

The **Resource Usages - <Action>** window appears, where <Action> is the name of the Action that you selected.

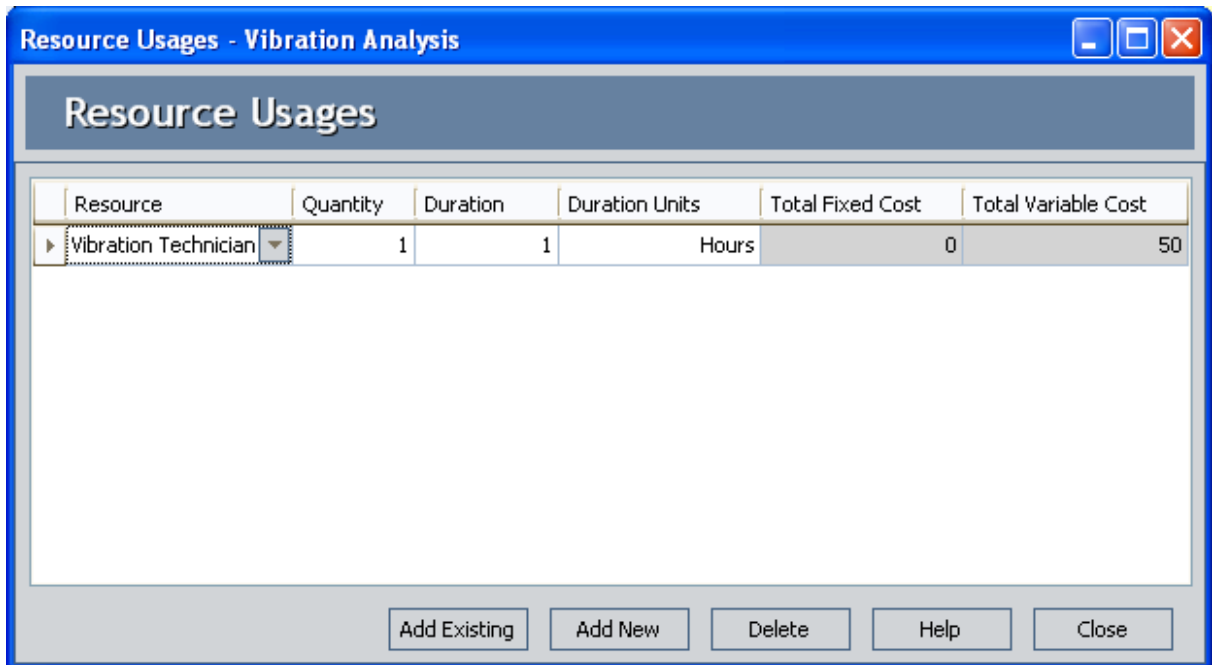

3. In the **Resource Usages** grid, [modify the properties of the Resource Usage record as desired](#).
4. Click the **Close** button.

Your changes are saved.

Removing Resources from Actions

When you remove a Resource from an Action, you delete the *System Resource Usage record* so that the Resource is not used by the selected Action. The actual System Resource record is still available for the System Reliability Analysis and can be used again if needed.

To remove a Resource from an Action:

1. While viewing the desired System Reliability Analysis and Scenario on the [System Reliability Scenarios - Actions page](#), in the [Diagram Hierarchy pane](#), select the Action whose Resource assignment you want to remove.
2. In the grid in the **Actions** pane, in the row containing the Action whose Resource assignments you want to remove, click the **Resource Usages** link.

The **Resource Usages - <Action>** window appears, where **<Action>** is the name of the Action that you selected.

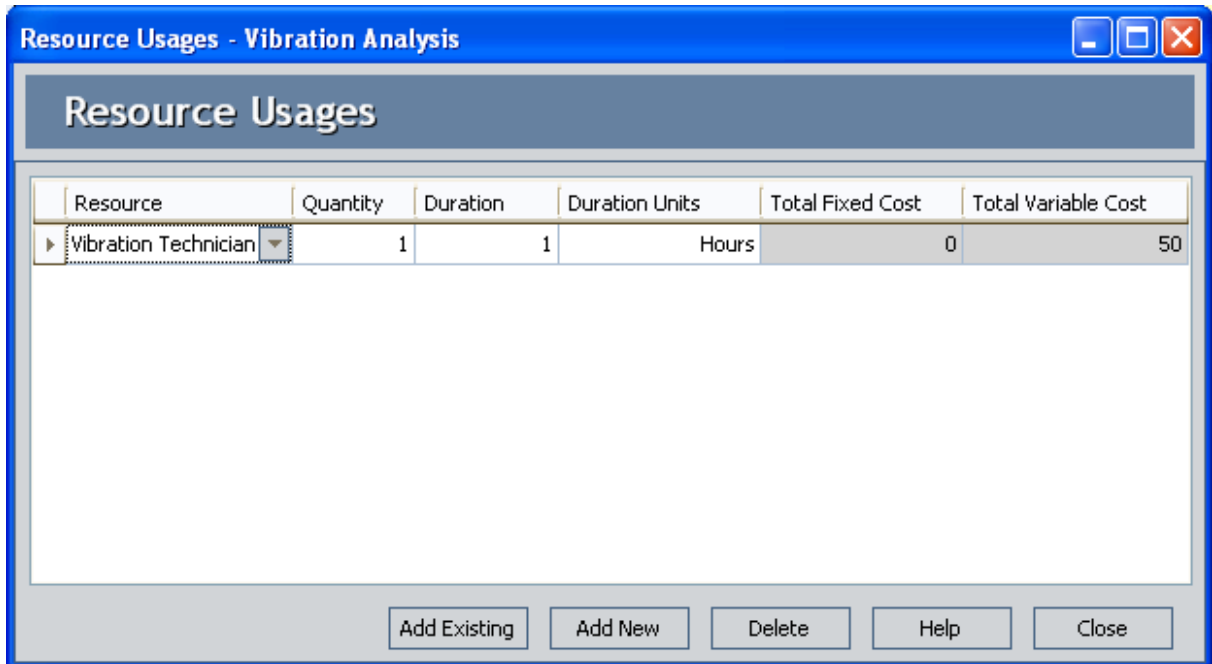

3. In the **Resource Usages** grid, select the Resource Usage record that you want to delete.
4. Click the **Delete** button.
A confirmation message appears, asking if you really want to delete the selected item(s).
5. Click the **Yes** button.

The Resource Usage is removed from the grid, and the System Resource Usage record is deleted from the database.

6. Click the **Close** button.

The **Resource Usages - <Action>** window closes.

About Optimizing Actions

In a System Reliability Analysis, you can *optimize Actions* to determine the most efficient interval at which to perform inspection or preventive maintenance Actions. The optimal interval balances the cost of the Actions and the reliability of the system.

You have two options for optimizing Actions:

- [You can optimize a single Action.](#)
- [You can optimize multiple Actions across multiple Scenarios.](#)

After an optimal interval has been calculated, you can apply it to your analysis by [replacing the current interval value with the optimal interval value](#).

When optimizing actions, you can run only one simulation at a time. While a simulation is running, however, you can continue working in other areas of the Meridium APM Framework by:

- Clicking anywhere on the Meridium APM Framework main window outside the **Run Simulation** dialog box. When you do so, the simulation will continue to run in the background, and the dialog box will be hidden behind the Meridium APM Framework window. When the simulation finishes, the dialog box will be returned to focus automatically.
- Clicking either the minimize or the close button on the **Run Simulation** dialog box. When you do so, the simulation will continue to run in the background, and the minimized dialog box will appear on your Windows taskbar. When the simulation finishes, the dialog box will be maximized and returned to focus automatically.

Optimizing a Single Action

To optimize a single Action:

1. While viewing the desired System Reliability Analysis and Scenario on the [System Reliability Scenarios - Actions page](#), in the [Diagram Hierarchy pane](#), select the element whose Action you want to optimize.
2. In the grid in the [Actions pane](#), select the Action that you want to optimize.
3. Below the grid in the **Actions** pane, click the **Optimize** button.

The **Action Interval Optimization** window appears.

The screenshot shows the 'Action Interval Optimization' window. The 'Settings' section includes the following fields: 'Action Name' (New Inspection), 'Interval Time Units' (Days), 'Current Interval' (1), 'Optimal Interval' (empty), 'Last Optimized' (empty), 'Min Interval' (1), 'Max Interval' (10), and 'Increment' (1). There are 'Run Simulation' and 'Apply Optimal Value' buttons. The 'Simulation Results' section has a toolbar and a legend for 'Lost Production Cost', 'Action Cost', 'Planned Correction Cost', 'Unplanned Correction Cost', and 'Total Cost'. The main area says 'No Data Available'. There are 'Close' and 'Help' buttons at the bottom.

In this image, the **Action Interval Optimization** window displays the data necessary to optimize the *New Inspection* Action.

4. In the **Min Interval** text box, type the desired minimum interval.
5. In the **Max Interval** text box, type the desired maximum interval.
6. In the **Increment** text box, type the desired increment.

Note: If desired, you can change the value in the **Current Interval** text box, which represents the current interval at which the current Action is performed. This text box is populated with the value in the Current Interval field in the System Action record. Modifying the value in the **Action Interval Optimization** window will cause the value in the System Action record to be updated with the same value.

7. Click the **Run Simulation** button.

The **Optimization Progress** dialog box appears, displaying a progress bar that indicates the progress of the optimization process.

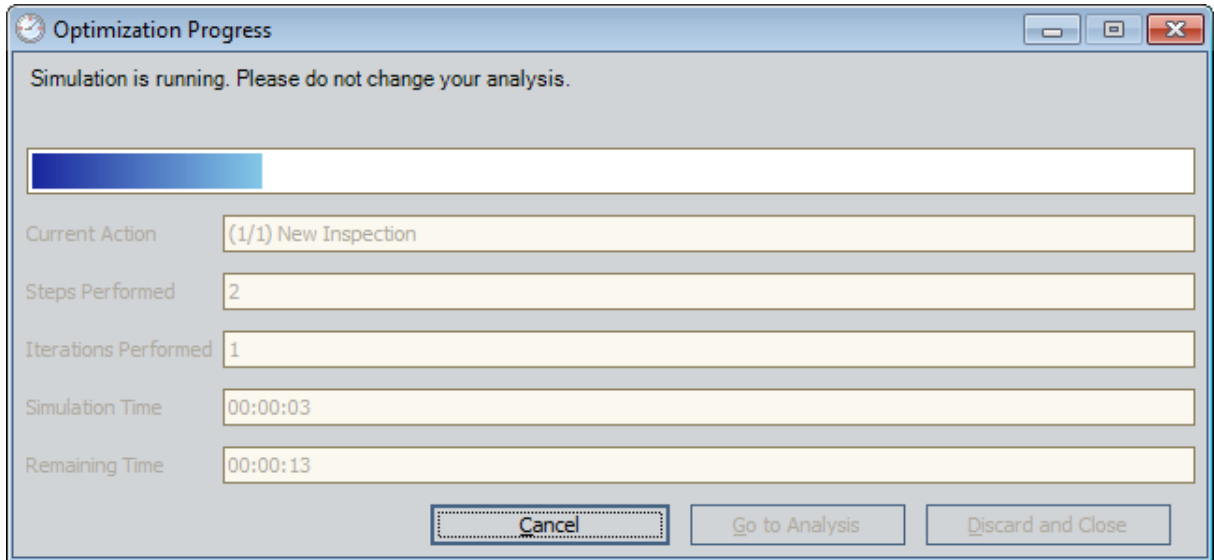

After the progress bar reaches the end, the **Go to Analysis** and **Discard and Close** buttons become enabled. If you do not want to view the results, you can click the **Discard and Close** button to close the **Optimization Progress** dialog box. These instructions assume that you want to view the results.

8. Click the **Go to Analysis** button.

The **Action Interval Optimization** window appears, displaying the Cost chart in the **Simulation Results** section and an updated value in **Optimal Interval** text box, as highlighted in the following image.

Optimizing a Single Action

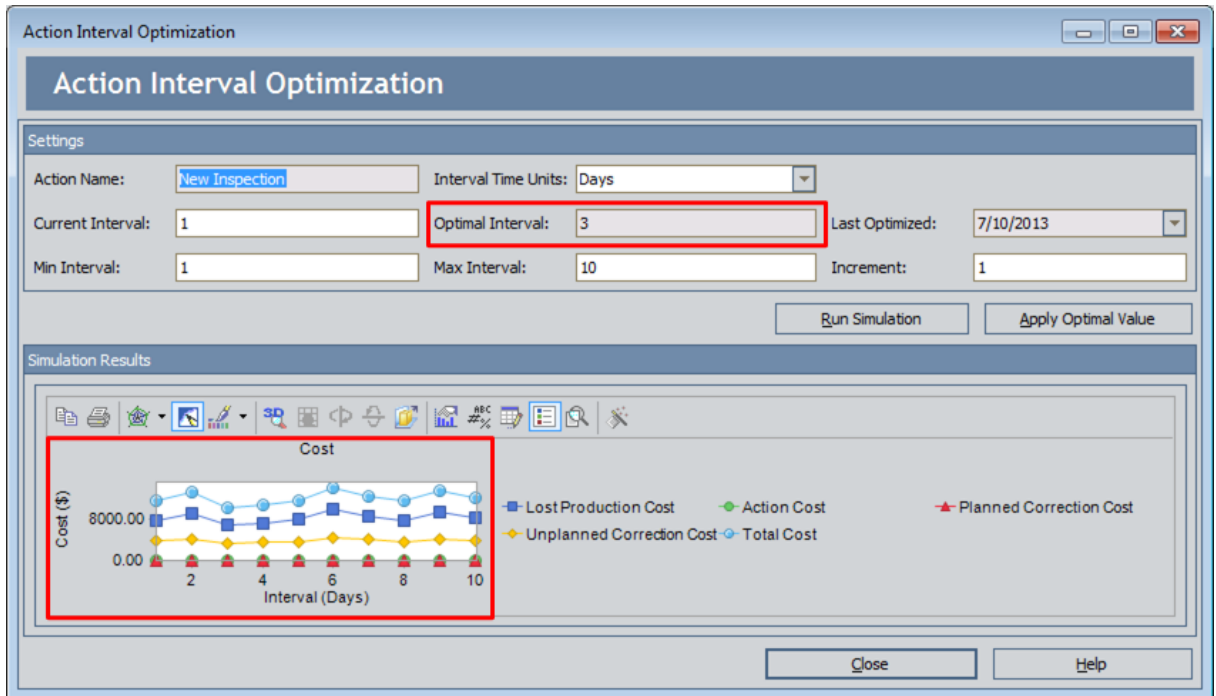

Optimizing Multiple Actions

To optimize multiple Actions within a System Reliability Analysis:

1. While viewing the desired System Reliability Analysis on any page, on the [Tools menu](#), click the **Optimize Actions** link.

The **Multiple Action Interval Optimization** window appears, displaying Actions in the System Reliability Analysis that can be optimized.

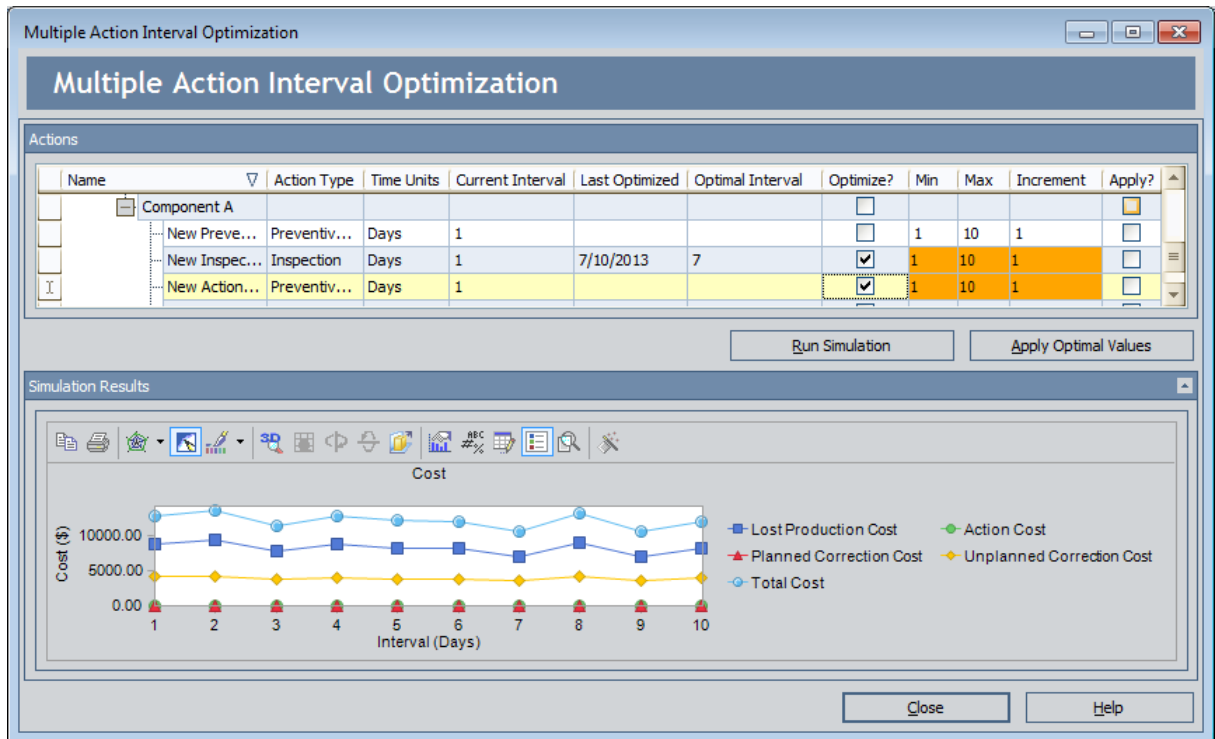

2. In the grid in the **Actions** pane, select the **Optimize** check box for the Action that you want to optimize.
3. In the **Min Interval** text box, type the desired minimum interval.
4. In the **Max Interval** text box, type the desired maximum interval.
5. In the **Increment** text box, type the desired increment.
6. Repeat steps 2 through 5 for other Actions that you want to optimize.

Note: If desired, you can change the data in the **Current Interval** text box, which represents the current interval at which the current Action is performed. This text box is populated with the value in the Current Interval field in the System Action record. Modifying the value in the **Multiple Action Interval Optimization** window will cause the value in the System Action record to be updated with the same value.

7. Below the grid in the **Actions** pane, click the **Run Simulation** button.

The **Optimization Progress** dialog box appears, displaying a progress bar that indicates the progress of the optimization process.

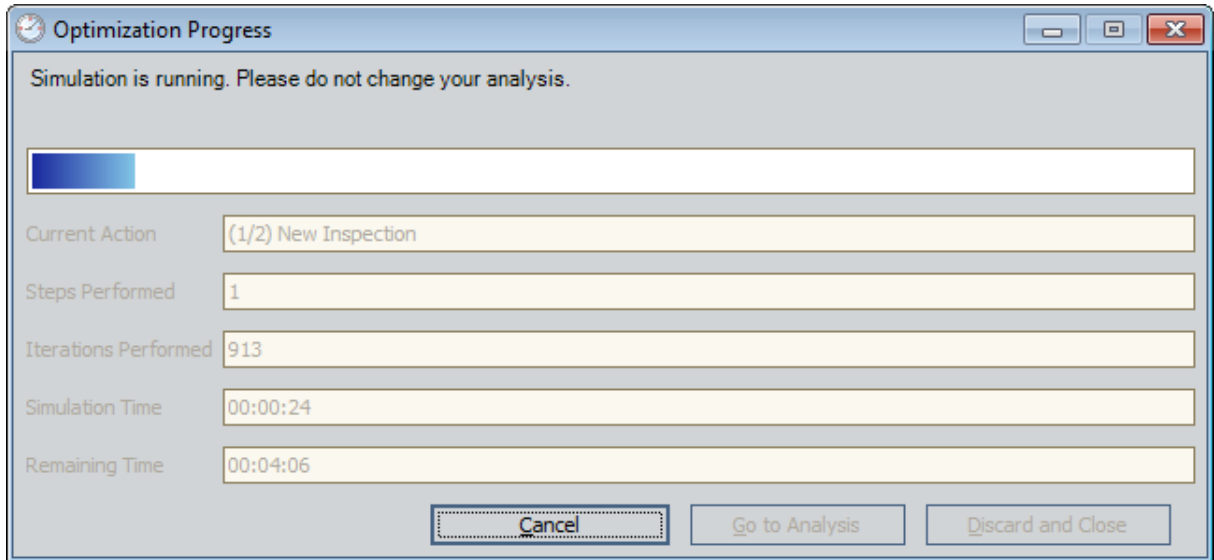

After the progress bar reaches the end, the **Go to Analysis** and **Discard and Close** buttons become enabled. If you do not want to view the results, you can click the **Discard and Close** button to close the **Optimization Progress** dialog box. These instructions assume that you want to view the results.

8. Click the **Go to Analysis** button.

The **MultipleAction Interval Optimization** window appears, displaying the Cost chart in the **Simulation Results** section and updated values in **Optimal Interval** cells, as highlighted in the following image.

Optimizing Multiple Actions

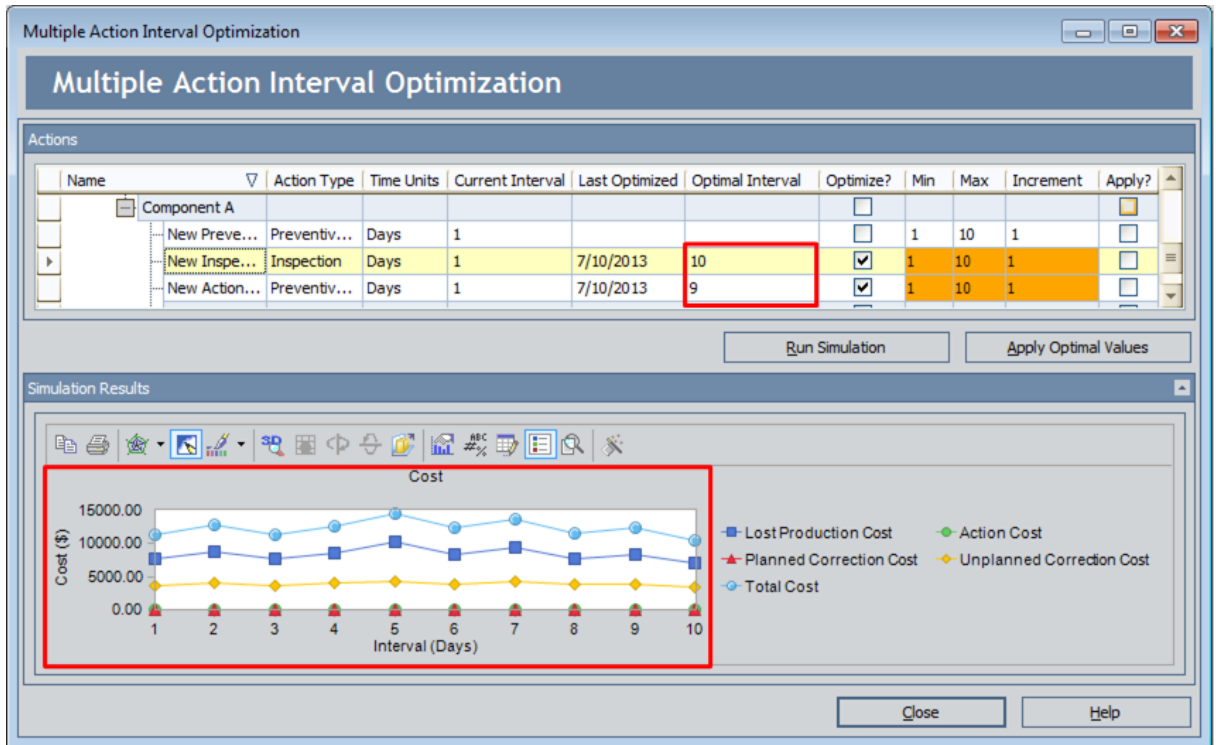

About Applying Optimal Action Intervals

When you [optimize Actions](#), you can determine the most efficient interval in which to perform inspection or preventive maintenance Actions. After you have found the optimal interval for an Action you can apply it to that Action. When you do so, the value in the Current Interval text box in the [Actions pane](#) and the value in the Interval field in the [System Action record](#) will be overwritten with the value that exists in the Optimal Interval text box.

After you apply the optimal interval, you will need to [rerun the simulation](#) for the System Reliability Analysis to update the result based upon the new action interval.

Applying Optimal Intervals to Actions

Applying the Optimal Value to a Single Action:

To apply the optimal interval to a Single Action:

1. Find the optimal Action interval value for the [Action you want to optimize](#).
2. On the **Action Interval Optimization** window, in the **Settings** section, click the **Apply Optimal Value** button.

Note: The **Apply Optimal Value** button is enabled only after you have optimized an Action. If you close the **Action Interval Optimization** window, you will have to optimize the Action again for the **Apply Optimal Value** button to become enabled.

The value in the **Optimal Interval** text box replaces the value in the **Current Interval** text box in the **Settings** section and in the Interval field in the associated System Action record.

Applying Optimal Intervals to Multiple Actions:

To apply optimal intervals to multiple Actions:

1. Find the optimal Action intervals for the [Actions you want to optimize](#).
2. In the grid in the **Actions** pane, in the **Apply** column, select the check box for the Actions whose current interval you want to replace with the optimal interval.
3. Below the grid in the **Actions** pane, click the **Apply Optimal Values** button.

The values in the **Optimal Interval** text boxes replace the values in the respective **Current Interval** text boxes in the grid in the **Actions** pane and in the Interval field in the associated System Action records.

Deleting Actions

To delete an Action:

1. On the [System Reliability Scenarios - Actions page](#), in the [Diagram Hierarchy pane](#), select the element whose Action you want to delete.
2. In the grid in the [Actions pane](#), select the Action that you want to delete.
3. Under the grid in the **Actions** pane, click the **Delete Action** button.
A confirmation message appears, asking if you really want to delete the Action.
4. Click the **Yes** button.
The Action is removed from the grid in the **Actions** pane..

About Global Events

A *Global Event* is an optional component of a System Reliability Analysis that groups together Actions requiring a system shutdown so that they will be performed at the same time, thereby maximizing the availability of the system. The information for a Global Event is stored in a [System Global Event record](#).

When you [create a Global Event](#), you select Actions that may be rescheduled and performed as part of the Global Event. The execution of the selected Actions is called a *Global Event*. To be performed with the Global Event, Actions must occur during the time period defined by the Max Delay and Max Advance values in the System Global Event record. Actions assigned to the Global Event that are performed outside of this time period will not be included in the Global Event, and their occurrence is not affected by the occurrence of the Global Event. The next occurrence of any recurring Actions that have been rescheduled and performed as part of a Global Event will be performed according to the values in the Interval and Interval Units fields in the System Action record.

Note: Actions that are represented by a [System Condition Monitor record](#) occur continuously and cannot be assigned to a Global Event. All other [Actions](#) can be performed in a Global Event.

For example, consider Scenario B in our System Reliability Analysis Example, which contains two Actions that require a system shutdown: Redesign Impellers and Replace Seals. The Redesign Impellers Action has a duration of one week, and the Replace Seals Action has a duration of one day. Performed independently of one another, they would result in a system shutdown lasting a total of eight days.

Now, assume that you group the two Actions together using a Global Event with a Max Delay value of 3 months and a Max Advance value of 4 weeks. This Global Event specifies that the two Actions will be rescheduled and performed together during the same system shutdown, as long as the Actions fall into the time period from 3 months before the Global Event and 4 weeks after the Global Event. Managing the Actions in this way would result in a shutdown lasting the longest of the two durations, or seven days. This approach is preferable, as it would save one day of costs associated with the system shutdown.

System Reliability Analyses support the use of two types of Global Events:

- [Action-driven Global Events](#).
- [Date-driven Global Events](#).

Note: While Global Events limit downtime and the history of a Global Event can be seen in the [Event Logs](#) generated from a System Reliability Analysis which contains a Global Event, the effects of Global Events are not presented explicitly anywhere in the simulation results. The effects of the Global Events are expressed as less downtime for the system, which means lower lost production costs.

About Action-Driven Global Events

An *Action-driven* Global Event is a collection of Actions that may occur based upon the occurrence of a driving Action. When the *driving Action* occurs, any Actions that fall into the time range specified by the Max Advance and Max Delay values are triggered to be rescheduled and performed with the driving Action. Action-driven Global Events can occur only one time in a simulation. If you select a recurring Action as the driving Action, the Global Event will occur the first time that the driving Action occurs. If you select more than one Action as the driving Action, then the first driving Action that occurs will trigger the other Actions in the Global Event.

For example, in Scenario B of our System Reliability Analysis Example, you might create an Action-driven Global Event, which is assigned both the Redesign Impellers and Replace Seal Actions, with the Redesign Impellers Action designated as the driving Action. In this case, when the Redesign Impellers Action occurs according to the properties specified in the System Action record that represents it, the Global Event will trigger any Replace Seals Action that falls within the time period specified by the Max Delay and Max Advance values to be rescheduled and completed with the occurrence of the Redesign Impellers Action.

About Date-Driven Global Events

A *date-driven* Global Event is a collection of Actions that may occur on a certain date. When the simulation reaches the date of the Global Event, any assigned Actions that fall into the time range specified by the Max Advance and Max Advance Duration values are triggered to be performed on the date of the Global Event. A date-driven Global Event can occur one or more times throughout the simulation period.

For example, in [Scenario B](#) of our [System Reliability Analysis Example](#), you might create a date-driven Global Event and specify that it should occur on a date halfway through the simulation. To this Global Event you would assign the Redesign Impellers and Replace Seals Actions. In this case, the Global Event would trigger both of the Actions which fall into the time period, specified by the Max Advance Duration and Max Delay Duration values, almost three and a half years into the simulation, regardless of what properties existed in the System Action records that represent the Redesign Impellers and Replace Seal Actions.

Global Events Pane

The **Global Events** pane appears on the [System Reliability Scenarios - Global Events page](#) and displays the Global Events associated with the Scenario that you are currently viewing.

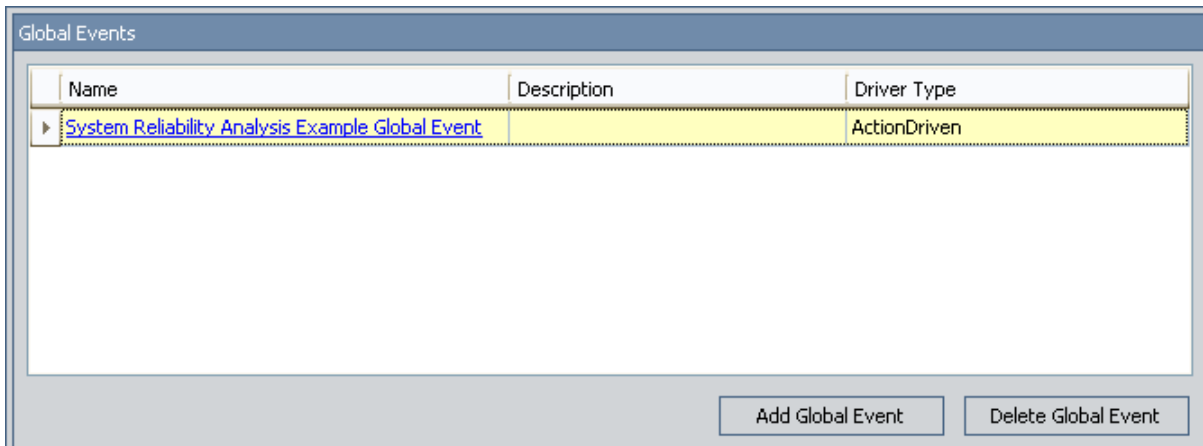

The screenshot shows a window titled "Global Events" containing a table with three columns: "Name", "Description", and "Driver Type". The first row is highlighted in yellow and contains the text "System Reliability Analysis Example Global Event" under "Name" and "ActionDriven" under "Driver Type". Below the table are two buttons: "Add Global Event" and "Delete Global Event".

Name	Description	Driver Type
System Reliability Analysis Example Global Event		ActionDriven

The grid in the **Global Events** pane contains the following columns:

- **Name:** Displays the value stored in the Name field of the [System Global Event record](#).
- **Description:** Displays the value stored in the Description field of the [System Global Event record](#).
- **Driver Type:** Displays the value stored in the Driver Type field of the [System Global Event record](#).

Below the grid in the **Global Events**pane, the following buttons appear:

- **Add Global Event:** Displays the **New Global Event** window, where you can create a new [System Global Event record](#).
- **Delete Global Event:** After asking for confirmation, [deletes the System Global Event record](#) that is currently selected in the grid in the **Global Event** pane.

Actions to Align Pane

The **Actions to Align** pane appears on the [System Reliability Scenarios - Global Events page](#) and displays the Actions that are currently assigned to the Global Event that is selected in the **Global Events** pane.

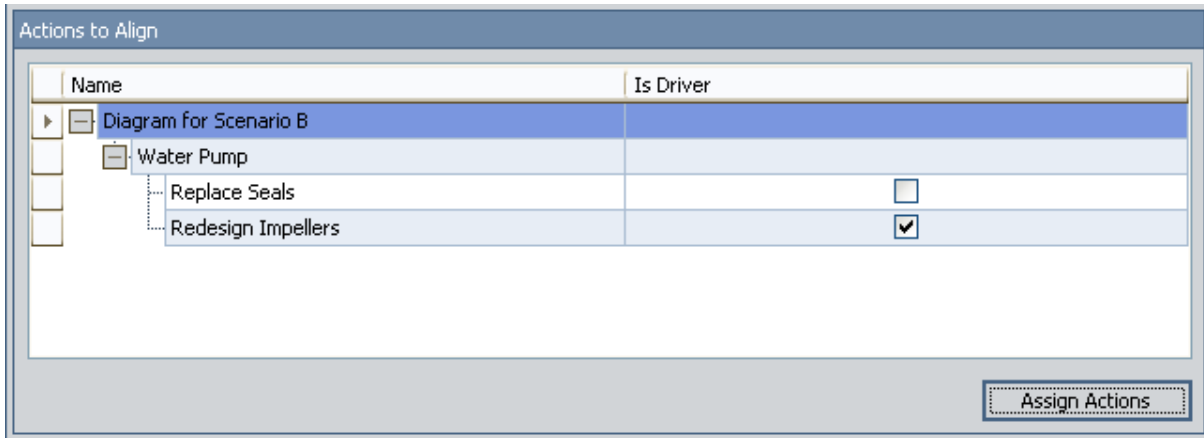

The grid in the **Actions to Align** pane displays the following columns:

- **Name:** Displays a hierarchy that lists the Actions that exist in the Scenario Diagram. The Actions appear in the hierarchy below the element to which they belong, with elements appearing below the Scenario Diagram to which they belong.

Note: For example, the preceding image displays the [Replace Seals and Redesign Impellers Actions](#), which are assigned to the Water Pump element, which exists in the Diagram for Scenario B.

- **Is Driver:** Displays check boxes that allow you to identify driving Action(s) for Action-driven Global Events. You cannot change the **Is Driver** status of the Action from this pane.

Below the grid in the **Actions to Align** pane, the following button appears:

- **Assign Action:** Displays the **Assign Actions** window, where you can [select Actions to assign to the current Global Event](#).

About Creating Global Events

To create a Global Event, you must complete two steps:

1. [Create a System Global Event record.](#)
2. [Assign Actions to the Global Event.](#)

Creating System Global Event Records

To create a System Global Event record:

1. While viewing the desired System Reliability Analysis and Scenario on the [System Reliability Scenarios - Global Events page](#), below the grid in the **Global Events** pane, click the **Add Global Event** button.

The **New Global Event** window appears, where you can create a new Global Event.

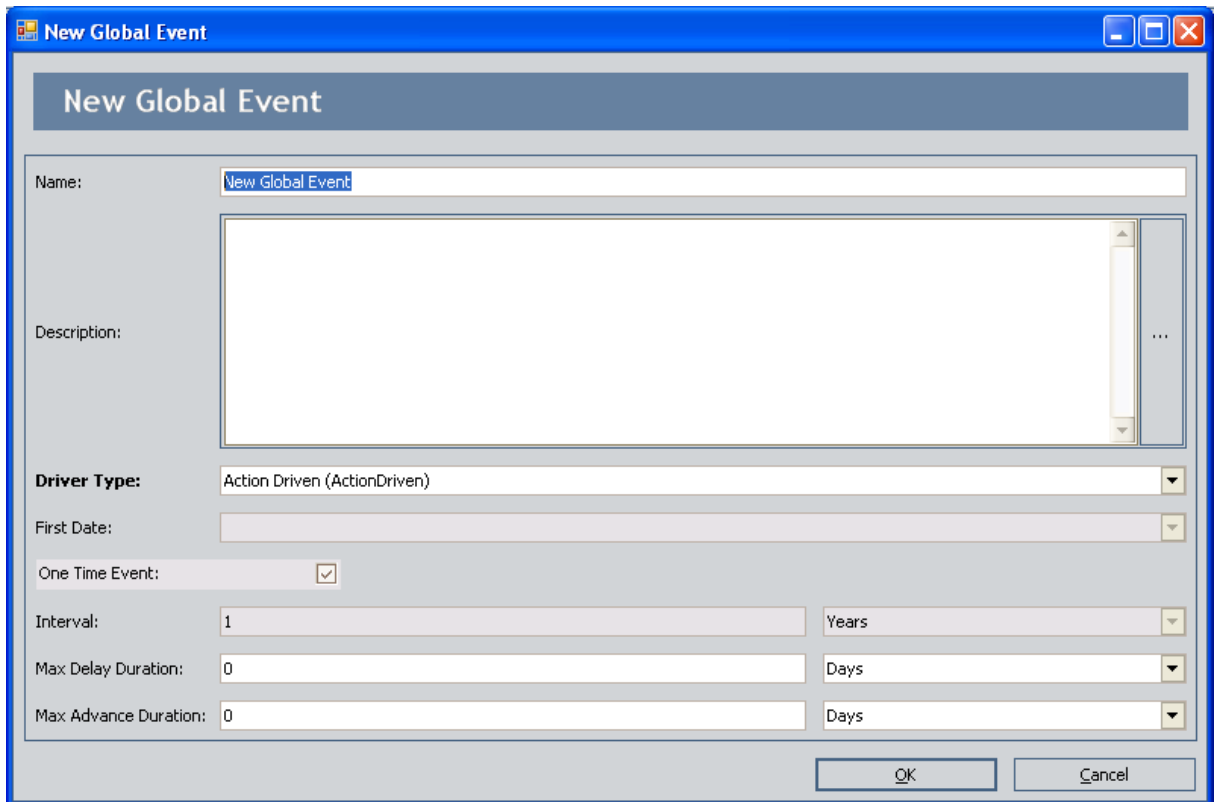

The screenshot shows a dialog box titled "New Global Event". The "Name" field contains "New Global Event". The "Description" field is empty. The "Driver Type" dropdown is set to "Action Driven (ActionDriven)". The "First Date" dropdown is empty. The "One Time Event" checkbox is checked. The "Interval" field contains "1" and the unit dropdown is set to "Years". The "Max Delay Duration" field contains "0" and the unit dropdown is set to "Days". The "Max Advance Duration" field contains "0" and the unit dropdown is set to "Days". The "OK" and "Cancel" buttons are at the bottom right.

The content of the New Global Event window is controlled by the default datasheet that is defined for the System Global Event family.

2. [Define the properties of the System Global Event record as desired.](#)
3. Click **OK**.

The System Global Event record is created and appears in the grid in the [Global Events pane](#).

About Assigning Actions to Global Events

When you assign Actions to a Global Event, you select the Actions that will be executed at the same time, as defined by the Global Event. Any Actions that should be performed during the qualifying time period, as defined by the values in the Max Delay Duration and Max Advance Duration fields, will be executed together.

Assigning Actions to Global Events

To assign an Action to a Global Event:

1. While viewing the desired System Reliability Analysis and Scenario on the [System Reliability Scenarios - Global Events page](#), in the grid in the **Global Events** pane, in the **Name** column, select the Global Event to which you want to assign Actions.
2. Below the grid in the **Actions to Align** pane, click the **Assign Actions** button.

The **Assign Actions** window appears, showing all of the Actions that exist for the Scenario.

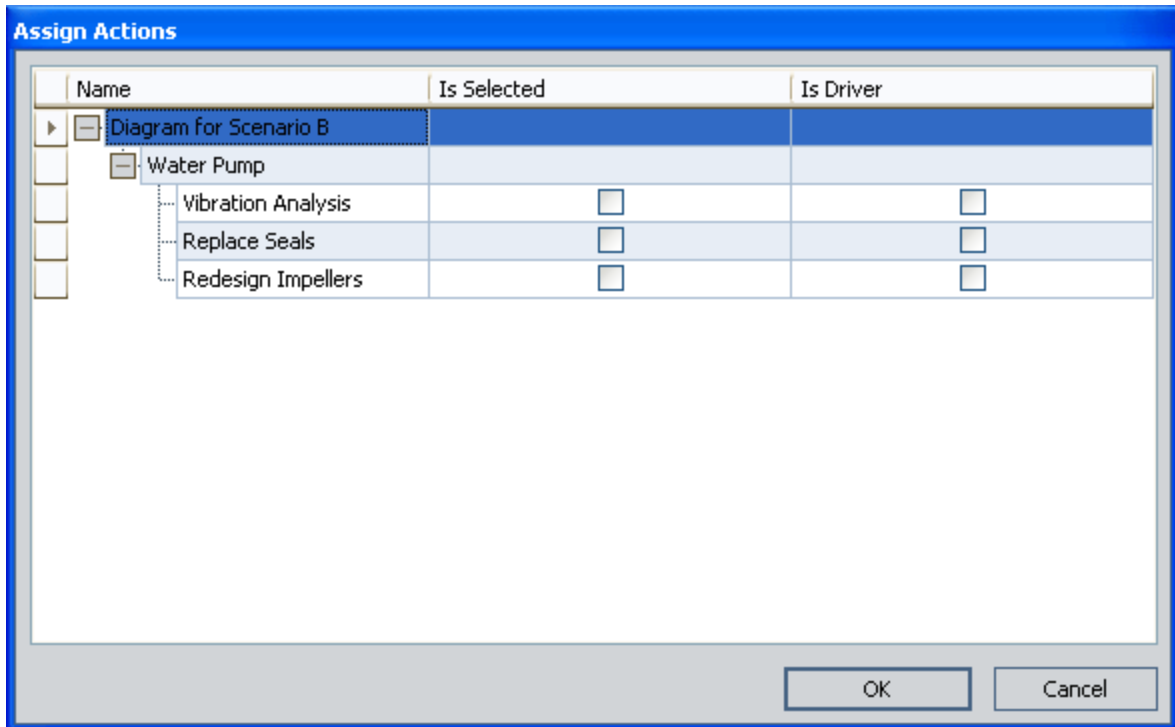

This image displays the Actions in [Scenario B](#) of our [System Reliability Analysis Example](#).

3. In the **Is Selected** column, select the check box for the Actions that you want to assign to the selected Global Event.
4. If the Global Event is driven by Actions, in the **Is Driver** column, select the check box for the Actions that you want to drive the selected Global Event.

Note: This column is disabled for date-driven Global Events.

5. Click **OK**.

Your selections are saved and appear in the **Actions to Align** pane.

CE Hint: If you want to select the **Is Driver** check box for an Action, you must first select the **Is Selected** check box.

Removing Actions from Global Events

When you remove an Action from a Global Event, it will no longer be delayed or advanced in time to be executed with the other grouped Actions in the Global Event.

To remove an Action from a Global Event:

1. While viewing the desired System Reliability Analysis and Scenario on the [System Reliability Scenarios - Global Events](#) page, in the grid in the **Global Events** pane, in the **Name** column, select the Global Event that contains the Actions that you want to remove.
2. Below the grid in the **Actions to Align** pane, click the **Assign Actions** button.

The **Assign Actions** window appears.

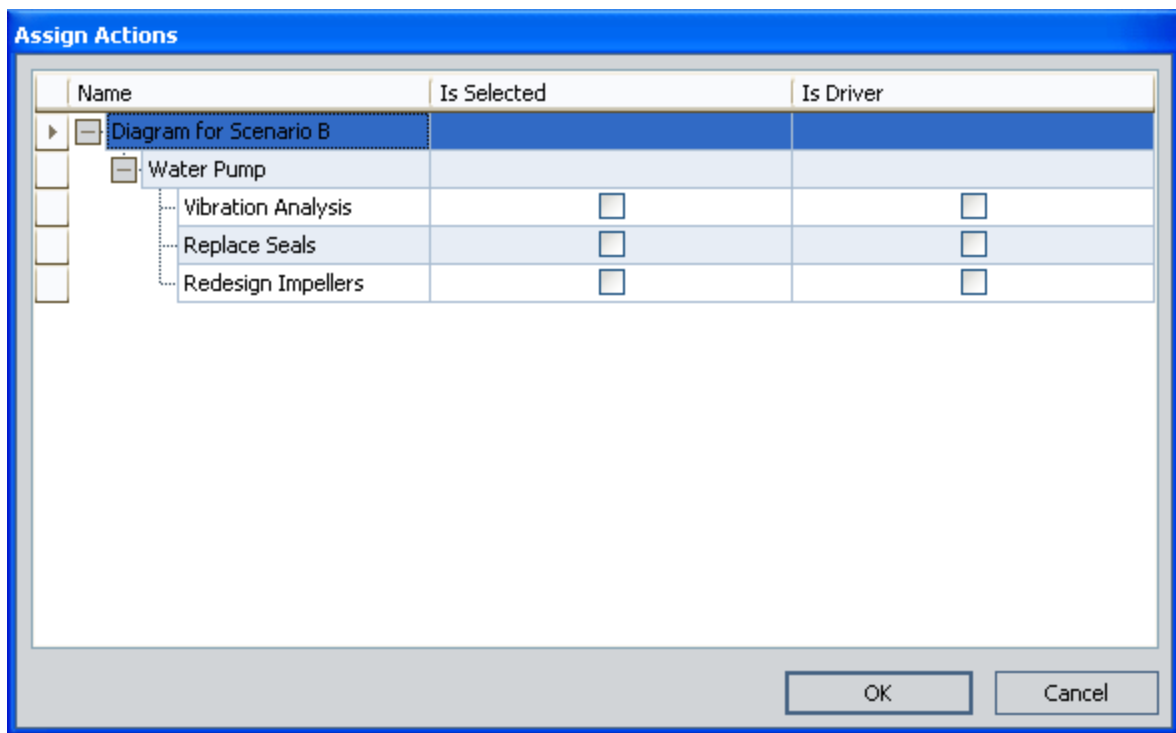

3. In the **Is Selected** column, clear the check box for any Actions that you want to remove from the Global Event.
4. Click **OK**.

Your changes are saved, and the **Actions to Align** pane is updated to reflect those changes.

Modifying System Global Event Records

To modify a System Global Event record:

1. While viewing the desired System Reliability Analysis and Scenario on the [System Reliability Scenarios - Global Events](#) page, in the grid in the **Global Events** pane, click the hyperlinked name of the System Global Event record that you want to modify.

The <Global Event> window appears, where <Global Event> is the name of the Global Event that you selected.

The screenshot shows a dialog box titled "System Reliability Analysis Example Global Event". The form inside contains the following fields and values:

- Name:** System Reliability Analysis Example Global Event
- Description:** (Empty text area)
- Driver Type:** Action Driven (ActionDriven)
- First Date:** (Empty date field)
- One Time Event:**
- Interval:** 1 (text box) and Years (dropdown)
- Max Delay Duration:** 6 (text box) and Months (dropdown)
- Max Advance Duration:** 6 (text box) and Months (dropdown)

Buttons for "OK" and "Cancel" are located at the bottom right of the dialog box.

This image displays the datasheet for a possible System Reliability Analysis Example Global Event which could be used in our [System Reliability Analysis Example](#).

2. [Modify the properties of the System Global Event record as desired.](#)
3. Click **OK**.

Your changes are saved.

Deleting Global Events

When you delete a Global Event, the [System Global Event record](#) that represents the Global Event is deleted. This removes any properties of the Global Event, such as the interval at which the Global Event may be repeated and which Actions may be performed with the Global Event, but the [System Action records](#) that represent the Actions that exist in the Scenario are not modified or deleted in any way.

To delete a Global Event:

1. While viewing the desired System Reliability Analysis and Scenario on the [System Reliability Scenarios - Global Events page](#), in the grid in the **Global Events** pane, select the Global Event that you want to delete.
2. Below the grid in the **Global Events** pane, click the **Delete Global Event** button.
A confirmation message appears, asking if you really want to delete the selected Global Event.
3. Click the **Yes** button.

The Global Event is removed from the grid in the **Global Events** pane and the System Global Event record is deleted from the database.

Overview of the System Reliability Scenarios - Grid Page

In addition to working with Scenarios on the [System Reliability Scenarios - Diagram page](#), you can also view Scenarios on the [System Reliability Scenarios - Grid page](#). On this page, you can view and modify certain properties of elements that exist in a given Scenario, but you cannot use this page to add or delete Scenario elements. By using the **Scenario** and **Filter** lists at the top of the [System Reliability Scenarios - Grid workspace](#), you can select options to view data that is specific to a given Scenario and element.

Site Map: [Reliability->System Reliability->System Reliability Analysis Example->Scenario C](#)

Scenario: Scenario C

Filter: Asset

Name	Production Contribution	Fixed Cost (\$)	Variable Cost (\$)	Variable Cost Units	Lost Production Cost (\$)	Lost Production Cost ...
Diagram for Scenario C	100.00	0.00	0.00	Per Day	100,000.00	Per Day
Bottling Subsystem	100.00	0.00	0.00	Per Day	0.00	Per Day
Bottling Line 1	40.00	0.00	0.00	Per Day	0.00	Per Day
Bottling Line 2	40.00	0.00	0.00	Per Day	0.00	Per Day
Bottling Line 3	40.00	0.00	0.00	Per Day	0.00	Per Day
Water Pump 1	100.00	5,000.00	50.00	Per Hour	0.00	Per Day
Water Pump 2	100.00	5,000.00	50.00	Per Hour	0.00	Per Day
Water Source	100.00	0.00	0.00	Per Day	0.00	Per Day

The main display area of the [System Reliability Scenarios - Grid page](#) contains a grid that shows information for the elements that exist in the selected Scenario. By default, the grid is configured to display certain columns in a particular order, depending upon the type of elements that are displayed. If desired, you can customize the appearance of the grid.

Within the grid, under the **Name** column, a *hierarchy* displays an organizational view of the elements in the Diagram associated with the selected Scenario. The root Subsystem is displayed at the top, with any elements belonging to the root Subsystem listed below it. Any other subsystems are listed below the root Subsystem, with any elements belonging to them listed below them.

For example, the preceding image shows [Scenario C](#) in our [System Reliability Analysis Example](#). In this image, *Diagram for Scenario C* appears at the top of the hierarchy and represents the root Subsystem for the Diagram. Below it appear the Subsystem and the Assets that exist at the main level of the Diagram: Bottling Subsystem, Water Pump 1, Water Pump 2, and Water Source. Below the Bottling Subsystem element are the Asset elements that make up that subsystem: Bottling Line 1, Bottling Line 2, and Bottling Line 3. The properties for each element appear in the columns to the right of the element name.

An icon appears to the left of each element to help identify it. The icons that appear in the list are the same as the ones used on the [System Reliability Scenarios - Diagram page](#). Actions, Risks, and Distributions are not represented by icons in the Diagram, but

they are represented by the following icons on the [System Reliability Scenarios - Grid page](#):

- Actions are represented by the 🧑🔧 icon.
- Risks are represented by the 🚫 icon.
- Time to Failure Distributions are represented by the 📊 icon.
- Time to Repair Distributions are represented by the 🛠️ icon.

Note: You can click the plus sign (+) to the left of any Subsystem icon to view additional information about a Subsystem element. Similarly, you can click any minus sign (-) to collapse that level of the hierarchy.

Within the grid, you can modify the properties of the Scenario elements. To do so, click in any cell, and modify the current value. Some properties cannot be modified via the grid. Editable cells correspond to modifiable fields in the records that store information for the elements in System Reliability Analyses. Disabled cells are used to display fields that do not exist or are disabled in the record for the element that is displayed in the grid. For example, in the image shown above, the **Production Contribution** cell for the Diagram for Scenario C Subsystem is disabled because the value in the Production Contribution field for a root System Subsystem record of a Diagram cannot be modified through System Reliability Analyses.

Using the **Scenario** and **Filter** lists, which appear at the top of the [System Reliability Scenarios - Grid workspace](#), you can select options to view data that is specific to a given Scenario and element. For instance, selecting *Action* in the **Filter** list will display a list of Actions that exist for the Asset and Switch elements in the Scenario that you selected in the **Scenario** list. The **Scenario** list contains the names of the System Scenario records that are associated with the current System Reliability Analysis. You can select any name in the list to view elements of that Scenario in the grid. The **Filter** list contains the following options:

- [Action](#)
- [Asset](#)
- [Buffer](#)
- [Distribution](#)
- [Link](#)
- [Risk](#)
- [Subsystem](#)
- [Switch](#)

You can select any item in the **Filter** list to view those elements for the Scenario that is selected in the **Scenario** list.

By Action

When you select *Action* in the **Filter** list on the [System Reliability Scenarios - Grid page](#), the grid will display data related to the Actions that exist in the Scenario selected in the **Scenario** list. The following image shows the grid that is displayed for the [System Reliability Analysis Example](#) when *Scenario B* is selected in the **Scenario** list and *Action* is selected in the **Filter** list.

Name	Action Cost (\$)	Interval	Interval Units	Duration	Duration Units	Detection Probability	Shutdown Required	One Time Action
Diagram for Scenario B							<input type="checkbox"/>	<input type="checkbox"/>
Bottling Subsystem							<input type="checkbox"/>	<input type="checkbox"/>
Bottling Line 1							<input type="checkbox"/>	<input type="checkbox"/>
Bottling Line 2							<input type="checkbox"/>	<input type="checkbox"/>
Bottling Line 3							<input type="checkbox"/>	<input type="checkbox"/>
Water Pump							<input type="checkbox"/>	<input type="checkbox"/>
Redesign Impellers	1,600.00	2.00	Years	2.00	Days		<input checked="" type="checkbox"/>	<input checked="" type="checkbox"/>
Replace Seals	2,000.00	2.00	Years	4.00	Hours		<input checked="" type="checkbox"/>	<input type="checkbox"/>
Vibration Analysis	0.00	3.00	Weeks	1.00	Hours	90.00	<input type="checkbox"/>	<input type="checkbox"/>
Water Source							<input type="checkbox"/>	<input type="checkbox"/>

The following columns of information are displayed in the grid when the *Action* option is selected in the **Filter** list:

- **Name:** Displays a hierarchy that lists the Subsystems, Assets, Switches, and Actions that exist in the Scenario. Actions appear in the hierarchy below the Asset, Switch, or Subsystem element to which they belong.
- **Action Cost (\$):** Displays the value that exists in the Action Cost field in the [System Action record](#).
- **Interval:** Displays the value that exists in the Interval field in the [System Action record](#).
- **Interval Units:** Displays the value that exists in the Interval Units field in the [System Action record](#).
- **Duration:** Displays the value that exists in the Duration field in the [System Action record](#).
- **Duration Units:** Displays the value that exists in the Duration Units field in the [System Action record](#).
- **Detection Probability:** Displays the value that exists in the Detection Probability field in the [System Action record](#).
- **Shutdown Required:** Displays the value that exists in the Shutdown Required field in the [System Action record](#).
- **One Time Action:** Displays the value that exists in the One Time Action field in the [System Action record](#).

By Asset

When you select *Asset* in the **Filter** list on the [System Reliability Scenarios - Grid page](#), the grid will display data related to the Assets and Subsystems that exist in the Scenario selected in the **Scenario** list. The following image shows the grid that is displayed for the [System Reliability Analysis Example](#) when *Scenario A* is selected in the **Scenario** list and *Asset* is selected in the **Filter** list.

Name	Production Contribution	Fixed Cost (\$)	Variable Cost (\$)	Variable Cost Units	Lost Production Cost (\$)	Lost Production Cost Units
Diagram for Scenario A	100.00	0.00	0.00	Per Day	100,000.00	Per Day
Bottling Subsystem	100.00	0.00	0.00	Per Day	0.00	Per Day
Bottling Line 1	40.00	0.00	0.00	Per Day	0.00	Per Day
Bottling Line 2	40.00	0.00	0.00	Per Day	0.00	Per Day
Bottling Line 3	40.00	0.00	0.00	Per Day	0.00	Per Day
Water Pump	100.00	5,000.00	50.00	Per Hour	0.00	Per Day
Water Source	100.00	0.00	0.00	Per Day	0.00	Per Day

The following columns of information are displayed in the grid when the *Asset* option is selected in the **Filter** list:

- **Name:** Displays a hierarchy that lists the Subsystems and Assets that exist in the Scenario. Assets appear below the Subsystem element to which they belong.
- **Production Contribution:** Displays the value that exists in the Production Contribution field in the [System Asset](#) or [System Subsystem record](#).
- **Fixed Cost:** Displays the value that exists in the Fixed Cost field in the [System Asset](#) or [System Subsystem record](#).
- **Variable Cost (\$):** Displays the value that exists in the Variable Cost field in the [System Asset](#) or [System Subsystem record](#).
- **Variable Cost Units:** Displays the value that exists in the Variable Cost Units field in the [System Asset](#) or [System Subsystem record](#).
- **Lost Production Cost (\$):** Displays the value that exists in the Los Production Cost field in the [System Asset](#) or [System Subsystem record](#).
- **Lost Production Cost Units:** Displays the value that exists in the Lost Production Cost Units field in the [System Asset](#) or [System Subsystem record](#).

By Buffer

When you select *Buffer* in the **Filter** list on the [System Reliability Scenarios - Grid page](#), the grid will display data related to the Buffers that exist in the Scenario selected in the **Scenario** list. The following image shows the grid that is displayed for the [System Reliability Analysis Example](#) when *Scenario A* is selected in the **Scenario** list and *Buffer* is selected in the **Filter** list.

Name	Description	Production Contribution	Initial Quantity in Percentage	Time to Empty	Time to Empty Units	Time to Refill	Time to Refill Units
Diagram for Scenario A		100.00					
Water Tank		100.00	100.00	0.50	Days	5.00	Days

The following columns of information are displayed in the grid when the *Buffer* option is selected in the **Filter** list:

- **Name:** Displays a hierarchy that lists the Buffers that exist in the Scenario, including Buffers that belong directly to the root Subsystem and Buffers that belong to any Subsystem elements. Buffers appear in the hierarchy below the Subsystem element to which they belong.
- **Description:** Displays the value that exists in the Description field in the [System Buffer record](#).
- **Production Contribution:** Displays the value that exists in the Production Contribution field in the [System Buffer](#) or [System Subsystem record](#).
- **Initial Quantity in Percentage:** Displays the value that exists in the Initial Quantity in Percentage field in the [System Buffer record](#).
- **Time to Empty:** Displays the value that exists in the Time to Empty field in the [System Buffer record](#).
- **Time to Empty Units:** Displays the value that exists in the Time to Empty Units field in the [System Buffer record](#).
- **Time to Refill:** Displays the value that exists in the Time to Refill field in the [System Buffer record](#).
- **Time to Refill Units:** Displays the value that exists in the Time to Refill Units field in the [System Buffer record](#).

By Distribution

When you select *Distribution* in the **Filter** list on the [System Reliability Scenarios - Grid page](#), the grid will display data in the Distribution records associated with the Scenario selected in the **Scenario** list. On the [System Reliability Scenarios - Grid page](#), Distribution records are shown as *properties* of the Risk elements with which they are associated.

The following image shows the grid that is displayed for the [System Reliability Analysis Example](#) when *Scenario A* is selected in the **Scenario** list and *Distribution* is selected in the **Filter** list.

Name	Distribution Type	Time Unit	Parameter 1	Parameter 2	Parameter 3
Diagram for Scenario A					
Water Source					
Water Source Failure					
TTF Distribution	Exponential	Years	20.00 (MTBF)		
TTR Distribution	Exponential	Weeks	2.00 (MTTR)		
Water Pump					
Seal Failure					
TTF Distribution	Weibull	Years	4.00 (Beta)	3.00 (Eta)	0.00 (Gamma)
TTR Distribution	SingleValue	Hours	12.00 (Value)		
Bearing Failure					
TTF Distribution	Exponential	Months	60.00 (MTBF)		
TTR Distribution	Exponential	Hours	8.00 (MTTR)		
Impeller Failure					
TTF Distribution	Exponential	Months	24.00 (MTBF)		
TTR Distribution	SingleValue	Hours	12.00 (Value)		
Bottling Subsystem					
Bottling Line 1					
Bottling Line Failure					
TTF Distribution	Exponential	Months	12.00 (MTBF)		
TTR Distribution	Exponential	Days	1.00 (MTTR)		
Bottling Line 2					
Bottling Line Failure					
TTF Distribution	Exponential	Months	12.00 (MTBF)		
TTR Distribution	Exponential	Days	1.00 (MTTR)		
Bottling Line 3					
Bottling Line Failure					
TTF Distribution	Exponential	Months	12.00 (MTBF)		
TTR Distribution	Exponential	Days	1.00 (MTTR)		

The following columns of information are displayed in the grid when the *Distribution* option is selected in the **Filter** list:

- **Name:** Displays a hierarchy that lists the Subsystems, Assets, Switches, Risks, and distributions that exist in the Scenario. Distributions appear in the hierarchy below the Risk to which they belong.
- **Distribution Type:** Displays the name of the family to which the Distribution record belongs.
- **Time Unit:** Displays the value that exists in the Unit field of the Distribution record.
- **Parameter 1:** Displays the value that exists in the Beta field in a Weibull record,

the MTBF field in an Exponential record, the Mean field in a Normal record, or the Mu field in a Lognormal record.

Note: When you select the value *Single Value* in the **Distribution Type** list on the **TTF Distribution** or **TTR Distribution** window, you create a *Normal* record with a Standard Deviation value of 0 (zero). For these records, the **Parameter 1** column displays the value that exists in the *Value* field, rather than the Mean field.

- **Parameter 2:** Displays the value that exists in the Eta field in a Weibull record, the Standard Deviation for a Normal record, or the Sigma field for a Lognormal record.
- **Parameter 3:** Displays the value that exists in the Gamma field in the Weibull record or Lognormal record.

By Link

When you select *Link* in the **Filter** list on the [System Reliability Scenarios - Grid page](#), the grid will display data related to the Links that exist in the Scenario selected in the **Scenario** list. The following image shows the grid that is displayed for the [System Reliability Analysis Example](#) when *Scenario A* is selected in the **Scenario** list and *Link* is selected in the **Filter** list.

Name	Minimum Predecessors
Diagram for Scenario A	
Bottling Subsystem	
Link	2

The following columns of information are displayed in the grid when the *Link* option is selected in the **Filter** list:

- **Name:** Displays a hierarchy that lists only the Subsystems which contain Links and the Links that exist in the Scenario. Links appear in the hierarchy below the Subsystem element to which they belong.
- **Minimum Predecessors:** Displays the value that exists in the Minimum Predecessors field in the [System Link record](#). You cannot modify this value from the [System Reliability Scenarios - Grid page](#).

By Risk

When you select *Risk* in the **Filter** list on the [System Reliability Scenarios - Grid page](#), the grid will display data related to the Risks that exist in the Scenario selected in the **Scenario** list. The following image shows the grid that is displayed for the [System Reliability Analysis Example](#) when *Scenario C* is selected in the **Scenario** list and *Risk* is selected in the **Filter** list.

Name	Fixed Unplanned Correcti...	Variable Unplanned Correcti...	Variable Unplanned Correction Co...	Planned Correct...	Planned Correcti...	Planned Correction Dur...	PF ...	PF Int...
Diagram for Scenario A			Per Day					
Water Source			Per Day					
Water Source Fa...	0.00	0.00	Per Day	0.00	0.00	Days		0.00 Days
Water Pump 1			Per Hour					
Seal Failure	1,500.00	1,000.00	Per Day	1,000.00	4.00	Hours		30.00 Days
Bearing Failure	2,000.00	1,000.00	Per Day	1,000.00	4.00	Hours		6.00 Weeks
Impeller Failure	1,500.00	1,000.00	Per Day	1,000.00	4.00	Hours		0.00 Days
Water Pump 2			Per Hour					
Seal Failure	1,500.00	1,000.00	Per Day	1,000.00	4.00	Hours		30.00 Days
Bearing Failure	2,000.00	1,000.00	Per Day	1,000.00	4.00	Hours		6.00 Weeks
Impeller Failure	1,500.00	1,000.00	Per Day	1,000.00	4.00	Hours		0.00 Days
Switch 1			Per Day					
Switch 2			Per Day					
Bottling Subsystem			Per Day					
Bottling Line 1			Per Day					
Bottling Line ...	0.00	0.00	Per Day	0.00	0.00	Days		0.00 Days
Bottling Line 2			Per Day					
Bottling Line ...	0.00	0.00	Per Day	0.00	0.00	Days		0.00 Days
Bottling Line 3			Per Day					
Bottling Line ...	0.00	0.00	Per Day	0.00	0.00	Days		0.00 Days

The following columns of information are displayed in the grid when the *Risk* option is selected in the **Filter** list:

- **Name:** Displays a hierarchy that lists the Subsystems, Assets, Switches, and Risks that exist in the Scenario. Risks appear in the hierarchy placed below the Asset or Switch element to which they belong.
- **Fixed Unplanned Correction Cost (\$):** Displays the value that exists in the Fixed Unplanned Correction Cost field in the System Risk record.
- **Variable Unplanned Correction Cost (\$):** Displays the value that exists in the Variable Unplanned Correction Cost field in the System Risk record.
- **Planned Correction Cost (\$):** Displays the value that exists in the Planned Correction Cost field in the System Risk record.
- **Planned Correction Cost Units:** Displays the value that exists in the Planned Correction Cost Units field in the System Risk record.
- **Planned Correction Duration:** Displays the value that exists in the Planned Correction Duration field in the System Risk record.
- **Planned Correction Duration Units:** Displays the value that exists in the Planned Correction Duration Units field in the System Risk record.
- **PF Interval:** Displays the value that exists in the PF Interval field in the System Risk record.

By Risk

- **PF Interval Units:** Displays the value that exists in the PF Interval Units field in the System Risk record.

By Subsystem

When you select *Subsystem* in the **Filter** list on the [System Reliability Scenarios - Grid page](#), the grid will display data related to the Subsystems that exist in the Scenario selected in the **Scenario** list. The following image shows the grid that is displayed for the [System Reliability Analysis Example](#) when *Scenario A* is selected in the **Scenario** list and *Subsystem* is selected in the **Filter** list.

Name	Production Contribution	Fixed Cost (\$)	Variable Cost (\$)	Variable Cost Units	Lost Production Cost (\$)	Lost Production Cost Units
Diagram for Scenario A	100.00	0.00	0.00	Per Day	100,000.00	Per Day
Bottling Subsystem	100.00	0.00	0.00	Per Day	0.00	Per Day

The following columns of information are displayed in the grid when the *Subsystem* option is selected in the **Filter** list:

- **Name:** Displays a hierarchy that lists the Subsystems that exist in the Scenario.
- **Production Contribution:** Displays the value that exists in the Production Contribution field in the [System Subsystem record](#).
- **Fixed Cost (\$):** Displays the value that exists in the Fixed Cost field in the [System Subsystem record](#).
- **Variable Cost (\$):** Displays the value that exists in the Variable Cost field in the [System Subsystem record](#).
- **Variable Cost Units:** Displays the value that exists in the Variable Cost Units field in the [System Subsystem record](#).
- **Lost Production Cost (\$):** Displays the value that exists in the Lost Production Cost field in the [System Subsystem record](#).
- **Lost Production Cost Units:** Displays the value that exists in the Lost Production Cost Units field in the [System Subsystem record](#).

By Switch

When you select *Switch* in the **Filter** list on the [System Reliability Scenarios - Grid page](#), the grid will display data related to the Switches that exist in the Scenario selected in the **Scenario** list. The following image shows the grid that is displayed for the [System Reliability Analysis Example](#) when *Scenario C* is selected in the **Scenario** list and *Switch* is selected in the **Filter** list.

Name	Is Initially On	Fixed Cost (\$) Δ	Variable Cost (\$)	Variable Cost Units	Lost Production Cost (\$)	Lost Production Cost Units
Diagram for Scenario A	<input type="checkbox"/>	0.00	0.00	Per Day	100,000.00	Per Day
Switch 1	<input checked="" type="checkbox"/>	0.00	0.00	Per Day	0.00	Per Day
Switch 2	<input type="checkbox"/>	0.00	0.00	Per Day	0.00	Per Day

The following columns of information are displayed in the grid when the *Switch* option is selected in the **Filter** list:

- **Name:** Displays a hierarchy that lists the Switches that exist in the Scenario, including Switches that belong directly to the root Subsystem and Switches that belong to any Subsystem elements. Buffers appear in the hierarchy below the Subsystem element to which they belong.
- **Is Initially On:** Displays the value that exists in the Is Initially On field in the [System Switch record](#).

Note: Because this field does not exist in [System Subsystem records](#), this cell is disabled in the row representing the root Subsystem.

- **Fixed Cost:** Displays the value that exists in the Fixed Cost field in the [System Switch](#) or the [System Analysis record](#).
- **Variable Cost:** Displays the value that exists in the Variable Cost field in the [System Switch](#) or the [System Analysis record](#).
- **Variable Cost Units:** Displays the value that exists in the Fixed Cost field in the [System Switch](#) or the [System Analysis record](#).
- **Lost Production Cost:** Displays the value that exists in the Lost Production Cost field in the [System Switch](#) or the [System Analysis record](#).
- **Lost Production Cost Units:** Displays the value that exists in the Lost Production Cost Units field in the [System Switch](#) or the [System Analysis record](#).

About Resources

Resources are optional components in a System Reliability Analysis that represent physical parts or materials, such as spare bearings or seals, or human resources, such as mechanics or technicians, that you may want to use within the analysis. You can create a Resource by defining its properties via the **Resource** window, which is shown in the following image.

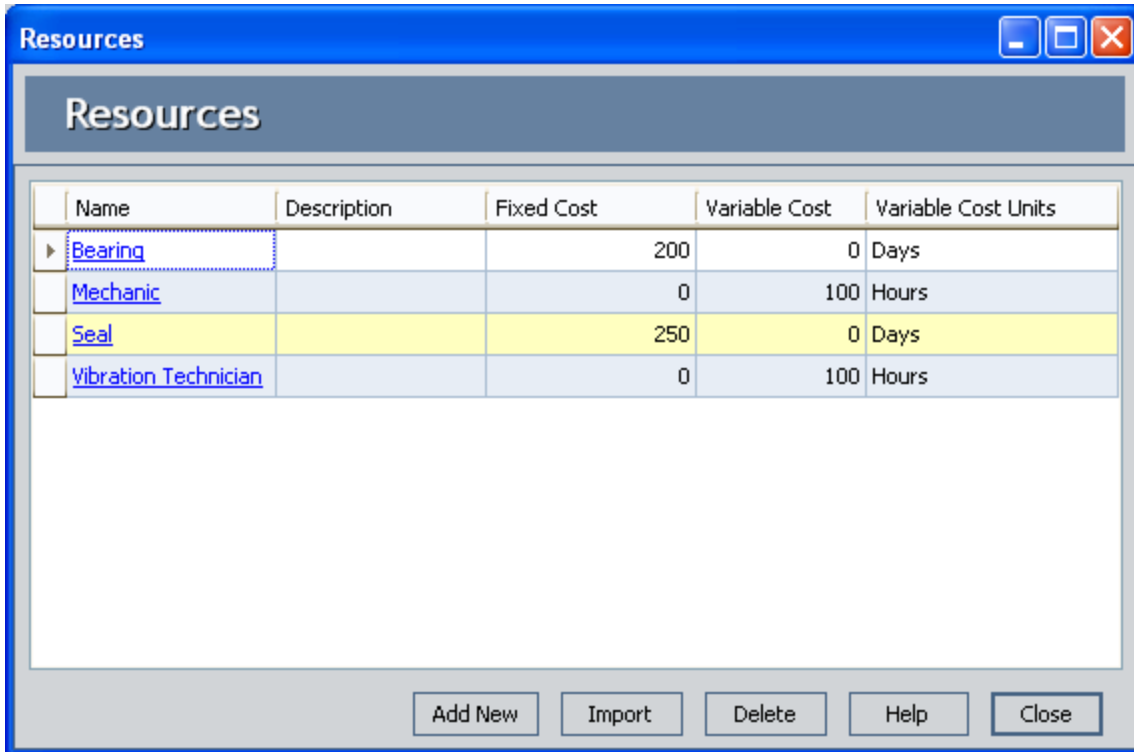

The properties of a Resource are stored in a [System Resource record](#), which is created when you save a new Resource.

After Resources exist for a System Reliability Analysis, you can assign them to Actions and Risks to tie the Resource and its cost with an occurrence of the associated event. For example, if you planned to create an Action that would perform certain maintenance actions, you might create a Mechanic Resource and assign the Mechanic to the Action.

Associating a Resource with an Action or a Risk will create a [System Resource Usage Record](#), which is linked to the appropriate [System Action](#) or System Risk record, which will store information that specifies how the resource will be used (e.g., the quantity and duration).

About Adding Resources to Analyses

You have two options for adding Resources to a System Reliability Analysis. You can:

- [Create new Resources from scratch.](#)
- [Import Resources that already exist in other System Reliability Analyses.](#)

Note: Resources can also be created within the context of Actions and Risks. Doing so will cause those Resources to be available at the analysis level so that they can be assigned to other Actions and Risks.

Creating Resources from Scratch

To create a new Resource for a System Reliability Analysis:

1. While viewing the desired System Reliability Analysis on any page, on the **Tools** menu, click the **Resources** link.

The **Resources** window appears.

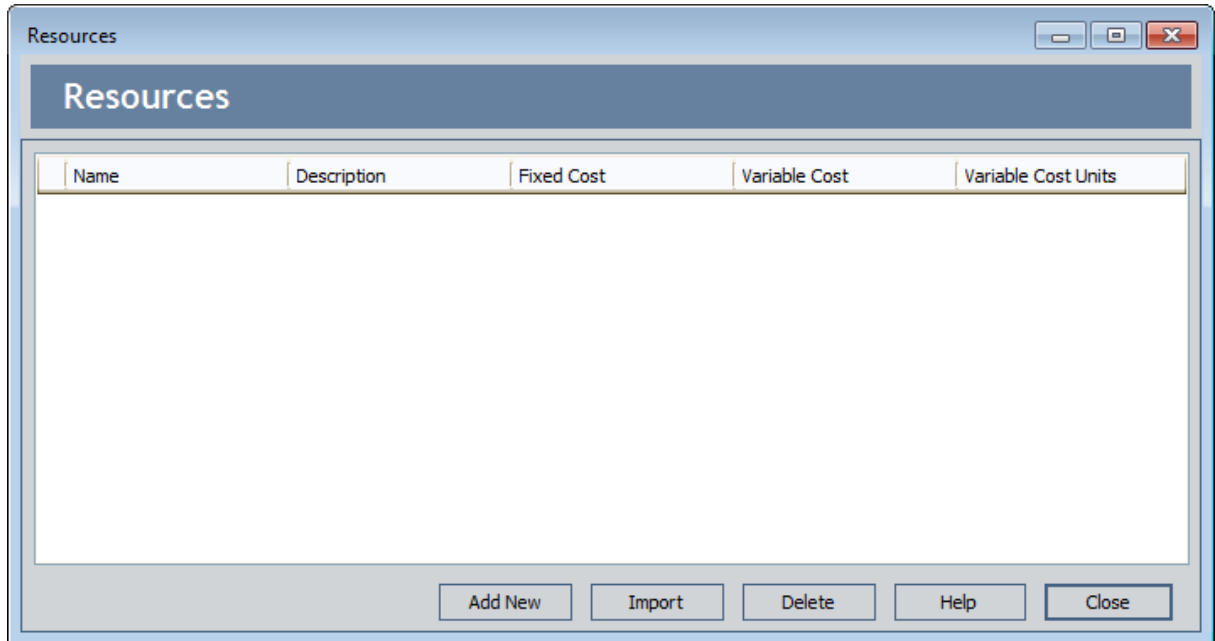

2. Click the **Add New** button.

The **Add New Resource** window appears.

The screenshot shows a dialog box titled "Add New Resource". It features a blue title bar with the text "Add New Resource" and standard window controls (minimize, maximize, close). The main content area is titled "Add New Resource" and contains the following fields:

- Name:** A text input field.
- Description:** A large text area with a vertical scrollbar on the right side.
- Fixed Cost:** A text input field containing the value "0".
- Variable Cost:** A text input field containing the value "0" and a dropdown menu set to "Per Day".
- Count Occurrences:** A checkbox that is checked.

At the bottom right of the dialog box are two buttons: "OK" and "Cancel".

The **Add New Resources** window displays the default datasheet that has been defined for the System Resource family.

3. [Define the properties of the System Resource record as desired.](#)
4. Click **OK**.

The Resource is created and appears in the grid on the **Resources** window.

Importing Existing Resources

When you import a Resource from one System Reliability Analysis into another, the Meridium APM system creates a copy of the existing System Resource and links the new record to the root System Analysis record of the target analysis.

To import a Resource from one analysis into another:

1. Open the System Reliability Analysis into which you want to import the Resource.
2. While viewing the desired System Reliability Analysis on any page, on the [Tools menu](#), click the **Resources** link.

The **Resource** window appears.

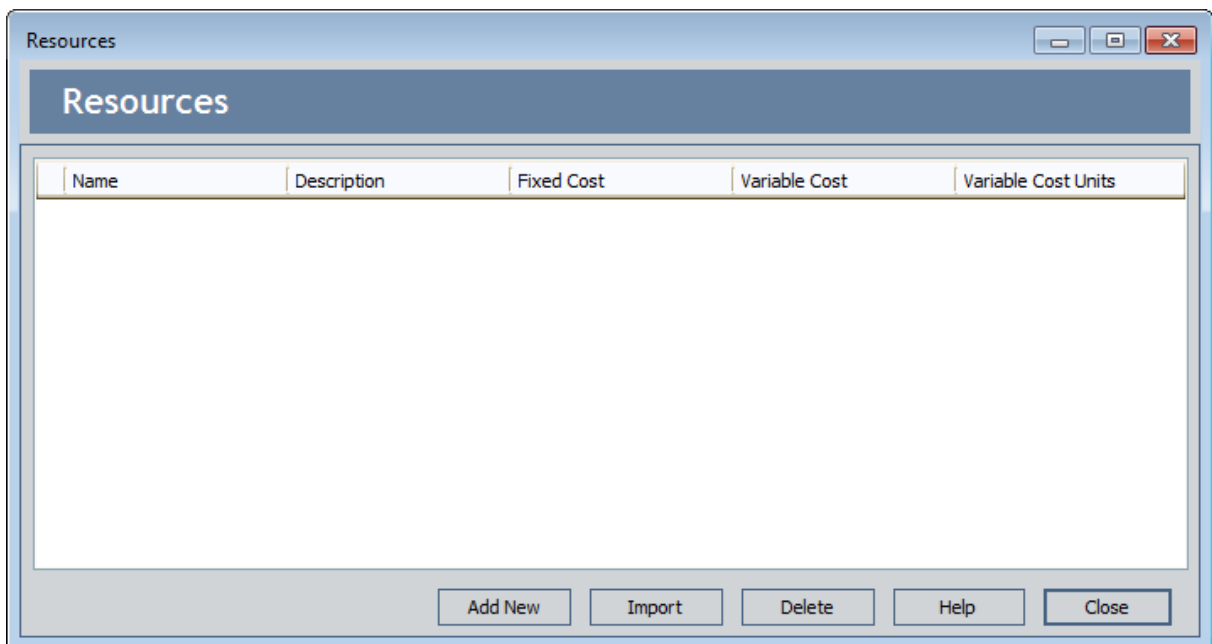

3. Click the **Import** button.

The **Resource Finder** window appears, which displays the Resources that are available to be imported.

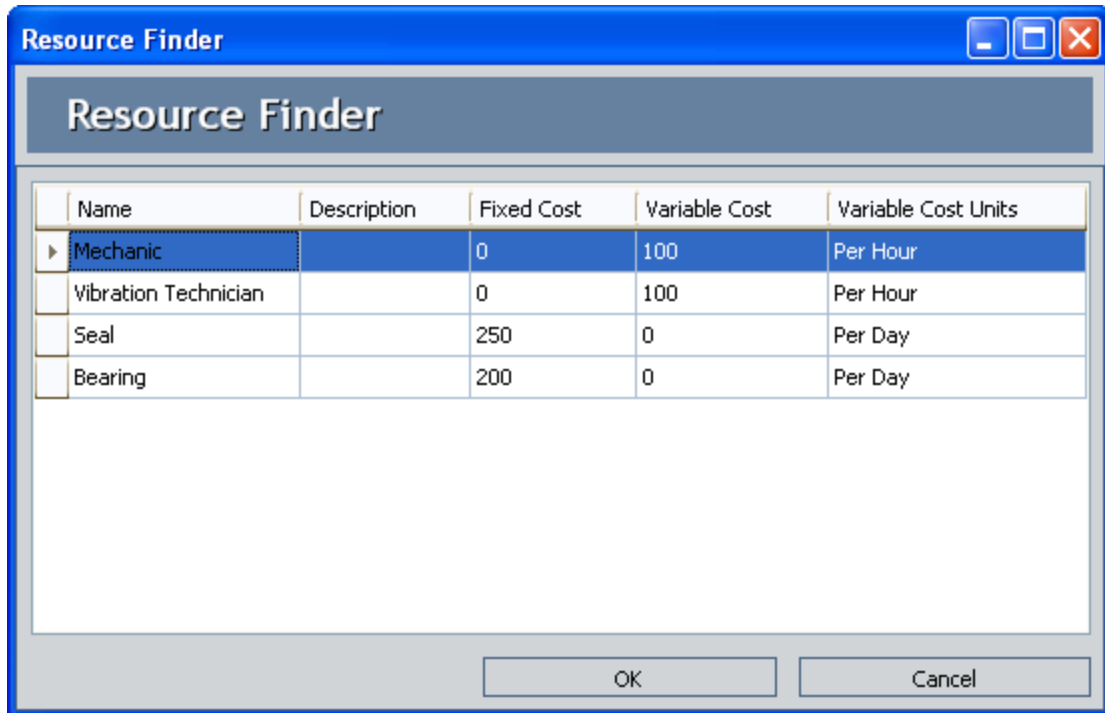

In this image, the **Resource Finder** window displays what Resources can be imported into an analysis, assuming the [System Reliability Analysis Example Resources](#) have already been created.

4. Select the row containing the Resource that you want to import.
5. Click **OK**.

A copy of the [System Resource record](#) is created, and the imported Resource appears on the **Resources** window.

Modifying Resources

To modify an existing Resource:

1. While viewing the desired System Reliability Analysis on any page, on the **Tools** menu, click the **Resources** link.

The **Resources** window appears.

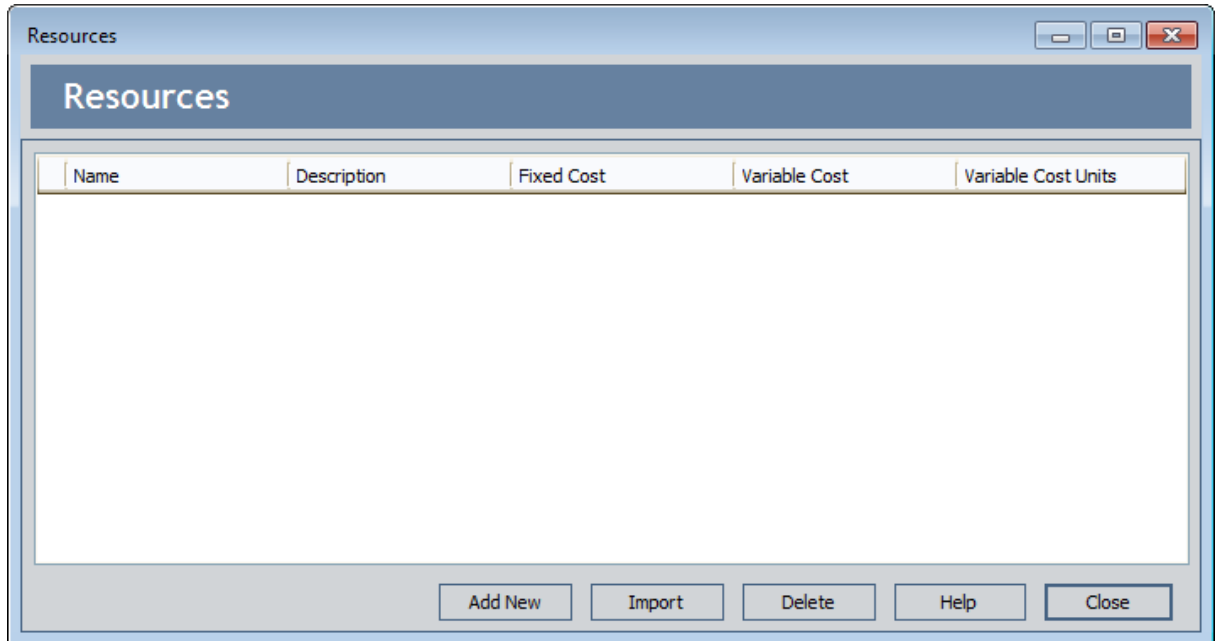

2. Click the hyperlinked name of the Resource that you want to modify.

The **<Resource Name>** dialog box appears, where **<Resource Name>** is the name of the System Resource record that you selected.

The screenshot shows a software dialog box titled "Vibration Technician". The dialog has a blue title bar with standard window controls. Inside, there is a header area with the text "Vibration Technician". Below this, there are several input fields: "Name:" with the value "Vibration Technician"; "Description:" with a large empty text area; "Fixed Cost:" with the value "0"; "Variable Cost:" with the value "100" and a unit dropdown menu currently set to "Per Hour"; and "Count Occurrences:" with an unchecked checkbox. At the bottom right, there are "OK" and "Cancel" buttons.

The <Resource Name> window displays the default datasheet that has been defined for the System Resource family. This image displays the **Vibration Technician** window, which defines the properties for the *Vibration Technician* System Resource record.

3. [Modify the fields in the System Resource record as desired.](#)
4. Click **OK**.

Your changes are saved.

Deleting Resources

To delete a Resource:

1. While viewing the desired System Reliability Analysis on any page, on the [Tools menu](#), click the **Resources** link.

The **Resource** window appears.

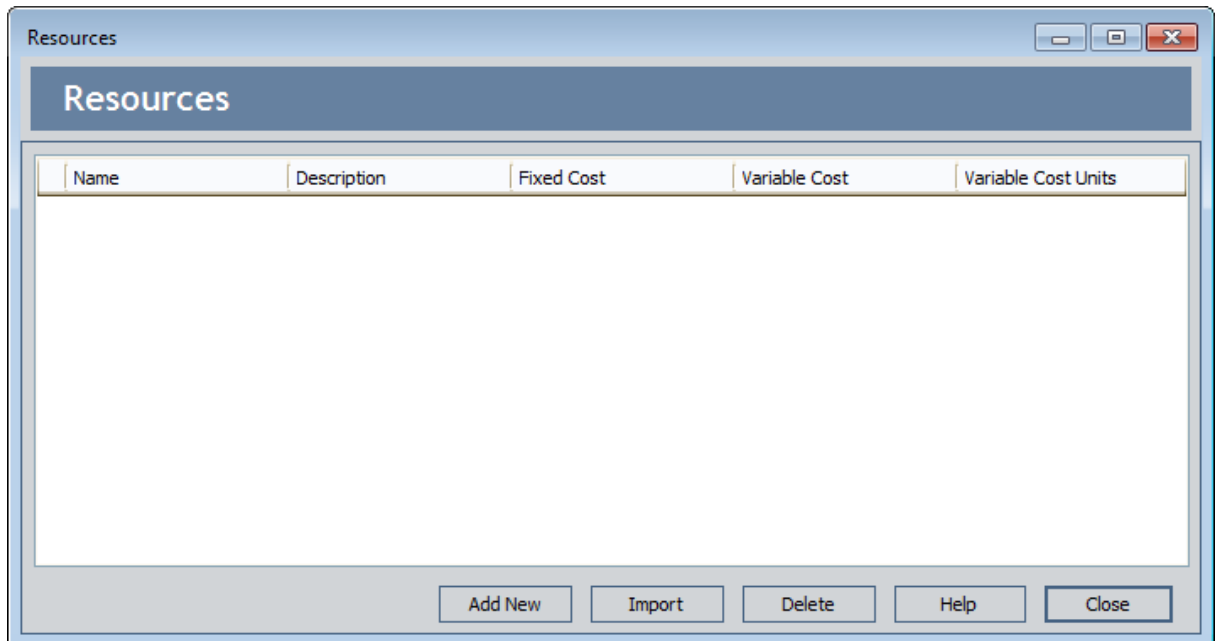

2. Select the row containing the System Resource record that you want to delete.
3. Click the **Delete** button.

A confirmation message appears, asking if you really want to delete the Resource.

4. Click the **Yes** button.

The Resource is removed from the grid in the **Resources** window. The System Resource record will be deleted from the database when you save your changes to the System Reliability Analysis.

About Running Simulations

When you run a simulation, you start the process of running Monte Carlo iterations for each Scenario in a System Reliability Analysis and viewing the results calculated from those simulations.

You will want to run the simulation after you have finished creating the System Reliability Analysis or if you make changes to a System Reliability Analysis that would affect the simulation results, such as changing the simulation parameters or modifying a Scenario. When you run the simulation, all Diagrams are validated. If all the Diagrams are valid or contain only Isolated Element errors, then:

- If changes have been made to the [analysis parameters](#), *all* Scenarios will be included in the simulation run.
- If no changes have been made to any of the analysis parameters, only the Scenarios that have been *modified* since the last simulation was run will be included in the new simulation run.
- If no changes have been made to the analysis parameters or any of the Scenarios, a message appears and you are directed to the [System Reliability Summary page](#).

Note: If no changes have been made to the analysis parameters or any of the Scenarios, but the **Random Seed** or **Event Log** check box is selected, then the simulation will include every Scenario in the new simulation run.

Keep in mind that it will take time to run simulations. Various factors influence the speed of the simulation process, including:

- The number of iterations defined.
- The complexity of the Scenarios (i.e., the number of Assets, Risks, Actions, and Subsystems).
- The frequency at which Actions occur.
- The frequency at which failures occur.

To shorten the run time of your simulation, you can reduce the number of iterations or the complexity of the analysis.

You can run only one simulation at a time. While a simulation is running, however, you can continue working in other areas of the Meridium APM Framework by:

- Clicking anywhere on the Meridium APM Framework main window outside the **Run Simulation** dialog box. When you do so, the simulation will continue to run in the background, and the dialog box will be hidden behind the Meridium APM Framework window. When the simulation finishes, the dialog box will be returned to focus automatically.

-or-

- Clicking either the minimize or the close button on the **Run Simulation** dialog box. When you do so, the simulation will continue to run in the background, and the

minimized dialog box will appear on your Windows taskbar. When the simulation finishes, the dialog box will be maximized and returned to focus automatically.

Running Simulations

To run a simulation:

1. On any page in System Reliability, on the [Tools menu](#), click the **Run Simulation** link.

The **Browse For Folder** window appears, where you can select or create a folder in which to store the Event Logs.

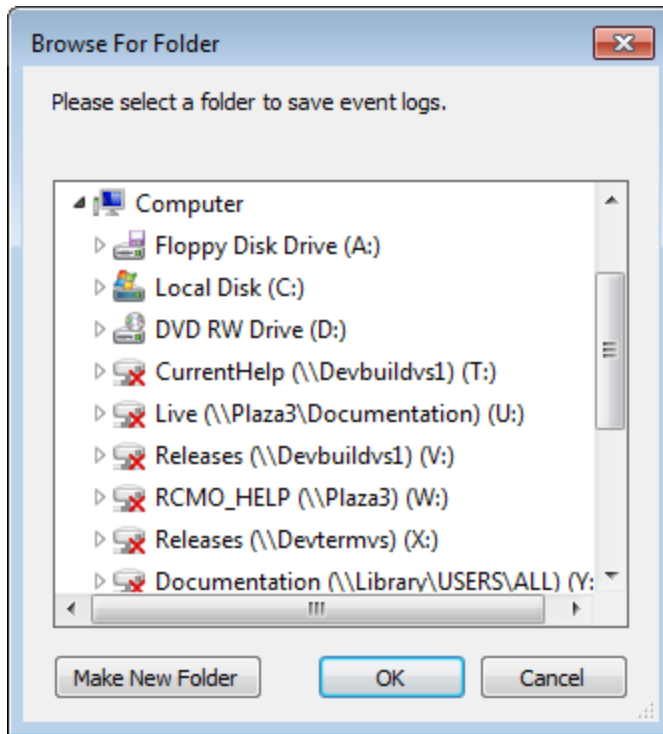

Note: If the **Enable Event Log** check box is cleared on the [System Reliability Analysis Definition page](#), the **Browse For Folder** dialog box will not appear.

2. Navigate to the location where you want to save the Event Logs.
3. Click **OK**.

The **Run Simulation** dialog box appears, displaying a progress bar that indicates the progress of the simulation.

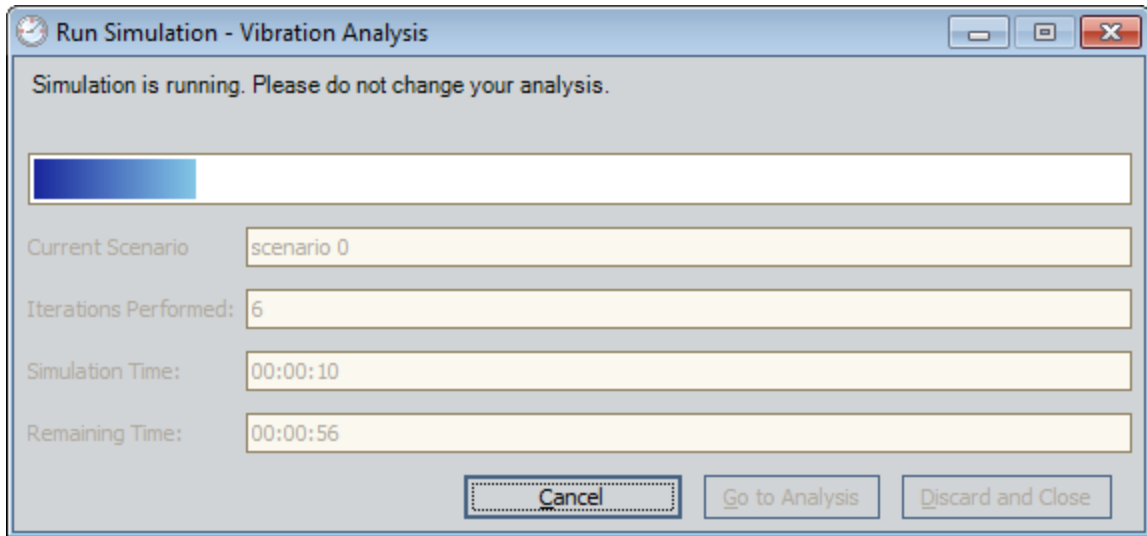

Note: If there are already Event Logs files in the folder that you select, a warning message will appear, indicating that any existing Event Log files may be overwritten.

After the progress bar reaches the end, the **Go to Analysis** and **Discard and Close** buttons become enabled. If you do not want to view the results, you can click the **Discard and Close** button to close the **Run Simulation** dialog box. These instructions assume that you want to view the results.

4. Click the **Go to Analysis** button.

The [System Reliability Summary page](#) appears.

About Event Logs

The Event Log is a diagnostic tool that lets you see what happens when you run simulations for a System Reliability Analysis. When the Enable Event Log field in the root System Analysis record is set to *True*, when you run the simulation, one text file will be produced for every iteration of every Scenario in the System Reliability Analysis that records every event that happens in the iteration. Each file is named **<Scenario Name>-<Iteration Number>.txt** where:

- **<Scenario Name>** is the name of the Scenario in the System Reliability Analysis.
- **<Iteration number>** is the number of the iteration that is detailed in the file.

The Event Log files can be saved to any desired location [when you run a simulation](#). The Event Log files are produced as text files, but can be opened in Microsoft Excel, where you will see the following columns of information:

- **Time:** The start time, in days, of the event.
- **Name:** The name of the Action, Risk, or element, as defined in its record, that is detailed in the row.
- **Event:** The event that is detailed in the row. The possible events that can be listed are:
 - **Alert:** A condition monitoring Action identifies a potential failure.
 - **Complete:** An Action is complete.
 - **Complete Unplanned Correction:** An unplanned correction has finished repairs to an element that has failed.
 - **Failed:** An element has failed. It will have to be replaced or repaired before it can run again.
 - **Global Event Occurs:** A Global Event has occurred and Actions that are assigned to that Global Event have been started.
 - **Running:** The element is running.
 - **Schedule next <Action> in <Number> Days:** A Global Event has changed the schedule of an Action, where **<Action>** is the name of the Action that has been rescheduled and **<Number>** is the number of days until the next occurrence of the Action.
 - **Shutdown:** An element is stopped because an Action has turned it off.
 - **Simulation Ends:** The simulation is complete.
 - **Standby:** A Switch element is turned off.
 - **Start:** An Action starts.
 - **Start Unplanned Correction:** An unplanned correction has started repairs to an element that has failed.
 - **Stopped:** The element is stopped.
- **Path:** The location in the Diagram of the item associated with the event.

Understanding the Content of the Event Log

The following image displays a part of the Event Log for one simulation of [Scenario A](#) for our [System Reliability Analysis Example](#).

	A	B	C	D
1	Time	Name	Event	Path
2	0	Start	Running	/Start
3	0	End	Running	/End
4	0	Start	Running	/Bottling Subsystem/Start
5	0	End	Running	/Bottling Subsystem/End
6	0	Bottling Line Failure	Running	/Bottling Subsystem/Bottling Line 1/Bottling Line Failure
7	0	Bottling Line 1	Running	/Bottling Subsystem/Bottling Line 1
8	0	Bottling Line Failure	Running	/Bottling Subsystem/Bottling Line 2/Bottling Line Failure
9	0	Bottling Line 2	Running	/Bottling Subsystem/Bottling Line 2
10	0	Bottling Line Failure	Running	/Bottling Subsystem/Bottling Line 3/Bottling Line Failure
11	0	Bottling Line 3	Running	/Bottling Subsystem/Bottling Line 3
12	0	Link	Running	/Bottling Subsystem/Link
13	0	Bottling Subsystem	Running	/Bottling Subsystem
14	0	Bearing Failure	Running	/Water Pump/Bearing Failure
15	0	Impeller Failure	Running	/Water Pump/Impeller Failure
16	0	Seal Failure	Running	/Water Pump/Seal Failure
17	0	Water Pump	Running	/Water Pump
18	0	Water Source Failure	Running	/Water Source/Water Source Failure
19	0	Water Source	Running	/Water Source
20	0	Water Tank	Running	/Water Tank
21	0	Diagram for Scenario A	Running	/
22	4.434529076	Impeller Failure	Failed	/Water Pump/Impeller Failure
23	4.434529076	Impeller Failure	Start Unplanned Correction	/Water Pump/Impeller Failure
24	4.434529076	Water Pump	Stopped	/Water Pump
25	4.434529076	Bearing Failure	Stopped	/Water Pump/Bearing Failure
26	4.434529076	Seal Failure	Stopped	/Water Pump/Seal Failure
27	4.434529076	Water Pump	Failed	/Water Pump
28	4.434529076	Water Source	Stopped	/Water Source
29	4.434529076	Water Source Failure	Stopped	/Water Source/Water Source Failure
30	4.76786241	Impeller Failure	Stopped	/Water Pump/Impeller Failure
31	4.76786241	Impeller Failure	Complete Unplanned Correction	/Water Pump/Impeller Failure
32	4.76786241	Water Pump	Stopped	/Water Pump
33	4.76786241	Bearing Failure	Running	/Water Pump/Bearing Failure
34	4.76786241	Impeller Failure	Running	/Water Pump/Impeller Failure
35	4.76786241	Seal Failure	Running	/Water Pump/Seal Failure
36	4.76786241	Water Pump	Running	/Water Pump
37	4.76786241	Water Source Failure	Running	/Water Source/Water Source Failure
38	4.76786241	Water Source	Running	/Water Source
39	260.4040794	Bottling Line Failure	Failed	/Bottling Subsystem/Bottling Line 2/Bottling Line Failure

As you can see in the following image, the simulation starts at time 0 (zero), at which point every element in the Diagram for Scenario A is listed as *Running*.

Understanding the Content of the Event Log

1	Time	Name	Event	Path
2		0 Start	Running	/Start
3		0 End	Running	/End
4		0 Start	Running	/Bottling Subsystem/Start
5		0 End	Running	/Bottling Subsystem/End
6		0 Bottling Line Failure	Running	/Bottling Subsystem/Bottling Line 1/Bottling Line Failure
7		0 Bottling Line 1	Running	/Bottling Subsystem/Bottling Line 1
8		0 Bottling Line Failure	Running	/Bottling Subsystem/Bottling Line 2/Bottling Line Failure
9		0 Bottling Line 2	Running	/Bottling Subsystem/Bottling Line 2
10		0 Bottling Line Failure	Running	/Bottling Subsystem/Bottling Line 3/Bottling Line Failure
11		0 Bottling Line 3	Running	/Bottling Subsystem/Bottling Line 3
12		0 Link	Running	/Bottling Subsystem/Link
13		0 Bottling Subsystem	Running	/Bottling Subsystem
14		0 Bearing Failure	Running	/Water Pump/Bearing Failure
15		0 Impeller Failure	Running	/Water Pump/Impeller Failure
16		0 Seal Failure	Running	/Water Pump/Seal Failure
17		0 Water Pump	Running	/Water Pump
18		0 Water Source Failure	Running	/Water Source/Water Source Failure
19		0 Water Source	Running	/Water Source
20		0 Water Tank	Running	/Water Tank
21		0 Diagram for Scenario A	Running	/

In the following image, at time 4.434529075, or about four days and ten hours, the *Impeller Failure* Risk caused a failure, which is detailed in row 22. This caused an unplanned correction to be started for the *Impeller Failure* Risk, which is detailed in row 23.

22	4.434529075	Impeller Failure	Failed	/Water Pump/Impeller Failure
23	4.434529075	Impeller Failure	Start Unplanned Correction	/Water Pump/Impeller Failure

In the following image, because the *Impeller Failure* Risk had an unplanned correction, the *Water Pump*, *Bearing Failure* Risk, and *Seal Failure* Risk are stopped, in lines 24, 25, and 26 respectively. This caused the *Water Pump* to fail, as seen in line 27.

24	4.434529076	Water Pump	Stopped	/Water Pump
25	4.434529076	Bearing Failure	Stopped	/Water Pump/Bearing Failure
26	4.434529076	Seal Failure	Stopped	/Water Pump/Seal Failure
27	4.434529076	Water Pump	Failed	/Water Pump

At the same time, in line 29, the *Water Source* was stopped, as you can see in the following image.

29	4.434529076	Water Source Failure	Stopped	/Water Source/Water Source Failure
----	-------------	----------------------	---------	------------------------------------

At time 4.76786241, the *Impeller Failure* Risk is still stopped, as you can see in line 30. In line 31, however, the unplanned correction for the *Impeller Failure* Risk is completed.

30	4.76786241	Impeller Failure	Stopped	/Water Pump/Impeller Failure
31	4.76786241	Impeller Failure	Complete Unplanned Correction	/Water Pump/Impeller Failure

At time 4.76786241, or about eight and a half hours after the initial *Impeller Failure* Risk in line 22, the *Water Pump* is still stopped, as seen in line 32. In lines 33-38, all of the Risks and elements are running again, so the system is able to run. The system is able to run until the next failure occurs, in line 39, at time 260.4044794.

Understanding the Content of the Event Log

32	4.76786241	Water Pump	Stopped	/Water Pump
33	4.76786241	Bearing Failure	Running	/Water Pump/Bearing Failure
34	4.76786241	Impeller Failure	Running	/Water Pump/Impeller Failure
35	4.76786241	Seal Failure	Running	/Water Pump/Seal Failure
36	4.76786241	Water Pump	Running	/Water Pump
37	4.76786241	Water Source Failure	Running	/Water Source/Water Source Failure
38	4.76786241	Water Source	Running	/Water Source
39	260.4040794	Bottling Line Failure	Failed	/Bottling Subsystem/Bottling Line 2/Bottling Line Failure

Refreshing Multiple Distributions

Using the **Refresh Distributions** link on the [Tools menu](#) refreshes all the distribution data that was associated with Risks in the System Reliability Analysis.

To refresh multiple Distributions:

1. While viewing the desired System Reliability Analysis on any page, on the [Tools menu](#), select the **Refresh Distributions** link.

A confirmation message appears, asking if you really want to refresh all distributions having associated distributions.

2. Click **OK**.

The distribution data is refreshed.

About the System Reliability Report

The baseline Meridium APM database includes the System Reliability Report, which you can use to view a summary of the results of a System Reliability Analysis. When you run the System Reliability Report, it will appear on the Report Viewer page.

The following table provides a list and description of the Catalog items that are used to generate the System Reliability Report. Each report provides a formatted view of the supporting query identified in the table. For additional details on the data that is included in the subreport, you can run any of the queries, which are stored in the Catalog folder \\Public\Meridium\Modules\Reliability Manager\Reports.

Report	Supporting Query	Description
SystemReliability	System Reliability – Main	Provides the information that is displayed in the Summary and Plots sections of the System Reliability Report.
SystemReliabilitySummaryResultReport	SystemReliability – SummaryResult	Provides the information that is displayed in the Simulation Result Summary section of the System Reliability Report.
SystemReliabilityElementResultReport	SystemReliability – ElementResult	Provides the information that is displayed in the Simulation Results - Elements section of the System Reliability Report.

Report	Supporting Query	Description
SystemReliabilityActionResultReport	System Reliability - ActionResult	Provides the information that is displayed in the Simulation Results - Actions section of the System Reliability Report.
SystemReliabilityResourceResultReport	SystemReliability - ResourceResult	Provides the information that is displayed in the Simulation Results - Resources section of the System Reliability Report.

Throughout this documentation, we refer to the main report, the subreports, and the supporting queries collectively as the *System Reliability Report*.

Each report query contains a prompt on the ENTY_KEY field of the System Analysis family. When you run the System Reliability Report while viewing a System Reliability Analysis, the ENTY_KEY of the System Analysis record associated with the current analysis is passed automatically to the prompt, and the results for the current System Analysis will be displayed. If you run one of the reports or queries listed in the table directly from the Catalog, however, you will need to supply the ENTY_KEY of a System Analysis record manually to retrieve results.

The System Reliability Report contains the following sections:

- [Summary](#)
- [Simulation Result Summary](#)
- [Plots](#)
- [Simulation Results - Elements](#)
- [Simulation Results - Actions](#)
- [Simulation Results - Resources](#)

Running the System Reliability Report

To run the System Reliability Report:

- While viewing the desired System Reliability Analysis on any page, on the [Tools menu](#), click the **Generate Report** link.

The System Reliability Report appears on the **Report Viewer** page.

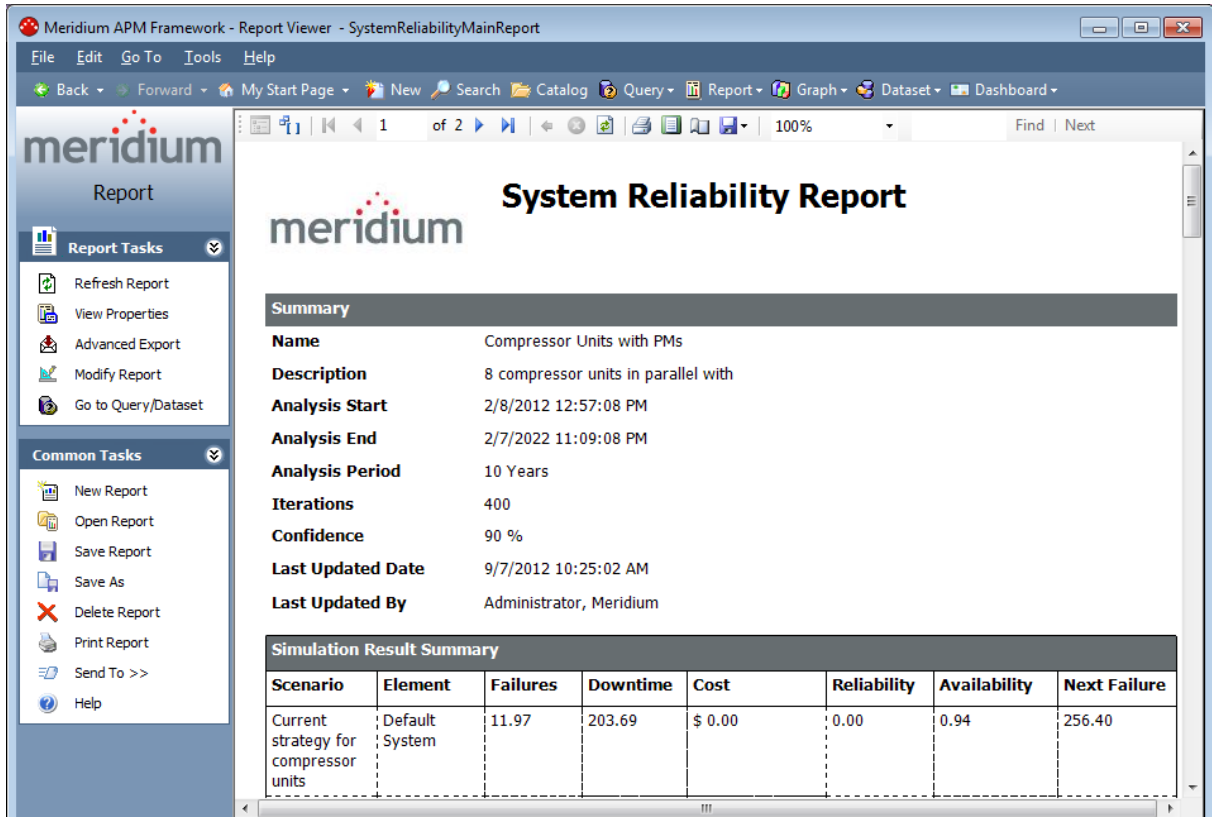

Summary Section

The **Summary** section of the [System Reliability Report](#) displays general summary information that is stored in the [System Analysis record](#).

Summary	
Name	System Reliability Analysis Example
Description	This is an example of a System Reliability Analysis for a water bottling facility.
Analysis Start	1/1/2010 12:00:00 AM
Analysis End	12/31/2016 4:44:24 PM
Analysis Period	7 Years
Iterations	1000
Confidence	90 %
Last Updated Date	4/29/2010 8:58:07 AM
Last Updated By	Administrator, Meridium

The following table lists each item in the **Analysis Summary** section and the corresponding Systems Analysis record fields whose data is displayed in the report:

Report Item	Record field(s)	Notes
Name	Analysis ID	None
Description	Description	None
Analysis Start	Analysis Start Date	None
Analysis End	Analysis End Date	None
Analysis Period	Period Period Units	None
Iterations	Iterations	None
Confidence	Confidence	None
Last Updated Date	LAST_UPDT_DT	None
Updated By	LAST_UPBY_SEUS_KEY	The name of the Security User associated with this value is displayed in the report.

Simulation Result Summary

The **Simulation Result Summary** section of the [System Reliability Report](#) displays a summary of the information that is displayed in the [Elements grid](#) on the [System Reliability Simulation Results page](#). Results for each scenario are stored in a System Element Result record. Additional information about each element within a scenario is displayed in the [Simulation Results - Elements Section](#) of the System Reliability Report.

Simulation Result Summary							
Scenario	Element	Failures	Downtime	Cost	Reliability	Availability	Next Failure
Scenario A	Diagram for Scenario A	0.87	5.13	\$ 994,803.63	0.41	1.00	1,095.69
Scenario B	Diagram for Scenario B	1.47	6.01	\$ 1,063,962.75	0.00	1.00	676.77
Scenario C	Diagram for Scenario C	0.43	4.15	\$ 899,180.69	0.66	1.00	1,213.28

The following table lists each item in the **Simulation Results Summary** section and the corresponding System Element Result record field whose data is displayed in the report.

Report Item	Record field(s)	Notes
Scenario	Scenario	None
Element	Element	None
Failures	Failures	None
Downtime	Downtime	None
Cost	Cost	None
Reliability	Reliability	The values in the Reliability column are formatted as decimals rather than as percentages, as in the Elements grid .
Availability	Availability	The values in the Availability column are formatted as decimals rather than as percentages, as in the Elements grid .
Next Failure	TTNF	None

Plots Section

The **Plots** section of the [System Reliability Report](#) displays the graphs that are shown on the [System Reliability Summary page](#). The following image shows the [Total Cost graph](#) for our [System Reliability Analysis Example](#).

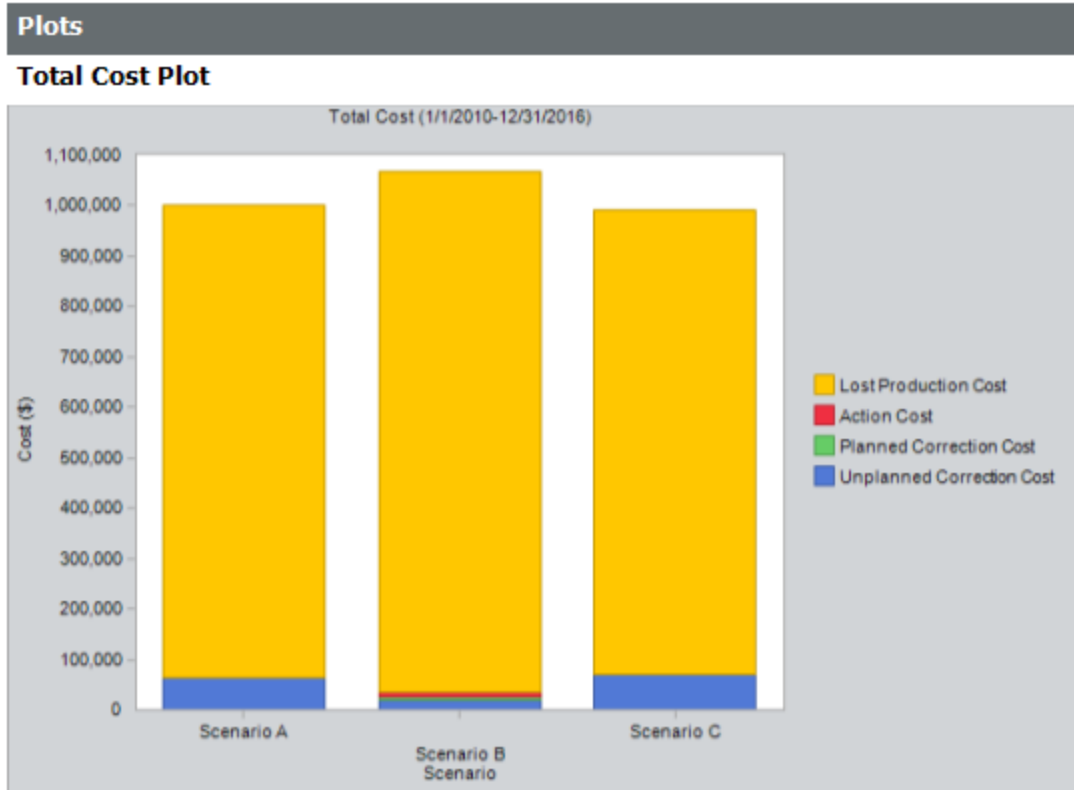

The **Plots** section displays the following graphs:

- [Total Cost](#).
- [Total Cost Trend](#).
- [Annual Action Cost](#).
- [Action Cost Trend](#).
- [Resource Occurrence](#).
- [Resource Time](#).
- [Resource Cost](#).

Simulation Results - Elements Section

The **Simulation Results - Elements** section of the [System Reliability Report](#) displays results for each Scenario and any Subsystems, Assets, Risks, Switches or Buffers that belong to it. This information, which is stored in System Element Result records, also appears in the [Elements grid](#) on the [System Reliability Simulation Results page](#). The following image shows the **Simulation Results - Elements** section for [Scenario A](#) in our [System Reliability Analysis Example](#).

Simulation Results - Elements						
Element	Failures	Downtime	Cost	Reliability	Availability	Next Failure
Scenario A						
Diagram for Scenario A	0.87	5.13	\$ 994,803.63	0.41	1.00	1,095.69
Bottling Subsystem	0.13	0.07	\$ 0.00	0.88	1.00	1,316.77
Bottling Line 1	6.92	6.82	\$ 0.00	0.00	1.00	367.82
Bottling Line Failure	6.92	6.82	\$ 0.00	0.00	1.00	367.82
Bottling Line 2	7.12	7.14	\$ 0.00	0.00	1.00	356.85
Bottling Line Failure	7.12	7.14	\$ 0.00	0.00	1.00	356.85
Bottling Line 3	7.03	7.11	\$ 0.00	0.00	1.00	362.18
Bottling Line Failure	7.03	7.11	\$ 0.00	0.00	1.00	362.18
Water Pump	8.01	3.77	\$ 63,024.32	0.00	1.00	5.62
Bearing Failure	1.37	0.45	\$ 5,180.84	0.25	1.00	987.85
Impeller Failure	3.52	1.76	\$ 7,040.00	0.03	1.00	641.76
Seal Failure	3.12	1.56	\$ 6,235.77	0.00	1.00	5.68
Water Source	0.36	5.12	\$ 0.00	0.69	1.00	1,226.70
Water Source Failure	0.36	5.12	\$ 0.00	0.69	1.00	1,226.70
Water Tank	7.31	5.06	\$ 0.00	0.00	1.00	

The results for each element are stored in a separate System Element Result record, and one row exists for each record. The following table lists each item in the **Simulation Results -Elements** section and the corresponding System Element Result record field whose data is displayed in the report.

Report Item	Record field(s)	Notes
Element	Element	The elements are listed directly below the root Subsystem of the Scenario to which they belong, with elements appearing below the element to which they belong.
Failures	Failures	None
Downtime	Downtime	None

Report Item	Record field(s)	Notes
Cost	Cost	None
Reliability	Reliability	The values in the Reliability column are formatted as decimals rather than as percentages, as in the Elements grid .
Availability	Availability	The values in the Availability column are formatted as decimals rather than as percentages, as in the Elements grid .
Next Failure	TTNF	None

Simulation Results - Actions Section

The **Simulation Results - Actions** section of the [System Reliability Report](#) displays results for the Actions that belong to each Scenario, which are stored in System Action Result records. This is the same information that appears in the [Actions grid](#) on the [System Reliability Simulation Results page](#). The following image shows the **Simulation Results - Actions** section for [Scenario B](#) in our [System Reliability Analysis Example](#).

Simulation Results - Actions			
Action	Occurrences	Cost	Detected Failures
Scenario B			
Vibration Analysis	121.99	\$ 12,198.60	1.38
Replace Seals	3.48	\$ 6,956.00	0.00
Redesign Impellers	1.00	\$ 1,600.00	0.00

The results for each action are stored in a separate System Action Result record, and one row exists for each record. The following table lists each item in the **Simulation Results - Actions** section and the corresponding System Action Result record field whose data is displayed in the report.

Report Item	Record field(s)	Notes
Action	Action	Actions are listed directly below the Scenario to which they belong.
Occurrences	Occurrences	None
Cost	Cost	None
Detected Failures	Detected Failures	None

Simulation Results - Resources Section

The **Simulation Results -Resources** section of the [System Reliability Report](#) displays results for each Resource used in the System Reliability Analysis, which are stored in System Resource Result records. This is the same information that appears in the [Resources grid](#) on the [System Reliability Simulation Results page](#). The following image shows the **Simulation Results - Results** section for our [System Reliability Analysis Example](#).

Simulation Results - Resources			
Resource	Occurrences	Time	Cost
Scenario A			
Bearing	2.74	0.00	\$ 548.00
Mechanic	0.00	0.46	\$ 1,096.00
Seal	1.37	0.00	\$ 342.50
Vibration Technician	0.00	0.00	\$ 0.00
Scenario B			
Bearing	2.84	0.00	\$ 567.20
Mechanic	0.00	0.24	\$ 582.00
Seal	0.04	0.00	\$ 9.25
Vibration Technician	0.00	5.08	\$ 12,198.60
Scenario C			
Bearing	2.91	0.00	\$ 581.20
Mechanic	0.00	0.48	\$ 1,162.40
Seal	1.45	0.00	\$ 363.25
Vibration Technician	0.00	0.00	\$ 0.00

The results for each element are stored in a separate System Resource Result record, and one row exists for each record. The following table lists each item in the **Simulation Results -Resources** section and the corresponding System Resources Result record field whose data is displayed in the report.

Report Item	Record field(s)	Notes
Resource	Action	The Resources are listed below the Scenario to which they belong.
Occurrences	Occurrences	None
Time	Time	None
Cost	Cost	None

What Can You Learn from a System Reliability Analysis?

When you run a Monte Carlo simulation, the Meridium APM system analyzes statistics about cost, performance, and reliability from the [iterations of the analysis](#) to calculate the simulation results. The simulation results are then presented on the [System Reliability Summary](#) and [System Reliability Simulation Results pages](#).

By reviewing the results of a System Reliability Analysis, you will be able to answer questions such as:

- [Which Scenario has the lowest overall cost associated with it?](#)
- [Which Scenario is the least reliable?](#)
- [Which Scenario has the highest failure rate?](#)
- [Which Actions were successful in mitigating risk and reducing cost?](#)
- [How many times were Resources used?](#)
- [How much did the Resources cost?](#)
- [For how long were the Resources used?](#)
- [How many times was an Action required?](#)

After reviewing the results of a System Reliability Analysis, you can identify which Scenario consistently provides the best reliability and produces the least amount of downtime and cost. Based upon the results, you might decide to complete any of the following steps:

- Refine the Scenarios by modifying the [analysis parameters](#) or [components](#) within the analysis or create new [components](#) to further analyze reliability and costs.
- Create [Recommendations](#) to implement changes to the current physical system to align it with the most desirable Scenario.

Understanding the Analysis Results

When you run a [Monte Carlo simulation](#), the Meridium APM system analyzes statistics about cost, performance, and reliability from the iterations of the Scenarios to calculate the simulation results. The data is presented in the [System Reliability Summary page](#) and the [System Reliability Simulation Results page](#).

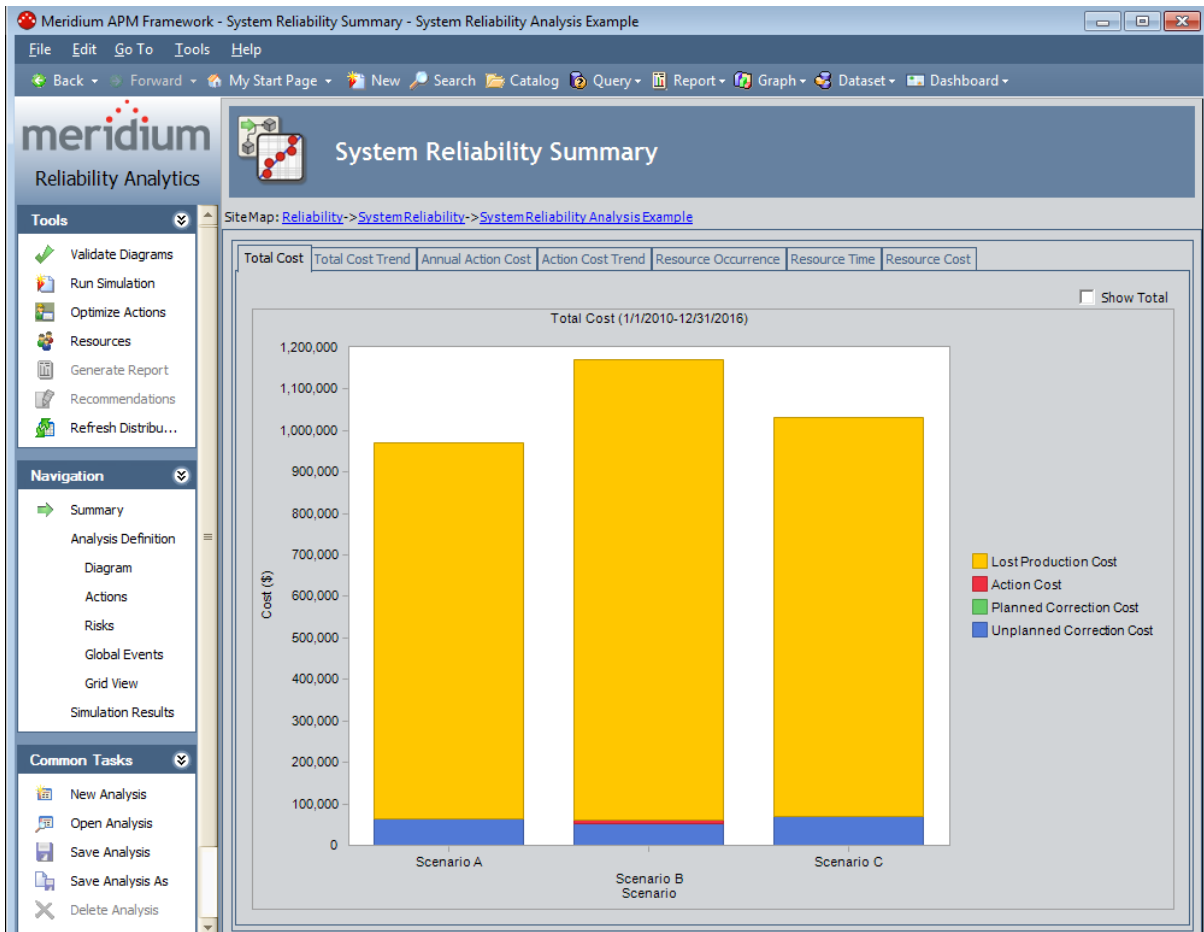

The [System Reliability Summary page](#) provides an overview of the costs and Resource statistics for the simulation using graphs on the following tabs:

- [Total Cost.](#)
- [Cost Trend.](#)
- [Annual Action Cost.](#)
- [Action Cost Trend.](#)
- [Resource Occurrence.](#)
- [Resource Time.](#)
- [Resource Cost.](#)

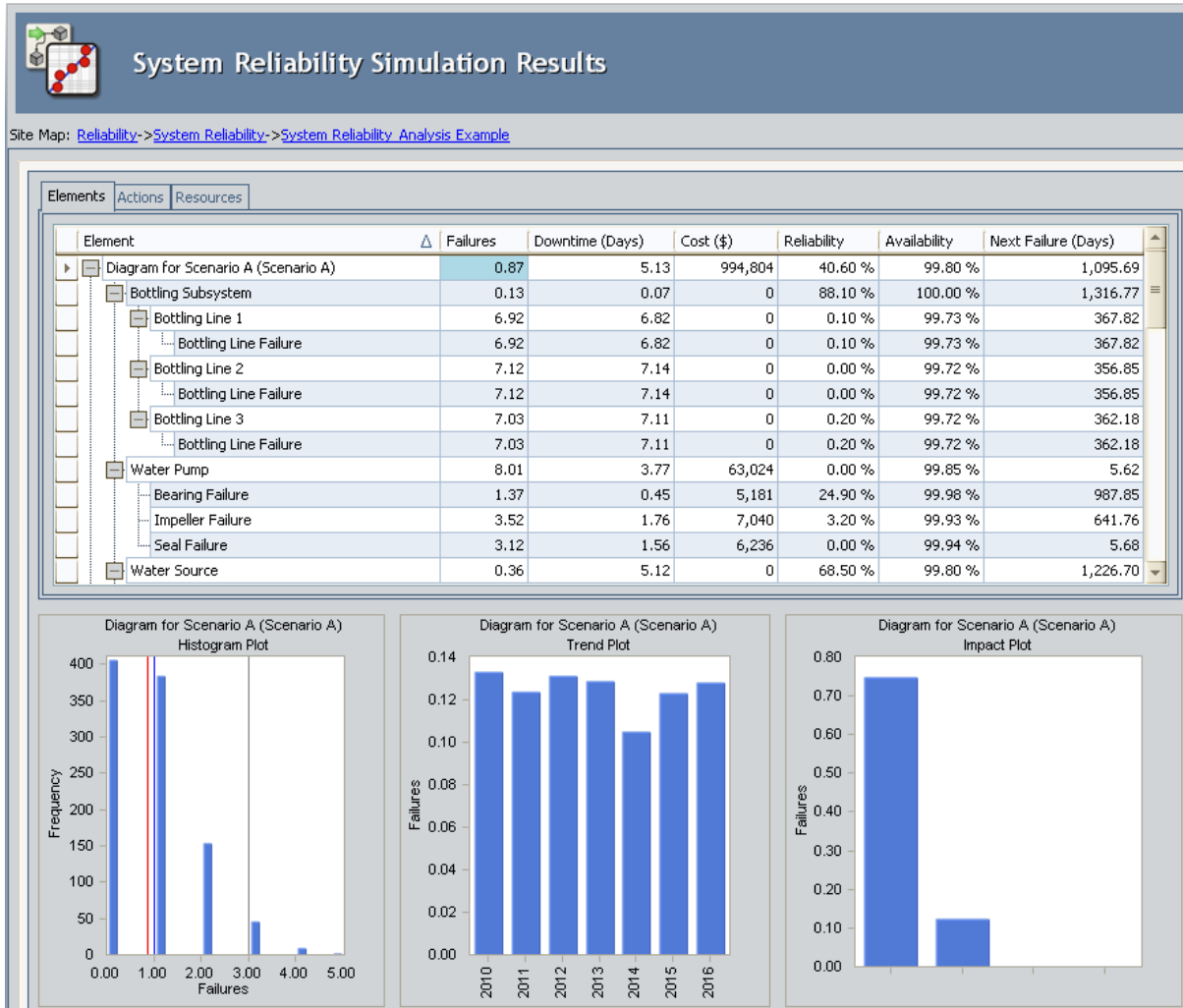

The simulation results are also presented in more detail on the [System Reliability Simulation Results page](#). The following grids are used to organize the data on the [System Reliability Simulation Results page](#):

- [Elements Grid](#).
- [Actions Grid](#).
- [Resources Grid](#).

By clicking a cell in the grid, you can view more detailed information in the following graphs:

- [Histogram](#).
- [Trend](#).
- [Impact](#).

What Is the Average Total?

The *average total* is the average of all the totals across all iterations of a simulation, which is calculated by the Meridium APM system for each simulation. Average totals are calculated for various types of numeric values in a simulation, such as cost in the [Total Cost Trend graph](#) or time in the [Resource Time graph](#).

In our System Reliability Example, the Total Cost Trend Graph, which is shown in the following image, displays the average total cost for each of the three Scenarios for each year in the simulation period. Our analysis had one thousand iterations, so one thousand separate values were calculated by the Meridium APM system for the total cost of each of the three Scenarios.



In this image, the 2010 column for Scenario A represents the average cost of the one thousand cost values that were calculated for Scenario A by the Meridium APM system.

What is the Simulation Period?

Some results of a System Reliability Analysis are presented according to the *simulation period* that you have selected. The *simulation period* is defined by the values in the following text boxes in the [Analysis Parameters pane](#) on the [System Reliability Analysis Definition page](#):

- The values in the two **Period** text boxes. The **Period** text boxes represent the Period and Period Units fields in the System Analysis record and determine the length of the simulation.
- The value in the **Time Analysis Type** text box. The **Time Analysis Type** text box represents the Time Analysis Type field in the System Analysis record, and the value determines whether results are calculated for each year or each month of the simulation. If the Time Analysis Type is set to:
 - *Yearly*, the graphs display values for each year included in the simulation period, which is defined by the values in the Period, Period Units, and Analysis Start Date fields in the System Analysis record.
 - *Monthly*, the graphs display values for each month included in the simulation period, which is determined by the values in the Period, Period Units, and Analysis Start Date fields in the System Analysis record.

For example, for our [System Reliability Analysis Example](#), the following values are selected.

System Analysis Field	Value
Period	7
Period Units	Years
Time Analysis Type	Yearly

So the [Total Cost Trend graph](#), which is shown in the following image, has seven groupings of columns, one to represent each year in our simulation period, as defined by the selections in the **Start Date** and **Period** text boxes.

What is the Simulation Period?

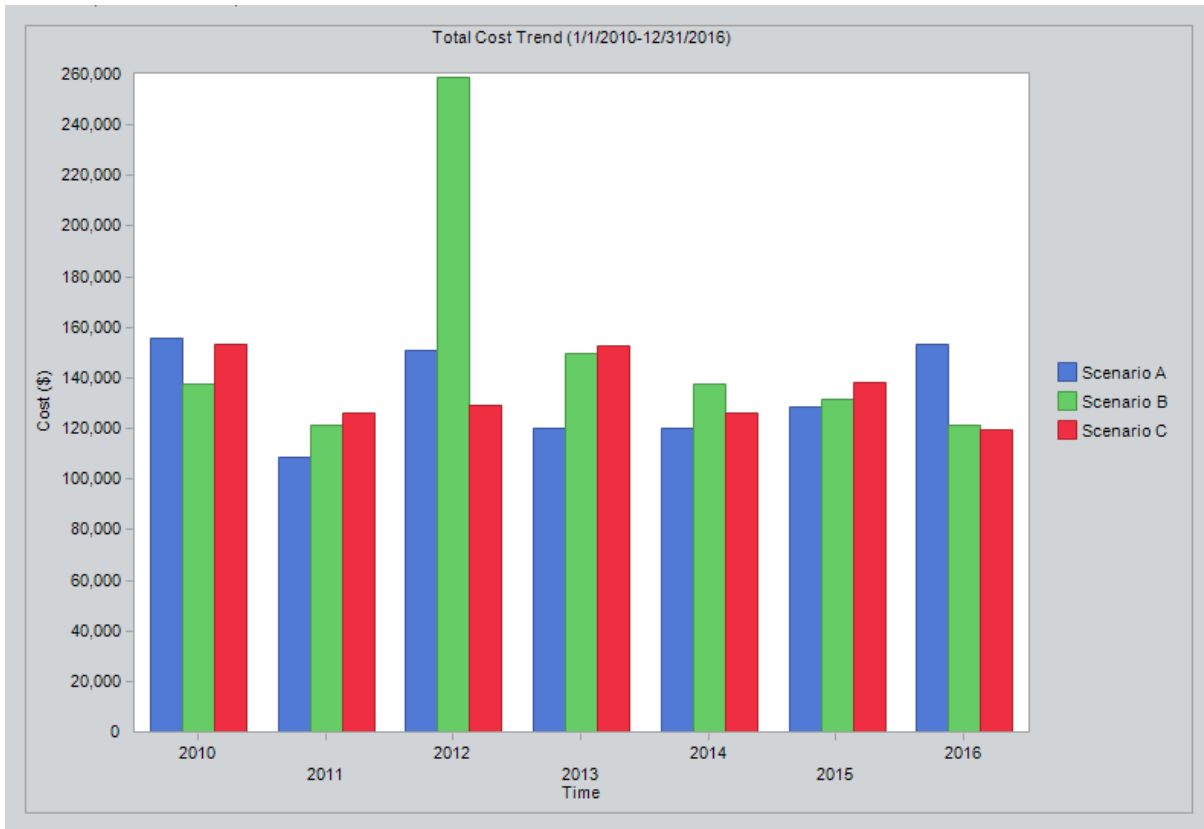

If the values were changed to reflect a *monthly* format, then the graph would change as well. For example, suppose the values were changed to those listed in the following table.

System Analysis Field	Value
Period	84
Period Units	Months
Time Analysis Type	Monthly

In this case, the following image shows what the graph would look like based on the updated values.

What is the Simulation Period?

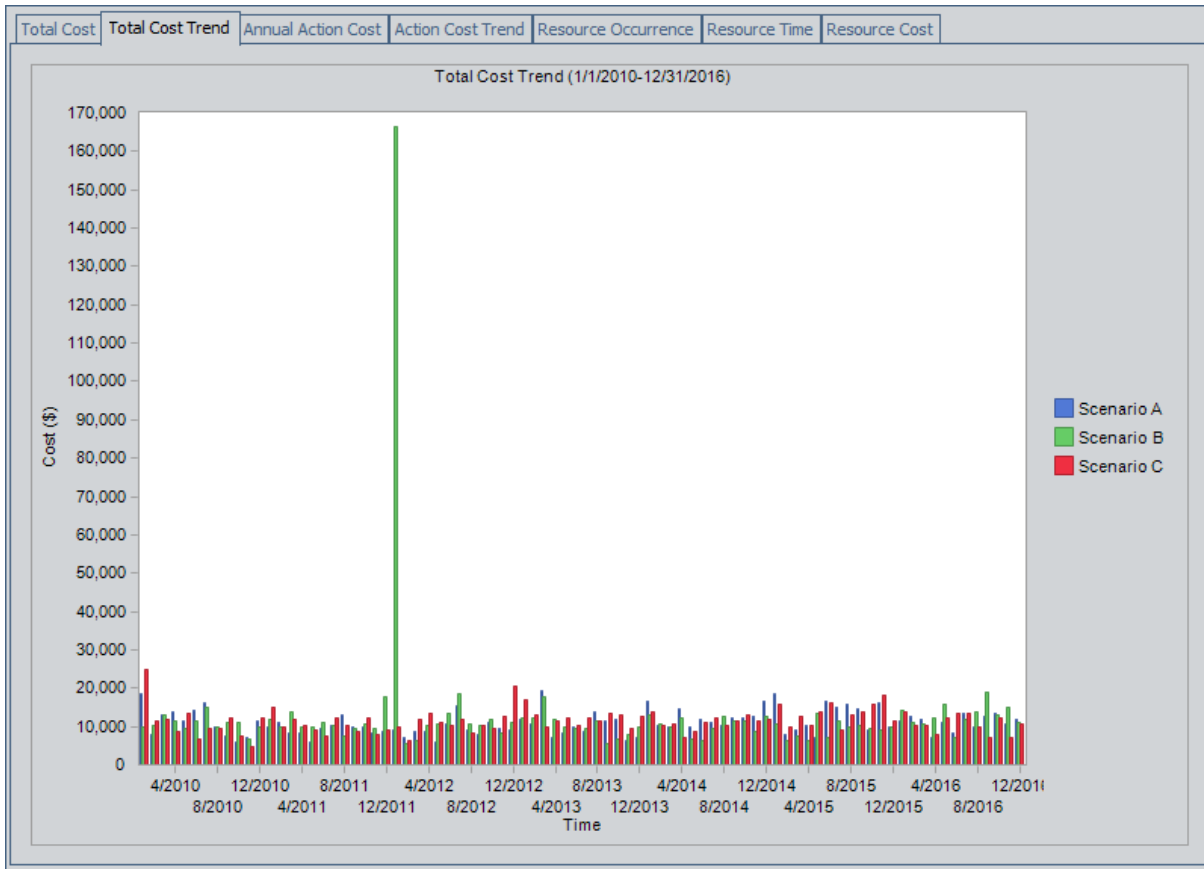

Show Total Check Box

The **Show Total** check box is a feature that is available on the following System Reliability Analysis results graphs:

- [Total Cost graph](#)
- [Annual Action Cost graph](#)
- [Resource Cost graph](#)

In these graphs, each column represents a separate Scenario. The **Show Total** check box determines how the columns are displayed, as described in the following list:

- When the **Show Total** check box is *cleared*, the graphs display one column that is divided into sections representing the individual cost types or resources within that Scenario. In addition, the legend displays labels for the individual categories that are represented in each column.
- When the **Show Total** check box is *selected*, the graphs display one column that is not divided into sections but instead displays the total cost associated with all categories in that Scenario. In addition, the legend displays the label *Total*.

The following image shows the [Total Cost graph](#) for our [System Reliability Analysis Example](#) when the **Show Total** check box is *selected*.

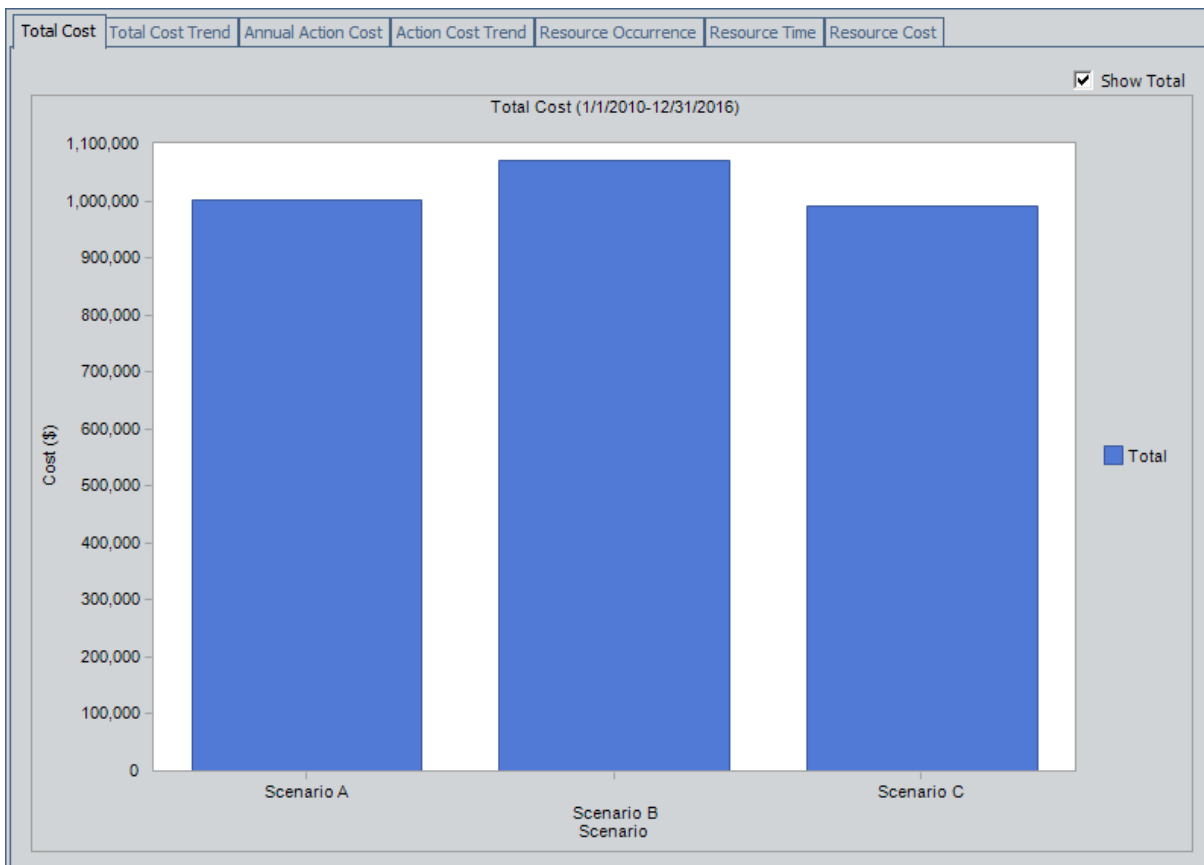

Show Total Check Box

The following image, on the other hand, shows the Total Cost graph for our System Reliability Analysis Example when the Show Total check box is *cleared*.

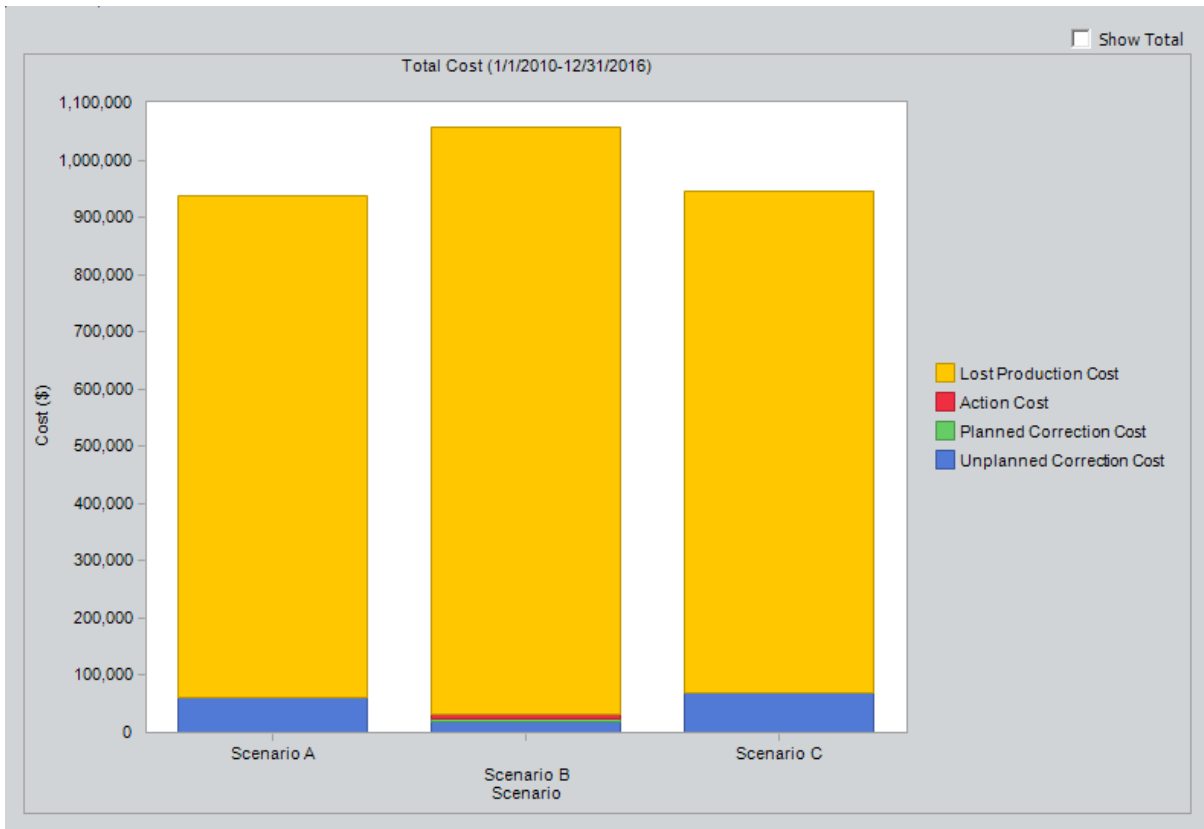

Total Cost Tab

The **Total Cost** tab on the **System Reliability Summary** page contains the Total Cost graph, which displays the [average total](#) cost for each Scenario. The total cost represents the sum of costs in the following categories: Lost Production Cost, Action Cost, Planned Correction Cost, and Unplanned Correction Cost.

The following image shows an example of the Total Cost graph.

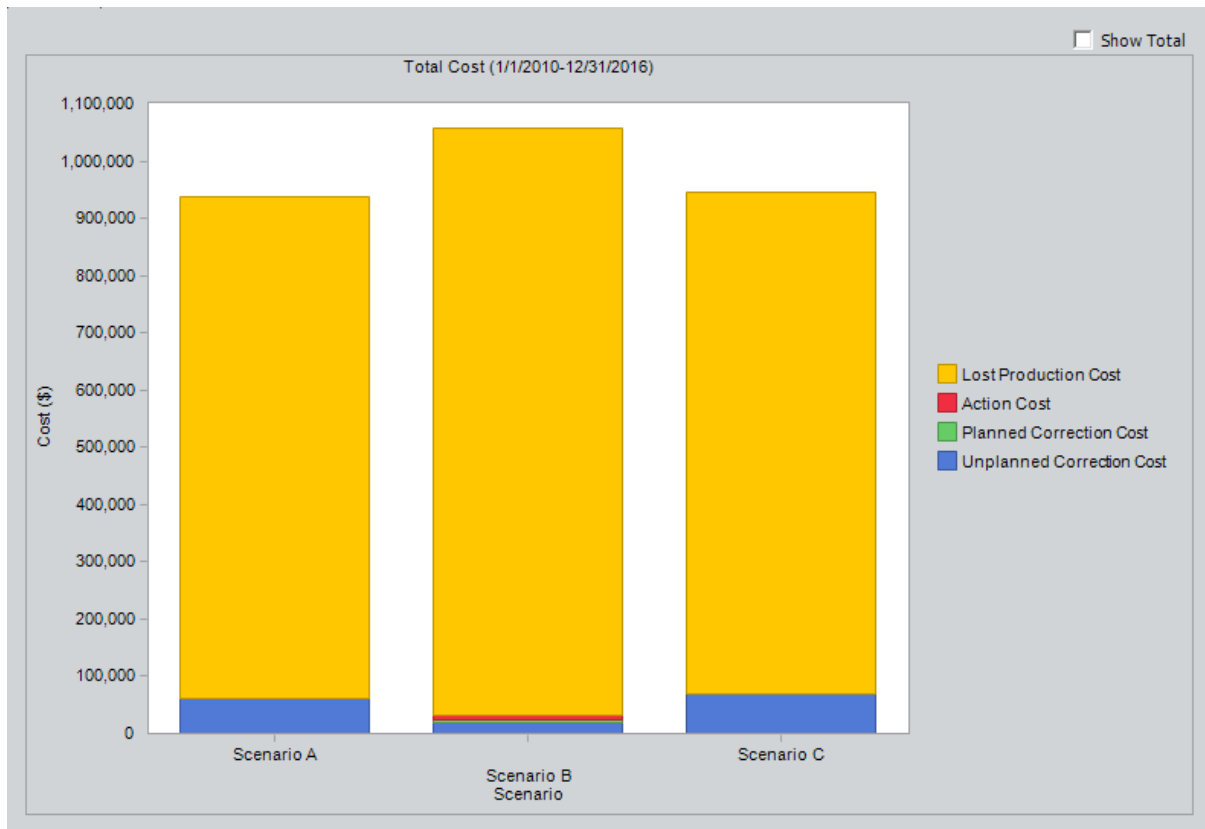

Note: If you prefer to see the various cost categories added together and presented in a single column for each Scenario, select the [Show Total](#) check box in the upper right corner of the plot.

The preceding image shows the **Total Cost** graph from our [System Reliability Analysis Example](#). Notice that in the Total Cost graph, [Scenario B](#) has the *highest* cost of all the Scenarios and that [Scenario C](#) has the *lowest* cost. Notice also that only Scenario B which is the only Scenario with Actions, has Action and Planned Correction costs, which are both associated with Actions. To see the data used to create these graphs, you can view the [Elements grid](#).

The categories in the Total Cost graph are calculated for each Scenario as described here:

- **Lost Production Cost:** The average lost production cost across all iterations. Lost production cost includes the cost of lost production for any element when it is stopped or unable to run, according to the value in the Lost Product Cost field of the record that represents that element.
- **Action Cost:** The average Action cost across all the iterations. Action cost includes any materials or personnel needed to complete any Actions that exist in the Scenario and any Resources used to complete the Actions. The following fields are used to calculate Action costs:
 - [System Action record](#): Action Cost.
 - [System Resource record](#): Fixed Cost, Variable Cost, and Variable Cost Units.
 - [System Resource Usage record](#): Duration, Duration Units, and Quantity.
- **Planned Correction Cost:** The average planned correction cost across all the iterations. Planned correction cost includes the cost to repair an element that is identified as having a potential failure by an inspection or condition monitoring Action and any Resources used. The following fields are used to calculate planned correction costs:
 - [System Subsystem record](#): Variable Cost, and Variable Cost Units.
 - [System Asset record](#): Variable Cost and Variable Cost Units.
 - [System Switch record](#): Variable Cost and Variable Cost Units.
 - **System Risk record:** Planned Correction Cost, Planned Correction Duration, and Planned Correction Duration Units.
 - [System Resource record](#): Fixed Cost, Variable Cost, and Variable Cost Units.
 - [System Resource Usage record](#): Duration, Duration Units, and Quantity.
- **Unplanned Correction Cost:** The average unplanned correction cost across all the iterations. Unplanned correction cost includes the cost to repair any failed element and any Resources used to do so. The following fields are used to calculate unplanned correction costs:
 - [System Subsystem record](#): Fixed Cost, Variable Cost and Variable Cost Units.
 - [System Asset record](#): Fixed Cost, Variable Cost, and Variable Cost Units.
 - [System Switch record](#): Fixed Cost, Variable Cost, and Variable Cost Units.
 - **System Risk record:** Fixed Unplanned Correction Cost, Variable Unplanned Correction Cost, and Variable Unplanned Correction Cost Units.
 - [System Resource record](#): Fixed Cost, Variable Cost, and Variable Cost Units.
 - [System Resource Usage record](#): Duration, Duration Units, and Quantity.

Total Cost Trend Tab

The **Total Cost Trend** tab on the **System Reliability Summary** page contains the Total Cost Trend graph, which displays the [average total cost](#) for each Scenario for each analysis time interval in the [simulation period](#).

The following image shows an example of the Total Cost Trend graph.

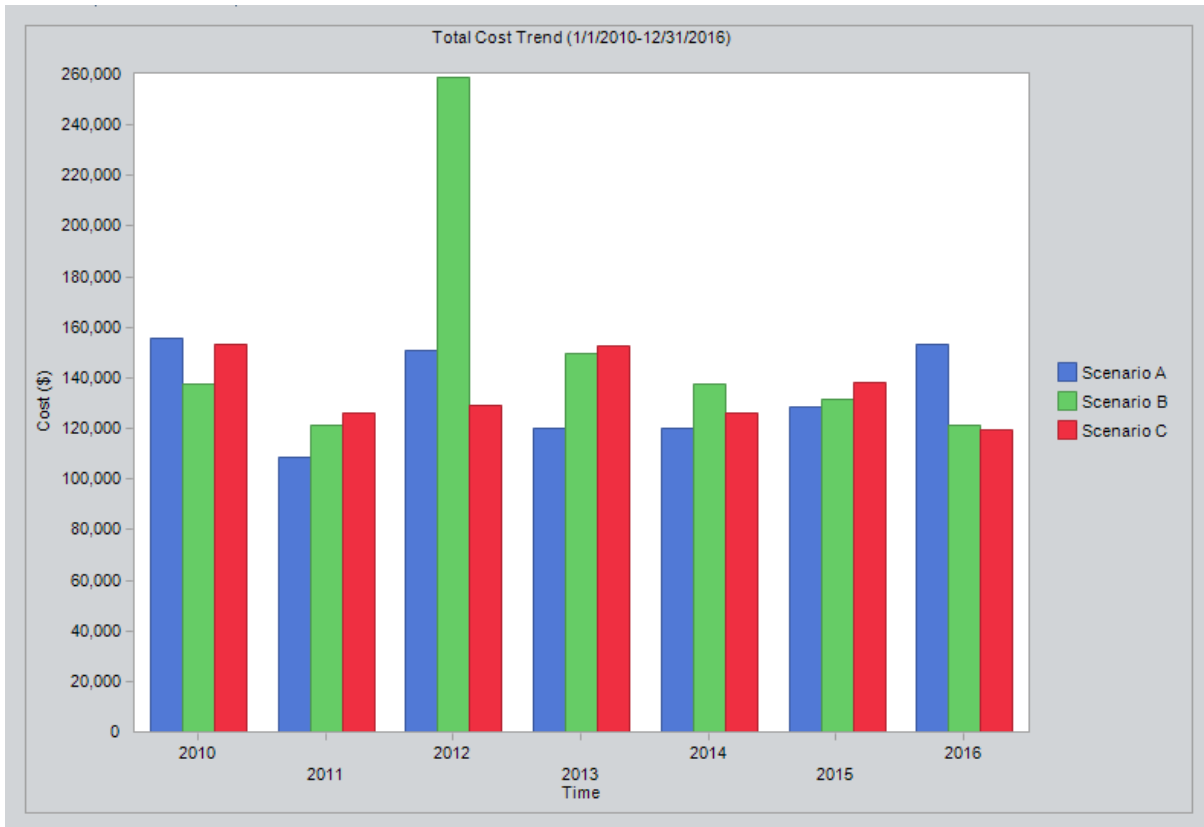

This image shows the Total Cost Trend graph for our [System Reliability Analysis Example](#). Note the following details about the Total Cost Trend graph shown in the image:

- The cost for [Scenario A](#) was the highest in 2015 and the lowest in 2011.
- The cost for [Scenario B](#) was the highest in 2012 and the lowest in 2011.
- The cost for [Scenario C](#) was the highest in 2011 and the lowest in 2014.

You can draw the following conclusions about the Scenarios from the graph shown in the image:

- Neither Scenario A nor Scenario C had large increases or decreases in costs over the simulation period.
- Scenario B had a large increase in costs in 2012. This was the year in which the *Redesign Impellers* Action took place, and the one singular occurrence of the

Redesign Impellers Action nearly doubled the costs of Scenario B. Additionally, by comparing the years *before* the Action to the years *after* the Action, you can see that the *Redesign Impellers* Action did not reduce the cost of the Scenario. In fact, costs were *higher* every year after the *Redesign Impellers* Action occurred. So, from the graph, you can conclude that you may want to refine Scenario B by modifying or replacing the *Redesign Impellers* Action.

CE Hint: While Scenario C had the lowest overall cost for the entire simulation period, according to the [Total Cost graph](#), it had the highest overall cost in 2011 and a higher cost than Scenario B for multiple years in the simulation. Keep in mind that having the lowest overall cost does not necessarily mean that the Scenario always has the lowest cost for every analysis time interval.

Annual Action Cost Tab

The **Annual Action Cost** tab on the **System Reliability Summary** page contains the Annual Action Cost graph, which displays the average cost of actions per year for each Scenario.

The following image shows an example of the Annual Action Cost graph.

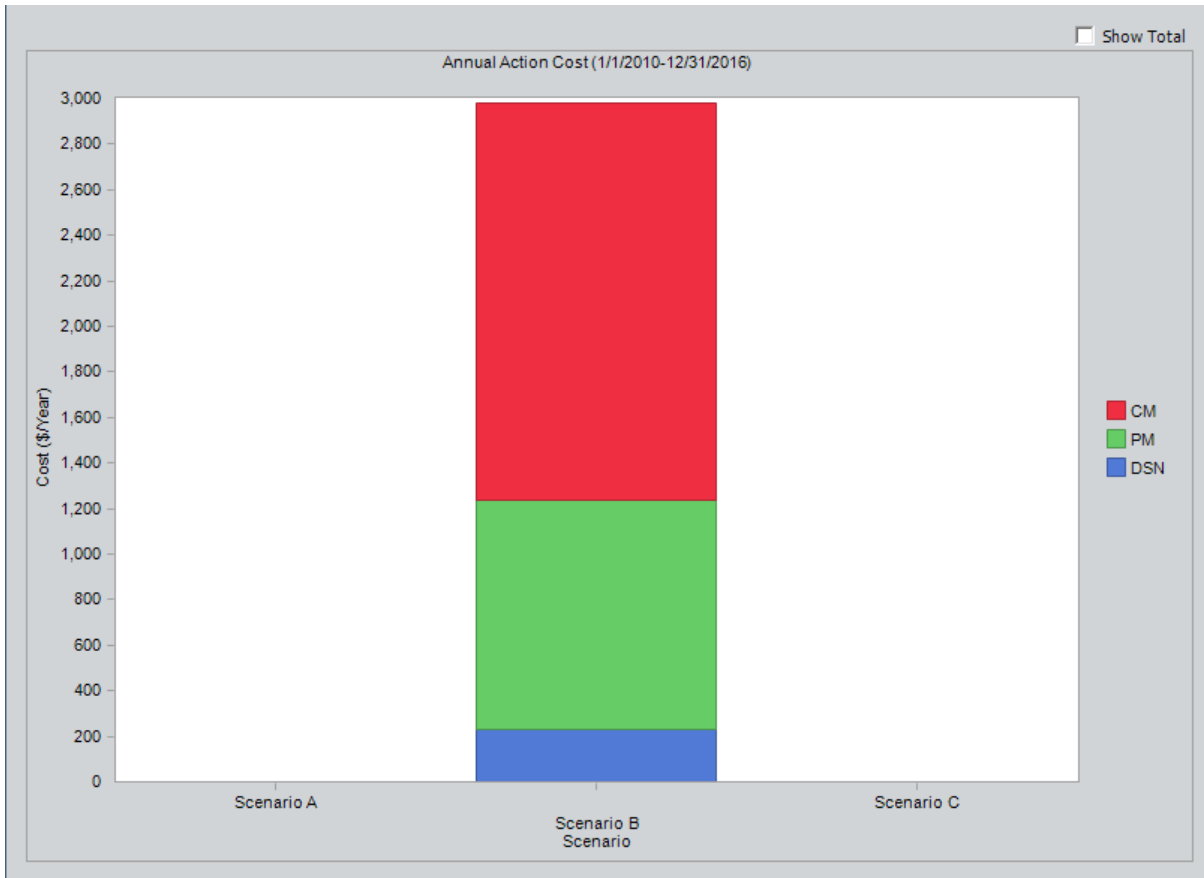

Note: If you prefer to see the various cost categories added together and presented in a single column for each Scenario, select the [Show Total](#) check box in the upper right corner of the plot.

This image shows the Annual Action Cost graph for our [System Reliability Analysis Example](#), where you can see that Scenario B is the only Scenario that had any action costs. If Scenario A or Scenario C had action costs, you could compare the annual action costs for each scenario on this graph.

You can also compare the cost of different types of actions on this page. In our example, you can see that condition-based maintenance (*Vibration Analysis*) is displayed by the red bar, preventative maintenance (*Replace Seals*) is displayed by the green bar, and redesign maintenance (*Redesign Impellers*) is displayed by the blue bar.

From this graph, you can see that vibration analysis has the highest annual cost, and you may conclude that using the Vibration Technician Resource to perform this action at such a frequent interval causes annual costs to be high. This may lead you to investigate whether the Vibration Technician Resource can be used less often and be just as effective.

Action Cost Trend Tab

The **Action Cost Trend** tab on the **System Reliability Summary** page contains the Action Cost Trend graph, which displays the average total cost for actions in each Scenario for the analysis time interval in the [simulation period](#).

The following image shows an example of the Action Cost Trend graph.

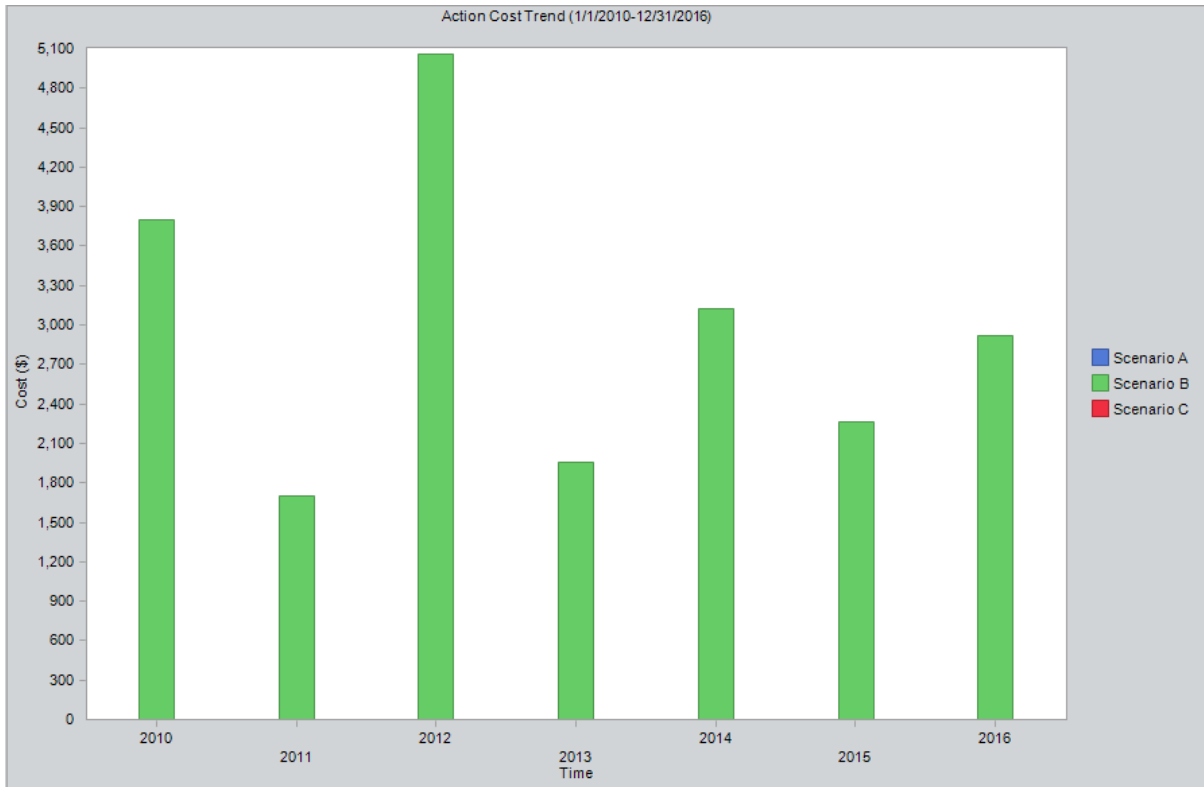

This image shows the Action Cost Trend graph for our [System Reliability Analysis Example](#), where you can see that Scenario B is the only Scenario that had any action costs. If Scenario A or Scenario C had action costs, you could compare the action costs over time for each scenario on this graph.

You can also use this graph to see an increase or decrease in action cost over time. When you compare the Action Cost Trend graph to the Cost Trend graph, we can see there was a large increase in costs in 2012 for both graphs. You may conclude that the large increase in total cost was due to an increase in action cost. This was the year in which the *Redesign Impellers* Action took place, and the one singular occurrence of the *Redesign Impellers* Action in 2012 is more than the actions in 2011 and 2013 combined. By comparing the Action Cost Trend graphs with other graphs, you may be able to determine whether this action is worth the cost increase and if you should implement this action again in the future.

Resource Occurrence Tab

The **Resource Occurrence** tab on the [System Reliability Summary page](#) contains the Resource Occurrence graph, which displays statistics about the total use of each Resource when the value in the Count Occurrence field of the associated System Resource record is set to True. The Resource occurrence count is calculated from the average total usage across all iterations.

Note: For System Resource records where the Count Occurrence field is set to *False*, the occurrence count of that Resource will be zero, and it will not be displayed on the graph. Note that the *Mechanic* Resource, whose Count Occurrence field value contains the value *False*, does not appear on the Resource Occurrence graph but is still used in the simulation and appears in both the Resource Time graph and the Resource Cost graph.

The following image shows an example of the Resource Occurrence graph.

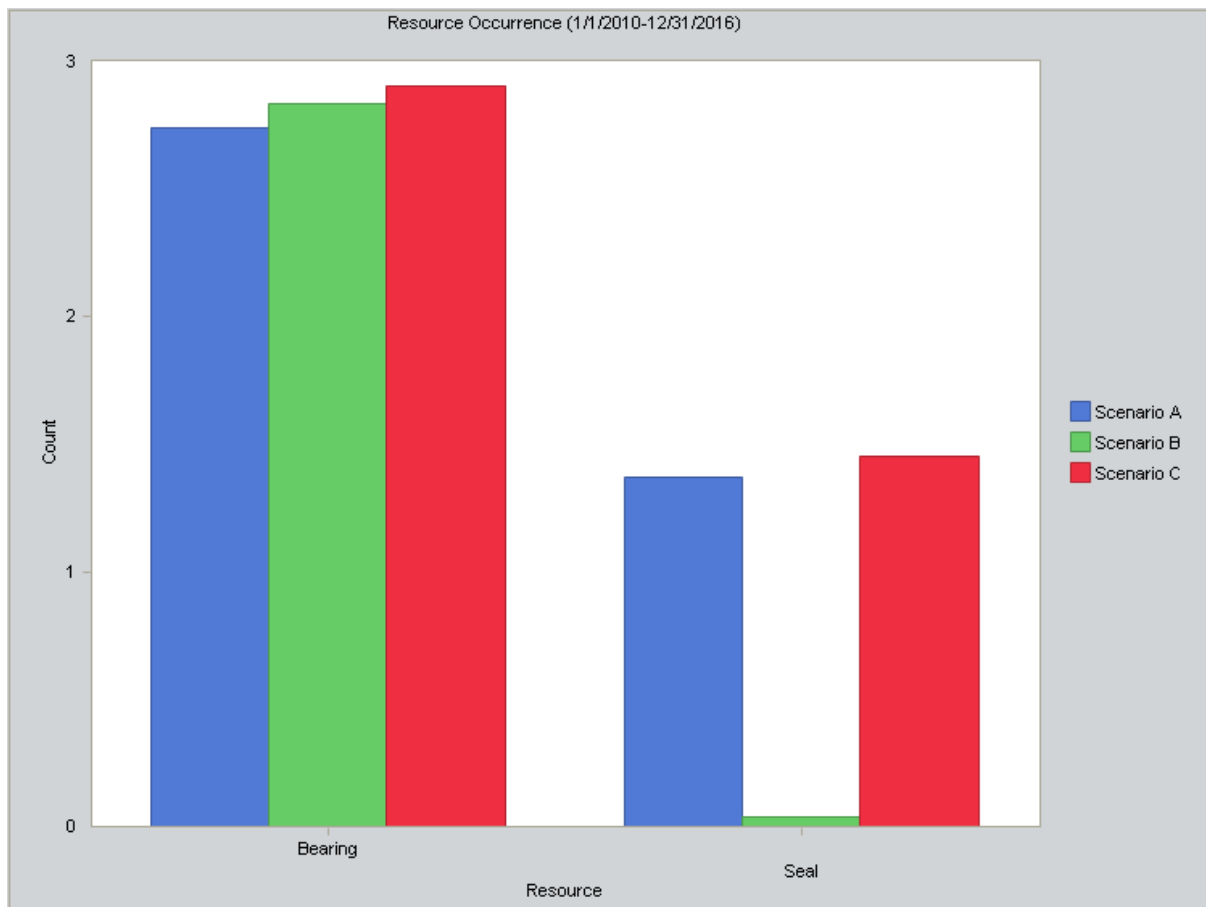

This image shows the Resource Occurrence graph for our [System Reliability Analysis Example](#), where you can see that the *Bearing* Resource was used almost three times for each Scenario. The Seal Resource was used more than once for [Scenario A and C](#) and about zero times for [Scenario B](#). The Seal Resource was not used as often in Scenario B

because seals were used only in *unplanned* Resource usages, which are due to Bearing failures, and the *Vibration Analysis* Action was able to find and repair any potential Bearing failure so that unplanned corrections did not occur.

From looking at this graph, you can conclude that you may want to refine this System Reliability Analysis by creating Actions to repair Bearings so they can be used longer, or you may want to add a *Vibration Analysis* Action to Scenario A and C so that the Seal Resource will be used less often.

Resource Time Tab

The **Resource Time** tab on the [System Reliability Summary page](#) contains the Resource Time graph, which displays the total amount of time that each Resource is used per Scenario. The total amount of time is calculated as the [average total](#) amount of time that the Resource is used for all the iterations.

The following image shows an example of the Resource Time graph.

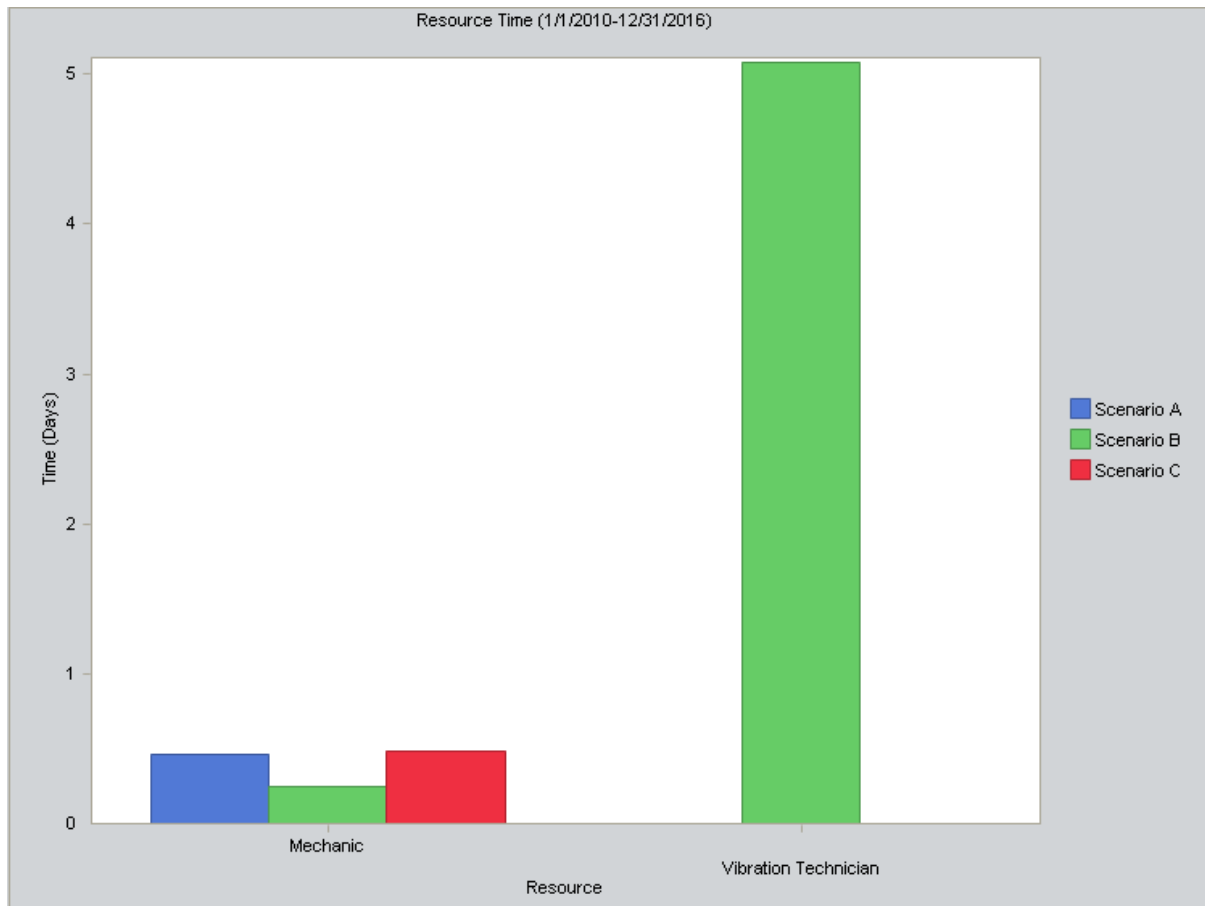

This image shows the **Resource Time** graph for our [System Reliability Analysis Example](#). Note that in the Resource Time graph, you can see that:

- The *Mechanic* Resource was used in all three Scenarios but more in Scenarios A and C than in Scenario B. This is because Scenario B has Actions that are designed to mitigate potential failures, so the Actions used the Mechanic Resources more efficiently for *maintaining* equipment and location rather than repairing failures. Based upon this information, you might further refine Scenario A and C by designing additional Actions to maintain equipment and locations in Scenario A and C.
- The *Vibration Technician* Resource was used by Scenario B but not by Scenario A or C. This is because the Vibration Technician Resource is assigned to an Action in Scenario B. You can see that the Vibration Technician Resource was used for

about five days in Scenario B. From this graph, you might conclude that you should refine Scenario B by investigating whether the Vibration Technician Resource can be used for less time and be just as effective.

Resource Cost Tab

The **Resource Cost** tab on the [System Reliability Summary page](#) contains the Resource Cost graph, which displays the total cost of all Resources used in the Scenario. The total cost is calculated for each Scenario as the [average total](#) Resource costs for all the iterations.

The following image shows an example of the Resource Cost graph.

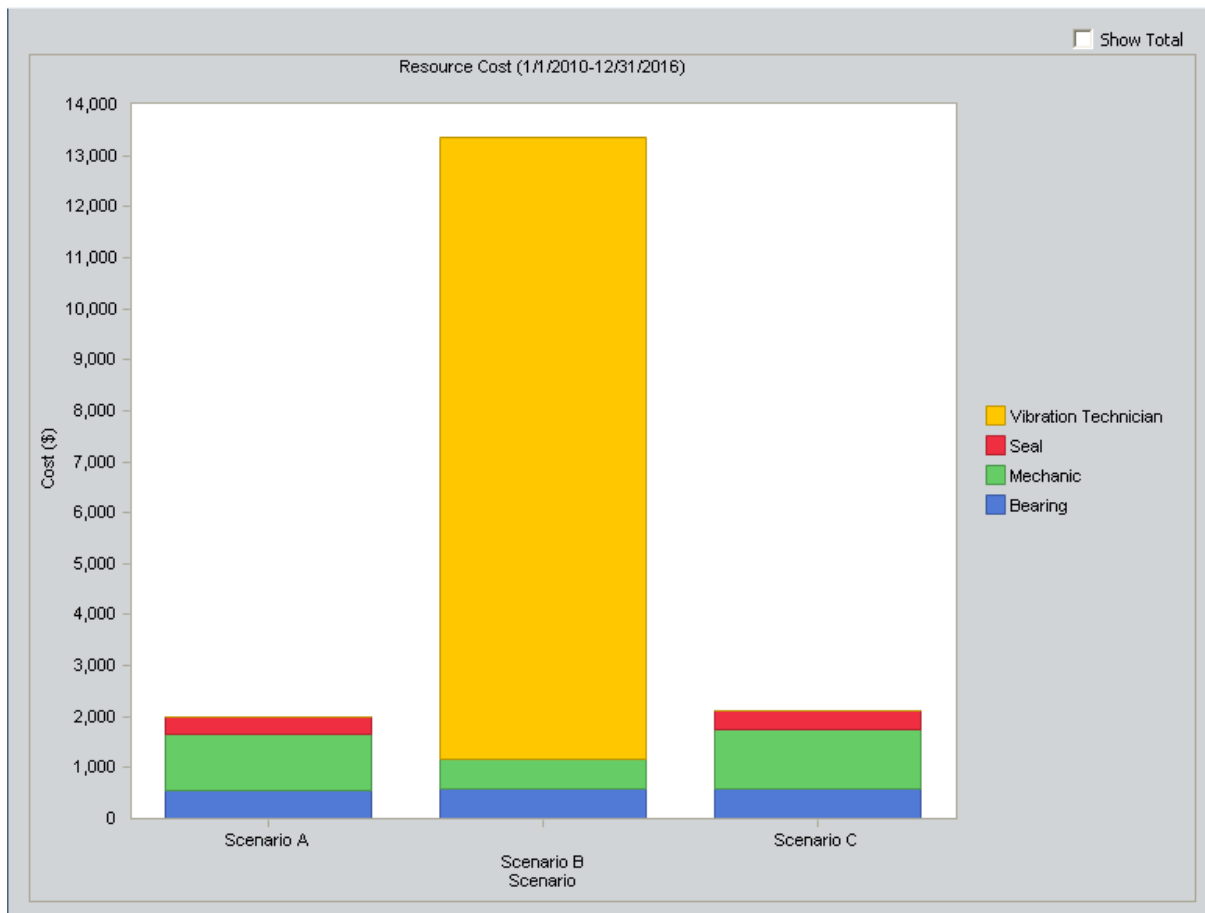

Note: If you prefer to see the various cost categories added together and presented in a single column for each Scenario, select the [Show Total](#) check box in the upper right corner of the plot.

The preceding image shows the Resource Cost graph for our [System Reliability Analysis Example](#). Note that in the Resource Cost Plot graph, you can see that:

- [Scenario A and C](#) used the Bearing, Mechanic, and Seal Resources for a total cost of around two thousand dollars. These Resources were used during *unplanned* corrections that occurred after a failure caused by the Bearing Failure Risk.
- [Scenario B](#) used the Bearing, Mechanic, and Vibration Technician Resources for a total cost of over \$13,000.

- The Vibration Technician Resource was used by the Vibration Analysis Action, which was implemented to mitigate the Bearing Failure Risk. This Resource accounted for the majority of costs, over \$12,000, in Scenario B.
- The Bearing and Mechanic Resources were used during *planned* corrections that were performed as a result of executing the Vibration Analysis Action. These two Resources were not used as much as the Vibration Technician Resource and accounted for a little over one thousand dollars.

Whereas an *unplanned* correction associated with the Bearing Failure Risk requires the use of the Bearing, Mechanic, and Seal Resources, a *planned* correction requires the use of only the Bearing and Mechanic Resources. The cost of the Vibration Technician Resource, which is required to identify the need for a planned correction, however, is much higher than the cost of the Seal Resource that is needed for an unplanned correction. Therefore, we can conclude that the Resource cost of the Actions implemented in Scenario B to mitigate the Bearing Failure Risk is more costly than the actual failure itself.

Note: While the Resource Cost graph for our example suggests that the cost of risk mitigation is higher than the cost of the risk itself, keep in mind that the Resource Cost Plot graph is only one aspect of the simulation results. Other factors, such as lost production cost and total correction costs, must also be taken into account in determining the total cost associated with a Scenario.

Elements Grid

The **Elements** grid on the [System Reliability Simulation Results page](#) displays specific results for the elements that exist in a System Reliability Analysis.

Element	Failures	Downtime (Days)	Cost (\$)	Reliability	Availability	Next Failure (Days)
Diagram for Scenario A (Scenario A)	0.87	5.13	994,804	40.60 %	99.80 %	1,095.69
Bottling Subsystem	0.13	0.07	0	88.10 %	100.00 %	1,316.77
Bottling Line 1	6.92	6.82	0	0.10 %	99.73 %	367.82
Bottling Line Failure	6.92	6.82	0	0.10 %	99.73 %	367.82
Bottling Line 2	7.12	7.14	0	0.00 %	99.72 %	356.85
Bottling Line Failure	7.12	7.14	0	0.00 %	99.72 %	356.85
Bottling Line 3	7.03	7.11	0	0.20 %	99.72 %	362.18
Bottling Line Failure	7.03	7.11	0	0.20 %	99.72 %	362.18
Water Pump	8.01	3.77	63,024	0.00 %	99.85 %	5.62
Bearing Failure	1.37	0.45	5,181	24.90 %	99.98 %	987.85
Impeller Failure	3.52	1.76	7,040	3.20 %	99.93 %	641.76
Seal Failure	3.12	1.56	6,236	0.00 %	99.94 %	5.68
Water Source	0.36	5.12	0	68.50 %	99.80 %	1,226.70
Water Tank	7.31	5.06	0	0.00 %	99.80 %	Infinity
Diagram for Scenario B (Scenario B)	1.47	6.01	1,063,963	0.00 %	99.77 %	676.77
Bottling Subsystem	0.10	0.06	0	90.40 %	100.00 %	1,242.70
Bottling Line 1	6.91	6.86	0	0.10 %	99.73 %	357.33

The following columns of information are displayed in the **Elements** grid:

- **Element:** Displays a hierarchy that lists the components in the System Reliability Analysis.
- **Failures:** The average number of times the selected item failed during the analysis period for all iterations of the Scenario to which it belongs.
- **Downtime (Days):** The average number of days that the selected item was out of service due to failures or shutdowns for all iterations of the Scenario to which it belongs.
- **Cost (\$):** The average total cost of the selected item for all iterations of the Scenario to which it belongs. This includes the cost of any items that belongs to the item, lost production costs, fixed costs, variable costs, Action costs, planned or unplanned correction costs, and Resource costs.
- **Reliability:** The percentage of iterations that the selected item never failed across the total number of iterations in the Scenario to which it belongs.

Note: Reliability is calculated from actual data collected from the iterations and does not represent an average value.

- **Availability:** The average percentage of the time that the selected item was available and running for the Scenario to which it belongs.
- **Next Failure (Days):** The average amount of time, in days, from the analysis Start Date until the next failure occurs for the selected item.

Actions Grid

The **Actions** grid on the [System Reliability Simulation Results page](#) displays specific results for each **Action** that exists in the System Reliability Analysis.

Action	Occurrences	Cost (\$)	Detected Failures
Diagram for Scenario A (Scenario A)			
Diagram for Scenario B (Scenario B)			
Water Pump			
Redesign Impellers	1.00	1,600	0.00
Replace Seals	3.48	6,956	0.00
Vibration Analysis	121.99	12,199	1.38
Diagram for Scenario C (Scenario C)			

The following columns of information are displayed in the **Actions** grid:

- **Action:** Displays a hierarchy that displays the Actions that exist in a System Reliability Analysis. The Actions appear below the element in the Diagram to which they belong.
- **Occurrences:** The average number of occurrences of the Action from all iterations of the Scenario to which it belongs.
- **Cost (\$):** The average cost of the Action, including any Resources used by the Action, for the Scenario to which it belongs.
- **Detected Failures:** The average number of potential failures detected in advance by the Action. This result is calculated only for [inspection](#) and [condition monitoring Actions](#), which are the only Actions that can detect potential failures.

Resources Grid

The **Resources** grid on the [System Reliability Simulation Results page](#) displays specific results for each Resource that exists in a System Reliability Analysis.

Resource		Occurrences	Time (Days)	Cost (\$)
Scenario A				
▶	Bearing	2.74	0.00	548
	Mechanic	0.00	0.46	1,096
	Seal	1.37	0.00	343
	Vibration Technician	0.00	0.00	0
Scenario B				
	Bearing	2.84	0.00	567
	Mechanic	0.00	0.24	582
	Seal	0.04	0.00	9
	Vibration Technician	0.00	5.08	12,199
Scenario C				
	Bearing	2.91	0.00	581
	Mechanic	0.00	0.48	1,162
	Seal	1.45	0.00	363
	Vibration Technician	0.00	0.00	0

The following columns of information are displayed in the **Resources** grid:

- **Resource:** Displays a hierarchy that displays the Resources that exist in the System Reliability Analysis. The Resources appear below the Scenario in the hierarchy to which they belong.
- **Occurrences:** The average number of times the Resource is used during the simulation period.

Note: For [System Resource records](#) in which the Count Occurrences field is set to *False*, the value in this column will be 0 (zero).

- **Time (Days):** The average amount of time, in days, accumulated by the Resource.
- **Cost (\$):** The average cost accrued by the Resource.

About the Histogram Plot

While the grids on the [System Reliability Simulation Results page](#) display average values, it can be helpful to understand the specific values that were used to calculate the averages. The Histogram Plot shows the distribution of the actual values from all iterations that were used to calculate the average value.

The distribution of the actual values spreads across a series of data ranges, which are called bins and are represented by columns on the Histogram Plot. When an actual value from an iteration falls into a bin, it is included in the associated column. The higher the column is, the more values have fallen into the bin.

Note: The number of columns that appear in the Histogram Plot is determined by the value in the Histogram Bins field in the root [System Analysis record](#).

Additional values are represented by the following lines in the Histogram Plot:

- **Optimistic Value:** Leftmost gray vertical line in the Histogram Plot. This line represents the lower level of the confidence interval.
- **Average Value:** Red line in the Histogram Plot. This line represents the mean value, which is the mean value of the values from the iterations of the Scenario.
- **Realistic Value:** Blue line in the Histogram Plot. This line represents the median value, which is the median value of the values from the iterations of the Scenario.

Note: If the median value falls in between two values, then the larger value will be used as the Realistic value.

- **Pessimistic Value:** Rightmost gray vertical line in the Histogram Plot. This line represents the upper level of the confidence interval.

About the Histogram Plot

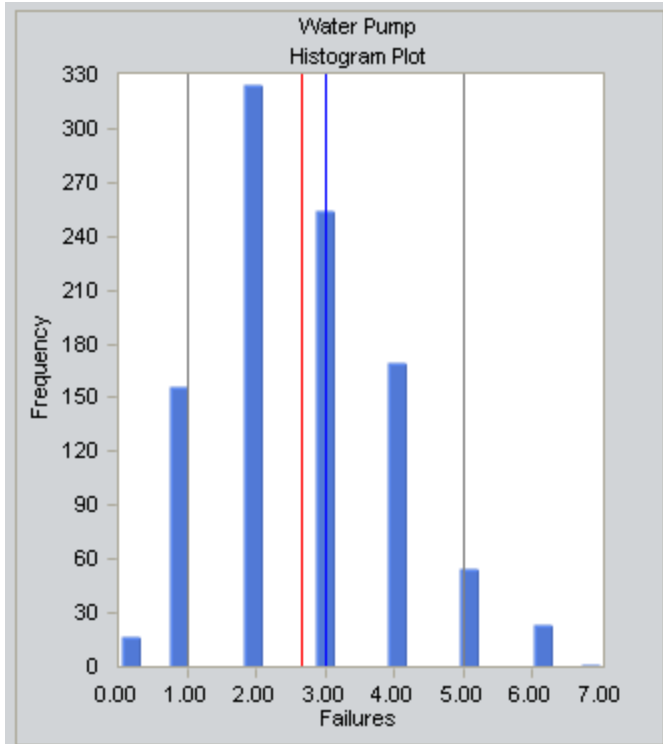

This image displays the Histogram Plot for the Failures of the Water Pump in Scenario B of the [System Reliability Analysis Example](#). In this example, 20 bins are defined for the Histogram Plot, and the actual iteration values fall into eight of those bins, which are visible on the chart:

- **Bin One:** Represents the range from 0.00 to 0.35 failures. This bin has a value of 17, indicating that there are 17 iterations where the Water Pump failed from 0.00 to 0.35 times.
- **Bin Three:** Represents the range from .70 to 1.05 failures. This bin has a value of 156, indicating that there are 156 iterations where the Water Pump failed from 0.70 to 1.05 times.
- **Bin Six:** Represents the range from 1.75 to 2.10 failures. This bin has a value of 324, indicating that there are 324 iterations where the Water Pump failed from 1.75 to 2.10 times.
- **Bin Nine:** Represents the range from 2.80 to 3.15 failures. This bin has a value of 254, indicating that there are 254 iterations where the Water Pump failed from 2.80 to 3.15 times.
- **Bin Twelve:** Represents the range from 3.85 to 4.20 failures. This bin has a value of 170, indicating that there are 170 iterations where the Water Pump failed from 3.85 to 4.20 times.
- **Bin Fifteen:** Represents the range from 3.85 to 4.20 failures. This bin has a value of 55, indicating that there are 55 iterations where the Water Pump failed from 3.85 to 4.20 times.

About the Histogram Plot

- **Bin Eighteen:** Represents the range from 4.90 to 5.25 failures. This bin has a value of 23, indicating that there are 23 iterations where the Water Pump failed from 4.90 to 5.25 times.
- **Bin Twenty:** Represents the range from 6.65 to 7.00 failures. This bin has a value of 1, indicating that there is 1 iteration where the Water Pump failed from 6.65 to 7.00 times.

Note: Bins that are not displayed on the graph and not listed here have a value of 0 (zero) for their ranges, indicating that NO iterations had a Water Pump failure within their ranges.

In addition, in the image shown above, four lines are visible:

- **Optimistic:** Represents the lower value of the confidence interval. This line has a value of 1.00, indicating that the lower confidence level value for a failure is 1.00.
- **Average:** Represents the mean value. This line has a value of 2.67, indicating the average number of failures is 2.67 failures.
- **Realistic:** Represents the median value. This line has a value of 3.00, indicating the median number of failures is 3.00 failures.
- **Pessimistic:** Represents the upper level of the confidence interval. This line has a value of 5.00, indicating that the upper confidence level value for a failure is 5.00.

Trend Plot

While the grids on the [System Reliability Simulation Results page](#) display average values, understanding the specific values that make up the average can be helpful as well. The Trend Plot shows the average value for each analysis time interval, as defined by the value in the Time Analysis Type field in the root System Analysis record. If the Time Analysis Type field is set to:

- *Yearly*, the Cost Trend Plot will display the Cost Trend for each year in the simulation period.
- *Monthly*, the Cost Trend Plot will display the Cost Trend for each month in the simulation period.

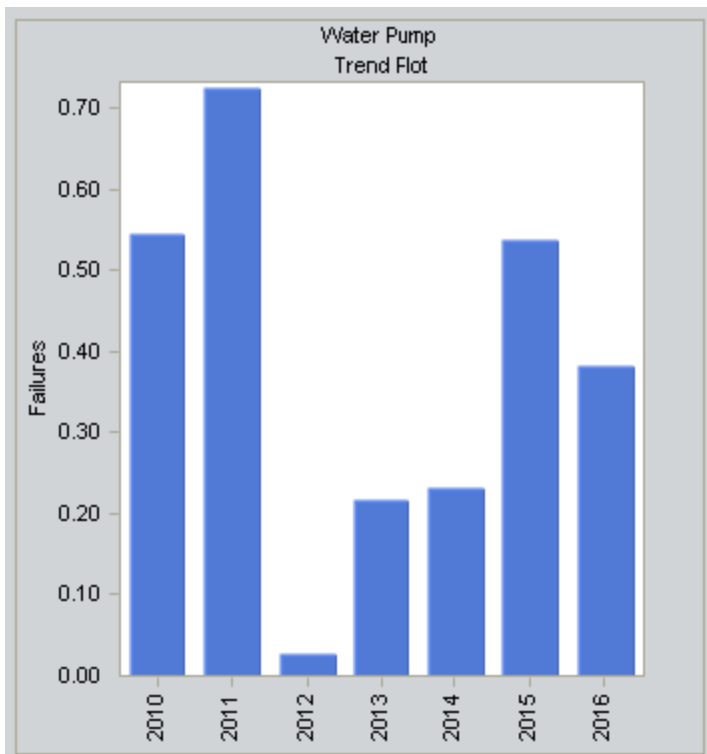

This image displays the Trend Plot for the Failures of the Water Pump in Scenario B of the [System Reliability Analysis Example](#), where you can see that the most Water Pump failures occurred in the second year of the simulation, while fewer occurred in the third year of the simulation. The information in the **Failure** column of the [Elements grid](#) indicates that the Water Pump failed a total average of 2.67 times across all iterations for Scenario A. The Trend Plot breaks out the total number of failures according to the year they occurred.

- **2010 Bar:** Represents the Water Pump failures in 2010. This bar has a value of 0.55, indicating the Water Pump failed 0.55 times in 2010.
- **2011 Bar:** Represents the Water Pump failures in 2011. This bar has a value of 0.72, indicating the Water Pump failed 0.72 times in 2011.

Trend Plot

- **2012 Bar:** Represents the Water Pump failures in 2012. This bar has a value of 0.03, indicating the Water Pump failed 0.03 times in 2012.
- **2013 Bar:** Represents the Water Pump failures in 2013. This bar has a value of 0.22, indicating the Water Pump failed 0.22 times in 2013.
- **2014 Bar:** Represents the Water Pump failures in 2014. This bar has a value of 0.23, indicating the Water Pump failed 0.23 times in 2014.
- **2015 Bar:** Represents the Water Pump failures in 2015. This bar has a value of 0.54, indicating the Water Pump failed 0.54 times in 2015.
- **2016 Bar:** Represents the Water Pump failures in 2016. This bar has a value of 0.38, indicating that the Water Pump failed 0.38 times in 2016.

The value in the grid represents the total failures for the entire simulation period, or the sum of all values in the Trend Plot, in this case 2.67.

Impact Plot

While the grids on the [System Reliability Simulation Results page](#) display average values, understanding the values that make up the average can be helpful as well. The Impact Plot shows how the average failure value is calculated as a total of the individual Risk failure averages.

Note: This plot is not shown for the **Reliability** column in the **Elements** tab, the **Actions** tab, or the **Resources** tab.

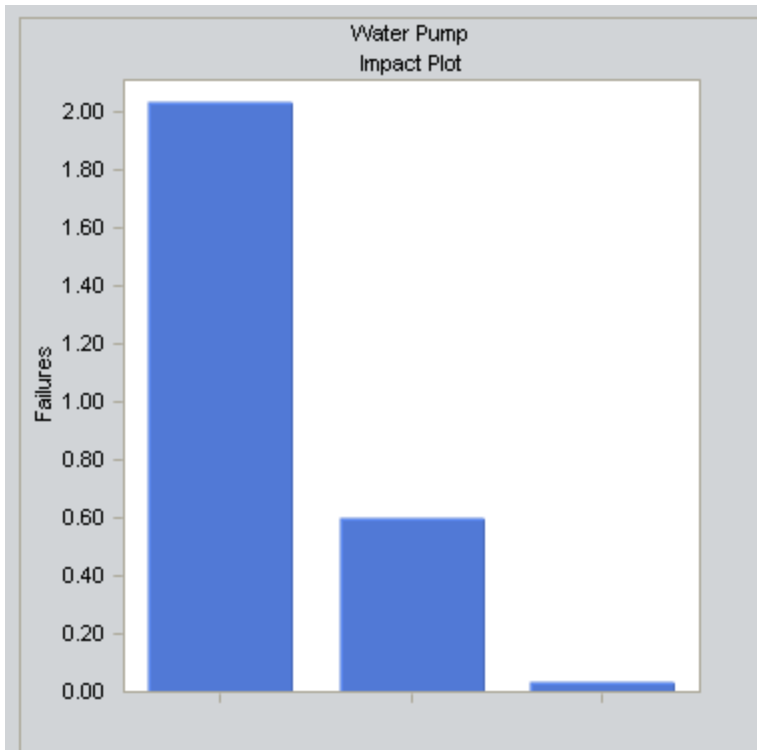

This image displays the Impact Plot for the Failures of the Water Pump in Scenario B of the [System Reliability Analysis Example](#). In this example, the information in the Failure column of the [Element grid](#) indicates that the Water Pump failed a total average of 2.67 times across all iterations for Scenario B. The Impact Plot breaks out the total number of failures according to the reason for the Water Pump failure:

- **Right bar:** Represents the Impeller Failure. This bar has a value of 2.03, indicating that the Water Pump failed as a result of an Impeller Failure 2.03 times.
- **Center bar:** Represents the Seal Failure. This bar has a value of 0.60, indicating that the Water Pump failed as a result of a Seal Failure .06 times.
- **Left bar:** Represents the Bearing Failure. This bar has a value of 0.04, indicating that the Water Pump failed as a result of a Bearing Failure 0.04 times.

The value in the grid represents the total of all failures for any reason, or the sum of all values in the Impact Plot, in this case 2.67.

Interpreting Simulation Results That Include Source and Additional Risks

The [results for a simulation](#) will appear differently depending upon whether or not the simulation includes source and additional Risks. It is important that you understand how to interpret simulation results that include source and additional Risks. When you set up a simulation to include source and additional Risks, you should keep in mind the information listed in this topic. This documentation assumes that you are familiar with System Risk records and their role in a System Reliability Analysis.

- If an unplanned correction causes a source Risk and any additional Risks to be reset, in the simulation results, the Failure associated with the unplanned correction of the source Risk will be attributed *only* to the source Risk.
- If a planned correction of a source Risk results in additional Risks being reset, in the simulation results, the following values will be attributed to each individual Risk:
 - Planned correction cost
 - Planned resource usages
 - Downtime

Downtime for each Risk will be calculated based upon the planned correction duration for that Risk.

- If an unplanned correction of a source Risk results in additional Risks being reset, in the simulation results, the following values will be attributed to each individual Risk:
 - Fixed unplanned correction cost
 - Variable unplanned correction cost
 - Unplanned resource usages
 - Downtime

Variable unplanned correction cost and downtime for each Risk will be calculated based upon the TTR distribution for that Risk.

- If planned or unplanned correction of a source Risk results in additional Risks being reset, in the simulation results, the Equipment or Functional Location record to which the System Risk records are linked will be populated with the *largest* downtime value of all the Risks (i.e. source and additional). For example, suppose that the following Risks are defined for a *Water Pump*:
 - A *Bearing failure* Risk that is a source Risk and whose downtime value is *1 day*.
 - A *Seal failure* Risk that is an additional Risk and whose downtime value is *2 days*.

In this case, when the *Bearing failure* Risk resets the *Seal failure* Risk, in the simulation results, a downtime value of *2 days* will be attributed to the *Water Pump*.

- If planned or unplanned correction has started for an additional Risk, and then, planned or unplanned correction starts for the source Risk that resets that additional Risk, the additional Risk will be reset only once, as a result of its own planned or unplanned correction. The additional Risk will not be reset two times as a result of its own planned or unplanned correction and the planned or unplanned correction of the source Risk. This will be reflected in the simulation results.

What is a Cost of Unreliability Analysis?

Performing a Cost of Unreliability Analysis allows you to calculate the cost of unreliable elements, systems, or units. A Cost of Unreliability Analysis uses cost and failure data to calculate the cost and impacts of forced shutdowns, caused by unscheduled maintenance, due to equipment failure. These costs results from causes such as:

- Unplanned labor.
- Production and disposal of unusable product.
- Purging the system of contaminated product.
- Cleanup or fines associated with spills or other environmental hazards.
- Lost Profit Opportunities (LPO).

Meridium APM Reliability presents cost figures using a normalized time period for every production unit. Different downtime intervals can be compared to determine their effect on maintenance and LPO costs. The Failure Data used for analysis can be viewed in a table and Cost of Unreliability graphs are provided for easy analysis and comparison.

The production system at a plant contains several kinds of production units. Each production unit consists of several types of equipment. In some business contexts, several units can be treated as a group. For a high-level business analysis of the cost of unreliability of your plant, perform a Cost of Unreliability Analysis on the basis of production unit failures and downtime.

Based on these results, you can narrow your focus and perform a Cost of Unreliability Analysis on group of equipment or locations to determine if patterns exist that indicate specific failure causes or specific elements with reliability problems (i.e., the bad actors).

Cost of Unreliability Analyses results also include MTBF trends. MTBF is a simple statistic that characterizes the overall reliability of a piece of equipment or location or a population of equipment or locations. A MTBF trend analysis shows the MTBF for a selected population of equipment or locations over time.

Data Used in a Cost of Unreliability Analysis

The following table shows the possible data for Cost of Unreliability Analyses in Meridium APM.

Data Needed	Description	Notes
Production Unit or Asset ID	The ID of the production unit, piece of equipment, or location.	This is a required field.
Installation Date	The date on which the piece of equipment or location was installed.	This field is optional.
Failure Date	The last date on which the piece of equipment or location failed. This date can have many different descriptions such as Out of Service Date, Shutdown Date, or Failure Date.	This is a required field.
Downtime	If this information is available, it can be used to make the estimation more accurate. "Return to service date" or "date repaired" can be used to estimate downtime.	This field is optional.
Time Units	The time units used to measure the downtime.	This field is optional.
Maintenance Cost	The cost of fixing the equipment after a failure occurs, including both the labor and the material costs.	This field is optional.
Lost Profit Opportunity	The profit that the company lost when it could not supply product to meet customer demand.	This field is optional.

Accessing the List of Cost of Unreliability Analyses

To view a list of existing Cost of Unreliability Analyses:

- On the **Reliability Start Screen**, click the **Unreliability Cost Analysis** link.

The **Select a Cost of Unreliability Analysis** page appears.

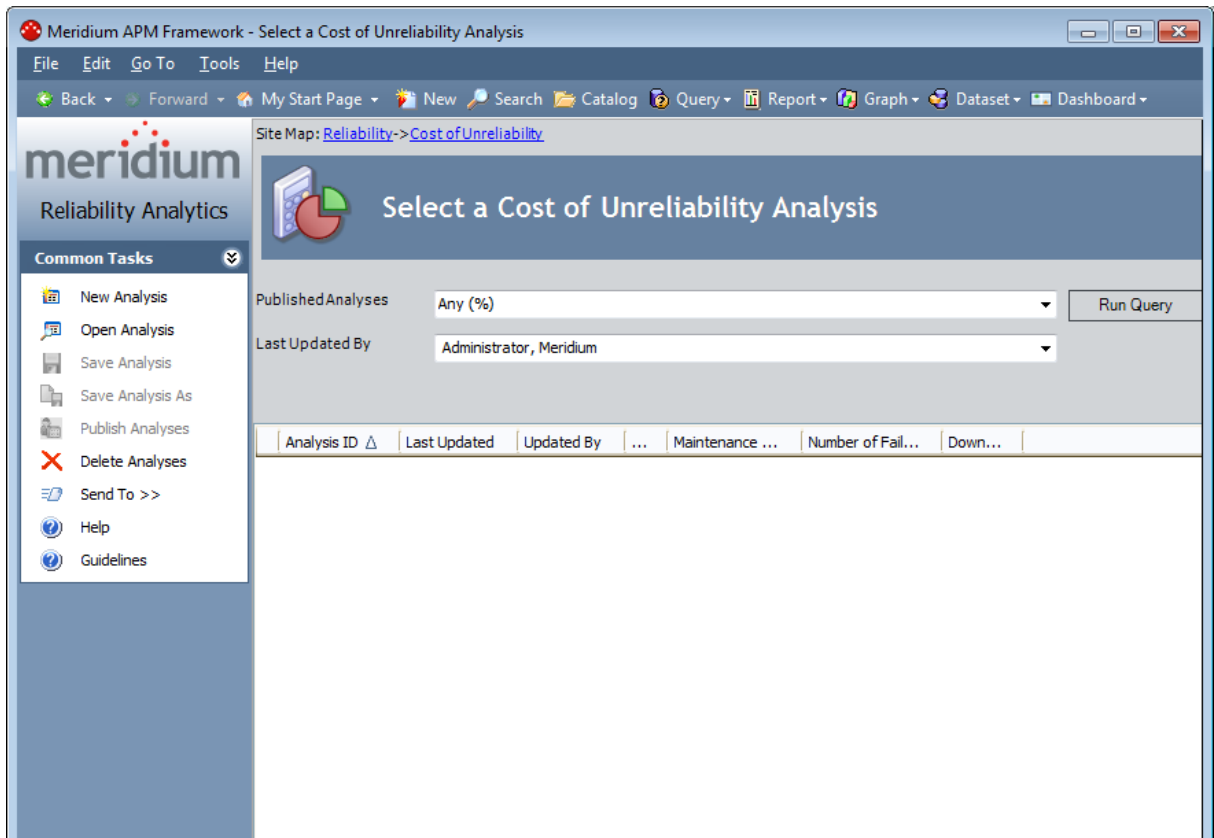

From this page, you can run the Unreliability Cost query to retrieve a list of Cost of Unreliability Analyses that exist in the database. From the list of analyses, you can access the analysis summary for any analysis. Alternatively, you can click the **New Analysis** link on the [Common Tasks menu](#) to begin the process of [creating a new analysis](#).

Aspects of the Cost of Unreliability List Page

The [Select a Cost of Unreliability Analysis page](#) lets you run the Unreliability Cost query to access a list of existing Cost of Unreliability Analyses that meet your query criteria.

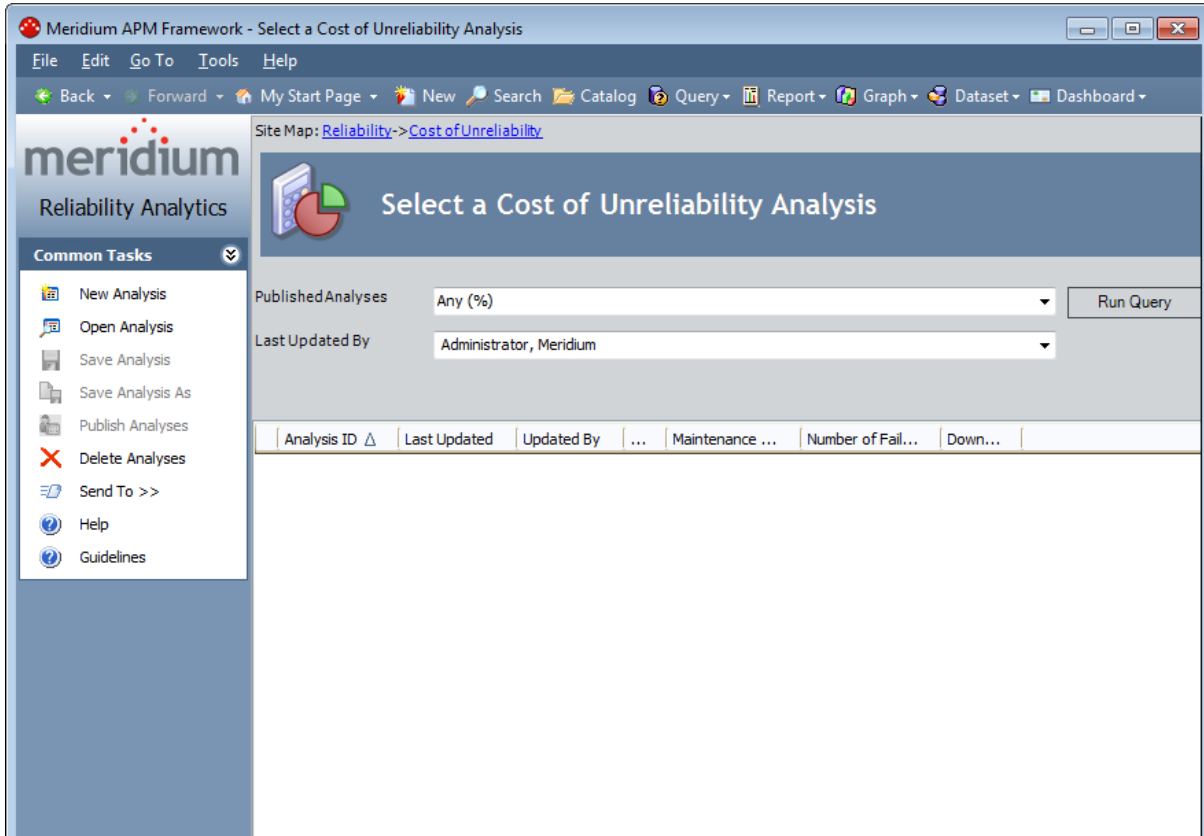

The Unreliability Cost query is stored in the Meridium APM Catalog folder \\Public\Meridium\Modules\Reliability Manager\Analyses. While the Unreliability Cost query can be [customized](#) for your specific implementation, the baseline Unreliability Cost query contains two prompts: **Published Analyses** and **Last Updated By**. These prompts appear at the top of the page as drop-down lists that contain various options.

The **Published Analyses** list contains the following options:

- **Any (%):** Will cause the query to return all Cost of Unreliability Analyses, either published or unpublished.
- **Yes (Y):** Will cause the query to return only published Cost of Unreliability Analyses.
- **No (N):** Will cause the query to return only unpublished Cost of Unreliability Analyses.

The **Last Updated By** list contains the following options:

- Your user name, which is selected by default and will cause the query to return only the Cost of Unreliability Analyses that were last updated by you.
- The user name of any user who last updated any Cost of Unreliability Analysis, which will cause the query to return only the Cost of Unreliability Analyses that were last updated by that user.
- The **[All Users]** option, which will cause the query to return a list of Cost of Unreliability Analyses updated by any user.

Each time you access the **Select a Cost of Unreliability Analysis from the List** page, the values that appear by default in the prompts will be used to filter the list. After you select different criteria, you can click the **Run Query** button to run the Unreliability Cost query and display the results in a grid at the bottom of the page.

Note: Although the results are returned by the Unreliability Cost query, query page size is ignored. The entire list of analyses is displayed at once.

The default Unreliability Cost query is configured to display the following columns of information: **Analysis ID**, **Last Updated** (date), **Updated By**, **LPO**, **Downtime**, **Number of Failures**, and **Maintenance Cost**. You can click any hyperlinked Analysis ID to open the associated analysis on the [Cost of Unreliability Analysis summary page](#). In addition, you can use the options on the [Common Tasks menu](#) to perform various tasks for the analyses in the list.

CEHint: If desired, you can customize the column display.

Common Tasks Menu

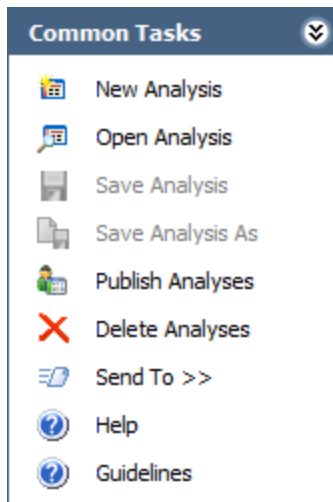

The **Common Tasks** menu on the **Select a Cost of Unreliability Analysis from the List** page contains the following links:

- **New Analysis:** Displays the [Cost of Unreliability Builder](#) to guide you through the process of creating a new Cost of Unreliability Analysis.
- **Open Analysis:** Displays the **Find Cost of Unreliability Analysis** window, where you can find and open an existing analysis.
- **Publish Analyses:** [Publishes](#) the selected analysis or analyses. If you select one or more analyses that are already published, this link reads **Unpublish Analyses** and will [unpublish](#) the selected analysis.
- **Delete Analysis:** After asking for confirmation, [deletes the analysis](#) or analyses selected in the list.
- **Send To:** Displays a submenu with options that let you provide a link to the current page on your desktop (create shortcut), in an email message, or on a Home Page.
- **Help:** Displays the context-sensitive Help topic for the **Select a Cost of Unreliability Analysis** page.
- **Guidelines:** Displays the Reliability Concepts, which provide reliability workflows and descriptions of reliability concepts.

Note: The **Save Analysis** and **Save Analysis As** options are always disabled on the **Select a Cost of Unreliability Analysis** page.

Using the Cost of Unreliability Builder

Using the **Cost of Unreliability Builder**, you can create a new Cost of Unreliability Analysis:

- [Based on a new or existing query or dataset.](#)
- [By manually entering data.](#)

You can access the Cost of Unreliability Builder from either the [Select a Cost of Unreliability Analysis](#) page or the [Cost of Unreliability Analysis](#) summary page.

Creating a Cost of Unreliability Analysis from a Query or Dataset

To create a Cost of Unreliability Analysis based on a query or dataset:

1. On the [Select a Cost of Unreliability](#) page or on the [Cost of Unreliability Analysis summary page](#), on the **Common Tasks** menu, click the **New Analysis** link.

The **Cost of Unreliability Builder** appears, displaying the **Welcome** screen.

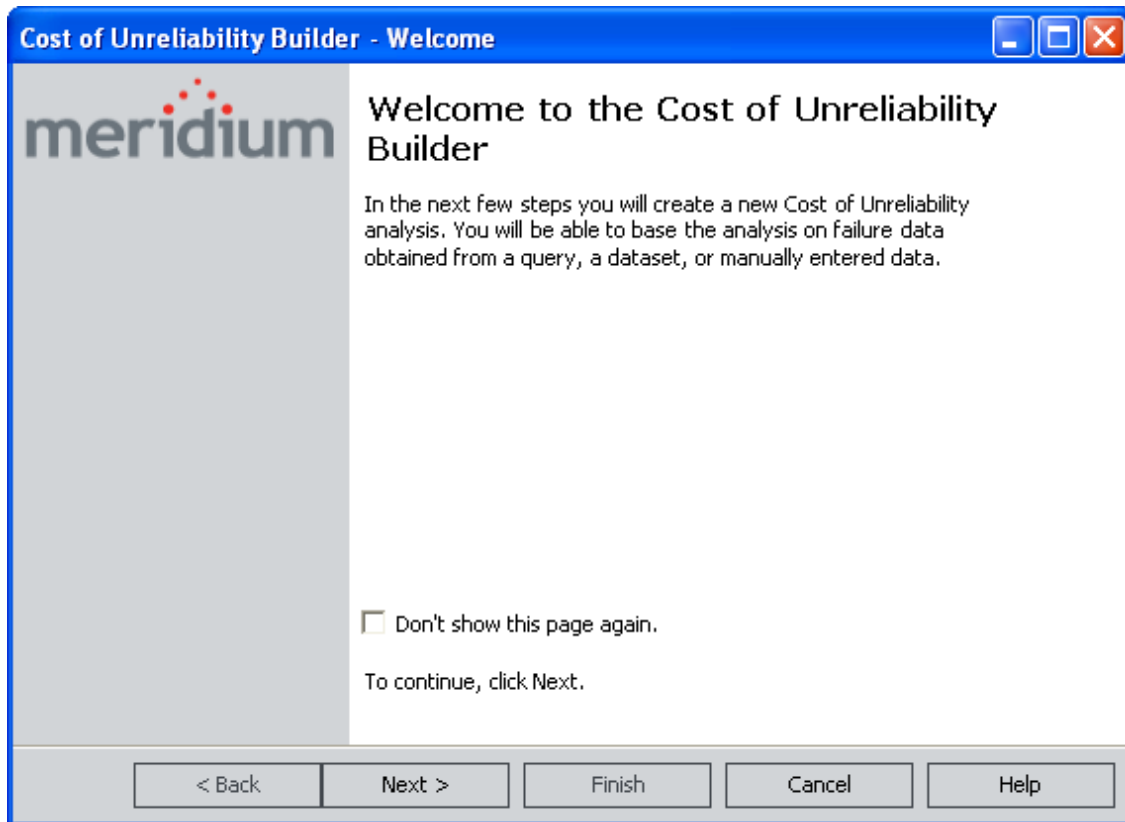

OEHint: Select the **Don't show this page again** check box to skip the **Welcome** screen in the future.

2. Click the **Next** button.

The **Select Data Source Type** screen appears.

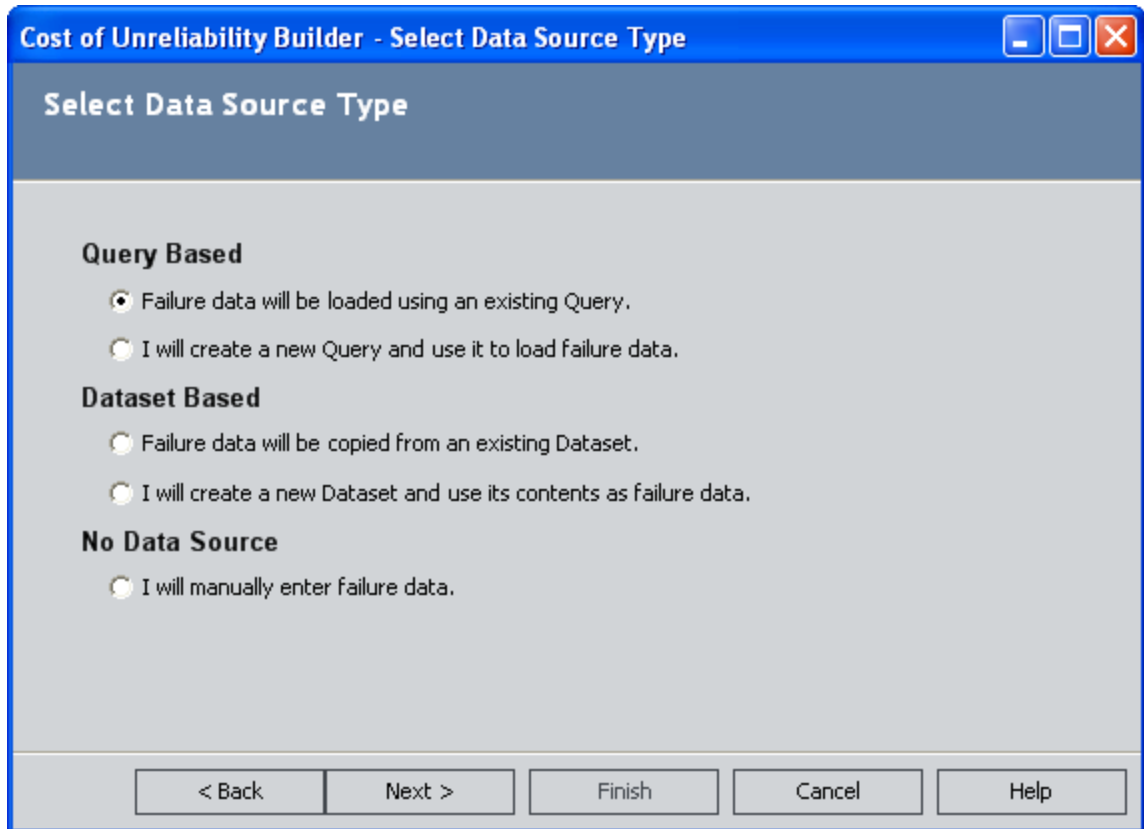

3. Select one of the following options:

- **Failure data will be loaded using an existing Query.** If you select this option, when you click the **Next** button, you will be asked to find and select the desired query in the Catalog.
- **I will create a new Query and use it to load the failure data.** If you select this option, when you click the **Next** button, the Query Builder will appear so that you can design a new query. Click the **Help** button in the Query Builder for details on building a new query.
- **Failure data will be copied from an existing Dataset.** If you select this option, when you click the **Next** button, you will be asked to find and select the desired dataset in the Catalog. Note that if the dataset you choose was created from a query that included installation, failure dates, or TTF data you will not be able to select either of those columns in the analysis. To avoid this problem, run the query in unformatted mode and then export to a dataset.
- **I will create a new Dataset and use it to load the failure data.** If you select this option, when you click the **Next** button, the Dataset Builder will appear so that you can design a new dataset. Click the **Help** button in the Dataset Builder for details on building a new dataset.

After you have selected or created the desired query or dataset, it appears on the **Select** screen of the **Cost of Unreliability Builder**.

4. Click the **Next** button.

The **Select Failure Fields** screen appears.

The screenshot shows a dialog box titled "Cost of Unreliability Builder - Select Failure Fields". The dialog has a blue title bar with standard window controls (minimize, maximize, close). The main content area is light gray and contains three dropdown menus. The first dropdown is labeled "Unit ID:" and has "Asset ID" selected. The second dropdown is labeled "Installation Date:" and is empty. The third dropdown is labeled "Failure Date:" and has "Installation Date" selected. At the bottom of the dialog, there are five buttons: "< Back", "Next >", "Finish", "Cancel", and "Help".

5. Select the desired fields:

- **Unit ID:** The name of the field that contains the IDs of the failed entities. This field is required and must be a text field.
- **Installation Date:** The field that contains the **Installation Date**, which is the date when the piece of equipment was installed.
- **Failure Date:** The field that contains the **Failure Date**, which is the date on which the failure events occurred (for example, the Out of Service date).

6. Click the **Next** button if you have downtime information you want to include in the analysis.

The **Provide Information for Downtime** screen appears.

The screenshot shows a dialog box titled "Cost of Unreliability Builder - Provide Information for Downtime". The main heading inside the dialog is "Provide Information for Downtime". There are two dropdown menus: "Downtime Field:" with "Downtime" selected, and "Time Units:" with "Days" selected. At the bottom of the dialog, there are five buttons: "< Back", "Next >", "Finish", "Cancel", and "Help".

7. In the **DowntimeField** list, select the appropriate field (e.g., Total Time to Repair).
8. In the **Time Units** list, select the time units for the downtime (e.g., Hours, Weeks, Months, Quarter, or Years).
9. Click the **Next** button if you want to provide information on cost.

The **Provide Information on Cost** screen appears.

Cost of Unreliability Builder - Provide Information on Cost

Provide Information on Cost

Maintenance Cost: [Dropdown]

Lost Profit Opportunity: [Dropdown]

Currency: \$ [Text Field]

< Back Next > Finish Cancel Help

10. You can generate an analysis without completing the optional fields on this screen, but you should include any available cost data in your analysis. Select the following fields from the data source that contain cost information:
 - **Maintenance Cost:** The cost of fixing the equipment after a failure occurs. Maintenance costs represents both the labor and the material costs
 - **LPO:** The profit that the company loses when it cannot supply product to meet customer demand. If customer demand can be met by supplying product from reserves, LPO would represent any profit loss attributable to higher costs to produce reserves over costs to produce current production (had production not been interrupted.) If delivery of the product is simply delayed, LPO represents any loss of revenue attributable to change in market prices during the delay or price discounts offered to keep the order.
 - **Currency:** The type of currency in which the cost data will be presented. Meridium APM automatically populates this field based on the regional settings of your computer. After you create the analysis, you can change the currency type that appears in the results listed on the summary page and on the axis labels of the plots.
11. Click the **Finish** button.

Meridium APM validates the field mappings and generates the analysis displaying the summary page with the results of the analysis.
12. On the **Common Tasks** menu, click the **Save Analysis** link to save the analysis.

Creating a Cost of Unreliability Analysis from Manually Entered Data

To enter the failure data manually for the Cost of Unreliability Analysis:

1. On the [Select a Cost of Unreliability](#) page or on the [Cost of Unreliability Analysis summary page](#), on the **Common Tasks** menu, click the **New Analysis** link.

The **Cost of Unreliability Builder** appears, displaying the Welcome screen.

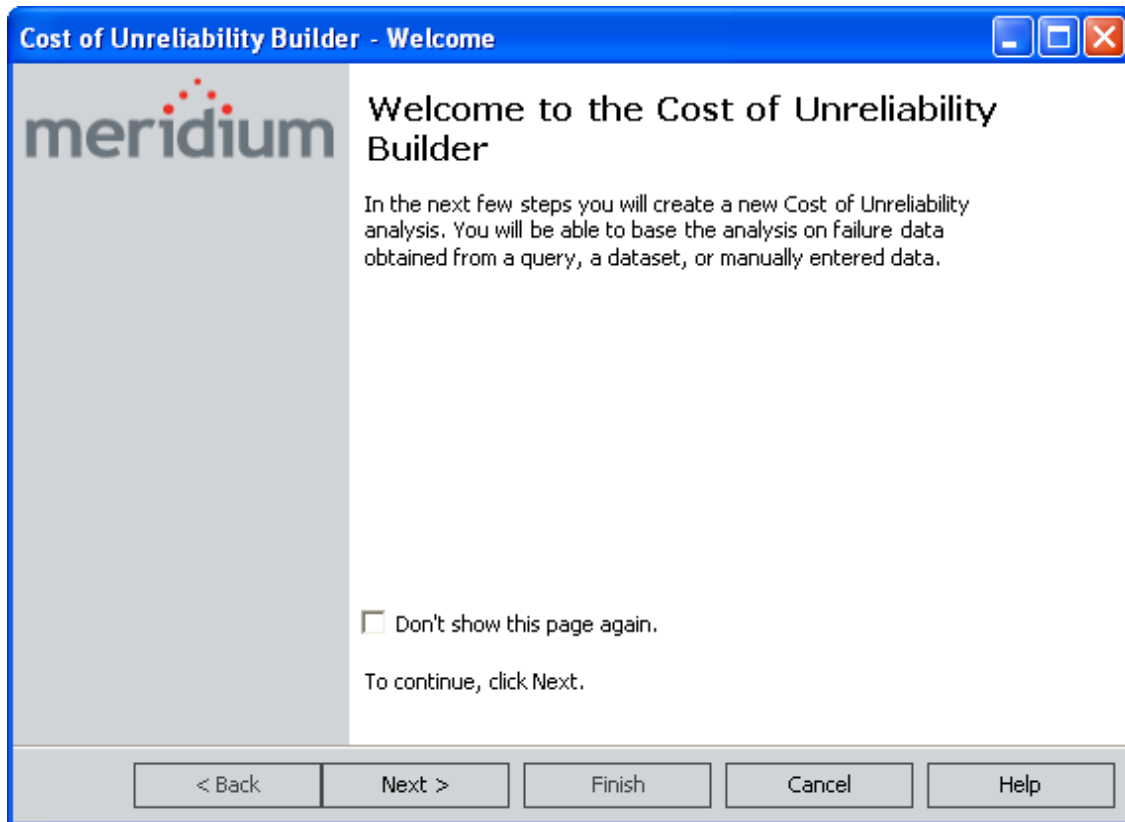

OEHint: If you do not want to view this screen the next time that you access the builder, select the **Don't show this page again** check box.

2. Click the **Next** button.

The **Select Data Source Type** screen appears.

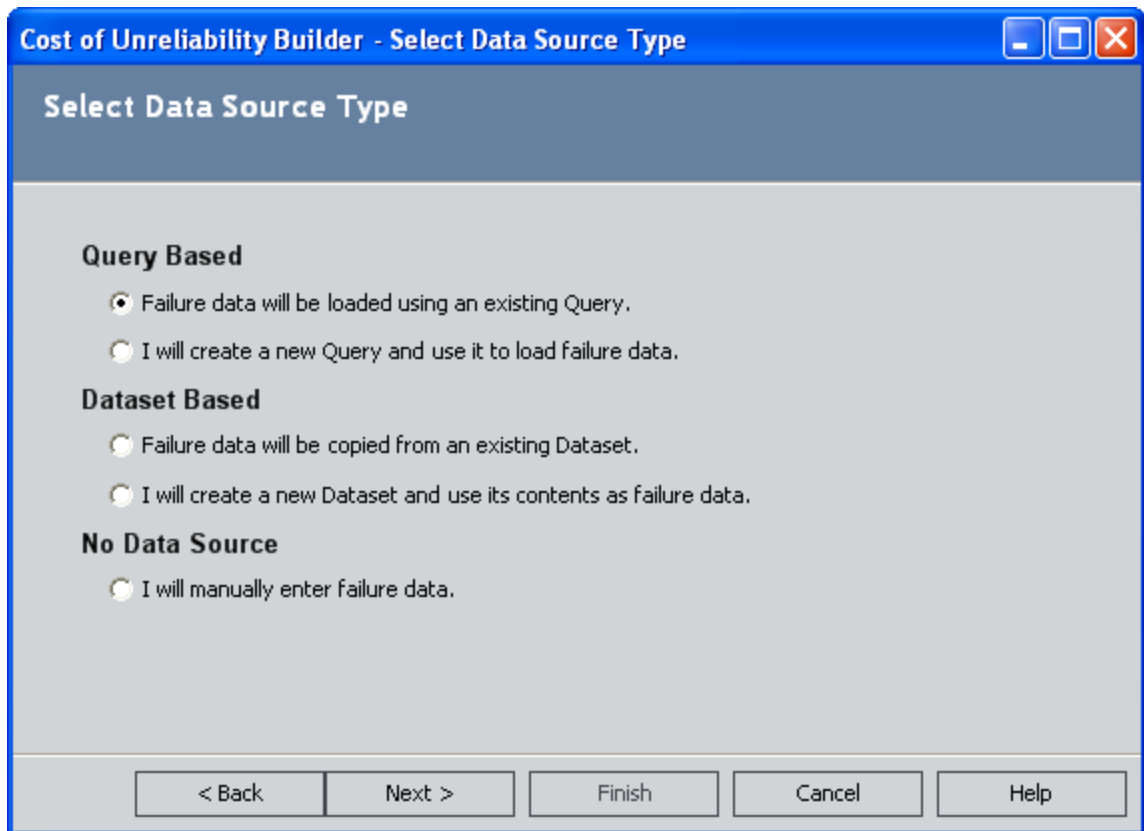

3. Click the **I will manually enter failure data** option, and then click the **Finish** button. The **Cost of Unreliability Builder** closes, and the **Failure Data** grid appears.

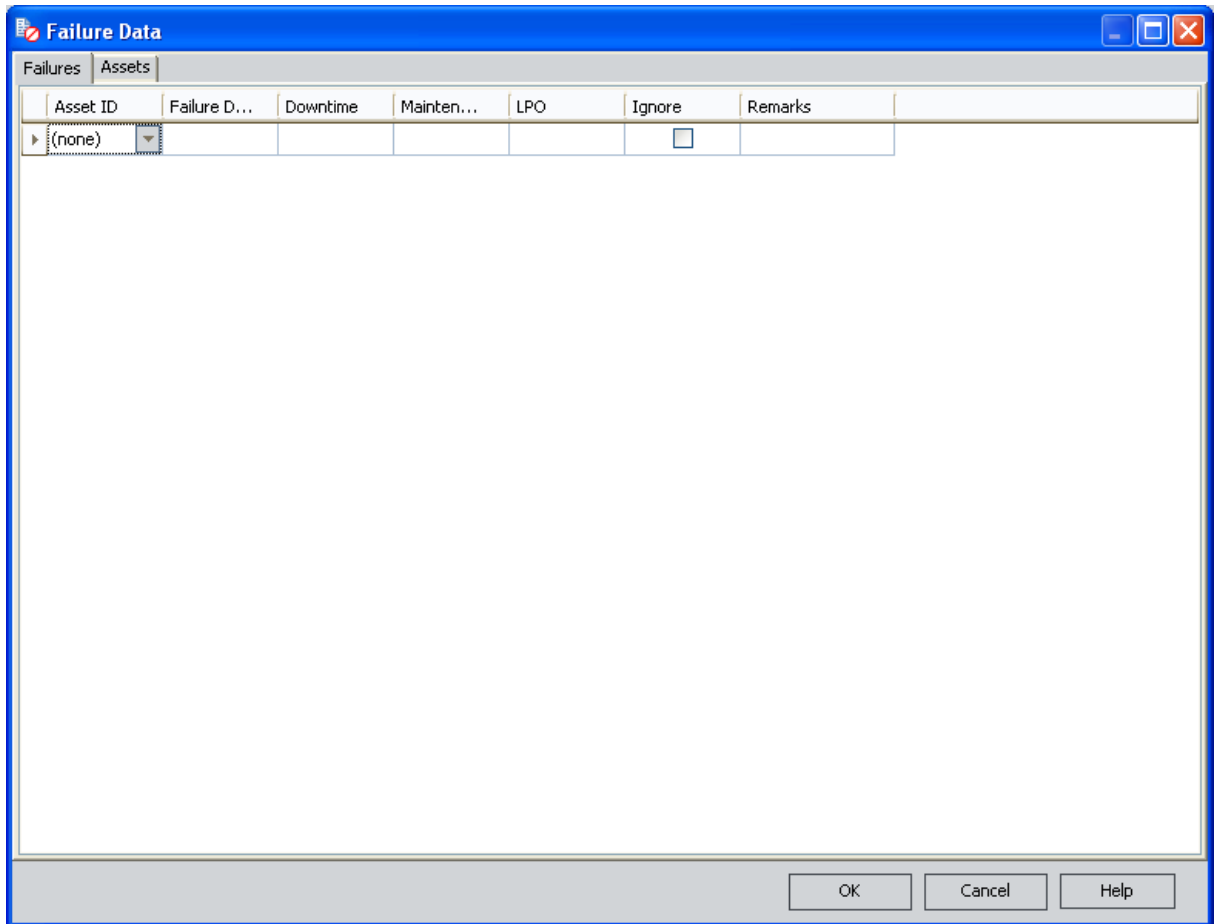

4. Enter the desired data on the [Failure Data grid](#). To enter data, you can manually type the data in the cells or you can use the clipboard operations (cut, copy, paste) to transfer data to the grid from other applications.
5. Click **OK** to save the data and generate the analysis. Note that a minimum of three failure data points is required to perform a calculation; otherwise, a warning message appears and the analysis will not be generated.

The **Failure Data** grid closes. Preferences are retained for the changes that you made to the grid, including the addition and deletion of rows, resized columns, grouped columns, and any sorting. Meridium APM generates the analysis and displays the summary page.

6. On the [Common Tasks menu](#), click the **Save Analysis** link to save the analysis.

Note: If any of the Installation dates specified on the **Assets** tab occur *after* any of the failure dates on the **Failures** tab, an error message appears explaining that "the value specified for MI_RELI_COST_MTBF_NBR is an undefined numeric value."

Accessing the Cost of Unreliability Analysis Summary Page

To access the Cost of Unreliability Analysis summary:

1. On the **Reliability Start Screen**, click the **Unreliability Cost Analysis** link.

The [Select a Cost of Unreliability Analysis page](#) appears.

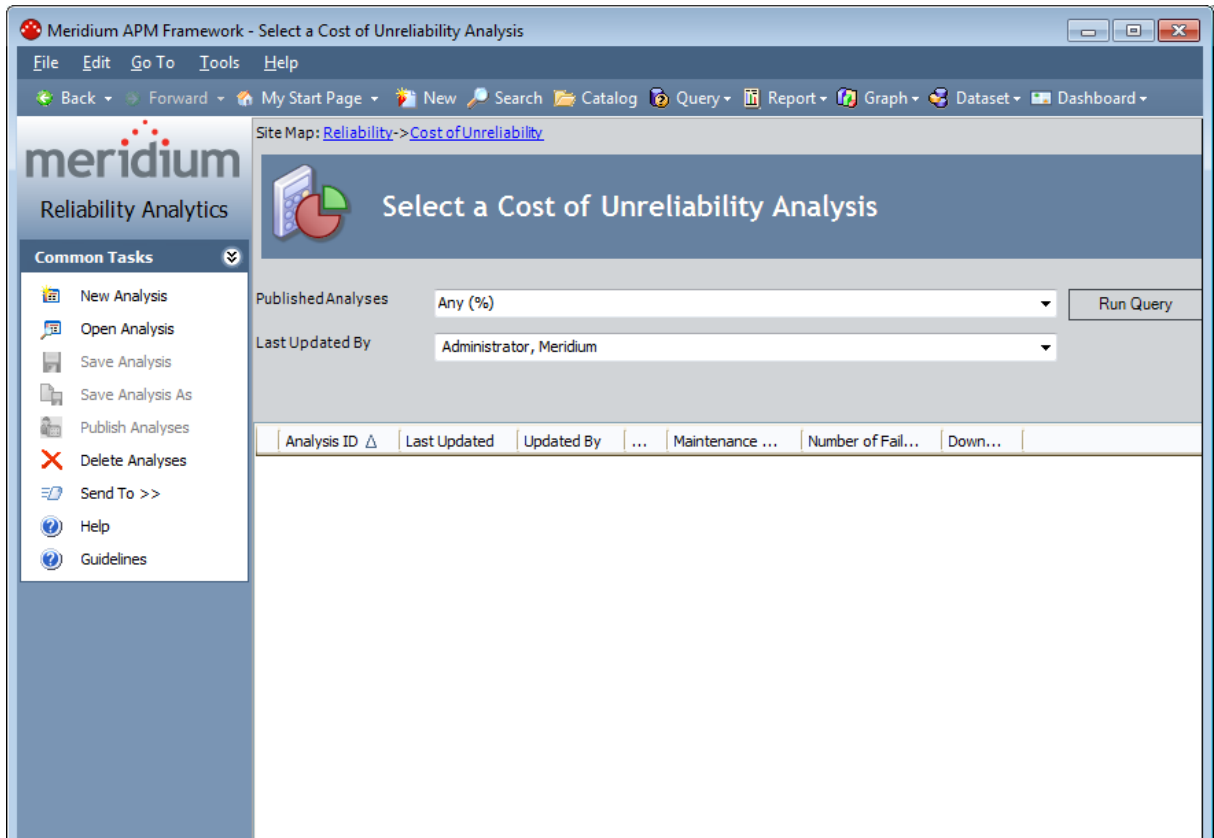

2. At the top of the page, in the fields provided, select the criteria that you want to use for limiting the list of Cost of Unreliability Analyses. The available criteria will vary, depending on how the Unreliability Cost query has been configured.

3. Click the **Run Query** button.

Meridium APM runs the Unreliability Cost query and displays the results in the grid at the bottom of the page.

4. In the results list, click the hyperlinked Analysis ID of the analysis that you want to open.

The **Cost of Unreliability Analysis** page appears, displaying the analysis summary for the analysis that you selected.

Note:When you open an existing analysis, the analysis will display the data and calculations that were last [saved](#) with the analysis. If you want to reload the underlying query or dataset and update calculations based on any changes to the underlying data, you must [reload the analysis](#) after opening it.

Overview of the Cost of Unreliability Analysis Summary

The **Cost of Unreliability Analysis** page displays summary information about the Cost of Unreliability Analysis. The information is divided into three sections:

- [Analysis Information](#)
- [Summary Results](#)
- [Analysis Options](#)

In addition, the **Cost of Unreliability Analysis** summary page contains three task menus: [Plot](#), [Analysis Tasks](#), and [Common Tasks](#).

Analysis Information Section

Analysis Information	
Analysis Name:	New Analysis 1 Rename
Description:	

The **Analysis Information** section contains information that identifies the current analysis, including the following:

- **Analysis Name:** The ID of the analysis.
- **Description:** The description of the analysis as defined when the analysis was saved. You can click the **Rename** link in this section or on the **Current Analysis** menu if you want to change either the name or the description of the analysis.
- **Rename:** Displays the **Rename Analysis** dialog box, where you can [rename the analysis](#).

Summary Results Section

The **Summary Results** section provides a summary of the results of the current analysis.

Summary Results	
Number of Units:	3
Number of Failures:	32
Maintenance Cost:	0.00 \$/Year
LPO:	0.00 \$/Year
Total Cost:	0.00 \$/Year
Availability:	86.5168 %
MTBF:	192.39 Days
MTTR:	12.50 Days
Downtime:	49.25 Days/Year

It includes the following information:

- **Number of Units:** The number of production units included in the analysis.
- **Number of Failures:** The number of failure events that occurred in the units being analyzed.
- **Maintenance Cost:** The total maintenance cost due to the failures.
- **LPO:** Lost Profit Opportunity represents the profit that the company loses when it cannot supply product to meet customer demand. If customer demand can be met by supplying product from reserves, LPO would be any profit loss attributable to higher costs to produce reserves over costs to produce current production (had production not been interrupted). If delivery of the product is delayed, LPO recognizes any loss of revenue attributable to change in market prices during the delay or price discounts offered to keep the order.
- **Total Cost:** The total cost associated with the failure event (includes parts, labor, or LPO).
- **Availability:** The percentage of the time that the unit(s) are productive.
- **MTBF:** The Mean Time Between Failures for the units being analyzed.
- **MTTR:** The Mean Time to Repair is the average amount of time that it takes to restart the production units(s) after a failure occurs.
- **Downtime:** The amount of time that an item is not available for use for any reason.

Note: You can [change the currency](#) that is displayed for the cost fields on the **Cost of Unreliability Analysis** summary page.

Analysis Options Section

The **Analysis Options** section contains the settings that were used to calculate the current analysis.

Analysis Options		Change
Analysis Period:	The analysis covers the period from 3/9/1990 to 2/14/2011.	
Reporting Period:	Pareto charts will be presenting Yearly results.	
Trend Frequency:	Trends will be presented using a Monthly basis.	
MTBF Calculation:	The MTBF is calculated using data from 1 Year.	

It includes the following information:

- **Analysis Period:** The start and end dates of the analysis. You can change the analysis period.
- **Reporting Period:** The interval in which results are calculated and presented for the pareto charts. You can [change the reporting period](#).
- **Trend Frequency:** The interval in which results are calculated and presented for the trends. You can [change the trend frequency](#).
- **MTBF Calculation:** Displays the time units used to calculate MTBF. You can [specify the length of the MTBF Period](#).
- **Change:** Displays the **Unit of Measure** dialog box, where you can specify units of measure.

Note: To view the failure data for the analysis, click the **Failure Data** link on the **Current Analysis** menu.

Plot Menu

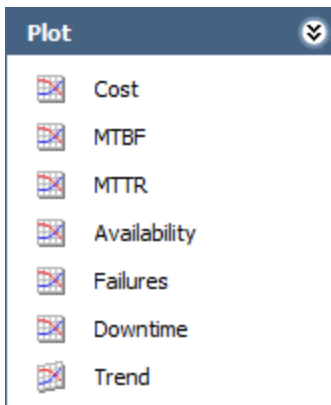

The **Plot** menu on the **Cost of Unreliability Analysis** page contains the following links:

- **Cost:** Displays the [Total Cost Pareto Chart](#) for the selected analysis.
- **MTBF:** Displays the [Mean Time Between Failures Pareto Chart](#) for the selected analysis.
- **MTTR:** Displays the [Mean Time to Repair Pareto Chart](#) for the selected analysis.
- **Availability:** Displays the [Availability Pareto Chart](#) for the selected analysis.
- **Failures:** Displays the [Number of Failures Pareto Chart](#) for the selected analysis.
- **Downtime:** Displays the [Downtime Pareto Chart](#) for the selected analysis.
- **Trend:** Displays the **Trend Builder**, which will walk you through the steps to [building a Trend Plot](#).

Plot Options Menu

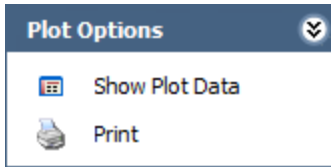

The **Plot Options** menu on the **Cost of Unreliability Analysis** page contains the following links:

- **Show Plot Data:** Displays the [Plot Data page](#), which contains the numeric data on which a given plot is based.
- **Print:** Displays the **Print** screen to print the **Total Cost Pareto Chart**.

Note: The **Plot Options** menu only appears on the **Total Cost Pareto Charts** screen.

Analysis Tasks Menu

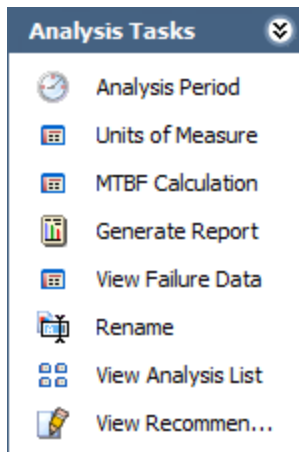

The **Analysis Tasks** menu on the **Cost of Unreliability Analysis** page contains the following links:

- **Analysis Period:** Displays the Analysis Period dialog box, where you can [change the Start Date and End Date of the analysis period](#).
- **Units of Measure:** Displays the **Units of Measure** dialog box where you can [specify the units](#) for the reporting period, trend frequency, MTBF, Downtime, and the currency.
- **MTBF Calculation Options:** Displays the **MTBF Calculation Options** dialog box, where you can [select the MTBF period units and period length](#).
- **Generate Report:** Displays the **Report Options** dialog box, where you can select the elements of the analysis that you want to include in a report.

Note: You must save the analysis before you can generate a report.

- **View Data Source:** Displays the data that serves as the source of the analysis. This link appears only if the analysis is based on a query or a dataset.
 - If the analysis is based on a query, this link will open the query results.
 - If the analysis is based on a dataset, this link will open the dataset.
- **Reload Data:** [Reloads the data](#) stored in the database. This link appears only if the analysis is based on a query or a dataset.
- **View Failure Data:** Displays the [Failure Data grid](#).
- **Rename:** Displays the **Rename Analysis** dialog box, where you can [change the name and description of the analysis](#). Note that a **Rename** link is also available in the **Analysis Information** section on the summary page.
- **View Analysis List:** Displays the [Select a Cost of Unreliability Analysis page](#), where you can view the list of existing Cost of Unreliability analyses.
- **View Recommendations:** Displays the [Recommendations page](#), where you can view and manage the Recommendation records associated with the analysis.

Common Tasks Menu

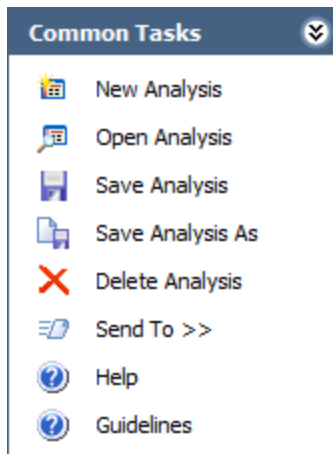

The **Common Tasks** menu on the **Cost of Unreliability Analysis** page contains the following links:

- **New Analysis:** Displays the [Cost of Unreliability Builder](#), which will guide you through the process of creating a new Cost of Unreliability Analysis.
- **Open Analysis:** Lets you locate an existing Cost of Unreliability analysis using the **Find Cost of Unreliability Analysis** window.
- **Save Analysis:** Saves the currently displayed analysis. If you are viewing a brand new analysis that has not yet been saved, this link will display the **Save Analysis** dialog box, where you can [save the analysis](#). If you are viewing an existing analysis, when you click this link, Meridium APM will save any changes that you made to the analysis since it was last saved.
- **Save Analysis As:** Displays the **Save this Analysis** dialog box, where you can choose to [save it with a different name](#).
- **Delete Analysis:** Deletes the currently displayed analysis.
- **Send To:** Displays a submenu with options that let you provide a link to the current page on your desktop (create shortcut), in an email message, or on a Home Page.
- **Help:** Displays the context-sensitive Help topic for the **Cost of Unreliability Analysis** summary page.
- **Guidelines:** Displays the Reliability Concepts, which provide reliability workflows and descriptions of reliability concepts.

About the Failure Data Window

The [Failure Data window](#) allows you to view the data associated with a Cost of Unreliability Analysis. Most of the fields on the **Failure Data** window correspond to [values that were used to create the analysis](#). For input fields:

- For an analysis based upon a query, the **Failure Data** window displays the information returned by the query.
- For an analysis based upon a dataset, the **Failure Data** window displays the information stored in the dataset.
- For an analysis based upon manually-entered data, the **Failure Data** window displays the information that you entered when you create the analysis.

Other fields show values that are calculated by the Meridium APM system and are read-only. All values in the **Failure Data** window are stored in the Failures field in the Unreliability Cost record.

You can modify certain values on this window in order to update data. In most cases, however, you would not want to change the data unless there was an error in the original data source. Some values are calculated by the Meridium APM system and cannot be modified.

The following image shows an example of the **Failure Data** window.

About the Failure Data Window

Asset ID	Failure Date Δ	Downtime	Maintenance Cost	LPO	Ignore	Remarks
PMP-5705	2/1/1990	9	2020.20990042144	332.0143467081	<input type="checkbox"/>	
PMP-5701	2/20/1990	9.3	1298.52692977848	19333.4427061766	<input type="checkbox"/>	
PMP-5705	3/7/1990	6.9	2594.70203893168	21279.2490206692	<input type="checkbox"/>	
PMP-5701	7/4/1990	1.1	4946.24735445916	34307.1673602369	<input type="checkbox"/>	
PMP-5705	7/25/1990	7.2	4681.99434802873	44070.9819919655	<input type="checkbox"/>	
PMP-5701	8/27/1990	1.5	9208.53814340028	41256.9948870403	<input type="checkbox"/>	
PMP-5705	9/19/1990	6.6	3979.76199014252	31680.4930936872	<input type="checkbox"/>	
PMP-5701	11/17/1990	3.9	9166.37633410612	45513.1356228871	<input type="checkbox"/>	
PMP-5705	11/27/1990	8.9	7355.77518969623	44689.0231023271	<input type="checkbox"/>	
PMP-5705	1/18/1991	4.5	3181.40800669455	1462.2379548532	<input type="checkbox"/>	
PMP-5701	2/17/1991	9.6	5095.24725617142	45071.3023737928	<input type="checkbox"/>	
PMP-5705	3/28/1991	0.9	6721.30374715849	21205.3046131296	<input type="checkbox"/>	
PMP-5705	5/29/1991	5.8	2037.3708435215	17862.9555460439	<input type="checkbox"/>	
PMP-5705	6/20/1991	9.4	1132.32422469399	42652.7676968302	<input type="checkbox"/>	
PMP-5701	7/4/1991	9.2	2536.57285953918	5826.9630186398	<input type="checkbox"/>	
PMP-5701	8/14/1991	1.7	3795.32353427688	37170.1560613366	<input type="checkbox"/>	
PMP-5705	10/9/1991	6.5	2669.48071969945	3397.9005692467	<input type="checkbox"/>	
PMP-5701	11/24/1991	1.2	5985.70013328063	8669.0283870865	<input type="checkbox"/>	
PMP-5705	12/28/1991	4.2	9083.41816832789	31347.8405722019	<input type="checkbox"/>	
PMP-5705	4/2/1992	8.9	363.10114818869	27708.6095949843	<input type="checkbox"/>	
PMP-5701	4/8/1992	1	7674.27894908138	49094.1395769235	<input type="checkbox"/>	
PMP-5701	4/14/1992	9.2	1206.82892822292	14111.134965814	<input type="checkbox"/>	
PMP-5705	5/16/1992	8.2	8129.64636107317	36821.1823407153	<input type="checkbox"/>	

Data Mapped to the Failure Data Window

When you create a Cost of Unreliability Analysis from a query or dataset, the **Cost of Unreliability Builder** will prompt you to map values from columns in the query or dataset to certain values in the Cost of Unreliability Analysis. The values that you select to map on the **Select Failure Fields**, **Provide Information For Downtime**, and **Provide Information on Cost** screens in the **Cost of Unreliability Builder** will then appear in the associated columns in the **Failure Data** window.

Note: If the analysis is based on a query or a dataset and contains additional columns that are not mapped to columns in the analysis dataset, those columns will appear in the **Failure Data** window with the column name in parentheses.

The following chart displays which columns are mapped from fields in the **Cost of Unreliability Builder** to columns in the **Failure Data** window.

Cost of Unreliability Builder Screen	Cost of Unreliability Builder Field	Failure Data Window Tab	Failure Data Window Column
Select Failure Fields	Unit ID	Failures, Assets	Asset ID
Select Failure Fields	Failure Date	Failures	Failure Date
Provide Information for Downtime	Downtime Field	Failures	Downtime
Provide Information on Cost	Maintenance Cost	Failures	Maintenance Cost
Provide Information on Cost	Lost Profit Opportunity	Failures	LPO
Select Failure Fields	Installation Date	Assets	Installation Date

Accessing the Failure Data for a Cost of Unreliability Analysis

To access the failure data on the Failure Data grid:

- On the [Cost of Unreliability Analysis summary page](#), on the [Analysis Tasks menu](#), click the **Failure Data** link.

The **Failure Data** window appears.

Asset ID	Failure Date	Downtime	Maintenance Cost	LPO	Ignore	Remarks
PMP-5705	2/1/1990	9	2020.20990042144	332.0143467081	<input type="checkbox"/>	
PMP-5701	2/20/1990	9.3	1298.52692977848	19333.4427061766	<input type="checkbox"/>	
PMP-5705	3/7/1990	6.9	2594.70203893168	21279.2490206692	<input type="checkbox"/>	
PMP-5701	7/4/1990	1.1	4946.24735445916	34307.1673602369	<input type="checkbox"/>	
PMP-5705	7/25/1990	7.2	4681.99434802873	44070.9819919655	<input type="checkbox"/>	
PMP-5701	8/27/1990	1.5	9208.53814340028	41256.9948870403	<input type="checkbox"/>	
PMP-5705	9/19/1990	6.6	3979.76199014252	31680.4930936872	<input type="checkbox"/>	
PMP-5701	11/17/1990	3.9	9166.37633410612	45513.1356228871	<input type="checkbox"/>	
PMP-5705	11/27/1990	8.9	7355.77518969623	44689.0231023271	<input type="checkbox"/>	
PMP-5705	1/18/1991	4.5	3181.40800669455	1462.2379548532	<input type="checkbox"/>	
PMP-5701	2/17/1991	9.6	5095.24725617142	45071.3023737928	<input type="checkbox"/>	
PMP-5705	3/28/1991	0.9	6721.30374715849	21205.3046131296	<input type="checkbox"/>	
PMP-5705	5/29/1991	5.8	2037.3708435215	17862.9555460439	<input type="checkbox"/>	
PMP-5705	6/20/1991	9.4	1132.32422469399	42652.7676968302	<input type="checkbox"/>	
PMP-5701	7/4/1991	9.2	2536.57285953918	5826.9630186398	<input type="checkbox"/>	
PMP-5701	8/14/1991	1.7	3795.32353427688	37170.1560613366	<input type="checkbox"/>	
PMP-5705	10/9/1991	6.5	2669.48071969945	3397.9005692467	<input type="checkbox"/>	
PMP-5701	11/24/1991	1.2	5985.70013328063	8669.0283870865	<input type="checkbox"/>	
PMP-5705	12/28/1991	4.2	9083.41816832789	31347.8405722019	<input type="checkbox"/>	
PMP-5705	4/2/1992	8.9	363.10114818869	27708.6095949843	<input type="checkbox"/>	
PMP-5701	4/8/1992	1	7674.27894908138	49094.1395769235	<input type="checkbox"/>	
PMP-5701	4/14/1992	9.2	1206.82892822292	14111.134965814	<input type="checkbox"/>	
PMP-5705	5/16/1992	8.7	8170.64636107317	36821.1873407153	<input type="checkbox"/>	

The failure data is divided into the **Failures** and **Assets** tabs. The [Failures tab](#) provides information about the failures. The [Assets tab](#) provides information about the equipment and locations involved in the failures.

Aspects of the Failure Data

Asset ID	Failure Date	Downtime	Maintenance Cost	LPO	Ignore	Remarks
PMP-5705	2/1/1990	9	2020.20990042144	332.0143467081	<input type="checkbox"/>	
PMP-5701	2/20/1990	9.3	1298.52692977848	19333.4427061766	<input type="checkbox"/>	
PMP-5705	3/7/1990	6.9	2594.70203893168	21279.2490206692	<input type="checkbox"/>	
PMP-5701	7/4/1990	1.1	4946.24735445916	34307.1673602369	<input type="checkbox"/>	
PMP-5705	7/25/1990	7.2	4681.99434802873	44070.9819919655	<input type="checkbox"/>	
PMP-5701	8/27/1990	1.5	9208.53814340028	41256.9948870403	<input type="checkbox"/>	
PMP-5705	9/19/1990	6.6	3979.76199014252	31680.4930936872	<input type="checkbox"/>	
PMP-5701	11/17/1990	3.9	9166.37633410612	45513.1356228871	<input type="checkbox"/>	
PMP-5705	11/27/1990	8.9	7355.77518969623	44689.0231023271	<input type="checkbox"/>	
PMP-5705	1/18/1991	4.5	3181.40800669455	1462.2379548532	<input type="checkbox"/>	
PMP-5701	2/17/1991	9.6	5095.24725617142	45071.3023737928	<input type="checkbox"/>	
PMP-5705	3/28/1991	0.9	6721.30374715849	21205.3046131296	<input type="checkbox"/>	
PMP-5705	5/29/1991	5.8	2037.3708435215	17862.9555460439	<input type="checkbox"/>	
PMP-5705	6/20/1991	9.4	1132.32422469399	42652.7676968302	<input type="checkbox"/>	
PMP-5701	7/4/1991	9.2	2536.57285953918	5826.9630186398	<input type="checkbox"/>	
PMP-5701	8/14/1991	1.7	3795.32353427688	37170.1560613366	<input type="checkbox"/>	
PMP-5705	10/9/1991	6.5	2669.48071969945	3397.9005692467	<input type="checkbox"/>	
PMP-5701	11/24/1991	1.2	5985.70013328063	8669.0283870865	<input type="checkbox"/>	
PMP-5705	12/28/1991	4.2	9083.41816832789	31347.8405722019	<input type="checkbox"/>	
PMP-5705	4/2/1992	8.9	363.10114818869	27708.6095949843	<input type="checkbox"/>	
PMP-5701	4/8/1992	1	7674.27894908138	49094.1395769235	<input type="checkbox"/>	
PMP-5701	4/14/1992	9.2	1206.82892822292	14111.134965814	<input type="checkbox"/>	
PMP-5705	5/16/1992	8.2	8128.64636107317	36821.1873407153	<input type="checkbox"/>	

CE Hint: You can group, filter, and sort the data on the Failure Data window.

By default, the following properties are listed on the **Failures** tab:

- **Datasheet:** The text view, which appears as a hyperlink that displays the datasheet associated with the event (e.g., a Work History record). This column appears only when a query is the data source for the analysis.
- **Asset ID:** The ID of the piece of equipment or location that failed. This value is mapped from a query or dataset or manually entered when you create the analysis.
- **Failure Date:** The date on which the failure of the piece of equipment or location occurred. This value is mapped from a query or dataset or manually entered when you create the analysis and is required.
- **Downtime:** The amount of corrective maintenance time for the piece of equipment or location after the failure occurs. This value is mapped from a query or dataset or manually entered when you create the analysis.

- **Maintenance Cost:** The cost of fixing the piece of equipment or location after a failure occurs (represents both the labor and the material costs). This value is mapped from a query or dataset or manually entered when you create the analysis.
- **LPO:** The profit the company loses when the production fails in an oversold market. It represents the difference between the market price of the product and the cost of producing it. This value is mapped from a query or dataset or manually entered when you create the analysis.
- **Ignore:** A value that indicates whether or not the data on the selected row is *ignored*, meaning excluded from the analysis calculations and plots. When *selected*, the data in the associated row will be excluded from the analysis. When *cleared*, data in the selected row will be included in the analysis. You can modify this value manually.

Note: A minimum of three failure data points is required to perform a calculation. If you exceed the maximum number of ignored datapoints, the application will display a warning message after you click **OK** on the **Failure Data** grid. The failure events marked ignored on the grid will not appear on the plots. Ignored datapoints are not included in MTBF calculations.

- **Remarks:** Comments about the failure event. You can enter a value in this column manually.

Aspects of the Asset Data

The screenshot shows a software window titled "Failure Data" with two tabs: "Failures" and "Assets". The "Assets" tab is active, displaying a table with the following data:

Asset ID	Installati...	Last Rep...	Mainten...	LPO	Total Cost	MTBF	MTTR	Downtime	Availability
PMP-5701	2/1/1990	5/18/2001 ...	25913.678...	122850.32...	148764.00...	73.670101...	5.7058159...	28.288168...	92.254909...
PMP-5705	2/1/1990	3/21/1998 ...	19112.636...	104997.84...	124110.48...	91.678348...	5.8288888...	23.221877...	93.642022...
*									

At the bottom of the window are three buttons: "OK", "Cancel", and "Help".

By default, the following properties are listed on the **Assets** tab:

- **Datasheet:** The text *view*, which appears as a hyperlink that displays the datasheet associated with the event (e.g., a Work History record). This column only appears when a query is the data source for the analysis.
- **Asset ID:** The ID of the piece of equipment or location that failed. This value is mapped from a query or dataset or manually entered when you create the analysis.
- **Installation Date:** The date on which the piece of equipment or location was installed. This value is mapped from a query or dataset or manually entered when you create the analysis.
- **Last Failure Date:** The last date on which the piece of equipment or location failed. This value is calculated by the Meridium APM system using the values in the **Failure Date** and the **Downtime** columns on the **Failures** tab and is read-only.
- **Maintenance Cost:** The total maintenance cost (represents both the labor and the material costs) of the corresponding piece of equipment or location in the **Asset ID** column. This value is the sum of the values in the **Maintenance Cost** column on

the **Failures** tab associated with each piece of equipment or location. This value is calculated by the Meridium APM system and is read-only.

- **LPO:** The total lost profit opportunity of the corresponding piece of equipment or location in the **Asset ID** column, which represents the difference between the market price of the product and the cost of producing it. This value is the sum of the values in the **LPO** column on the **Failures** tab associated with each piece of equipment or location. This value is calculated by the Meridium APM system and is read-only.
- **Total Cost:** The total cost caused by element failures and system shutdowns. It includes the cost of maintenance to fix problems and the lost profit opportunity of the reduction in output. This value is calculated by the Meridium APM system using the costs in the **LPO** and **Maintenance Cost** fields and is read-only.
- **MTBF:** The average time between failures for a production unit after a failure occurs. Values in this column are calculated by the Meridium APM system and are read-only.
- **MTTR:** The time from when an item fails to when it is returned to productive service. Values in this column are calculated by the Meridium APM system and are read-only.
- **Downtime:** The amount of time that an item is not available for use for any reason. This value is the sum of the values in the **Downtime** column on the **Failures** tab associated with each piece of equipment or location. This value is calculated by the Meridium APM system and is read-only.
- **Availability:** The percentage of the time that a production unit is up and running versus the Calendar time. Availability describes the past performance of equipment, but not time in service or capacity. Availability is not tied to production and profits. Values in this column are calculated by the Meridium APM system and are read-only.

Specifying the Units of Measurement

If you change the units of measurement for a Cost of Unreliability Analysis, the Meridium APM system recalculates the analysis results that appear on the plots and the summary page and converts them to the units that you select.

To change the units of measurement that are used to generate the analysis results:

1. On the [Cost of Unreliability Analysis summary page](#), on the [Analysis Tasks menu](#), click the **Units of Measure** link.

Note: You can also change the units of measurement by clicking the **Change** link in the [Analysis Options section](#) of the **Cost of Unreliability Analysis** summary.

The **Units of Measure** dialog box appears.

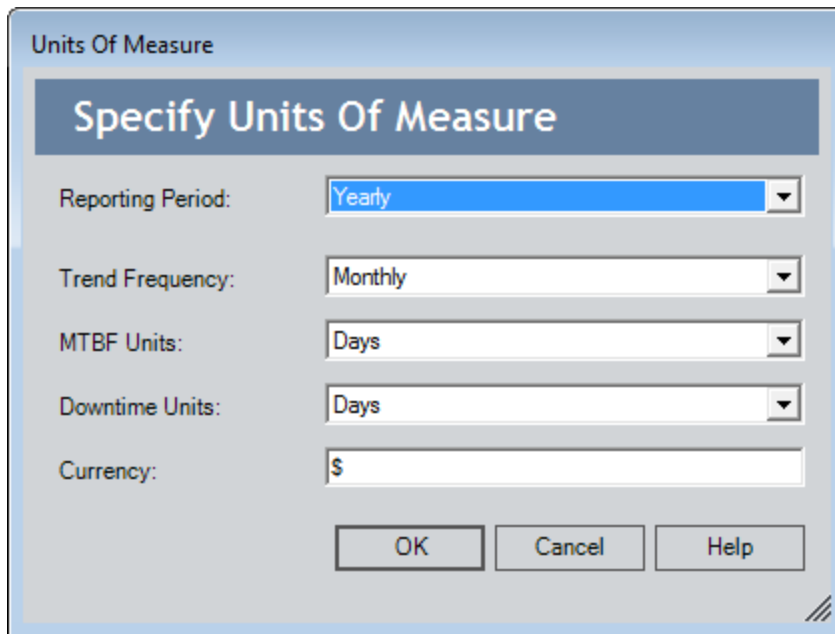

2. In the following text boxes, and select a unit from the list.
 - **Reporting Period:** The interval in which results are calculated and presented for the Pareto charts (Yearly, Quarterly, Monthly, Daily, Weekly, or Hourly).
 - **Trend Frequency:** The units of measure for the trend frequency (Yearly, Quarterly, Monthly, Weekly, Daily, or Hourly).
 - **MTBF Units:** The units of measure for the MTBF (Year, Quarter, Month, Day, Week, or Hour).
 - **Downtime Units:** The units of measure for the downtime (Year, Quarter, Month, Day, Week, or Hour).

Note: If you change the value in the **Downtime Unit** text box, the units of measure for both the failure data and the analysis results will change to the value that you select. You cannot change the downtime units for the failure data independently from the analysis results.

- **Currency:** Populated based on the preference that is stored for the currency in the regional settings on your computer. If you enter a different currency in the **Currency** field, when you click **OK**, the system displays the new currency on the axis label of the plots.

Note: The system does not convert any existing values to the equivalent value of the new currency.

3. Click **OK** to accept the changes and close the **Units of Measure** dialog box.

The y-axis and x-axis on each plot will display the new units. The new units will also appear on the analysis summary screen.

Selecting MTBF Calculation Options



Mean Time Between Failures (MTBF) is a simple statistic that characterizes the overall reliability of a piece of equipment or location or a set of equipment or locations. The MTBF trend analysis shows the MTBF for a selected set of equipment or locations over time. The MTBF metric is trended using a moving average. You can control the period that will be used to calculate the MTBF at every step.

To determine how the system will calculate MTBF trends:

1. On the [Cost of Unreliability Analysis summary page](#), on the [Analysis Tasks menu](#), click the **MTBF Calculation** link.

The **MTBF Calculation Options** dialog box appears. On this dialog box, you can specify the period over which the calculation of MTBF is performed.

The screenshot shows a dialog box titled "MTBF Calculation Options". Inside the dialog, there is a header "MTBF Calculation Options". Below the header, there are two input fields. The first is "MTBF Period Units" with a dropdown menu currently showing "Years". The second is "MTBF Period Length" with a text box containing the number "1". At the bottom of the dialog, there are three buttons: "OK", "Cancel", and "Help".

2. In the **MTBF Period Units** list, select a unit for the MTBF Period from the following options:
 - Years
 - Quarters
 - Months
 - Weeks
 - Days
 - Hours
3. To specify the length of the MTBF period, type a number or click the  or  buttons to populate the **MTBF Period Length** text box with the appropriate number. For example, if you selected **Years** in the **MTBF Period Units** field, the number you enter in the **MTBF Period Length** field will indicate the number of years that will be used to calculate MTBF.
4. Click **OK**.

When you view the analysis summary page, the MTBF is recalculated and displayed in the specified time period.

Total Cost Pareto

The Total Cost Pareto chart displays the Total Cost per the specified reporting period. The Lost Profit Opportunity (LPO) per the reporting period and Maintenance Cost per reporting period are shown. The Cost of Unreliability is an estimate of the total cost caused by element failures and system shutdowns. It includes the cost of maintenance to fix problems and the lost profit opportunity of the reduction in output. The analyzed production units are listed on the x-axis and the specified reporting period is shown on the y-axis.

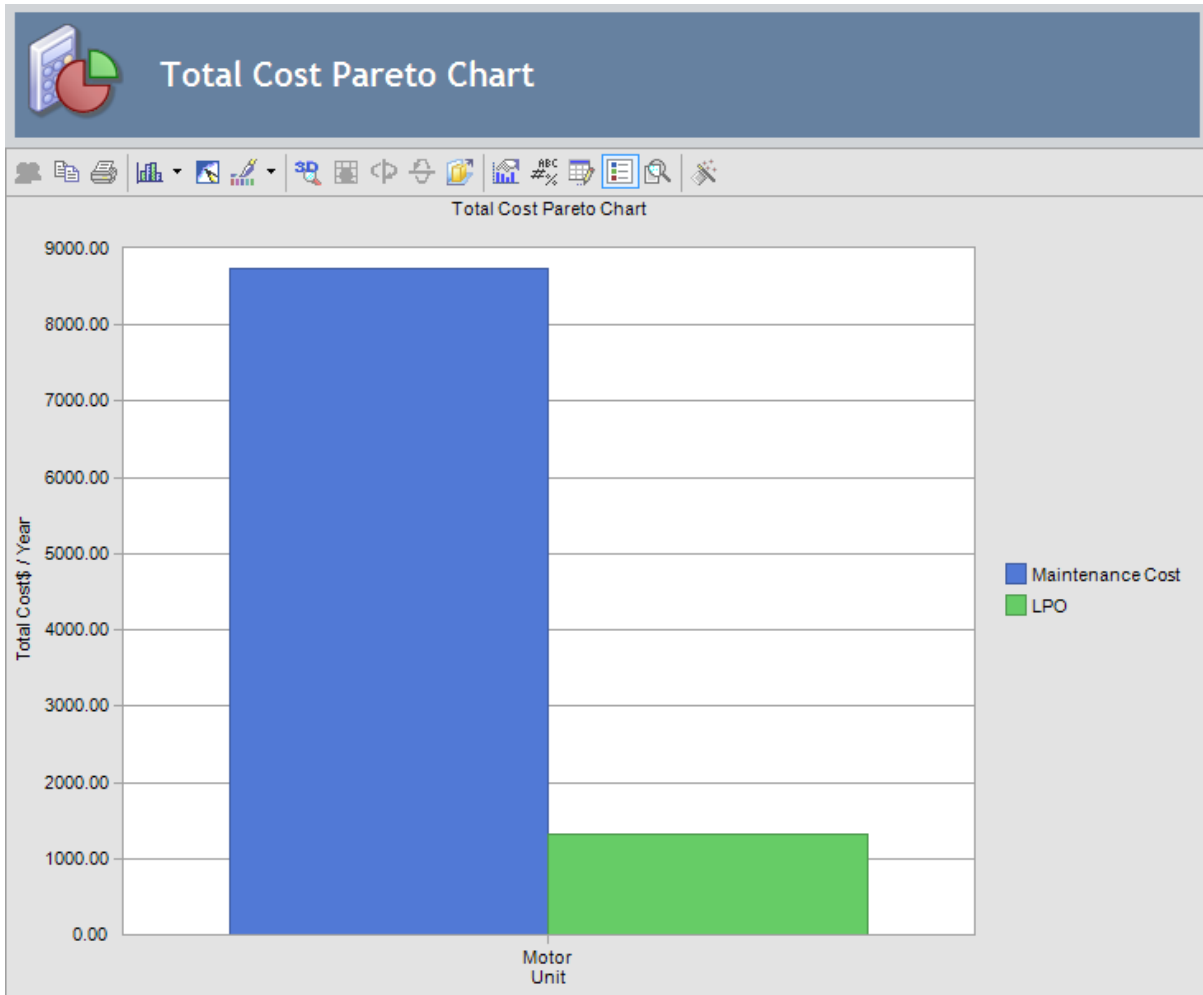

While viewing this plot, you can:

- Pause on the LPO bar or the Maintenance Cost bar on the Cost plot to display a tool tip listing the corresponding cost value associated with that production unit.
- Click the **Show Plot Data** link on the [Plot Options menu](#) to view the underlying plot data on the [Plot Data page](#).

Note: Change the reporting period by [specifying the units of measurement](#).

Mean Time Between Failures Pareto

The MTBF Pareto plot displays the Mean Time Between Failures for each production unit. MTBF is the average time between failures for a production unit. The MTBF plot displays the units on the x-axis and the MTBF values are shown on the y-axis.

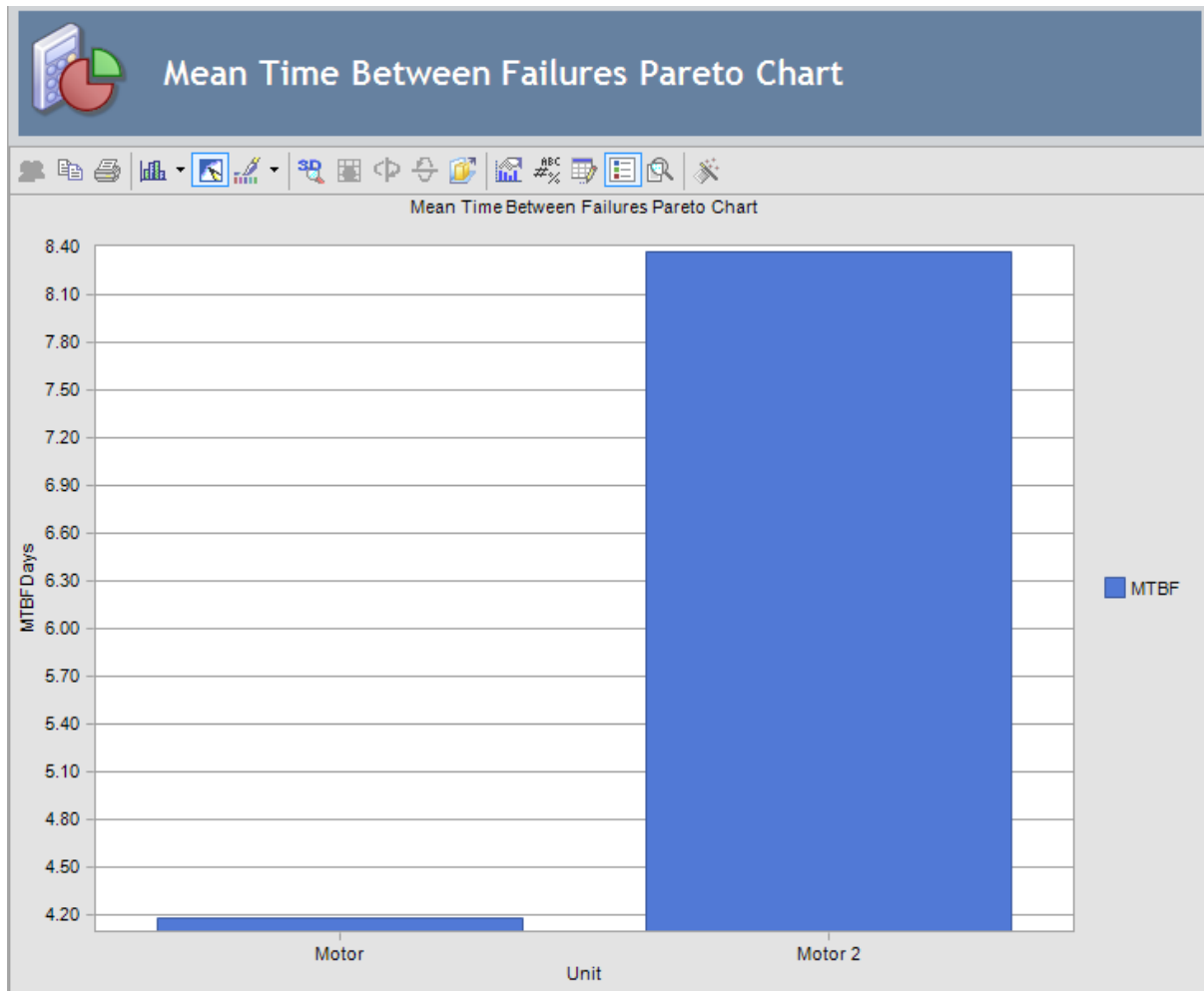

Note: The higher the value of MTBF for an item, the more reliable the item is.

While viewing this plot, you can:

- Pause on a piece of equipment or location to view a tool tip displaying the MTBF value for that production unit.
- Click the **Show Plot Data** link on the [Plot Options menu](#) to view the **Plot Data** page for the MTBF plot.

Note: You can change the MTBF Units by [specifying the units of measurement](#).

Mean Time To Repair Pareto

The MTTR Pareto plot displays the Mean Time to Repair for each production unit. MTTR is the time from when a production unit fails to when it is returned to productive service. The MTTR plot displays MTTR values on the x-axis and the units on the y-axis.

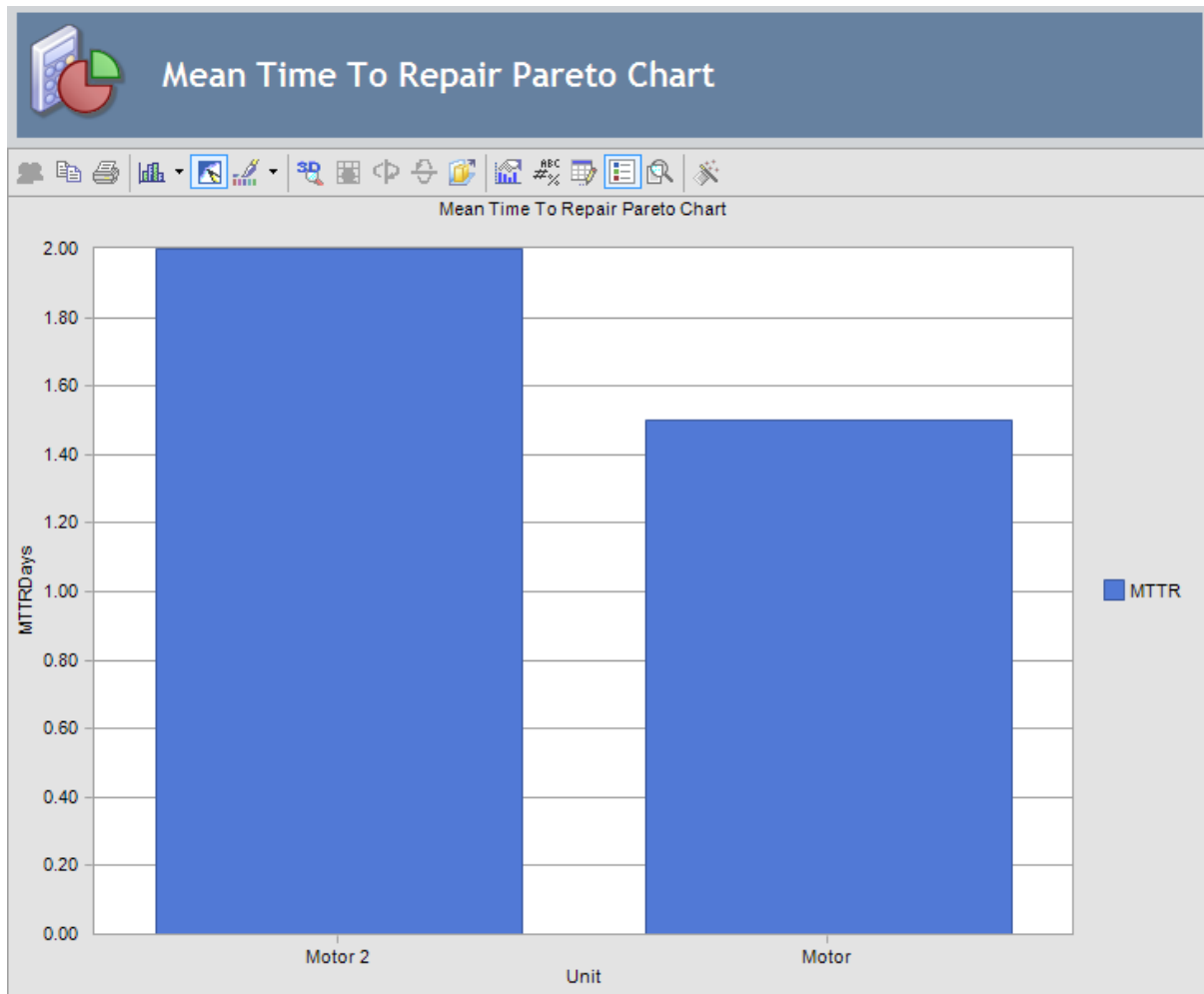

Note: The higher the value of MTTR, the more costly and more difficult it will be to conduct repairs.

While viewing this plot, you can:

- Pause on a piece of equipment or location to display a tool tip displaying the MTTR value for that production unit.
- [View the underlying plot data](#), by clicking the **Show Plot Data** link on the [Plot Options menu](#).

Note: You can change the MTTR Units by [specifying the units of measurement](#).

Availability Pareto

The Availability Pareto plot displays the percentage of time that a production unit is up and running versus the Calendar time. Availability describes the past performance of equipment but not time in service or capacity; availability is not tied to production and profits. The production units are listed on the x-axis and the availability is shown on the y-axis.

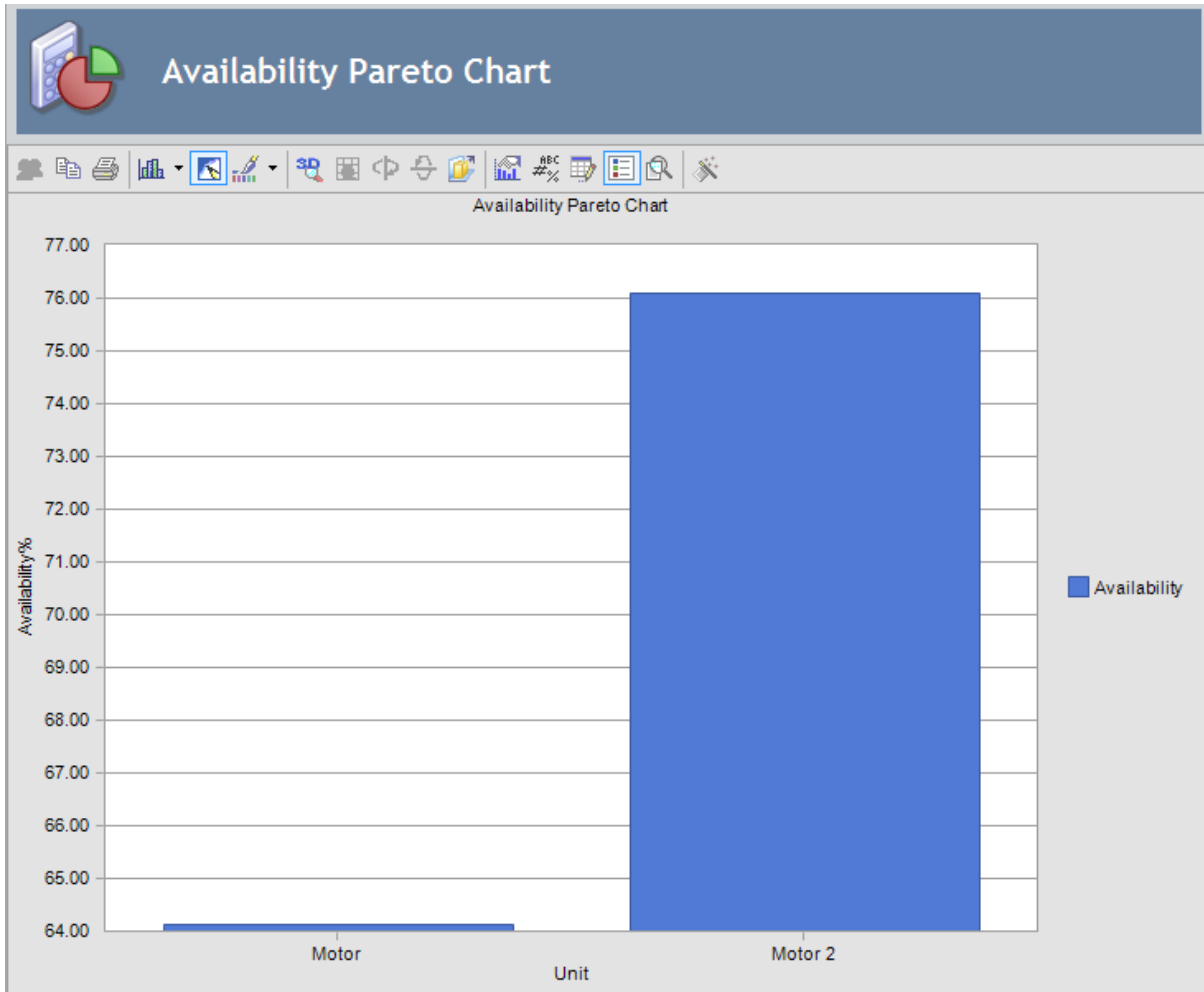

Availability is a measure of equipment or unit up-time. You can use the Availability value to determine how much product can be produced in a given period, assuming 100% capacity is normally achieved.

While viewing this plot, you can:

- Pause on a unit to display a tool tip listing the availability of that production unit.
- Click the **Show Plot Data** link on the [Plot Options menu](#) to view the underlying plot data on the [Plot Data page](#).

Note: Change the equipment or unit up-time by [specifying the units of measurement](#).

Number of Failures Pareto

The Number of Failures Pareto chart lists the number of failures per year for each of the production units being analyzed within the analysis period. The units are listed on the x-axis and the number of failures are shown on the y-axis.

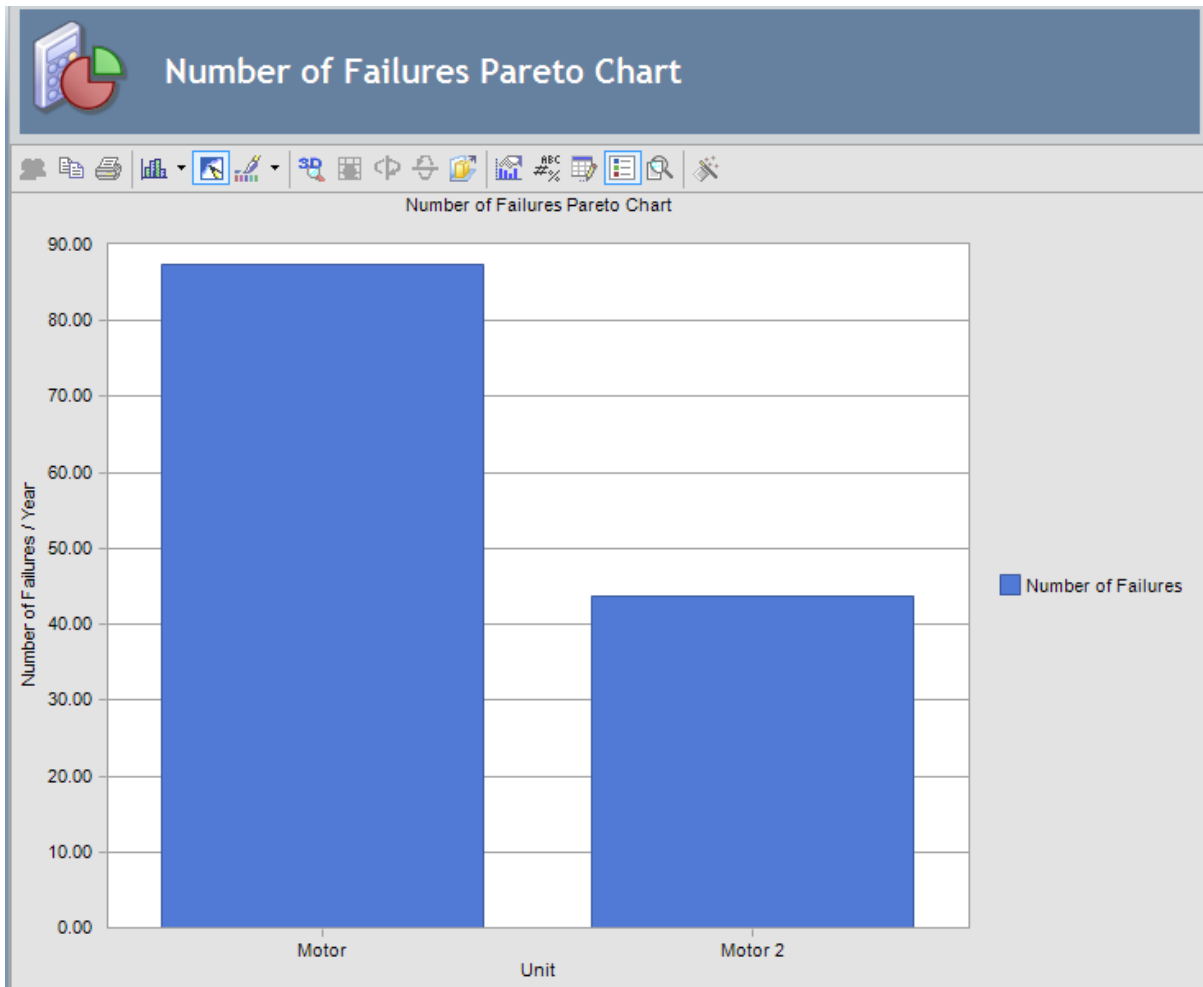

While viewing this plot, you can:

- View the number of failures for a production unit. To do so, pause on a unit to display a tool tip listing the availability of that production unit.
- Click the **Show Plot Data** link on the [Plot Options menu](#) to view the [Plot Data page](#) for the current chart.

Note: Change the reporting period by [specifying the units of measurement](#).

Downtime Pareto

Downtime is the amount of time that an item is not available for use for any reason. While the Failures Plot displays the number of shutdowns, the Downtime Pareto plot displays the downtime for each production unit. The units are listed on the x-axis and the values for the downtime are shown on the y-axis.

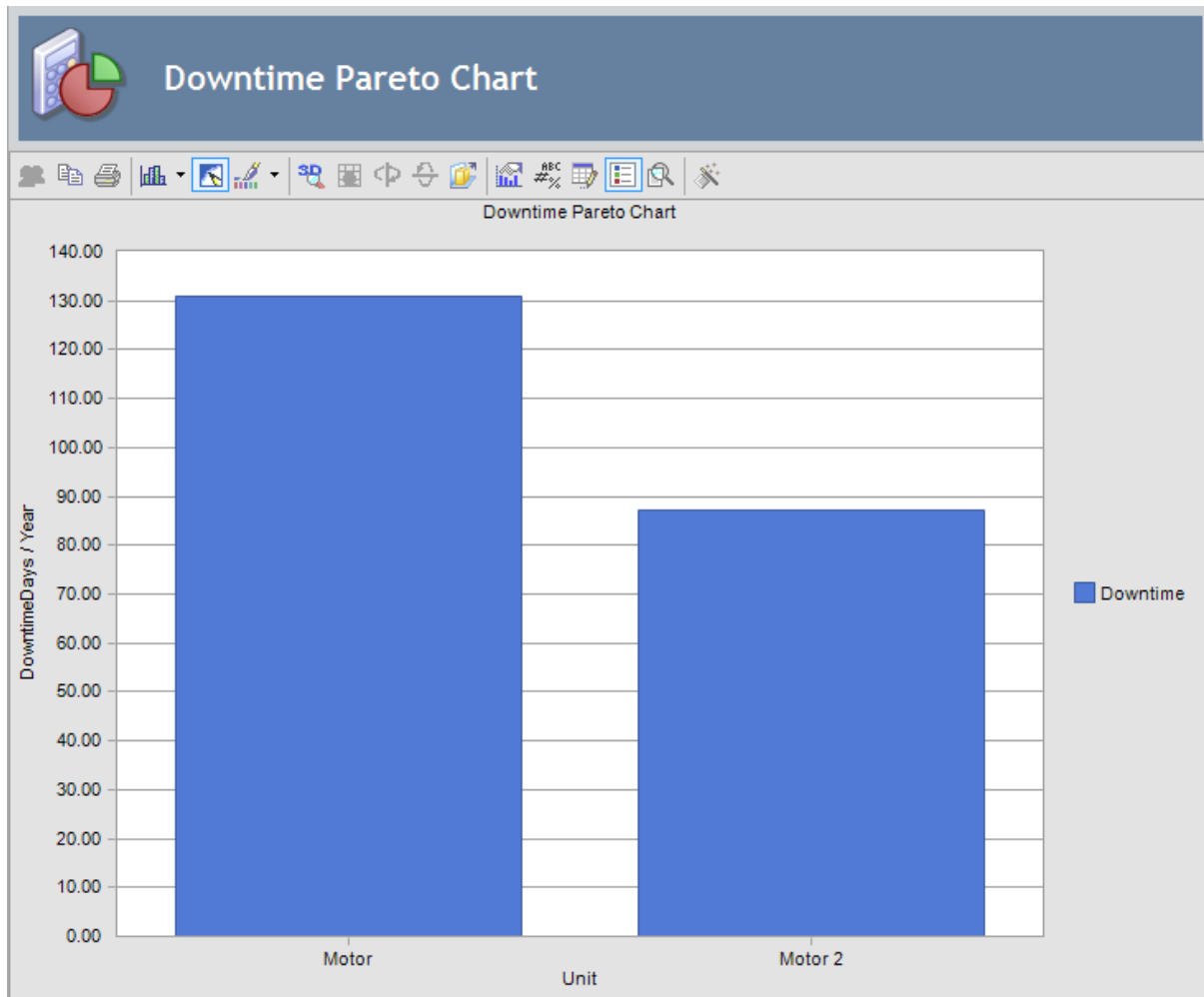

While viewing this plot, you can:

- Pause on a unit to display a tool tip listing the downtime for that production unit.
- Click the **Show Plot Data** link on the [Plot Options menu](#) to view the [Plot Data page](#) for the current chart.

Note: Change the downtime by [specifying the units of measurement](#).

Generating and Viewing a Trend Plot

The Trend plot shows the selected metric as a function of time. Using the Trend Builder, you can choose to either show a global trend for all units or show trends for individual units. The trend frequency determines the duration between the measurements in the Trend plot.

To generate a MTBF trend analysis that shows the MTBF for a selected set of equipment or locations over time:

1. On the [Cost of Unreliability Analysis summary page](#), on the **Plot** menu, click the **Trend** link.

The **Trend Builder** appears, displaying the **Welcome** screen.

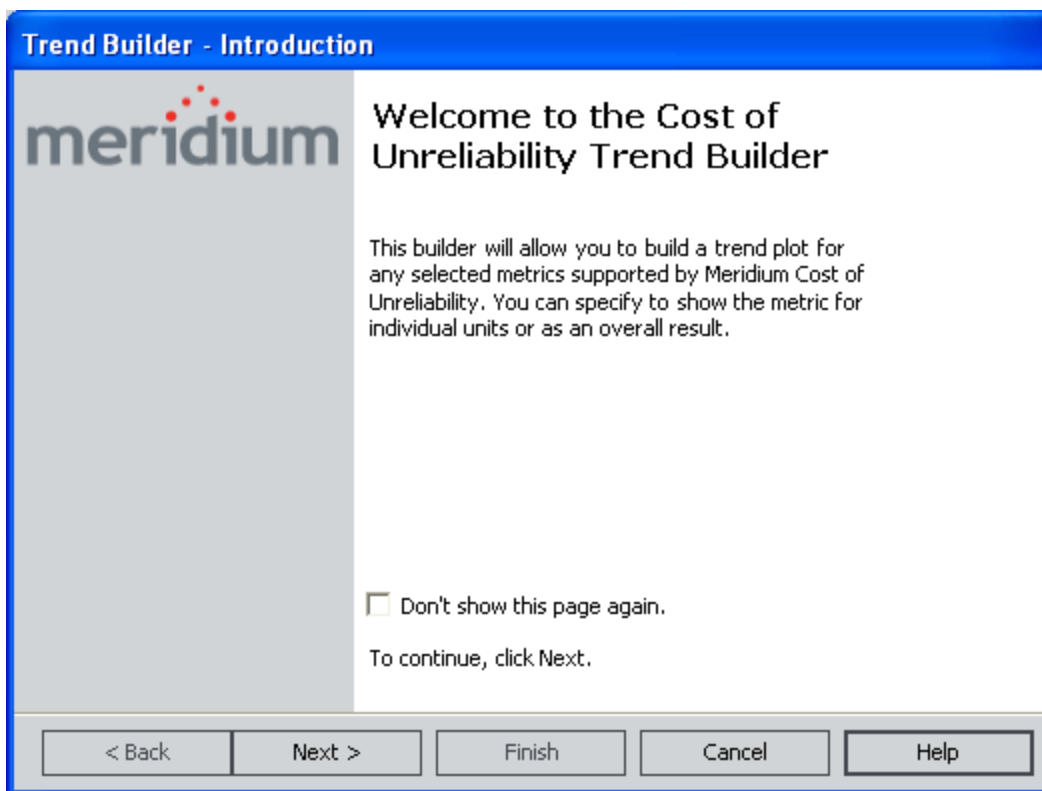

CEHint: Select the **Don't show this page again** check box to skip the Welcome screen in the future.

2. Click the **Next** button.

The **Plot Type** screen appears.

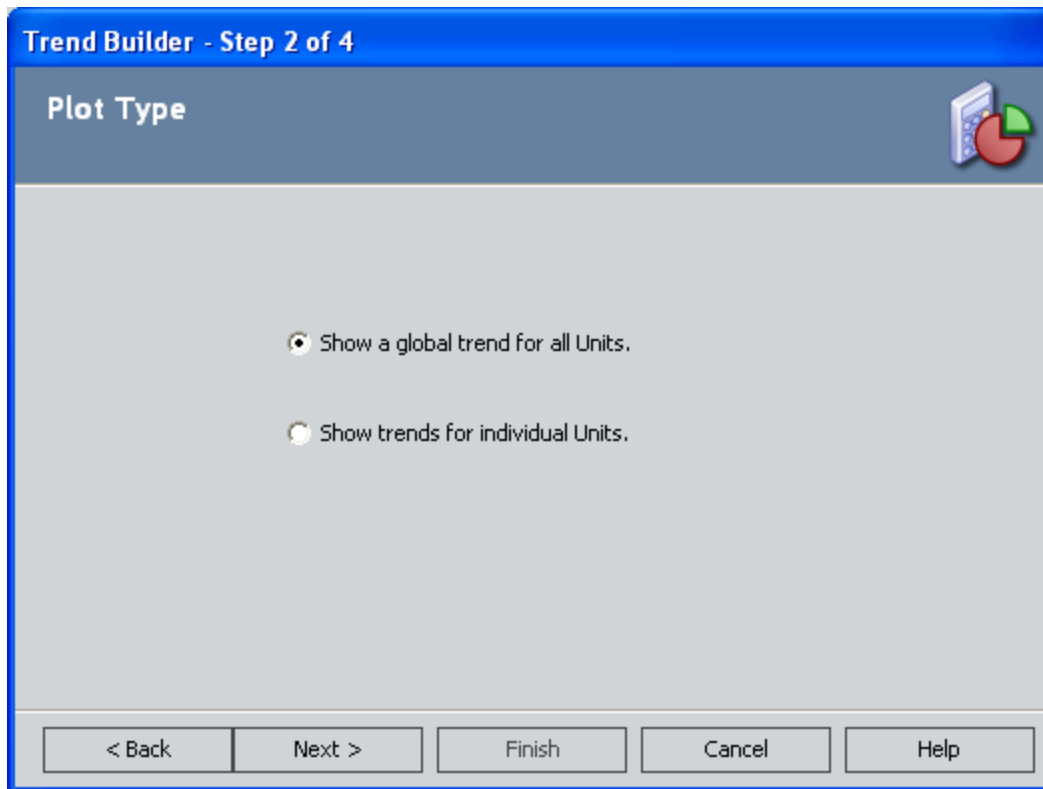

3. Select either the **Show a global trend for all Units** option or the **Show trends for individual Units** option, and click the **Next** button.

The **Select Units** screen appears.

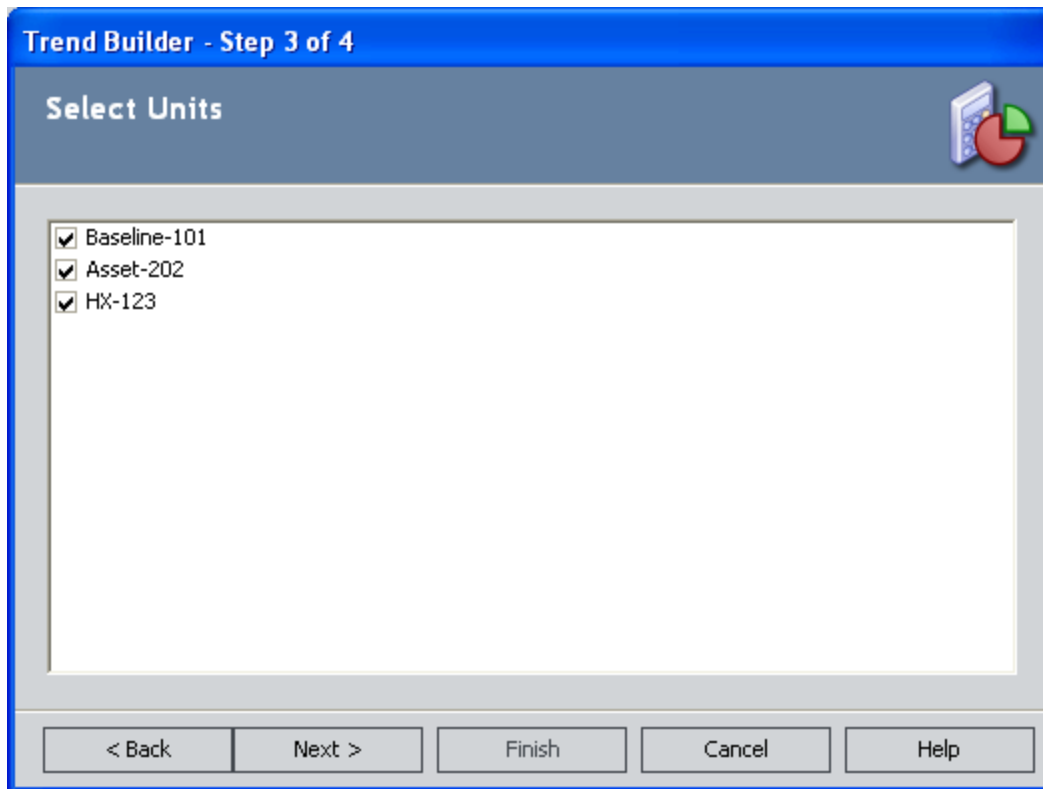

Note: The production units that are included in the analysis are listed on this screen.

4. Click a check box in front of a unit to select that unit. If you do not want to view the trends for a selected unit, clear the check box located in front of the unit.
5. Click the **Next** button.

The **Select Measures** screen appears. You may select up to two measures to illustrate in the Trend plot.

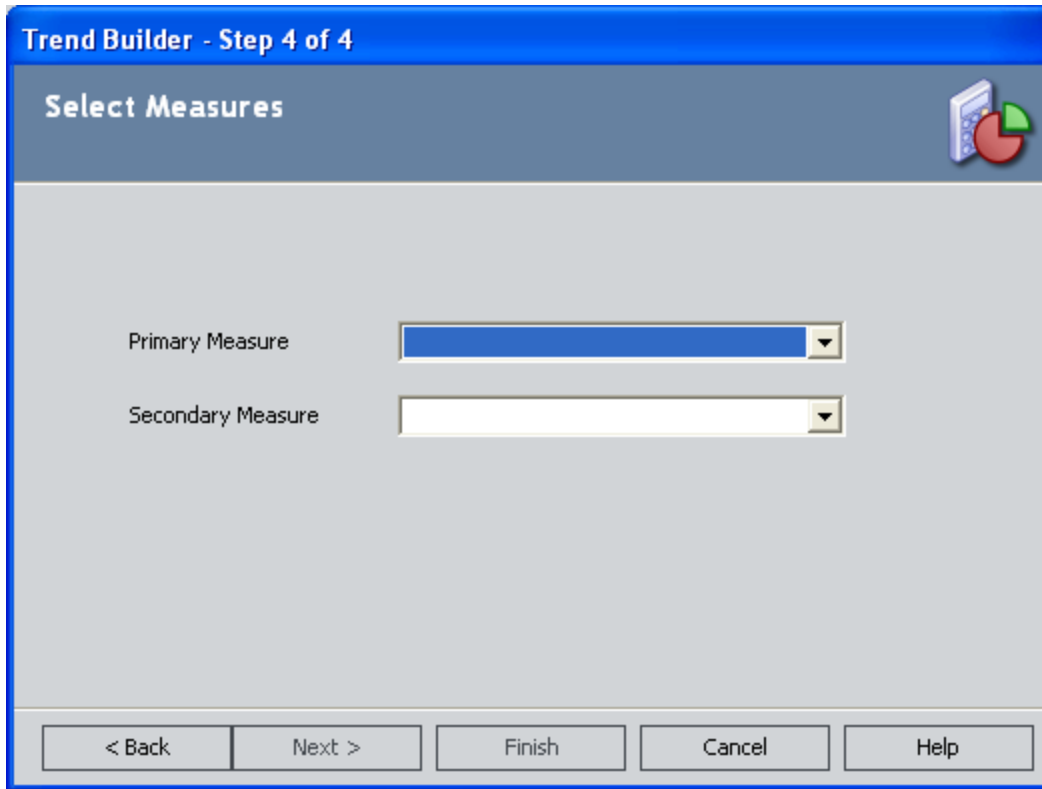

6. In the **Primary Measure** list, select the desired measure.

The **Finish** button will become enabled after you make a selection. If you do not want to select a secondary measure, skip to step 9 of these instructions.

7. In the **Secondary Measure** list, select the desired secondary measure.
8. Click the **Finish** button.

The Trend plot appears. The trend values on the plot match the values that you define on the [Units of Measurement dialog box](#). Trend dates appear on the x-axis.

Generating and Viewing a Trend Plot

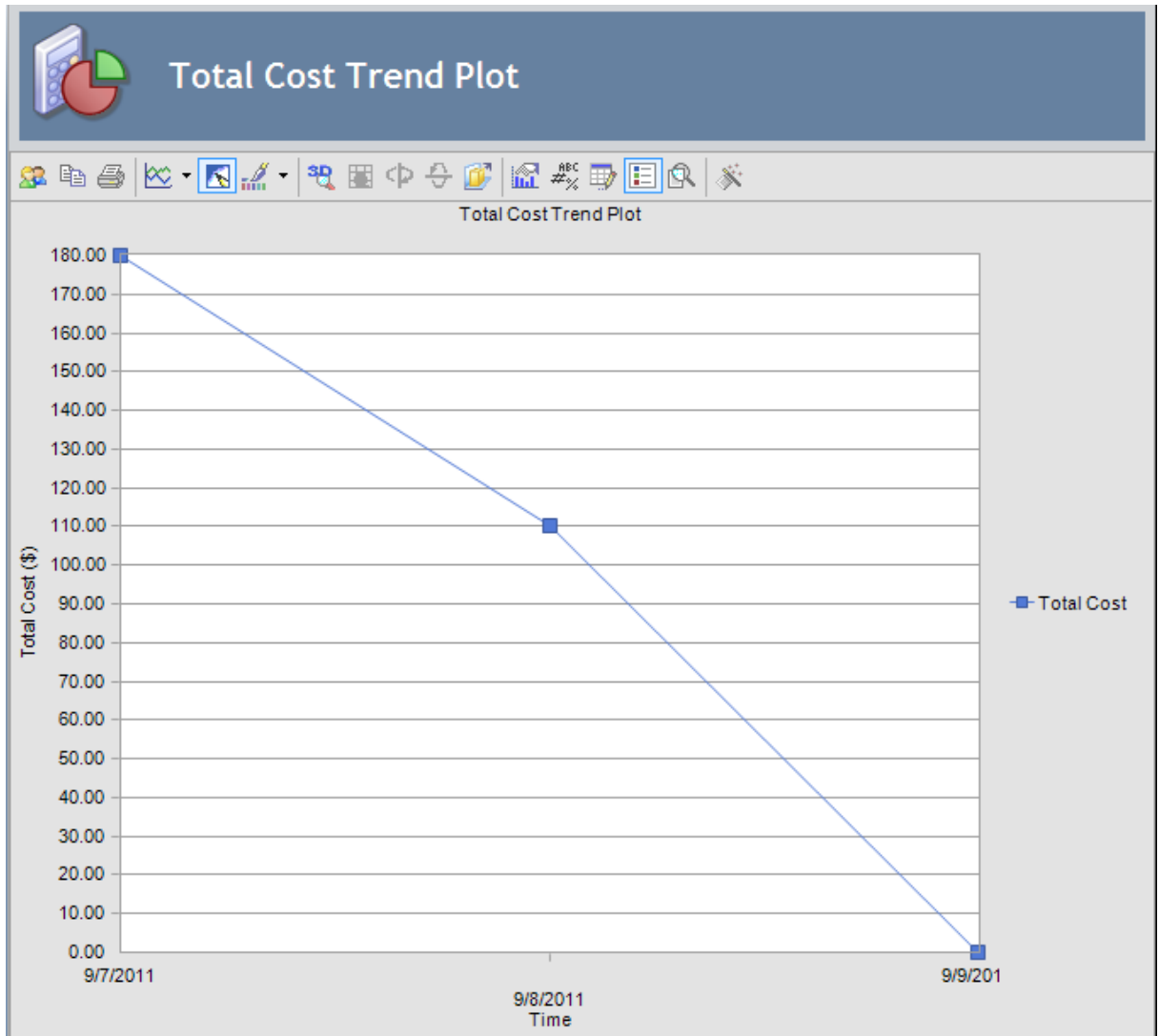

Note: To [view the underlying plot data](#) on which a given plot is based, click the [Show Plot Data](#) link in the [Plot Options](#) menu.

Viewing Underlying Plot Data

The **Plot Data** page displays the numeric data on which a given plot is based. Depending on the chart type, the numeric data includes information such as the Unit, Cost, MTBF, MTTR, Availability, Number of Failures, and Downtime.

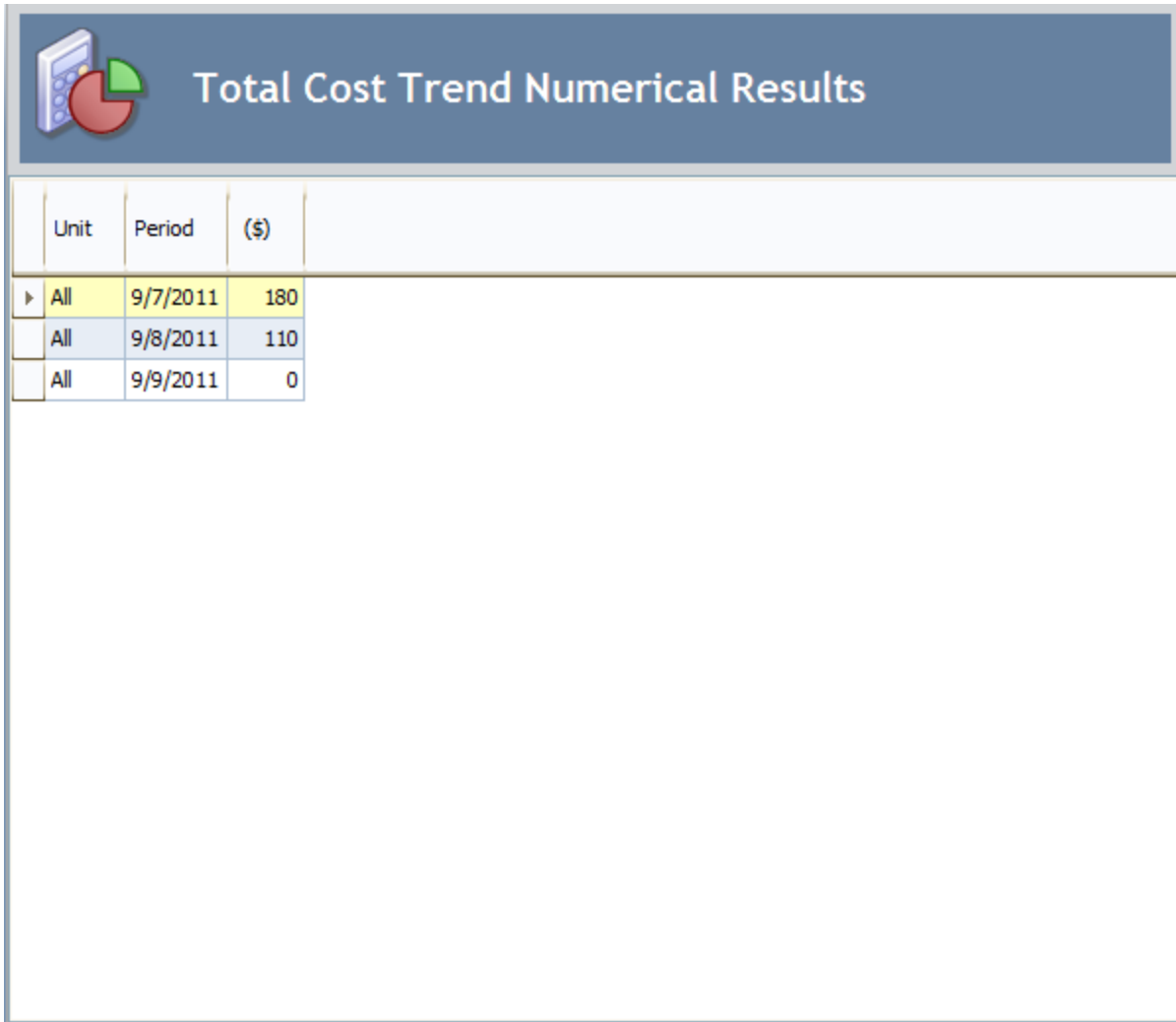

CEHint: You can [specify the units of measurement](#), which includes the downtime.

Overview of the Cost of Unreliability Report

The baseline Meridium APM database includes the Cost of Unreliability Report, which you can use to view a summary of the results of a Cost of Unreliability Analysis. When you run the Cost of Unreliability Report, it will appear on the **Report Viewer** page.

The Cost of Unreliability Report is built from the following Catalog items:

- The main report, *CostAnalysisReport*, which is stored in the Catalog folder \\Public\Meridium\Modules\Reliability Manager\SSRS.
- The subreport, *AssetsSubreportUnreliability*, which is stored in the Catalog folder \\Public\Meridium\Modules\Reliability Manager\Reports.
- The subreport, *FailuresSubreportUnreliability*, which is stored in the Catalog folder \\Public\Meridium\Modules\Reliability Manager\Reports.
- The supporting query that supplies data in the main report and subreports, *Unreliability Cost Query*, which is stored in the Catalog folder \\Public\Meridium\Modules\Reliability Manager\Reports.

Throughout this documentation, we refer to the main report, the subreports, and the supporting query collectively as the *Cost of Unreliability Report*.

The Cost of Unreliability Report contains a prompt on the ENTY_KEY field in the Unreliability Cost family. When you run the Cost of Unreliability Report while viewing a Cost of Unreliability Analysis, the ENTY_KEY of the Unreliability Cost record associated with the current analysis is passed automatically to the prompt, and the results for the current Cost of Unreliability Analysis are displayed. If you run the main report (i.e., *CostAnalysisReport*) or the supporting query (i.e., *Unreliability Cost Query*) directly from the Catalog, however, you will need to supply the ENTY_KEY of an Unreliability Cost record manually to retrieve results. The subreports (i.e., Catalog items *AssetsSubreportUnreliability* and *FailuresSubreportUnreliability*) cannot be run directly from the Catalog.

The Cost of Unreliability Report contains the following sections:

- Analysis Summary
- Assets
- Failure Data
- Plots

Running the Cost of Unreliability Report

You can run the Cost of Unreliability report to view a summary of the results of a Cost of Unreliability Analysis.

To run the Cost of Unreliability Report:

1. While viewing the desired Cost of Unreliability Analysis on any page, on the **Analysis Tasks** menu, click the **Generate Report** link.

The **Report Options** dialog box appears. The following image shows what the **Report Options** dialog box looks like by default.

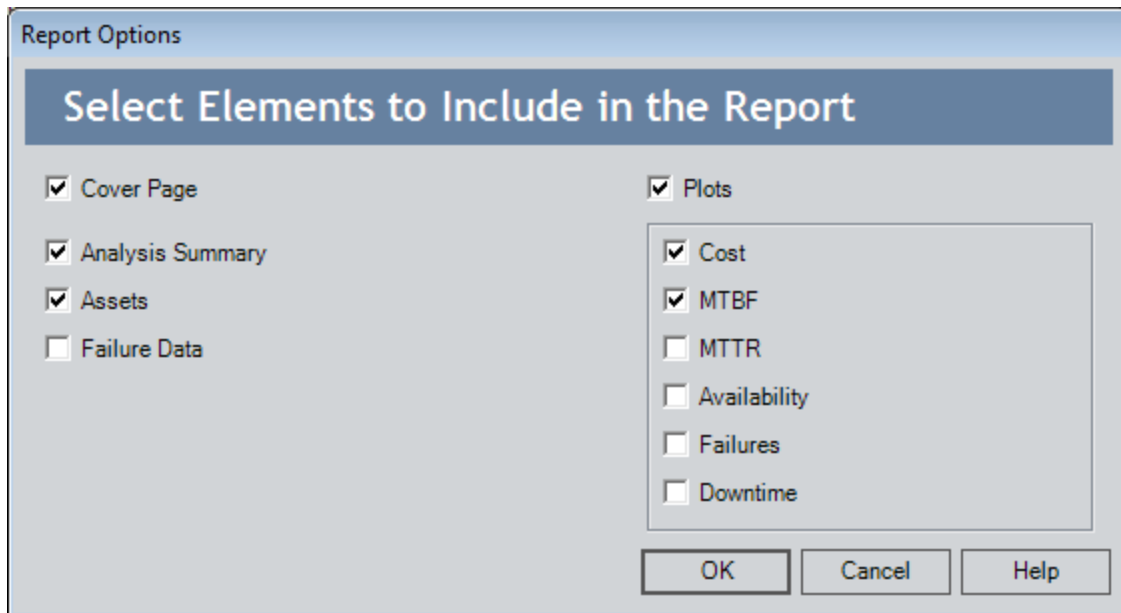

2. Select the desired elements to be included in the report, and click **OK**.

The Cost of Unreliability Report appears on the **Report Viewer** page.

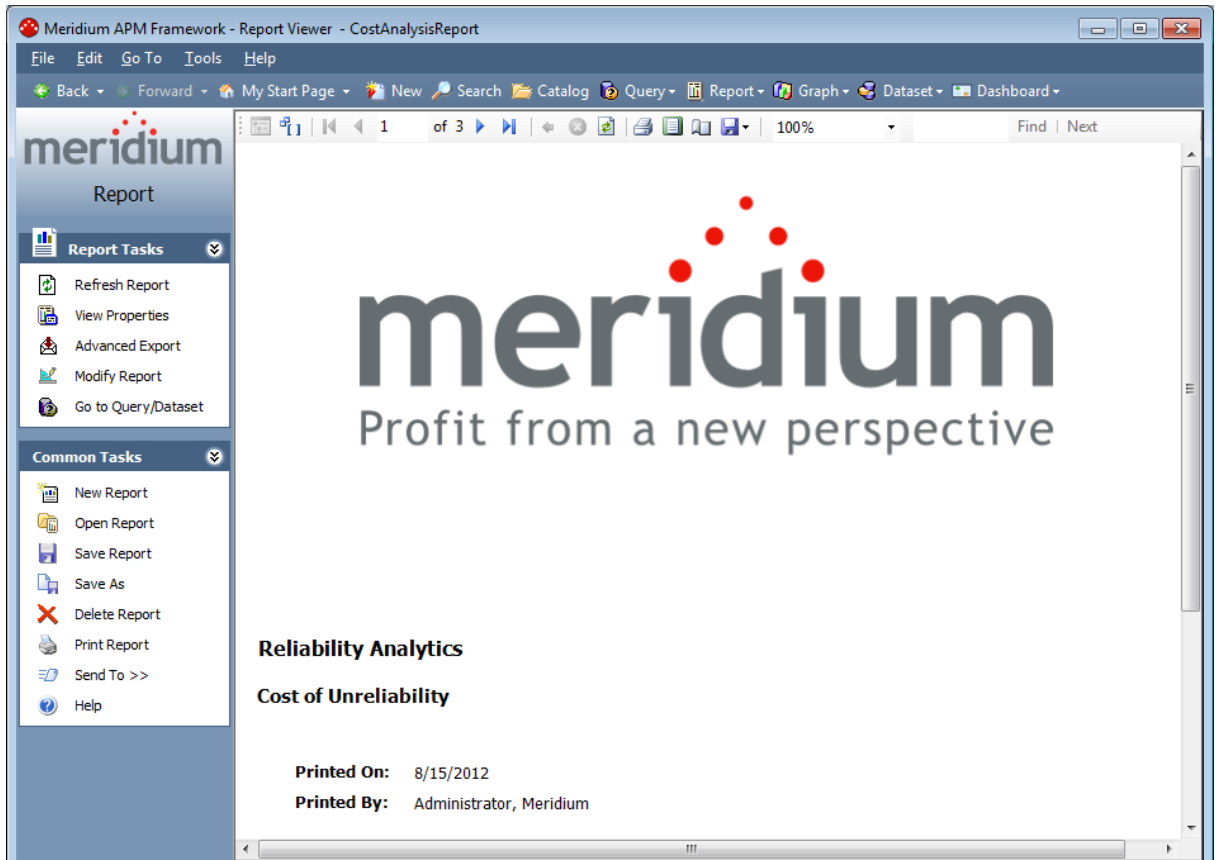

Analysis Summary Section

The **Analysis Summary** section of the Cost of Unreliability Report displays information that exists in the Unreliability Cost record.

Analysis Summary	
Analysis Name:	CUC Analysis 44
Analysis Description:	
Analysis Start Date:	2/20/1990
Analysis End Date:	5/19/2001 12:37:00 PM
Number of Assets:	2
Number of Failures:	101
Maintenance Cost:	45,026.32 \$/Year
LPO:	227,848.17 \$/Year
Total Cost:	272,874.49 \$/Year
Availability:	85.90 %
MTBF:	40.85 Days
MTTR:	5.76 Days
Downtime:	51.51 Days/Year
Last Modified:	8/15/2012
Modified By:	Administrator, Meridium

The following table lists each item in the **Analysis Summary** section and the corresponding Unreliability Cost record field whose data is displayed in the report.

Report Item	Unreliability Cost Field(s)	Notes
Analysis Name	Analysis ID	None
Analysis Description	Short Description	None
Analysis Start	Analysis Start Date	None
Analysis End	Analysis End Date	None
Number of Assets	Units	None
Number of Failures	Number of Failures	None
Maintenance Cost	Maintenance Cost Currency	None

Report Item	Unreliability Cost Field(s)	Notes
LPO	LPO Currency	None
Total Cost	Currency	The value in the Total Cost field is the sum of the values in the Maintenance Cost and LPO fields.
Availability	Availability	None
MTBF	MTBF	None
MTTR	MTTR	None
Downtime	Downtime	None
Last Modified	LAST_UPDT_DT	None
Modified By	LAST_UPBY_SEUS_KEY	The name of the Security User associated with this value is displayed in the report.

Assets Section

The **Assets** section of the Cost of Unreliability Report displays values that are stored in the Failures field in the Unreliability Cost record.

Assets									
Asset ID	Installation Date	Last Replacement	Maintenance Cost	LPO	Total Cost	MTBF	MTTR	Downtime	Availability
PMP-5701	2/1/1990	5/18/2001	25,913.68	122,850.30	148,764.00	73.67	5.71	28.29	92.25
PMP-5705	2/1/1990	3/21/1998	19,112.64	104,997.80	124,110.50	91.68	5.83	23.22	93.64

The following values are displayed in the **Assets** section, and they are stored in the Failures field in the Unreliability Cost record:

- Asset ID
- Installation Date
- Last Replacement
- Maintenance Cost
- LPO
- Total Cost
- MTBF
- MTTR
- Downtime
- Availability

Failure Data Section

The **Failure Data** section of the Cost of Unreliability Report displays values that are stored in the Failures field in the Unreliability Cost record.

Failure Data						
Asset ID	Failure Date	Downtime	Maintenance Cost	LPO	Ignore	Remarks
PMP-5701	2/20/1990	9.30	1,298.53	19,333.44	false	
	7/4/1990	1.10	4,946.25	34,307.17	false	
	8/27/1990	1.50	9,208.54	41,257.00	false	
	11/17/1990	3.90	9,166.38	45,513.14	false	
	2/17/1991	9.60	5,095.25	45,071.30	false	
	7/4/1991	9.20	2,536.57	5,826.96	false	
	8/14/1991	1.70	3,795.32	37,170.16	false	
	11/24/1991	1.20	5,985.70	8,669.03	false	
	4/8/1992	1.00	7,674.28	49,094.14	false	
	4/14/1992	9.20	1,206.83	14,111.13	false	
	5/24/1992	0.30	4,380.17	46,022.85	false	

The following values are displayed in the **Failure Data** section, and they are stored in the Failures field in the Unreliability Cost record:

- Asset ID
- Failure Date
- Downtime
- Maintenance Cost
- LPO
- Ignore
- Remarks

Plots Section

The **Plots** section of the Cost of Unreliability Report displays the graphs that are accessed via the **Plots** menu on the [Cost of Unreliability Analysis Summary page](#). The following image shows an example of a Total Cost Pareto Chart graph.

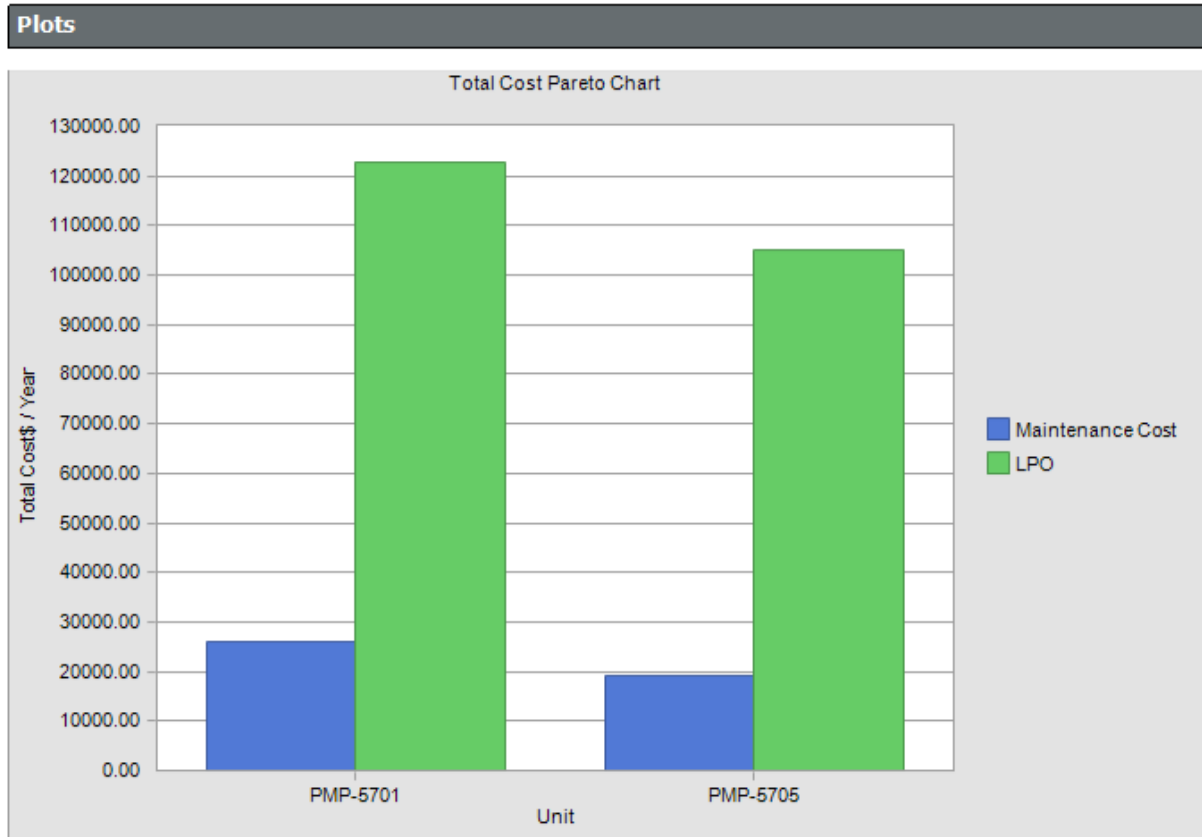

The **Plots** section of the Cost of Unreliability Report displays the following graphs:

- [Total Cost Pareto Chart](#)
- [Mean Time Between Failures Pareto Chart](#)
- [Mean Time To Repair Pareto Chart](#)
- [Availability Pareto Chart](#)
- [Number of Failures Pareto Chart](#)
- [Downtime Pareto Chart](#)

Results of a Cost of Unreliability Analysis

The Cost of Unreliability Analysis works much like a Distribution or Growth Analysis. The analysis can be based on a query or dataset, or the data can be entered manually. After the analysis is built, it is stored in the database and displayed in a list of the existing Cost of Unreliability Analyses for further analysis. If data is brought into the Cost of Unreliability analysis from a query, then results are automatically updated with the new data that has entered the Meridium APM database since the document was originally constructed.

The results of the Cost of Unreliability Analysis appear on the summary page and include the following properties:

- **Number of Units:** The number of production units included in the analysis.
- **Number of Failures:** The number of failure events that occurred in the units being analyzed.
- **Maintenance Cost:** The maintenance cost due to failures.
- **LPO:** The profit that the company lost when the production failed in an oversold market. It represents the difference between the market price of the product and the cost of producing it.
- **Total Cost:** The total cost associated with the failure event (includes parts, labor, LPO, etc.). It may be calculated in a query or a field in the database.
- **Availability:** The percentage of the time that the unit is productive.
- **MTBF:** The Mean Time Between Failures for the units being analyzed.
- **MTTR:** The Mean Time to Repair, i.e., the average amount of time that it takes to restart the production unit(s) after a failure occurs.
- **Downtime:** The amount of time that an item is not available for any reason.

In addition to the results shown on the summary page, a Cost of Unreliability Analysis generates the following graphs, which show all the data in a dynamic format:

- Cost Pareto
- MTBF Pareto
- MTTR Pareto
- Failures Pareto
- Downtime Pareto

In addition a Trend Plot can be generated that shows the MTBF for a set of equipment or locations over time. You can view the underlying plot data by clicking the **Show Plot Data** link on the **Plot Options** menu while you are viewing a plot. The numeric results are presented in a grid.

Saving Changes to an Existing Analysis

You must save an analysis any time you make changes that you want to retain. The following instructions provide details on saving changes to an existing analysis. You can use these instructions on any page where you see the **Save Analysis** link enabled on the **Common Tasks** menu. These instructions assume that the analysis has already been saved when it was originally created.

To save changes to an existing analysis:

- On the **Common Tasks** menu, click the **Save Analysis** link.

Your changes are saved to the existing analysis.

Copying an Analysis

You can use the **Save Analysis As** option to save an existing analysis with a different name. This will create two copies of the analysis: one with the original name and one with the new name.

To copy an existing analysis and save it with a different name:

1. On the analysis summary page of the analysis you are currently viewing, on the **Common Tasks** menu, click the **Save Analysis As** link.

The **Save Analysis As** dialog box appears.

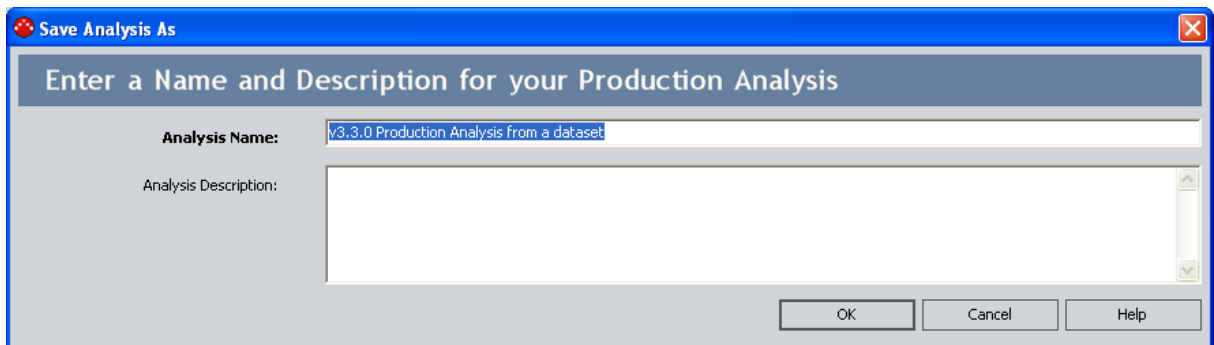

Note: When you access this dialog box from the **Cost of Unreliability Analysis** page, it is called the **Save Analysis** dialog box. The features and functions, however, are the same as shown in the preceding image.

2. In the **Analysis Name** text box, type the name that you want to use for the analysis copy. The name is required and must be unique for the type of analysis you are saving.
3. If desired, in the **Analysis Description** text box, type a description of the analysis.
4. Click **OK**.

The Meridium APM system creates a copy of the analysis and returns you to the page from which you initiated the Save As operation.

Renaming an Analysis

You can change the name of an analysis via the **Rename Analysis** dialog box. You can access this dialog box:

- By clicking the **Rename** link on the Analysis Tasks menu on the [Reliability Growth Analysis page](#), the [Probability Distribution Results page](#), and the [Cost of Unreliability Analysis page](#).

-or-

- By clicking the **Rename Analysis** link on the [Production Analysis page](#).

To rename an analysis:

1. On the appropriate page and task menu, click the **Rename** or **Rename Analysis** link.

The **Rename Analysis** dialog box appears.

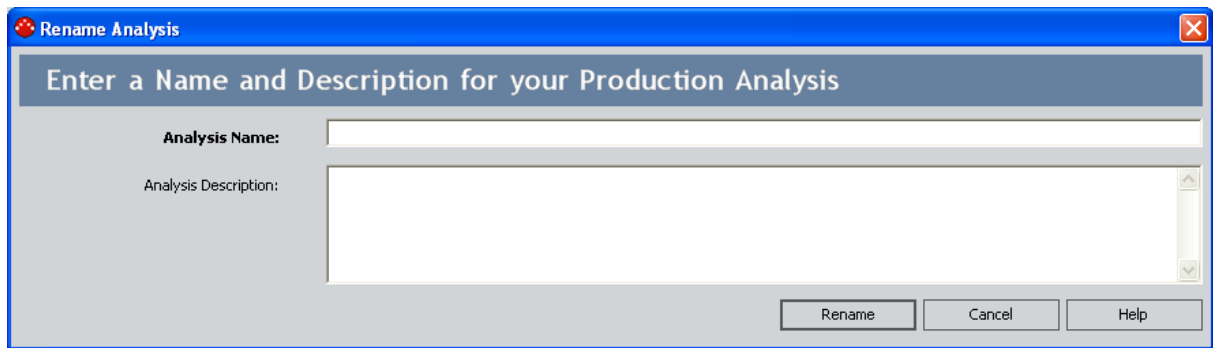

2. In the **Analysis Name** text box, type a new name for the analysis.
3. If desired, in the **Analysis Description** text box, type a new description for the analysis.
4. Click the **Rename** button.

The analysis name is updated in any appropriate sections on the summary page and in the site map to reflect the change. In addition, the Description field in any appropriate sections will reflect any changes.

5. Click the **Save** link on the appropriate task menu to save the changes to the analysis name.

Note: While your changes appear as soon as you close the **Rename** dialog box, the new name is not actually saved until you [save the analysis](#).

Setting the Confidence Level for an Analysis

For [Reliability Growth](#), [Reliability Distribution](#), and [Probability Distribution](#) Analyses, the confidence level specifies how the optimistic and realistic scenarios will be selected in a Monte Carlo Simulation. The confidence level will be checked against the number of iterations to ensure that the confidence limits are statistically significant. The default Confidence Level for an analysis is 90 percent.

Note: Confidence is not calculated for TTR distributions.

The following instructions provide details on setting the confidence level for these analysis types. Note that you can also [define the level of confidence for System Reliability Analyses](#), but these instructions do not apply to that analysis type.

To set the confidence level for an analysis:

1. On the summary page of the analysis you are currently viewing, click the **Confidence Level** link on the appropriate task menu.

OEHint: The **Confidence Level** link is located on the **Current Analysis, Analysis Tasks, or Distribution Options** task menu, depending upon the type of analysis you are viewing.

The **Confidence Level** dialog box appears.

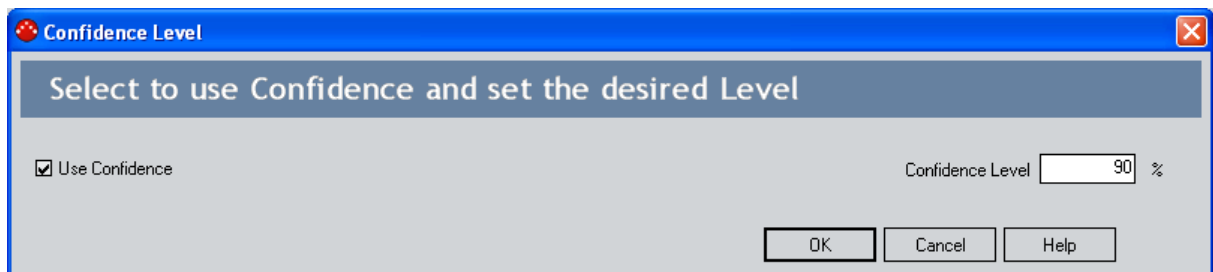

2. Select the **Use Confidence** check box to activate the Confidence Level and enable the Confidence Level field.
3. In the Confidence Level field, enter a numeric value between zero (0) and 100 to represent the desired Confidence Level.
4. Click **OK**.

The Meridium APM system calculates the confidence intervals for the analysis based on the percentage you entered in the Confidence Level field.

Changing the Distribution Type

When you create a Reliability Distribution Analysis or a Probability Distribution Analysis, the distribution type is set to Weibull by default. After the analysis is created, you can change the distribution type, if desired.

You can change the fit method via the **Distribution Type** dialog box. You can access this dialog box:

- For a Reliability Distribution Analysis by clicking the **Distribution Type** link on the **Analysis Tasks** menu on the [Time To Failure Distribution page](#) or the [Time to Repair Distribution page](#).
- or-
- For a Probability Distribution Analysis by clicking the **Distribution Type** link on the **Distribution Options** menu on the [Probability Distribution Results page](#).

To change the distribution type:

1. On the appropriate page and task menu, click the **Distribution Type** link.

The **Distribution Type** dialog box appears.

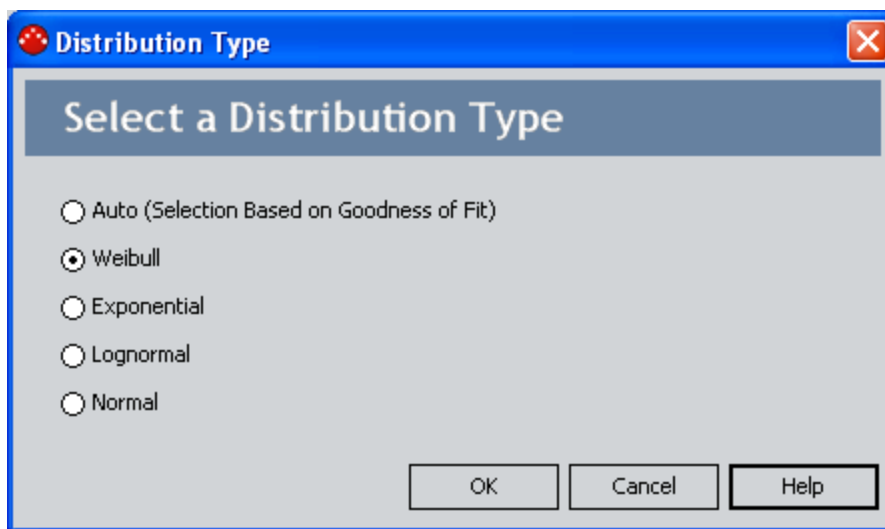

2. On the **Distribution Type** dialog box, select: **Auto**, **Weibull**, **Normal**, **LogNormal**, or **Exponential**.

CE Hint: Select **Auto** if you want the Meridium APM system to select the appropriate distribution type based on the results of the Goodness of Fit test.

3. Click **OK**.

The analysis is recalculated based on the selected distribution type.

Modifying the Fit Method

The [Kolmogorov-Smirnov test](#) is a Goodness of Fit (GOF) test applied to Reliability Distribution and Probability Distribution Analyses to determine how well the data fits the analytical curve. When you create an analysis, the fit method is set to Least Squares by default. After you have created an analysis, you can modify the fit method using the instructions in this topic.

The method of fit for a Distribution Analysis can be:

- **Least Squares:** A curve-fitting estimation method that relies on linear regression techniques to estimate the parameters for the distribution.
- **Maximum Likelihood Estimators:** A curve-fitting estimation method that maximizes the likelihood function for a given population. This method includes a survivor function that estimates changes in reliability as the piece of equipment or location survives beyond a certain age.

To modify the fit method:

1. On the analysis summary page of the analysis you are currently viewing, click the **Fit Method** link on the appropriate task menu.

 **Hint:** The **Fit Method** link is located on the **Analysis Tasks** or **Distribution Options** task menu, depending upon the type of Distribution Analysis you are viewing.

The **Fit Method** dialog box appears.

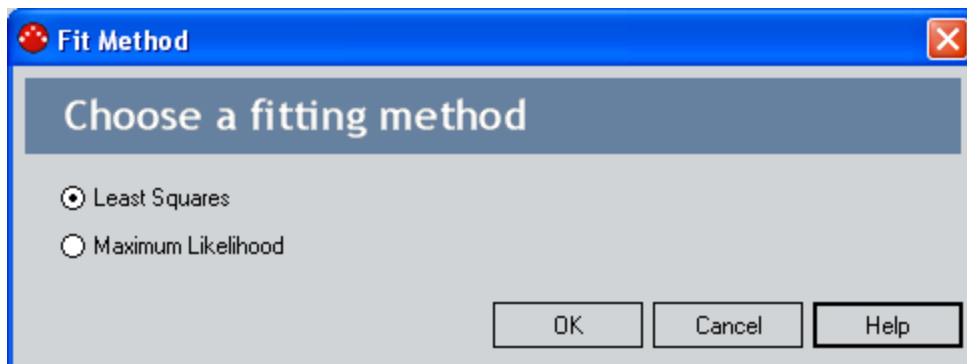

2. On the **Fit Method** dialog box, select the **Least Squares** or **Maximum Likelihood** option.
3. Click **OK**.

The analysis is recalculated based on the selected fit method.

Changing the Distribution Parameters

In Reliability Distribution Analyses and Probability Distribution Analyses, the parameters of the distribution are defined on the **Distribution Parameters** dialog box.

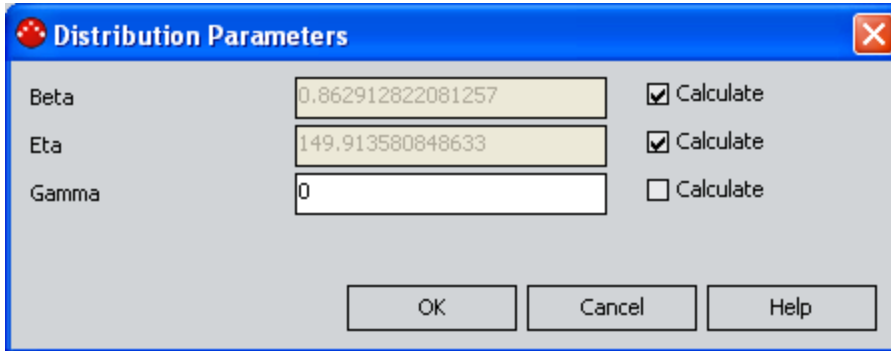

Parameter	Value	Calculate
Beta	0.862912822081257	<input checked="" type="checkbox"/>
Eta	149.913580848633	<input checked="" type="checkbox"/>
Gamma	0	<input type="checkbox"/>

You have the option of specifying that these values should be calculated automatically or manually specifying values for the Beta, Eta, and Gamma parameters. On the **Distribution Parameters** dialog box, the **Calculate** check box is selected for any parameter that has been calculated by the system. By clearing the **Calculate** check box, you can enable the corresponding parameter text box and enter a different value.

You can access the **Distribution Parameters** dialog box:

- For Reliability Distribution Analyses by clicking the **Change** link in the **Distribution Parameters** section of the [Time To Failure Distribution page](#) or the [Time to Repair Distribution page](#).
- or-
- For Probability Distribution Analyses by clicking the **Parameters** link on the **Distribution Options** menu on the [Probability Distribution Results page](#).

To modify the distribution parameters:

1. Click the appropriate link on the appropriate page.

The **Distribution Parameters** dialog box appears.

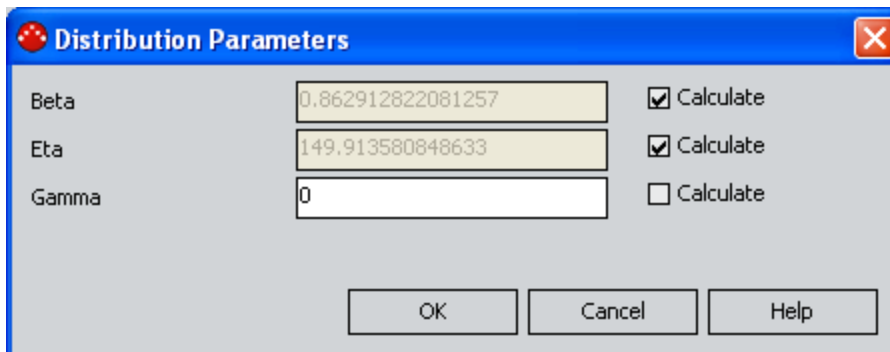

Parameter	Value	Calculate
Beta	0.862912822081257	<input checked="" type="checkbox"/>
Eta	149.913580848633	<input checked="" type="checkbox"/>
Gamma	0	<input type="checkbox"/>

Changing the Distribution Parameters

2. Clear the **Calculate** check box next to the parameter(s) whose value you want to modify.

The parameter field(s) are enabled.

3. Type the desired value for the parameter.
4. Click **OK**.

Note: If you reselect the **Calculate** check box after manually entering data and then click **OK**, the manually entered data for the parameter will not be retained. If you decide not to use the parameters you entered, click **Cancel**, and the previous selection will be used in the calculations.

The system recalculates the analysis based on the selected distribution parameter.

Modifying the Analysis Period

In [Reliability Growth](#), [Reliability Distribution](#), and [Unreliability Cost](#) Analyses, the analysis period specifies the date range over which an analysis occurs. The start date specifies the first date of the analysis and the end date specifies the last date of the analysis. The default analysis period has a start date equal to the first failure date and an end date equal to the current date. When the default analysis period is used, each time you open an analysis, the end date is updated to the current date. You can adjust the analysis period to focus the analysis on a specific period of time.

The following instructions provide details on modifying the analysis period in these analysis types. Note that you can also [modify the analysis period for a Spares Analysis](#), but these instructions do not apply to that analysis type.

To modify the current analysis period:

1. On the summary page of the analysis you are currently viewing, click the **Analysis Period** link on the appropriate task menu.

CEHint: The **Analysis Period** link is located on the **Analysis Tasks** or the **Current Analysis** task menu, depending upon the type of analysis you are viewing.

The **Analysis Period** dialog box appears.

2. Clear the **Start Date** check box, and then type or select the desired date.

Note: To ensure that all failure dates appear on the plots, make sure the start date is *before* the date associated with the first datapoint. Only failures that occur *after* the start date will appear on the plots.

3. Clear the **End Date** check box, and then type or select the desired date.
4. Click **OK**.

The Meridium APM system saves the analysis period and recalculates the analysis using the selected dates.

Note: If you want to change the analysis period back to the default analysis period, select the **Start Date** and **End Date** check boxes.

Choosing the Time Units for an Analysis

For [Reliability Growth](#) and [Reliability Distribution](#) Analyses, the time units are used for expressing time values for calculations performed within the analysis. For example, a calculation may indicate the amount of time that elapsed between a failure event and the end date of the analysis period. This value would be expressed in the Time Units for the analysis.

Your Time Units selection will depend on what type of data you are using and what type of analysis you are performing. For example, in an analysis that shows the distribution of failures for a number of equipment or locations over many years, *years* might be an appropriate unit of time. For an analysis designed to evaluate failures for a single piece of equipment or location within a very specific time period, a smaller unit of time would be appropriate. For this reason, you have the option of choosing the Time Units that are most appropriate for a given analysis.

Note: Downtime for TTF calculations should always be provided using days. When the failure data contains downtime, the system selects **Days** by default.

The following instructions provide details on modifying the time units for a Reliability Growth or Reliability Distribution Analysis. Note that you can also [modify the time units for a System Reliability Analysis](#), but these instructions do not apply to that analysis type.

To change the time units for an analysis:

1. On the **Reliability Growth Analysis** page, on the **Current Analysis** menu, click the **Time Units** link.

-or-

On the **Reliability Distribution Summary** page, on the **Analysis Tasks** menu, click the **Time Units** link.

The **Time Units** dialog box appears.

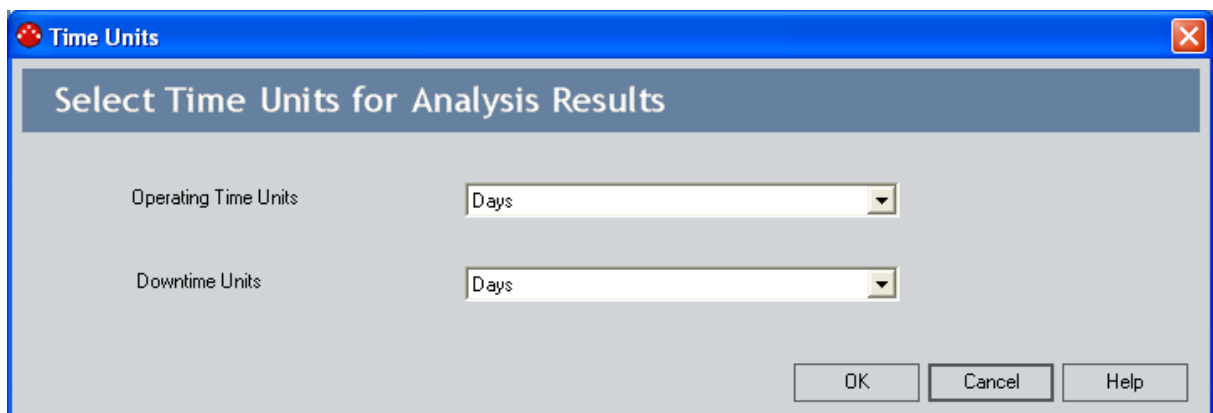

2. On the **Time Units** dialog box, in the **Operating Time Units** list, select **Days, Years, Quarters, Months, Weeks, or Hours**.
3. In the **Downtime Units** list, select **Days, Years, Quarters, Months, Weeks, or Hours**.
4. Click **OK**.

The Meridium APM system automatically recalculates the analysis based on the new time units and displays the new units on the plot pages and the summary page.

Modifying Analysis Data via the Failure Data Window

You can use the **<Measurement> Data** window to modify the data in any enabled field. This allows you to correct errors in the data or adjust data as needed. Note that only certain fields in the **<Measurement> Data** window can be modified. Fields that contain calculations by the Meridium APM system are disabled.

Datasheet	Asset ID	Date	Time (Da...	Downtim...	Failures	Ignore	Remarks	Cumulati...	Segment
view	000000000...	9/2/1992	0	0	1	<input checked="" type="checkbox"/>		0	
view	000000000...	2/26/1995	0	0	1	<input checked="" type="checkbox"/>		0	
view	000000000...	7/20/1998	0	0	1	<input type="checkbox"/>		0	
view	000000000...	12/14/1998	147	0	1	<input type="checkbox"/>		147	
view	000000000...	2/7/1999	202	0	1	<input type="checkbox"/>		202	
view	000000000...	6/26/1999	341	0	1	<input type="checkbox"/>		341	
view	000000000...	8/1/1999	376.7	0	1	<input type="checkbox"/>		376.7	
view	000000000...	9/5/1999	411.8	0	1	<input type="checkbox"/>		411.8	
view	000000000...	1/1/2001	895.8	0	1	<input type="checkbox"/>		895.8	
view	000000000...	1/2/2001	896.6	0	1	<input type="checkbox"/>		896.6	
view	000000000...	2/7/2002	1297.6	0	1	<input type="checkbox"/>		1297.6	
view	000000000...	7/11/2002	1451.9	0	1	<input type="checkbox"/>		1451.9	
view	000000000...	12/10/2002	1603.6	0	1	<input type="checkbox"/>		1603.6	
view	000000000...	5/12/2003	1756.6	0	1	<input type="checkbox"/>		1756.6	
view	000000000...	7/2/2003	1807.6	0	1	<input type="checkbox"/>		1807.6	
view	000000000...	11/28/2005	2687.6	0	1	<input type="checkbox"/>		2687.6	
view	000000000...	1/30/2006	2750.6	0	1	<input type="checkbox"/>		2750.6	
* view	(none)					<input type="checkbox"/>			

When you modify data and click **OK**, the analysis will be updated to reflect any changes that you made.

- For an analysis that is based upon manually entered data, the changes that you make via the **<Measurement> Data** window will be saved for the analysis.
- For an analysis that is based upon a query or a dataset, the query or dataset will not be modified with the updated data. Additionally, any record returned by the query will not be updated with your changes. The changes will be saved to the analysis *only*.

After you modify the data and save the analysis, the modified data will appear each time you open the analysis. If you want to revert to the original data, you can [reload the](#)

[original data](#) to the analysis. In addition, if a query or dataset has changed in the database, you can reload the data in order for your analysis to contain those changes.

Reloading Analysis Data

When you create and save analyses that are based on a query or dataset, the Meridium APM system takes a snapshot of the data that exists at the time of creation and saves it along with the analysis. When you open an existing analysis, the Meridium APM system loads the data that was last saved with the analysis. This means that any changes to the underlying query or dataset will not be reflected automatically when you open an existing analysis.

Note: If the query or dataset has been deleted or renamed, when you try to open an associated analysis, an error message will be displayed, and the data will not be refreshed.

If you want to refresh an analysis based upon changes to the underlying query or dataset or to load new data that has been added since the analysis was last saved (e.g., the analysis is based on a query that retrieves failures for a piece of equipment or location, and a new failure record has been added to the database), you will need to reload the analysis manually after opening it.

The instructions in this topic provide details on reloading a reliability analysis. This feature is available for the following analyses types:

- [Production Analyses.](#)
- [Reliability Growth Analyses.](#)
- [Reliability Distribution Analyses.](#)
- [Production Analyses.](#)
- [Probability Distribution Analyses.](#)
- [Cost of Unreliability Analyses.](#)

Note: Reloading analysis data resets the analysis period only if it is based on the analysis data. Start Dates and End Dates that have been set explicitly will not be overwritten.

To reload an analysis to display the most recent data:

1. On the summary page of the analysis you are currently viewing, click the **Reload Data** link.

Hint: The **Reload Data** link is located on the **Analysis Tasks** or **Current Analysis** task menu, depending upon the type of analysis you are viewing.

A confirmation message appears, asking if you want to overwrite the current data with the data stored in the database.

2. Click **OK**.

The analysis is updated to reflect the data currently stored in the query or dataset.

Note: If you are reloading analysis data that is based on a query and an index out of range error message appears, there is an error in the query. You should modify the query or recreate the analysis in order to reload the correct data.

Generating a Report for an Analysis

By generating a report for an analysis, you are converting the analysis into a format that can be printed. When you generate a report for an analysis, you will be given various options for what you can include in the report, such as a cover page and specific information about the analysis. The selections will vary, depending upon which analysis you are printing. Likewise, the selections you make will depend upon your printing needs.

The following instructions provide details on generating reports for the following analysis types:

- Production Analysis.
- Reliability Growth Analysis.
- Reliability Distribution Analysis.
- Probability Distribution Analysis.
- Cost of Unreliability Analysis.

The steps for [creating a report in a System Reliability Analysis](#) or a [Spares Analysis](#) differ from the steps to create a report in other analyses.

Note: Before you can generate a report for an analysis, you must save it to the database.

To generate a report for an analysis:

1. On the analysis summary page of the analysis you are currently viewing, click the **Generate Report** link.

CEHint: The **Generate Report** link is located on the **Analysis Tasks** or **Current Analysis** task menu, depending upon the type of analysis you are viewing.

The **Report Options** dialog box appears.

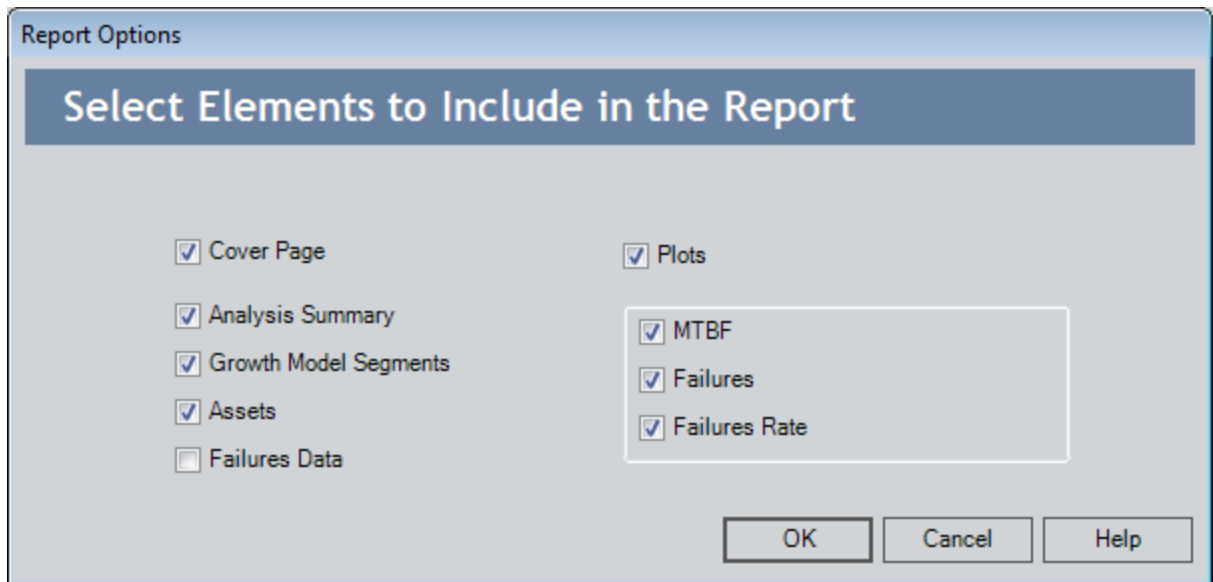

The specific options that you see on the **Report Options** dialog box will vary, depending on which type of analysis you are printing.

2. Select the check boxes next to the items that you want to include in the report. Note that some options are selected by default. You can clear the check box for any item that you do not want to include the report.
3. Click **OK**.

The report appears on the Report Viewer page.

About Publishing and Unpublishing Analyses

Reliability analyses contain a field that lets you flag each analysis as either *published* or *unpublished*. If the **Published** flag is selected, the analysis is considered to be *published*. If the **Published** flag is not selected, the analysis is considered to be *unpublished*. The **Published** flag is meant to indicate to other users the state of a given analysis. New analyses are unpublished by default.

The **Published** flag is provided to let you customize the analysis list to display only published analyses, only unpublished analyses, or both. Each of the default analysis list queries ([Probability Distribution](#), [Reliability Distribution](#), [Reliability Growth](#), [Systems Reliability](#), [Unreliability Cost](#), and [Spares](#)) contains a **Published Analyses** prompt, which lets you filter the analysis list on the value of the **Published** flag in each analysis.

Note: The baseline analysis list queries are stored in the Meridium APM Catalog in the following folder: Public\Meridium\Modules\Reliability Manager\Analyses. While they are configured by default to contain the **Published Analyses** prompt, you can customize the queries to meet the specific needs of your implementation.

After you run the analysis list query and display the desired results in the analysis list, you can publish or unpublish any analysis from the following pages:

- [Select a Growth Analysis from the Listpage.](#)
- [Select a Distribution Analysis from the Listpage.](#)
- [Probability Distribution Listpage.](#)
- [Select a System Reliability Analysis from the Listpage.](#)
- [Select a Cost of Unreliability Analysis page.](#)
- [Select a Spares Analysis from the List page.](#)

Note that the **Published** flag is not available on the analysis summary page, only the analysis list page. You can also modify the value of this flag by opening the analysis record in Record Manager and modifying the value in the **Published** field of the record.

Note: There are no baseline permissions or recommended workflows that determine who can publish and unpublish analyses or that define when analyses should be published or unpublished. By default, any user can publish or unpublish any analysis at any time.

Publishing Analyses

To publish an analysis that is currently unpublished:

1. On the appropriate analysis list page, in the list of analyses, select one or more unpublished analyses that you want to publish.

Note: The **Common Tasks** link will appear as **Publish Analyses** only when you select an unpublished analysis. Otherwise, the link will appear as **Unpublish Analyses**. If you select a combination of published and unpublished analyses, the name of the link will be appropriate for the *last* analysis in the list. Clicking the link will perform that action for ALL the analyses. Therefore, to publish all analyses, you should select only unpublished analyses.

2. On the **Common Tasks** menu, click the **Publish Analyses** link.

A confirmation message appears, asking if you really want to publish the selected analysis.

3. Click the **Yes** button.

The analysis is published.

Note: If you selected multiple analyses, a confirmation message appears for each analysis. Respond to the confirmation messages, as desired, until all the analyses have been published.

Unpublishing Analyses

To unpublish an analysis that is currently published:

1. On the appropriate analysis list page, in the list of analyses, select one or more analyses that you want to publish.

Note: The **Common Tasks** link will appear as **Unpublish Analyses** only when you select a published analysis. Otherwise, the link will appear as **Publish Analyses**. If you select a combination of published and unpublished analyses, the name of the link will be appropriate for the *last* analysis in the list. Clicking the link will perform that action for ALL the analyses. Therefore, to unpublish all analyses, you should select only published analyses.

2. On the **Common Tasks** menu, click the **Unpublish Analyses** link.

A confirmation message appears, asking if you really want to unpublish the selected analysis.

3. Click the **Yes** button.

The analysis is unpublished.

Note: If you selected multiple analyses, a confirmation message appears for each analysis. Respond to the confirmation messages, as desired, until all the analyses have been unpublished.

Customizing the Display of Plots

You can customize the graph properties in the following ways:

- **Displaying logarithmic scales.** This is especially helpful for the y-axis of the Failure Rate plot, where very small values cannot be shown beside much larger values. Note that the **Probability** plot has a special built-in scaling and should not be changed under normal circumstances.
- Zooming in on a plot area.
- **Resetting the plot display.** If you change any setting on a plot, all user-defined settings will be saved with the analysis. Note that if labels and scaling are modified, they will no longer be dynamic. If you reset the plot display, you delete all user-defined settings and revert to the original chart configuration.

Note: Resetting the plot is a specific feature of Reliability Analytics and is not common to standard Meridium APM graphs.

To reset the display of the plot while you are viewing it:

- Right-click the background of the plot, and select the **Reset Chart Format** option from the shortcut menu.

The system applies the default settings to the plot.

Working with Data Censoring in Analyses

[Reliability Distribution](#) and [Probability Distribution Analyses](#) support the functionality of right-censoring, which accounts for the period of time from the last failure date to the analysis end date. You can censor datapoints in a Distribution Analysis to update the Time To Failure (TTF) values to exclude it as a failure but include the operating time of the piece of equipment or location.

For example, part of a piece of equipment could need replacing for maintenance reasons that are represented in your analysis by a datapoint. You can censor that datapoint since you do not know when the piece of equipment *would have failed* if this replacement had not occurred, but you still want to take into account the time that the piece of equipment did operate for calculation purposes.

When you censor datapoints on an analysis, the graph will shift up or down to account for the updated TTF values.

To censor datapoints in a Distribution analysis:

- For a Reliability Distribution or Probability Distribution Analysis, while viewing one of the following plots, right-click the desired datapoints and select **Censored**.
 - Probability Plot.
 - Failure Rate Plot.
 - Probability Density Function Plot.
 - Cumulative Density Function Plot.
- or-
- For a Distribution Analysis, on [the Failure Data window](#), select the **Censored** check box for the desired datapoints.

Datasheet	Asset ID	Failure D...	TTF	Downtime	Ignore	Remarks	Censored	(Taxono...	(Maintai...
view	G0014-037	2/25/2001	0	126	<input type="checkbox"/>		<input checked="" type="checkbox"/>	Centrifugal ...	SEALS - RO...
view	G0014-037	5/18/2001	0	270	<input checked="" type="checkbox"/>		<input type="checkbox"/>	Centrifugal ...	SEALS - RO...
view	G0014-037	7/19/2001	0	40.8	<input checked="" type="checkbox"/>		<input type="checkbox"/>	Centrifugal ...	SEALS - RO...
view	G0014-037	9/3/2001	0	216	<input checked="" type="checkbox"/>		<input type="checkbox"/>	Centrifugal ...	SEALS - RO...
view	G0014-037	1/3/2002	0	54	<input checked="" type="checkbox"/>		<input type="checkbox"/>	Centrifugal ...	SEALS - RO...
view	G0014-037	4/16/2002	0	456	<input checked="" type="checkbox"/>		<input type="checkbox"/>	Centrifugal ...	SEALS - ME...
view	G0014-037	7/7/2002	0	0	<input checked="" type="checkbox"/>		<input type="checkbox"/>	Centrifugal ...	SEALS - ME...
view	G0014-037	8/1/2002	0	40.8	<input checked="" type="checkbox"/>		<input type="checkbox"/>	Centrifugal ...	SEALS - CA...
view	G0014-037	1/21/2003	689.45	20.4	<input type="checkbox"/>		<input type="checkbox"/>	Centrifugal ...	SEALS - CA...
view	G0014-037	3/21/2003	0	270	<input checked="" type="checkbox"/>		<input type="checkbox"/>	Centrifugal ...	SEALS - CA...
view	G0014-037	6/3/2003	0	244.8	<input checked="" type="checkbox"/>		<input type="checkbox"/>	Centrifugal ...	SEALS - CA...
view	G0014-037	7/27/2003	0	285.6	<input checked="" type="checkbox"/>		<input type="checkbox"/>	Centrifugal ...	SEALS - CA...
view	G0014-037	10/29/2003	0	72	<input checked="" type="checkbox"/>		<input type="checkbox"/>	Centrifugal ...	SEALS - CA...
view	G0014-037	11/11/2004	659.05	336	<input type="checkbox"/>		<input type="checkbox"/>	Centrifugal ...	SEALS - CA...
view	G0014-037	2/26/2005	0	144	<input checked="" type="checkbox"/>		<input type="checkbox"/>	Centrifugal ...	SEALS - CA...
view	G0014-037	10/5/2006	679	168	<input type="checkbox"/>		<input type="checkbox"/>	Centrifugal ...	SEALS - CA...
view	G0014-037	10/11/2007	0	162	<input checked="" type="checkbox"/>		<input type="checkbox"/>	Centrifugal ...	SEALS - FU...
view	G0014-037	1/25/2009	836	336	<input type="checkbox"/>		<input type="checkbox"/>	Centrifugal ...	SEALS - FU...
* view	(none)				<input type="checkbox"/>		<input type="checkbox"/>		

Additionally, when you first create a Reliability Distribution Analysis, an automatically censored datapoint for each defined piece of equipment or location will appear on the plot. Each automatically censored datapoint represents the analysis End Date (specified in the [Analysis Period dialog box](#)) for each defined piece of equipment or location.

Note: Probability Distribution Analyses do not use automatically censored datapoints.

For example, if the analysis contains three defined pieces of equipment, then three automatically censored datapoints will appear in each plot of a Reliability Distribution Analysis. If you change the analysis End Date (specified in the [Analysis Period dialog box](#)), then the plots will shift up or down to accommodate the updated analysis End Date and TTF values.

Note: Although automatically censored datapoints appear on the plots, they do not appear in the [Failure Data grid](#) and, therefore, cannot be uncensored.

When you pause on an automatically censored datapoint, the following information will appear:

- **Auto-Censored**
- **Name:** Specified on the [Asset tab](#) of the [Failure Data grid](#).
- **Installation Date:** Specified on the [Asset tab](#) of the [Failure Data grid](#).
- **TTF value:** Represents the time between the last failure date and the analysis End Date.

About Reliability Recommendations

When you perform an analysis in Reliability Analytics, you may determine that certain actions should be taken as a result of the analysis. For example, if the results of an analysis suggest that a piece of equipment is likely to fail soon, you may want to recommend that the piece of equipment be replaced.

These recommendations can be recorded in a Reliability Recommendation record and linked to the analysis. After Reliability Recommendation records have been created for an analysis, you will be able to [access the list of Recommendation records](#) associated with that analysis. From the list of Recommendation records, you can view the details of each Recommendation record.

Accessing the Recommendations Page

The [Recommendations page](#) serves as the starting point for accessing Recommendations functionality for a Reliability Analytics analysis. From the **Recommendations** page, you can view a summary of the existing Reliability Recommendation records, [create new Reliability Recommendation records](#), and [access the details of any Reliability Recommendation record](#).

To access the Recommendations page in Reliability Analytics:

- On the analysis summary page of the analysis you are currently viewing, click the **View Recommendations** link on the appropriate task menu.

OE Hint: The **View Recommendations** link is located on the **Current Analysis** or **Analysis Tasks** menu, depending on which type of analysis you are viewing.

-or-

On any page of a System Reliability Analysis that has been saved, click the **Recommendations** link on the [Tools menu](#).

The **Recommendations** page appears.

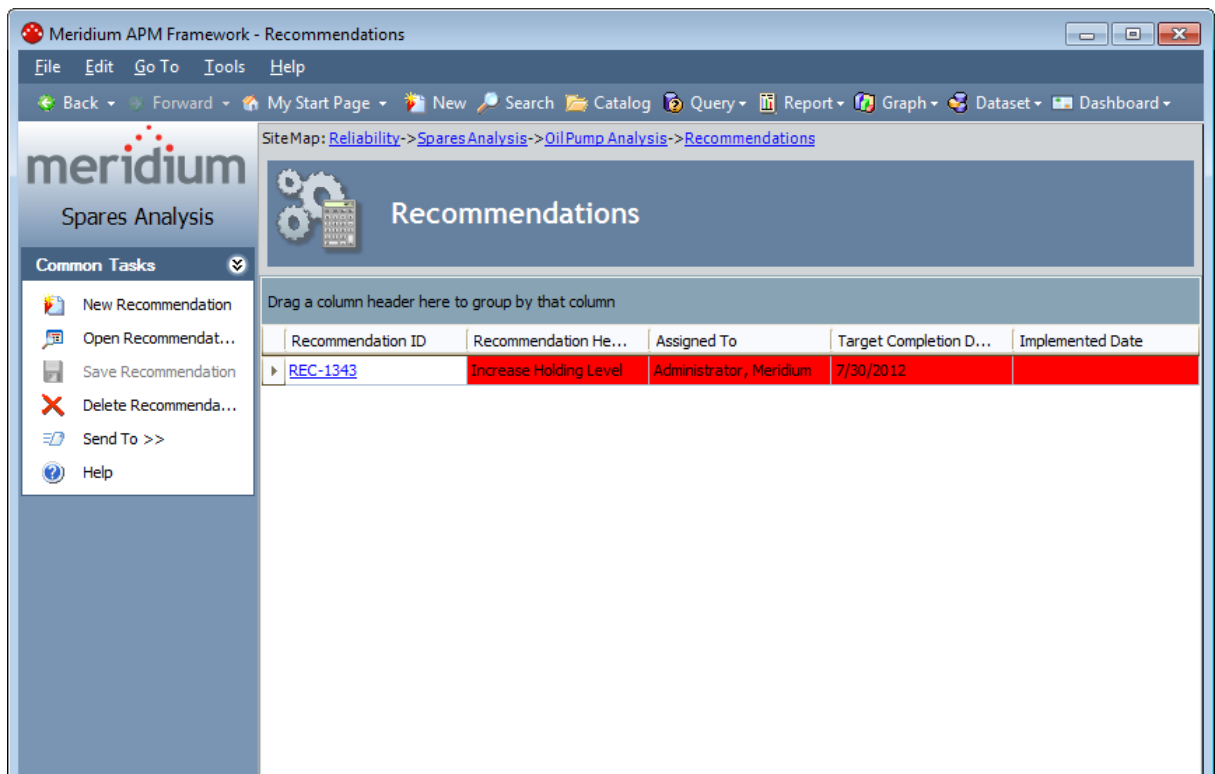

Aspects of the Recommendations Page

The **Recommendations** page displays a list of Reliability Recommendation records that are linked to a given Reliability Analytics analysis. The main display area contains a grid, which displays the list of Reliability Recommendation records.

Site Map: [Reliability](#)->[System Reliability](#)->[SubSystem](#)->[Recommendations](#)



Recommendations

Drag a column header here to group by that column

Recommendation ID 	Recommendation Headline	Assigned To	Target Completion Date	Implemented Date
Recommendation 1			5/15/2010	
Recommendation 2			5/11/2010	
Recommendation 3			5/10/2010	5/12/2010
Recommendation 4			5/29/2010	

By default, the grid contains the following columns of information:

- **Recommendation ID**
- **Recommendation Headline**
- **Assigned To**
- **Target Completion Date**
- **Implemented Date**

If desired, you can use the standard grid-customization feature to modify the appearance of the default display.

Each row in the list is color coded to indicate the status of the Reliability Recommendation record.

- **No color:** Indicates that the Reliability Recommendation record does not meet any of the following conditions.
- **Red:** Indicates that the Reliability Recommendation record is overdue. Recommendations are colored red when the Target Completion Date is on or before the current date.
- **Yellow:** Indicates that the Reliability Recommendation record is due in two weeks or less. Recommendations are colored yellow when the Target Completion Date is within 14 days of the current date.
- **Green:** Indicates that the Reliability Recommendation record has been completed.

About the Task Menus on the Recommendations Page

The [Common Tasks menu](#) on the **Recommendations** page offers options that are specific to the list of Reliability Recommendation records. The **Common Tasks** menu is always available on the **Recommendations** page and always contains the same options, regardless of the analysis type.

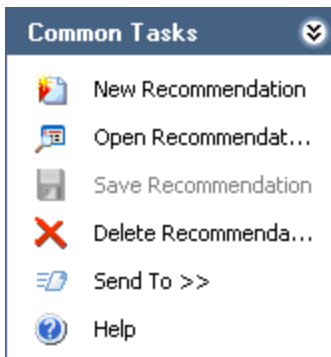

For the following analyses, the **Common Tasks** menu is the *only* task menu that appears on the **Recommendations** page:

- Production.
- Spares.
- System Reliability.

For the following analyses, the task menus that appear on the **Recommendations** page are specific to that type of analysis you are viewing, and their options are similar to those on the analysis summary page:

- Reliability Growth.
- Reliability Distribution.
- Probability Distribution.
- Unreliability Cost.

For example, if you are viewing the **Recommendations** page for a Reliability Distribution Analysis record, four task menus will be available: **Plots**, **Tools**, **Analysis Tasks**, and **Common Tasks**. The [Plots](#), [Tools](#), and [Analysis Tasks](#) menus are specific to the Reliability Distribution analysis and contain most of the same options that are available on the [Reliability Distribution Summary page](#).

Note: When you are viewing a Reliability Recommendation record, on the **Analysis Tasks** menu, the **View Summary** link appears in place of the **View Recommendations** link, which appears when you are viewing the analysis summary. Clicking this link will display the analysis summary for the current analysis.

Common Tasks Menu

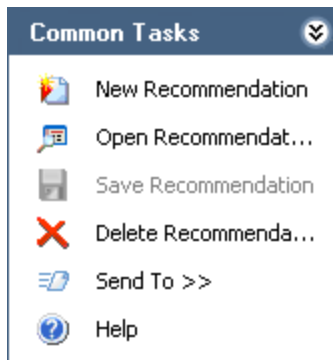

The **Common Tasks** menu on the **Recommendations** page contains the following links:

- **New Recommendation:** Displays the **Recommendation Details** page, displaying a [new Reliability Recommendation record](#). You can enter details for the record and then save it to the database.
- **Open Recommendation:** Opens the selected Reliability Recommendation record on the [Recommendation Details page](#).
- **Save Recommendation:** This link is always disabled on the [Recommendations page](#).
- **Delete Recommendation:** After asking for confirmation, deletes the selected Reliability Recommendation record(s).
- **Send To:** Displays a submenu with options that let you provide a link to the current page on your desktop (create shortcut), in an email message, or on a Home Page.
- **Help:** Displays the context-sensitive Help topic for the **Recommendations** page.

Aspects of the Recommendation Details Page

The **Recommendation Details** page displays the details of a Reliability Recommendation record. The main display area contains the Reliability Recommendation datasheet, which contains the **General Information** and **Alerts** tabs by default. You can use the fields in the datasheet to record information associated with the Reliability Recommendation record.

	Value(s)
Recommendation ID	REC-21
Recommendation Headline	Increase Holding Level
Recommendation Description	Increase Holding Level from 1 to 2
Recommendation Basis	Spares Analysis
Analysis ID	Oil Pump Analysis
Required Equipment Status	
Business Impact	
Target Completion Date	8/28/2009 12:00:00 AM
Mandatory Date	
Recommendation Priority	High (HIGH)
Status	Created (CREATED)
Author Name	Demo, Joe Demo
Reviewer Name	
Assigned To Name	Implementer, Implementer
Final Approver Name	
Implemented Date	
Equipment ID	
Technical Number	
Functional Location ID	

A toolbar appears above the datasheet and contains buttons that let you perform tasks associated with currently displayed Reliability Recommendation record. The following buttons are available:

 Displays a blank datasheet on the **Recommendation Details** page so that you can create a new Reliability Recommendation record. If you have not yet saved the change to the current record, the system first displays a message, asking if you want to save your changes.

 Saves the currently displayed Reliability Recommendation record.

 Saves the currently displayed Reliability Recommendation record and then immediately displays a blank datasheet on the **Recommendation Details** page so that you can create a new Reliability Recommendation record.

 After asking for confirmation, deletes the Reliability Recommendation record that is currently displayed.

 Copies the information from the currently displayed record and displays it in a new record so that you can create a new Reliability Recommendation record based on an existing record.

 Displays the **Preview** window, which shows a preview of how the Reliability Recommendation record will be printed. From the **Preview** window, you can print the record details.

 Displays the **Reference Documents** window, where you can view, edit, and create reference documents for the current record. This button is enabled only if the Reliability Recommendation family is related to the Reference Document family through the Has Reference Documents relationship.

 Displays **Field Change History** dialog box, which shows the change log for all the fields for which history is set to be kept.

About the Task Menus on the Recommendation Details Page

The [Common Tasks menu](#) on the **Recommendation Details** page offers options that are specific to the Reliability Recommendation record you are viewing. The **Common Tasks** menu is always available on the **Recommendation Details** page and always contains the same options, regardless of the analysis type.

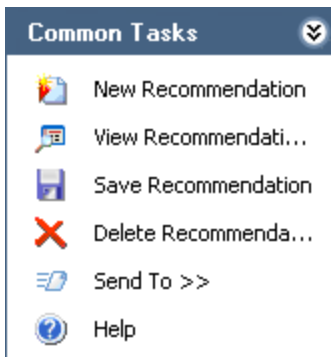

[The same task menus that are available for each analysis on the Recommendations page](#) are available on the **Recommendation Details** page. They are specific to that type of analysis you are viewing and their options are similar to those on the analysis summary page.

For example, if you are viewing the **Recommendation Details** page for a Reliability Recommendation record that is linked to a Reliability Distribution Analysis record, four task menus will be available: **Plots**, **Tools**, **Analysis Tasks**, and **Common Tasks**. The [Plots](#), [Tools](#), and [Analysis Tasks](#) menus are specific to the Reliability Distribution analysis and contain most of the same options that are available on the **Reliability Distribution Summary** page.

Note: When you are viewing a Reliability Recommendation record, on the **Analysis Tasks** menu, the **View Summary** link appears in place of the **View Recommendations** link, which appears when you are viewing the analysis summary. Clicking this link will display the analysis summary for the analysis to which the current Reliability Recommendation record is linked.

Common Tasks Menu

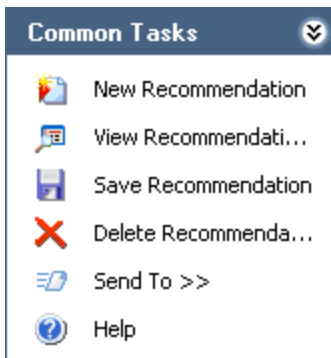

The **Common Tasks** menu on the [Recommendation Details page](#) contains the following links:

- **New Recommendation:** Displays a blank datasheet on the Recommendation Details page. You can enter details for the record and then save it to the database by clicking the **Save Recommendation** link.
- **View Recommendations:** Takes you to the [Recommendations page](#), which displays a list of all the Reliability Recommendation records that are linked to the current analysis.
- **Save Recommendation:** Saves the **Reliability Recommendation** record that you are currently viewing.
- **Delete Recommendation:** After asking for confirmation, deletes the currently displayed Recommendation record and then displays the **Recommendations** page.
- **Send To:** Displays a submenu with options that let you provide a link to the current page on your desktop (create shortcut), in an email message, or on a Home Page.
- **Help:** Displays the context-sensitive Help topic for the **Recommendations Details** page.

Creating a New Reliability Recommendation Record

You can create a new Reliability Recommendation record either from the [Recommendations page](#) or the [Recommendation Details page](#). Note that when you create a new Reliability Recommendation record, it will be linked automatically to the Reliability Analytics analysis for which it is created.

To create a new Reliability Recommendation record:

1. On the **Recommendations** or **Recommendation Details** page, on the **Common Tasks** menu, click the **New Recommendation** link.

The **Recommendation Details** page appears, displaying a blank Reliability Recommendation datasheet.

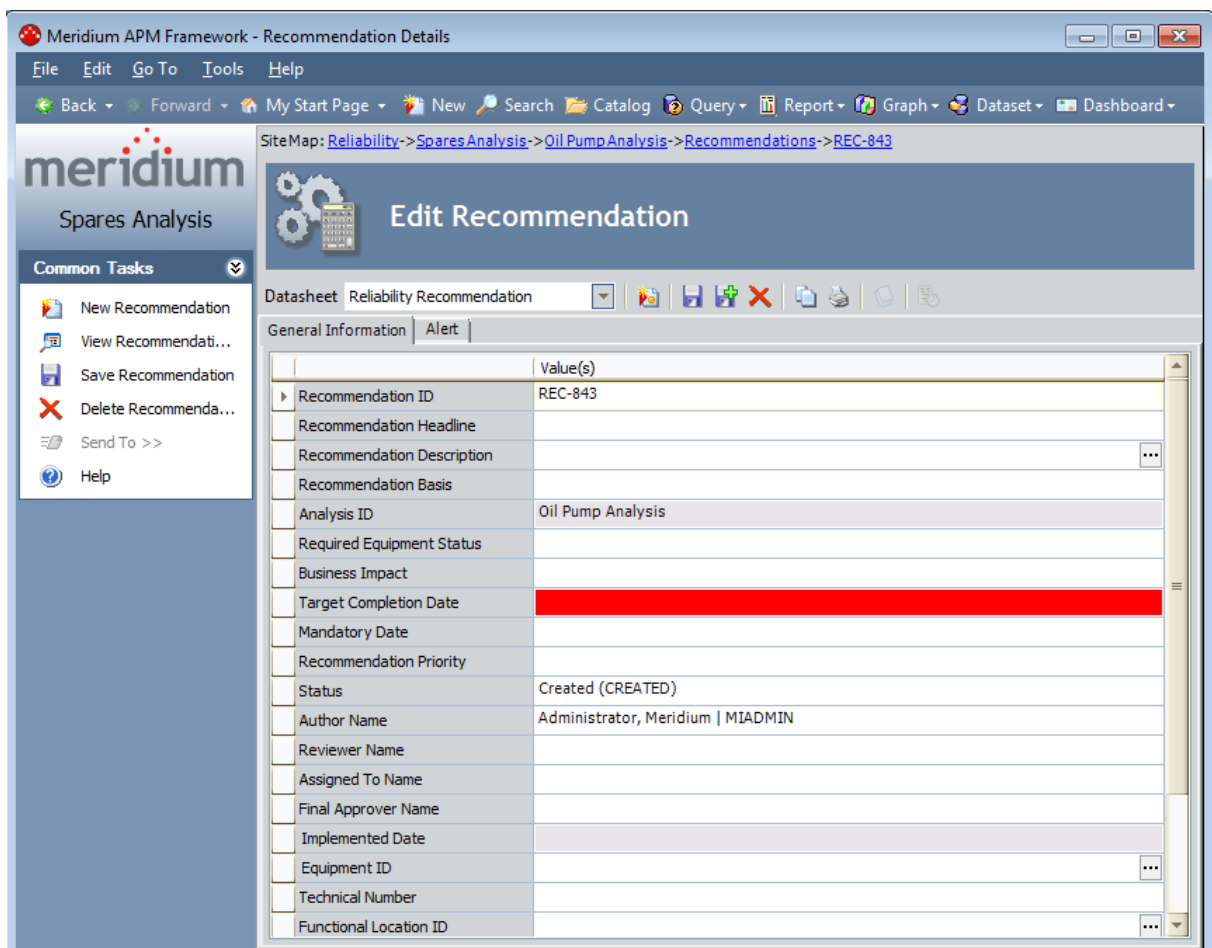

2. On the **General Information** tab, [enter values into any editable field](#).
3. If you want to notify the person responsible for completing the recommended action, click the **Alert** tab, and enter values as desired.
4. When you have finished defining all the properties of the Reliability

Recommendation record, on the **Common Tasks** menu, click the **Save Recommendation** link.

The Reliability Recommendation record is saved to the database and linked to appropriate analysis. If you filled out the appropriate fields on the **Alert** tab *and* the value in the Status field of the Reliability Recommendation record is *Approved* or *In Progress*, an Alert record that is associated with the analysis is created. This creates a scheduled item in the Schedule Manager, and an email message is sent to the specified recipient(s) according to the schedule defined on the **Alert** tab.

For example, if on January 5, 2005, you specify to send an email message to John Smith one day before the Target Completion Date, and the Target Completion Date is set to January 29, 2005, the Alert record and scheduled item would be created on January 5, 2005, but the email message would not be sent until January 28, 2005.

Fields in Reliability Recommendation Records

The following table provides information about Reliability Recommendation fields that are unique to Reliability Recommendation records (i.e., they do not exist on the Meridium General Recommendation datasheet).

Field	Data Type	Description	Behavior and Usage
Analysis ID	Character	The ID of the associated analysis.	This field is populated automatically with the Record ID of the analysis to which the Reliability Recommendation record will be linked when it is saved.
Assigned To Name	Character	The first and last name of the person who should perform the recommended action.	This field contains a list of all Security Users in the database, presented in the following format: <last name>, <first name>, <user ID>
Completion Comments	Text	Details about the completed recommendation.	This field is required when the value in the Status field is <i>Rejected</i> , <i>Superseded</i> , or <i>Cancelled</i> .
Final Approver Name	Character	The first and last name of the person who should approve the information in the Recommendation record after the recommended action has been performed.	This field contains a list of all Security Users in the database, presented in the following format: <last name>, <first name>, <user ID>
Recommendation Basis	Character	The reason the recommended action is needed.	You can type any value in this field.

Fields in Reliability Recommendation Records

Field	Data Type	Description	Behavior and Usage
Reviewer Name	Character	The first and last name of the person who should review the information in the Recommendation record before the recommended action is performed.	This field contains a list of all Security Users in the database, presented in the following format: <last name>, <first name>, <user ID>

Field	Data Type	Description	Behavior and Usage
Status	Character	The status of the recommendation.	<p>On the datasheet, the Status field contains a list of all System Codes in the MI_STATUS System Code Table that reference the CORE_RECOMMENDATION_STATUS System Code Table.</p> <p>The value in the Status field is set automatically to <i>Created</i> but can be changed if needed.</p> <p>You can change the status to:</p> <ul style="list-style-type: none"> ■ <i>Approved</i> only if your Security User information is stored in the Final Approver Name field. ■ <i>Reviewed</i> only if your Security User information is stored in the Reviewer Name field. ■ <i>Rejected, Cancelled, or Superseded</i> only if the Completion Comments field contains a value. The Completion Comments field is not, however, on the baseline Reliability Recommendation datasheet, so an administrative

Field	Data Type	Description	Behavior and Usage
			<p>user will need to add it to the data-sheet before you can select one of these three statuses.</p> <ul style="list-style-type: none"> ■ <i>In Progress</i> or <i>Implemented</i> only if you Security User information is stored in the Assigned To Name field. <p>Note that the value in the Status field is not related in any way to the <i>state</i> (per the State Configuration) of the Recommendation record.</p>

Opening an Existing Reliability Recommendation Record

To open an existing Reliability Recommendation record:

1. [Access the Recommendations page](#) for the appropriate analysis.

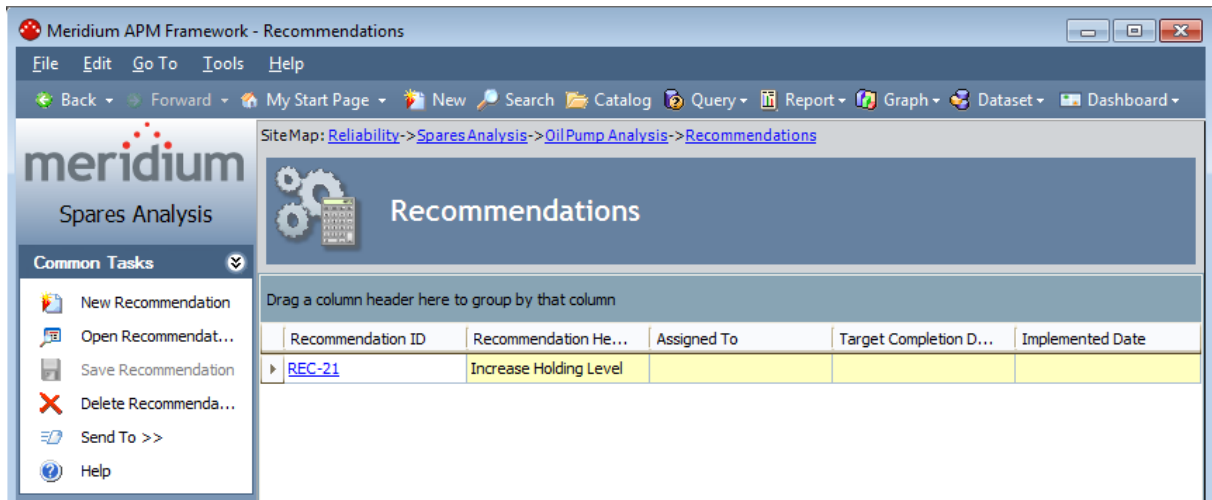

2. In the list of Reliability Recommendation records, click the hyperlinked **Recommendation ID** of the Reliability Recommendation record that you want to view.

The selected Recommendation record appears on the **Recommendation Details** page, where you can view and modify the record information, as desired.

Opening an Existing Reliability Recommendation Record

The screenshot displays the Meridium APM Framework interface for editing a recommendation record. The window title is 'Meridium APM Framework - Recommendation Details'. The breadcrumb trail is 'Reliability > Spares Analysis > Oil Pump Analysis > Recommendations > REC-21'. The main heading is 'Edit Recommendation'. The 'Datasheet' is set to 'Reliability Recommendation'. The 'General Information' tab is active, showing a table of fields and their values.

	Value(s)
Recommendation ID	REC-21
Recommendation Headline	Increase Holding Level
Recommendation Description	Increase Holding Level from 1 to 2
Recommendation Basis	Spares Analysis
Analysis ID	Oil Pump Analysis
Required Equipment Status	
Business Impact	
Target Completion Date	8/28/2009 12:00:00 AM
Mandatory Date	
Recommendation Priority	High (HIGH)
Status	Created (CREATED)
Author Name	Demo, Joe Demo
Reviewer Name	
Assigned To Name	Implementer, Implementer
Final Approver Name	
Implemented Date	
Equipment ID	
Technical Number	
Functional Location ID	

3. If you make any changes to the Reliability Recommendation record, on the [Common Tasks menu](#), click the **Save Recommendation** link to save your changes.

Deleting an Analysis

You can use the following instructions to delete any type of analysis in Reliability Analytics.

To delete an analysis:

1. In the list of analyses, click the **Analysis ID** of the analysis you want to delete.
2. On the **Common Tasks** menu, click the **Delete Analysis** link.

If you selected one item to delete, a message will appear asking you to confirm that you want to delete the analysis. Click the **Yes** button to delete the item.

-or-

If you selected multiple items to delete, a message will appear, listing the first selected item. You must confirm that you want to delete the item(s), either simultaneously or one at a time.

- To delete the entire group of selected items without further confirmation, click the **Yes to All** button.
- To delete one item at a time, click the **Yes** button to delete only the item that is currently marked for deletion.
- If there is an item that you selected that you do not want to delete, click the **No** button when the confirmation message appears.
- If you do not want to perform any deletions, click **Cancel**.

The analysis is removed from the list and deleted from the database.

About the Reliability Analytics Catalog Folder Structure

The Reliability Manager Catalog folders contain queries and reports that are used by Reliability Analytics to display information contained in the records that participate in the various Reliability Analytics data models. The Catalog folder \\Public\Meridium\Modules\Reliability Manager contains the following subfolders:

- **Analyses:** Contains queries that support the lists that are displayed on the following pages in Reliability Analytics:
 - [Select a Production Analysis from the List](#)
 - [Select a Spates Analysis from the List](#)
 - [Select a Growth Analysis from the List](#)
 - [Select a Distribution Analysis from the List](#)
 - [Probability Distribution List](#)
 - [Select a System Reliability Analysis from the List](#)
 - [Select a Cost of Unreliability Analysis](#)
 - [Automation Rule List Screen](#)
- **Queries:** Contains queries that you can use for creating Reliability Growth Analyses and Reliability Distribution Analyses from Associated Pages. These queries are not used in the baseline product but can be by custom Associated Pages.
- **Reports:** Contains SQL Server Reporting Services reports that display data and information for Reliability Analyses.
- **SSRS:** Contains SQL Server Reporting Services reports that are not used by the Meridium APM system. If you want to use these reports, use the matching reports that exist in the **Reports** folder.

Analyses Folder

The Catalog folder \\Public\Meridium\Modules\Reliability Manager\Analyses contains the following queries.

Query Name	Behavior and Usage
All Production Data	Returns fields from Production Data and Production Loss records. This query is used to map fields from records in the Production Loss Accounting module to the Production Data field in a Production Analysis record.
Automation Rules	After prompting you to select a Security User, returns a list of all Reliability Automation Rules that were last updated by that Security User. This query is run automatically on the Automation Rule List Screen .
Combined Production Data Codes	Combines the results of the Production Event Code - Max Loss, Production Impact Code - Max Loss, and Production OEE Code- Max Loss queries. The All Production Data query uses this query to map values from Production Event Code, Impact Codes, and OEE Code fields in Production Loss records to the Production Data field in a Production Analysis record.
Probability Distribution	After prompting for the published status and a Security User, returns a list of all Probability Distribution Analyses that meet the selected published criteria and were last updated by the selected Security User. This query is run automatically on the Probability Distribution List page .
Production Event Code - Max Loss	Returns the value in the Production Event field of a Production Loss record associated with a given date. If there are multiple Production Loss records for that date, this query retrieves the production event code associated with the highest loss.
Production Impact Code - Max Loss	Returns the value in the Impact Code field of a Production Loss record associated with a given date. If there are multiple Production Loss records for that date, this query retrieves the impact code associated with the highest loss.

Query Name	Behavior and Usage
Production OEE Code - Max Loss	Returns the value in the OEE Code field of a Production Loss record associated with a given date. If there are multiple Production Loss records for that date, this query retrieves the OEE code associated with the highest loss.
Production Weibull	After prompting for a Security User, returns a list of all Production Analyses that were last updated by the selected Security User. This query is run automatically on the Select a Production Analysis from the List page .
Reliability Distribution	After prompting for the published status and a Security User, returns a list of all Reliability Distribution Analyses that meet the selected published criteria and were last updated by the selected Security User. This query is run automatically on the Select a Distribution Analysis from the List page .
Reliability Growth	After prompting for the published status and a Security User, returns a list of all Reliability Growth Analyses that meet the selected published criteria and were last updated by the selected Security User. This query is run automatically on the Select a Growth Analysis from the List page .
Spares	After prompting for the published status and a Security User, returns a list of all Spares Analyses that meet the selected published criteria and were last updated by the selected Security User. This query is run automatically on the Select a Spares Analysis from the List page .
System Reliability	After prompting for the published status and a Security User, returns a list of all System Reliability Analyses that meet the selected published criteria and were last updated by the selected Security User. This query is run automatically on the Select a System Reliability Analysis from the List page .
Unreliability Cost	After prompting for the published status and a Security User, returns a list of all Cost of Unreliability Analyses that meet the selected published criteria and were last updated by the selected Security User. This query is run automatically on the Select a Cost of Unreliability Analysis page .

Note: You should not change the names of these queries or move them to another Catalog folder. Doing so will cause the pages referenced above to stop working. You can, however, modify the content of the queries if desired.

Queries Folder

The Catalog folder \\Public\Meridium\Modules\Reliability Manager\Queries contains the following queries.

Query Name	Behavior and Usage
Equipment - Work History	After prompting you to select an Equipment ID, returns the Equipment record that contains the selected value in the Equipment ID field and the related Work History records to which the Equipment record is linked. This query can be used to create an Associated Page that will create Reliability Growth and Reliability Distribution Analyses automatically from an Equipment record.
Functional Location - Work History	After prompting you to select a Functional Location, the Functional Location record that contains the selected value in the Location field and the related Work History records to which that Functional Location record is linked. This query can be used to create an Associated Page that will create Reliability Growth and Reliability Distribution Analyses automatically from a Functional Location record.

Note: Before you use these queries to create Associated Pages for these families you should review them to determine whether you want to make modifications that will support the use of additional parameters within the [Reliability Growth](#) or [Reliability Distribution](#) URLs.

Reports Folder

The Catalog folder \\Public\Meridium\Modules\Reliability Manager\Reports contains the items with the following names:

- **assetSubreportDistribution**
- **AssetsubreportGrowth**
- **AssetsubreportUnreliability**
- **CostAnalysisReport:** Displays the **Enter Query Parameters** dialog box, where you must where you must supply information from the Unreliability Cost record for which you are trying to view the Cost of Unreliability Report.
- **DistributionAnalysisReport:** Displays the **Enter Query Parameters** dialog box, where you must where you must supply information from the Reliability Distribution record for which you are trying to view the Reliability Distribution Report.
- **Exponential Distribution Query**
- **FailuresubreportGrowth**
- **FailuresubreportUnreliability**
- **GrowthAnalysisQuery**
- **GrowthAnalysisReport:** Displays the **Enter Query Parameters** dialog box, where you must where you must supply information from the Reliability Growth record for which you are trying to view the Reliability Growth Report.
- **Lognormal Distribution Query**
- **Normal Distribution Query**
- **ProbabilityDistributionQuery**
- **ProbDistReport:** Displays the **Enter Query Parameters** dialog box, where you must where you must supply information from the Distribution record for which you are trying to view the Probability Distribution Report.
- **ProductionAnalysisQuery**
- **ProductionAnalysisQueryLines**
- **ProductionAnalysisQueryRegions**
- **ProductionAnalysisReport:** Displays the **Enter Query Parameters** dialog box, where you must where you must supply information from the Production Analysis record for which you are trying to view the Production Analysis Report.
- **ReliabilityDistributionQuery**
- **ReliabilityDistritbutionTTR**
- **ReliabilityExponentialTTF**
- **ReliabilityExponentialTTR**
- **ReliabilityLognormalTTF**

- ReliabilityLognormalTTR
- ReliabilityNormalTTF
- ReliabilityNormalTTR
- ReliabilityWeibullTTF
- ReliabilityWeibullTTR
- Spares
- Spares Analysis - Applications
- Spares Analysis - Charts
- Spares Analysis - ChartsMain
- Spares Analysis - Main
- Spares Analysis - Spares
- Spares Analysis - SparesMain
- SparesAnalysis
- SparesApplication
- SparesChart
- SubreportDistributionAnalysis
- SubReportProbDist
- SubreportProductionAnalysis
- System Reliability - ActionResult
- System Reliability - ElementResult
- System Reliability - Main
- System Reliability - ResourceResult
- System Reliability - SummaryResult
- SystemReliabilityActionResultReport
- SystemReliabilityElementResultReport
- SystemReliabilityMainReport
- SystemReliabilityResourceResultReport
- SystemReliabilitySummaryResultReport
- Unreliability Cost Query
- Weibull Distribution Query

SSRS Folder

The items in the Catalog folder \\Public\Meridium\Modules\Reliability Manager\SSRS are not used by the Meridium APM system.

Production Analysis

A Production Analysis record stores information about an analysis used to determine the reliability of a production process. The following table provides an alphabetical list and description of the fields that exist for the Production Analysis family, which appear by default on the Production Analysis datasheet. The information in the table reflects the baseline state and behavior of these fields. This list is not comprehensive.

Field Caption	Datasheet Caption	Data Type	Description	Behavior and Usage
Analysis ID	Analysis ID	Character	The name of the Production Analysis.	This value is populated automatically with the value that you type in the Analysis Name text box when you save or rename the Production Analysis.
Analysis Type	Analysis Type	Character	The type of analysis being conducted.	This field is populated automatically with the value <i>Production Analysis</i> . You can modify this value to something more specific, if desired.
Analysis End Date	End Date	Date	The last date that production output is measured for the analysis.	This field is populated automatically with the latest date in your dataset in the field defined in the Production Date list on the Select Production Fields screen of the Production Analysis Builder .

Field Caption	Datasheet Caption	Data Type	Description	Behavior and Usage
Analysis Start Date	Start Date	Date	The first date that production output is measured for the analysis.	This field is populated automatically with the earliest date in your dataset in the field defined in the Production Date list on the Select Production Fields screen of the Production Analysis Builder .
Ignored Points	Ignored Points	Number	The number of datapoints that were ignored because they would inaccurately skew the Reliability Loss calculations.	This field is populated automatically with the number of points that have been ignored via the Edit Production Data window.
Margin Value	Margin Value	Number	The value by which the Meridium APM system will multiply the production loss to determine the cost. For example, if production was lost for 10 cases of bottles, and a production loss for one case costs 10 dollars, the Margin Value would be 10. Production Loss (10 cases) x Margin Value (\$10) = a cost of \$100.	This field is populated automatically with the value 1. Alternatively, you can change the margin value via the Margin Value dialog box.

Field Caption	Datasheet Caption	Data Type	Description	Behavior and Usage
Margin Unit	Margin Value Unit	Number	The unit, or currency, of the cost associated with the calculated production losses.	This field is set to \$by default. Alternatively, you can change the margin units via the Margin Currency dialog box.
Min Production	Min Production	Number	The minimum production value , or the value that is to replace data that cannot be plotted (i.e., zero or negative output values). If your data contains zeros or negative values, they will be replaced with the minimum production value.	If your dataset contains zeros or negative values, this field is populated automatically with the minimum production value you chose when you created the analysis. Alternatively, you can change the minimum production value via the Minimum Production Output dialog box.
Pro Reliability	Proc Reliability	Number	The percentage of time in the Analysis Period that the process is reliable. For example, if the Pro Reliability value is 65%, the process would be reliable 65% of the time.	This field is populated automatically with the value of the Process Reliability line that you define on the Production Analysis plot.
Short Description	Short Description	Character	Additional information about the analysis.	You can manually type additional information about the Production Analysis in this field.

Field Caption	Datasheet Caption	Data Type	Description	Behavior and Usage
Total Points	Total Points	Number	The total number of datapoints in the analysis.	This field is populated automatically with the number of points in the dataset that you defined when creating the analysis.
Unit ID	Unit ID	Character	The name of the unit on which the analysis is being performed.	This field is populated automatically with values from your dataset in the field defined in the Unit ID list on the Select Production Fields screen of the Production Analysis Builder .
Unit of Measure	Unit of Measure	Character	The units of production output (e.g., barrels).	This value will be populated automatically with the value you define in the Units of Measure dialog box. This value will be the basis for the units along the x-axis in the Production Analysis plot and in the Production Loss Regions pane.

Production Losses

A Production Losses record stores information about a loss of production and the cost associated with it. The following table provides an alphabetical list and description of the fields that exist for the Production Losses family, which appear by default on the Production Losses datasheet. The information in the table reflects the baseline state and behavior of these fields.

Field Caption	Data Type	Description	Behavior and Usage
Area Start	Number	The value of the data-point that marks the beginning of the area measured for losses.	The value in this field depends on the value identified in the Losses Type field. This field is applicable only to Reliability and Sub-Reliability Losses .
Area End	Number	The end of the area measured for losses.	This field depends on the value identified in the Losses Type field. This field is applicable only to Sub-Reliability Losses .
Losses Cost	Number	The total monetary amount that was lost as a result of the production loss.	This field is populated automatically with the cost of the production loss, which is calculated by multiplying the production loss in the defined region with the Margin Value. This value also appears in the Cost column of the Production Loss Regions window for the corresponding loss.
Losses Type	Character	A description of the type of production loss calculated by the Production Analysis.	The value in this field is populated with one of the following values: <ul style="list-style-type: none"> • Efficiency/Utilization Loss • Reliability Loss • Sub Reliability Loss • Total Loss The value in this field will also serve as the Record ID for the Production Loss record.

Field Caption	Data Type	Description	Behavior and Usage
Production Losses	Number	The amount of production that was lost as a result of the reliability of the production process.	This field is populated automatically with the amount of production output that was lost in the defined region. This value also appears in the Quantity column in Production Loss Regions window for the corresponding loss.
Unit of Cost	Character	The unit, or currency, of the cost associated with the production loss.	This value is populated automatically with \$ by default. Alternatively, you can change the margin units via the Margin Currency dialog box.
Unit of Measure	Character	The units of production output (e.g., barrels).	This value will be populated automatically with the value you define in the Units of Measure dialog box.

Reliability Growth

A Reliability Growth record stores information about an analysis that tracks changes in Mean Time Between Failure (MTBF) over a specified period of time to determine strategies or repairs necessary to increase the reliability of a product. The following table provides an alphabetical list and description of the fields that exist for the Reliability Growth family. The information in the table reflects the baseline state and behavior of these fields. This list is not comprehensive.

Field Caption	Data Type	Description	Behavior and Usage	Data-sheet
Analysis End Date	Date	The date on which the Reliability Growth Analysis will end.	This field is only used for analyses based on dates. This value is populated automatically with the value in the End Date section of the Analysis Period dialog box .	This field does not exist by default on the Reliability Growth data-sheet.
Analysis End Time	Number	The cumulative operating time at which the analysis will end.	This field is only used for analyses based on cumulative operating time. This value is populated automatically with the value in the End Time section of the Analysis Period dialog box .	This field does not exist by default on the Reliability Growth data-sheet.

Field Caption	Data Type	Description	Behavior and Usage	Data-sheet
Analysis ID	Character	The name of the Growth Analysis.	This field is populated automatically with the value that you entered in the Analysis Name text box when you save the Growth Analysis.	This field does not exist by default on the Reliability Growth data-sheet.
Analysis Start Date	Date	The date on which the Reliability Growth Analysis will begin.	This field is only used for analyses based on dates. This value is populated automatically with the value in the Start Date section of the Analysis Period dialog box .	This field does not exist by default on the Reliability Growth data-sheet.
Analysis Start Time	Time	The cumulative operating time at which the Reliability Growth Analysis will begin.	This field is only used for analyses based on cumulative operating time. This value is populated automatically with the value in the Start Time section of the Analysis Period dialog box .	This field does not exist by default on the Reliability Growth data-sheet.

Field Caption	Data Type	Description	Behavior and Usage	Data-sheet
Asset Installation Field	Character	The name of the field in the query or dataset that contains equipment or location installation data.	This field is populated automatically with the value you select in the Installation Date list on the Select Data Fields screen in the Reliability Growth Builder when you create an analysis based on dates.	This field does not exist by default on the Reliability Growth data-sheet.
Date Based Extrapolation	Logical	Indicates if the user specified the extrapolation based on a date.	If you extrapolate the analysis results based on failure dates, this value is set automatically to <i>True</i> . If you choose to extrapolate based on time or there is no extrapolation at all, this value is set to <i>False</i> .	Reliability Growth
Downtime Field	Character	The name of the field in the query or dataset that contains downtime data.	This field is populated automatically with the value you select in the Downtime Field list on the Provide Information for Downtime screen in the Reliability Growth Builder when you create an analysis based on dates.	This field does not exist by default on the Reliability Growth data-sheet.

Field Caption	Data Type	Description	Behavior and Usage	Data-sheet
Downtime Units	Character	The units associated with downtime.	This field is populated automatically with the value you select in the Time Units list on the Provide Information for Downtime screen in the Reliability Growth Builder when you create an analysis based on dates. You can select one of the following options: <ul style="list-style-type: none"> • Hours • Days • Weeks • Months • Quarters • Years 	This field does not exist by default on the Reliability Growth data-sheet.
Extrapolated	Logical	Indicates if the analysis results will be extrapolated beyond the analysis end date.	If you choose to extrapolate the results , this value will be automatically set to <i>True</i> .	Reliability Growth
Extrapolation Date	Date	Indicates the date and time you extrapolated the analysis.	If the Date Based Extrapolation field is set to <i>True</i> , this field is populated automatically with the date and time you extrapolated the analysis in the Meridium APM Framework.	Reliability Growth

Field Caption	Data Type	Description	Behavior and Usage	Data-sheet
Extrapolation Time	Numerical	Indicates the total operating time that will be cumulated when the extrapolation point is reached.	If the Extrapolated field is set to <i>True</i> and the Date Based Extrapolation field is set to <i>False</i> , this field is populated automatically with the cumulative operating time that corresponds with the extrapolation time you set in the Extrapolation dialog box.	Reliability Growth
Failure Date Field	Character	The name of the field in the query or dataset that contains the dates on which the piece of equipment or location failed.	This field is populated automatically with the value you select in the Date list on the Select Data Fields screen in the Reliability Growth Builder when you create an analysis based on dates.	This field does not exist by default on the Reliability Growth data-sheet.
Failure Number Field	Character	The name of the field in the query or dataset that contains the number of failures recorded at each measurement.	This field is populated automatically with the value you select in the <Measurement> list on the Select Data Fields screen in the Reliability Growth Builder when you create an analysis.	This field does not exist by default on the Reliability Growth data-sheet.

Field Caption	Data Type	Description	Behavior and Usage	Data-sheet
Failure Rate Plot	Binary	Contains an image of the <Measurement> Rate Trend graph.	This field is used to display the <Measurement> Rate Trend graph in the Plots section in the Reliability Growth report.	This field does not exist by default on the Reliability Growth data-sheet.
Failures	Text	Contains the data that is displayed in the <Measurement> Data window.	This field is used to populate the Assets and <Measurement> Data sections in the Reliability Growth report.	This field does not exist by default on the Reliability Growth data-sheet.
Failures Plot	Binary	Contains an image of the Cumulative<Measurement> Plot graph.	This field is used to display the Cumulative <Measurement> Plot graph in the Plots section in the Reliability Growth report.	This field does not exist by default on the Reliability Growth data-sheet.

Field Caption	Data Type	Description	Behavior and Usage	Data-sheet
Failure Time Field	Character	The name of the field in the query or dataset that contains the cumulative operating time at which the piece of equipment or location failed.	This field is populated automatically with the value you select in the Cumulative Operating Time list on the Select Data Fields screen in the Reliability Growth Builder when you create an analysis based on cumulative operating time.	This field does not exist by default on the Reliability Growth data-sheet.
Is Grouped Data	Logic	Indicates whether or not the data is grouped.	If this value is <i>True</i> , the data is grouped data and contains more than one failure at each measurement. If this value is <i>False</i> , the data is not grouped and contains only one failure at each measurement. This value depends on the type of data that is mapped to the Failure Number Field.	This field does not exist by default on the Reliability Growth data-sheet.
Is Non-Event Data	Logic	Indicates whether or not the data is event count.	If this value is <i>True</i> , the data is not event count (e.g., cost). If this value is <i>False</i> , the data is event count (e.g., number of failures). This field is populated depending on the value you select in the Measurement Data Format section of the Select Data Format screen of the Reliability Growth Builder when you create the analysis.	This field does not exist by default on the Reliability Growth data-sheet.

Field Caption	Data Type	Description	Behavior and Usage	Data-sheet
Measurement Name	Character	The name of the data you are measuring throughout the analysis (e.g., cost, events).	This field is populated automatically with the value you enter in the Measurement Name text box on the Select Data Format screen in the Reliability Growth Builder when you create an analysis. After you create an analysis, you can change the value in the Measurement Name field via the Data Format dialog box . The measurement name is displayed throughout the analysis results.	This field does not exist by default on the Reliability Growth data-sheet.
MTBF Plot	Binary	Contains an image of the MTB<Measurement> Trend graph.	This field is used to display the MTB<Measurement>Trend graph in the Plots section in the Reliability Growth report.	This field does not exist by default on the Reliability Growth data-sheet.
Short Description	Character	A brief description of the analysis.	This field is populated automatically with the value that you entered in the Analysis Description text box when you save the Growth Analysis.	This field does not exist by default on the Reliability Growth data-sheet.

Growth Model

A Growth Model record stores information about the Reliability Growth model used to develop a Reliability Growth Analysis. The following table provides an alphabetical list and description of the fields that exist for the Growth Model family, which appear by default on the Growth Model datasheet. The information in the table reflects the baseline state and behavior of these fields.

Field Caption	Data Type	Description	Behavior and Usage
Analysis ID	Character	The name of the Reliability Growth Analysis.	This field is populated automatically with the value in the Analysis ID field of the Reliability Growth record to which the Growth Model is linked.
Beta	Number	A value that represents the slope of the Cumulative Failures plot.	This field is populated automatically with the Beta value calculated by the Meridium APM system. The Beta value indicates whether the MTBF is increasing, decreasing, or remaining constant.
GOF Critical Value	Number	The value used to determine whether the analysis passed the goodness of fit (GOF) test.	This value is calculated automatically by the Meridium APM system. If the value in this field is greater than the value in the GOF Statistic field, the Passed GOF field is set to <i>True</i> .
GOF Statistic	Number	A value that demonstrates the preciseness of fit.	This value is calculated automatically by the Meridium APM system. If the value in this field is less than the value in the GOF Critical Value field, the Passed GOF field is set to <i>True</i> .

Field Caption	Data Type	Description	Behavior and Usage
Lambda	Number	The scale parameter that equals the Y-intercept of the Cumulative Failures Plot at time $t=1$.	This field is populated automatically with the value calculated by the Meridium APM system.
Model Start Date	Date	The date the model was started.	This field is populated automatically with the start date of the segment.
Number of Failures	Number	The total number of failures in the dataset used to calculate the growth model.	This field is populated automatically with the total number of failures in the Failure Data grid.
Offset	Number	The operating time offset for this model relative to the beginning of the analysis.	If there beginning operating time and the beginning observation time are the same, this field will be automatically populated with 0. If there is a difference, this field will be automatically populated with the difference between beginning operating time and beginning observation time.
Passed GOF	Logical	Indicates whether the model passed the Goodness-of-Fit test or not.	The analysis passes the GOF test when the value in the GOF Statistic field is less than the value in the GOF Critical Value field.

Field Caption	Data Type	Description	Behavior and Usage
Sequence	Number	The chronological order of this model in the analysis.	This field is populated automatically with the segment number that corresponds to the Growth Model record. If there is only one segment, this field is populated automatically with <i>1 (None)</i> .
Time Terminated	Logical	Indicates if the end date of the model is time-based.	If this field is set to <i>True</i> , then the end of the model is time-based. Otherwise, the end of the model is failure-based.
Total Observation Time	Number	The total amount of time that the equipment is in operation during the specified analysis period.	This field is populated automatically with the total operating time calculated from your dataset. This value appears in the Analysis Period section of the Reliability Growth Analysis page and is the <i>t</i> value in the AMSAA Reliability Growth Model.

Distribution

A Distribution record stores information about the distribution of failures over the life of equipment. The following table provides an alphabetical list and description of the fields that exist for the Distribution family, which appear by default on the Distribution, Exponential, Normal, MI Lognormal, and MI Weibull datasheets. The information in the table reflects the baseline state and behavior of these fields. This list is not comprehensive.

Field Caption	Datasheet Caption	Data Type	Description	Behavior and Usage
Analysis ID	Analysis ID	Character	The name of the Reliability Distribution Analysis associated with the Distribution record.	This field is populated automatically with the value in the Analysis ID field of the Reliability Distribution record to which the Distribution record is linked.
Confidence Level	Confidence Level	Number	Indicates the percentage of uncertainty in a Goodness of Fit method.	This value is set to 90 by default. You can enter a value between one (1) and one hundred (100) using the Confidence Level dialog box .

Field Caption	Datasheet Caption	Data Type	Description	Behavior and Usage
Fit Method	Fit Method	Character	The type of Goodness-of-Fit test used to determine how well the data fits the analytical curve.	<p>In a Reliability Distribution Analysis, this value is displayed in the Distribution Properties section on the Time to Repair Distribution and Time to Failure Distribution pages. In a Probability Distribution Analysis, this value is displayed in the Distribution section on the Probability Distribution Results page. You can select one of the following options using the Fit Method dialog box:</p> <ul style="list-style-type: none"> • Least Squares • Maximum Likelihood
GOF P-Value	GOF P-Value	Number	The probability that the value in the GOF Statistic field is due to random error.	This value is calculated automatically by the Meridium APM system. The value used to determine whether the analysis passed the goodness of fit (GOF) test.

Field Caption	Datasheet Caption	Data Type	Description	Behavior and Usage
GOF Statistic	GOF Statistic	Number	A value that indicates the preciseness of the fit of the data to the model.	This value is calculated automatically by the Meridium APM system. Typically, the lower the GOF Statistic, the better the fit.
Mean	Mean	Number	The average point of the distribution. This is <i>not</i> necessarily the same as the average point of the dataset.	<p>This value is calculated by the Meridium APM system and is populated automatically. The value is calculated using distribution parameters, which vary depending on the type of distribution. For example, for a Weibuill distribution, this value is calculated using the following formula:</p> $Mean = Eta \times Gamma(1 + \frac{1}{Beta})$

Field Caption	Datasheet Caption	Data Type	Description	Behavior and Usage
Median	Median	Number	The middle point of the distribution. This is <i>not</i> necessarily the same as the middle point of the dataset.	<p>This value is calculated by the Meridium APM system and is populated automatically. The value is calculated using distribution parameters, which vary depending on the type of distribution. For example, for a Weibull distribution, this value is calculated using the following formula:</p> $Median = Eta \times (Ln(2))^{\frac{1}{Beta}}$
Passed	Passed	Logical	Indicates whether the model passed the Goodness-of-Fit test or not.	<p>If the P-value is less than or equal to 1 minus the confidence level, the goodness of fit test has failed and this value is set automatically to <i>False</i> by the Meridium APM system. Otherwise, the goodness of fit test is successful and this value is set to <i>True</i>.</p>
Published	Published	Logical	Indicates whether the analysis has been published.	<p>If the analysis has been published, this value is set to <i>True</i>. If the analysis has not been published, this value is set to <i>False</i>.</p>

Field Caption	Datasheet Caption	Data Type	Description	Behavior and Usage
R-Squared	R-Squared	Number	The R-Squared Correlation Coefficient, which describes the strength of a linear model.	This value is calculated by the Meridium APM system and populated automatically. This value measures how closely the points fall to the least squares line, providing an indication of how confident one can be of predictions made with the line. An R-Squared value greater than 0.9 is considered a good fit for linear regression.
Standard Deviation	Standard Deviation	Number	The variability of the random variable around the mean.	This value is calculated by the Meridium APM system and populated automatically.
Units	Units	Character	The time units associated with the independent variable.	This value is associated with the value in the Variable field. This value is only populated for a Distribution record associated with a Probability Distribution Analysis. This value is populated automatically with the value you specify in the Units text box on the Random Variable dialog box .

Field Caption	Datasheet Caption	Data Type	Description	Behavior and Usage
Variable	Variable	Character	The name of the independent variable, which associates a numerical value with every event (e.g., Down-time).	This value is only populated for a Distribution record associated with a Probability Distribution Analysis. This value is populated automatically with the value you specify in the Random Variable text box on the Random Variable dialog box .

About System Action Families

Actions in System Reliability Analyses are represented by records in the following families:

- [System Condition Monitor](#).
- [System Inspection](#).
- [System Preventive Maintenance](#).
- [System Special Action](#).

System Condition Monitor

System Condition Monitor records store information about continuous, condition-based maintenance Actions. The following table provides an alphabetical list and description of the fields that exist for the System Condition Monitor family and appear by default on the System Condition Monitor datasheet. The information in the table reflects the baseline state and behavior of these fields. This list is not comprehensive.

Field Caption	Data Type	Description	Behavior and Usage
Action Cost	Number	A numeric value that specifies the cost associated with any materials or personnel needed to complete the Action.	This value is set to 0 (zero) by default. For System Condition Monitor records, this value represents a one-time expense that is incurred when the Action is started.
Action Type	Character	The category into which the Action can be classified.	This field is populated automatically with <i>Condition-Based Maintenance (Predictive) (CM)</i> and is disabled.
Condition Monitoring Type	Character	A field that contains a value indicating whether the Action occurs continuously or periodically at regular intervals.	In System Condition Monitor records, which store information for Actions that occur constantly, this field is populated automatically with <i>Continuous</i> and is disabled.
Description	Text	A text field that stores any additional information about the Action.	On the System Inspection datasheet, you can define this value manually by clicking the  button and entering text in the Description dialog box.

Field Caption	Data Type	Description	Behavior and Usage
Detection Probability	Number	A numeric value representing the probability that the Action will identify a potential failure resulting from any Risk and correct that failure before it occurs.	<p>This value is set to <i>100</i> by default. For an Action with no assigned Risks, any value stored in this field will be ignored.</p> <p>For example, a System Condition Monitor record with the Detection Probability value <i>50</i> has a 50% chance of identifying a potential failure resulting from a Risk. In other words, the Action will detect one out of two potential failures resulting from any Risks assigned to the Action.</p>
GUID	Character	A value that uniquely identifies the record within a System Reliability Analysis.	<p>This value is generated automatically by the Meridium APM system and does not appear on the System Condition Monitor datasheet. In System Reliability Analyses, GUIDs are used to identify records because Entity Keys will not exist until a record is saved. Because a System Reliability Analysis may contain unsaved records, it is necessary to use a value that uniquely identifies those records within the system.</p>

Field Caption	Data Type	Description	Behavior and Usage
Name	Character	The name of the Action.	You can define this value manually. This value is used to identify Actions in the System Reliability Analyses. For example, the Name column appears by default in the grid in the Actions pane on the System Reliability Scenarios - Actions page and displays values that exist in the Name field to identify the System Action records that are displayed in the grid.

System Inspection

System Inspection records store information about periodic, condition-based maintenance Actions. The following table provides an alphabetical list and description of the fields that exist for the System Inspection family and appear by default on the System Inspection datasheet. The information in the table reflects the baseline state and behavior of these fields. This list is not comprehensive.

Field Caption	Data Type	Description	Behavior and Usage
Action Cost	Number	A numeric value that specifies the cost associated with any materials or personnel needed to complete the Action.	This value is set to 0 (zero) by default. For System Inspection records, this value represents an expense that is incurred every time the Action occurs.
Action Type	Character	The category into which the Action can be classified.	This field is populated automatically with <i>Condition-Based Maintenance (Predictive) (CM)</i> and is disabled.
Condition Monitoring Type	Character	A value that indicates whether the Action occurs continuously or periodically at regular intervals.	In System Inspection records, which store information for Actions that occur periodically, this field is populated automatically with <i>Periodic</i> and is disabled.
Description	Text	A text field that stores any additional information about the Action.	On the System Inspection datasheet, you can define this value manually by clicking the  button and entering text in the Description dialog box.

Field Caption	Data Type	Description	Behavior and Usage
Detection Probability	Number	A numeric value representing the probability that the Action will identify a potential failure resulting from any Risk and correct that failure before it occurs.	<p>This value is set to <i>100</i> by default. For an Action with no assigned Risks, any value stored in this field will be ignored.</p> <p>An Action can detect a potential failure only when the Action occurs during a Risk's PF Interval, as defined by the value in the PF Interval and PF Interval Units fields in the System Risk record. If the Action does not occur during the PF Interval, the Action cannot identify the potential failure, and the value in the Detection Probability field will be ignored. To make the Action occur during the PF Interval of a Risk, you can manually modify the values in the PF Interval and PF Interval Units fields of the System Risk record, or you can optimize the Action.</p> <p>For example, setting the Detection Probability to <i>50</i> would indicate that the Action has a 50% chance of identifying a potential failure resulting from any Risk if the Action occurs during the PF Interval of the Risks. In other words, the Action will detect one out of two potential failures resulting from any Risks assigned to the Action when the Action occurs</p>

Field Caption	Data Type	Description	Behavior and Usage
			during the PF Interval of the Risks.
Duration	Number	A numeric value that, combined with the value in the Duration Units field, identifies the total time required to complete the Action. For example, if the value in the Duration field is <i>4</i> and the value in the Duration Units field is <i>Hours</i> , then the Action will take four hours to complete.	This value is set to 0 (zero) by default.
Duration Units	Character	The time units associated with the value in the Duration field.	<p>You can select a value from the following options:</p> <ul style="list-style-type: none"> • Minutes • Hours • Days • Weeks • Months • Years

Field Caption	Data Type	Description	Behavior and Usage
GUID	Character	A value that uniquely identifies the record within a System Reliability Analysis.	This value is generated automatically by the Meridium APM system and does not appear on the System Inspection datasheet. In System Reliability Analyses, GUIDs are used to identify records because Entity Keys will not exist until a record is saved. Because a System Reliability Analysis may contain unsaved records, it is necessary to use a value that uniquely identifies those records within the system.
Interval	Number	A numeric value that, combined with the value in the Interval Units field, indicates how often the Action will occur. For example, if the value in the Interval field is 4 and the value in the Interval Units field is <i>Months</i> , then the Action will occur every four months during the simulation period.	This value is set to 1 by default.
Interval Units	Character	The time units associated with the value in the Interval field.	You can select a value from the following options: <ul style="list-style-type: none"> • Minutes • Hours • Days • Weeks • Months • Years

Field Caption	Data Type	Description	Behavior and Usage
Name	Character	The name of the Action.	You can define this value manually. This value is used to identify Actions in the System Reliability Analyses. For example, the Name column appears by default in the grid in the Actions pane on the System Reliability Scenarios - Actions page and displays values that exist in the Name field to identify the System Action records that are displayed in the grid.
One Time Action	Logical	Indicates whether the Action will occur one time or will be repeated more than once.	If this value is <i>True</i> , the Action will occur once. If this value is <i>False</i> , the Action will occur more than once. For example, an Action to inspect the vibration level of a pump might occur several times a year. In this case, the value in the One Time Action field of the corresponding System Inspection record would be <i>False</i> . An Action to inspect a newly installed pump for any installation errors might occur only once, in which case the value in the One Time Action field of the corresponding System Inspection record would be <i>True</i> . This value is set to <i>False</i> by default.

Field Caption	Data Type	Description	Behavior and Usage
Shutdown Required	Logical	Indicates whether the Action requires the piece of equipment or location to be shut down in order for the Action to be completed.	<p>If this value is <i>True</i>, the piece of equipment or location must be shut down in order for the Action to be completed. If this value is <i>False</i>, the Action can be completed while the piece of equipment or location is running.</p> <p>For example, an Action to inspect the vibration level of a pump could be completed while the pump is running, so the value in the Shutdown Required field would be <i>False</i>. An Action to inspect the internal components of a pump would be completed while the pump is not running, so the value in the Shutdown Required field would be <i>True</i>. This value is set to <i>False</i> by default.</p>

System Preventive Maintenance

System Preventative Maintenance records store information about time-based maintenance Actions. The following table provides an alphabetical list and description of the fields that exist for the System Preventative Maintenance family and appear by default on the System Preventative Maintenance datasheet. The information in the table reflects the baseline state and behavior of these fields. This list is not comprehensive.

Field Caption	Data Type	Description	Behavior and Usage
Action Cost	Number	A numeric value that specifies the cost associated with any materials or personnel needed to complete the Action.	This value is set to 0 (zero) by default. For System Preventive Maintenance records, this value represents an expense that is incurred every time the Action occurs.
Action Type	Character	The category into which the Action can be classified.	This field is populated automatically with <i>Time-Based Maintenance (Preventive) (PM)</i> and is disabled.
Condition Monitoring Type	Character	A value that indicates whether the Action occurs continuously or periodically at regular intervals.	This field is not used for System Preventive Maintenance records and is disabled.
Description	Text	A text field that stores any additional information about the Action.	On the System Preventative Maintenance datasheet, you can define this value manually by clicking the  button and entering text in the Description dialog box.

Field Caption	Data Type	Description	Behavior and Usage
Duration	Number	A numeric value that, combined with the value in the Duration Units field, identifies the total time required to complete the Action. For example, if the value in the Duration field is <i>4</i> and the value in the Duration Units field is <i>Hours</i> , then the Action will take four hours to complete.	This value is set to 0 (zero) by default.
Duration Units	Character	The time units associated with the value in the Duration field.	You can select a value from the following options: <ul style="list-style-type: none"> • Minutes • Hours • Days • Weeks • Months • Years
GUID	Character	A value that uniquely identifies the record within a System Reliability Analysis.	This value is generated automatically by the Meridium APM system and does not appear on the System Preventative Maintenance datasheet. In System Reliability Analyses, GUIDs are used to identify records because Entity Keys will not exist until a record is saved. Because a System Reliability Analysis may contain unsaved records, it is necessary to use a value that uniquely identifies those records within the system.

Field Caption	Data Type	Description	Behavior and Usage
Interval	Number	A numeric value that, combined with the value in the Interval Units field, indicates how often the Action will occur. For example, if the value in the Interval field is <i>4</i> and the value in the Interval Units field is <i>Months</i> , then the Action will occur every four months during the simulation period.	This value is set to <i>1</i> by default.
Interval Units	Character	The time units associated with the value in the Interval field.	<p>You can select a value from the following options:</p> <ul style="list-style-type: none"> • Minutes • Hours • Days • Weeks • Months • Years
Name	Character	The name of the Action.	<p>You can define this value manually. This value is used to identify Actions in the System Reliability Analyses. For instance, the Name column appears by default in the grid in the Actions pane on the System Reliability Scenarios - Actions page and displays values that exist in the Name field to identify the System Action records that are displayed in the grid.</p>

Field Caption	Data Type	Description	Behavior and Usage
One Time Action	Logical	Indicates whether the Action will occur one time or will be repeated more than once.	If this value is <i>True</i> , the Action will occur once. If this value is <i>False</i> , the Action will occur more than once. For example, an Action to inspect the vibration level of a pump might occur several times a year. In this case, the value in the One Time Action field of the corresponding System Inspection record would be <i>False</i> . An Action to inspect a newly installed pump for any installation errors might occur only once, in which case the value in the One Time Action field of the corresponding System Inspection record would be <i>True</i> . This value is set to <i>False</i> by default.

Field Caption	Data Type	Description	Behavior and Usage
Shutdown Required	Logical	Indicates whether the Action requires the piece of equipment or location to be shut down in order for the Action to be completed.	<p>If this value is <i>True</i>, the piece of equipment or location must be shut down in order for the Action to be completed. If this value is <i>False</i>, the Action can be completed while the piece of equipment or location is running.</p> <p>For example, an Action to inspect the vibration level of a pump could be completed while the pump is running, so the value in the Shutdown Required field would be <i>False</i>. An Action to inspect the internal components of a pump would be completed while the pump is not running, so the value in the Shutdown Required field would be <i>True</i>. This value is set to <i>True</i> by default.</p>

System Special Action

System Special Action records store information about procedural, redesign, or training Actions.. The following table provides an alphabetical list and description of the fields that exist for the System Special Action family and appear by default on the System Special Action datasheet. The information in the table reflects the baseline state and behavior of these fields. This list is not comprehensive.

Field Caption	Data Type	Description	Behavior and Usage
Action Cost	Number	A numeric value that specifies the cost associated with any materials or personnel needed to complete the Action.	This value is set to 0 (zero) by default. For System Special Action records, this value represents an expense that is incurred every time the Action occurs.
Action Type	Character	The category into which the Action can be classified.	<p>You can select a value from the following options when you create the System Special Action record:</p> <ul style="list-style-type: none"> • Procedure (PROC) • Redesign (DSN) • Training (TRN) <p>After you make your selection, this field will be disabled so that the value cannot be modified.</p>
Condition Monitoring Type	Character	A value that indicates whether the Action occurs continuously or periodically at regular intervals.	This field is not used for System Special Action records and is disabled.
Description	Text	A text field that stores any additional information about the Action.	On the System Preventative Maintenance datasheet, you can define this value manually by clicking the  button and entering text in the Description dialog box.

Field Caption	Data Type	Description	Behavior and Usage
Duration	Number	A numeric value that, combined with the value in the Duration Units field, identifies the total time required to complete the Action. For example, if the value in the Duration field is <i>4</i> and the value in the Duration Units field is <i>Hours</i> , then the Action will take four hours to complete.	This value is set to 0 (zero) by default.
Duration Units	Character	The time units associated with the value in the Duration field.	You can select a value from the following options: <ul style="list-style-type: none"> • Minutes • Hours • Days • Weeks • Months • Years
GUID	Character	A value that uniquely identifies the record within a System Reliability Analysis.	This value is generated automatically by the Meridium APM system and does not appear on the System Special Action datasheet. In System Reliability Analyses, GUIDs are used to identify records because Entity Keys will not exist until a record is saved. Because a System Reliability Analysis may contain unsaved records, it is necessary to use a value that uniquely identifies those records within the system.

Field Caption	Data Type	Description	Behavior and Usage
Interval	Number	A numeric value that, combined with the value in the Interval Units field, indicates how often the Action will occur. For example, if the value in the Interval field is 4 and the value in the Interval Units field is <i>Months</i> , then the Action will occur every four months during the simulation period.	This value is set to 1 by default.
Interval Units	Character	The time units associated with the value in the Interval field.	You can select a value from the following options: <ul style="list-style-type: none"> • Minutes • Hours • Days • Weeks • Months • Years
Name	Character	The name of the Action.	You can define this field manually. This value is used to identify Actions in the System Reliability Analyses. For instance, the Name column appears by default in the grid in the Actions pane on the System Reliability Scenarios - Actions page and displays values that exist in the Name field to identify the System Action records that are displayed in the grid.

Field Caption	Data Type	Description	Behavior and Usage
One Time Action	Logical	Indicates whether the Action will occur one time or will be repeated more than once.	If this value is <i>True</i> , the Action will occur once. If this value is <i>False</i> , the Action will occur more than once. For example, an Action to inspect the vibration level of a pump might occur several times a year. In this case, the value in the One Time Action field of the corresponding System Special Action record would be <i>False</i> . An Action to inspect a newly installed pump for any installation errors might occur only once, in which case the value in the One Time Action field of the corresponding System Special Action record would be <i>True</i> . This value is set to <i>True</i> by default.

Field Caption	Data Type	Description	Behavior and Usage
Shutdown Required	Logical	Indicates whether the Action requires the piece of equipment or location to be shut down in order for the Action to be completed.	<p>If this value is <i>True</i>, the piece of equipment or location must be shut down in order for the Action to be completed. If this value is <i>False</i>, the Action can be completed while the piece of equipment or location is running.</p> <p>For example, an Action to inspect the vibration level of a pump could be completed while the pump is running, so the value in the Shutdown Required field would be <i>False</i>. An Action to inspect the internal components of a pump would be completed while the pump is not running, so the value in the Shutdown Required field would be <i>True</i>. This value is set to <i>True</i> by default.</p>

System Analysis

System Analysis records store general information about a System Analysis. The following table provides an alphabetical list and description of the fields that exist for the System Analysis family. The information in the table reflects the baseline state and behavior of these fields. This list is not comprehensive.

Note: In the following table, the bold field captions identify [properties that can be defined for a System Reliability Analysis](#) in the **Analysis Parameters** pane on the **System Reliability Analysis Definition** page.

Field	Datasheet Caption	Data Type	Description	Behavior and Usage	Datasheet
Action Cost Plot	None	Binary	A field that is used internally by the Meridium APM system to store the image of the Annual Action Cost graph .	You should not modify the value in this field. Doing so will cause the analysis to become corrupt, and you will no longer be able to open it.	This field does not exist by default on the System Analysis datasheet.
Action Cost Trend Plot	None	Binary	A field that is used internally by the Meridium APM system to store the image of the Action Cost Trend graph .	You should not modify the value in this field. Doing so will cause the analysis to become corrupt, and you will no longer be able to open it.	This field does not exist by default on the System Analysis datasheet.

Field	Datasheet Caption	Data Type	Description	Behavior and Usage	Data-sheet
Analysis End Date	None	Date	The date on which the analysis ends (i.e., when the simulation will stop running).	This value is calculated by adding the amount of time defined by the values in the Period and Period Units fields to the value in the Analysis Start Date field. This field is populated automatically.	This field does not exist by default on the System Analysis data-sheet.
Analysis ID	Name	Character	A value that identifies the System Reliability Analysis throughout System Reliability.	This value is populated automatically with <i>New Analysis 1</i> . You can define this field manually. The Analysis ID column appears by default on the Select a System Reliability Analysis from the List page and displays values that exist in the Analysis ID field to identify the System Analysis records that are displayed in the grid.	System Analysis

Field	Datasheet Caption	Data Type	Description	Behavior and Usage	Data-sheet
Analysis Result	None	Binary	A field that is used internally by the Meridium APM system to store the data that appears in the Elements , Actions , and Resources grids on the System Reliability Simulation Results page .	You should not modify the value in this field. Doing so will cause the analysis to become corrupt, and you will no longer be able to open it.	This field does not exist by default on the System Analysis data-sheet.

Field	Datasheet Caption	Data Type	Description	Behavior and Usage	Data-sheet
Analysis Start Date	Start Date	Date	The first date of the analysis.	You can define this field manually. This field is labeled Start Date in the Analysis Parameters pane on the System Reliability Analysis Definition page . The amount of time defined by the values in the Period and Period Units fields is added to the value in this field to determine how long the simulation will run.	System Analysis

Field	Datasheet Caption	Data Type	Description	Behavior and Usage	Data-sheet
Con- fidence	Con- fidence (%)	Number	A numeric value that represents the con- fidence level of sim- ulation res- ults.	This value determines the Optimistic and Pessimistic values in the Histogram Plot graph on the System Reliability Simulation Results page . The default value for this field is 90. If you accept the default value, when you look at the Histogram Plot graph, you will know that there is a 90% chance that the value in any cell in the grids on the System Reliability Simulation Results page in the analysis lies within the range between the Optimistic and Pessimistic values.	System Analysis

Field	Datasheet Caption	Data Type	Description	Behavior and Usage	Data-sheet
Cost Plot	None	Binary	A field that is used internally by the Meridium APM system to store the image of the Total Cost graph .	You should not modify the value in this field. Doing so will cause the analysis to become corrupt, and you will no longer be able to open it.	This field does not exist by default on the System Analysis data-sheet.
Cost Trend Plot	None	Binary	A field that is used internally by the Meridium APM system to store the image of the Total Cost Trend graph .	You should not modify the value in this field. Doing so will cause the analysis to become corrupt, and you will no longer be able to open it.	This field does not exist by default on the System Analysis data-sheet.

Field	Datasheet Caption	Data Type	Description	Behavior and Usage	Data-sheet
Currency	Currency	Character	The currency used to display financial results in various places throughout System Reliability.	This value is set to \$by default. The Cost column appears by default in the Elements grid on the System Reliability Simulation Results page. The value that exists in the Currency field is included in the Cost column header. For example, if you specify \$ in the Currency field, the label for the Cost column will be Cost (\$) .	System Analysis
Description	Description	Text	A text field that stores any additional information about the analysis.	On the System Analysis datasheet, you can define this value manually by clicking the  button and entering text in the Description dialog box.	System Analysis

Field	Datasheet Caption	Data Type	Description	Behavior and Usage	Data-sheet
Enable Event Log	Enable Event Log	Logical	Indicates whether Event Log files will be generated when a simulation is run.	This value is <i>False</i> by default. If this field contains the value <i>True</i> , Event Log files will be generated when a simulation is run. If this field contains the value <i>False</i> , Event Log files will not be generated when the simulation is run.	System Analysis
Histogram Bins	Histogram Bins	Number	A numeric value that defines the number of bins, or columns, that will be displayed on the Histogram Plot graph on the System Reliability Simulation Results page .	The default value for this field is 20. If you accept the default value, when you look at the Histogram Plot graph on the System Reliability Simulation Results page, there will be twenty bins on the Histogram Plot graph.	System Analysis

Field	Datasheet Caption	Data Type	Description	Behavior and Usage	Data-sheet
Iterations	Iterations	Number	A numeric value that identifies the number of times the system will be simulated in order to compile simulation results.	<p>In the simple Monte Carlo example provided in this documentation, one iteration represents a single roll of the dice. The more iterations you use in an analysis, the more reliable the simulation results will be. The default value for this field is 1,000.</p> <p>The value you specify in the Iterations field must be compatible with the value that you specify in the Confidence field. The required number of iterations is dependent upon the confidence boundary, as defined by the value in the Confidence field. The following equation is used to determine the required num-</p>	System Analysis

Field	Datasheet Caption	Data Type	Description	Behavior and Usage	Data-sheet
				<p>ber of iterations:</p> <p>Minimum Number of Iterations = $40/(1 - \text{Confidence Field Value})$</p> <p>In other words, the number of iterations must be high enough to provide a statistically significant confidence level. For example, a System Reliability Analysis with a value of <i>90</i> in the Confidence field would require a value of at least <i>400</i> in the Iterations field, as shown in the following calculation:</p> <p>Minimum Number of Iterations = $40/(1 - 90\%)$</p> <p>Minimum Number of Iterations = $40/.1$</p> <p>Minimum Number of Iterations =</p>	

Field	Datasheet Caption	Data Type	Description	Behavior and Usage	Data-sheet
				400 If you enter a value in the Iterations field that is below the required value, an error message will appear, and you will be required to specify another value before you can save the analysis.	

Field	Datasheet Caption	Data Type	Description	Behavior and Usage	Data-sheet
Period	Period	Number	A numeric value that identifies the time period over which an analysis occurs.	This value is set to <i>1</i> by default. The value in the Period Units field determines the time units that will be applied to the value in the Period field.	System Analysis
Period Units	Period	Character	The time units associated with the value in the Period field.	You can select a value from one of the following options: <ul style="list-style-type: none"> • Hours • Days • Weeks • Months • Years 	System Analysis
Published	None	Logical	A logical field that indicates whether an analysis is published.	The value in this field is <i>False</i> by default. If this value is <i>True</i> , the analysis is published . If this value is <i>False</i> , the analysis is unpublished .	This field does not exist by default on the System Analysis data-sheet.

Field	Datasheet Caption	Data Type	Description	Behavior and Usage	Data-sheet
Random Seed	Random Seed	Logical	Indicates whether or not different random numbers will be used for the system-generated inputs for each run of the simulation so that different results are returned each time.	This value is set to <i>False</i> by default. If the Random Seed field is set to <i>True</i> , different inputs will be used for each simulation so that different results will be generated each time the simulation is run even if you have made no changes to the analysis. If the Random Seed field is set to <i>False</i> , the same results will be generated each time you run the simulation, provided that you have made no changes to the analysis.	System Analysis
Resource Cost Plot	None	Binary	A field that is used internally by the Meridium APM system to store the image of the Resource Cost graph .	You should not modify the value in this field. Doing so will cause the analysis to become corrupt, and you will no longer be able to open it.	This field does not exist by default on the System Analysis data-sheet.

Field	Datasheet Caption	Data Type	Description	Behavior and Usage	Data-sheet
Resource Occurrence Plot	None	Binary	A field that is used internally by the Meridium APM system to store the image of the Resource Occurrence graph .	You should not modify the value in this field. Doing so will cause the analysis to become corrupt, and you will no longer be able to open it.	This field does not exist by default on the System Analysis data-sheet.
Time Analysis Type	Time Analysis Type	Character	A field whose value determines how results are displayed in the Total Cost Trend Plot on the System Reliability Summary page and Trend Plot on the System Reliability Simulation Results page .	This value is <i>Yearly</i> by default. If this field is set to <i>Yearly</i> , the x-axis will display results for every year in the simulation period. If this field is set to <i>Monthly</i> , the x-axis will display results for every month in the simulation period.	System Analysis

Field	Datasheet Caption	Data Type	Description	Behavior and Usage	Data-sheet
Visual Attributes	None	Text	A field that is used internally by Meridium APM and stores visual information, such as chart settings and diagram positioning.	You should not modify the value in this field. Doing so will cause the analysis to become corrupt, and you will no longer be able to open it.	This field does not exist by default on the System Analysis data-sheet.

System Asset

System Asset records store information about equipment and locations that exist in the System Analysis diagram. The following table provides an alphabetical list and description of the fields that exist for the System Asset family and appear by default on the System Asset datasheet. The information in the table reflects the baseline state and behavior of these fields. This list is not comprehensive.

Field Caption	Data Type	Description	Behavior and Usage
Description	Text	A detailed description that allows you to identify the piece of equipment or location and distinguish it from other pieces of equipment and locations.	On the System Asset datasheet, you can define this value manually by clicking the  button and entering text in the Description dialog box.
Equipment Type	Character	A detailed description of the equipment type that allows you to identify the equipment type and distinguish it from other equipment types.	You can define this value manually by typing a value into the Equipment Type field.
Fixed Cost	Number	The fixed cost of the piece of equipment or location when it fails. Fixed cost does not change as a result of other variables such as downtime. An example of fixed unplanned correction cost is the cost of a new piece of equipment.	The Fixed Cost is set to 0 (zero) by default.

Field Caption	Data Type	Description	Behavior and Usage
GUID	Character	A value that uniquely identifies the record within a System Reliability Analysis.	This value is generated automatically by the Meridium APM system and disabled. In System Reliability Analyses, GUIDs are used to identify records because Entity Keys will not exist until a record is saved. Because a System Reliability Analysis may contain unsaved records, it is necessary to use a value that uniquely identifies those records within the system.
Lost Production Cost	Number	The financial amount of lost production per unit of time when the system is stopped or unable to run.	The Lost Production Cost is set to 0 (zero) by default.
Lost Production Cost Units	Character	The time units associated with the value in the Lost Production Cost field.	You can select a value from the following options: <ul style="list-style-type: none"> • Per Hour • Per Day • Per Week • Per Month • Per Year
Name	Character	The name of the piece of equipment or location.	This value is populated automatically with <i>Asset</i> . You can define this value manually.

Field Caption	Data Type	Description	Behavior and Usage
Production Contribution	Number	<p>The percentage that this piece of equipment or location will contribute to the overall production capacity of its parent system, with respect to other elements that are running in parallel to the piece of equipment or location.</p> <p>For example, if two pieces of equipment are running in parallel with one another and each one contributes 50% to the overall production output, you would enter a value of 50 in the Production Contribution field of each piece of equipment or location. The Production Contribution of each element in the Diagram will be used to calculate the overall production loss of the parent system when one or more elements are down.</p>	<p>The Production Contribution is set to 100 by default. If the piece of equipment or location does not contribute to the overall production output of its parent system, you can set the Production Contribution to 0 (zero).</p>
Variable Cost	Number	<p>The cost incurred during downtime due to failures or shutdowns.</p>	<p>The Variable Cost is set to 0 (zero) by default.</p>
Variable Cost Units	Character	<p>The time units associated with the value in the Variable Cost field.</p>	<p>You can select a value from the following options:</p> <ul style="list-style-type: none"> • Per Hour • Per Day • Per Week • Per Month • Per Year

System Buffer

System Buffer records store information about buffers that exist in the System Analysis diagram. The following table provides an alphabetical list and description of the fields that exist for the System Buffer family and appear by default on the System Buffer data-sheet. The information in the table reflects the baseline state and behavior of these fields. This list is not comprehensive.

Field Caption	Data Type	Description	Behavior and Usage
Description	Text	Any additional information regarding the buffer.	On the System Buffer data-sheet, you can define this value manually by clicking the  button and entering text in the Description dialog box.
Fixed Cost	Number	The cost of lost production when the buffer fails.	The value is set to 0 (zero) by default.
GUID	Character	A value that uniquely identifies the record within a System Reliability Analysis.	This value is generated automatically by the Meridium APM system and disabled. In System Reliability Analyses, GUIDs are used to identify records because Entity Keys will not exist until a record is saved. Because a System Reliability Analysis may contain unsaved records, it is necessary to use a value that uniquely identifies those records within the system.
Initial Quantity in Percentage	Number	The percentage of product that the storage tank contains at the time of a failure.	The value is set to 100 by default.
Lost Production Cost	Number	The cost of lost production per unit of time when the buffer is not running.	The Lost Production Cost is set to 0 (zero) by default.

Field Caption	Data Type	Description	Behavior and Usage
Lost Production Cost Units	Character	The time units for the Lost Production Cost field.	You can select a value from the following options: <ul style="list-style-type: none">• Per Hour• Per Day• Per Week• Per Month• Per Year
Name	Character	The name of the buffer.	This value is populated automatically with <i>Buffer</i> . You can define this value manually.

Field Caption	Data Type	Description	Behavior and Usage
Production Contribution	Number	The percentage that this piece of equipment or location will contribute to the overall production capacity of its parent system, with respect to other elements that are running in parallel to the piece of equipment or location. For example, if two pieces of equipment are running in parallel with one another and each one contributes 50% to the overall production output, you would enter a value of 50 in the Production Contribution field of each piece of equipment. The Production Contribution of each element in the Diagram will be used to calculate the overall production loss of the parent system when one or more elements are down.	The Production Contribution is set to 100 by default. If the piece of equipment does not contribute to the overall production output of its parent system, you can set the Production Contribution to 0 (zero).
Time to Empty	Number	The time that it will take for the contents of a full buffer to empty when it is used.	The Time to Empty is set to 0 (zero) by default.

Field Caption	Data Type	Description	Behavior and Usage
Time to Empty Units	Character	The time units that apply to the value in the Time to Empty field.	You can select a value from the following options: <ul style="list-style-type: none"> • Hours • Days • Weeks • Months • Years
Time to Refill	Number	The time that it will take for the contents of an empty buffer to refill completely after it has been emptied.	The Time to Refill is set to 0 (zero) by default.
Time to Refill Units	Character	The time units that apply to the value in the Time to Refill field.	You can select a value from the following options: <ul style="list-style-type: none"> • Hours • Days • Weeks • Months • Years
Variable Cost	Number	The cost incurred during the downtime due to the buffer failing.	The Variable Cost is set to 0 (zero) by default.
Variable Cost Units	Character	The time units associated with the value in the Variable Cost field.	You can select a value from the following options: <ul style="list-style-type: none"> • Per Hour • Per Day • Per Week • Per Month • Per Year

System Global Event

System Global Event records store information about global events, which group together Actions requiring a system shutdown so that they will be performed at the same time, thereby maximizing the availability of the system. The following table provides an alphabetical list and description of the fields that exist for the System Global Event family. The information in the table reflects the baseline state and behavior of these fields. This list is not comprehensive.

Field Caption	Data Type	Description	Behavior and Usage	Datasheet
Description	Text	A text field that stores any additional information about the Global Event.	On the System Global Event datasheet, you can define this value manually by clicking the  button and entering text in the Description dialog box.	System Global Event

Field Caption	Data Type	Description	Behavior and Usage	Datasheet
<p>Driver Type</p>	<p>Character</p>	<p>Indicates whether the Global Event will be started with an action or on a certain date.</p>	<p>This value is required. The following options are available:</p> <ul style="list-style-type: none"> <p>ActionDriven (ActionDriven): The Global Event will start on the date the driving Action(s) begin and will trigger the start of any other Actions that are assigned to the Global Event. If more than one Action has been designated as a driving Action, the Global Event will occur when the first driving Action occurs. If no Action has been designated as a driving Action, the Global Event will not occur.</p> <p>DateDriven (DateDriven): The Global Event will start on the date in the First Date field. If no date exists in the First Date field, the Global Event will start one interval period, as defined by the values in the Interval and Interval Units fields, into</p> 	<p>System Global Event</p>

Field Caption	Data Type	Description	Behavior and Usage	Datasheet
			the simulation.	
Event Definition	Text	The Actions assigned to the Global Event.	This value that is used internally by the Meridium APM system to store information identifying the Actions assigned to the Global Event and does not appear on the System Global Event datasheet.	None

Field Caption	Data Type	Description	Behavior and Usage	Datasheet
First Date	Date	The date on which the Global Event will occur for the first time.	If no value exists in the First Date field, date-driven Global Events will start one interval period, as defined by the values in the Interval and Interval Units fields, into the simulation. This field is disabled in System Global Event records that contain the value <i>Action Driven (ActionDriven)</i> in the Driver Type field.	System Global Event
GUID	Character	A value that uniquely identifies the record within a System Reliability Analysis.	This value is generated automatically by the Meridium APM system and does not appear on the System Global Event datasheet. In System Reliability Analyses, GUIDs are used to identify records because Entity Keys will not exist until a record is saved. Because a System Reliability Analysis may contain unsaved records, it is necessary to use a value that uniquely identifies those records within the system.	None

Field Caption	Data Type	Description	Behavior and Usage	Datasheet
Interval	Number	A numeric value that indicates how often the Global Event will occur. For example, if the value in the Interval field is <i>4</i> and the value <i>Months</i> exists in the Interval Units field, then the Global Event will occur every 4 months during the simulation period.	This field is enabled only if the value in the Driver Type field is <i>Date Driven (DateDriven)</i> and the value in the One Time Event field is <i>False</i> .	System Global Event
Interval Units	Character	The time units associated with the value in the Interval field.	You can select a value from the following options: <ul style="list-style-type: none"> • Hours • Days • Weeks • Months • Years 	System Global Event

Field Caption	Data Type	Description	Behavior and Usage	Datasheet
Max Advance Duration	Number	<p>A numeric value that identifies the maximum time that an Action can be advanced forward to be completed with the other Actions assigned to the Global Event.</p> <p>For example, if the Max Advance Duration field contains the value 3 and the Max Advance Duration Units field contains the value <i>Months</i>, then any Action that would be performed 3 months or less after the Global Event can be moved forward in time and completed with the rest of the Actions that are assigned to the Global Event.</p>	This value is set to 0 (zero) by default.	System Global Event

Field Caption	Data Type	Description	Behavior and Usage	Datasheet
Max Advance Duration Units	Character	The time units associated with the value in the Max Advance Duration field.	You can select a value from the following options: <ul style="list-style-type: none">• Hours• Days• Weeks• Months• Years	System Global Event

Field Caption	Data Type	Description	Behavior and Usage	Datasheet
Max Delay Duration	Number	<p>A numeric value that identifies the maximum time that an Action can be delayed to be completed with the other Actions that are assigned to the Global Event.</p> <p>For example, if the Max Delay Duration field contains the value 2 and the Max Advance Duration Units field contains the value <i>Weeks</i>, then any Action that would be performed 2 weeks or less before the Global Event can be delayed in time and completed with the rest of the Actions that are assigned to a Global Event.</p>	This value is set to 0 (zero) by default.	System Global Event

Field Caption	Data Type	Description	Behavior and Usage	Datasheet
Max Delay Duration Units	Character	The time units associated with the value in the Max Delay Duration field.	<p>You can select a value from the following options:</p> <ul style="list-style-type: none"> • Hours • Days • Weeks • Months • Years 	System Global Event
Name	Character	The name of the Global Event.	<p>You can define this value manually. This value is used to identify Global Events in System Reliability Analyses. For example, the Name column appears by default in the Global Events pane on the System Reliability Scenarios - Global Events page and displays values that exist in the Name field to identify the System Global Event records that are displayed in the grid.</p>	System Global Event

Field Caption	Data Type	Description	Behavior and Usage	Datasheet
One Time Event	Logical	Indicates whether the Global Event will occur one time or can be repeated more than once.	<p>If this value is <i>True</i>, the Global Event will occur once. If this value is <i>False</i>, the Global Event will occur more than once.</p> <p>For example, you might create an Action to replace an expensive piece of machinery. If the Action requires a complete shutdown, to reduce total downtime of the system, you could create a one-time Global Event with the value is <i>True</i> in the One Time Event field that would reschedule any assigned Actions to be completed during the required shutdown. In contrast, Actions that are repeated several times would be assigned to a recurring Global Event with the value <i>False</i> in the One Time Event field because the Global Event would be needed several times to minimize downtime in a simulation period.</p>	System Global Event

System Link

System Link records store information about links that connect other elements that work together to produce output. The following table provides an alphabetical list and description of the fields that exist for the System Link family and appear by default on the System Link datasheet. The information in the table reflects the baseline state and behavior of these fields. This list is not comprehensive.

Field Caption	Data Type	Description	Behavior and Usage
Description	Text	Any additional information regarding the link.	On the System Link datasheet, you can define this value manually by clicking the  button and entering text in the Description dialog box.
Fixed Cost	Number	The cost of lost production when the link fails. Fixed cost does not change as a result of other variables such as downtime.	This value is set to 0 (zero) by default.
GUID	Character	Contains a value that uniquely identifies the record within a System Reliability Analysis.	This value is generated automatically by the Meridium APM system and disabled. In System Reliability Analyses, GUIDs are used to identify records because Entity Keys will not exist until a record is saved. Because a System Reliability Analysis may contain unsaved records, it is necessary to use a value that uniquely identifies those records within the system.
Lost Production Cost	Number	The cost of lost production per unit of time when the link is not running.	The Lost Production Cost is set to 0 (zero) by default.

Field Caption	Data Type	Description	Behavior and Usage
Lost Production Cost Units	Character	The time units for the Lost Production Cost field.	You can select a value from the following options: <ul style="list-style-type: none">• Per Hour• Per Day• Per Week• Per Month• Per Year
Minimum Predecessors	Number	The minimum number of predecessors that the link can have.	The value in this field cannot exceed the actual number of predecessors. Attempting to enter a number greater than the number of actual predecessors results in the value reverting to the previous value.

Field Caption	Data Type	Description	Behavior and Usage
Production Contribution	Number	<p>The percentage that this piece of equipment or location will contribute to the overall production capacity of its parent system, with respect to other elements that are running in parallel to the piece of equipment or location.</p> <p>For example, if two pieces of equipment are running in parallel with one another and each one contributes 50% to the overall production output, you would enter a value of 50 in the Production Contribution field of each piece of equipment or location. The Production Contribution of each element in the Diagram will be used to calculate the overall production loss of the parent system when one or more elements are down.</p>	<p>The Production Contribution is set to 100 by default. If the piece of equipment or location does not contribute to the overall production output of its parent system, you can set the Production Contribution to 0 (zero).</p>
Variable Cost	Number	<p>The cost incurred during the downtime due to the link failing.</p>	<p>The Variable Cost is set to 0 (zero) by default.</p>
Variable Cost Units	Character	<p>The time units associated with the value in the Variable Cost field.</p>	<p>You can select a value from the following options:</p> <ul style="list-style-type: none"> • Per Hour • Per Day • Per Week • Per Month • Per Year

System Resource

System Resource records store information about physical parts or materials, such as spare bearings or seals, or human resources, such as mechanics or technicians. The following table provides an alphabetical list and description of the fields that exist for the System Resource family and appear by default on the System Resource datasheet. The information in the table reflects the baseline state and behavior of these fields.

Field Caption	Data Type	Description	Behavior and Usage
Count Occurrences	Logical	Indicates whether the occurrences of the associated Resource Usages will be displayed in the Resource Occurrence Plot on the System Reliability Summary page .	If this value is <i>True</i> , the associated Resource Usages will be displayed on the Resource Occurrence Plot. If this value is <i>False</i> , the Resource Usages will not be displayed. This value is <i>True</i> by default.
Description	Text	Any additional information regarding the Resource.	On the System Resource datasheet, you can define this value manually by clicking the  button and entering text in the Description dialog box.
Fixed Cost	Number	The expense of the Resource that is not dependent on the amount of time the Resource is used.	This value is set to 0 (zero) by default.
Name	Character	The name of the Resource (e.g., Mechanic).	You can define this value manually by typing a value into the Name field.

Field Caption	Data Type	Description	Behavior and Usage
GUID	Character	A value that uniquely identifies the record within a System Reliability Analysis.	This value is generated automatically by the Meridium APM system and does not appear on the System Resource datasheet by default. In System Reliability Analyses, GUIDs are used to identify records because Entity Keys will not exist until a record is saved. Because a System Reliability Analysis may contain unsaved records, it is necessary to use a value that uniquely identifies those records within the system.
Variable Cost Units	Number	The time units associated with the Variable Cost Field.	The Variable Cost is set to 0 (zero) by default.
Variable Cost	Character	The cost of the Resource that is dependent on the Variable Cost Units.	You can select a value from the following options: <ul style="list-style-type: none"> • Per Hour • Per Day • Per Week • Per Month • Per Year

System Resource Usage

System Resource records store information about how a Resource will be used. The following table provides an alphabetical list and description of the fields that exist for the System Resource Usage family and appear by default on the System Resource Usage datasheet. The information in the table reflects the baseline state and behavior of these fields.

Field Caption	Data Type	Description	Behavior and Usage
Duration	Number	The length of time that a Resource will be used by an Action or Risk. If an Action requires a Mechanic Resource for four hours, then the Duration would be <i>four</i> .	This value is set to 0 (zero) by default.
Duration Units	Character	The units of time associated with the value in the Duration field. If an Action requires a Mechanic Resource for four hours, then the Duration Units would be <i>Hours</i> .	You can select a value from the following options: <ul style="list-style-type: none"> • Hours • Days • Weeks • Months • Years
GUID	Character	A value that uniquely identifies the System Resource Usage record within a System Reliability Analysis.	This value is generated automatically by the Meridium APM system and disabled. In System Reliability Analyses, GUIDs are used to identify records because Entity Keys will not exist until a record is saved. Because a System Reliability Analysis may contain unsaved records, it is necessary to use a value that uniquely identifies those records within the system.

Field Caption	Data Type	Description	Behavior and Usage
Quantity	Number	The quantity of a Resource that will be used by an Action or Risk. If an Action requires three Mechanic Resources, then the quantity would be <i>three</i> .	This value is set to 1 (one) by default.
Resource GUID	Character	Contains a value that uniquely identifies the System Resource record that is associated with the System Resource Usage record within a System Reliability Analysis.	This value is generated automatically by the Meridium APM system and disabled. In System Reliability Analyses, GUIDs are used to identify records because Entity Keys will not exist until a record is saved. Because a System Reliability Analysis may contain unsaved records, it is necessary to use a value that uniquely identifies those records within the system.

System Risk

System Risk records store details about a [Risk](#) in a System Analysis and the cost of an equipment or location failure due to that Risk. Multiple System Risk records can be linked to a single System Asset record to represent multiple ways in which that piece of equipment or location can fail. The following table provides an alphabetical list and description of the fields that exist for the System Risk family and appear on the System Risk datasheet by default. The information in the table reflects the baseline state and behavior of these fields. This list is not comprehensive.

Field	Data Type	Description	Behavior and Usage
Description	Text	Additional information that is used to identify the Risk.	You can type a description of the Risk into this field manually or click the  button to type a description using the Text Editor.
Failure Without Replacement	Logical	Indicates whether or not the piece of equipment or location is replaced after each failure that results from the Risk.	This field contains the value <i>False</i> by default. If this value is <i>True</i> , the piece of equipment or location is not replaced after each failure (as good as old). If this value is <i>False</i> , the piece of equipment or location is replaced after each failure (as good as new).
Fixed Unplanned Correction Cost	Number	Indicates the set cost of a piece of equipment or location when it fails as a result of the Risk. Fixed cost does not change as a result of other variables such as downtime. An example of fixed unplanned correction cost is the cost of a new piece of equipment.	This field contains the value <i>0</i> by default.

Field	Data Type	Description	Behavior and Usage
Is Active	Logical	Indicates whether or not the piece of equipment's or location's operating time accumulates while the system is running. After a potential failure is detected, this value indicates whether the piece of equipment's or location's remaining life is reduced when the system is active or latent.	<p>This value is a characteristic of the piece of equipment or location to which the Risk is related and should be the same for all Risks related to the same piece of equipment or location. This field contains the value <i>True</i> by default. If the value is <i>True</i>, the piece of equipment's or location's operating time will accumulate while the system is running, and the value in the Is Latent field should be <i>False</i>. This means that the v or location will lose lifetime while the system is running.</p> <p>For example, when a car (i.e., the system) is moving, a tire's (i.e., piece of equipment's) lifetime is being used up. The tire is active.</p>

Field	Data Type	Description	Behavior and Usage
Is Latent	Logical	Indicates whether or not the piece of equipment's or location's operating time accumulates while the system is idle. After a potential failure is detected, this value indicates whether the piece of equipment's or location's remaining life is reduced when the system is active or latent.	<p>This value is a characteristic of the piece of equipment or location to which the Risk is related and should be the same for all Risks related to the same piece of equipment or location. This field contains the value <i>False</i> by default. If this value is <i>True</i>, the piece of equipment's or location's operating time will accumulate while the system is idle, and the value in the Is Active field should be <i>False</i>. This means the piece of equipment or location will lose lifetime when the system is not running.</p> <p>For example, when a car (i.e., the system) is stopped, the brake's (i.e., piece of equipment's) lifetime is being used up. The brake is latent.</p>
Last Failure	Date	Indicates the most recent date that the piece of equipment or location failed due to the Risk.	You can use the Calendar tool to select the date of the most recent equipment or location replacement.
Name	Character	The name of the Risk.	You can type the name of the Risk in this field manually. This value is used to identify Risks in the System Reliability Analysis. For instance, in the Risks pane on the System Reliability Scenarios - Risks page, the Name column displays values that exist in the Name field to identify Risks that are displayed in the grid.

Field	Data Type	Description	Behavior and Usage
Number of Sub-components	Number	The number of subcomponents to which the Risk applies.	This field contains the value <i>1</i> by default. The value should be greater than <i>1</i> only if the value in the Failure Without Replacement field contains the value <i>True</i> .
Percentage of PF Interval to Wait	Number	A numeric value that indicates how long to wait to repair the piece of equipment or location after detecting a potential failure due to this Risk.	<p>This field contains the value <i>0</i> by default and should be used only if the value in the Repair Immediately field is <i>False</i>. This value indicates at what percentage of the value in the PF Interval field the piece of equipment or location should be repaired.</p> <p>For example, an engineer monitors a Risk more frequently after a potential failure is detected and does not want to repair the piece of equipment or location immediately. If a potential failure is detected at the start of the PF Interval, and the engineer knows that the piece of equipment or location will not actually fail for 10 more days (i.e., a PF Interval of <i>10</i>), he might decide to initiate a repair strategy six days later, or at 60 percent of the PF Interval. In this case, the Percentage of PF Interval to Wait is 60 percent.</p>

Field	Data Type	Description	Behavior and Usage
PF Interval	Number	The time between when a potential failure is detectable and when an actual failure will occur.	This field contains the value 0 by default. This value is used along with the value in the Percentage of PF Interval to Wait field to determine when a piece of equipment or location should be repaired after a failure. The P-F Interval is determined by the user and is not calculated by the system.
PF Interval Units	Character	The time units associated with the PF Interval.	This value is set to <i>Days</i> by default. You can select from a list of the following options: <ul style="list-style-type: none"> • Minutes • Hours • Days • Weeks • Months • Years
Planned Correction Cost	Number	The total cost (i.e., fixed cost plus variable cost) of a planned correction that will prevent the Risk from resulting in a functional failure. An example of a planned correction is a routine equipment cleaning.	This field contains the value 0 by default. A planned correction does not happen as a result of a failure.

Field	Data Type	Description	Behavior and Usage
Planned Correction Duration	Number	The time required to implement a planned correction.	This field contains the value <i>0</i> by default.
Planned Correction Duration Units	Character	The time units associated with the Planned Correction Duration.	This value is set to <i>Days</i> by default. You can select from a list of the following options: <ul style="list-style-type: none"> • Hours • Days • Weeks • Months • Years
Repair Immediately	Logical	A value that indicates whether or not the piece of equipment or location should be repaired immediately if a potential failure due to this Risk is detected.	This value is set to <i>True</i> by default. If the value is <i>True</i> , the piece of equipment or location should be repaired as soon as an inspection detects a failure, regardless of the remaining life of the piece of equipment or location. If the value is <i>False</i> , the piece of equipment or location should be repaired according to the value in the Percentage of PF Interval to Wait field.

Field	Data Type	Description	Behavior and Usage
Variable Unplanned Correction Cost	Number	A number that indicates the variable cost associated with the downtime of an piece of equipment or location when it fails due to the Risk. An example of variable unplanned correction cost is the cost of labor per time period of the mechanic that repairs the piece of equipment or location.	This field contains the value 0 by default.
Variable Unplanned Correction Cost Units	Character	The time units associated with the Variable Unplanned Correction Cost.	This value is set to <i>Per Day</i> by default. You can select from a list of the following options: <ul style="list-style-type: none"> • Per Hour • Per Day • Per Week • Per Month • Per Year

System Scenario

System Scenario records store general information about a scenario in a System Reliability Analysis. The following table provides an alphabetical list and description of the fields that exist for the System Scenario family. The information in the table reflects the baseline state and behavior of these fields. This list is not comprehensive.

Field Caption	Data Type	Description	Behavior and Usage	Datasheet
Description	Text	A brief description that helps distinguish a given Scenario from other Scenarios that exist within a certain System Reliability Analysis. For example, the value in the Description field may indicate how the Diagram associated with one Scenario differs from the Diagram associated with another.	On the System Scenario datasheet, you can define this value manually by clicking the  button and entering text in the Description dialog box.	System Scenario

Field Caption	Data Type	Description	Behavior and Usage	Datasheet
GUID	Character	Contains a value that uniquely identifies the record within a System Reliability Analysis.	This value is generated automatically by the Meridium APM system and does not appear on the System Scenario datasheet. In System Reliability Analyses, GUIDs are used to identify records because Entity Keys will not exist until a record is saved. Because a System Reliability Analysis may contain unsaved records, it is necessary to use a value that uniquely identifies those records within the system.	None
Name	Character	The name of the scenario.	This value is populated automatically with <i>New Scenario 1</i> . You can define this value manually.	System Scenario

Field Caption	Data Type	Description	Behavior and Usage	Datasheet
Is Result Valid	Logical	A logical value that indicates whether the current simulation results are valid.	If this value is <i>True</i> , the current simulation results are valid. If the simulation has been modified or changed in any way, this field will be set to <i>False</i> until the simulation has been run again.	None

System Sensor

System Sensor records store information about a sensor that detects the failure of a piece of equipment or location and notifies Switches of the failure. The following table provides an alphabetical list and description of the fields that exist for the System Sensor family. The information in the table reflects the baseline state and behavior of these fields.

Field Caption	Data Type	Description	Behavior and Usage	Datasheet
Activated Switches	Text	Identifies the switches that the sensor activates.	In the Sensor's Properties pane on the System Reliability Scenarios - Diagram page, the Activated Switches cell contains a list of all Switch elements in the diagram. In the list, you can select the check box to the left of any switch that the sensor activates. After you make your selections, the names of those Switch elements will appear in the Activated Switches cell. These values are stored as text in the Activated Switches field.	None

Field Caption	Data Type	Description	Behavior and Usage	Datasheet
Deactivated Switches	Text	Identifies the switches that the sensor deactivates.	In the Sensor's Properties pane on the System Reliability Scenarios - Diagram page, the Deactivated Switches cell contains a list of all Switch elements in the diagram. In the list, you can select the check box to the left of any switch that the sensor deactivates. After you make your selections, the names of those Switch elements will appear in the Deactivated Switches cell. These values are stored as text in the Deactivated Switches field.	None
Description	Text	Any additional information about the sensor.	On the System Sensor datasheet, you can define this value manually by clicking the  button and entering text in the Description dialog box.	System Sensor

Field Caption	Data Type	Description	Behavior and Usage	Datasheet
GUID	Character	A value that uniquely identifies the record within a System Reliability Analysis.	This value is generated automatically by the Meridium APM system and disabled. In System Reliability Analyses, GUIDs are used to identify records because Entity Keys will not exist until a record is saved. Because a System Reliability Analysis may contain unsaved records, it is necessary to use a value that uniquely identifies those records within the system.	System Sensor
Monitored Elements	Text	Identifies the Diagram elements that the sensor monitors.	In the Sensor's Properties pane on the System Reliability Scenarios - Diagram page, the Monitored Elements cell contains a list of all elements in the diagram. In the list, you can select the check box to the left of any element that a given sensor monitors. After you make your selections, the names of those elements will appear in the Monitored Elements cell. These values are stored as text in the Monitored Elements field.	None

Field Caption	Data Type	Description	Behavior and Usage	Datasheet
Name	Character	The name of the sensor.	This value is populated automatically with <i>Sensor</i> . You can define this value manually.	System Sensor

System Subsystem

System Subsystem records store information about a system of equipment or locations. The following table provides an alphabetical list and description of the fields that exist for the System Subsystem family. The information in the table reflects the baseline state and behavior of these fields. This list is not comprehensive.

Field Caption	Data Type	Description	Behavior and Usage	Datasheet
Connections	Text	This field is used internally by the Meridium APM system to store connections in the diagram.	This field does not appear on the System Subsystem datasheet.	None
Diagram	Binary	This field is used internally by the Meridium APM system to store the diagram.	This field does not appear on the System Subsystem datasheet.	None
Description	Text	Any additional information regarding the subsystem.	On the System Subsystem datasheet, you can define this value manually by clicking the  button and entering text in the Description dialog box.	System Subsystem
Element Properties	Text	This field is used internally by the Meridium APM system to store element properties.	This field does not appear on the System Subsystem datasheet.	None

Field Caption	Data Type	Description	Behavior and Usage	Datasheet
Fixed Cost	Number	The cost of lost production when the subsystem fails. Fixed cost does not change as a result of other variables such as downtime.	This value is set to 0 (zero) by default.	System Subsystem
GUID	Character	A value that uniquely identifies the record within a System Reliability Analysis.	This value is generated automatically by the Meridium APM system and disabled. In System Reliability Analyses, GUIDs are used to identify records because Entity Keys will not exist until a record is saved. Because a System Reliability Analysis may contain unsaved records, it is necessary to use a value that uniquely identifies those records within the system.	System Subsystem
Lost Production Cost	Number	The cost of lost production per unit of time when the subsystem is not running.	The Lost Production Cost is set to 0 (zero) by default.	System Subsystem

Field Caption	Data Type	Description	Behavior and Usage	Datasheet
Lost Production Cost Units	Character	The time units for the Lost Production Cost field.	You can select a value from the following options: <ul style="list-style-type: none">• Per Hour• Per Day• Per Week• Per Month• Per Year	System Subsystem

Field Caption	Data Type	Description	Behavior and Usage	Datasheet
<p>Production Contribution</p>	<p>Number</p>	<p>The percentage that this piece of equipment or location will contribute to the overall production capacity of its parent system, with respect to other elements that are running in parallel to the piece of equipment or location.</p> <p>For example, if two pieces of equipment are running in parallel with one another and each one contributes 50% to the overall production output, you would enter a value of 50 in the Production Contribution field of each piece of equipment. The Production Contribution of each element in the Dia-</p>	<p>The Production Contribution is set to 100 by default. If the piece of equipment or location does not contribute to the overall production output of its parent system, you can set the Production Contribution to 0 (zero). The value in the Production Contribution field of the Default subsystem or Root Subsystem is disabled on that subsystem's Properties pane.</p>	<p>System Subsystem</p>

Field Caption	Data Type	Description	Behavior and Usage	Datasheet
		gram will be used to calculate the overall production loss of the parent system when one or more elements are down.		
Variable Cost	Number	The cost incurred during the down-time due to subsystem failures or shutdowns.	The Variable Cost is set to 0 (zero) by default.	System Subsystem
Variable Cost Units	Character	The time units associated with the value in the Variable Cost field.	You can select a value from the following options: <ul style="list-style-type: none"> • Per Hour • Per Day • Per Week • Per Month • Per Year 	System Subsystem

System Switch

System Switch records store information about components that are activated or deactivated by a Sensor when a failure occurs. The following table provides an alphabetical list and description of the fields that exist for the System Switch family and appear by default on the System Switch datasheet. The information in the table reflects the baseline state and behavior of these fields. This list is not comprehensive.

Field Caption	Data Type	Description	Behavior and Usage
Description	Text	A description of the switch that allows you to identify the switch and distinguish it from other switches.	On the System Switch datasheet, you can define this value manually by clicking the  button and entering text in the Description dialog box.
Equipment Type	Character	A description of the equipment type that allows you to identify the equipment type and distinguish it from other equipment types.	You can define this value manually by typing a value into the Equipment Type field.
Fixed Cost	Number	The cost to fix the switch when it fails. Fixed cost does not change as a result of other variables such as downtime.	This value is set to 0 (zero) by default.
GUID	Character	A value that uniquely identifies the record within a System Reliability Analysis.	This value is generated automatically by the Meridium APM system and disabled. In System Reliability Analyses, GUIDs are used to identify records because Entity Keys will not exist until a record is saved. Because a System Reliability Analysis may contain unsaved records, it is necessary to use a value that uniquely identifies those records within the system.

Field Caption	Data Type	Description	Behavior and Usage
Is Initially On	Logical	A flag that indicates whether the Switch is initially on or off.	If this value is <i>False</i> , then the Switch is turned off initially. If this value is <i>True</i> , then the Switch is turned on initially. This value is set to <i>True</i> by default.
Lost Production Cost	Number	The cost of lost production per unit of time when the switch is not running.	The Lost Production Cost is set to 0 (zero) by default.
Lost Production Cost Units	Character	The time units for the Lost Production Cost field.	You can select a value from the following options: <ul style="list-style-type: none"> • Per Hour • Per Day • Per Week • Per Month • Per Year
Name	Character	The name of the switch.	This value is populated automatically with <i>Switch</i> . You can define this value manually.

Field Caption	Data Type	Description	Behavior and Usage
Production Contribution	Number	<p>The percentage that this piece of equipment or location will contribute to the overall production capacity of its parent system, with respect to other elements that are running in parallel to the piece of equipment or location.</p> <p>For example, if two pieces of equipment are running in parallel with one another and each one contributes 50% to the overall production output, you would enter a value of 50 in the Production Contribution field of each piece of equipment. The Production Contribution of each element in the Diagram will be used to calculate the overall production loss of the parent system when one or more elements are down.</p>	<p>The Production Contribution is set to 100 by default. If the piece of equipment or location does not contribute to the overall production output of its parent system, you can set the Production Contribution to 0 (zero).</p>
Variable Cost	Number	<p>The cost incurred during the downtime due to failures or shutdowns.</p>	<p>The Variable Cost is set to 0 (zero) by default.</p>
Variable Cost Units	Character	<p>The time units associated with the value in the Variable Cost field.</p>	<p>You can select a value from the following options:</p> <ul style="list-style-type: none"> • Per Hour • Per Day • Per Week • Per Month • Per Year

Unreliability Cost

An Unreliability Cost record stores information about an analysis that calculates the cost of unreliable elements, systems, or units. The following table provides an alphabetical list and description of the fields that exist for the Unreliability Cost family, which appear by default on the Unreliability Cost datasheet. The information in the table reflects the baseline state and behavior of these fields.

Field Caption	Data Type	Description	Behavior and Usage
Analysis ID	Character	The name of the Cost of Unreliability Analysis.	This field is populated automatically with the value you entered in the Analysis Name text box when you save the Unreliability Cost Analysis.
Asset ID Field	Character	The field name in the query or dataset that retrieves the names of the equipment and locations on which the analysis is being performed.	This value will be automatically populated with the value you selected in the Unit ID list on the Select Failure Fields screen of the Cost of Unreliability Builder .
Automatically Generated	Logical	Indicates whether the analysis is automatically generated.	If this value is set to <i>True</i> , the Cost of Unreliability Analysis is automatically generated by a Reliability Automation Rule.
Availability	Number	The percentage of the time that a production unit is up and running versus the Calendar time.	This value is calculated based on the downtime of a piece of equipment or location during the analysis period. This value also appears in the Availability column on the Assets tab of the Failure Data window.
Currency	Character	The currency used to display financial results in various places throughout Unreliability Cost.	This value is set to \$ by default unless specified otherwise.

Field Caption	Data Type	Description	Behavior and Usage
Datasource ID	Character	The location of the data source associated with the source data.	If the value in the Datasource Type field is <i>Query</i> or <i>Dataset</i> , this value is populated automatically with a file location where the data can be accessed.
Datasource Type	Character	The type of data source associated with the source data.	This value will be populated automatically with <i>Query</i> or <i>Dataset</i> if the failure data comes from a query or dataset. If you enter manual failure data this value will be populated automatically with <i>None</i> .
Downtime	Number	The amount of time that a unit is not available for use for any reason.	This field is populated automatically with a value mapped from the query or dataset. The value corresponds with the field named in the Downtime Field field.
Downtime Field	Character	The field name in the query or dataset that retrieves the Downtime data.	This field is populated automatically with the value you entered in the Downtime field on the Provide Information for Downtime screen in the Cost of Unreliability Builder .
Downtime Units	Character	The time unit that downtime is measured in (e.g., days).	This field is populated automatically with the value you entered in the Time Units field on the Provide Information for Downtown screen in the Cost of Unreliability Builder . Alternatively, you can change this value via the Units of Measure dialog box.

Field Caption	Data Type	Description	Behavior and Usage
Failure Date Field	Character	The field name in the query or dataset that retrieves the Failure Date data. Failure Dates are the dates on which the piece of equipment or location failed.	This value is populated automatically with the value you selected in the Failure Date list on the Select Failure Fields screen of the Cost of Unreliability Builder .
Failures	Text	The failure data used for the Unreliability Growth Analysis.	On the Unreliability Cost datasheet, this field is populated automatically with the value <i><FailureDataset></i> . When you click the  button, the Failures dialog box appears with the code for your failure dataset.
Installation Date Field	Character	The field name in the query or dataset that retrieves the installation date data. The installation date is the day on which the piece of equipment or location was installed.	This value is populated automatically with the value you selected in the Installation Date list on the Select Failure Fields screen of the Cost of Unreliability Builder .
LPO	Number	Lost Profit Opportunity, or profit that the company loses when it cannot supply product to meet customer demand.	This field is populated automatically with a value in the LPO column on the Assets tab of the Failure Data window. The value corresponds with the field named in the LPO Field field.
LPO Field	Character	The field name in the query or dataset that retrieves lost profit opportunity data.	This value is populated automatically with the value you selected in the Lost Profit Opportunity list on the Provide Information on Cost screen of the Cost of Unreliability Builder .

Field Caption	Data Type	Description	Behavior and Usage
Maintenance Cost	Number	The cost of fixing the equipment after a failure occurs, including both the labor and the material costs.	This field is populated automatically with a value in the Maintenance Cost column on the Assets tab of the Failure Data window. The value corresponds with the field named in the Maintenance Cost Field field.
Maintenance Cost Field	Character	The field name in the query or dataset that retrieves the maintenance cost data.	This value is populated automatically with the value you selected in the Maintenance Cost list on the Provide Information on Cost screen of the Cost of Unreliability Builder .
MTBF	Number	The Mean Time Between Failures for the units being analyzed.	The value in this field is calculated by the Meridium APM system and is populated automatically.
MTBF Period Length	Number	The amount of time over which the calculation of MTBF is performed.	You can define this value manually using the MTBF Calculation dialog box.
MTBF Period Units	Character	The time units the MTBF Period are measured in.	You can define this value manually using the MTBF Calculation dialog box.
MTBF Units	Character	The units the MTBF are measure in.	You can define this value manually using the Units of Measure dialog box.
MTTR	Number	The Mean Time to Repair, or the average amount of time that it takes to restart the production units(s) after a failure occurs.	The value in this field is calculated by the Meridium APM system and is populated automatically.

Field Caption	Data Type	Description	Behavior and Usage
Published	Logical	Indicates whether an analysis is published (<i>True</i>) or unpublished (<i>False</i>).	This field is set to <i>True</i> when the analysis is published.
Report Period	Character	The time interval in which results are calculated and presented for the Pareto charts.	You can define the reporting period manually using the Units of Measure dialog box.
Trend Frequency	Character	The time interval in which results are calculated and presented for the trends.	You can define the trend frequency manually using the Units of Measure dialog box.
Units	Number	The number of production units included in the analysis.	This value is populated automatically with the number of units that were specified in the failure dataset you entered for this analysis.

Parameters for the Reliability Production URL

The URL for displaying Reliability Production Analyses, **meridium://Reliability/Production**, accepts the parameters described in the following table. Note that to create a functional URL, you must define at least the Page parameter.

Note: Some parameter values for the Reliability Production Analysis URL are case sensitive. When constructing URLs for Reliability Production Analyses, use the exact case that appears in the following table.

Parameter Name	Description	Accepted Value(s)	Notes
EntyKey	Specifies which Reliability Production Analysis you want to view.	The Entity Key of the desired analysis.	Use this parameter when Page=ProductionAnalysis.
Page	Specifies whether to display the list of existing analyses or a specific analysis.	List ProductionAnalysis Builder	<ul style="list-style-type: none"> • List: Displays the Select a Production Analysis from the list page. • Production Analysis: Displays the Production Analysis page for the analysis specified by the EntyKey parameter. When you use the ProductionAnalysis parameter, you must also use the EntyKey parameter. • Builder: Launches the Production Analysis Builder, which you can use to create a new analysis.
Query	Specifies the Catalog path of the query that you want to use for creating a new analysis.	The Catalog path of the query that you want to use for creating a new analysis.	This parameter must be used when Page=Production Analysis. When you specify a query, the new analysis will be created using the first date field in the query as the production date and the first numeric field as the production amount.

Examples of the Production Analysis URLs

- **meridium://Reliability/Production?Page=List**
Displays the **Select a Production Analysis from the listpage**.
- **meridium://Reliability/Production?Page=ProductionAnalysis&EntyKey=2866882**
Displays the **Production Analysis** page for the Reliability Production Analysis with the Entity Key 2866882.
- **meridium://Reliability/Production?Page=ProductionAnalysis&Query=y=Public\Meridium\Queries\Production Data**
Creates a new analysis using the data returned by the Production Data query. The first date field in the query is used for the Production Date, and the first numeric field in the query is used for the Production amount.
- **meridium://Reliability/Production?Page=Builder**
Launches the **Production Analysis Builder**, where you can begin the process of creating a new analysis.

Parameters for the Spares Analysis URL

The URL for displaying Reliability Spares Analyses, `meridium://Reliability/Spares/Analysis`, accepts the parameters described in the following table.

Parameters	Description	Accepted Value(s)	Notes
AnalysisKey	Specifies the analysis for which you want to view Recommendations.	The Entity Key of the desired Spares Analysis record.	Use this parameter when <code>Page=Recommendations</code> or <code>Page=RecommendationDetail</code> to view the Recommendation information for the Spares Analysis associated with the specified Entity Key.
EntyKey	Specifies which Spares Analysis that you want to view.	The Entity Key of the desired analysis.	You can use this parameter alone to open the Spares Analysis associated with the specified Entity Key.
Page	Specifies whether to display the Recommendations page or the Recommendation Details page for the analysis specified by the EntyKey parameter.	Recommendations RecommendationDetail	<ul style="list-style-type: none"> • Recommendations: Displays the Recommendations page for the analysis specified by the EntyKey parameter. • Recommendation Detail: Displays the Recommendation Details page for the Recommendation record identified by the RecommKey parameter.

Parameters for the Spares Analysis URL

Parameters	Description	Accepted Value(s)	Notes
Recom- mKey	Specifies which Recommendation record you want to view on the Recommendation Details page.	The Entity Key of the desired Recommendation record.	This parameter is required when Page=RecommendationDetail. You can set the parameter value to 0 (zero) to create a new Recommendation for the analysis defined by the specified Entity Key.

Examples of the Spares Analysis URLs

- <meridium://Reliability/Spares/List>
Displays the **Select a Spares Analysis from the List** page.
- <meridium://Reliability/Spares/Analysis>
Displays a new Spares Analysis record on the **Spares Analysis** page, where you can create a new Spares Analysis.
- <meridium://Reliability/Spares/Analysis?EntyKey=64251730965>
Displays the **Spares Analysis** page for the Spares Analysis record with the Entity Key 64251730965.
- <meridium://Reliability/Spares/Analysis?Page=Recommendations&AnalysisKey=64251730965>
Opens the **Recommendations** page, which displays the Recommendation records associated with the Spares Analysis record with the Entity Key 64251730965.
- <meridium://Reliability/Spares/Analysis?Page=RecommendationDetail&RecommKey=64251731123&AnalysisKey=64251731092>
Opens the **Recommendations Details** page, which displays the Recommendation record with the Entity Key 64251731123 and linked to the analysis with the Entity Key 64251731092.

Parameters for the Reliability Growth URL

The URL for displaying Reliability Growth Analyses, `meridium://Reliability/Growth`, accepts the parameters described in the following table. Note that to create a functional URL, you must define at least the **Page** parameter.

Note: Some parameter values for the Reliability Growth Analysis URL are case sensitive. When constructing URLs for Reliability Growth Analyses, use the exact case that appears in the following table.

Parameter Name	Description	Accepted Value(s)	Notes
Action	Performs the action specified by the value.	Find Create CreateTask ReloadData AutoCreate	<ul style="list-style-type: none"> • Find: Launches the Find Reliability Growth Analysis window and displays <i>Reliability Growth</i> in the Search In field. • Create: Launches the Reliability Growth Builder. • Create Task: Launches the New Task Builder. • Reload Data: Reloads the underlying query or dataset on which a given analysis is based, updating the analysis with the most current information in the database. This parameter must be used in conjunction with the EntyKey parameter, as it is meant to reload that data for an <i>existing</i> analysis. • AutoCreate: Automatically creates a Reliability Growth Analysis using a query. This parameter must be used in conjunction with the QueryPath parameter. <p>Note that to use this</p>

Parameter Name	Description	Accepted Value(s)	Notes
			parameter with the values Find, Create, CreateTask, and ReloadData you must define the Page parameter.
AssetIDField	Specifies the query column that contains the ID of the piece of equipment or location that will be used for the Reliability Growth Analysis.	The Alias of the desired field. If no Alias exists, the Field ID will be accepted.	<ul style="list-style-type: none"> • This parameter is required when the Action parameter is set to AutoCreate and you are creating a Reliability Growth Analysis based on failure dates. • This parameter is optional when you are creating a Reliability Growth Analysis based on cumulative operating time.

Parameter Name	Description	Accepted Value(s)	Notes
COTField	Specifies the query column that contains the cumulative operating time for a Reliability Growth Analysis.	The Alias of the desired field. If no Alias exists, the Field ID will be accepted.	This parameter is required when the Action parameter is set to AutoCreate and you are creating a Reliability Growth Analysis based on cumulative operating time.
COTUnits	Specifies the units for cumulative operating time for a Reliability Growth Analysis.	Hours Days Weeks Months Quarters Years Custom	This parameter is optional when the Action parameter is set to AutoCreate and the URL contains the COTField parameter.
CustomCOTUnits	Specifies custom units for cumulative operating time for a Reliability Growth Analysis.	Any text (e.g., miles).	This parameter is optional when the Action parameter is set to AutoCreate and the URL contains the COT Field parameter. If the value for the COTUnits parameter is <i>Custom</i> then this parameter is required and cannot be empty.
DowntimeField	Specifies the query column that contains the downtime (e.g., Total Time to Repair) that will be used for the Reliability Growth Analysis.	The Alias of the desired field. If no Alias exists, the Field ID will be accepted.	This parameter is optional when the Action parameter is set to AutoCreate and the URL contains the AssetIDField parameter and the FailureDateField parameter.

Parameter Name	Description	Accepted Value(s)	Notes
DownTimeUnits	The time units that will be used for downtime.	Hours Days Weeks Months Quarters Years	This parameter is optional when the Action parameter is set to AutoCreate and the URL contains the AssetIDField parameter and the FailureDateField parameter.
EntyKey	Specifies which Reliability Growth Analysis you want to view.	The Entity Key of the desired analysis.	Use this parameter when the Page parameter is set to Summary, MTBFPlot, FailuresPlot, MultipleGrowthAnalysis, DetailedResults, Recommendations, or RecommendationDetail.
FailureDateField	Specifies the query column that contains the failure dates of the equipment or locations that will be used for the Reliability Growth Analysis.	The Alias of the desired field. If no Alias exists, the Field ID will be accepted.	<ul style="list-style-type: none"> This parameter is required when the Action parameter is set to AutoCreate and you are creating a Reliability Growth Analysis based on failure dates. This parameter is optional when you are creating a Reliability Growth Analysis based on cumulative operating time.

Parameter Name	Description	Accepted Value(s)	Notes
InstallationDateField	Specifies the query column that contains the installation date of the equipment or locations that will be used for the Reliability Growth Analysis.	The Alias of the desired field. If no Alias exists, the Field ID will be accepted.	This parameter is optional when the Action parameter is set to AutoCreate and the URL contains the AssetIDField parameter and the FailureDateField parameter.
IsEventData	Indicates whether the dataset used in the Reliability Growth Analysis contains event-based data.	True, true False, false	This parameter is optional when the Action parameter is set to AutoCreate and the URL can be used when creating a Reliability Growth Analysis based on dates or cumulative operating time. If you do not specify a value for this parameter, the default value will be <i>True</i> .
MeasurementName	Specifies the name of the data you are measuring throughout the analysis (e.g., failures, cost, events).	Any Text.	This parameter is optional when the Action parameter is set to AutoCreate and the URL can be used when creating a Reliability Growth Analysis based on dates or cumulative operating time. If you do not specify a value for this parameter, the default value will be <i>Failures</i> .

Parameters for the Reliability Growth URL

Parameter Name	Description	Accepted Value(s)	Notes
NumberOfFailuresField	Specifies the query column that contains the number of failures per datapoint in the Reliability Growth Analysis.	The Alias of the desired field. If no Alias exists, the Field ID will be accepted.	This parameter is optional when the Action parameter is set to AutoCreate and can be used when creating a Reliability Growth Analysis based on failure dates or cumulative operating time.
QueryPath	Specifies the path of the query you will use to automatically create a Reliability Growth Analysis.	The path of the desired query in the Meridium APM Framework.	This parameter is required when the Action parameter is set to AutoCreate in order to indicate which query will be used to create the Reliability Growth Analysis.

Parameter Name	Description	Accepted Value(s)	Notes
Page	Specifies whether to display the list of existing analyses or a specific analysis.	List Summary MTBFPlot FailuresPlot MultipleGrowthAnalysis DetailedResults Recommendations RecommendationDetail	<ul style="list-style-type: none"> • List: Displays the Select a Growth Analysis from the List page. • Summary: Displays Reliability Growth Analysis page for the analysis specified by the EntyKey parameter. • MTBFPlot: Displays the MTBF Plot page for the analysis specified by the EntyKey parameter. • FailuresRatePlot: Displays the Failures Rate Plot page for the analysis specified by the EntyKey parameter. • FailuresPlot: Displays the Cumulative Failures Plot page for the analysis specified by the EntyKey parameter. • MultipleGrowthAnalysis: Displays the Multiple Growth Analysis page for the analyses specified by the EntyKey parameter. • DetailedResults: Displays the AMSAA Reliability Growth Model page for the ana-

Parameters for the Reliability Growth URL

Parameter Name	Description	Accepted Value(s)	Notes
			<p>ysis specified by the EntyKey parameter.</p> <ul style="list-style-type: none"> • Recommendations: Displays the Recommendations page for the analysis specified by the EntyKey parameter. • RecommendationDetail: Displays the Recommendation Details page for the Recommendation record identified by the RecommKey parameter.
RecommKey	Specifies which Recommendation record you want to view.	The Entity Key of the desired Recommendation record.	Use this parameter in conjunction with the RecommendationDetail parameter. You can set the parameter value to 0 (zero) to create a new Recommendation.

Parameters for the Reliability Growth URL

Parameter Name	Description	Accepted Value(s)	Notes
Start Time	Specifies the start time for the Reliability Growth Analysis.	A numerical number.	This parameter is optional when the Action parameter is set to AutoCreate and the URL contains the COTField parameter. You can set this parameter to indicate a start time for the Reliability Growth Analysis. If this parameter is not included, the start time will be the first failure time.

Examples of Reliability Growth URLs

- <meridium://Reliability/Growth?Page=Summary&EntyKey=2866882>
Displays the **Reliability Growth Analysis** summary for the Reliability Growth Analysis with the Entity Key 2866882.
- <meridium://Reliability/Growth?Page=Summary&Action=ReloadData&EntyKey=2866882>
Opens the Reliability Growth Analysis with the Entity Key 2866882 but instead of displaying the results and calculations that were last saved, this URL *reloads* the underlying query or dataset to update the analysis with the most current information in the database. Note that if the analysis is based on a query that contains a prompt, using Action=ReloadData will cause the **Enter parameter values** dialog box to not be displayed. Instead, the query will be executed using the prompt values that were supplied when the analysis was last saved. To display the **Enter parameter values** dialog box to change the prompt values, you will need to use the **Reload Data** link on the task menu.
- <meridium://Reliability/Growth?Page=Summary&Action=Create>
Launches the **Reliability Growth Builder**, which takes you step-by-step through the process of creating a new Reliability Growth Analysis.
- <meridium://Reliability/Growth?Page=MTBFPlot&EntyKey=2866882>
Displays the **MTBF Plot Screen** for the analysis with the Entity Key 2866882.
- <meridium://Reliability/Growth?Page=Recommendations&AnalysisKey=2812175>
Opens the Recommendations page, which displays the Recommendation records associated with the analysis with the Entity Key 2812175.
- <meridium://Reliability/Growth?Page=RecommendationDetail&RecommKey=0&EntyKey=2812175&AnalysisKey=2812175>
Opens a new Recommendation record, which, when saved, will be linked to the analysis with the Entity Key 2812175.
- <meridium://Reliability/Growth?Page=RecommendationDetail&RecommKey=1234567&EntyKey=2812175&AnalysisKey=2812175>
Opens on the **Recommendation Details** page of the Recommendation record with the Entity Key 1234567 that is linked to the analysis with the Entity Key 2812175.
- <meridium://Reliability/Growth?Page=MultipleGrowthAnalysis&AnalysisKeys=64251548660,64251622390>
Opens the **MultipleGrowth Analysis** page, which displays both the analysis with the Entity Key 64251548660 and the analysis with the Entity Key 64251622390.

Parameters for the Reliability Distribution URL

The URL for displaying Reliability Distribution Analyses, **meridium://Reliability/Distribution**, accepts the parameters described in the following table. Note that to create a functional URL, you must define at least the Page parameter.

Note: Some parameter values for the Reliability Distribution URL are case sensitive. When constructing URLs for Reliability Distribution Analyses, use the exact case that appears in the following table.

Parameter Name	Description	Accepted Value(s)	Notes
Action	Performs the Action specified by the value.	Find Create CreateTask ReloadData AutoCreate	<ul style="list-style-type: none"> • Find: Launches the Find a Reliability Distribution Analysis window with <i>Reliability Growth</i> selected in the Search In field. • Create: Launches the Reliability Growth Builder. • CreateTask: Launches the New Task Builder. • ReloadData: Reloads the underlying query or dataset on which a given analysis is based, updating the analysis with the most current information in the database. This parameter must be used in conjunction with the EntyKey parameter, as it is meant to reload that data for an <i>existing</i> analysis. • AutoCreate: Automatically creates a Reliability Distribution Analysis using a query. This parameter must be used in con-

Parameter Name	Description	Accepted Value(s)	Notes
			<p>junction with the QueryPath parameter.</p> <p>Note that to use this parameter with the values Find, Create, CreateTask, and ReloadData you must define the Page parameter.</p>
AssetIDField	Specifies the query column that contains the ID of the equipment or locations that will be used for the Reliability Distribution Analysis.	The Alias of the desired field. If no Alias exists, the Field ID will be accepted.	This parameter is required when the Action parameter is set to AutoCreate in order to identify the equipment or locations that will be used for the Reliability Distribution Analysis.
DowntimeField	Specifies the query column that contains the downtime of the equipment or locations that will be used for the Reliability Distribution Analysis.	The Alias of the desired field. If no Alias exists, the Field ID will be accepted.	This parameter is optional when the Action parameter is set to AutoCreate and can be used when creating a Reliability Distribution Analysis based on failure dates or time to failure.

Parameter Name	Description	Accepted Value(s)	Notes
DownTimeUnits	The time units for downtime.	Hours Days Weeks Months Quarters Years	This parameter is optional when the Action parameter is set to AutoCreate and can be used when creating a Reliability Distribution Analysis based on failure dates or time to failure.
EntyKey	Specifies which Reliability Distribution analysis you want to view.	The Entity Key of the desired analysis.	Use this parameter when the Page parameter is set to Summary, Distribution, ProbabilityPlot, FailureRatePlot, CDFPlot, PDFPlot, PMOptimization, FailureProbability, Recommendations, or RecommendationDetail. Specify multiple Entity Keys when the Page parameter is set to CompositePlot.
FailureDateField	Specifies the query column that contains the failure dates of the equipment or locations that will be used for the Reliability Distribution Analysis.	The Alias of the desired field. If no Alias exists, the Field ID will be accepted.	This parameter is required when the Action parameter is set to AutoCreate in order to build a Reliability Distribution Analysis based on failure dates.

Parameter Name	Description	Accepted Value(s)	Notes
FailureWithReplacement	Indicates whether the equipment or locations are replaced after a failure. If this parameter does not exist, it means replaced after failure.	True False	This parameter is optional when the Action parameter is set to AutoCreate and can be used when creating a Reliability Distribution Analysis based on failure dates or time to failure.
InstallationDateField	Specifies the query column that contains the installation date of the equipment or locations that will be used for the Reliability Distribution Analysis.	The Alias of the desired field. If no Alias exists, the Field ID will be accepted.	This parameter is optional when the Action parameter is set to AutoCreate and the URL contains the FailureDateField parameter.
NumberOfFailuresField	Specifies the query column that contains the number of failures per datapoint in the Reliability Distribution Analysis.	The Alias of the desired field. If no Alias exists, the Field ID will be accepted.	This parameter is optional when the Action parameter is set to AutoCreate and can be used when creating a Reliability Distribution Analysis based on failure dates or time to failure.

Parameter Name	Description	Accepted Value(s)	Notes
Number-OfSubcomponentsField	Specifies the query column that contains the number of sub-components that will be used for the Reliability Distribution Analysis.	The Alias of the desired field. If no Alias exists, the Field ID will be accepted.	This parameter is optional when the Action parameter is set to AutoCreate and can be used when creating a Reliability Distribution Analysis based on failure dates or time to failure.
QueryPath	Specifies the path of the query you will use to automatically create a Reliability Distribution Analysis.	The path of the desired query.	This parameter is required when the Action parameter is set to AutoCreate to indicate which query will be used to create the Reliability Distribution Analysis.

Parameter Name	Description	Accepted Value(s)	Notes
Page	Specifies whether to display the list of existing analyses or a specific analysis.	List Summary Distribution ProbabilityPlot FailureRatePlot CDFPlot PDFPlot PMOptimization FailureProbability CompositePlot Recommendations RecommendationDetail	<ul style="list-style-type: none"> • List: Displays the Select a Distribution Analysis from the List page. • Summary: Displays Reliability Distribution Summary page for the analysis specified by the EntyKey parameter. • Distribution: Displays the Time to Failure Distribution or Time to Repair Distribution page for the analysis specified by the EntyKey parameter. • ProbabilityPlot: Displays the Probability Plot page for the analysis specified by the EntyKey parameter. • FailureRatePlot: Displays the Failure Rate Plot page for the analysis specified by the EntyKey parameter. • CDFPlot: Displays the Cumulative Distribution Function Plot page for

Parameter Name	Description	Accepted Value(s)	Notes
			<p>the analysis specified by the EntyKey parameter.</p> <ul style="list-style-type: none"> • PDFPlot: Displays the Probability Density Function Plot page for the analysis specified by the EntyKey parameter. • PMOptimization: Displays the Preventive Maintenance Optimization dialog box, where you can record PM optimization values for the analysis specified by the EntyKey parameter. • FailureProbability: Displays the Failure Probability Calculation dialog box, where you can perform calculation values for the analysis specified by the EntyKey parameter. • CompositePlot: Displays the Multiple Distribution Plots page for the analyses specified by the EntyKey parameter.

Parameter Name	Description	Accepted Value(s)	Notes
			<ul style="list-style-type: none"> • Recommendations: Displays the Recommendations page for the analysis specified by the EntyKey parameter. • RecommendationDetail: Displays the Recommendation Details page for the Recommendation record identified by the RecommKey parameter.
RecommKey	Specifies which Recommendation record you want to view.	The Entity Key of the desired Recommendation record.	Use this parameter in conjunction with the RecommendationDetail parameter. You can set the parameter value to (zero) to create a new Recommendation.
ReplacementField	Specifies the query column that contains the replacements that will be used for the Reliability Distribution Analysis.	The Alias of the desired field. If no Alias exists, the Field ID will be accepted.	This parameter is optional when the Action parameter is set to AutoCreate and can be used when creating a Reliability Distribution Analysis based on failure dates or time to failure.

Parameter Name	Description	Accepted Value(s)	Notes
TTFField	Specifies the query column that contains the time to failure of the equipment or locations that will be used for the Reliability Distribution Analysis.	The Alias of the desired field. If no Alias exists, the Field ID will be accepted.	This parameter is required when the Action parameter is set to AutoCreate in order to build a Reliability Distribution Analysis based on time to failure.
TTFUnits	The time units for time to failure.	Hours Days Weeks Months Quarters Years	This parameter is optional when the Action parameter is set to AutoCreate and the URL contains the TTFField parameter.
Type	Specifies the type of multiple distribution plot to display.	ProbabilityPlot FailureRatePlot PDFPlot CDFPlot	Use this parameter when Page=CompositePlot. Note also that to display a multiple distribution plot, you must specify more than one Entity Keys for the EntyKey parameter.
Var	Specifies the type of distribution to display.	TTF TTR	Use this parameter when Page=Distribution. If you do not specify this parameter, the distribution type will default to Time to Failure (TTF).

Examples of Reliability Distribution URLs

- <meridium://Reliability/Distribution?Page=List>
Displays the **Select a Distribution Analysis from the List** page.
- <meridium://Reliability/Distribution?Page=Summary&EntyKey=1234567>
Displays the **Reliability Distribution Summary** page for the Reliability Distribution Analysis with the Entity Key 1234567.
- <meridium://Reliability/Distribution?Page=Summary&Action=ReloadData&EntyKey-y=2866882>
Opens the Reliability Distribution Analysis with the Entity Key 2866882 but instead of displaying the results and calculations that were last saved, this URL will *reload* the underlying query or dataset to update the analysis with the most current information in the database. Note that if the analysis is based on a query that contains a prompt, using Action=ReloadData will not cause the **Enter parameter values** dialog box to be displayed. Instead, the query will be executed using the prompt values that were supplied when the analysis was last saved. To display the **Enter parameter values** dialog box to change the prompt values, you will need to use the **Reload Data** link on the task menu.
- <meridium://Reliability/Distribution?Page=Distribution&Var=TTR&EntyKey=1234567>
Displays the **Time to Repair Distribution** page for the Reliability Distribution Analysis with the Entity Key 1234567.
- <meridium://Reliability/Distribution?Page=CompositePlot&Type=PDFPlot&EntyKey=123,124,125>
Opens the **Multiple Distribution Plot** page, displaying the composite PDF plot for the entities with the Entity Keys 123, 124, and 125.
- <meridium://Reliability/Distribution?Page=Recommendations&AnalysisKey=2812175>
Opens the Recommendations page, which displays the Recommendation records associated with the analysis with the Entity Key 2812175.
- <meridium://Reliability/Distribution?Page=RecommendationDetail&RecommKey=0&EntyKey=2812175&AnalysisKey=2812175>
Opens a new Recommendation record, which, when saved, will be linked to the analysis with the Entity Key 2812175.
- <meridium://Reliability/Distribution?Page=RecommendationDetail&RecommKey=1234567&EntyKey=2812175&AnalysisKey=2812175>

Examples of Reliability Distribution URLs

Opens the **Recommendation Details** page, which displays the Recommendation record with the Entity Key 1234567 and linked to the analysis with the Entity Key 2812175.

Parameters for the Probability Distribution URL

The URL for displaying Probability Distribution Analyses, **meridium://Reliability/Distribution/General**, accepts the parameters described in the following table. Note that to create a functional URL, you must define at least the Page parameter.

Note: Some parameter values for the Probability Distribution URL are case sensitive. When constructing URLs for Probability Distribution Analyses, use the exact case that appears in the following table.

Parameter Name	Description	Accepted Value(s)	Notes
Action	Performs the Action specified by the value.	Find Create CreateTask ReloadData	<ul style="list-style-type: none"> • Find: Launches the Find a Reliability Distribution Analysis window. • Create: Launches the Reliability Growth Builder. • CreateTask: Launches the New Task Builder. • ReloadData: Reloads the underlying query or dataset on which a given analysis is based, updating the analysis with the most current information in the database. This parameter must be used in conjunction with the EntyKey parameter, as it is meant to reload that data for an <i>existing</i> analysis. <p>Note that to use this parameter, you must also define the Page parameter.</p>

Parameters for the Probability Distribution URL

Parameter Name	Description	Accepted Value(s)	Notes
EntyKey	Specifies which Probability Distribution analysis you want to view.	The Entity Key of the desired analysis.	<p>Use this parameter when the Page parameter is set to Summary, Distribution, ProbabilityPlot, FailureRatePlot, CDFPlot, PDFPlot, PMOptimization, FailureProbability, Recommendations, or RecommendationDetail.</p> <p>Specify multiple Entity Keys when Page=CompositePlot.</p>

Parameter Name	Description	Accepted Value(s)	Notes
Page	Specifies whether to display the list of existing analyses or a specific analysis.	List Summary ProbabilityPlot PDFPlot CDFPlot Recommendations RecommendationDetail	<ul style="list-style-type: none"> • List: Displays the Select a Distribution Analysis from the List page. • Summary: Displays Reliability Distribution Summary page for the analysis specified by the EntyKey parameter. • ProbabilityPlot: Displays the Probability Plot page for the analysis specified by the EntyKey parameter. • CDFPlot: Displays the Cumulative Distribution Function Plot page for the analysis specified by the EntyKey parameter. • PDFPlot: Displays the Probability Density Function Plot page for the analysis specified by the EntyKey parameter. • Recommendations: Displays the Recommendations page for the analysis specified by the EntyKey parameter. • RecommendationDetail: Displays the Recommendation Details page for the Recommendation record identified by the RecommKey para-

Parameters for the Probability Distribution URL

Parameter Name	Description	Accepted Value(s)	Notes
			meter.
Recom- mKey	Specifies which Recommendation record you want to view.	The Entity Key of the desired Recommendation record.	Use this parameter in conjunction with the RecommendationDetail parameter. You can set the parameter value to 0 (zero) to create a new Recommendation.

Examples of Probability Distribution URLs

- <meridium://Reliability/Distribution/General?Page=List>
Displays the **Probability Distribution List** page, from which you can open an existing Probability Distribution Analysis.
- <meridium://Reliability/Distribution/General?Page=Summary&EntyKey=1234567>
Displays the **Probability Distribution Results** page for the Probability Distribution Analysis with the Entity Key 1234567.
- <meridium://Reliability/Distribution/General?Page=Summary&Action=ReloadData&EntyKey=2866882>
Opens the Probability Distribution Analysis with the Entity Key 2866882 but instead of displaying the results and calculations that were last saved, this URL will *reload* the underlying query or dataset to update the analysis with the most current information in the database. Note that if the analysis is based on a query that contains a prompt, using Action=ReloadData will not cause the **Enter parameter values** dialog box to be displayed. Instead, the query will be executed using the prompt values that were supplied when the analysis was last saved. To display the **Enter parameter values** dialog box to change the prompt values, you will need to use the **Reload Data** link on the task menu.
- <meridium://Reliability/Distribution/General?Page=Recommendations&AnalysisKey=2812175>
Opens the Recommendations page, which displays the Recommendation records associated with the analysis with the Entity Key 2812175.
- <meridium://Reliability/Distribution/General?Page=RecommendationDetail&RecommKey=0&EntyKey=2812175&AnalysisKey=2812175>
Opens a new Recommendation record, which, when saved, will be linked to the analysis with the Entity Key 2812175.
- <meridium://Reliability/Distribution/General?Page=RecommendationDetail&RecommKey=1234567&EntyKey=2812175&AnalysisKey=2812175>
Opens on the **Recommendation Details** page the Recommendation record with the Entity Key 1234567 and linked to the analysis with the Entity Key 2812175.

Parameters for the System Reliability URL

The URL for displaying Reliability System analyses, **meridium://Reliability/SystemReliability**, accepts the parameters described in the following table. Note that to create a functional URL, you must define at least the Page parameter.

Parameter Name	Description	Accepted Value(s)	Notes
AnalysisKey	Specifies which System Reliability Analysis you want to view.	The Entity Key of the desired System Analysis record.	You can use this parameter when the Page parameter is set to <i>Analysis</i> , <i>Recommendations</i> or <i>RecommendationDetail</i> .
Page	Determines which page is displayed.	List Analysis Recommendations RecommendationDetail	<ul style="list-style-type: none"> • List: Displays the Reliability System Analysis page. • Analysis: Displays the System Reliability Summary page for an analysis that has results. Displays the System Reliability Definition page for an analysis that <i>does not</i> have results. • Recommendations: Displays the Recommendations page. • RecommendationDetail: Displays the Recommendation Details page. <p>Depending on which value you specify for the Page parameter, other parameters and values may be required to create a fully functional URL. See the examples for more details.</p>

Parameters for the System Reliability URL

Parameter Name	Description	Accepted Value(s)	Notes
Recom- mKey	Determines which Reliability Recommendation record to display on the Recommendation Details page.	The Entity Key of the desired Reliability Recommendation record.	You can use this parameter when the Page parameter is set to <i>RecommendationDetail</i> .

Examples of the System Reliability URL

- <meridium://Reliability/SystemReliability?Page=List>
Displays the **Select a System Reliability Analysis from the List** page.
- <meridium://Reliability/SystemReliability?Page=Analysis>
Displays a new System Reliability Analysis on the **System Reliability Analysis Definition** page.
- <meridium://Reliability/SystemReliability?Page=Analysis&AnalysisKey=01234567890>
If the System Analysis record identified by the Entity Key 01234567890 *has* results, displays the **System Reliability Summary** page.

-or-
If the System Analysis record identified by the Entity Key 01234567890 does not results, displays the **System Reliability Analysis Definition** page.
- <meridium://Reliability/SystemReliability?Page=Recommendations&AnalysisKey=01234567890>
Displays the **Recommendations** page, which displays a list of Reliability Recommendation records that are linked to the System Analysis record identified by the Entity Key 01234567890.
- <meridium://Reliability/SystemReliability?Page=RecommendationDetail&RecommKey=11223344556&AnalysisKey=01234567890>
Displays the **Recommendation Details** page for the Reliability Recommendation record represented by the Entity Key 11223344556, which is linked to the System Analysis record identified by the Entity Key 01234567890.

Parameters for the Cost of Unreliability Analysis URL

The URL for displaying Cost of Unreliability Analyses, `meridium://Reliability/Cost`, accepts the parameters described in the following table. Note that to create a functional URL, you must define at least the Page parameter.

Note: Some parameter values for the Cost of Unreliability URL are case sensitive. When constructing URLs for Cost of Unreliability Analyses, use the exact case that appears in the following table.

Parameter Name	Description	Accepted Value(s)	Notes
Action	Performs the action specified by the value.	Find Create CreateTask ReloadData	<ul style="list-style-type: none"> • Find: Launches the Find Cost of Unreliability Analysis window with <i>Unreliability Cost</i> selected in the Search In field. • Create: Launches the Reliability Growth Builder. • CreateTask: Launches the New Task Builder. • ReloadData: Reloads the underlying query or dataset on which a given analysis is based, updating the analysis with the most current information in the database. This parameter must be used in conjunction with the <code>EntyKey</code> parameter, as it is meant to reload that data for an <i>existing</i> analysis. <p>Note that to use this parameter, you must also define the Page parameter.</p>

Parameters for the Cost of Unreliability Analysis URL

Parameter Name	Description	Accepted Value(s)	Notes
EntyKey	Specifies which Cost of Unreliability Analysis you want to view.	The Entity Key of the desired analysis.	Use this parameter when the Page parameter is set to Summary, ParetoPlot, PlotData, Recommendations, or RecommendationDetail.
Metric	Specifies the type of plot to display.	MaintCost,LPO MTBF MTTR Avail Failures Downtime	Use this parameter when you use the ParetoPlot or PlotData parameter.

Parameter Name	Description	Accepted Value(s)	Notes
Page	Specifies whether to display the list of existing analyses or a specific analysis.	List Summary ParetoPlot PlotData Recommendations RecommendationDetail	<ul style="list-style-type: none"> • List: Displays the Select a Cost of Unreliability Analysis page. • Summary: Displays the Cost of Unreliability page for the analysis specified by the EntyKey parameter. • ParetoPlot: Displays for the specified analysis the plot indicated by the Metric parameter. • PlotData: Displays the Plot Data page for the specified analysis and the plot type indicated by the Metric parameter. • Recommendations: Displays the Recommendations page for the analysis specified by the EntyKey parameter. • RecommendationDetail: Displays the Recommendation Details page for the Recommendation record identified by the RecommKey parameter.
RecommKey	Specifies which Recommendation record you want to view.	The Entity Key of the desired Recommendation record.	Use this parameter in conjunction with the RecommendationDetail parameter. You can set the parameter value to 0 (zero) to create a new Recommendation.

Examples of Cost of Unreliability URLs

- [meridium://Reliability/Cost?Page=List](#)
Displays the **Select a Cost of Unreliability Analysis** page.
- [meridium://Reliability/Cost?Page=Summary&EntyKey=1234567](#)
Displays the **Cost of Unreliability Analysis** summary page for the analysis with the Entity Key 1234567.
- [meridium://Reliability/Growth?Page=Summary&Action=ReloadData&EntyKey=2866882](#)
Opens the Cost of Unreliability Analysis with the Entity Key 2866882 but instead of displaying the results and calculations that were last saved, this URL will *reload* the underlying query or dataset to update the analysis with the most current information in the database. Note that if the analysis is based on a query that contains a prompt, using Action=ReloadData will not cause the **Enter parameter values** dialog box to be displayed. Instead, the query will be executed using the prompt values that were supplied when the analysis was last saved. To display the **Enter parameter values** dialog box to change the prompt values, you will need to use the **Reload Data** link on the task menu.
- [meridium://Reliability/Cost?Page=ParetoPlot&Metric=MTBF&EntyKey=1234567](#)
Displays the MTBF plot for the analysis with the Entity Key 1234567.
- [meridium://Reliability/Cost?Page=PlotData&Metric=Failures&EntyKey=1234567](#)
Opens the **Plot Data** page, displaying the failure data for the analysis with the Entity Key 1234567.
- [meridium://Reliability/Cost?Page=Recommendations&AnalysisKey=2812175](#)
Opens the **Recommendations** page, which displays the Recommendation records associated with the analysis with the Entity Key 2812175.
- [meridium://Reliability/Cost?Page=RecommendationDetail&RecommKey=0&EntyKey=2812175&AnalysisKey=2812175](#)
Opens a new Reliability Recommendation record, which, when saved, will be linked to the analysis with the Entity Key 2812175.
- [meridium://Reliability/Cost?Page=RecommendationDetail&RecommKey=1234567&EntyKey=2812175&AnalysisKey=2812175](#)
Opens on the **Recommendation Details** page the Recommendation record with the key 1234567 and linked to the analysis with the Entity Key 2812175.

Action

An operation that can be performed against a piece of equipment, location, or switch. Actions can represent inspections, general maintenance, or specific events that mitigate Risks, such as training or procedures.

Actions can be unique events that happen only once during a simulation period, or they can be repeated at certain times during the simulation period.

Average Total

The average of all the totals across all iterations of a simulation. Average totals are calculated for various types of numeric values in a simulation, such as cost in the [Total Cost Trend graph](#) or time in the [Resource Time graph](#).

Confidence Level

A value that indicates the percentage of uncertainty of the Goodness of Fit method. This percentage is usually determined by experience or an industry standard and limits how closely the data must fit the model in order for it to pass the Goodness of Fit test.

Cumulative Operating Time (COT)

The amount of time a piece of equipment or location has been in operation.

Event Log

A text file that stores failure predictions and hypothetical repair scenarios. Event logs are created when you [run a Monte Carlo simulation](#).

Failure

The inability of a piece of equipment to perform its intended function. A failure may involve the complete loss of function, a partial loss of function, or the potential loss of function.

Global Event

A component of a System Reliability Analysis that groups together Actions requiring a system shutdown so that they will be performed at the same time, thereby maximizing the availability of the system.

Goodness of Fit (GOF) Test

A test that determines how well your analysis data fits the calculated data model.

Kolmogorov-Smirnov Test

A Goodness of Fit (GOF) test applied to Reliability Distribution and Probability Distribution Analyses to determine how well the data fits the analytical curve.

Least Squares

A curve-fitting estimation method of fit that relies on linear regression techniques to estimate the parameters for a distribution.

Maximum Likelihood Estimators (MLE)

A curve-fitting estimation method of fit that maximizes the likelihood function for a given population. This method includes a survivor function that estimates changes in reliability as the piece of equipment or location survives beyond a certain age.

Reliability

How likely it is that a piece of equipment will perform its intended function without failure for a given period of time. Reliability is expressed as a percentage and is expressed mathematically as $(1 - \text{The Probability of Failure})$.

Resources

Components in a System Reliability Analysis that represent physical parts or materials, such as spare bearings or seals, or human resources, such as mechanics or technicians, that you may want to use within the analysis.