



Meridium APM Reliability Centered Maintenance

3.6.1.3.0



Meridium APM Reliability Centered Maintenance

3.6.1.3.0

Copyright © Meridium, Inc. 2017

All rights reserved. Printed in the U.S.A.

This software/documentation contains proprietary information of Meridium, Inc.; it is provided under a license agreement containing restrictions on use and disclosure. All rights including reproduction by photographic or electronic process and translation into other languages of this material are fully reserved under copyright laws. Reproduction or use of this material in whole or in part in any manner without written permission from Meridium, Inc. is strictly prohibited.

Meridium is a registered trademark of Meridium, Inc.

All trade names referenced are the service mark, trademark or registered trademark of the respective manufacturer.

About This Document

This file is provided so that you can easily print this section of the Meridium APM Help system.

You should, however, use the Help system instead of a printed document. This is because the Help system provides hyperlinks that will assist you in easily locating the related instructions that you need. Such links are not available in a print document format.

The Meridium APM Help system can be accessed within Meridium APM itself or via the Meridium APM Documentation Website (<https://www.meridium.com/documentation/WebHelp/WebHelpMaster.htm>).

Note: If you do not have access to the Meridium APM Documentation Website, contact [Meridium Global Support Services](#).

Table of Contents

Meridium APM Reliability Centered Maintenance	1
Copyright and Legal	2
About This Document	3
Table of Contents	4
Overview of Reliability Centered Maintenance	17
RCM System Requirements	18
Function	19
Functional Failure	20
Failure Mode	21
Failure Effect	22
Recommendation	23
Overview of the RCM Data Structure	25
Overview of the RCM Data Model	26
When RCM FMEA Asset Records Are NOT Linked to Equipment or Functional Location Records	30
When RCM FMEA Asset Records Are Linked to Equipment or Functional Location Records	32
Illustration of the RCM Data Model Integrated with Asset Criticality Analysis	34
RCM FMEA Analysis State Configuration	35
Initial State	36
Datasheet Configuration	37
Reserved States and Operations	38
State Configuration Roles	39
About RCM Recommendations	40
RCM and the Record Manager	42
Accessing the RCM Start Page	43
Aspects of the RCM Start Page	44
First-Time Deployment Workflow	45
Upgrade or Update Reliability Centered Maintenance to 3.6.1.3.0	47

Associating RCM Analyses with a Specific Site	49
About the RCM Administration Page	50
RCM Security Groups	51
About Virtual and Physical Equipment and Locations	55
Has Recommendations Relationship	56
Creating the Evaluation Security User	57
Creating a Scheduled Item for Evaluations	58
About Queries Used by RCM	63
Accessing the RCM Administration Page	65
About the Evaluation Query	67
Creating the Evaluation Query	68
Example of an Evaluation Query	70
Selecting the Evaluation Query	72
Defining the Recommendation Review Query	73
Defining the Template Query	74
Defining the Analysis List Query	75
Clearing the Current Query Selection	76
Using the RCM Site Map	77
Navigating RCM as a Member of the MI RCM Viewer Security Group	78
Options for Opening an RCM Analysis	79
Accessing the RCM Analysis List	80
Aspects of the RCM Analysis List Page	81
Analysis Tasks Menu	82
Common Tasks Menu	83
Opening an Analysis from the Analysis List	84
Deleting RCM Analyses	85
Accessing the RCM Recently Used Analyses Page	86
Aspects of the RCM Recently Used Analyses Page	87
Analysis Tasks Menu	88
Common Tasks Menu	89

Opening a Recently Used Analysis	90
Workflow for Creating an RCM Analysis	91
Starting a New RCM Analysis	92
About the RCM Explorer Page	94
About Accessing the RCM Explorer Page	95
About the RCM Explorer Pane	96
The Shortcut Menu in the RCM Explorer Pane	98
About the Datasheet Area	101
Analysis Tasks Menu	102
Common Tasks Menu	104
Template Tasks Menu	106
Reports Menu	107
Associated Pages Menu	108
What is the RCM Analysis Team?	109
Accessing the RCM Team Members Page	110
Aspects of the RCM Team Members Page	111
Analysis Tasks Menu	112
Team Members Tasks Menu	113
Common Tasks Menu	114
Adding an Existing User to the RCM Analysis Team	115
Creating a New User to Add to the RCM Analysis Team	116
Modifying Information about a Team Member	117
Removing Team Members from the RCM Analysis Team	118
Accessing the RCM Asset List Page	119
Aspects of the RCM Asset List Page	120
Analysis Tasks Menu	121
Assets Tasks Menu	122
Common Tasks Menu	123
Creating a New RCM FMEA Asset Record to Add to the List	124
Copying an Existing RCM FMEA Asset Record	125

Modifying an RCM FMEA Asset Record	126
Linking an RCM FMEA Asset Record to an Equipment or Functional Location Record	127
Viewing the Equipment or Functional Location Record that is Linked to an RCM FMEA Asset Record	129
Unlinking an RCM FMEA Asset Record from the Related Equipment or Functional Location Record	130
Deleting an RCM FMEA Asset Record	131
Defining Functions	132
Defining Functional Failures	133
Defining Failure Modes	134
Defining Failure Effects	136
The Decision Logic Builder	138
Defining Recommendations	140
About Copying, Cutting, and Pasting Analysis Elements	142
Using the Cut Function	143
Using the Copy Function	144
Using the Paste Function	145
Modifying an Analysis Node in the RCM Explorer Pane	146
Deleting an Analysis or Analysis Node in the RCM Explorer Pane	147
About RCM Templates	148
Accessing the RCM Templates Page	149
Aspects of the RCM Templates Page	150
Template Tasks Menu	152
Common Tasks Menu	153
Accessing the Template Builder	154
Using the Template Builder to Create a New RCM Template from Scratch	155
Creating an RCM Template from an Existing RCM Analysis	159
About Creating New RCM Analyses from RCM Templates	161
Creating a New Analysis from an RCM Template without RCM FMEA Asset Records	162

Accessing the Apply Template Builder	163
Using the Apply Template Builder to Create a New RCM Analysis	164
Creating New Nodes Using an RCM Template	170
Accessing the Apply Template Builder to Apply an RCM Analysis Node	172
Using the Apply Template Builder to Add Function, Functional Failure, or Failure Mode Nodes to an Analysis	173
Modifying Existing RCM Templates	177
Deleting RCM Templates	178
About the RCM Template Explorer Page	179
Accessing the RCM Template Explorer Page	180
About the RCM Template Explorer Pane	181
The Shortcut Menu in the RCM Template Explorer Pane	182
About the Datasheet Area	184
Analysis Tasks Menu	185
Common Tasks Menu	187
Template Tasks Menu	189
<Node> Reports Menu	190
Associated Pages Menu	191
Accessing the RCM Asset List Page for RCM Templates	192
About the RCM Asset List Page for RCM Templates	193
Analysis Tasks Menu	194
Asset Tasks Menu	195
Common Tasks Menu	196
Accessing the RCM Team Members Page for an RCM Template	197
About the RCM Team Members Page for RCM Templates	198
Analysis Tasks Menu	199
Team Member Tasks Menu	200
Common Tasks Menu	201
Introduction to RCM Reports	202
About Running Reports in RCM	203

Accessing the RCM Reports Page	204
Opening a Report	205
Running Reports Specific to an Analysis or Analysis Element	206
About Managing RCM Recommendations	207
Accessing Recommendation Management from the RCM Explorer Page	208
Features of the Recommendation Management Page when Accessed from RCM	209
Asset Tasks Menu	210
Viewing Master Recommendations from Consolidated Recommendations	211
About Evaluations	213
About Analysis Evaluations	214
About Equipment/Location Evaluations	215
About Recommendation Evaluations	216
About Date-Based Evaluations	217
Setting up a Date-Based Evaluation	218
About Event-Based Evaluations	221
Setting Up an Event-Based Evaluation	222
Modifying Evaluation Criteria	224
Disabling Recurring Evaluations	225
About the Catalog Folder Structure for RCM Reports	226
Baseline RCM Reports	228
Failure Finding Activity	231
System Code Tables Used by RCM	233
URL Paths for RCM Features	234
Parameters for the Start Page URL	235
Examples of the Start Page URL	236
Parameters for the Administration Page URL	237
Examples of the Administration Page URL	238
Parameters for the Manage Tasks URL	239
Examples of the Manage Tasks URL	240
Parameters for the Analysis List URL	241

Examples of the Analysis List URL	242
Parameters for the Recently Used Analyses URL	243
Examples of the Recently Used Analyses URL	244
Parameters for the Templates URL	245
Examples of the Templates URL	246
Parameters for the Reports URL	247
Examples of the Reports URL	248
Parameters for the Team Members and Asset List URL	249
Examples of the Team Members and Asset List URL	250
Parameters for the Explorer URL	251
Examples of the Explorer URL	252
Failure Effect	253
Failure Mode	254
Function	255
Functional Failure	256
RCM Analysis	257
Recommendation	258
SAE Standards	259
Overview of Failure Modes and Effects Analysis	260
FMEA System Requirements	261
Overview of the FMEA Data Structure	262
Overview of the FMEA Data Model	263
When RCM FMEA Asset Records Are NOT Linked to Equipment or Functional Location Records	267
When RCM FMEA Asset Records Are Linked to Equipment or Functional Location Records	269
Illustration of the FMEA Data Model Integrated with Asset Criticality Analysis	271
RCM FMEA Analysis State Configuration	272
Initial State	273
Datasheet Configuration	274

Reserved States and Operations	275
State Configuration Roles	276
About FMEA Recommendations	277
FMEA and the Record Manager	279
Accessing the FMEA Start Page	280
Aspects of the FMEA Start Page	281
First-Time Deployment Workflow	282
Upgrade or Update Failure Modes and Effects Analysis to 3.6.1.3.0	284
FMEA Configuration Tasks	286
Associating FMEA Analyses with a Specific Site	288
FMEA Security Groups	289
About Virtual and Physical Equipment and Locations	293
Has Recommendations Relationship	294
Creating the Evaluation Security User	295
Creating a Scheduled Item for Evaluations	296
About Queries Used by FMEA	301
Accessing the FMEA Administration Page	303
About the Evaluation Query	304
Creating the Evaluation Query	305
Example of an Evaluation Query	307
Selecting the Evaluation Query	309
Defining the Recommendation Review Query	310
Defining the Template Query	311
Defining the Analysis List Query	312
Clearing the Current Query Selection	313
Using the FMEA Site Map	314
Navigating FMEA as a Member of the MI RCM Viewer Security Group	315
Workflow for Creating an FMEA Analysis	316
Starting a New FMEA Analysis	317
Options for Opening an FMEA Analysis	318

Accessing the FMEA Analysis List Page	319
Aspects of the FMEA Analysis List Page	320
Analysis Tasks Menu	321
Common Tasks Menu	322
Opening an Analysis from the FMEA Analysis List	323
Accessing the FMEA Recently Used Analyses Page	324
Aspects of the FMEA Recently Used Analyses Page	325
Analysis Tasks Menu	326
Common Tasks Menu	327
Opening a Recently Used FMEA Analysis	328
Deleting FMEA Analyses	329
About the FMEA Explorer Page	330
About Accessing the FMEA Explorer Page	331
About the FMEA Explorer Pane	332
Using the Shortcut Menu in the FMEA Explorer Pane	334
About the Datasheet Area	336
Analysis Tasks Menu	338
Common Tasks Menu	340
Template Tasks Menu	342
Reports Menu	343
Associated Pages Menu	344
What is the FMEA Analysis Team?	345
Accessing the FMEA Team Members Page	346
Aspects of the FMEA Team Members Page	347
Analysis Tasks Menu	348
Team Members Tasks Menu	349
Common Tasks Menu	350
Adding an Existing User to the FMEA Analysis Team	351
Creating a New User to Add to the FMEA Analysis Team	352
Modifying Information about a Team Member	353

Removing Team Members from the FMEA Analysis Team	354
Adding Equipment and Locations to an FMEA Analysis	355
Linking an RCM FMEA Asset Record to an Equipment or Functional Location Record	356
Viewing the Equipment or Functional Location Record that is Linked to an RCM FMEA Asset Record	358
Unlinking RCM FMEA Asset Records from Equipment or Functional Location Records	359
Defining Failure Modes	360
Defining Failure Effects	361
The Decision Logic Builder	363
Defining Recommendations	365
About Copying, Cutting, and Pasting Analysis Elements	367
Using the Cut Function	368
Using the Copy Function	369
Using the Paste Function	370
Modifying an Analysis Node in the FMEA Explorer Pane	371
Deleting an Analysis or Analysis Node in the FMEA Explorer Pane	372
About FMEA Templates	373
Accessing the FMEA Templates Page	374
Aspects of the FMEA Templates Page	375
Template Tasks Menu	377
Common Tasks Menu	378
Accessing the Template Builder	379
Using the Template Builder to Create a New FMEA Template from Scratch	380
Creating an FMEA Template from an Existing FMEA Analysis	384
About Creating New FMEA Analyses from FMEA Templates	387
Creating a New Analysis from an FMEA Template Without RCM FMEA Asset Records	388
Accessing the Apply Template Builder	389
Using the Apply Template Builder to Create a New FMEA Analysis	390

Creating New FMEA Analysis Nodes from an FMEA Template	394
Modifying Existing FMEA Templates	396
Deleting FMEA Templates	397
About the FMEA Template Explorer Page	398
Accessing the FMEA Template Explorer Page	399
About the FMEA Template Explorer Pane	400
The Shortcut Menu in the FMEA Template Explorer Pane	401
About the Datasheet Area	403
Analysis Tasks Menu	404
Common Tasks Menu	405
Template Tasks Menu	407
<Node> Reports Menu	408
Associated Pages Menu	409
Accessing the FMEA Team Members Page for an FMEA Template	410
About the FMEA Team Members Page for FMEA Templates	411
Analysis Tasks Menu	412
Team Member Tasks Menu	413
Common Tasks Menu	414
Introduction to FMEA Reports	415
About Running Reports in FMEA	416
Accessing the FMEA Reports Page	417
Opening a Report	418
Running Reports Specific to an Analysis or Analysis Element	419
About Managing FMEA Recommendations	420
Accessing Recommendation Management from the FMEA Explorer Page	421
Features of the Recommendation Management Page when Accessed from FMEA	422
Asset Tasks Menu	423
Viewing Master Recommendations from Consolidated Recommendations	424
About Evaluations	426

About Analysis Evaluations	427
About Equipment/Location Evaluations	428
About Recommendation Evaluations	429
About Date-Based Evaluations	430
Setting Up a Date-Based Evaluation	431
About Event-Based Evaluations	434
Setting Up an Event-Based Evaluation	435
Modifying Evaluation Criteria	438
Disabling Recurring Evaluations	439
About the Catalog Folder Structure for FMEA Reports	440
The Baseline FMEA Reports	442
Failure Finding Activity	445
System Code Tables Used by FMEA	447
URL Paths for FMEA Features	448
Parameters for the Start Page URL	450
Examples of the Start Page URL	451
Parameters for the Administration Page URL	452
Examples of the Administration Page URL	453
Parameters for the Manage Tasks URL	454
Examples of the Manage Tasks URL	455
Parameters for the Analysis List URL	456
Examples of the Analysis List URL	457
Parameters for the Recently Used Analyses URL	458
Examples of the Recently Used Analyses URL	459
Parameters for the Templates URL	460
Examples of the Templates URL	461
Parameters for the Reports URL	462
Examples of the Reports URL	463
Parameters for the Team Members URL	464
Examples of the Team Members URL	465

Parameters for the Explorer URL	466
Examples of the Explorer URL	468
Asset	469
Failure Effect	470
Failure Mode	471
FMEA Analysis	472
Recommendation	473
SAE Standards	474

Overview of Reliability Centered Maintenance

Reliability Centered Maintenance (RCM) is a methodology for identifying equipment and location strategies for maintainability and reliability. The RCM method stresses the value of maintaining equipment and location to preserve the *function* of the system rather than for the purpose of preserving the physical equipment and locations themselves. In other words, as long as the function is preserved, a complete failure of a piece of equipment or location or a component within that system may be acceptable. RCM provides a means for determining optimal maintenance and operational strategies based on the probability and consequence of the analyzed failure modes.

The Meridium APM RCM implementation utilizes the following seven basic questions that are outlined in SAE Standard JA1011, "Evaluation Criteria for Reliability-Centered Maintenance (RCM) Processes":

1. What are the functions and desired performance of the (asset/system) in its present operating context ([Functions](#))?
2. In what ways can it fail to fulfill its functions ([Functional Failures](#))?
3. What causes each functional failure ([Failure Modes](#))?
4. What happens when each failure occurs ([Failure Effect](#))?
5. In what way does each failure matter (Failure Consequences)?
6. What should be done to predict or prevent each failure ([Recommendations](#))?
7. What should be done if a suitable RCM task cannot be found (Default Actions)?

RCM System Requirements

The *RCM and FMEA* [license](#) is required to take advantage of RCM functionality. In addition, your system must contain the [basic Meridium APM system architecture](#).

After you have installed and configured the basic architecture, you will need to [perform some configuration tasks](#) specifically for the RCM module.

When the RCM module is active, the Failure Modes and Effects Analysis (FMEA) modules is also active. You will also need to perform some [configuration tasks specifically for FMEA](#).

Function

To prevent failures within a given system, the functions of the system must first be defined. In an RCM Analysis, a function defines what the owner of the system wants it to do. A system can have one or more functions, each of which is defined in a separate record. To define all the possible functions of a system, it can be helpful to think through the functions of each individual piece of equipment and location defined for a given system. For example, a function for a cooling tower may be defined with the following statement:

Provide 500 gallons per minute of water at a maximum of 90 degrees Fahrenheit under all ambient conditions.

The analysis team should also define whether each function is *evident* or *hidden*. Evident functions are those in which, under normal circumstances, an operating crew would notice a failure. Hidden functions are those in which a failure may not be noticed.

The SAE Standard JA1011, "Evaluation Criteria for Reliability-Centered Maintenance (RCM) Processes," specifies the following requirements for functions:

- The operating context of the asset shall be defined.
- All the functions of the asset/system shall be identified (all primary and secondary functions, including the functions of all protective devices).
- All function statements shall contain a verb, an object, and a performance standard (quantified in every case where this can be done).
- Performance standards incorporated in function statements shall be the level of performance desired by the owner or user of the asset/system in its operating context.

Functional Failure

After a system's functions have been defined, the next step is to define all the ways in which each function can fail, each of which is defined as a functional failure. For each function, the analysis team should consider each reasonable way in which a function could fail. The following example shows one possible function and a related functional failure for a cooling tower:

- **Function:** Provide 500 gallons per minute of water at a maximum of 90 degrees Fahrenheit under all ambient conditions.
- **Functional Failure:** Unable to produce 500 gallons per minute of water due to failure of one supply pump.

The following item is defined as a requirement for failures according to the SAE Standard JA1011, "Evaluation Criteria for Reliability-Centered Maintenance (RCM) Processes":

- All the failed states associated with each Function shall be identified.

Failure Mode

After all the functional failures have been defined, one or more failure modes can be defined for each failure. The analysis team should determine which failure modes are reasonably likely to occur. If the RCM Analysis is being conducted on a system that does not yet exist physically, the mode(s) will be theoretical, unless other similar types of systems currently exist and historical data for these systems is available. Note that the SAE Standard JA1011, "Evaluation Criteria for Reliability-Centered Maintenance (RCM) Processes," specification recommends that an RCM team review all modes in which deterioration, design defects, and human error could cause the failure.

Failure modes are often closely related to individual pieces of equipment or components of the defined piece of equipment. Values stored at the equipment level allow the team to link a mode to a location, the equipment to that location, and a component to that equipment. Maintenance and reliability statistics for failure modes can be stored at the equipment or component level and can be analyzed and updated using the Meridium APM RCM module.

The SAE Standard JA1011, "Evaluation Criteria for Reliability-Centered Maintenance (RCM) Processes," defines the following requirements for failure modes:

- All Failure Modes reasonably likely to cause each Functional Failure shall be identified.
- The method used to decide what constitutes a "reasonably likely" Failure Mode shall be acceptable to the owner or user of the asset.
- Lists of Failure Modes shall include Failure Modes that have happened before, Failure Modes that are currently being prevented by existing maintenance programs, and Failure Modes that have not yet happened but that are thought to be reasonably likely (credible) in the operating context.
- Lists of Failure Modes should include any event or process that is likely to cause a Functional Failure, including deterioration, design defects, and human error whether caused by operators or maintainers (unless human error is being actively addressed by analytical processes apart from RCM).

Failure Effect

After all the failure modes have been defined, one or more failure effects can be defined for each mode. A failure effect documents the consequence a failure occurring. Most RCM methodologies use failure effects to capture the safety, environmental, and economic (or production) impact associated with a failure.

The SAE Standard JA1011, "Evaluation Criteria for Reliability-Centered Maintenance (RCM) Processes," defines the following requirements for failure effects:

- Failure effects shall describe what would happen if no specific task is done to anticipate, prevent, or detect the failure.
- Failure effects shall include all the information needed to support the evaluation of the consequences of the failure, including the following data:
 - The evidence (if any) that the failure has occurred (in the case of hidden functions, what would happen if a multiple failure occurred).
 - What the failure does (if anything) to kill or injure someone, or to have an adverse effect on the environment.
 - What the failure does (if anything) to have an adverse effect on production or operations.
 - What physical damage (if any) is caused by the failure.
 - What (if anything) must be done to restore the function of the system after the failure.

Recommendation

For each failure effect, one or more recommended actions can be defined. Generally, for the equipment or location and system owner, recommended actions should be designed to reduce to an acceptable level the probability and consequence of the related failure. Recommendations are the result of the Failure Mode and Risk Matrix Analysis. Each Failure Mode will have one or many recommendations for how the failure can be avoided in the future.

After the RCM Analysis team has fully analyzed the system and while the information is still readily available, the team should define the criteria for reevaluation of the recommendation. For example, the analysis team can define whether a Recommendation record should be reevaluated based on time, a condition, a defined date, a system process change, or a change in the design code.

The SAE Standard JA1011, "Evaluation Criteria for Reliability-Centered Maintenance (RCM) Processes," specifies the following requirements for Recommendation records:

- All scheduled tasks shall comply with the following criteria:
 - In the case of an evident Failure Mode that has safety or environmental consequences, the task shall reduce the probability of the Failure Mode to a level that is tolerable to the owner or user of the asset.
 - In the case of a hidden Failure Mode where the associated multiple failure has safety or environmental consequences, the task shall reduce the probability of the hidden Failure Mode to an extent which reduces the probability of the associated multiple failure to a level that is tolerable to the owner or user of the asset.
 - In the case of an evident Failure Mode that does not have safety or environmental consequences, the direct and indirect costs of doing the task shall be less than the direct and indirect costs of the Failure Mode when measured over comparable periods of time.
 - In the case of a hidden Failure Mode where the associated multiple failure does not have safety or environmental consequences, the direct and indirect costs of doing the task shall be less than the direct and indirect costs of the multiple failure plus the cost of repairing the hidden Failure Mode when measured over comparable periods of time.
- **On-Condition Tasks:** Any on-condition task (or predictive or condition-based or condition monitoring task) that is selected shall satisfy the following additional criteria:
 - There shall exist a clearly defined potential failure.
 - There shall exist an identifiable P-F interval (or failure development period).
 - The task interval shall be less than the shortest likely P-F interval.
 - It shall be physically possible to do the task at intervals less than the P-F interval.

- The shortest time between the discovery of a potential failure and the occurrence of the Functional Failure (the P-F interval minus the task interval) shall be long enough for predetermined action to be taken to avoid, eliminate, or minimize the consequences of the Failure Mode.
- **Schedule Discard Task:** Any scheduled discard task that is selected shall satisfy the following criteria:
 - There shall be a clearly defined (preferably a demonstrable) age at which there is an increase in the conditional probability of the Failure Mode under consideration.
 - A sufficiently large proportion of the occurrences of this Failure Mode shall occur after this age to reduce the probability of premature failure to a level that is tolerable to the owner or user of the asset.
- **Scheduled Restoration Tasks:** Any scheduled restoration task that is selected shall satisfy the following additional criteria:
 - There shall be a clearly defined (preferably a demonstrable) age at which there is an increase in the conditional probability of the Failure Mode under consideration.
 - A sufficiently large proportion of the occurrences of this Failure Mode shall occur after this age to reduce the probability of premature failure to a level that is tolerable to the owner or user of the asset.
 - The task shall restore the resistance to failure (condition) of the component to a level that is tolerable to the owner or user of the asset.
- **Failure Finding Task:** Any failure-finding task that is selected shall satisfy the following additional criteria (failure-finding does not apply to evident Failure Modes):
 - The basis upon which the task interval is selected shall take into account the need to reduce the probability of the multiple failure of the associated protected system to a level that is tolerable to the owner or user of the asset.
 - The task shall confirm that all components covered by the Failure Mode description are functional.
 - The failure-finding task and associated interval selection process should take into account any probability that the task itself might leave the hidden function in a failed state.
 - It shall be physically possible to do the task at the specified intervals.

Overview of the RCM Data Structure

The Meridium APM RCM module uses families to represent the various components of an RCM Analysis, as defined by the standard, accepted RCM methodology. The Meridium APM system leverages its fundamental [entity and relationship family infrastructure](#) to store data related to an RCM Analysis.

Each RCM Analysis is represented at the root level by an *RCM FMEA Analysis* record. FMEA Analyses use the same root analysis family. RCM Analyses are distinguished from FMEA Analyses via the Analysis Type field in the RCM FMEA Analysis record. The analysis type can be either *RCM* or *FMEA*. For an RCM FMEA Analysis that will be used for an RCM Analysis, the analysis type is *RCM*.

Note: Because both RCM and FMEA Analysis records belong to the same family, a query on the RCM FMEA Analysis family will return results that include all analyses of any type. To limit your results to include only one analysis type, you will need to include the Analysis Type field in your query and define criteria to filter on either *RCM* or *FMEA*.

For an RCM Analysis (a record in which the analysis type is *RCM*), the RCM FMEA Analysis record can be linked to RCM Function records through the Has RCM Function relationship. RCM Function records can be, in turn, linked to RCM Functional Failure records through the Has RCM Functional Failures relationship, and so on, for all components of the analysis. Together, the root RCM FMEA Analysis record and all the records that are linked to it, either directly or indirectly, make up the RCM Analysis.

Overview of the RCM Data Model

The following table provides a summary of the entity families and relationship families that are used to develop an RCM Analysis.

Records in this entity family:	...Can be linked to records in this entity family:	...Through a relationship definition on this relationship family:
RCM FMEA Analysis	RCM Function	Has RCM Function
RCM Function	RCM Functional Failure	Has RCM Functional Failure
RCM Functional Failure	RCM FMEA Failure Mode	Has RCM FMEA Failure Mode
RCM FMEA Failure Mode	RCM FMEA Failure Effect	Has RCM FMEA Failure Effect
RCM FMEA Failure Effect	RCM FMEA Recommendation	Has RCM FMEA Recommendation

In addition, the following families and relationship are used by RCM but not within the analysis tree itself.

Records in this entity family:	...Can be linked to records in this entity family:	...Through this relationship:	Purpose
RCM FMEA Analysis	Human Resource	Has RCM FMEA Team Member	Facilitates the construction of the RCM Analysis Team Members list. Through this relationship, Human Resource records are linked directly to the RCM FMEA Analysis record.
RCM FMEA Analysis	RCM FMEA Asset	Has RCM FMEA Asset	Facilitates the construction of the RCM equipment list. In this way, the RCM FMEA Asset records are linked directly to the RCM FMEA Analysis record. Note, however, that RCM FMEA Asset records do not appear in the analysis tree of an RCM Analysis.

Records in this entity family:	...Can be linked to records in this entity family:	...Through this relationship:	Purpose
RCM FMEA Analysis	RCM FMEA Task	Has Tasks	Allows Task records generated from Recommendation records to be linked to the RCM FMEA Analysis record for which the recommendation was created. Note that in the current version of Meridium APM, RCM FMEA Task records cannot be created from RCM FMEA Recommendation records. Instead, RCM FMEA Recommendation records can be used to create Action records in ASM. This relationship still exists, however, to support legacy RCM FMEA Task records.
RCM FMEA Recommendation	RCM FMEA Task	Has Tasks	Allows RCM FMEA Recommendation records to be linked to RCM FMEA Task records that are generated from those recommendations. Note that in the current version of Meridium APM, RCM FMEA Task records cannot be created from RCM FMEA Recommendation records. Instead, RCM FMEA Recommendation records can be used to create Action records in ASM. This relationship still exists, however, to support legacy RCM FMEA Task records.
RCM FMEA Asset	Asset Strategy	Has Strategy	Facilitates the promotion of RCM FMEA Asset records to Asset Strategy records via Recommendation Management. This link is established when an RCM FMEA Analysis is linked to a physical or "virtual" piece of equipment or location for which you have defined Recommendation records.

Records in this entity family:	...Can be linked to records in this entity family:	...Through this relationship:	Purpose
RCM FMEA Asset	Asset Strategy Template	Has Strategy	Facilitates the promotion of RCM FMEA Asset records to Asset Strategy Template records via Recommendation Management. This link is established when an RCM FMEA Analysis is linked to a "virtual" piece of equipment or location for which you have defined Recommendation records.
RCM FMEA Asset	RCM FMEA Task	Has Tasks	<p>Allows RCM FMEA Asset records to be linked to RCM FMEA Task records. This link is established only when a Task record is generated from a recommendation where the related RCM FMEA Asset record (i.e., the RCM FMEA Asset record that is linked to the RCM FMEA Analysis record) is not linked to an Equipment or Functional Location record.</p> <p>Note that in the current version of Meridium APM, RCM FMEA Task records cannot be created from RCM FMEA Recommendation records. Instead, RCM FMEA Recommendation records can be used to create Action records in ASM. This relationship still exists, however, to support legacy RCM FMEA Task records.</p>
RCM FMEA Asset	Task History	Has Task History	Facilitates the rejection of RCM FMEA Task records that are linked to RCM FMEA Asset records. When you reject an RCM FMEA Task record, a Task History record is created and linked to the RCM FMEA Asset record through the Has Task History relationship.

Records in this entity family:	...Can be linked to records in this entity family:	...Through this relationship:	Purpose
RCM FMEA Analysis	Has Templates	RCM FMEA Template	Facilitates the creation of RCM Templates.
RCM FMEA Asset	Has Templates	RCM FMEA Template	Facilitates the creation of RCM Templates.
RCM Function	Has Templates	RCM FMEA Template	Facilitates the creation of RCM Templates.
RCM Functional Failure	Has Templates	RCM FMEA Template	Facilitates the creation of RCM Templates.
RCM FMEA Failure Mode	Has Templates	RCM FMEA Template	Facilitates the creation of RCM Templates.
RCM FMEA Failure Effect	Has Templates	RCM FMEA Template	Facilitates the creation of RCM Templates.
RCM FMEA Recommendation	Has Templates	RCM FMEA Template	Facilitates the creation of RCM Templates.
RCM FMEA Recommendation	Mitigates Risk	Risk Assessment	Allows you to determine how a recommendation mitigates a risk.

Note also that the following families are related to the RCM FMEA Template family through the Has Templates relationship to facilitate the creation of RCM Templates:

- RCM FMEA Analysis
- RCM FMEA Asset
- RCM FMEA Failure Effect
- RCM FMEA Failure Mode
- RCM FMEA Recommendation
- RCM Function
- RCM Functional Failure

When RCM FMEA Asset Records Are NOT Linked to Equipment or Functional Location Records

Each RCM FMEA Analysis record can optionally be linked to one or more RCM FMEA Asset records to create the equipment and location list for the analysis. The equipment and location list helps define what is being evaluated through the RCM Analysis. Each RCM FMEA Asset record can be linked to an Equipment or Functional Location record. Alternatively, RCM FMEA Asset records can stand alone and not be linked to Equipment or Functional Location records to represent "virtual" equipment and locations. A given RCM Analysis can contain both linked and unlinked RCM FMEA Asset records.

The following image provides a diagram of the relationships that will be created when an RCM FMEA Asset record is not linked to an Equipment or Functional Location record.

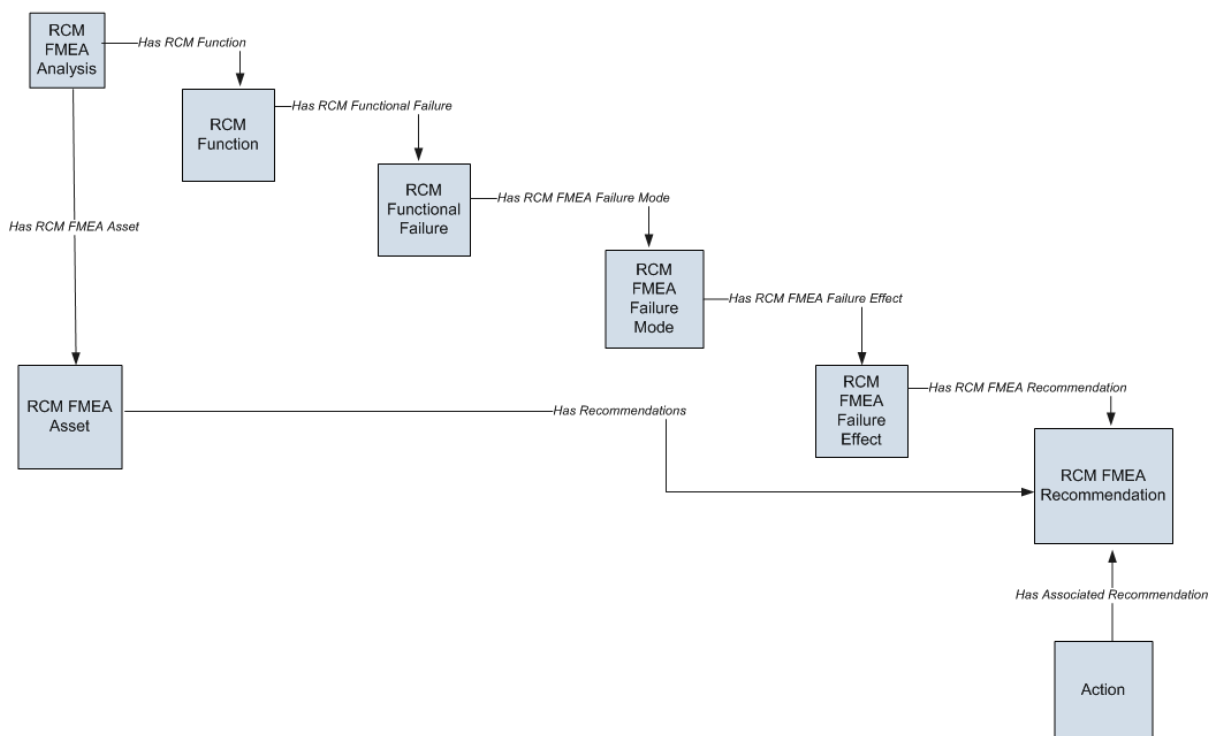

Note: While Human Resource records are not depicted in this diagram, they can be linked to the RCM FMEA Analysis record through the Has RCM FMEA Team Member relationship.

Note the following about the preceding image:

- The RCM FMEA Asset box in the diagram represents a *single* RCM FMEA Asset record within an analysis. The RCM FMEA Analysis record can be linked to multiple RCM FMEA Asset records, each of which can optionally be linked to an Equipment or Functional Location record.

When RCM FMEA Asset Records Are NOT Linked to Equipment or Functional Location Records

- In this scenario, where the RCM FMEA Asset record is not linked to an Equipment or Functional Location record:
- When an RCM FMEA Recommendation record is created for the analysis, the **Note:** For any linking to occur, the Asset ID of the desired RCM FMEA Asset record must be selected manually in the RCM FMEA Failure Mode record.
- When an RCM FMEA Recommendation record is promoted to an Action record, the Action record will be linked to a Proposed Strategy record and associated with a new Asset Strategy, along with a new Action record, a new Risk record is also created and linked to the RCM FMEA Failure Effect record to which the RCM FMEA Recommendation record is linked. Certain fields in the Risk record will be populated automatically with values in the RCM FMEA Failure Effect record.

In addition to the families included in the preceding image, the following families are used by the Decision Logic Builder in RCM:

- Decision Tree Consequence
- Decision Tree Response
- Decision Tree Structure

Within the baseline Meridium APM family hierarchy, these families are subfamilies of the Meridium Reference Tables family. Baseline records are provided in each of these families to support the Decision Logic Builder functionality.

When RCM FMEA Asset Records Are Linked to Equipment or Functional Location Records

The following image provides a diagram of the links that will be created when an RCM FMEA Asset record is linked to an Equipment or Functional Location record.

Note: All relationships depicted in the image are part of the Meridium APM baseline database.

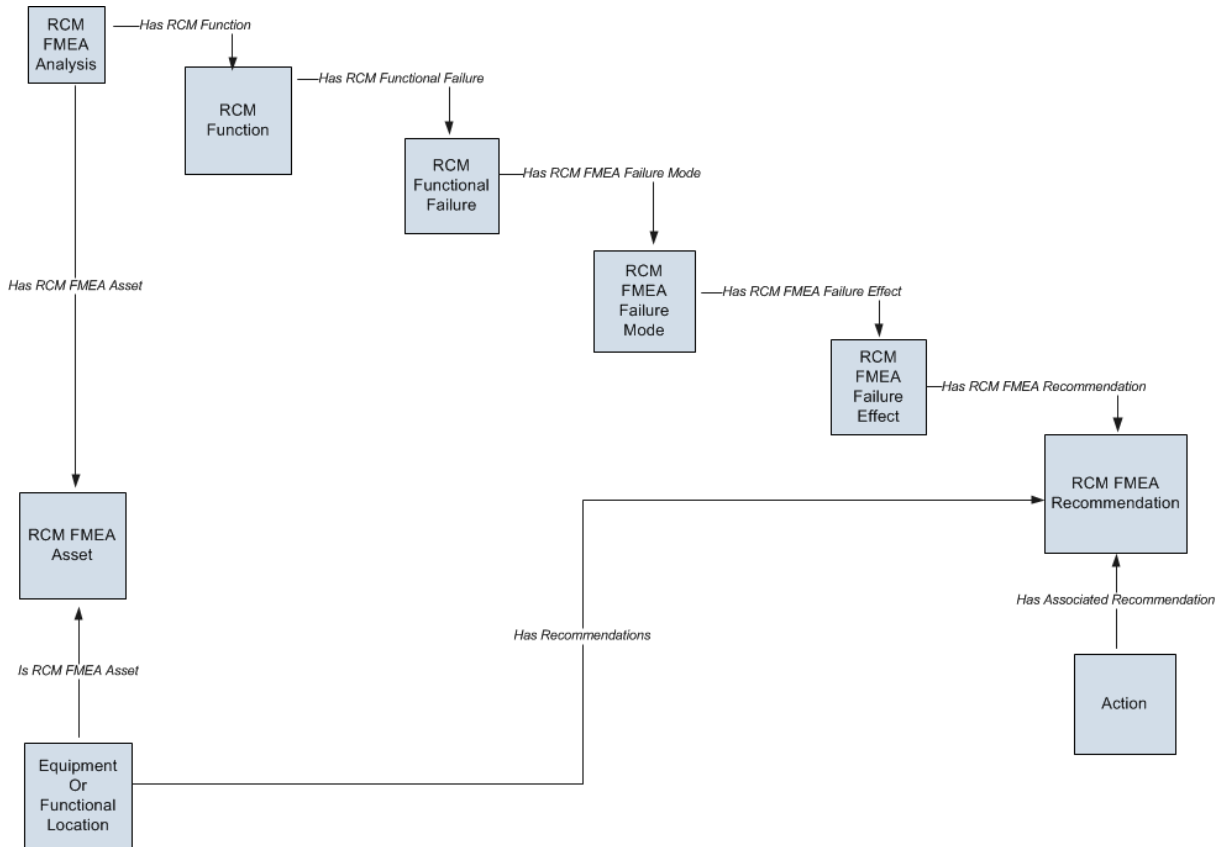

Note: While Human Resource records are not depicted in this diagram, they can be linked to the RCM FMEA Analysis record through the Has RCM FMEA Team Member relationship.

Note the following about the preceding image:

- The RCM FMEA Asset box in the diagram represents a *single* RCM FMEA Asset record within an analysis. The RCM FMEA Analysis record can be linked to multiple RCM FMEA Asset records, each of which can optionally be linked to an Equipment or Functional Location record.
- The Equipment or Functional Location box represents the Equipment and Functional Location families for which the Is RCM FMEA Asset and Has

Recommendations relationships have been defined between that family and the specified predecessor or successor.

- In this scenario, where the RCM FMEA Asset record is linked to an Equipment or Functional Location record:

- When an RCM FMEA Recommendation record is created for the analysis, the

Note: For any linking to occur, the Asset ID of the desired RCM FMEA Asset record must be selected manually in the RCM FMEA Failure Mode record.

- When an RCM FMEA Recommendation record is promoted to an Action record, the Action record will be linked to a Proposed Strategy record and associated with the Equipment or Functional Location record.

In addition to the families included in the preceding image, the following families are used by the Decision Logic Builder in RCM:

- Decision Tree Consequence
A new Risk Assessment record is also created and linked to the Action record. Certain fields in the Risk Assessment record will be populated automatically with values in the RCM FMEA Failure Effect record.
- Decision Tree Response
A new Risk Assessment record is also created and linked to the Action record. Certain fields in the Risk Assessment record will be populated automatically with values in the RCM FMEA Recommendation record.
- Decision Tree Structure

Within the baseline Meridium APM family hierarchy, these families are subfamilies of the Meridium Reference Tables family. Baseline records are provided in each of these families to support the Decision Logic Builder functionality.

Illustration of the RCM Data Model Integrated with Asset Criticality Analysis

RCM Analyses can be created automatically when an Asset Criticality Analysis System record is promoted from Asset Criticality Analysis (ACA) to RCM. The following illustration shows how the families in the RCM data model are related to the families in the ACA data model. In this illustration, the boxes represent entity families, and the arrows represent relationship families. You can determine the cardinality of a relationship by the direction of the arrow (i.e., the family to which the arrow points is the successor family).

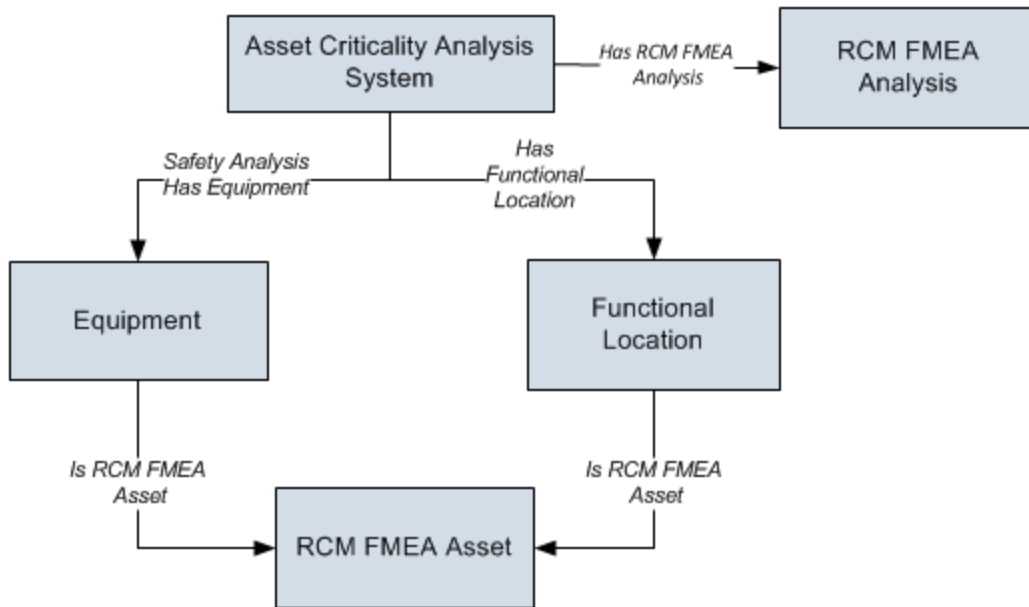

RCM FMEA Analysis State Configuration

By default, the following baseline State Configuration exists for the RCM FMEA Analysis family.

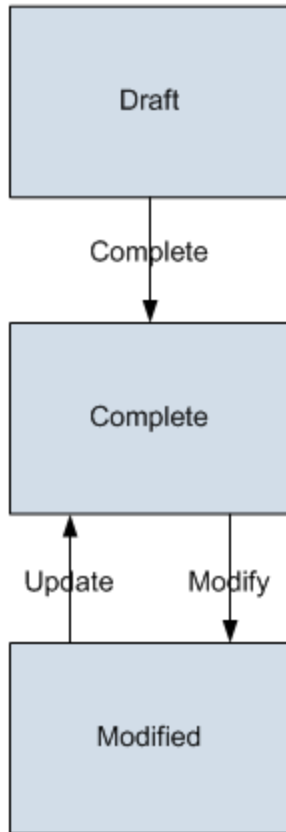

Initial State

The Draft state is the initial state of all new RCM FMEA Analysis records.

Datasheet Configuration

By default, states and operations will appear on the datasheet when you are viewing an RCM FMEA Analysis record in RCM, FMEA, the Record Manager, or the Bulk Data Form.

Reserved States and Operations

By default, NO states or operations displayed in the preceding diagram are reserved. This means that you can remove or modify any of these states or operation. You can also add your own states and operations to the State Configuration.

State Configuration Roles

By default, the MI RCM User State Configuration Role is assigned to all states in the RCM FMEA Analysis State Configuration. If desired, you can assign other State Configuration Roles to any state. In addition, for each state, the **Require a specific user to be assigned to a state** check box is *selected*.

About RCM Recommendations

You can manage RCM FMEA Recommendation records in an RCM Analysis using the following methods:

- On the **RCM Explorer** page
- Via [the Recommendation Management feature](#)

Both methods use standard State Configuration functionality to control the available states and the operations that can be used to transition recommendations from one state to the next.

Via the **RCM Explorer** page, you will have access only to *non-reserved* states and operations. The available operations will be displayed on the **Operations** submenu, which appears in the upper, right corner of the datasheet just as in the Record Manager. The following diagram shows the non-reserved baseline states that will be available on the **RCM Explorer** page.

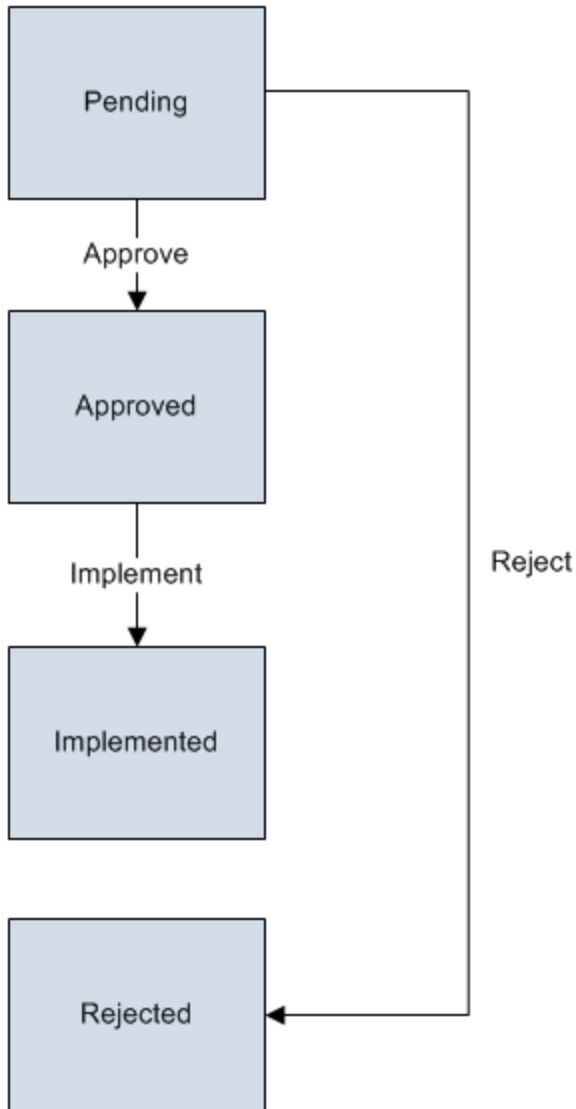

Note: This image shows the non-reserved states that are included in the State Configuration for the RCM FMEA Recommendation family in the baseline RCM product. If custom non-reserved states have been added to your system, they will also be available from the **Operations** menu.

If you [manage RCM FMEA Recommendations via Recommendation Management](#), however, you will have access to both reserved and non-reserved states.

RCM and the Record Manager

To ensure data integrity, records that make up analyses and templates in RCM should be created and managed using only the tools provided in the RCM module. Therefore, the Meridium APM system prevents you from creating or modifying certain records in the Record Manager.

While you *view* records in these families via the Record Manager, the datasheet will be disabled and a link will be displayed above the **Datasheet** list, which you can click to view in RCM the corresponding analysis or template that includes that record. When you do so, that record will be selected in the explorer automatically. The text that appears for this link will vary for each record and is displayed in the format **<Record ID> (<Family Caption>)**, where **<Record ID>** is the ID for the record and **<Family Caption>** is the family caption of the family to which the record belongs. For example, the following image shows the link that appears above the **Datasheet** list in the Record Manager when you are viewing an RCM FMEA Failure Mode record.



The following list contains the families whose datasheet is disabled in the Record Manager:

- RCM FMEA Analysis
- RCM FMEA Asset
- RCM FMEA Failure Mode
- RCM FMEA Failure Effect
- RCM Function
- RCM Funcational Failure
- RCM FMEA Recommendation
- RCM FMEA Recommendation
- RCM FMEA Template

Accessing the RCM Start Page

The **RCM Start Page** serves as the starting point for all tasks related to RCM. The following instructions provide details on accessing the **RCM Start Page**.

To access the **RCM Start Page**:

- On the Meridium APM Framework main menu, click **Go To**, point to **Asset Strategy**, and then click **Reliability Centered Maintenance**.

The [RCM Start Page](#) appears.

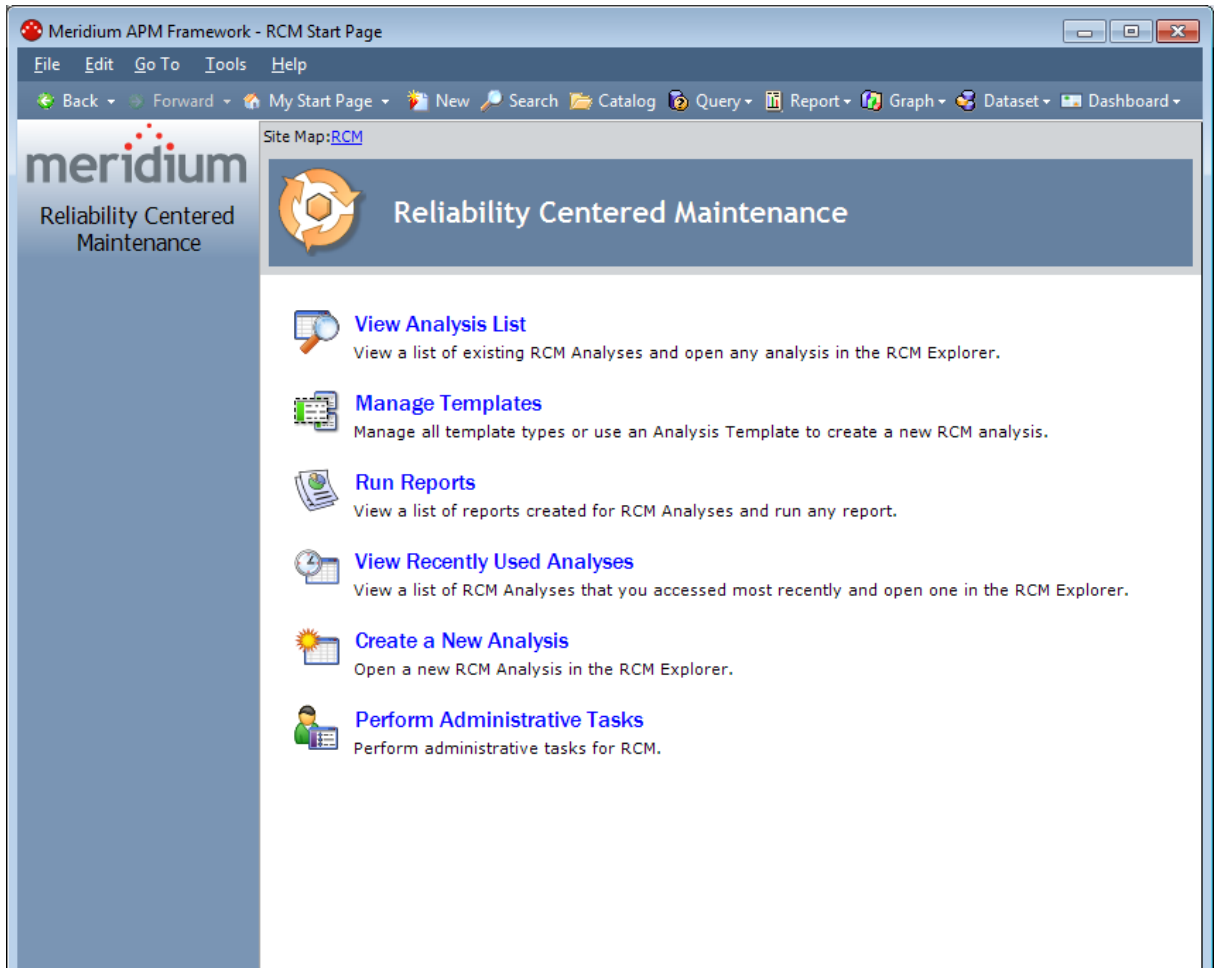

Aspects of the RCM Start Page

The **RCM Start Page** displays the following links, which you can use to access various features in RCM:

- **View Analysis List:** Opens the [RCM Analysis List page](#), from which you can open an existing RCM Analysis on the [RCM Explorer](#) page.
- **Manage Templates:** Displays the [RCM Templates page](#), where you can view a list of RCM Templates and use any template to create a new RCM Analysis.
- **Run Reports:** Displays the [RCM Reports page](#), which displays the reports that have been associated with all RCM Analyses.
- **View Recently Used Analyses:** Displays the [RCM Recently Used Analyses page](#), where you can open an RCM Analysis that you accessed recently.
- **Create a New Analysis:** Launches the [RCM Explorer](#) page, where you can create an RCM Analysis.
- **Manage Tasks:** Displays the [RCM Manage Tasks](#) page, which displays a list of RCM Analyses that have one or more Task records associated with them.

Note: This link appears only if the **Show Manage Tasks on the Start Page** option is enabled on the [RCM Administration](#) page.

- **Perform Administrative Tasks:** Displays the [RCM Administration](#) page, where you can define various administrative settings for RCM.

Note: This link appears only if you are a Super User or a member of the MI RCM Administrator Security Group.

First-Time Deployment Workflow

Deploying and configuring RCM for the first time includes completing multiple steps, which are outlined in the table in this topic. The steps in this section of the documentation provide all the information that you need to deploy and configure RCM on top of the basic Meridium APM system architecture.

Whether a step is required or optional is indicated in the **Required/Optional** cell. Steps are marked as *Required* if you must perform the step to take advantage of RCM functionality.

The person responsible for performing each task may vary within your organization. We recommend, however, that the steps be performed in relatively the same order in which they are listed in the table.

Step	Task	Required/Optional	Notes
1	Review the RCM data model to determine which relationship definitions you will need to modify to include your custom equipment and location families. Modify any relationship definitions as needed.	Optional	This task is necessary only if you store equipment and location information in families other than the baseline Equipment and Functional Location families.
2	Define sites to associate with RCM Analyses.	Optional	None
3	Assign Security Users to one or more of the RCM Security Groups via the Configuration Manager application.	Required	None
4	Create the Evaluation Security User via the Configuration Manager application.	Optional	None
5	Create a scheduled item for executing RCM event-based and date-based evaluations.	Optional	None
6	Define the Evaluation query.	Optional	None

Step	Task	Required/Optional	Notes
7	Define the Recommendation Review query.	Optional	This task is necessary only if you do not want to use the baseline query that is defined by default.
8	Define the Template query.	Optional	This task is necessary only if you do not want to use the baseline query that is defined by default.
9	Define the Analysis List query.	Optional	This task is necessary only if you do not want to use the baseline query.

Upgrade or Update Reliability Centered Maintenance to 3.6.1.3.0

The following tables list the steps that are required to update or upgrade RCM to 3.6.1.3.0. These steps assume that you have completed the steps for upgrading the [basic Meridium APM system architecture](#).

Update from any version V3.6.1.0.0 through V3.6.1.2.0

This module will be updated to 3.6.1.3.0 automatically when you update the components in the basic Meridium APM system architecture. No additional steps are required.

Upgrade from any version V3.6.0.0.0 through V3.6.0.12.6

RCM will be upgraded to 3.6.1.3.0 automatically when you upgrade the components in the [basic Meridium APM system architecture](#). No additional steps are required.

Upgrade from any version V3.5.1.0.0 through V3.5.1.12.0

RCM will be upgraded to 3.6.1.3.0 automatically when you upgrade the components in the [basic Meridium APM system architecture](#). No additional steps are required.

Upgrade from any version V3.5.0 SP1 LP through V3.5.0.1.9.0

RCM will be upgraded to 3.6.1.3.0 automatically when you upgrade the components in the [basic Meridium APM system architecture](#). No additional steps are required.

Upgrade from any version V3.5.0 through V3.5.0.0.7.1

RCM will be upgraded to 3.6.1.3.0 automatically when you upgrade the components in the [basic Meridium APM system architecture](#). No additional steps are required.

Upgrade from any version V3.4.5 through V3.4.5.0.1.4

Step	Task	Required/Optional	Notes
1	Assign Security Users to the MI RCM Viewer Security Group.	Required	None

2	Add values to the Recommended Resource System Code Table.	Required	This System Code Table is used to populate the Recommended Resource field in RCM FMEA Recommendation records
---	---	----------	--

Associating RCM Analyses with a Specific Site

Some companies that use the Meridium APM software have facilities at multiple sites, or locations, where each site contains unique equipment and locations. If desired, you can define the sites in your organization and associate equipment and locations with the site to which they belong. When you create RCM Analyses for those pieces of equipment and locations, you will need to [select the appropriate site on the Analysis datasheet of the RCM Analysis](#).

To help streamline the analysis-creation process, after you select a site on the Analysis datasheet, the Meridium APM system will allow you to [add Equipment and Functional Location records to the RCM Analysis](#) only if those pieces of equipment and locations belong to that site.

You can also associate risk matrices with specific sites. If a Risk Matrix is associated with a site and an RCM Analysis is associated with the same site, when you define the unmitigated risk for a [failure effect](#), rather than seeing the default Risk Matrix, you will see the Risk Matrix that is associated with that site.

About the RCM Administration Page

Note: To access administrative features in RCM, you must be a Super User or a member of the MI RCM Administrator Security Group.

Via the **RCM Administration** page, you can:

- [Define the Evaluation query.](#)
- [Define the Recommendation Review query.](#)
- [Define the Template query.](#)
- [Define the Analysis List query.](#)

These queries must be defined before users can perform evaluations and approvals for RCM Analyses and before they can view RCM Templates.

Additionally, via the **RCM Administration** page, you can choose whether or not the **Manage Tasks** link will appear on the **RCM Start Page**.

RCM Security Groups

The RCM module uses the following baseline Security Groups:

- **MI RCM Administrator:** The MI RCM Administrator Security Group has *no* family-level privileges configured for it in the baseline Meridium APM database. Users who are members of this group will see the **Administration** link on the **RCM Start Page** in the Meridium APM Framework application and will, therefore, have access to administrative functions in RCM. Users who do not belong to this Security Group will not see this link and, therefore, will not be able to access the administrative functions.

Because the MI RCM Administrator Security Group has *no* family-level privileges assigned to it by default, to access features and functions in RCM, members of the MI RCM Administrator Security Group will also need to be assigned to the MI RCM User or MI RCM Viewer Security Group.

- **MI RCM User:** The MI RCM User Security Group has access to *all* features in RCM.
- **MI RCM Viewer:** The MI RCM Viewer Security Group has view-only access to RCM. Users belonging to the MI RCM Viewer Security Group will not have access to features that result in the creation, update, or deletion of records or links between records.

The following table shows the family-level privileges assigned to the MI RCM User and RCM Viewer Security Groups.

Family Caption	MI RCM User	MI RCM Viewer
Entity families		
Action	View	View
Asset Criticality Analysis System	View	None
Consequence Definition	View	View
Decision Tree Consequence	View	View
Decision Tree Response	View	View
Decision Tree Structure	View	View
Human Resource	View, Update, Insert, Delete	View
Mitigates Risk	View, Update, Insert, Delete	View
Probability Definition	View	View
Protection Level	View	View

Family Caption	MI RCM User	MI RCM Viewer
RCM FMEA Analysis	View, Update, Insert, Delete	View
RCM FMEA Asset	View, Update, Insert, Delete	View
RCM Function	View, Update, Insert, Delete	View
RCM Functional Failure	View, Update, Insert, Delete	View
RCM FMEA Failure Mode	View, Update, Insert, Delete	View
RCM FMEA Failure Effect	View, Update, Insert, Delete	View
RCM FMEA Recommendation	View, Update, Insert, Delete	View
RCM FMEA Template	View, Update, Insert, Delete	View
RCM FMEA Task	View, Update, Insert, Delete	View
Reference Documents	View, Update, Insert, Delete	View
Risk Assessment	View, Update, Insert, Delete	View
Risk Category	View	View
Risk Matrix	View	View
Risk Rank	View, Update, Insert, Delete	View
Risk Threshold	View	View
Site Reference	View	View

Family Caption	MI RCM User	MI RCM Viewer
Task History <div style="border: 1px solid black; background-color: #ffffcc; padding: 5px; margin-top: 10px;"> Note: The Task History relationship family is inactive in the baseline Meridium APM database. </div>	View, Update, Insert, Delete	View
Relationship families		
Has Associated Recommendation	View	View
Has Consolidated Recommendations	View	View
Has Driving Recommendation	View	View
Has RCM FMEA Team Member	View, Update, Insert, Delete	View
Has RCM FMEA Analysis	View, Insert, Delete	None
Has RCM FMEA Asset	View, Update, Insert, Delete	View
Has RCM Function	View, Update, Insert, Delete	View
Has RCM Functional Failure	View, Update, Insert, Delete	View
Has RCM FMEA Failure Mode	View, Update, Insert, Delete	View
Has RCM FMEA Failure Effect	View, Update, Insert, Delete	View
Has RCM FMEA Recommendation	View, Update, Insert, Delete	View
Has Reference Values	View	View
Has Recommendations	View, Update, Insert, Delete	View
Has Reference Documents	View, Update, Insert, Delete	View
Has Risk	View	None

Family Caption	MI RCM User	MI RCM Viewer
Has Risk Category	View, Update, Insert, Delete	View
Has Site Reference	View	View
Has Superseded Recommendations	View	View
Has Task History Note: The Has Task History relationship family is inactive in the baseline Meridium APM database.	View, Update, Insert, Delete	View
Has Tasks	View, Update, Insert, Delete	View
Has Templates	View, Update, Insert, Delete	View
Is Based on RCM FMEA Failure Effect	View	View
Is RCM FMEA Asset	View, Update, Insert, Delete	View

With these privileges, any user who is a member of the MI RCM User Security Group will have access to ALL records involved in RCM Analyses. In addition to these baseline privileges, which you can grant by assigning users to the MI RCM User Security Group, you will need to grant RCM users permission to the [Equipment or Functional Location family if it is related to the RCM FMEA Asset family](#) through the Is RCM FMEA Asset relationship.

Note: You may also want to grant some users permission to modify the items in the following Catalog folders: \\Public\Meridium\Modules\RCM.

About Virtual and Physical Equipment and Locations

When you define RCM FMEA Asset records for your RCM Analyses, you have the following options:

- You can create standalone RCM FMEA Asset records that represent *virtual* equipment and locations (i.e., equipment and locations that do not physically exist and are not represented by Equipment and Functional Location records).
- You can create RCM FMEA Asset records that are linked to Equipment or Functional Location records in your database. This option allows you to make your RCM FMEA Asset records representative of the *actual* equipment and locations in your system. This allows certain values from the related Equipment or Functional Location record to be passed to other records in the analysis, such as the Failure Effect and Recommendation.

The baseline RCM implementation includes default rules that will map the certain values from the Equipment or Functional Location record to the fields of the related RCM FMEA Asset record. In this way, the RCM FMEA Asset record will store identifying information about its related Equipment or Functional Location record. In addition, the values stored in the Asset ID field will be available for selection when you create Failure Mode and Recommendation records. You can modify the rules that are delivered with the baseline RCM implementation to map additional fields from the Equipment or Functional Location record to the RCM FMEA Asset record.

In addition, the Meridium APM baseline database is configured with the [Has Recommendations](#) and Has Strategy relationships, so the Meridium APM system will link Equipment or Functional Location records to RCM FMEA Recommendation records and to Asset Strategy records.

Has Recommendations Relationship

The Has Recommendations relationship allows Equipment or Functional Location records that have been linked to RCM FMEA Asset records to be linked to RCM FMEA Recommendation records. In the Meridium APM baseline database, the following families are related to the RCM FMEA Recommendation family through the Has Recommendations family to facilitate this workflow:

- Equipment
- Functional Location
- RCM FMEA Asset

Therefore, any RCM FMEA Asset record that is linked to an Equipment or Functional Location record is also linked to the RCM FMEA Recommendation record. If you are following the Meridium APM Best Practice, you will not have to define the Has Recommendations relationship for the equipment and locations that you have defined for RCM or FMEA. However, if you want to define RCM FMEA Assets from any family other than the baseline Equipment or Functional Location families, you will have to create a relationship definition to link records in those families to RCM FMEA Recommendation records through the Has Recommendations relationship family.

Note: If you define the Has Recommendations relationship for any family other than the baseline Equipment and Functional Location families, be sure to use the *Has Recommendations* family and not the Has RCM FMEA Recommendations family, which is reserved for linking RCM FMEA Failure Effect records to RCM FMEA Recommendation records within RCM Analyses.

When you create an RCM FMEA Failure Mode record for an RCM Analysis, the value in the *Related Asset ID* field will indicate the ID of the related RCM FMEA Asset record. For RCM Analyses, the Related Asset ID must be selected manually. If the RCM FMEA Asset record is linked to an Equipment or Functional Location record, the Asset ID comes from the Equipment or Functional Location record.

When you create RCM FMEA Failure Effect records for that Failure Mode and then create RCM FMEA Recommendation records for those Failure Effects, the Meridium APM system will pass to the Recommendations the Related Asset ID from the associated RCM FMEA Failure Mode record.

- If the RCM FMEA Asset record is not linked to an Equipment or Functional Location record, the RCM FMEA Recommendation record will be linked *to the RCM FMEA Asset record*.
- If the RCM FMEA Asset record *is* linked to an Equipment or Functional Location record, the RCM FMEA Recommendation record will be linked *to the Equipment or Functional Location record*.

Creating the Evaluation Security User

When you set up an evaluation for an RCM Recommendation, the Meridium APM system will create a scheduled item for that evaluation and store it in the Meridium APM Schedule Manager. The scheduled item will be executed according to the schedule that is set up for the evaluation. As with other actions that you perform in the Meridium APM system, the execution of the scheduled item requires user authentication. Therefore, to execute scheduled evaluations, you must set up a Security User for that purpose.

When the scheduled item for an evaluation is executed, three things happen:

- If it is an event-based evaluation, the Meridium APM system runs the Evaluation Query. Therefore, the Evaluation User must have whatever privileges are necessary to execute the Evaluation Query that you create. The specific privileges that are required will vary, depending on which families are queried by the Evaluation Query.
- The Meridium APM system updates the associated Recommendation record with the execution date. Therefore, the Evaluation User must have View and Update privileges on the RCM FMEA Recommendation family.
- The Meridium APM system sends the evaluation email message to the appropriate email address. This action requires no special privileges.

Therefore, to set up evaluations, you must set up a Meridium APM Security User that has the privileges described above.

Creating a Scheduled Item for Evaluations

In RCM, you can define criteria for evaluating the whole analysis or parts of the analysis in the future. The evaluation feature allows you to be notified or to notify someone else when certain conditions are met.

To enable this functionality, you will need to create a scheduled item in the Meridium APM Schedule Manager using the following instructions. When the scheduled item is run, it will evaluate any date-based criteria and run the Evaluation query that is used by any event-based criteria to determine whether or not the criteria have been met. When the scheduled item is executed:

- For any date-based evaluations that have been configured, an email message will be sent for each item whose dates indicates that it is due for evaluation.
- For any event-based evaluations that have been configured, an email message will be sent only if the count and cost returned by the Evaluation query are greater than the count and cost defined in the event-based evaluation criteria.

To create a scheduled item for Evaluations:

1. Launch the Meridium APM Schedule Manager application and log in.
2. At the bottom of the **Meridium APM Scheduler - Scheduled Items** window, click the **Add New** link.

The **Choose a Meridium Assembly** dialog box appears.

3. Open the **Meridium.RCM.dll** file.

The **Choose an Object Type** dialog box appears.

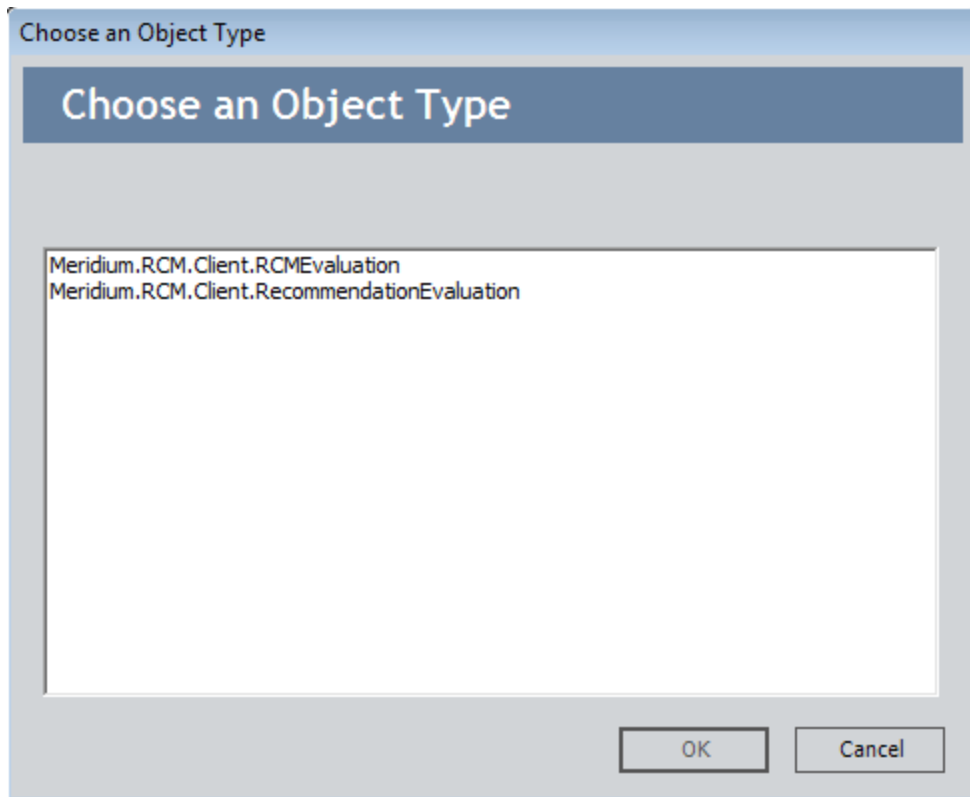

4. Select the object type **Meridium.RCM.Client.RCMEvaluation**, and click **OK**.

The **Schedule RCM Evaluation** window appears, and the **Task** tab is displayed by default.

Schedule RCM Evaluation

Schedule RCM Evaluation

Task | User

Last Executed: Never

Next Execution: 5/1/2012 1:05 PM

Recurring Item

Occurs

Every 1 minute(s)

Every 1 day(s)

Each Sunday every 1 week(s)

Every 1 month(s) on day 1 of the month

Every 1 year(s) on May 01

OK Cancel

5. On the **Task** tab, define a schedule that will execute the scheduled item on a recurring basis. The frequency by which you want to execute the scheduled item is up to you.
6. Click the **User** tab.
The **User** tab appears.

The image shows a software dialog box titled "Schedule RCM Evaluation". The dialog has a dark blue header with the title "Schedule RCM Evaluation" in white. Below the header, there are two tabs: "Task" and "User". The "User" tab is selected. Under the "User" tab, there are two text input fields: "User ID" and "Password". At the bottom right of the dialog are "OK" and "Cancel" buttons.

7. In the **User ID** and **Password** text boxes, enter the Meridium APM username and password for a user who has at least:
 - The privileges that are necessary to execute the Evaluation Query. The specific privileges that are required will vary, depending on which families are included in the Evaluation Query.
 - View and Update privileges to the RCM FMEA Recommendation family.
 - View and Update privileges to the RCM FMEA Asset family.
 - View and Update privileges to the RCM FMEA Analysis family.
8. Click **OK**.

The scheduled item is created and a new row appears in the **Scheduled Items** grid.

Creating a Scheduled Item for Evaluations

Scheduled Items				
Item Type <input type="text"/>				
ID	Caption	Description	Last Execution	Next Execution
<input type="checkbox"/> Item Type: Meridium.RCM.Client.RCMEvaluation				
<input type="checkbox"/>	RCM/FMEA Evaluation	Evaluate RCM/FMEA Analyses for...	1/1/0001 12:00:00 AM	5/1/2012 1:05:23 PM

About Queries Used by RCM

RCM relies upon queries to perform certain functions. For example, when you access the **RCM Analysis List** page, the Meridium APM system runs the Analysis List query and returns a list of analyses that meet the query criteria. From the list of analyses, you can [open an analysis](#) in the RCM Explorer.

Except in the case of the [Evaluation query](#), which you must create manually, when a query is required to enable certain functionality, the baseline RCM product contains a default query for you to use. The default query will be used automatically unless you choose to use a different query.

You can use the default query exactly as it is shipped, or you can modify it to meet your specific needs. As long as you do not rename the query or move it to a different location in the Catalog, it will be used automatically in RCM. If you do change the name of the query or move it to a different location, you will need to modify the appropriate Administrative setting to point to your custom query.

The following table provides a list and description of the queries that are provided for use within RCM. Each of these queries is stored in the folder \\Public\Meridium\Modules\RCM in the Catalog. In addition to the queries listed in the table, RCM also uses the [Evaluation query](#), which must be [created manually](#) and then [selected](#) on the **RCM Administration** page.

Query	Description	Name of Default Query in the Catalog
Recommendation Review query	Used for reviewing recommendations and promoting them to actions.	Review recommendations
Template query	Used for generating the list of available templates when you load templates for creating new analyses or analysis nodes .	Template List
Analysis List query	Used for generating the list of analyses that appears on the RCM Analysis List page .	Enterprise Analysis List

Note that a copy of each baseline query is also stored in the folder \\Baseline\Meridium\Modules\RCM. The items in the Baseline folder cannot be modified, so this folder serves as a permanent record of the content that is delivered with the baseline Meridium APM product. While a copy of each query is stored in the Baseline folder, the Meridium APM system *reads* the query from the folder \\Public\Meridium\Modules\RCM, so you can customize the baseline functionality by modifying the query in the folder \\Public\Meridium\Modules\RCM.

The Baseline folder will be updated with any changes made to the baseline content in future releases. If you modify an item in the folder \\Public\Meridium\Modules\RCM and

later decide that you want to revert to the baseline functionality, you can recover the baseline query from the folder \\Baseline\Meridium\Modules\RCM.

Accessing the RCM Administration Page

Note: To access administrative features in RCM, you must be a Super User or a member of the MI RCM Administrator Security Group.

To access the RCM Administration page:

- On the [RCM Start Page](#), click the **Perform Administrative Tasks** link.

The **RCM Administration** page appears.

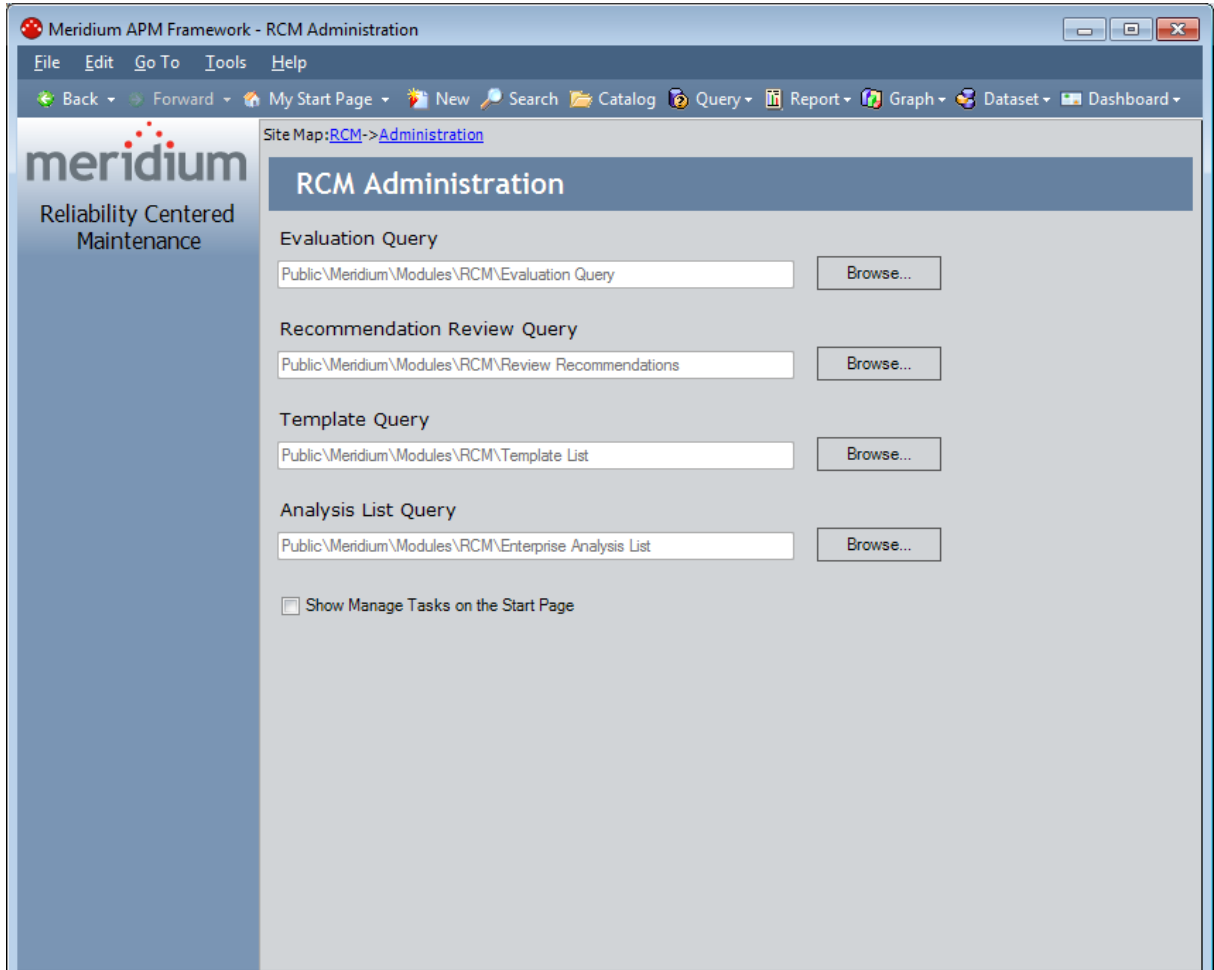

The **RCM Administration** page displays all the administrative settings that must be defined for RCM to work properly. A read-only value in the field associated with a setting indicates that the setting is defined. For new installations the **Template Query** and **Analysis List Query** are defined automatically. The other settings must be defined manually. In addition, you can modify the value for any setting that is already defined, including the ones that are defined automatically in the baseline RCM product.

Note: The **RCM Administration** page also contains the **Show Manage Tasks on the Start Page** check box. You should not select this check box. If you do, the **Manage Tasks** link will appear on the **RCM Start Page**. This link provides access to a feature that does not work properly.

About the Evaluation Query

For each RCM Analysis, you can configure date-based and event-based evaluations. A date-based evaluation relies entirely upon the date and time to determine when an evaluation email message should be sent. An event-based evaluation, on the other hand, relies upon failure data to determine when an evaluation email message should be sent.

When you set up an event-based evaluation, you will use the **Event-Based Evaluation** dialog box to define criteria for sending the evaluation message.

Note that you can set up the evaluation to be based on failure count, failure cost, and date. This means that to configure effective event-based evaluations, you must define an Evaluation query that determines the following for a given piece of equipment or location:

- The number of failures that have occurred for the piece of equipment or location since a given date.
- The total cost of the failures that have occurred for the piece of equipment or location since a given date.

Each day after the specified start date, the Meridium APM system will run the Evaluation query for the associated Equipment or Functional Location record. When the record meets the failure count and/or cost criteria, the Meridium APM system will send an evaluation message to the email address specified in the **Notify** field.

Creating the Evaluation Query

The specific families included in your Evaluation query will vary, depending on your data model. Regardless of your data structure, however, your query must follow the guidelines provided here.

It must contain two columns of output:

- **Count**, which returns a numeric value representing the total number of failures for a given piece of equipment or location. The alias for this column must be exactly *Count*.
- **Cost**, which returns a numeric value representing the total cost of failures for a given piece of equipment or location and failure mode. The alias for this column must be exactly *Cost*.

The query must contain three prompts in the following order:

- **ID**: Accepts the Record ID (i.e., the value in the *ENTY_ID* field) of the record representing the piece of equipment or location. Note that the record can be either an [RCM FMEA Asset record](#) itself or a [related Equipment or Functional Location record](#), depending on whether or not the [RCM FMEA Asset record has been linked to an Equipment or Functional Location record](#).

Note: In the baseline RCM implementation, the value in the *ENTY_ID* field from the RCM FMEA Asset or an Equipment or Functional Location record is passed to the RCM FMEA Failure Mode record and to subsequent RCM FMEA Recommendation records. If you are setting up an event-based evaluation at the recommendation level and you have modified your business rules to pass a *different* value to the RCM FMEA Failure Mode record and the Recommendation record, then you will need to set up the Evaluation query appropriately.

- **Failure Mode**: Accepts the value in the Failure Mode Name field in the Failure Mode record that is linked to either the Recommendation record (if you are setting an evaluation at the *recommendation* level) or the RCM FMEA Asset record (if you are setting up an evaluation at the *equipment or location* level). When the Meridium APM system runs the Evaluation query, it will extract the value from the Failure Mode Name field in the Failure Mode record and pass it in as the value for this prompt.

Note: The Failure Mode parameter expression should include the operator *like* instead of *is equal to* (=).

- **Date**: Accepts the date defined in the evaluation item. When you create an event-based evaluation, you specify a date *after which* you want to start counting failures and failure cost. For example, you might specify to be notified when a given piece of equipment has five failures, beginning 1/1/2005. In this case, the date 1/1/2005 will be passed to the Evaluation query. If the specified piece of equipment has had five failures since that date, then the evaluation email message will be sent.

Note: The Asset ID, Failure Mode, and Date fields should not be included in the output.

The specific tables that you query will vary, depending on your data model. For example, you might query the Equipment family to retrieve the Asset ID and the Work Order family to retrieve the failure data, where the Equipment and Work Order families are related through the Asset Has Maintenance relationship.

Whatever families you query, be sure that the table from which you retrieve the failure mode should contain the same values that will be stored in the Failure Mode Name field in RCM FMEA Failure Mode records. In the baseline RCM implementation, the Failure Mode Name field in RCM FMEA Failure Mode records is simply a character field that will accept any character string. Because values will be passed from this field to the Evaluation query, however, it is important that the values stored in the Failure Mode Name field *match* the failure modes that are stored in the records that are queried by the Evaluation query. How you choose to do this is up to you.

For example, you might modify the Failure Mode Name field in the RCM FMEA Failure Mode family to provide a restricted list of values or to use System Codes. Then, you might apply the same rules to the Failure Mode field of the family that is used by the Evaluation query. Just keep in mind that whatever is stored in the RCM FMEA Failure Mode Name field will be passed to the Failure Mode prompt in the Evaluation query. If the values passed to the Evaluation query are different from the values stored in failure data table used by the query, the query will not return the data need to trigger an event-based evaluation.

Example of an Evaluation Query

Note: The following example is meant to serve as a guideline for creating an Evaluation query. The specific families that you query and fields that you include will vary, depending on your data model.

Suppose that you want to create event-based evaluations for equipment that belongs to an RCM Analysis. The following image shows the design grid for an example of an Evaluation query.

Field	[Failure ID]	[Total Failure Cost]	[Equipment ID]	[Failure Mode]	[Failure Date / Time]
Alias	Count	Cose	Equipment ID	Failure Mode	Failure Date / Time
Table	[Event]	[Event]	[Equipment]	[Event]	[Event]
Sort					
Sort Index					
Include	<input checked="" type="checkbox"/>	<input checked="" type="checkbox"/>	<input type="checkbox"/>	<input type="checkbox"/>	<input type="checkbox"/>
Display	<input checked="" type="checkbox"/>	<input checked="" type="checkbox"/>	<input type="checkbox"/>	<input type="checkbox"/>	<input type="checkbox"/>
Hyperlink					
Criteria			(? :s :caption='Equip...	(? :s :caption='Failur...	(? :s :caption='Date' ...
Or					

When you run the query manually, the **Enter parameter values** dialog box will look like the following image.

The dialog box titled "Enter parameter values" contains three text input fields. The first field is labeled "Equipment ID", the second is labeled "Failure ID", and the third is labeled "Date". At the bottom right of the dialog, there are two buttons: "OK" and "Cancel".

Example of an Evaluation Query

This means that when the Meridium APM system runs the query automatically according to the schedule set up in the Schedule Manager, the following values will be passed in for the prompts:

- The Record ID of the Equipment record.
- The value in the Failure Mode Name field in the Failure Mode record that is linked to the RCM FMEA Asset record to which the Equipment record is linked.
- The date specified as the *Starting from* date in the evaluation criteria.

After the appropriate values have been passed in for the prompts, the query will return results similar to those shown in the following image.

Count	Cost
3	7764.41

In this particular case, the results show the failure count and failure cost:

- For failures of the specified type, as determined by the specified failure mode.
- That occurred for the piece of equipment or location identified by the specified Record ID.
- Since the date specified by the *Starting from* date in the evaluation criteria.

These results will be examined by the Meridium APM system and compared to the failure count and cost thresholds defined for the evaluation. If the necessary criteria have been met (i.e., if the failure count and/or cost returned by the query exceed the values defined for the evaluation), the Meridium APM system will send an evaluation email message to the appropriate person. If the criteria have not been met, the email message will not be sent.

Selecting the Evaluation Query

After you have created the Evaluation query and saved it in the Catalog, you must define that query in the RCM administrative settings.

To define the Evaluation query:

1. Access the [RCM Administration page](#).
2. To the right of the **Evaluation Query** text box, click the **Browse** button.
The **Evaluation Query** dialog box appears.
The hierarchy in the left pane represents the Catalog folder structure.
3. In the hierarchy on the left, navigate to and select the folder containing the query that you want to use as the Evaluation query.
4. In the pane on the right, select the query that you want to use as the Evaluation query.
5. Click **OK**.

The **Evaluation Query** text box is populated with the path to the query that you selected.

Defining the Recommendation Review Query

The Recommendation Review query is used for building the list of recommendations that appears in the pane on the left of the **RCM Review Recommendations** page. The Recommendation Review query should retrieve a list of RCM FMEA Recommendation records that are linked to a given RCM Analysis.

The baseline RCM product contains a default Recommendation Review query called *Review Recommendations*, which is stored in the folder \\Public\Meridium\Modules\RCM. This query will be used automatically by RCM. If you prefer to create your own query and use it instead, you will need to select that query via the RCM administrative settings.

Note: If necessary, you can customize the default query without having to modify the administrative settings. As long as you do not change the query name or location, the Meridium APM system will use the default query automatically even if you change the content.

The following instructions provide details on selecting the RCM Review Recommendations query. Note that you need to perform this procedure only if you choose to use a query other than the one that is delivered.

To define the Recommendation Review query:

1. Access the [RCM Administration page](#).
2. To the right of the **Recommendation Review Query** text box, click the **Browse** button.

The **Recommendation Review Query** dialog box appears.

The hierarchy in the left pane represents the Catalog folder structure.

3. In the hierarchy on the left, navigate to and select the folder containing the query that you want to use as the Recommendation Review query.
4. In the pane on the right, select the query that you want to use as the Recommendation Review query.
5. Click **OK**.

The **Recommendation Review Query** text box is populated with the path to the query that you selected.

Defining the Template Query

The Template query is used by RCM to load [RCM Analysis Templates](#). The baseline RCM product contains a default query called *Template List*, which is stored in the folder \\Public\Meridium\Modules\RCM. This query is run automatically when you access the **RCM Templates** page.

The Template List query uses a parameter that displays results based on Template Type. The Template Type that the query uses will depend on how you access the **RCM Templates** page. For instance, when you access the **RCM Templates** page from the **RCM Start Page**, the default parameter is *Analysis*. However, if you access the **RCM Templates** page via the **RCM Template Explorer** page, the root node in the tree determines which Template Type the query uses as the parameter. For example, if you are working with an RCM Template with the Template Type *Function*, when you access the **RCM Templates** page, the query will search and return results for all RCM templates created at the Function level.

If you prefer to create your own query and use it instead, you will need to select that query via the RCM administrative settings.

Note: If necessary, you can customize the default query without having to modify the administrative settings. As long as you do not change the query name or location, RCM will use the default query automatically even if you change the content.

The following instructions provide details on selecting the Template query. Note that you need to perform this procedure only if you choose to use a query other than the one that is delivered.

To define the Template query:

1. Access the [RCM Administration page](#).
2. To the right of the **Template Query** text box, click the **Browse** button.
The **Template Query** dialog box appears.
The hierarchy in the left pane represents the Catalog folder structure.
3. In the hierarchy on the left, navigate to and select the folder containing the query that you want to use as the Template query.
4. In the pane on the right, select the query that you want to use as the Template query.
5. Click **OK**.

The **Template Query** text box is populated with the path to the query that you selected.

Defining the Analysis List Query

The Analysis List query is used by RCM to generate a list of analyses that appears on the [RCM Analysis List page](#). The baseline RCM product contains a default query called *Enterprise Analysis List*, which is stored in the folder \\Public\Meridium\Modules\RCM. This query will be used automatically by RCM. If you prefer to create your own query and use it instead, you will need to select that query via the RCM administrative settings.

Note: If necessary, you can customize the default query without having to modify the administrative settings. As long as you do not change the query name or location, RCM will use the default query automatically even if you change the content.

The following instructions provide details on selecting the RCM Analysis List query. Note that you need to perform this procedure only if you choose to use a query other than the one that is delivered.

To select the Analysis List query:

1. Access the [RCM Administration page](#).
2. To the right of the **Analysis List Query** text box, click the **Browse** button.
The **Analysis List Query** dialog box appears.
The hierarchy in the left pane represents the Catalog folder structure.
3. In the hierarchy on the left, navigate to and select the folder containing the query that you want to use as the Analysis List query.
4. In the pane on the right, select the query that you want to use as the Analysis List query.
5. Click **OK**.

The **Analysis List Query** text box is populated with the path to the query that you selected.

Clearing the Current Query Selection

After you have selected the [Evaluation](#), [Recommendation Review](#), [Template](#), or [Analysis List](#) query, the query path appears in the text box on the **RCM Administration** page. The text is read-only, so to modify the query selection, you must use the procedure that you used to select the original query. If, on the other hand, you want to delete the current query selection so that NO query is selected, use the following instructions.

To delete the current RCM query selection:

1. Access the [RCM Administration page](#).
2. To the right of the text box for the query that you want to clear, click the **Browse** button.

The appropriate query selection dialog box appears, depending on which **Browse** button you clicked.

3. In the Catalog hierarchy on the left, select any folder.

The pane on the right will display any queries that are stored in that folder. Do not select a query.

4. Click **OK**.

The query path that was previously displayed in the text box is deleted.

Using the RCM Site Map

The Site Map in RCM allows you navigate from the current page to the **RCM Start Page** by clicking the **RCM** link in the Site Map. The Site Map appears at the top of the workspace on every page within RCM. The page that you are currently viewing appears as a hyperlink in the Site Map after the delimiter >.

The following image shows an example of the Site Map in RCM as it appears on the **RCM Analysis List** page. A red outline has been added to the image to highlight the Site Map.

The screenshot shows the Meridium APM Framework - RCM Analysis List interface. The Site Map navigation bar at the top is highlighted with a red box, showing 'Site Map:RCM->Analysis List'. Below it is a table titled 'Select RCM Analysis from the List' with columns for Analysis Short D..., System Name, Analysis Type, Analysis State, and Last Updated By. The table contains five rows of analysis data.

Analysis Short D...	System Name	Analysis Type	Analysis State	Last Updated By
Main Fractionator	Main Fractionator	RCM	Draft	Demo, Joe
HeaterDrPMP	Heater Drain	RCM	Draft	Demo, Joe
SRU1-Sour Water	Sour Water Feed	RCM	Draft	Demo, Joe
SRU1-Sour Water	Sour Water Feed	RCM	Draft	Demo, Joe
SRU1-Sour Water	Sour Water Feed	RCM	Draft	Demo, Joe

Page: 1 of 1 5 records found Page Size: 1000

Navigating RCM as a Member of the MI RCM Viewer Security Group

Unlike members of the MI RCM User Security Group, who have access to ALL features in the RCM modules, members of the MI RCM Viewer Security Group will have view-only access to RCM. In other words, members of the MI RCM Viewer Security Group cannot create, modify, or delete records or links between records. These users can, however, view the contents of analyses.

When you are logged in as a member of this Security Group, options that would result in the creation, update, or deletion of records or links between records will be disabled, including datasheets. In other words, if you do not have privileges to perform the action, the associated option will be disabled.

For example, when you are viewing an analysis on the **RCM Explorer** page, the RCM FMEA Analysis datasheet will be disabled. In addition, links like the **New Function** link on the **Common Tasks** menu will be disabled. While links like the **Set Up Assets** link on the **Analysis Tasks** menu will remain enabled and provide access to the **RCM Asset List** page.

Throughout this documentation, we assume that you are familiar with the privileges associated with the Security Group to which you belong. The documentation does not specify how options in the RCM module behave based upon your security privileges.

Options for Opening an RCM Analysis

You have several options for opening existing RCM Analyses. Your choice of where and how to open an analysis will depend primarily on your personal preference. You can open an analysis from:

- The [RCM Analysis List page](#), which displays a list of RCM Analyses retrieved by the query that has been set up for the purpose of generating the analysis list.
- The [RCM Recently Used Analyses page](#), which displays a list of the four analyses that you last accessed.

Accessing the RCM Analysis List

From the **RCM Analysis List** page, you can run the query that has been set up for the purpose of retrieving a list of existing RCM Analyses and then, from the list of analyses, open an analysis.

To access the **RCM Analysis List** page:

- On the **RCM Start Page**, click the **View Analysis List** link.

The **RCM Analysis List** page appears.

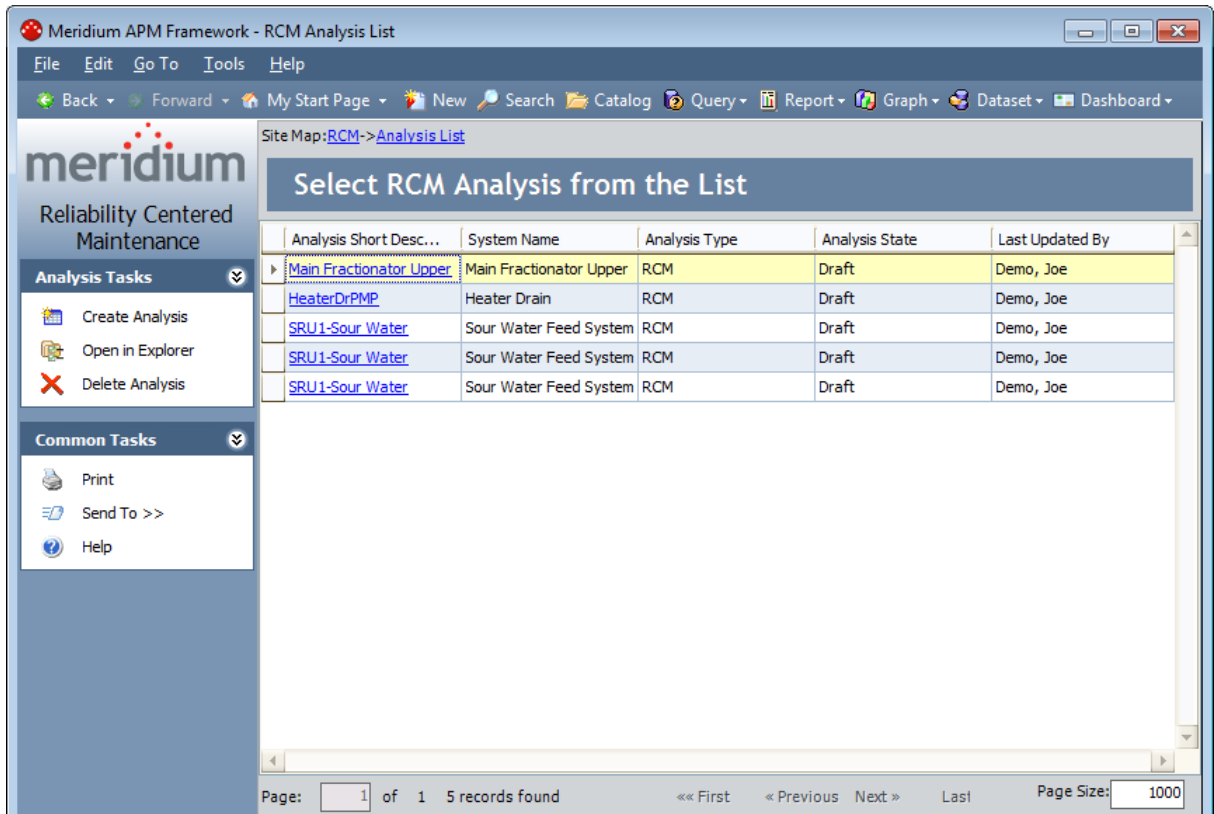

Aspects of the RCM Analysis List Page

The main display area of the **RCM Analysis List** page contains a grid that displays a list of analyses retrieved by the [Analysis List query](#). If the Analysis List query contains one or more prompts, those prompts will appear in fields above the grid, along with a **Run Query** button. You can select a value for each prompt and then click the **Run Query** button to retrieve results based on your selections.

Note: The default **Enterprise Analysis List** query does not contain any prompts. Prompts will appear above the grid only if a custom query has been configured by an administrative user.

The specific columns that appear in the results grid will vary, depending on how the query has been configured. If the query has been properly configured, the grid will display the **Analysis Short Description** column, which will contain a hyperlinked description of the analysis. You can click any link to open the associated analysis.

The **RCM Analysis List** page contains the following task menus: [Analysis Tasks](#) and [Common Tasks](#).

Analysis Tasks Menu

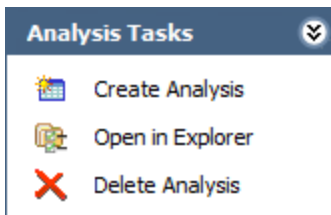

The **Analysis Tasks** menu on the **RCM Analysis List** page contains the following links:

- **Create Analysis:** Opens the [RCM Explorer](#) page, displaying a new RCM Analysis.
- **Open in Explorer:** Opens the selected RCM Analysis on the [RCM Explorer page](#). This link is disabled if more than one RCM Analysis record is selected in the grid.
- **Delete Analysis:** After asking for confirmation, deletes the analysis that is currently selected. Note that deleting an analysis from the **RCM Analysis List** page will delete the RCM FMEA Analysis record and all the records to which it is linked (i.e., all the analysis elements).

Common Tasks Menu

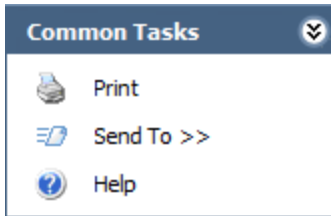

The **Common Tasks** menu on the **RCM Analysis List** page contains the following links:

- **Print:** Displays the **Preview** window, from which you can select various print options and print the list of analyses.
- **Send To:** Displays a submenu with options that let you provide a link to the current page on your desktop (create shortcut), in an email message, or on a Home Page.
- **Help:** Displays the context-sensitive Help topic for the **RCM Analysis List** page.

Opening an Analysis from the Analysis List

To open an analysis:

- In the **Analysis Short Description** column, click the link for the analysis that you want to open.

-or-

Select the row containing the analysis that you want to open, and on the **Analysis Tasks** menu, click the **Open in Explorer** link.

-or-

Right-click any analysis in the list, and then click **Open in explorer**.

The selected analysis appears on the [RCM Explorer page](#).

Deleting RCM Analyses

The following instructions provide details on deleting an RCM Analysis record via the **RCM Analysis List** page. You can also delete an RCM Analysis record, however, using the shortcut menu in the [RCM Explorer pane](#).

When you delete an RCM Analysis record, you are also deleting all the records that are linked to that record that make up the RCM Analysis.

To delete an RCM Analysis record:

1. [Access the RCM Analysis List page](#).
2. Select the row(s) containing the RCM Analysis record(s) that you want to delete.
3. On the **Analysis Tasks** menu, click the **Delete Analysis** link.
A confirmation message appears, asking if you really want to delete the selected analysis or analyses (if you selected multiple rows).
4. Click **OK**.
The selected record(s) is deleted.

Accessing the RCM Recently Used Analyses Page

To view a list of recently accessed analyses:

- On the [RCM Start Page](#), click the **View Recently Used Analyses** link.

The **RCM Recently Used Analyses** page appears, displaying a list of RCM Analyses that you have viewed most recently.

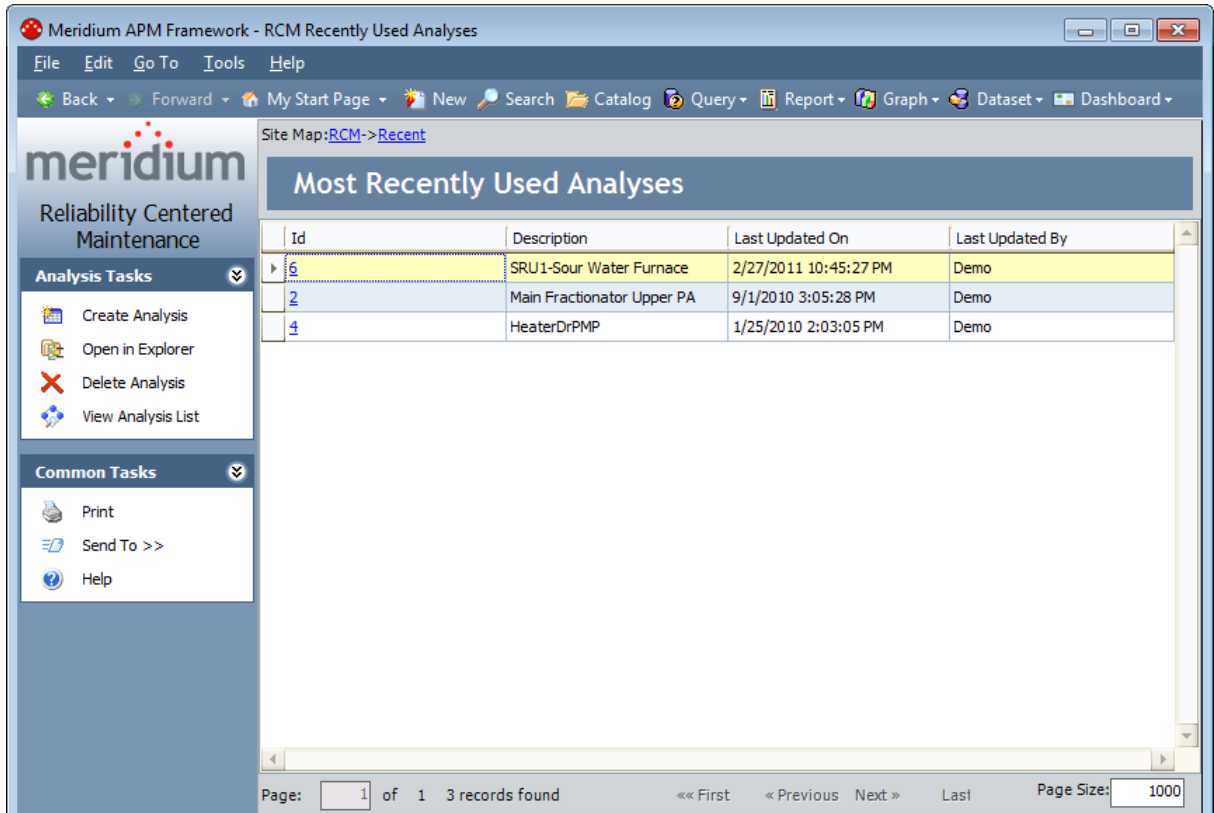

Aspects of the RCM Recently Used Analyses Page

The **RCM Recently Used Analyses** page displays a list of the last four analyses that you have opened. By default, the grid contains the following columns:

- **Id:** The value stored in the Analysis ID field in the corresponding record. This value appears as a hyperlink, which you can click to open the analysis.
- **Description:** The value stored in the Analysis Short Description field in the corresponding record.
- **Last Updated On:** The date on which the corresponding record was last updated.
- **Last Updated By:** The user name of the user who was logged in when the record was last updated.

You can [customize the default grid display](#), if desired. If you have not yet viewed any analyses, the **There are no recently viewed links available** link will appear in place of the grid. You can click the link to return to the **RCM Start Page**.

The **RCM Recently Used Analyses** page contains two task menus: [Analysis Tasks](#) and [Common Tasks](#).

Analysis Tasks Menu

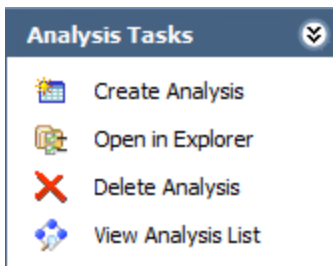

The **Analysis Tasks** menu on the **RCM Recently Used Analyses** page contains the following links:

- **Create Analysis:** Opens the [RCM Explorer](#) page, displaying a new RCM Analysis.
- **Open in Explorer:** Opens the selected RCM Analysis on the [RCM Explorer page](#). This link is disabled if more than one RCM Analysis record is selected in the grid.
- **Delete Analysis:** After asking for confirmation, deletes the analysis that is currently selected. Note that deleting an analysis from the **RCM Recently Used Analyses** page will delete the RCM FMEA Analysis record and all the records to which it is linked (i.e., all the analysis elements).
- **View Analysis List:** Displays the **RCM Analysis List** page, which displays a list of all the RCM analyses that exist.

Common Tasks Menu

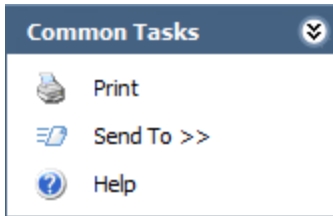

The **Common Tasks** menu on the **RCM Recently Used Analyses** page contains the following links:

- **Print:** Displays the **Preview** window, from which you can select various print options and print the list of analyses.
- **Send To:** Displays a submenu with options that let you provide a link to the current page on your desktop (create shortcut), in an email message, or on a Home Page.
- **Help:** Displays the context-sensitive Help topic for the **RCM Recently Used Analyses** page.

Opening a Recently Used Analysis

To open an analysis:

- In the **Id** column, click the hyperlinked ID of the analysis that you want to open.

-or-

Select the row containing the analysis that you want to open, and on the **Analysis Tasks** menu, click the **Open in Explorer** link.

-or-

Right-click any analysis in the list, and then click **Load selected analysis into explorer**.

The selected analysis appears on the [RCM Explorer page](#).

Workflow for Creating an RCM Analysis

The following list represents the basic steps that should be completed in an RCM Analysis. Note that none of the steps are required, but the more steps you complete, the more thorough your analysis will be. In addition, note that the [RCM data model](#) dictates that certain elements be defined before certain other elements can be defined.

1. [Create the root-level RCM Analysis record](#).
2. Create the analysis team.
3. Define the equipment and location list, which helps define the RCM system. Note that each RCM FMEA Asset record can optionally be [linked to an Equipment or Functional Location record](#).
4. [Define the functions](#) of the system.
5. [Define functional failures](#) for each system function.
6. [Define failure modes](#) for each functional failure.
7. [Define the failure effects](#) for each failure mode.
8. [Define recommendations](#) for each failure effect.
9. [Define conditions for evaluation](#) of the recommended actions.
10. [Create Task records](#) based on the recommendations.
11. Schedule tasks in Task Management and perform the associated work.
12. Update the analysis based on [evaluation email](#) received for recommendations.

Meridium APM provides various tools that you can use to accomplish these tasks. The tools that you use will depend on your personal preference and your workflow.

Starting a New RCM Analysis

The following instructions provide details on creating a new analysis from scratch. Note that you can also create a new RCM analysis using the following methods:

- [Load an RCM Template](#).
- [Promote an Asset Criticality Analysis System record from Asset Criticality Analysis \(ACA\) to RCM](#).

The following instructions provide details on creating a new RCM Analysis from the **RCM Start Page**. You can also create a new RCM Analysis using the **Create Analysis** link that appears on the **Analysis Tasks** menus throughout RCM.

To create a new analysis from scratch:

1. On the [RCM Start Page](#), click the **Create a New Analysis** link.

The [RCM Explorer page](#) appears, displaying a new analysis.

2. In the **Analysis** datasheet, enter the desired analysis information. Note that the default **Analysis** datasheet contains two tabs:
 - **Analysis Identification:** Stores identifying information, such as the analysis ID and description. Note that the **Analysis ID** and **Analysis Type** cells are populated automatically and cannot be modified. The **Analysis Short Description** cell is also populated with a default value but can be modified if needed.
 - **System Definition:** Stores general information about the system that is being analyzed, including information about the system boundaries. The **System Definition** tab also contains the Site Reference field, where you can select the site to which this analysis belongs. The list contains the Record ID of all Site Reference records that exist in the database.

Note: After an RCM Analysis contains an Equipment or Functional Location record that is linked to a Site Reference record, the Site Reference field is disabled.

3. Click the **Save** button , which appears above the datasheet.

The new RCM FMEA Analysis record is saved to the database in the [Draft state](#). After you have saved the analysis, the task menu options become enabled so that you can perform additional tasks associated with the analysis. The next step in setting up the new analysis is to [define the asset list](#), [set up the analysis team](#), or [create the first Function record](#).

Note that if you selected a value in the Site Reference field:

- When you define the equipment and location list, you will be able to [link RCM FMEA Asset records to Equipment or Functional Location records](#) that are linked to that Site Reference record.

Starting a New RCM Analysis

- When you define the unmitigated risk rank associated with a failure effect, you will see the Risk Matrix that is built using the Risk Matrix record that is linked to that Site Reference record.

About the RCM Explorer Page

The **RCM Explorer** page is the page that you will use to work with RCM Analyses. The layout of the **RCM Explorer** page is similar to that of the Record Manager, where it is divided into three main areas:

- The following task menus:
 - [Analysis Tasks menu](#)
 - [Common Tasks menu](#)
 - [Template Tasks menu](#)
 - [Associated Pages menu](#)
 - [Analysis Reports menu](#)
- The [RCM Explorer pane](#), which displays the RCM Analysis in a hierarchical view so that you can view the RCM FMEA Analysis record itself along with all the related records, which, together, make up the analysis.
- The [datasheet area](#), which displays the information stored in the record for the selected node.

Note that throughout our discussion of the **RCM Explorer** page, we assume that you are familiar with the basic concepts and navigational features of the Record Manager. We limit our discussion primarily to features that are specific to the **RCM Explorer** page and that deviate from the standard functionality of the Record Manager.

About Accessing the RCM Explorer Page

You can access the **RCM Explorer** page in various ways, depending on the task that you want to perform:

- [You can access it to create a new RCM Analysis from scratch.](#)
- [You can open an existing analysis from the **RCM Analysis List** page.](#)
- [You can open an existing analysis from the **RCM Recently Used Analyses** page.](#)
- [You can access it and then load an analysis template that you will use to create a new analysis.](#)

About the RCM Explorer Pane

When you open an RCM Analysis on the **RCM Analysis** page, the RCM Analysis family appears at the root level in the **RCM Explorer** pane. Below the root record, arranged in a hierarchical view, the **RCM Explorer** pane displays the other components of the analysis. When you first open an RCM Analysis, only Function nodes will be displayed in the **RCM Explorer** pane, provided that one or more RCM Function records have been linked to the root RCM FMEA Analysis record. The following image displays an example of the **RCM Explorer** pane.

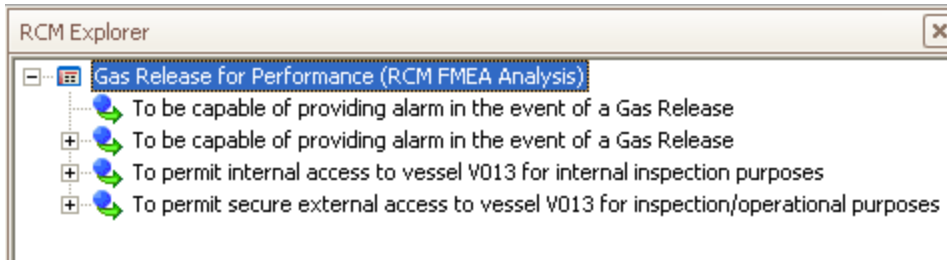

You can click the plus sign (+) to the left of any Function node to expand it and view the associated functional failure records. You can expand any Functional Failure node to view the associated Failure Mode records. You can continue expanding the tree to view all the components involved in the analysis. Components are linked to one another according to the relationships defined in the [RCM data model](#). The following image shows an example of a fully expanded branch of the tree. Notice that each analysis node has its own icon to help you identify it in the tree.

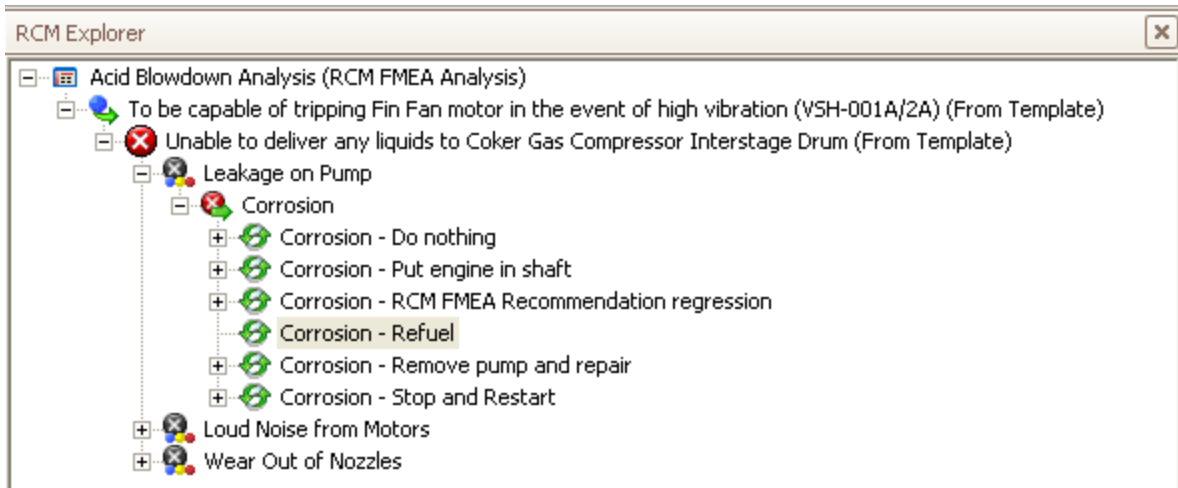

CEHint: You can also right-click any branch of the tree and then click **Hide Children** or **Show Children**, as appropriate, to expand or collapse that branch.

Selecting a node in the tree will cause the datasheet for that record to appear in the [data-sheet area](#) of the **RCM Explorer** page.

Note that unlike the standard **Record Explorer** pane, which displays all the records in the record hierarchy that are linked to the root record through any relationship, the **RCM Explorer** pane displays only the records belonging to the families that make up the RCM Analysis components, according to the [RCM data model](#). Therefore, you will see only the records that make up a given RCM Analysis.

The Shortcut Menu in the RCM Explorer Pane

If you right-click a node in the **RCM Explorer** pane, a shortcut menu will appear, displaying options associated with the RCM Analysis and its components. The specific options that are available on the menu will vary, depending which analysis node you select. The following image shows the options that appear on the shortcut menu when you right-click a Function node.



The following options are available on the shortcut menu in the **RCM Explorer** pane:

- **Save:** Saves any changes that you have made to the currently selected record (i.e., the record whose datasheet is displayed on the right side of the page).
- **Save as Template:** Displays the **<Node ID> (new RCM FMEA Template)** window, where **<Node ID>** is the ID of the node that is currently selected in the tree. This window facilitates the creation of a new RCM FMEA Template at the level of the currently selected node.
- **Load Template:** Facilitates the creation of a new RCM Analysis node as a successor of the currently selected node by applying an existing RCM Template.
 - If you are applying a Function node, Functional Failure node, or Failure Mode node, this link will launch the **Apply Template Builder**, which guides you step-by-step through the process of applying a template to the new analysis node in the current RCM Analysis. The **Apply Template Builder** allows you to replace any RCM FMEA Asset record associated with the template you want to apply with RCM FMEA Asset records that are linked to the current analysis.

Note: If you are applying a Failure Mode node, the **Apply Template Builder** will also give you an option to load into the current RCM Analysis an FMEA Asset Template.

- If you are applying a Failure Effect node or a Recommendation node, this link will open the **Templates** window, which displays a list of templates that you can use for [adding a new node to the selected Analysis node](#). The list of templates displayed in the **Templates** window is appropriate to the type of node that is currently selected.
- **Cut:** Copies the currently selected node and all its nodes and then deletes the records from the database. A temporary copy of the records is saved so that you can link them to a different record using the **Paste** function. For example, you can cut an RCM Functional Failure record from one Function record and then paste it to a different Function record.
- **Copy:** Copies the selected record but does not remove it from the analysis tree. After you have copied a record, the **Paste** option will appear on the shortcut menu so that you can paste the record in a different location in the analysis. Note that if the selected analysis component has children, a prompt appears, asking if you want to copy just the selected record or the selected record and all its child records.
- **Paste:** Links the copied record to the record that you select in the **RCM Explorer** pane. Note that this menu option appears only after you have copied a record and only if you select a record to which it is possible to link the copied record, according to the relationship definitions that exist.
- **Delete:** Deletes the selected record from the analysis and from the database. When you use this option, a prompt appears, asking if you want to delete the selected component only or the selected component and all its subcomponents.
 - If you choose to delete the selected component and all its children, the Meridium APM system will delete all the records from the analysis and from the database.
 - If you choose to delete the selected component and not the children, the Meridium APM system will delete the selected record from the database and will remove any subcomponents from the analysis. The children will not, however, be deleted from the database.
- **New [Node]:** Creates a new record and links it to the selected record. The type of record that is created will depend on which record you select when you access the shortcut menu. For example, if you select a Function record, this option will read **New Failure** and will result in the creation of a new Functional Failure record.
- **Reference Documents:** Displays the **Reference Documents** window, where you can [manage the Reference Documents](#) associated with the record.
- **[Node] Reports:** Displays a submenu, containing a list of reports that are associated with the selected component. For example, when you select an RCM Function record, this option will be labeled **Function Reports**. This menu option appears only if reports exist for the currently selected node.
- **Show Children:** For a given node of the analysis tree, expands the hierarchy to display the immediate children of that node. This option appears only when you select a collapsed node that has children.

- **Hide Children:** For a given node of the analysis tree, collapses the hierarchy to hide the children of that node. This option appears only when you select a node that has children and that is currently expanded.
- **Show All:** Completely expands the currently selected node.
- **Help:** Displays the context-sensitive Help topic for the **RCM Explorer** page.

About the Datasheet Area

The datasheet area, which appears on the right side of the **RCM Explorer** page, displays the datasheet for the record that is currently selected in the **RCM Explorer** pane. For example, when you select an RCM Failure Effect record in the **RCM Explorer** pane, the datasheet area displays the Failure Effect datasheet, which is populated with the values that exist in the Failure Effect record, outlined in red in the following image.

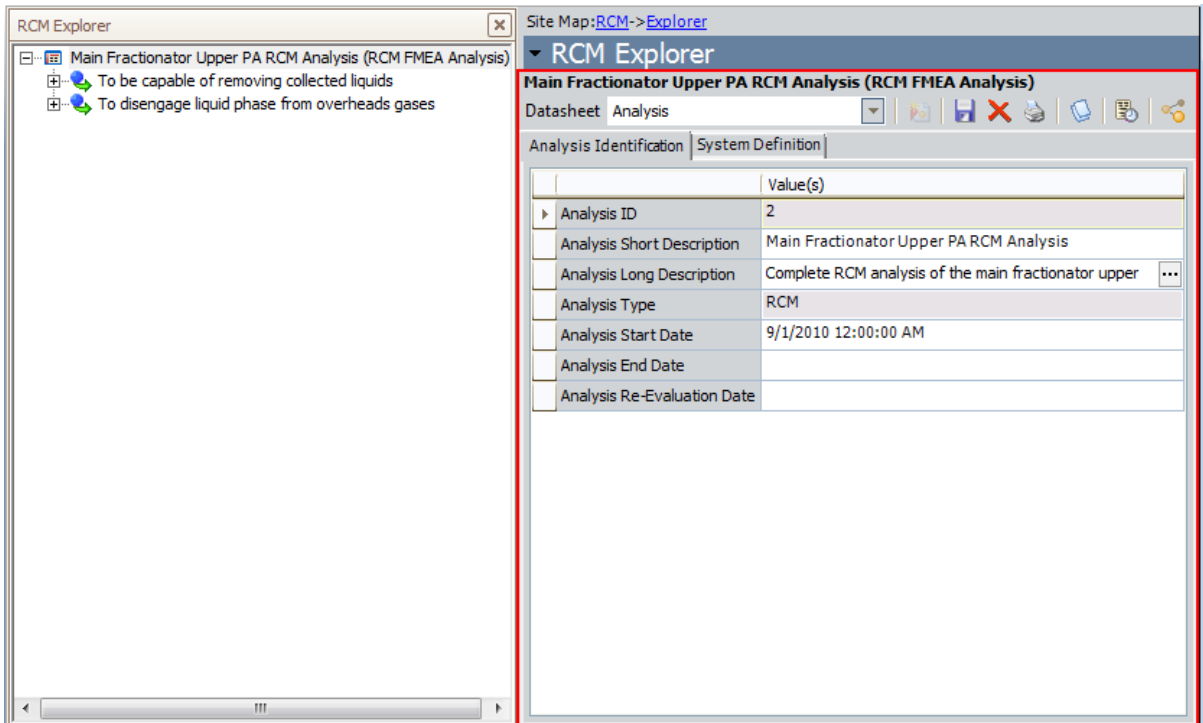

In the datasheet area, you can view the information that currently exists for the selected record and modify the information if needed. After you make changes to the record information, you can click the **Save** link on the **Common Tasks** menu to save your changes. If you make changes to a record via the datasheet and then select a different node in the **RCM Explorer** pane, you will be prompted to save your changes before displaying the datasheet for the newly selected node.

The other features of the datasheet area, such as the buttons that appear above the datasheet itself, are the same as those that are available in the Record Manager.

Note: The **New** button  above the datasheet creates a new record in the same family as the selected record. For example, if you are viewing an RCM FMEA Recommendation record and you click the **New** button above the datasheet, a new RCM FMEA Recommendation record would appear in the datasheet area. Because the **RCM Explorer** page can display only one analysis at a time, the **New** button is disabled when you are viewing the RCM FMEA Analysis record.

Analysis Tasks Menu

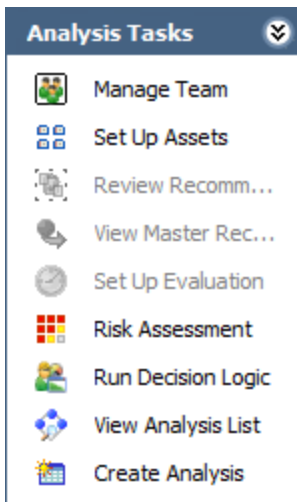

The **Analysis Tasks** menu on the **RCM Explorer** page contains the following links:

- **Manage Team:** Displays the [RCM Team Members page](#), where you can set up your RCM Analysis Team.
- **Set Up Assets:** Displays the [RCM Asset List page](#), where you can set up the equipment and location list for the current analysis.
- **Review Recommendations:** Displays the [Recommendation Management page](#), where you can [review and manage the Recommendation records](#) associated with the current analysis. This link is enabled only if one or more RCM FMEA Recommendation records exist for the current analysis.
- **View Master Recommendation:** If the selected Recommendation record was consolidated with one or more other Recommendation records, this link [opens the master consolidated Recommendation record in a stand-alone window](#). This link is enabled only if the selected Recommendation record is in the *Consolidated* state.
- **Set Up Evaluation:** Displays the **Set Up <Node> Evaluation** dialog box, where <Node> is the type of node that is selected in the **RCM Explorer** pane. You can use this dialog box to define criteria for sending [evaluation email](#). This link is enabled only an Analysis or Recommendation node is selected in the tree.
- **Risk Assessment:** Displays the Risk Assessment feature.
 - If a [Failure Effect node](#) is selected in the analysis tree, the **Unmitigated Risk Assessment** window appears.
 - If a [Recommendation node](#) is selected in the analysis tree and a value has been selected for at least one Category in the corresponding *unmitigated* Risk Assessment, the **Risk Mitigation Assessment** window appears.
- **Run Decision Logic:** Launches the [Decision Logic Builder](#). This link is enabled only if a Failure Effect node is selected in the tree.

- **View Analysis List:** Displays the **RCM Analysis List** page, from which you can [open an existing RCM Analysis](#).
- **Create Analysis:** Opens the [RCM Explorer](#) page, displaying a new RCM Analysis.

Common Tasks Menu

The **Common Tasks** menu on the **RCM Explorer** page contains the following links:

- **New [Node]:** Creates a new record, whose type is indicated by the **[Node]** name and links it to the selected record. The name of this link changes, depending on which node you select. For example, when you select a Function node in the **RCM Explorer** pane, this link reads **New Failure** and lets you create an RCM Functional Failure record and link it to the selected function.

Note: This link is disabled when you select a Recommendation node since Recommendation records represent the lowest level in the RCM Analysis hierarchy. In other words, you cannot add a record to the analysis when a Recommendation node is selected.

- **Save:** Saves the currently selected record. For example, if you select a Function node in the **RCM Explorer** pane, when you click this link, the Meridium APM system will save any changes that you have made to that Function record.
- **Delete:** Deletes the selected record from the analysis and from the database. When you use this option, a prompt appears, asking if you want to delete the selected component only or the selected component and all its subcomponents.
 - If you choose to delete the selected component and all its children, the Meridium APM system will delete all the records from the analysis and from the database.
 - If you choose to delete the selected component and not the children, the Meridium APM system will delete the selected record from the database and will remove any subcomponents from the analysis. The children will not, however, be deleted from the database.
- **Cut:** Copies the currently selected node and all its nodes and then deletes the records from the database. A temporary copy of the records is saved so that you can then link them to a different record using the **Paste** function. For example, you can cut an RCM Functional Failure record from one Function record and then paste it to a different Function record.
- **Copy:** Copies the selected record but does not remove it from the analysis tree. After you have copied a record, the **Paste** option will appear on the shortcut menu so that you can paste the record in a different location in the analysis. Note that if the selected analysis component has children, a prompt appears, asking if you want to copy just the selected record or the selected record and all its subrecords.

Note: If you cut or copy and analysis node, when you paste the node, the Meridium APM system will generate for the pasted node a new ID that is appropriate to where you paste it.

- **Paste:** Links the copied record to the record that you select in the **RCM Explorer** pane. Note that this menu option appears only after you have copied a record and only if you select a record to which it is possible to link the copied record, according to the relationship definitions that exist.

- **Print:** Displays the **Preview** window, which shows a preview of how the current data-sheet will be printed. From the **Preview** window, you can select print options and print the record.
- **Reference Documents:** Displays the **Reference Documents** window, where you can manage the Reference Documents associated with the record.
- **Send To:** Displays a submenu with options that let you **provide a link to the current page on your desktop (create shortcut), in an email message, or on a Home Page.**
- **Help:** Displays the context-sensitive Help topic for the **RCM Explorer** page.

Template Tasks Menu

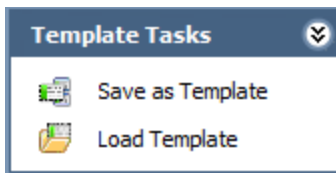

The **Template Tasks** menu on the **RCM Explorer** page contains the following links:

- **Save as Template:** Displays the **[Record ID](New RCM FMEA Template)** window, where **[Record ID]** is the record ID of the selected analysis node. You can use this window to [save the current analysis or analysis node as an RCM Template](#).
- **Load Template:** Displays the **Templates** window, which displays a list of RCM Templates that you can use for [adding a new node to the selected Analysis node](#). The list of RCM Templates displayed in the window is appropriate to the type of node that is currently selected.

Reports Menu

The **Reports** menu on the **RCM Explorer** page displays the captions of the reports that are associated with the node currently selected in the **RCM Explorer** pane. The name of the menu will change as appropriate, depending on which node you select. For example, when you select the root-level analysis node, the menu is labeled **Analysis Reports** and displays a list of reports associated with the Analysis node.

Each analysis node has a related [folder in the Catalog](#) that is used to determine which reports to display for which analysis component. This menu appears only if reports exist in the Catalog folder associated with the selected node.

Associated Pages Menu

The **Associated Pages** menu on the **RCM Explorer** page displays Associated Pages that have been configured via the URL Manager for the family of the analysis node that is currently selected in the **RCM Explorer** pane.

Note: The **Associated Pages** menu will not be filtered based on the type of analysis that you are viewing. Any Associated Page that you configured for a family that is used by both RCM and FMEA Analyses will appear when you are viewing an RCM Analysis and when you are viewing an FMEA Analysis.

What is the RCM Analysis Team?

The *RCM Analysis Team* defines which users will participate in the RCM Analysis. The RCM Analysis Team actually consists of Human Resource records that are linked to the RCM FMEA Analysis record. The **FMEA Team Members** page simply provides a customized view for working with Human Resource records that are linked to the RCM FMEA Analysis record. To add people to the RCM Analysis Team, you can either [select a Human Resource record that currently exists in the Meridium APM database](#), or you can [create a new Human Resource record](#).

You can set up the RCM Analysis Team on the **RCM Team Members** page, which is accessible from the RCM Explorer after you have [created a new analysis](#) or [opened an existing analysis](#).

Accessing the RCM Team Members Page

To access the RCM Team Members page:

- On the RCM Explorer page, on the Analysis Tasks menu, click the Manage Team link.

The [RCM Team Members page](#) appears.

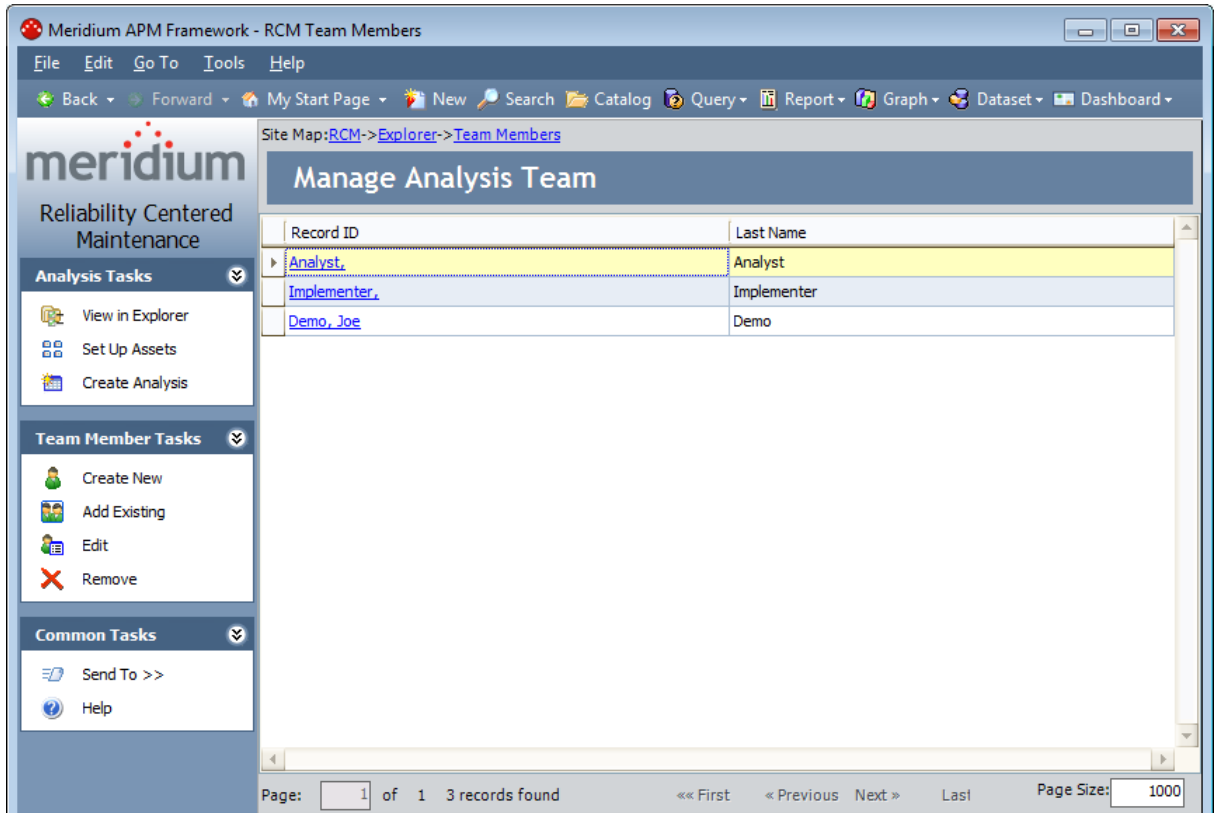

Aspects of the RCM Team Members Page

The **RCM Team Members** page for RCM Templates has similar features to the [RCM Team Members page that is configured for RCM Analyses](#). The **RCM Team Members** page contains a grid that displays a list of all the Human Resource records that are linked to the RCM Template. The grid is divided into two columns:

- **Record ID:** The Record ID of the Human Resource record.
- **Last Name:** The value in the Last Name field in the Human Resource record.

The **RCM Team Members** page also contains three task menus, which let you perform tasks specific to the RCM Analysis Team: **Analysis Tasks**, **Team Members Tasks**, and **Common Tasks**.

From the **RCM Team Members** page, you can:

- [Add team members using existing Human Resource records.](#)
- [Add team members by creating new Human Resource records.](#)
- [Modify information about a team member by modifying the corresponding Human Resource record.](#)
- [Remove team members from the RCM Analysis Team.](#)

Analysis Tasks Menu

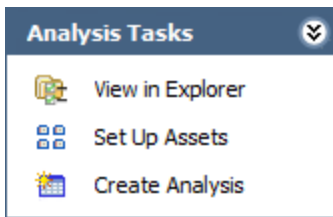

The **Analysis Tasks** menu on the **RCM Team Members** page contains the following links:

- **View in Explorer:** Opens the current analysis on the [RCM Explorer page](#).
- **Set Up Assets:** Displays the [RCM Asset List page](#), where you can manage the equipment and location list for the analysis.
- **Create Analysis:** Opens the [RCM Explorer](#) page, displaying a new RCM Analysis.

Team Members Tasks Menu

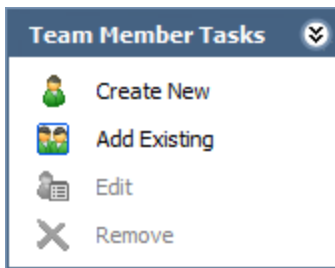

The **Team Members Tasks** menu on the **RCM Team Members** page contains the following links:

- **Create New:** Displays the **Create New Team Member** dialog box, where you can create a new Human Resource record and add that person to the RCM Analysis Team.
- **Add Existing:** Displays the **Find a Human Resource** dialog box, where you can [search for existing Human Resource records to add](#) to the RCM Analysis Team.
- **Edit:** Displays the **Edit Team Member** dialog box, where you can [modify the information stored in the selected Human Resource record](#).
- **Remove:** After asking for confirmation, removes the selected Human Resource record from the RCM Analysis Team. Note that this does not delete the Human Resource record from the database.

Common Tasks Menu

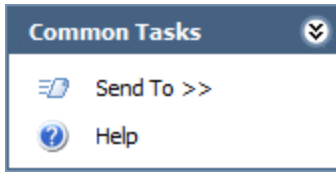

The **Common Tasks** menu on the **RCM Team Members** page contains the following links:

- **Send To:** Displays a submenu with options that let you provide a link to the current page on your desktop (create shortcut), in an email message, or on a Home Page.
- **Help:** Displays the context-sensitive Help topic for the **RCM Team Members** page.

Adding an Existing User to the RCM Analysis Team

To add a team member to the RCM Analysis Team using an existing Human Resource record:

1. On the [RCM Team Members page](#), on the **Team Member Tasks** menu, click the **Add Existing** link.

The **Find a Human Resource** window appears.

2. Specify search criteria to find the desired Human Resource record. Note that the Human Resource family is selected in the **Search In** list by default. You cannot select a different family, but you can define additional criteria if desired.
3. Click the **Find Now** button.

The Human Resource records that match your search criteria appear in a list at the bottom of the window.

4. In the list of results, select the record that you want to add to the RCM Analysis Team.
5. Click the **Select** button.

The Human Resource record that you selected appears in the list on the [RCM Team Members page](#).

Creating a New User to Add to the RCM Analysis Team

To add a team member to the RCM Analysis Team by creating a new Human Resource record:

1. On the [RCM Team Members page](#), on the **Team Member Tasks** menu, click the **Create New** link.

The **Create New Team Member** dialog box appears.

2. On the datasheet, complete the desired fields to identify the new Human Resource. Note that a **Last Name** is required.
3. Click the **Save** button.

The new Human Resource record is created and added to the RCM Analysis Team.

Modifying Information about a Team Member

To modify the Human Resource record for an RCM Analysis Team member:

1. On the [RCM Team Members page](#), in the list of team members, click the hyper-linked Record ID of the Human Resource record that you want to modify.

The **Edit Team Member** dialog box appears.

2. Make the desired changes.
3. Click the **Save** button.

Your changes are saved to the database.

Removing Team Members from the RCM Analysis Team

Note: Removing a team member from the RCM Analysis Team simply breaks the link between the Human Resource record and the RCM FMEA Analysis record. It does not delete the Human Resource record from the database.

To remove a Human Resource record from the RCM Analysis Team:

1. On the [RCM Team Members page](#), in the list of team members, select the row containing the Human Resource record that you want to remove from the RCM Analysis Team.

2. On the **Team Members Task** menu, click the **Remove** link.

A message appears, asking if you really want to remove the Human Resource record from the RCM Analysis Team.

3. Click the **Yes** button.

The Human Resource record is removed from the RCM Analysis Team.

Accessing the RCM Asset List Page

An RCM system includes a set of equipment and locations, their functions, and their boundaries. One of the most important steps in defining the system is to set up the equipment and location list. After you have opened an existing analysis or created a new analysis, you can access the **RCM Asset List** page to set up the equipment and location list that will help define the analysis system.

To access the RCM Asset List page and set up the equipment and location list for an analysis:

- With the analysis [open on the RCM Explorer page](#), on the **Analysis Tasks** menu, click the **Set Up Assets** link.

The RCM Asset List page appears.

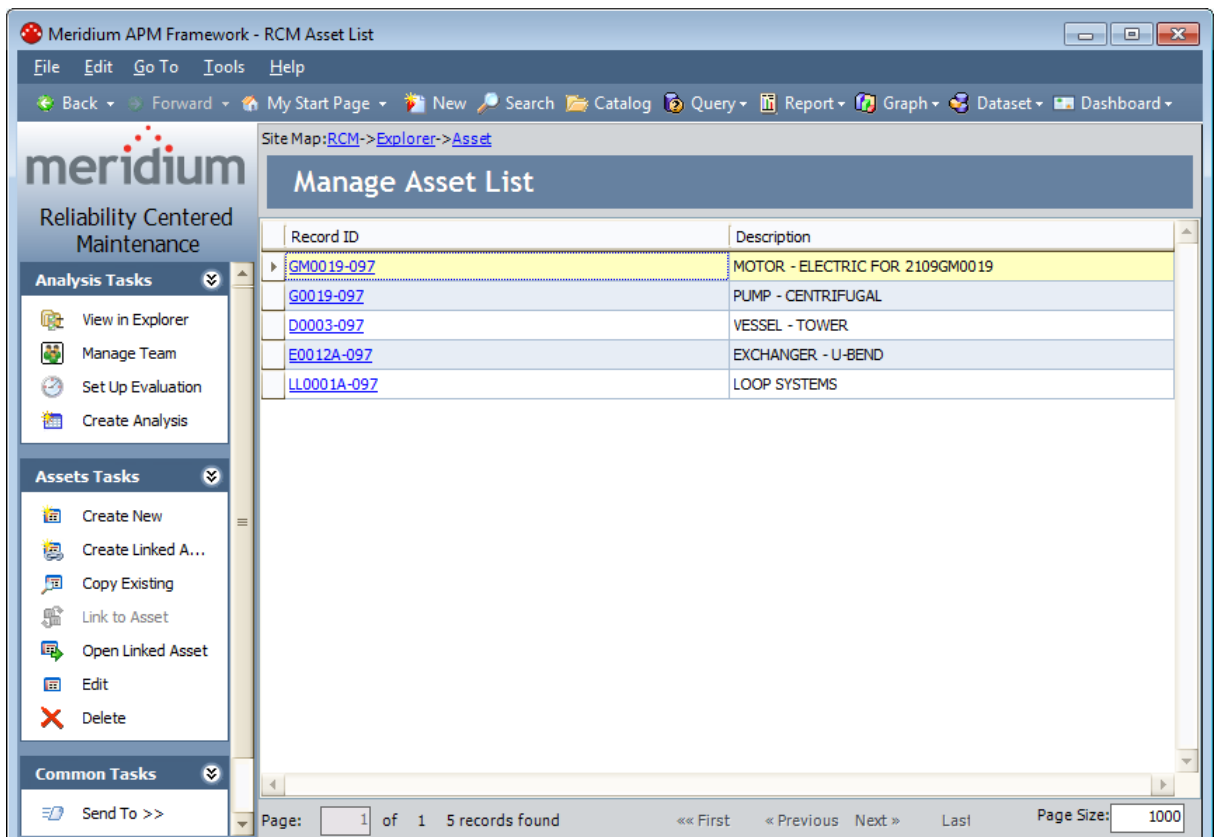

Note: You can also access the RCM Asset List page from the RCM Team Members page.

Aspects of the RCM Asset List Page

The **RCM Asset List** page contains a grid that displays a list of all the RCM FMEA Asset records involved in the analysis. The grid is divided into two columns:

- **Record ID:** The Record ID of the RCM FMEA Asset record.
- **Description:** The value from the **Description** field in the RCM FMEA Asset record.

The **RCM Asset List** page also contains three task menus, which let you perform tasks specific to the equipment and location list: [Analysis Tasks](#), [Asset Tasks](#), and [Common Tasks](#).

From the **RCM Asset List** page, you can:

- [Add RCM FMEA Asset records to the system.](#)
- [Modify RCM FMEA Asset records.](#)
- [Link RCM FMEA Asset records to Equipment or Functional Location records.](#)
- [Delete RCM FMEA Asset records.](#)

Analysis Tasks Menu

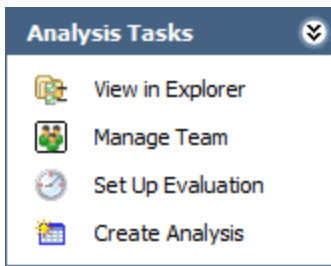

The **Analysis Tasks** menu on the **RCM Asset List** page contains the following links:

- **View in Explorer:** Displays the current analysis on the [RCM Explorer page](#).
- **Manage Team:** Opens the [RCM Team Members page](#), where you can set up the analysis team for the current analysis.
- **Set Up Evaluation:** Displays the **Set Up Asset Evaluation** dialog box, where you can define criteria for sending [evaluation email](#) for the piece of equipment or location that appears in the selected row (either an RCM FMEA Asset record or an Equipment or Functional Location record that is linked to an RCM FMEA Asset record).
- **Create Analysis:** Opens the [RCM Explorer](#) page, displaying a new RCM Analysis.

Assets Tasks Menu

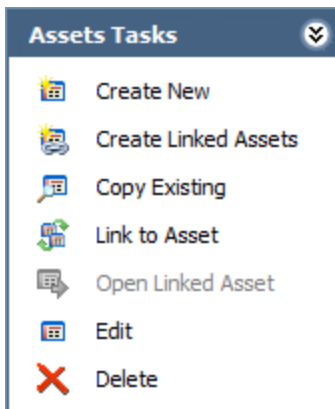

The **Assets Tasks** menu on the **RCM Asset List** page contains the following links:

- **Create New:** Displays the **Create New Asset Record** dialog box, where you can enter the information for a new RCM FMEA Asset record and add it to the analysis.
- **Copy Existing:** Displays the **Find Asset Records** dialog box, where you can search for an existing RCM FMEA Asset record and create a copy of it to link to the analysis.
- **Link to Asset:** Displays the **Find Asset** dialog box, where you can search for an Equipment or Functional Location record to [link to the selected RCM FMEA Asset record](#). This link is enabled only when the selected RCM FMEA Asset record has not yet been linked to an Equipment or Functional Location record. If no families are related to the RCM FMEA Asset family using the Is RCM FMEA Asset relationship, the *No Relationships Defined* error message appears.
- **Open Linked Asset:** [Opens in Record Manager](#) the Equipment or Functional Location record that is currently linked to the selected RCM FMEA Asset record. This link is enabled only when the selected RCM FMEA Asset record is linked to an Equipment or Functional Location record.
- **Edit:** Displays the **Edit Asset Record** dialog box, where you can modify the content of the selected RCM FMEA Asset record.
- **Delete:** After asking for confirmation, deletes the selected RCM FMEA Asset record from the database. Note that if the RCM FMEA Asset record is linked to an Equipment or Functional Location record, the link will also be deleted.

Common Tasks Menu

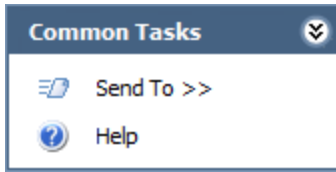

The **Common Tasks** menu on the **RCM Asset List** page contains the following links:

- **Send To:** Displays a submenu with options that let you **provide a link to the current page on your desktop (create shortcut), in an email message, or on a Home Page.**
- **Help:** Displays the context-sensitive Help topic for the **RCM Asset List** page.

Creating a New RCM FMEA Asset Record to Add to the List

To create a new RCM FMEA Asset record and add it to the equipment and location list:

1. On the [RCM Asset List page](#), on the **Assets Tasks** menu, click the **Create New** link.
The **Create New Asset Record** dialog box appears.
2. In the fields provided, enter the information for the new RCM FMEA Asset record.
3. Click **OK**.

The new RCM FMEA Asset record is created and appears in the list on the **RCM Asset List** page.

Copying an Existing RCM FMEA Asset Record

If an RCM FMEA Asset record already exists that is appropriate for the piece of equipment or location that you want to add to the system, you can create a copy of the existing record.

To create a copy of an existing RCM FMEA Asset record:

1. On the [RCM Asset List page](#), on the **Assets Tasks** menu, click the **Copy Existing** link.

The **Find Asset Records** dialog box appears.

2. Enter the search criteria necessary to find the desired RCM FMEA Asset.
3. Click the **Find Now** button.

A list of records that match your search criteria appears in the lower portion of the screen.

4. In the list of results, select the row containing the record that you want to copy.
5. Click the **Select** button.

A copy of the selected RCM FMEA Asset record is created. The ID and Description are regenerated automatically to make them appropriate for the current analysis. The copy that was created appears in the grid on the **RCM Asset List** page.

Modifying an RCM FMEA Asset Record

To modify an RCM FMEA Asset record:

1. On the [RCM Asset List page](#), in the list of Asset records, click the hyperlinked Record ID of the RCM FMEA Asset record that you want to modify.

The **Edit Asset Record** dialog box appears.

2. Modify the record data, as desired.
3. Click **OK**.

Your changes are saved to the database.

Linking an RCM FMEA Asset Record to an Equipment or Functional Location Record

If your system has been properly [configured](#), you will have the option of linking RCM FMEA Asset records to Equipment or Functional Location records in your database. This gives you the ability to use an RCM Analysis to analyze both "virtual" equipment and locations (which are *not* represented by existing Equipment and Functional Location records) and physical equipment and locations (which *are* represented by Equipment and Functional Location records).

When RCM FMEA Asset records are linked to Equipment or Functional Location records, information from the Equipment or Functional Location record will be passed to various elements in the analysis. In addition, the Equipment or Functional Location record will then be linked to any Recommendation records or Task records that are created for the piece of equipment or location.

The first step in linking RCM FMEA Asset records to Equipment or Functional Location records is to add the RCM FMEA Asset to the equipment and location list of a given analysis. You can do this either by [copying an existing RCM FMEA Asset record](#) or by [creating a new RCM FMEA Asset record](#). After the RCM FMEA Asset record exists on the equipment and location list, you can link it to an Equipment or Functional Location record.

Note that if the **System Definition** tab of the Analysis datasheet contains a value in the Site Reference field, you will be able to link RCM FMEA Asset records only to Equipment or Functional Location records that are linked to that Site Reference record. Likewise, if the **System Definition** tab does not yet contain a value in the Site Reference field, when you add a piece of equipment or location to the RCM Analysis, the Site Reference field will be updated automatically to display the ID of the Site Reference record that is linked to the Equipment or Functional Location record representing the piece of equipment or location. You will then be able to link RCM FMEA Asset records only to Equipment or Functional Location records that are linked to that Site Reference record.

To link an RCM FMEA Asset record to an Equipment or Functional Location record:

1. On the [RCM Asset List page](#), in the list of RCM FMEA Asset records, select the row containing record that you want to link to an Equipment or Functional Location record.
2. On the **Assets Tasks** menu, click the **Link to Asset** link.

Note: This link is enabled only when you select a row containing an RCM FMEA Asset record that is not already linked to an Equipment or Functional Location record.

The **Find Asset** window appears.

3. In the **Search In** list, select the family on which to search.

Note: The **Search In** list contains the families that are related to the RCM FMEA Asset family through the Is RCM FMEA Asset relationship.

4. Specify any additional, desired search criteria, and click the **Find Now** button.

The records that match your search criteria appear in the list at the bottom of the page.

5. Select the row representing the record that you want to link to the RCM FMEA Asset record.
6. Click the **Select** button.

The list on the **RCM Asset List** page displays an updated list of RCM FMEA Asset records. The ID of the record that you just linked is updated to reflect the ID of the related record. If your system has been configured to do so, additional fields may also be mapped from the Equipment or Functional Location record to the RCM FMEA Asset record. If desired, you can [open the linked record in Record Manager](#).

Viewing the Equipment or Functional Location Record that is Linked to an RCM FMEA Asset Record

When an RCM FMEA Asset record is linked to an Equipment or Functional Location record, you can view the associated Equipment or Functional Location record from the **RCM Asset List** page. After you open the Equipment or Functional Location record in the [Record Manager](#), all the standard Record Manager features will be available to you.

To view the Equipment or Functional Location record that is linked to the RCM FMEA Asset record:

1. On the [RCM Asset List page](#), in the list of existing RCM FMEA Asset records, select the row representing the RCM FMEA Asset record whose related record you want to view.
2. On the **Assets Tasks** menu, click the **Open Linked Asset** link.

The Record Manager appears, displaying the linked record.

Unlinking an RCM FMEA Asset Record from the Related Equipment or Functional Location Record

The **RCM Asset List** page provides no direct method for unlinking an RCM FMEA Asset record from its related Equipment or Functional Location record. If you need to unlink an RCM FMEA Asset record from an Equipment or Functional Location record, either to create a virtual piece of equipment or location or to relink the RCM FMEA Asset record to a different record, use one of the following procedures:

- On the **RCM Asset List** page, [copy the RCM FMEA Asset record](#). The new RCM FMEA Asset record will not be linked to an Equipment or Functional Location record. You can then [delete the original, linked RCM FMEA Asset record](#).
- Open the RCM FMEA Asset record in Record Manager and remove the link between the RCM FMEA Asset record and the Equipment or Functional Location record.

Note: If you link an RCM FMEA Asset record to the wrong record, you will need to unlink the two records using one of the preceding options and then [relink](#) the RCM FMEA Asset record to the desired record. You cannot modify an existing link in a single step.

You should unlink RCM FMEA Asset records from Equipment or Functional Location records *only* if no RCM FMEA Recommendation or RCM FMEA Task records have been created and linked to the RCM FMEA Asset record. Unlinking records may result in RCM FMEA Recommendations and RCM FMEA Task records that are linked to record no longer involved in the Analysis. If you unlink an RCM FMEA Asset record from an Equipment or Functional Location record and then *relink* the RCM FMEA Asset records to a different one, if the original record had been linked to one or more RCM FMEA Recommendation records, the existing links will be updated automatically so that the Recommendations are linked to the new record. Links between existing RCM FMEA Task records and Equipment or Functional Location records will, however, not be modified.

Deleting an RCM FMEA Asset Record

You can delete RCM FMEA Asset records via the **RCM Asset List** page. Deleting RCM FMEA Asset records in this way will delete the RCM FMEA Asset record both from the analysis system and from the database. If the RCM FMEA Asset record is linked to an Equipment or Functional Location record, the link between the RCM FMEA Asset record and the Equipment or Functional Location record will be broken, but the Equipment or Functional Location record will not be deleted from the database.

To delete an RCM FMEA Asset record:

1. On the [RCM Asset List page](#), in the list of RCM FMEA Asset records, select the row containing the record that you want to delete.
2. On the **Assets Tasks** menu, click the **Delete** link.
A confirmation message appears, asking if you really want to delete the record.
3. Click the **Yes** button.

The RCM FMEA Asset record is deleted from the database. If the record was linked to an Equipment or Functional Location record, that link is broken.

Defining Functions

The first step in conducting an RCM analysis is to define all the functions of the system. The following instructions provide details on creating a Function node. You can repeat these steps to create as many Function nodes as are necessary in your analysis.

To add an RCM Function record to an RCM Analysis:

1. With the analysis [open on the RCM Explorer page](#), select the analysis node in the **RCM Explorer** pane.
2. On the **Common Tasks** menu, click the **New Function** link.

-or-

Right-click the analysis node, and then click **New Function**.

A new Function node is added to the tree in the **RCM Explorer** pane.

The **RCM Function** datasheet is displayed in the datasheet area on the right side of the page.

3. In the **RCM Function** datasheet, enter the information for the new RCM Function record. Note that the **Function ID** is generated automatically by the system and cannot be modified. The **Function Name** is also generated automatically. This can be modified but is required.
4. When you are finished entering the function information, on the **Common Tasks** menu, click the **Save** link.

The information that you entered for the RCM Function record is saved to the database. At this point, you can:

- Select the analysis node in the **RCM Explorer** pane to create another RCM Function record.
- [Define an RCM Functional Failure record](#) for the RCM Function record that you just created.

Defining Functional Failures

For each function that you define for an RCM analysis, you can define one or more functional failures. A functional failure describes a way in which a given function can fail.

To add an RCM Functional Failure record to an RCM Analysis:

1. With the analysis [open on the RCM Explorer page](#), in the **RCM Explorer** pane, select the Function node of the RCM Function record to which you want to link the new RCM Functional Failure record.
2. On the **Common Tasks** menu, click the **New Failure** link.

-or-

Right-click the Function node, and then click **New Failure**.

A new Failure node is added to the tree in the **RCM Explorer** pane.

The **RCM Function Failure** datasheet is displayed in the datasheet area on the right side of the page.

3. On the **RCM Function Failure** datasheet, enter the information for the new RCM Functional Failure record. Note that the **Functional Failure ID** is generated automatically by the system and cannot be modified. The **Functional Failure Name** is also generated automatically. This can be modified but is required.
4. When you are finished entering the functional failure information, on the **Common Tasks** menu, click the **Save** link.

The information that you entered for the RCM Functional Failure record is saved to the database. At this point, you can:

- Select a Function node to create another RCM Functional Failure record.
- [Create a new failure mode](#) for the RCM Functional Failure record that you just created.

Defining Failure Modes

A failure mode defines how a functional failure is likely to occur. Failure modes are often, but not always, related to specific equipment or locations or to components within equipment and locations. Both RCM and FMEA analyses can have multiple failure modes defined for them.

To add an RCM Failure Mode record to an RCM analysis:

1. With the analysis [open on the RCM Explorer page](#), in the **RCM Explorer** pane, select the Functional Failure node of the RCM Functional Failure record to which you want to link the new RCM FMEA Failure Mode record.

2. On the **Common Tasks** menu, click the **New Mode** link.

-or-

Right-click the Failure node, and then click **New Mode**.

A new Failure Mode node is added to the tree in the **RCM Explorer** pane.

The RCM Failure Mode datasheet is displayed in the datasheet area on the right side of the page.

3. On the RCM Failure Mode datasheet, enter the information for the new RCM FMEA Failure Mode record. Note that:

- The Failure Mode ID value is generated automatically by the system and cannot be modified.
- The Failure Mode Name value is also generated automatically. This can be modified but is required.
- The Related Asset ID field contains a list of IDs from the RCM FMEA Asset records that are linked to the RCM FMEA Analysis record. You can select any ID from the list. Your selection will determine whether the RCM FMEA Asset record or the Equipment or Functional Location record is linked to subsequent Recommendation records. If you select an RCM FMEA Asset record where the Asset Type field contains a value, that value will be used to populate the Related Asset Type field in the associated RCM FMEA Failure Mode record and the RCM FMEA Recommendation record.

Note: If you modify the value in the Related Asset ID field of an existing Failure Mode record, the links to any recommendations will also be updated. Note, however, that if RCM FMEA Task records have been linked to the Recommendation record, changing the Related Asset ID in the Failure Mode record will not update the link to the Task record. The RCM FMEA Task record will continue to be linked to the RCM FMEA Asset or Asset record to which the Recommendation record was linked when the Task record was originally created.

4. When you are finished entering the failure mode information, on the **Common Tasks** menu, click the **Save** link.

The information that you entered for the RCM FMEA Failure Mode record is saved to the database. At this point, you can:

- Select a Functional Failure node and create another RCM FMEA Failure Mode record.
- [Create a new failure effect](#) for the RCM FMEA Failure Mode record that you just created.

Defining Failure Effects

A failure effect defines what would happen if a given failure mode occurred. Failure effects can be used to define the environmental, safety, and economic consequences of failure modes.

To add an RCM Failure Effect record to an RCM Analysis:

1. With the analysis [open on the RCM Explorer page](#), in the **RCM Explorer** pane, select the Failure Mode node of the RCM FMEA Failure Mode record to which you want to link the new RCM FMEA Failure Effect record.

2. On the **Common Tasks** menu, click the **New Effect** link.

-or-

Right-click the Failure Mode node, and then click **New Effect**.

A new Failure Effect node is added to the tree in the **RCM Explorer** pane.

The **RCM Failure Effect** datasheet is displayed in the datasheet area on the right side of the page.

3. On the **RCM Failure Effect** datasheet, enter the information for the new RCM FMEA Failure Effect record. Note that the **Effect ID** is generated automatically and cannot be modified. The **Effect Name** is also generated automatically. This can be modified but is required.

4. On the **Analysis Tasks** menu, click the **Risk Assessment** link.

The **Unmitigated Risk Assessment** window appears.

5. Using the Risk Matrix provided, define the unmitigated risk rank associated with the failure effect, and click the **Save** button.

Note the following:

- If the Site Reference field on the Analysis datasheet contains a value, you will see the Risk Matrix that is built using the Risk Matrix record that is linked to that Site Reference record.
 - If any tab represents a risk category that does not apply to the failure effect that you are assessing, you can select the **Not Applicable** check box on that tab. When you do so, the tab will be disabled, and the tab label will be updated to contain the text *N/A*.
 - The unmitigated risk rank that you selected in the Risk Assessment feature appears in the Unmitigated Risk field on the RCM Failure Effect datasheet.
 - The Financial Risk Rank that you selected in the Risk Assessment feature appears in the Unmitigated Financial Risk field on the RCM Failure Effect datasheet.
 - The *highest* unmitigated risk rank that you select on any *non-financial* tab appears in the Driving Risk Rank field on the RCM Failure Effect datasheet.
 - The tab that contains the highest non-financial unmitigated risk rank appears in the Driving Risk Category field on the RCM Failure Effect datasheet.
 - The **Risk Of** cell contains the value in the Effect Name field in the RCM FMEA Failure Effect record.
 - The text that you type in the **Basis for Assessment** dialog box is saved in the RCM FMEA Failure Effect record.
6. On the **Analysis Tasks** menu, click the **Run Decision Logic** link.
- The **Decision Logic Builder** appears, displaying the Welcome screen.
7. [Use the Decision Logic Builder](#) to identify actions that will mitigate the associated failure effect.
- After you complete the Decision Logic Builder, the responses that you provided to the questions and the recommended action will be recorded on the **Logic Builder** tab on the RCM Failure Effect datasheet.
8. When you are finished entering the failure effect information, on the **Common Tasks** menu, click the **Save** link.
- The information that you entered for the RCM FMEA Failure Effect record is saved to the database. At this point, you can:
- Create another RCM FMEA Failure Effect record.
 - [Define a recommendation](#) for the RCM FMEA Failure Effect record that you just created.

The Decision Logic Builder

The **Decision Logic Builder** guides you step-by-step through answering questions that will result in suggestions for mitigating a given failure effect. After you use the **Decision Logic Builder** to determine which actions should be taken to mitigate the effects of the failure, you can [create recommendations](#) that are based upon the recommended actions.

When you go through the **Decision Logic Builder**, you will be presented with a series of questions. You will respond Yes or No to each of the questions. When you have reached the end of the **Decision Logic Builder**, you will be presented with a recommended action that is based upon the responses to the questions that were presented. Your responses to the questions and the recommended action will be recorded in text fields in the RCM FMEA Failure Effect record. After you complete the **Decision Logic Builder**, you can view a summary of your responses on the **Logic Builder** tab of the [RCM Failure Effect datasheet](#).

The **Decision Logic Builder** is based upon the concepts and decision diagrams in SAE Standard JA1012, "A Guide to the Reliability-Centered Maintenance (RCM) Standard." The process and terminology used in the **Decision Logic Builder** are described in more detail in this standards document. To use the **Decision Logic Builder** effectively, you will need to be familiar with this standard.

To use the Decision Logic Builder:

1. [Open an RCM Analysis](#).
2. In the **RCM Explorer** pane, select a Failure Effect node.
3. On the **Analysis Tasks** menu, click the **Run Decision Logic** link.
The **Decision Logic Builder** appears, displaying the Welcome screen.
4. Click the **Next** button.
The **Logic Selection** screen appears.
5. Click the **Yes** button to respond *Yes* to the question.
-or-
Click the **No** button to respond *No* to the question.
The next question is displayed immediately after you click the **Yes** or **No** button.
6. Continue clicking the **Yes** or **No** button in response to each question that is displayed. The number of questions that are presented will depend upon your responses.
When you have responded to all the questions, a suggested action will be displayed.
7. Click the **Finish** button.

The **Decision Logic Builder** closes. You can click the **Logic Builder** tab on the RCM Failure Effect datasheet to view a summary of your responses and the suggested action.

CEHint: If you want to modify your responses, click the **Run Decision Logic** link on the **Analysis Tasks** menu and proceed through the **Decision Logic Builder** again. The information on the **Logic Builder** tab will be updated after you complete the builder. If you close the **Decision Logic Builder** before responding to all questions and clicking the **Finish** button, the information on the **Logic Builder** tab will not be updated.

Defining Recommendations

Hint: For help with defining Recommendation records, on the **RCM Explorer** page, you can click the **Decision Tree** link on the **Recommendation Tasks** menu to access the Decision Tree document that has been configured for use with RCM.

To add an RCM FMEA Recommendation record to an RCM Analysis:

1. With the analysis [open on the RCM Explorer page](#), in the **RCM Explorer** pane, select the Failure Effect node of the RCM FMEA Failure Effect record to which you want to link the new RCM FMEA Recommendation record.
2. On the **Common Tasks** menu, click the **New Recommendation** link.

-or-

Right-click the Failure Effect node, and then click **New Recommendation**.

A new Recommendation node is added to the tree in the **RCM Explorer** pane. The **RCM Recommendation** datasheet is displayed in the datasheet area on the right side of the page.

3. On the **RCM Recommendation** datasheet, enter the information for the new RCM FMEA Recommendation record. Note that:
 - The Recommendation ID is generated automatically and cannot be modified.
 - The Recommendation Headline is also generated automatically. This can be modified but is required.
 - The **Asset ID** cell is populated automatically with the value in the **Related Asset ID** cell in the related [Failure Mode](#). You can modify this field, if desired. We recommend, however, that you accept the default value. If you modify this value, [recommendation evaluation email](#) may not be generated properly. In addition, the Meridium APM system relies upon this value to relate any Task records generated from the recommendation to the associated RCM FMEA Asset record or Equipment or Functional Location record.
 - If you select **Failure Finding (FF)** in the **Action Type** list, the cells below the *****Failure Finding Activity***** section become enabled. The value in the **FFI** cell is calculated using the values in [the MMF, MTIVE, MTED, and n cells](#).

Note that if you want the calculated FFI value to appear in the Interval field, select the **Use Calculated FFI Results** check box. In addition, if you want to see the FFI value in a different unit (e.g., Months), select the desired interval in the **Display FFI Units As** list. The value in the **Interval** cell will be updated to reflect the selected unit.

Note: Changes that you make to the values in existing RCM FMEA Recommendation records will not have any effect on the RCM FMEA Task records to which they are already linked.

4. On the **Analysis Tasks** menu, click the **Risk Assessment** link.

The **Risk Mitigation Assessment** window appears.

5. Using the Risk Matrix provided, define the mitigated risk rank associated with the recommendation, and click the **Save** button. Note that:
 - The **Risk Of** cell contains the value in the Effect Name field in the RCM FMEA Failure Effect record to which the RCM FMEA Recommendation record is linked.
 - The **Mitigated By** cell contains the value in the Recommendation Headline field in the RCM FMEA Recommendation record.
 - The **Not Applicable** check box is disabled when you are assessing the mitigated risk of a Recommendation record. The **Not Applicable** check box selection will be inherited from the associated [Failure Effect's risk assessment](#).
 - The text that you type in the **Basis for Assessment** dialog box is saved in the RCM FMEA Failure Effect record to which the RCM FMEA Recommendation record is linked.

The mitigated risk rank that you selected in the Risk Assessment feature appears in the Mitigated Risk field on the RCM Recommendation datasheet. The financial risk rank that you selected in the Risk Assessment feature appears in the Mitigated Financial Risk field on the RCM Recommendation datasheet.

6. When you are finished entering the recommendation information, on the **Common Tasks** menu, click the **Save** link.

The information that you entered for the RCM Recommendation record is saved to the database.

About Copying, Cutting, and Pasting Analysis Elements

To help streamline the analysis-development process, RCM lets you cut, copy, and paste analysis elements. You can use these options to cut or copy individual analysis nodes and then paste them to another location within the same analysis. Note the following about using the cut, copy, and paste functions:

- The Cut function creates a copy of the cut elements and then deletes the records from the database. When you paste the cut elements, the Meridium APM system will create new records. Note also that the Cut function automatically copies all nodes of the selected node.
- When you paste copied analysis elements, the IDs are generated automatically in the same way as they are when you create a new analysis element. The Meridium APM system looks at the other nodes on the level where you are pasting, finds the highest numeric value of all the current IDs, adds one (1) to the highest value, and assigns that as the ID value for the newly pasted node. The ID helps uniquely identify each element with respect to its location in the analysis.
- When you paste copied analysis elements, the names are not regenerated.
- When you copy or cut and then paste an analysis node that is linked to one or more Reference Document records, the Reference Document records will also be copied or cut and then pasted.

Using the Cut Function

To cut an analysis node and paste it to another location within the same analysis:

1. In the **RCM Explorer** pane, select the node that you want to cut.
2. Press **Ctrl+X** on your keyboard.

-or-

On the **Common Tasks** menu, click the **Cut** link.

-or-

Click the right mouse button, and then click **Cut**.

If the node that you selected has successor nodes, a message appears, asking if you want to copy all the child elements.

3. Click **OK**.

The selected node and all its nodes are copied and then deleted from the database.

Note: If you want to paste the node that you cut, you must do so immediately before copying or cutting another node; otherwise the cut node and its nodes will be lost permanently. You will be able to paste the cut node only once.

Using the Copy Function

To make a copy of an analysis node to paste in an additional location within the same analysis:

1. In the **RCM Explorer** pane, select the node that you want to copy.
2. Press **Ctrl+C** on your keyboard.

-or-

On the **Common Tasks** menu, click the **Copy** link.

-or-

Click the right mouse button, and then click **Copy**.

If the node that you selected has successor nodes, a message appears, asking if you want to copy all the child elements.

3. Click the **Yes** button to copy all the child elements of the selected element.

-or-

Click the **No** button to copy only the selected node.

Note: If you want to paste the node that you copied to a different location, do not delete the copied node. The copied node will not be available for pasting after you delete it.

Using the Paste Function

After you [copy a node](#) or [cut a node](#), you can paste the copied element(s) to another node. The Paste function will automatically paste the copied node and any nodes that were copied along with it.

Note: A cut node can be pasted only once. A copied node can be pasted multiple times but cannot be pasted after the copied node is deleted from the database.

To paste the copied element(s) to another location:

1. Select the node on which you want to paste the copied elements.

Note: The node that you select as the target for the Paste operation must be appropriate for the node that was copied. For example, if you copy a Recommendation node, you must select a Failure Effect node in order to paste the copied elements. The Paste function will be enabled only after you select an appropriate node.

2. Press **Ctrl+V** on your keyboard.

-or-

On the **Common Tasks** menu, click the **Paste** link.

-or-

Click the right mouse button, and then click **Paste**.

The element is pasted to the selected location.

Modifying an Analysis Node in the RCM Explorer Pane

You can use the following instructions to modify any node in an RCM Analysis, including the root-level analysis node.

To modify the information associated with an analysis element in the RCM Explorer pane:

1. With the analysis [open on the RCM Explorer page](#), in the **RCM Explorer** pane, expand the analysis tree to locate the node representing the record that you want to modify.

2. Select the node.

The datasheet associated with that record appears in the datasheet area on the right side of the page.

3. In the datasheet, modify the values in any editable field.
4. On the **Common Tasks** menu, click the **Save** link.

Your changes are saved to the database.

Deleting an Analysis or Analysis Node in the RCM Explorer Pane

In the **RCM Explorer** pane, you can delete any analysis element, or you can delete the root-level analysis node to delete the entire analysis. Note that if you choose to delete an element that contains elements, *all elements will also be deleted*. Note also that deleting a Recommendation record will also delete any related scheduled item that exists for that recommendation in Schedule Manager.

To delete an analysis or analysis element from the RCM Explorer pane:

1. In the **RCM Explorer** pane, expand the tree, and select the node representing the element that you want to delete.

CEHint: To delete the entire analysis, select the root-level analysis node.

2. On the **Common Tasks** menu, click the **Delete** link.

A message appears, asking if you really want to delete the selected element and all its children.

3. Click **OK**.

The selected node and its nodes are deleted from the database.

- If you deleted the element of an analysis, the next highest node is selected in the analysis tree in the **RCM Explorer** pane.
- If you deleted the root-level analysis node, you are directed to the [RCM Start Page](#).

About RCM Templates

An *RCM Template* is a copy of an entire RCM Analysis or one or more RCM Analysis nodes (e.g., Failure Effects) that can be used to create a new RCM Analysis or append nodes to an existing RCM Analysis. RCM Template records belong to the RCM FMEA Template family. Together, the RCM FMEA Template record and all the records that are related to it make up the *RCM Template*.

You can use RCM Templates to streamline the analysis-development process by reducing the amount of time spent entering data that is already used in a similar analysis.

You can work with RCM Templates via the locations in the following list. Where you work with RCM Templates will determine the tasks that you can perform on that RCM Template. You can use the following lists as a guide for determining which method to use when working with RCM Templates:

- On the **RCM Explorer** page, you can perform the following tasks:
 - [Create RCM Templates from an existing analysis.](#)
 - [Create new analysis elements from an RCM Template.](#)
 - [Manage analysis elements.](#)
- On the **RCM Template Explorer** page, you can perform the following tasks:
 - [Create new RCM Templates from scratch.](#)
 - [Create new template elements from an existing RCM Template.](#)
 - [Manage template elements in RCM Templates](#), similar to how you manage analysis elements in RCM Analyses using the **RCM Explorer** pane.
- On the **RCM Templates** page, you can perform the following tasks:
 - [Create RCM Analyses from an existing RCM Template.](#)
 - [Create RCM Templates from scratch.](#)
 - [Modify RCM Templates.](#)
 - [Delete RCM Templates.](#)

Accessing the RCM Templates Page

To access the RCM Templates page:

- On the RCM Start Page, click the **Manage Templates** link.

-or-

On the RCM Template Explorer page, on the **Analysis Tasks** menu, click the **Manage Templates** link.

The [RCM Templates page](#) appears.

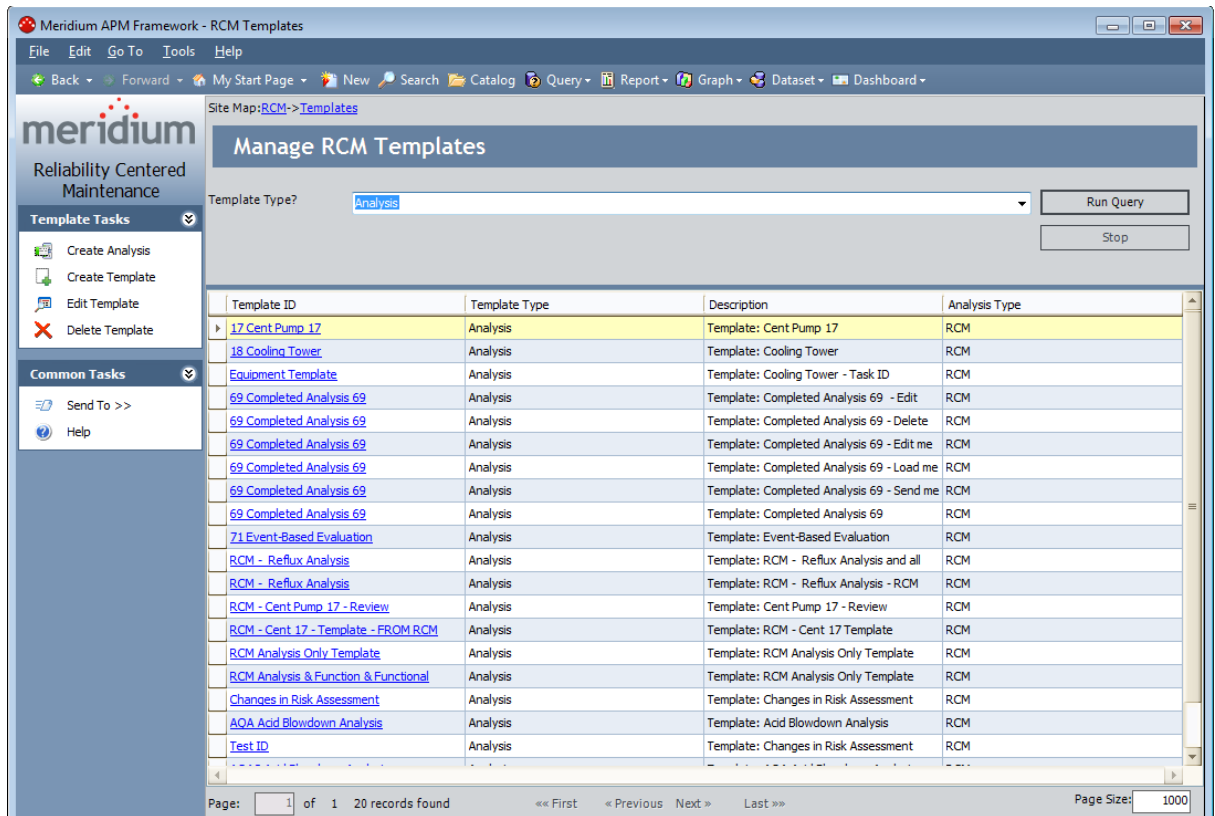

Aspects of the RCM Templates Page

The **RCM Templates** page displays the results of the query that is defined for the **Template Query** setting on the **RCM Administration** page. By default, this page displays the results of the *Template List* query, which is stored in the \\Public\Meridium\Modules\RCM folder in the Meridium APM Catalog. This query contains one prompt, *Template Type*, which appears as a list at the top of the **RCM Templates** page. The **Template Type** list contains the following values, which you can use to filter the query results that appear at the bottom of the page:

- **Analysis:** Displays the RCM Templates that were created at the analysis level. This value is selected by default when you access the **RCM Templates** page from the **RCM Start Page**. If you access the **RCM Templates** page from the **RCM Template Explorer** page, however, the query will use the prompt value that corresponds to the type of template that you are working with when you access the **RCM Templates** page.
- **Asset:** This value is not used for RCM Templates.
- **Failure Effect:** Displays the RCM Templates that were created at the failure effect level.
- **Failure Mode:** Displays the RCM Templates that were created at the failure mode level.
- **Function:** Displays the RCM Templates that were created at the function level.
- **Function Failure:** Displays the RCM Templates that were created at the function failure level.
- **Recommendation:** Displays the RCM Templates that were created at the recommendation level.

You can select any value from the **Template Type** list, and then click the **Run Query** button to view the corresponding query results. Note that each of the values in the preceding list corresponds to a value that can be stored in the Template Type field in the corresponding RCM FMEA Template record.

Note: Throughout this documentation, our descriptions of the RCM Templates functionality assume that you are using the default [Template List query](#). If you have modified the default query or if you are using a different query, the RCM Template functionality for your implementation may vary slightly from our descriptions.

The query results section contains the following columns:

- **Template ID:** The Record ID of the RCM FMEA Template record.
- **Template Type:** The type of template. This value is determined by the family of the root node in the template. For example, if the root node in the template is a Failure Mode, the **Template Type** cell will contain the value *Failure Mode*.
- **Description:** The description of the template that is stored in the Description field in the RCM FMEA Template record.

- **Analysis Type:** The type of analysis to which the template applies (i.e., RCM or FMEA). By default, the query results on this page will contain only RCM FMEA Template records whose Analysis Type field contains the value *RCM*.

The **RCM Templates** page contains the following task menus: [Template Tasks](#) and [Common Tasks](#).

Template Tasks Menu

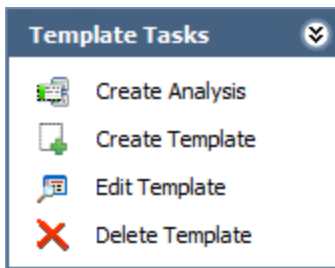

The **Template Tasks** menu on the **RCM Templates** page contains the following links:

- **Create Analysis:** Creates a new RCM Analysis based upon the RCM Template that is currently selected in the results grid.
 - If the template that you want to use to create a new analysis is linked to at least one RCM FMEA Asset record, this link will display the [Apply Template Builder](#), which you can use to specify whether you want to keep or replace the RCM FMEA Asset record(s) and then apply the template accordingly.
 - If the template that you want to use to create a new analysis is not linked to any RCM FMEA Asset records, this link will create the analysis from the template and open it on the **RCM Explorer** page.

This link is enabled only when the results displayed on the **RCM Templates** page contains records whose Template Type is *Analysis*. This link is disabled if more than one RCM FMEA Template record is selected in the grid.

- **Create Template:** Displays the **Template Builder**, which guides you step-by-step through the process of [creating an RCM Template from scratch](#).
- **Edit Template:** Displays the selected RCM Template record on the **RCM Template Explorer** page, where you can [modify the record](#) and save your changes. This link is enabled only when at least one record appears in the results grid. This link is disabled if more than one RCM FMEA Template is selected in the grid.
- **Delete Template:** After asking for confirmation, [deletes the selected RCM FMEA Template](#) record from the database. This link is enabled only when at least one record appears in the grid. You can select multiple records to delete.

Common Tasks Menu

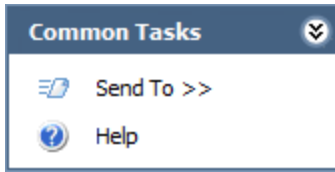

The **Common Tasks** menu on the **RCM Templates** page contains the following links:

- **Send To:** Displays a submenu with options that let you provide a link to the current page on your desktop (create shortcut), in an email message, or on a Home Page.
- **Help:** Displays the context-sensitive Help topic for the **RCM Templates** page.

Accessing the Template Builder

You can use the **Template Builder** to [create a new RCM Template from scratch](#). To access the **Template Builder**:

- On the [RCM Templates page](#), on the **Template Tasksmenu**, click the **Create Template** link.

-or-

On the [RCM Template Explorer page](#), on the **Analysis Tasksmenu**, click the **Create Template** link.

The **Template Builder** appears, displaying the Welcome screen.

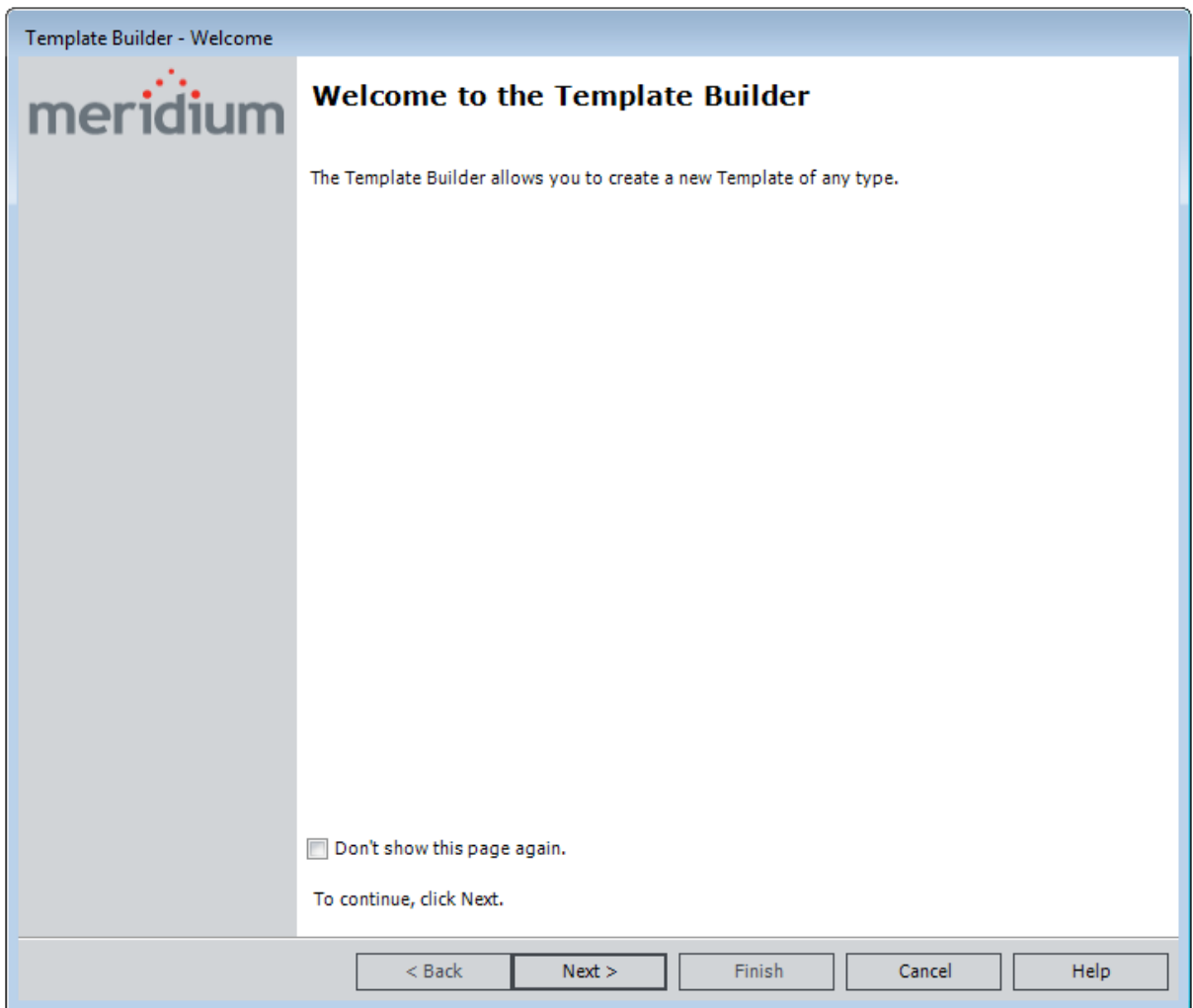

Using the Template Builder to Create a New RCM Template from Scratch

The following instructions provide details on creating a new RCM Template using the **Template Builder**.

To create a new RCM Template from scratch:

1. [Access the Template Builder](#).
2. On the Welcome screen, click the **Next** button.

The **Select Template Type** screen appears.

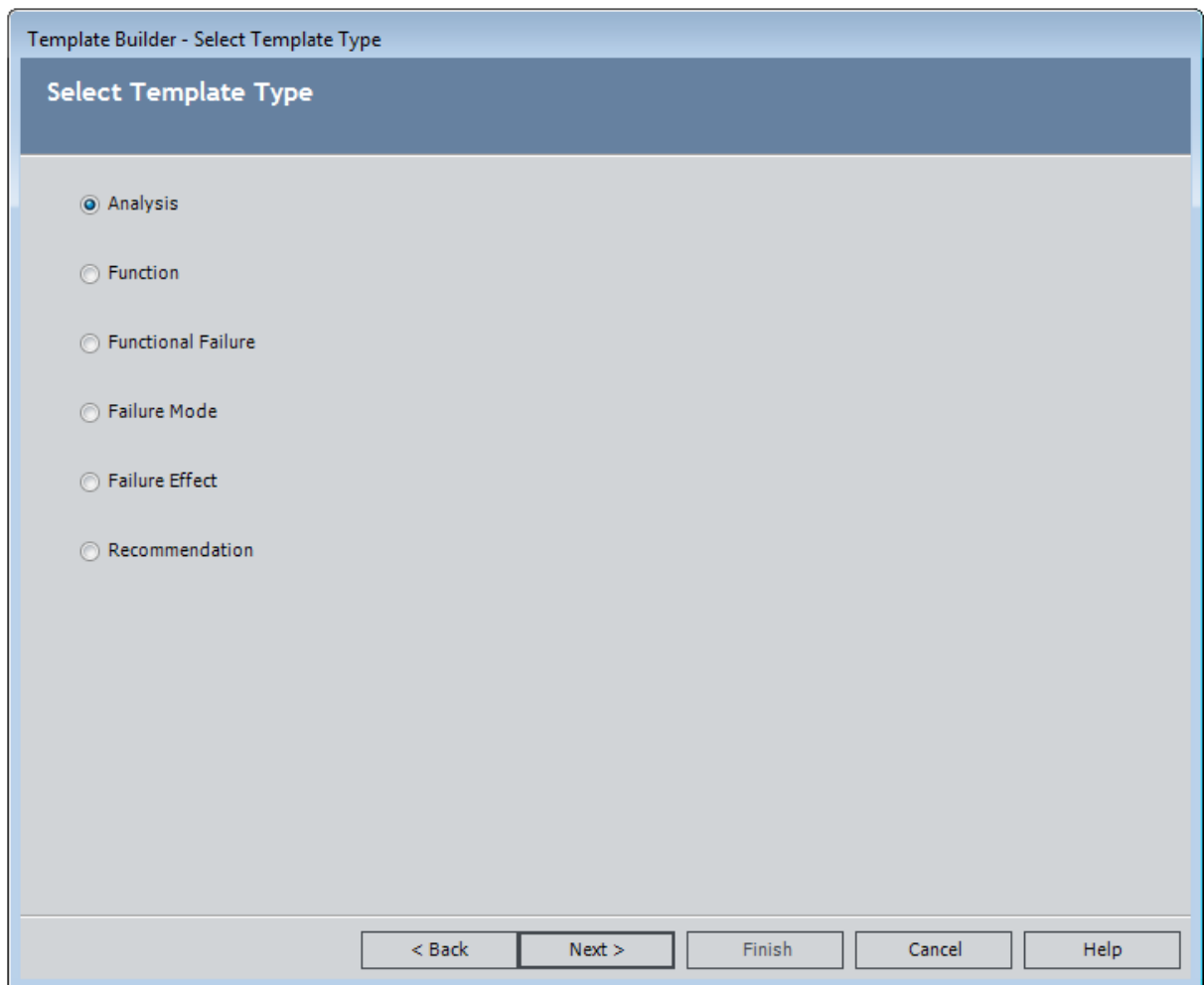

3. Select the Template Type for which you want to create an RCM template, and then click the **Next** button.

The **Define Root Node** screen appears, displaying the datasheet for the family that corresponds to the template type that you selected on the previous screen. For

example, if you selected the **Analysis** option, you will create an RCM Template whose root node will represent an RCM FMEA Analysis record. In this case, the Analysis datasheet for the RCM FMEA Analysis family will appear on the **Define Root Node** screen, as shown in the following image.

	Value(s)
▶ Analysis ID	242
Analysis Short Description	[REDACTED]
Analysis Long Description	
Analysis Type	RCM
Analysis Start Date	
Analysis End Date	
Analysis Re-Evaluation Date	

4. Provide values in the fields as needed, and then click the **Next** button.

The **Define Template** screen appears, displaying the RCM FMEA Template datasheet.

	Value(s)
▸ ID	
Type	Analysis
Description	Template:
Analysis Type	RCM
Status	
Author	MIADMIN
Created On	7/2/2012 1:18:07 PM
Approver	
Approved Date	

The following fields contain values by default:

- The **Type** cell is disabled and populated automatically with the template type value, which indicates the family of the record from which the template was created.
 - The **Analysis Type** cell is disabled and populated automatically with *RCM*.
 - The **Author** cell is disabled and populated automatically.
 - The **Created On** cells is disabled and populated automatically.
6. Provide values in the fields on the datasheet, as needed.
 7. Click the **Finish** button.

The RCM Template is created and appears on the [RCM Template Explorer page](#), where the root node in the [RCM Template Explorer pane](#) corresponds to the template type value that you selected.

Using the Template Builder to Create a New RCM Template from Scratch

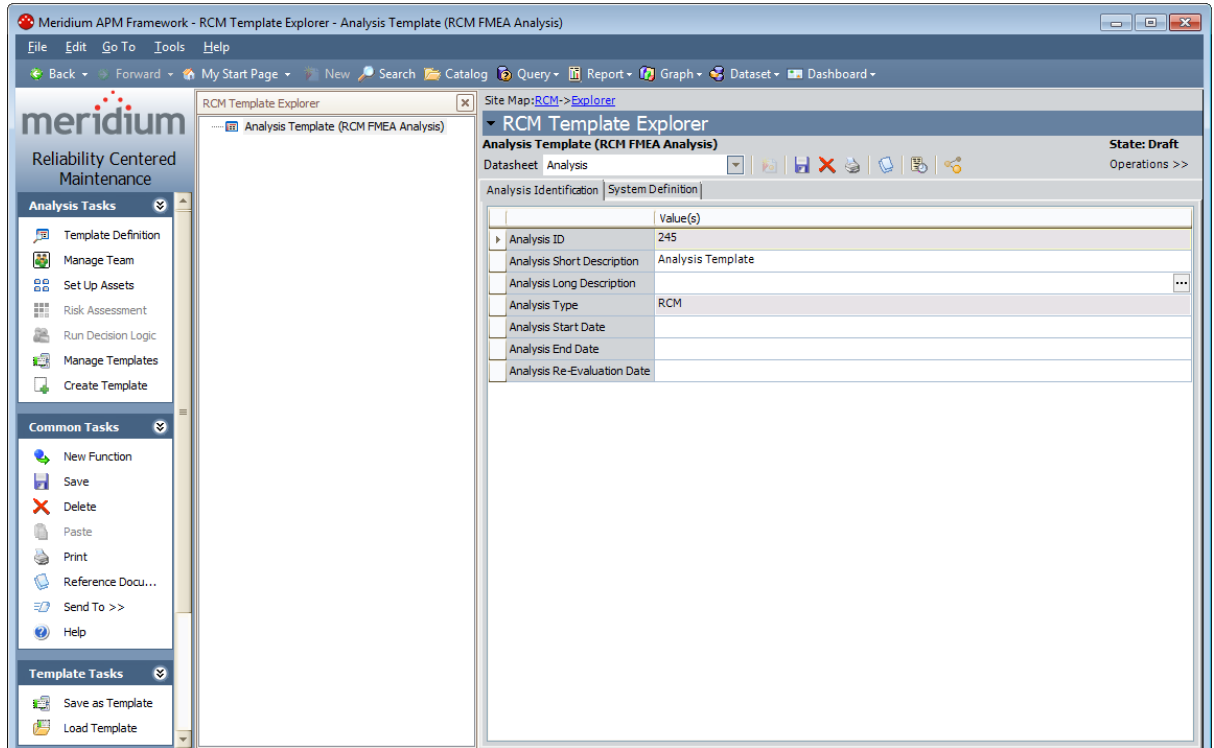

Creating an RCM Template from an Existing RCM Analysis

When you use an RCM Template to [create a new analysis](#) or to [create new nodes in an existing analysis](#), ALL the nodes that are included in the RCM Template will be applied to the target analysis. From the [RCM Explorer page](#), you can create a new RCM Template from an RCM Analysis or any analysis element.

When you create an RCM Template from the root RCM Analysis node, the RCM Template will include:

- The RCM Analysis node.
- Any related RCM FMEA Asset records that make up the **RCM Asset** list.

Note: If the analysis includes RCM FMEA Asset records that are linked to Equipment or Functional Location records, the links will not be maintained when the RCM Template is created. In this way, the RCM FMEA Asset records that are linked to the RCM Template will become *virtual equipment and locations*. When you create a new analysis from the RCM Template in this case, you will be given the option to keep or replace virtual equipment and locations with Equipment or Functional Location records.

- Any related Human Resource records that make up the **Team Member** list.
- Any Function, Functional Failure, Failure Mode, Failure Effect, and Recommendation nodes included in the analysis.
- Any related Risk Assessments.
- Any Reference Documents that are linked to the analysis elements.

When you create an RCM Template from an analysis element other than the Analysis node (i.e., a node that appears *below* the root Analysis node), the RCM Template will include the selected node and all of its successor nodes. The root node in the RCM Template determines the nodes to which the template can be applied in a target RCM Analysis, with respect to the record hierarchy. For example, an RCM Template whose root node is a Failure Mode can be applied only to a Functional Failure node.

To create a new RCM Template from an existing RCM Analysis:

1. [Open the desired analysis on the RCM Explorer page](#).
2. In the **RCM Explorer** pane, select the node that you want to use as the root node in the RCM Template.
3. On the **Template Tasks** menu, click the **Save as Template** link.

A new RCM FMEA Template record appears in a new window.

	Value(s)
ID	RCM - Reflux Analysis
Type	Analysis
Description	Template: RCM - Reflux Analysis
Analysis Type	RCM
Status	
Author	MIADMIN
Created On	7/2/2012 3:07:22 PM
Approver	
Approved Date	

On the RCM FMEA Template datasheet, the following fields contain values by default:

- The **Type** cell is disabled and populated automatically with the template type value, which indicates the family of the record from which the template was created.
 - The **Analysis Type** cell is disabled and populated automatically with *RCM*.
 - The **Author** cell is disabled and populated automatically.
 - The **Created On** cell is disabled and populated automatically.
4. Provide values in the fields on the datasheet, as needed.
 5. Click **OK**.

The new template is created and appears on the [RCM Template Explorer page](#), where you view and modify its contents. At this point you can use the template to create or modify RCM Analyses.

About Creating New RCM Analyses from RCM Templates

You can create a new RCM Analysis from any RCM Template whose root node is the RCM Analysis node. Depending upon whether the RCM Template is associated with RCM Asset records or not, the steps that you perform to create the new analysis will vary.

- If you are [applying an RCM Template that is not associated with any RCM FMEA Asset records](#), you will follow a one-step template application process via the **RCM Templates** page.
- If you are [applying an RCM Template that is associated with at least one RCM FMEA Asset record](#), you will use the **Apply Template Builder**, which provides an option for you to keep the virtual equipment and locations associated with the template or replace them with Equipment and Functional Location records in the Meridium APM database.

Creating a New Analysis from an RCM Template without RCM FMEA Asset Records

The following instructions provide details on creating a new RCM Analysis from an RCM Template that is not linked to any RCM FMEA Asset records. These instructions assume that the Analysis node is the root node of the RCM Template you are using to create a new RCM Analysis.

To create a new RCM Analysis from an RCM Template:

1. [Access the RCM Templates page](#).
2. In the results grid, select the row containing the RCM Template that you want to use to create a new RCM Analysis.
3. On the **Template Tasks** menu, click the **Create Analysis** link.

The RCM Analysis is created and displayed on the [RCM Explorer page](#) where you can view and modify its contents.

Accessing the Apply Template Builder

The following instructions provide details on accessing the **Apply Template Builder**, which you can use to create a new RCM Analysis from a template and specify whether you want to keep or replace the RCM FMEA Asset record(s) that are associated with the template.

These instructions assume that the RCM Template that you are using to create a new RCM Analysis is associated with at least one RCM FMEA Asset record.

To access the Apply Template Builder:

1. [Access the RCM Templates page.](#)
2. In the results grid, select the row containing the RCM Template that you want to use to create a new RCM Analysis.
3. On the **Template Tasks** menu, click the **Create Analysis** link.

The **Apply Template Builder** appears, displaying the Welcome screen.

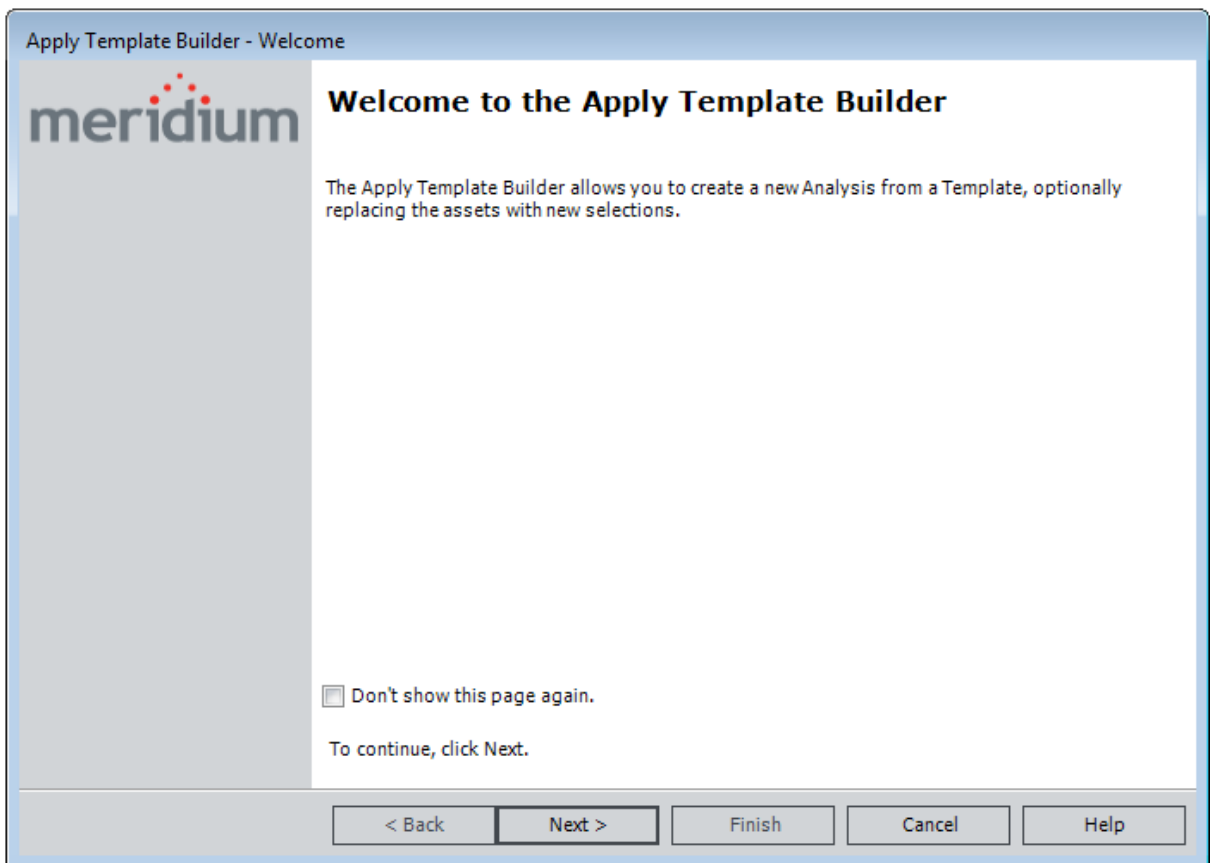

Using the Apply Template Builder to Create a New RCM Analysis

Using the **Apply Template Builder**, you can choose to keep or replace any RCM FMEA Asset record that is associated with the template that you are using to create a new RCM Analysis. These instructions assume that the template is associated with at least one RCM FMEA Asset record.

To create a new RCM Analysis using the Apply Template Builder:

1. [Access the Apply Template Builder](#).
2. On the Welcome screen, click the **Next** button.

The **Review Template Assets** screen appears, displaying the list of RCM FMEA Asset records that are associated with the RCM Template. Below the grid, the **Keep these assets** option is selected by default.

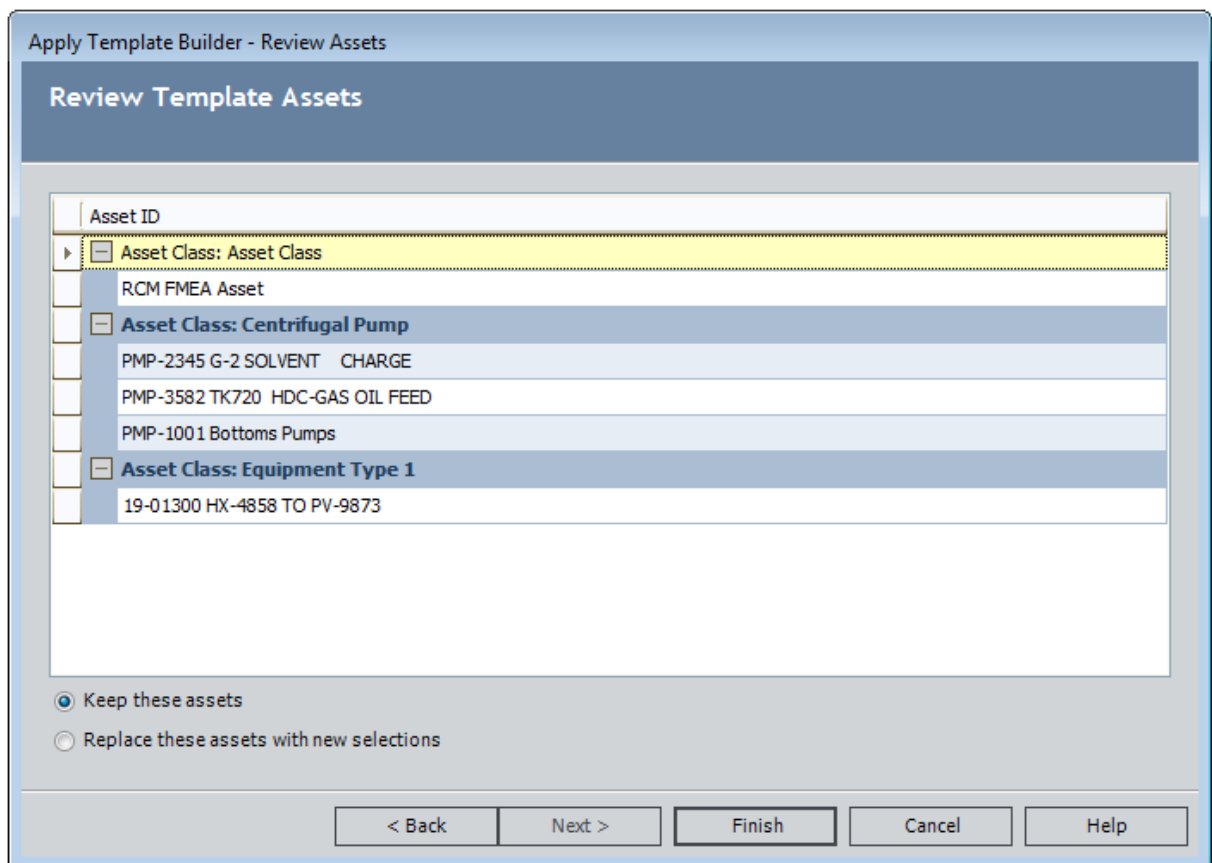

3. If you want to apply to the new RCM Analysis all the RCM FMEA Asset records that are associated with the template, accept the default option and click the **Finish** button.

Note: If you choose the **Keep these assets** option, the new RCM Analysis will not be linked to any Equipment or Functional Location records (i.e., physical equipment and locations).

-or-

If you want to replace the RCM FMEA Asset records that are associated with the template, select the **Replace these assets with new selections** option, and then click the **Next** button.

The **Select Asset Replacements** screen appears.

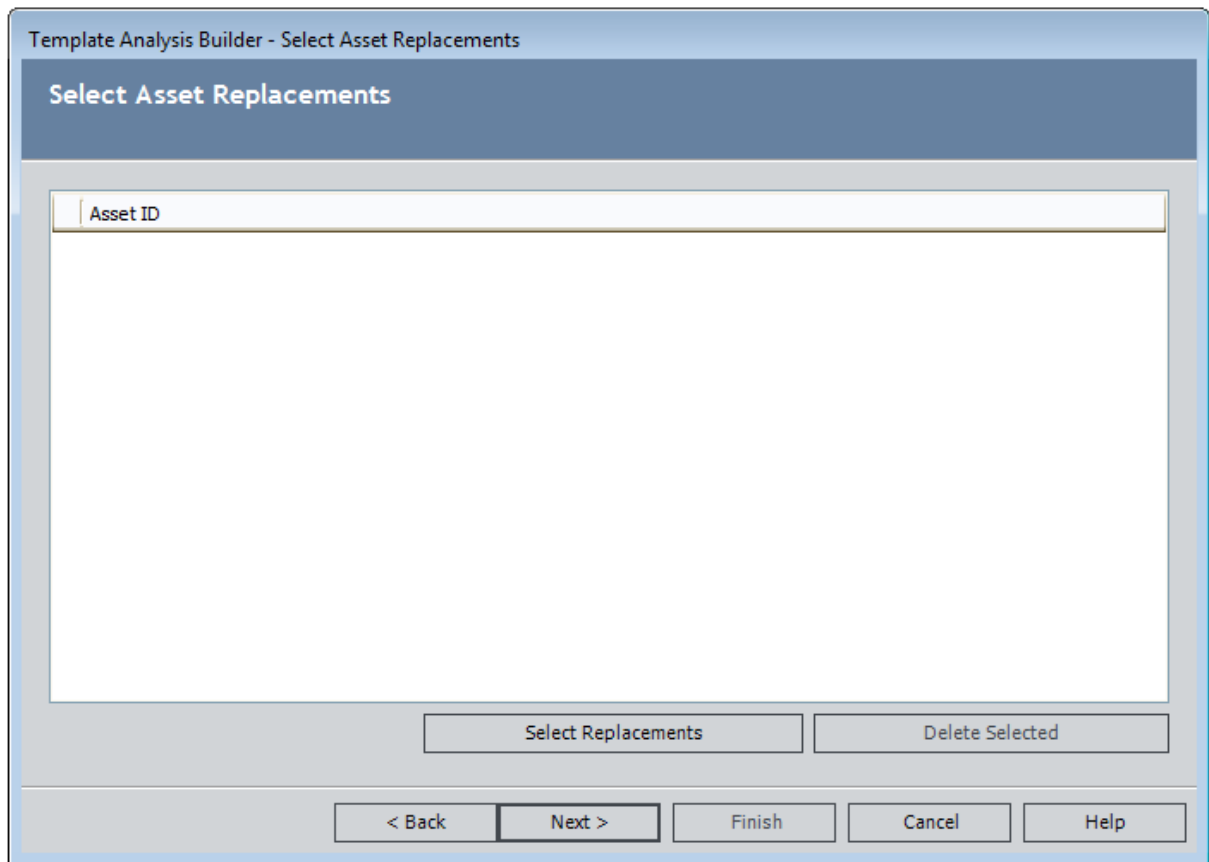

4. On the **Select Asset Replacements** screen, click the **Select Replacements** button.
The **Find Asset** window appears.

Note: The **Search In** list contains only families that are related to the RCM FMEA Asset family through the Is RCM FMEA Asset relationship.

5. In the **Search In** list, select the family whose records you want to link to the RCM Analysis, and then click the **Find Now** button.

The results appear in the grid.

6. Select the records that you want to use as replacements for the RCM FMEA Asset records that are currently linked to the RCM Template, and then click the **Select** button.

The system checks to see if the selected equipment and locations can be added to the analysis.

- If any cannot be added to the analysis, those records are displayed in a separate window with a message indicating why the record cannot be added.
- The records that can be added to the RCM Analysis are displayed in the grid on the **Select Asset Replacements** screen. The records are grouped by *Asset Class*.

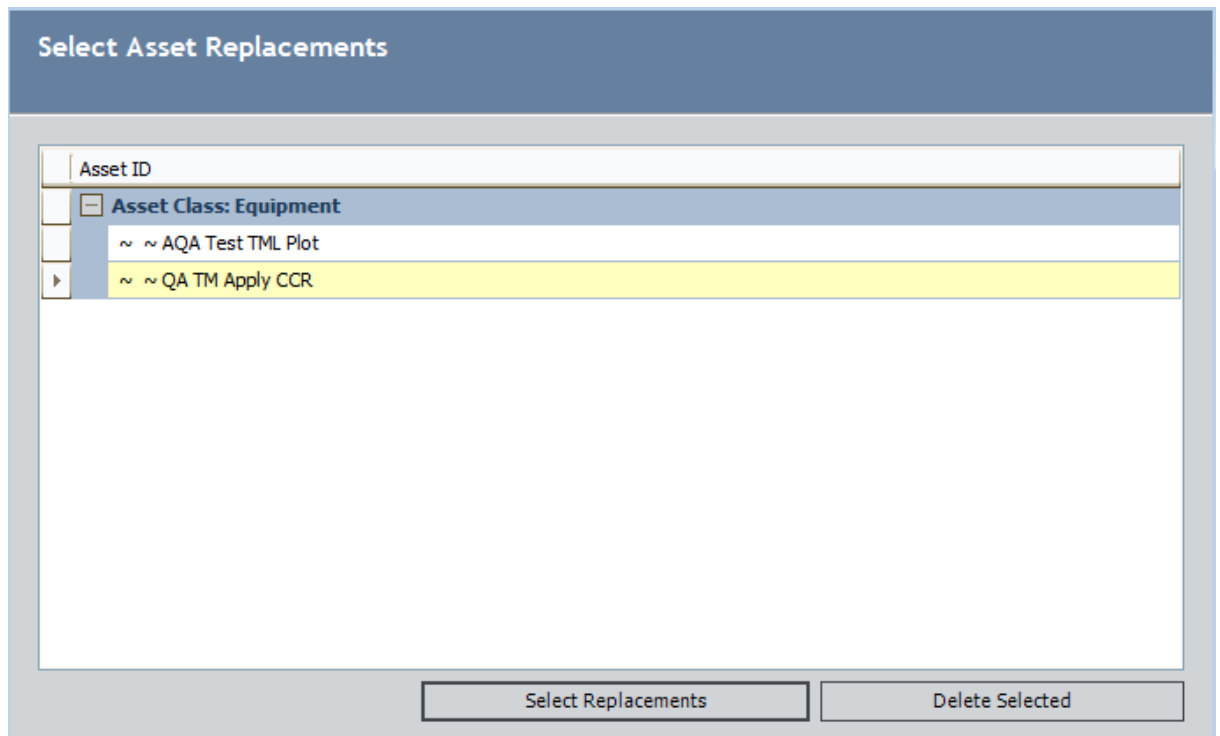

7. You can continue adding Equipment and Functional Location records in this way. When you are finished, click the **Next** button.

The **Review/Replace Template Assets** screen appears.

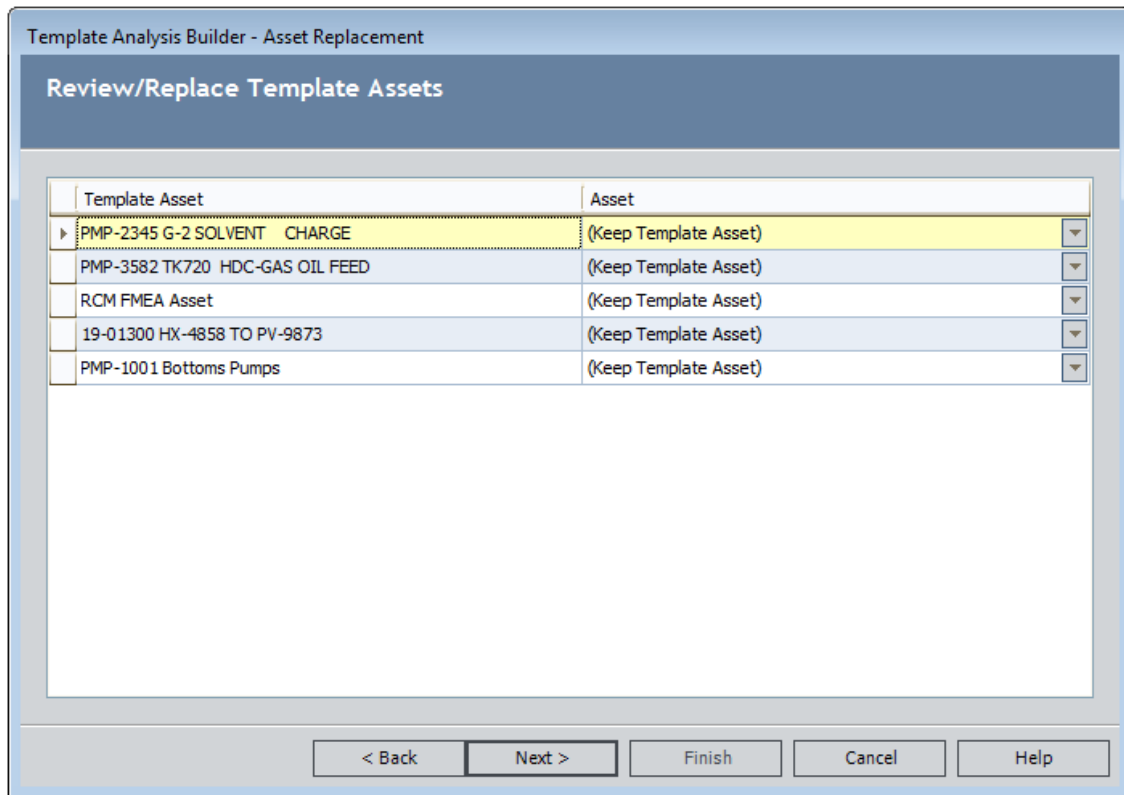

This screen contains two columns:

- **Template Asset:** Contains the RCM FMEA Asset records that are currently associated with the RCM Template.
 - **Asset:** Contains a list that you can use to specify what you want to do with the RCM FMEA Asset record in that row. The **Asset** list contains the following values:
 - **(Keep Template Asset):** Indicates that you want to add the RCM FMEA Asset record to the RCM Analysis without linking it to an Equipment or Functional Location record. This option is selected by default.
 - **(Discard Template Asset):** Indicates that you do not want to add the RCM FMEA Asset record to the RCM Analysis. Note that this option does not delete the RCM FMEA Asset from the RCM Template.
 - **<Selected Assets>:** The Equipment and Functional Location records that you selected in the previous steps.
8. For each RCM FMEA Asset record in the **Template Asset** column, select the option in the **Asset** column that corresponds to the action that you want to take.
 9. Click the **Next** button.

The **Review/Replace Template Asset Assignments** screen appears, where the Failure Mode records that are associated with the template appear in rows, as shown in the following image.

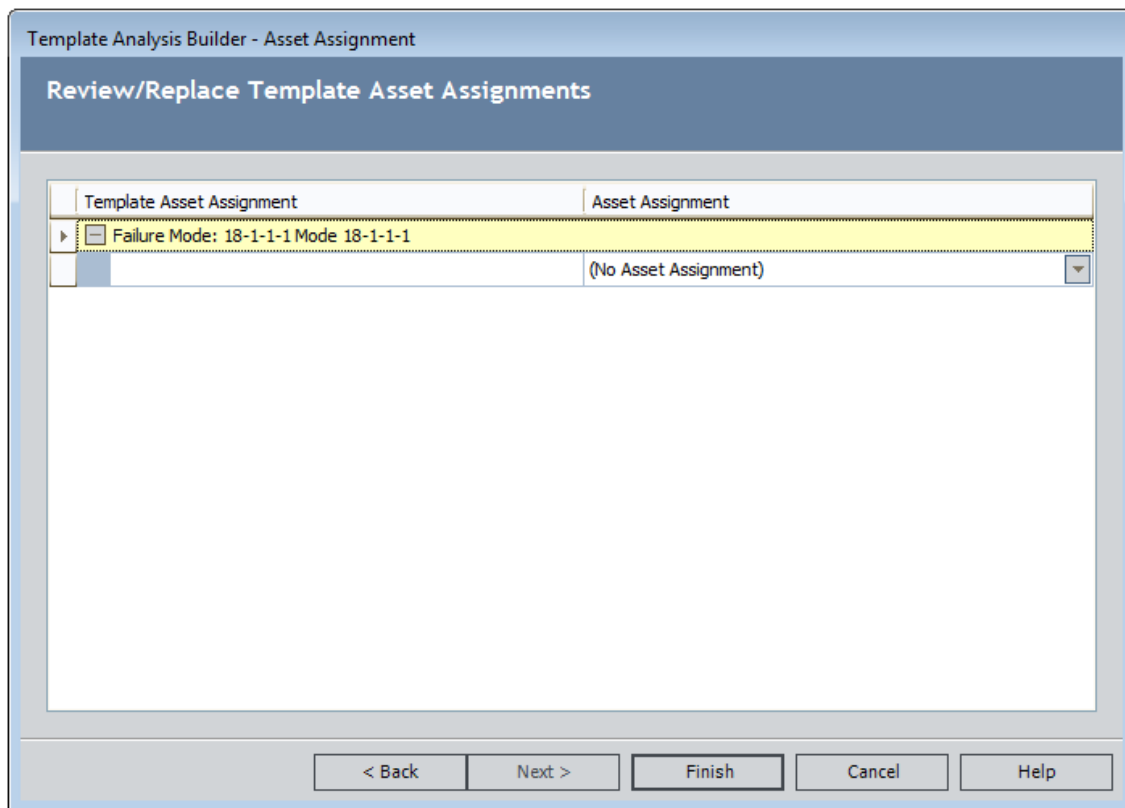

This screen contains the following items:

- **Failure Mode:** Contains the names of the Failure Mode that are linked to the RCM Template. Each Failure Mode appears in a separate row. This row serves as a grouping for the values that appear in the **Template Asset Assignment** and **Asset Assignment** columns.
- **Template Asset Assignment:** Contains the ID of the RCM FMEA Asset records that are linked to the Failure Modes in the template. If the Failure Mode is not linked to one of these records, this cell will be blank.
- **Asset Assignment:** Contains options that you can use to specify the Equipment or Functional Location record, if any, you want to link to the Failure Mode in the same row. The values that appears in this list by default are determined based upon your selection in the previous step. This list contains the following options:
 - **(No Asset Assignment):** Indicates that you do not want to link an Equipment or Functional Location record to the Failure Mode.
 - **<Selected Asset>:** The Equipment, Functional Location, and RCM FMEA Asset records that you selected on previous screens.

10. For each Failure Mode in the **Template Asset Assignment** column, select the option in the **Asset Assignment** list that corresponds to the action that you want to take.
11. Click the **Finish** button.

The new RCM Analysis is created and appears on the [RCM Explorer page](#), where you can view and modify its contents.

Creating New Nodes Using an RCM Template

The following instructions provide details on adding nodes to an existing RCM Analysis using an RCM Template whose root node is a node other than the Analysis node (e.g., Failure Mode).

To create new analysis nodes using an RCM Template:

1. [Open in the RCM Analysis](#) to which you want to add nodes using a template.
2. In the [RCM Explorer pane](#), select the node below which you want to add the new nodes. For example, if you want to add a new Failure Mode node below a Functional Failure node, select the Functional Failure node.
3. On the **Template Tasks** menu, click the **Load Templates** link.

If you are applying a Function node, Functional Failure node, or Failure Mode node, the **Apply Template Builder** appears, which gives you the option to keep or replace any RCM FMEA Asset record that is associated with the template. In this case, see the section of the documentation for [applying a Function, Functional Failure, or Failure Mode node to a current RCM Analysis](#).

-or-

If you are applying a Failure Effect node or a Recommendation node, the **Templates** window appears, displaying a list of templates that you can use to add new nodes to the current RCM Analysis.

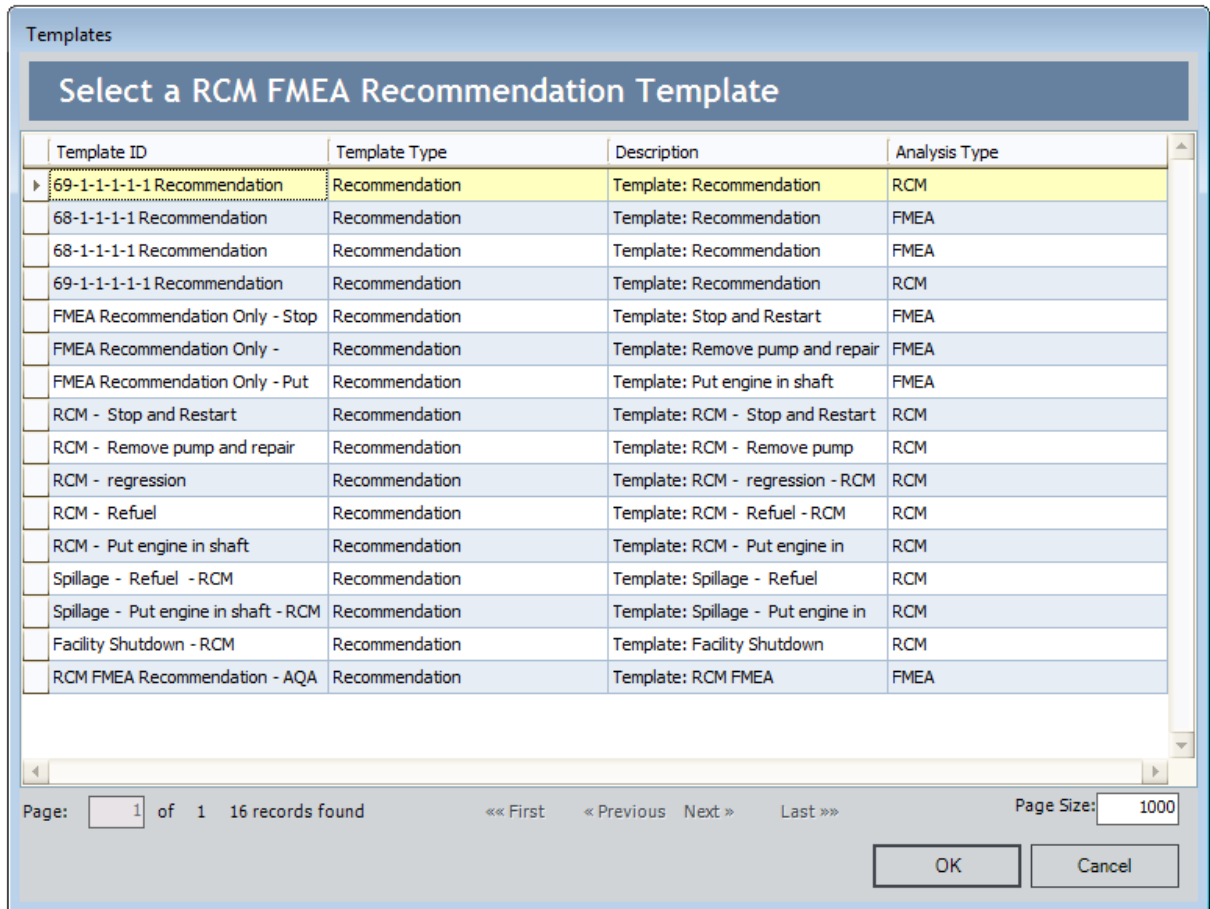

This list contains only the templates whose root nodes can be added as a successor to the node that is currently selected in the RCM Analysis. For example, if an RCM Failure Mode node is selected, the **Templates** window will display all the RCM FMEA Templates whose root node is a Failure Effect node. Because RCM FMEA Template records can be used in both RCM and FMEA Analyses, you may see both RCM Templates and FMEA Templates in this list.

4. Select the row containing the RCM FMEA Template record whose nodes you want to add to the RCM Analysis, and then click **OK**.

The nodes in the RCM Template are added to the RCM Analysis as successors to the currently selected node.

5. On the **Common Tasks** menu, click the **Save** link.

Your changes are saved.

Accessing the Apply Template Builder to Apply an RCM Analysis Node

You can use the **Apply Template Builder** to apply to an existing RCM Analysis a template whose root node is a Function, Functional Failure, or Failure Mode. When you apply a template in this way, you will have the option to replace the RCM FMEA Asset records from the template with Equipment or Functional Location records in the analysis.

To access the **Apply Template Builder** to apply a Function, Functional Failure, or Failure Mode node and its successors:

1. In the [RCM Explorer pane](#), select the node to which you want to add successor nodes. For example, if you want to add an RCM Function node, you must select the RCM Analysis node in the tree.
2. On the **Template Tasks** menu, click the **Load Template** link.

The **Apply Template Builder** appears, displaying the Welcome screen.

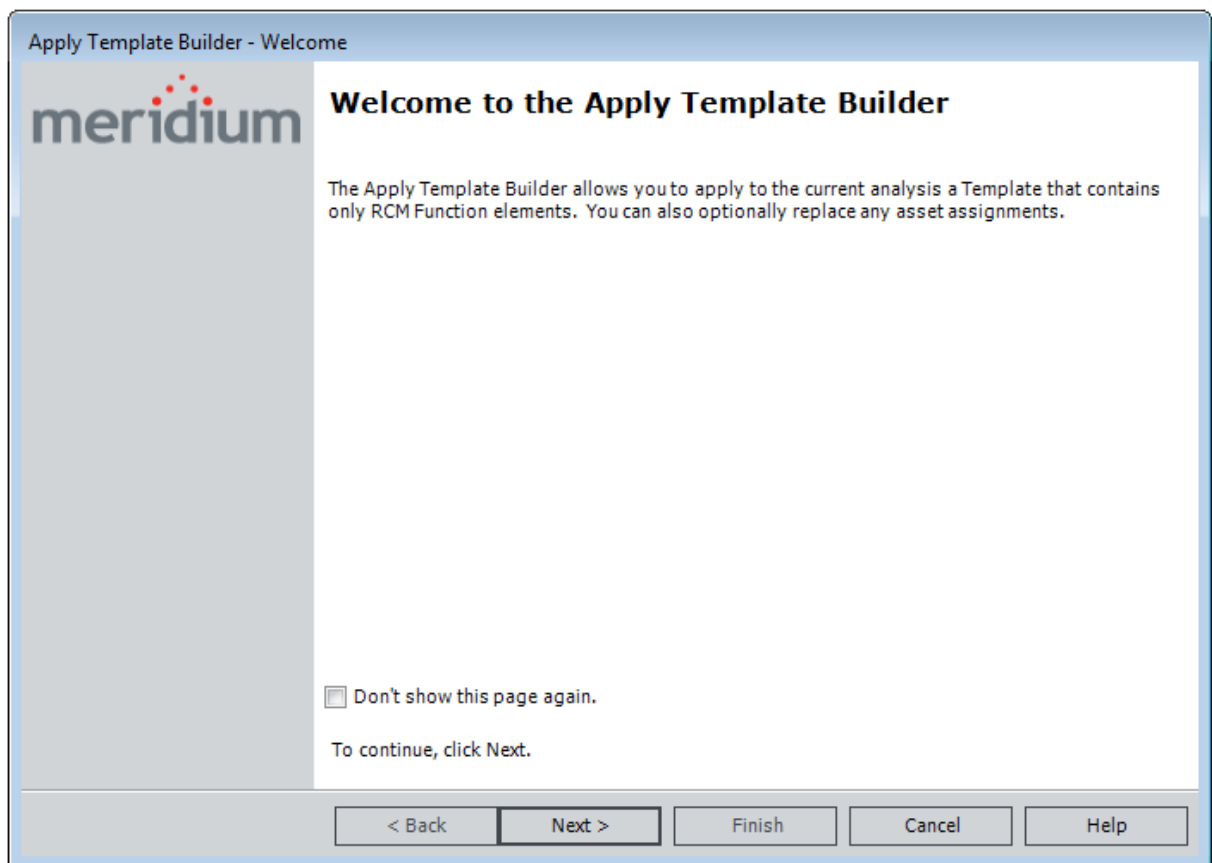

Using the Apply Template Builder to Add Function, Functional Failure, or Failure Mode Nodes to an Analysis

The following instructions provide details on using the **Apply Template Builder** to add nodes to an existing analysis using a template whose root node is a Function, Functional Failure, or Failure Mode. Failure Mode nodes can be applied via an RCM or FMEA template.

Note: You can also use these instructions to create new template elements in an RCM Template.

To use the Apply Template Builder to create a new RCM Analysis node:

1. [Access the Apply Template Builder.](#)
2. Click the **Next** button.

If you are applying a Function or Functional Failure node, the **Select Template** screen appears.

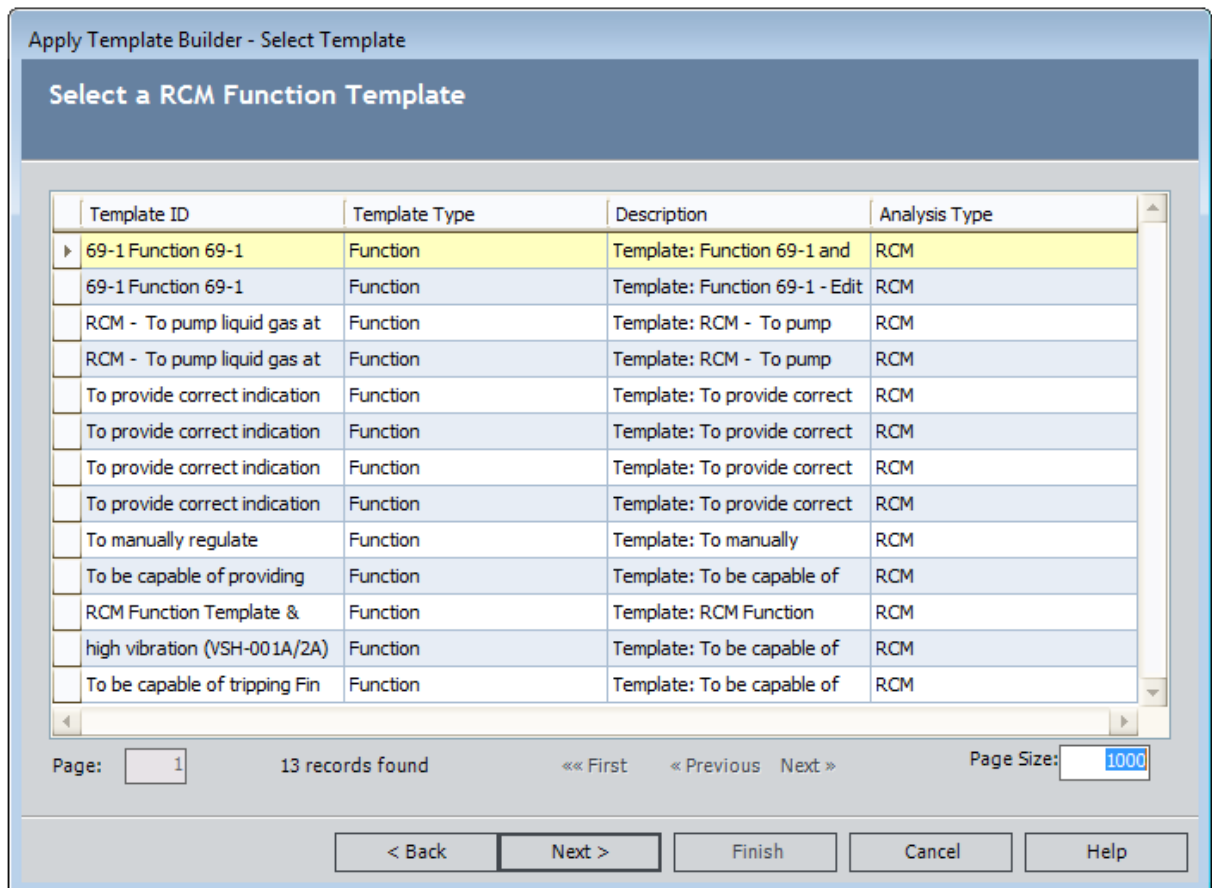

If this screen appears, skip step 3, and proceed to step 4.

-or-

If you are adding a Failure Mode node, the **Select Type** screen appears. In this case, you can select to apply either an RCM FMEA Failure Mode Template or an FMEA Asset Template to the current analysis.

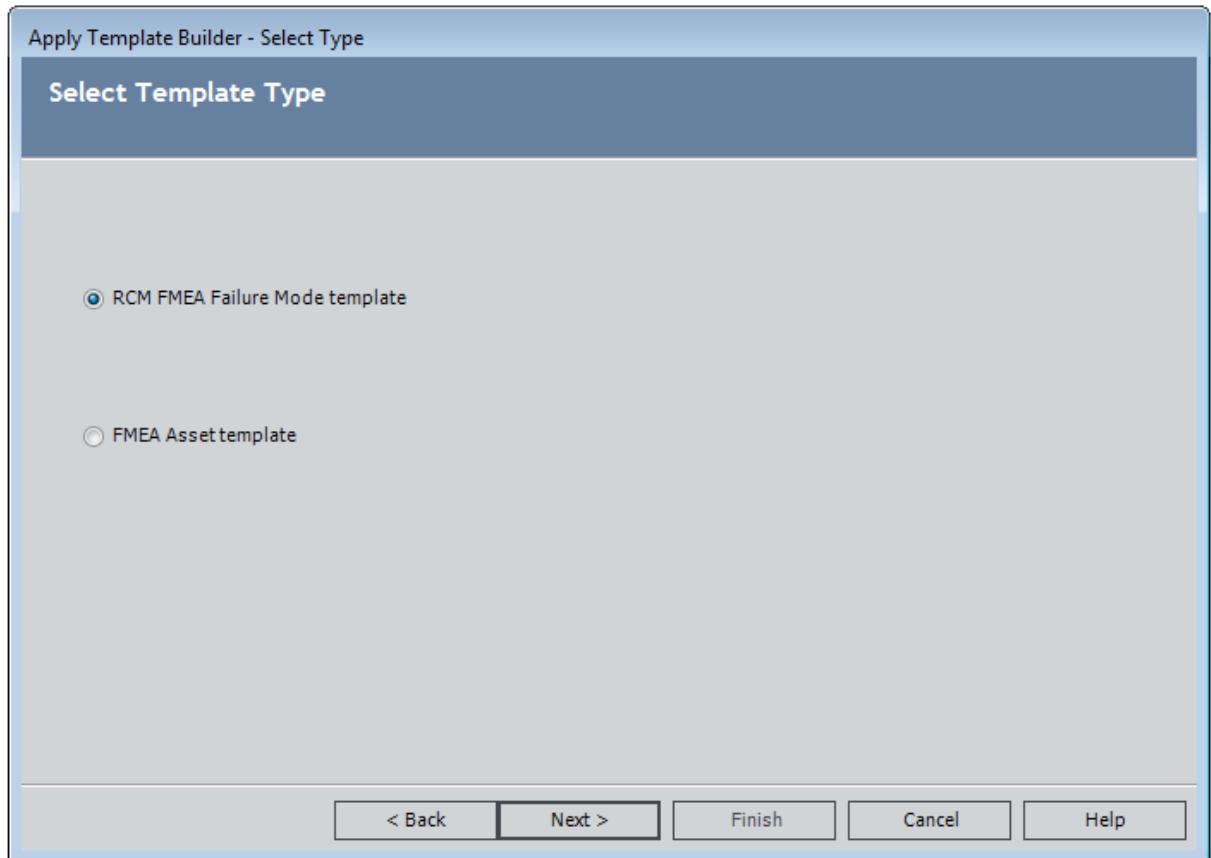

3. Select the option that represents the type of template you want to apply, and then click the **Next** button. You can choose from the following options:

- **RCM FMEA Failure Mode template**
- **FMEA Asset template**

The **Select Template** screen appears, as shown in the image following step 2. The workspace will be titled according to the template type that you selected on the previous screen (i.e., either **RCM FMEA Failure Mode** or **FMEA Asset**).

4. On the **Select Template** screen, select the row containing the template that you want to apply to the current analysis, and then click the **Next** button.

The **Review/Replace Template Asset Assignments** screen appears.

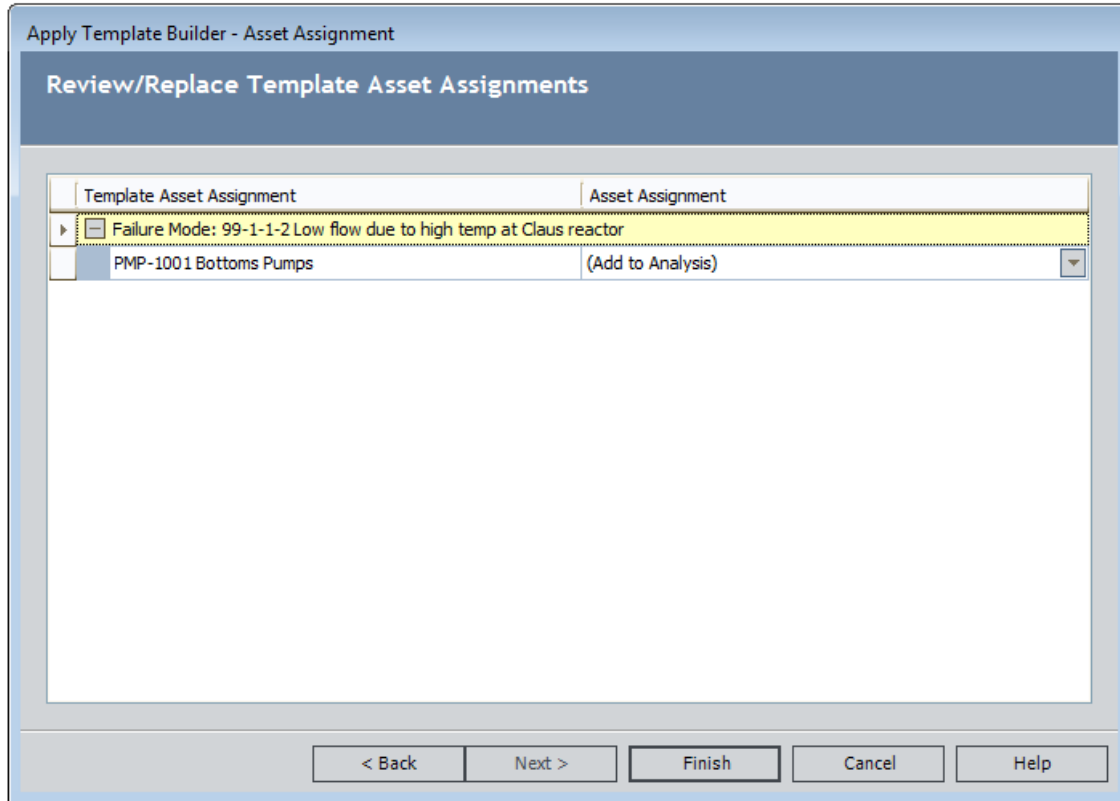

This screen displays a grid with the following items:

- **Failure Mode:** Contains the names of the Failure Modes that are linked to the RCM Template. Each Failure Mode appears in a separate row. This row serves as a grouping for the values that appear in the **Template Asset Assignment** and **Asset Assignment** columns.
- **Template Asset Assignment:** The ID of the RCM FMEA Asset records that are linked to the Failure Modes in the template. If the Failure Mode is not linked to one of these records, this cell will be blank.
- **Asset Assignment:** A list that contains the following values, which you can use to specify what action you want to take with the Equipment, Functional Location, or RCM FMEA Asset record in that row:
 - **(Add to Analysis):** Indicates that you want to add the RCM FMEA Asset record to the target analysis and maintain the link between the Failure Mode record as it exists in the template. This option is selected by default in a row where an ID appears in the **Template Asset Assignment** cell in that row but does not already appear in the list of equipment and locations that exist for the target analysis.
 - **(No Asset Assignment):** Indicates that you do not want to create a link between the Failure Mode record and a record representing a piece of equipment or location. This option is selected by default in a row where the **Template Asset Assignment** cell is empty for a Failure

Mode. You can select this option in a row where a record ID appears in the **Template Asset Assignment** cell to indicate that you do not want to maintain in the target analysis the link between the Failure Mode and the record representing the piece of equipment or location as it exists in the template.

- **<Asset IDs>**: IDs of the existing records representing equipment and locations that are already part of the target analysis. You can select one of these options to indicate that you want to create a link between the Failure Mode and the record with that ID in the target analysis. This option is selected by default if a record with the same ID already exists in the list of equipment and locations for the target analysis.
5. For each Equipment or Functional Location record that appears in the **Template Asset Assignment** column, select the option in the **Asset Assignment** list that corresponds to the action that you want to take with that record in the analysis.
 6. Click the **Finish** button.

The **RCM Explorer** page returns to focus and the new analysis node has been added to the tree.

Modifying Existing RCM Templates

To modify an existing RCM Template:

1. [Access the RCM Templates page.](#)
2. Use the query to locate the RCM Template that you want to modify.
3. In the grid, click the hyperlinked ID of the RCM Template that you want to modify.

The **RCM Templates Explorer** page appears, displaying the selected RCM FMEA Template record.

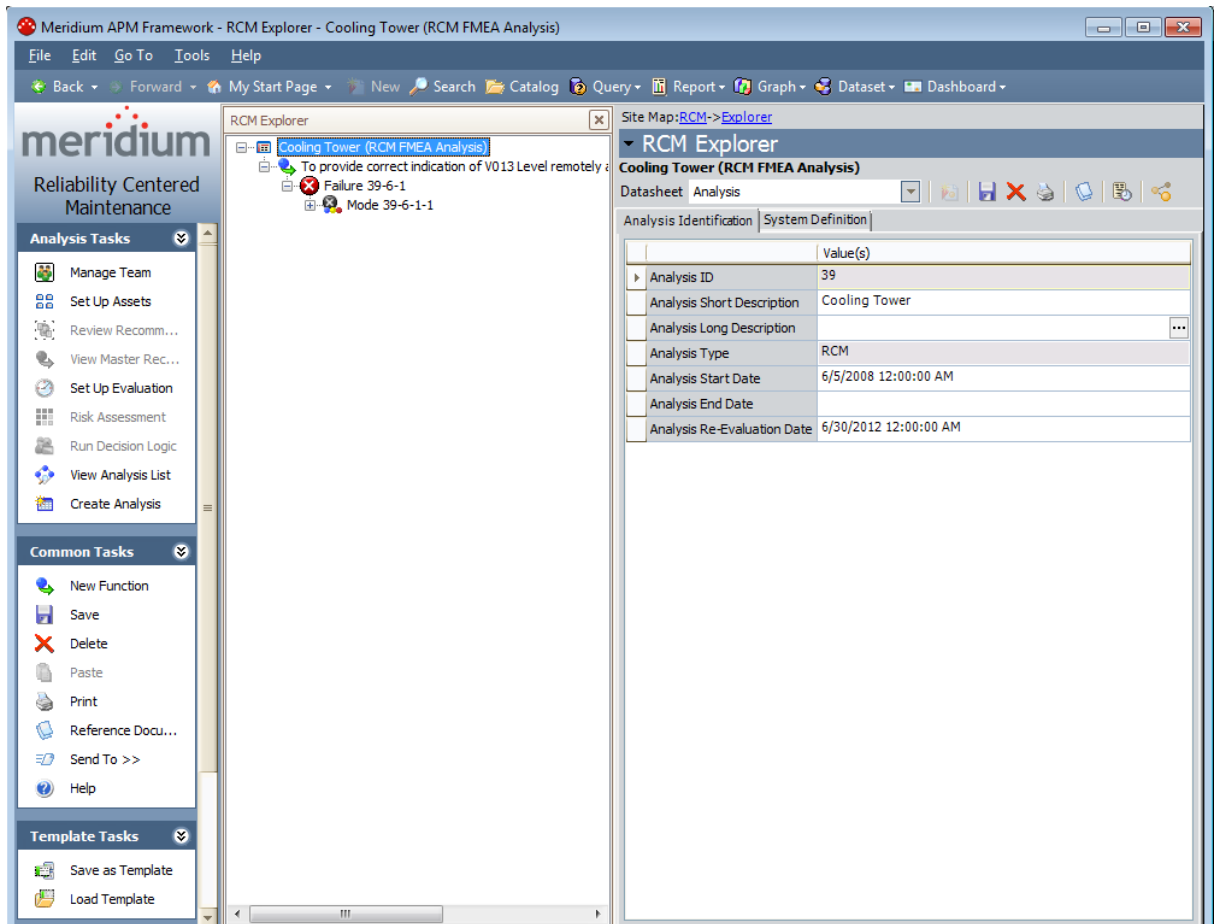

4. Modify the template as needed.
5. Click the **Save** button.

Your changes are saved.

Deleting RCM Templates

The following instructions provide details on deleting an RCM Template via the **RCM Templates** page. You can also delete an RCM Template via the [RCM Template Explorer page](#).

To delete an RCM Template:

1. [Access the RCM Templates page](#).
2. In the grid, select the row containing the RCM Template that you want to delete.
3. On the **Template Tasks** menu, click the **Delete Template** link.

A confirmation message appears, asking if you really want to delete the selected RCM Template.

4. Click the **Yes** button.

The selected RCM FMEA Template record is deleted from the database and is removed from the query results on the **RCM Templates** page.

About the RCM Template Explorer Page

The **RCM Template Explorer** page is the page that you will use to work with RCM templates. The layout of the **RCM Template Explorer** page is similar to that of the Record Manager, where it is divided into three main areas:

- The task menu pane, which contains the following task menus:
 - [Analysis Tasks](#)
 - [Common Tasks](#)
 - [Template Tasks](#)
 - [Reports](#)
 - [Associated Pages](#)
- [RCM Template Explorer pane](#).
- The [datasheet area](#), which displays the information stored in the record for the selected node.

Throughout our discussion of the **RCM Template Explorer** page, we assume that you are familiar with the basic concepts and navigational features of the Record Manager. We limit our discussion primarily to features that are specific to the **RCM Template Explorer** page or that deviate from the standard functionality of the Record Manager.

Accessing the RCM Template Explorer Page

You can access the RCM Template Explorer page by performing the following tasks:

- [Modifying an existing RCM Template.](#)
- [Creating a new RCM Template from scratch.](#)
- [Creating an RCM Template from an existing RCM Analysis.](#)

The following image shows what the RCM Template Explorer page looks when you access it from an existing RCM Template.

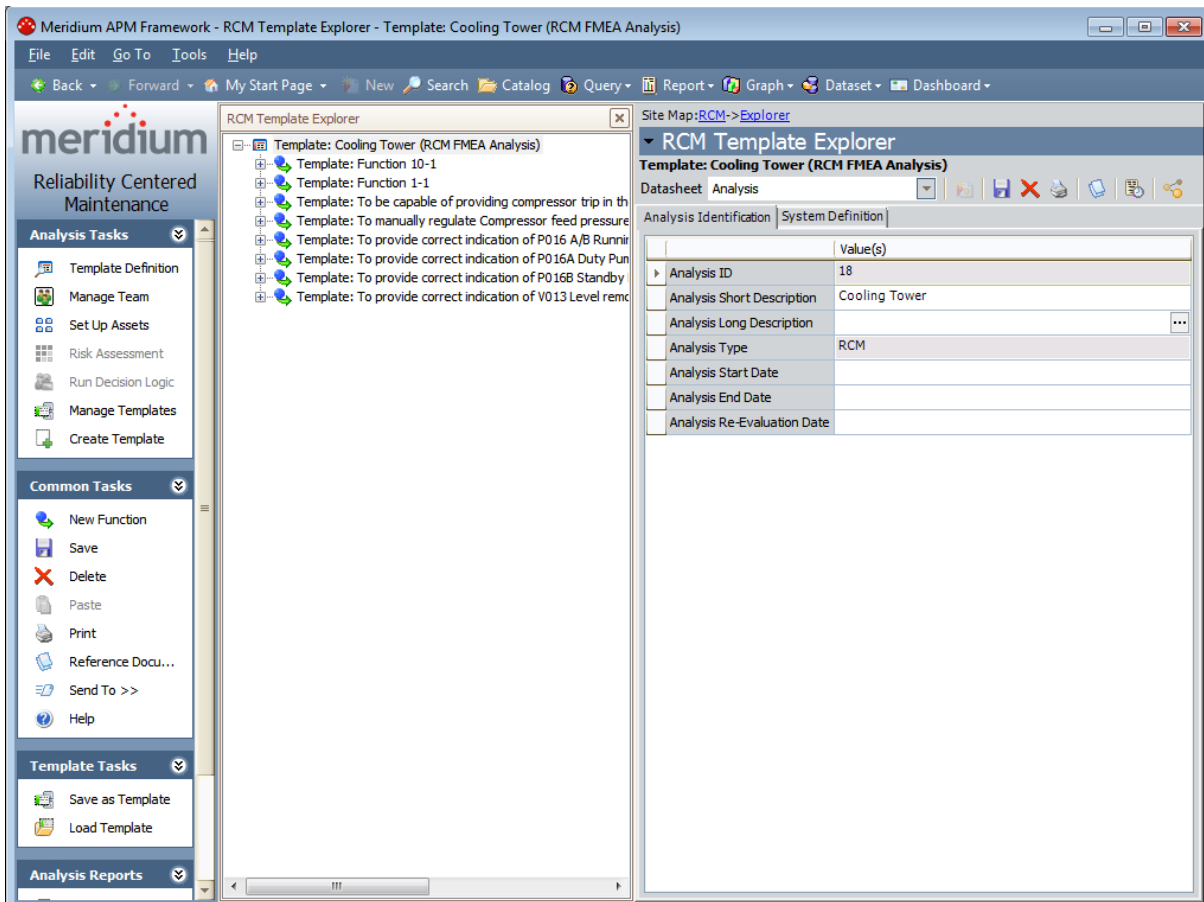

About the RCM Template Explorer Pane

When you open an RCM FMEA Template record on the **RCM Template Explorer** page, in the **RCM Template Explorer** pane, the root node corresponds to the node from which the template was created. Below the root record, the **RCM Template Explorer** pane displays the other components of the template arranged in a hierarchy.

When you first open an RCM Template, only the root node and the nodes that represent direct successor records of that root node appear in the **RCM Template Explorer** pane. You can click the plus sign (+) to the left of any node to expand it and view the next successor record that exists in the tree.

The RCM Template components are linked to one another through relationships that are defined in the [RCM data model](#). The following image shows an example of a fully expanded branch of the tree. Notice that each template node is represented by an icon, which distinguishes that analysis element in the tree.

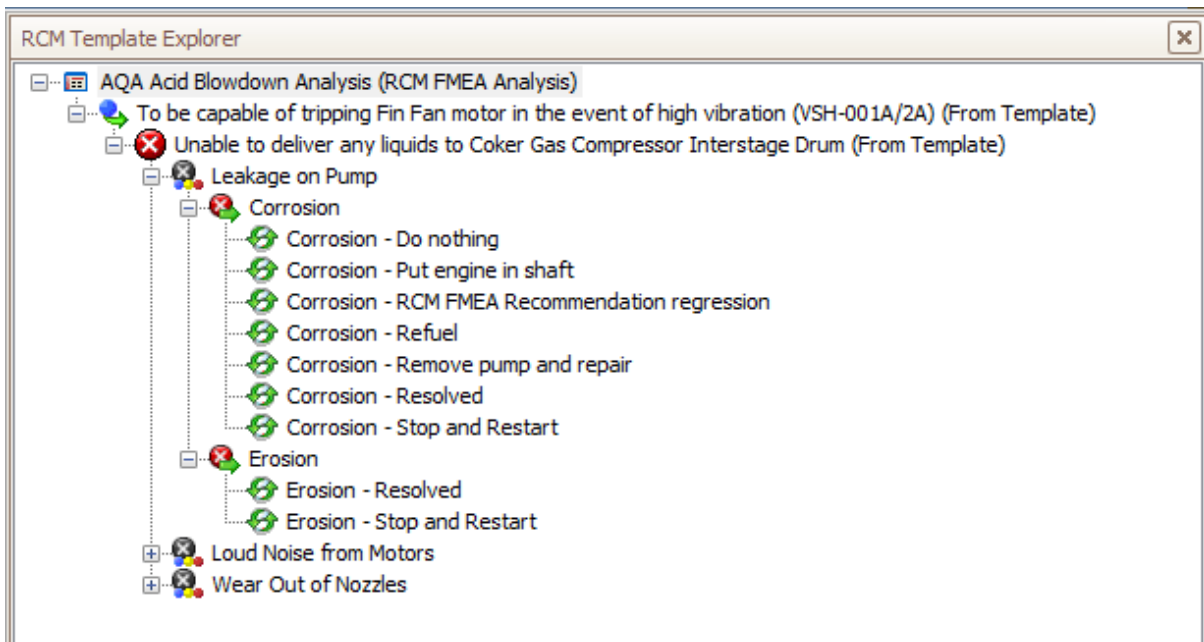

CE Hint: You can also right-click any branch of the tree and then click **Hide Children**, **Show Children**, or **Show All** as appropriate, to expand or collapse that branch.

When you select a node in the tree, the datasheet for that record is displayed in the [data-sheet area](#) on the **RCM Template Explorer** page.

Note that unlike the standard **Record Explorer** pane, which displays all the records in the record hierarchy that are linked to the root record through any relationship, the **RCM Template Explorer** pane displays only the records belonging to the families that make up the RCM Template analysis, according to the [RCM data model](#).

The Shortcut Menu in the RCM Template Explorer Pane

The **RCM Template Explorer** pane contains a shortcut menu that appears when you right-click any node in the tree. The shortcut menu contains the options that you can use to work with the RCM Template and its components. The specific options that are available on the menu will vary, depending on the node that is selected when you access the shortcut menu. For example, the following image shows the options that appear on the shortcut menu when you right-click a *Function node*.

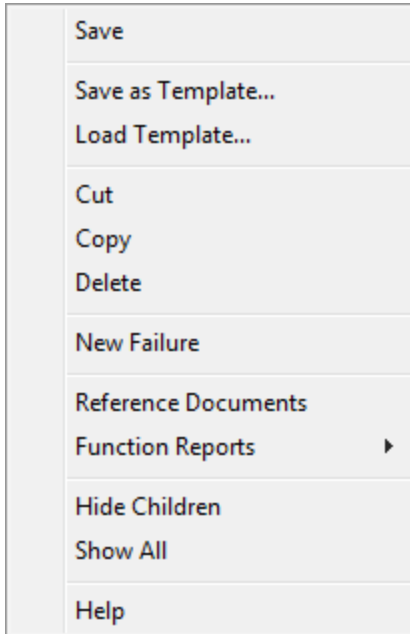

The following options are available on the shortcut menu in the **RCM Template Explorer** pane:

- **Save:** Saves any changes that you have made to the record that is currently selected.
- **Save as Template:** Displays a new RCM FMEA Template record in a new window, from which you can create a new RCM Template using the currently selected node as the root node.
- **Load Template:** Facilitates the creation of a new analysis elements by applying an existing RCM Template to the currently selected node.
- **Cut:** Removes the currently selected node and all its successor nodes from the tree so that you can paste them in a different location. After you have cut a node, the **Paste** option will appear on the shortcut menu so that you can paste the node in a different location in the tree.
- **Copy:** Copies the selected node. After you have copied a node, the **Paste** option will appear on the shortcut menu so that you can paste a copy of that node in a

different location in the tree. If the selected template element has successor nodes, a prompt appears, asking if you want to copy only the selected node or the selected node and all its successor nodes.

- **Paste:** Pastes the cut or copied nodes in the selected location. Note that this menu option appears only after you have copied or cut a node and if you select a predecessor node that participates in a relationship with the node that you want to paste.
- **Delete:** Deletes the selected node and all its subnodes from the template and from the database.
- **New <Node>:** Where <Node> is the analysis element that you want to create. The name of this link will change depending upon the predecessor node that is selected in the tree. This link creates a new record in the family indicated by the <Node> value and links it to the selected predecessor record. For example, if you select a Function node, this link will be labeled **New Failure** and will result in the creation of a new Functional Failure record that is linked to the Function record that is represented by the selected Function node.
- **Reference Documents:** Displays the **Reference Documents** window, where you can [manage the Reference Documents](#) associated with the record.
- **<Node> Reports:** Where <Node> is the analysis element whose reports you want to view. When you point to this link, a submenu appears and contains a list of reports that are associated with the selected component. For example, when you select an RCM Function node, this option will be labeled **Function Reports**. This menu option appears only if reports exist for the family that is represented by the selected node.
- **Show Children:** Expands the hierarchy to display the successor nodes that appear directly below a given node. This option appears only when you select a collapsed predecessor node.
- **Hide Children:** Collapses the hierarchy to hide the successor nodes that appear directly below a given node. This option appears only when you select an expanded predecessor node.
- **Show All:** Expands ALL successor nodes that exist below the selected node.
- **Help:** Displays the context-sensitive Help topic for the **RCM Template Explorer** page.

About the Datasheet Area

The datasheet area appears to the right side on the **RCM Template Explorer** page and displays the datasheet for the node that is currently selected in the **RCM Template Explorer** pane. For example, when you select an RCM Failure Effect node in the **RCM Template Explorer** pane, the datasheet area displays the Failure Effect record. The following image shows an example of the datasheet area on the **RCM Template Explorer** page. A red outline has been added to the image to highlight this area.

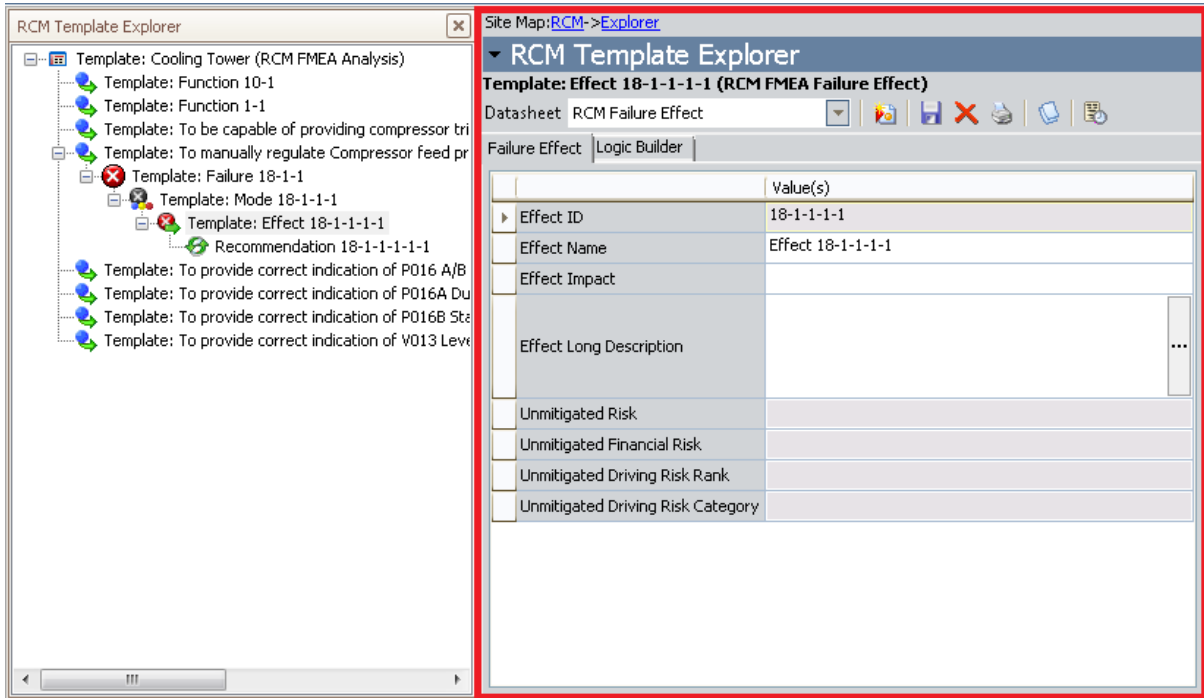

The features of the datasheet area, such as the buttons that appear above the datasheet itself, are the same as those that are available in the Record Manager.

Analysis Tasks Menu

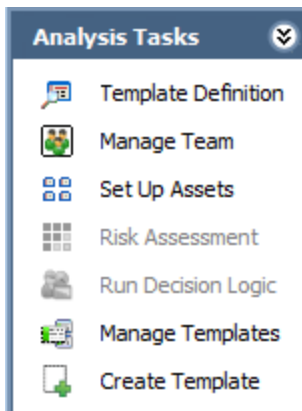

The **Analysis Tasks** menu on the **RCM Template Explorer** page contains links that you can use to work with the analysis elements in the **RCM Template Explorer** pane. The links on this menu are hidden or disabled based upon the node that is selected in the tree.

The **Analysis Tasks** menu on the **RCM Template Explorer** page contains the following links:

- **Template Definition:** Displays the datasheet for the current RCM FMEA Template record. This link is available for *all* template types.
- **Manage Team:** Displays the **RCM Team Members** page, where you can create and manage Human Resource records for an RCM Analysis Template. This link appears only when you are working with a template whose root node is an Analysis node.
- **Set Up Assets:** Displays the **Manage Asset List** page. This link appears only when you are working with a template whose root node is an Analysis node.
- **Risk Assessment:** Displays the Risk Assessment feature. This link is enabled only when:
 - A Failure Effect node is selected in the tree.
 - A Recommendation node is selected in the tree and a value has been selected for at least one Category in the corresponding *unmitigated* Risk Assessment.

This link does not appear when you are working with a template whose root node is an RCM Recommendation node.

- **Run Decision Logic:** Displays the [Decision Logic Builder](#). This link is enabled only when you select a Failure Effect node in the tree. This link does not appear when you are working with a template whose root node is an RCM Recommendation node.
- **Manage Templates:** Displays the **RCM Templates** page. By default, the value in the Template Type query prompt is set to the Template Type of the template you were previously viewing.

- **Create Template:** Displays the **Template Builder**, which you can use to [create a new RCM Template from scratch](#).

Common Tasks Menu

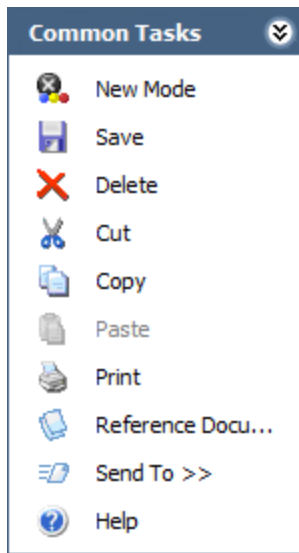

The **Common Tasks** menu on the **RCM Template Explorer** page contains links that you can use to work with the analysis elements in the **RCM Template Explorer** pane. These links are hidden or disabled based on the node that is selected in the tree.

The **Common Tasks** menu on the **RCM Template Explorer** page contains the following links:

- **New <Node>**: Where **<Node>** is the analysis element that you want to create. The name of this link will change depending upon the predecessor node that is selected in the tree. This link creates a new record in the family indicated by the **<Node>** value and links it to the selected predecessor record. For example, if you select a Function node, this link will be labeled **New Failure** and will result in the creation of a new Functional Failure record that is linked to the Function record that is represented by the selected Function node.
- **Save**: Saves the selected record.
- **Delete**: Deletes the selected record and all its subnodes from the template and from the database.
- **Cut**: Removes the currently selected node and all its successor nodes from the tree so that you can paste them in a different location. After you have cut a node, the **Paste** option will appear on the shortcut menu so that you can paste the node in a different location in the tree.
- **Copy**: Copies the selected node. After you have copied a node, the **Paste** option will appear on the shortcut menu so that you can paste a copy of that node in a different location in the tree. If the selected template element has successor nodes, a prompt appears, asking if you want to copy only the selected node or the selected node and all its successor nodes.

- **Paste:** Pastes the cut or copied nodes in the selected location. Note that this menu option appears only after you have copied or cut a node and if you select a predecessor node that participates in a relationship with the node that you want to paste.
- **Print:** Displays the **Preview** window. From the **Preview** window, you can select print options and print the record.
- **Reference Documents:** Displays the **Reference Documents** window, where you can manage the Reference Documents associated with the selected record.
- **Send To:** Displays a submenu with options that let you .This link is enabled only when you are viewing a saved analysis.
- **Help:** Displays the context-sensitive Help topic for the **RCM Template Explorer** page.

Template Tasks Menu

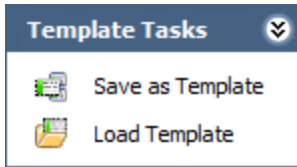

The **Template Tasks** menu on the **RCM Template Explorer** page contains the following links:

- **Save as Template:** Displays a new RCM FMEA Template record in a new window, from which you can create a new RCM Template using the currently selected node as the root node.
- **Load Template:** Facilitates the creation of a new RCM Template node by applying an existing RCM Template.
 - If you are applying a Function node, Functional Failure node, or Failure Mode node, this link will display the [Apply Template Builder](#).
 - If you are applying a Failure Effect node or a Recommendation node, this link will open the **Templates** window, which displays a list of templates that you can use for adding a new node to the selected node.

<Node> Reports Menu

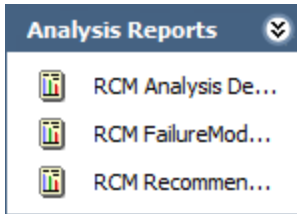

The **<Node> Reports** menu on the **RCM Template Explorer** page displays the reports associated with the node currently selected in the **RCM Template Explorer** pane. The name of the menu will change as appropriate, depending on which node you select. For example, when you select the root-level analysis node, the menu is labeled **Analysis Reports** and displays a list of reports associated with the Analysis node, as shown in the preceding image.

Each template node has a related [folder in the Catalog](#) that is used to determine which reports to display for which template component. This menu appears only if reports exist in the Catalog folder associated with the selected node.

Associated Pages Menu

The **Associated Pages** menu on the **RCM Template Explorer** page displays Associated Pages that have been configured via the URL Manager for the family of the node that is currently selected in the **RCM Template Explorer** pane.

Note: The **Associated Pages** menu will not be filtered based on the type of template that you are viewing. Any Associated Page that you configured for a family that is used by both RCM and FMEA Templates will appear when you are viewing an RCM Template and when you are viewing an FMEA Template.

Accessing the RCM Asset List Page for RCM Templates

To access the RCM Asset List page for an RCM Template:

- While viewing an RCM Template on the [RCM Template Explorer page](#), on the Analysis Tasks menu, click the **Set up Assets** link.

-or-

On the [RCM Team Members page](#), on the Analysis Tasks menu, click the **Set Up Assets** link.

The **RCM Asset List** page appears, displaying the RCM FMEA Asset records that are linked to the current RCM Template.

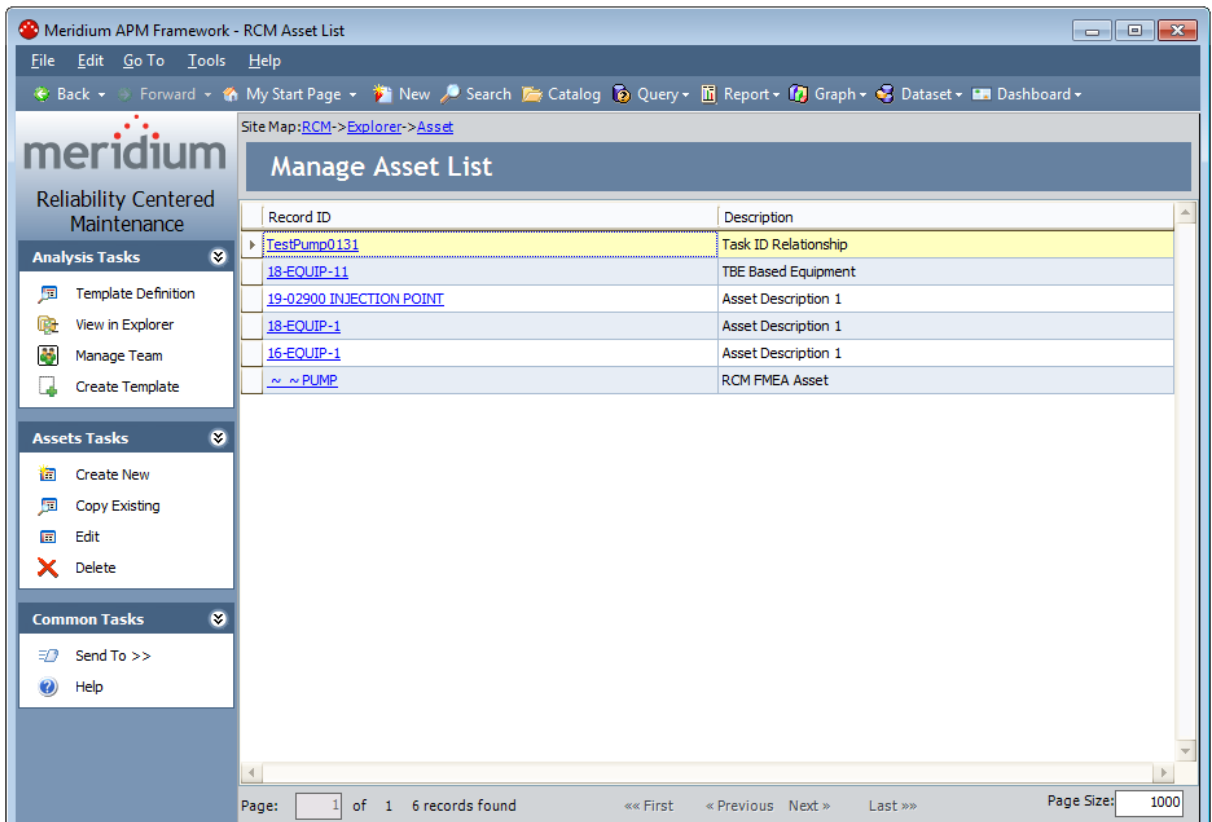

About the RCM Asset List Page for RCM Templates

The **RCM Asset List** page for RCM Templates contains similar features to the [RCM Asset List page that is configured for RCM Analyses](#). The **RCM Asset List** page contains a grid that displays the list of RCM FMEA Asset records that are associated with the template. Each row in the grid represents one RCM FMEA Asset record. For each RCM FMEA Asset record, the following information is displayed:

- **Record ID:** The Record ID of the RCM FMEA Asset record.
- **Description:** The value stored in the Description field in the RCM FMEA Asset record.

The **RCM Asset List** page also contains the following task menus, which let you perform tasks specific to the equipment and location list: [Analysis Tasks menu](#), [Asset Tasks menu](#), and [Common Tasks menu](#).

From the **RCM Asset List** page, you can:

- [Add RCM FMEA Asset records to the current template.](#)
- [Modify RCM FMEA Asset records that belong to the current template.](#)
- [Delete RCM FMEA Asset records that belong to the current template.](#)

Analysis Tasks Menu

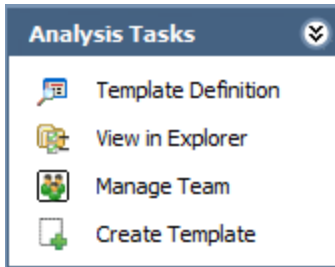

The **Analysis Tasks** menu on the **RCM Asset List** page contains the following links:

- **Template Definition:** Displays the RCM FMEA Template record for the associated RCM Template.
- **View in Explorer:** Displays the associated RCM Template on the **RCM Template Explorer** page.
- **Manage Team:** Opens the **RCM Team Members** page for RCM Templates, where you can set up the team for the current template.
- **Create Template:** Displays the **Template Builder**, which you can use to [create a new RCM Template from scratch](#).

Asset Tasks Menu

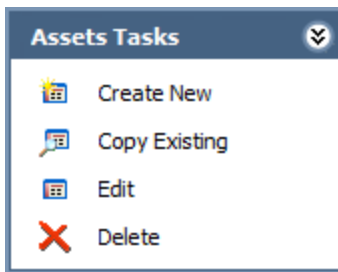

The **Assets Tasks** menu on the **RCM Asset List** page contains the following links:

- **Create New:** Displays a new RCM FMEA Asset record in a new window, where you can define the new RCM FMEA Asset record and link it to the template.
- **Copy Existing:** Displays the **Find Asset Records** dialog box, where you can search for an existing RCM FMEA Asset record to create a copy of it and link it to the analysis.
- **Edit:** Displays the **Edit Asset Record** dialog box, where you can modify the contents of the selected RCM FMEA Asset record.
- **Delete:** After asking for confirmation, deletes the selected RCM FMEA Asset record from the database.

Common Tasks Menu

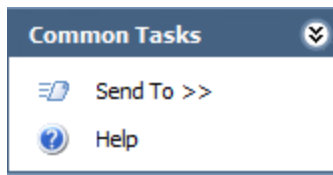

The **Common Tasks** menu on the **RCM Asset List** page contains the following links:

- **Send To:** Displays a submenu with options that let you **provide a link to the current page on your desktop (create shortcut), in an email message, or on a Home Page.**
- **Help:** Displays the context-sensitive Help topic for the **RCM Asset List** page for RCM Templates.

Accessing the RCM Team Members Page for an RCM Template

To access the RCM Team Members Page for an RCM Template:

- While viewing an RCM Template on the [RCM Template Explorer page](#), on the **Analysis Tasks** menu, click the **Manage Team** link.

-or-

While working with an RCM Template on the [RCM Asset List page](#), on the **Analysis Tasks** menu, click the **Manage Team** link.

The **RCM Team Members** page appears, displaying a list of Human Resource records that have been defined for the associated RCM Template.

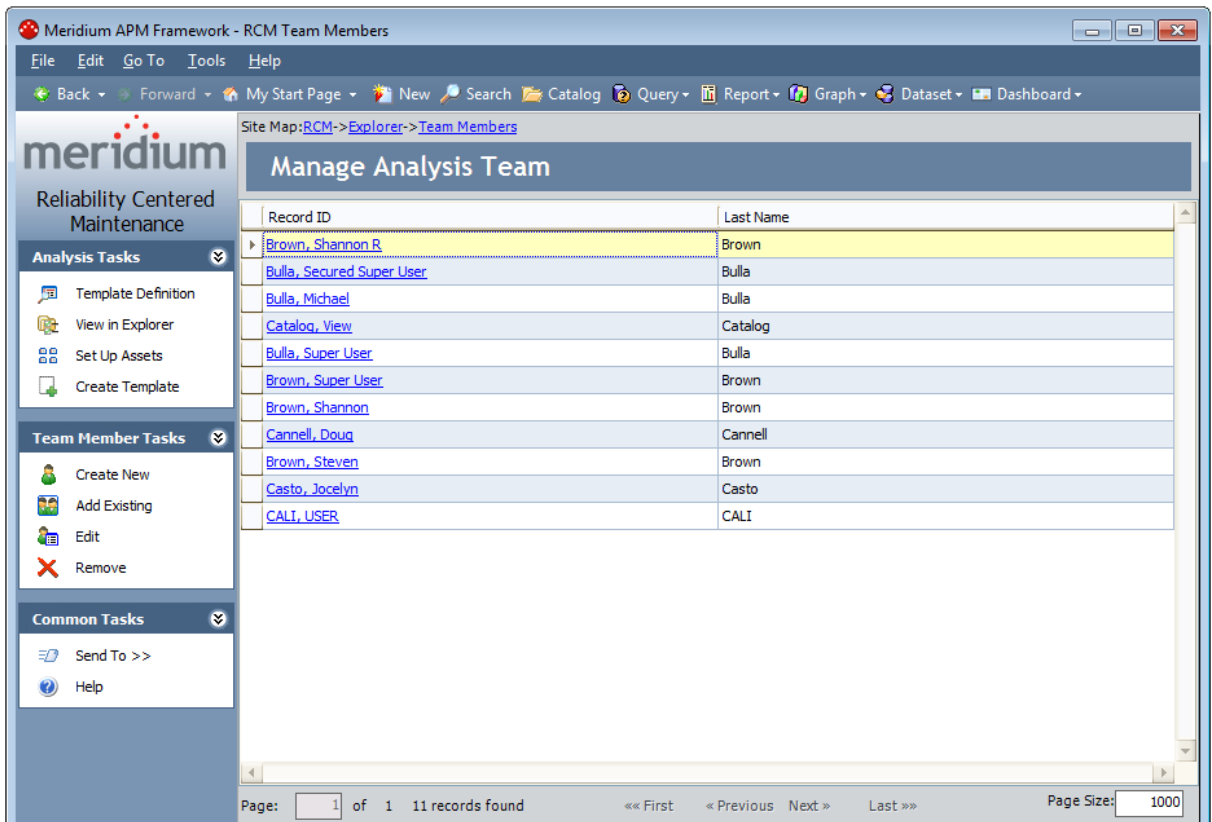

About the RCM Team Members Page for RCM Templates

The **RCM Team Members** page for RCM Templates contains a grid that displays the list of Human Resource records that make up the RCM Analysis Team. Each row in the grid represents one Human Resource record. For each Human Resource record in the grid, the following information is displayed:

- **Record ID:** The Record ID of the Human Resource record.
- **Last Name:** The value in the Last Name field in the Human Resource record.

The **RCM Team Members** page also contains three task menus, which let you perform tasks specific to the RCM Analysis Team: [Analysis Tasks](#), [Team Members Tasks](#), and [Common Tasks](#).

From the **RCM Team Members** page, you can:

- [Add team members using existing Human Resource records.](#)
- [Add team members by creating new Human Resource records.](#)
- [Modify information about a team member by modifying the corresponding Human Resource record.](#)
- [Remove team members from the RCM Analysis Team.](#)

Analysis Tasks Menu

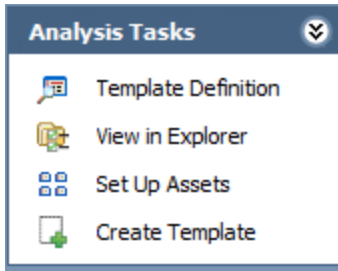

The **Analysis Tasks** menu on the **RCM Team Members** page contains the following links:

- **Template Definition:** Displays the RCM FMEA Template record for the associated RCM Template.
- **View in Explorer:** Opens the current RCM Template on the [RCM Template Explorer page](#).
- **Set Up Assets:** Displays the [RCM Asset List page for RCM Templates](#), where you can manage the equipment and location list for the template.
- **Create Template:** Displays the **Template Builder**, which you can use to [create a new RCM Template from scratch](#).

Team Member Tasks Menu

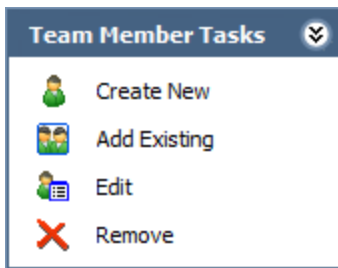

The **Team Members Tasks** menu on the **RCM Team Members** page contains the following links:

- **Create New:** Displays the **Create New Team Member** dialog box, where you can create a new Human Resource record and add that person to the RCM Analysis Team.
- **Add Existing:** Displays the **Find a Human Resource** dialog box, where you can [search for existing Human Resource records to add](#) to the RCM Analysis Team.
- **Edit:** Displays the **Edit Team Member** dialog box, where you can [modify the information stored in the selected Human Resource record](#).
- **Remove:** After asking for confirmation, removes the selected Human Resource record from the RCM Analysis Team. Note that this does not delete the Human Resource record from the database.

Common Tasks Menu

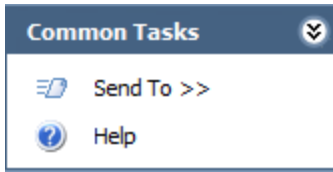

The **Common Tasks** menu on the **RCM Team Members** page contains the following links:

- **Send To:** Displays a submenu with options that let you **provide a link to the current page on your desktop (create shortcut), in an email message, or on a Home Page.**
- **Help:** Displays the context-sensitive Help topic for the **RCM Team Members** page for RCM Templates.

Introduction to RCM Reports

Meridium APM supports two types of reports in RCM:

- [Reports that are generic and apply to any analysis.](#)
- [Reports that apply to a specific analysis or analysis node.](#)

RCM relies upon the Catalog folder structure to determine which reports appear where throughout the RCM interface. Each analysis element has a corresponding Catalog folder. When you are viewing that analysis element, the reports stored in the associated Catalog folder will be available.

For example, when you are viewing an RCM Analysis on the **RCM Explorer** page and you select a Function node, the [Function Reports menu](#) will display a list of reports stored in the following Catalog folder: \\Public\Meridium\Modules\RCM\Function. In addition, the Catalog contains a generic folder for storing reports that appear on the **RCM Reports** page and will apply to any analysis.

When you view an RCM report, the Meridium APM system will run the report and open it on the **Report Viewer** page, where all the standard report functionality will be available to you.

About Running Reports in RCM

The baseline RCM product contains a set of [pre-configured RCM reports](#) that you can run when you are viewing an RCM Analysis on the **RCM Explorer** page. In addition, by creating your own custom reports and storing them in the appropriate [folder in the Catalog](#), you will be able to access and [view reports associated with given analysis node](#). In addition, the baseline RCM product contains a Catalog folder for storing generic RCM reports, which can be [accessed easily from the RCM Start Page](#).

When you view an RCM report, the Meridium APM system will run the report and open it on the **Report Viewer** page, where all the standard report functionality will be available to you.

Accessing the RCM Reports Page

The **RCM Reports** page displays a list of generic reports that have been configured for use with RCM. Generic RCM reports should be stored in the following Catalog folder: \\Public\Meridium\Modules\RCM. The **RCM Reports** page will display any report stored in that folder.

The **RCM Reports** page displays the caption of the report as it exists in the Catalog. Therefore, when saving reports to the folder \\Public\Meridium\Modules\RCM, you will want to make sure that you use captions that are descriptive enough to identify the purpose of the report to other users.

Note: The baseline RCM implementation does not include any reports that will appear on the **RCM Reports** page. By default, the baseline RCM product contains one baseline report in the folder \\Public\Meridium\Modules\RCM: RCM AnalysisTeamSubReport. Because this report is a sub-report of the RCM Analysis Description report, it is automatically filtered out of the reports list and not displayed on the **RCM Reports** page. Any other report that you store in the folder \\Public\Meridium\Modules\RCM will, however, appear on this page.

To access the RCM Reports page:

- On the [RCM Start Page](#), click the **Run Reports** link.

The **RCM Reports** page appears.

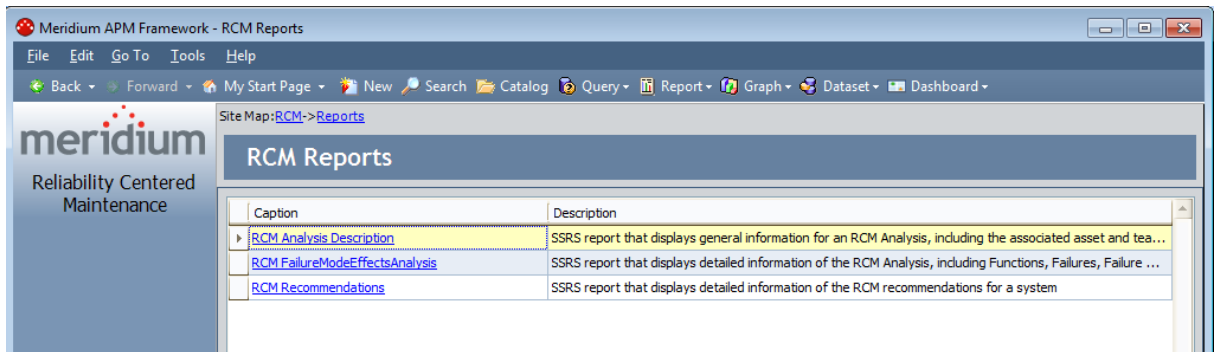

Opening a Report

The **RCM Reports** page displays a list of reports that are stored in the following Catalog folder: \\Public\Meridium\Modules\RCM. Each report caption appears as a hyperlink.

To run a report that is displayed in the list on the RCM Reports page:

- Click any hyperlinked report caption.

The results of the report appear on the **Report Viewer** page.

Running Reports Specific to an Analysis or Analysis Element

Reports that have been defined for the root-level analysis node or for a specific analysis element and stored in the [correct folder in the Catalog](#) will appear when you are viewing an analysis or analysis element on the **RCM Explorer** page.

For example, when you are viewing an RCM Analysis on the **RCM Explorer** page and you select a Function node, the [Function Reports menu](#) will display a list of reports that are stored in the following Catalog folder: \\Public\Meridium\Modules\RCM\Function. In addition, you can right-click any analysis node in the **RCM Explorer** pane and access a shortcut menu which will also display a list of reports that have been configured for that node.

To run an RCM report:

- [From any of these menus](#), click the name of the desired report.

The results of the report appear on the **Report Viewer** page.

About Managing RCM Recommendations

You can access Recommendation Management and work with RCM FMEA Recommendation records via the [Analysis Tasks menu on the RCM Explorer page](#).

When you access Recommendation Management via RCM, [additional options are available for working with RCM FMEA Recommendation records](#).

Accessing Recommendation Management from the RCM Explorer Page

To review RCM recommendations and manage them in Recommendation Management:

1. [Access the RCM Explorer page.](#)
2. On the **Analysis Tasks** menu, click the **Review Recommendations** link.

The [Recommendation Management page](#) appears, displaying a list of RCM FMEA Recommendation records that exist for the current analysis.

Features of the Recommendation Management Page when Accessed from RCM

When you access Recommendation Management from an RCM Analysis, the **Recommendation Management** page contains features in addition to those that are available when you access the **Recommendation Management** page directly.

This page is divided in the following sections:

- **Recommendation Management workspace:** Contains a grid that displays the Recommendation records that are linked to the equipment and locations that are associated with the current RCM Analysis.
- **Task menus:** The following task menus are available: **Recommendation Tasks** menu, **Asset Tasks menu**, **Common Tasks** menu, and **Associated Pages** menu.

Additionally, when you access the **Recommendation Management** page from RCM, a site map appears at the top of the page and allows you to navigate back to the source analysis.

The following image shows an example of the **Recommendation Management** page when accessed from RCM.

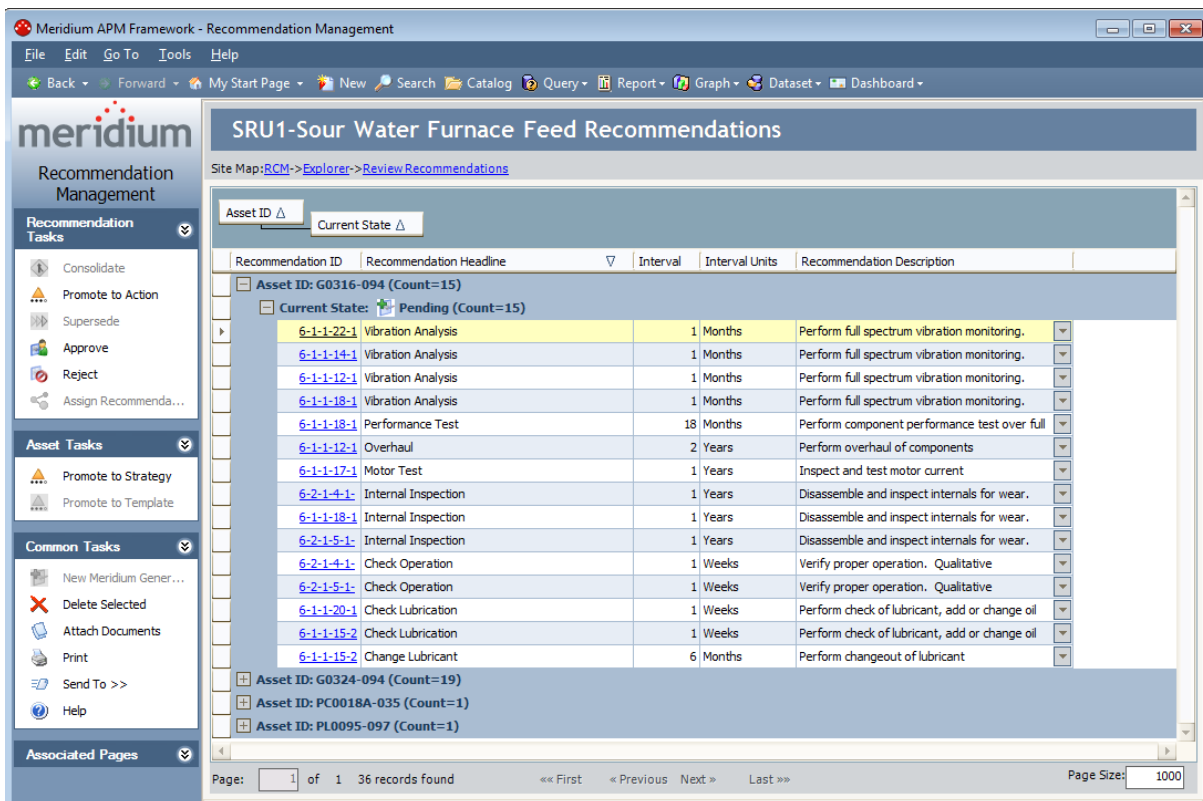

Asset Tasks Menu

The **Asset Tasks** menu is available when you access Recommendation Management from RCM or FMEA.

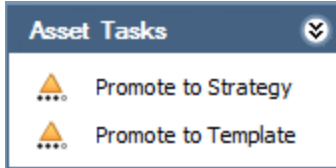

The RCM FMEA **Asset Tasks** menu on the **Recommendation Management** page contains the following links:

- **Promote to Strategy:** Promotes to an Asset Strategy all the RCM FMEA Asset, Equipment, or Functional Location records that are linked to the RCM FMEA Recommendation records in the grid. This link is enabled only if the RCM FMEA Recommendation records are linked to a record representing a piece of equipment or location.
- **Promote to Template:** Promotes to an Asset Strategy Template the RCM FMEA Asset record that is linked to the selected RCM FMEA Recommendation record. This link is enabled only if the selected RCM FMEA Recommendation record is linked to an RCM FMEA Asset record.

Viewing Master Recommendations from Consolidated Recommendations

If you have [consolidated RCM Recommendation records](#) to create a master RCM Recommendation record, while you are viewing one of those consolidated Recommendation records on the **RCM Explorer** page, you can access the master Recommendation.

The following instructions assume that you are already viewing a consolidated RCM Recommendation record on the **RCM Explorer** page (i.e., the state of the Recommendation record is *Consolidated*).

You can determine the current state of the selected Recommendation record from the visual indicator above the datasheet toolbar, as outlined in red in the following image.

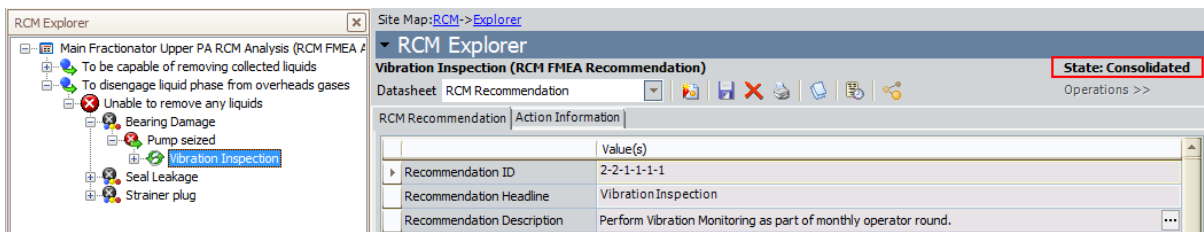

To view a master Recommendation record from a consolidated Recommendation record:

- On the **RCM Explorer** page, on the **Analysis Tasks** menu, click the **View Master Recommendation** link.

The **View Master Recommendation** window appears, displaying the datasheet of the master Recommendation record.

View Master Recommendation
Operations >>

View Master Recommendation

Datasheet: FMEA Recommendation
Operations >>

FMEA Recommendation | Action Information

	Value(s)
▶ Recommendation ID	2-CREC-0001
Recommendation Headline	Visual Seal Inspection
Recommendation Description	Run Pump up for 1 hour min to achieve successful seal flushing and check for external visual leaks. ...
Asset ID	G0019-097
Technical Number	
Asset Shutdown Required?	<input type="checkbox"/>
Business Impact	
Mitigated Risk	12
Mitigated Financial Risk	50000
Comments	...
Create Work Request?	<input type="checkbox"/>
Work Request Reference	
Work Request Equipment	
Work Request Functional L...	
Target Completion Date	

OK
Cancel

About Evaluations

After you create an RCM Analysis, you can define criteria for evaluating the whole analysis or parts of the analysis in the future. Specifically, you can define criteria for evaluating:

- [The entire analysis.](#)
- [Any equipment or locations that are included in the analysis.](#)
- [Any recommendations that are included in the analysis.](#)

The evaluation feature allows you to be notified, or to notify someone else, when certain conditions are met. You can create two types of evaluations:

- A date-based evaluation, where email messages are sent on a one-time or recurring basis and are triggered when the current date and time match the date and time specified in the evaluation criteria.
- An event-based evaluation, where email messages are sent when a piece of equipment or location meets the failure cost and/or count criteria specified for the evaluation.

If you want to evaluate an entire analysis, you can configure only a date-based evaluation.

If you want to evaluate equipment, locations, or recommendations that are included in an analysis, you can configure a date-based evaluation, an event-based evaluation, or both types of evaluations for each piece of equipment, location, or recommendation.

After evaluation criteria exists and the RCM/FMEA Evaluation [scheduled item is created](#) via the Meridium APM Schedule Manager, the scheduled item will be executed on the Next Evaluation Date that is specified in the scheduled item. When it is executed, the Meridium APM system will determine whether or not an email message should be sent based on the existing evaluation criteria.

Note that evaluation criteria defined is stored in the associated record itself. For example, if you define evaluation criteria for an analysis, the criteria is stored in the RCM FMEA Analysis record. The facility for defining date-based evaluation criteria is essentially a user interface that will guide you in populating fields in the associated record. Note that the values that appear on the datasheet can be modified via the datasheet itself, provided that you have the appropriate permissions. To ensure that you enter all the values necessary for setting up valid evaluations, however, we recommend that you use the evaluation interface instead of the datasheet.

About Analysis Evaluations

After you create an RCM Analysis, you can define criteria for evaluating the analysis in the future to determine:

- How valid the original analysis was.
- Whether the analysis needs to be modified.

For each analysis, you can create a date-based evaluation, where email messages are sent on a one-time or recurring basis and are triggered when the current date and time match the date and time specified in the evaluation criteria.

When an email message is sent, it will contain the following information:

- The description of the RCM Analysis for which the evaluation was configured, as it is stored in the Analysis Short Description field in the RCM FMEA Analysis record.
- A statement indicating that the specified analysis needs to be reviewed.
- A hyperlink that will open on the **RCM Explorer** page the RCM Analysis that needs to be reviewed.

About Equipment/Location Evaluations

After you add equipment and locations to an RCM Analysis, you can define criteria for evaluating each piece of equipment or location in the future to determine the status of the piece of equipment or location and its failures. Note that the piece of equipment or location can be represented by either an [RCM FMEA Asset record](#) itself or a [related Equipment or Functional Location record](#), depending on whether or not the [RCM FMEA Asset record has been linked to an Equipment or Functional Location record](#).

Two types of evaluations can be created for each piece of equipment or location:

- A date-based evaluation, where email messages are sent on a one-time or recurring basis and are triggered when the current date and time match the date and time specified in the evaluation criteria.
- An event-based evaluation, where email message are sent when the piece of equipment or location meets the failure cost and/or count criteria specified for the evaluation.

Note: Configuring an event-based evaluation at an equipment/location level results in the same functionality as configuring an event-based evaluation at the [recommendation](#) level for the piece of equipment or location that is related to that recommendation. Both options will use the Evaluation Query to evaluate failures for that piece of equipment or location. The only difference you will see is in the text of the email message that is sent. If you set it up at the *equipment/location* level, the message will indicate that the piece of equipment or location needs to be reviewed. If you set up the evaluation at the *recommendation* level, the message will indicate that the recommendation needs to be reviewed. It is up to you to determine if you want to create the event-based evaluation at the equipment/location level or the recommendation level. Your decision will probably depend on whether you want the email recipients to evaluate the entire piece of equipment or location or the specific recommendation.

When an email message is sent, it will contain the following information:

- The ID of the RCM FMEA Asset record that identifies the piece of equipment or location for which the evaluation was configured.
- A statement indicating that the specified piece of equipment or location needs to be reviewed.
- A hyperlink that will open on the **RCM Explorer** page the RCM Analysis to which the specified piece of equipment or location belongs.

Note that the content for date-based and event-based evaluation email is the same and cannot be customized.

About Recommendation Evaluations

After you create Recommendation records for an RCM Analysis, you can define criteria for evaluating each recommendation in the future to determine:

- How valid the original recommendation was.
- Whether the recommendation needs to be modified.
- Whether additional recommendations should be created based on the validity of a given recommendation.

Two types of evaluations can be created for each recommendation:

- A date-based evaluation, where email messages are sent on a one-time or recurring basis and are triggered when the current date and time match the date and time specified in the evaluation criteria.
- An event-based evaluation, where email messages are sent when the piece of equipment or location related to the recommendation meets the failure cost and/or count criteria specified for the evaluation.

Note: Configuring an event-based evaluation at a recommendation level results in the same functionality as configuring an event-based evaluation at the [equipment/location level](#) for the piece of equipment or location that is related to that recommendation. Both options will use the Evaluation Query to evaluate failures for that piece of equipment or location. The only difference you will see is in the text of the email message that is sent. If you set up the evaluation at the *recommendation* level, the message will indicate that the recommendation needs to be reviewed. If you set it up at the *equipment/location* level, the message will indicate that the piece of equipment or location needs to be reviewed. It is up to you to determine if you want to create the event-based evaluation at the recommendation level or the equipment/location level. Your decision will probably depend on whether you want the email recipients to evaluate the specific recommendation or the entire piece of equipment or location.

When an email message is sent, it will contain the following information:

- The ID of the RCM FMEA Recommendation record for which the evaluation was configured.
- A statement indicating that the specified recommendation needs to be reviewed.
- A hyperlink that will open on the **RCM Explorer** page the RCM Analysis to which the specified Recommendation record belongs.

Note that the content for date-based and event-based evaluation email is the same and cannot be customized.

About Date-Based Evaluations

A date-based evaluation is an evaluation that triggers an email message to be sent one time or on a recurring basis, according to the schedule that you define. With date-based evaluations, the *only* criteria that must be defined are date and time. Therefore, you can [set up date-based evaluations](#) if you want to review an analysis, equipment or location, or recommendation on a specific date or on a specific schedule.

When you create a date-based evaluations, you define a Next Evaluation Date. When the RCM/FMEA Evaluation scheduled item is executed, an email message will be generated for every item whose date-based criteria indicates that it is due for evaluation.

If you set up date-based evaluation criteria to generate a one-time evaluation email, after the message has been sent, no additional messages will be sent. For example, suppose you configure a one-time date-based evaluation for an RCM Analysis and enter a Next Evaluation Date of 5/15/2010. If the RCM/FMEA Evaluation scheduled item is executed on 5/14/2010, a message will not be sent. If, however, the scheduled item is executed on 5/15/2010, a message will be sent. If the scheduled item is executed again a day later on 5/16/2010, another message will not be sent.

Note: After a message for a one-time date-based evaluation is sent, the evaluation criteria will continue to be stored in the record, but no additional messages will be sent. To re-enable the evaluation and send a new message, you must [modify the evaluation criteria](#) in some way.

You can also specify that you want to evaluate an analysis, the piece of equipment or location, or recommendation on a recurring schedule. For recurring, date-based evaluations, after the scheduled item is executed the first time, the Next Evaluation Date is updated in both the record (e.g., RCM FMEA Analysis record) and in the scheduled item, according to the interval that you define. The scheduled item is then executed on the next evaluation date, after which the Next Evaluation Date is updated again, and so on, indefinitely or until you [disable evaluations](#).

For example, you may want to implement a policy such that all recommendations should be reviewed six months after they are created. In this case, a one-time, date-based evaluation would be appropriate. Or you may want recommendations to be reviewed once every year, in which case you would use a recurring, date-based evaluation. Regardless of the desired schedule, as long as date and time are the only criteria that must be met, you can set up a date-based evaluation.

Setting up a Date-Based Evaluation

A date-based evaluation is an evaluation that will be sent one time or on a recurring basis, according to the schedule that you define. In date-based evaluations, the *only* criteria that must be met are date and time. Therefore, you can set up date-based evaluations if you want to review an analysis, piece of equipment or location, or recommendation on a specific date or on a specific schedule. For example, you may want to implement a policy that all recommendations should be reviewed six months after they are created. Or you may want recommendations to be reviewed once every year. Regardless of the desired schedule, as long as date and time are the only criteria that must be met, you can set up a date-based evaluation.

To set up a date-based evaluation:

1. [Open the desired analysis.](#)
2. Expand the analysis hierarchy until you find the node for which you want to set up evaluation criteria.
3. Select the node, and then on the **Analysis Tasks** menu, click the **Set Up Evaluation** link.

The **Set Up <Node> Evaluation** dialog box appears, where <Node> is the type of node that is currently selected in the **RCM Explorer** pane.

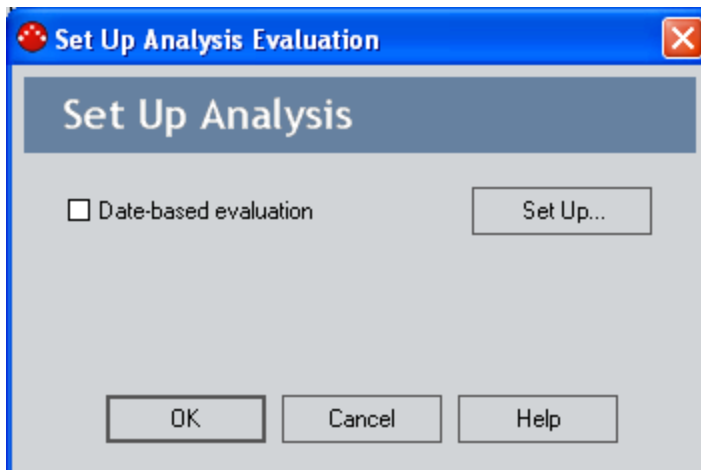

4. Select the **Date-based evaluation** check box.

The **Date-Based Evaluation** dialog box appears.

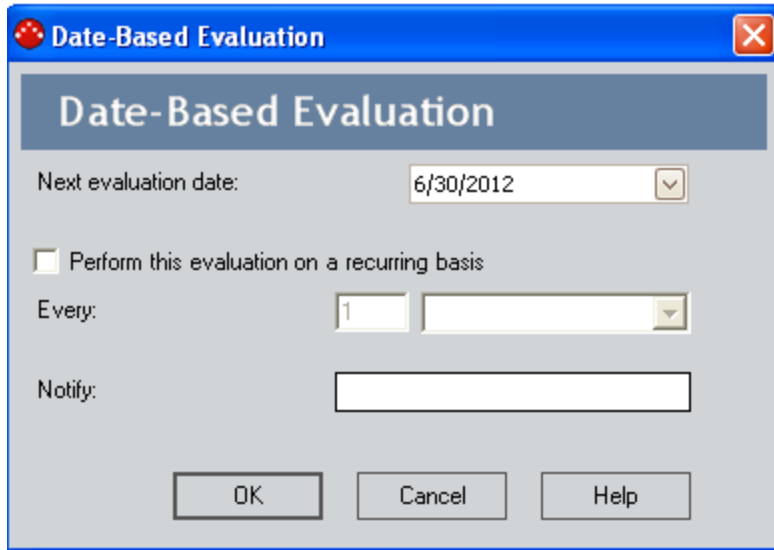

5. In the **Next evaluation date** text box, type the next date for the evaluation to occur. Note that:
 - If you are defining criteria for a one-time, date-based evaluation, the **Next evaluation date** represents the one-and-only date and time that the evaluation email message will be sent.
 - If you are defining criteria for a recurring evaluation, the **Next evaluation date** represents the *first* date and time that the evaluation email message will be sent. Subsequent messages will be sent at intervals defined in the **Every** fields. Each time an evaluation message is sent, the **Next evaluation date** will be incremented according to the specified interval. The updated value can be viewed on the **Evaluation** tab of the **FMEA Recommendation** datasheet and on the **Date-based Evaluation** dialog box. The time, however, will always be the same as what you first set in the **Next evaluation date** field.
6. If you want the evaluation to be performed on a recurring basis:
 - a. Select the **Perform this evaluation on a recurring basis** check box. Doing so will enable the **Every** fields.
 - b. In the **Every** text box, type a value representing the interval on which the re-evaluation should occur.
 - c. In the list to the right of the text box, select a unit of time (Days, Weeks, Months, or Years) to define the specified interval.

For example, if you type **6** and select **Months**, the evaluation email will be sent first on the **Next evaluation date** and then every six months after that.
7. In the **Notify** text box, type the email address to which the evaluation email should be sent. You must supply a valid email address in order to set up a functional evaluations.

Note: If you are defining both date-based and event-based evaluation criteria, the email address for both must be the same. This is because the record contains one email address field that is used by both evaluation types. For this same reason, if you have already defined event-based evaluation criteria for an item, the email address that you specified for the event-based evaluation will appear in the **Notify** field on the **Date-based evaluation** dialog box.

8. Click **OK**.

The evaluation criteria are saved, and the **Date-based Evaluation** dialog box closes. Note that the **Date-based evaluation** check box is selected on the **Set Up Recommendation** dialog box, indicating that date-based criteria have been defined.

9. Click **OK** to close the **Set Up <Node> Evaluation** dialog box.

-or-

Select the **Event-based evaluation** check box to [define event-based evaluation criteria](#).

About Event-Based Evaluations

If your RCM system has been properly configured and your RCM Analysis contains all the necessary components, it will contain RCM FMEA Asset nodes that are linked to Equipment or Functional Location records, and each RCM FMEA Recommendation record will be associated with a specific piece of equipment or location. By setting up event-based evaluation criteria, you can configure the Meridium APM system to send evaluation email messages based on the failure data that is associated with that piece of equipment or location. Specifically, event-based evaluations let you specify that when a given piece of equipment or location exceeds a certain number of failures or a certain failure cost, an email message should be sent to the specified person.

Event-based evaluation scheduled items are executed for the *first* time on the **Starting from** date, which you define when you [set up the event-based evaluation](#). After that, they will be executed daily, at the *time* specified in the **Starting from** field. Each time the Meridium APM system runs an event-based evaluation scheduled item, it executes the [Evaluation query](#) and sends an email message only if the Count and Cost returned by the query are greater than the count and cost defined in the event-based evaluation criteria.

Setting Up an Event-Based Evaluation

If your RCM system has been properly configured and your RCM Analysis contains all the necessary components, it will contain RCM FMEA Asset records (which can be linked to Equipment or Functional Location records), and each RCM FMEA Recommendation record will be associated with a specific piece of equipment or location. By setting up event-based evaluation criteria, you can configure the Meridium APM system to send evaluation email messages based on the failure data that is associated with a piece of equipment or location. Specifically, event-based evaluations let you specify that when a given piece of equipment or location exceeds a certain number of failures or a certain failure cost, and email should be sent to the specified person.

Note: For event-based evaluations to work properly, the [Evaluation query](#) must first be created and defined. These instructions assume that the Evaluation query has already been set up.

To defined event-based evaluation criteria:

1. [Open the desired analysis](#).
2. Expand the analysis hierarchy until you find the RCM FMEA Asset node or the Recommendation node for which you want to set up evaluation criteria.
3. Select the desired node, and then on the **Analysis Tasks** menu, click the **Set Up Evaluation** link.

The **Set Up <Node> Evaluation** dialog box appears, where **<Node>** is the type of node that is currently selected in the **RCM Explorer** pane.

4. Select the **Event-based evaluation** check box.

The **Event-Based Evaluation** dialog appears.

5. If you want to send evaluation email messages based on the number of failures that occur for a given piece of equipment or location, select the **Failure count greater than** check box, and in the text box, type the number of failures that must occur before an evaluation email message will be sent to the email address specified in the **Notify** field.

CEHint: Accept the default value of **0** (zero) if you want the first failure to trigger a evaluation message.

6. If you want to send evaluation email messages based on the total failure cost associated with a piece of equipment or location, select the **Failure cost greater than** check box, and in the text box, type a value representing the failure cost that must be exceeded before an evaluation email message will be sent.

CEHint: Accept the default value of **0** (zero) if you want any failure cost to trigger an evaluation message.

7. In the **Starting from** box, type the date after which you want to start counting failures and adding up failure costs. When the RCM/FMEA Evaluation scheduled item is run, it will take into consideration only the failures that occurred on this date and later.

Note: Unlike date-based evaluations, which are executed according to a schedule that you define and will result in the generation of a message each time they are run, event-based evaluations are run for the *first* time on the **Starting from** date. After that, they will be executed daily, at the *time* specified in the **Starting from** field. Each time the RCM/FMEA Evaluation scheduled item is run, it executes the [Evaluation query](#) and sends a message only if the count and cost returned by the query are greater than the count and cost defined in the event-based evaluation criteria.

8. In the **Notify** text box, type the email address to which the evaluation email should be sent. While Meridium APM performs no validation on this field, you must supply a valid email address in order to set up a functional evaluation.

Note: If you are defining both date- and event-based evaluation criteria, the email address for both has to be the same. This is because the records contain one email address field that is used by both evaluation types. For this same reason, if you have already defined date-based evaluation criteria for a record, the email address that you specified for the date-based evaluation will appear in the **Notify** field on the **Event-based evaluation** dialog box.

9. Click **OK**.

The evaluation criteria are saved, and the **Event-based Evaluation** dialog box closes. Note that the **Event-based evaluation** check box is selected on the **Set Up <Node> Evaluation dialog box**, indicating that event-based criteria have been defined.

10. Click **OK** to close the **Set Up <Node> Evaluation dialog box**.

-or-

Select the **Date-based evaluation** check box to [define date-based evaluation criteria](#).

Modifying Evaluation Criteria

You can use the following instructions to modify the date- or event-based evaluation criteria that you have already defined.

To modify existing evaluation criteria:

1. [Open the desired analysis.](#)
2. Expand the analysis hierarchy until you find the node for which you want to set up evaluation criteria.
3. Select the desired node, and on the appropriate **Analysis Tasks** menu, click the **Set Up Evaluation** link.

The **Set Up <Node> Evaluation** dialog box appears, where **<Node>** is the type of node that is currently selected in the **RCM Explorer** pane.

4. Click the **Set Up** button to the right of the criteria that you want to modify.
5. The [Date-based Evaluation](#) or [Event-based Evaluation](#) dialog box appears, as appropriate.
6. Modify the criteria, as desired.

Note: Keep in mind that if both types of criteria are set, modifying the email address for one will also modify the email address for the other. Note also that modifying the email address may re-trigger one-time, date-based evaluations that have already been executed.

7. When you are finished modifying the criteria, click **OK** to save your changes.

Disabling Recurring Evaluations

After you define evaluation criteria for a analysis, piece of equipment or location, or recommendation, the criteria will continue to be stored in the corresponding record until you clear the values manually. The criteria will continue to trigger evaluation email only as long as the evaluations are enabled. To disable evaluations, simply clear the check boxes on the **Set Up <Node> Evaluation** dialog box appears, where **<Node>** is the type of node that is currently selected in the **RCM Explorer** pane.

While this will not clear the evaluation criteria, it will discontinue the evaluation email.

About the Catalog Folder Structure for RCM Reports

RCM uses the Catalog folder structure to determine which reports to display where throughout the RCM interface. You will need to understand how the folder structure is used in order to interpret the reports that appear when you are viewing an analysis and to know where to store custom reports, depending on where you want them to be available.

The following table provides a list and description of the RCM folders that exist by default in the Catalog.

Folder	Behavior and Usage
\\Public\Meridium\Modules\RCM	Used to store generic reports related to RCM Analyses. The reports stored in this folder will appear on the RCM Reports page .
\\Public\Meridium\Modules\RCM\Analysis	Used to store reports related to the RCM Analysis node, which is the root-level node in an RCM Analysis. These reports appear on the Analysis Reports menu when you select the Analysis node in the RCM Explorer pane . Several baseline reports are provided in this folder.
\\Public\Meridium\Modules\RCM\Effect	Used to store reports related to the RCM FMEA Failure Effect records in an RCM Analysis. These reports appear on the Effect Reports menu when you select the Failure Effect node in the RCM Explorer pane .
\\Public\Meridium\Modules\RCM\Equipment List	Used to store reports related to the RCM FMEA Asset records in an RCM Analysis.

Folder	Behavior and Usage
\\Public\Meridium\Modules\RCM\Failure	Used to store reports related to the RCM Functional Failure records in an RCM Analysis. These reports appear on the Failure Reports menu when you select the Functional Failure node in the RCM Explorer pane .
\\Public\Meridium\Modules\RCM\Function	Used to store reports related to the RCM Function records in an RCM Analysis. These reports appear on the Function Reports menu when you select the Function node in the RCM Explorer pane .
\\Public\Meridium\Modules\RCM\Mode	Used to store reports related to the RCM FMEA Failure Mode records in an RCM Analysis. These reports appear on the Mode Reports menu when you select the Failure Mode node in the RCM Explorer pane .
\\Public\Meridium\Modules\RCM\Recommendation	Used to store reports related to the RCM FMEA Recommendation records in an RCM Analysis. These reports appear on the Recommendation Reports menu when you select the Recommendation node in the RCM Explorer pane .
\\Public\Meridium\Modules\RCM\SSRS	Used to store reports that were used in a previous release. This Catalog folder and its contents are not used by the Meridium APM product.

Baseline RCM Reports

By default, the baseline RCM product contains a set of pre-configured reports for use with RCM. If desired, you can customize these reports or use them as the basis for creating your own reports. The following table contains a list and description of the baseline RCM reports that are delivered with the baseline RCM product. Note that the **Stored In** column contains an abbreviated Catalog path, where each of the folders is a subfolder within the Catalog folder \\Public\Meridium\Modules.

In this table, the values listed in the **Report** column refer to the report *names*. The baseline captions are the same as the names.

Note that the Catalog folder \\Baseline\Meridium\Modules contains subfolders that match the folders listed in the table. These folders contain copies of the reports that are delivered as baseline RCM content. The items in the \\Baseline folder cannot be modified and serve as a historical record of the items that were delivered with the baseline product. The Meridium APM system *reads* from the [subfolders in the \\Public folder](#), so the reports in the Baseline folder are not actually used. The \\Baseline folder will be updated with any changes made to the baseline content in future releases.

Note: Because these reports provide a formatted view of the information stored in your analyses, for them to work properly, your analyses must contain accurate, complete data. In addition, note that for complex analyses, the reports may span multiple pages.

Report	Stored In	Behavior and Usage
RCM Analysis Description	RCM\Analysis	<p>Provides an overview of the analysis, including the analysis name, analysis description, and a list of the team members and equipment and locations associated with the analysis.</p> <p>This report contains three sections of information:</p> <ul style="list-style-type: none"> • The report header, which contains identifying information about the analysis. • The Associated Assets section, which contains a list of all the equipment and location associated with the Analysis, grouped by equipment or location type. • The Team Member section, which contains a list of analysis team members that is generated by the report <i>RCM AnalysisTeamSubReport</i>, sorted by last name, first name, and then middle initial.
RCM AnalysisTeamSubReport	RCM	<p>Used by the report <i>RCM Analysis Description</i> to insert a list of team members involved in the analysis. Note that although this report is stored in the folder \\Public\Meridium\Modules\RCM, the Meridium APM system is hard coded not to display this report on the RCM Reports page.</p>
RCM FailureModeEffectsAnalysis	RCM\Analysis	<p>Provides details of the functions, functional failures, failure modes, and failure effects associated with a given RCM Analysis.</p>

Report	Stored In	Behavior and Usage
RCM Recommendations	RCMAnalysis	Provides details about each recommendation for all the failure modes in the analysis. Additional, related information such as Consequence and calculated Ranking are also included in the report to provide context for reviewing recommendations.

Failure Finding Activity

When you define an [RCM](#) recommendation and specify the Action Type as Failure Finding, you can use the Failure Finding Activity cells, shown in the following image, to calculate the failure finding task interval (FFI).

The screenshot shows the 'RCM Explorer' interface for an 'RCM FMEA Recommendation (RCM FMEA Recommendation)' with a state of 'Proposed'. The 'Action Information' tab is active, displaying a table for configuring the 'Failure Finding Activity'. The table includes fields for Action Type, Interval, Interval Units, Nonrecurring, Performance Interval, Performance Interval Units, Estimated Cost, Estimated Cost Basis, Recommended Resource, and a section for Failure Finding Activity parameters: MMF, MTIVE, MTED, n, FFI (0.000 Years), Display FFI Units As (Years), and Use Calculated FFI Results.

	Value(s)
Action Type	Failure Finding (FF)
Interval	
Interval Units	
Nonrecurring	<input type="checkbox"/>
Performance Interval	
Performance Interval Units	
Estimated Cost	
Estimated Cost Basis	
Recommended Resource	
Failure Finding Activity	
MMF	
MTIVE	
MTED	
n	
FFI	0.000 (Years)
Display FFI Units As	Years
Use Calculated FFI Results	<input type="checkbox"/>

The following equation is used to calculate FFI:

$$FFI = MTIVE \times [(n + 1)(MTED)/MMF]^{1/n}$$

Note that the information used for the FFI calculation is based upon the concepts in SAE Standard JA1012, "A Guide to the Reliability-Centered Maintenance (RCM) Standard." The process and terminology used in the FFI calculation are described in more detail in this standards document. To use the Failure Finding Activity cells effectively, you will need to be familiar with this standard.

In addition, the FFI calculation is based upon information in the book "Reliability-Centered Maintenance" by John Moubray.

The following table describes the Failure Finding Activity cells in the Meridium APM Framework.

Cell	Description
MMF	<p>Stores the mean time between <i>multiple failures</i>.</p> <p>For example, a 1 in 1,000,000 probability of a multiple failure in one year implies a mean time between failures of 1,000,000 years.</p> <p>The probability of multiple failures occurring in any one year is 1/MMF.</p>
MTIVE	<p>Stores the mean time between failures of the <i>protective device</i>.</p>
MTED	<p>Stores the mean time between failures of the <i>protected function</i>.</p> <p>For example, if the demand rate of the protected function is once in 200 years, this equals a probability of failure for the protected function of 1 in 200 in any one year, or a mean time between failures of the protected function of 200 years.</p> <p>The probability of failure of the protected function in any one year is 1/MTED.</p>
n	<p>The number of <i>protective devices</i>.</p>

System Code Tables Used by RCM

The following System Code Tables are used by RCM.

Table ID	Table Description	Function
MI_FUNCTION_SUB_TYPE	Function Sub Types	Used to populate the Sub Function list in RCM Function records.
MI_FUNCTION_TYPE	Function Type	Used to populate the Function Type list in RCM Function records.
SC_RECOM_RESOURCE	Recommended Resource	Used to populate the Recommended Resource list in RCM FMEA Recommendation records.

URL Paths for RCM Features

The following table lists and describes the paths for accessing features in RCM. Note that to construct a valid URL, you must prepend **meridium://** to the paths listed in the following table. In some cases, you must define parameters after the path in order to create a functional link.

Note that there is one root address only for each RCM or FMEA feature, and the root address accepts parameters that let you determine whether the feature will be specific to RCM or FMEA. If you do not specify a parameter where a parameter is accepted, the root address will launch the feature for RCM and not FMEA. To launch the feature for FMEA, you must expand the root address by adding parameters.

Feature	URL Path	Description
Start Page	RCM	Displays the RCM Start Page .
Administration Page	RCM/Admin	Displays the RCM Administration page.
Manage Tasks Page	RCM/Approver	Displays the RCM Manage Tasks .
Analysis List	RCM/Find	Displays the RCM Analysis List page, from which you can open an existing analysis.
Recent Analyses	RCM/Recent	Displays the RCM Recently Used Analyses page, from which you can open an existing analysis.
Templates	RCM/Templates	Displays the RCM Templates page, where you can use templates to create a new analysis or analysis node. In addition to the Type parameter, this path accepts parameters that let you customize the URL.
Reports	RCM/Report	Displays the RCM Reports page, where you can view a list of reports that have been configured for RCM.
Team Member and Asset Lists	RCM/List	Displays the RCM Team Members or RCM Asset List page.
Explorer	RCM/Explorer	Serves as the path for accessing the RCM Explorer page. In addition to the Type parameter, the path <i>requires</i> parameters which allow you to create a new analysis or load an existing analysis.

Parameters for the Start Page URL

The URL for accessing the **RCM Start Page** is `meridium://RCM`. A link constructed from this path with no parameters will display the **RCM Start Page**.

Note: This path accepts one [parameter that lets you modify the URL to access the FMEA Start Page](#).

Examples of the Start Page URL

- meridium://RCM

Displays the **RCM Start Page**.

Parameters for the Administration Page URL

The URL for accessing the **RCM Administration** page is `meridium://RCM/Admin`. A link constructed from this path with no parameters will display the **RCM Administration** page.

Note: This path accepts one [parameter that lets you modify the URL to access the FMEA Administration page](#).

Examples of the Administration Page URL

- meridium://RCM/Admin

Displays the **RCM Administration** page.

Parameters for the Manage Tasks URL

The base URL for the **RCM Manage Tasks** page is `meridium://RCM/Approver`. A link constructed from the base URL with no parameters will display the **RCM Manage Tasks** page.

Note: This path accepts one [parameter that lets you modify the URL to access the FMEA Manage Tasks page](#).

Examples of the Manage Tasks URL

- meridium://RCM/Approver

Opens the **RCM Manage Tasks** page, which displays a list of RCM Analyses that have associated Task records.

Parameters for the Analysis List URL

The URL for accessing the **RCM Analysis List** page is **meridium://RCM/Find**. A link constructed from this path with no parameters will display the **RCM Analysis List** page.

Note: This path accepts one [parameter that lets you modify the URL to access the FMEA Analysis List page](#).

Examples of the Analysis List URL

- meridium://RCM/Find

Displays the **RCM Analysis List** page, from which you can open an existing RCM Analysis in the RCM Explorer.

Parameters for the Recently Used Analyses URL

The URL for accessing the **RCM Recently Used Analyses** page is **meridium://RCM/Recent**. A link constructed from this path with no parameters will display the **RCM Recently Used Analyses** page.

Note: This path accepts one [parameter that lets you modify the URL to access the FMEA Recently Used Analyses page](#).

Examples of the Recently Used Analyses URL

- meridium://RCM/Recent

Displays the **RCM Recently Used Analyses** page, where you can open an existing analysis in the RCM Explorer.

Parameters for the Templates URL

The URL for accessing the **RCM Templates** page is `meridium://RCM/Templates`. A link constructed from this path with no parameters will display the **RCM Templates** page. The path accepts the following additional parameters.

Note: This path also accepts the Type [parameter that lets you modify the URL to access the FMEA Templates page](#).

Parameter Name	Description	Accepted Value(s)	Notes
AnalysisKey	The Entity Key of the analysis to which the entity identified by the SelectedKey value is linked.	A numeric Entity Key.	This parameter is required whenever you want to use a Template to create a new analysis node. Whenever you specify the SelectedKey parameter, you must also use the AnalysisKey parameter, even if the AnalysisKey and the SelectedKey are the same value (i.e., if you are loading templates to link to the analysis node).
SelectedKey	The Entity Key of the entity to which you want to link a new analysis node.	A numeric Entity Key.	This parameter is required whenever you want to use a Template to create a new analysis node. Whenever you specify the SelectedKey parameter, you must also use the AnalysisKey parameter.

Examples of the Templates URL

- `meridium://RCM/Templates`

Displays the **RCM Templates** page. Note that accessing the **RCM Templates** page in this way is like accessing it from the **RCM Start Page**, where you can find analysis templates and use them to create a new RCM Analysis. Note that because the Context parameter has been omitted, clicking a hyperlinked Template ID will load the analysis template on the **RCM Explorer** page.

- `meridium://RCM/Templates?SelectedKey=1234567&AnalysisKey=2345678`

Opens the **RCM Templates** page, where you can search for templates that can be linked to the record identified by the key 1234567. For example, if entity 1234567 is a Failure Mode record, you would want to find Failure Effect templates. From the list of templates, you can click a hyperlinked Template ID to open analysis 2345678 on the **RCM Explorer** page, where a new analysis node, based on the selected template, will be linked to entity 1234567.

Parameters for the Reports URL

The URL for accessing the **RCM Reports** page is **meridium://RCM/Report**. A link constructed from this path with no parameters will display the **RCM Reports** page.

Note: This path accepts one [parameter that lets you modify the URL to access the FMEA Reports page](#).

Examples of the Reports URL

- meridium://RCM/Report

Displays the **RCM Reports** page, where you can view a list of reports that have been configured for RCM Analyses and are stored in the **Public\Meridium\Modules\RCM** folder in the Catalog.

Parameters for the Team Members and Asset List URL

The base URL for accessing the **RCM Team Members** or **RCM Asset List** pages is **meridium://RCM/List**. This URL accepts the parameters described in the following table. Note that a URL constructed from the path with NO parameters is invalid.

Parameter Name	Description	Accepted Value(s)	Notes
Analysis	Specifies the analysis for which you want to open the team member or equipment and location list.	The Entity Key of the desired analysis.	This parameter must be used in conjunction with the ListType parameters.
ListType	Lets you specify what you want to set up for a given analysis.	Equipment Team	This parameter should be used in conjunction with the Analysis parameter. These parameter values are case sensitive.

Examples of the Team Members and Asset List URL

- <meridium://RCM/List?Analysis=64251517623&ListType=Team>

Opens the **RCM Team Members**, where you can set up the Analysis Team for the analysis with the Entity Key 64251517623.

- <meridium://RCM/List?Analysis=64251517623&ListType=Equipment>

Opens the **RCM Asset List** page, where you can set up the equipment and location list for the RCM Analysis with the Entity Key 64251517623.

Parameters for the Explorer URL

The URL for accessing the **RCM Explorer** page is `meridium://RCM/Explorer`. Note that the URL path alone is not a valid URL. Use the information in the following table to choose parameters that will allow you to construct a functional link.

Note: This path also accepts the Type [parameter that lets you modify the URL to access the FMEA Explorer page](#).

Parameter Name	Description	Accepted Value(s)	Notes
DatasheetID	Specifies the datasheet that should be displayed on the RCM Explorer page.	The Data-sheet ID of the desired datasheet.	The Datasheet ID must correspond to a datasheet that has been defined for the specified family. If you omit this parameter, the default datasheet will be used. This parameter is optional.
EntityKey	Specifies the Entity Key of the record that you want to open on the RCM Explorer page.	The numeric Entity Key of the entity that you want to open.	This parameter value should correspond to an entity belonging to the family identified by the FamilyKey parameter. <i>This parameter is required</i> whenever you are loading an existing analysis.
FamilyKey	Specifies the Family Key for record(s) that you want to open on the RCM Explorer page.	The numeric Family Key of any family involved in an RCM Analysis.	This parameter specifies the Family Key of each <i>root</i> record. The Family Key that you specify should correspond to the EntityKey parameter value. <i>This parameter is required</i> whenever you are loading an existing analysis.
Mode	Used for creating a new analysis.	Create	This parameter is <i>required</i> whenever you want to load a new analysis on the RCM Explorer page.

Examples of the Explorer URL

- **meridium://RCM/Explorer?Mode=Create**

Opens a new RCM Analysis on the **RCM Explorer** page.

- **meridium://RCM/Explorer?EntityKey=1234567&FamilyKey=2345678**

Opens the analysis with the Entity Key 1234567, which belongs to the family with the Family Key 2345678.

Failure Effect

In an RCM Analysis, the consequence of a failure occurring. Most RCM methodologies use failure effects to capture the safety, environmental, and economic (or production) impact associated with a failure.

Failure Mode

In an RCM Analysis, the cause of a functional failure.

Function

In an RCM Analysis, the definition of what the owner of the system wants to do. A system can have one or more functions, each of which is defined in a separate record.

Functional Failure

In an RCM Analysis, a way in which a function can fail.

RCM Analysis

A means for determining optimal maintenance and operational strategies based on the probability and consequence of the analyzed failure modes. A Meridium APM RCM Analysis consists of the following components:

- [Function](#)
- [Functional Failure](#)
- [Failure Mode](#)
- [Failure Effect](#)
- [Recommendation](#)

Recommendation

In an RCM Analysis, the recommended action to take for a failure effect. Generally, for the equipment or location and system owner, recommended actions should be designed to reduce to an acceptable level the probability and consequence of the related failure.

SAE Standards

Technical standards and recommended practices for the aerospace, automotive, and commercial-vehicle industries published by SAE International.

Overview of Failure Modes and Effects Analysis

Whereas an RCM Analysis evaluates a system with respect to its function for the purpose of determining how to avoid functional failures, a Failure Modes and Effects Analysis (FMEA) Analysis focuses on the equipment and locations themselves and analyzes how each piece of equipment or location can fail and the effect of each failure. In other words, an RCM Analysis is conducted for the purpose of maintaining the *function* of a system. An FMEA Analysis is conducted for the purpose of maintaining the system itself.

Specifically, FMEA is a method of identifying the potential failures of equipment and locations, describing the possible effect of each failure, and making recommendations for actions that can be taken to prevent the failures from occurring. In Meridium APM, an FMEA Analysis consists of the following components:

- **Asset:** After you create the root-level FMEA Analysis record, which serves as the base record to which all analysis nodes are linked, you can define equipment and locations, which define what is being analyzed by the FMEA Analysis. Each FMEA Analysis can have one or more pieces of equipment or locations, which are stored as RCM FMEA Asset records.

An FMEA Analysis can contain ["virtual"](#) equipment and locations, which are RCM FMEA Asset records that are not linked to Equipment or Functional Location records, and [actual](#) equipment and locations, which are RCM FMEA Asset records that *are* linked to Equipment or Functional Location records.

- **Failure Modes:** After you have defined the equipment and locations for an FMEA Analysis, you can define one or more failure modes for each piece of equipment and location. Failure modes describe the ways in which each piece of equipment and location failure is likely to occur and are stored in RCM FMEA Failure Mode records.
- **Failure Effects:** For each failure mode, you can then define failure effects, which describe the consequences of a failure occurring. Failure effects might describe the safety, environmental, and economic (or production) impact associated with a failure. In Meridium APM, you can define a Risk Matrix that will be available in the analysis and can help you define the effects of each failure mode.
- **Recommendations:** For each failure effect, one or more recommended actions can be defined and stored in an RCM FMEA Recommendation record. A Recommendation record defines what should be done to avoid the risk defined by the Failure Modes and failure effects. Recommendations can be determined, in part, using the Decision Tree document that has been set up for use with FMEA Analyses.

In addition, for each FMEA Analysis, you can define an FMEA team, which is a list of people who are involved in the analysis.

FMEA System Requirements

The *RCM and FMEA license* is required to take advantage of FMEA functionality. In addition, your system must contain the [basic Meridium APM system architecture](#).

After you have installed and configured the basic system architecture, you will need to [perform some configuration tasks](#) specifically for the FMEA module.

When the FMEA module is active, the Reliability Centered Maintenance (RCM) modules is also active. You will also need to [perform some configuration tasks specifically for RCM](#).

Overview of the FMEA Data Structure

Within the FMEA module uses families to represent the various components of an FMEA Analysis. Meridium APM leverages its fundamental entity and relationship family infrastructure to store data related to an FMEA Analysis.

Each FMEA Analysis is represented at the root level by an **RCM FMEA Analysis** family record. RCM Analyses use the same root analysis family. FMEA Analyses are distinguished from RCM Analyses via the **Analysis Type** field in the RCM FMEA Analysis record. The **Analysis Type** can be either **RCM** or **FMEA**. For an RCM FMEA Analysis that will be used for an FMEA Analysis, the **Analysis Type** is **FMEA**.

Note: Because both RCM and FMEA Analysis records belong to the same family, a query on the **RCM FMEA Analysis** family will return results that include all analyses of any type. To limit your results to include only one analysis type, you will need to include the **Analysis Type** field in your query and define criteria to filter on either **RCM** or **FMEA**.

For an FMEA Analysis (a record in which the **Analysis Type** is **FMEA**), the RCM FMEA Analysis record can be linked to RCM FMEA Asset records through the Has RCM FMEA Asset relationship. RCM FMEA Asset records can, in turn, be linked to RCM FMEA Failure Mode records through the Has RCM FMEA Failure Mode relationship, and so on, for all components of the analysis. Together, the root RCM FMEA Analysis record and all the records that are linked to it, either directly or indirectly, make up the FMEA Analysis.

Overview of the FMEA Data Model

The following table provides a summary of the entity families and relationship families that are used to develop an FMEA Analysis.

Records in this entity family:	...Can be linked to records in this entity family:	...Through a relationship definition on this relationship family:
RCM FMEA Analysis	RCM FMEA Asset	Has RCM FMEA Asset
RCM FMEA Asset	RCM FMEA Failure Mode	Has RCM FMEA Failure Mode
RCM FMEA Failure Mode	RCM FMEA Failure Effect	Has RCM FMEA Failure Effect
RCM FMEA Failure Effect	RCM FMEA Recommendation	Has RCM FMEA Recommendation

The following families and relationship are also used by FMEA but not within the analysis itself.

Records in this entity family:	...Can be linked to records in this entity family:	...Through this relationship:	Purpose
RCM FMEA Analysis	Human Resource	Has RCM FMEA Team Member	Facilitates the construction of the RCM Analysis Team Members list. Through this relationship, Human Resource records are linked directly to the RCM FMEA Analysis record.

Records in this entity family:	...Can be linked to records in this entity family:	...Through this relationship:	Purpose
RCM FMEA Analysis	RCM FMEA Task	Has Tasks	Allows Task records generated from Recommendation records to be linked to the RCM FMEA Analysis record for which the recommendation was created. Note that in the current version of Meridium APM, RCM FMEA Task records cannot be created from RCM FMEA Recommendation records. Instead, RCM FMEA Recommendation records can be used to create Action records in ASM. This relationship still exists, however, to support legacy RCM FMEA Task records.
RCM FMEA Recommendation	RCM FMEA Task	Has Tasks	Allows RCM FMEA Recommendation records to be linked to RCM FMEA Task records that are generated from those recommendations. Note that in the current version of Meridium APM, RCM FMEA Task records cannot be created from RCM FMEA Recommendation records. Instead, RCM FMEA Recommendation records can be used to create Action records in ASM. This relationship still exists, however, to support legacy RCM FMEA Task records.
RCM FMEA Asset	Asset Strategy	Has Strategy	Facilitates the promotion of RCM FMEA Asset records to Asset Strategy records via Recommendation Management. This link is established when an RCM FMEA Analysis is linked to a physical or "virtual" piece of equipment or location for which you have defined Recommendation records.

Records in this entity family:	...Can be linked to records in this entity family:	...Through this relationship:	Purpose
RCM FMEA Asset	Asset Strategy Template	Has Strategy	Facilitates the promotion of RCM FMEA Asset records to Asset Strategy Template records via Recommendation Management. This link is established when an RCM FMEA Analysis is linked to a "virtual" piece of equipment or location for which you have defined Recommendation records.
RCM FMEA Asset	RCM FMEA Task	Has Tasks	<p>Allows RCM FMEA Asset records to be linked to RCM FMEA Task records. This link is established only when a Task record is generated from a recommendation where the related RCM FMEA Asset record (i.e., the RCM FMEA Asset record that is linked to the RCM FMEA Analysis record) is not linked to an Equipment or Functional Location record.</p> <p>Note that in the current version of Meridium APM, RCM FMEA Task records cannot be created from RCM FMEA Recommendation records. Instead, RCM FMEA Recommendation records can be used to create Action records in ASM. This relationship still exists, however, to support legacy RCM FMEA Task records.</p>
RCM FMEA Asset	Task History	Has Task History	Facilitates the rejection of RCM FMEA Task records that are linked to RCM FMEA Asset records. When you reject an RCM FMEA Task record, a Task History record is created and linked to the RCM FMEA Asset record through the Has Task History relationship.

Records in this entity family:	...Can be linked to records in this entity family:	...Through this relationship:	Purpose
RCM FMEA Analysis	Has Templates	RCM FMEA Template	Facilitates the creation of RCM Templates.
RCM FMEA Asset	Has Templates	RCM FMEA Template	Facilitates the creation of RCM Templates.
RCM FMEA Failure Mode	Has Templates	RCM FMEA Template	Facilitates the creation of RCM Templates.
RCM FMEA Failure Effect	Has Templates	RCM FMEA Template	Facilitates the creation of RCM Templates.
RCM FMEA Recommendation	Has Templates	RCM FMEA Template	Facilitates the creation of RCM Templates.
RCM FMEA Recommendation	Mitigates Risk	Risk Assessment	Allows you to determine how a recommendation mitigates a risk.

Note also that the following families are related to the RCM FMEA Template family through the Has Templates relationship to facilitate the creation of FMEA Templates:

- RCM FMEA Analysis
- RCM FMEA Asset
- RCM FMEA Failure Effect
- RCM FMEA Failure Mode
- RCM FMEA Recommendation

When RCM FMEA Asset Records Are NOT Linked to Equipment or Functional Location Records

In an FMEA Analysis, the root-level Analysis node (i.e., the RCM FMEA Analysis record) can be linked to one or more RCM FMEA Asset records. Each RCM FMEA Asset record can be linked to an Equipment or Functional Location record. Alternatively, RCM FMEA Asset records can stand alone and not be linked to Equipment or Functional Location records to represent "virtual" equipment and locations. A given FMEA Analysis can contain both linked and unlinked RCM FMEA Asset records.

The following image provides a diagram of the relationships that will be created in an FMEA Analysis when an RCM FMEA Asset record is not linked to an Equipment or Functional Location record.

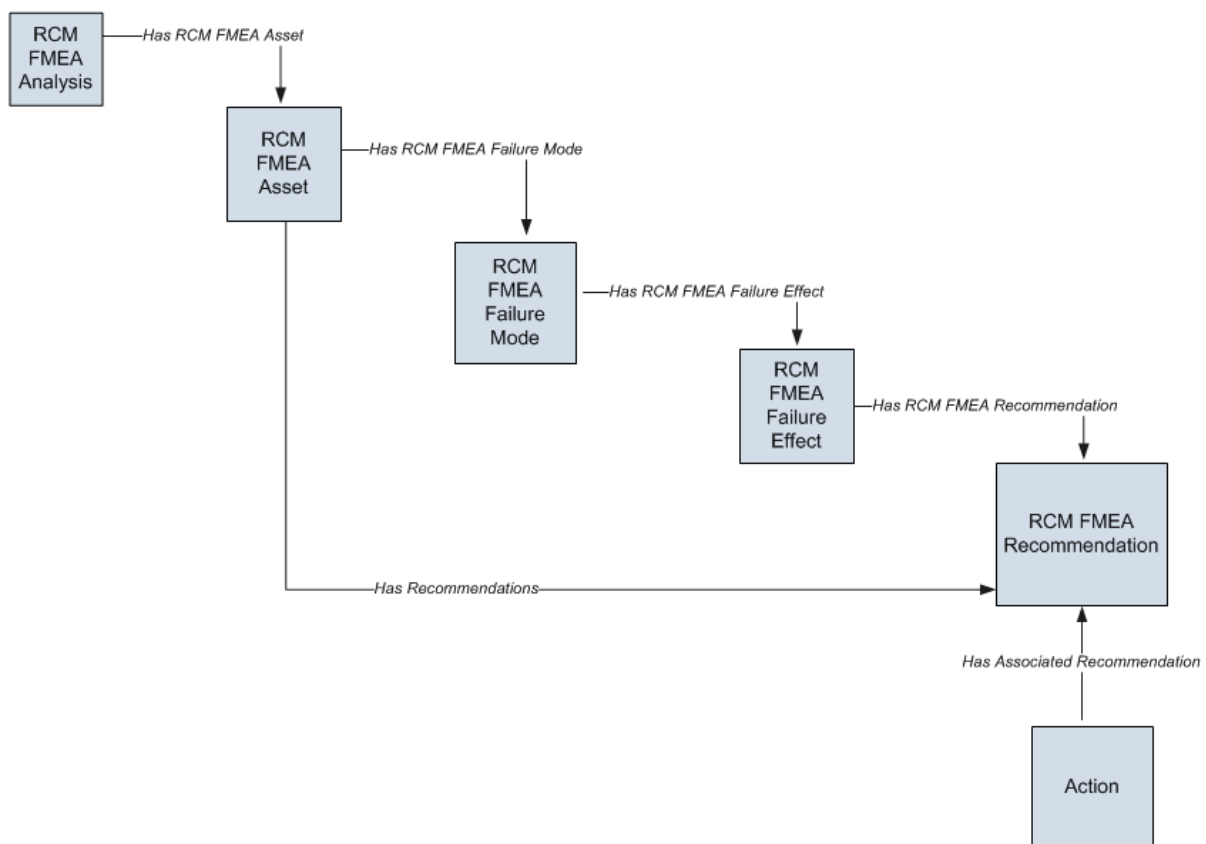

Note: While Human Resource records are not depicted in this diagram, they can be linked to the RCM FMEA Analysis record through the Has RCM FMEA Team Member relationship.

Note the following about the preceding image:

When RCM FMEA Asset Records Are NOT Linked to Equipment or Functional Location Records

- The RCM FMEA Asset box in the diagram represents a *single* RCM FMEA Asset record within an analysis. The RCM FMEA Analysis record can be linked to multiple RCM FMEA Asset records, each of which can optionally be linked to an Equipment or Functional Location record.
- In this scenario, where the RCM FMEA Asset record is not linked to an Equipment or Functional Location record, when an RCM FMEA Recommendation record is:
 - Created for the analysis, the Recommendation record is linked to the RCM FMEA Asset record.
 - Promoted to an Action record, the Action record will be linked to a Proposed Strategy record and associated with the RCM FMEA Asset record.

In addition to the families included in the preceding image, the following families are used by the Decision Logic Builder in FMEA.

- Decision Tree Consequence
- Decision Tree Response
- Decision Tree Structure

Within the baseline Meridium APM family hierarchy, these families are subfamilies of the Meridium Reference Tables family. Baseline records are provided in each of these families to support the Decision Logic Builder functionality.

When RCM FMEA Asset Records Are Linked to Equipment or Functional Location Records

The following image provides a diagram of the links that will be created for an FMEA Analysis when an RCM FMEA Asset record *is* linked to an Equipment or Functional Location record.

Note: All relationships depicted in the image are part of the Meridium APM baseline database.

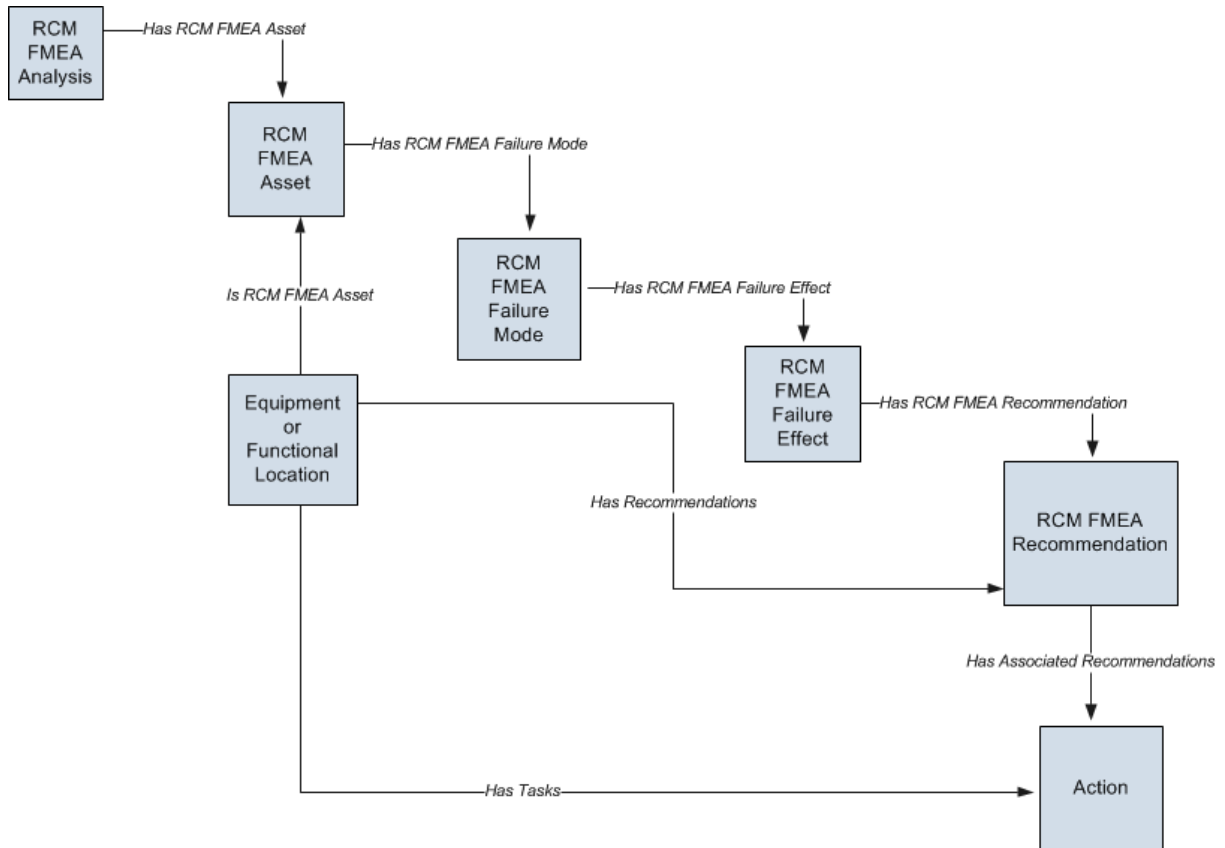

Note: While Human Resource records are not depicted in this diagram, they can be linked to the RCM FMEA Analysis record through the Has RCM FMEA Team Member relationship.

Note the following about the preceding image:

- The RCM FMEA Asset box in the diagram represents a *single* RCM FMEA Asset record within an analysis. The RCM FMEA Analysis record can be linked to multiple RCM FMEA Asset records, each of which can optionally be linked to an Equipment or Functional Location record.
- The Equipment or Functional Location box represents the Equipment or

Functional Location family for which the Is RCM FMEA Asset, Has Recommendations, and Has Tasks have been defined between that family and the specified predecessor or successor.

- In this scenario, where the RCM FMEA Asset record is linked to an Equipment or Functional Location record:
 - When an RCM FMEA Recommendation record is created for the analysis, the Recommendation record is linked to the Equipment or Functional Location record to which the RCM FMEA Asset record is linked.
 - When an RCM FMEA Recommendation record is promoted to an Action record, the Action record will be linked to a Proposed Strategy record and associated with the Equipment or Functional Location record. For details, see the ASM Help.

In addition to the families included in the preceding image, the following families are used by the Decision Logic Builder in FMEA:

- Decision Tree Consequence
- Decision Tree Response
- Decision Tree Structure

Within the baseline Meridium APM family hierarchy, these families are subfamilies of the Meridium Reference Tables family. Baseline records are provided in each of these families to support the Decision Logic Builder functionality.

Illustration of the FMEA Data Model Integrated with Asset Criticality Analysis

FMEA Analyses can be created automatically when an Asset Criticality Analysis System record is promoted from Asset Criticality Analysis (ACA) to FMEA. The following illustration shows how the families in the FMEA data model are related to the families in the ACA data model. In this illustration, the boxes represent entity families, and the arrows represent relationship families. You can determine the cardinality of a relationship by the direction of the arrow (i.e., the family to which the arrow points is the successor family).

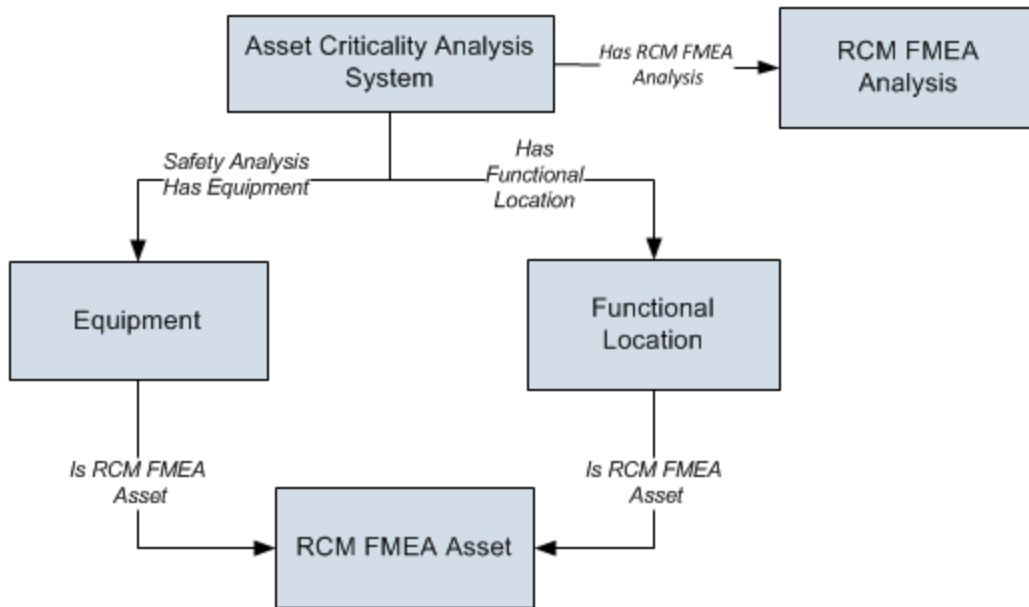

RCM FMEA Analysis State Configuration

By default, the following baseline State Configuration exists for the RCM FMEA Analysis family.

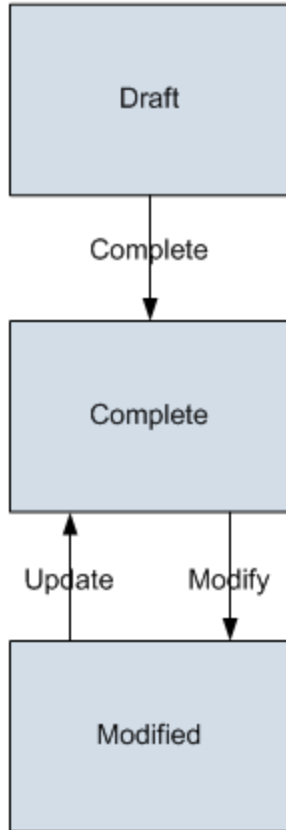

Initial State

The Draft state is the initial state of all new RCM FMEA Analysis records.

Datasheet Configuration

By default, states and operations will appear on the datasheet when you are viewing an RCM FMEA Analysis record in RCM, FMEA, the Record Manager, or the Bulk Data Form.

Reserved States and Operations

By default, NO states or operations displayed in the preceding diagram are reserved. This means that you can remove or modify any of these states or operation. You can also add your own states and operations to the State Configuration.

State Configuration Roles

By default, the MI RCM User State Configuration Role is assigned to all states in the RCM FMEA Analysis State Configuration. If desired, you can assign other State Configuration Roles to any state. In addition, for each state, the **Require a specific user to be assigned to a state** check box is *selected*.

About FMEA Recommendations

You can manage RCM FMEA Recommendation records in an FMEA Analysis using the following methods:

- On the **FMEA Explorer** page
- Via [the Recommendation Management feature](#)

Both methods use standard State Configuration functionality to control the available states and the operations that can be used to transition recommendations from one state to the next.

Via the **FMEA Explorer** page, you will have access only to *non-reserved* states and operations. The available operations will be displayed on the **Operations** submenu, which appears in the upper, right corner of the datasheet just as in the Record Manager. The following diagram shows the non-reserved baseline states that will be available on the **FMEA Explorer** page.

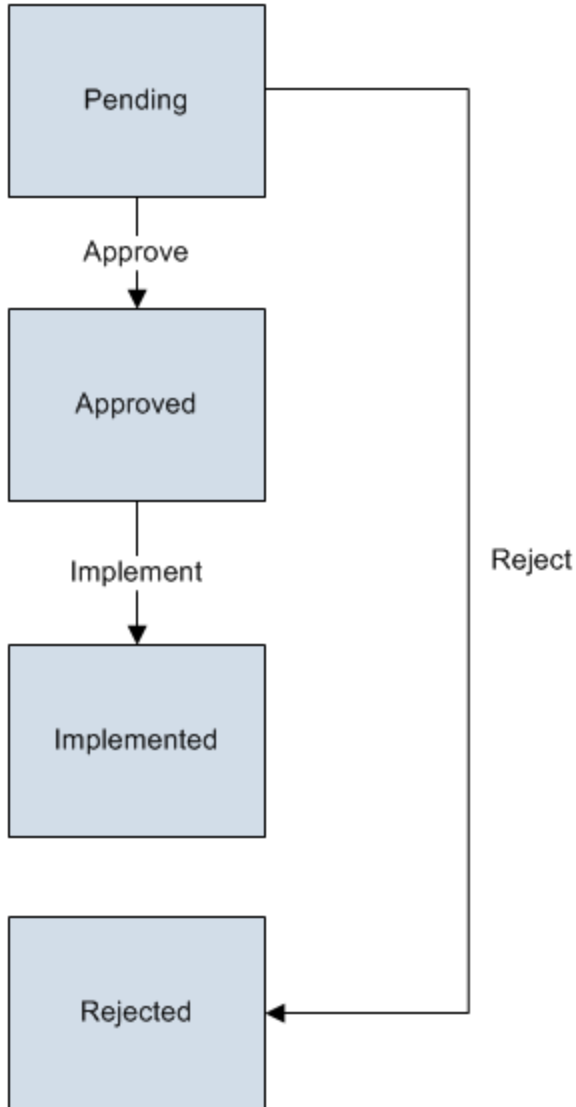

Note: This image shows the non-reserved states that are included in the State Configuration for the RCM FMEA Recommendation family in the baseline FMEA product. If custom non-reserved states have been added to your system, they too will be available from the **Operations** menu.

If you [manage recommendations via Recommendation Management](#), however, you will have access to both reserved and non-reserved states.

FMEA and the Record Manager

To ensure data integrity, records that make up analyses and templates in FMEA should be created and managed using only the tools provided in the FMEA module. Therefore, the Meridium APM system prevents you from creating or modifying certain records in the Record Manager.

While you *view* records in these families via the Record Manager, the datasheet will be disabled and a link will be displayed above the **Datasheet** list, which you can click to view in FMEA the corresponding analysis or template that includes that record. When you do so, that record will be selected in the explorer automatically. The text that appears for this link will vary for each record and is displayed in the format **<Record ID> (<Family Caption>)**, where **<Record ID>** is the ID for the record and **<Family Caption>** is the family caption of the family to which the record belongs. For example, the following image shows the link that appears above the **Datasheet** list in the Record Manager when you are viewing an RCM FMEA Failure Mode record.



The following list contains the families whose datasheet is disabled in the Record Manager:

- RCM FMEA Analysis
- RCM FMEA Asset
- RCM FMEA Failure Mode
- RCM FMEA Failure Effect
- RCM FMEA Recommendation
- RCM FMEA Recommendation
- RCM FMEA Template

Accessing the FMEA Start Page

The **FMEA Start Page** serves as the starting point for all tasks related to FMEA. The following instructions provide details on accessing the **FMEA Start Page**.

To access the **FMEA Start Page**:

- On the Meridium APM Framework main menu, click **Go To**, point to **Asset Strategy**, and then click **Failure Modes and Effects Analysis**.

The [FMEA Start Page](#) appears.

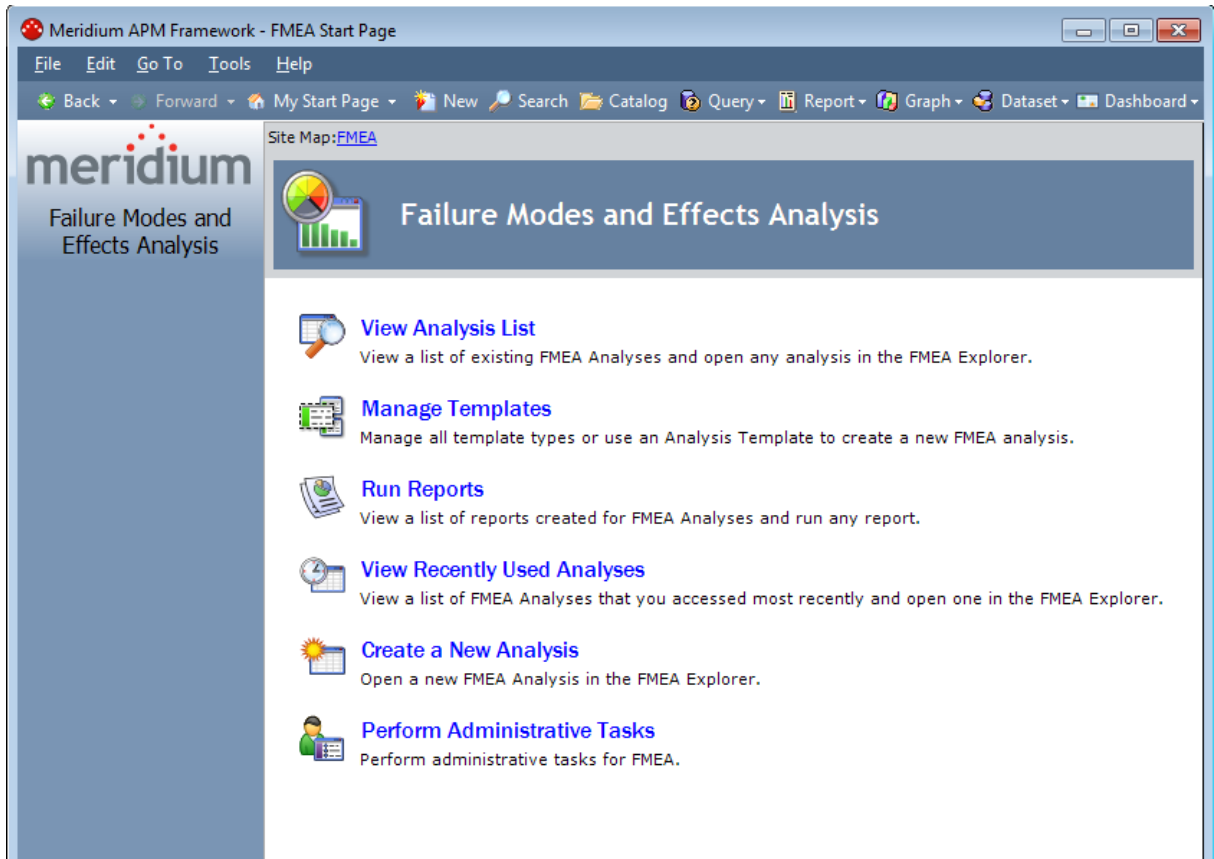

Aspects of the FMEA Start Page

The **FMEA Start Page** displays the following links, which you can use to access various features in FMEA:

- **View Analysis List:** Opens the [FMEA Analysis List page](#), from which you can open an existing FMEA Analysis on the [FMEA Explorer](#) page.
- **Manage Templates:** Displays the [FMEA Templates page](#), where you can view a list of FMEA Templates and use any of the templates to create a new FMEA Analysis.
- **Run Reports:** Displays the [FMEA Reports page](#), which displays the reports that have been associated with all FMEA Analyses.
- **View Recently Used Analyses:** Displays the [FMEA Recently Used Analyses page](#), where you can open an FMEA Analysis that you accessed recently.
- **Create a New Analysis:** Launches the [FMEA Explorer](#) page, where you can create an FMEA Analysis.
- **Manage Tasks:** Displays the [FMEA Manage Tasks](#) page, which displays a list of FMEA Analyses that have one or more associated Task records.

Note: This link appears only if the **Show Manage Tasks on the Start Page** option is enabled on the [FMEA Administration](#) page.

- **Perform Administrative Tasks:** Displays the [FMEA Administration](#) page, where you can [configure administrative settings](#) for FMEA.

Note: This link appears only if you are a Super User or a member of the MI RCM Administrator Security Group.

First-Time Deployment Workflow

Deploying and configuring FMEA for the first time includes completing multiple steps, which are outlined in the table in this topic. The steps in this section of the documentation provide all the information that you need to deploy and configure FMEA on top of the basic Meridium APM system architecture.

Whether a step is required or optional is indicated in the **Required/Optional** cell. Steps are marked as *Required* if you must perform the step to take advantage of FMEA functionality.

The person responsible for completing each task may vary within your organization. We recommend, however, that the steps be performed in relatively the same order in which they are listed in the table.

Step	Task	Required/Optional	Notes
1	Review the FMEA data model to determine which relationship definitions you will need to modify to include your custom equipment and location families.	Optional	This task is necessary only if you store equipment and location information in families other than the baseline Equipment and Functional Location families.
2	Define sites to associate with FMEA Analyses.	Optional	None
3	Assign Security Users to one or more of the FMEA Security Groups via the Configuration Manager application.	Required	None
4	Create the Evaluation Security User via the Configuration Manager application.	Optional	None
5	Create a scheduled item for executing RCM event-based and date-based evaluations.	Optional	None
6	Define the Evaluation query.	Optional	None
7	Define the Recommendation Review query.	Optional	This task is necessary only if you do not want to use the baseline query that is defined by default.

Step	Task	Required/Optional	Notes
8	Define the Template query.	Optional	This task is necessary only if you do not want to use the baseline query that is defined by default.
9	Define the Analysis List query.	Optional	This task is necessary only if you do not want to use the baseline query.

Upgrade or Update Failure Modes and Effects Analysis to 3.6.1.3.0

The following tables list the steps that are required to update or upgrade FMEA to 3.6.1.3.0. These steps assume that you have completed the steps for upgrading the [basic Meridium APM system architecture](#).

Update from any version V3.6.1.0.0 through V3.6.1.2.0

This module will be updated to 3.6.1.3.0 automatically when you update the components in the basic Meridium APM system architecture. No additional steps are required.

Upgrade from any version V3.6.0.0.0 through V3.6.0.12.6

FMEA will be upgraded to 3.6.1.3.0 automatically when you upgrade the components in the [basic Meridium APM system architecture](#). No additional steps are required.

Upgrade from any version V3.5.1.0.0 through V3.5.1.12.0

FMEA will be upgraded to 3.6.1.3.0 automatically when you upgrade the components in the [basic Meridium APM system architecture](#). No additional steps are required.

Upgrade from any version V3.5.0 SP1 LP through V3.5.0.1.9.0

FMEA will be upgraded to 3.6.1.3.0 automatically when you upgrade the components in the [basic Meridium APM system architecture](#). No additional steps are required.

Upgrade from any version V3.5.0 through V3.5.0.0.7.1

FMEA will be upgraded to 3.6.1.3.0 automatically when you upgrade the components in the [basic Meridium APM system architecture](#). No additional steps are required.

Upgrade from any version V3.4.5 through V3.4.5.0.1.4

Step	Task	Required/Optional	Notes
1	Assign Security Users to the MI RCM Viewer Security Group via the Configuration Manager application.	Required	None

Step	Task	Required/Optional	Notes
2	Add values to the Recommended Resource System Code Table via the Configuration Manager application.	Required	This System Code Table is used to populate the Recommended Resource field in RCM FMEA Recommendation records

FMEA Configuration Tasks

The following table lists the configuration tasks that an administrative user will need to perform before other users can begin using the Failure Modes and Effects Analysis module.

Task	Required/Optional?	Notes
Review the FMEA data model to determine which relationship definitions you will need to modify to include your custom equipment and location families.	Optional	This task is necessary only if you store equipment and location information in families other than the baseline Equipment and Functional Location families.
Assign Security Users to one or more of the FMEA Security Groups.	Required	Users will need permissions to the FMEA families in order to use the FMEA module.
Define sites to associate with FMEA Analyses.	Optional	None
Map additional fields to the RCM FMEA Asset record.	Optional	You need to complete this task only if you store equipment and location information in families other than the baseline Equipment and Functional Location families or if you use the baseline Equipment and Functional Location families but want to map fields in addition to those that are already mapped in the baseline product.
Create the Evaluation Security User.	Required	None
Create a scheduled item for executing FMEA event-based and date-based evaluations.	Required	None
Define the Evaluation query.	Required	None

Task	Required/Optional?	Notes
Define the Recommendation Review query.	Optional	This task is necessary only if you do not want to use the baseline query that is defined by default.
Define the Template query.	Optional	This task is necessary only if you do not want to use the baseline query that is defined by default.
Define the Analysis List query.	Required	The queries in this list must be defined before users can perform evaluations and approvals for FMEA Analyses and before they can view FMEA Templates.

Associating FMEA Analyses with a Specific Site

Some companies that use the Meridium APM software have facilities at multiple sites, or locations, where each site contains unique equipment and locations. If desired, you can define the sites in your organization and associate assets with the site to which they belong. When you create FMEA Analyses for those pieces of equipment and locations, you will need to [select the appropriate site on the Analysis datasheet of the FMEA Analysis](#).

To help streamline the analysis-creation process, after you select a site on the Analysis datasheet, the Meridium APM system will allow you to [add Equipment and Functional Location records to the FMEA Analysis](#) only if the pieces of equipment and locations belong to that site.

You can also associate Risk Matrices with specific sites. If a Risk Matrix is associated with a site and an FMEA Analysis is associated with the same site, when you define the unmitigated risk for a [failure effect](#), rather than seeing the default Risk Matrix, you will see the Risk Matrix that is associated with that site.

FMEA Security Groups

The FMEA module uses the following baseline Security Groups:

- **MI RCM Administrator:** The MI RCM Administrator Security Group has *no* family-level privileges configured for it in the baseline Meridium APM database. Users who are members of this group will see the **Administration** link on the **RCM Start Page** in the Meridium APM Framework application and will, therefore, have access to administrative functions in FMEA. Users who do not belong to this Security Group will not see this link and, therefore, will not be able to access the administrative functions.

Because the MI RCM Administrator Security Group has *no* family-level privileges assigned to it by default, to access features and functions in FMEA, members of the MI RCM Administrator Security Group will also need to be assigned to the MI RCM User or MI RCM Viewer Security Group.

- **MI RCM User:** The MI RCM User Security Group has access to *all* features in FMEA.
- **MI RCM Viewer:** The MI RCM Viewer Security Group has view-only access to FMEA. Users belonging to the MI RCM Viewer Security Group will not have access to features that result in the creation, update, or deletion of records or links between records.

The following table shows the family-level privileges assigned to the MI RCM User and RCM Viewer Security Groups.

Family Caption	MI RCM User	MI RCM Viewer
Entity families		
Action	View	View
Asset Criticality Analysis System	View	None
Consequence Definition	View	View
Decision Tree Consequence	View	View
Decision Tree Response	View	View
Decision Tree Structure	View	View
Human Resource	View, Update, Insert, Delete	View
Mitigates Risk	View, Update, Insert, Delete	View
Probability Definition	View	View
Protection Level	View	View

Family Caption	MI RCM User	MI RCM Viewer
RCM FMEA Analysis	View, Update, Insert, Delete	View
RCM FMEA Asset	View, Update, Insert, Delete	View
RCM Function	View, Update, Insert, Delete	View
RCM Functional Failure	View, Update, Insert, Delete	View
RCM FMEA Failure Mode	View, Update, Insert, Delete	View
RCM FMEA Failure Effect	View, Update, Insert, Delete	View
RCM FMEA Recommendation	View, Update, Insert, Delete	View
RCM FMEA Template	View, Update, Insert, Delete	View
RCM FMEA Task	View, Update, Insert, Delete	View
Reference Documents	View, Update, Insert, Delete	View
Risk Assessment	View, Update, Insert, Delete	View
Risk Category	View	View
Risk Matrix	View	View
Risk Rank	View, Update, Insert, Delete	View
Risk Threshold	View	View
Site Reference	View	View

Family Caption	MI RCM User	MI RCM Viewer
Task History <div style="border: 1px solid black; background-color: #ffffcc; padding: 5px; margin-top: 10px;"> Note: The Task History relationship family is inactive in the baseline Meridium APM database. </div>	View, Update, Insert, Delete	View
Relationship families		
Has Associated Recommendation	View	View
Has Consolidated Recommendations	View	View
Has Driving Recommendation	View	View
Has RCM FMEA Team Member	View, Update, Insert, Delete	View
Has RCM FMEA Analysis	View, Insert, Delete	None
Has RCM FMEA Asset	View, Update, Insert, Delete	View
Has RCM Function	View, Update, Insert, Delete	View
Has RCM Functional Failure	View, Update, Insert, Delete	View
Has RCM FMEA Failure Mode	View, Update, Insert, Delete	View
Has RCM FMEA Failure Effect	View, Update, Insert, Delete	View
Has RCM FMEA Recommendation	View, Update, Insert, Delete	View
Has Reference Values	View	View
Has Recommendations	View, Update, Insert, Delete	View
Has Reference Documents	View, Update, Insert, Delete	View
Has Risk	View	None

Family Caption	MI RCM User	MI RCM Viewer
Has Risk Category	View, Update, Insert, Delete	View
Has Site Reference	View	View
Has Superseded Recommendations	View	View
Has Task History <div data-bbox="235 569 662 730" style="border: 1px solid black; padding: 5px; margin: 5px 0;"> <p>Note: The Has Task History relationship family is inactive in the baseline Meridium APM database.</p> </div>	View, Update, Insert, Delete	View
Has Tasks	View, Update, Insert, Delete	View
Has Templates	View, Update, Insert, Delete	View
Is Based on RCM FMEA Failure Effect	View	View
Is RCM FMEA Asset	View, Update, Insert, Delete	View

With these privileges, any user who is a member of the MI RCM User Security Group will have access to ALL records involved in FMEA Analyses. In addition to these baseline privileges, which you can grant by assigning users to the MI RCM User Security Group, you will need to grant FMEA users permission to the [Equipment or Functional Location family if it is related to the RCM FMEA Asset family](#) through the Is RCM FMEA Asset relationship.

Note: You may also want to grant some users permission to modify the items in the following Catalog folders: \\Public\Meridium\Modules\RCM.

About Virtual and Physical Equipment and Locations

When you define RCM FMEA Asset records for your FMEA Analyses, you have the following options:

- You can create standalone RCM FMEA Asset records that represent "virtual" equipment and locations (i.e., equipment and locations that do not physically exist and are not represented by Equipment and Functional Location records).
- You can create RCM FMEA Asset records that are linked to Equipment or Functional Location records in your database. This option allows you to make your RCM FMEA Asset records representative of the *actual* equipment and locations in your system. This allows certain values from the related Equipment or Functional Location record to be passed to other records in the analysis, such as the Failure Effect and Recommendation.

The baseline FMEA implementation includes default rules that will map the certain values from the Equipment or Functional Location record to the fields of the related RCM FMEA Asset record. In this way, the RCM FMEA Asset record will store identifying information about its related Equipment or Functional Location record. In addition, the values stored in the Asset ID field will be available for selection when you create Failure Mode and Recommendation records. If desired, you can modify the rules that are delivered with the baseline FMEA implementation to map additional fields from the Equipment or Functional Location record to the RCM FMEA Asset record.

In addition, the Meridium APM baseline database is configured with the [Has Recommendations](#) and Has Strategy relationships, so the Meridium APM system will link Equipment or Functional Location records to RCM FMEA Recommendation records and to Asset Strategy records.

Has Recommendations Relationship

The Has Recommendations relationship allows Equipment or Functional Location records that have been linked to RCM FMEA Asset records to be linked to RCM FMEA Recommendation records. In the Meridium APM baseline database, the following families are related to the RCM FMEA Recommendation family through the Has Recommendations family to facilitate this workflow:

- Equipment
- Functional Location
- RCM FMEA Asset

Therefore, any RCM FMEA Asset record that is linked to an Equipment or Functional Location record is also linked to the RCM FMEA Recommendation record. If you are following the Meridium APM Best Practice, you will not have to define the Has Recommendations relationship for the equipment and locations that you have defined for RCM or FMEA. However, if you want to define RCM FMEA Assets from any family other than the baseline Equipment or Functional Location families, you will have to create a relationship definition to link those records to RCM FMEA Recommendation records through the Has Recommendations relationship family.

Note: If you define the Has Recommendations relationship for any families other than the baseline Equipment and Functional Location families, be sure to use the *Has Recommendations* family and not the Has RCM FMEA Recommendations family, which is reserved for linking RCM FMEA Failure Effect records to RCM FMEA Recommendation records within FMEA Analyses.

When you create an RCM FMEA Failure Mode record for an RCM Analysis, the value in the *Related Asset ID* field will indicate the ID of the related RCM FMEA Asset record. For RCM Analyses, the Related Asset ID must be selected manually. If the RCM FMEA Asset record is linked to an Equipment or Functional Location record, the Asset ID comes from the Equipment or Functional Location record.

When you create RCM FMEA Failure Effect records for that Failure Mode and then create RCM FMEA Recommendation records for those Failure Effects, the Meridium APM system will pass to the Recommendations the Related Asset ID from the associated RCM FMEA Failure Mode record.

- If the RCM FMEA Asset record is not linked to an Equipment or Functional Location record, the RCM FMEA Recommendation record will be linked *to the RCM FMEA Asset record*.
- If the RCM FMEA Asset record IS linked to an Equipment or Functional Location record, the RCM FMEA Recommendation record will be linked *to the Equipment or Functional Location record*.

Creating the Evaluation Security User

When you set up an evaluation for an FMEA Recommendation, the Meridium APM system will create a scheduled item for that evaluation and store it in the Meridium APM Schedule Manager. The scheduled item will be executed according to the schedule that is set up for the evaluation. As with other actions that you perform in the Meridium APM system, the execution of the scheduled item requires user authentication. Therefore, to execute scheduled evaluations, you must set up a Security User for that purpose.

When the scheduled item for an evaluation is executed, three things happen:

- If it is an event-based evaluation, the Meridium APM system runs the Evaluation Query. Therefore, the Evaluation User must have whatever privileges are necessary to execute the Evaluation Query that you create. The specific privileges that are required will vary, depending on which families are queried by the Evaluation Query.
- The Meridium APM system updates the associated Recommendation record with the execution date. Therefore, the Evaluation User must have View and Update privileges on the RCM FMEA Recommendation family.
- The Meridium APM system sends the evaluation email message to the appropriate email address. This action requires no special privileges.

Therefore, to set up evaluations, you must set up a Meridium APM Security User that has the privileges described above.

Creating a Scheduled Item for Evaluations

In FMEA, you can define criteria for evaluating the whole analysis or parts of the analysis in the future. The evaluation feature allows you to be notified, or to notify someone else, when certain conditions are met.

To enable this functionality, you will need to create a scheduled item in the Meridium APM Schedule Manager to evaluate any date-based criteria and run the Evaluation query that is used by any event-based criteria to determine whether or not the criteria have been met. When the scheduled item is executed:

- For any date-based evaluations that have been configured, an email message will be sent for each item whose dates indicates that it is due for evaluation.
- For any event-based evaluations that have been configured, an email message will be sent only if the count and cost returned by the Evaluation query are greater than the count and cost defined in the event-based evaluation criteria.

To create a scheduled item for Evaluations:

1. Launch the Meridium APM Schedule Manager application and log in.
2. At the bottom of the **Meridium APM Scheduler - Scheduled Items** window, click the **Add New** link.

The **Choose a Meridium Assembly** dialog box appears.

3. Open the **Meridium.RCM.dll** file.

The **Choose an Object Type** dialog box appears.

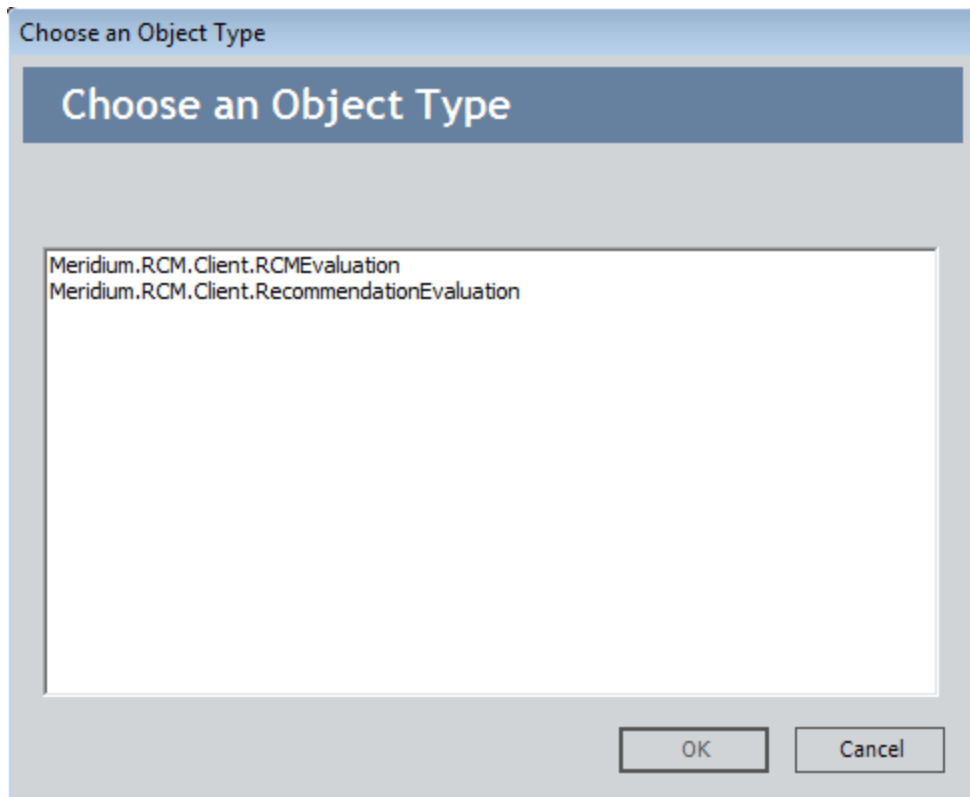

4. Select the object type **Meridium.RCM.Client.RCMEvaluation**, and click **OK**.

The **Schedule RCM Evaluation** window appears, and the **Task** tab is displayed by default.

Schedule RCM Evaluation

Schedule RCM Evaluation

Task | User

Last Executed Never

Next Execution 5/1/2012 1:05 PM

Recurring Item

Occurs

Every 1 minute(s)

Every 1 day(s)

Each Sunday every 1 week(s)

Every 1 month(s) on day 1 of the month

Every 1 year(s) on May 01

OK Cancel

5. On the **Task** tab, define a schedule that will execute the scheduled item on a recurring basis. The frequency by which you want to execute the scheduled item is up to you.
6. Click the **User** tab.
The **User** tab appears.

The image shows a software dialog box titled "Schedule RCM Evaluation". The dialog has a dark blue header with the title "Schedule RCM Evaluation" in white. Below the header, there are two tabs: "Task" and "User". The "User" tab is selected. Under the "User" tab, there are two text input fields: "User ID" and "Password". At the bottom right of the dialog are "OK" and "Cancel" buttons.

7. In the **User ID** and **Password** text boxes, enter the Meridium APM username and password for a user who has at least:
 - The privileges that are necessary to execute the Evaluation Query. The specific privileges that are required will vary, depending on which families are included in the Evaluation Query.
 - View and Update privileges to the RCM FMEA Recommendation family.
 - View and Update privileges to the RCM FMEA Asset family.
 - View and Update privileges to the RCM FMEA Analysis family.
8. Click **OK**.

The scheduled item is created and a new row appears in the **Scheduled Items** grid.

Creating a Scheduled Item for Evaluations

Scheduled Items				
Item Type <input type="text"/>				
ID	Caption	Description	Last Execution	Next Execution
<input type="checkbox"/> Item Type: Meridium.RCM.Client.RCMEvaluation				
<input type="checkbox"/>	RCM/FMEA Evaluation	Evaluate RCM/FMEA Analyses for...	1/1/0001 12:00:00 AM	5/1/2012 1:05:23 PM

About Queries Used by FMEA

FMEA relies on queries to perform certain functions. For example, when you access the **FMEA Analysis List** page, the Meridium APM system runs the Analysis List query and returns a list of analyses that meet the query criteria. From the list of analyses, you can [open an analysis](#) in the FMEA Explorer.

Except in the case of the Evaluation query, which you must create manually, when a query is required to enable certain functionality, the baseline FMEA product contains a default query for you to use. The default query will be used automatically unless you choose to use a different query.

You can use the default query exactly as it is shipped, or you can modify it to meet your specific needs. As long as you do not rename the query or move it to a different location in the Catalog, it will be used automatically in FMEA. If you do change the name of the query or move it to a different location, you will need to modify the appropriate Administrative setting to point to your custom query.

The following table provides a list and description of the queries that are provided for use within FMEA. Each of these queries is stored in the folder \\Public\Meridium\Modules\FMEA in the Catalog. In addition to the queries listed in the table, FMEA also uses the [Evaluation query](#), which must be [created manually](#) and then [selected](#) on the **FMEA Administration** page.

Query	Description	Name of Default Query in the Catalog
Recommendation Review query	Used for reviewing recommendations and promoting them to actions.	Review Recommendations
Template query	Used for generating the list of available templates when you load templates for creating new analyses or analysis nodes .	Template List
Analysis List query	Used for generating the list of analyses that appears on the FMEA Analysis List page .	Enterprise Analysis List

Note that a copy of each baseline query is also stored in the folder \\Baseline\Meridium\Modules\FMEA. The items in the Baseline folder cannot be modified, so this folder serves as a permanent record of the content that is delivered with the baseline Meridium APM product. While a copy of each query is stored in the Baseline folder, the Meridium APM system *reads* the query from the folder \\Public\Meridium\Modules\FMEA, so you can customize the baseline functionality by modifying the query in the folder \\Public\Meridium\Modules\FMEA.

The Baseline folder will be updated with any changes made to the baseline content in future releases. If you modify an item in the folder \\Public\Meridium\Modules\FMEA

and later decide that you want to revert to the baseline functionality, you can recover the baseline query from the folder \\Baseline\Meridium\Modules\FMEA.

Accessing the FMEA Administration Page

Note: To access administrative features in FMEA, you must be a Super User or a member of the MI RCM Administrator Security Group.

To access the FMEA Administration page:

- On the [FMEA Start Page](#), click the **Perform Administrative Tasks** link.

The **FMEA Administration** page appears.

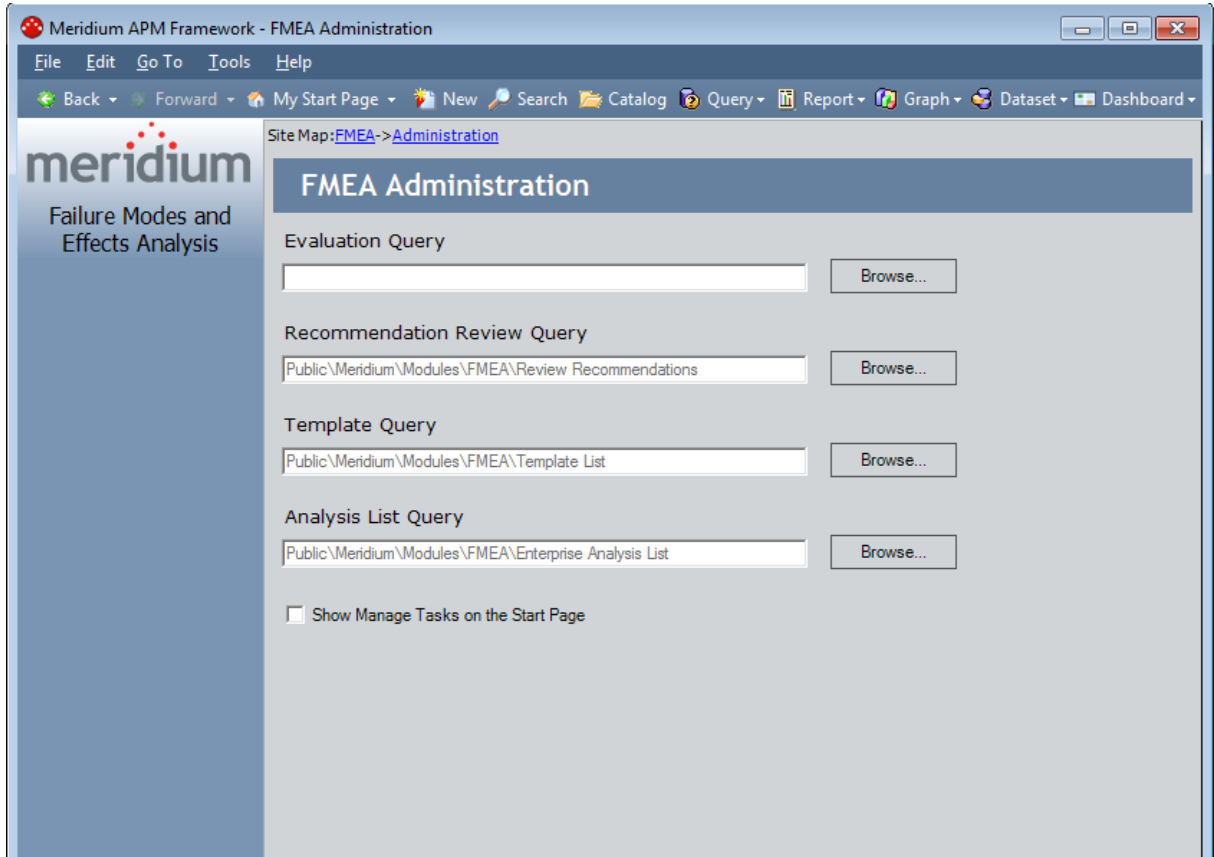

The **FMEA Administration** page displays all the administrative settings that must be defined for FMEA to work properly. A read-only value in the field associated with a setting indicates that the setting is already defined. For new installations the **Template Query** and **Analysis List Query** are defined automatically. The other settings must be defined manually. In addition, you can modify the value for any setting that is already defined, including the ones that are defined automatically in the baseline FMEA product.

Note: The **FMEA Administration** page also contains the **Show Manage Tasks on the Start Page** check box. You should not select this check box. If you do, the **Manage Tasks** link will appear on the **FMEA Start Page**. This link provides access to a feature that does not work properly.

About the Evaluation Query

For each FMEA Analysis, you can configure date-based and event-based evaluations. A date-based evaluation relies entirely upon the date and time to determine when an evaluation email message should be sent. An event-based evaluation, on the other hand, relies upon failure data to determine when an evaluation email message should be sent.

When you set up an event-based evaluation, you will use the **Event-Based Evaluation** dialog box to define criteria for sending the evaluation email message.

Note that you can set up the evaluation to be based on failure count, failure cost, and date. This means that to configure effective event-based evaluations, you must define an Evaluation query that determines the following for a given piece of equipment or location:

- The number of failures that have occurred for the piece of equipment or location since a given date.
- The total cost of the failures that have occurred for the piece of equipment or location since a given date.

Each day after the specified start date, the Meridium APM system will run the Evaluation query for the associated Equipment or Functional Location record. When the record meets the failure count and/or cost criteria, the Meridium APM system will send an evaluation email message to the email address specified in the **Notify** field.

Creating the Evaluation Query

The specific families included in your Evaluation query will vary, depending on your data model. Regardless of your data structure, however, your query must follow the guidelines provided here.

It must contain two columns of output:

- **Count**, which returns a numeric value representing the total number of failures for a given piece of equipment or location. The alias for this column must be exactly *Count*.
- **Cost**, which returns a numeric value representing the total cost of failures for a given piece of equipment or location and failure mode. The alias for this column must be exactly *Cost*.

The query must contain three prompts in the following order:

- **ID**: Accepts the Record ID (i.e., the value in the *ENTY_ID* field) of the record representing the piece of equipment or location. Note that the record can be either an [RCM FMEA Asset record](#) itself or a [related Equipment or Functional Location record](#), depending on whether or not the [RCM FMEA Asset record has been linked to an Equipment or Functional Location record](#).

Note: In the baseline FMEA implementation, the value in the *ENTY_ID* field from the RCM FMEA Asset or an Equipment or Functional Location record is passed to the RCM FMEA Failure Mode record and to subsequent RCM FMEA Recommendation records. If you are setting up an event-based evaluation at the recommendation level and you have modified your business rules to pass a *different* value to the RCM FMEA Failure Mode record and the Recommendation record, then you will need to set up the Evaluation query appropriately.

- **Failure Mode**: Accepts the value in the Failure Mode Name field in the Failure Mode record that is linked to either the Recommendation record (if you are setting an evaluation at the *recommendation* level) or the RCM FMEA Asset record (if you are setting up an evaluation at the *equipment/location* level). When the Meridium APM system runs the Evaluation query, it will extract the value from the Failure Mode Name field in the Failure Mode record and pass it in as the value for this prompt.

Note: The Failure Mode parameter expression should include the operator *like* instead of *is equal to* (=).

- **Date**: Accepts the date defined in the evaluation item. When you create an event-based evaluation, you specify a date *after which* you want to start counting failures and failure cost. For example, you might specify to be notified when a given piece of equipment has five failures, beginning 1/1/2005. In this case, the date 1/1/2005 will be passed to the Evaluation query. If the specified piece of equipment has had five failures since that date, then the evaluation email message will be sent.

Note: The Asset ID, Failure Mode, and Date fields should not be included in the output.

The specific tables that you query will vary, depending on your data model. For example, you might query the Equipment family to retrieve the Asset ID and the Work Order family to retrieve the failure data, where the Equipment and Work Order families are related through the Asset Has Maintenance relationship.

Whatever families you query, be sure that the table from which you retrieve the failure mode should contain the same values that will be stored in the Failure Mode Name field in RCM FMEA Failure Mode records. In the baseline FMEA implementation, the Failure Mode Name field in RCM FMEA Failure Mode records is simply a character field that will accept any character string. Because values will be passed from this field to the Evaluation query, however, it is important that the values stored in the Failure Mode Name field *match* the failure modes that are stored in the records that are queried by the Evaluation query. How you choose to do this is up to you.

For example, you might modify the Failure Mode Name field in the RCM FMEA Failure Mode family to provide a restricted list of values or to use System Codes. Then, you might apply the same rules to the Failure Mode field of the family that is used by the Evaluation query. Just keep in mind that whatever is stored in the RCM FMEA Failure Mode Name field will be passed to the Failure Mode prompt in the Evaluation query. If the values passed to the Evaluation query are different from the values stored in failure data table used by the query, the query will not return the data need to trigger an event-based evaluation.

Example of an Evaluation Query

Note: The following example is meant to serve as a guideline for creating an Evaluation query. The specific families that you query and fields that you include will vary, depending on your data model.

Suppose that you want to create event-based evaluations for equipment that belongs to an FMEA Analysis. The following image shows the design grid for an example of an Evaluation query.

Field	[Failure ID]	[Total Failure Cost]	[Equipment ID]	[Failure Mode]	[Failure Date / Time]
Alias	Count	Cose	Equipment ID	Failure Mode	Failure Date / Time
Table	[Event]	[Event]	[Equipment]	[Event]	[Event]
Sort					
Sort Index					
Include	<input checked="" type="checkbox"/>	<input checked="" type="checkbox"/>	<input type="checkbox"/>	<input type="checkbox"/>	<input type="checkbox"/>
Display	<input checked="" type="checkbox"/>	<input checked="" type="checkbox"/>	<input type="checkbox"/>	<input type="checkbox"/>	<input type="checkbox"/>
Hyperlink					
Criteria			(? :s :caption='Equip...	(? :s :caption='Failur...	(? :s :caption='Date' ...
Or					

When you run the query manually, the **Enter parameter values** dialog box will look like the following image.

The dialog box titled "Enter parameter values" contains three text input fields. The first field is labeled "Equipment ID", the second is labeled "Failure ID", and the third is labeled "Date". At the bottom right of the dialog, there are two buttons: "OK" and "Cancel".

Example of an Evaluation Query

This means that when the Meridium APM system runs the query automatically according to the schedule set up in the Schedule Manager, the following values will be passed in for the prompts:

- The Record ID of the Equipment record.
- The value in the Failure Mode Name field in the Failure Mode record that is linked to the RCM FMEA Asset record to which the Equipment record is linked.
- The date specified as the *Starting from* date in the evaluation criteria.

After the appropriate values have been passed in for the prompts, the query would return results similar to those shown in the following image.

Count	Cost
3	7764.41

In this particular case, the results show the failure count and failure cost:

- For failures of the specified type, as determined by the specified failure mode.
- That occurred for the piece of equipment or location identified by the specified Record ID.
- Since the date specified by the *Starting from* date in the evaluation criteria.

These results will be examined by the Meridium APM system and compared to the failure count and cost thresholds defined for the evaluation. If the necessary criteria have been met (i.e., if the failure count and/or cost returned by the query exceed the values defined for the evaluation), the Meridium APM system will send an evaluation email message to the appropriate person. If the criteria have not been met, the email message will not be sent.

Selecting the Evaluation Query

After you have created the Evaluation query and saved it in the Catalog, you must define that query in the FMEA Administrative settings.

To define the Evaluation query:

1. Access the [FMEA Administration page](#).
2. To the right of the **Evaluation Query** text box, click the **Browse** button.
The **Evaluation Query** dialog box appears.
The hierarchy in the left pane represents the Catalog folder structure.
3. In the hierarchy on the left, navigate to and select the folder containing the query that you want to use as the Evaluation query.
4. In the pane on the right, select the query that you want to use as the Evaluation query.
5. Click **OK**.

The **Evaluation Query** text box is populated with the path to the query that you selected.

Defining the Recommendation Review Query

The Recommendation Review query is used for building the list of recommendations that appears in the pane on the left of the **FMEA Review Recommendations** page. The Recommendation Review query should retrieve a list of FMEA FMEA Recommendation records that are linked to a given FMEA Analysis.

The baseline FMEA product contains a default Recommendation Review query called *Review Recommendations*, which is stored in the folder \\Public\Meridium\Modules\FMEA. This query will be used automatically by FMEA. If you prefer to create your own query and use it instead, you will need to select that query via the FMEA administrative settings.

Note: If necessary, you can customize the default query without having to modify the administrative settings. As long as you do not change the query name or location, the Meridium APM system will use the default query automatically even if you change the content.

The following instructions provide details on selecting the FMEA Review Recommendations query. Note that you need to perform this procedure only if you choose to use a query other than the one that is delivered.

To define the Recommendation Review query:

1. Access the [FMEA Administration page](#).
2. To the right of the **Recommendation Review query** text box, click the **Browse** button.

The **Recommendation Review Query** dialog box appears.

The hierarchy in the left pane represents the Catalog folder structure.

3. In the hierarchy on the left, navigate to and select the folder containing the query that you want to use as the Recommendation Review query.
4. In the pane on the right, select the query that you want to use as the Recommendation Review query.
5. Click **OK**.

The **Recommendation Review query** text box is populated with the path to the query that you selected.

Defining the Template Query

The Template query is used by FMEA to load [FMEA Analysis Templates](#). The baseline FMEA product contains a default Template query called *Template List*, which is stored in the folder \\Public\Meridium\Modules\FMEA. This query is run automatically when you access the **FMEA Templates** page.

The Template List query uses a parameter that displays results based on Template Type. The Template Type that the query uses will depend on how you access the **FMEA Templates** page. For instance, when you access the **FMEA Templates** page from the **FMEA Start Page**, the default parameter is *Analysis*. However, if you access the **FMEA Templates** page via the **FMEA Template Explorer** page, the root node in the tree determines which Template Type the query uses as the parameter. For example, if you are working with an FMEA Template with the Template Type *Function*, when you access the **FMEA Templates** page, the query will search and results for all FMEA templates created at the Function level.

If you prefer to create your own query and use it instead, you will need to select that query via the FMEA administrative settings.

Note: If necessary, you can customize the default query without having to modify the administrative settings. As long as you do not change the query name or location, FMEA will use the default query automatically even if you change the content.

The following instructions provide details on selecting the Template query. Note that you need to perform this procedure only if you choose to use a query other than the one that is delivered.

To define the Template query:

1. Access the [FMEA Administration page](#).
2. To the right of the **Template Query** text box, click the **Browse** button.
The **Template Query** dialog box appears.
The hierarchy in the left pane represents the Catalog folder structure.
3. In the hierarchy on the left, navigate to and select the folder containing the query that you want to use as the Template query.
4. In the pane on the right, select the query that you want to use as the Template query.
5. Click **OK**.

The **Template Query** text box is populated with the path to the query that you selected.

Defining the Analysis List Query

The Analysis List query is used by the system to generate a list of analyses that appears on the [FMEA Analysis List page](#). The baseline FMEA product contains a default Analysis List query called *Enterprise Analysis List*, which is stored in the folder \\Public\Meridium\Modules\FMEA. This query will be used automatically by FMEA. If you prefer to create your own query and use it instead, you will need to select that query via the FMEA administrative settings.

Note: If necessary, you can customize the default query without having to modify the administrative settings. As long as you do not change the query name or location, FMEA will use the default query automatically even if you change the content.

The following instructions provide details on selecting the FMEA Analysis List query. Note that you need to perform this procedure only if you choose to use a query other than the one that is delivered.

To define the Analysis List query:

1. Access the [FMEA Administration page](#).
2. To the right of the **Analysis List Query** text box, click the **Browse** button.
The **Analysis List Query** dialog box appears.
The hierarchy in the left pane represents the Catalog folder structure.
3. In the hierarchy on the left, navigate to and select the folder containing the query that you want to use as the Analysis List query.
4. In the pane on the right, select the query that you want to use as the Analysis List query.
5. Click **OK**.

The **Analysis List Query** text box is populated with the path to the query that you selected.

Clearing the Current Query Selection

After you have selected the [Evaluation](#), [Recommendation Review](#), [Template](#), or [Analysis List](#) query, the query path appears in the text box on the **FMEA Administration** page. The text is read-only, so to modify the query selection, you must use the procedure that you used to select the original query. If, on the other hand, you want to delete the current query selection so that NO query is selected, use the following instructions.

To delete the current FMEA query selection:

1. Access the [FMEA Administration page](#).
2. To the right of the text box for the query that you want to clear, click the **Browse** button.

The appropriate query selection dialog box appears, depending on which **Browse** button you clicked.

3. In the Catalog hierarchy on the left, select any folder.

The pane on the right will display any queries that are stored in that folder. Do not select a query.

4. Click **OK**.

The query path that was previously displayed in the text box is deleted.

Using the FMEA Site Map

The Site Map in FMEA allows you navigate from the current page to the **FMEA Start Page** by clicking the **FMEA** link in the Site Map. The Site Map appears at the top of the workspace on every page within FMEA. The page that you are currently viewing appears as a hyperlink in the Site Map after the delimiter >.

The following image shows an example of the Site Map in RCM as it appears on the **FMEA Recently Used Analyses** page. A red outline has been added to the image to highlight the Site Map.

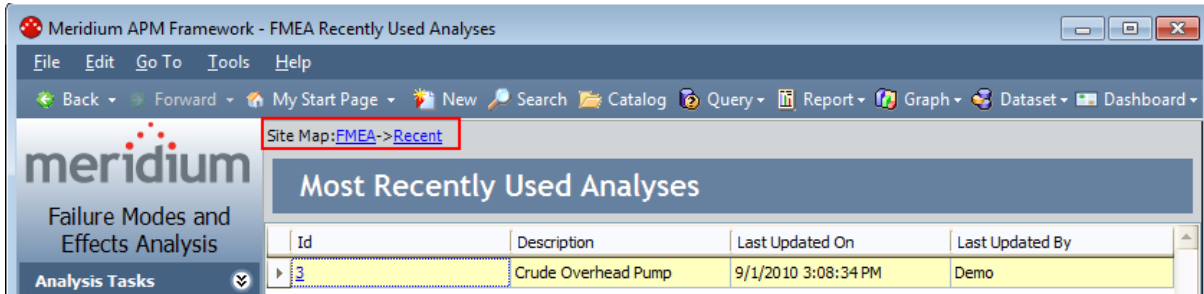

Navigating FMEA as a Member of the MI RCM Viewer Security Group

Unlike members of the RCM User Security Group, who have access to ALL features in the FMEA module, members of the MI RCM Viewer Security Group will have view-only access to FMEA. In other words, members of the MI RCM Viewer Security Group cannot create, modify, or delete records or links between records. These users can, however, view the contents of analyses.

When you are logged in as a member of this Security Group, options that would result in the creation, update, or deletion of records or links between records will be disabled, including datasheets. In other words, if you do not have privileges to perform the action, the associated option will be disabled.

For example, when you are viewing an analysis on the **FMEA Explorer** page, the RCM FMEA Analysis datasheet will be disabled. In addition, links like the **Link to Asset** link on the **Common Tasks** menu will be disabled. While links like the **Manage Team** link on the **Analysis Tasks** menu will remain enabled and provide access to the **FMEA Team Members** page.

Throughout this documentation, we assume that you are familiar with the privileges associated with the Security Group to which you belong. The documentation does not specify how options in the FMEA module behave based upon your security privileges.

Workflow for Creating an FMEA Analysis

In Meridium APM, conducting an FMEA Analysis consists of:

1. [Creating the root-level analysis record](#), which stores identifying information about the analysis itself.
2. [Creating the analysis team](#).
3. [Linking RCM FMEA Assets to the analysis record](#) to define what is being analyzed.
4. For each piece of equipment or location, [identifying the potential failure modes](#).
5. For each failure mode, [identifying the possible failure effects](#).
6. For each failure effect, [defining one or more recommendations](#).

Starting a New FMEA Analysis

The following instructions provide details on creating a new analysis from scratch. Note that you can also create a new RCM analysis using the following methods:

- [Load an FMEA Template](#).
- Promote an Asset Criticality Analysis System record from Asset Criticality Analysis (ACA) to FMEA.

The following instructions provide details on creating a new FMEA Analysis from the **FMEA Start Page**. You can also create a new FMEA Analysis using the **Create Analysis** link that appears on the **Analysis Tasks** menus throughout FMEA.

To create a new analysis from scratch:

1. On the [FMEA Start Page](#), click the **Create a New Analysis** link.

The **FMEA Explorer** page appears, displaying a new analysis.

2. In the **Analysis** datasheet, enter the desired analysis information. Note that the default Analysis datasheet contains two tabs:
 - **Analysis Identification:** Stores identifying information, such as the analysis ID and description. Note that the **Analysis ID** and **Analysis Type** cells are populated automatically and cannot be modified. The **Analysis Short Description** cell is also populated with a default value but can be modified if needed.
 - **System Information:** Stores information about the system that is being analyzed. The **System Definition** tab also contains the Site Reference field, where you can select the site to which this analysis belongs. The list contains the Record ID of all Site Reference records that exist in the database.

Note: After an FMEA Analysis contains an Equipment or Functional Location record that is linked to a Site Reference record, the Site Reference field is disabled.

3. Click the **Save** button , which appears above the datasheet.

The new RCM FMEA Analysis record is saved to the database in the [Draft state](#). After you have saved the analysis, the task menu options become enabled so that you can perform additional tasks associated with the analysis.

Options for Opening an FMEA Analysis

You have several options for opening existing FMEA Analyses. Your choice of where and how to open an analysis will depend primarily on your personal preference. You can open an analysis from:

- The [FMEA Analysis List page](#).
- The [FMEA Recently Used Analyses page](#).

Accessing the FMEA Analysis List Page

From the **FMEA Analysis List** page, you can run the query that has been set up for the purpose of retrieving a list of existing FMEA Analyses and then, from the list of analyses, open an analysis.

To access the **FMEA Analysis List** page:

- On the **FMEA Start Page**, click the **View Analysis List** link.

The **FMEA Analysis List** page appears.

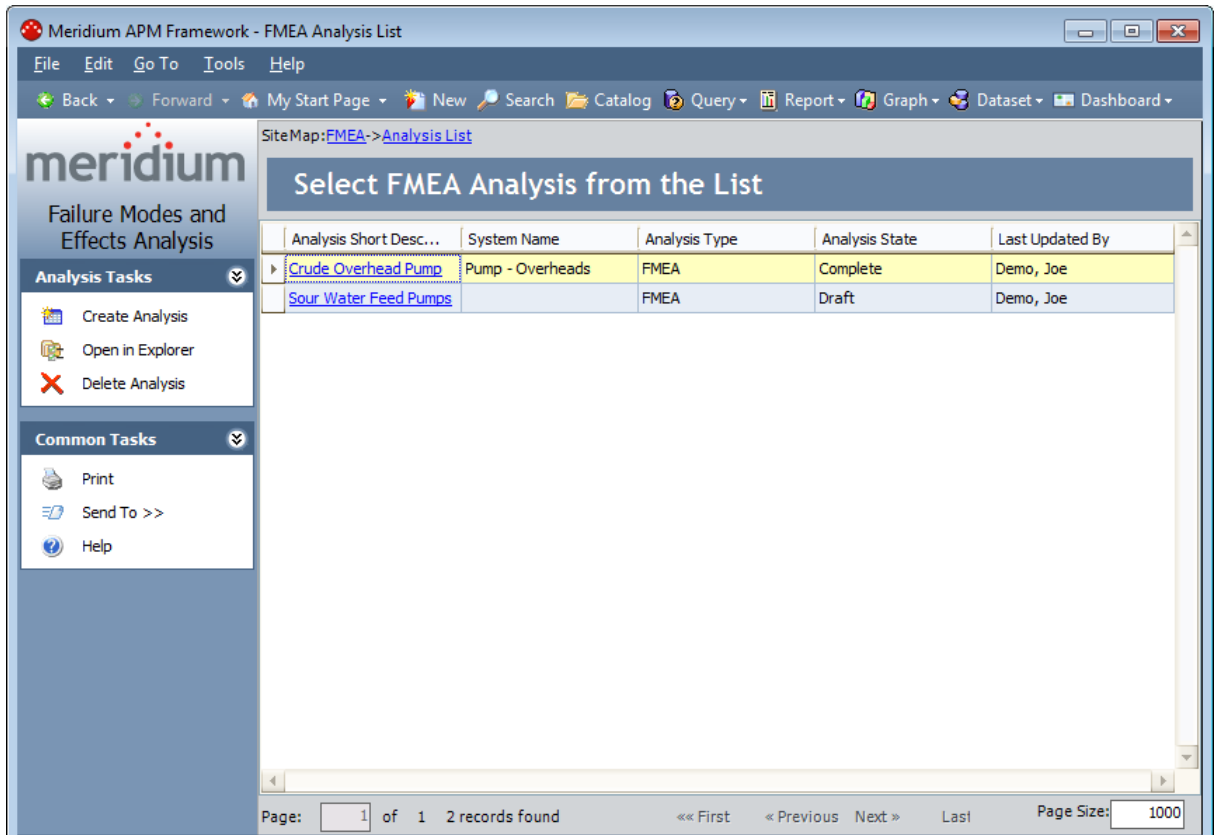

Aspects of the FMEA Analysis List Page

The main display area of the **FMEA Analysis List** page contains a grid that displays a list of analyses retrieved by the [Analysis List query](#). If the Analysis List query contains one or more prompts, those prompts will appear in fields above the grid, along with a **Run Query** button. You can select a value for each prompt and then click the **Run Query** button to retrieve results based on your selections. For more information on this feature, [click here](#).

Note: The default **Enterprise Analysis List** query does not contain any prompts. Prompts will appear above the grid only if a custom query has been configured by an administrative user.

The specific columns that appear in the grid will vary, depending on how the query has been configured. If the query has been properly configured, the grid will display the **Analysis Short Description** column, which will contain a hyperlinked description of the analysis. You can click any link to open the associated analysis.

The **FMEA Analysis List** page contains the following task menus: [Analysis Tasks](#) and [Common Tasks](#).

Analysis Tasks Menu

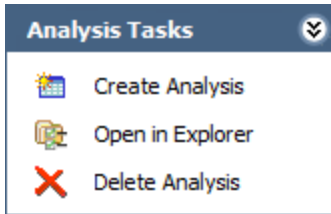

The **Analysis Tasks** menu on the **FMEA Analysis List** page contains the following links:

- **Create Analysis:** Opens the [FMEA Explorer](#) page, displaying a new FMEA Analysis.
- **Open in Explorer:** Opens the selected FMEA Analysis on the [FMEA Explorer page](#). This link is disabled if more than one FMEA Analysis record is selected in the grid.
- **Delete Analysis:** After asking for confirmation, deletes the analysis that is currently selected. Note that deleting an analysis from the **FMEA Analysis List** page will delete the RCM FMEA Analysis record and all the records to which it is linked (i.e., all the analysis elements).

Common Tasks Menu

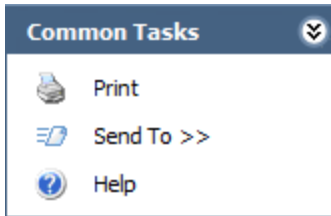

The **Common Tasks** menu on the **FMEA Analysis List** page contains the following links:

- **Print:** Displays the Preview window, from which you can select various print options and print the list of analyses.
- **Send To:** Displays a submenu with options that let you .
- **Help:** Displays the context-sensitive Help topic for the **FMEA Analysis List** page.

Opening an Analysis from the FMEA Analysis List

To open an analysis from the Analysis List:

- In the **Analysis Short Description** column, click the link for the analysis that you want to open.

-or-

Select the row containing the analysis that you want to open, and on the **Analysis Tasks** menu, click the **Open in Explorer** link.

-or-

Right-click any analysis in the list, and then click **Open in explorer**.

The selected analysis appears on the [FMEA Explorer page](#).

Accessing the FMEA Recently Used Analyses Page

To access the FMEA Recently Used Analyses page:

- On the [FMEA Start Page](#), click the **View Recently Used Analyses** link.

The **FMEA Recently Used Analyses** page appears, displaying a list of FMEA Analyses that you have viewed most recently.

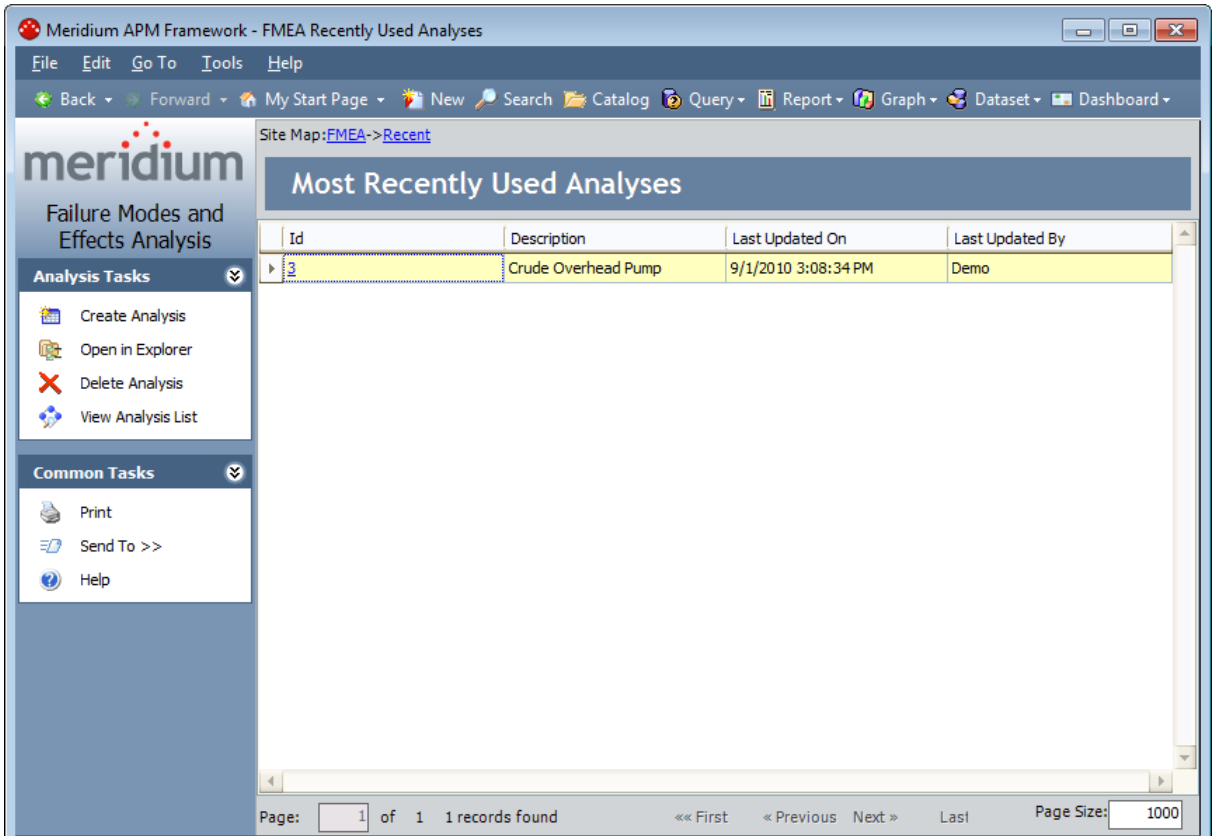

Aspects of the FMEA Recently Used Analyses Page

The **FMEA Recently Used Analyses** page displays a list of the last four analyses that you accessed. By default, the grid contains the following columns:

- **Id:** The value stored in the Analysis ID field in the corresponding record. This value appears as a hyperlink, which you can click to open the analysis.
- **Description:** The value stored in the Analysis Short Description field in the corresponding record.
- **Last Updated Date:** The date on which the corresponding record was last updated.
- **Last Updated By:** The user name of the user who was logged in when the record was last updated.

You can [customize the default grid display](#), if desired. If you have not yet viewed any analyses, a **There are no recently viewed links available** link will appear in place of the grid. You can click the link to return to the [FMEA Start Page](#).

The **FMEA Recently Used Analyses** page contains two task menus: [Analysis Tasks](#) and [Common Tasks](#).

Analysis Tasks Menu

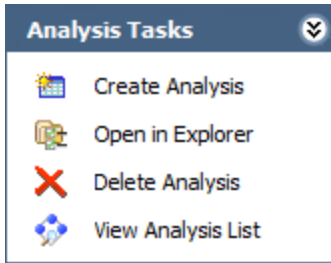

The **Analysis Tasks** menu on the **FMEA Recently Used Analyses** page contains the following links:

- **Create Analysis:** Opens the [FMEA Explorer](#) page, displaying a new FMEA Analysis.
- **Open in Explorer:** Opens the selected FMEA Analysis on the [FMEA Explorer page](#). This link is disabled if more than one FMEA Analysis record is selected in the grid.
- **Delete Analysis:** After asking for confirmation, deletes the analysis that is currently selected. Note that deleting an analysis from the **FMEA Recently Used Analyses** page will delete the RCM FMEA Analysis record and all the records to which it is linked (i.e., all the analysis elements).
- **View Analysis List:** Displays the **FMEA Analysis List** page, which displays a list of all the FMEA Analyses that exist.

Common Tasks Menu

The **Common Tasks** menu on the **FMEA Recently Used Analyses** page contains the following links:

- **Print:** Displays the Preview window, from which you can select various print options and print the list of analyses.
- **Send To:** Displays a submenu with options that let you .
- **Help:** Displays the context-sensitive Help topic for the **FMEA Recently Used Analyses** page.

Opening a Recently Used FMEA Analysis

To open an analysis on the FMEA Explorer page:

- In the **Id** column, click the hyperlinked ID of the analysis that you want to open.

-or-

Select the row containing the analysis that you want to open, and on the **Analysis Tasks** menu, click the **Open in Explorer** link.

-or-

Right-click any analysis in the list, and then click **Load selected analysis into explorer**.

The selected analysis appears on the [FMEA Explorer page](#).

Deleting FMEA Analyses

The following instructions provide details on deleting an RCM Analysis record via the **FMEA Analysis List** page. You can also delete an RCM Analysis record, however, using the shortcut menu in the [FMEA Explorer pane](#).

When you delete an FMEA Analysis record, you are also deleting all the records that are linked to that record that make up the FMEA Analysis.

To delete an FMEA Analysis record:

1. [Access the FMEA Analysis List page](#).
2. Select the row(s) containing the RCM Analysis record(s) that you want to delete.
3. On the **Analysis Tasks** menu, click the **Delete Analysis** link.
A confirmation message appears, asking if you really want to delete the selected analysis or analyses (if you selected multiple rows).
4. Click **OK**.
The selected record(s) is deleted.

About the FMEA Explorer Page

An FMEA Analysis can include RCM FMEA Asset, Failure Mode, Failure Effect, and Recommendation records. In Meridium APM, each FMEA Analysis is defined at the root level in a record that belongs to the RCM FMEA Analysis family. Other components of the analysis, such as failure modes and failure effects, are defined in records that are linked either directly or indirectly to the root RCM FMEA Analysis record, according to the families and relationships definitions outlined in the [FMEA data model](#).

Because each FMEA Analysis is represented by multiple, linked records, managing FMEA Analyses involves managing these various records, both as a group and individually. Meridium APM provides the [FMEA Explorer page](#) to facilitate working with these linked records. The layout of the **FMEA Explorer** page is similar to that of the Record Manager, where it is divided into three main areas:

- The following task menus:
 - [Analysis Tasks](#)
 - [Common Tasks](#)
 - [Template Tasks](#)
 - [Reports](#)
 - [Associated Pages](#)
- The [FMEA Explorer pane](#), which displays the hierarchy of records involved in the FMEA Analysis.
- The [datasheet area](#), which displays the information stored in the record for the selected node.

Note that throughout our discussion of the **FMEA Explorer** page, we assume that you are familiar with the basic concepts and navigational features of the Record Manager. We limit our discussion primarily to features that are specific to the **FMEA Explorer** page and that deviate from the standard functionality of the Record Manager.

Note: We recommend that you *not* work with FMEA Analyses in the Record Manager, except to [view Equipment or Functional Location records that are linked to RCM FMEA Asset records](#). Instead, you should work with RCM Analyses on the **FMEA Explorer** page.

About Accessing the FMEA Explorer Page

You can access the **FMEA Explorer** page in various ways, depending on the task that you want to perform:

- [You can access it to create a new FMEA Analysis from scratch.](#)
- [You can open an existing analysis from the **FMEA Analysis List** page.](#)
- [You can open an existing analysis from the **FMEA Recently Used Analyses** page.](#)
- [You can access it and load an analysis template to use to create a new analysis.](#)

About the FMEA Explorer Pane

When you open an FMEA Analysis on the **FMEA Explorer** page, the RCM FMEA Analysis family appears at the root level in the **FMEA Explorer** pane. Below the root record, arranged in a hierarchical view, the **FMEA Explorer** pane displays the other components of the analysis. When you first open an FMEA Analysis, only Asset nodes will be displayed in the **FMEA Explorer** pane, provided that one or more RCM FMEA Asset records have been linked to the root RCM FMEA Analysis record. The following image displays an example of the **RCM Explorer** pane.

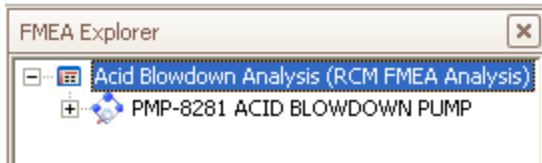

You can click the plus sign (+) to the left of the any RCM FMEA Asset node to expand it and view the associated Failure Mode records. You can expand any Failure Mode node to view the associated Failure Effect records. You can continue expanding the tree to view all the components involved in the analysis. Components are linked to one another according to the relationships defined in the [FMEA data model](#). The following image shows an example of a fully expanded branch of the tree. Notice that each analysis node has its own icon to help you identify it in the tree.

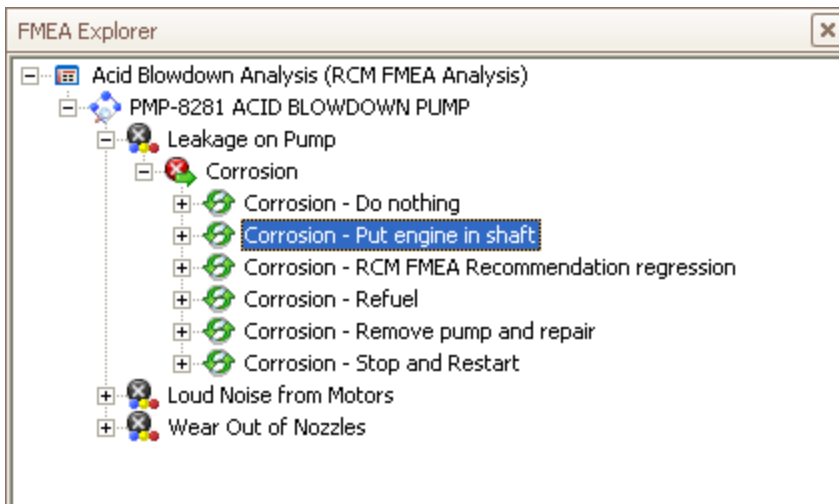

Hint: You can also right-click any branch of the tree and then click **Hide Children** or **Show Children**, as appropriate, to expand or collapse that branch.

Selecting a node in the tree will cause the datasheet for that record to appear in the [datasheet area](#) of the **FMEA Explorer** page.

Note that unlike the standard **Record Explorer** pane, which displays all the records in the record hierarchy that are linked to the root record through any relationship, the **FMEA Explorer** pane displays only the records belonging to the families that make up the

About the FMEA Explorer Pane

FMEA Analysis components, according to the FMEA data model. Therefore, you will see only the records that make up a given FMEA Analysis.

Using the Shortcut Menu in the FMEA Explorer Pane

If you right-click a node in the **FMEA Explorer** pane, a shortcut menu will appear, displaying options associated with the FMEA Analysis and its components. The specific options that are available on the menu will vary, depending on which analysis node you select. The following image shows the options that appear on the shortcut menu when you right-click a Failure Mode node.

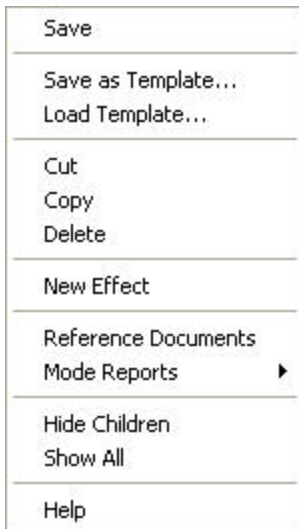

The following options are available on the shortcut menu in the **FMEA Explorer** pane:

- **Save:** Saves any changes that you have made to the currently selected record (i.e., the record whose datasheet is displayed on the right side of the page).
- **Save as Template:** Displays the **<Node ID> (new RCM FMEA Template)** window, where **<Node ID>** is the ID of the node that is currently selected in the tree, where you can save the current analysis node(s) as an analysis template.
- **Load Template:** Displays the **Templates** window, which displays a list of Templates that you can use for [adding a new node to the selected Analysis node](#). The list of Templates displayed in the window is appropriate to the type of node that is currently selected.
- **Cut:** Copies the currently selected node and all its nodes and then deletes the records from the database. A temporary copy of the records is saved so that you link them to a different record using the **Paste** function. For example, you can cut a Failure Mode node from one RCM FMEA Asset node and then paste it to a different RCM FMEA Asset node.
- **Copy:** Copies the selected record but does not remove it from the analysis tree. After you have copied a record, the **Paste** option will appear on the shortcut menu so that you can paste the record in a different location in the analysis. Note that if the selected analysis component has children, a prompt appears, asking if you want to copy just the selected record or the selected record and all its child

records.

- **Delete:** Deletes the selected record from the analysis and from the database. When you use this option, a prompt appears, asking if you want to delete the selected component only or the selected component and all its subcomponents.
- If you choose to delete the selected component and all its children, the Meridium APM system will delete all the records from the analysis and from the database.
- If you choose to delete the selected component and not the children, the Meridium APM system will delete the selected record from the database and will remove any subcomponents from the analysis. The children will not, however, be deleted from the database.
- **Paste:** Links the copied record to the record that you select in the **FMEA Explorer** pane. Note that this menu option appears only after you have copied a record and only if you select a record to which it is possible to link the copied record, according to the relationship definitions that exist.
- **New [Analysis Component]:** Creates a new record and links it to the selected record. The type of record that is created will depend on which record you select when you access the shortcut menu. For example, if you select a Failure Mode node, this option will read **New Effect** and will result in the creation of a new Failure Effect record.
- **Reference Documents:** Displays the **Reference Documents** window, where you can [manage the Reference Documents](#) associated with the record.
- **[Component] Reports:** Displays a submenu, containing a list of reports that are associated with the selected component. For example, when you select an Failure Mode node, this option will be labeled **Mode Reports**.
- **Show Children:** For a given node of the analysis tree, expands the hierarchy to display the immediate children of that node. This option appears only when you select a collapsed node that has children.

CE Hint: To expand a node entirely (i.e., to expand its children, its children's children, and so on), use the **Expand Node** option.

- **Hide Children:** For a given node of the analysis tree, collapses the hierarchy to hide the children of that node. This option appears only when you select a node that has children and that is currently expanded.
- **Show All:** Completely expands the currently selected node.
- **Help:** Displays the context-sensitive Help topic for the **FMEA Explorer** page.

About the Datasheet Area

The datasheet area, which appears on the right side of the **FMEA Explorer** page, displays the datasheet for the record that is currently selected in the **FMEA Explorer** pane. For example, when you select a Failure Effect node in the **FMEA Explorer** pane, the datasheet area displays the FMEA Failure Effect datasheet, which is populated with the values that exist in the RCM FMEA Failure Effect record, outlined in red in the following image.

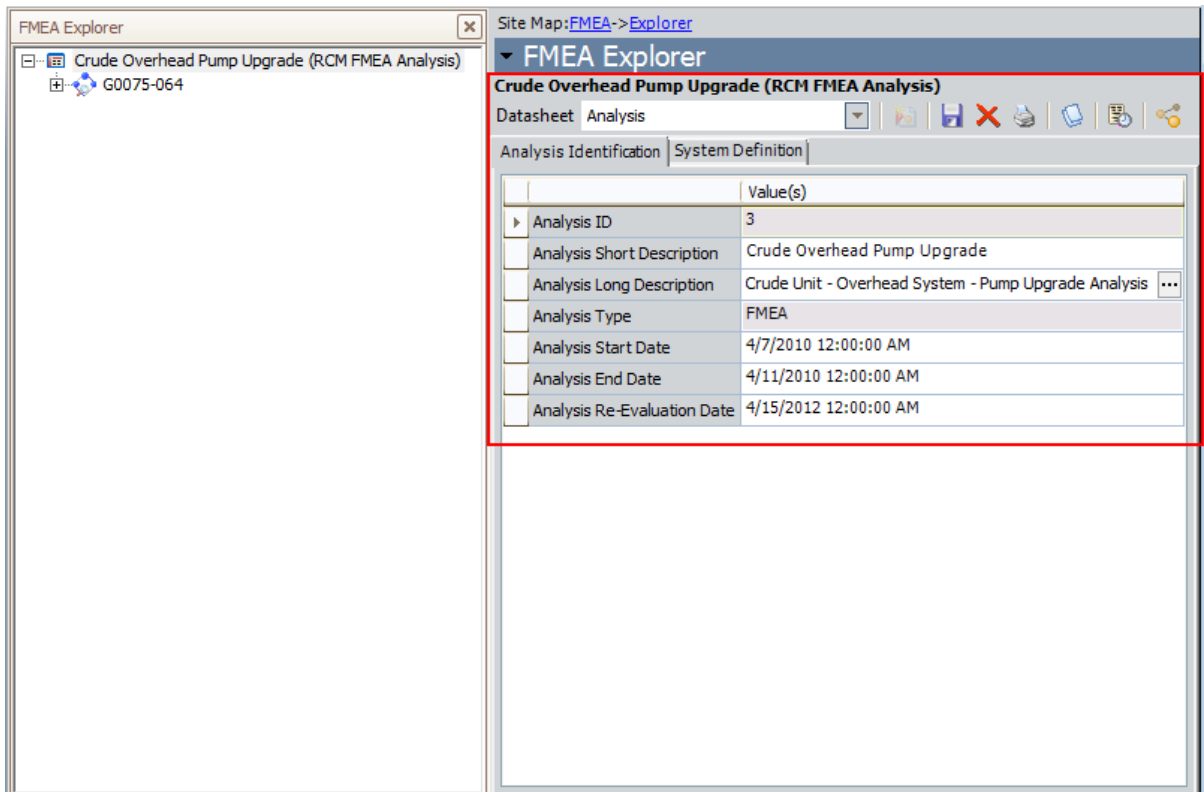

In the datasheet area, you can view the information that currently exists for the selected record and modify the information if needed. After you make changes to the record information, you can click the **Save** link on the **Common Tasks** menu to save your changes. If you make changes to a record via the datasheet and then select a different node in the **FMEA Explorer** pane, you will be prompted to save your changes before displaying the datasheet for the newly selected node.

The other features of the datasheet area, such as the buttons that appear above the datasheet itself, are the same as those that are available in the Record Manager.

Note: The **New** button  above the datasheet creates a new record in the same family as the selected record. For example, if you are viewing an RCM FMEA Recommendation record and you click the **New** button above the datasheet, a new RCM FMEA Recommendation record would appear in the datasheet area. Because the

FMEA Explorer page can display only one analysis at a time, the **New** button is disabled when you are viewing the RCM FMEA Analysis record.

Analysis Tasks Menu

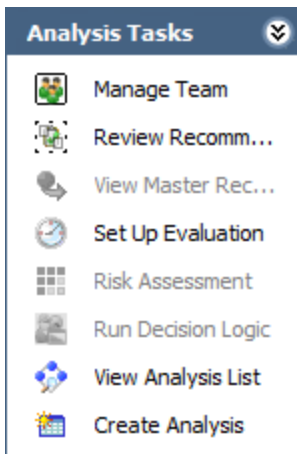

The **Analysis Tasks** menu on the **FMEA Explorer** page contains the following links:

- **Manage Team:** Displays the **FMEA Team Members** page, where you can set up your FMEA Analysis Team.
- **Review Recommendations:** Displays the [Recommendation Management page](#) where you can [review and manage the Recommendation records](#) that are associated with the current analysis. This link is enabled only if one or more RCM FMEA Recommendation records exist for the current analysis.
- **View Master Recommendation:** If the selected Recommendation record was consolidated with one or more other Recommendation records, this link [opens the master consolidated Recommendation record in a stand-alone window](#). This link is enabled only if the selected Recommendation record is in the *Consolidated* state.
- **Set Up Evaluation:** Displays the **Set Up <Node> Evaluation** dialog box, where <Node> is the type of the node that is currently selected in the **FMEA Explorer** pane. You can use this dialog box to define criteria for sending [evaluation email](#). This link is enabled only if an Analysis, RCM FMEA Asset, or Recommendation node is selected in the tree.
- **Risk Assessment:** Displays the Risk Assessment feature.
 - If a [Failure Effect node](#) is selected in the analysis tree, the **Unmitigated Risk** window appears.
 - If a [Recommendation node](#) is selected in the analysis tree and a value has been selected for at least one Category in the corresponding *unmitigatedRisk* Assessment, the **Risk Mitigation Assessment** window appears.
- **Run Decision Logic:** Launches the [Decision Logic Builder](#). This link is enabled only if a Failure Effect node is selected in the tree.

Analysis Tasks Menu

- **View Analysis List:** Displays the **FMEA Analysis List** page, from which you can [open an existing FMEA Analysis](#).
- **Create Analysis:** Opens the [FMEA Explorer](#) page, displaying a new FMEA Analysis.

Common Tasks Menu

The **Common Tasks** menu on the **FMEA Explorer** page contains the following links:

- **New [Node]:** Creates a new record, whose type is indicated by the **[Node]** name and links it to the selected record. The name of this link changes, depending on which mode you select. For example, when you select an RCM FMEA Asset node in the **FMEA Explorer** pane, this link reads **New Mode** and lets you create an RCM FMEA Failure Mode record and link it to the selected RCM FMEA Asset node.

Note: This link does not appear when you select a Recommendation node since Recommendation records represent the lowest level in the FMEA Analysis hierarchy.

- **Link to Asset:** Opens the **Find Items** window, where you can search for an Equipment or Functional Location record and link it to the selected RCM FMEA Asset record. This link is enabled only when you select an RCM FMEA Asset record that is not currently linked to an Equipment or Functional Location Asset record.
- **Open Linked Asset:** Opens in the Record Manager the Equipment or Functional Location record that is linked to the currently selected RCM FMEA Asset record. This link is enabled only when you select an RCM FMEA Asset record that *is* currently linked to an Equipment or Functional Location record.
- **Save:** Saves the currently selected record. For example, if a Failure Mode node is selected in the **FMEA Explorer** pane, when you click this link, the Meridium APM system will save any changes that you have made to that Failure Mode record.
- **Delete:** Deletes the selected record from the analysis and from the database. When you use this option, a prompt appears, asking if you want to delete the selected component only or the selected component and all its subcomponents.
 - If you choose to delete the selected component and all its children, the Meridium APM system will delete all the records from the analysis and from the database.
 - If you choose to delete the selected component and not the children, the Meridium APM system will delete the selected record from the database and will remove any subcomponents from the analysis. The children will not, however, be deleted from the database.
- **Cut:** Copies the currently selected node and all its nodes and then deletes the records from the database. A temporary copy of the records is saved so that you can then link them to a different record using the **Paste** function. For example, you can cut a Failure Mode node from one Asset node and then paste it to a different Asset node.
- **Copy:** Copies the selected record but does not remove it from the analysis tree. After you have copied a record, the **Paste** option will appear on the shortcut menu so that you can paste the record in a different location in the analysis. Note that if the selected analysis component has children, a prompt appears, asking if you want to copy just the selected record or the selected record and all its child records.

Note: If you cut or copy an analysis node, when you paste the node, the Meridium APM system will generate for the pasted node a new ID that is appropriate to where you paste it.

- **Paste:** Links the currently copied record to the record that you select in the **FMEA Explorer** pane. Note that this menu option appears only after you have copied a record and only if you select a record to which it is possible to link the copied record, according to the relationship definitions that exist.
- **Print:** Displays the **Preview** window, which shows a preview of how the current data-sheet will be printed. From the **Preview** window, you can select print options and print the record.
- **Send To:** Displays a submenu with options that let you .
- **Help:** Displays the context-sensitive Help topic for the **FMEA Explorer** page.

Template Tasks Menu

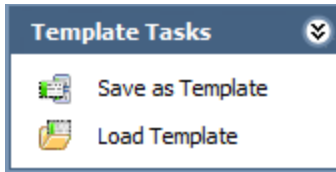

The **Template Tasks** menu on the **FMEA Explorer** page contains the following links:

- **Save as Template:** Displays the **[Record ID](New RCM FMEA Template)** window, where **[Record ID]** is the record ID of the selected analysis node. You can use this window to [save the current analysis or analysis node as an FMEA Template](#).
- **Load Template:** Displays the **Templates** window, which displays a list FMEA Templates that you can use for [adding a new node to the selected Analysis node](#). The list of FMEA Templates displayed in the window is appropriate to the type of node that is currently selected.

Reports Menu

The **Reports** menu on the **FMEA Explorer** page displays the captions of the reports that are associated with the node currently selected in the **FMEA Explorer** pane. The name of the menu will change as appropriate, depending on which node you select. For example, when you select the root-level analysis node, the menu is labeled **Analysis Reports** and displays a list of reports associated with the Analysis node.

Each analysis node has a related [folder in the Catalog](#) that is used to determine which reports to display for which analysis node. This menu appears only if reports exist in the Catalog folder associated with the selected node.

Associated Pages Menu

The **Associated Pages** menu on the **FMEA Explorer** page displays Associated Pages that have been configured via the URL Manager for the family of the analysis node that is currently selected in the **FMEA Explorer** pane.

Note: The **Associated Pages** menu will not be filtered based on the type of analysis that you are viewing. Any Associated Page that you configured for a family that is used by both RCM and FMEA Analyses will appear when you are viewing an RCM Analysis and when you are viewing an FMEA Analysis.

What is the FMEA Analysis Team?

The *FMEA Analysis Team* defines which users will participate in the FMEA Analysis. The FMEA Analysis Team actually consists of Human Resource records that are linked to the RCM FMEA Analysis record. The **FMEA Team Members** page simply provides a customized view for working with Human Resource records that are linked to the RCM FMEA Analysis record. To add people to the FMEA Analysis Team, you can either [select a Human Resource record that currently exists in the Meridium APM database](#), or you can [create a new Human Resource record](#).

You can configure your FMEA Analysis Team on the **FMEA Team Members** page, which is [accessible](#) from the [FMEA Explorer page](#).

Accessing the FMEA Team Members Page

To access the FMEA Team Members page from the FMEA Explorer page:

- On the FMEA Explorer page, on the Analysis Tasks menu, click the Manage Team link.

The [FMEA Team Members page](#) appears.

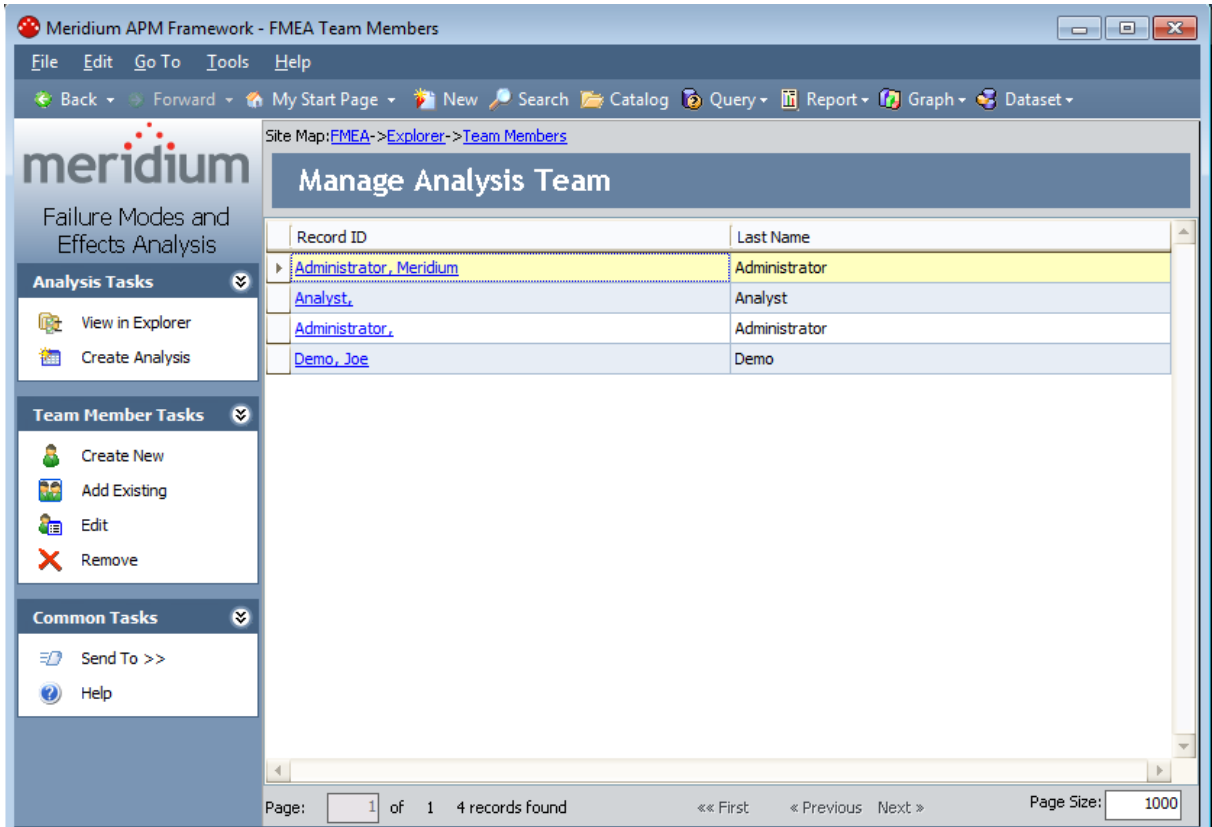

Aspects of the FMEA Team Members Page

The **FMEA Team Members** page contains a grid that displays a list of all the Human Resource records that make up the FMEA Analysis Team. The grid is divided into two columns:

- **Record ID:** The Record ID of the Human Resource record.
- **Last Name:** The value in the Last Name field of the Human Resource record.

The **FMEA Team Members** page also contains three task menus, which let you perform tasks specific to the FMEA Analysis Team: [Analysis Tasks](#), [Team Members Tasks](#), and [Common Tasks](#).

From the **FMEA Team Members** page, you can:

- [Add team members using existing Human Resource records.](#)
- [Add team members by creating new Human Resource records.](#)
- [Modify information about a team member.](#)
- [Remove team members from the FMEA Analysis Team.](#)

Analysis Tasks Menu

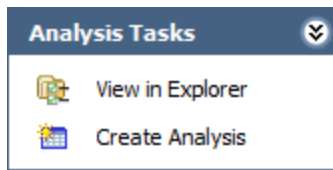

The **Analysis Tasks** menu on the **FMEA Team Members** page contains the following link:

- **View in Explorer:** Displays the current FMEA Analysis on the [FMEA Explorer page](#).
- **Create Analysis:** Opens the [FMEA Explorer](#) page, displaying a new FMEA Analysis.

Team Members Tasks Menu

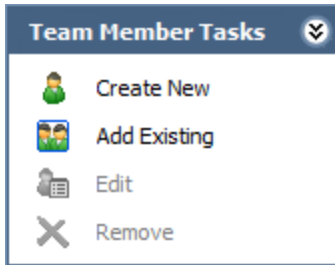

The **Team Members Tasks** menu on the **FMEA Team Members** page contains the following links:

- **Create New:** Displays the **Create New Team Member** dialog box, where you can [create a new Human Resource record](#) and add that person to the FMEA Analysis Team.
- **Add Existing:** Displays the **Find a Human Resource** dialog box, where you can [search for existing Human Resource records to add](#) to the FMEA Analysis Team.
- **Edit:** Displays the **Edit Team Member** dialog box, where you can [modify the information stored in the selected Human Resource record](#).
- **Remove:** After asking for confirmation, [removes the selected Human Resource record from the FMEA Analysis Team](#). Note that this does not delete the Human Resource record from the database.

Common Tasks Menu

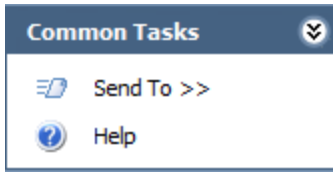

The **Common Tasks** menu on the **FMEA Team Members** page contains the following links:

- **Send To:** Displays a submenu with options that let you .
- **Help:** Displays the context-sensitive Help topic for the **FMEA Team Members** page.

Adding an Existing User to the FMEA Analysis Team

To add a team member to the FMEA Analysis Team using an existing Human Resource record:

1. On the [FMEA Team Members page](#), on the **Team Member Tasks** menu, click the **Add Existing** link.

The **Find a Human Resource** window appears.

2. Specify search criteria to find the desired Human Resource record. Note that the Human Resource family is selected in the **Search In** list by default. You cannot select a different family, but you can define additional criteria if desired.
3. Click the **Find Now** button.

The Human Resource records that match your search criteria appear in a list at the bottom of the window.

4. In the list of results, select the record that you want to add to the analysis team.
5. Click the **Select** button.

The Human Resource record that you selected appears in the list on the **FMEA Team Members** page.

Creating a New User to Add to the FMEA Analysis Team

To add a team member to the FMEA Analysis Team by creating a new Human Resource record:

1. On the [FMEA Team Members page](#), on the **Team Member Tasks** menu, click the **Create New** link.

The **Create New Team Member** dialog box appears.

Create New Team Member

Datasheet: MI Human Resource

Last Name [Redacted]

First Name []

Middle Initial []

Job Title []

Company []

Address1 []

Address2 []

City []

State []

Postal Code []

Country []

Phone1 []

Phone2 []

Fax []

Domain []

Email Address []

Facility []

Site Code []

Business Unit []

Area of Responsibility []

Department []

Comments []

Promote to User

OK Cancel

2. On the datasheet, complete the desired fields to identify the new Human Resource. Note that a **Last Name** is required.
3. Click the **Save** button.

The new Human Resource record is created and added to the FMEA Analysis Team.

Modifying Information about a Team Member

To modify the Human Resource record for an FMEA Analysis Team member:

1. On the [FMEA Team Members page](#), in the list of team members, click the hyper-linked Record ID of the Human Resource record that you want to modify.

The **Edit Team Member** dialog box appears.

2. Make the desired changes.
3. Click the **Save** button.

Your changes are saved to the database.

Removing Team Members from the FMEA Analysis Team

Note: Removing a team member from the FMEA Analysis Team simply breaks the link between the Human Resource record and the RCM FMEA Analysis record. It does not delete the Human Resource record from the database.

To remove a Human Resource record from the FMEA Analysis Team:

1. On the [FMEA Team Members page](#), in the list of team members, select the row containing the Human Resource record that you want to remove from the team.

2. On the **Team Members Task** menu, click the **Remove** link.

A message appears, asking if you really want to remove the Human Resource record from the FMEA Analysis Team.

3. Click the **Yes** button.

The Human Resource record is removed from the FMEA Analysis Team.

Adding Equipment and Locations to an FMEA Analysis

To add an RCM FMEA Asset record to an FMEA Analysis via the FMEA Explorer page:

1. With the analysis [open on the FMEA Explorer page](#), select the Analysis node in the FMEA Explorer pane.
2. On the **Common Tasks** menu, click the **New Asset** link.

-or-

Right-click the analysis node, and then click **New Asset**.

A new RCM FMEA Asset node is added to the tree in the **FMEA Explorer** pane.

3. Select the new RCM FMEA Asset node to display the **FMEA Asset** datasheet in the datasheet area on the right side of the page.
4. On the **FMEA Asset** datasheet, enter the information for the new RCM FMEA Asset record. Note that the Asset ID is generated automatically by the system and cannot be modified. The Asset Description is also generated automatically. This can be modified but is required.
5. When you are finished entering the information, on the **Common Tasks** menu, click the **Save** link.

The information that you entered for the RCM FMEA Asset record is saved to the database. At this point, you can:

- Re-select the Analysis node and add another RCM FMEA Asset record to the analysis.
- [Add a Failure Mode](#) to the RCM FMEA Asset record that you just created or to another RCM FMEA Asset record.

Linking an RCM FMEA Asset Record to an Equipment or Functional Location Record

If your system has been properly [configured](#), you will have the option of linking RCM FMEA Asset records to Equipment or Functional Location records in your database. This gives you the ability to use an FMEA Analysis to analyze both "virtual" equipment and locations (which are not represented by existing Equipment and Functional Location records), and physical equipment and locations (which are represented by existing Equipment and Functional Location records).

When RCM FMEA Asset records are linked to Equipment and Functional Location records, information from the Equipment or Functional Location record will be passed to various elements in the analysis. In addition, the Equipment or Functional Location record will then be linked to any Recommendation records or Task records that are created for the piece of equipment or location.

The first step in linking RCM FMEA Asset records to Equipment or Functional Location records is to [add the RCM FMEA Asset record](#) to the FMEA Analysis. After the RCM FMEA record exists on the equipment and location list, you can link the RCM FMEA Asset record to an Equipment or Functional Location record.

Note that if the **System Definition** tab of the Analysis datasheet contains a value in the Site Reference field, you will be able to link RCM FMEA Asset records only to Equipment or Functional Location records that are linked to that Site Reference record. Likewise, if the **System Definition** tab does not yet contain a value in the Site Reference field, when you add a piece of equipment or location to the FMEA Analysis, the Site Reference field will be updated automatically to display the ID of the Site Reference record that is linked to that Equipment or Functional Location record. You will then be able to link RCM FMEA Asset records only to Equipment or Functional Location records that are linked to that Site Reference record.

To link an RCM FMEA Asset record to an Equipment or Functional Location record:

1. On the **FMEA Explorer** page, locate the RCM FMEA Asset record that you want to link to an Equipment or Functional Location record.
2. On the **Common Tasks** menu, click the **Link to Asset** link.

Note: This link is enabled only when you select an RCM FMEA Asset record that is not already linked to an Equipment or Functional Location record.

The **Find Asset** window appears, displaying a search form.

3. In the **Search In** list, select the family on which to search.

Note: The **Search In** list contains the families for that are related to the RCM FMEA Asset family through the Is RCM FMEA Asset relationship.

4. Specify any additional, desired search criteria, and click the **Find Now** button.

The records that match your search criteria appear in the list at the bottom of the page.

5. Select the row representing the record that you want to link to the RCM FMEA Asset record.
6. Click the **Select** button link.

The **Find Items** window closes, and the description of the RCM FMEA Asset record is updated in the **FMEA Explorer** pane to reflect the information contained in the selected record. In the RCM FMEA Asset record datasheet, the ID is updated to reflect the ID of the linked record. If your system has been configured to do so, additional fields may also be mapped from the Equipment or Functional Location record to the RCM FMEA Asset record. If desired, you can [open the linked record in Record Manager](#).

Viewing the Equipment or Functional Location Record that is Linked to an RCM FMEA Asset Record

When an RCM FMEA Asset record is linked to an Equipment or Functional Location record, you can view the associated record from the **FMEA Explorer** page. After you open the Equipment or Functional Location in the [Record Manager](#), all the standard Record Manager features will be available to you.

To view the Equipment or Functional Location record that is linked to the RCM FMEA Asset record:

1. On the **FMEA Explorer** page, in the analysis tree, select the node of the RCM FMEA Asset record whose related record you want to view.
2. On the **Common Tasks** menu, click the **Open Linked Assets** link.

The Record Manager appears, displaying the linked record.

Unlinking RCM FMEA Asset Records from Equipment or Functional Location Records

The **FMEA Explorer** page provides no direct method for unlinking an RCM FMEA Asset record from its related Equipment or Functional Location record. If you need to unlink an RCM FMEA Asset record from an Equipment or Functional Location record, either to create a virtual piece of equipment or location or to relink the RCM FMEA Asset record to a different record, use one of the following procedures:

- In the **FMEA Explorer** pane, [copy or cut and then paste](#) the RCM FMEA Asset record to create a new RCM FMEA Asset record. The new RCM FMEA Asset record will not be linked to an Equipment or Functional Location record. You can then [delete the original, linked RCM FMEA Asset record](#).
- Open the RCM FMEA Asset record in Record Manager and remove the link between the RCM FMEA Asset record and the Equipment or Functional Location record.

Note: If you link an RCM FMEA Asset record to the wrong Equipment or Functional Location record, you will need to unlink the RCM FMEA Asset record from the incorrect record using one of the preceding options and then [relink](#) the RCM FMEA Asset record to the desired record. You cannot modify an existing link in a single step.

You should unlink RCM FMEA Asset records from Equipment or Functional Location records *only* if no RCM FMEA Recommendation or RCM FMEA Task records have been created and linked to the RCM FMEA Asset record. Unlinking equipment and locations may result in RCM FMEA Recommendations and RCM FMEA Task records that are linked to records no longer involved in the analysis. If you unlink an RCM FMEA Asset record from an Equipment or Functional Location record and then *relink* the RCM FMEA Asset to a different one, if the original record had been linked to one or more RCM FMEA Recommendation records, the existing links will be updated automatically so that the Recommendation records are linked to the new record. Links between existing RCM FMEA Task records and Equipment or Functional Location records will, however, not be modified.

Defining Failure Modes

To add an RCM FMEA Failure Mode record to an FMEA Analysis:

1. With the analysis [open on the FMEA Explorer pane](#), in the **FMEA Explorer** pane, select the Asset node of the RCM FMEA Asset record to which you want to link the new RCM FMEA Failure Mode record.

2. On the **Common Tasks** menu, click the **New Mode** link.

-or-

Right-click the Asset node, and then click **New Mode**.

A new Failure Mode node is added to the tree in the **FMEA Explorer** pane.

The FMEA Failure Mode datasheet is displayed in the datasheet area on the right side of the page.

3. In the FMEA Failure Mode datasheet, enter the information for the new RCM FMEA Failure Mode record. Note that:

- The Failure Mode ID value is generated automatically by the system and cannot be modified.
- The Failure Mode Name value is generated automatically. This can be modified but is required.
- The Related Asset ID field contains the Asset ID from the RCM FMEA Asset record to which the Failure Mode node has been added. If the RCM FMEA Asset record contains a value in the Asset Type field, that value will be used to populate the Related Asset Type field in the associated RCM FMEA Failure Mode record and the RCM FMEA Recommendation record.

4. When you are finished entering the failure mode on the **Common Tasks** menu, click the **Save** link.

The information that you entered for the RCM FMEA Failure Mode record is saved to the database. At this point, you can:

- Select an Asset node and create another RCM FMEA Failure Mode record.
- [Add a failure effect](#) to the RCM FMEA Failure Mode record that you just created or to a different RCM FMEA Failure Mode record.

Defining Failure Effects

To add an FMEA Failure Effect record to an FMEA Analysis:

1. With the analysis [open on the FMEA Explorer pane](#), in the **FMEA Explorer** pane, select the Failure Mode node of the RCM FMEA Failure Mode record to which you want to link the new RCM FMEA Failure Effect record.
2. On the **Common Tasks** menu, click the **New Effect** link.

-or-

Right-click the Failure Mode node, and then click **New Effect**.

A new Failure Effect node is added to the tree in the **FMEA Explorer** pane.

The **FMEA Failure Effect** datasheet is displayed in the datasheet area on the right side of the page.

3. In the FMEA Failure Effect datasheet, enter the information for the new RCM FMEA Failure Effect record. Note that the **Failure Effect ID** is generated automatically by the system and cannot be modified. The **Effect Name** is also generated automatically. This can be modified but is required.
4. On the **Analysis Tasks** menu, click the **Risk Assessment** link.

The **Unmitigated Risk Assessment** window appears.

5. Using the Risk Matrix provided, define the unmitigated risk rank associated with the failure effect, and click the **Save** button.

Note the following:

- If any tab represents a risk category that does not apply to the failure effect that you are assessing, you can select the **Not Applicable** check box on that tab. When you do so, the tab will be disabled, and the tab label will be updated to contain the text *N/A*.
- The unmitigated risk rank that you selected in the Risk Assessment feature appears in the Unmitigated Risk field on the FMEA Failure Effect datasheet.
- The financial risk rank that you selected in the Risk Assessment feature appears in the Unmitigated Financial Risk field on the FMEA Failure Effect datasheet.
- The *highest* unmitigated risk rank that you select on any *non-financial* tab appears in the Driving Risk Rank field on the FMEA Failure Effect datasheet.
- The tab that contains the highest non-financial unmitigated risk rank appears in the Driving Risk Category field on the FMEA Failure Effect datasheet.
- The **Risk Of** cell contains the value in the Effect Name field in the RCM FMEA Failure Effect record.
- The text that you type in the **Basis for Assessment** dialog box is saved in the RCM FMEA Failure Effect record.

6. On the **Analysis Tasks** menu, click the **Run Decision Logic** link.

The **Decision Logic Builder** appears, displaying the Welcome screen.

7. [Use the Decision Logic Builder](#) to identify actions that will mitigate the associated failure effect.

After you complete the **Decision Logic Builder**, the responses that you provided to the questions and the recommended action will be recorded on the **Logic Builder** tab on the RCM Failure Effect datasheet.

8. When you are finished entering the failure effect information, on the **Common Tasks** menu, click the **Save** link.

The information that you entered for the RCM FMEA Failure Effect record is saved. At this point, you can:

- Select a Failure Mode node and create another RCM FMEA Failure Effect record.
- [Create a recommendation](#) for the RCM FMEA Failure Effect record that you just created or for a different RCM FMEA Failure Effect record.

The Decision Logic Builder

The **Decision Logic Builder** guides you step-by-step through answering questions that will result in suggestions for mitigating a given failure effect. After you use the **Decision Logic Builder** to determine which actions should be taken to mitigate the effects of the failure, you can [create recommendations](#) that are based upon the recommended actions.

When you go through the **Decision Logic Builder**, you will be presented with a series of questions. You will respond Yes or No to each of the questions. When you have reached the end of the **Decision Logic Builder**, you will be presented with a recommended action that is based upon the responses to the questions that were presented. Your responses to the questions and the recommended action will be recorded in text fields in the RCM FMEA Failure Effect record. After you complete the **Decision Logic Builder**, you can view a summary of your responses on the **Logic Builder** tab of the [FMEA Failure Effect datasheet](#).

The Meridium APM **Decision Logic Builder** is based upon the concepts and decision diagrams in SAE Standard JA1012, "A Guide to the Reliability-Centered Maintenance (RCM) Standard." The process and terminology used in the Meridium APM Decision Logic Builder are described in more detail in this standards document. To use the **Decision Logic Builder** effectively, you will need to be familiar with this standard.

To use the Decision Logic Builder:

1. [Open an FMEA Analysis](#).
2. In the analysis tree, select a Failure Effect node.
3. On the **Analysis Tasks** menu, click the **Run Decision Logic** link.
The **Decision Logic Builder** appears, displaying the Welcome screen.
4. Click the **Next** button.
The **Logic Selection** screen appears.
5. Click the **Yes** button to respond *Yes* to the question.
-or-
Click the **No** button to respond *No* to the question.
The next question is displayed immediately after you click the **Yes** or **No** button.
6. Continue clicking the **Yes** or **No** button in response to each question that is displayed. The number of questions that are presented will depend upon your responses.
When you have responded to all the questions, a suggested action will be displayed.
7. Click the **Finish** button.

The **Decision Logic Builder** closes. You can click the **Logic Builder** tab on the FMEA Failure Effect datasheet to view a summary of your responses and the suggested action.

CEHint: If you want to modify your responses, click the **Run Decision Logic** link on the **Analysis Tasks** menu and proceed through the **Decision Logic Builder** again. The information on the **Logic Builder** tab will be updated after you complete the builder. If you close the **Decision Logic Builder** before responding to all questions and clicking the **Finish** button, the information on the **Logic Builder** tab will not be updated.

Defining Recommendations

Hint: For help with defining Recommendation records, on the **FMEA Explorer** page, you can click the **Decision Tree** link on the **Analysis Tasks** menu to access the Decision Tree document that has been configured for use with FMEA.

To add an RCM FMEA Failure Effect record to an FMEA Analysis:

1. With the analysis [open on the FMEA Explorer pane](#), in the **FMEA Explorer** pane, select the Failure Effect node of the RCM FMEA Failure Effect record to which you want to link the new RCM FMEA Recommendation record.
2. On the **Common Tasks** menu, click the **New Recommendation** link.

-or-

Right-click the Failure Effect node, and then click **New Recommendation**.

A new Recommendation node is added to the tree in the **FMEA Explorer** pane.

The **FMEA Recommendation** datasheet is displayed in the datasheet area on the right side of the page.

3. On the **FMEA Recommendation** datasheet, enter the information for the new RCM FMEA Recommendation record. Note that:

- The **Recommendation ID** is generated automatically by the system and cannot be modified.
- The **Recommendation Headline** is also generated automatically. This can be modified but is required.
- The **Asset ID** cell is populated automatically with the value in the **Related Asset ID** cell in the related [Failure Mode](#). You can modify this field, if desired. We recommend, however, that you accept the default value. If you modify this value, [recommendation evaluation email](#) may not be generated properly. In addition, the Meridium APM system relies upon this value to relate any Task records generated from the recommendation to the associated RCM FMEA Asset record or Equipment or Functional Location record.
- If you select **Failure Finding (FF)** in the **Action Type** list, the cells below the *****Failure Finding Activity***** section become enabled. The value in the **FFI** cell is calculated using the values in [the MMF, MTIVE, MTED, and n cells](#).

Note that if you want the calculated FFI value to appear in the Interval field, select the **Use Calculated FFI Results** check box. In addition, if you want to see the FFI value in a different unit (e.g., Months), select the desired interval in the **Display FFI Units As** list. The value in the **Interval** cell will be updated to reflect the selected unit.

Note: Changes that you make to the values in existing RCM FMEA Recommendation records will not have any effect on the RCM FMEA Task records to which they are already linked.

4. On the **Analysis Tasks** menu, click the **Risk Assessment** link.

The **Risk Mitigation Assessment** window appears.

5. Using the Risk Matrix provided, define the mitigated risk rank associated with the recommendation, and click the **Save** button. Note that:
 - The **Risk Of** cell contains the value in the Effect Name field in the RCM FMEA Failure Effect record to which the RCM FMEA Recommendation record is linked.
 - The **Mitigated By** cell contains the value in the Recommendation Headline field in the RCM FMEA Recommendation record.
 - The **Not Applicable** check box is disabled when you are assessing the mitigated risk of a Recommendation record. The **Not Applicable** check box selection will be inherited from the associated [Failure Effect's risk assessment](#).
 - The text that you type in the **Basis for Assessment** dialog box is saved in the RCM FMEA Failure Effect record to which the RCM FMEA Recommendation record is linked.

The mitigated risk rank that you selected in the Risk Assessment feature appears in the Mitigated Risk field on the FMEA Recommendation datasheet. The financial risk rank that you selected in the Risk Assessment feature appears in the Mitigated Financial Risk field on the FMEA Recommendation datasheet.

6. When you are finished entering the recommendation information, on the **Common Tasks** menu, click the **Save** link.

The information that you entered for the RCM FMEA Recommendation record is saved. If desired, at this point, you can select another Failure Effect node and create another new Recommendation record for the analysis.

About Copying, Cutting, and Pasting Analysis Elements

To help streamline the analysis-development process, FMEA lets you cut, copy, and paste analysis elements. You can use these options to cut or copy individual analysis nodes and then paste them to another location within the same analysis. Note the following about using the cut, copy, and paste functions:

- The Cut function creates a copy of the cut elements and then deletes the records from the database. When you paste the cut elements, the Meridium APM system will create new records. Note also that the Cut function automatically copies all nodes of the selected node.
- When you paste copied analysis elements, the IDs are generated automatically in the same way as they are when you create a new analysis element. The Meridium APM system looks at the other nodes on the level where you are pasting, finds the highest numeric value of all the current IDs, adds one (1) to the highest value, and assigns that as the ID value for the newly pasted node. The ID helps uniquely identify each element with respect to its location in the analysis.
- When you paste copied analysis elements, the names are not regenerated.
- When you copy or cut and then paste an analysis node that is linked to one or more Reference Document records, the Reference Document records will also be copied or cut and then pasted.

Using the Cut Function

To cut an analysis node and paste it to another location within the same analysis:

1. In the **FMEA Explorer** pane, select the node that you want to cut.
2. Press **Ctrl+X** on your keyboard.

-or-

On the **Common Tasks** menu, click the **Cut** link.

-or-

Click the right mouse button, and then click **Cut**.

If the node that you selected has successor nodes, a message appears, asking if you want to copy all the child elements.

3. Click **OK**.

The selected node and all its nodes are copied and then deleted from the database.

Note: If you want to paste the node that you cut, you must do so immediately before copying or cutting another node; otherwise the cut node and its nodes will be lost permanently. You will be able to paste the cut node only once.

Using the Copy Function

To make a copy of an analysis node to paste in an additional location within the same analysis:

1. In the **FMEA Explorer** pane, select the node that you want to copy.
2. Press **Ctrl+C** on your keyboard.

-or-

On the **Common Tasks** menu, click the **Copy** link.

-or-

Click the right mouse button, and then click **Copy**.

If the node that you selected has successor nodes, a message appears, asking if you want to copy all the child elements.

3. Click the **Yes** button to copy all the child elements of the selected element.

-or-

Click the **No** button to copy only the selected node.

Note: If you want to paste the node that you copied to a different location, do not delete the copied node. The copied node will not be available for pasting after you delete it.

Using the Paste Function

After you [copy a node](#) or [cut a node](#), you can paste the copied element(s) to another node. The Paste function will automatically paste the copied node and any nodes that were copied along with it.

Note: A *cut* node can be pasted only once. A *copied* node can be pasted multiple times but cannot be pasted after the copied node is deleted from the database.

To paste the copied element(s) to another location:

1. In the **FMEA Explorer** pane, select the node on which you want to paste the copied elements.

Note: The node that you select as the target for the Paste operation must be appropriate for the node that was copied. For example, if you copy a Recommendation node, you must select a Failure Effect node in order to paste the copied elements. The Paste function will be enabled only after you select an appropriate node.

2. Press **Ctrl+V** on your keyboard.

-or-

On the **Common Tasks** menu, click the **Paste** link.

-or-

Click the right mouse button, and then click **Paste**.

The element is pasted to the selected location.

Modifying an Analysis Node in the FMEA Explorer Pane

You can use the following instructions to modify any node in an FMEA analysis, including the root-level analysis node.

To modify the information associated with an analysis element in the FMEA Explorer pane:

1. With the analysis [open on the FMEA Explorer page](#), in the **FMEA Explorer** pane, expand the analysis tree to locate the node representing the record that you want to modify.

2. Select the node.

The datasheet associated with that record appears in the datasheet area on the right side of the page.

3. In the datasheet, modify the values in any editable field.
4. On the **Common Tasks** menu, click the **Save** link.

Your changes are saved to the database.

Deleting an Analysis or Analysis Node in the FMEA Explorer Pane

On the **FMEA Explorer** page, you can delete any analysis element, or you can delete the root-level Analysis node to delete the entire analysis. Note that:

- If you choose to delete an element that contains elements, *all elements will also be deleted*.
- If you delete an Asset node and the RCM FMEA Asset record is linked to an Equipment or Functional Location record, the link between the RCM FMEA Asset record and the Equipment or Functional Location record will be broken. The Asset record will not, however, be deleted from the database.
- Deleting a Recommendation record will also delete any related scheduled items that exist for that recommendation in Meridium APM Schedule Manager.

To delete an analysis or analysis element via the FMEA Explorer pane:

1. In the **FMEA Explorer** pane, expand the tree, and select the node representing the element that you want to delete.

CEHint: To delete the entire analysis, select the root-level Analysis node.

2. On the **Common Tasks** menu, click the **Delete** link.

A message appears, asking if you really want to delete the selected element and all its children.

3. Click **OK**.

The selected node and its nodes are deleted from the database.

- If you deleted the element of an analysis, the next highest node is selected in the analysis tree in the **FMEA Explorer** pane.
- If you deleted the root-level Analysis node, you are directed to the [FMEA Start Page](#).

About FMEA Templates

An *FMEA Template* is a copy of an entire FMEA Analysis or one or more FMEA Analysis nodes (e.g. Failure Effects) that can be used to create a new FMEA Analysis or append nodes to an existing FMEA Analysis. FMEA Template records belong to the RCM FMEA Template family. Together, the RCM FMEA Template record and all the records that are related to it make up the *FMEA Template*.

You can use FMEA Templates to streamline the analysis-development process by reducing the amount of time spent entering data that is already used in a similar analysis.

You can work with FMEA Templates via the locations in the following list. Where you work with FMEA Templates will determine the tasks that you can perform on that FMEA Template. You can use the following lists as a guide for determining which method to use when working with FMEA Templates:

- On the **FMEA Explorer** page, you can perform the following tasks:
 - [Create FMEA Templates from an existing analysis.](#)
 - [Create new analysis elements from an FMEA Template.](#)
 - [Manage analysis elements.](#)
- On the **FMEA Template Explorer** page, you can perform the following tasks:
 - [Create FMEA Templates from scratch.](#)
 - [Create new template elements from existing FMEA Templates.](#)
 - [Manage analysis elements in FMEA Templates](#) similar to how you manage analysis elements in FMEA Analyses using the **FMEA Explorer** pane.
 - [Create new analyses from an FMEA Template.](#)
- On the **FMEA Templates** page, via the [Template Tasks menu](#), you can perform the following tasks:
 - Create an FMEA Analysis from an existing FMEA Template.
 - Create an FMEA Template from scratch.
 - Edit an FMEA Template.
 - Delete an FMEA Template.

Accessing the FMEA Templates Page

To access the FMEA Templates page:

- On the FMEA Start Page, click the **Manage Templates** link.
- or-
- On the FMEA Template Explorer page, on the **Analysis Tasks** menu, click the **Man-
age Templates** link.

The [FMEA Templates](#) page appears.

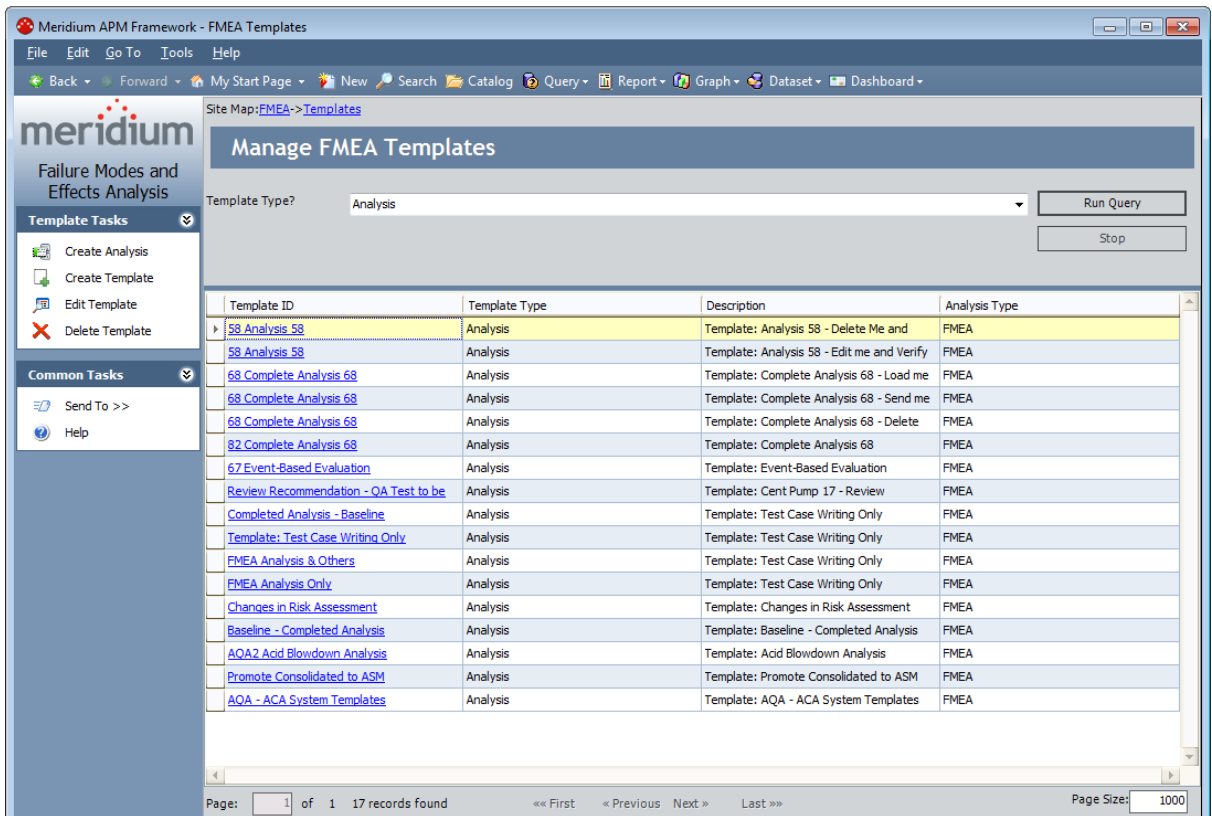

Aspects of the FMEA Templates Page

The **FMEA Templates** page displays the results of the query that is defined for the **Template Query** setting on the **FMEA Administration** page. By default, this page displays the *Template List* query, which is stored in the \\Public\Meridium\Modules\FMEA folder in the Meridium APM Catalog. This query contains one prompt, *Template Type*, which appears as a list at the top of the **FMEA Templates** page. The **Template Type** list contains the following values, which you can use to filter the query results that appear at the bottom of the page:

- **Analysis:** Displays the FMEA Templates that were created at the analysis level.

Note: This value is selected by default when you access the **FMEA Templates** page from the **FMEA Start Page**. However, if you access the **FMEA Templates** page from the **FMEA Template Explorer** page, the query uses as the prompt the *Template Type* that is associated with the template that you are currently viewing on the **FMEA Template Explorer** page.

- **Asset:** Displays the FMEA Templates that were created at the equipment and location level.
- **Failure Effect:** Displays the FMEA Templates that were created at the failure effect level.
- **Failure Mode:** Displays the FMEA Templates that were created at the failure mode level.
- **Function:** This value is not used in FMEA.
- **Function Failure:** This value is not used in FMEA.
- **Recommendation:** Displays the FMEA Templates that were created at the recommendation level.

You can select any value from the **Template Type** list, and then click the **Run Query** button to view the corresponding query results. Note that each of the values listed above corresponds to a value that can be stored in the *Template Type* field in the corresponding RCM FMEA Template record.

Note: Throughout this documentation, our descriptions of the FMEA Templates functionality assume that you are using the default [Template List query](#). If you have modified the default query or if you are using a different query, the FMEA Template functionality for your implementation may vary slightly from our descriptions.

The query results section contains the following columns:

- **Template ID:** The Record ID of the RCM FMEA Template record.
- **Template Type:** The type of template. This value is determined by the family of the root node in the template. For example, if the root node in the template is a Failure Mode, the **Template Type** cell will contain the value *Failure Mode*.
- **Description:** The description of the template that is stored in the Description field

in the corresponding RCM FMEA Template record.

- **Analysis Type:** The type of analysis to which the template applies (i.e., RCM or FMEA). By default, the query results on this page will contain only RCM FMEA Template records whose Analysis Type is *FMEA*.

The **FMEA Templates** page contains the following task menus: [Template Tasks](#) and [Common Tasks](#).

Template Tasks Menu

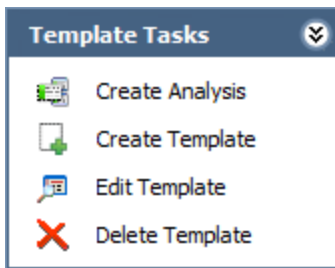

The **Template Tasks** menu on the **FMEA Templates** page contains the following links:

- **Create Analysis:** Creates a new FMEA Analysis based upon the FMEA Template that is currently selected in the results grid.
 - If the template from which you want to create a new analysis is linked to at least one RCM FMEA Asset record, this link will display the [Apply Template Builder](#), which you can use to specify whether you want to keep or replace the RCM FMEA Asset record(s) and then apply the template accordingly.
 - If the template from which you want to create a new analysis is not linked to any RCM FMEA Asset records, this link will create the analysis from the template and open it on the **FMEA Explorer** page.

This link is enabled only when the results displayed on the **FMEA Templates** page contains records whose Template Type is *Analysis*. This link is disabled if more than one RCM FMEA Template record is selected in the grid.

- **Create Template:** Displays the **Template Builder**, which guides you step-by-step through the process of [creating an FMEA Template from scratch](#).
- **Edit Template:** Displays the selected RCM FMEA Template record on the **FMEA Template Explorer** page, where you can [modify the record](#) and save your changes. This link is enabled only when at least one record appears in the results grid. In addition, this link is disabled if more than one RCM FMEA Template is selected in the grid.
- **Delete Template:** After asking for confirmation, [deletes the selected RCM FMEA Template](#) record from the database. This link is enabled only when at least one record appears in the grid. You can select multiple records to delete at one time.

Common Tasks Menu

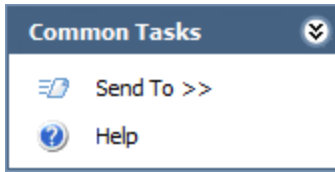

The **Common Tasks** menu on the **FMEA Templates** page contains the following links:

- **Send To:** Displays a submenu with options that let you .
- **Help:** Displays the context-sensitive Help topic for the **FMEA Templates** page.

Accessing the Template Builder

You can use the **Template Builder** to [create a new FMEA Template from scratch](#). To access the **Template Builder**:

- On the [FMEA Templates page](#), on the **Template Tasks** menu, click the **Create Template** link.

-or-

On the [FMEA Template Explorer page](#), on the **Analysis Tasks** menu, click the **Create Template** link.

The **Template Builder** appears, displaying the Welcome screen.

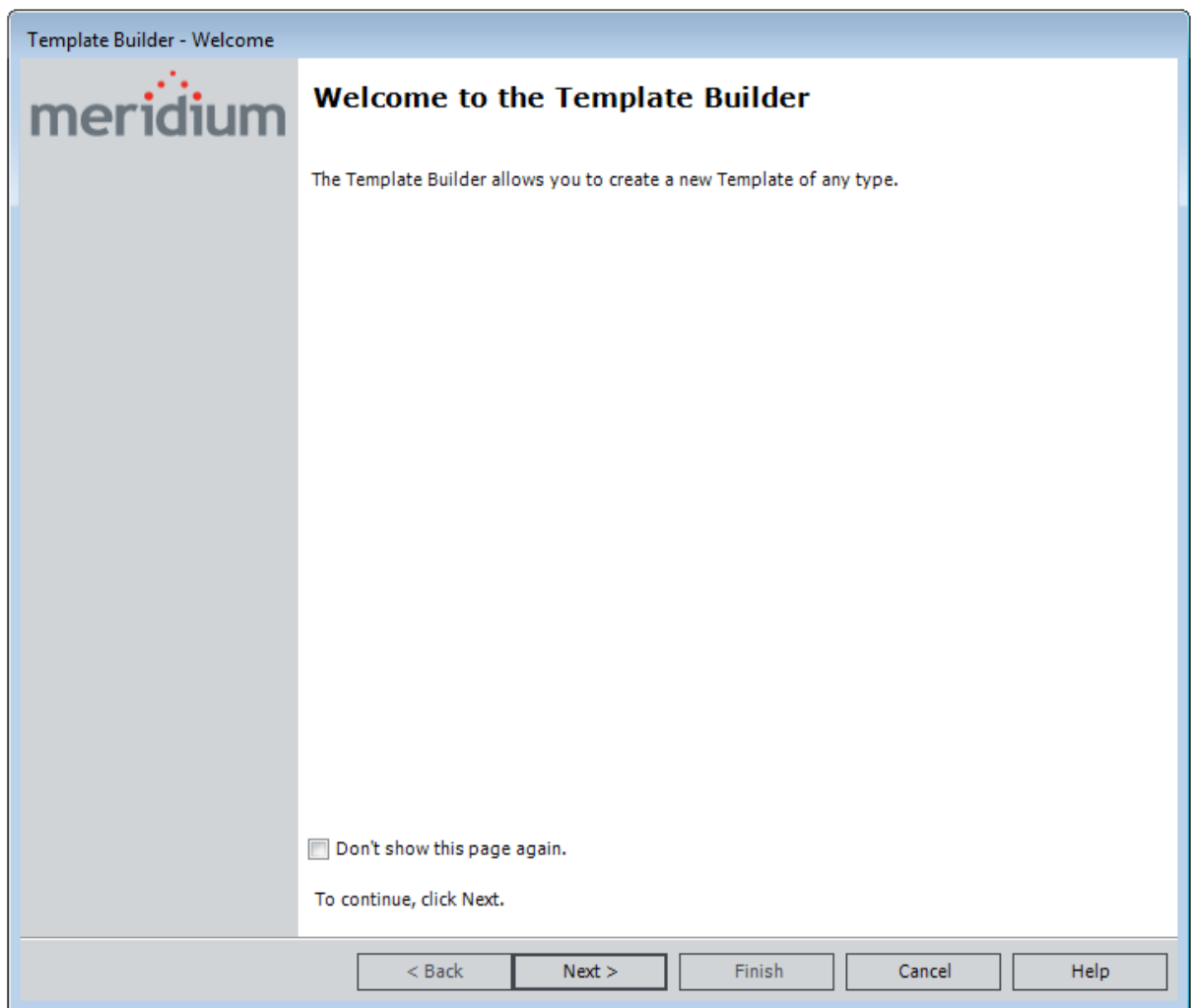

Using the Template Builder to Create a New FMEA Template from Scratch

The following instructions provide details on creating a new FMEA Template using the **Template Builder**.

To create a new FMEA Template from scratch:

1. [Access the Template Builder](#).
2. On the Welcome screen, click the **Next** button.

The **Select Template Type** screen appears.

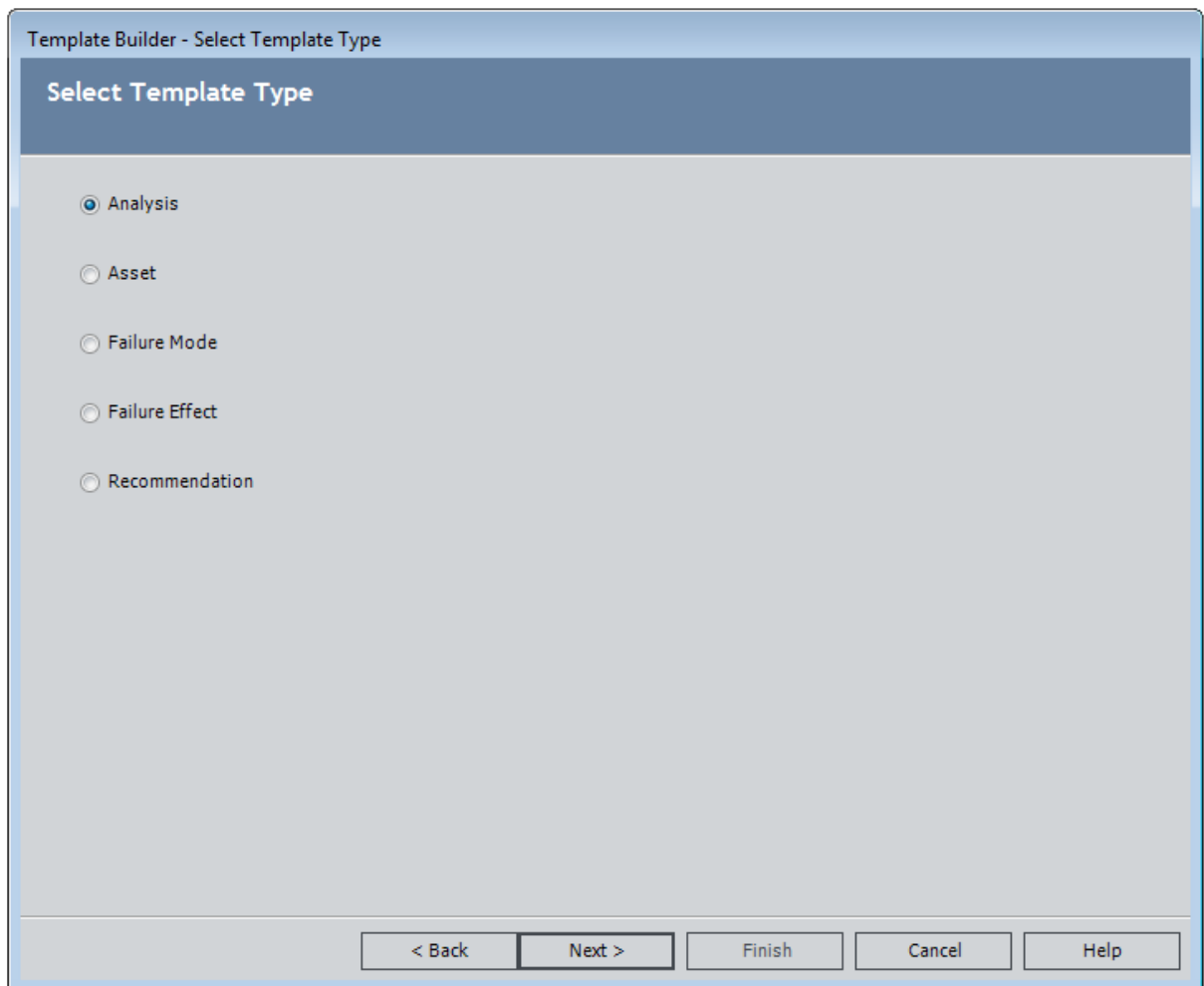

3. Select the Template Type for which you want to create an FMEA template, and click the **Next** button.

The **Define Root Node** screen appears, displaying the datasheet for the Template Type that you selected in the previous step. For example, if you are creating an

FMEA Template whose root node will represent an RCM FMEA Analysis record, the datasheet for an RCM FMEA Analysis record will appear on the **Define Root Node** screen, as shown in the following image.

	Value(s)
Analysis ID	246
Analysis Short Description	
Analysis Long Description	
Analysis Type	FMEA
Analysis Start Date	
Analysis End Date	
Analysis Re-Evaluation Date	

Note: The ID value is generated automatically by the Meridium APM system and can not be modified. If you are creating an FMEA Template at the analysis level, the Analysis Short Description field on the Analysis datasheet is required, as shown in the preceding image.

4. Provide values in the fields as needed, and then click the **Next** button.

The **Define Template** screen appears, displaying the RCM FMEA Template datasheet.

Template Builder - Define Template

Define Template

Datasheet: RCM FMEA Template

General

	Value(s)
▶ ID	
Type	Analysis
Description	Template:
Analysis Type	FMEA
Status	
Author	MIADMIN
Created On	7/2/2012 2:17:36 PM
Approver	
Approved Date	

< Back Next > Finish Cancel Help

The following fields contain values by default:

- The **Type** cell is disabled and populated automatically with the template type value, which indicates the family of the record from which the template was created.
 - The **Analysis Type** cell is disabled and populated automatically with *FMEA*.
 - The **Author** cell is disabled and populated automatically.
 - The **Created On** cell is disabled and populated automatically.
5. Complete the details of the datasheet, as desired.
 6. Click the **Finish** button.

The FMEA Template is created and appears on the [FMEA Template Explorer page](#), where the Template Type that you defined is the root node in the [FMEA Template Explorer pane](#), and the datasheet for the new template record appears in the [datasheet area](#).

Using the Template Builder to Create a New FMEA Template from Scratch

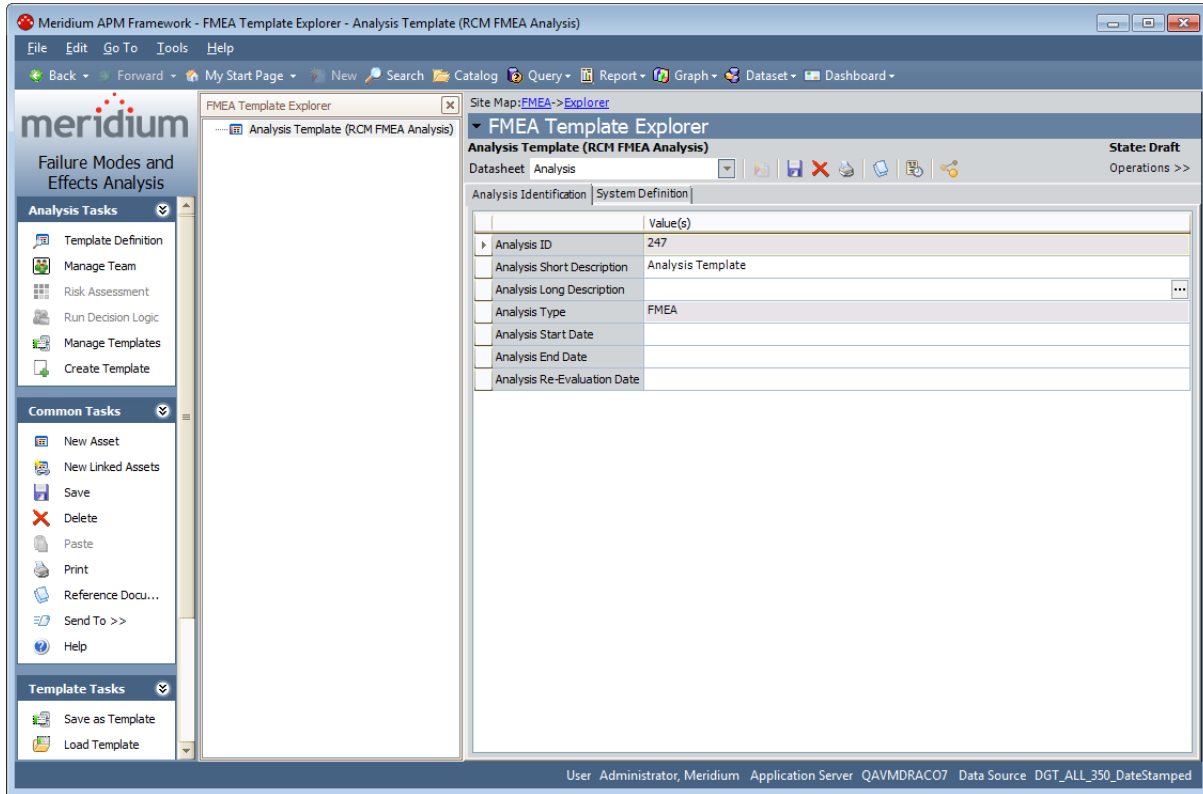

Creating an FMEA Template from an Existing FMEA Analysis

When you use an FMEA Template to create a new analysis or to create new nodes in an existing analysis, *all* the nodes that are included in the FMEA Template will be applied to the target analysis. From the [FMEA Explorer page](#), you can create a new FMEA Template from an FMEA Analysis or any analysis element.

When you create an FMEA Template from the root FMEA Analysis node, the FMEA Template will include:

- The FMEA Analysis node.
- Any related Human Resource records that make up the **Team Member** list.
- Any Asset, Failure Mode, Failure Effect, and Recommendation nodes included in the analysis.
- Any Reference Documents that are linked to the analysis elements.
- Any related Risk Assessments.

Note: If you create an FMEA Template that includes RCM FMEA Asset records that are linked to Equipment or Functional Location records, the links will not be maintained when the FMEA Template is created. In this way, the RCM FMEA Asset records that are linked to the FMEA Template will become *virtual equipment and locations*. When you create a new analysis from the FMEA Template, you will be given the choice to keep or replace virtual equipment and locations with Equipment or Functional Location records.

When you create an FMEA Template from an analysis element other than the Analysis node (i.e., a node that appears *below* the Analysis node), the RCM Template will include the selected node and all of its successor nodes. The root node in the FMEA Template determines the nodes to which the template can be applied in the target FMEA Analysis, with respect to the record hierarchy. For example, an FMEA Template whose root node is a Failure Effect can be applied only to a Failure Mode node.

To create a new FMEA Template from an existing FMEA Analysis:

1. Open the desired analysis on the **FMEA Explorer** page.
2. In the **FMEA Explorer** pane, select the node that you want to use as the root node in the FMEA Template.
3. On the **Template Tasks** menu, click the **Save as Template** link.

A new RCM FMEA Template record appears in a new window.

Field	Value(s)
ID	Analysis 58
Type	Analysis
Description	Template: Analysis 58
Analysis Type	FMEA
Status	
Author	MIADMIN
Created On	7/2/2012 4:01:49 PM
Approver	
Approved Date	

On the RCM FMEA Template datasheet, the following fields contain values by default:

- The **Type** cell is disabled and populated automatically with the template type value, which indicates the family of the record from which the template was created.
 - The **Analysis Type** cell is disabled and populated automatically with *FMEA*.
 - The **Author** cell is disabled and populated automatically.
 - The **Created On** cell is disabled and populated automatically.
4. Complete the details of the datasheet as needed.
 5. Click **OK**.

The new template is created and appears on the [FMEA Template Explorer page](#), where you can view and modify its contents. If you created the FMEA Template at the Analysis node level, you will be able to [use the FMEA Template for creating](#)

[new FMEA Analyses](#). Otherwise, you can [apply the FMEA Template to an existing analysis to create new analysis nodes](#) based on the ones in the template.

About Creating New FMEA Analyses from FMEA Templates

You can create a new FMEA Analysis from any FMEA Template whose root node is an Analysis node. Depending upon whether the template is associated with RCM FMEA Asset records or not, the steps that you perform to create the new analysis will vary.

- If you are applying an FMEA Template that is not associated with any RCM FMEA Asset records, you will follow a one-step template application process via the **FMEA Templates** page.
- If you are applying an FMEA Template that is associated with at least one RCM FMEA Asset record, you will use the **Apply Template Builder**, which provides an option for you to replace the virtual equipment and locations with Equipment or Functional Location records.

Creating a New Analysis from an FMEA Template Without RCM FMEA Asset Records

The following instructions provide details on creating a new FMEA Analysis by applying an FMEA Template. These instructions assume that the Analysis node is the root node in the FMEA Template that you are using to create a new FMEA Analysis and that the template is not associated with any RCM FMEA Asset records.

To create a new FMEA Analysis from an FMEA Template:

1. [Access the FMEA Templates page](#).
2. In the grid, select the row containing the FMEA Template that you want to use to create a new FMEA Analysis.
3. On the **Template Tasks** menu, click the **Create Analysis** link.

The FMEA Analysis is created and displayed on the [FMEA Explorer page](#), where you can view and modify its contents.

Accessing the Apply Template Builder

The following instructions provide details on accessing the **Apply Template Builder**, which you can use to create a new FMEA Analysis from a template and specify whether you want to keep or replace the RCM FMEA Asset record(s) that are associated with the template.

These instructions assume that the FMEA Template that you are using to create a new FMEA Analysis is associated with at least one RCM FMEA Asset record.

To access the Apply Template Builder:

1. [Access the FMEA Templates page](#).
2. In the results grid, select the row containing the FMEA Template that you want to use to create a new FMEA Analysis.
3. On the **Template Tasks** menu, click the **Create Analysis** link.

The **Apply Template Builder** appears, displaying the Welcome screen.

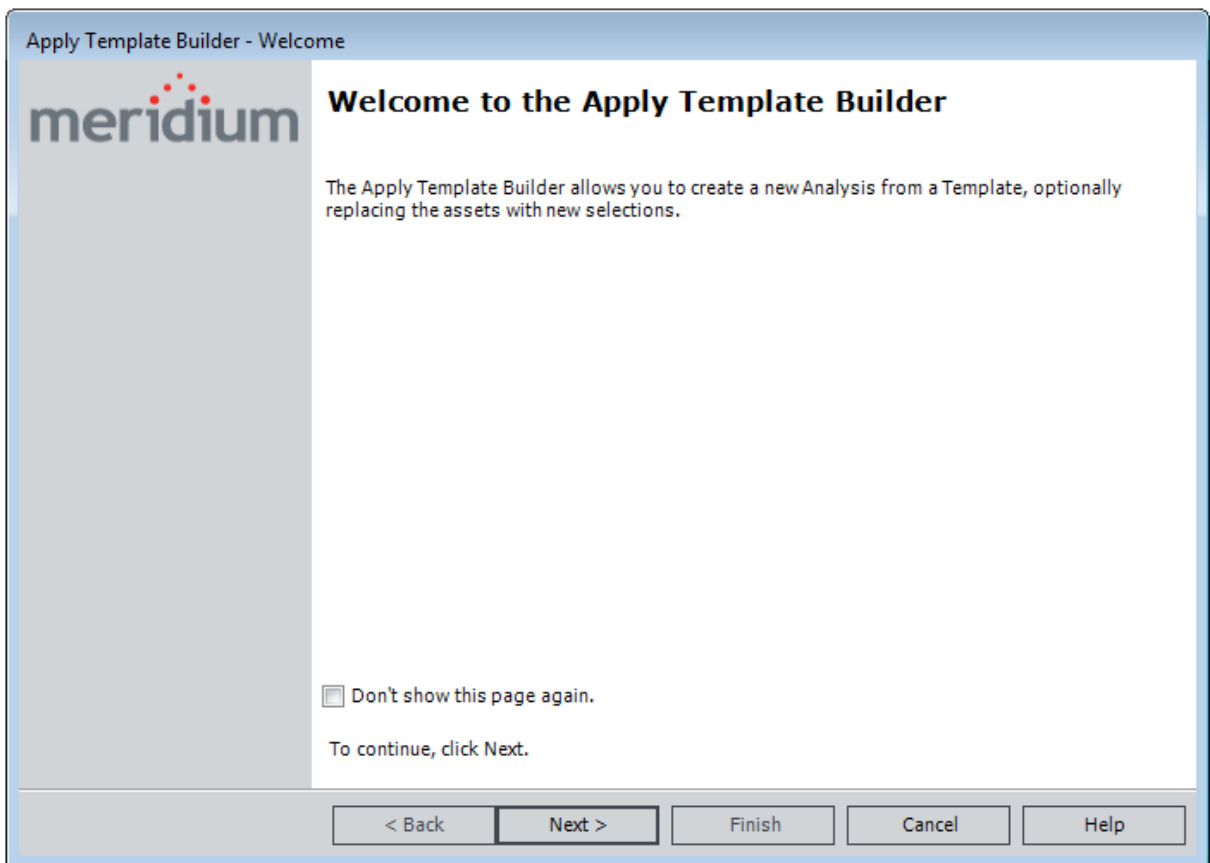

Using the Apply Template Builder to Create a New FMEA Analysis

Using the **Apply Template Builder**, you can choose to keep or exchange any RCM FMEA Asset record that is associated with the template that you are applying to a new FMEA Analysis. These instructions assume that the template with which you are creating a new FMEA Analysis is associated with at least one RCM FMEA Asset record.

To create a new FMEA Analysis using the Apply Template Builder:

1. [Access the Apply Template Builder](#).
2. On the Welcome screen, click the **Next** button.

The **Review Template Assets** screen appears, displaying a list of RCM FMEA Assets that are associated with the selected FMEA Template. Below the grid, the **Keep these assets** option is selected by default.

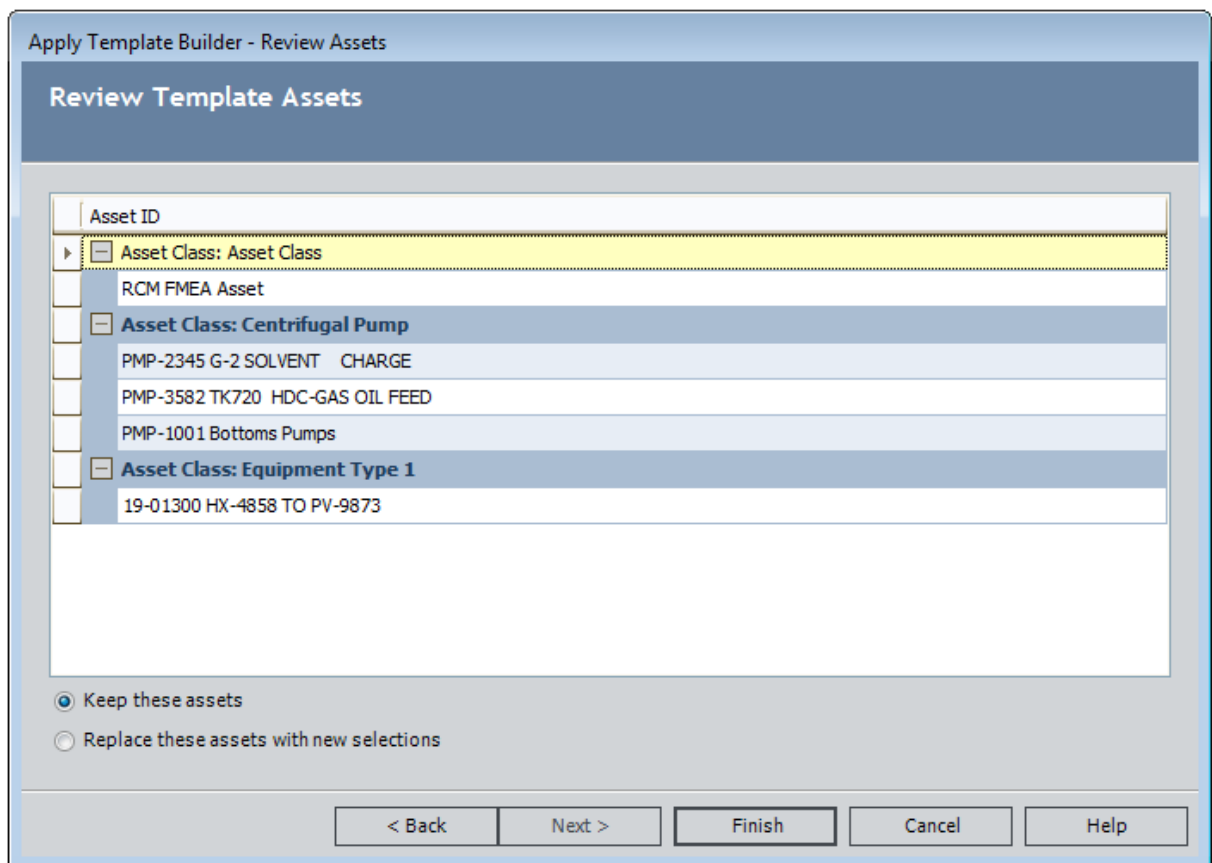

3. If you want to apply to the analysis all the RCM FMEA Asset records that are associated with the template, click the **Finish** button.

Note: If you choose the **Keep these assets** option, the new FMEA Analysis will not be linked to any Equipment or Functional Location records (i.e., physical equipment and locations).

-or-

If you want to replace the RCM FMEA Asset records that are associated with the template, select the **Replace these assets with new selections** option, and then click the **Next** button.

The **Select Asset Replacements** screen appears.

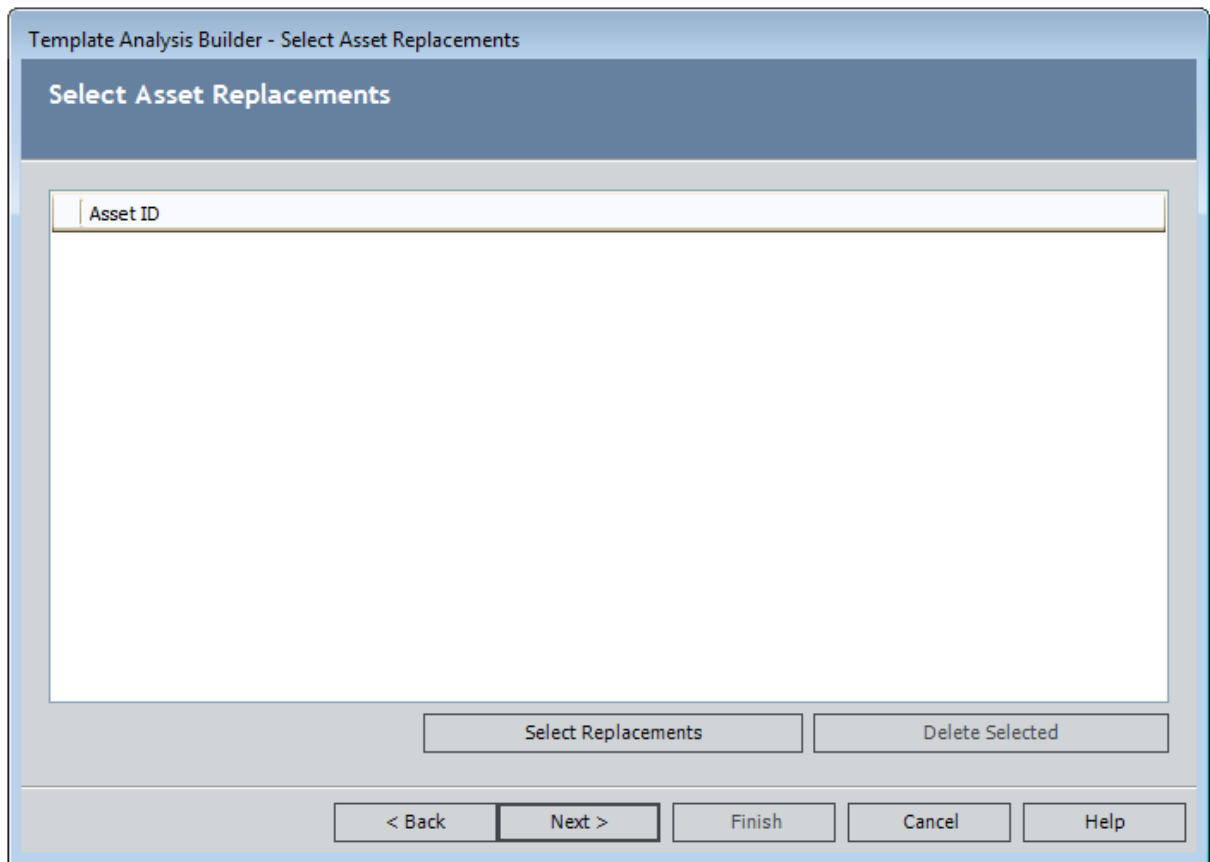

4. On the **Select Asset Replacements** screen, click the **Select Replacements** button.

The **Find Asset** window appears.

Note: The **Search In** list will contain only families that are related to the RCM FMEA Asset family through the Is RCM FMEA Asset relationship.

5. In the **Search In** list, select the family from which you will apply equipment and location records to the analysis, and then click the **Find Now** button.

The results appear in a grid.

6. Select the records that you want to use as replacements for the RCM FMEA Asset records that are currently linked to the FMEA Template, and then click the **Select** button.

The system checks to see if the selected equipment and locations can be added to the analysis:

- If any cannot be added to the analysis, those records are displayed in a separate window with a message indicating why the record cannot be added.
 - The RCM FMEA Asset records can be added are successfully linked to the FMEA Analysis.
7. You can continue adding Equipment and Functional Location records in this way. When you are finished, click the **Next** button.

The **Review/Replace Template Assets** screen appears.

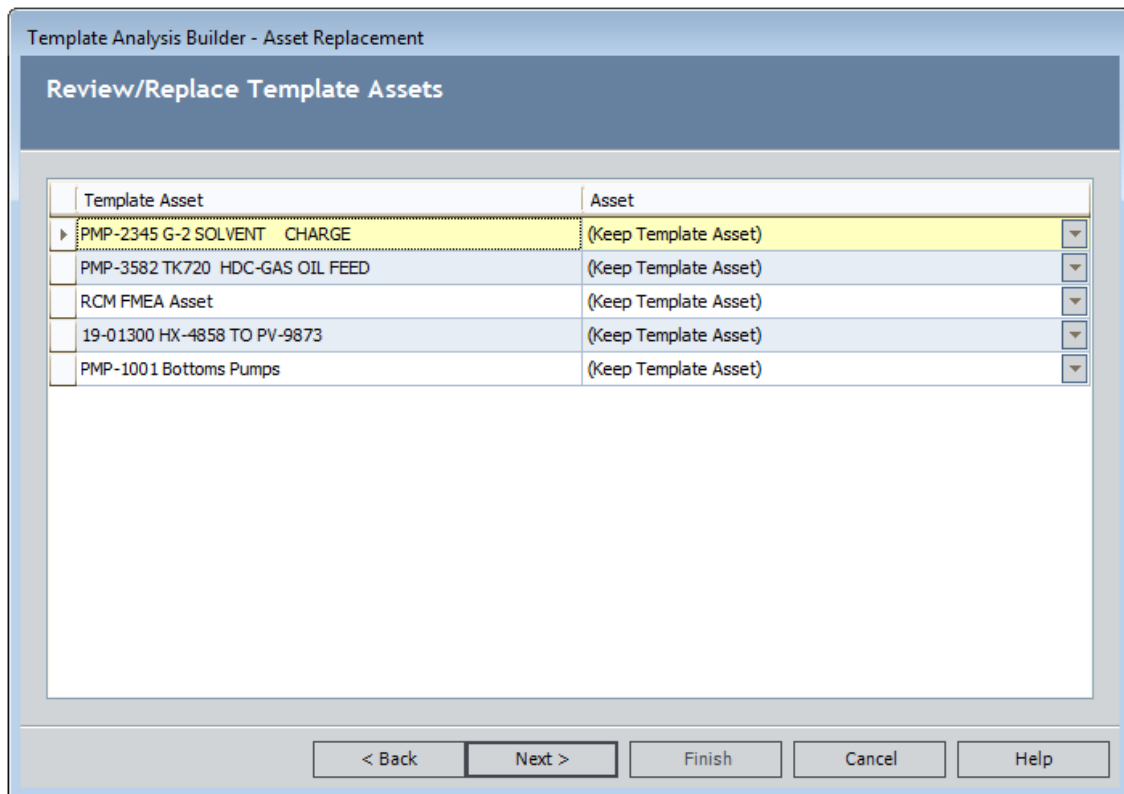

This screen contains two columns:

- **Template Asset:** Contains the RCM FMEA Asset records that are currently associated with the FMEA Template.
- **Asset:** Contains a list that you can use to specify what you want to do with the RCM FMEA Asset record in that row. The **Asset** list contains the following values:

- **(Keep Template Asset):** Indicates that you want to add the RCM FMEA Asset record to the FMEA Analysis without linking it to an Equipment or Functional Location record. This option is selected by default.
 - **(Discard Template Asset):** Indicates that you do not want to add the RCM FMEA Asset record or any of its subnodes to the FMEA Analysis. Note that this option does not delete the RCM FMEA Asset from the FMEA Template.
 - **<Selected Assets>:** Indicates that you want to replace the RCM FMEA Asset record that is linked the FMEA Template with the Equipment and Functional Location records that you selected in the previous steps.
8. For each RCM FMEA Asset record in the **Template Asset** column, select the option in the **Asset Assignment** list that corresponds to the action that you want to take.
 9. Click the **Finish** button.

The new FMEA Analysis is created and displayed on the [FMEA Explorer page](#), where you can view and modify its contents.

Creating New FMEA Analysis Nodes from an FMEA Template

While working with an existing FMEA Analysis, you can create new nodes (e.g., Failure Effects) by applying an FMEA Template.

Note: You can also use these instructions to create new template elements from an FMEA Template.

To create new analysis nodes from an FMEA Template:

1. Open on the [FMEA Explorer page](#) the FMEA Analysis to which you want to apply Analysis nodes.
2. In the [FMEA Explorer pane](#), locate the node below which you want to add new analysis nodes. For example, if you want to link new Failure Effect records to a Failure Mode record, select the Failure Mode node.
3. On the **Template Tasks** menu, click the **Load Template** link.

The **Templates** window appears.

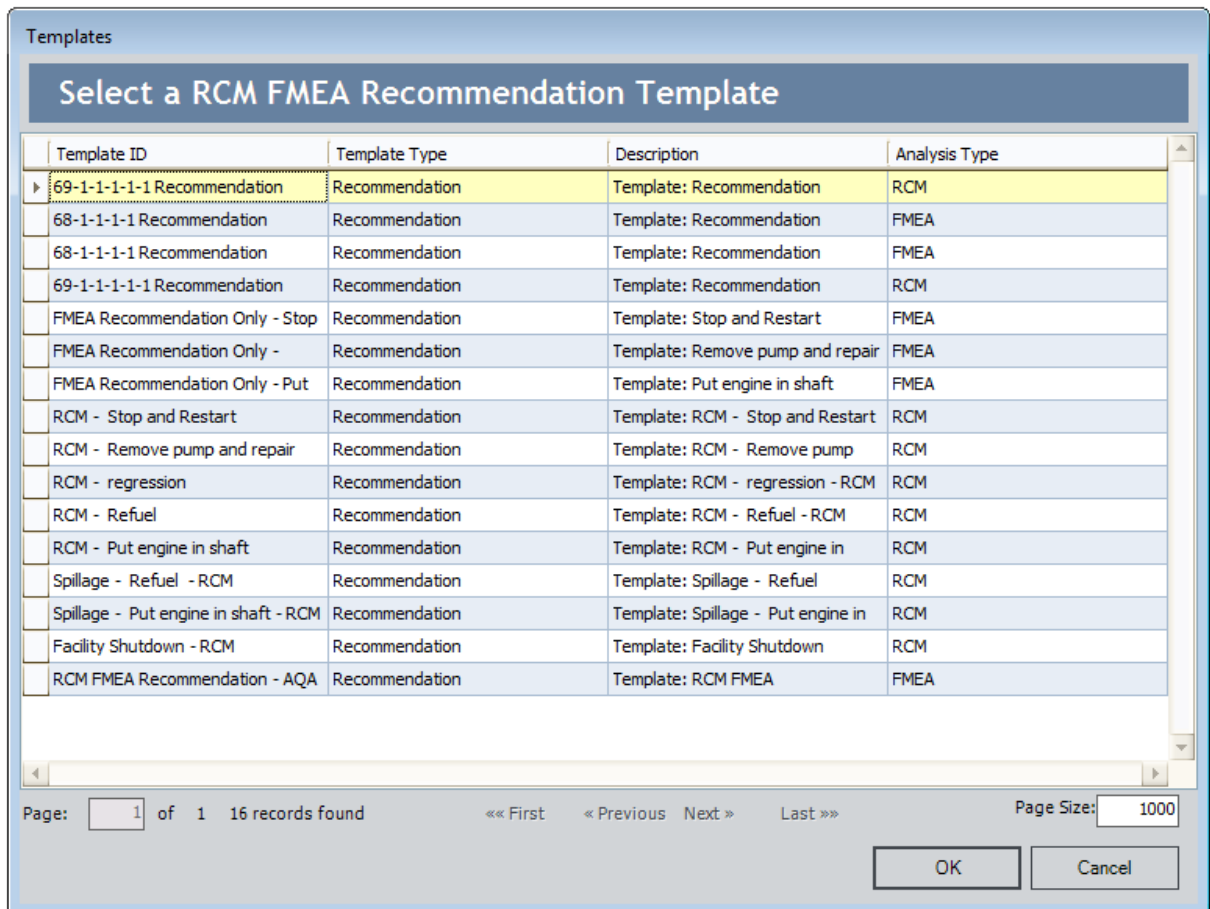

The **Templates** window displays a list of all the RCM FMEA Template records that can be used to create a successor node for the selected node. For example, if you selected a Failure Mode node, the **Templates** window will display all the Failure Effect Templates that can be used to create a Failure Effect node. Because RCM FMEA Template records can be shared across RCM and FMEA analyses, this list will contain both RCM Templates and FMEA Templates.

4. Select the row containing the RCM FMEA Template record that you want to use to create the new node, and then click **OK**.

The FMEA Template is applied to the FMEA Analysis, and then the node that corresponds to the root node from the template is selected by default in the **FMEA Explorer** pane.

Modifying Existing FMEA Templates

To modify an existing FMEA Template:

1. [Access the FMEA Templates page.](#)
2. In the query results grid, click the hyperlinked ID of the FMEA Template that you want to modify.

The **FMEA Template Explorer** page appears, displaying the RCM FMEA Template record that you selected.

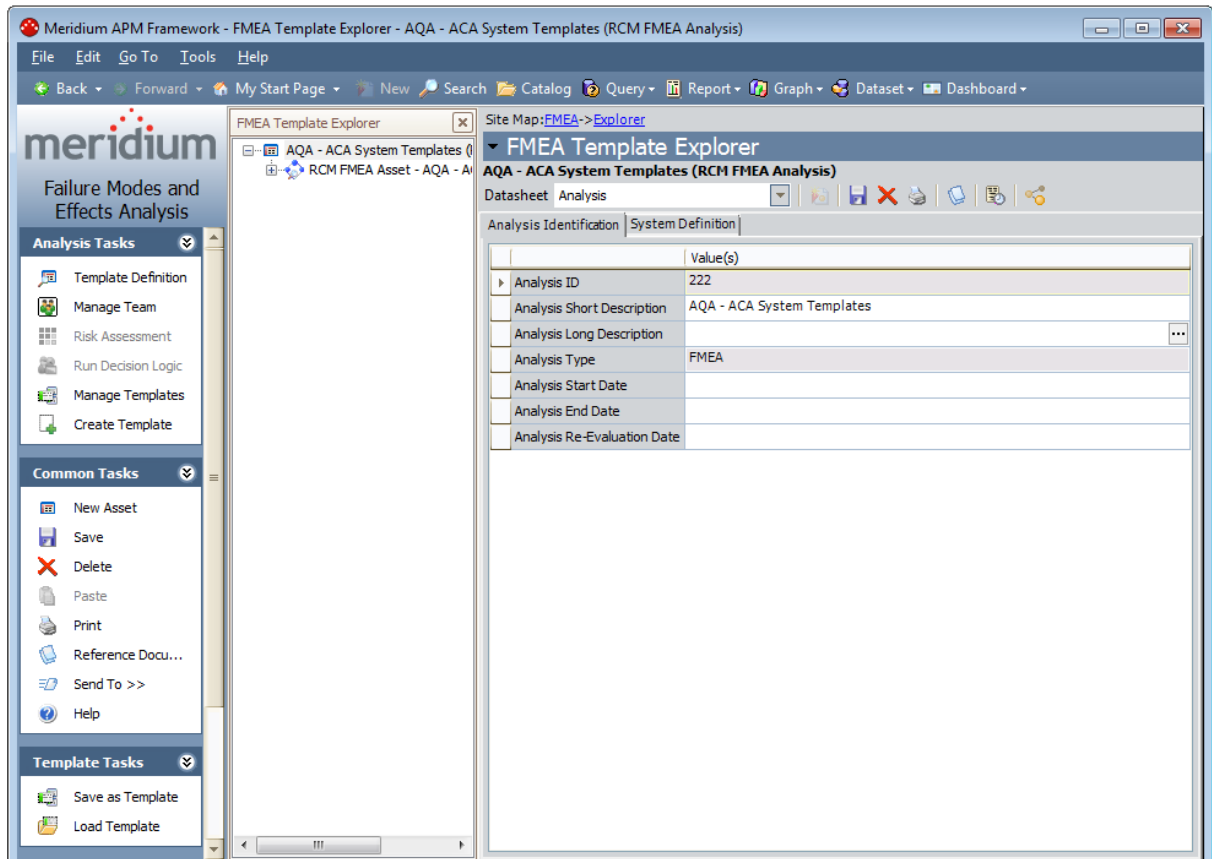

3. Modify the template as needed.
4. Click the **Save** button.

Your changes are saved to the database.

Deleting FMEA Templates

The following instructions provide details on deleting an FMEA Template via the **FMEA Templates** page. You can also delete an FMEA Template via the [FMEA Template Explorer](#) page.

To delete an FMEA Template:

1. [Access the FMEA Templates page](#).
2. In the grid, select the row containing the FMEA Template that you want to delete.
3. On the **Template Tasks** menu, click the **Delete Template** link.

A confirmation message appears, asking if you really want to delete the selected FMEA Template.

4. Click the **Yes** button.

The **FMEA Templates** page refreshes, and the RCM FMEA Template record is deleted from the database.

About the FMEA Template Explorer Page

The **FMEA Template Explorer** page is the page that you will use to work with FMEA templates. It displays an FMEA Template in a hierarchical view so that you can view the RCM FMEA Template record itself along with all the related records.

The layout of the **FMEA Template Explorer** page is similar to that of the Record Manager, where it is divided into three main areas:

- The task menu pane, which contains the following task menus:
 - [Analysis Tasks](#)
 - [Common Tasks](#)
 - [Template Tasks](#)
 - [Reports](#)
 - [Associated Pages](#)
- [FMEA Template Explorer pane](#)
- The [datasheet area](#), which displays the information stored in the record for the selected node.

Note that throughout our discussion of the **FMEA Template Explorer** page, we assume that you are familiar with the basic concepts and navigational features of the Record Manager. We limit our discussion primarily to features that are specific to the **FMEA Template Explorer** page and that deviate from the standard functionality of the Record Manager.

Accessing the FMEA Template Explorer Page

You can access the FMEA Template Explorer page by performing the following tasks:

- [Modifying an existing FMEA Template.](#)
- [Creating a new FMEA Template from scratch.](#)
- [Creating an FMEA Template from an existing FMEA Analysis.](#)

The following image shows what the FMEA Template Explorer page looks like when you access it from an existing FMEA Template.

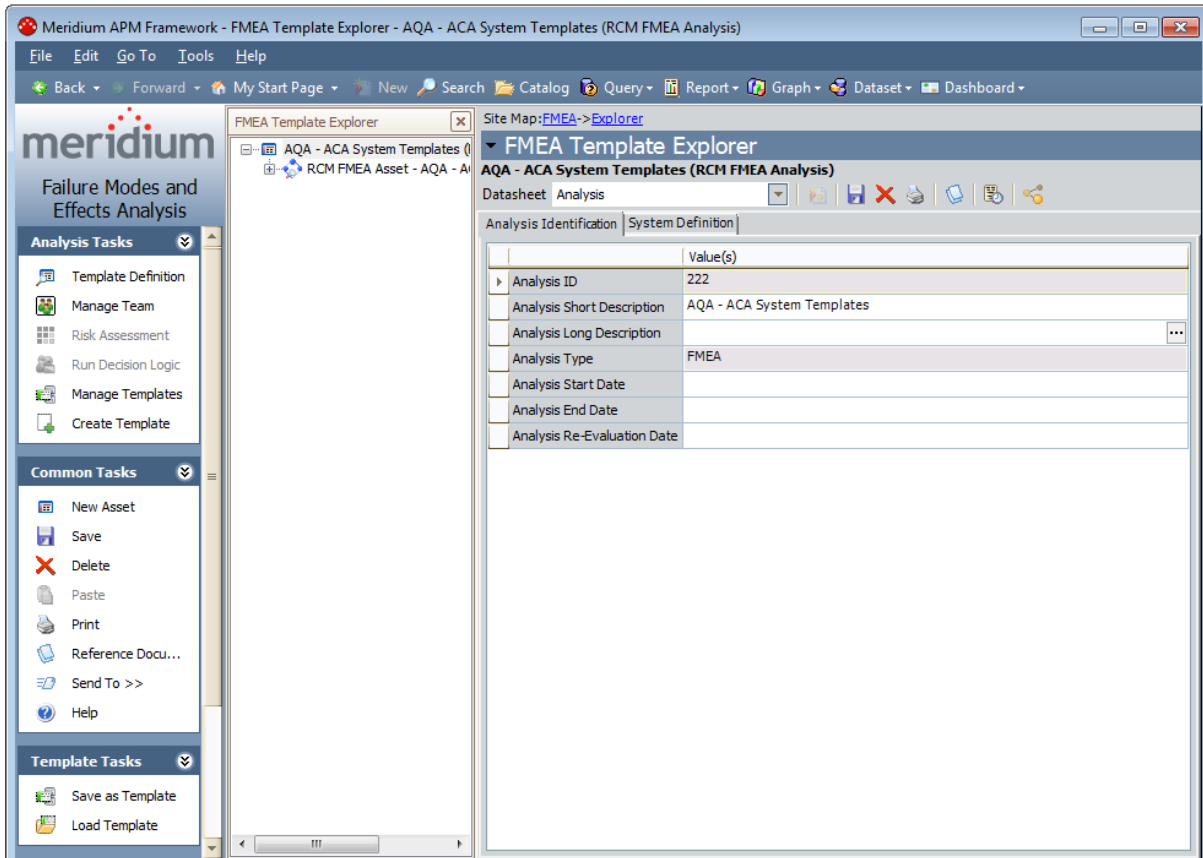

About the FMEA Template Explorer Pane

When you open an FMEA Template on the **FMEA Template Explorer** page, in the **FMEA Template Explorer** pane, the root node corresponds to the node from which the FMEA Template was created. Below the root record, the **FMEA Template Explorer** pane displays the other components of the template arranged in a hierarchy.

When you first open an FMEA Template, only the root node and the nodes that represent direct successor records of that root node appear in the **FMEA Template Explorer** pane. You can click the plus sign (+) to the left of any node to expand it and view the next record that exists in the tree. You can continue expanding the tree to view all the components involved in the FMEA Template.

Components within in the **FMEA Template Explorer** pane are linked to one another according to the relationships defined in the [FMEA data model](#). The following image shows an example of a fully expanded branch of the tree. Notice that each template node is represented by an icon, which distinguishes that analysis element in the tree.

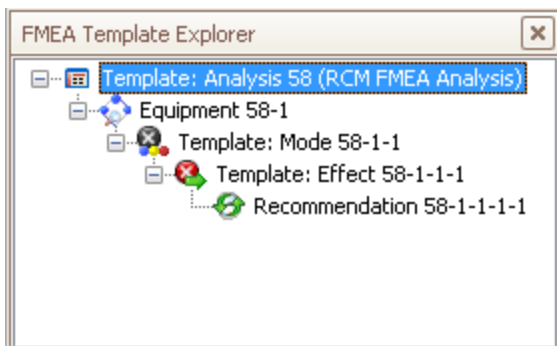

CE Hint: You can also right-click any branch of the tree and then click **Hide Children**, **Show Children**, or **Show All**, as appropriate, to expand or collapse that branch.

Selecting a node in the tree will cause the datasheet for that record to appear in the [data-sheet area](#) of the **FMEA Template Explorer** page.

Note that unlike the standard **Record Explorer** pane, which displays all the records in the record hierarchy that are linked to the root record through any relationship, the **FMEA Template Explorer** pane displays only the records belonging to the families that make up the FMEA Template components, according to the [FMEA data model](#).

The Shortcut Menu in the FMEA Template Explorer Pane

If you right-click a node in the **FMEA Template Explorer** pane, a shortcut menu will appear, displaying options associated with the FMEA Template and its components. The specific options that are available on the menu will vary, depending which node you select. The following image shows the options that appear on the shortcut menu when you right-click a Failure Mode node.

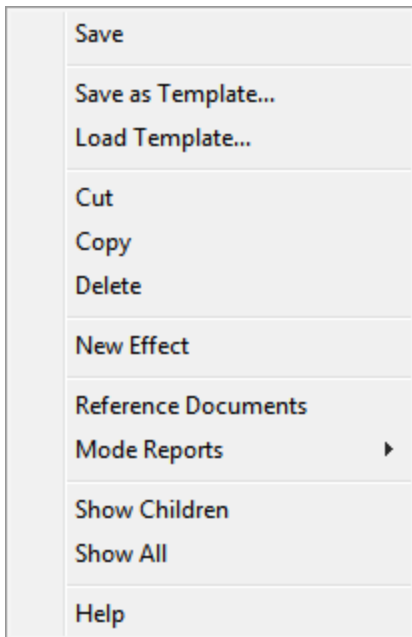

The following options are available on the shortcut menu in the **FMEA Template Explorer** pane:

- **Save:** Saves any changes that you have made to the record that is currently selected.
- **Save as Template:** Displays a new RCM FMEA Template record in a new window, from which you can create a new FMEA Template using the currently selected node as the root node.
- **Load Template:** Facilitates the creation of a new FMEA Template node by applying an existing FMEA Template to the currently selected node.
- **Cut:** Removes the currently selected node and all its successor nodes from the tree so that you can paste them in a different location. After you have cut a node, the **Paste** option will appear on the shortcut menu so that you can paste the node in a different location in the tree.
- **Copy:** Copies the selected node. After you have copied a node, the **Paste** option will appear on the shortcut menu so that you can paste a copy of that node in a different location in the tree. If the selected template element has successor nodes, a prompt appears, asking if you want to copy only the selected node or the selected

node and all its successor nodes.

- **Paste:** Pastes the cut or copied nodes in the selected location. Note that this menu option appears only after you have copied or cut a node and if you select a predecessor node that participates in a relationship with the node that you want to paste.
- **Delete:** Deletes the selected node and all its subnodes from the template and from the database.
- **New <Node>:** Where <Node> is the analysis element that you want to create. The name of this link will change depending upon the predecessor node that is selected in the tree. This link creates a new record in the family indicated by the <Node> value and links it to the selected predecessor record. For example, if you select a Failure Mode node, this link will be labeled New Effect and will result in the creation of a new Failure Effect record that is linked to the Failure Mode record that is represented by the selected Failure Mode node.
- **Reference Documents:** Displays the **Reference Documents** window, where you can [manage the Reference Documents](#) associated with the record.
- **<Node> Reports:** Where <Node> is the analysis element whose reports you want to view. When you point to this link, a submenu appears and contains a list of reports that are associated with the selected component. For example, when you select an RCM Function node, this option will be labeled **Function Reports**. This menu option appears only if reports exist for the family that is represented by the selected node.
- **Show Children:** Expands the hierarchy to display the successor nodes that appear directly below a given node. This option appears only when you select a collapsed predecessor node.
- **Hide Children:** Collapses the hierarchy to hide the successor nodes that appear directly below a given node. This option appears only when you select an expanded predecessor node.
- **Show All:** Expands *all* successor nodes that exist below the selected node.
- **Help:** Displays the context-sensitive Help topic for the **FMEA Template Explorer** page.

About the Datasheet Area

The datasheet area, which appears on the right side of the **FMEA Template Explorer** page, displays the datasheet for the record that is currently selected in the **FMEA Template Explorer** pane. For example, when you select an FMEA Failure Effect record in the **FMEA Template Explorer** pane, the datasheet area displays the Failure Effect datasheet, which is populated with the values that exist in the Failure Effect record. The following image shows an example of the datasheet area on the **FMEA Template Explorer** page. A red outline has been added to the image to highlight this area.

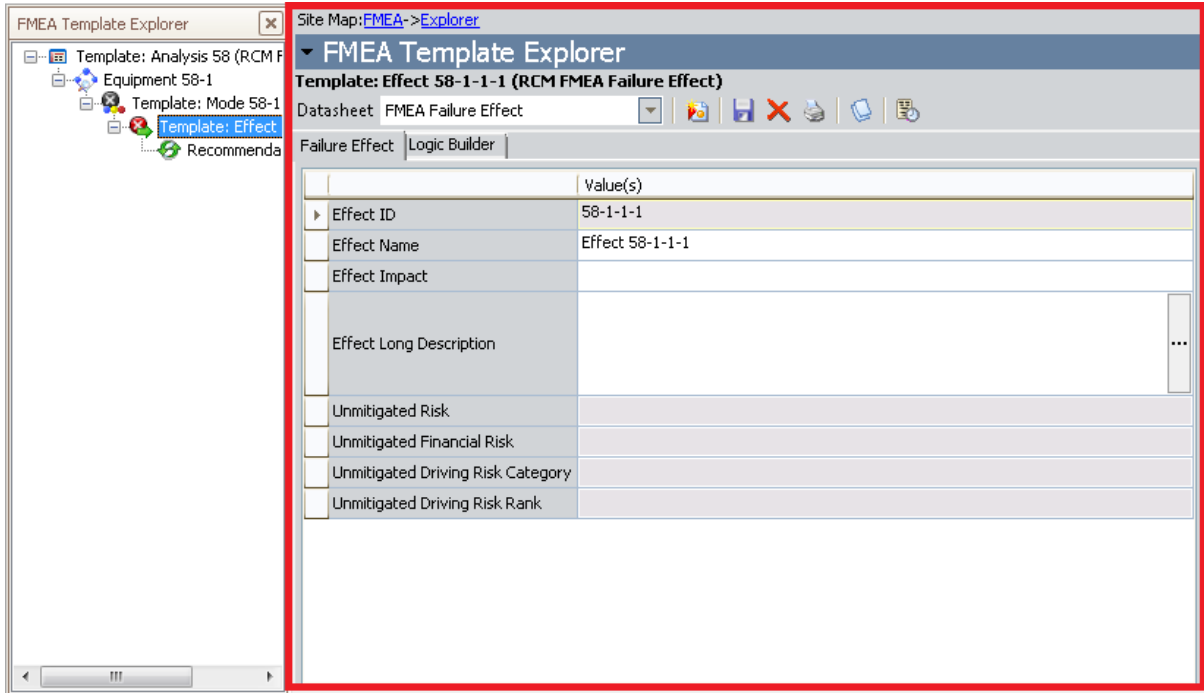

The features of the datasheet area, such as the buttons that appear above the datasheet itself, are the same as those that are available in the Record Manager.

Analysis Tasks Menu

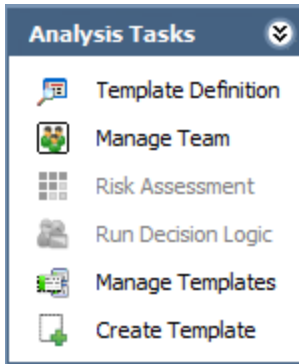

The **Analysis Tasks** menu on the **FMEA Template Explorer** page contains links that you can use to work with the analysis elements in the **FMEA Template Explorer** pane. The links on this menu are hidden or disabled based upon the node that is selected in the tree.

The following list describes the links that have been defined for the **Analysis Tasks** menu:

- **Template Definition:** Displays the datasheet for the current RCM FMEA Template record. This link is available for ALL template types.
- **Manage Team:** Displays the **FMEA Team Members** page, where you can create and manage Human Resource records for an FMEA Analysis Template.

Note: This link appears only when you are working with a template whose root node is an Analysis node.

- **Risk Assessment:** Displays the Risk Assessment feature. This link is enabled only when:
 - If a Failure Effect node is selected in the tree.
 - If a Recommendation node is selected in the tree and a value has been selected for at least one Category in the corresponding *unmitigated* Risk Assessment.

This link does not appear when you are working with a template whose root node is a Recommendation node.

- **Run Decision Logic:** Displays the [Decision Logic Builder](#). This link is enabled only when you select a Failure Effect node in the tree. This link does not appear when you are working with a template whose root node is a Recommendation node.
- **Manage Templates:** Displays the **FMEA Templates** page. By default, the value in the Template Type query prompt is set to the Template Type of the template you were previously viewing.
- **Create Template:** Displays the **Template Builder**, which you can use to [create a new FMEA Template from scratch](#).

Common Tasks Menu

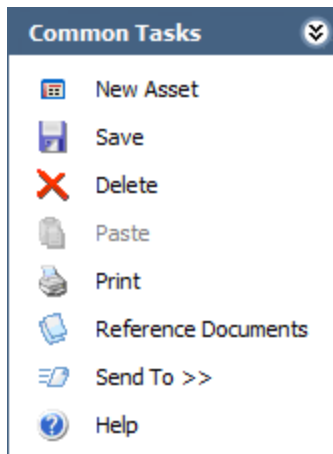

The **Common Tasks** menu on the **FMEA Template Explorer** page contains links that you can use to work with the analysis elements in the **FMEA Template Explorer** pane. These links are hidden or disabled based on the node that is selected in the tree.

The **Common Tasks** menu on the **FMEA Template Explorer** page contains the following links:

- **New <Node>**: Where **<Node>** is the analysis element that you want to create. The name of this link will change depending upon the predecessor node that is selected in the tree. This link creates a new record, whose type is indicated by the **<Node>** name and links it to the selected predecessor node. For example, when you select an Asset node in the **FMEA Template Explorer** pane, this link reads **New Mode** and lets you create an RCM FMEA Failure Mode record and link it to the selected Asset node.
- **Save**: Saves the currently selected record.
- **Delete**: Deletes the selected record and all its successor records from the template and from the database.
- **Cut**: Removes the currently selected node and all its successor nodes from the tree so that you can paste them in a different location. After you have cut a node, the **Paste** option will appear on the shortcut menu so that you can paste the node in a different location in the tree.
- **Copy**: Copies the selected node. After you have copied a node, the **Paste** option will appear on the shortcut menu so that you can paste a copy of that node in a different location in the tree. If the selected template element has successor nodes, a prompt appears, asking if you want to copy only the selected node or the selected node and all its successor nodes.
- **Paste**: Pastes the cut or copied nodes in the selected location. Note that this menu option appears only after you have copied or cut a node and if you select a predecessor node that participates in a relationship with the node that you want to paste.

Common Tasks Menu

- **Print:** Displays the **Preview** window. From the Preview window, you can select print options and print the record.
- **Send To:** Displays a submenu with options that let you .
- **Help:** Displays the context-sensitive Help topic for the **FMEA Template Explorer** page.

Template Tasks Menu

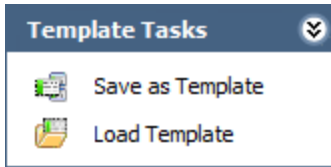

The **Template Tasks** menu on the **FMEA Template Explorer** page contains the following links:

- **Save as Template:** Displays a new RCM FMEA Template record in a new window, from which you can create a new FMEA Template using the currently selected node as the root node. This window facilitates the creation of a new RCM FMEA Template.
- **Load Template:** Displays the **Templates** window, which displays a list FMEA Templates that you can use for applying a new node to the selected FMEA Template node. The list of FMEA Templates displayed in the window is appropriate to the type of node that is currently selected.

<Node> Reports Menu

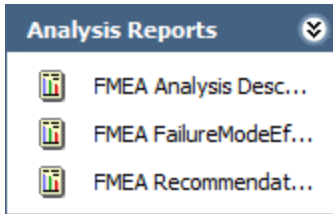

The **<Node> Reports** menu on the **FMEA Template Explorer** page displays the reports associated with the node currently selected in the **FMEA Template Explorer** pane. The name of the menu will change as appropriate, depending on which node you select. For example, when you select the root-level analysis node, the menu is labeled **Analysis Reports** and displays a list of reports associated with the Analysis node, as shown in the preceding image.

Each template node has a related [folder in the Catalog](#) that is used to determine which reports to display for which template component. This menu appears only if reports exist in the Catalog folder associated with the selected node.

Associated Pages Menu

The **Associated Pages** menu on the **FMEA Template Explorer** page displays Associated Pages that have been configured via the URL Manager for the family of the analysis node that is currently selected in the **FMEA Template Explorer** pane.

Note: The **Associated Pages** menu will not be filtered based on the type of template that you are viewing. Any Associated Page that you configured for a family that is used by both RCM and FMEA Templates will appear when you are viewing an RCM Template and when you are viewing an FMEA Template.

Accessing the FMEA Team Members Page for an FMEA Template

To access the FMEA Team Members Page for an FMEA Template:

1. [Open an existing FMEA Template on the FMEA Template Explorer page.](#)
2. On the **Analysis Tasks** menu, click the **Manage Team** link.

The **FMEA Team Members** page appears, displaying a list of Human Resource records that have been defined for the associated FMEA Template.

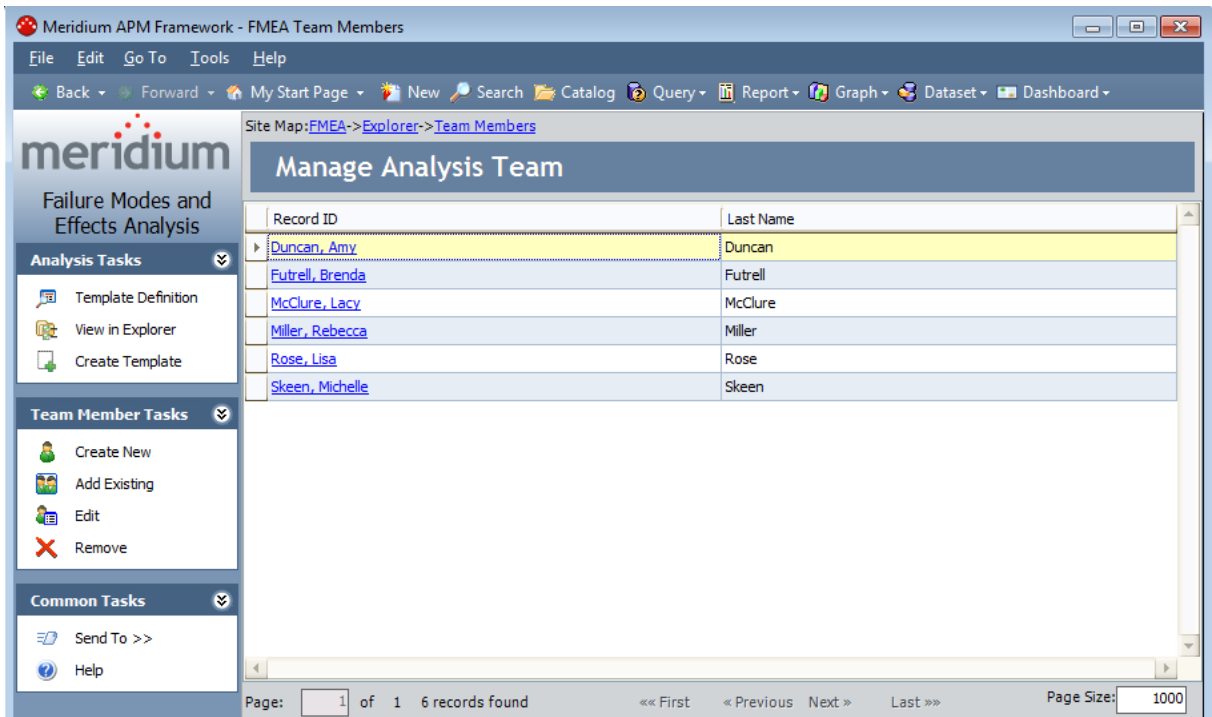

About the FMEA Team Members Page for FMEA Templates

The **FMEA Team Members** page for FMEA Templates contains a grid that displays a list of all the Human Resource records that make up the FMEA Analysis Team. Each row in the grid represents one Human Resource record. For each record in the grid, the following information is displayed:

- **Record ID:** The Record ID of the Human Resource record.
- **Last Name:** The value stored in the Last Name field in the Human Resource record.

The **FMEA Team Members** page also contains the following task menus: [Analysis Tasks](#), [Team Members Tasks](#), and [Common Tasks](#).

From the **FMEA Team Members** page, you can:

- [Add team members using existing Human Resource records.](#)
- [Add team members by creating new Human Resource records.](#)
- [Modify information about a team member.](#)
- [Remove team members from the FMEA Analysis Team.](#)

Analysis Tasks Menu

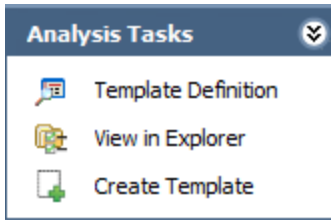

The **Analysis Tasks** menu on the **FMEA Team Members** page contains the following links:

- **Template Definition:** Displays the RCM FMEA Template record associated with the current FMEA Template.
- **View in Explorer:** Displays the current FMEA Template on the [FMEA Template Explorer page](#).
- **Create Template:** Displays the **Template Builder**, which you can use to [create a new FMEA Template from scratch](#).

Team Member Tasks Menu

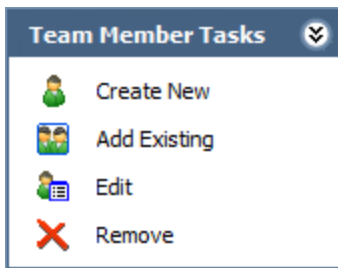

The **Team Members Tasks** menu on the **FMEA Team Members** page contains the following links:

- **Create New:** Displays the **Create New Team Member** dialog box, where you can [create a new Human Resource record](#) and add that person to the FMEA Analysis Team.
- **Add Existing:** Displays the **Find a Human Resource** dialog box, where you can [search for existing Human Resource records to add](#) to the FMEA Analysis Team.
- **Edit:** Displays the **Edit Team Member** dialog box, where you can [modify the information stored in the selected Human Resource record](#).
- **Remove:** After asking for confirmation, [removes the selected Human Resource record from the FMEA Analysis Team](#). Note that this does not delete the Human Resource record from the database.

Common Tasks Menu

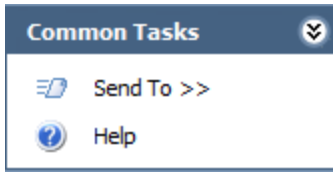

The **Common Tasks** menu on the **FMEA Team Members** page contains the following links:

- **Send To:** Displays a submenu with options that let you .
- **Help:** Displays the context-sensitive Help topic for the **FMEA Team Members** page for FMEA Templates.

Introduction to FMEA Reports

Meridium APM supports two types of reports in FMEA:

- [Reports that are generic and apply to any analysis.](#)
- [Reports that apply to a specific analysis or analysis node.](#)

FMEA relies upon the Catalog folder structure to determine which reports appear where throughout the FMEA interface. Each analysis element has a corresponding Catalog folder. When you are viewing that analysis element, the reports stored in that Catalog folder will be available.

For example, when you are viewing an FMEA Analysis on the **FMEA Explorer** page and you select a Failure Effect node, the [Effect Reports menu](#) will display a list of reports stored in the following Catalog folder: \\Public\Meridium\Modules\FMEA\Effect.

In addition, the Catalog contains a generic folder for storing reports that appear on the **FMEA Reports** page and will apply to any analysis.

About Running Reports in FMEA

The baseline FMEA product contains a set of [pre-configured FMEA reports](#) that you can run when you are viewing an FMEA Analysis on the **FMEA Explorer** page. In addition, by creating your own custom reports and storing them in the appropriate [folder in the Catalog](#), you will be able to access and [view reports associated with given analysis node](#). In addition, the baseline FMEA product contains a Catalog folder for storing generic FMEA reports, which can be [accessed easily from the FMEA Start Page](#).

When you view an FMEA report, the Meridium APM system will run the report and open it on the **Report Viewer** page, where all the standard report functionality will be available to you.

Accessing the FMEA Reports Page

The **FMEA Reports** page displays a list of generic reports that have been configured for use with FMEA. Generic FMEA reports should be stored in the following Catalog folder: \\Public\Meridium\Modules\FMEA. The **FMEA Reports** page will display any report stored in that folder.

The **FMEA Reports** page displays the caption of the report as it exists in the Catalog. Therefore, when saving reports to the folder \\Public\Meridium\Modules\FMEA, you will want to make sure that you use captions that are descriptive enough to identify the purpose of the report to other users.

Note: The baseline FMEA implementation does not include any reports that will appear on the **FMEA Reports** page. By default, the baseline FMEA product contains one baseline report in the folder \\Public\Meridium\Modules\FMEA: FMEA AnalysisTeamSubReport. Because this report is a sub-report of the FMEA Analysis Description report, it is automatically filtered out of the reports list and not displayed on the **FMEA Reports** page. Any other report that you store in the folder \\Public\Meridium\Modules\FMEA will, however, appear on this page.

To access the FMEA Reports page:

- On the **FMEA Start Page**, click the **Run Reports** link.

The **FMEA Reports** page appears.

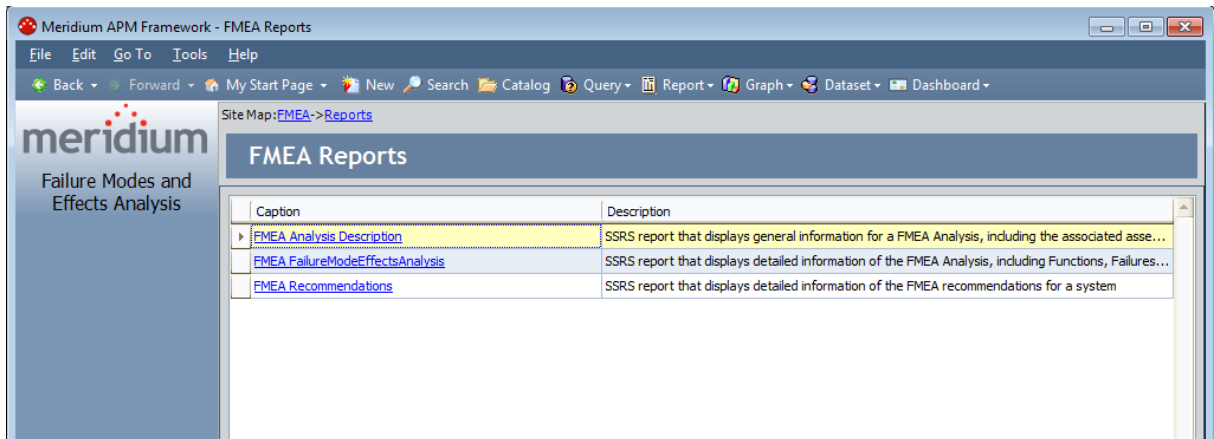

Opening a Report

The **FMEA Reports** page displays a list of reports that are stored in the following Catalog folder: \\Public\Meridium\Modules\FMEA. Each report caption appears as a hyperlink.

To run a report that appears in the list on the FMEA Reports page:

- Click any hyperlinked report caption.

The results of the report appear on the **Report Viewer** page.

Running Reports Specific to an Analysis or Analysis Element

Reports that have been defined for the root-level Analysis node or for a specific analysis element and stored in the [correct folder in the Catalog](#) will appear when you are viewing an analysis or analysis element on the **FMEA Explorer** page.

For example, when you are viewing an FMEA Analysis on the FMEA Explorer page and you select a Failure Effect node, the [Effect Reports menu](#) will display a list of reports that are stored in the following Catalog folder: \\Public\Meridium\Modules\FMEA\Effect. In addition, you can right-click any analysis node in the **FMEA Explorer** pane and access a shortcut menu which will also display a list of reports that have been configured for that node.

To run an FMEA report:

- [From any of these menus](#), click the name of the desired report.

The results of the report appear on the [Report Viewer page](#).

About Managing FMEA Recommendations

You can access Recommendation Management and work with RCM FMEA Recommendation records via the [Analysis Tasks menu on the FMEA Explorer page](#).

When you access Recommendation Management via FMEA, [additional options are available for working with RCM FMEA Recommendation records](#).

Accessing Recommendation Management from the FMEA Explorer Page

To review FMEA Recommendations and manage them in Recommendation Management:

1. [Access the FMEA Explorer page.](#)
2. On the **Analysis Tasks** menu, click the **Review Recommendations** link.

The [Recommendation Management page](#) appears, displaying a list of RCM FMEA Recommendation records that exist for the current analysis.

Features of the Recommendation Management Page when Accessed from FMEA

When you access Recommendation Management from an FMEA Analysis, the **Recommendation Management** page contains features in addition to those that are available when you access the **Recommendation Management** page directly.

This page is divided in the following sections:

- **Recommendation Management workspace:** Contains a grid that displays the Recommendation records that are linked to the equipment and locations that are associated with the current FMEA Analysis.
- **Task menus:** The following task menus are available: **Recommendation Tasks** menu, [Asset Tasks menu](#), **Common Tasks** menu, and **Associated Pages** menu.

Additionally, when you access the **Recommendation Management** page from FMEA, a site map appears at the top of the page and allows you to navigate back to the source analysis.

The following image shows an example of the **Recommendation Management** page when accessed from FMEA.

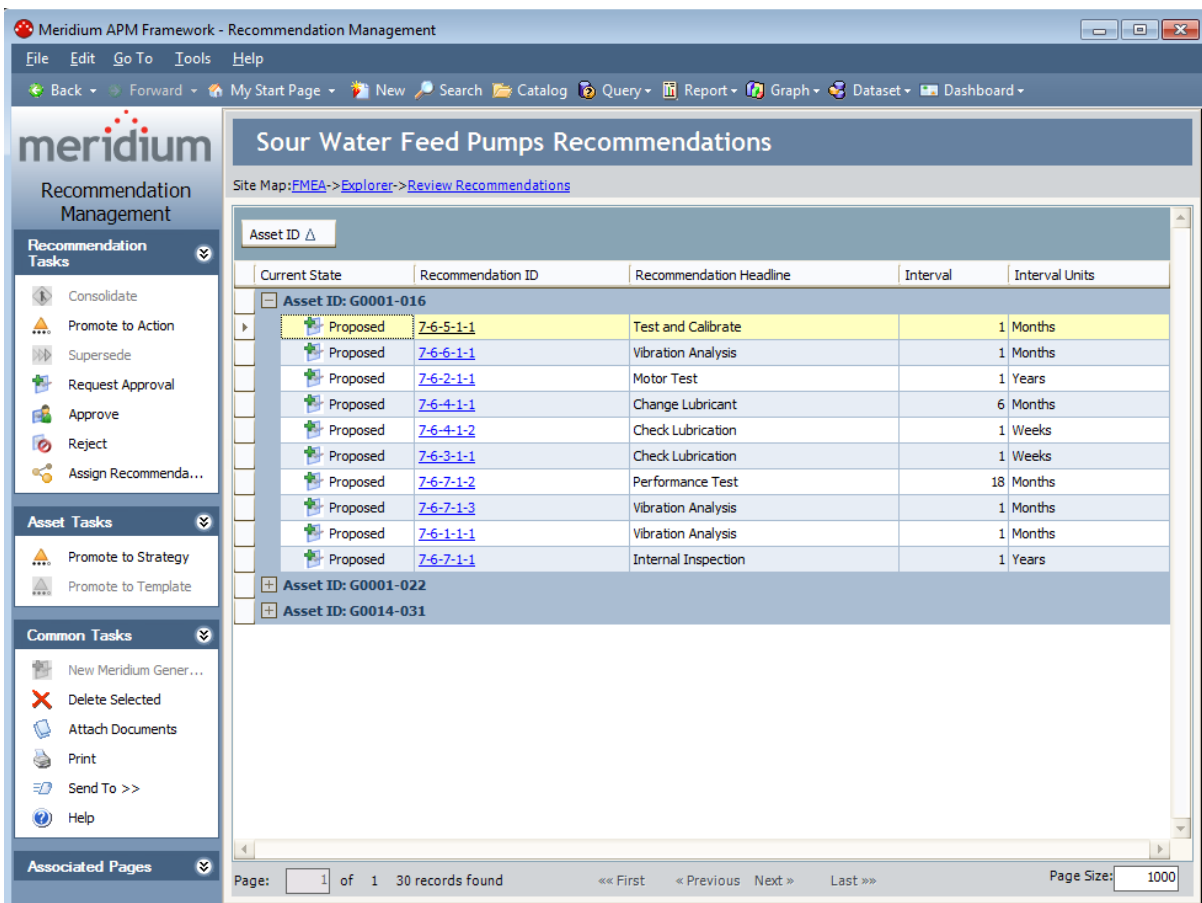

Asset Tasks Menu

The **Asset Tasks** menu is available when you access Recommendation Management from FMEA.

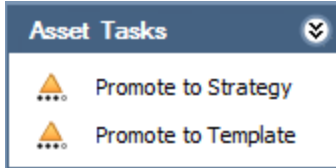

The **Asset Tasks** menu on the **Recommendation Management** page contains the following links:

- **Promote to Strategy:** Promotes to an Asset Strategy all the RCM FMEA Asset, Equipment, or Functional Location records that are linked to the RCM FMEA Recommendation records in the grid. This link is enabled only if the RCM FMEA Recommendation records are linked to a record representing a piece of equipment or location.
- **Promote to Template:** Promotes to an Asset Strategy Template the RCM FMEA Asset record that is linked to the selected RCM FMEA Recommendation record. This link is enabled only if the selected RCM FMEA Recommendation record is linked to an RCM FMEA Asset record.

Viewing Master Recommendations from Consolidated Recommendations

If you have [consolidated FMEA Recommendation records](#) to create a master FMEA Recommendation record, while you are viewing one of those consolidated Recommendation records on the **FMEA Explorer** page, you can access the master Recommendation.

The following instructions assume that you are already viewing a consolidated FMEA Recommendation record on the **FMEA Explorer** page (i.e., the state of the Recommendation record is *Consolidated*).

You can determine the current state of the selected Recommendation record from the visual indicator above the datasheet toolbar, as outlined in red in the following image.

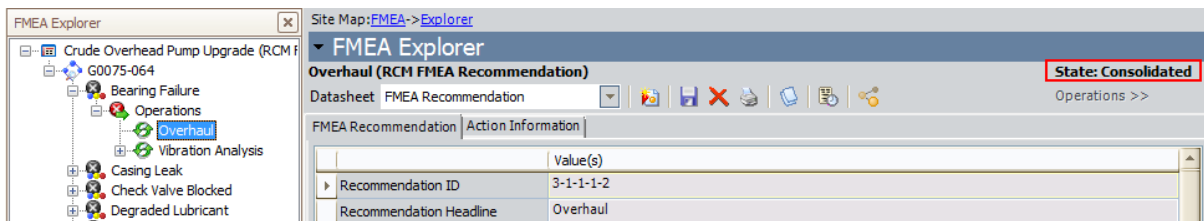

To view a master Recommendation record from a consolidated Recommendation record:

- On the **FMEA Explorer** page, on the **Analysis Tasks** menu, click the **View Master Recommendation** link.

The **View Master Recommendation** window appears, displaying the datasheet of the master Recommendation record.

View Master Recommendation

View Master Recommendation

Datasheet FMEA Recommendation

FMEA Recommendation | Action Information

	Value(s)
▶ Recommendation ID	3-CREC-0002
Recommendation Headline	Overhaul
Recommendation Description	Perform complete overhaul of pump to inspect and replace worn components. ...
Asset ID	G0075-064
Technical Number	
Asset Shutdown Required?	<input checked="" type="checkbox"/>
Business Impact	System
Mitigated Risk	
Mitigated Financial Risk	15000
Comments	...
Create Work Request?	<input type="checkbox"/>
Work Request Reference	
Work Request Equipment	
Work Request Functional Lo...	
Target Completion Date	

OK Cancel

About Evaluations

After you create an FMEA Analysis, you can define criteria for evaluating the whole analysis or parts of the analysis in the future. Specifically, you can define criteria for evaluating:

- [The entire analysis.](#)
- [Any equipment or locations that are included in the analysis.](#)
- [Any recommendations that are included in the analysis.](#)

The evaluation feature allows you to be notified, or to notify someone else, when certain conditions are met. You can create two types of evaluations:

- A date-based evaluation, where email messages are sent on a one-time or recurring basis and are triggered when the current date and time match the date and time specified in the evaluation criteria.
- An event-based evaluation, where email messages are sent when a piece of equipment or location meets the failure cost and/or count criteria specified for the evaluation.

If you want to evaluate an entire analysis, you can configure only a date-based evaluation.

If you want to evaluate equipment, locations, or recommendations that are included in an analysis, you can configure a date-based evaluation, an event-based evaluation, or both types of evaluations for each piece of equipment or location or recommendation.

After evaluation criteria exists and the RCM/FMEA Evaluation [scheduled item is created](#) via the Meridium APM Schedule Manager, the scheduled item will be executed on the Next Evaluation Date that is specified in the scheduled item. When it is executed, the Meridium APM system will determine whether or not an email message should be sent based on the existing evaluation criteria.

Note that evaluation criteria defined is stored in the associated record itself. For example, if you define evaluation criteria for an analysis, the criteria is stored in the RCM FMEA Analysis record. The facility for defining date-based evaluation criteria is essentially a user interface that will guide you in populating fields in the associated record. Note that the values that appear on the datasheet can be modified via the datasheet itself, provided that you have the appropriate permissions. To ensure that you enter all the values necessary for setting up valid evaluations, however, we recommend that you use the evaluation interface instead of the datasheet.

About Analysis Evaluations

After you create an FMEA Analysis, you can define criteria for evaluating the analysis in the future to determine:

- How valid the original analysis was.
- Whether the analysis needs to be modified.

For each analysis, you can create a date-based evaluation, where email messages are sent on a one-time or recurring basis and are triggered when the current date and time match the date and time specified in the evaluation criteria.

When an email message is sent, it will contain the following information:

- The description of the FMEA Analysis for which the evaluation was configured, as it is stored in the Analysis Short Description field in the RCM FMEA Analysis record.
- A statement indicating that the specified analysis needs to be reviewed.
- A hyperlink that will open on the **FMEA Explorer** page the FMEA Analysis that needs to be reviewed.

About Equipment/Location Evaluations

After you add equipment and locations to an FMEA Analysis, you can define criteria for evaluating each piece of equipment or location in the future to determine the status of the piece of equipment or location and its failures. Note that the piece of equipment or location can be represented by either an [RCM FMEA Asset record](#) itself or a [related Equipment or Functional Location record](#), depending on whether or not the [RCM FMEA Asset record has been linked to an Equipment or Functional Location record](#).

Two types of evaluations can be created for each piece of equipment or location:

- A date-based evaluation, where email messages are sent on a one-time or recurring basis and are triggered when the current date and time match the date and time specified in the evaluation criteria.
- An event-based evaluation, where email messages are sent when the piece of equipment or location meets the failure cost and/or count criteria specified for the evaluation.

Note: Configuring an event-based evaluation at an equipment/location level results in the same functionality as configuring an event-based evaluation at the [recommendation](#) level for the piece of equipment or location that is related to that recommendation. Both options will use the Evaluation Query to evaluate failures for that piece of equipment or location. The only difference you will see is in the text of the email message that is sent. If you set it up at the *equipment/location* level, the message will indicate that the piece of equipment or location needs to be reviewed. If you set up the evaluation at the *recommendation* level, the message will indicate that the recommendation needs to be reviewed. It is up to you to determine if you want to create the event-based evaluation at the equipment/location level or the recommendation level. Your decision will probably depend on whether you want the email recipients to evaluate the entire piece of equipment or location or the specific recommendation.

When a message is sent, it will contain the following information:

- The ID of the RCM FMEA Asset record that identifies the piece of equipment or location for which the evaluation was configured.
- A statement indicating that the specified piece of equipment or location needs to be reviewed.
- A hyperlink that will open on the **FMEA Explorer** page the FMEA Analysis to which the specified piece of equipment or location belongs.

Note that the content for date-based and event-based evaluation email is the same and cannot be customized.

About Recommendation Evaluations

After you [create Recommendation records](#) for an FMEA Analysis, you can define criteria for evaluating each recommendation in the future to determine:

- How valid the original recommendation was.
- Whether the recommendation needs to be modified.
- Whether additional recommendations should be created based on the validity of a given recommendation.

Two types of evaluations can be created for each recommendation:

- A date-based evaluation, where email messages are sent on a one-time or recurring basis and are triggered when the current date and time match the date and time specified in the evaluation criteria.
- An event-based evaluation, where email messages are sent when the piece of equipment or location related to the recommendation meets the failure cost and/or count criteria specified for the evaluation.

Note: Configuring an event-based evaluation at a recommendation level results in the same functionality as configuring an event-based evaluation at the equipment/location level for the piece of equipment or location that is related to that recommendation. Both options will use the Evaluation Query to evaluate failures for that piece of equipment or location. The only difference you will see is in the text of the email message that is sent. If you set up the evaluation at the *recommendation* level, the message will indicate that the recommendation needs to be reviewed. If you set it up at the *equipment/location* level, the message will indicate that the piece of equipment or location needs to be reviewed. It is up to you to determine if you want to create the event-based evaluation at the recommendation level or the equipment/location level. Your decision will probably depend on whether you want the email recipients to evaluate the specific recommendation or the entire piece of equipment or location.

When a message is sent, it will contain the following information:

- The ID of the RCM FMEA Recommendation record for which the evaluation was configured.
- A statement indicating that the specified recommendation needs to be reviewed.
- A hyperlink that will open on the **FMEA Explorer** page the FMEA Analysis to which the specified Recommendation record belongs.

Note that the content for date-based and event-based evaluation email is the same and cannot be customized.

About Date-Based Evaluations

A date-based evaluation is an evaluation that triggers an email message to be sent one time or on a recurring basis, according to the schedule that you define. With date-based evaluations, the *only* criteria that must be defined are date and time. Therefore, you can [set up date-based evaluations](#) if you want to review an analysis, piece of equipment or location, or recommendation on a specific date or on a specific schedule.

When you create a date-based evaluations, you define a Next Evaluation Date. When the RCM/FMEA Evaluation scheduled item is executed, an email message will be generated for every item whose date-based criteria indicates that it is due for evaluation.

If you set up date-based evaluation criteria to generate a one-time evaluation email message, after the message has been sent, no additional messages will be sent. For example, suppose you configure a one-time date-based evaluation for an FMEA Analysis and enter a Next Evaluation Date of 5/15/2010. If the RCM/FMEA Evaluation scheduled item is executed on 5/14/2010, a message will not be sent. If, however, the scheduled item is executed on 5/15/2010, a message will be sent. If the scheduled item is executed again a day later on 5/16/2010, another message will not be sent.

Note: After a message for a one-time date-based evaluation is sent, the evaluation criteria will continue to be stored in the record, but no additional messages will be sent. To re-enable the evaluation and send a new message, you must [modify the evaluation criteria](#) in some way.

You can also specify that you want to evaluate an analysis, piece of equipment or location, or recommendation on a recurring schedule. For recurring, date-based evaluations, after the scheduled item is executed the first time, the Next Evaluation Date is updated in both the record (e.g., RCM FMEA Analysis record) and in the scheduled item, according to the interval that you define. The scheduled item is then executed on the next evaluation date, after which the Next Evaluation Date is updated again, and so on, indefinitely or until you [disable evaluations](#).

For example, you may want to implement a policy such that all recommendations should be reviewed six months after they are created. In this case, a one-time, date-based evaluation would be appropriate. Or you may want recommendations to be reviewed once every year, in which case you would use a recurring, date-based evaluation. Regardless of the desired schedule, as long as date and time are the only criteria that must be met, you can set up a date-based evaluation.

Setting Up a Date-Based Evaluation

A date-based evaluation is an evaluation that will be sent one time or on a recurring basis, according to the schedule that you define. In date-based evaluations, the *only* criteria that must be met are date and time. Therefore, you can set up date-based evaluations if you want to review an analysis, piece of equipment or location, or recommendation on a specific date or on a specific schedule. For example, you may want to implement a policy that all recommendations should be reviewed six months after they are created. Or you may want recommendations to be reviewed once every year. Regardless of the desired schedule, as long as date and time are the only criteria that must be met, you can set up a date-based evaluation.

To set up a date-based evaluation:

1. [Open the desired analysis.](#)
2. Expand the analysis hierarchy until you find the node for which you want to set up evaluation criteria.
3. Select the node, and then on the **Analysis Tasks** menu, click the **Set Up Evaluation** link.

The **Set Up <Node> Evaluation** dialog box appears, where <Node> is the type of node that is currently selected in the **FMEA Explorer** pane.

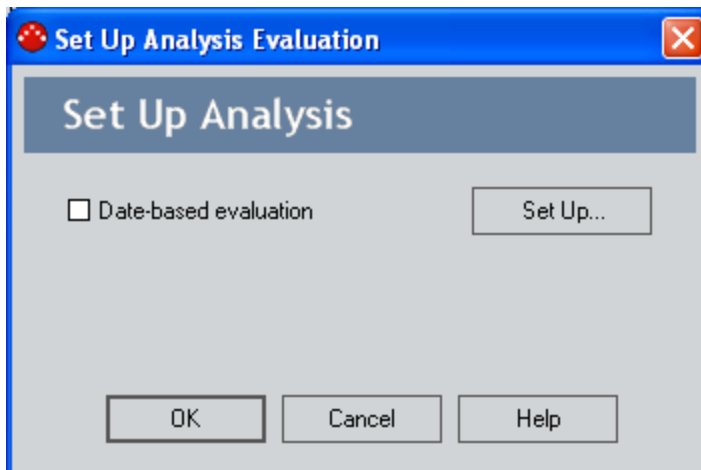

4. Select the **Date-based evaluation** check box.

The **Date-Based Evaluation** dialog box appears.

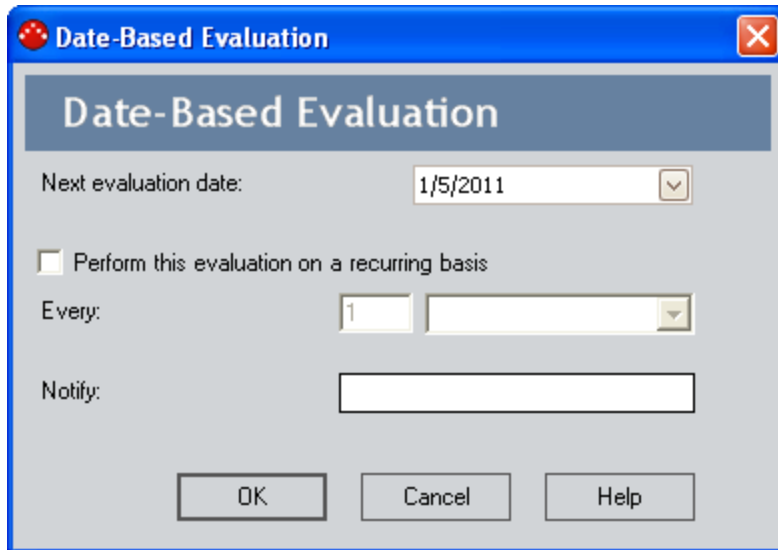

5. In the **Next evaluation date** text box, type the next date for the evaluation to occur. Note that:
 - If you are defining criteria for a one-time, date-based evaluation, the **Next evaluation date** represents the one-and-only date and time that the evaluation email message will be sent.
 - If you are defining criteria for a recurring evaluation, the **Next evaluation date** represents the *first* date and time that the evaluation email message will be sent. Subsequent email messages will be sent at intervals defined in the **Every** fields. Each time an evaluation email message is sent, the **Next evaluation date** will be incrementally updated according to the specified interval. The updated value can be viewed on the **Evaluation** tab of the **FMEA Recommendation** datasheet and on the **Date-based Evaluation** dialog box. The time, however, will always be the same as what you first set in the **Next evaluation date** field.
6. If you want the evaluation to be performed on a recurring basis:
 - a. Select the **Perform this evaluation on a recurring basis** check box. Doing so will enable the **Every** fields.
 - b. In the **Every** text box, type a value representing the interval on which the re-evaluation should occur.
 - c. In the list to the right of the text box, select a unit of time (Days, Weeks, Months, or Years) to define the specified interval.

For example, if you type **6** and select **Months**, the evaluation email message will be sent first on the **Next evaluation date** and then every six months after that.
7. In the **Notify** text box, type the email address to which the evaluation email should be sent. You must supply a valid email address in order to set up a functional evaluations.

Note: If you are defining both date-based and event-based evaluation criteria, the email address for both must be the same. This is because the record contains one email address field that is used by both evaluation types. For this same reason, if you have already defined event-based evaluation criteria for an item, the email address that you specified for the event-based evaluation will appear in the **Notify** field on the **Date-based evaluation** dialog box.

8. Click **OK**.

The evaluation criteria are saved, and the **Date-based Evaluation** dialog box closes. Note that the **Date-based evaluation** check box is selected on the **Set Up Recommendation** dialog box, indicating that date-based criteria have been defined.

9. Click **OK** to close the **Set Up <Node> Evaluation** dialog box.

-or-

Select the **Event-based evaluation** check box to [define event-based evaluation criteria](#).

About Event-Based Evaluations

If your FMEA system has been properly configured and your FMEA Analysis contains all the necessary components, it will contain RCM FMEA Asset nodes that are linked to Equipment or Functional Location records, and each Recommendation record will be associated with a specific piece of equipment or location. By setting up event-based evaluation criteria, you can configure the Meridium APM system to send evaluation email based on the failure data that is associated with that piece of equipment or location. Specifically, event-based evaluations let you specify that when a given piece of equipment or location exceeds a certain number of failures or a certain failure cost, an email message should be sent to the specified person.

Event-based evaluation scheduled items are executed for the *first* time on the **Starting from** date, which you define when you [set up the event-based evaluation](#). After that, they will be executed daily, at the *time* specified in the **Starting from** field. Each time the Meridium APM system runs an event-based evaluation scheduled item, it executes the [Evaluation query](#) and sends an email message only if the Count and Cost returned by the query are greater than the count and cost defined in the event-based evaluation criteria.

Setting Up an Event-Based Evaluation

If your FMEA system has been properly configured and your FMEA Analysis contains all the necessary components, it will contain RCM FMEA Asset records (which can be linked to Equipment and Functional Location records), and each Recommendation record will be associated with a specific piece of equipment or location. By setting up event-based evaluation criteria, you can configure the Meridium APM system to send evaluation email based on the failure data that is associated with a piece of equipment or location. Specifically, event-based evaluations let you specify that when a given piece of equipment or location exceeds a certain number of failures or a certain failure cost, and email message should be sent to the specified person.

Note: For event-based evaluations to work properly, the [Evaluation query](#) must first be created and defined. These instructions assume that the Evaluation query has already been set up.

To defined event-based evaluation criteria:

1. [Open the desired analysis](#).
2. Expand the analysis hierarchy until you find the RCM FMEA Asset node or the Recommendation node for which you want to set up evaluation criteria.
3. Select the desired node, and then on the **Analysis Tasks** menu, click the **Set Up Evaluation** link.

The **Set Up <Node> Evaluation** dialog box appears, where <Node> is the type of node that is currently selected in the **FMEA Explorer** pane.

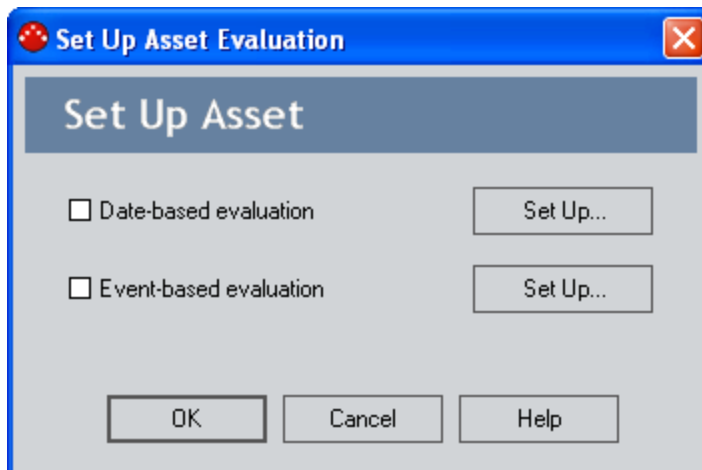

4. Select the **Event-based evaluation** check box.

The **Event-Based Evaluation** dialog appears.

Event-Based Evaluation

Failure count greater than: 0

Failure cost greater than: 0

Starting from: 1/6/2011

Notify:

OK Cancel Help

5. If you want to send evaluation email based on the number of failures that occur for a given piece of equipment or location, select the **Failure count greater than** check box, and in the text box, type the number of failures that must occur before an evaluation email message will be sent to the email address specified in the **Notify** field.

CEHint: Accept the default value of **0** (zero) if you want the first failure to trigger an evaluation email message.

6. If you want to send evaluation email based on the total failure cost associated with a piece of equipment or location, select the **Failure cost greater than** check box, and in the text box, type a value representing the failure cost that must be exceeded before an evaluation email message will be sent.

CEHint: Accept the default value of **0** (zero) if you want any failure cost to trigger an evaluation email message.

7. In the **Starting from** box, type the date after which you want to start counting failures and adding up failure costs. When the RCM/FMEA Evaluation scheduled item is run, it will take into consideration only the failures that occurred on this date and later.

Note: Unlike date-based evaluations, which are executed according to a schedule that you define and will result in the generation of an email message each time they are run, event-based evaluations are run for the *first* time on the **Starting from** date. After that, they will be executed daily, at the *time* specified in the **Starting from** field. Each time the RCM/FMEA Evaluation scheduled item is run, it executes the [Evaluation Query](#) and sends an email message only if the count and cost returned by the query are greater than the count and cost defined in the event-based evaluation criteria.

8. In the **Notify** text box, type the email address to which the evaluation email message should be sent. While Meridium APM performs no validation on this field, you must supply a valid email address in order to set up a functional evaluation.

Note: If you are defining both date- and event-based evaluation criteria, the email address for both has to be the same. This is because the records contain one email address field that is used by both evaluation types. For this same reason, if you have already defined date-based evaluation criteria for a record, the email address that you specified for the date-based evaluation will appear in the **Notify** field on the **Event-based evaluation** dialog box.

9. Click **OK**.

The evaluation criteria are saved, and the **Event-based Evaluation** dialog box closes. Note that the **Event-based evaluation** check box is selected on the **Set Up <Node> Evaluation dialog box**, indicating that event-based criteria have been defined.

10. Click **OK** to close the **Set Up <Node> Evaluation dialog box**.

-or-

Select the **Date-based evaluation** check box to [define date-based evaluation criteria](#).

Modifying Evaluation Criteria

You can use the following instructions to modify the date- or event-based evaluation criteria that you have already defined.

To modify existing evaluation criteria:

1. [Open the desired analysis.](#)
2. Expand the analysis hierarchy until you find the node for which you want to set up evaluation criteria.
3. Select the desired node, and on the appropriate **Analysis Tasks** menu, click the **Set Up Evaluation** link.

The **Set Up <Node> Evaluation** dialog box appears, where **<Node>** is the type of node that is currently selected.

4. Click the **Set Up** button to the right of the criteria that you want to modify.
5. The [Date-based Evaluation](#) or [Event-based Evaluation](#) dialog box appears, as appropriate.
6. Modify the criteria, as desired.

Note: Keep in mind that if both types of criteria are set, modifying the email address for one will also modify the email address for the other. Note also that modifying the email address may re-trigger one-time, date-based evaluations that have already been executed.

7. When you are finished modifying the criteria, click **OK** to save your changes.

Disabling Recurring Evaluations

After you define evaluation criteria for a analysis, piece of equipment or location, or recommendation, the criteria will continue to be stored in the corresponding record until you clear the values manually. The criteria will continue to trigger evaluation email only as long as the evaluations are enabled. To disable evaluations, simply clear the check boxes on the **Set Up <Node> Evaluation** dialog box appears, where **<Node>** is the type of node that is currently selected in the **FMEA Explorer** pane.

While this will not clear the evaluation criteria, it will discontinue the evaluation email.

About the Catalog Folder Structure for FMEA Reports

FMEA uses the Catalog folder structure to determine which reports to display where throughout the FMEA interface. You will need to understand how the folder structure is used in order to interpret the reports that appear when you are viewing an analysis and to know where to store custom reports, depending on where you want them to be available.

The following table provides a list and description of the FMEA folders that exist by default in the Catalog.

Folder	Contents
\\Public\Meridium\Modules\FMEA	Used to store generic reports related to FMEA Analyses. The reports stored in this folder will appear on the FMEA Reports page .
\\Public\Meridium\Modules\FMEA\Analysis	Used to store reports related to the FMEA Analysis node, which is the root-level node in an FMEA Analysis. These reports appear on the Analysis Reports menu when you select the Analysis node in the FMEA Explorer pane . Several baseline reports are provided in this folder.
\\Public\Meridium\Modules\FMEA\Effect	Used to store reports related to the RCM FMEA Effect records in an FMEA Analysis. These reports appear on the Effect Reports menu when you select the Failure Effect node in the FMEA Explorer pane .
\\Public\Meridium\Modules\FMEA\Equipment	Used to store reports related to the RCM FMEA Asset records in an FMEA analysis.

Folder	Contents
<p>\\Public\Meridium\Modules\FMEA\Mode</p>	<p>Used to store reports related to the RCM FMEA Mode records in an FMEA Analysis. These reports appear on the Mode Reports menu when you select the Failure Mode node in the FMEA Explorer pane.</p>
<p>\\Public\Meridium\Modules\FMEA\Recommendation</p>	<p>Used to store reports related to the RCM FMEA Recommendation records in an FMEA Analysis. These reports appear on the Recommendation Reports menu when you select the Recommendation node in the FMEA Explorer pane.</p>
<p>\\Public\Meridium\Modules\FMEA\SSRS</p>	<p>Used to store reports that were used in a previous release. This Catalog folder and its contents are not used by the Meridium APM product.</p>

The Baseline FMEA Reports

By default, the baseline FMEA product contains a set of pre-configured reports for use with FMEA. If desired, you can customize these reports or use them as the basis for creating your own reports. The following table contains a list and description of the baseline FMEA reports that are delivered with the baseline FMEA product. Note that the **Stored In** column contains an abbreviated Catalog path, where each of the folders listed is a subfolder within the Catalog folder \\Public\Meridium\Modules.

In this table, the values listed in the **Report** column refer to the report *names*. The baseline captions are the same as the names.

Note that the Catalog folder \\Baseline\Meridium\Modules contains subfolders that match the folders listed in the table. These folders contain copies of the reports that are delivered as baseline FMEA content. The items in the \\Baseline folder cannot be modified and serve as a historical record of the items that were delivered with the baseline product. The Meridium APM system *reads* from the [subfolders in the \\Public folder](#), so the reports in the Baseline folder are not actually used. The \\Baseline folder will be updated with any changes made to the baseline content in future releases.

Note: Because these reports provide a formatted view of the information stored in your analyses, for them to work properly, your analyses must contain accurate, complete data. In addition, note that for complex analyses, the reports may span multiple pages.

Report	Stored In	Behavior and Usage
FMEA Analysis Description	FMEAAnalysis	<p>Provides an overview of the analysis, including the analysis name, analysis description, and a list of the team members and equipment and locations that are associated with the analysis.</p> <p>This report contains three sections of information:</p> <ul style="list-style-type: none"> • The report header, which contains identifying information about the analysis. • The Associated Assets section, which contains a list of all the equipment and locations that are associated with the Analysis, grouped by equipment or location type. • The Team Member section, which contains a list of analysis team members that is generated by the report <i>FMEA AnalysisTeamSubReport</i>, sorted by last name, first name, and then middle initial.
FMEA AnalysisTeamSubReport	FMEA	<p>Used by the report <i>FMEA Analysis Description</i> report to insert a list of team members involved in the analysis. Note that although this report is stored in the folder \\Public\Meridium\Modules\FMEA, the Meridium APM system is hard coded not to display this report on the FMEA Reports page.</p>
FMEA FailureModeEffectsAnalysis	FMEAAnalysis	<p>Provides details of the functions, functional failures, failure modes, and failure effects associated with a given FMEA Analysis.</p>

Report	Stored In	Behavior and Usage
FMEA Recommendations	FMEAAnalysis	Provides details about each recommendation for all the failure modes in the analysis. Additional, related information such as Consequence and calculated Ranking are also included in the report to provide context for reviewing recommendations.

Failure Finding Activity

When you define an [FMEA](#) recommendation and specify the Action Type as Failure Finding, you can use the Failure Finding Activity cells, shown in the following image, to calculate the failure finding task interval (FFI).

The screenshot shows the 'RCM Explorer' interface for an 'RCM FMEA Recommendation (RCM FMEA Recommendation)' with a 'State: Proposed'. The 'Action Information' tab is active, displaying a table for configuring failure finding activity. The table includes fields for Action Type, Interval, Interval Units, Nonrecurring, Performance Interval, Performance Interval Units, Estimated Cost, Estimated Cost Basis, Recommended Resource, and a section for Failure Finding Activity parameters: MMF, MTIVE, MTED, n, FFI (0.000 Years), Display FFI Units As (Years), and Use Calculated FFI Results.

	Value(s)
Action Type	Failure Finding (FF)
Interval	
Interval Units	
Nonrecurring	<input type="checkbox"/>
Performance Interval	
Performance Interval Units	
Estimated Cost	
Estimated Cost Basis	
Recommended Resource	
Failure Finding Activity	
MMF	
MTIVE	
MTED	
n	
FFI	0.000 (Years)
Display FFI Units As	Years
Use Calculated FFI Results	<input type="checkbox"/>

The following equation is used to calculate FFI:

$$FFI = MTIVE \times [(n + 1)(MTED)/MMF]^{1/n}$$

Note that the information used for the FFI calculation is based upon the concepts in SAE Standard JA1012, "A Guide to the Reliability-Centered Maintenance (RCM) Standard." The process and terminology used in the FFI calculation are described in more detail in this standards document. To use the Failure Finding Activity cells effectively, you will need to be familiar with this standard.

In addition, the FFI calculation is based upon information in the book "Reliability-Centered Maintenance" by John Moubray.

The following table describes the Failure Finding Activity cells in the Meridium APM Framework.

Cell	Description
MMF	<p>Stores the mean time between <i>multiple failures</i>.</p> <p>For example, a 1 in 1,000,000 probability of a multiple failure in one year implies a mean time between failures of 1,000,000 years.</p> <p>The probability of multiple failures occurring in any one year is 1/MMF.</p>
MTIVE	<p>Stores the mean time between failures of the <i>protective device</i>.</p>
MTED	<p>Stores the mean time between <i>failures of the protected function</i>.</p> <p>For example, if the demand rate of the protected function is once in 200 years, this equals a probability of failure for the protected function of 1 in 200 in any one year, or a mean time between failures of the protected function of 200 years.</p> <p>The probability of failure of the protected function in any one year is 1/MTED.</p>
n	<p>The number of <i>protective devices</i>.</p>

System Code Tables Used by FMEA

The following System Code Table is used by FMEA.

Table ID	Table Description	Function
SC_RECOM_RESOURCE	Recommended Resource	Use to populate the Recommended Resource list in RCM FMEA Recommendation records.

URL Paths for FMEA Features

The following table lists and describes the paths for accessing features in FMEA. Note that to construct a valid URL, you must prepend **meridium://** to the paths listed in the following table. In some cases, you must define parameters after the path in order to create a functional link.

Note that there is one root address only for each RCM or FMEA feature, and the root address accepts parameters that let you determine whether the feature will be specific to RCM or FMEA. If you do not specify a parameter where a parameter is accepted, the root address will launch the feature for RCM and not FMEA. To launch the feature for FMEA, you must expand the root address by adding parameters.

Feature	URL Path	Description
Start Page	RCM	Serves as the root address for accessing the FMEA Start Page . This path accepts one parameter .
Administration Page	RCM/Admin	Serves as the root address for accessing the FMEA Administration page. This path accepts one parameter .
Manage Tasks Page	RCM/Approver	Serves as the root address for accessing the FMEA Manage Tasks page. This path accepts one parameter .
Analysis List	RCM/Find	Opens the FMEA Analysis List page, from which you can open an existing analysis. This path accepts one parameter .
Recent Analyses	RCM/Recent	Opens the FMEA Recently Used Analyses page, from which you can open an existing analysis. This path accepts one parameter .
Templates	RCM/Templates	Opens the FMEA Templates page, where you can use templates to create a new analysis or analysis node. In addition to the Type parameter, this path accepts parameters that let you customize the URL.
Reports	RCM/Report	Displays the FMEA Reports page, where you can view a list of reports that have been configured for FMEA. This path accepts one parameter .
Team Members	RCM/List	Displays the FMEA Team Members page. This path accepts multiple parameters .

Feature	URL Path	Description
Explorer	RCM/Explorer	Serves as the path for accessing the FMEA Explorer page. In addition to the Type parameter, the path <i>requires</i> parameters which allow you to create a new analysis or load an existing analysis.

Parameters for the Start Page URL

The URL for accessing the **FMEA Start Page** is `meridium://RCM`. A link constructed from this path with no parameters will display the **RCM Start Page**. The path accepts one parameter that lets you modify the URL to access the **FMEA Start Page**.

Parameter Name	Description	Accepted Value (s)
Type	Specifies that you want to display the FMEA Start Page .	FMEA

Examples of the Start Page URL

- [meridium://RCM?Type=FMEA](#)
Displays the **FMEA Start Page**.

Parameters for the Administration Page URL

The URL for accessing the **FMEA Administration** page is `meridium://RCM/Admin`. A link constructed from this path with no parameters will display the **RCM Administration** page. The path accepts one parameter that lets you modify the URL to access the **FMEA Administration** page.

Parameter Name	Description	Accepted Value(s)
Type	Specifies that you want to display the FMEA Administration page.	FMEA

Examples of the Administration Page URL

- [meridium://RCM/Admin?Type=FMEA](#)
Displays the **FMEA Administration** page.

Parameters for the Manage Tasks URL

The base URL for the **FMEA Manage Tasks** page is `meridium://RCM/Approver`. A link constructed from the base URL with no parameters will display the **RCM Manage Tasks** page. You must use the parameters described in the following table to access the **FMEA Manage Tasks** page.

Parameter Name	Description	Accepted Value(s)
Type	Specifies that you want to display the FMEA Manage Tasks page.	FMEA

Examples of the Manage Tasks URL

- [meridium://RCM/Approver?Type=FMEA](#)

Opens the **FMEA Manage Tasks** page, which displays a list of FMEA Analyses that have associated Task records.

Parameters for the Analysis List URL

The URL for accessing the **FMEA Analysis List** page is `meridium://RCM/Find`. A link constructed from this path with no parameters will display the **RCM Analysis List** page. The path accepts one parameter that lets you modify the URL to access the **FMEA Analysis List** page.

Parameter Name	Description	Accepted Value(s)
Type	Specifies that you want to display the FMEA Analysis List page.	FMEA

Examples of the Analysis List URL

- [meridium://RCM/Find?Type=FMEA](#)

Displays the **FMEA Analysis List** page, from which you can open an existing FMEA Analysis in the FMEA Explorer.

Parameters for the Recently Used Analyses URL

The URL for accessing the **FMEA Recently Used Analyses** page is **meridium://RCM/Recent**. A link constructed from this path with no parameters will display the **RCM Recently Used Analyses** page. The path accepts one parameter that lets you modify the URL to access the **FMEA Recently Used Analyses** page.

Parameter Name	Description	Accepted Value(s)
Type	Specifies that you want to display the FMEA Recently Used Analyses page.	FMEA

Examples of the Recently Used Analyses URL

- [meridium://RCM/Recent?Type=FMEA](#)

Displays the **FMEA Recently Used Analyses** page, where you can open an existing analysis in the FMEA Explorer.

Parameters for the Templates URL

The URL for accessing the **FMEA Templates** page is `meridium://RCM/Templates`. A link constructed from this path with no parameters will display the **RCM Templates** page. The path accepts the following additional parameters that lets you access the **FMEA Templates** page and modify the behavior of the URL.

Parameter Name	Description	Accepted Value(s)	Notes
AnalysisKey	The Entity Key of the analysis to which the entity identified by the SelectedKey value is linked.	A numeric Entity Key.	This parameter is required whenever you want to use a Template to create a new analysis node. Whenever you specify the SelectedKey parameter, you must also use the AnalysisKey parameter, even if the AnalysisKey and the SelectedKey are the same value (i.e., if you are loading templates to link to the analysis node).
SelectedKey	The Entity Key of the entity to which you want to link a new analysis node.	A numeric Entity Key.	This parameter is required whenever you want to use a Template to create a new analysis node. Whenever you specify the SelectedKey parameter, you must also use the AnalysisKey parameter.
Type	Specifies that you want to display the FMEA Templates page.	FMEA	None

Examples of the Templates URL

- <meridium://RCM/Templates?Type=FMEA>

Displays the **FMEA Templates** page. Note that accessing the **FMEA Templates** page in this way is like accessing it from the **FMEA Start Page**, where you can find *analysis* templates and use them to create a new FMEA Analysis. Because the Context parameter has been omitted, clicking a hyperlinked Template ID will load the analysis template on the **FMEA Explorer** page.

- <meridium://RCM/Templates?Type=FMEA&SelectedKey=1234567&AnalysisKey=2345678>

Opens the **FMEA Templates** page, where you can search for templates that can be linked to the record identified by the key 1234567. For example, if entity 1234567 is a Failure Mode record, you would want to find Failure Effect Templates. From the list of Templates, you can click a hyperlinked Template ID to open analysis 2345678 on the **FMEA Explorer** page, where a new analysis node, based on the selected template, will be linked to entity 1234567.

Parameters for the Reports URL

The URL for accessing the **FMEA Reports** page is `meridium://RCM/Report`. A link constructed from this path with no parameters will display the **RCM Reports** page. The path accepts one parameter that lets you modify the URL to access the **FMEA Reports** page.

Parameter Name	Description	Accepted Value(s)
Type	Specifies that you want to display the FMEA Reports page.	FMEA

Examples of the Reports URL

- <meridium://RCM/Report?Type=FMEA>

Displays the **FMEA Reports** page, where you can view a list of reports that have been configured for FMEA Analyses and are stored in the Catalog folder \\Public\Meridium\Modules\FMEA.

Parameters for the Team Members URL

The base URL for accessing the **FMEA Team Members** pages is **meridium://RCM/List**. This URL accepts the parameters described in the following table. Note that a URL constructed from the path with NO parameters is invalid.

Parameter Name	Description	Accepted Value(s)	Notes
Analysis	Specifies the analysis for which you want to open the team member list.	The Entity Key of the desired analysis.	This parameter must be used in conjunction with the ListType parameters.
ListType	Lets you specify what you want to set up for a given analysis.	Team	This parameter should be used in conjunction with the Analysis parameter. These parameter values are case sensitive.

Examples of the Team Members URL

- <meridium://RCM/List?Analysis=64251517623&ListType=Team>

Opens the **FMEA Team Members**, where you can set up the Analysis Team for the analysis with the Entity Key 64251517623.

Parameters for the Explorer URL

The URL for accessing the **FMEA Explorer** page is **meridium://RCM/Explorer**. Note that the URL path alone is not a valid URL. Use the information in the following table to choose parameters that will allow you to construct a functional link.

Parameter Name	Description	Accepted Value(s)	Notes
DatasheetID	Specifies the datasheet that should be displayed on the FMEA Explorer page.	The Datasheet ID of the desired datasheet.	The Datasheet ID must correspond to a datasheet that has been defined for the specified family. If you omit this parameter, the default datasheet will be used. This parameter is optional.
EntityKey	Specifies the Entity Key of the record that you want to open on the FMEA Explorer page.	The numeric Entity Key of the entity that you want to open.	This parameter value should correspond to an entity belonging to the family identified by the FamilyKey parameter. <i>This parameter is required</i> whenever you are loading an existing analysis.
FamilyKey	Specifies the Family Key for record(s) that you want to open on the FMEA Explorer page.	The numeric Family Key of any family involved in an FMEA Analysis.	This parameter specifies the Family Key of each <i>root</i> record. The Family Key that you specify should correspond to the EntityKey parameter value. <i>This parameter is required</i> whenever you are loading an existing analysis.
Mode	Used for creating a new analysis.	Create	This parameter is <i>required</i> whenever you want to load a new analysis on the FMEA Explorer page.

Parameters for the Explorer URL

Parameter Name	Description	Accepted Value(s)	Notes
Type	Used for creating a new FMEA Analysis.	FMEA	This parameter is <i>required</i> whenever you want to <i>create</i> a new FMEA Analysis on the FMEA Explorer page, as specified by the Mode parameter. You can omit this parameter whenever you specify the EntityKey and FamilyKey parameters.

Examples of the Explorer URL

- **meridium://RCM/Explorer?Mode=Create&Type=FMEA**

Opens a new FMEA Analysis on the **FMEA Explorer** page.

- **meridium://RCM/Explorer?EntityKey=1234567&FamilyKey=2345678**

Opens the analysis with the Entity Key 1234567, which belongs to the family with the Family Key 2345678. The analysis will be opened on the **RCM Explorer** page if the Analysis Type in the record with the Entity Key 1234567 is *RCM*.

Asset

In an FMEA Analysis, the equipment and locations that define what is being analyzed.

Failure Effect

In an FMEA Analysis, the consequence of a failure occurring. Failure effects might describe the safety, environmental, and economic (or production) impact associated with a failure.

Failure Mode

In an FMEA Analysis, the way in which a piece of equipment or location failure is likely to occur.

FMEA Analysis

A method of identifying the potential failures of equipment and locations, describing the possible effect of each failure, and making recommendations for actions that can be taken to prevent the failures from occurring. In Meridium APM, an FMEA Analysis consists of the following components:

- Asset
- Failure Modes
- Failure Effects
- Recommendations

Recommendation

In an FMEA Analysis, the recommended action to take to avoid the risk defined by the failure modes and failure effects. Recommendations can be determined, in part, using the Decision Tree document that has been set up for use with FMEA Analyses.

SAE Standards

Technical standards and recommended practices for the aerospace, automotive, and commercial-vehicle industries published by SAE International.