



Meridium APM PROACT

3.6.1.2.0



Meridium APM PROACT

3.6.1.2.0

Copyright © Meridium, Inc. 2017

All rights reserved. Printed in the U.S.A.

This software/documentation contains proprietary information of Meridium, Inc.; it is provided under a license agreement containing restrictions on use and disclosure. All rights including reproduction by photographic or electronic process and translation into other languages of this material are fully reserved under copyright laws. Reproduction or use of this material in whole or in part in any manner without written permission from Meridium, Inc. is strictly prohibited.

Meridium is a registered trademark of Meridium, Inc.

All trade names referenced are the service mark, trademark or registered trademark of the respective manufacturer.

About This Document

This file is provided so that you can easily print this section of the Meridium APM Help system.

You should, however, use the Help system instead of a printed document. This is because the Help system provides hyperlinks that will assist you in easily locating the related instructions that you need. Such links are not available in a print document format.

The Meridium APM Help system can be accessed within Meridium APM itself or via the Meridium APM Documentation Website (<https://www.meridium.com/documentation/WebHelp/WebHelpMaster.htm>).

Note: If you do not have access to the Meridium APM Documentation Website, contact [Meridium Global Support Services](#).

Table of Contents

| | |
|---|----|
| Meridium APM PROACT | 1 |
| Copyright and Legal | 2 |
| About This Document | 3 |
| Table of Contents | 4 |
| Overview of Root Cause Analysis | 18 |
| What is PROACT for Meridium? | 19 |
| What is a Root Cause Analysis? | 20 |
| RCA System Requirements | 21 |
| Root Cause Analysis Data Model | 22 |
| About Analysis States | 24 |
| Defining When a Root Cause Analysis Should Be Performed | 26 |
| Steps in Developing an RCA Analysis | 27 |
| About This Example | 28 |
| Defining When an Analysis Should Be Performed: An Example | 29 |
| Ordering the Analysis: An Example | 30 |
| An Example of Preserving Failure Event Data | 34 |
| Analyzing Data: An Example | 39 |
| Communicating Findings and Recommendations: An Example | 46 |
| Tracking for Results: An Example | 49 |
| About the RCA Analysis Example | 50 |
| Example Data in the RCA Analysis Record | 51 |
| Example Data in the RCA Critical Success Factor Records | 52 |
| Example Data in the RCA Event Record | 53 |
| Example Data in the RCA Failure Mode Records | 54 |
| Example Data in the RCA Hypothesis Records | 55 |
| Example Data in the RCA Logic Gate Records | 60 |
| Example Data in the RCA Preserve Item Records | 62 |
| Example Data in the RCA Recommendation Record | 67 |

| | |
|---|-----|
| Example Data in the RCA Sequence Node Records | 68 |
| Example Data in the RCA Team Member Records | 69 |
| Example Data in the RCA Tracking Item Record | 70 |
| Example Data in the RCA Verification Record | 71 |
| Example Data in the Equipment Record | 72 |
| Accessing Root Cause Analysis | 73 |
| Aspects of the Root Cause Analysis Start Page | 74 |
| First-Time Deployment Workflow | 76 |
| Upgrade or Update Root Cause Analysis to 3.6.1.2.0 | 78 |
| About RCA Security | 79 |
| About Root Cause Analysis Security Privileges | 80 |
| RCA Security Groups | 81 |
| A Note About RCA Team Member Roles | 84 |
| Accessing the Administrative Functions Page | 85 |
| Aspects of the Administrative Functions Page | 86 |
| Default Team Charter Section | 87 |
| Default Critical Success Factors Section | 88 |
| Select Tracking Evaluation Query | 89 |
| Template Creation Permissions | 90 |
| Common Tasks Menu | 91 |
| About the Team Charter | 92 |
| Modifying the Default Team Charter | 94 |
| About Critical Success Factors | 95 |
| Creating New Default Critical Success Factors | 97 |
| Modifying Existing Default Critical Success Factors | 99 |
| Deleting Default Critical Success Factors | 101 |
| About Tracking Evaluations | 103 |
| Creating the Tracking Evaluation Scheduled Item | 104 |
| Specifying the Tracking Evaluation Query | 107 |
| Defining Template Creation Permissions | 109 |

| | |
|---|-----|
| About Configuring Queries for Custom Families | 110 |
| Customizing Family Key Queries | 111 |
| Customizing the Functional Location from Asset Query | 112 |
| Customizing the Tracking Evaluation Query | 113 |
| About Navigating the RCA Module | 114 |
| Using the RCA Site Map | 115 |
| About Ordering Analyses | 116 |
| Accessing the New Analysis Builder | 117 |
| Developing a New RCA Analysis | 119 |
| About Equipment, Locations, and RCA Analyses | 127 |
| Accessing the Manage Assets Page | 128 |
| Aspects of the Manage Assets Page | 129 |
| Manage Assets Menu | 130 |
| Common Tasks Menu | 131 |
| PReserve Menu | 132 |
| Order Menu | 133 |
| Analyze Menu | 134 |
| Communicate Menu | 135 |
| Track Menu | 136 |
| Linking Equipment and Functional Location Records to RCA Analysis Records | 137 |
| Opening Equipment and Functional Location Records Linked to RCA Analysis Records | 138 |
| Unlinking Equipment or Functional Location Records from RCA Analysis Records | 140 |
| About CSFs | 141 |
| Accessing the Critical Success Factors Page | 142 |
| Aspects of the Critical Success Factors Page | 143 |
| Manage Assets Menu | 144 |
| Common Tasks Menu | 145 |
| PReserve Menu | 146 |
| Order Menu | 147 |

| | |
|---|-----|
| Analyze Menu | 148 |
| Communicate Menu | 149 |
| Track Menu | 150 |
| Creating a New RCA Critical Success Factor Record | 151 |
| Viewing or Modifying the Details of a Critical Success Factor | 154 |
| Deleting Critical Success Factors | 157 |
| About the Team Charter | 158 |
| Modifying the Team Charter | 159 |
| About the RCA Analysis Team | 160 |
| Accessing the Team Page | 161 |
| Aspects of the Team Page | 162 |
| Manage Assets Menu | 164 |
| Common Tasks Menu | 165 |
| Manage Human Resources Menu | 166 |
| PReserve Menu | 167 |
| Order Menu | 168 |
| Analyze Menu | 169 |
| Communicate Menu | 170 |
| Track Menu | 171 |
| About Adding New Team Members to the RCA Analysis Team | 172 |
| Adding Team Members Who Already Have Human Resource Records | 173 |
| Creating New Users and adding them to the Analysis Team | 176 |
| Viewing the Human Resource Record for Existing Team Members | 177 |
| Modifying Human Resource Records for Existing Team Members | 178 |
| Changing the Principal Analyst | 179 |
| Deleting Team Members from the Analysis | 180 |
| About Preserving Failure Data | 181 |
| The 5 P's | 182 |
| Accessing the Preserve Failure Data Page | 183 |
| Aspects of the Preserve Failure Data Page | 184 |

| | |
|--|-----|
| Manage Assets Menu | 186 |
| Common Tasks Menu | 187 |
| PReserve Menu | 188 |
| Order Menu | 189 |
| Analyze Menu | 190 |
| Communicate Menu | 191 |
| Track Menu | 192 |
| Accessing the Preserve Record Details Page | 193 |
| Aspects of the Preserve Record Details Page | 194 |
| Common Tasks Menu | 195 |
| Creating a New RCA Preserve Item Record | 196 |
| Modifying Existing RCA Preserve Item Records | 198 |
| Linking Reference Document Records to Existing Preserve Item Records | 200 |
| Copying an RCA Preserve Item Record to Create a New Record | 202 |
| Deleting an RCA Preserve Item Record | 204 |
| About Analyzing Data | 205 |
| What is a Failure Event? | 206 |
| What's the Difference Between an Event Diagram and a Logic Tree? | 207 |
| Overview of the Event Diagram and Logic Tree Data Model | 209 |
| Defining the Failure Event | 211 |
| Linking Reference Document Records to Existing Failure Event Records | 213 |
| Accessing the Event Diagram Page | 214 |
| Aspects of the Event Diagram Page | 216 |
| Manage Assets Menu | 219 |
| Common Tasks Menu | 220 |
| Event Diagram Menu | 221 |
| PReserve Menu | 222 |
| Order Menu | 223 |
| Analyze Menu | 224 |
| Communicate Menu | 225 |

| | |
|--|-----|
| Track Menu | 226 |
| Using the Shortcut Menu in the Diagram Canvas | 227 |
| About Creating a New Event Diagram | 228 |
| Adding Node to the Event Diagram | 229 |
| Connecting Sequence Nodes | 230 |
| Viewing and Modifying the Record Associated with Each Node | 231 |
| Cutting, Copying, and Pasting Nodes | 232 |
| Deleting Nodes from the Event Diagram | 233 |
| Deleting Node Connectors | 234 |
| Displaying the Event Diagram on a Full Screen | 235 |
| Hiding or Displaying the Selected Node Datasheet Section | 236 |
| Hiding and Displaying the Available Nodes Palette Section | 237 |
| Exporting the Event Diagram | 238 |
| What is a Logic Tree? | 240 |
| Accessing the Logic Tree Page | 242 |
| Aspects of the Logic Tree Page | 244 |
| Aspects of the Options Pane | 246 |
| Manage Assets Menu | 250 |
| Tree Tasks Menu | 251 |
| PReserve Menu | 253 |
| Order Menu | 254 |
| Analyze Menu | 255 |
| Communicate Menu | 256 |
| Track Menu | 257 |
| Using the Shortcut Menu in the Diagram Canvas | 258 |
| Workflow for Creating a New Logic Tree | 260 |
| What is a Failure Mode? | 261 |
| Adding Failure Mode Nodes to the Logic Tree | 263 |
| What is a Hypothesis? | 265 |
| About Hypothesis States | 268 |

| | |
|--|-----|
| Adding Hypothesis Nodes to the Logic Tree | 270 |
| About the Build List Tab | 272 |
| Adding a New Hypothesis to the Build List Tab | 273 |
| Importing a Hypothesis and Adding it to the Build List Tab | 275 |
| Adding Hypotheses from the Build List Tab to the Logic Tree | 278 |
| Modifying an Existing Hypothesis on the Build List Tab | 280 |
| Deleting a Hypothesis from the Build List Tab | 281 |
| Deleting All Hypotheses from the Build List Tab | 282 |
| Changing the State of an RCA Hypothesis Record | 283 |
| Identifying the Root Cause for Hypotheses Proven True | 284 |
| About Importing Existing Failure Modes and Hypotheses | 285 |
| Aspects of the Search Tool Window | 287 |
| About the Search Results Section | 290 |
| Specifying Search Text Only | 291 |
| Specifying Analysis Search Text Only | 293 |
| Specifying Search Text and Analysis Search Text | 295 |
| Performing the Import Operation | 297 |
| What is a Verification? | 301 |
| Adding a New Verification to a Hypothesis Node | 303 |
| Copying and Pasting an RCA Verification Record | 305 |
| Finding Hypothesis Nodes with No Verifications or Incomplete Verifications | 307 |
| What is a Logic Gate? | 308 |
| Example of Logic Gate Nodes | 309 |
| Enabling Logic Gates | 310 |
| Adding a Logic Gate to the Logic Tree | 311 |
| Changing the Gate Type of a Logic Gate | 312 |
| Viewing and Modifying Existing Logic Tree Node Records | 313 |
| Expanding and Collapsing Logic Tree Nodes | 314 |
| Finding Nodes in the Logic Tree | 316 |
| Manually Arranging Nodes Within the Logic Tree | 318 |

| | |
|---|-----|
| Sending Links to Verification Records to Team Members | 321 |
| Cutting, Copying, and Pasting Logic Tree Nodes | 323 |
| Managing Reference Document Records for Logic Tree Nodes | 324 |
| Deleting Nodes from the Logic Tree | 325 |
| Changing the Tree View | 327 |
| Displaying the Logic Tree on a Full Screen | 329 |
| Zooming In and Out on the Logic Tree | 330 |
| Applying a Different Line Style | 331 |
| Changing the Color of the Logic Tree Section | 332 |
| Changing the Spacing for Levels and Nodes | 334 |
| Changing the Size and Color of the Font | 335 |
| Resetting the Logic Tree to Display Default Settings | 337 |
| Accessing the Overview Map | 338 |
| Using the Overview Map | 339 |
| Exporting Logic Trees | 342 |
| About Communicating Findings and Implementing Recommendations | 344 |
| Accessing the Communicate Records Page | 345 |
| Overview of the Communicate Records Page | 346 |
| Manage Assets Menu | 348 |
| Common Tasks Menu | 349 |
| PReserve Menu | 350 |
| Order Menu | 351 |
| Analyze Menu | 352 |
| Communicate Menu | 353 |
| Track Menu | 354 |
| Completing the RCA Communicate Datasheet | 355 |
| Viewing and Modifying Values on the RCA Communicate Datasheet | 357 |
| What is a Recommendation? | 358 |
| About Equipment, Locations, and RCA Recommendations | 360 |
| Workflow for Proposing and Implementing Recommendations | 361 |

| | |
|---|-----|
| Creating RCA Recommendation Records | 363 |
| Copying RCA Recommendation Records | 365 |
| Opening an Existing RCA Recommendation Record | 367 |
| Aspects of the Recommendation Details Page | 368 |
| Deleting RCA Recommendation Records | 370 |
| About RCA Reports | 371 |
| Accessing the List of RCA Reports | 372 |
| Overview of the Reports List Page | 373 |
| Manage Assets Menu | 374 |
| Common Tasks Menu | 375 |
| PReserve Menu | 376 |
| Order Menu | 377 |
| Analyze Menu | 378 |
| Communicate Menu | 379 |
| Track Menu | 380 |
| About Opening an RCA Report | 381 |
| Opening the Comprehensive Analysis Report | 382 |
| Opening an Individual Report | 388 |
| About Available Reports | 389 |
| Components of the Comprehensive Analysis Report | 390 |
| Cover Page | 391 |
| Topics Included in this Report | 392 |
| Preserve (5P's) | 393 |
| Data Collection | 394 |
| Data Collection File Links | 396 |
| Order | 397 |
| Team Members | 398 |
| Charter | 399 |
| Critical Success Factors | 400 |
| Analyze | 401 |

| | |
|--|-----|
| Event Diagram | 402 |
| Logic Tree | 403 |
| Verification Logs | 404 |
| Verification Log File Links | 405 |
| Communicate | 406 |
| Event Summary | 407 |
| Summary of Findings | 408 |
| Executive Summary Recommendations | 409 |
| Recommendation File Links | 410 |
| Acknowledgements | 411 |
| Track | 412 |
| Tracking Item Summary | 413 |
| Analysis-At-A-Glance | 414 |
| About the PROACT RCA Analysis-At-A-Glance Overview | 415 |
| Analysis and Team Data Subsection | 416 |
| Assets Subsection | 418 |
| Status of Preserve, Analyze, and Communication Subsections | 419 |
| Analysis Summary Report | 422 |
| Cause Report | 424 |
| Logic Tree Summary Report | 426 |
| Verification Report | 427 |
| Recommendation Report | 428 |
| Team Member Report | 429 |
| Preserve Items Report - Group by Category | 431 |
| Preserve Items Report - Group by Team Member | 432 |
| About Tracking and Reevaluating Analysis Results | 433 |
| Accessing the List of Existing RCA Tracking Item Records | 434 |
| Aspects of the Analysis Tracking Items Page | 436 |
| Manage Assets Menu | 437 |
| Common Tasks Menu | 438 |

| | |
|--|------------|
| PReserve Menu | 439 |
| Order Menu | 440 |
| Analyze Menu | 441 |
| Communicate Menu | 442 |
| Track Menu | 443 |
| Accessing the Tracking Item Details Page | 444 |
| Aspects of the Tracking Item Details Page | 445 |
| Creating New RCA Tracking Item Records | 446 |
| Linking Equipment or Functional Location Records to RCA Tracking Item Records | 448 |
| Viewing the Contents of RCA Tracking Item Records | 449 |
| Modifying Existing RCA Tracking Item Records | 450 |
| Copying RCA Tracking Item Records | 451 |
| Deleting RCA Tracking Item Records | 453 |
| About the Spell Check Feature | 454 |
| Checking the Spelling in an Analysis | 455 |
| Specifying a Language for the Dictionary | 458 |
| Accessing the My PROACT Page | 459 |
| Aspects of the My PROACT Page | 460 |
| Common Tasks Menu | 462 |
| Other Tasks Menu | 463 |
| Viewing the Details of an Analysis | 464 |
| Viewing the Details of a Preserve Item | 465 |
| Viewing the Details of an RCA Verification Record | 466 |
| Viewing the Details of an RCA Recommendation Record | 467 |
| About the Principal Analyst's View | 468 |
| Accessing the PA PROACT Page | 469 |
| Aspects of the PA PROACT Page | 470 |
| Common Tasks Menu | 472 |
| Other Tasks Menu | 473 |
| Viewing the Details of an In-Progress RCA Analysis | 474 |

| | |
|--|-----|
| Viewing Assigned Incomplete RCA Preserve Item Records | 475 |
| Viewing and Modifying Assigned RCA Verification Records | 477 |
| Viewing and Modifying Assigned RCA Recommendation Records | 479 |
| About Sending Email to Team Members | 481 |
| Sending Email About RCA Preserve Item Records | 482 |
| Sending Email about RCA Verification Records | 484 |
| Accessing the Manage Analyses Page | 486 |
| Aspects of the Manage Analyses Page | 487 |
| Common Tasks Menu | 488 |
| About Copying Existing Analyses | 490 |
| Copying an Existing Analysis to Develop a New Analysis | 491 |
| Linking Reference Document Records to RCA Analysis Records | 493 |
| Creating RCA Analysis Templates | 495 |
| Publishing an Analysis | 497 |
| Unpublishing an Analysis | 498 |
| Deleting an RCA Analysis or Analysis Template | 499 |
| Accessing the Analysis Page | 500 |
| Aspects of the Analysis Page | 502 |
| Manage Assets Menu | 504 |
| PReserve Menu | 505 |
| Order Menu | 506 |
| Analyze Menu | 507 |
| Communicate Menu | 508 |
| Track Menu | 509 |
| About the Catalog Items Used by PROACT Reports | 510 |
| Catalog Items Used by the Comprehensive Analysis Report | 511 |
| Catalog Items Used by the Individual Reports | 518 |
| RCA Analysis | 521 |
| RCA Event | 527 |
| RCA Preserve Item | 529 |

| | |
|---|-----|
| RCA Recommendation | 533 |
| RCA Tracking Item | 549 |
| RCA Verification | 551 |
| URL Paths for Root Cause Analysis | 556 |
| Parameter for the Administrative Functions URL | 558 |
| Examples of the Administrative Functions URL | 559 |
| Parameters for the RCA Analysis URL | 560 |
| Examples of the RCA Analysis URL | 561 |
| Parameters for the Analysis Builder URL | 562 |
| Examples of the Analysis Builder URL | 564 |
| Parameters for the Recommendation Records URL | 565 |
| Examples of Recommendation Records URLs | 566 |
| Parameters for the Critical Success Factors URL | 567 |
| Examples of the Critical Success Factors URL | 568 |
| Parameters for the Event Diagram URL | 569 |
| Examples of the Event Diagram URL | 570 |
| Parameters for the Logic Tree URL | 571 |
| Examples of the Logic Tree URL | 572 |
| Parameters for the Manage Assets URL | 573 |
| Examples of the Manage Assets URL | 574 |
| Parameters for the My PROACT URL | 575 |
| Examples of the My PROACT URL | 576 |
| Parameters for the Preserve Records URL | 577 |
| Examples of the Preserve Failure Records URL | 578 |
| Parameters for the RCA Reports URL | 579 |
| Examples of the RCA Reports URL | 580 |
| Parameters for the RCA Team URL | 581 |
| Examples of the RCA Team URL | 582 |
| Parameters for the Tracking Items URL | 583 |
| Examples of the Tracking Items URL | 584 |

Table of Contents

| | |
|---------------------------------------|------------|
| Critical Success Factors | 585 |
| Event Diagram | 586 |
| Failure Event | 587 |
| Logic Tree | 588 |
| RCA Analysis Team | 589 |
| Team Charter | 590 |

Overview of Root Cause Analysis

The Meridium APM Root Cause Analysis (RCA) module lets you conduct a root cause analysis, which allows you to track and analyze causes of equipment and location failures. When you create an [RCA Analysis](#), you are using Meridium APM Framework Tools to facilitate a standard process that is based on the [PROACT® for Meridium methodology](#).

Note: The RCA module is based on the PROACT® RCA Methodology and Software, © Copyright 1996 - 2004, RCI-Reliability Center Incorporated. All rights reserved. Used with Permission.

When a piece of equipment or location in your facility fails, there could be any number of causes that led up to the failure. If you investigate the causes, you might find that each failure stems from another higher-level cause. If this *root* cause remains unidentified, the failures will likely persist.

For instance, consider an example of a car that has had trouble starting every month for the past three months. In this case, you might determine that:

- In the first month, the cold weather caused the failure.
- In the second month, the battery was low.
- In the third month, the fuel in the tank was low.

If you were to conduct a root cause analysis on the car, you may find that while each month's failure had its own apparent cause, the *root cause* of each failure was that a spark plug needed to be replaced.

To help you identify the root causes of failures in your facility, you can assemble an RCA Analysis Team that will:

- Collect data relevant to the failure.
- Analyze the data.
- Develop hypotheses about the root cause.
- Develop recommendations for preventing the failure from occurring or lessen the impact of the failure in the future.
- Implement recommended solutions.
- Track implemented solutions and re-evaluate them if necessary.

What is PROACT for Meridium?

PROACT for Meridium is a methodology that is used in the RCA module and allows you to conduct a root cause analysis. The *PROACT* acronym stems from the following steps, where we have capitalized the letters that make up the acronym:

- **PReserve:** Team members gather and record information (i.e., failure data) about a piece of equipment's or location's failure.
- **Order:** The Principal Analyst:
 - Defines the goals of the RCA Analysis.
 - Assembles the team members who will conduct the RCA Analysis.
- **Analyze:** Team members review and analyze the available information and then record any conclusions.
- **Communicate:** Team members submit to the decision makers in the organization their hypotheses about the cause of the failure and their recommendations for solutions to the failure.
- **Track:** Team members track the success of the solutions that were implemented. A re-evaluation can be performed, if necessary.

You can use these steps as a guideline for [conducting a root cause analysis in the RCA module](#), which consists of creating the data in Meridium APM that is necessary to complete these five steps of the PROACT for Meridium methodology and implement successful solutions.

Note: These steps do not need to be completed in the exact order that they are listed above. It is important, however, that *all* steps of the methodology be completed. For more information, see the workflow for conducting a root cause analysis.

What is a Root Cause Analysis?

A *root cause analysis* is the process of analyzing equipment and locations failures down to their root cause, which can include but is not limited to deficiencies in management systems and in the piece of equipment or location itself.

In the Meridium APM Framework, an *RCA Analysis* is the combination of [an RCA Analysis record and a group of records that are linked to it](#) that store all the information necessary for the team to identify a root cause for a piece of equipment's or location's failure. The Root Cause Analysis module provides an interface that you can use to create an RCA Analysis, using the steps in the [PROACT for Meridium methodology](#) to facilitate the completion of a root cause analysis.

When the RCA Analysis is complete, it can be published and made available to users who are not [members of the analysis team](#), allowing them to view the results using Meridium APM Framework Tools.

RCA System Requirements

The *Root Cause Analysis* license is required to take advantage of RCA functionality. In addition, your system must contain the basic Meridium APM system architecture.

After you have installed and configured the basic system architecture, you will need to perform some configuration tasks specifically for the RCA module.

Root Cause Analysis Data Model

The Root Cause Analysis data model uses families to represent the various components of an RCA Analysis, as defined by the standard, accepted PROACT for Meridium methodology. Meridium APM leverages its fundamental entity and relationship family infrastructure to store data related to an RCA Analysis.

Each RCA Analysis is represented at the root level by an *RCA Analysis* record. The RCA Analysis record can be linked to an RCA Event record through the RCA Analysis Relationship. RCA Event records can, in turn, be linked to RCA Failure Mode records, RCA Sequence Node records, and so on for all components of the RCA Analysis. Together, the root RCA Analysis record and all the records that are linked to it, either directly or indirectly, make up the *RCA Analysis*.

The following image shows the entity families and relationship families that are used to create an RCA Analysis.

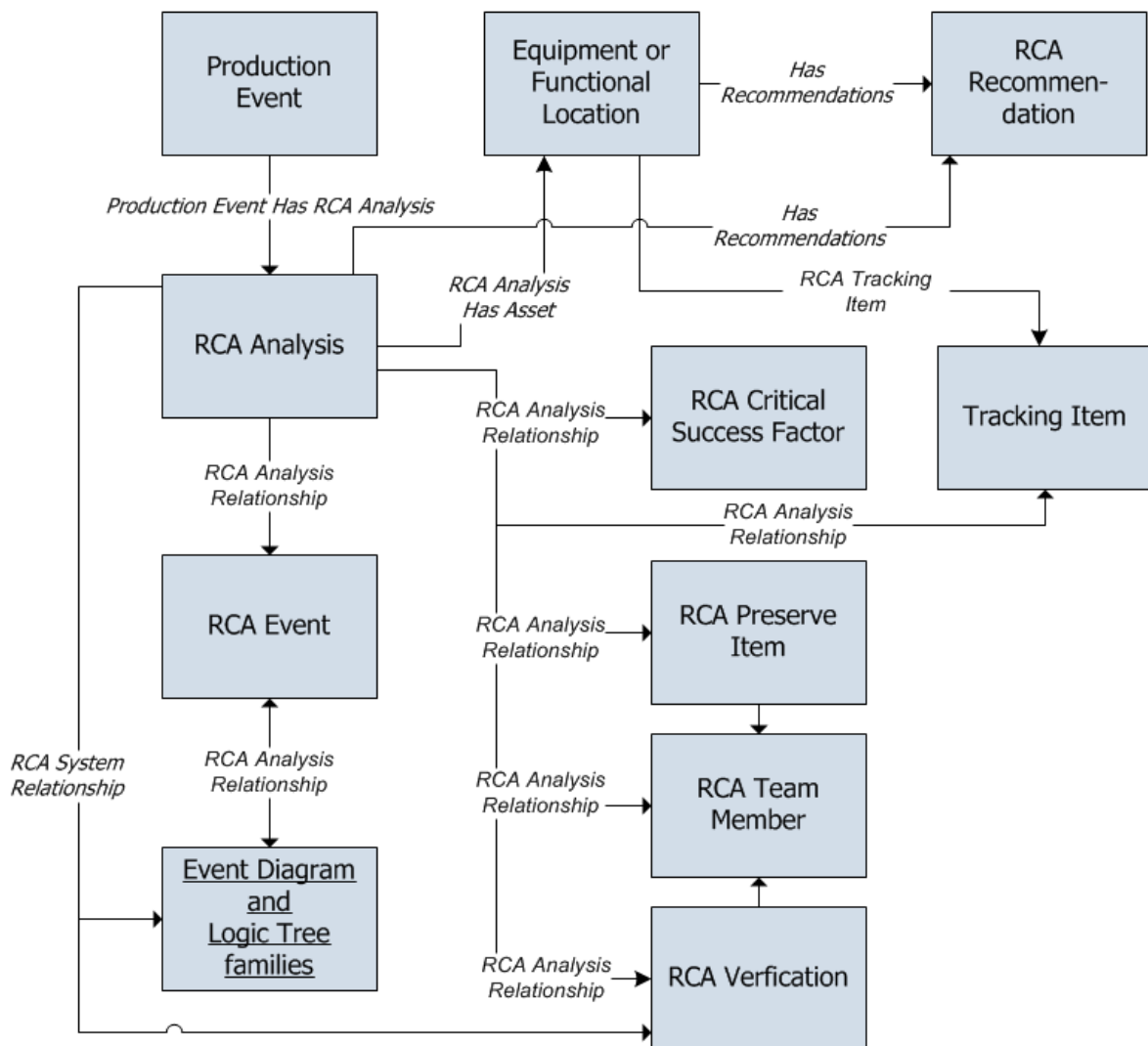

Note: RCA Recommendation records can be linked to [any Equipment record and any Functional Location record](#). They may or may not be the same Equipment or Functional Location records that are linked to the RCA Analysis record.

The Root Cause Analysis Best Practice specifies that you will create RCA Analyses either for equipment or locations. Either option may be valid, depending upon the analysis. Throughout the RCA documentation, we assume that you are following the Meridium APM best practice and storing your equipment and location information in Equipment and Functional Location Records. Additionally, we assume that you are following the RCA Best Practice and linking your RCA Analysis records to either Equipment or Functional Location records.

In addition to the relationships that appear in this image, records in the following families can be linked to records in the RCA Reference Document family through a relationship definition on the Has Reference Documents family:

- RCA Analysis
- RCA Critical Success Factor
- RCA Event
- RCA Failure Mode
- RCA Preserve Item
- RCA Recommendation
- RCA Team Member
- RCA Tracking Item
- RCA Verification

Additionally, the following families are used by the RCA module but are not related to any other family in the data model:

- The RCA Image family is used to display an image of the Event Diagram and the Logic Tree in the Comprehensive Analysis Report
- The Alert family is used to send alert emails.

About Analysis States

The state of an RCA Analysis record is stored in the State field and is represented by a value of 0, 1, or 2. The State field is not included on any of the baseline datasheets that exist for the RCA Analysis family. The state of an RCA Analysis is determined by actions that you take in the RCA module. When you perform an action (e.g., publish an analysis), the value in the State field changes automatically, which transitions the analysis from one state to another. The default value is 0. After an RCA Analysis is published, the value changes to 1. After an RCA Analysis is produced from an existing analysis (i.e., as a template), the value changes to 2. On the [Manage Analyses page](#), the numeric values are translated into text via code that exists in the Meridium APM system.

RCA Analyses can have one of the states in the following list. The number in parentheses indicates the value in the State field that corresponds to each state. Only the name of the state will appear on the [Manage Analyses page](#). The numbers are not displayed in Root Cause Analysis:

- **In Progress (0):** Indicates that an RCA Analysis has not yet been completed. Only Meridium APM users who are members of the RCA Analysis Team and members of the MI PROACT Administrator Security Group can [view and modify an RCA Analysis](#) via the **My PROACT** page when it is in the In Progress state. RCA Analyses will remain in the In Progress state until the Principal Analyst publishes the analysis. Additionally, a Published RCA Analysis that is unpublished will return to the In Progress state.
- **Published (1):** Indicates that an RCA Analysis has been completed. After the RCA Analysis is complete, the Principal Analyst can [publish the analysis](#), which will assign the Published state to the analysis and populate the Date Published field in the RCA Analysis record with the date on which it was published. When an RCA Analysis is published, Meridium APM users, regardless of whether they are members of the analysis team or not, will have read-only access to the RCA Analysis as long as they have the following security permissions:
 - View privileges to all RCA Analysis families, including the RCA Analysis Relationships and RCA System Relationships families.
 - Insert privileges on the RCA Analysis family.
 - Update privileges on the RCA Image family.

If a Published [RCA Analysis is unpublished](#), the RCA Analysis will return to the In Progress state, but the value in the Date Published field will not be updated until the analysis is published again.

- **Template (2):** Indicates that an RCA Analysis has been produced from an existing analysis using the **Produce Template** link. RCA Analyses in the Template state are identical to RCA Analyses that are in the In Progress state, except that they do not have an analysis team defined.
 - Super Users, members of the MI PROACT Administrators Security Group, and Principal Analysts can [transition analyses to in the Template state](#).

Note: Principal Analysts can create RCA Analysis Templates only if the [Template Creation Permissions setting has been enabled](#).

- Only Super Users and members of the MI PROACT Administrators Security Group can modify an RCA Analysis that is in the Template state.

Defining When a Root Cause Analysis Should Be Performed

Before you begin conducting a root cause analysis using the Root Cause Analysis module, members of your organization should determine which events require further investigation through a root cause analysis. This involves defining criteria that standardizes when a root cause analysis should *always* be performed.

The root cause analysis criteria should be defined according to the needs and resources within your organization. For instance, the criteria can be based strictly on the data collected in Failure records. For example, the criteria might be that a root cause analysis is automatically performed when a piece of equipment fails more than two times in a 12-month period. The criteria can also be less restrictive, allowing an area manager or reliability engineer to initiate a root cause analysis even if a failure does not meet the standard criteria.

Regardless of the specific criteria that you use, your goal should be to define criteria that will allow personnel to know *when* a root cause analysis should always be conducted, ensuring that failure events are analyzed in a consistent and methodical way.

Steps in Developing an RCA Analysis

After you have [configured the RCA module](#), members of your organization must [define the general criteria that dictate when an RCA Analysis should be performed](#). When a piece of equipment or location in your facility meets this criteria, you should perform an RCA Analysis according to the steps in the PROACT for Meridium methodology using the Root Cause Analysis module.

The following list outlines the steps in the PROACT for Meridium methodology and the corresponding tasks that you should complete in Meridium APM to develop an RCA Analysis.

1. **Order the analysis:** Use the **New Analysis Builder** to complete the initial steps required for the RCA Analysis. When you are finished, an RCA Analysis record is created. Using the **New Analysis Builder**, you will:
 - Select the Equipment or Functional Location record on which the RCA Analysis is based.
 - Select the members of the RCA Analysis Team.
 - Select or add Critical Success Factors to the RCA Analysis.
 - Select or modify the Team Charter.
2. **Preserve failure data:** [Create RCA Preserve Item records](#) and assign them to team members.

Note: While the PROACT acronym lists the Preserve step first, the order in which you perform the associated task in Meridium APM differs.

3. **Analyze the data:** Create an [Event Diagram and a Logic Tree](#) diagram to provide a visual representation of the data that was collected. Using the diagrams, you can analyze the data, develop hypotheses, and verify hypotheses. When you [develop and verify hypotheses](#), you will create the corresponding RCA Hypothesis and RCA Verification records.
4. **Communicate findings and recommendations:** Update the RCA Analysis record, create [RCA Recommendation records](#), and [generate reports](#) to communicate the team's conclusions to the decision makers in your organization.
5. **Track and reevaluate results:** Using RCA Tracking Item records to track the success or failure of the solutions that were implemented. If necessary, reevaluate and modify the team's recommendations.

About This Example

This section of the documentation provides topics that correspond to each step in the [workflow for developing an RCA Analysis](#). In each topic, the workflow for creating a Root Cause Analysis will be illustrated through examining the recurring failure(s) of a cooling water pump. The following topics appear in this section of the documentation and are intended to be read in order:

- [Defining the criteria for when an RCA Analysis should be performed.](#)
- [Ordering the analysis.](#)
- [Preserving failure event data.](#)
- [Analyzing data.](#)
- [Communicating findings and recommendations.](#)
- [Tracking results.](#)

Note: The information contained in these topics assumes that you are the user who will be performing the associated step in Root Cause Analysis and that all RCA administrative tasks have been completed.

Defining When an Analysis Should Be Performed: An Example

Before you can begin conducting an RCA Analysis, you [need to establish the criteria that standardizes when a Root Cause Analysis *should* be performed](#). For example, the manager of the plant where the cooling water pump exists might specify criteria as:

- If any pump fails one or more times per week for more than two successive weeks, regardless of the cost for repairs, an RCA study should be conducted.
- or-
- If any pump fails catastrophically (e.g., causes the system to shut off), an RCA Analysis should be conducted.

Now, assume that in January 2012, the bearing temperature alarm on the outboard bearing of a cooling water pump sounded. By the time the operator arrived, the motor temperature had increased and caused the system to shut off, resulting in loss of production. According to the criteria that was developed, these conditions dictate that an RCA Analysis should be performed. The first step is to *order* the analysis.

Ordering the Analysis: An Example

After the cooling water pump failure meets the criteria for requiring an RCA Analysis, the first step is to *order the analysis*. The user who will serve as the Principal Analyst can complete this step by using the **New Analysis Builder** to initiate the development of the RCA Analysis for the recurring failures of the cooling water pump.

To order the analysis for our example:

1. Access the **New Analysis Builder**.
2. When the **New Analysis Builder** appears, the **PROACT Analysis Datasheet** screen is displayed, where you would define the RCA Analysis record, as shown in the following image.

| | Value(s) |
|----------------------|---|
| Analysis Name | Cooling Water Pump |
| Analysis Description | A analysis to determine the root cause of the ... |
| Start Date | 1/6/2012 |
| End Date | 1/15/2012 |
| Comments | Comments ... |
| Analysis Type | Mechanical |
| Event Narrative | Investigate what caused the motor temperature ... |
| Date Published | |
| Cost | \$200,000.00 (United States Dollar) |
| Frequency | 1 |

In the **Frequency of Failures** text box, the number 1 represents the number of failures that occurred for the cooling water pump.

3. When you click the **Next** button, the **Linked Assets** screen will appear, where you can search for the desired Equipment or Functional Location record and select it.

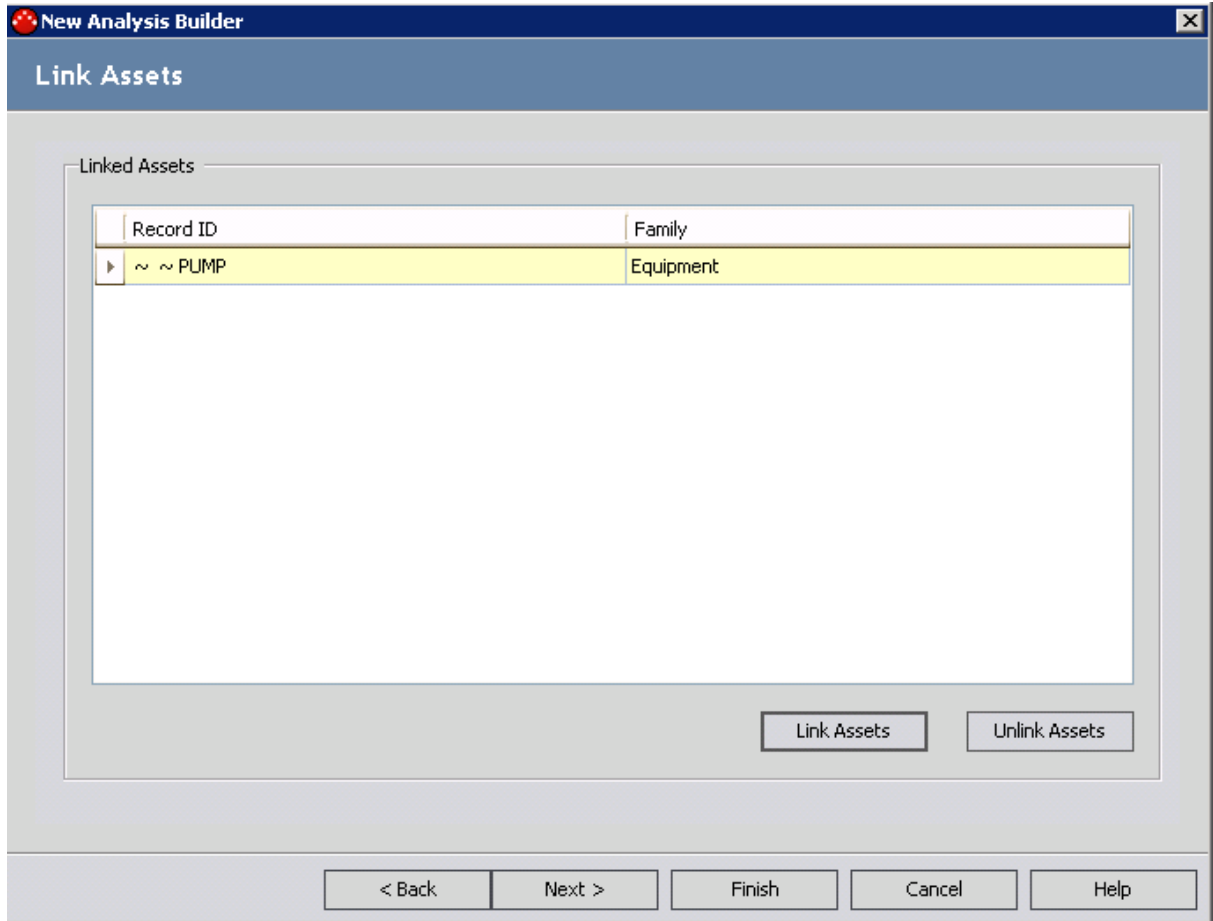

4. You will then click the **Next** button to display the **Select Team Members** screen, where you can define the RCA Analysis Team by selecting the names of the users who would contribute a wide range of expertise to the team. In this case, you would select:
- The analyst, Suzie Jones, to help gather information surrounding the failure.
 - The mechanic, Pete Handy, because he will repair the cooling water pump.
 - The engineer, Bob Speck, because he is an expert on systems and safety guidelines.

The following image shows the **Select Team Members** screen after the RCA Analysis Team has been selected. The Principal Analyst is Jane Doe, who is an expert on facilitating team discussion and documenting discussion notes.

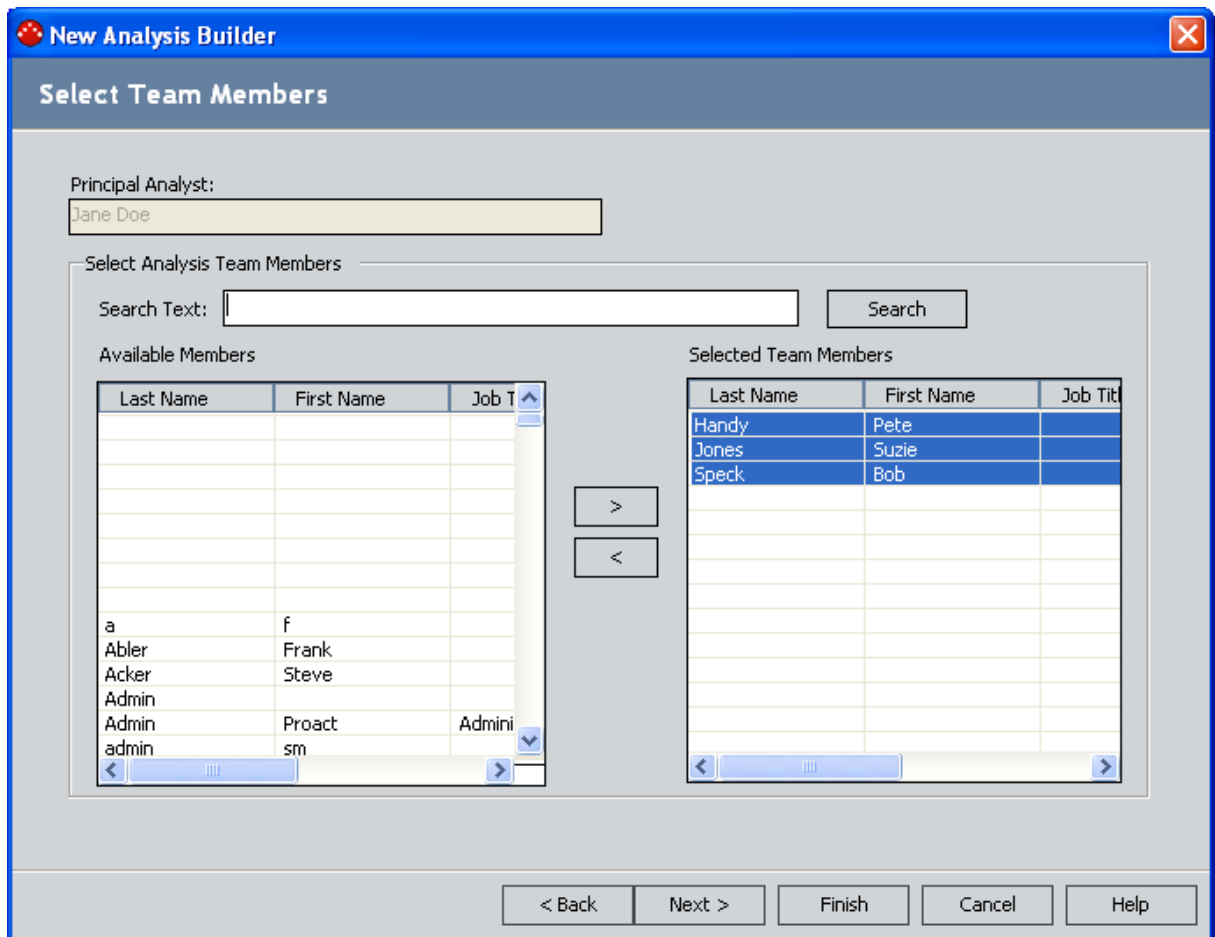

5. On the **Select CSF** screen, you can accept the default Critical Success Factors or create new ones. For this example, you want to accept the default Critical Success Factors, so select each Critical Success Factor in the **Available CSF** grid and proceed to the next screen.
6. On the **Enter Team Charter** screen, you can type your own Team Charter or accept the default Team Charter. For this example, you want to accept the default Team Charter and modify it so that it appears as the following image shows.

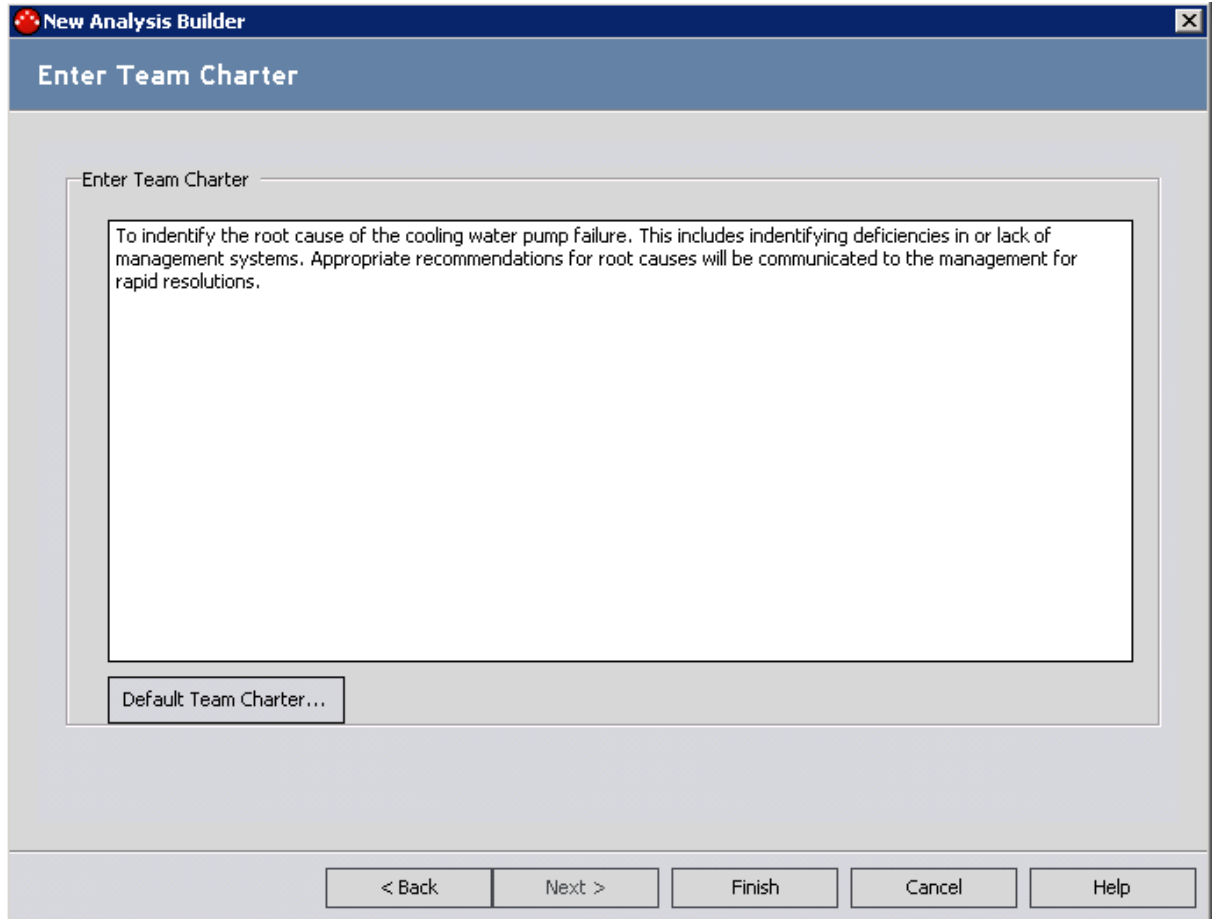

7. After you define the Team Charter, you can click the **Finish** button to exit the **New Analysis Builder** and begin [preserving the failure data for the RCA Analysis](#).

After you click the **Finish** button, the RCA Analysis record and all initial information for the RCA Analysis is saved, and the **Preserve Failure Data** page appears.

An Example of Preserving Failure Event Data

After you have ordered the RCA Analysis, you can begin *preserving* failure event data, which consists of creating RCA Preserve Item records that contain a data-collection task that should be completed by the team member to whom the record is assigned. Each task can be categorized according to the 5 P's (i.e., Parts, Paper, People, Position, Paradigms), which indicates the type of data that should be collected.

To preserve failure event data for our example:

- On the **Preserve Failure Data** page, create RCA Preserve Item records and assign them to the team members who will complete the task specified in the record. For this example, you should create RCA Preserve Item records that contain the information as it appears in each of the following tables.

| RCA Preserve Item 1 | |
|-------------------------------------|---|
| Field | Value(s) |
| Assign To | Pete Handy |
| Data Category | Parts |
| Data to Collect | The pieces of the cooling water pump that could have caused the pump to overheat. |
| Collection Strategy | Document (pictures and observations) the condition of the components of the pump. |
| Date Due | 1/8/2012 |
| Send Alert on Due Date? | True |
| Days Before Due Date to Be Notified | 1 |
| Frequency of Alert After Due Date | Daily |
| Alert Email Body | This is a reminder to gather and document the pieces of the pump that could have caused the pump to overheat and report back to the team. |
| Completed? | No |

An Example of Preserving Failure Event Data

| RCA Preserve Item 1 | |
|-----------------------|--|
| Date Completed | |

| RCA Preserve Item 2 | |
|--|--|
| Field | Value(s) |
| Assign To | Suzie Jones |
| Data Category | Paper |
| Data to Collect | Standard operating procedures and frequent failure information |
| Collection Strategy | Research |
| Date Due | 1/9/2012 |
| Send Alert on Due Date? | True |
| Days Before Due Date to Be Notified | 1 |
| Frequency of Alert After Due Date | Daily |
| Alert Email Body | This is a reminder to gather the standard operating procedures and frequent failure information and report back to the team. |
| Completed? | No |
| Date Completed | |

An Example of Preserving Failure Event Data

| RCA Preserve Item 3 | |
|-------------------------------------|---|
| Field | Value(s) |
| Assign To | Bob Speck |
| Data Category | People |
| Data to Collect | Operating procedures used by those who maintain the pump. |
| Collection Strategy | Interview the floor operators who are assigned to the pump. |
| Date Due | 1/10/2012 |
| Send Alert on Due Date? | True |
| Days Before Due Date to Be Notified | 1 |
| Frequency of Alert After Due Date | Daily |
| Alert Email Body | This is a reminder to interview operators assigned to the pump and document their operating procedures and report back to the team. |
| Completed? | No |
| Date Completed | |

| RCA Preserve Item 4 | |
|---------------------|-----------|
| Field | Value(s) |
| Assign To | Bob Speck |
| Data Category | Position |

An Example of Preserving Failure Event Data

| RCA Preserve Item 4 | |
|--|--|
| Data to Collect | Environment surrounding the pump. |
| Collection Strategy | Tools, pictures, diagrams |
| Date Due | 1/10/2012 |
| Send Alert on Due Date? | True |
| Days Before Due Date to Be Notified | 1 |
| Frequency of Alert After Due Date | Daily |
| Alert Email Body | This is a reminder to investigate the environment where the pump exists and report back to the team. |
| Completed? | No |
| Date Completed | |

| RCA Preserve Item 5 | |
|----------------------------|--|
| Field | Value(s) |
| Assign To | Jane Doe (Principal Analyst) |
| Data Category | Paradigms |
| Data to Collect | Common assumptions made when a pump fails. |
| Collection Strategy | Research and interview. |
| Date Due | 1/10/2012 |

An Example of Preserving Failure Event Data

| RCA Preserve Item 5 | |
|-------------------------|-------|
| Send Alert on Due Date? | False |
| Completed? | No |
| Date Completed | |

After each team member has collected the data that is specified in the RCA Preserve Item record, they should record their findings for the rest of the team through artifacts, including Reference Document records and hard copies of documents. After all the RCA Preserve Item records have been completed, the team can begin to [analyze the data](#).

Analyzing Data: An Example

After the team has preserved the failure data, the team can begin to *analyze the data*. To help you visualize the event and organize the team's hypotheses, you should create an Event Diagram and a Logic Tree to facilitate and organize the team's analysis.

To analyze failure event data for our example:

1. Access the **Event Diagram** page, and define the failure event by creating an RCA Event record. For this example, you would complete the RCA Failure Event data-sheet as the following image shows.

| | Value(s) |
|------------------|--|
| Label | Overheating in Pump 1 |
| Long Description | Investiage the cause for a cooling water |
| Event Start Date | 01/06/2012 |
| Event ID | RCA-18/09/2012 |
| Event End Date | 01/15/2012 |

2. Diagram the events that led up to and immediately followed the failure event. For this example, you would create the Event Diagram as shown in the following image. The team should note the trend in the failures that occurred in the past. In this way, the team may be able to identify a pattern in the events prior to the RCA Analysis that may indicate the underlying cause(s) for these failures.

Analyzing Data: An Example

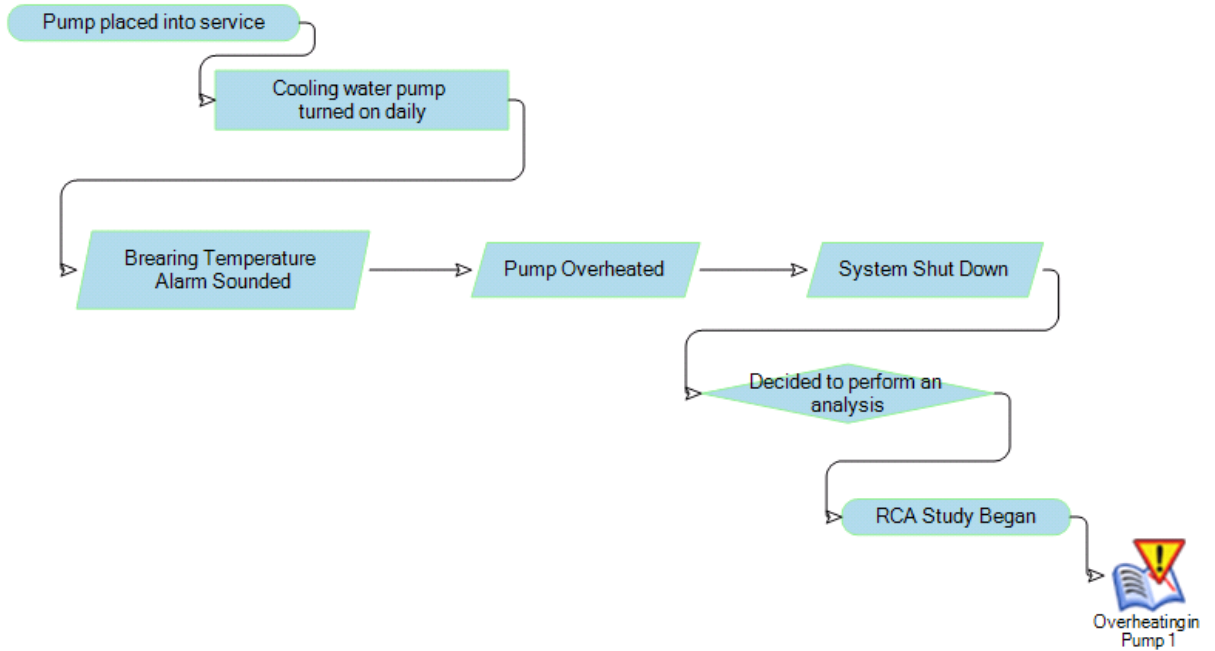

3. Diagram each failure mode in detail. For this example, you would create a Logic Tree like the one shown in the following image.

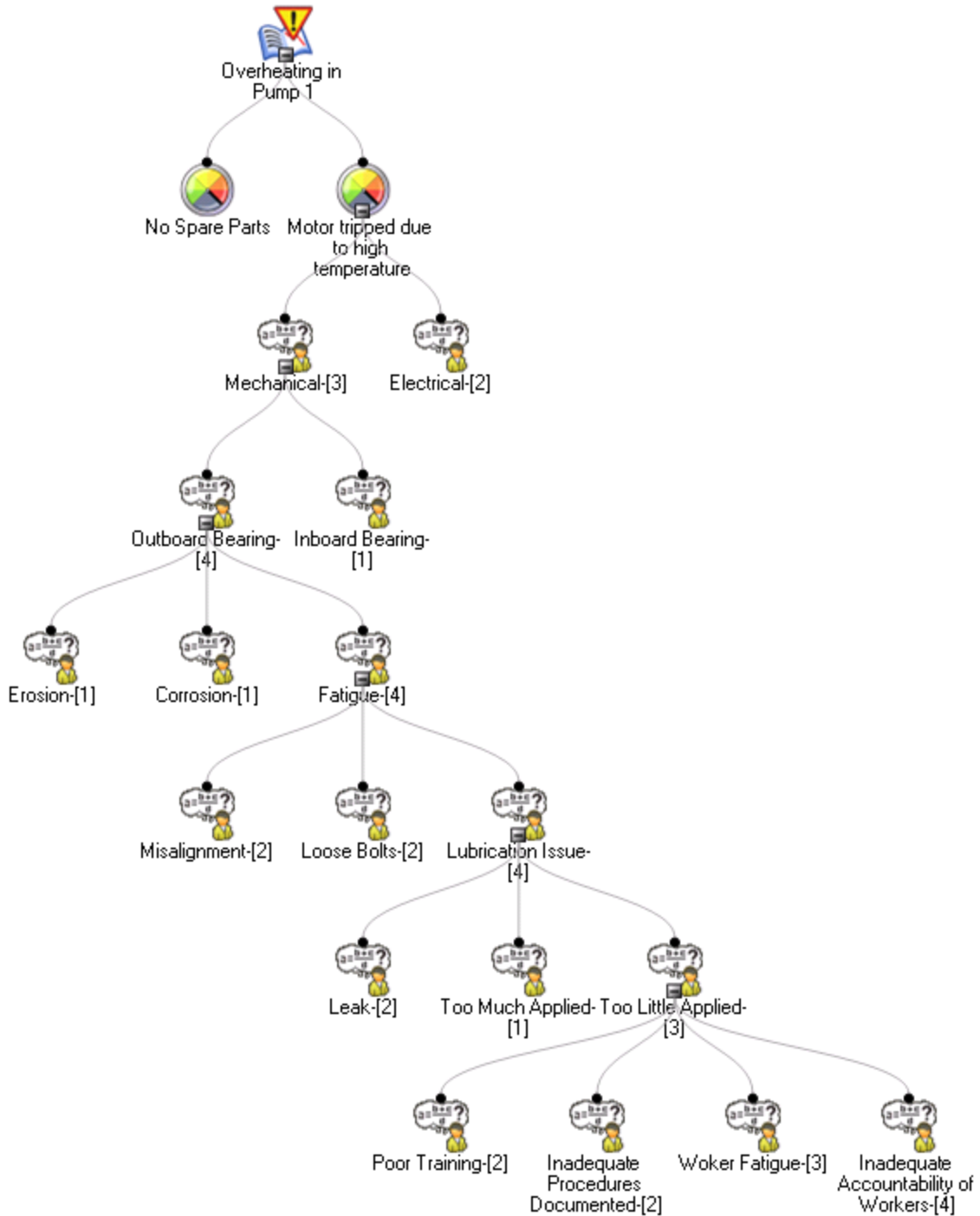

In the Logic Tree in this image, you can see that two Failure Mode nodes are linked to the Failure Event node, and multiple Hypothesis nodes are linked to the *Motor Tripped due to high temperature* Failure Mode node.

4. Now that several likely hypotheses have been introduced, the team will need to rule out hypotheses. To rule out a hypothesis or prove a hypothesis, the

hypothesis will need to be tested against the data that is available to the team (i.e., the failure event data and the team of experts).

The Principal Analyst should create RCA Verification records and assign them to team members who will be responsible for completing the associated task. The following image shows an example of an RCA Verification record that contains a task to test the *Mechanical* hypothesis. The record is assigned to the team member Pete Handy, the mechanic.

The screenshot shows a window titled "Verification Properties" with a sub-header "Verification Data Sheet". Below the sub-header, there is a "Datasheet" dropdown menu set to "RCA Verification". Underneath, there is a "Verification Details" section containing a table with the following data:

| | Value(s) |
|-------------------------------------|---|
| Method | Inspect wiring to make sure the cause was ... |
| Outcome | Confirmed the problem was mechanical. ... |
| Due Date | 1/10/2012 |
| Send Alert on Due Date? | <input type="checkbox"/> |
| Days Before Due Date to be Notified | |

Below the table, there is an "Assign to:" dropdown menu set to "Pete Handy". At the bottom right of the window, there are "Save" and "Cancel" buttons.

The task defined in this RCA Verification record instructs Pete Handy to inspect the wiring for the cooling water pump to ensure that the problem was not electrical, but mechanical.

- When a hypothesis has been tested using the task specified in the RCA Verification record, the state of the associated RCA Hypothesis record should be set to *True* if the hypothesis is true or *Not True* if the hypothesis is not true. For example, the following image shows the Logic Tree after Pete Handy has completed the RCA Verification record to which he was assigned. Pete Handy concluded that the wiring did not the cause the pump to overheat, so the problem must be mechanical.

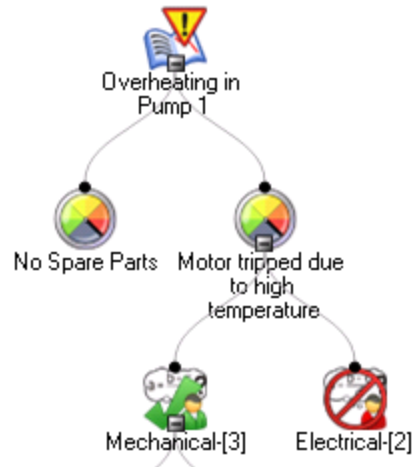

After the state of the *Mechanical* RCA Hypothesis record is set to *True*, the team can continue down the logic tree until they identify the root cause. Causes can be further identified as physical, human, or latent. For example, the following image shows the Logic Tree after ALL the RCA Verification records have been completed. The team has concluded that inadequate accountability of workers has led to insufficient lubricant being applied to the outboard bearing, which caused the motor's temperature to increase and the pump to overheat.

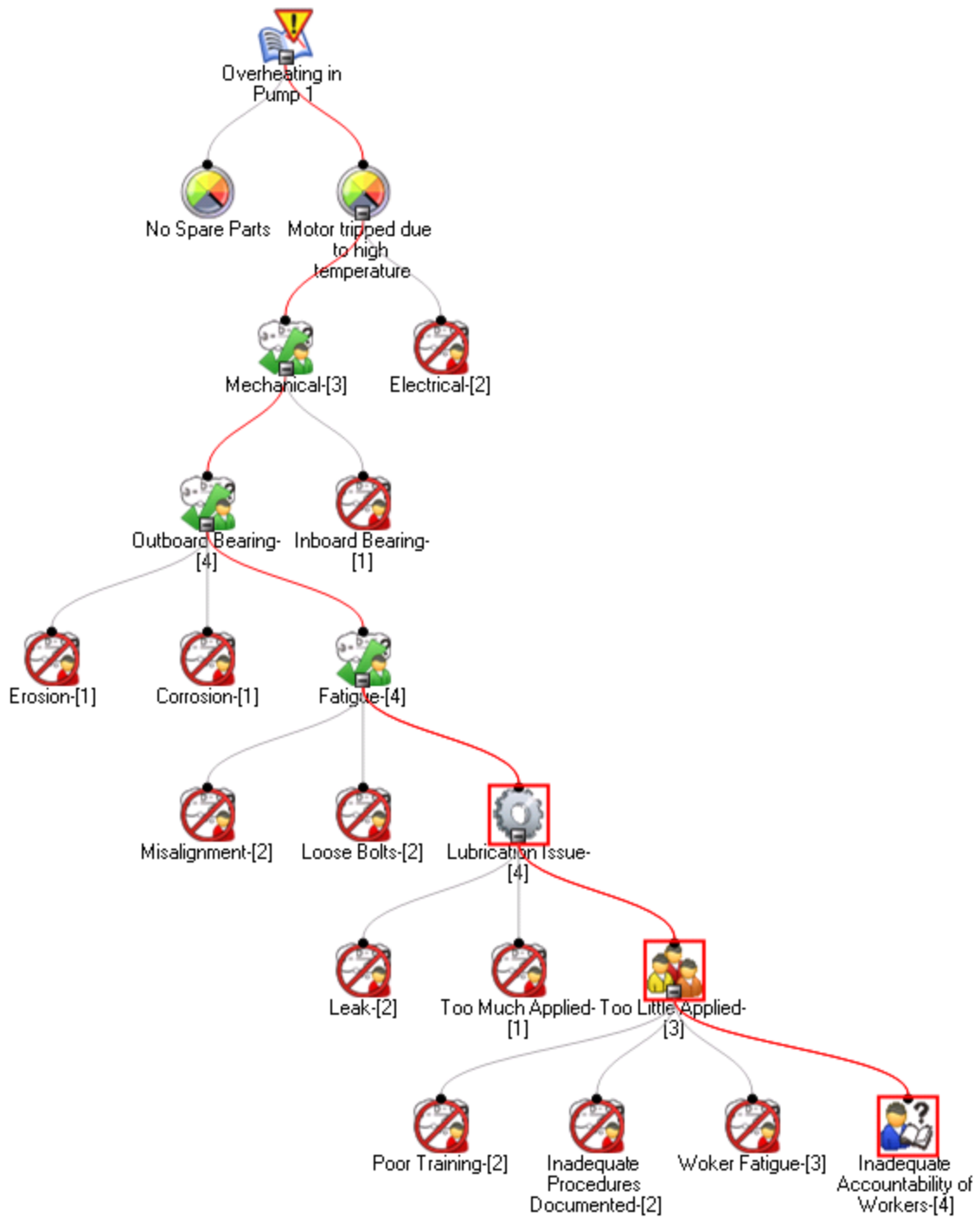

In this case, the root cause for the pump failure would be identified as *latent* (i.e., inadequate accountability of workers), which lead to *human* (i.e., too little applied) and *physical* (i.e., lubrication issue) causes. Now that a hypothesis has been verified and the root cause has been determined, you can create RCA Recom-

mendation records to [communicate your findings](#) on how to prevent this failure in the future.

Communicating Findings and Recommendations: An Example

Now that the team has determined the root cause of the cooling water pump failure to be inadequate accountability of workers, you will want to record your findings and create RCA Recommendation records. After recommendations have been implemented, you can share the results of the RCA Analysis with others.

To communicate findings and recommendations for our example:

1. On the RCA Communicate datasheet for the example RCA Analysis, complete the Mechanism and Acknowledgments fields as appropriate. In the following image, the Mechanism and Acknowledgments fields are outlined in red, and the datasheet is completed as it should be for this example.

| Communicate Findings and Recommendations | |
|--|---|
| Datasheet RCA Communicate | |
| Analysis Details | |
| | Value(s) |
| Start Date | 1/6/2012 |
| End Date | 1/15/2012 |
| Comments | Comments ... |
| Analysis Type | Mechanical |
| Event Narrative | Investigate what caused the motor temperature in the water pump to increase and overheat. ... |
| Date Published | |
| Summary of Findings | Inadequate accountability of workers led to insufficient lubricant being applied to the outboard bearing of the pump. ... |
| Acknowledgments | Pete Handy of Cooling Systems, Inc. for helping with the investigation of the pump. ... |

2. After the RCA Communicate datasheet has been completed, you can recommend actions and propose them for implementation. In this case, the team has decided that requiring workers to document and report performed maintenance will make them accountable for procedures performed, and will reduce the risk of a failure in the future. To propose this recommendation, you would create an RCA Recommendation record as shown in the following image.

Communicating Findings and Recommendations: An Example

Datasheet RCA Recommendation

General Information | Alert

| | Value(s) |
|----------------------------------|---|
| Recommendation ID | REC-1376 |
| Recommendation Headline | Create a new performed maintenance report. |
| Recommendation Description | This report will require workers to document each time they perform a routine |
| Recommendation Basis | |
| RCA Analysis ID | Cooling Water Pump |
| Equipment ID | PUMP |
| Technical Number | |
| Functional Location ID | |
| Required Equipment Status | On-Line (ON-LINE) |
| Business Impact | Production (PRODUCTION) |
| Target Completion Date | Monday, February 20, 2012 |
| Mandatory Date | 28-Feb-2012 |
| Recommendation Priority | Medium (MEDIUM) |
| Status | Created (CREATED) |
| Author Name | Administrator, Meridium MIADMIN |
| Reviewer Name | |
| Assigned To Name | Jones, Suzie |
| Final Approver Name | Administrator, Meridium MIADMIN |
| Cause | Inadequate Accountability of Workers |
| Cause Type | Cause Latent |
| Close-Out Comments | |
| Implemented Date | |
| Create Work Request? | <input checked="" type="checkbox"/> |
| Work Request Reference | |
| Work Request Equipment | |
| Work Request Functional Location | |

3. On the RCA Recommendation datasheet, on the **Alert** tab, you can schedule an alert email to be sent to the team member responsible for completing the implementation of the recommendation. To do so, you would complete the fields on the **Alert** tab for REC-1376 as the shown in the following image.

| Datasheet: RCA Recommendation | |
|---|---|
| General Information Alert | |
| | Value(s) |
| <input type="checkbox"/> Alert Responsible Party When Due? | <input checked="" type="checkbox"/> |
| <input type="checkbox"/> Days Before Due Date to be Alerted | 4 (Days) |
| <input type="checkbox"/> Frequency of Alert After Due Date | Daily |
| <input type="checkbox"/> Implementation Alert Text | You have four days remaining to complete the new required report. ... |
| <input type="checkbox"/> Reevaluate? | <input type="checkbox"/> |
| <input type="checkbox"/> Reevaluation Date | |
| <input type="checkbox"/> Reevaluation Alert List | |
| <input type="checkbox"/> Reevaluation Alert Body Text | ... |

4. After an RCA Recommendation record has been created, the RCA Analysis is almost complete. If desired, you can run reports based on the information that was gathered during the RCA Analysis and even publish the RCA Analysis to distribute the information to others.

After the recommended action has been implemented, you will need to continue [tracking the success of the recommended solution](#).

Tracking for Results: An Example

After the RCA Analysis findings have been communicated and the recommendation has been implemented, the team will want to *track* the effectiveness of the recommendation to see if the new report has prevented the cooling water pump from failing thus far. Tracking for results involves creating RCA Tracking Item records, scheduling the Tracking Evaluations in the Meridium APM Schedule Manager, and modifying the existing recommendation or creating a new one based on the discoveries that are made through re-evaluation.

To keep track of the success of the implemented recommendations for our example:

1. Create RCA Tracking Item records and assign them to the team member(s) responsible for tracking the recommendation. An email message will be sent to the team member if the values in the Count and Cost field are exceeded. In this case, you would create an RCA Tracking Item record as shown in the following image.

| | Value(s) |
|-----------------|---|
| Active | <input checked="" type="checkbox"/> |
| Start Date | 3/1/2012 |
| Count | 2 |
| Cost | 10000 |
| Alert | Williams, Bob |
| Message Subject | Cooling Water Pump Improvement |
| Message Text | Cooling water pump 1 has failed and needs to be re-evaluated. ... |

The value 2 in the Count field indicates that if the number of Failure records linked to the Equipment record *Pump* exceeds two, the alert email will be sent to Bob Williams. Note also that in the Cost field, the value 45 indicates that if the sum of the failure cost exceeds \$10,000, the alert email will be sent to Bob Williams.

In this case, the cooling water pump has not incurred any failures since the recommendation was implemented.

2. The recommendation should continue to be tracked by a member of the RCA Analysis Team through RCA Tracking Item records and the Schedule Manager.

At this point, the RCA Analysis is considered complete, and you can publish the RCA Analysis and share reports with individuals outside of the RCA Analysis Team.

About the RCA Analysis Example

In this area of the documentation, we list the specific data used in the [example RCA Analysis](#). This information is provided for your reference.

Note: In these topics, we list only the fields that contain a value. In the case of numeric fields, this includes fields that contain a value of zero (0). Fields that contain NO value are not listed here.

The following topics contain details on the specific data in our example RCA Analysis:

- [Example Data in the RCA Analysis Record](#)
- [Example Data in the RCA Critical Success Factor Records](#)
- [Example Data in the RCA Event Record](#)
- [Example Data in the RCA Failure Mode Records](#)
- [Example Data in the RCA Hypothesis Records](#)
- [Example Data in the RCA Logic Gate Records](#)
- [Example Data in the RCA Preserve Item Records](#)
- [Example Data in the RCA Recommendation Record](#)
- [Example Data in the RCA Sequence Node Records](#)
- [Example Data in the RCA Team Member Records](#)
- [Example Data in the RCA Tracking Item Record](#)
- [Example Data in the RCA Verification Record](#)
- [Example Data in the Equipment Record](#)

Example Data in the RCA Analysis Record

Like all RCA Analyses, the [example RCA Analysis](#) contains one RCA Analysis record. The following values exist in that record.

| Field | Description |
|-----------------------------|---|
| Analysis Description | An analysis to determine the root cause of the pump overheating. |
| Analysis Name | Cooling Water Pump |
| Analysis Type | Mechanical |
| Charter | To identify the root causes of the cooling water pump failure. This includes identifying deficiencies in or lack of management systems. Appropriate recommendations for root causes will be communicated to the management for rapid resolutions. |
| Comments | Comments |
| Equipment ID | Pump |
| End Date | 1/15/2012 |
| Event Narrative | Investigate what caused the motor temperature in the water pump to increase and overheat. |
| Frequency | 1 |
| Start Date | 1/6/2012 |

Example Data in the RCA Critical Success Factor Records

The [example RCA Analysis](#) has six RCA Critical Success Factor records, which represent the default CSFs. Each RCA Critical Success Factor record contains a different value in the Critical Success Factor field. Each bullet in the following list displays the value that exists in one of these RCA Critical Success Factor records:

- A cross-functional section of plant personnel/experts will participate in the analysis.
- A disciplined RCFA approach will be utilized.
- A measurement process will be used to track the progress of approved recommendations.
- All analysis hypothesis will be verified or disproven.
- Management agrees to fairly evaluate the analysis team findings and recommendations.
- No one will be disciplined for honest mistakes.

Example Data in the RCA Event Record

The [example RCA Analysis](#) contains one RCA Event record. The following values exist in that record.

| Field | Description | Notes |
|-------------------------|---|---|
| Event End Date | 1/15/2012 | None |
| Event ID | RCA-9/18/2012 | The Event ID field is populated automatically with the date the record is created and is disabled so that value cannot be changed. If you choose to recreate this example RCA Event record, your Event ID value will be different from the value listed here. |
| Event Start Date | 1/6/2012 | None |
| Label | Overheating in Pump 1 | None |
| Long Description | Investigate the cause of a cooling water pump to overheat and shut down the system. | None |

Example Data in the RCA Failure Mode Records

The [example RCA Analysis](#) has four RCA Failure Mode records. The following values exist in those records.

| RCA Failure Mode Record ID | Values Specified |
|--|--|
| No Spare Parts | <p>Label: No Spare Parts</p> <p>Description: No spare parts caused the pump to be out of commission for a longer amount of time.</p> |
| Motor tripped due to high temperature. | <p>Label: Motor tripped due to high temperature.</p> <p>Description: The motor shut off because the temperature became too hot and the system was shut down.</p> |

Example Data in the RCA Hypothesis Records

The [example RCA Analysis](#) has multiple RCA Hypothesis records. The following chart displays the values for these records, in the order they appear in the Logic Tree.

Note: The ID fields are automatically populated and if you choose to reproduce this example, your ID values might be different from the values listed here.

| RCA Hypothesis Record ID | Values Specified |
|--------------------------|---|
| Level 1 | |
| Mechanical | <p>Label: Mechanical</p> <p>Descriptions: The increase in temperature was due to a mechanical failure.</p> <p>Confidence Factor: Likely (3)</p> <p>State: Hypothesis True</p> <p>ID: Hyp-365</p> |
| Electrical | <p>Label: Electrical</p> <p>Descriptions: The increase in temperature was due to an electrical failure.</p> <p>Confidence Factor: Possibly True (2)</p> <p>State: Hypothesis Not True</p> <p>ID: Hyp-362</p> |
| Level 2 | |
| Outboard bearing | <p>Label: Outboard bearing</p> <p>Descriptions: The outboard bearing had a mechanical problem.</p> <p>Confidence Factor: Highly Likely (4)</p> <p>State: Hypothesis True</p> <p>ID: Hyp-364</p> |

| RCA Hypothesis Record ID | Values Specified |
|--------------------------|--|
| Inboard bearing | <p>Label: Inboard bearing</p> <p>Descriptions: The inboard bearing had a mechanical problem.</p> <p>Confidence Factor: Somewhat True (1)</p> <p>State: Hypothesis Not True</p> <p>ID: Hyp-363</p> |
| Level 3 | |
| Erosion | <p>Label: Erosion</p> <p>Descriptions: The outboard bearing eroded after overuse.</p> <p>Confidence Factor: Somewhat True (1)</p> <p>State: Hypothesis Not True</p> <p>ID: Hyp-367</p> |
| Corrosion | <p>Label: Corrosion</p> <p>Descriptions: The outboard bearing corroded and was rusty.</p> <p>Confidence Factor: Somewhat True (1)</p> <p>State: Hypothesis Not True</p> <p>ID: Hyp-361</p> |
| Fatigue | <p>Label: Fatigue</p> <p>Descriptions: The outboard bearing was overheated due to a weakness of materials.</p> <p>Confidence Factor: Highly Likely (4)</p> <p>State: Hypothesis Not True</p> <p>ID: Hyp-368</p> |
| Level 4 | |

| RCA Hypothesis Record ID | Values Specified |
|--------------------------|--|
| Misalignment | <p>Label: Misalignment</p> <p>Descriptions: The outboard bearing was not aligned correctly.</p> <p>Confidence Factor: Possibly True (2)</p> <p>State: Hypothesis Not True</p> <p>ID: Hyp-369</p> |
| Loose Bolts | <p>Label: Loose Bolts</p> <p>Descriptions: Bolts were loose and caused the outboard bearing to become loose.</p> <p>Confidence Factor: Possibly True (2)</p> <p>State: Hypothesis Not True</p> <p>ID: Hyp-370</p> |
| Lubrication Issue | <p>Label:Lubrication Issue</p> <p>Descriptions: The outboard bearing was not receiving the right amount of lubrication.</p> <p>Confidence Factor: Highly Likely (4)</p> <p>State: Cause Physical</p> <p>ID: Hyp-371</p> |
| Level 5 | |
| Leak | <p>Label: Leak</p> <p>Descriptions: The lubricant was leaking from the pump.</p> <p>Confidence Factor: Possibly True (2)</p> <p>State: Hypothesis Not True</p> <p>ID: Hyp-372</p> |

| RCA Hypothesis Record ID | Values Specified |
|----------------------------------|---|
| Too Much Applied | <p>Label: Too much applied</p> <p>Descriptions: There was too much lubricant, causing, the bearing to operate too quickly and overheat.</p> <p>Confidence Factor: Possibly True (2)</p> <p>State: Hypothesis Not True</p> <p>ID: Hyp-373</p> |
| Too Little Applied | <p>Label: Too little applied</p> <p>Descriptions: There was not enough lubricant, causing friction and an increase in temperature.</p> <p>Confidence Factor: Likely (3)</p> <p>State: Cause Human</p> <p>ID: Hyp-374</p> |
| Level 6 | |
| Poor training | <p>Label: Poor training</p> <p>Descriptions: Workers were not properly training on applying lubricant to the bearing.</p> <p>Confidence Factor: Possibly True (2)</p> <p>State: Hypothesis Not True</p> <p>ID: Hyp-375</p> |
| Inadequate Procedures Documented | <p>Label: Inadequate Procedures Documented</p> <p>Descriptions: Workers are referencing procedure documentation that is not clear.</p> <p>Confidence Factor: Possibly True (2)</p> <p>State: Hypothesis Not True</p> <p>ID: Hyp-376</p> |

Example Data in the RCA Hypothesis Records

| RCA Hypothesis Record ID | Values Specified |
|--------------------------------------|--|
| Worker Fatigue | <p>Label: Worker Fatigue</p> <p>Descriptions: Workers are overworked and are not able to perform at an acceptable level.</p> <p>Confidence Factor: Likely (3)</p> <p>State: Cause Physical</p> <p>ID: Hyp-377</p> |
| Inadequate Accountability of Workers | <p>Label: Inadequate Accountability of Workers</p> <p>Descriptions: Workers are not being held accountable for the maintenance procedures they are required to perform.</p> <p>Confidence Factor: Highly Likely (4)</p> <p>State: Cause Latent</p> <p>ID: Hyp-378</p> |

Example Data in the RCA Logic Gate Records

The [example RCA Analysis](#) contains four RCA Logic Gate records, which represent [Logic Gate nodes](#) and are used in the [Logic Tree](#). These Logic Gate nodes must be [enabled](#) to be seen on the Logic Tree.

In the following table, the Logic Gates are numbered as they appear in the Logic Tree from left to right. For each RCA Logic Gate record, the table displays the value in the Gate Type field of the RCA Logic Gate record and identifying information about the records (e.g., RCA Failure Mode) to which it is linked.

| RCA Logic Gate Record | Value Specified | Linked To |
|-----------------------|-----------------|---|
| 1 | Gate Type: Or | <ul style="list-style-type: none"> • RCA Failure Mode: Motor tripped due to high temperature • RCA Hypothesis: Mechanical • RCA Hypothesis: Electrical |
| 2 | Gate Type: Or | <ul style="list-style-type: none"> • RCA Failure Mode: Motor tripped due to high temperature • RCA Hypothesis: Mechanical • RCA Hypothesis: Inboard Bearing • RCA Hypothesis: Outboard Bearing |
| 3 | Gate Type: Or | <ul style="list-style-type: none"> • RCA Failure Mode: Motor tripped due to high temperature • RCA Hypothesis: Outboard Bearing • RCA Hypothesis: Corrosion • RCA Hypothesis: Erosion • RCA Hypothesis: Fatigue |
| 4 | Gate Type: Or | <ul style="list-style-type: none"> • RCA Failure Mode: Motor tripped due to high temperature • RCA Hypothesis: Fatigue • RCA Hypothesis: Loose Bolts • RCA Hypothesis: Lubrication Issue • RCA Hypothesis: Misalignment |

Example Data in the RCA Logic Gate Records

| RCA Logic Gate Record | Value Specified | Linked To |
|-----------------------|----------------------|--|
| 5 | Gate Type: Or | <ul style="list-style-type: none"> • RCA Failure Mode: Motor tripped due to high temperature • RCA Hypothesis: Lubrication Issue • RCA Hypothesis: Leak • RCA Hypothesis: Too Little Applied • RCA Hypothesis: Too Much Applied |
| 6 | Gate Type: Or | <ul style="list-style-type: none"> • RCA Failure Mode: Motor tripped due to high temperature • RCA Hypothesis: Too Little Applied • RCA Hypothesis: Inadequate Accountability of Workers • RCA Hypothesis: Inadequate Procedures Documented • RCA Hypothesis: Poor Training • RCA Hypothesis: Worker Fatigue |

Example Data in the RCA Preserve Item Records

The [example RCA Analysis](#) contains five RCA Preserve Item records. The following values exist in those records.

| RCA Preserve Item Record ID | Values Specified | Linked To |
|--|---|--|
| <p>Paper-Standard operating procedures and frequent failure information.</p> | <p>Data Category: Paper</p> <p>Data to Collect: Standard operating procedures and frequent failure information.</p> <p>Collection Strategy: Research</p> <p>Date Due: 1/9/2012</p> <p>Send Alert on Due Date?: True</p> <p>Days Before Due Date to be Notified: 1 (Days)</p> <p>Frequency of Alert After Due Date:Daily</p> <p>Alert Email Body: This is a reminder to gather the standard operating procedures and frequent failure information and report back to theteam.</p> <p>Completed?: No</p> | <p>The RCA Team Member record for Suzie Jones.</p> |

Example Data in the RCA Preserve Item Records

| RCA Preserve Item Record ID | Values Specified | Linked To |
|---|---|---|
| <p>Paradigms-Common assumptions made when a pump fails.</p> | <p>Data Category: Paradigms</p> <p>Data to Collect: Common assumptions made when a pump fails.</p> <p>Collection Strategy: Research and interview.</p> <p>Date Due: 1/10/2012</p> <p>Sent Alert on Due Date:False</p> <p>Completed:No</p> | <p>The RCA Team Member record for Jane Doe.</p> |

| RCA Preserve Item Record ID | Values Specified | Linked To |
|--|--|---|
| <p>Parts-The pieces of the cooling water pump that could have caused the pump to overheat.</p> | <p>Data Category: Parts</p> <p>Data to Collect: The pieces of the cooling water pump that could have caused the pump to overheat.</p> <p>Collection Strategy: Document (pictures and observations) the condition of the components of the pump.</p> <p>Date Due: 1/8/2012</p> <p>Send Alert on Due Date?: True</p> <p>Days Before Due Date to be Notified: 1 (Days)</p> <p>Frequency of Alert After Due Date:Daily</p> <p>Alert Email Body: This is a reminder to gather and document the pieces of the pump that could have caused the pump to overheat and report back to the team.</p> <p>Completed?: No</p> | <p>The RCA Team Member record for Pete Handy.</p> |

| RCA Preserve Item Record ID | Values Specified | Linked To |
|--|---|--|
| <p>People-Operating procedures used by those who use the pump.</p> | <p>Data Category: People</p> <p>Data to Collect: Operating procedures used by those who maintain the pump.</p> <p>Collection Strategy: Interview the floor operators who are assigned to the pump.</p> <p>Date Due: 2/10/2012</p> <p>Send Alert on Due Date?: True</p> <p>Days Before Due Date to be Notified: 1 (Days)</p> <p>Frequency of Alert After Due Date: Daily</p> <p>Alert Email Body: This is a reminder to interview operators assigned to the pump and document their operating procedures and report back to the team.</p> <p>Completed?: No</p> | <p>The RCA Team Member record for Bob Speck.</p> |

Example Data in the RCA Preserve Item Records

| RCA Preserve Item Record ID | Values Specified | Linked To |
|---|--|---|
| Position-Environment surrounding the pump | <p>Data Category: Position</p> <p>Data to Collect: Environment surrounding the pump.</p> <p>Collection Strategy: Tools, pictures, diagrams.</p> <p>Date Due: 1/10/2012</p> <p>Send Alert on Due Date?: Yes</p> <p>Days Before Due Date to be Notified: 1 (Days)</p> <p>Frequency of Alert After Due Date: Daily</p> <p>Alert Email Body: This is a reminder to investigate the environment where the pump exists and report back to them.</p> <p>Completed?: No</p> | The RCA Team Member record for Bob Speck. |

Example Data in the RCA Recommendation Record

The [example RCA Analysis](#) contains one RCA Recommendation record. The following values exist in that record.

| Field | Description |
|--------------------------------------|---|
| Alert Responsibility Party When Due? | True |
| Assigned To Name | Suzie Jones |
| Author Name | Jane Doe |
| Business Impact | Production (PRODUCTION) |
| Cause | Inadequate accountability of workers. |
| Cause Type | Cause Latent |
| Days Before Date To Be Alerted | 4 |
| Final Approver Name | Jane Doe |
| Frequency of Alert After Due Date | Daily |
| Implementation Alert Text | You have less than 4 days to complete the new required report. |
| Mandatory Date | 2/28/2012 |
| RCA Analysis ID | Cooling Water Pump |
| Recommendation Description | This report will require workers to document each time they perform a routine procedure, which will hold them accountable for pump maintenance. |
| Recommendation Headline | Create a new performed maintenance report. |
| Recommendation ID | REC-1376 |
| Recommendation Priority | Medium (Medium) |
| Required Equipment Status | On-Line (ON-LINE) |
| Reviewer Name | Jane Doe |
| Status | Created (CREATED) |
| Target Completion Date | Monday, February 20, 2012 |

Example Data in the RCA Sequence Node Records

The [example RCA Analysis](#) has nine RCA Sequence Node records, which are displayed on the Event Diagram. For each RCA Sequence Node record, the following table lists the type of node and the values that exist in the RCA Sequence Node record.

| Type of Node | Values |
|--------------|--|
| Start/Finish | Label: Pump place into service Event Start Date: 1/1/2011 12:00 AM Event End Date: 1/1/2011 12:00 AM |
| Process | Label: Cooling water pump turned on daily Event Start Date: 1/1/2011 12:00 AM Event End Date: 1/6/2012 12:00 AM |
| Operation | Label: Bearing Temperature Alarm sounded Event Start Date: 1/6/2012 12:00 AM Event End Date: 1/6/2012 12:00 AM |
| Operation | Label: Pump Overheated Event Start Date: 1/6/2012 12:00 AM Event End Date: 1/6/2012 12:00 AM |
| Operation | Label: System shut down Event Start Date: 1/6/2012 12:00 AM Event End Date: 1/6/2012 12:00 AM |
| Decision | Label: Decided to perform an analysis Event Start Date: 1/6/2012 12:00 AM Event End Date: 1/6/2012 12:00 AM |
| Start/Finish | Label: RCA Study began Event Start Date: 1/16/2012 12:00 AM Event End Date: 1/6/2012 12:00 AM |

Example Data in the RCA Team Member Records

The [example RCA Analysis](#) contains four RCA Team Member records. For each RCA Team Member record, the following table lists the value in the Member Type field in the RCA Team Member record and the first and last name in the Human Resource record to which it is linked.

| Value Specified | Linked To Human Resource Record |
|-------------------|---------------------------------|
| Principal Analyst | Jane Doe |
| Member | Suzie Jones |
| Member | Pete Handy |
| Member | Bob Speck |

Example Data in the RCA Tracking Item Record

The [example RCA Analysis](#) contains one RCA Tracking Item record. The following values exist in that record.

| Field | Description |
|-----------------|---|
| Active | True |
| Start Date | 3/1/2012 |
| Count | 2 |
| Cost | 10,000 |
| Alert | Williams, Bob |
| Message Subject | Cooling Water Pump Improvement |
| Message Text | Cooling water pump 1 has failed and needs to be re-evaluated. |

Example Data in the RCA Verification Record

The [example RCA Analysis](#) contains two RCA Verification records. The following values exist in that record.

| RCA Verification Record ID | Values Specified |
|---|---|
| Inspect wiring to make sure the cause was not electrical. | Due Date: 1/10/2012 Method: Inspect wiring to make sure the cause was not electrical. Completed: False |
| Perform a metallurgical analysis to determine why the bearing failed. | Due Date: 1/10/2012 Method: Perform a metallurgical analysis to determine why the bearing failed. Completed: False |

Example Data in the Equipment Record

The [example RCA Analysis](#) contains one Equipment record. The following value exists in that record.

- **Equipment ID:** Pump

Accessing Root Cause Analysis

To access Root Cause Analysis:

- On the Meridium APM Framework main menu, click **Go To**, point to **Failure Elimination**, and then click **Root Cause Analysis**.

The **Root Cause Analysis Start Page** appears.

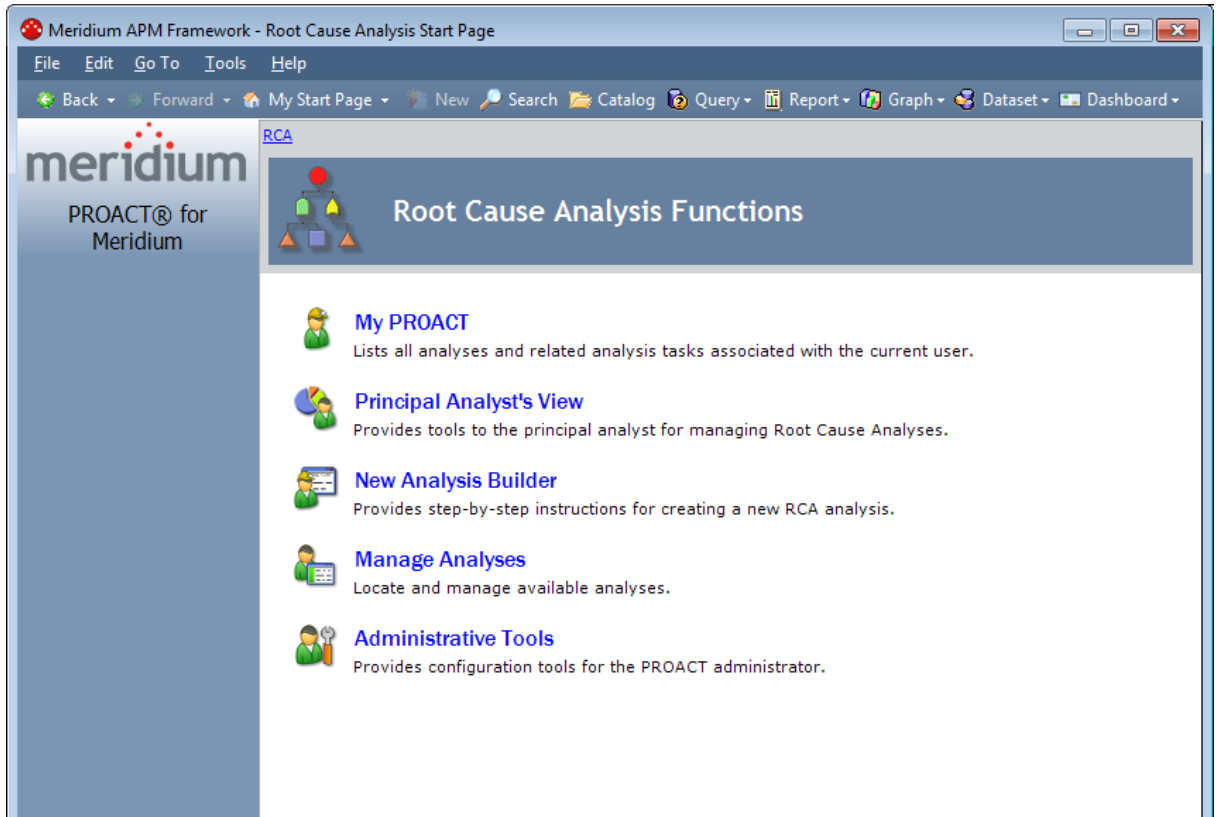

Aspects of the Root Cause Analysis Start Page

The **Root Cause Analysis Start Page** provides links to features that are available in Root Cause Analysis. You can click any link to access the corresponding feature.

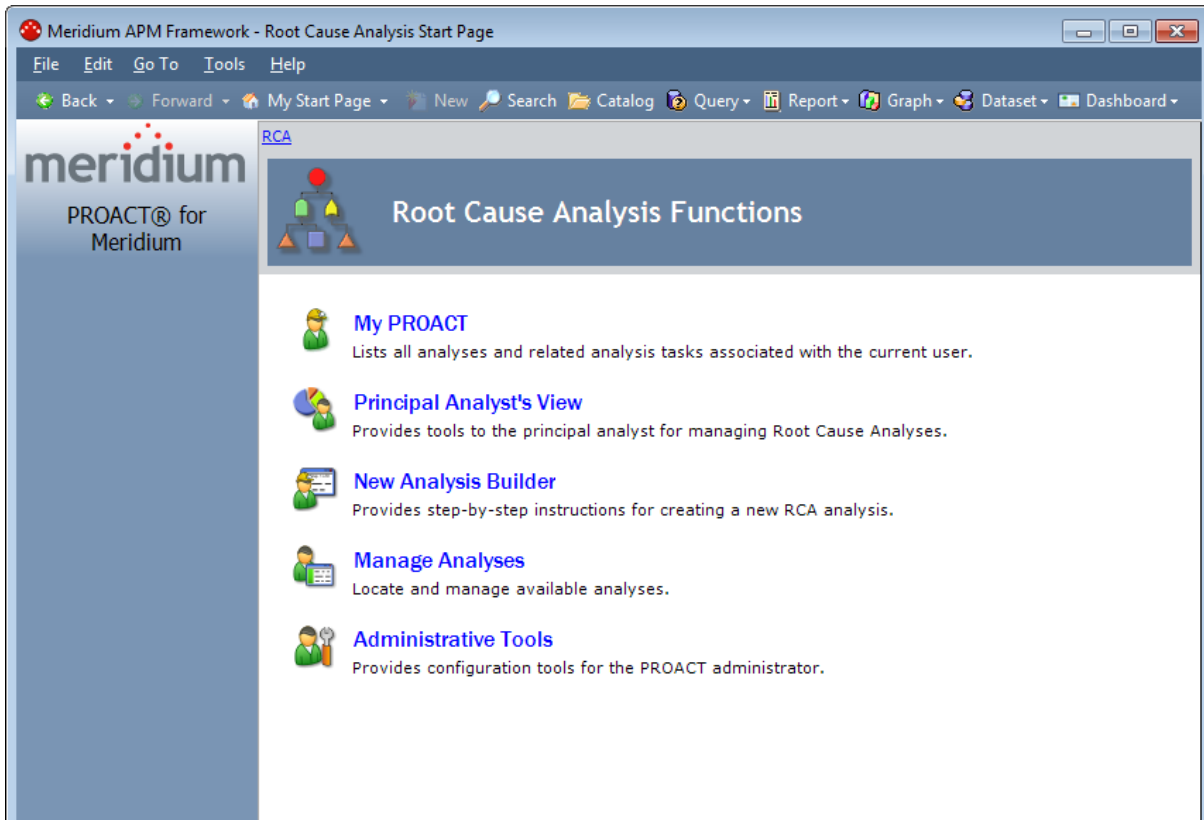

The **PROACT Start Page** contains the following links:

- **My PROACT**: Displays the **My PROACT** page, where you can track unpublished RCA Analyses in which you are a member of the RCA Analysis Team. To access the feature, you must be:
 - A member of the MI PROACT Administrator Security Group.
 - or-
 - A member of the MI PROACT Team Member Security Group.
 - or-
 - A Super User

If you are not, when you click this link, a message will appear, indicating that you do not have the necessary permissions.

- **Principal Analyst's View**: Displays the **PA PROACT** page, where you can view and manage all unpublished RCA Analyses in which you are the Principal Analyst. To access this feature, you must be:

- You must be a member of the MI PROACT Administrator Security Group.
-or-
- A member of the MI PROACT Team Member Security Group.
-or-
- A Super User.

If you are not, when you click this link, a message will appear, indicating that you do not have the necessary permissions.

- **New Analysis Builder:** Displays the **New Analysis Builder**, which guides you step-by-step through the initial steps required for developing a new RCA Analysis. To access this feature, you must be:
 - A member of the MI PROACT Administrator Security Group.
-or-
 - A member of the MI PROACT Team Member Security Group.
-or-
 - A Super User.

If you are not, when you click this link, a message will appear, indicating that you do not have the necessary permissions.

- **Manage Analyses:** Displays the **Manage Analyses** page, where you can view a list of all existing RCA Analyses. To access this feature, you must be:
 - A member of the MI PROACT Administrator Security Group.
-or-
 - A member of the MI PROACT Team Member Security Group.
-or-
 - A member of the MI PROACT Viewer Security Group.
-or-
 - A Super User.

If you are not, when you click this link, a message will appear, indicating that you do not have the necessary permissions. After you click this link, you will be granted access only to the features allowed by your specific family-level privileges.

- **Administrative Tools:** Displays the **Administrative Functions** page, where you can perform administrative tasks for Root Cause Analysis. This link appears only if you are a Super User or a member of the MI PROACT Administrator Security Group.

First-Time Deployment Workflow

Deploying and configuring the RCA module the first time includes completing multiple steps, which are outlined in the table in this topic. The steps in this section of the documentation provide all the information that you need to deploy and configure RCA on top of the .

Whether a step is required or optional is indicated in the **Required/Optional** cell. Steps are marked as *Required* if you must perform the step to take advantage of RCA functionality.

The person responsible for completing each task may vary within your organization. We recommend, however, that the steps be performed in relatively the same order in which they are listed in the table.

| Step | Task | Required/Optional | Notes |
|------|--|-------------------|---|
| 1 | Review the RCA data model to determine which relationship definitions you will need to modify to include your custom equipment and location families. Modify any relationship definitions as needed via the Configuration Manager application. | Optional | This task is necessary only if you store equipment and location information in families other than the baseline Equipment and Functional Location families. |
| 2 | Assign Security Users to one or more RCA Security Groups via the Configuration Manager application. | Required | Users will not be able to access RCA unless they belong to an RCA Security Group. |
| 3 | Specify the Team Charter that will appear in the New Analysis Builder by default when you create a new RCA Analysis. | Optional | A default Team Charter exists in the baseline Meridium APM database and will be used if you do not define one of your own. |
| 4 | Specify the Critical Success Factors that will appear in the New Analysis Builder by default when you create a new RCA Analysis. | Optional | Default Critical Success Factors exist in the baseline Meridium APM database and will be used if you do not define one of your own. |

| Step | Task | Required/Optional | Notes |
|------|---|-------------------|---|
| 5 | Define the Tracking Evaluation Query. | Optional | This task is necessary only if you do not want to use the baseline query, which is defined by default. |
| 6 | Create a scheduled item to enable Tracking Evaluations. You can do so via the Meridium APM Framework application. | Required | A scheduled item must be created via the Meridium APM Schedule Manager to run your Tracking Evaluation query on a regular basis. |
| 7 | Specify whether Principal Analysts will be allowed to create RCA Analysis Templates. | Optional | By default, only Super Users and members of the MI PROACT Administrator Security Group are allowed to create RCA Analysis Templates . You can, however, specify that you want to allow Principal Analysts to create RCA Analysis Templates. |
| 8 | Modify queries that are configured by default to return Equipment and Functional Location records. | Optional | This task is necessary only if you are using families other than the baseline Equipment and Functional Location families to store your equipment and location data. |

Upgrade or Update Root Cause Analysis to 3.6.1.2.0

The following tables list the steps that are required to update or upgrade RCA to 3.6.1.2.0. These steps assume that you have completed the steps for upgrading the basic Meridium APM system architecture.

Update from any version V3.6.1.0.0 through V3.6.1.1.0

This module will be updated to 3.6.1.2.0 automatically when you update the components in the basic Meridium APM system architecture. No additional steps are required.

Upgrade from any version V3.6.0.0.0 through V3.6.0.12.4

RCA will be upgraded to 3.6.1.2.0 automatically when you upgrade the components in the basic Meridium APM system architecture. No additional steps are required.

Upgrade from any version V3.5.1.0.0 through V3.5.1.12.0

RCA will be upgraded to 3.6.1.2.0 automatically when you upgrade the components in the basic Meridium APM system architecture. No additional steps are required.

Upgrade from any version V3.5.0 SP1 LP through V3.5.0.1.9.0

RCA will be upgraded to 3.6.1.2.0 automatically when you upgrade the components in the basic Meridium APM system architecture. No additional steps are required.

Upgrade from any version V3.5.0 through V3.5.0.0.7.1

RCA will be upgraded to 3.6.1.2.0 automatically when you upgrade the components in the basic Meridium APM system architecture. No additional steps are required.

Upgrade from any version V3.4.5 through V3.4.5.0.1.4

RCA will be upgraded to 3.6.1.2.0 automatically when you upgrade the components in the basic Meridium APM system architecture. No additional steps are required.

About RCA Security

To use RCA, a Meridium APM Security User must be a Super User or a member of one of the following Security Groups:

- **MI PROACT Administrator:** Allows access to ALL RCA features, including administrative features.
- **MI PROACT Team Member:** Allows access to all RCA features, *except* the administrative features. The **Administrative Tools** link on the **PROACT Start Page** will appear only to Security Users who are Super Users or belong to the MI PROACT Administrator Security Group.
- **MI PROACT Viewer:** Allows view-only access to the RCA module. Members of the MI PROACT Viewer Security Group will be able to view existing analyses but will not be able to create or modify them. When a Security User belongs to the MI PROACT Viewer Security Group, only the **Manage Analyses** link on the **PROACT Start Page** will be functional.

[Each of these Security Groups has a set of family-level privileges associated with it,](#) which are needed in order to provide access to the records used throughout RCA. Access to RCA features, however, is not granted through privileges alone but through *membership in these groups* and the privileges associated with them. Granting RCA family-level privileges at the Security User level or through a custom Security Group will not provide access to RCA.

Throughout the RCA documentation, when we explain how to perform a certain task, we assume that the user is a member of the Security Group that allows access to that task.

Note: In addition to assigning Security Users to these Security Groups, you will need to grant users family-level privileges to any custom family that participates in a relationship with a baseline RCA family.

About Root Cause Analysis Security Privileges

In addition to the family-level privileges that must be granted to users via the Configuration Manager application, in RCA, permission to perform certain tasks is granted based upon a user's role on a given RCA Analysis team. There are two types of RCA Analysis Team members:

- **Principal Analyst:** The member of the RCA Analysis Team who is responsible for facilitating and coordinating the RCA Analysis. The user who [completes the initial steps required for an RCA Analysis](#) is automatically designated the Principal Analyst by default. You can designate a different team member as the Principal Analyst if needed. For a given RCA Analysis, the Principal Analyst can:
 - View, modify, copy, delete, and publish the RCA Analysis.
 - Copy, delete, and unpublish the RCA Analysis

Note: Published RCA Analyses cannot be modified by any user, including the Principal Analyst. If needed, the Principal Analyst can unpublish the RCA Analysis, modify it, and then republish it.

- Create RCA Analysis Templates from the RCA Analysis.

Note: Principal Analysts can create RCA Analysis Templates only if permission to do so has been granted through the **Template Creation Permissions** setting on the [Administrative Functions](#) page.

- **Analysis Team Member:** Any user who is a [member of an RCA Analysis Team](#). Analysis team members who have Meridium APM user accounts can view any unpublished RCA Analysis to which they belong. Team members can modify the RCA Analysis information, the Logic Tree, and the Event Diagram but cannot modify the RCA Analysis Team.

Note: The preceding descriptions of Root Cause Analysis roles assume that the user has FULL privileges to ALL RCA families.

In addition to RCA Analysis Team members, a Meridium APM user who is not a member of the RCA Analysis Team can view a read-only copy of any *published* RCA Analysis as long as that user has View privileges to all RCA Analysis families, including the RCA Analysis Relationships and RCA System Relationships families. That user will also need additional Insert privileges on the RCA Analysis family and Update privileges on the RCA Image family.

RCA Security Groups

The following Security Groups are provided for RCA:

- MI PROACT Administrator
- MI PROACT Team Member
- MI PROACT Viewer

Membership in these Security Groups provides Security Users with access to RCA. The baseline privileges for these Security Groups are listed in the following table. Note, however, that access to RCA is not granted through these privileges but through membership in these Security Groups.

| Family | MI PROACT Administrator | MI PROACT Team Member | MI PROACT Viewer |
|--|------------------------------|------------------------------|------------------|
| Equipment | View | View | View |
| Equipment Has Equipment | View | View | View |
| Functional Location | View | View | View |
| Functional Location Has Equipment | View | View | View |
| Functional Location Has Functional Location(s) | View | View | View |
| Group Assignment | View, Update, Insert | View, Update, Insert | View |
| Has Recommendations | View, Update, Insert, Delete | View, Update, Insert, Delete | View |
| Has Reference Documents | View, Update, Insert, Delete | View, Update, Insert, Delete | View |
| Human Resource | View, Update, Insert | View, Update, Insert | View |
| Is a User | View, Update, Insert | View, Update, Insert | View |
| Notification | View, Update, Insert, Delete | View, Update, Insert, Delete | View |

| Family | MI PROACT Administrator | MI PROACT Team Member | MI PROACT Viewer |
|-----------------------------------|------------------------------|------------------------------|----------------------|
| Production Event Has RCA Analysis | View, Update, Insert, Delete | View, Update, Insert, Delete | View |
| RCA Analysis | View, Update, Insert, Delete | View, Update, Insert, Delete | View |
| RCA Build List Item | View, Update, Insert, Delete | View, Update, Insert, Delete | View |
| RCA Critical Success Factor | View, Update, Insert, Delete | View, Update, Insert, Delete | View |
| RCA Event | View, Update, Insert, Delete | View, Update, Insert, Delete | View |
| RCA Failure Mode | View, Update, Insert, Delete | View, Update, Insert, Delete | View |
| RCA Hypothesis | View, Update, Insert, Delete | View, Update, Insert, Delete | View |
| RCA Logic Gate | View, Update, Insert, Delete | View, Update, Insert, Delete | View |
| RCA Preserve Item | View, Update, Insert, Delete | View, Update, Insert, Delete | View |
| RCA Recommendation | View, Update, Insert, Delete | View, Update, Insert, Delete | View |
| RCA Sequence Node | View, Update, Insert, Delete | View, Update, Insert, Delete | View |
| RCA Team Member | View, Update, Insert, Delete | View, Update, Insert, Delete | View |
| RCA Tracking Item | View, Update, Insert, Delete | View, Update, Insert, Delete | View |
| RCA Verification | View, Update, Insert, Delete | View, Update, Insert, Delete | View |
| Reference Document | View, Update, Insert, Delete | View, Update, Insert, Delete | View |
| RCA Image | View, Update, Insert, Delete | View, Update, Insert, Delete | View, Update, Insert |

RCA Security Groups

| Family | MI PROACT Administrator | MI PROACT Team Member | MI PROACT Viewer |
|---------------------------------|------------------------------|------------------------------|------------------|
| RCA Analysis Has Asset | View, Update, Insert, Delete | View, Update, Insert, Delete | View |
| RCA Analysis Relationships | View, Update, Insert, Delete | View, Update, Insert, Delete | View |
| RCA System Relationships | View, Update, Insert, Delete | View, Update, Insert, Delete | View |
| RCA Tracking Item Relationships | View, Update, Insert, Delete | View, Update, Insert, Delete | View |
| Security User | View | View | View |
| User Assignment | View, Update, Insert | View, Update, Insert | View |

A Note About RCA Team Member Roles

RCA security is somewhat unique because Security Group membership is used in conjunction with a user's role within a given analysis to determine what that user can and cannot do with that analysis. Each analysis has:

- A Principal Analyst who can perform all functions related to the analysis.
- Analysis team members, who can perform most functions related to analysis but are restricted from performing some tasks that are reserved for the Principal Analyst.
- Viewers, who can only view the analysis after it has been published.

Permissions granted through these roles will *override* access granted through RCA Security Group membership. This means, for example, that some functions may be restricted for members for the MI PROACT Administrator Security Group when they are working with an analysis in which they are not the Principal Analyst.

For a complete description of the functions that are allowed and not allowed based on a user's role within an analysis, see the RCA Help. Note that privileges granted through roles are done through data filters that are defined on the baseline Analysis family for RCA Analyses.

Accessing the Administrative Functions Page

Note: To access the **Administrative Functions** page, you must be a Super User or a member of the MI PROACT Administrator Security Group.

To access the Administrative Functions page:

- In the Meridium APM Framework application, on the [Root Cause Analysis Start Page](#), click the **Administrative Tools** link.

The **Administrative Functions** page appears.

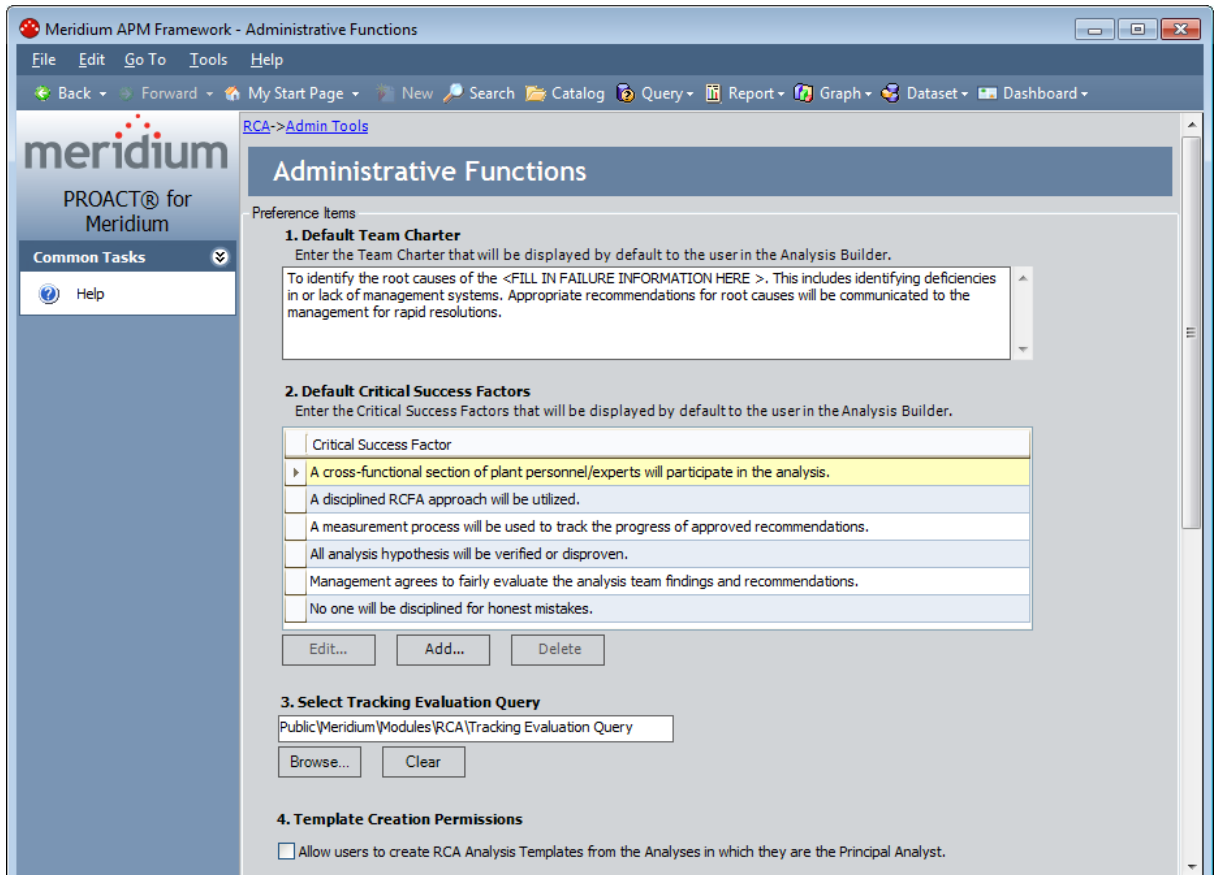

Aspects of the Administrative Functions Page

The **Administrative Functions** page contains the following sections, which allow you to perform various administrative functions for the RCA module:

- [Default Team Charter](#)
- [Default Critical Success Factors](#)
- [Select Tracking Evaluation Query](#)
- [Template Creation Permissions](#)

At the bottom of the page, the following buttons appear:

- **Save:** Saves the changes that were made to the settings on the **Administrative Functions** page and then displays the **Root Cause Analysis Start Page**.
- **Cancel:** After displaying a confirmation message, saves or discards your changes depending upon your response and then displays the [Root Cause Analysis Start Page](#).

The **Administrative Functions** page contains one task menu: [Common Tasks](#).

Default Team Charter Section

The following image shows the **Default Team Charter** section of the [Administrative Functions page](#).

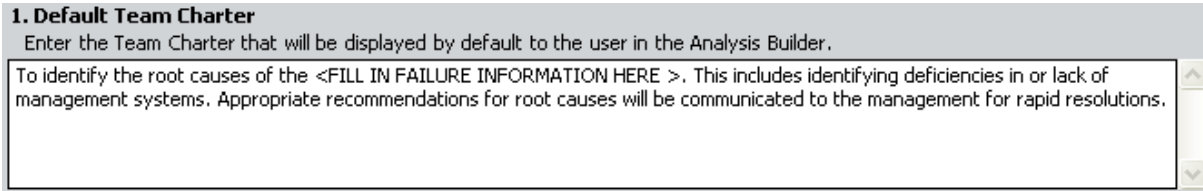

The **Default Team Charter** section contains a text box, where you can specify the [Team Charter](#) that will appear by default when you click the **Default Team Charter** button on the **Enter Team Charter** screen in the **New Analysis Builder**. A Team Charter is provided in the baseline Meridium APM database. You can use the baseline Team Charter or [specify a custom Team Charter](#).

Default Critical Success Factors Section

The following image shows the **Default Critical Success Factors** section of the [Administrative Functions page](#).

2. Default Critical Success Factors
Enter the Critical Success Factors that will be displayed by default to the user in the Analysis Builder.

| Critical Success Factor |
|---|
| ▶ A cross-functional section of plant personnel/experts will participate in the analysis. |
| A disciplined RCFA approach will be utilized. |
| A measurement process will be used to track the progress of approved recommendations. |
| All analysis hypothesis will be verified or disproven. |
| Management agrees to fairly evaluate the analysis team findings and recommendations. |
| No one will be disciplined for honest mistakes. |

Edit... Add... Delete

The **Default Critical Success Factors** section contains a list of the Critical Success Factors (CSFs) that will appear by default in the **Available CSF** section on the **Select CSF** screen in the **New Analysis Builder**. Below the list of default CSFs, the following buttons appear:

- **Edit:** Displays the selected default CSF on the **Critical Success Factor** dialog box, where you can modify the text as desired. This button is enabled only when a row is selected in the list.
- **Add:** Displays a blank **Critical Success Factor** dialog box, where you can define a new default CSF.
- **Delete:** Displays a confirmation message and then deletes the selected default CSF. This button is enabled only when a row is selected in the list.

Select Tracking Evaluation Query

The following image shows the **Select Tracking Evaluation Query** section of the [Administrative Functions page](#).

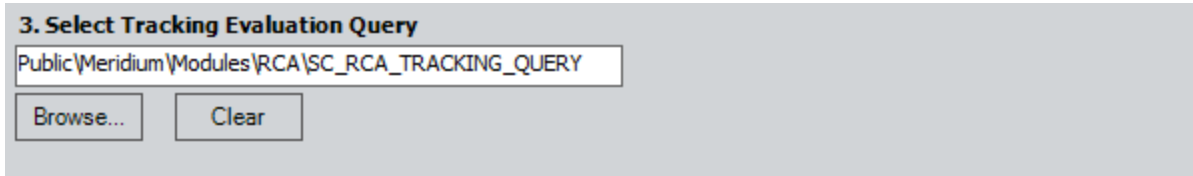

The **Select Tracking Evaluation Query** section contains a text box that stores the [path to the query that returns the number and costs of failures that have occurred for a given piece of equipment or location after a specific date](#). Based upon this information, you can [send a Tracking Item notification email to the recipient specified in the RCA Tracking Item record](#).

By default, the **Select Tracking Evaluation Query** text box contains the Catalog path to the Tracking Evaluation Query that is provided in the baseline Meridium APM database, *Tracking Evaluation Query*, which is stored in the Catalog folder \\Public\Meridium\Modules\RCA.

Below the **Select Tracking Evaluation Query** text box, the following buttons appear:

- **Browse:** Displays the **Open Query** window, where you can navigate to a different query.
- **Clear:** Removes the value that appears in the **Select Tracking Evaluation Query** text box.

Template Creation Permissions

The following image shows the **Template Creation Permissions** section of the [Administrative Functions page](#).

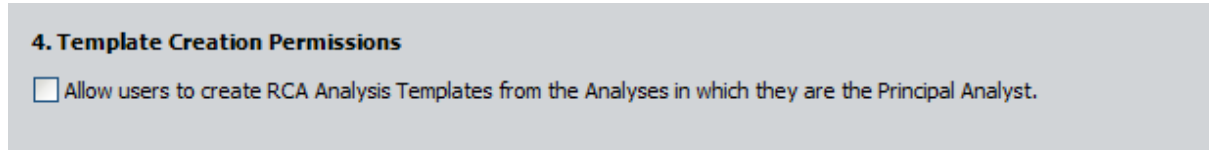

The **Template Creation Permissions** section contains a check box that lets you determine [whether or not Principal Analysts will be allowed to create RCA Analysis Templates](#). By default, this check box is *cleared*, indicating that only Super Users and members of the MI PROACT Administrator Security Group will be allowed to create RCA Analysis Templates. You can select the check box to also allow Principal Analysts to create RCA Templates.

Common Tasks Menu

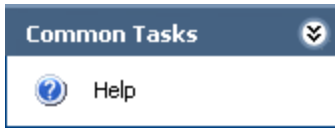

The **Common Tasks** menu on the **Administrative Functions** page one option:

- **Help:** Displays the context-sensitive Help topic for the **Administrative Functions** page.

About the Team Charter

The *Team Charter* is a statement that defines the goal that the RCA Analysis Team wants to achieve through conducting an RCA Analysis. The RCA Analysis Team can refer to the Team Charter throughout the analysis to determine if the goal is being achieved. A Team Charter is provided in the baseline Meridium APM database and appears in the **Default Team Charter** section of the [Administrative Functions](#) page. The following image shows the Team Charter that is defined in the baseline Meridium APM database as it appears on the **Administrative Functions** page.

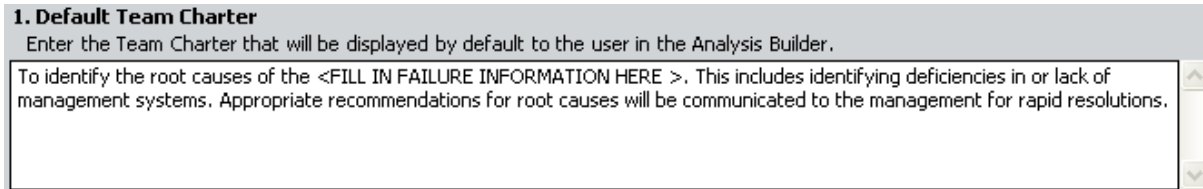

When you complete the initial steps required for a new RCA Analysis via the **New Analysis Builder**, you will be prompted to specify the Team Charter on the **Enter Team Charter** screen. This screen displays the Team Charter that is defined in the **Default Team Charter** section on the **Administrative Functions** page (shown in the previous image). The following image shows the **Enter Team Charter** screen in the **New Analysis Builder**.

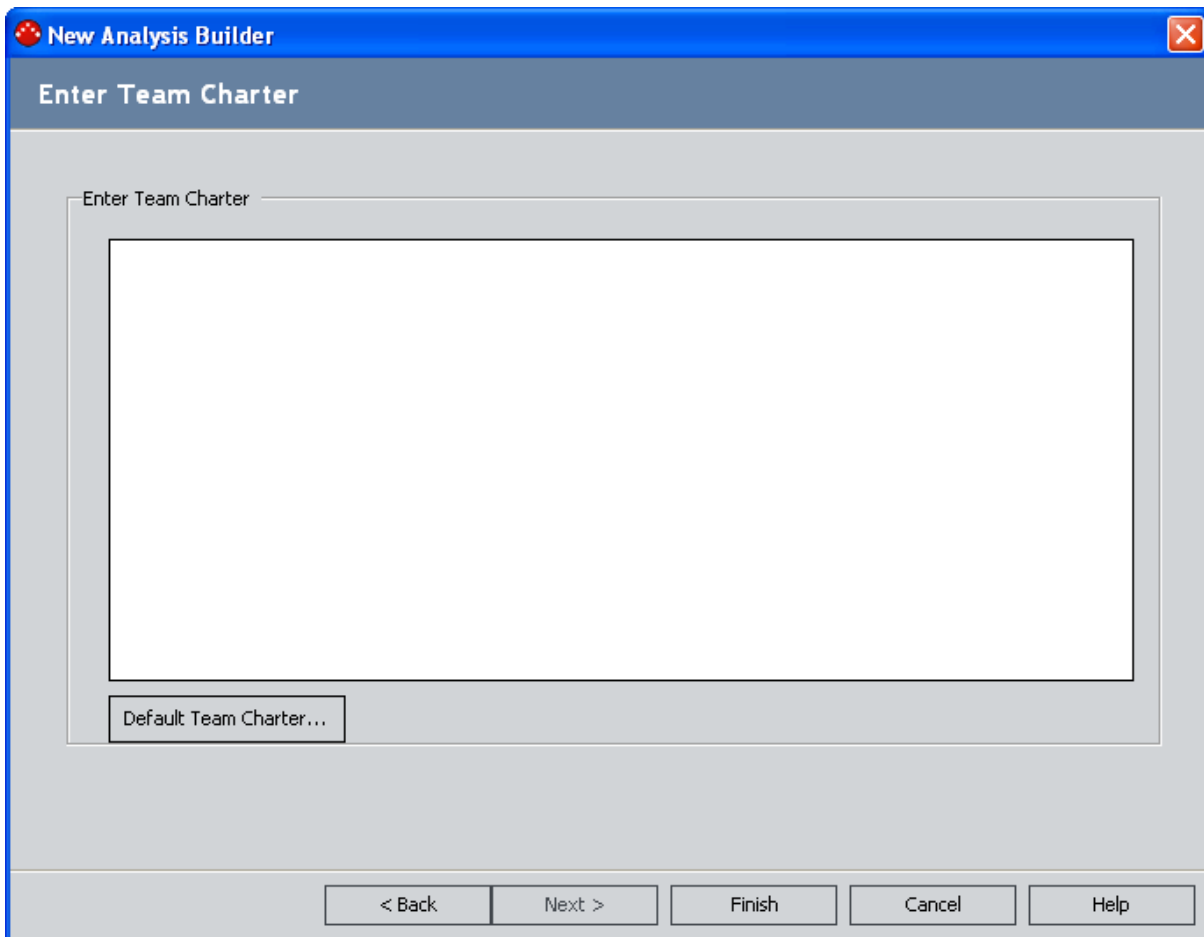

On the **Enter Team Charter** screen in the **New Analysis Builder**, you can choose to:

- Accept the default Team Charter
- Modify the default Team Charter.
- Create a new Team Charter.

Modifying the Default Team Charter

The following instructions provide details on modifying the Team Charter that will be displayed in the **New Analysis Builder** by default. When you modify the baseline Team Charter, the text that you specify will be saved in place of the baseline text.

To modify the default Team Charter:

1. In the Meridium APM Framework application, on the [Administrative Functions page](#), in the **Default Team Charter** text box, modify the text as desired.
2. At the bottom of the page, click the **Save** button.

Your changes are saved, and the **Root Cause Analysis Start Page** appears.

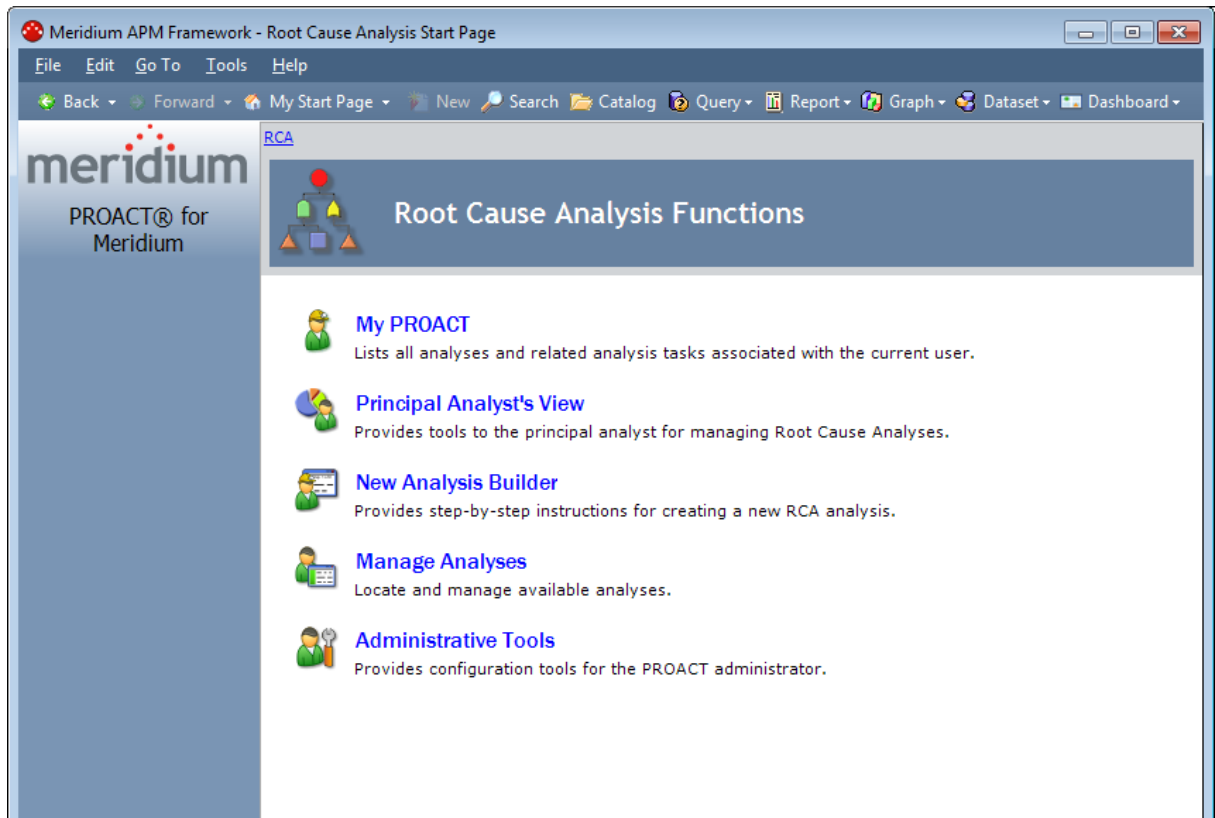

About Critical Success Factors

Critical Success Factors (CSFs) are elements of a Root Cause Analysis that indicate whether or not the RCA Analysis effort has been successful. The RCA Analysis effort is considered to be successful if the RCA Analysis Team adheres to and meets the standards defined by the Critical Success Factors (CSFs). The RCA Analysis Team can define CSFs that are specific to a given RCA Analysis or that are more generic to the work process.

When you create an RCA Analysis via the **New Analysis Builder**, you will be prompted to select the CSFs for the analysis on the **Select CSF** screen. You can choose from a list of Critical Success Factors that appears in the **Available CSF** section on that screen. This list contains the CSFs that are defined in the **Default Critical Success Factors** section on the **Administrative Functions** page. Throughout this documentation, we refer to the CSFs that appear in this list as *default CSFs*.

A list of default CSFs is provided with the baseline RCA module and is displayed on the **Administrative Functions** page. If desired, an administrative user can [customize the list of default CSFs](#). The following image shows the baseline default CSFs as they appear in the **Default Critical Success Factors** section on the **Administrative Functions** page.

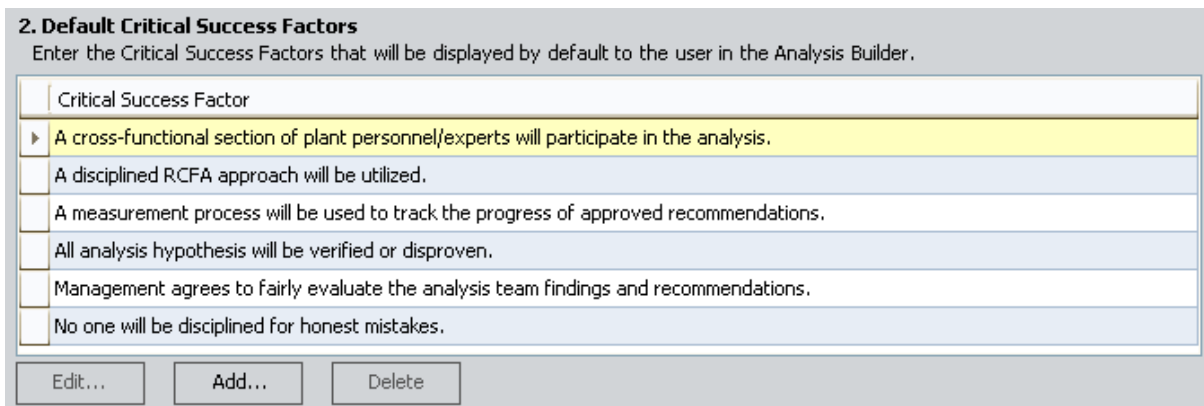

In the **New Analysis Builder**, on the **Select CSF** screen, you can:

- Use the default CSFs that are displayed in the **Available CSF** section.
- or-
- Define your own custom CSFs via the **Custom CSF** text box.

The following image shows the **Select CSF** screen as it appears in the **New Analysis Builder**.

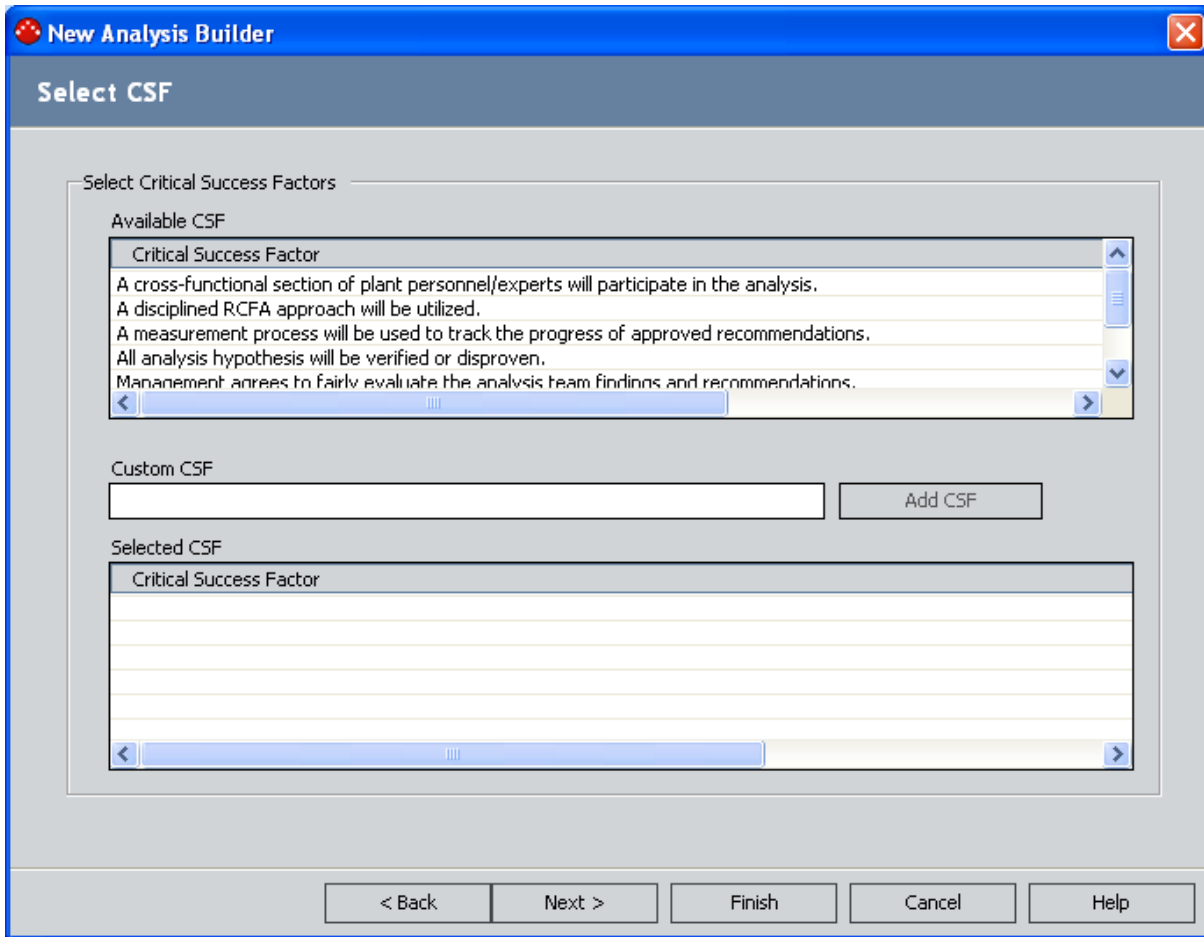

Creating New Default Critical Success Factors

You can create default CSFs that are specific to a certain RCA Analysis or that are generic to any RCA Analysis. After you create a new default CSF, it will appear in the:

- **Default Critical Success Factors** section on the **Administrative Functions** page.
- **Available CSF** list on the **Select CSF** screen in the **New Analysis Builder**.

The following instructions provide details on creating a new default Critical Success Factor via the **Administrative Functions** page.

To create a new default Critical Success Factor:

1. In the Meridium APM Framework application, on the [Administrative Functions page](#), in the [Default Critical Success Factors section](#), click the **Add** button.

The **Critical Success Factor** dialog box appears.

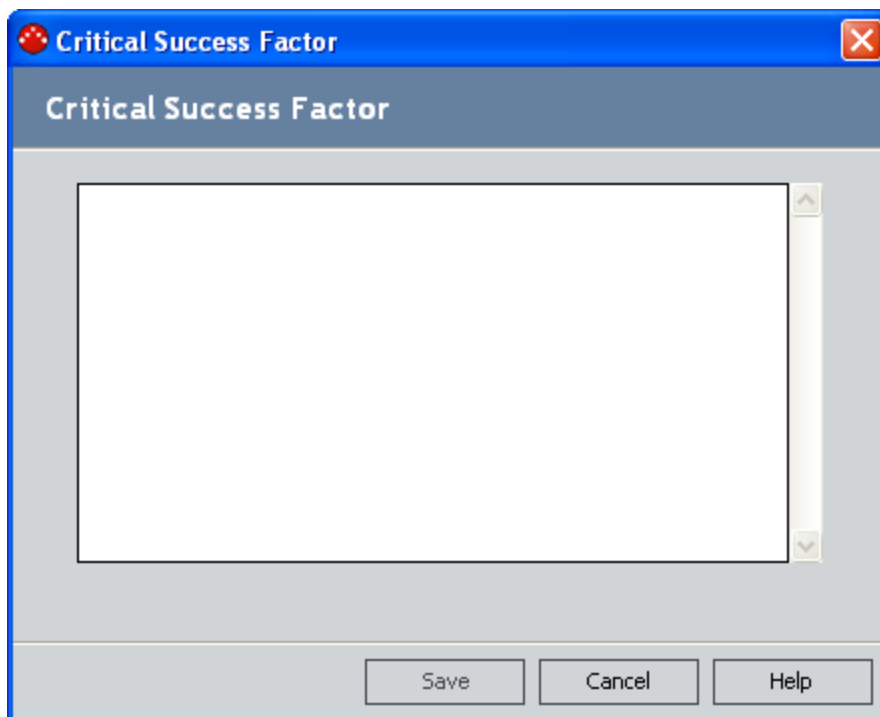

2. In the text box, type the text that defines the Critical Success Factor.
3. Click the **Save** button.

The **Critical Success Factor** dialog box closes, and the new default CSF appears in the list in the **Default Critical Success Factors** section.

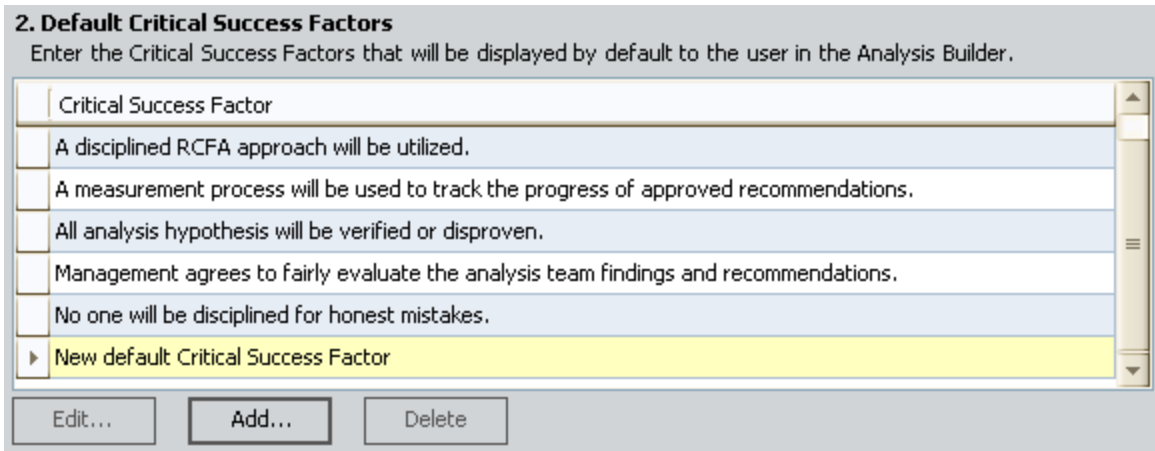

4. At the bottom of the **Administrative Functions** page, click the **Save** button. Your changes are saved, and the **Root Cause Analysis Start Page** appears.

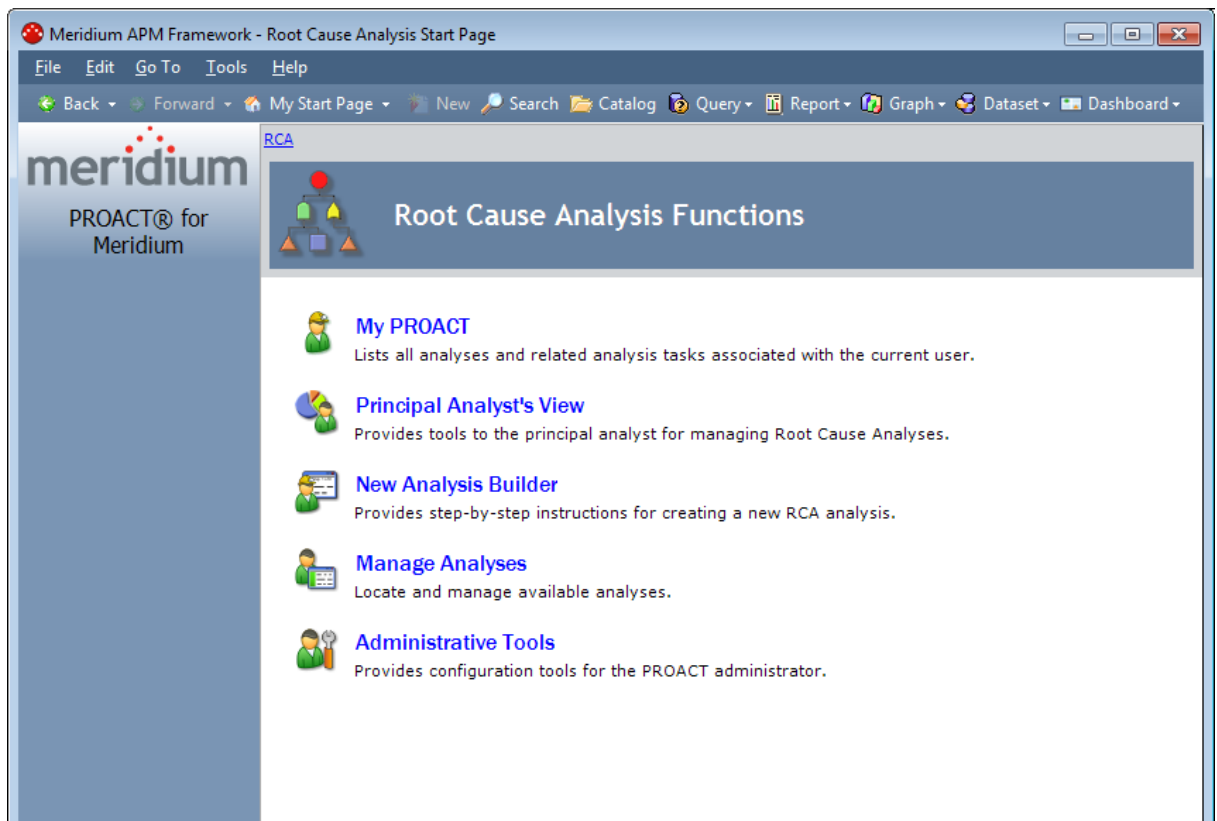

Modifying Existing Default Critical Success Factors

The following instructions provide details on modifying default CSFs via the **Default Critical Success Factors** section on the **Administrative Functions** page.

You can modify a default CSF to make it more relevant to a specific RCA Analysis, or you can modify a default CSF to make it generic to your work process. After you modify a default CSF, your changes will appear in the:

- **Default Critical Success Factors** section on the **Administrative Functions** page.
- **Available CSF** list on the **Select CSF** screen of the **New Analysis Builder**.

To modify an existing default Critical Success Factor:

1. In the Meridium APM Framework application, on the [Administrative Functions page](#), in the list in the [Default Critical Success Factors section](#), select the row containing the default CSF that you want to modify.
2. Click the **Edit** button.

The **Critical Success Factor** dialog box appears, displaying the text that is currently defined for the default CSF that you selected.

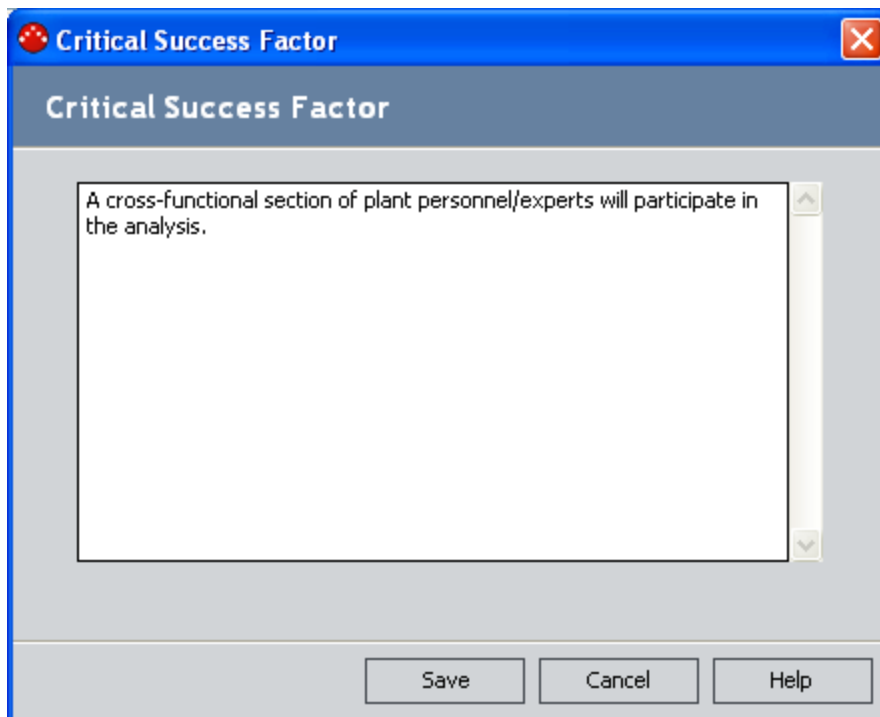

3. Modify the text as desired.
4. Click the **Save** button.

The **Critical Success Factors** dialog box closes, and your changes appear in the list in the **Default Critical Success Factors** section on the **Administrative Functions**

page. In the following image, the selected row contains a default CSF that was modified.

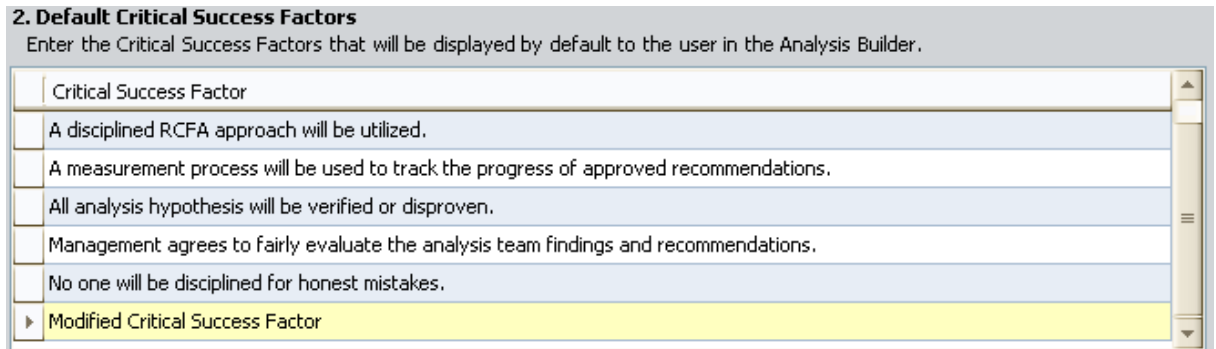

5. At the bottom of the **Administrative Functions** page, click the **Save** button
Your changes are saved, and the **Root Cause Analysis Start Page** appears.

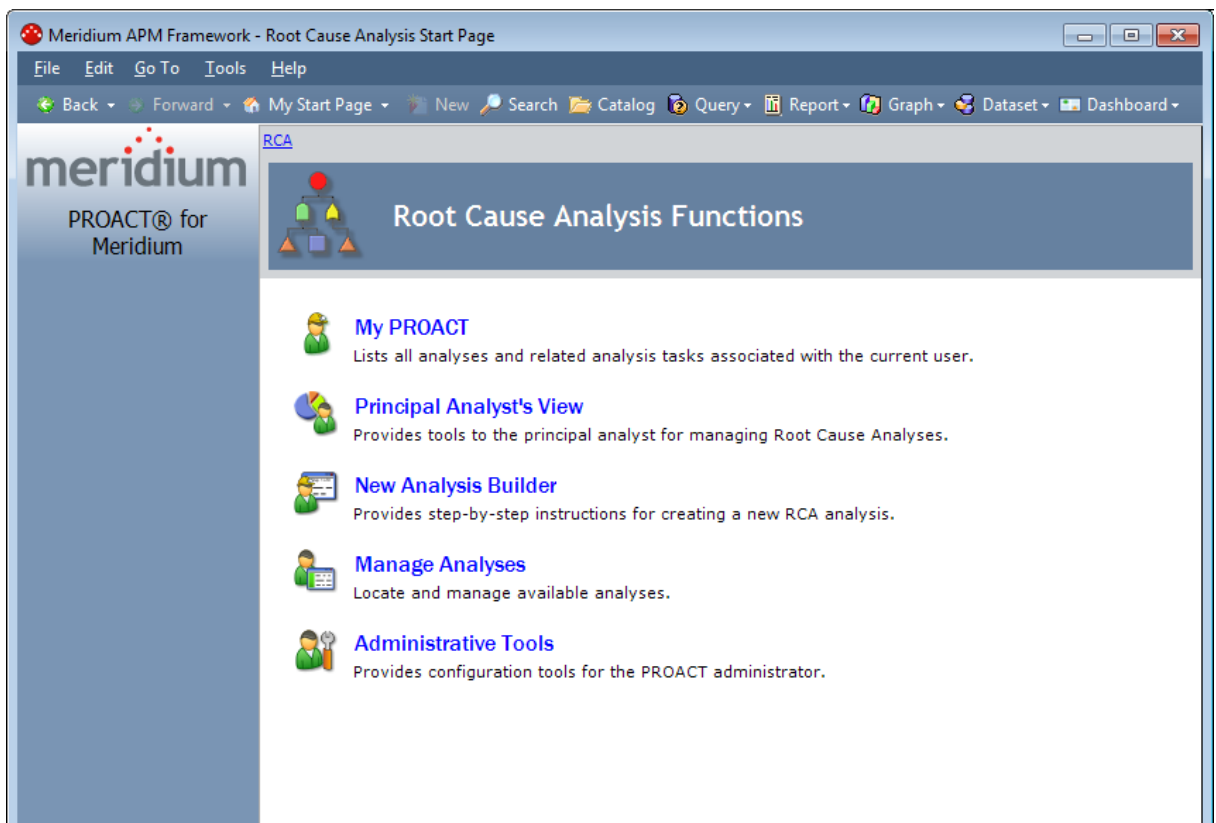

Deleting Default Critical Success Factors

If desired, you can delete a default CSF that you do not want use for any RCA Analyses. When you delete a default CSF, it will be removed from the:

- **Default Critical Success Factors** section on the **Administrative Functions** page.
- **Available CSF** list on the **Select CSF** screen in the **New Analysis Builder**.

To delete a default Critical Success Factor:

1. In the Meridium APM Framework application, on the [Administrative Functions page](#), in the list in the [Default Critical Success Factors section](#), select the row containing the default CSF that you want to delete.
2. Click the **Delete** button.

A confirmation message appears, asking if you really want to delete the default CSF.
3. Click the **Yes** button.

The selected default CSF is deleted and removed from the list in the **Default Critical Success Factors** section.
4. At the bottom of the **Administrative Functions** page, click the **Save** button, Your changes are saved, and the **Root Cause Analysis Start Page** appears.

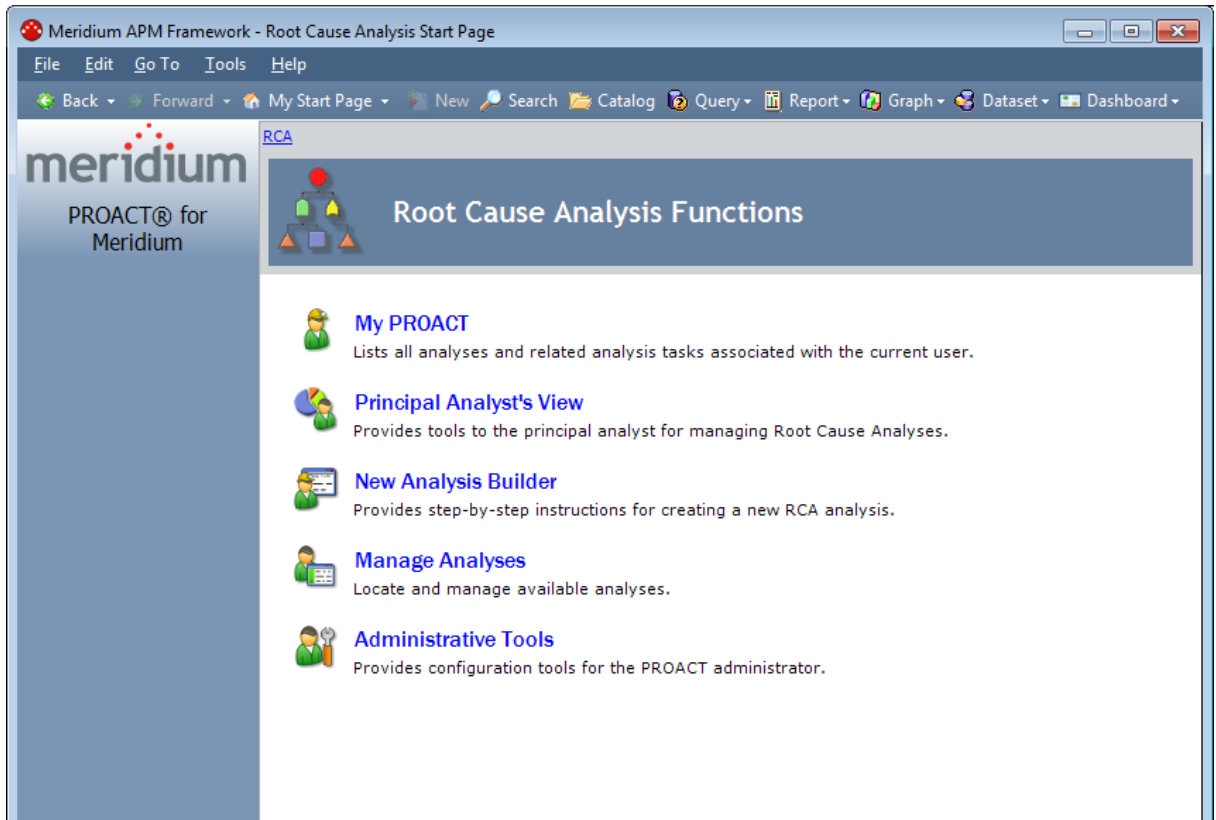

About Tracking Evaluations

Tracking Evaluations are scheduled items that you can create in the Meridium APM Schedule Manager and use to track the success of a recommendation that was implemented as the result of an RCA Analysis. Tracking Evaluations are executed at regular intervals as determined by the Schedule Manager. When the Tracking Evaluation is executed, if certain conditions are met, a Tracking Item notification will be sent via email to a specified recipient, notifying the recipient that the recommendation requires re-evaluation.

The Meridium APM system will use the query that is specified in the **Select Tracking Evaluation Query** section on the [Administrative Functions page](#) to return the number and costs of failures that have occurred for a given piece of equipment or location after a specific date. The baseline RCA product provides a query for this purpose, *Tracking Evaluation Query*, which is stored in the Catalog folder \\Public\Meridium\Modules\RCA.

The baseline *Tracking Evaluation Query* returns the number and costs of failures that have occurred for a given piece of equipment or location after a specific date. This information is stored in records in the baseline Equipment, Functional Location, and Work History families. If you are following the Meridium APM Best Practice and using Equipment and Functional Location records to store your equipment and location information and Work History records to store your failure information, you should not need to modify this query.

When the Tracking Evaluation scheduled item is executed, the Meridium APM system will run the query that is specified on the **Administrative Functions** page and retrieve the failure count and cost data for the Equipment or Functional Location record that is linked to a given RCA Tracking Item record. The Meridium APM system will compare the results of the query against the reevaluation criteria stored in the Start Date, Count, and Cost fields in the RCA Tracking Item record. If the criteria are exceeded, a Tracking Item notification email will be sent to the recipient specified in the Alert field in the RCA Tracking Item record.

Note: Recommendations will continue to be tracked in this way until the value in the Start Date field in the RCA Tracking Item record is updated or until the **Active** check box in the RCA Tracking Item record is cleared.

If you are following the Meridium APM Best Practice, to enable complete Tracking Evaluation functionality, you will at least need to [create a Tracking Evaluation scheduled item in the Meridium APM Schedule Manager](#). If you are not following the Meridium APM Best Practice, in addition to creating the scheduled item, you will also need to [create your own Tracking Evaluation query](#) and [define it on the Administrative Functions page](#).

Creating the Tracking Evaluation Scheduled Item

In Root Cause Analysis, you can [create an RCA Tracking Item record](#) that contains criteria that defines when an implemented recommendation for a piece of equipment or location requires reevaluation. When the criteria stored in the RCA Tracking Item record is met, an email message will be sent to the specified user.

To enable this functionality, you will need to create a scheduled item in the Meridium APM Schedule Manager to run that query on a regular basis to determine whether or not the criteria have been met. When the scheduled item is executed, if the Tracking Evaluation query returns results that exceed the criteria defined in RCA Tracking Item records, an email message will be sent to the responsible team member.

To create a scheduled item that will execute tracking evaluations for Root Cause Analysis:

1. Launch the Meridium APM Schedule Manager and log in.
2. On the **Scheduled Items** window, click the **Add New...** link.

The **Choose a Meridium Assembly** window appears.

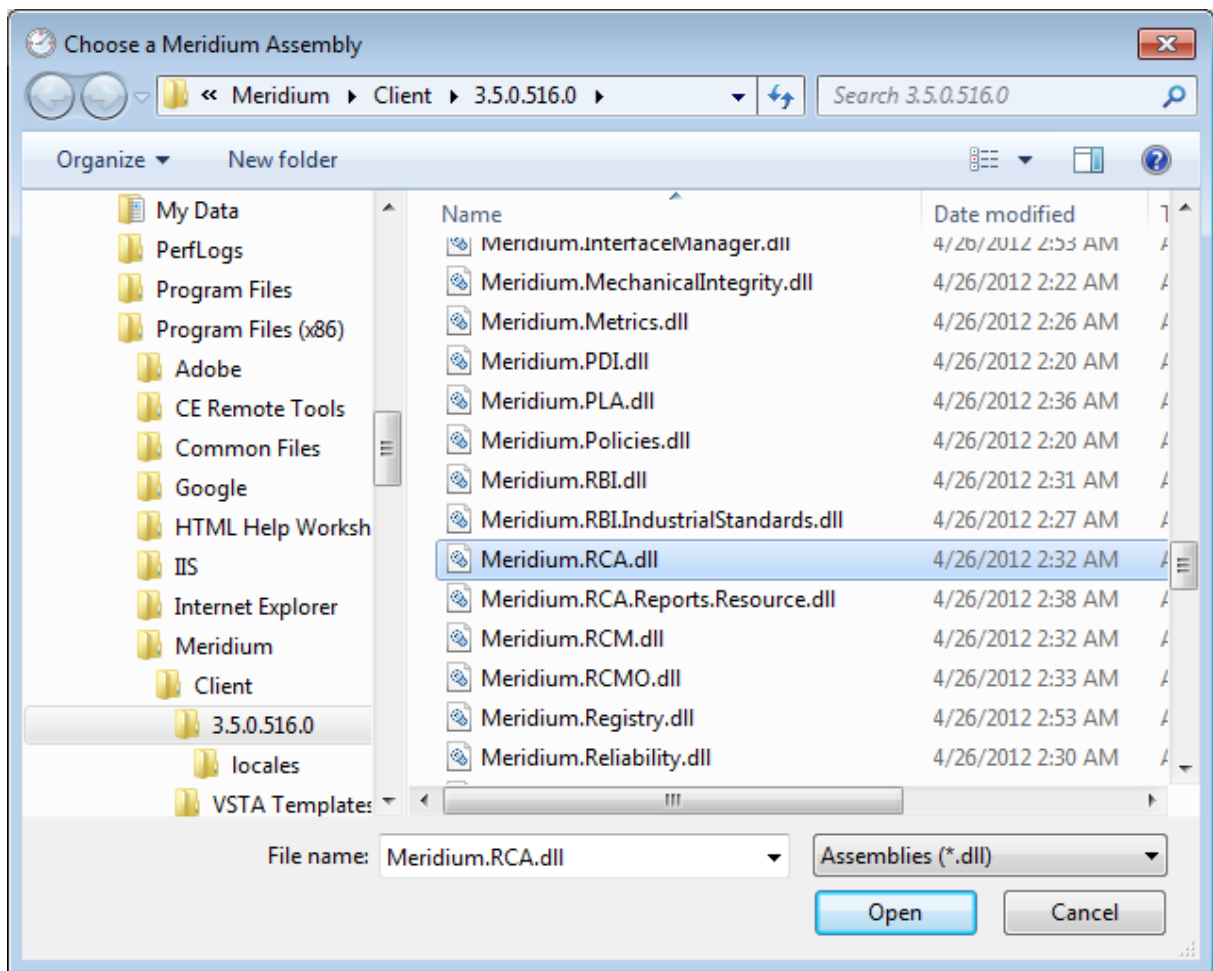

3. Select the file **Meridium.RCA.dll**, and click the **Open** button.

The **Schedule PROACT Tracking Evaluation** dialog box appears, displaying the **Task** tab.

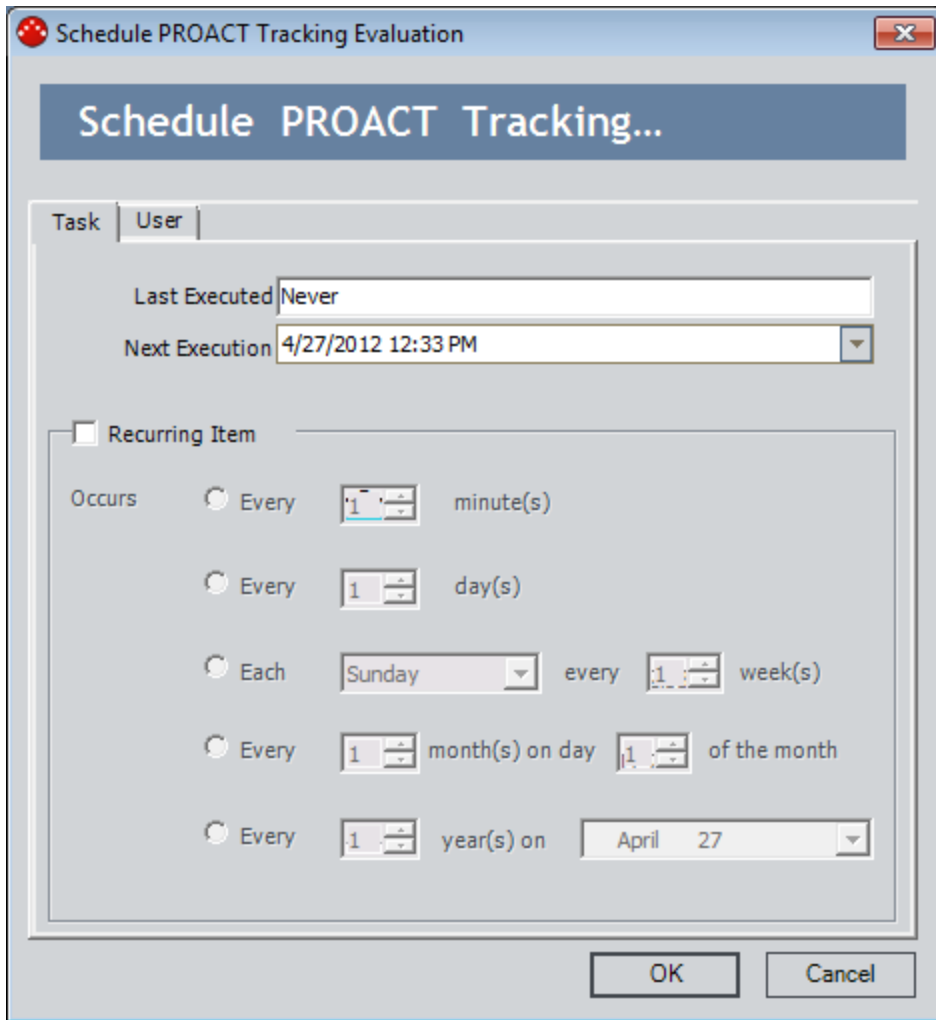

4. Select the **Recurring item** check box, and then select the frequency for the execution. The frequency that you select will determine how often the criteria is examined to see if it has meet the conditions specified in the RCA Tracking Item record.
5. Click the **User** tab.

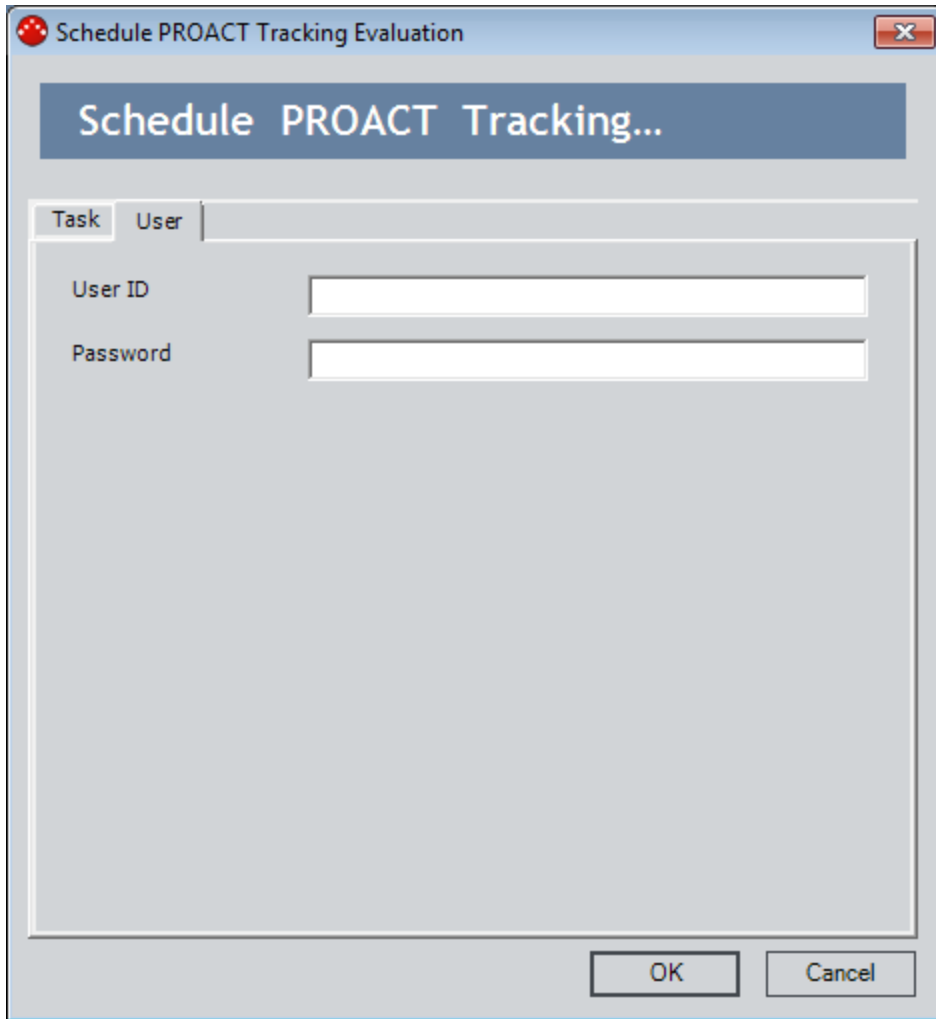

6. On the **User** tab, type the user ID of a user who has at least View permissions to the Catalog folder where the Tracking Evaluation query is stored and to the families that are included in the query.
7. In the **Password** text box, type the password associated with the user ID that you specified in the previous step.
8. Click **OK**.

The scheduled item is saved and appears in the **Scheduled Items** window.

Specifying the Tracking Evaluation Query

If you do not want to use the [baseline Tracking Evaluation Query](#), you can specify a [custom Tracking Evaluation Query](#) to track the success of a recommendation that was implemented as the result of an RCA Analysis.

To specify the Tracking Evaluation query that you want to use:

1. In the Meridium APM Framework application, on the [Administrative Functions page](#), in the **Select Tracking Evaluation Query** section, click the **Browse** button.

The **Open Query** dialog box appears.

2. Navigate to the desired query, and then click the **Open** button.

The path and file name of the query appears in the **Select Tracking Evaluation Query** field.



3. Click the **Save** button.

Your changes are saved, and the **Root Cause Analysis Start Page** appears.

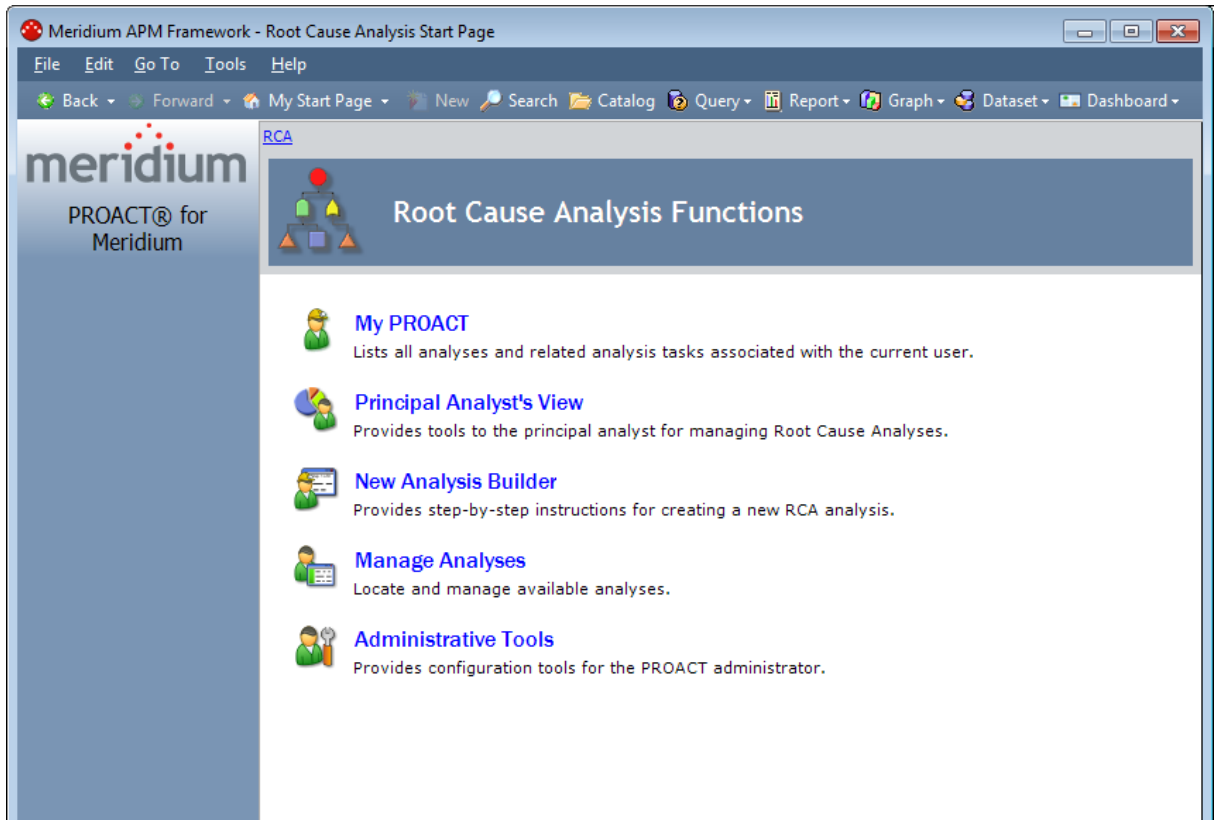

Defining Template Creation Permissions

By default, only Super Users and members of the MI PROACT Administrator Security Group are allowed to [create RCA Analysis Templates](#). You can, however, also specify that you want to allow Principal Analysts to create RCA Analysis Templates.

To specify whether or not Principal Analysts will be allowed to create RCA Analysis Templates:

1. In the Meridium APM Framework application, access the [Administrative Functions page](#), and scroll down to the **Template Creation Permissions** section.
2. If you want RCA users to be allowed to create RCA Analysis Templates from any RCA Analysis for which they are the Principal Analyst, *select* the check box.

-or-

If you do not want Principal Analysts to be allowed to create RCA Analysis Templates, *clear* the check box. By default, the check box is cleared.

Note: Regardless of whether this check box is selected or cleared, Super Users and members of the MI PROACT Administrator Security Group will be allowed to create an RCA Analysis Template from any RCA Analysis. Additionally, RCA users serving the Analysis Team Member role in an analysis will not be allowed to create RCA Analysis Templates.

3. Click the **Save** button.

Your changes are saved, and the **Root Cause Analysis Start Page** appears.

About Configuring Queries for Custom Families

If you have defined equipment and location information the baseline Equipment and Functional Location families and defined failure information in the Work History family, you will be able to use the baseline RCA queries without performing any configuration tasks.

If you have defined this information in families outside of these baseline families, you will need to modify existing queries in order to perform certain tasks in the Root Cause Analysis module. These queries are stored in the following folder in the Meridium APM Catalog: \\Public\Meridium\Modules\RCA.

The following queries will need to be configured to incorporate non-baseline families:

- [Get Equipment Family Key Query](#)
- [Get Functional Location Family Key Query](#)
- [Functional Location from Asset Query](#)
- [Tracking Evaluation Query](#)

Note: The queries *Select Query-Does Not Have Equipment* and *Select Query- Has Equipment* were previously used to identify equipment and location families, but now the Meridium APM system identifies equipment and location families using the RCA Has Asset relationship. These queries still exist in the Catalog folder \\Public\Meridium\Modules\RCA but are not used and do not need to be modified to use custom families.

Customizing Family Key Queries

If you are using non-baseline families to store equipment and location information, you will need to modify the *Get Equipment Family Key* and *Get Functional Location Family Key* queries to use your custom families and fields.

The baseline *Get Equipment Family Key* query returns the following fields from the Equipment family:

- FMLY_KEY
- Equipment Technical Number

In an RCA Recommendation record, when you search for a record using the Equipment ID field, the Meridium APM system uses this query to populate the **Search In** list with the value *Equipment* automatically. This query is also used to populate the Technical Number field automatically. If you are using a non-baseline family to store information about equipment, you will need to modify the query to return the Family Key of the family that you use to store equipment data. You can also modify the query to populate the Technical Number field in an RCA Recommendation record with a value that you use to identify equipment.

The baseline *Get Functional Location Family Key* query returns the following fields from the Functional Location family:

- FMLY_KEY

In an RCA Recommendation record, when you search for a record using the Functional Location ID field, the Meridium APM system uses this query to populate the **Search In** list with the value *Functional Location* automatically. If you are using a non-baseline family to store location information, you will need to modify the query to return the Family Key of the family that you use to store location data.

Customizing the Functional Location from Asset Query

If you are using non-baseline families to store equipment and location information, you will need to modify the *Functional Location from Asset* query to use your custom families and fields.

The baseline *Functional Location from Asset* query returns the following fields:

- **From the Equipment Family:** The ENTY_KEY field. The following prompt is defined for the this field.
 - ((? :n :caption='Equipment Key'))
- **From the Functional Location Family:** The ENTY_ID and ENTY_KEY fields.

In an RCA Recommendation record, if the Equipment record you selected using the Equipment ID field is linked to a Functional Location record, the Meridium APM system uses this query to populate the Functional Location ID field in the RCA Recommendation record automatically. If you are using non-baseline families, you will need to modify the query to return the Record ID and Entity Key of records that belong to the family that you use to store location data.

Customizing the Tracking Evaluation Query

If you are using non-baseline families to store equipment, location, and failure information, you will need to modify this query to use your custom families and fields. The baseline query contains a union statement and, therefore, can be modified via the SQL code only. Alternatively, you can create a new query in the Meridium APM Framework application. Custom families must follow the same guidelines used for baseline families.

The following elements are returned from the baseline families using the baseline *Tracking Evaluation Query*. The Equipment and Functional Location families are related to the Work History family via the Has Work History relationship.

- **Equipment family or Functional Location family:** The ENTY_KEY field. The following prompt is defined for the ENTY_KEY field:

- ((? :n :caption= 'ENTITY_KEY' :id=ENTY_KEY))

If you are using a non-baseline family, you will need to provide the ENTY KEY of your custom family and add the baseline prompt.

- **Work History family:** The ENTY_KEY, Total Cost, and Event Start Date fields. The following prompt is defined for the Event Start Date field.

- (>(? :d :caption='START_DATE' :id=START_DATE))

If you are using a non-baseline event family, you will need to add fields that you can use as *Count*, *Cost*, and *Date* columns. The following list contains information on how the criteria in each column are used by the Meridium APM system:

- **Count:** Used to count the number of failures that the piece of equipment or location has incurred since the start date that is specified in the RCA Tracking Item record. The Count column must have the alias *Count* defined for it.
- **Cost:** Used to calculate the total cost of the failures that the piece of equipment or location has incurred since the start date that is specified in the RCA Tracking Item record. The Cost column must have the alias *Cost* defined for it.
- **Date:** Used to compare the date on which the failures occurred to the start date that is specified in the RCA Tracking Item record. The Date column must contain the baseline prompt.

If you modify the baseline Tracking Evaluation Query or create a custom one, you will need to [specify that query as the default query on the Administrative Functions page](#).

About Navigating the RCA Module

Within the Meridium APM Framework application, the RCA module provides the following navigational tools:

- A [start page](#) with links that provide access to the main features of RCA. You can use these links to [develop an RCA Analysis](#).
- A [Site Map](#) that you can use to navigate within the RCA module. The Site Map indicates your current location and shows the typical path for arriving there. To access a previous page, you can click its hyperlinked name in the Site Map.

Using the RCA Site Map

The Site Map in RCA allows you to navigate from the current page to other pages in RCA. The **RCA** link, which provides access to the **Root Cause Analysis Start Page**, will always be available. Links to other pages may also be available, depending upon your location in the application. You can click any link that is available to access the corresponding page.

The following image shows an example of what the Site Map looks like on the **Analysis** page. A red outline has been added to the image to highlight the Site Map.

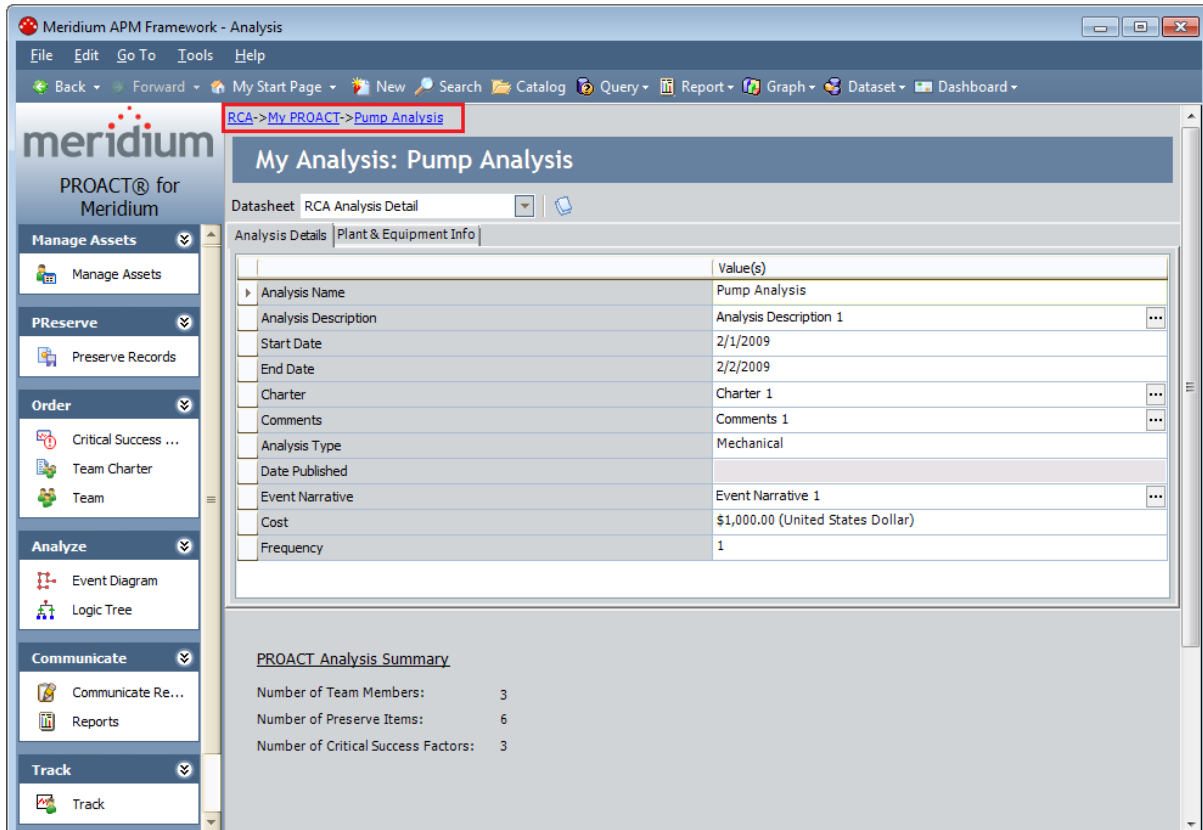

About Ordering Analyses

After all of the Root Cause Analysis administrative tasks have been completed, you can *order the analysis*. Ordering the analysis consists of completing the following steps via the **New Analysis Builder**:

- Create the RCA Analysis record.
- Link the RCA Analysis record to the desired Equipment or Functional Location records.
- Define Critical Success Factors (CSFs).
- Define the Team Charter.
- Set up the RCA Analysis Team.

The user that completes these tasks will be added to the RCA Analysis Team automatically as the Principal Analyst. If desired, after completing these steps, you can [designate a different team member as the Principal Analyst](#).

Note: You can define CSFs, the Team Charter, and the RCA Analysis Team outside of the **New Analysis Builder**, if needed. For more information, see the related topics in this section of the documentation.

Accessing the New Analysis Builder

You can access the **New Analysis Builder** in various ways, depending on the page that you are currently viewing in Root Cause Analysis.

To access the **New Analysis Builder**:

- If you are on the [Root Cause Analysis Start Page](#), click the **New Analysis Builder** link.
- If you are on the [PA PROACT page](#) (i.e., the Principal Analyst's View), on the **Common Tasks** menu, click the **New Analysis** link.
- If you are on the [My PROACT page](#), on the **Common Tasks** menu, click the **New Analysis** link.
- If you are on the [Manage Analyses page](#), on the **Common Tasks** menu, click the **Create Analysis** link. From the **Manage Analyses** page, you can also [copy an existing RCA Analysis to create a new one](#) or use an RCA Analysis Template to create a new RCA Analysis.

The **New Analysis Builder** appears, displaying a new RCA Analysis record.

The screenshot shows a window titled "New Analysis Builder" with a sub-header "RCA Analysis Datasheet". Below the header is a "Datasheet" dropdown menu set to "RCA Analysis" and a toolbar with icons for file operations. The main area is labeled "Analysis Details" and contains a table with the following structure:

| | Value(s) |
|----------------------|----------|
| ▶ Analysis Name | |
| Analysis Description | ... |
| Start Date | |
| End Date | |
| Comments | ... |
| Analysis Type | |
| Event Narrative | ... |
| Date Published | |

At the bottom of the window are five buttons: "< Back", "Next >", "Finish", "Cancel", and "Help".

After you access the **New Analysis Builder**, you will need to [proceed through the builder and supply information on each screen](#) in order to create a new analysis.

Developing a New RCA Analysis

To create a new RCA Analysis using the New Analysis Builder:

1. [Access the New Analysis Builder.](#)

The **New Analysis Builder** appears, displaying **RCA Analysis Datasheet** screen.

| | Value(s) |
|------------------------|----------|
| ▶ Analysis Name | |
| □ Analysis Description | ... |
| □ Start Date | |
| □ End Date | |
| □ Comments | ... |
| □ Analysis Type | |
| □ Event Narrative | ... |
| □ Date Published | |
| □ Cost | |
| □ Frequency | |

2. On the **Analysis Details** tab, enter values in the available fields. The Analysis Name field is required and must be unique.
3. Click the **Next** button.

The **Link Assets** screen appears.

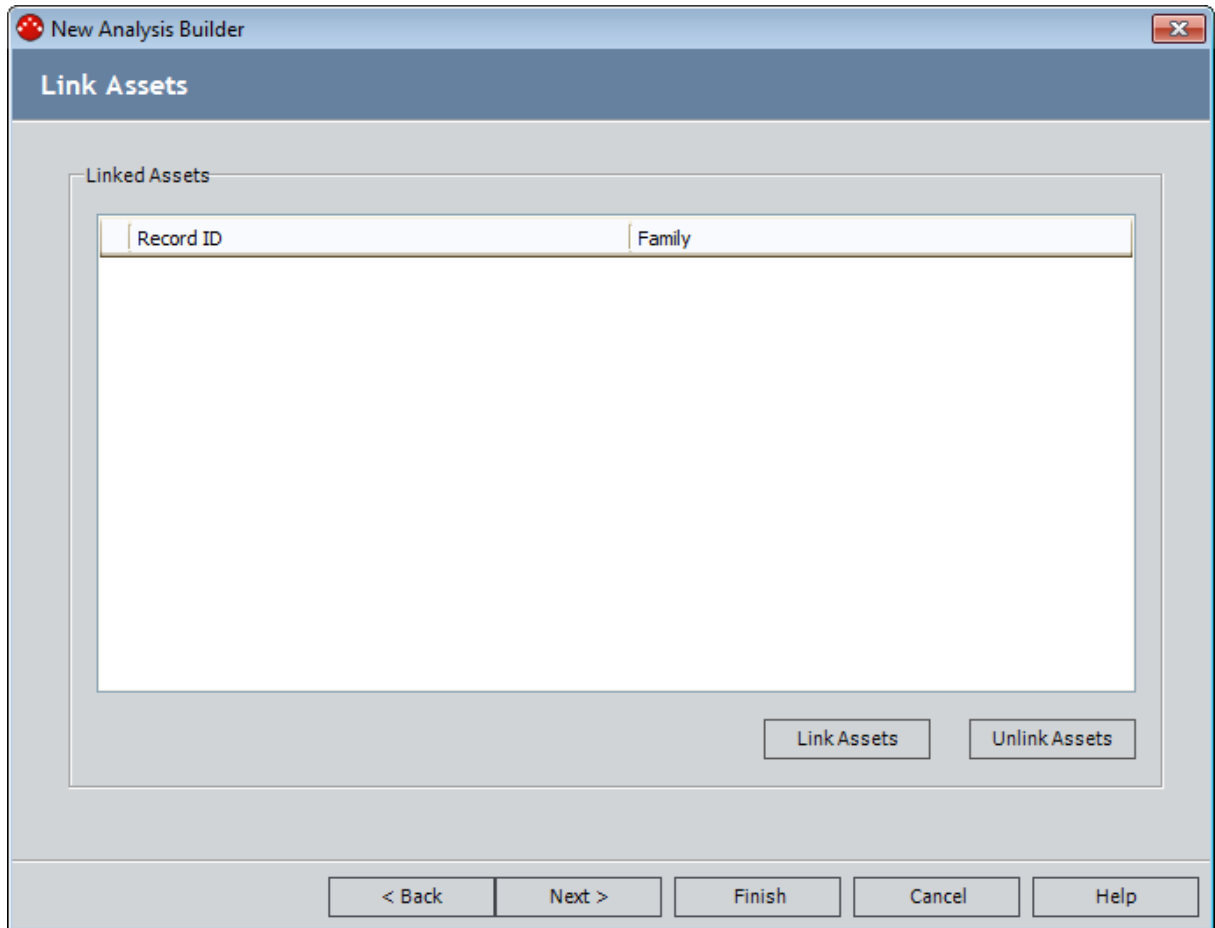

4. At the bottom of the **Link Assets** screen, click the **Link Assets** button.

The **Find Asset** window appears.

5. Perform a search to find the [Equipment records that you want to link to the RCA Analysis record](#).
6. In the search results, select the rows that contain the desired records, and then click the **Select** button.

The **Select an Asset** screen returns to focus.

Each Equipment record you selected is linked to the RCA Analysis record and appears on the **Linked Assets** screen. The **Record ID** column is populated with the Record ID of the Equipment record that you selected from the list, and the **Family** column is populated with *Equipment*.

7. Click the **Link Assets** button again.

The **Find Asset** window appears.

8. Perform a search to find the [Functional Location records that you want to link to the RCA Analysis record](#).
9. In the search results, select the rows that contain the desired records, and then click the **Select** button.

The **Select an Asset** screen returns to focus.

Each Functional Location record you selected is linked to the RCA Analysis record and appears on the **Linked Assets** screen. The **Record ID** column is populated with the Record ID of the Functional Location record that you selected from the list, and the **Family** column is populated with *Functional Location*.

10. Click the **Next** button.

The **Select Team Members** screen appears.

Principal Analyst:
Meridium Administrator

Select Analysis Team Members

Search Text:

| Available Members | | | Selected Team Members | | |
|-------------------|------------|-----------|-----------------------|------------|-----------|
| Last Name | First Name | Job Title | Last Name | First Name | Job Title |
| Administrator | | | | | |
| Almond | Steve | | | | |
| Analyst | | | | | |
| Aukerman | Milo | | | | |
| Black | Evan | | | | |
| Demo | Joe | | | | |
| Egerton | Stephen | | | | |
| Elimination | Failure | Failure | | | |
| Foundation | APM | APM Fi | | | |
| Green | Micah | | | | |
| Green | Eric | Analys | | | |
| Implementer | | | | | |
| Integrity | Mechanical | Mecha | | | |
| Leader | Packade | Packac | | | |

< Back Next > Finish Cancel Help

Note: The **New Analysis Builder** displays a list of available members with a Human Resource record already defined in the Meridium APM database. If you want to add a team member whose name does not appear in the list, you must first [create a Human Resource record for the user](#) outside of the **New Analysis Builder**. You can then add the user to the team via the **Team** page.

11. In the **Available Members** list, select the users that you want to add to the RCA Analysis Team, and click the  button. The user who creates the RCA Analysis is added automatically to the RCA Analysis Team as the Principal Analyst. Note also that you can filter the list of users by typing criteria in the **Search Text** box and clicking the **Search** button.

OEHint: You can add members to the RCA Analysis Team via the drag-and-drop method or by double-clicking a user.

The selected users appear in the **Selected Team Members** list.

OEHint: If needed, you can use the  button, the drag-and-drop method, or the double-click method to remove selected team members from the **Selected Team Members** list.

12. When you are finished adding members to the list, click the **Next** button.

The **Select CSF** screen appears.

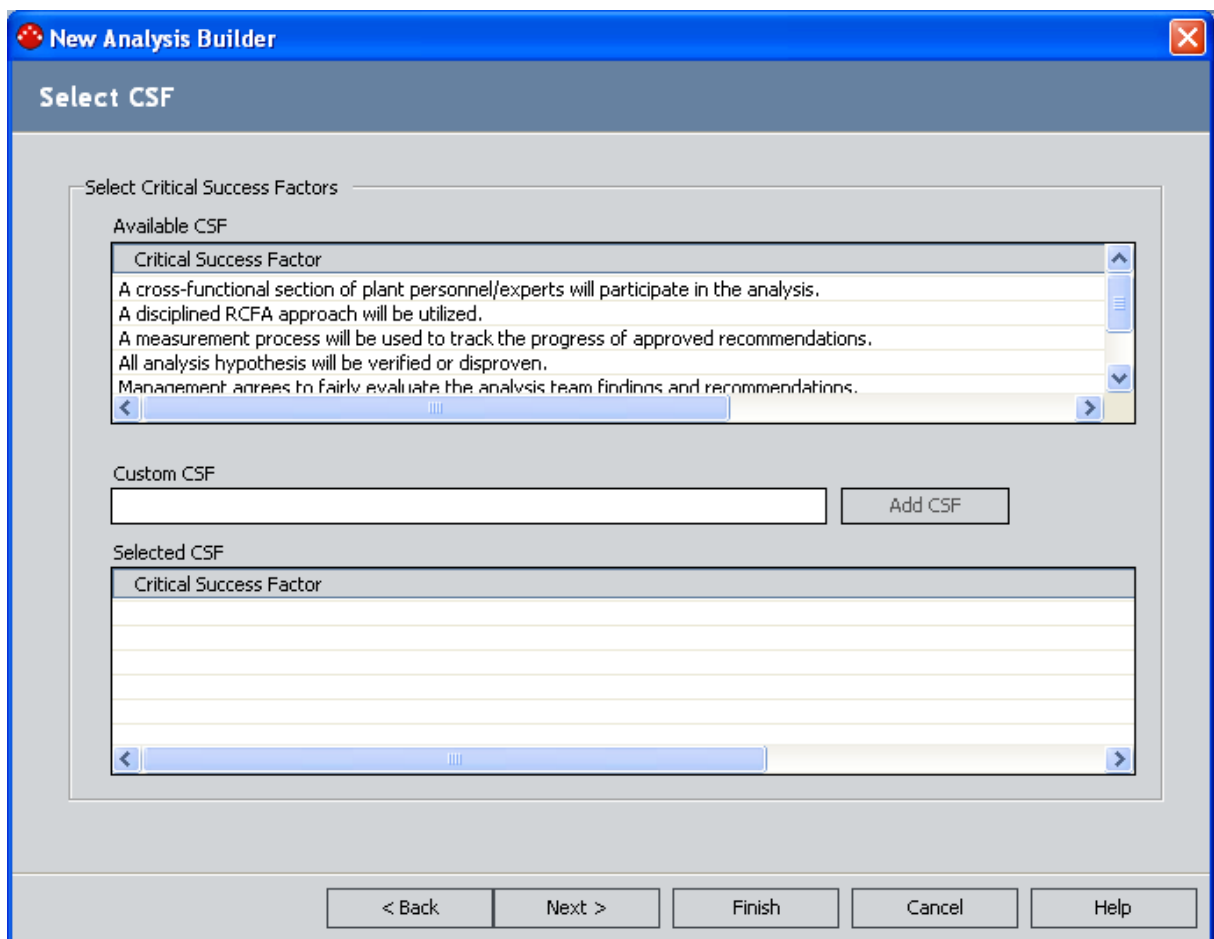

New Analysis Builder

Select CSF

Select Critical Success Factors

Available CSF

| Critical Success Factor |
|---|
| A cross-functional section of plant personnel/experts will participate in the analysis. |
| A disciplined RCFA approach will be utilized. |
| A measurement process will be used to track the progress of approved recommendations. |
| All analysis hypothesis will be verified or disproven. |
| Management agrees to fairly evaluate the analysis team findings and recommendations. |

Custom CSF

Selected CSF

| Critical Success Factor |
|-------------------------|
| |
| |
| |
| |
| |

< Back Next > Finish Cancel Help

13. In the **Available CSF** list, select the [desired Critical Success Factors \(CSFs\)](#). The list contains the [CSFs that an administrative user has pre-configured for use with RCA Analyses](#). You can select any CSF from the list by double-clicking it or by using the drag-and-drop method to add it to the **Selected CSF** list.

The selected CSFs appear in the **Selected CSF** list.

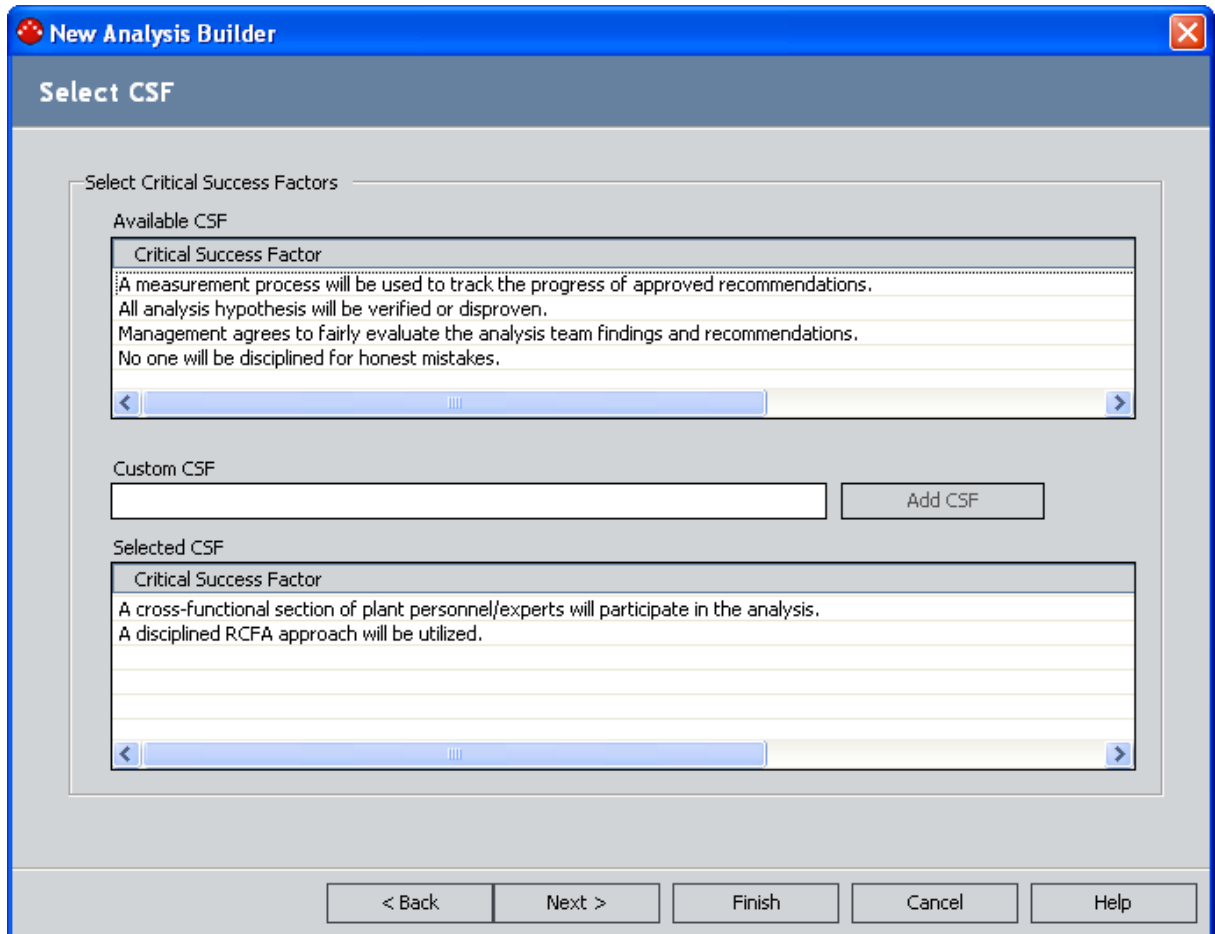

14. If you want to add a custom CSF to the RCA Analysis, type the appropriate text in the **Custom CSF** text box, and then click the **Add CSF** button.

The new CSF appears in the **Selected CSF** list. You can add as many custom CSFs you like.

Hint: If needed, you can remove a CSF from the **Selected CSF** list by double-clicking it or by using the drag-and-drop method to add it back to the **Available CSF** list.

15. When you have finished selecting the CSFs that you want to include in the analysis, click the **Next** button.

The **Enter Team Charter** screen appears.

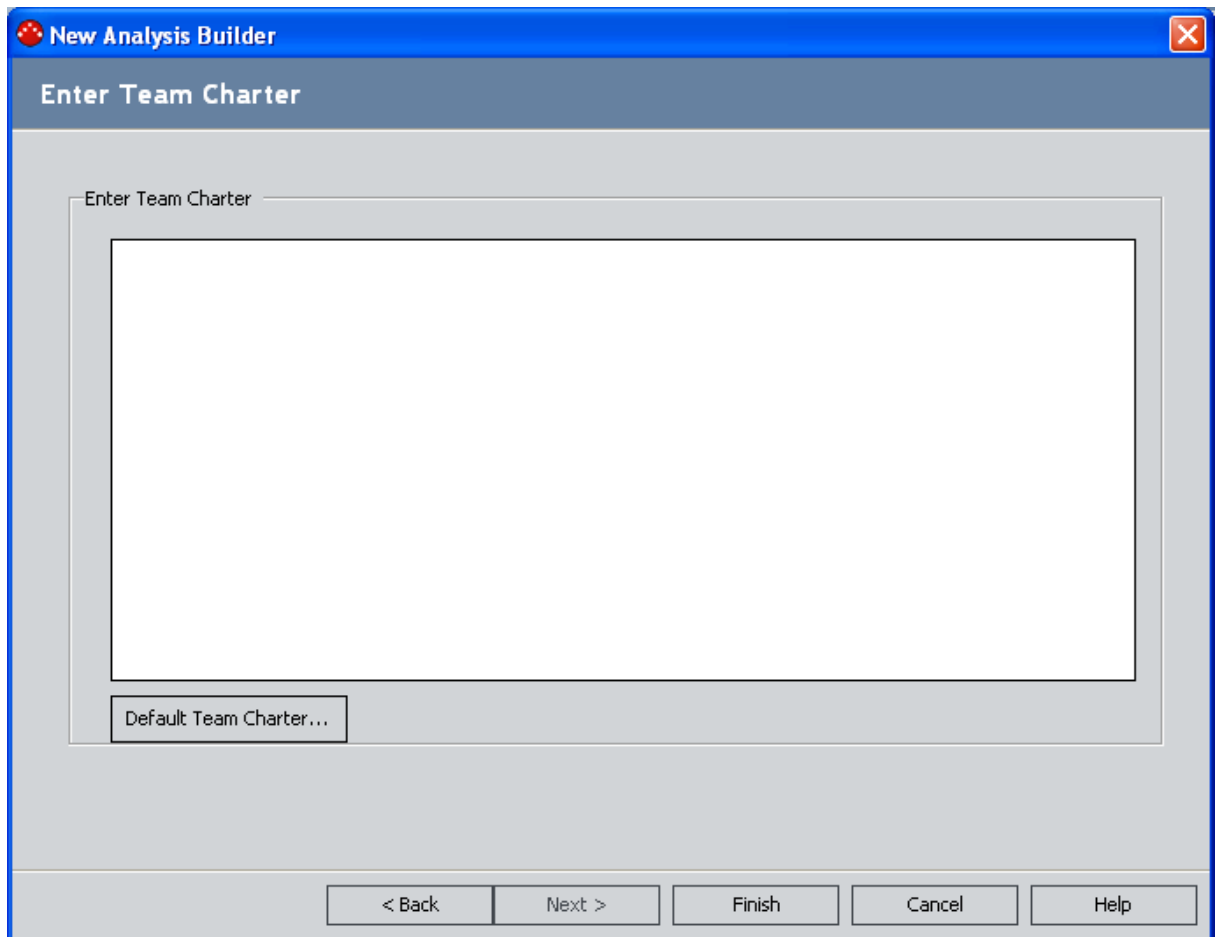

16. On the **Enter Team Charter** screen, you can:
- Create a custom Team Charter by typing the Team Charter in the text box in the **Enter Team Charter** section.
- or-
- Use the default Team Charter that an administrative user has defined by clicking the **Default Team Charter** button. The **Default Team Charter** dialog box appears.

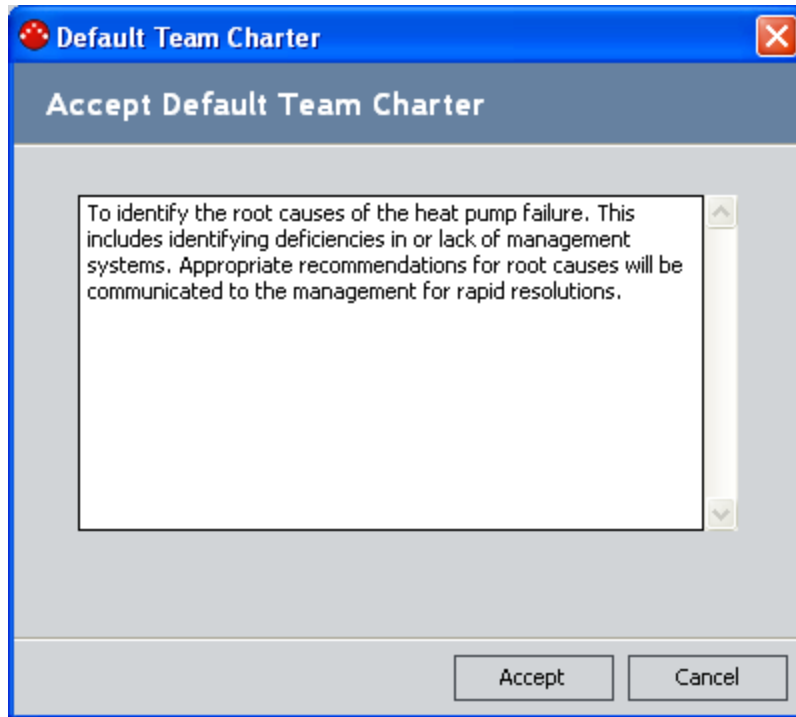

Click the **Accept** button to use the default Team Charter. You can then modify the default Team Charter in the text box in the **Enter Team Charter** section, if desired.

17. When you are finished defining the Team Charter, on the **Enter Team Charter** screen, click the **Finish** button.

The new RCA Analysis is created and saved, and the **Preserve Failure Data** page appears.

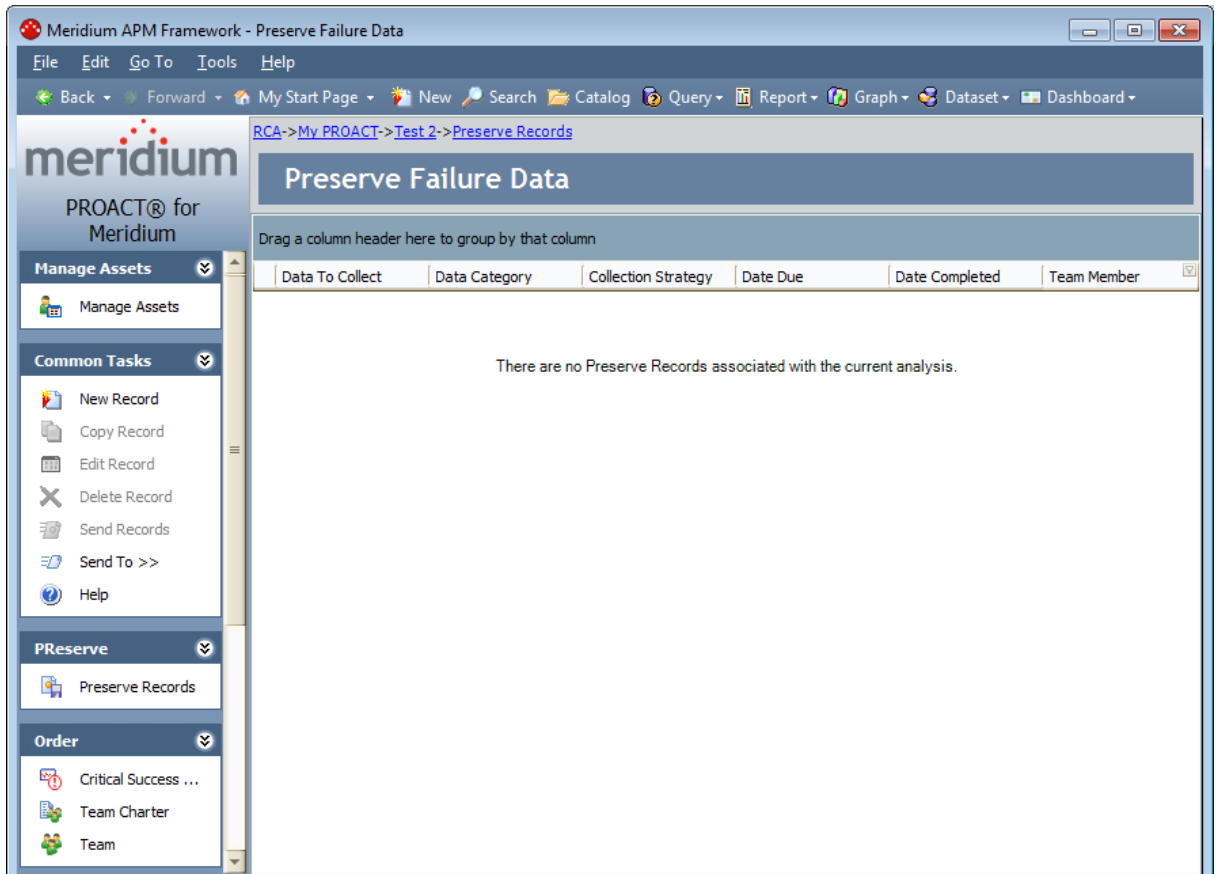

From the **Preserve Failure Data** page, you can begin the next step of the RCA Analysis by [creating RCA Preserve Item records](#) and linking them to the RCA Analysis record.

About Equipment, Locations, and RCA Analyses

You can link Equipment and Functional Location records to an RCA Analysis record. You should link all Equipment and Functional Location records related to the RCA Analysis in order to keep a full record of the equipment and locations that are impacted by the RCA Analysis results.

You can link only Equipment records, only Functional Location records, or both types of records simultaneously to an RCA Analysis record. Consider the following examples.

1. You want to run an RCA Analysis on a pump, which is always located in the same place. You link the pump's Equipment record to the RCA Analysis record.
2. You want to run an RCA Analysis on an incident that occurred at a specific plant and you aren't sure which pump was involved. You link the plant's Functional Location record to the RCA Analysis record.
3. You want to run an RCA Analysis on a pump that was previously located in another plant and has been installed in a new plant. You link both the pump's Equipment record (which is already linked to the new plant's Functional Location record) and the old plant's Functional Location record to the RCA Analysis record.
4. You want to run an RCA Analysis involving multiple pumps that are all experiencing similar failures. You link multiple Equipment records to the same RCA Analysis record.

You can link Equipment or Functional Location records to the RCA Analysis record [when you complete the initial steps required for an RCA Analysis](#), or you can link Equipment or Functional Location records to an existing RCA Analysis record [via the Manage Assets page](#).

For existing RCA Analysis records, Equipment or Functional Location records can be managed from the **Manage Assets** page, where you can:

- [Link Equipment or Functional Locations records to an RCA Analysis.](#)
- [View Equipment or Functional Location records that are currently linked to an RCA Analysis.](#)
- [Unlink Equipment or Functional Location records from an RCA Analysis.](#)

Accessing the Manage Assets Page

To access the Manage Assets page:

- On the [Analysis page](#), on the **Manage Assets** menu, click the **Manage Assets** link.

The **Manage Assets** page appears, displaying a list of Equipment or Functional Location records that have been linked to the RCA Analysis record for the current analysis.

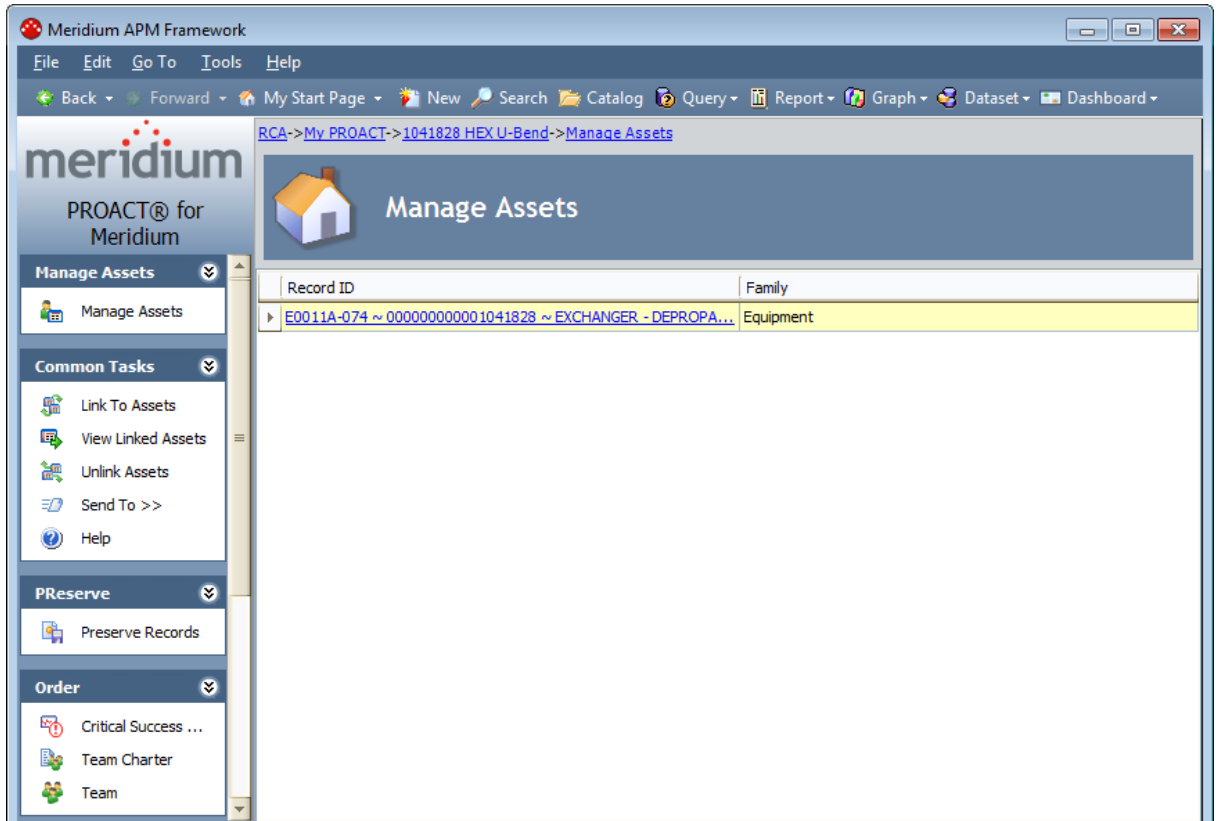

Aspects of the Manage Assets Page

The **Manage Assets** page displays a list of Equipment and Functional Location records that are linked to the RCA Analysis record associated with the current RCA Analysis.

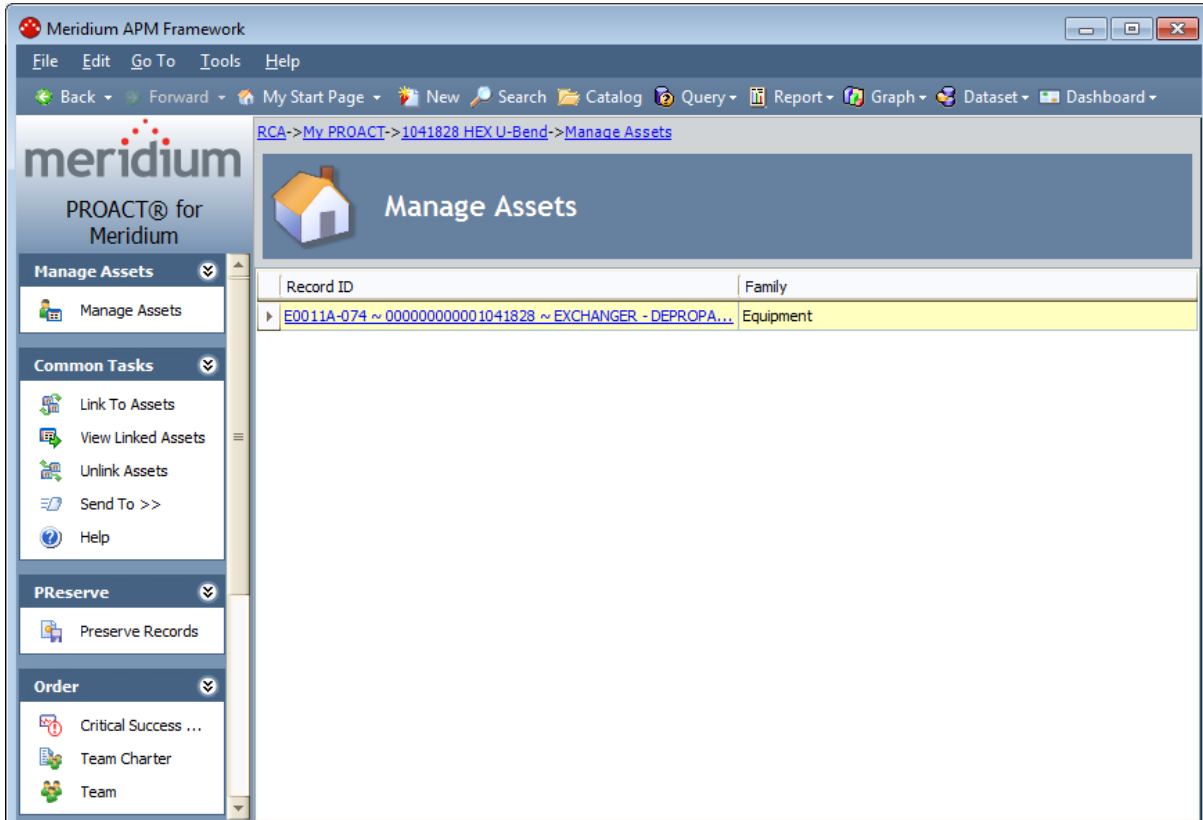

The grid on the **Manage Assets** page contains the Record ID and family of each record that is linked to the RCA Analysis record. For Equipment records, the **Record ID** column is populated with the Record ID of the linked Equipment record, and the **Family** column is populated with *Equipment*. For Functional Location records, the **Record ID** column is populated with the Record ID of the linked Functional Location record, and the **Family** column is populated with *Functional Location*. By default, linked records will be listed alphabetically, first by the **Family** column, and then by the **Record ID** column.

The **Manage Assets** page contains the following task menus:

- [Manage Assets](#)
- [Common Tasks](#)
- [PReserve](#)
- [Order](#)
- [Analyze](#)
- [Communicate](#)
- [Track](#)

Manage Assets Menu



The **Manage Assets** menu on the **Manage Assets** page contains the following link:

- **Manage Assets:** Displays the **Manage Assets** page, where you can link, view, and unlink Equipment and Functional Location records associated with the current RCA analysis.

Common Tasks Menu

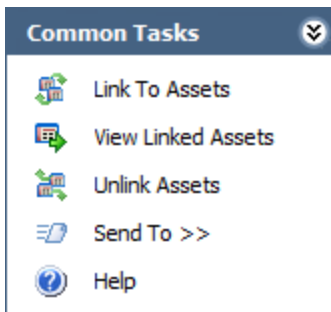

The **Common Tasks** menu on the **Manage Assets** page contains the following links:

- **Link to Assets:** Displays the **Asset Finder** window, where you can search for the Equipment or Functional Location records that you want to link to the RCA Analysis record.
- **View Linked Assets:** Displays the selected Equipment or Functional Location records in the Record Manager. This link is enabled only if the current RCA Analysis is already linked to an Equipment or Functional Location record.
- **Unlink Assets:** Displays a confirmation message, asking if you really want to unlink the selected Equipment or Functional Location records from the current RCA Analysis and then deletes the link between the RCA Analysis record and the Equipment or Functional Location records. This link is enabled only if the current RCA Analysis is already linked to an Equipment or Functional Location record.
- **Send To:** Displays a submenu of options that let you **provide a link to the current page on your desktop (create shortcut), in an email message, or on a Home Page.**
- **Help:** Displays the context sensitive help topic for the **Manage Assets** page.

PReserve Menu



The **PReserve** menu on the **Manage Assets** page contains the following link:

- **Preserve Records:** Displays the **Preserve Failure Data** page, where you can [view and manage RCA Preserve Item records for the current RCA Analysis](#).

Order Menu

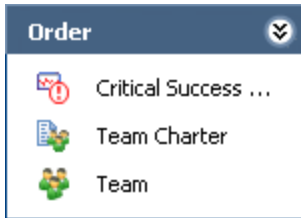

The **Order** menu on the **Manage Assets** page contains the following links:

- **Critical Success Factors:** Displays the **Critical Success Factors** page.
- **Team Charter:** Displays the **Team Charter** dialog box, where you can view and modify the Team Charter.
- **Team:** Displays the **Team** page, where you can view and manage Human Resource records for the members of the RCA Analysis Team.

Analyze Menu

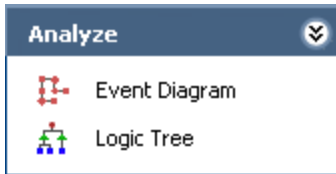

The **Analyze** menu on the **Manage Assets** page contains the following links:

- **Event Diagram:** Displays the **Event Diagram** page, where you can view and modify the Event Diagram for the current RCA Analysis.
- **Logic Tree:** Displays the **Logic Tree** page, where you can view and modify the Logic Tree for the current RCA Analysis.

Communicate Menu



The **Communicate** menu on the **Manage Assets** page contains the following links:

- **Communicate Records:** Displays the **Communicate Records** page, where you can [view, modify, and send Communicate records and RCA Recommendation records](#).
- **Reports:** Displays the **Reports List** page, where you can [view and manage reports](#) based on the data from the current RCA Analysis.

Track Menu



The **Track** menu on the **Manage Assets** page contains the following link:

- **Track:** Displays the **Analysis Tracking Items** page, where you can view and manage the [RCA Tracking Item records](#) for the current RCA Analysis.

Linking Equipment and Functional Location Records to RCA Analysis Records

The following instructions provide details on linking an Equipment or Functional Location record to an existing RCA Analysis record.

To link an Equipment record or Functional Location record to an existing RCA Analysis record:

1. [Access the Manage Assets page.](#)
2. On the **Common Tasks** menu, click the **Link to Assets** link.
The **Asset Finder** window appears.
3. Perform a search to find the Equipment or Functional Location record you want to link to the RCA Analysis record.
4. In the search results list, select the Equipment or Functional Location records that you want to link to the RCA Analysis record.
5. Click the **Select** button.

The **Asset Finder** window closes, and the selected Equipment or Functional Location records appear on the **Manage Assets** page and are now linked to the RCA Analysis record.

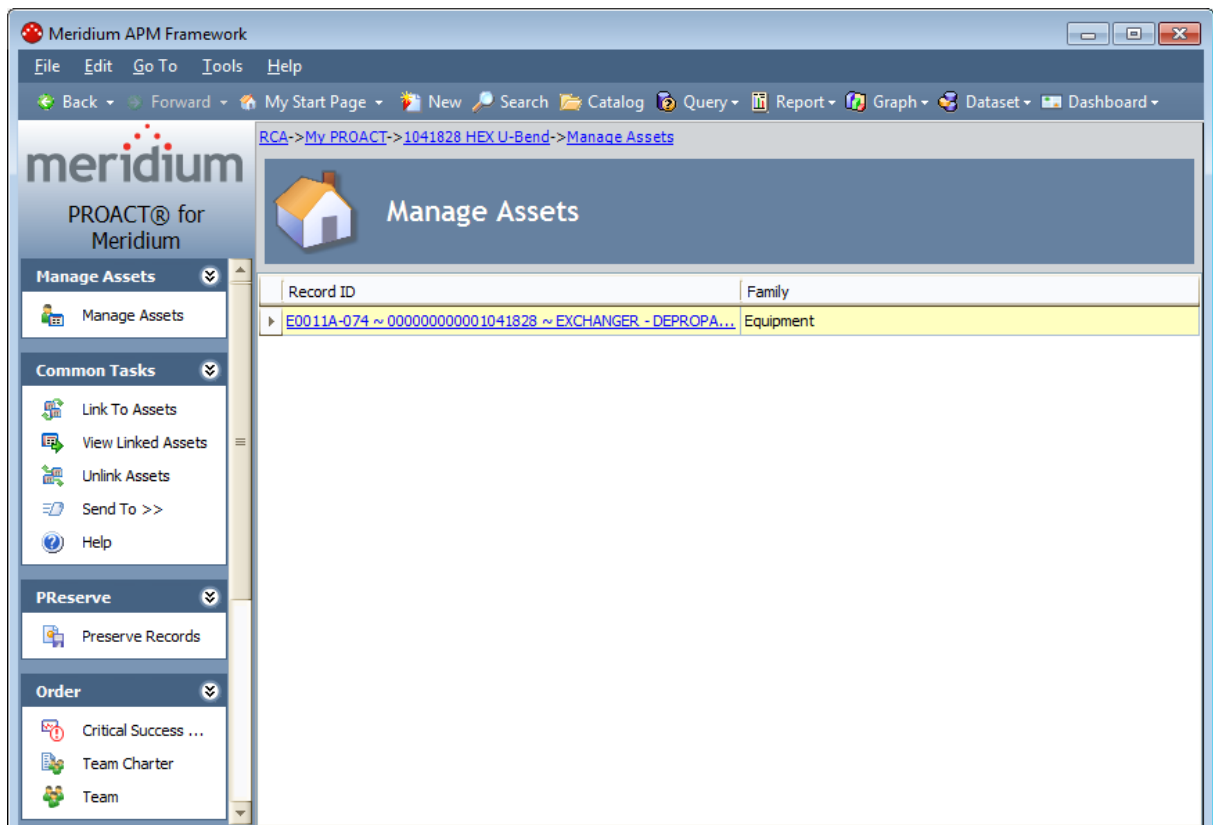

Opening Equipment and Functional Location Records Linked to RCA Analysis Records

To open the Equipment or Functional Location records that are currently linked to an RCA Analysis:

1. [Access the Manage Assets page.](#)
2. In the grid, select the rows containing the Equipment or Functional Location records that you want to open.

CEHint: Alternatively, if you only want to open one Equipment or Functional Location record, you can click the hyperlinked Record ID of the record you want to view.

3. On the **Common Tasks** menu, click the **View Linked Assets** link.

The Record Manager appears, displaying the selected Equipment and Functional Location records.

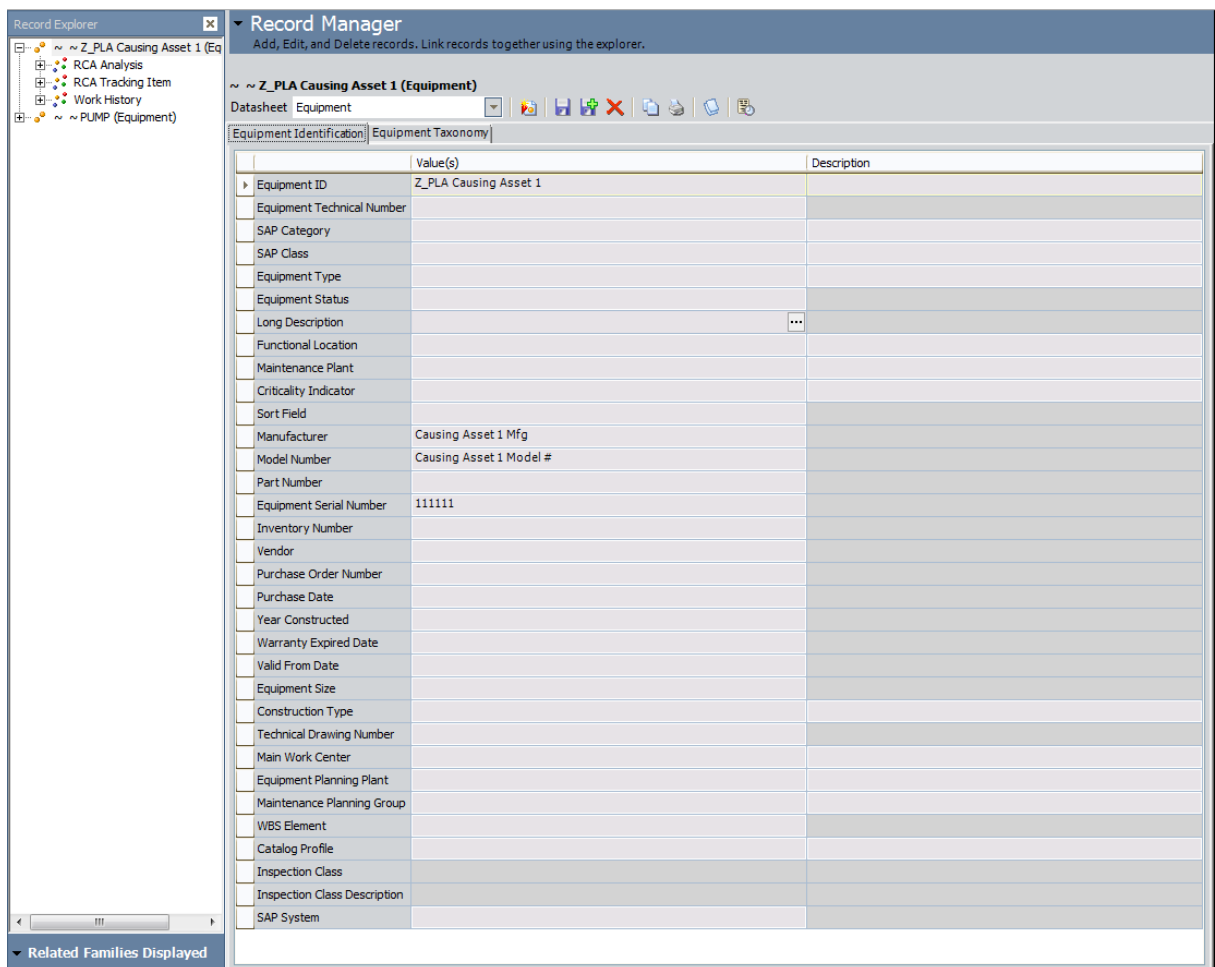

If you selected more than one record, multiple records will appear in Record Manager. The first record that you selected in the grid on the **Manage Assets** page will be expanded in the **Record Explorer** pane and displayed in the datasheet area. The rest of the records appear collapsed in the **Record Explorer** pane.

Unlinking Equipment or Functional Location Records from RCA Analysis Records

To unlink an Equipment or Functional Location record from an RCA Analysis record:

1. [Access the Manage Assets page.](#)
2. Select the Equipment and Functional Location records you want to unlink from the analysis by selecting one or more rows in the **Manage Assets** grid.
3. On the **Common Tasks** menu, click the **Unlink Assets** link.

A confirmation message appears, asking if you really want to delete the link.

4. Click **OK**.

The links between the selected Equipment and Functional Location records and the RCA analysis record are deleted, and the Equipment and Functional Location records no longer appear in the list on the **Manage Assets** page.

About CSFs

Critical Success Factors (CSFs) are elements of an RCA Analysis that allow the analysis team to evaluate whether or not the analysis effort has been successful. The RCA Analysis effort is considered to be successful if the analysis team adheres to and meets the standards defined by the CSFs.

RCA uses two types of CSFs.

- **Default CSFs:** RCA Critical Success Factors that are available for use in all RCA Analyses. Default CSFs are stored as system preferences and appear on the **Administrative Functions** page and in the **New Analysis Builder**. Default CSFs are not stored in a record until they are added to an RCA Analysis. When a Default CSF is added, a new RCA Critical Success Factor record is created and populated automatically with the Default CSF text, then linked to the RCA Analysis record.
- **Custom CSFs:** RCA Critical Success Factor records that are linked to a specific RCA Analysis record. When Custom CSFs are created for an RCA Analysis, a new RCA Critical Success Factor record is created and linked to the RCA Analysis record.

A baseline set of Default CSFs is provided with the RCA module and appear on the **Administrative Functions** page, where an administrative user can modify them and define their own Default CSFs. All Default CSFs (baseline and custom) will be available for selection in the **New Analysis Builder** when you create an RCA Analysis.

Additionally, you can define Custom CSFs for each RCA Analysis. Custom CSFs are defined for a single RCA Analysis and stored in RCA Critical Success Factor records. You can define custom CSFs via the **New Analysis Builder** and the **Critical Success Factors** page.

All RCA Critical Success Factor records for the current RCA Analysis are displayed on the [Critical Success Factor page](#). An RCA Critical Success Factor record exists for each CSF that is linked to an RCA Analysis record.

Accessing the Critical Success Factors Page

To access the Critical Success Factors page:

- On the [Analysis page](#), on the **Order** menu, click the **Critical Success Factors** link.

The **Critical Success Factors** page appears, displaying a list of CSFs that have been created for the current RCA Analysis.

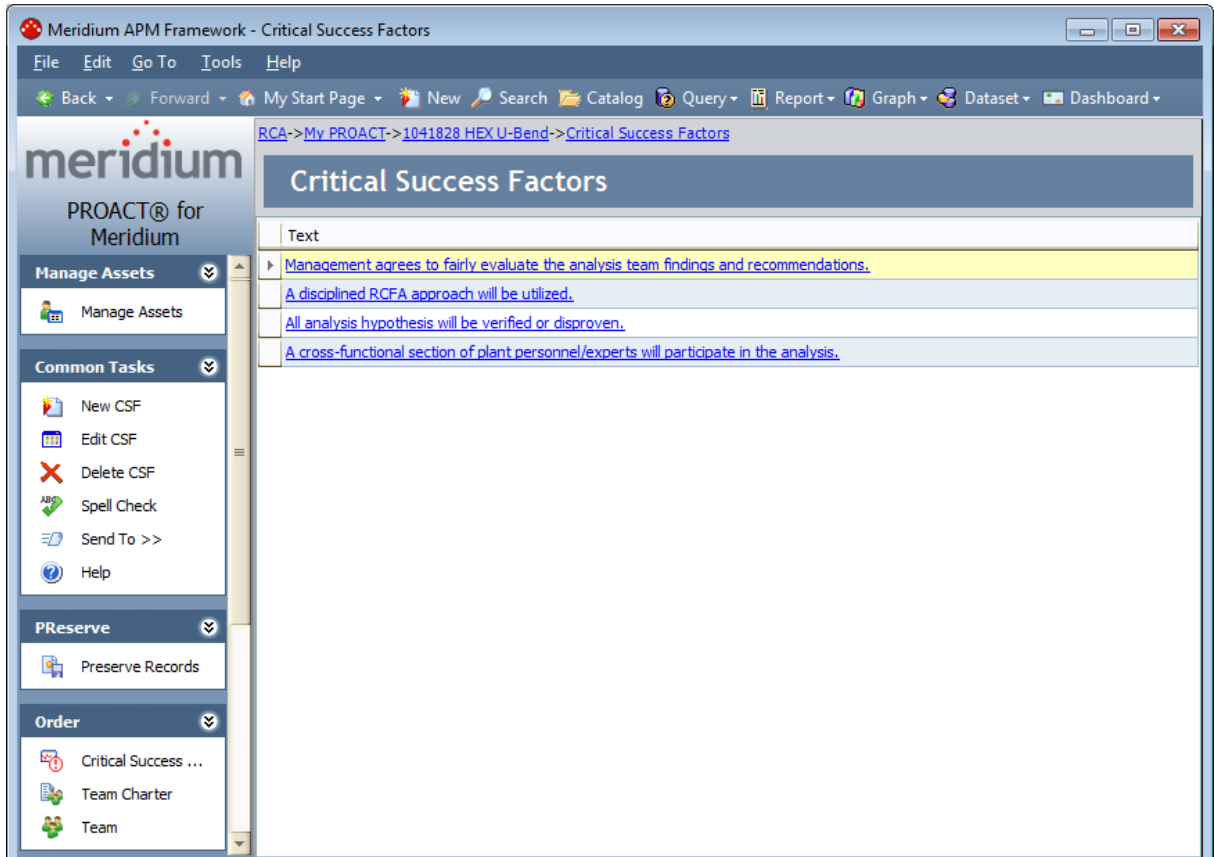

Aspects of the Critical Success Factors Page

The **Critical Success Factors** page displays a list of Critical Success Factors that have been created for the current RCA Analysis.

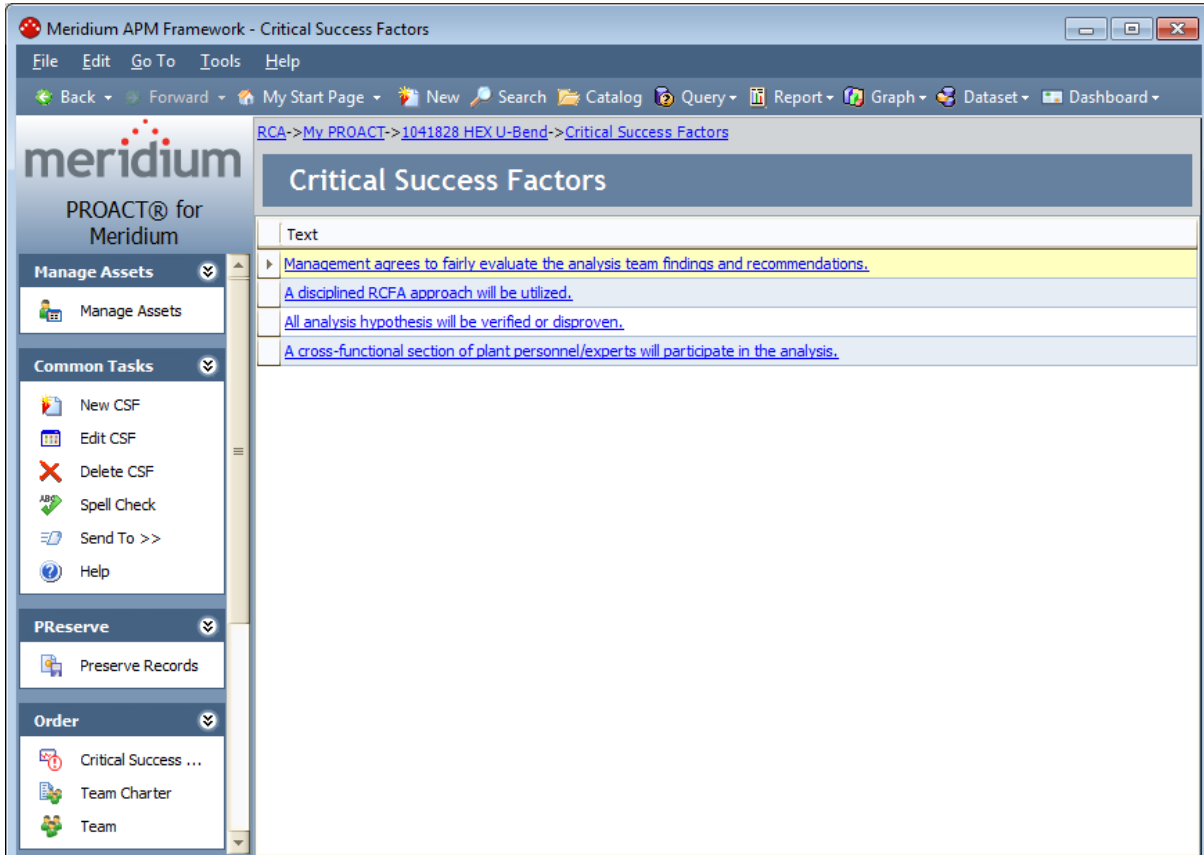

The **Critical Success Factors** page contains the following task menu:

- [Manage Assets](#)
- [Common Tasks](#)
- [PReserve](#)
- [Order](#)
- [Analyze](#)
- [Communicate](#)
- [Track](#)

Manage Assets Menu



The **Manage Assets** menu on the **Critical Success Factors** page contains the following link:

- **Manage Assets:** Displays the **Manage Assets** page, where you can link, view, and unlink Equipment and Functional Location records associated with the current RCA analysis.

Common Tasks Menu

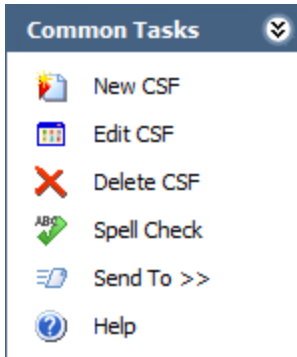

The **Common Tasks** menu on the **Critical Success Factors** page contains the following links:

- **New CSF:** Displays the **CSF Details** page, where you can [create a new RCA Critical Success Factor record](#).
- **Edit CSF:** Displays the **CSF Details** page, where you can [modify the selected RCA Critical Success Factor record](#).
- **Delete CSF:** After displaying a confirmation message, [deletes the selected RCA Critical Success Factor record](#).
- **Spell Check:** Displays the **Spell Check** dialog box, which allows you to perform a [spell check operation](#) on the text and character fields in records belonging to the current RCA Analysis.
- **Send To:** Displays a submenu of options that let you provide a link to the current page on your desktop (create shortcut), in an email message, or on a Home Page.
- **Help:** Displays the context sensitive help topic for the **Critical Success Factors** page.

PReserve Menu



The **PReserve** menu on the **Critical Success Factors** page contains the following link:

- **Preserve Records:** Displays the **Preserve Failure Data** page, where you can [view and manage RCA Preserve Item records for the current RCA Analysis](#).

Order Menu

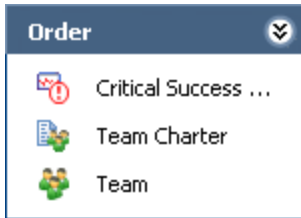

The **Order** menu on the **Critical Success Factors** page contains the following links:

- **Critical Success Factors:** Displays the **Critical Success Factors** page. This link is available on other pages in Root Cause Analysis.
- **Team Charter:** Displays the **Team Charter** dialog box, where you can view and modify the Team Charter.
- **Team:** Displays the **Team** page, where you can view and manage Human Resource records for the members of the RCA Analysis Team.

Analyze Menu

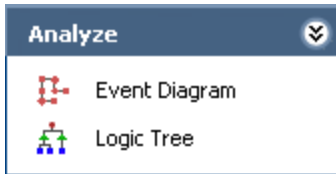

The **Analyze** menu on the **Critical Success Factors** page contains the following links:

- **Event Diagram:** Displays the **Event Diagram** page, where you can view and modify the Event Diagram for the current RCA Analysis.
- **Logic Tree:** Displays the **Logic Tree** page, where you can view and modify the Logic Tree for the current RCA Analysis.

Communicate Menu



The **Communicate** menu on the **Critical Success Factors** page contains the following links:

- **Communicate Records:** Displays the **Communicate Records** page, where you can [view, modify, and send Communicate records and RCA Recommendation records.](#)
- **Reports:** Displays the **Reports List** page, where you can [view and manage reports](#) based on the data from the current RCA Analysis.

Track Menu



The **Track** menu on the **Critical Success Factors** page contains the following link:

- **Track:** Displays the **Analysis Tracking Items** page, where you can view and manage the [RCA Tracking Item records](#) for the current RCA Analysis.

Creating a New RCA Critical Success Factor Record

The following instructions provide information on creating a new RCA Critical Success Factor record from the **Critical Success Factors** page.

To create a new RCA Critical Success Factor record for an RCA Analysis:

1. On the [Critical Success Factors page](#), on the **Common Tasks** menu, click the **New CSF** link.

The **CSF Details** page appears, displaying a new RCA Critical Success Factor record.

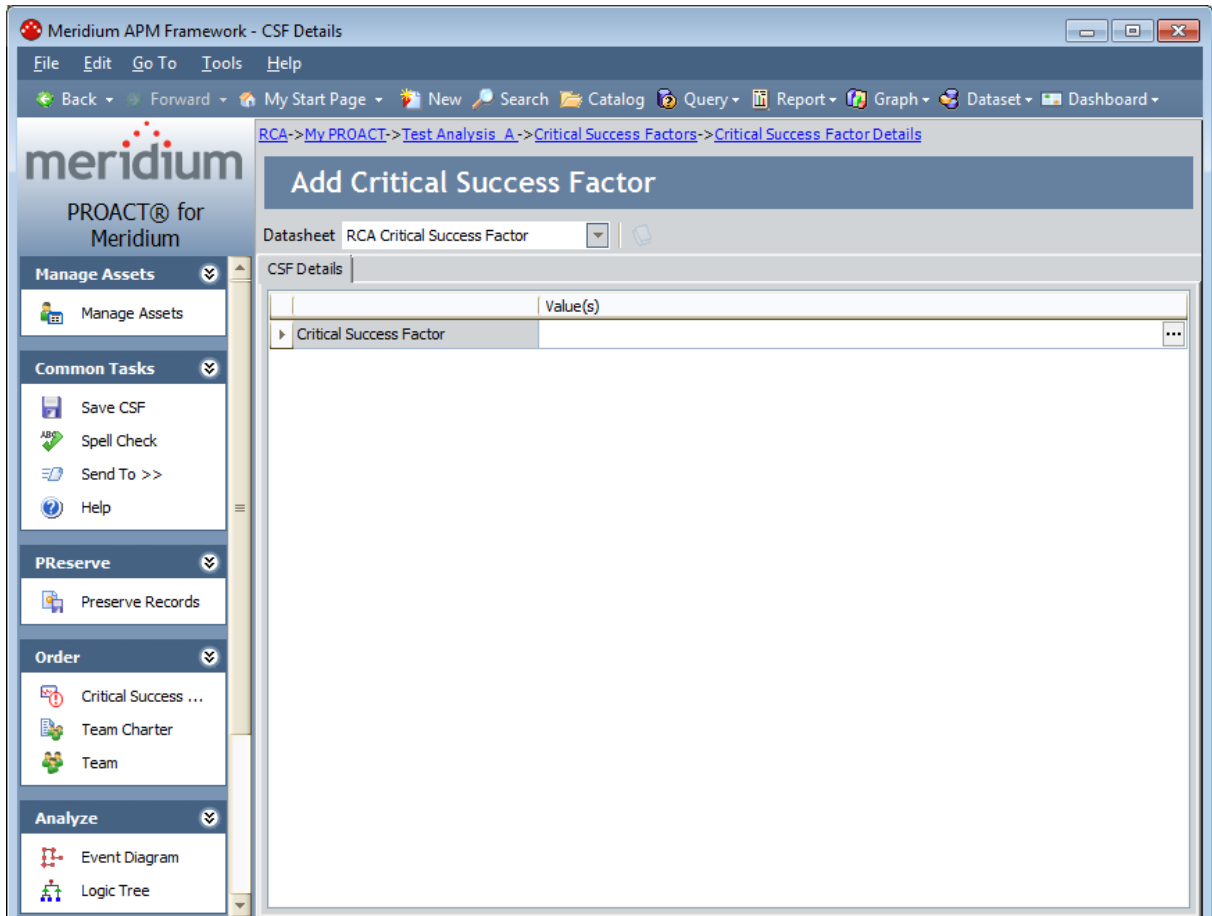

2. In the **Value(s)** column, type the details of the CSF, or click the  button to enter the details using the Text Editor, which is shown in the following image.

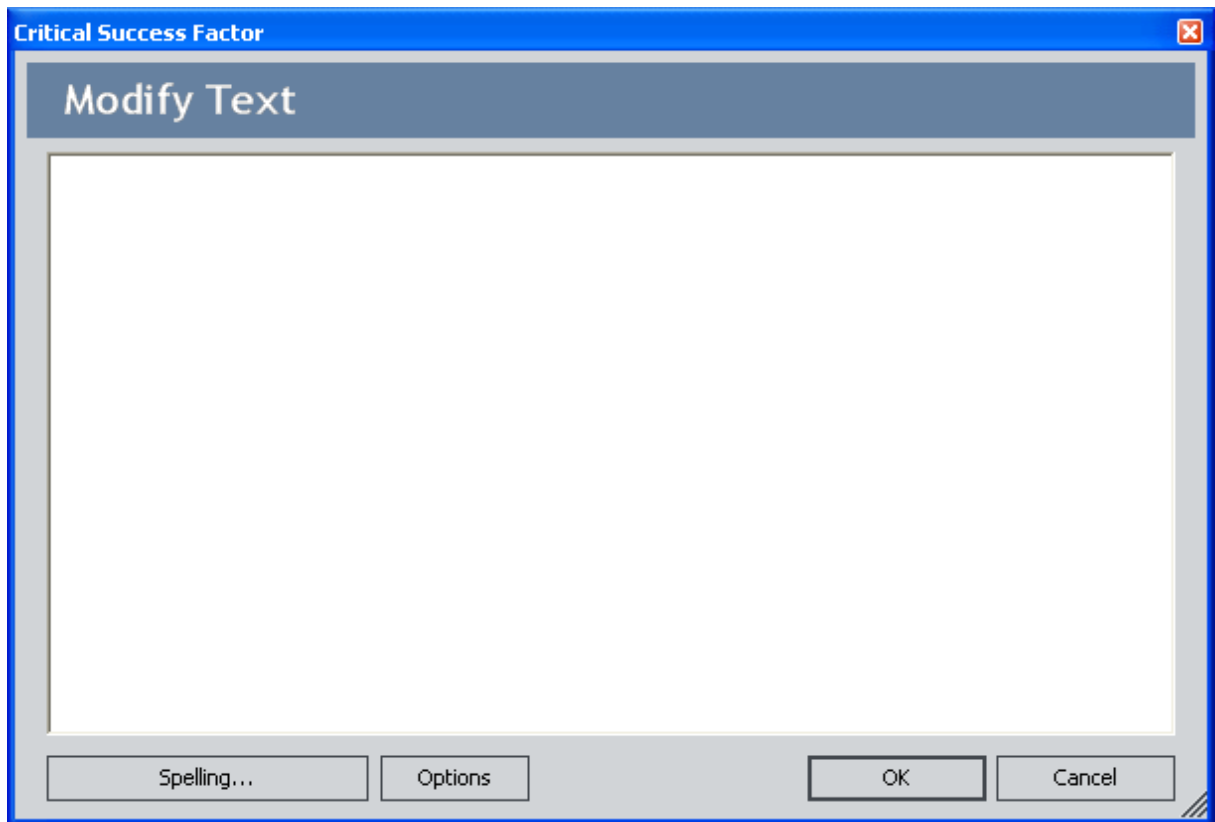

3. On the **Common Tasks** menu, click the **Save CSF** link.

The RCA Critical Success Factor record is created and linked automatically to the RCA Analysis record for the current RCA Analysis, and the **Critical Success Factors** page appears.

Creating a New RCA Critical Success Factor Record

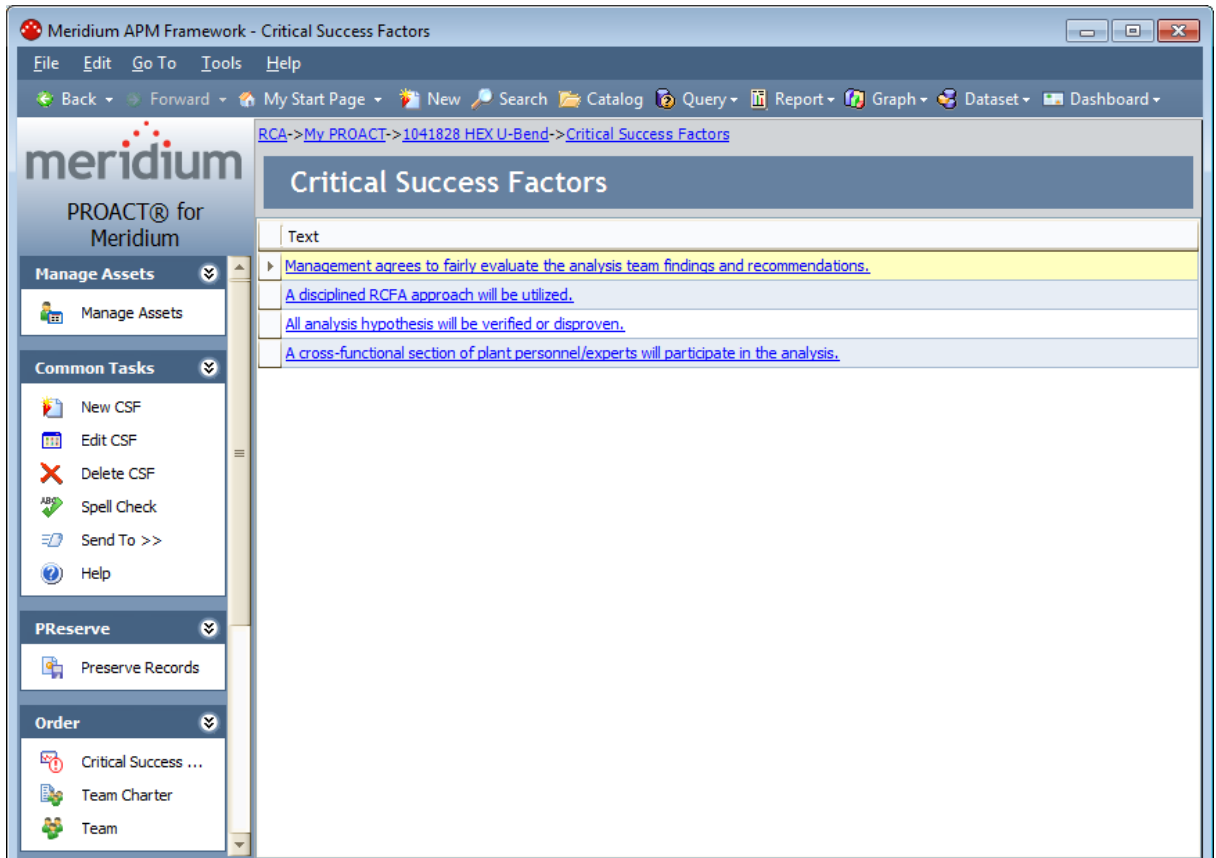

Viewing or Modifying the Details of a Critical Success Factor

To view or modify the details of a CSF:

1. On the [Critical Success Factors page](#), in the list of RCA Critical Success Factor records, click the hyperlink for the record whose details you want to view or modify.

The **CSF Details** page appears, displaying the details of the selected CSF.

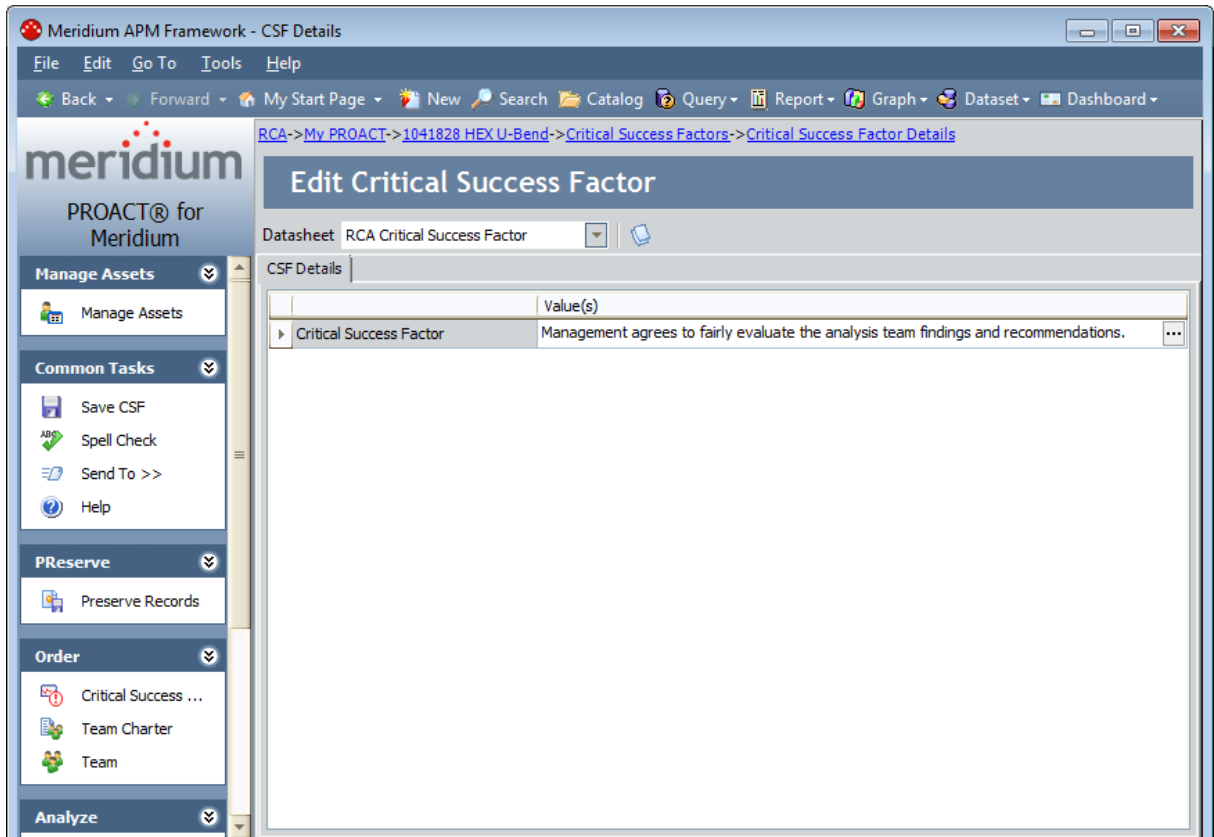

2. In the Value(s) column, modify the text as desired. You can click the **...** button to modify the text using the Text Editor, which is shown in the following image.

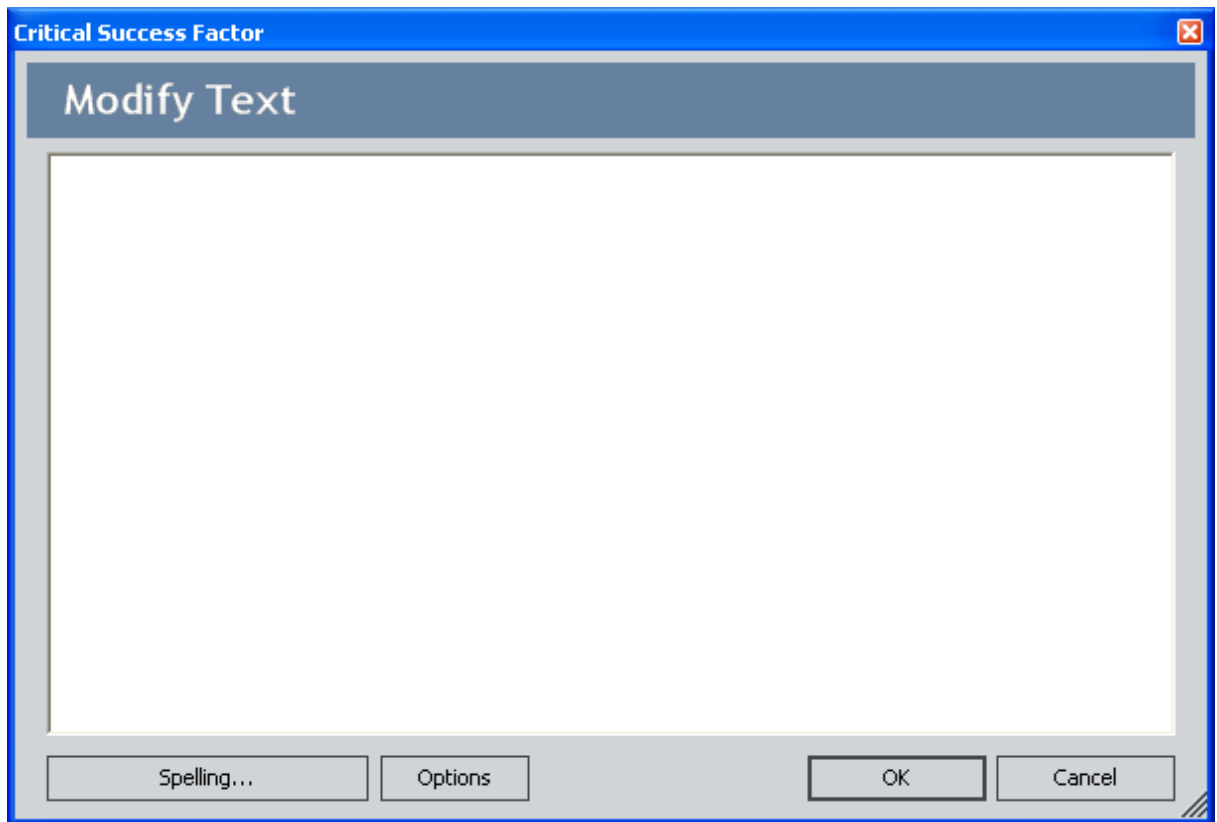

3. On the **Common Tasks** menu, click the **Save CSF** link.
Your changes are saved, and the **Critical Success Factors** page appears.

Viewing or Modifying the Details of a Critical Success Factor

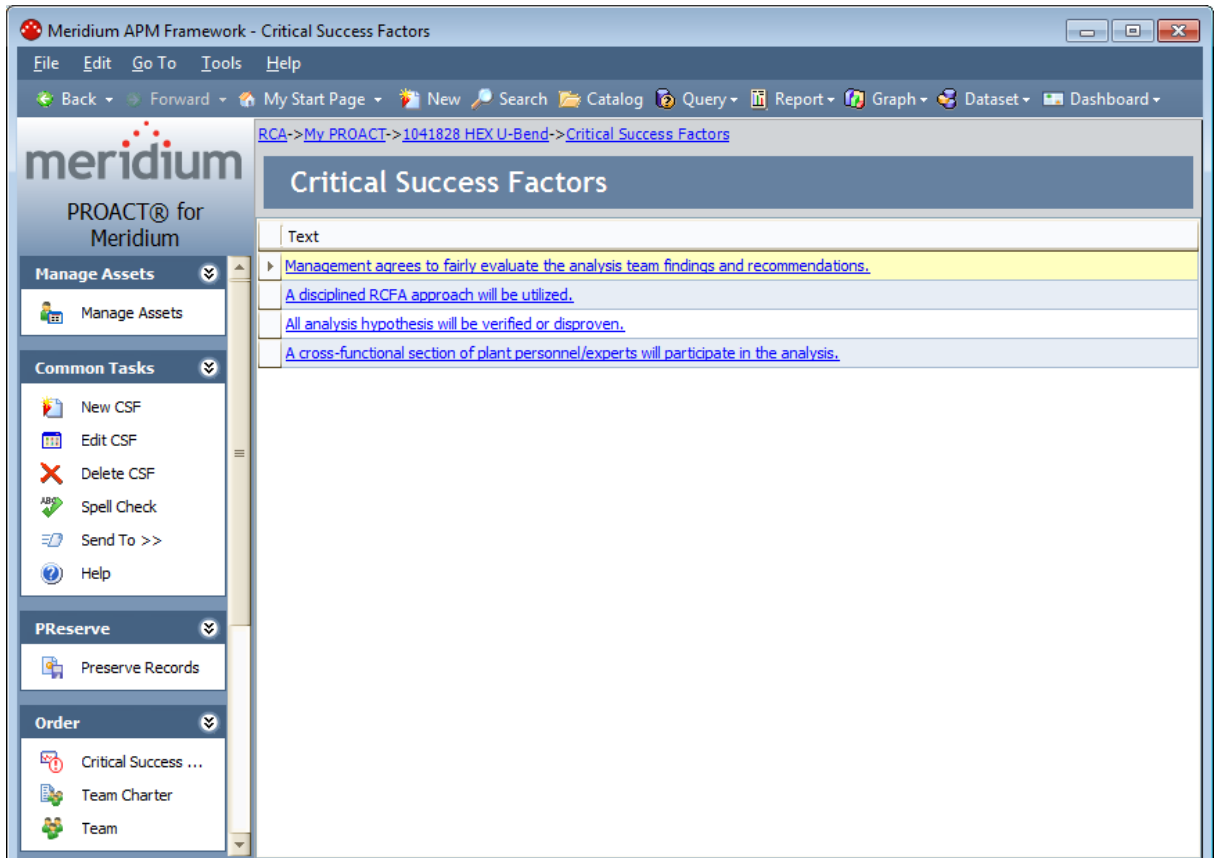

Deleting Critical Success Factors

To remove a Critical Success Factor from the RCA Analysis:

1. On the [Critical Success Factors page](#), in the **Critical Success Factors** list, select the row containing the CSF that you want to delete.

| Critical Success Factors | |
|-------------------------------------|---|
| | Text |
| <input type="checkbox"/> | Management agrees to fairly evaluate the analysis team findings and recommendations. |
| <input type="checkbox"/> | A cross-functional section of plant personnel/experts will participate in the analysis. |
| <input type="checkbox"/> | A disciplined RCFA approach will be utilized. |
| <input type="checkbox"/> | No one will be disciplined for honest mistakes. |
| <input type="checkbox"/> | All analysis hypothesis will be verified or disproven. |
| <input checked="" type="checkbox"/> | A measurement process will be used to track the progress of approved recommendations. |

2. On the **Common Tasks** menu, click the **Delete CSF** link.

A confirmation message appears, asking if you really want to delete the CSF.

3. Click the **Yes** button.

The CSF is removed from the RCA Analysis, the link between the RCA Critical Success Factor record and the RCA Analysis record is removed, and the CSF no longer appears in the list on the **Critical Success Factors** page.

| Critical Success Factors | |
|-------------------------------------|---|
| | Text |
| <input type="checkbox"/> | Management agrees to fairly evaluate the analysis team findings and recommendations. |
| <input type="checkbox"/> | A cross-functional section of plant personnel/experts will participate in the analysis. |
| <input type="checkbox"/> | A disciplined RCFA approach will be utilized. |
| <input type="checkbox"/> | No one will be disciplined for honest mistakes. |
| <input checked="" type="checkbox"/> | All analysis hypothesis will be verified or disproven. |

About the Team Charter

The *Team Charter* defines the goal that the RCA Analysis Team wants to achieve by developing an RCA Analysis. The baseline RCA module contains a default Team Charter that you can modify and use as desired. An administrative user will specify [the default Team Charter](#) that can be accessed in the **New Analysis Builder** when you create the RCA Analysis. You can modify the default Team Charter as desired.

After you have defined a Team Charter for the RCA Analysis, you can view and modify it via the **Order** menu on most pages in Root Cause Analysis by clicking the **Team Charter** link.

Modifying the Team Charter

The following instructions provide details on modifying the Team Charter for an RCA Analysis.

To modify the Team Charter for an RCA Analysis:

1. On the [Analysis page](#), on the **Order** menu, click the **Team Charter** link.

The **Team Charter** dialog box appears, displaying the current Team Charter. If the Team Charter was not modified when the initial steps required for an RCA Analysis were completed, the default text will be displayed in the text box.

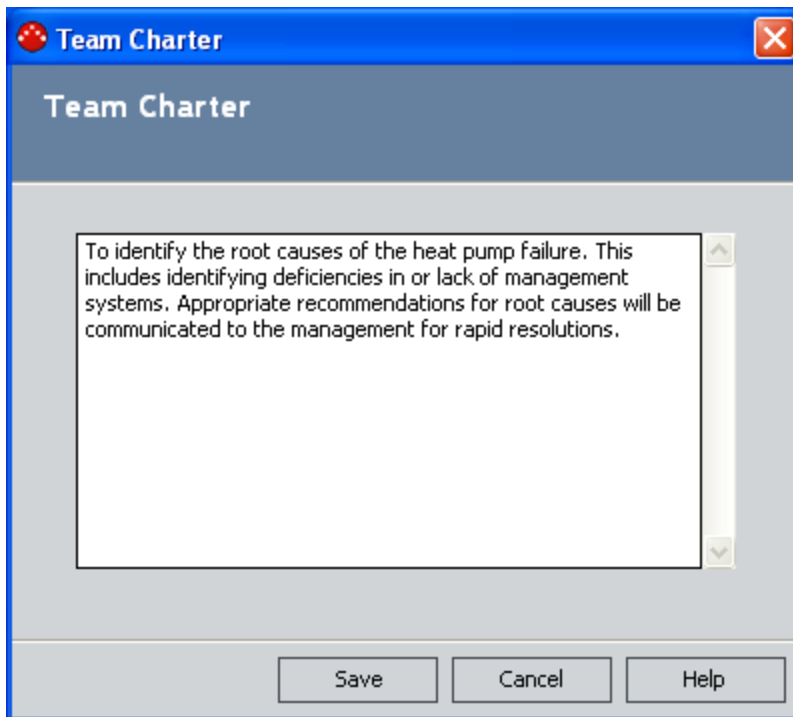

2. Modify the existing text or type new text as desired.
3. Click the **Save** button.

Your changes are saved, and the **Team Charter** dialog box closes.

About the RCA Analysis Team

The *RCA Analysis Team* is the group of individuals who will complete the [steps required for a comprehensive RCA Analysis](#). Security permissions in Root Cause Analysis are based upon family-level privileges and a user's role within a given RCA Analysis. Root Cause Analysis users who are members of the RCA Analysis Team will have one of the following RCA Analysis team member roles:

- **Principal Analyst:** The user who is responsible for facilitating and coordinating the RCA Analysis.
- **Analysis Team Member:** Any user who is a member of an RCA Analysis Team.

When you add new members to the RCA Analysis Team, an RCA Team Member record is created automatically and linked to the RCA Analysis record and the individual's Human Resource record. If the same team member is linked to multiple analyses, an RCA Team Member record will exist for *each* RCA Analysis team in which they are a member. The RCA Team Member record stores the RCA Analysis Team member's role (i.e., Team Member or Principal Analyst). A given team member's role determines the [security privileges](#) that the user has in Root Cause Analysis.

You can add Meridium APM users and non-Meridium APM users to the RCA Analysis Team.

- Meridium APM users will have an existing Meridium APM Security User account and an associated Human Resource record that is created automatically when the Security User account is created.
- Non-Meridium APM users will not have a Meridium APM Security User account. To add a non-Meridium APM user to the RCA Analysis Team, you first need to create a Human Resource record for that user. You can do so via [the Team page](#) in Root Cause Analysis or using Meridium APM Framework Tools.

Note: A Meridium APM Security User record is required for logging in to the Meridium APM Framework application and using Root Cause Analysis. RCA Analysis team members who do not have a Security User account may participate in and contribute to the analysis but will not be able to use the application.

After you add a new team member to the RCA Analysis Team, that user will inherit the [security privileges](#) associated with the user's team member role (e.g., Principal Analyst).

Accessing the Team Page

You can access the **Team** page via the **Order** menu on any of the following pages:

- Analysis page
- Preserve Failure Data page
- Preserve Record Details page
- Critical Success Factors page
- Event Diagram page
- Logic Tree page

To access the **Team** page:

- On the **Order** menu, click the **Team** link.

The **Team** page appears, displaying a list of the users who are members of the RCA Analysis Team for the current RCA Analysis.

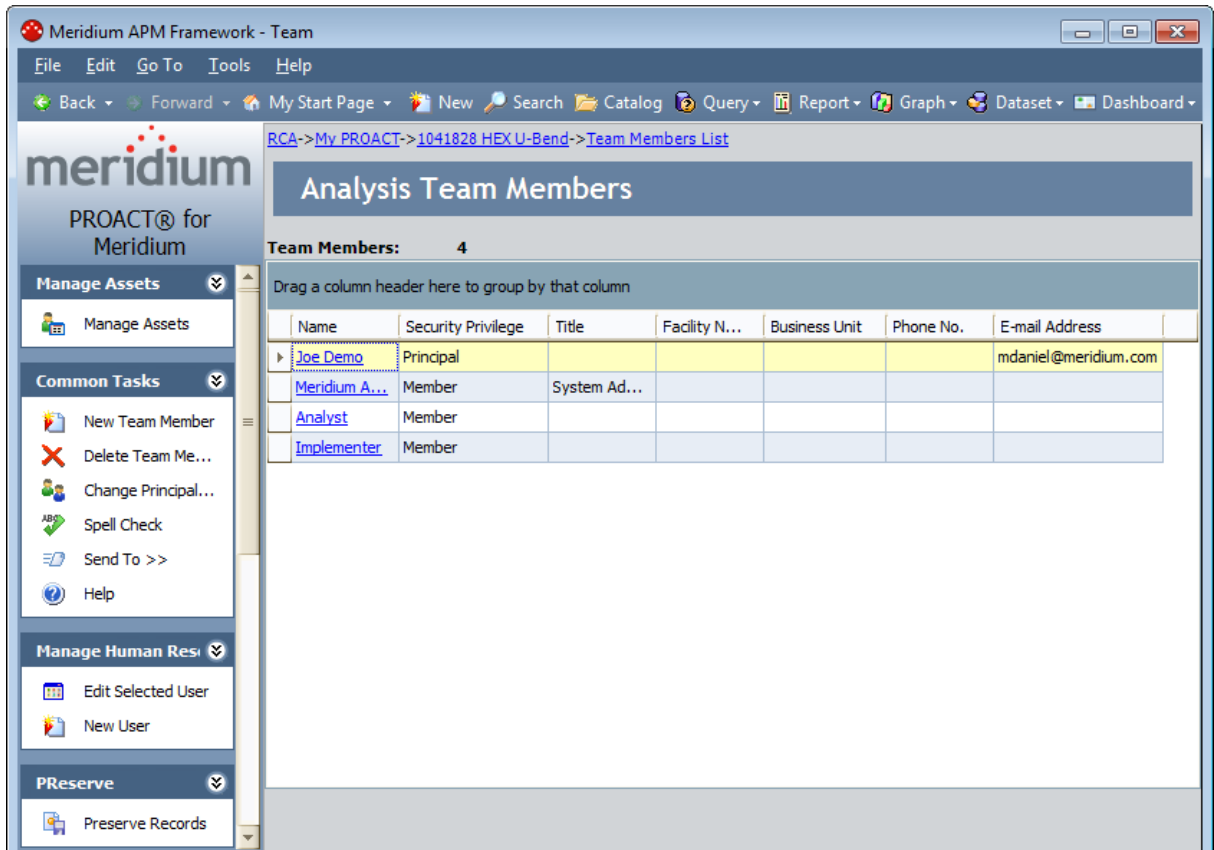

Aspects of the Team Page

The **Team** page displays a list of all the members of the RCA Analysis Team for the current RCA Analysis.

The screenshot shows the Meridium APM Framework - Team application window. The browser address bar indicates the path: RCA->My PROACT->1041828 HEX U-Bend->Team Members List. The page title is "Analysis Team Members". Below the title, it states "Team Members: 4". A table lists the team members with columns for Name, Security Privilege, Title, Facility Name, Business Unit, Phone No., and E-mail Address. The first row is highlighted in yellow and shows "Joe Demo" as the Principal Analyst with the email mddaniel@meridium.com. Other team members listed are Meridium Analyst and Implementer, both with Member security privileges.

| Name | Security Privilege | Title | Facility N... | Business Unit | Phone No. | E-mail Address |
|---------------|--------------------|--------------|---------------|---------------|-----------|-----------------------|
| Joe Demo | Principal | | | | | mddaniel@meridium.com |
| Meridium A... | Member | System Ad... | | | | |
| Analyst | Member | | | | | |
| Implementer | Member | | | | | |

The values that appear in each column on the **Team** page are stored in the team member's Human Resource record and RCA Team Member record. The following information appears for each team member in the list:

- **Name:** The name of the team member. This value is stored in the Human Resource record.
- **Security Privilege:** The role assigned to the team member. The team member who is the Principal Analyst is assigned *Principal* security privileges. All other team members are assigned *Member* security privileges. This value is stored in the RCA Team Member record.
- **Title:** The job title of the team member. This value is stored in the Human Resource record.
- **Facility Name:** The name of the facility that the team member represents. This value is stored in the Human Resource record.
- **Business Unit:** The business unit within the facility that the team member represents. This value is stored in the Human Resource record.

- **Phone No.:** The phone number for the team member. This value is stored in the Human Resource record.
- **E-mail Address:** The email address for the team member. This value is stored in the Human Resource record.

Note: You can customize the display of the team member grid in several ways including, adding additional columns, sorting columns, and filtering the list.

On the **Team** page, you can:

- [View](#) and [modify](#) the contents of team members' Human Resource records.
- [Add new team members to the RCA Analysis Team.](#)
- [Delete team members.](#)

The **Team** page contains the following task menus:

- [Manage Assets](#)
- [Common Tasks](#)
- [Manage Human Resources](#)
- [PReserve](#)
- [Order](#)
- [Analyze](#)
- [Communicate](#)
- [Track](#)
- **Associated Pages**

Note: Items appear on the **Associated Pages** menu only if Associated Pages have been configured for the RCA Analysis family.

Manage Assets Menu



The **Manage Assets** menu on the **Team** page contains the following link:

- **Manage Assets:** Displays the **Manage Assets** page, where you can link, view, and unlink Equipment and Functional Location records associated with the current RCA analysis.

Common Tasks Menu

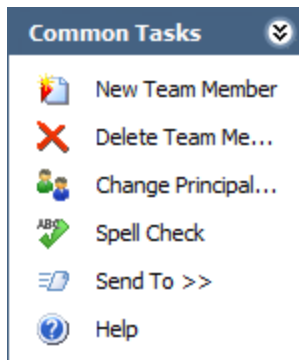

The **Common Tasks** menu on the **Team** page contains the following links:

- **New Team Member:** Displays the **Find Team Member** window, where you can search the Human Resource family for the record associated with the user that you want to add as a new team member. This link is enabled only if you are a member of the MI PROACT Administrator Security Group, a Super User, or the Principal Analyst for the current RCA Analysis.
- **Delete Team Member:** Removes the selected RCA Analysis Team member from the RCA Analysis Team after displaying a confirmation message. This link is enabled only if the row containing a team member's name is selected and you are a member of the MI PROACT Administrator Security Group, a Super User, or the Principal Analyst for the current RCA Analysis.
- **Change Principal Analyst:** Changes the selected user to the Principal Analyst role after displaying a confirmation message. This link is enabled only if a row containing a team member's name is selected and you are a member of the MI PROACT Administrator Security Group, a Super User, or the Principal Analyst for the current RCA Analysis.
- **Spell Check:** Displays the **Spell Check** dialog box, which allows you to perform a [spell check operation](#) on the text and character fields in records belonging to the current RCA Analysis.
- **Send To:** Displays a submenu of options that let you provide a link to the current page on your desktop (create shortcut), in an email message, or on a Home Page.
- **Help:** Displays the context-sensitive help topic for the **Team** page.

Manage Human Resources Menu



The **Manage Human Resources** menu on the **Team** page contains the following links:

- **Edit Selected User:** Displays the **User Details** page, where you can view and modify the Human Resource record associated with the selected team member. This link is enabled only if a row containing a team member's name is selected and you are a member of the MI PROACT Administrator Security Group, a Super User, or the Principal Analyst for the current RCA Analysis.
- **New User:** Displays the **User Details** page, where you can define a Human Resource record for a non-Meridium APM user and add them to the RCA Analysis Team. This link is enabled only if you are a member of the MI PROACT Administrator Security Group, a Super User, or the Principal Analyst for the current RCA Analysis.

PReserve Menu



The **PReserve** menu on the **Team** page contains the following link:

- **Preserve Records:** Displays the **Preserve Failure Data** page, where you can [view and manage RCA Preserve Item records for the current RCA Analysis](#).

Order Menu

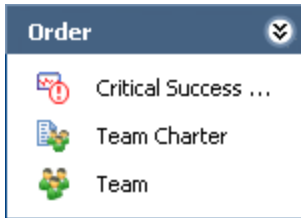

The **Order** menu on the **Team** page consists of the following links:

- **Critical Success Factors:** Displays the **Critical Success Factors** page.
- **Team Charter:** Displays the **Team Charter** dialog box, where you can view and modify the Team Charter.
- **Team:** Displays the **Team** page, where you can view and manage Human Resource records for the members of the RCA Analysis Team. This link is available on other pages in Root Cause Analysis.

Analyze Menu

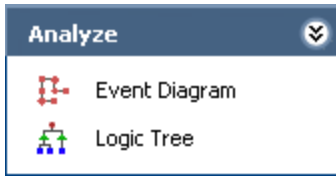

The **Analyze** menu on the **Team** page contains the following links:

- **Event Diagram:** Displays the **Event Diagram** page, where you can view and modify the Event Diagram for the current RCA Analysis.
- **Logic Tree:** Displays the **Logic Tree** page, where you can view and modify the Logic Tree for the current RCA Analysis.

Communicate Menu



The **Communicate** menu on the **Team** page contains the following links:

- **Communicate Records:** Displays the **Communicate Records** page, where you can [view, modify, and send Communicate records and RCA Recommendation records](#).
- **Reports:** Displays the **Reports List** page, where you can [view and manage reports](#) based on the data from the current RCA Analysis.

Track Menu



The **Track** menu on the **Team** page contains the following link:

- **Track:** Displays the **Analysis Tracking Items** page, where you can view and manage the [RCA Tracking Item records](#) for the current RCA Analysis.

About Adding New Team Members to the RCA Analysis Team

Two options appear on the **Team** page that let you add a new member to the RCA Analysis Team:

- **New Team Member:** Use this option if you want to [add to the RCA Analysis Team a user who already has a Human Resource record](#). This option appears as a link on the **Common Tasks** menu.
- **New User:** Use this option if you want to [add to the RCA Analysis Team a user who does not have an existing Human Resource record](#). This option appears as a link on the **Manage Human Resources** menu.

Note: If a Team Member will need to perform tasks within the RCA module, in addition to the Human Resource record, the Team Member must also have a Security User record. Using the Meridium APM Framework, you can promote a Human Resource record to a Security User record.

Adding Team Members Who Already Have Human Resource Records

The following instructions provide details on adding a person to the RCA Analysis Team who already has a Human Resource record. If the person who you want to add to the RCA Analysis Team does not have a Human Resource record, you will need to [create the Human Resource record and automatically add the person to the RCA Analysis Team](#).

Note: A given Human Resource record can be added to the RCA Analysis Team only once.

To add a person to the RCA Analysis Team who already has a Human Resource record:

1. [Access the Team page](#).

The **Team** page appears, displaying a list of existing team members.

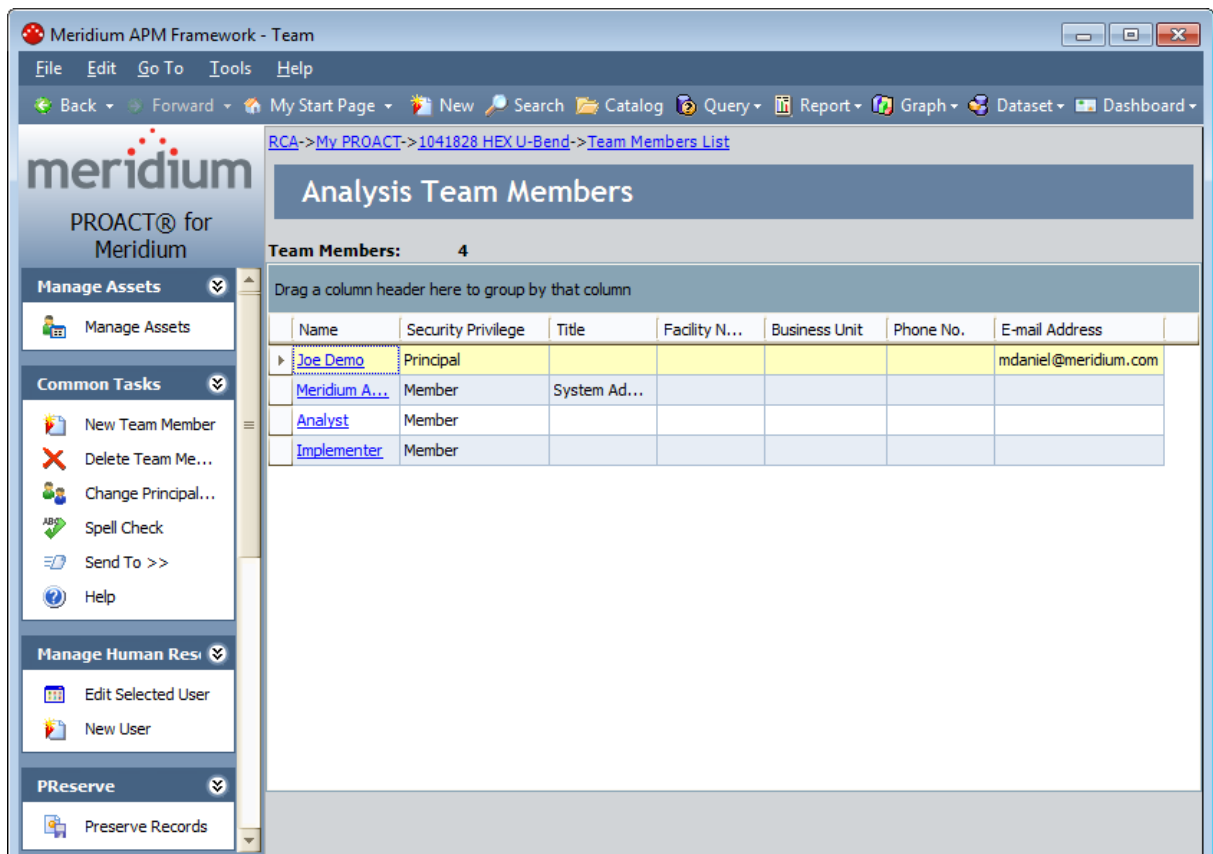

2. On the **Common Tasks** menu, click the **New Team Member** link.

The **Find Team Member** window appears. The **Search In** list contains the Human Resource family by default and cannot be changed.

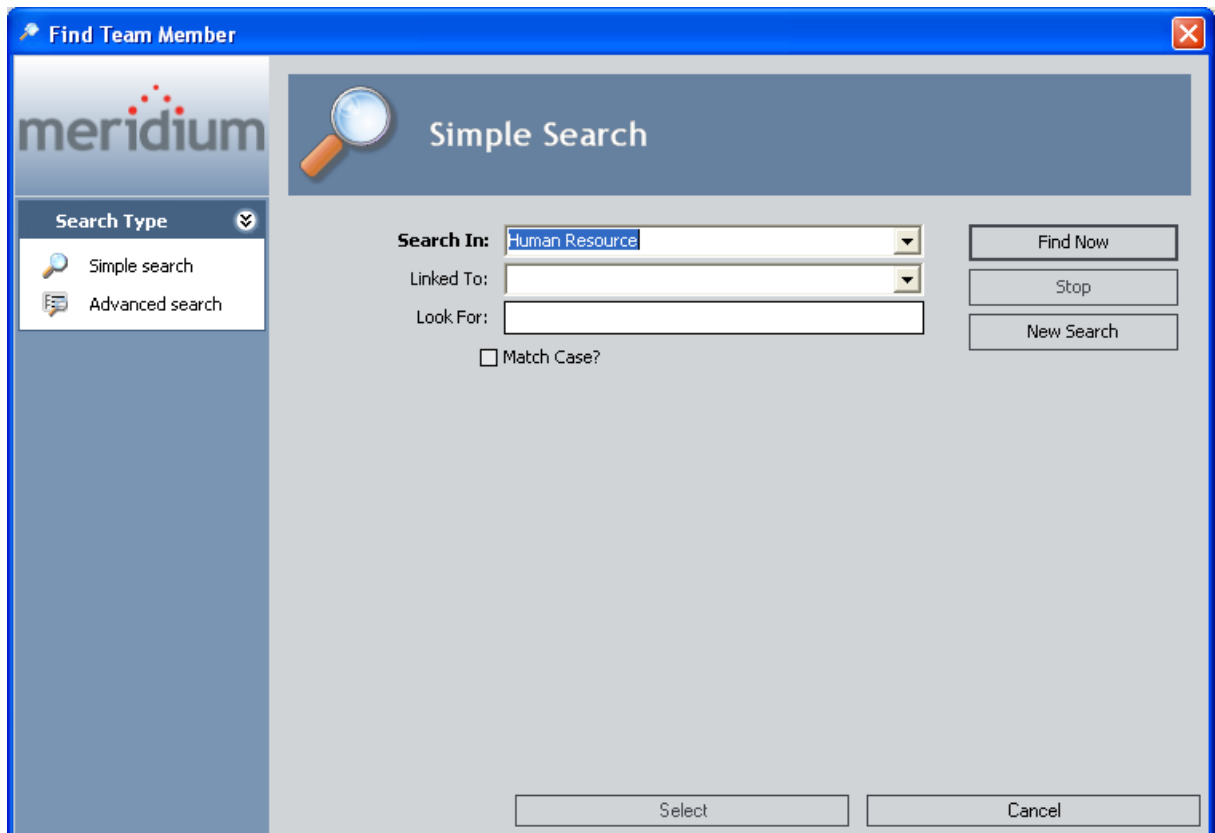

3. Perform a search in the **Human Resources** family to locate the desired team member.

The search results appear.

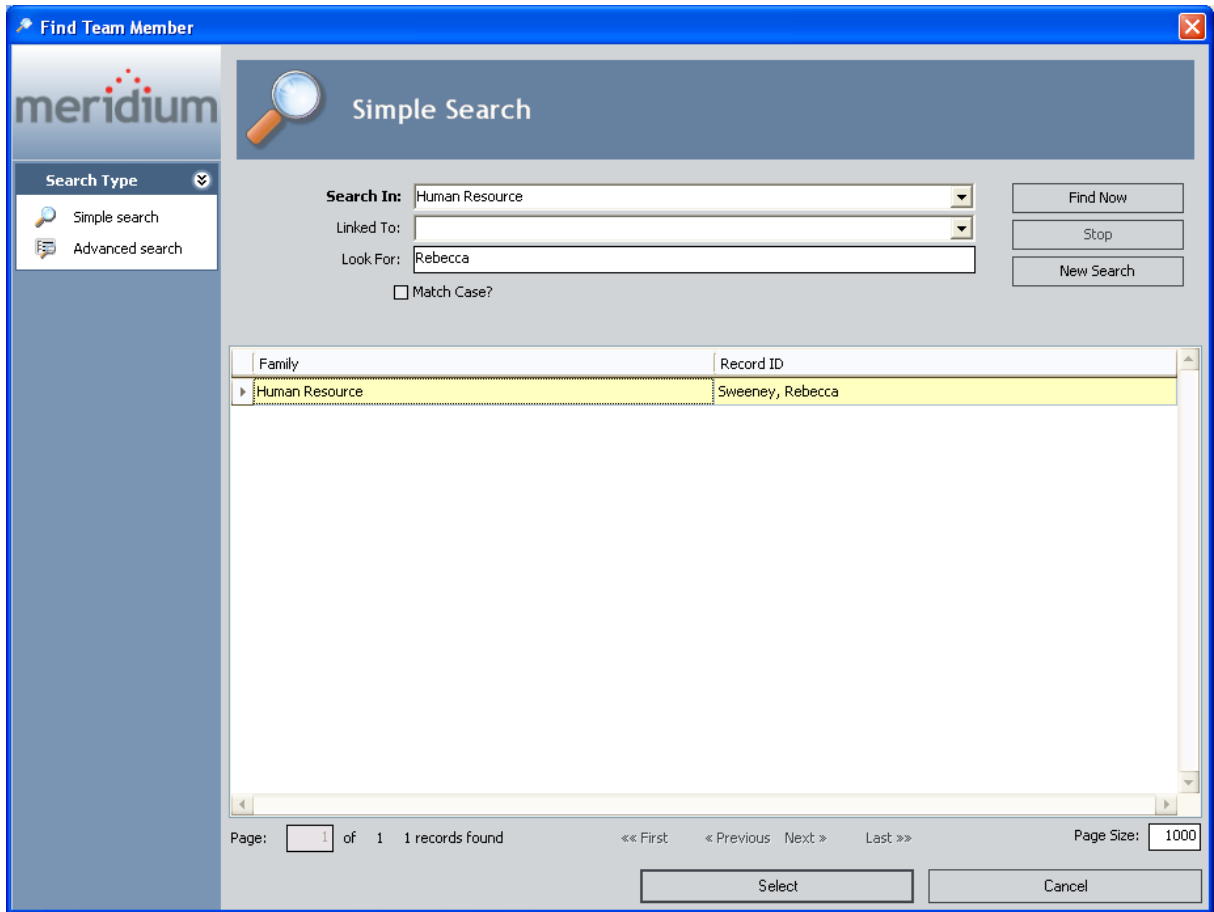

4. In the results list, select the row containing the desired team member, and then click the **Select** button.

The selected person is added to the list of team members. An RCA Team Member record is created for that user automatically and linked to that user's Human Resource record and to the RCA Analysis record for the current RCA Analysis.

Note: A given Human Resource record cannot be added to the RCA Analysis Team more than once. If you try to add a team member who is already listed on the **Team** page, a message appears, indicating that the person is already a member of the RCA Analysis Team.

Creating New Users and adding them to the Analysis Team

A person who does not have a Human Resource record can be added to an RCA Analysis Team, provided that you create a new Human Resource record for that person. The following instructions provide details on creating a Human Resource record and *automatically* adding the person to the RCA Analysis Team.

To create a new Human Resource record and add it to the RCA Analysis Team automatically:

1. On the [Team page](#), on the **Manage Human Resources** menu, click the **New User** link.

The **User Details** page appears, displaying the MI Human Resource datasheet.

Meridium APM Framework - User Details

File Edit Go To Tools Help

Back Forward My Start Page New Search Catalog Query Report Graph Dataset Dashboard

meridium

PROACT® for Meridium

Manage Assets

Manage Assets

Common Tasks

Save User

Send To >>

Help

Associated Pages

RCA -> My PROACT -> 1041828 HEX U-Bend -> Team Members List -> New User

Add New Team Member

Datasheet: MI Human Resource

Last Name

First Name

Middle Initial

Job Title

Company

Address1

Address2

City

State

Postal Code

Country

Phone1

Phone2

Fax

Domain

Email Address

Facility

Site Code

Business Unit

Area of Responsibility

Department

Comments

Promote to User

2. In the Last Name field, type the last name of the team member. This field is required.
3. Complete the remaining fields on the datasheet as desired.
4. On the **Common Tasks** menu, click the **Save User** link.

The new Human Resource record is saved, the **Team** page appears, displaying that person in the list of team members for the current RCA Analysis, and an associated RCA Team Member record is created for that user automatically and linked to that user's Human Resource record and the RCA Analysis record for the current RCA Analysis.

Viewing the Human Resource Record for Existing Team Members

Only members of the MI PROACT Team Member Security Group or MI PROACT Administrator Security Group can view the contents of Human Resource records.

To view the Human Resource record for an existing team member:

- On the [Team page](#), in the list of team members, click the hyperlink associated with the team member whose Human Resource record you want to view.

The **PROACT** page appears, displaying the Human Resource record for the selected team member. The fields are read-only.

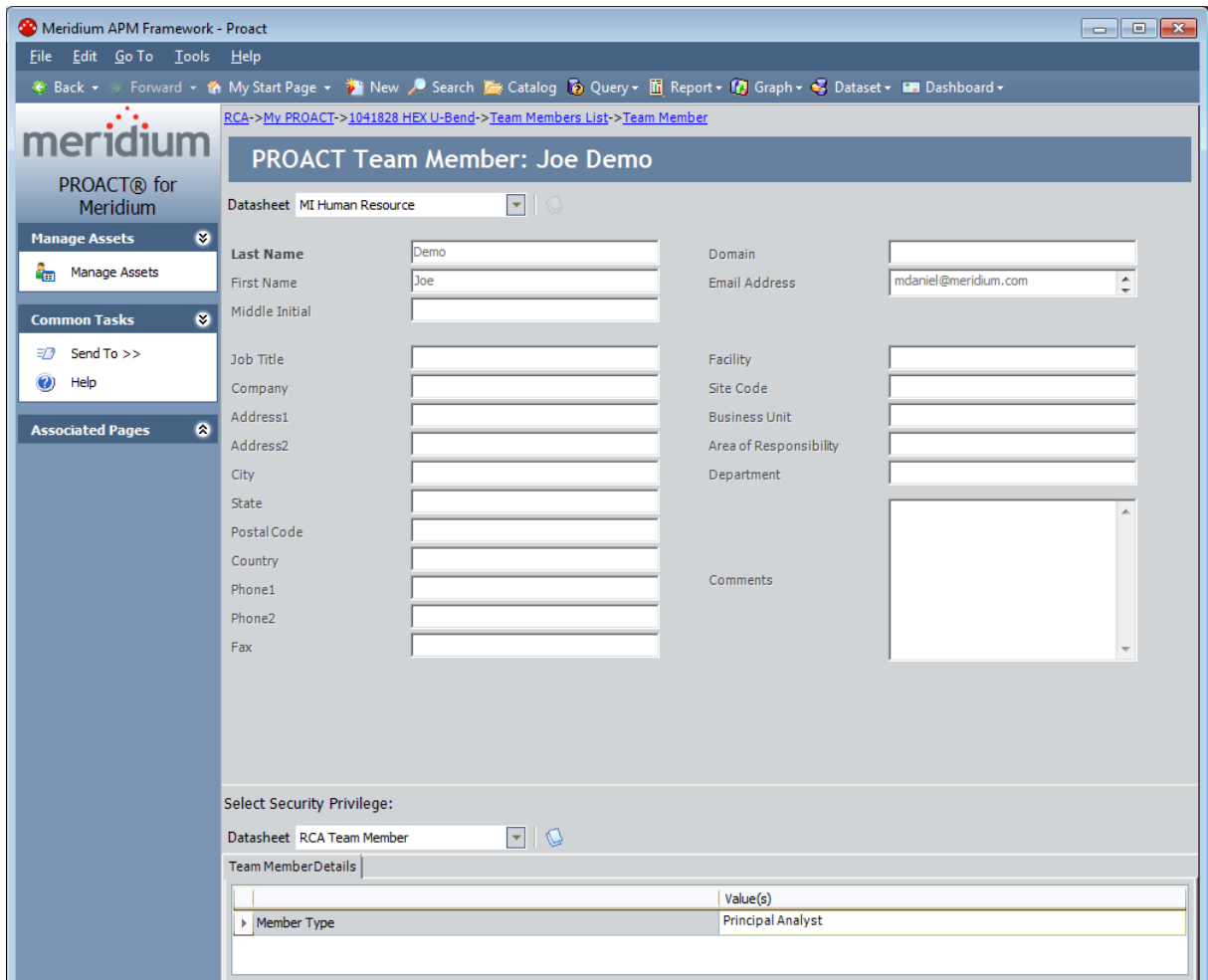

Modifying Human Resource Records for Existing Team Members

Only Members MI PROACT Administrator Security Group, Super Users, or the Principal Analyst can modify the contents of a Human Resource record.

To modify the Human Resource record for a team member:

1. On the [Team page](#), select the row containing the team member whose Human Resource record you want to modify.

On the **Manage Human Resources** menu, click the **Edit Selected User** link.

The **User Details** page appears, displaying the Human Resource record for the selected team member.

Meridium APM Framework - User Details

File Edit Go To Tools Help

Back Forward My Start Page New Search Catalog Query Report Graph Dataset Dashboard

RCA->My PROACT->1041828 HEX U-Bend->Team Members List->New User

meridium PROACT® for Meridium

Manage Assets Manage Assets

Common Tasks Save User Send To >> Help

Associated Pages

Edit Team Member

Datasheet MI Human Resource

Last Name Demo

First Name Joe

Middle Initial

Job Title

Company

Address1

Address2

City

State

Postal Code

Country

Phone1

Phone2

Fax

Domain

Email Address mdaniel@meridium.com

Facility

Site Code

Business Unit

Area of Responsibility

Department

Comments

2. Modify the fields as needed.
3. On the **Common Tasks** menu, click the **Save User** link.

Your changes are saved, and the **Team** page appears.

Note: If you modify the Last Name, First Name, or Middle Initial field, after you save the record, your changes will not be displayed in the grid on the **Team** page immediately. Your changes ARE saved in the Human Resource record. The next time that you access the **Team** page or the Human Resource record for the user, you will see your changes.

Changing the Principal Analyst

To change the Principal Analyst for an RCA Analysis, you must be a Super User, a member of the MI PROACT Administrator Security Group, or the existing Principal Analyst.

To change the Principal Analyst for a RCA Analysis:

1. On the [Team page](#), select the row containing the team member that want to make the new Principal Analyst.

| Analysis Team Members | | | | | | |
|---|--------------------|----------|---------------|---------------|-----------|-----------------------|
| Team Members: | | 3 | | | | |
| Drag a column header here to group by that column | | | | | | |
| Name | Security Privilege | Title | Facility Name | Business Unit | Phone No. | E-mail Address |
| Patrick Aultice | Member | | | | | paultice@meridium.com |
| ▶ Rebecca Sweeney | Member | | | | | |
| Sam Smith | Member | | | | | |

2. On the **Common Tasks** menu, click the **Change Principal Analyst** link.

A message appears, asking if you really want the selected team member to become the new Principal Analyst.

3. Click the **Yes** button.

The user's RCA Team Member record and the value in the **Security Privilege** column is updated to reflect the change.

| Analysis Team Members | | | | | | |
|---|--------------------|----------|---------------|---------------|-----------|-----------------------|
| Team Members: | | 3 | | | | |
| Drag a column header here to group by that column | | | | | | |
| Name | Security Privilege | Title | Facility Name | Business Unit | Phone No. | E-mail Address |
| Patrick Aultice | Member | | | | | paultice@meridium.com |
| ▶ Rebecca Sweeney | Principal | | | | | |
| Sam Smith | Member | | | | | |

Deleting Team Members from the Analysis

The following instructions provide details on deleting a team member from an RCA Analysis Team. When you delete a team member from the RCA Analysis Team, you are deleting the associated RCA Team Member record only. The associated Human Resource record is not deleted.

If a team member is linked to one or more RCA Preserve Item records, RCA Verifications, or RCA Recommendation records, when the team member is deleted from the RCA Analysis Team, the items that were previously assigned to that team member will appear on the **PA PROACT** page for the Principal Analyst to re-assign to other team members.

To delete a team member from the RCA Analysis Team:

1. On the [Team page](#), select the row containing the team member that you want to delete.

| Analysis Team Members | | | | | | |
|---|--------------------|-------|---------------|---------------|-----------|-----------------------|
| Team Members: 3 | | | | | | |
| Drag a column header here to group by that column | | | | | | |
| Name | Security Privilege | Title | Facility Name | Business Unit | Phone No. | E-mail Address |
| Patrick Aultice | Member | | | | | paultice@meridium.com |
| ▶ Rebecca Sweeney | Principal | | | | | |
| Sam Smith | Member | | | | | |

2. On the **Common Tasks** menu, click the **Delete Team Member** link.
A message appears, asking if you really want to delete the team member.
3. Click the **Yes** button.

The team member is deleted from the RCA Analysis Team.

| Analysis Team Members | | | | | | |
|---|--------------------|-------|---------------|---------------|-----------|-----------------------|
| Team Members: 2 | | | | | | |
| Drag a column header here to group by that column | | | | | | |
| Name | Security Privilege | Title | Facility Name | Business Unit | Phone No. | E-mail Address |
| ▶ Patrick Aultice | Member | | | | | paultice@meridium.com |
| Sam Smith | Member | | | | | |

About Preserving Failure Data

In an RCA Analysis, *preserving failure data* involves collecting a wide range of information related to the equipment or location failure that the team will analyze. The collected data is stored in *RCA Preserve Item records*, which contain task-related data for the collection of the failure data. In this way, RCA Preserve Item records are essentially tasks assigned to the team member who should collect the failure data specified in the record by a certain date. For example, an RCA Preserve Item record may contain a task to collect all the broken pieces of a piece of equipment.

Using the [Preserve Failure Data page](#), you can create new RCA Preserve Item records or modify existing RCA Preserve Item records for the current RCA Analysis. After the tasks defined in the RCA Preserve Item records are complete, the team can begin to analyze the data that was collected.

The 5 P's

When you create a RCA Preserve Item record, the type of data that you want a member of the RCA Analysis Team to collect is identified by one of the following categories, known as the 5 P's:

- **People:** Indicates that human witnesses should be questioned about the incident. Witnesses might include the person who is responsible for the maintenance of the piece of equipment or location associated with the failure event, the operator, or even the stock room attendant.
- **Parts:** Indicates that physical pieces of the equipment should be collected (i.e., the broken pieces). This may also include collecting a functional piece of equipment to test against the broken one.
- **Paper:** Indicates that any data or information that exists about the piece of equipment or location should be gathered. This could include recent performance reports, schedules, Meridium APM data, specifications, and so on.
- **Position:** Indicates that the environment in which the piece of equipment or location exists should be documented and considered. This could include, for example, the temperature of the room at the time of the incident or the proximity of one piece of equipment or location to another.
- **Paradigms:** Indicates that any trends or common assumptions about the cause of the incident should be noted. The intent of noting these paradigms is to remove this assumption from the investigation (i.e., remove any bias from the analysis).

On the [RCA Preserve Failure Data Item datasheet](#), in the **Data Category** box, you can type or select one of the 5 P's. The following image shows the list of the of the 5 P's. A red outline has been added to the image to highlight these values.

The screenshot shows a software interface for a 'RCA Preserve Failure Data Item' datasheet. The 'Preserve Record Details' section is visible, with a table listing various data fields. The 'Data Category' field is selected, and its dropdown menu is open, displaying a list of five categories: 'Parts', 'Paper', 'People', 'Position', and 'Paradigms'. A red rectangular outline is drawn around this list to highlight it. Other fields in the table include 'Data to Collect', 'Collection Strategy', 'Date Due', 'Send Alert on Due Date?', 'Alert Email Body', 'Completed?', and 'Date Completed'.

| Field | Value(s) |
|-------------------------|---|
| Data Category | Parts, Paper, People, Position, Paradigms |
| Data to Collect | |
| Collection Strategy | |
| Date Due | |
| Send Alert on Due Date? | |
| Alert Email Body | |
| Completed? | X |
| Date Completed | |

Accessing the Preserve Failure Data Page

To access the Preserve Failure Data page:

- On the **Analysis** page, on the **PReserve** menu, click the **Preserve Records** link.

The **Preserve Failure Data** page appears, displaying a list of the RCA Preserve Item records that are associated with the current RCA Analysis.

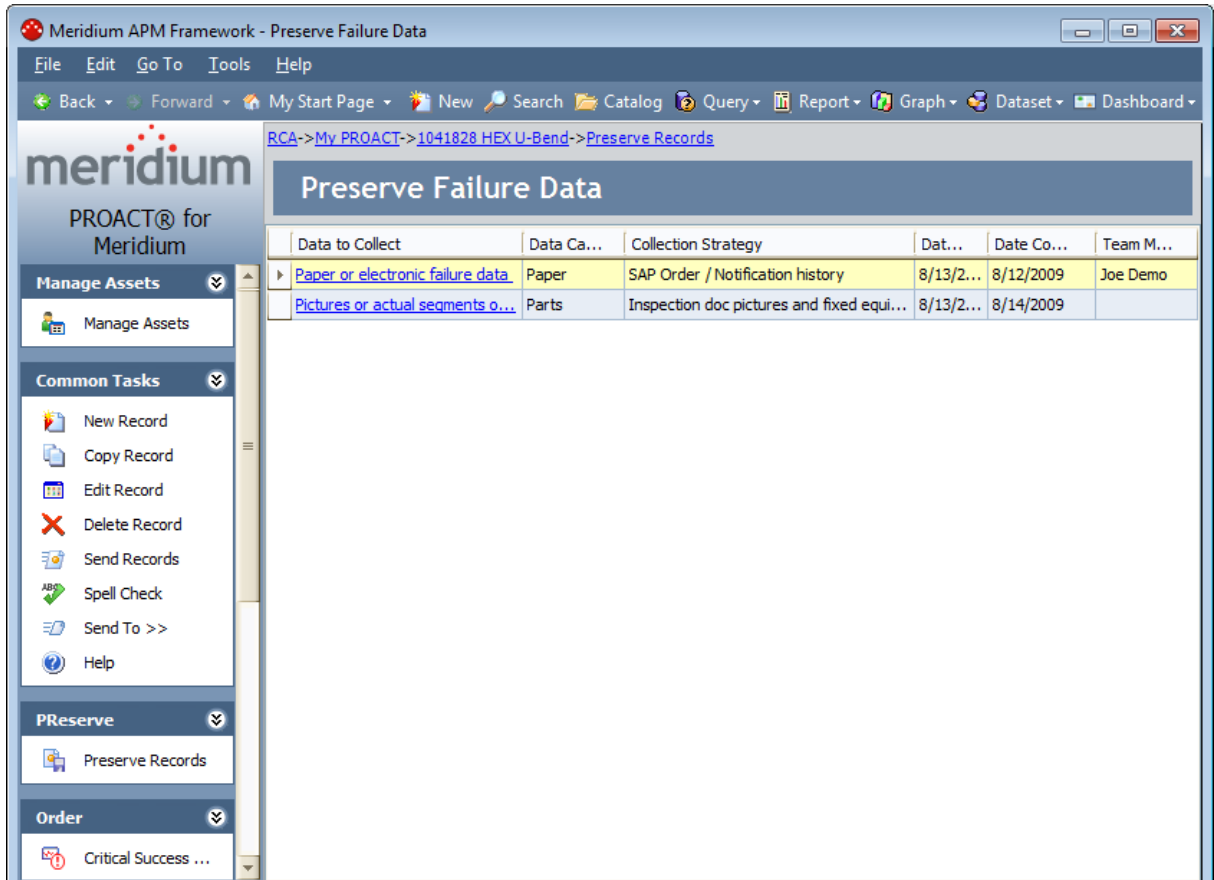

From the **Preserve Failure Data** page, you can click a link to view the details for any RCA Preserve Item record. If no RCA Preserve Item records have been created for the current RCA Analysis, a message is displayed, indicating that there are no RCA Preserve Item records associated with the current RCA Analysis.

Aspects of the Preserve Failure Data Page

The **Preserve Failure Data** page displays a list of the RCA Preserve Item records that exist for a given RCA Analysis.

The screenshot shows the Meridium APM Framework interface for the 'Preserve Failure Data' page. The breadcrumb trail is 'RCA->My PROACT->1041828 HEX U-Bend->Preserve Records'. The table below displays the records:

| Data to Collect | Data Category | Collection Stra... | Date Due | Date Completed | Team Member |
|--|---------------|-----------------------|-----------|----------------|-------------|
| Paper or electroni... | Paper | SAP Order / Notifi... | 8/13/2009 | 8/12/2009 | Joe Demo |
| Pictures or actual ... | Parts | Inspection doc pic... | 8/13/2009 | 8/14/2009 | |

For each RCA Preserve Item record, the following information appears:

- **Data To Collect:** A specific description of the data that should be collected, as specified in the **Data Category** column. Each description listed in the **Data to Collect** column is a hyperlink that you can click to view the RCA Preserve Item record on the **Preserve Failure Details** page.
- **Data Category:** The type of data that should be collected about the problem that you want to analyze: People, Parts, Paper, Position, or Paradigms.
- **Collection Strategy:** A description of the way in which the data should be collected (e.g., acquire production logs from a line supervisor).
- **Date Due:** The deadline for collecting the failure data.
- **Date Completed:** The date when the data collection was completed.
- **Team Member:** The team member responsible for completing the task specified in the RCA Preserve Item record.

Note: You can customize the display of the team member grid in several ways including, adding additional columns, sorting columns, and filtering the list.

On the **Preserve Failure Data** page, you can perform tasks related to the RCA Analysis by using the options available on the task menus: [Manage Assets](#), [Common Tasks](#), [PReserve](#), [Order](#), [Analyze](#), [Communicate](#), [Track](#), and **Associated Pages**.

Note: If one or more RCA Preserve Item records exists for the RCA Analysis, the **Associated Pages** menu displays items that have been configured for the RCA Preserve Item family via the URL Manager. If no items have been configured or if items have been configured but an RCA Preserve Item record does not exist, the **Associated Pages** menu will be empty.

Manage Assets Menu



The **Manage Assets** menu on the **Preserve Failure Data** page contains the following link:

- **Manage Assets:** Displays the **Manage Assets** page, where you can link, view, and unlink Equipment and Functional Location records associated with the current RCA analysis.

Common Tasks Menu

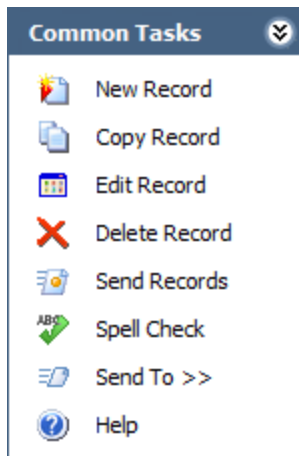

The **Common Tasks** menu on the **Preserve Failure Data** page contains the following links:

- **New Record:** Displays the **Preserve Record Details** page, where you can [create an RCA Preserve Item record](#).
- **Copy Record:** Copies the selected RCA Preserve Item record.
- **Edit Record:** Displays the **Preserve Record Details** page, where you can [modify the selected RCA Preserve Item record](#).
- **Delete Record:** Displays a confirmation message, asking if you really want to delete the record, and then deletes the selected RCA Preserve Item record.
- **Send Record:** Allows you to send a link to the selected RCA Preserve Item record to an email recipient.
- **Spell Check:** Displays the **Spell Check** dialog box, which allows you to perform a [spell check operation](#) on the text and character fields in records belonging to the current RCA Analysis.
- **Send To:** Displays a submenu with options that let you send a link to the current page to your desktop (create shortcut), an email recipient, or a Home Page.
- **Help:** Displays the context-sensitive Help topic for the **Preserve Failure Data** page.

PReserve Menu



The **PReserve** menu on the **Preserve Failure Data** page contains the following link:

- **Preserve Records:** Displays the **Preserve Failure Data** page, which lists existing RCA Preserve Item records for the current RCA Analysis.

Order Menu

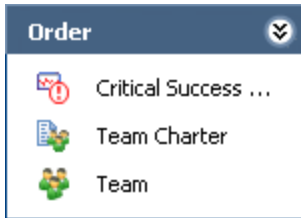

The **Order** menu on the **Preserve Failure Data** page contains the following links:

- **Critical Success Factors:** Displays the **Critical Success Factors** page, which displays existing RCA Critical Success Factor records that are linked to the current RCA Analysis.
- **Team Charter:** Displays the **Team Charter** dialog box, which contains the Team Charter for the current RCA Analysis.
- **Team:** Displays the list of **Team** page, where you can view the RCA Team Members records that are linked to the current RCA Analysis.

Analyze Menu

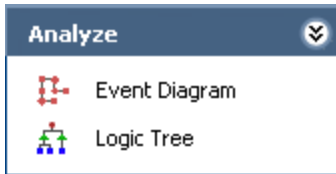

The **Analyze** menu on the **Preserve Failure Data** page contains the following links:

- **Event Diagram:** Displays the **Event Diagram** page for the current RCA Analysis. If this is the first time that you have accessed the **Event Diagram** page for the current RCA Analysis, the **RCA Event** dialog box will appear automatically so that you can [define the failure event](#).
- **Logic Tree:** Displays the **Logic Tree** page for the current RCA Analysis, where you can organize the process of analyzing the issue to evaluate the root cause of the failure event. If this is the first time that you have accessed the **Logic Tree** page for the current RCA Analysis, the **RCA Event** dialog box will appear automatically so that you can [define the failure event](#) for the current RCA Analysis.

Communicate Menu



The **Communicate** menu on the **Preserve Failure Data** page contains the following links:

- **Communicate Records:** Displays the **Communicate Records** page for the current RCA Analysis, where you can create RCA Recommendation records that are linked to it.
- **Reports:** Displays the **Reports List** page, where you can view a list of reports that have been configured for Root Cause Analysis.

Track Menu



The **Track** menu on the **Preserve Failure Data** page contains the following link:

- **Track:** Displays the **Analysis Tracking Items** page, where you can view, modify, and create RCA Tracking Item records that are linked to the current RCA Analysis.

Accessing the Preserve Record Details Page

The **Preserve Record Details** page lets you view the details of an RCA Preserve Item record. You can access the **Preserve Record Details** page via the following methods:

- [Create a new RCA Preserve Item record.](#)
- or-
- [Open an existing RCA Preserve Item record.](#)

Aspects of the Preserve Record Details Page

The **Preserve Record Details** page displays the contents of a single RCA Preserve Item record on the RCA Preserve Failure Data Item datasheet.

Above the datasheet, the **Assign To** list appears and contains the names of the users who are currently assigned to the RCA Analysis Team. You can select a name from the list to assign this person as the owner of the task that is defined in the RCA Preserve Item record.

The following image shows what the **Preserve Record Details** page looks like after you create a new RCA Preserve Item record.

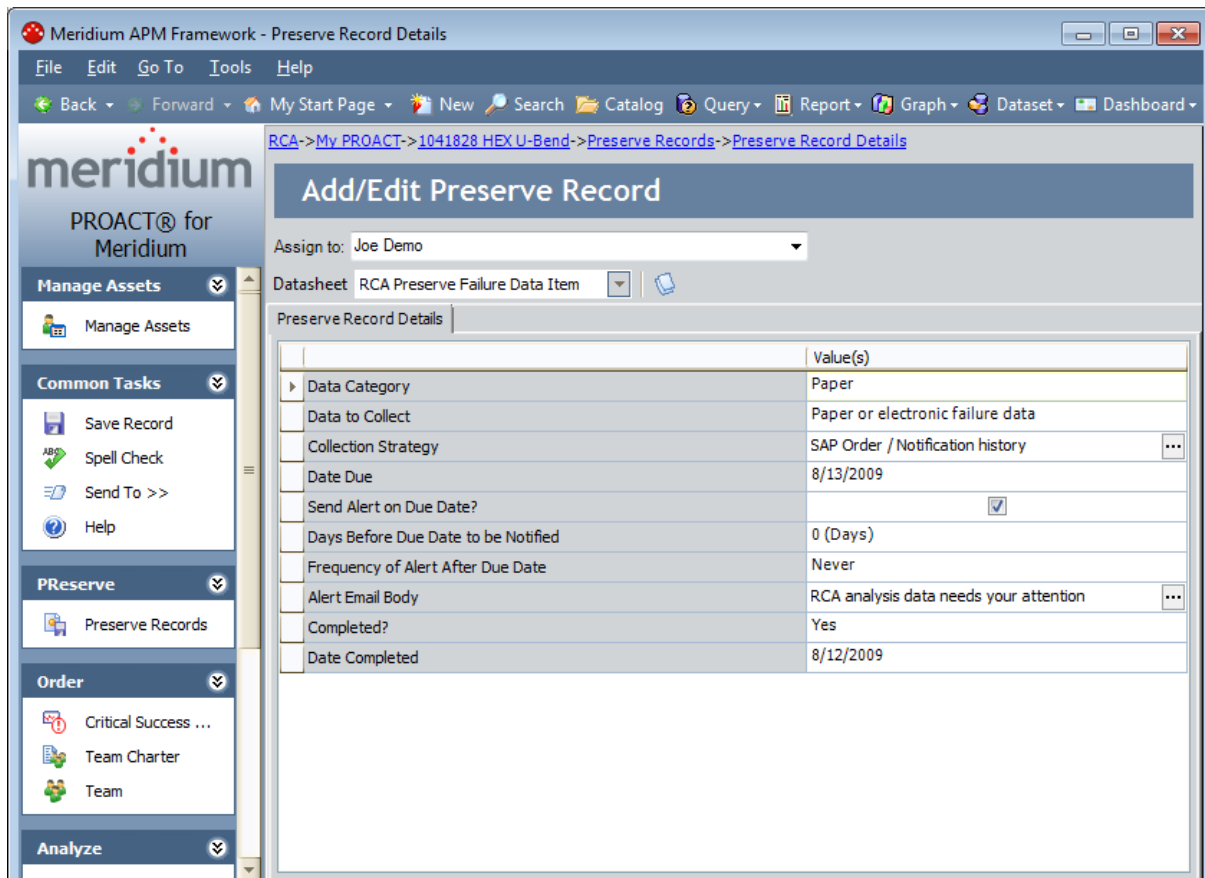

| Field | Value(s) |
|-------------------------------------|--|
| Data Category | Paper |
| Data to Collect | Paper or electronic failure data |
| Collection Strategy | SAP Order / Notification history |
| Date Due | 8/13/2009 |
| Send Alert on Due Date? | <input checked="" type="checkbox"/> |
| Days Before Due Date to be Notified | 0 (Days) |
| Frequency of Alert After Due Date | Never |
| Alert Email Body | RCA analysis data needs your attention |
| Completed? | Yes |
| Date Completed | 8/12/2009 |

The **Preserve Record Details** page contains the same [task menus that appear on the Preserve Failure Data page](#). The [Common Tasks menu](#), however, contains different links.

Common Tasks Menu

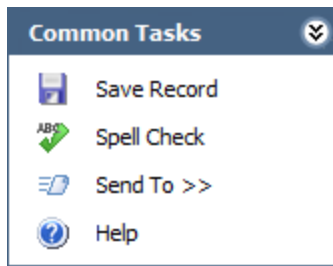

The **Common Tasks** menu on the **Preserve Record Details** page contains the following links:

- **Save Record:**Saves the current record.
- **Spell Check:** Displays the **Spell Check** dialog box, which allows you to perform a [spell check operation](#) on the text and character fields in records belonging to the current RCA Analysis.
- **Send To:** Displays a submenu with options that let you provide a link to the current page on your desktop (create shortcut), in an email message, or on a Home Page.
- **Help:** Displays the context-sensitive Help topic for the **Preserve Record Details** page.

Creating a New RCA Preserve Item Record

Any team member can create an RCA Preserve Item record for a given RCA Analysis. You can create a new RCA Preserve Item record from scratch, as described in the following instructions, or you can [copy an existing RCA Preserve Item record](#) to create a new record.

You can create multiple RCA Preserve Item records for one RCA Analysis using different data categories. You can use the 5 P's in the **Data Category** list to categorize the type of data that should be collected.

To create an RCA Preserve Item record for an RCA Analysis:

1. On [the Preserve Failure Data page](#), on the **Common Tasks** menu, click the **New Record** link.

The **Preserve Record Details** page appears.

The screenshot shows the 'Add/Edit Preserve Record' page in the Meridium APM Framework. The page is titled 'Meridium APM Framework - Preserve Record Details'. The main content area is titled 'Add/Edit Preserve Record'. There is a dropdown menu for 'Assign to:' and a 'Datasheet' dropdown set to 'RCA Preserve Failure Data Item'. Below this is a table titled 'Preserve Record Details' with two columns: 'Data Category' and 'Value(s)'. The table contains the following rows:

| Data Category | Value(s) |
|-------------------------------------|--------------------------|
| Data to Collect | |
| Collection Strategy | ... |
| Date Due | |
| Send Alert on Due Date? | <input type="checkbox"/> |
| Days Before Due Date to be Notified | |
| Frequency of Alert After Due Date | |
| Alert Email Body | ... |
| Completed? | No |
| Date Completed | |

2. In the **Assign To** list, select the team member to whom the task will be assigned.
3. Complete the [details of the RCA Preserve Item record](#) as desired.
4. On the **Common Tasks** menu, click the **Save Record** link.

The RCA Preserve Item record is saved, and the **Preserve Failure Data** page appears.

Creating a New RCA Preserve Item Record

The screenshot displays the Meridium APM Framework interface for 'Preserve Failure Data'. The window title is 'Meridium APM Framework - Preserve Failure Data'. The interface includes a menu bar (File, Edit, Go To, Tools, Help) and a navigation bar with options like Back, Forward, My Start Page, New, Search, Catalog, Query, Report, Graph, Dataset, and Dashboard. The breadcrumb path is 'RCA->My PROACT->1041828 HEX U-Bend->Preserve Records'. The main content area is titled 'Preserve Failure Data' and contains a table with the following data:

| Data to Collect | Data Category | Collection Stra... | Date Due | Date Completed | Team Member |
|--|---------------|-----------------------|-----------|----------------|-------------|
| Paper or electroni... | Paper | SAP Order / Notif... | 8/13/2009 | 8/12/2009 | Joe Demo |
| Pictures or actual ... | Parts | Inspection doc pic... | 8/13/2009 | 8/14/2009 | |

The interface also features a sidebar with 'Manage Assets' and 'Common Tasks' sections. The 'Common Tasks' section includes options like New Record, Copy Record, Edit Record, Delete Record, Send Records, Spell Check, Send To >>, and Help. The 'PReserve' section includes 'Preserve Records'.

Modifying Existing RCA Preserve Item Records

Only the Principal Analyst and members of the RCA Analysis Team can modify RCA Preserve Item records that belong to a given RCA Analysis.

To modify an existing RCA Preserve Item record:

1. On [the Preserve Failure Data page](#), in the **Data to Collect** cell, click the hyperlink for the RCA Preserve Item record that you want to modify.

The **Preserve Record Details** page appears.

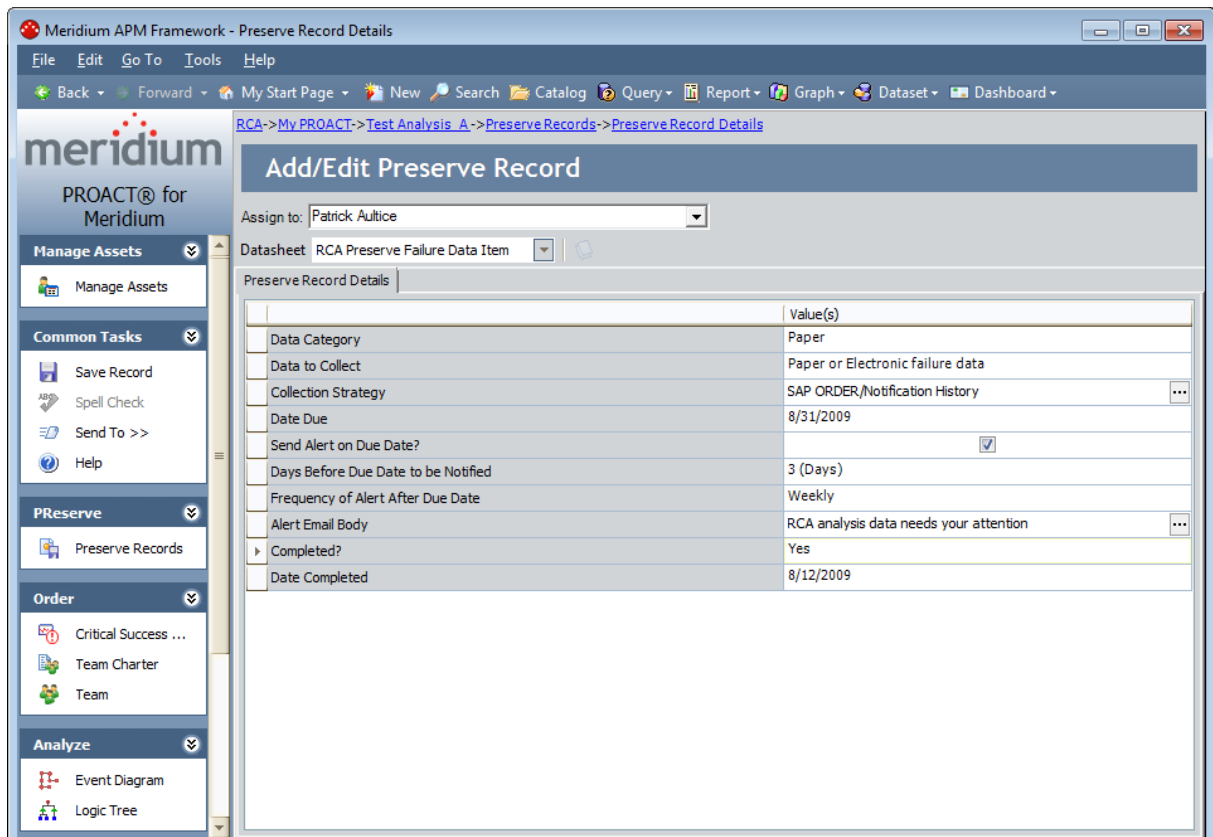

2. Modify the [details of the RCA Preserve Item record](#) as desired.
3. On the **Common Tasks** menu, click the **Save Record** link.

The RCA Preserve Item record is updated and saved, and the **Preserve Failure Data** page appears.

Modifying Existing RCA Preserve Item Records

The screenshot displays the Meridium APM Framework interface for managing 'Preserve Failure Data'. The window title is 'Meridium APM Framework - Preserve Failure Data'. The interface includes a menu bar (File, Edit, Go To, Tools, Help) and a navigation bar with options like Back, Forward, My Start Page, New, Search, Catalog, Query, Report, Graph, Dataset, and Dashboard. The breadcrumb path is 'RCA->My PROACT->1041828 HEX U-Bend->Preserve Records'. The main content area is titled 'Preserve Failure Data' and contains a table with the following data:

| Data to Collect | Data Category | Collection Stra... | Date Due | Date Completed | Team Member |
|--|---------------|-----------------------|-----------|----------------|-------------|
| Paper or electroni... | Paper | SAP Order / Notif... | 8/13/2009 | 8/12/2009 | Joe Demo |
| Pictures or actual ... | Parts | Inspection doc pic... | 8/13/2009 | 8/14/2009 | |

The interface also features a sidebar with 'Manage Assets' and 'Common Tasks' sections. The 'Common Tasks' section includes options like New Record, Copy Record, Edit Record, Delete Record, Send Records, Spell Check, Send To >>, and Help. The 'PReserve' section includes 'Preserve Records'.

Linking Reference Document Records to Existing Preserve Item Records

If desired, you can link additional information to an RCA Preserve Item record. For example, if the data category for the RCA Preserve Item record is *Paper*, you may want to link the associated reference documents to the record. You can do so by linking Reference Document records to RCA Preserve Item records.

Note: You cannot link a Reference Document record to an RCA Preserve Item record when it is first created. The reference documents icon is enabled only after you have saved the RCA Preserve Item record.

To link a Reference Document record to an RCA Preserve Item record:

1. [Access the RCA Preserve Item record](#) to which you want to link a Reference Document record.

The **Preserve Record Details** page appears, displaying the details of the selected record.

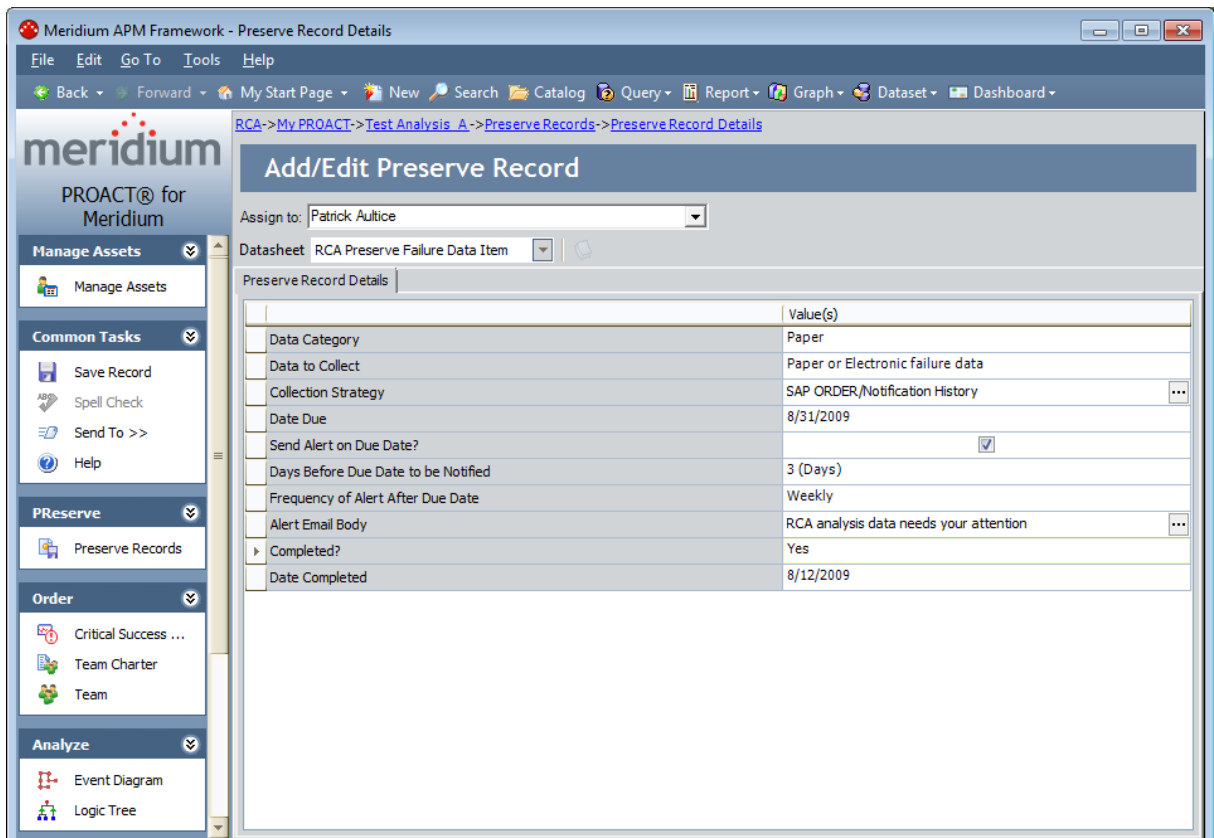

2. At the top of the datasheet, click the reference documents icon. 

The standard **Reference Documents** window appears.

3. Add the desired Reference Document records to the RCA Preserve Item record.
The **Preserve Record Details** page returns to focus.

Copying an RCA Preserve Item Record to Create a New Record

When you copy an existing RCA Preserve Item record, a new Preserve Item record is created and populated automatically with data from the source record. Only the Principal Analyst and members of the RCA Analysis Team can copy an RCA Preserve Item record for an RCA Analysis for which they are a member of the RCA Analysis Team.

To create a new RCA Preserve Item record by copying an existing one:

1. On the [Preserve Failure Data page](#), select the row containing the record that you want to copy.

| Preserve Failure Data | | | | | |
|---|---------------|---------------------------|----------|----------------|-----------------|
| Drag a column header here to group by that column | | | | | |
| Data to Collect | Data Category | Collection Strategy | Date Due | Date Completed | Team Member |
| ▶ Test Analysis A ... | Parts | Test Analysis_A - Co... | 8/6/2008 | | Patrick Aultice |
| Analysis 1 - Data ... | Parts | Analysis 1 - Collectio... | 8/6/2008 | | Patrick Aultice |

2. On the **Common Tasks** menu, click the **Copy Record** link.

The **Preserve Record Details** page appears, displaying a copy of the RCA Preserve Item record you selected. The values in all fields are populated automatically with data from the source record.

Copying an RCA Preserve Item Record to Create a New Record

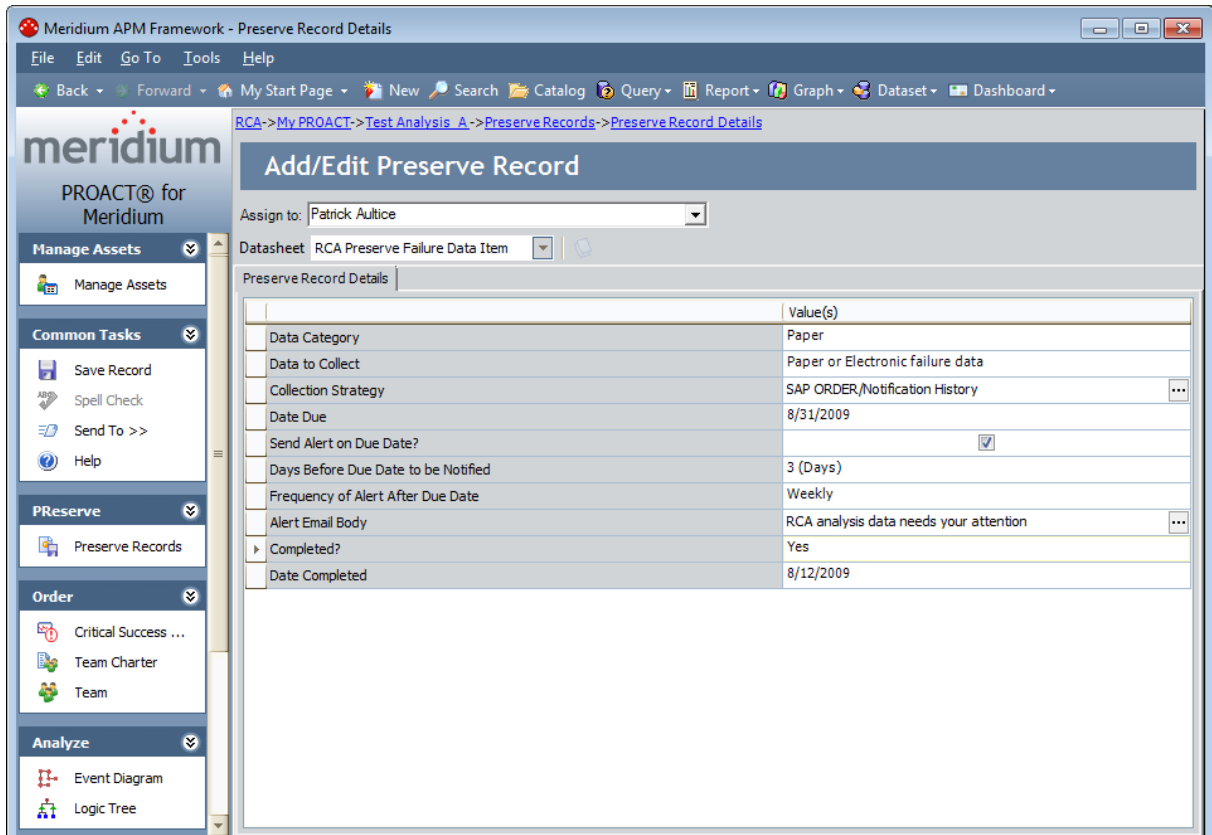

3. [Modify the fields](#) on the RCA Preserve Failure Data Item datasheet as needed.
4. On the **Common Tasks** menu, click the **Save Record** link.

The RCA Preserve Item record is saved to the database and linked to the RCA Analysis record for the current RCA Analysis. The **Preserve Failure Data** page appears, displaying the record in the **Preserve Failure Data** list.

| Preserve Failure Data | | | | | | |
|---|---------------------------------------|---------------|---------------------------|----------|----------------|-----------------|
| Drag a column header here to group by that column | | | | | | |
| | Data to Collect | Data Category | Collection Strategy | Date Due | Date Completed | Team Member |
| | Test Analysis A -... | Parts | Test Analysis_A - C... | 8/6/2008 | | Patrick Aultice |
| | Analysis 1 - Data ... | Parts | Analysis 1 - Collectio... | 8/6/2008 | | Patrick Aultice |
| | Test Analysis A -... | Parts | Test Analysis_A - C... | 8/6/2008 | | Patrick Aultice |

Deleting an RCA Preserve Item Record

Only the Principal Analyst and members of the RCA Analysis Team can delete a RCA Preserve Item record from a given RCA Analysis.

To delete an RCA Preserve Item record:

1. On the [Preserve Failure Data page](#), select the row containing the record that you want to delete.

| Preserve Failure Data | | | | | |
|---|---------------|---------------------------|----------|----------------|-----------------|
| Drag a column header here to group by that column | | | | | |
| Data to Collect | Data Category | Collection Strategy | Date Due | Date Completed | Team Member |
| ▶ Test Analysis A ... | Parts | Test Analysis_A - Co... | 8/6/2008 | | Patrick Aultice |
| ▶ Analysis 1 - Data ... | Parts | Analysis 1 - Collectio... | 8/6/2008 | | Patrick Aultice |

2. On the **Common Tasks** menu, click the **Delete Record** link.

A confirmation message appears, asking if you really want to delete the record.

3. Click the **Yes** button.

The record is removed from the **Preserve Failure Data** list and is deleted from the database.

| Preserve Failure Data | | | | | |
|---|---------------|---------------------------|----------|----------------|-----------------|
| Drag a column header here to group by that column | | | | | |
| Data to Collect | Data Category | Collection Strategy | Date Due | Date Completed | Team Member |
| ▶ Analysis 1 - Data ... | Parts | Analysis 1 - Collectio... | 8/6/2008 | | Patrick Aultice |

About Analyzing Data

In an RCA Analysis, *analyzing data* involves compiling the information that has been collected thus far in the RCA Analysis and representing it visually in order to facilitate discussion. Event Diagrams and Logic Trees let you represent visually the events that are associated with a piece of equipment's or location's failure and the cause-and-effect relationships that may have led to a failure event.

You can create an Event Diagram on the **Event Diagram** page and a Logic Tree on the **Logic Tree** page. In both diagrams, you can add nodes to the Failure Event node that represent components of the RCA Analysis. For example, if you define the Failure Event node as a fire, in the Event Diagram you can add to the Failure Event node upstream nodes that depict the chain of events that preceded the failure event. Additionally, in the Logic Tree, you would add to the Failure Event node downstream nodes that represent all the possible causes for the failure event.

What is a Failure Event?

The *failure event* is a short description of the problem that you and your team are analyzing. Your team could be analyzing a failure event that is comprised of several failures over a specified period of time, or one failure (e.g., a larger event, such as a fire). The first time that you access the **Event Diagram** page or the **Logic Tree** page for a given RCA Analysis, you will be prompted to define the failure event in an RCA Event record, which will be used as the Failure Event node. The following image shows an example of a completed RCA Event record.

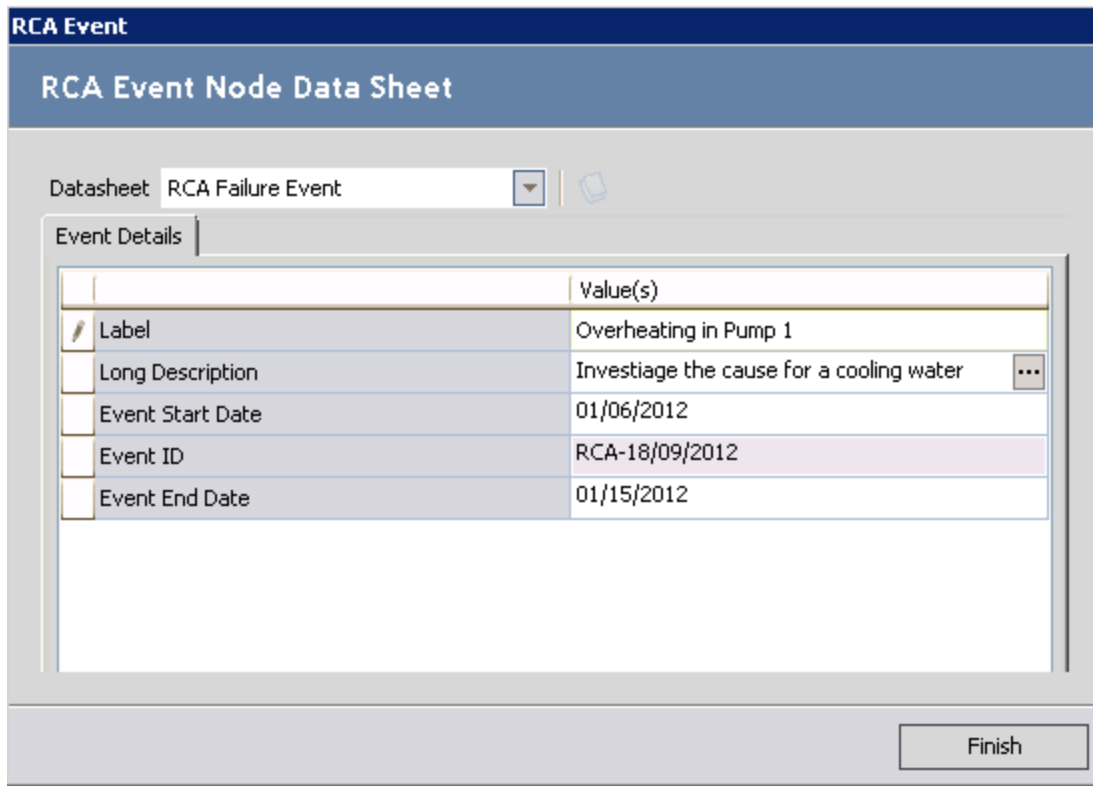

The screenshot shows a software interface titled "RCA Event" with a sub-header "RCA Event Node Data Sheet". Below the header, there is a dropdown menu for "Datasheet" set to "RCA Failure Event". A tab labeled "Event Details" is active. The main area contains a table with the following data:

| | Value(s) |
|------------------|---|
| Label | Overheating in Pump 1 |
| Long Description | Investigate the cause for a cooling water ... |
| Event Start Date | 01/06/2012 |
| Event ID | RCA-18/09/2012 |
| Event End Date | 01/15/2012 |

A "Finish" button is located at the bottom right of the form.

Each RCA Analysis will have one Failure Event node, which will always appear at the root level of the [Logic Tree hierarchy](#) and as the first node in the [Event Diagram](#). For example, the following image shows the Failure Event node as it appears in the Logic Tree in our [Cooling Water Pump example](#).



You cannot remove the Failure Event node from the Logic Tree or the Event Diagram. You can modify the RCA Event record, if desired.

What's the Difference Between an Event Diagram and a Logic Tree?

The following image shows an Event Diagram that was created using the **Event Diagram** page. The Event Diagram can depict the cause-and-effect of events that led to the failure event and post-failure activities. In other words, the Event Diagram provides a way for the RCA Analysis Team to view and organize the chain of events prior to the failure event and identify possible work process issues.

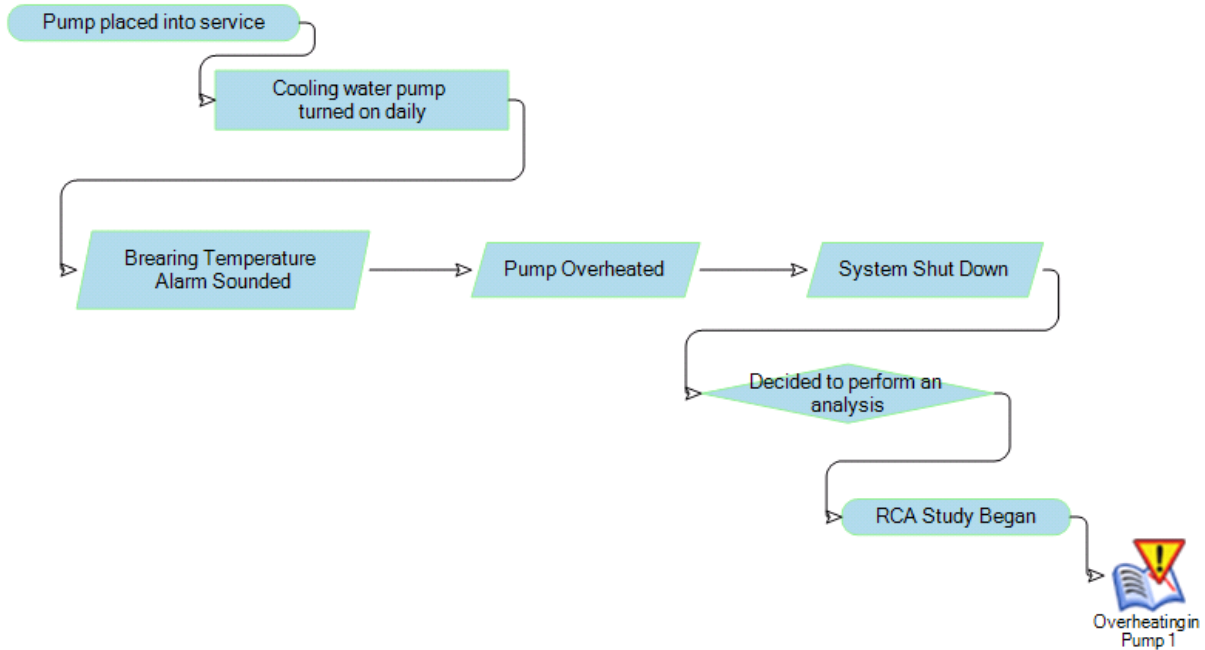

The following image shows a Logic Tree that was created using options on the **Logic Tree** page. The Logic Tree can depict, starting with the failure event, possible causes and hypotheses related to the event itself. In other words, the Logic Tree provides a way for the RCA Analysis Team to organize and record discussion points on the possible causes of the failure event.

What's the Difference Between an Event Diagram and a Logic Tree?

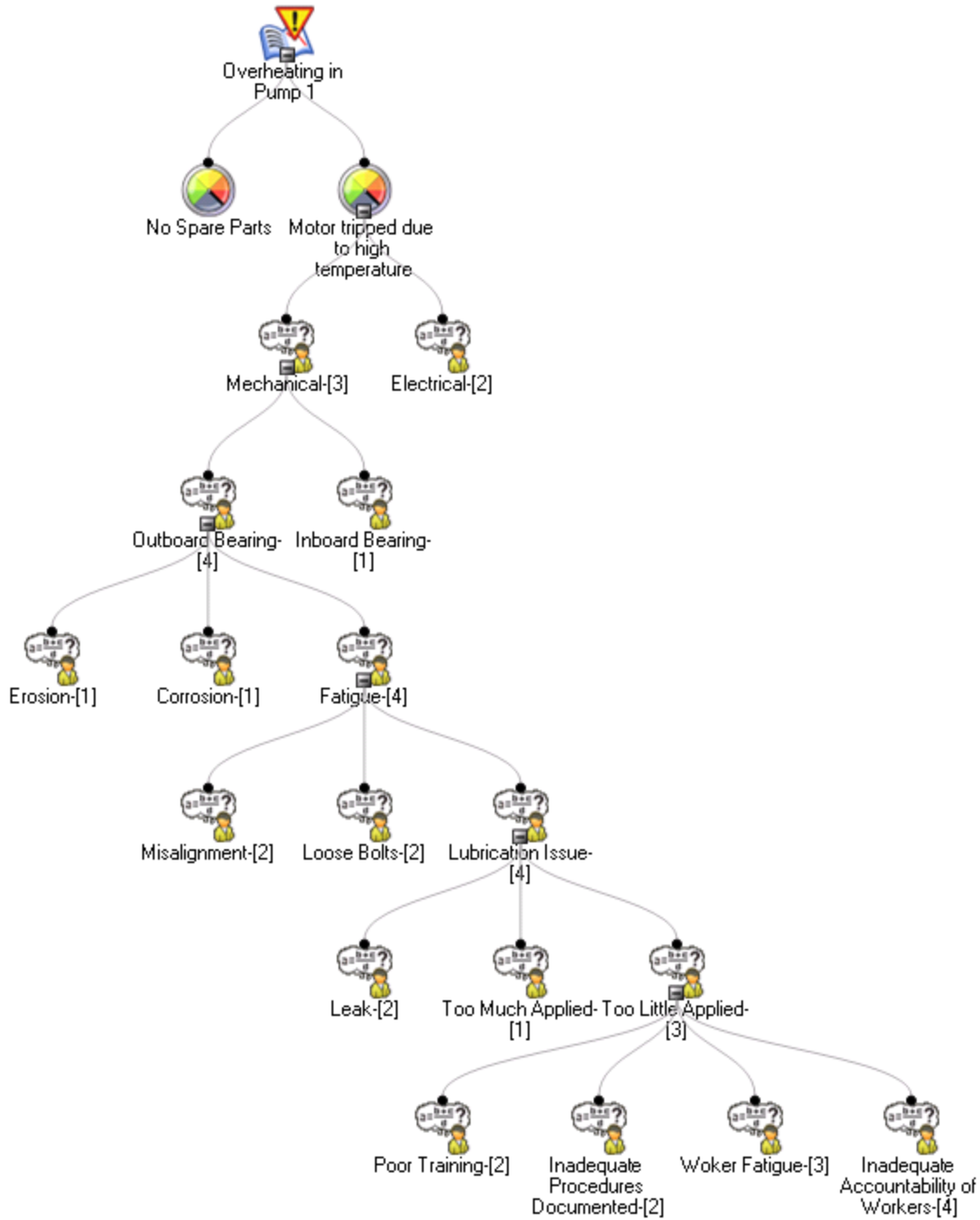

Overview of the Event Diagram and Logic Tree Data Model

An Event Diagram and a Logic Tree consist of an RCA Event record and all the records that are linked to it directly or indirectly. For example, after you define the failure event, you can create RCA Failure Mode records to link to the RCA Event record, and then you can link RCA Hypothesis records to the RCA Failure Mode records, and so on.

The following image shows the entity families and relationship families that are used to create an Event Diagram and a Logic Tree in Root Cause Analysis. The Logic Tree and the Event Diagram share an RCA Event record. The RCA Sequence Node family is used only by the Event Diagram. All of the other families are used by the Logic Tree.

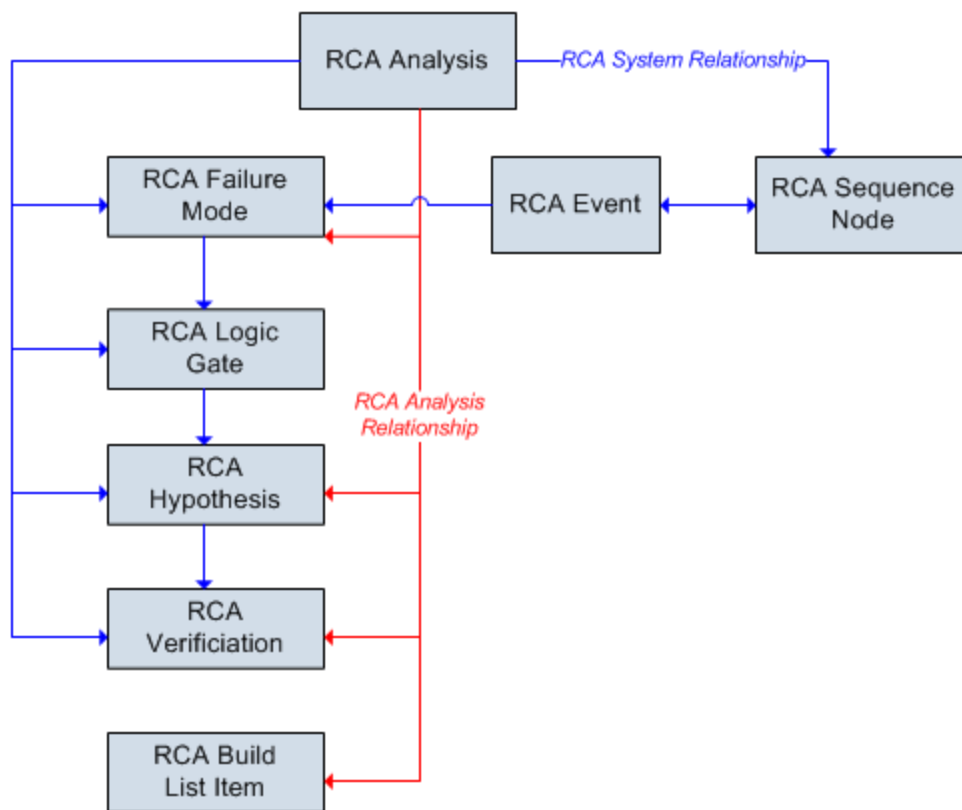

Records in the RCA Logic Gate family can be linked to other records in the RCA Logic Gate family. Additionally, records in the RCA Sequence Node family can be linked to other records in the RCA Sequence Node family.

In addition to the relationships that appear in the image, records in the following families can be linked to records in the RCA Reference Document family through a relationship definition on the Has Reference Documents family:

Overview of the Event Diagram and Logic Tree Data Model

- RCA Event
- RCA Hypothesis
- RCA Logic Gate

Defining the Failure Event

The first time that you access the **Event Diagram** page or the **Logic Tree** page for a given RCA Analysis, the **RCA Event** dialog box will appear, where you can create an [RCA Event](#) record. When you create an RCA Event record, you are also defining the associated Failure Event node. After you create a Failure Event node, you cannot delete it via Root Cause Analysis, but you can modify the RCA Event record, if necessary. Only one RCA Event record can be defined for each RCA Analysis.

Note: If you previously accessed the **Logic Tree** page or the **Event Diagram** page and defined a Failure Event node, you will not see the **RCA Event** dialog box prompting you to define it again. Instead, you will see the Failure Event node in the main display area (i.e., the design canvas or Logic Tree section). The following instructions assume that this is your first time accessing the **Event Diagram** page or the **Logic Tree** page for the current RCA Analysis.

To define the failure event for the RCA Analysis:

1. On the **Analysis** page, on the **Analyze** menu, click the **Event Diagram** or **Logic Tree** link.

The **RCA Event** dialog box appears.

The screenshot shows the 'RCA Event' dialog box with the 'RCA Event Node Data Sheet' tab selected. The 'Datasheet' dropdown is set to 'RCA Failure Event'. The 'Event Details' section contains a table with the following data:

| | Value(s) |
|------------------|----------------|
| Label | |
| Long Description | ... |
| Event Start Date | |
| Event ID | RCA-17/12/2010 |
| Event End Date | |

A 'Finish' button is located at the bottom right of the dialog box.

3. Populate the [fields on RCA Failure Event datasheet](#) as desired.

4. Click the **Finish** button.

The RCA Event record is created and linked automatically to the RCA Analysis record for the current RCA Analysis. The Failure Event node appears in the diagram canvas on the **Event Diagram** page or in the Logic Tree section on the **Logic Tree** page.

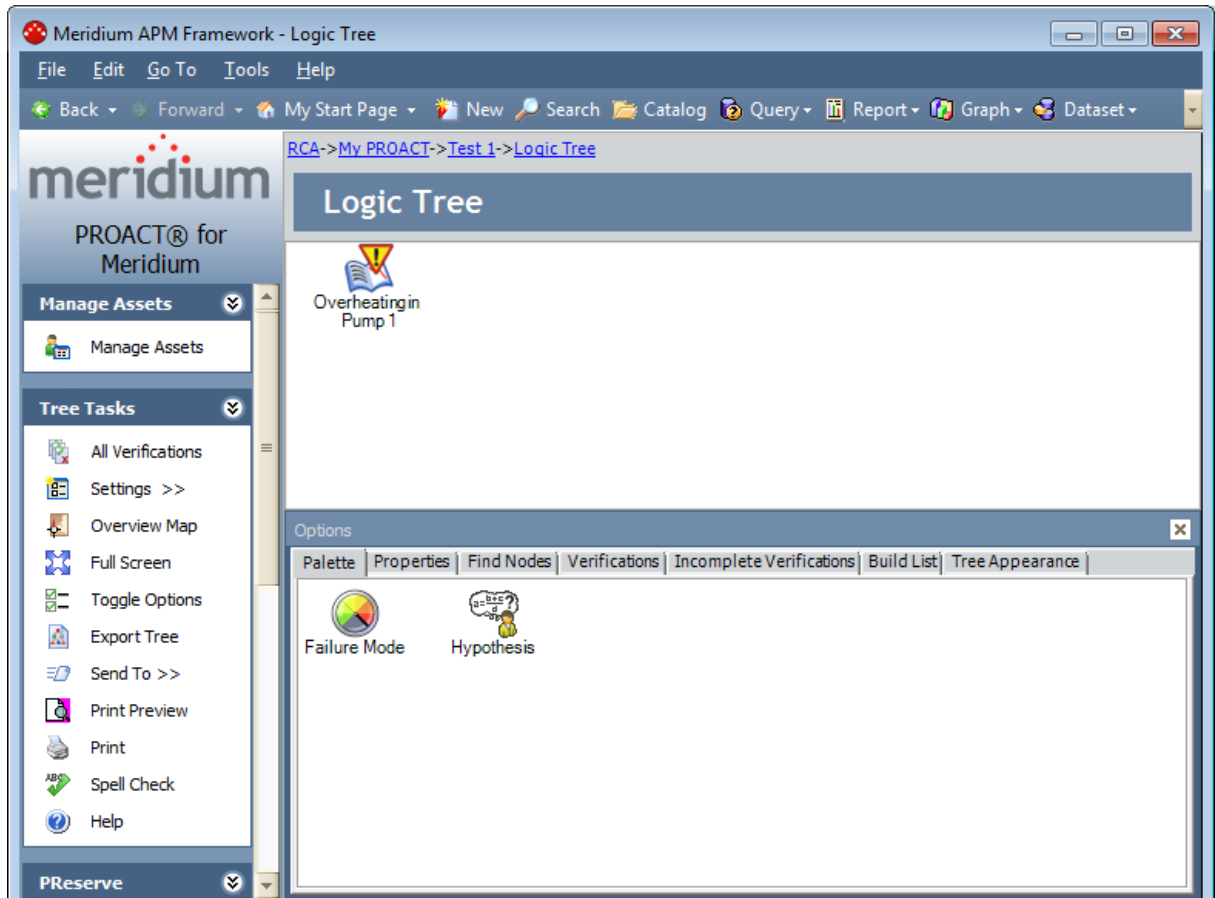

Linking Reference Document Records to Existing Failure Event Records

If desired, you can create a new Reference Document record to link to the Failure Event record for the current RCA Analysis. You can also search for an existing Reference Document record and link it to the Failure Event record for the selected RCA Analysis. The following instructions assume that you want to create a new Reference Document record.

Note that you will not be able to add a reference document to a Failure Event record upon creation. The reference document icon is enabled only after you have saved the Failure Event record.

To link a Reference Document record to the Failure Event record:

1. Access the datasheet for the desired RCA Event record.

| | Value(s) |
|------------------|----------------|
| ▶ Label | Test Failure |
| Long Description | ... |
| Event Start Date | |
| Event ID | RCA-17/03/2011 |
| Event End Date | |

At the top of the datasheet, click the reference documents icon. 

The standard **Reference Documents** window appears.

2. Add the desired Reference Document records to the Failure Event record.

The **Reference Documents** window closes, and the **Event Diagram** page returns to focus.

Accessing the Event Diagram Page

About Accessing the Event Diagram Page

You can access the **Event Diagram** page via the **Analyze** menu on any of the following pages:

- [Analysis page](#)
- [Preserve Failure Data page](#)
- [Preserve Record Details page](#)
- [Critical Success Factors page](#)
- [Event Diagram page](#)
- [Logic Tree page](#)

If an RCA Event record has already been created and linked to the current RCA Analysis, the Event Diagram will be displayed on the **Event Diagram** page, as shown in the following image.

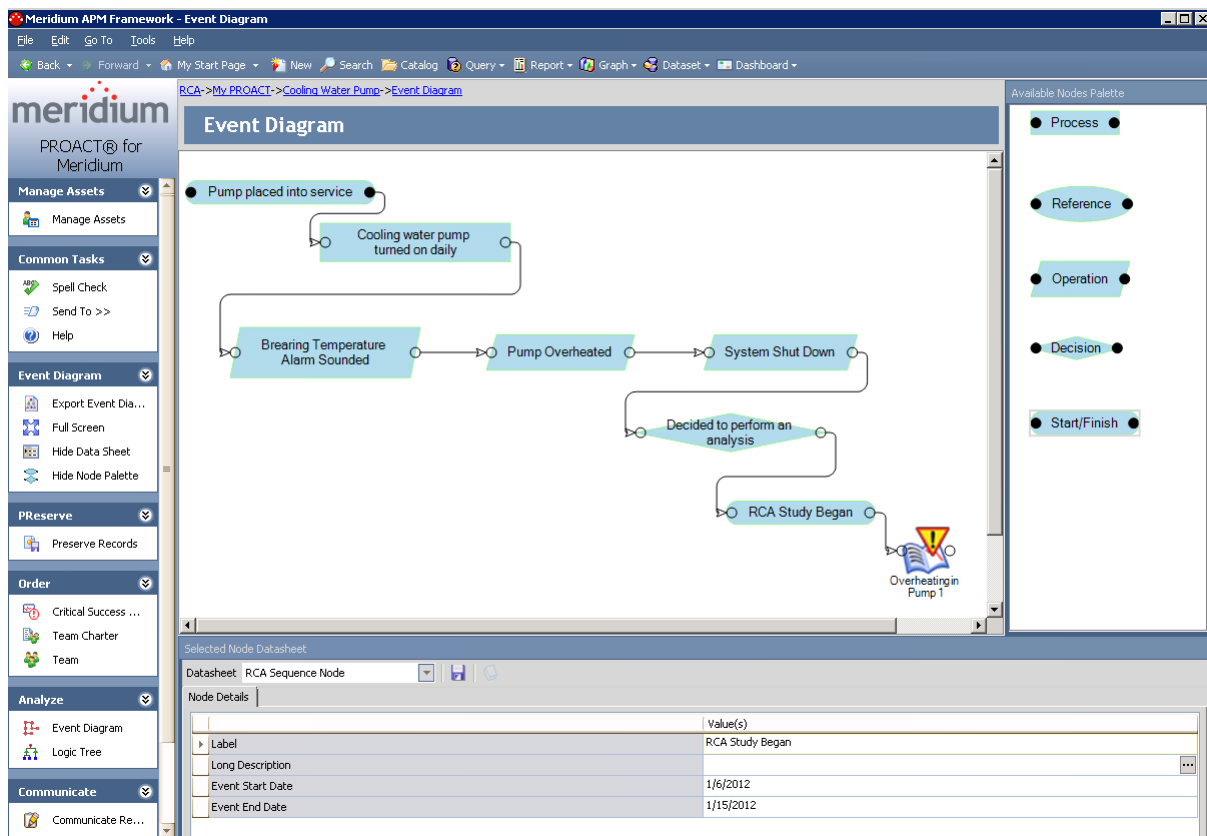

If an RCA Event record has not yet been created for the current RCA Analysis, the **RCA Event** dialog box will appear, prompting you to [define information for the failure event](#).

| | Value(s) |
|------------------|----------------|
| Label | |
| Long Description | |
| Event Start Date | |
| Event ID | RCA-03/03/2011 |
| Event End Date | |

Note: If the RCA Analysis was created from a Production Event record in the PLA module, several of the fields in the RCA Event record will be populated automatically with values from that Production Event record.

Accessing the Event Diagram Page

To access the Event Diagram page:

- On the [Analyze menu](#), click the **Event Diagram** link.

Either the **Event Diagram** page or the **RCA Event** dialog box appears, depending upon whether or not an RCA Event record has been created for the current RCA Analysis.

Aspects of the Event Diagram Page

The **Event Diagram** page consists of the sections shown in the following image. Numbered labels have been added to the image to identify the sections on the page.

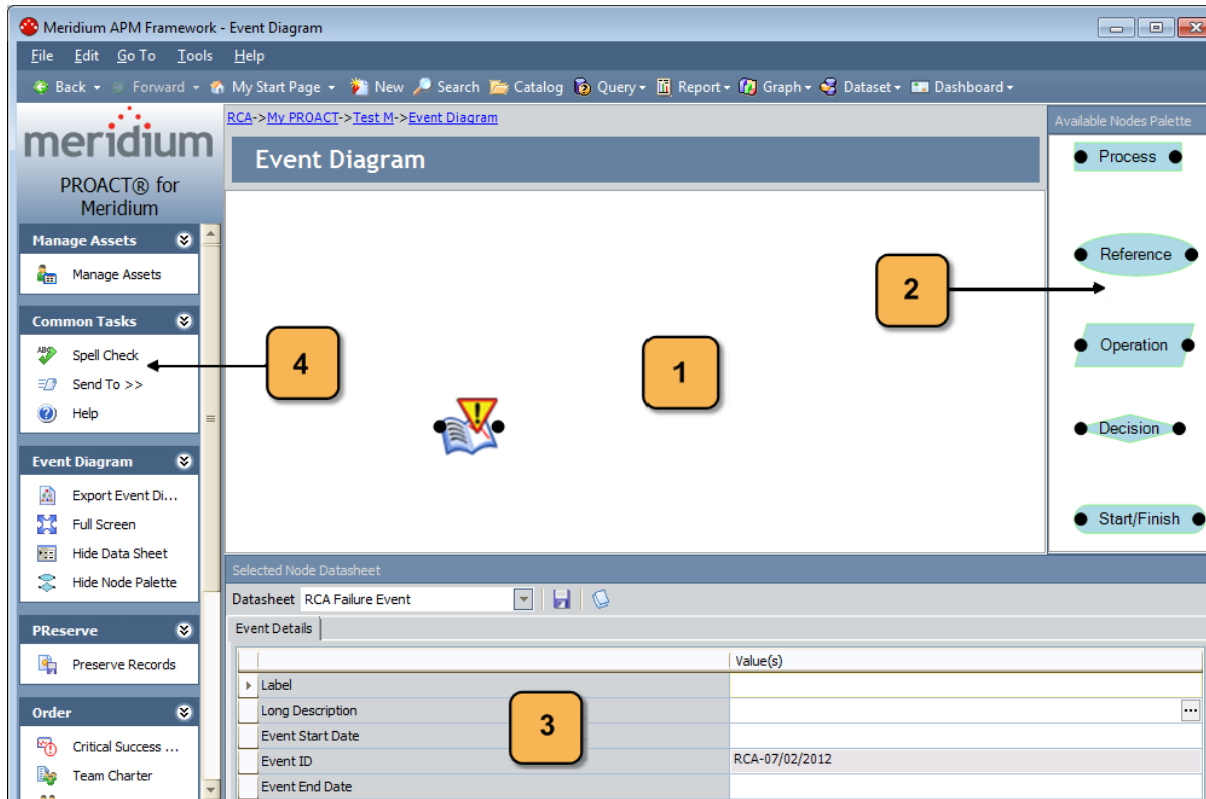

The **Event Diagram** page consists of the following sections, as identified by the numbers in the preceding image:

1. **Diagram canvas:** An interactive drawing interface upon which you can build a diagram that represents the order of events that occurred leading up to and immediately after the failure event. You can right-click the diagram canvas to display a [shortcut menu](#), containing options that let you modify the way the **Event Diagram** page looks.
2. **Available Nodes Palette pane:** Contains a group of icons that you can use to diagram the events. You can add nodes from the **Available Nodes Palette** to the diagram canvas on the **Event Diagram** page. When you add any type of node to the Event Diagram, you are creating an RCA Sequence Node record in the database and linking it to the RCA Analysis record for the current RCA Analysis. The RCA Sequence Node record contains information related to the event for which you are creating the associated node.

You can hide or display the **Available Nodes Palette** pane via the **Event Diagram** menu by clicking the **Hide Node Palette** or **Show Node Palette** link, as

appropriate. Additionally, you can reposition the palette by clicking the title bar and dragging it to the desired location.

Note: When two nodes are connected, a link between the two records is immediately created within the database. If a node is moved within the diagram, the links between the records are updated accordingly.

The following table describes the nodes in the **Available Nodes Palette** section.

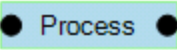
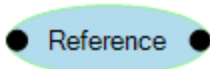
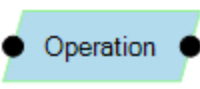
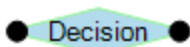
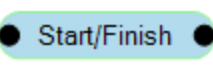
| This node | Can be used to represent... |
|---|---|
|  Process | A single step or an entire sub-process within a larger process. |
|  Reference | A printed document or report. |
|  Operation | Material or information entering or leaving the system, such as customer order (input) or a product (output). |
|  Decision | A decision or branching point. |
|  Start/Finish | A step that marks the starting or ending point of the event. |

CE Hint: The descriptions in this table describe the generic, intended use of these nodes. You can use the nodes according to the needs of your organization.

3. **Selected Node Datasheet section:** Displays the contents of the RCA Sequence Node record for the selected node. The following fields are available in the RCA Sequence Node record:
 - **Label:** A description of the event that the node represents, as you want it to appear in the Event Diagram.
 - **Long Description:** A detailed description of the event. You can click the  button to type the description in the Text Editor.
 - **Event Start Date:** The date the event started. You can type or select the date on which the event started.
 - **Event End Date:** The date the event ended. You can type or select the date on which the event ended.

You can select any node in the diagram to view the associated datasheet for that node. You can hide or display the **Selected Node Datasheet** section via the **Event Diagram** menu by clicking the **Hide Data Sheet** or **Show Data Sheet** link, as appropriate. Additionally, you can reposition the **Selected Node Datasheet** section by clicking the title bar and dragging it to the desired location.

4. **Task Menu pane:** Displays the [Manage Assets menu](#), [Common Tasks menu](#), the [Event Diagram menu](#), the [PReserve menu](#), the [Order menu](#), the [Analyze menu](#), the [Communicate menu](#), and the [Track menu](#), which you can use to navigate throughout Root Cause Analysis to perform various tasks.

Manage Assets Menu



The **Manage Assets** menu on the **Event Diagram** page contains the following link:

- **Manage Assets:** Displays the **Manage Assets** page, where you can link, view, and unlink Equipment and Functional Location records associated with the current RCA analysis.

Common Tasks Menu

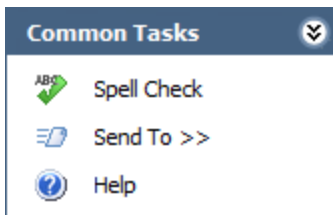

The **Common Tasks** menu on the **Event Diagram** page contains the following links:

- **Spell Check:** Displays the **Spell Check** dialog box, which allows you to perform a [spell check operation](#) on the text and character fields in records belonging to the current RCA Analysis.
- **Send To:** Displays a submenu with options that let you provide a link to the current page on your desktop (create shortcut), in an email message, or on a Home Page.
- **Help:** Displays the context-sensitive Help topic for the **Event Diagram** page.

Event Diagram Menu

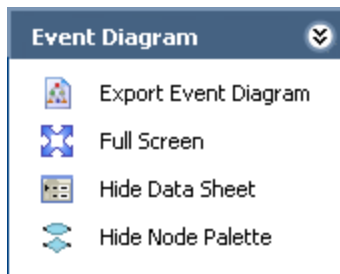

The **Event Diagram** menu on the **Event Diagram** page contains the following links:

- **Export Event Diagram:** Displays the **Export Event Diagram** dialog box, where you navigate to a location where you can export the current Event Diagram as an image file.
- **Full Screen:** Maximizes the Meridium APM window and hides the frame around the diagram canvas (including the task menu pane), and displays only the Event Diagram, the **Selected Node Datasheet** pane and the **Available Nodes Palette**. To return to the regular view, right-click the diagram canvas, and clear the **Full Screen** option.
- **Hide Data Sheet:** Lets you hide the **Selected Node Datasheet** section. When you hide the datasheet, a **Show Data Sheet** link will appear on the **Event Diagram** menu in place of the **Hide Data Sheet** option.
- **Hide Node Palette:** Lets you hide the **Available Nodes Palette** section. When you hide the palette, a **Show Node Palette** link will appear on the **Event Diagram** menu in place of **Hide Node Palette** option.

PReserve Menu



The **PReserve** menu on the **Event Diagram** page contains the following link:

- **Preserve Records:** Displays the [Preserve Failure Data page](#), which lists the existing RCA Preserve Item records that are linked to the current RCA Analysis.

Order Menu

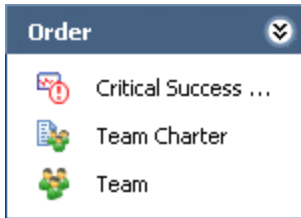

The **Order** menu on the **Event Diagram** page contains the following links:

- **Critical Success Factors:** Displays the **Critical Success Factors** page, which lists the existing RCA Critical Success Factor records that are linked to the RCA Analysis record for the current RCA Analysis.
- **Team Charter:** Displays the **Team Charter** dialog box, which contains the defined Team Charter for the current RCA Analysis.
- **Team:** Displays the **Team** page, which lists the RCA Team Member records that are linked to the RCA Analysis record for the current RCA Analysis.

Analyze Menu

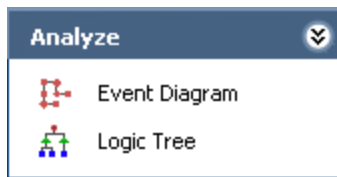

The **Analyze** menu on the **Event Diagram** page contains the following links:

- **Event Diagram:** Displays the [Event Diagram page](#) for the current RCA Analysis.
- **Logic Tree:** Displays the [Logic Tree page](#) for the current RCA Analysis.

Communicate Menu



The **Communicate** menu on the **Event Diagram** page contains the following links:

- **Communicate Records:** Displays the **Communicate Records** page, where you can [view, modify, and send RCA Analysis records and RCA Recommendation records](#).
- **Reports:** Displays the **Reports List** page, where you can [view and manage reports](#) based on the data from the current RCA Analysis.

Track Menu



The **Track** menu on the **Event Diagram** page contains the following link:

- **Track:** Displays the **Analysis Tracking Items** page, where you can add, edit, or delete RCA Tracking Item records for the current RCA Analysis.

Using the Shortcut Menu in the Diagram Canvas

To access the shortcut menu in the diagram canvas:

- Right-click anywhere in the design canvas.

The shortcut menu appears.

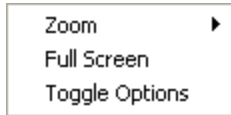

The following options on the shortcut menu let you modify the way the **Event Diagram** page appears.

- **Zoom:** Displays a submenu of options that let you change the magnification at which you are viewing the Event Diagram. When you select a magnification from the submenu, the design canvas refreshes and displays the Event Diagram at the specified magnification.
- **Full Screen:** Maximizes the Meridium APM window and hides the frame around the diagram canvas (including the task menu pane), and displays only the Event Diagram, the **Selected Node Datasheet** pane and the **Available Nodes Palette**. When this option is selected, a check mark appears to the left of the option. To return to the regular view, right-click the diagram canvas and clear the **Full Screen** option.
- **Toggle Options:** Hides the **Selected Node Datasheet** pane and **Available Nodes Palette**. To hide this pane individually, you can use the **Hide Data Sheet** and **Hide Node Palette** options on the **Event Diagram** task menu.

About Creating a New Event Diagram

The **Event Diagram** page provides tools that you can use to create the Event Diagram: a visual representation of the events that led up to and immediately followed the failure event. From the **Event Diagram** page, you can view and modify an existing Event Diagram or create a new Event Diagram.

Building the Event Diagram consists of the following steps:

1. [Defining the failure event.](#)
2. [Adding desired nodes to the Event Diagram.](#)
3. [Adding the node connectors to the Event Diagram.](#)

Adding Node to the Event Diagram

To add a node to the Event Diagram:

1. In the **Available Nodes Palette** section, click the icon that represents the type of node you want to add, and drag it to the desired location on the diagram canvas.

Note: A plus sign (+) appears next to the pointer to indicate that the new node can be linked to the existing node.

After you release the mouse button, the **RCA Event Diagram** dialog box appears, displaying the RCA Sequence Node datasheet.

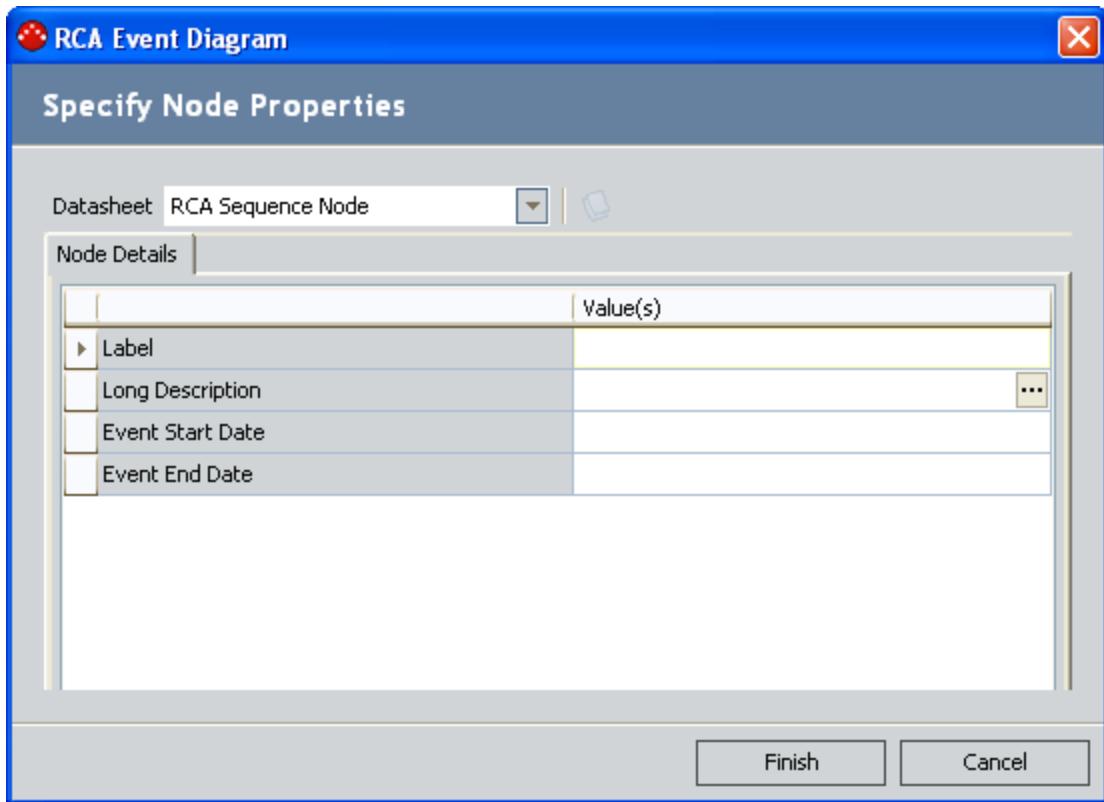

The screenshot shows a dialog box titled "RCA Event Diagram" with a sub-header "Specify Node Properties". Below the sub-header, there is a "Datasheet" dropdown menu set to "RCA Sequence Node". Underneath, there is a "Node Details" section with a table. The table has two columns: "Label" and "Value(s)". The rows in the table are:

| Label | Value(s) |
|------------------|----------|
| Label | |
| Long Description | |
| Event Start Date | |
| Event End Date | |

At the bottom of the dialog box, there are two buttons: "Finish" and "Cancel".

2. Provide values in the fields on the datasheet, as needed.
3. Click the **Finish** button.

The RCA Sequence Node record is saved and linked automatically to the RCA Analysis record for the current RCA Analysis, and the associated node appears in the diagram canvas on the **Event Diagram** page.

Connecting Sequence Nodes

You can create connections between the nodes in the Event Diagram to establish a relationship between the nodes. Each node in the diagram canvas has two *ports* that are used for connecting nodes to another node. Each port is designated by a circle on the right and left of the node. You can create as many connections as you need to build the Event Diagram. More than one connector can be attached to the same port of a node, allowing you to create parallel events. As you connect the nodes to build the Event Diagram, links are created between the items using a predecessor-successor relationship definition that exists between them.

Note: The predecessor is the node that precedes the node that is currently selected in the Event Diagram. The successor is the node that succeeds the node that is currently selected in the Event Diagram.

To connect nodes in an Event Diagram:

1. On the **Event Diagram** page, in the diagram canvas, click the circle on the node from which you want to initiate the connection, also known as the predecessor node.
2. Press and hold your mouse button down, and drag your pointer to the port of the successor node. As you drag your pointer, a line appears.
3. When your pointer touches the port of the successor node, release the mouse button.

An arrow appears, connecting the two nodes, and a link between the two records is automatically created.

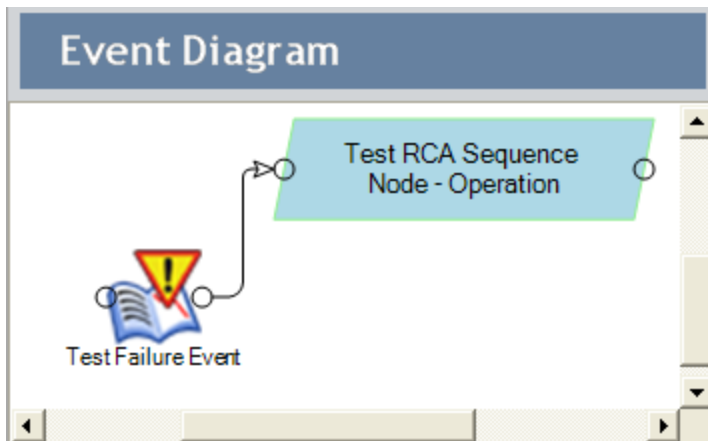

Viewing and Modifying the Record Associated with Each Node

To view and modify the record associated with a given node:

1. On the **Event Diagram** page, In the design canvas, click the node whose datasheet you want to view.

The associated datasheet appears in the **Selected Node Datasheet** section at the bottom of the page, and the selected node is highlighted in green.

The screenshot displays the 'Event Diagram' interface. At the top, the breadcrumb path is 'RCA->My PROACT->Test Analysis->Event Diagram'. The main design canvas shows a 'Test Failure Event' icon connected to a 'Test RCA Sequence Node - Operation' node, which is highlighted with a green border. To the right, the 'Available Nodes Palette' contains three items: 'Process', 'Reference', and 'Operation'. Below the design canvas is the 'Selected Node Datasheet' section. It features a dropdown menu set to 'RCA Sequence Node' and a 'Save' icon. Under the 'Node Details' tab, there is a table with the following structure:

| | Value(s) |
|------------------|------------------------------------|
| Label | Test RCA Sequence Node - Operation |
| Long Description | ... |
| Event Start Date | |
| Event End Date | |

2. Modify the record as desired.
3. At the top of the datasheet, click the **Save** icon. 

Your changes are saved to the database.

Cutting, Copying, and Pasting Nodes

After you create various nodes in your Event Diagram, you can cut, copy, and paste them as needed throughout the Event Diagram. Copying multiple nodes also copies any connectors between the nodes, as long as the connectors are selected when you perform the copy function. Cutting a single node in the middle of the Event Diagram also cuts successor nodes and as any connectors between them.

CE Hint: If you do not want to cut successor nodes along with a predecessor node, you should remove the connector between them before cutting the predecessor node.

To cut or copy a node in the Event Diagram:

1. On the **Event Diagram** page, in the design canvas, right-click the node that you want to cut or copy, and on the shortcut menu, click the **Cut** or **Copy** option.

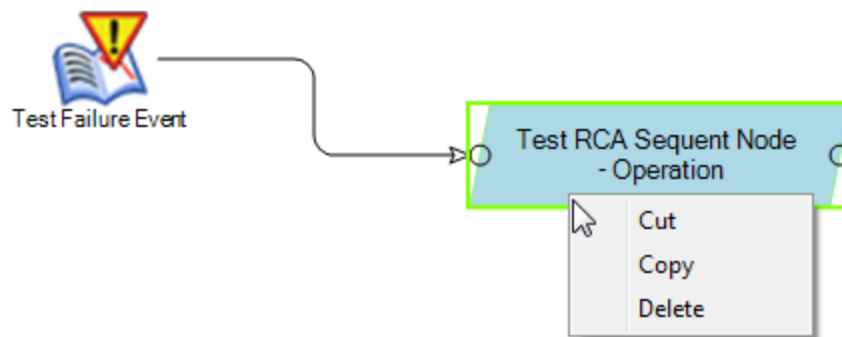

Note: If you select the **Cut** option and the node has successor nodes, the successor nodes will also be cut.

2. Navigate to the area on the Event Diagram canvas that you want to paste the node, right-click and select the **Paste** option from the shortcut menu.

The node is pasted to the Event Diagram canvas. If you chose to copy the node, a new RCA Sequence Node record is created for the pasted node.

Deleting Nodes from the Event Diagram

If desired, you can remove a node from the Event Diagram. When you delete a node from the Event Diagram, you are deleting the associated RCA Sequence Node record and any links to the associated RCA Sequence Node record.

CE Hint: If you do not want to delete successor nodes, you should remove the connectors before deleting the predecessor node. If you delete a predecessor node without first deleting the connector between it and the successor nodes, the records associated with the successor nodes will also be deleted.

To delete a node from the Event Diagram:

1. On the **Event Diagram** page, in the design canvas, right-click the node, and on the shortcut menu, click **Delete**.

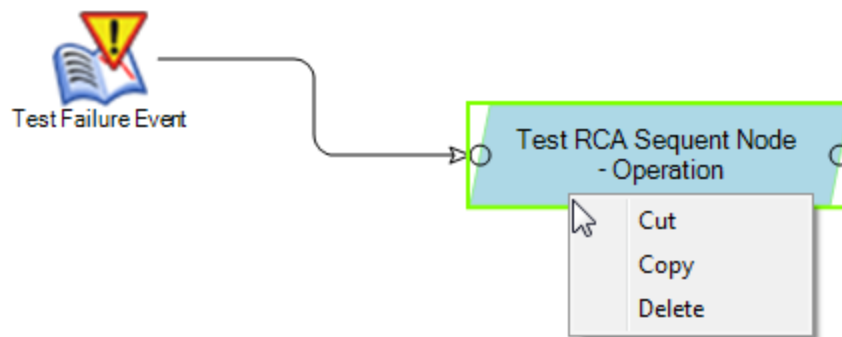

A message appears, explaining that deleting the node will also delete all of its successors and asking if you really want to delete the node.

2. Click the **Yes** button.

The RCA Sequence Node record is deleted along with any Sequence Node records associated with the successor nodes, and the predecessor node and any successor node(s) no longer appear in the diagram canvas.

Deleting Node Connectors

When you delete a connector between two given nodes in the Event Diagram, you are deleting the link between the two records.

To delete a connector from an Event Diagram:

1. On the **Event Diagram** page, in the diagram canvas, click the desired connector to select it.

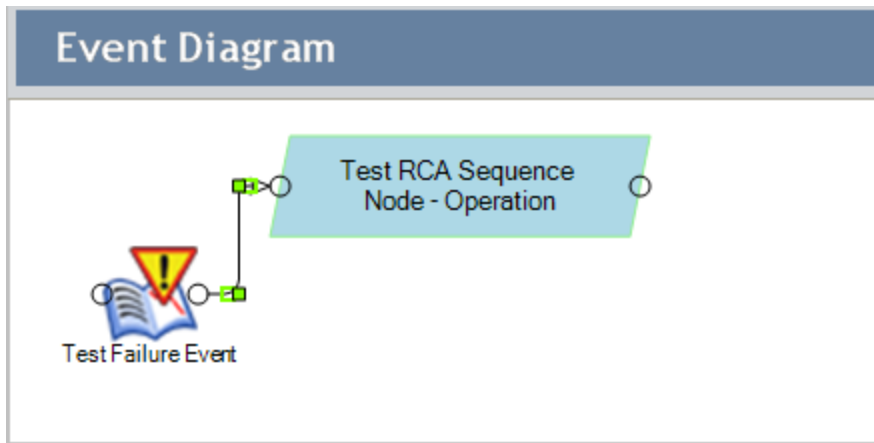

2. Press the Delete key.

A message appears, asking if you really want to delete the connector.

3. Click the **Yes** button.

The connector is deleted from the Event Diagram. The Meridium APM system also updates the record links for each node when one or more connectors attached to the node are deleted.

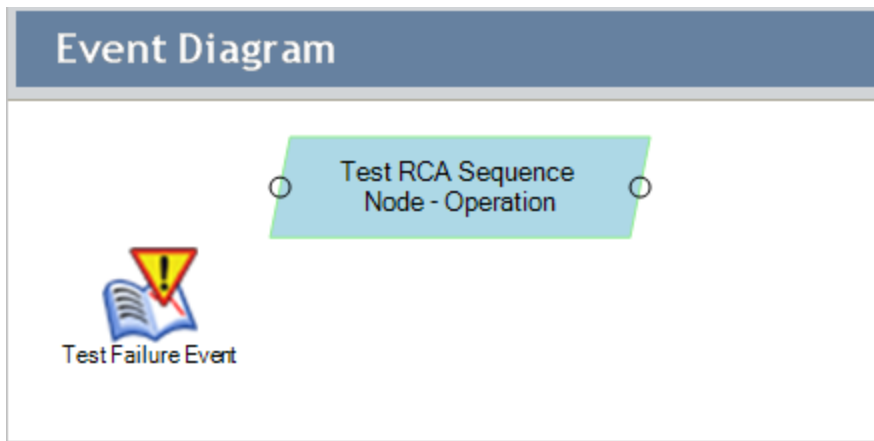

Displaying the Event Diagram on a Full Screen

Displaying an Event Diagram on a full screen can be useful for showing the Event Diagram in a presentation. The following instructions provide details on displaying the Event Diagram on a full screen.

To display the Event Diagram on a full screen:

- On the [Event Diagram page](#), on the **Event Diagram** menu, click the **Full Screen** link.

The Event Diagram appears on a full screen. All of the options available from the right-click menus in normal mode are also available in the full screen mode.

-or-

Right-click the diagram canvas, and then click **Full Screen**.

To return to normal mode from the full screen mode:

- Press the Esc key.

-or-

Right-click the diagram canvas, and then click **Full Screen**.

Hiding or Displaying the Selected Node Datasheet Section

To hide the Selected Node Datasheet section:

- On the **Event Diagram** task menu, click the **Hide Data Sheet** link.
The **Selected Node Datasheet Section** is removed from the **Event Diagram** page.

To display the Selected Node Datasheet section:

- On the **Event Diagram** task menu, click the **Show Data Sheet** link.
The **Selected Node Datasheet Section** appears on the **Event Diagram** page.

Hiding and Displaying the Available Nodes Palette Section

To hide the Available Nodes Palette section:

- On the **Event Diagram** page, on the **Event Diagram** task menu, click the **Hide Node Palette** link.

The **Available Nodes Palette** section is removed from the **Event Diagram** page.

To display the Available Nodes Palette section:

- On the **Event Diagram** page, on the **Event Diagram** task menu, click the **Show Node Palette** link.

The **Available Nodes Palette** section appears on the **Event Diagram** page.

Exporting the Event Diagram

If desired, you can export the Event Diagram as an image and save it to another location, such as your local hard drive. You can export the Event Diagram in any of the following image formats:

- Bitmap (.BMP)
- Graphic Interchange Format (.GIF)
- Joint Photographic Experts Group (.JPG)
- Portable Network Graphics (.PNG)
- Tag Image File Format (.TIF)

The following instructions assume that you have already created an Event Diagram for the RCA Analysis.

To export the Event Diagram:

1. On the [Event Diagram page](#), on the [Event Diagram menu](#), click the **Export Event Diagram** link.

The **Export Event Diagram** dialog box appears.

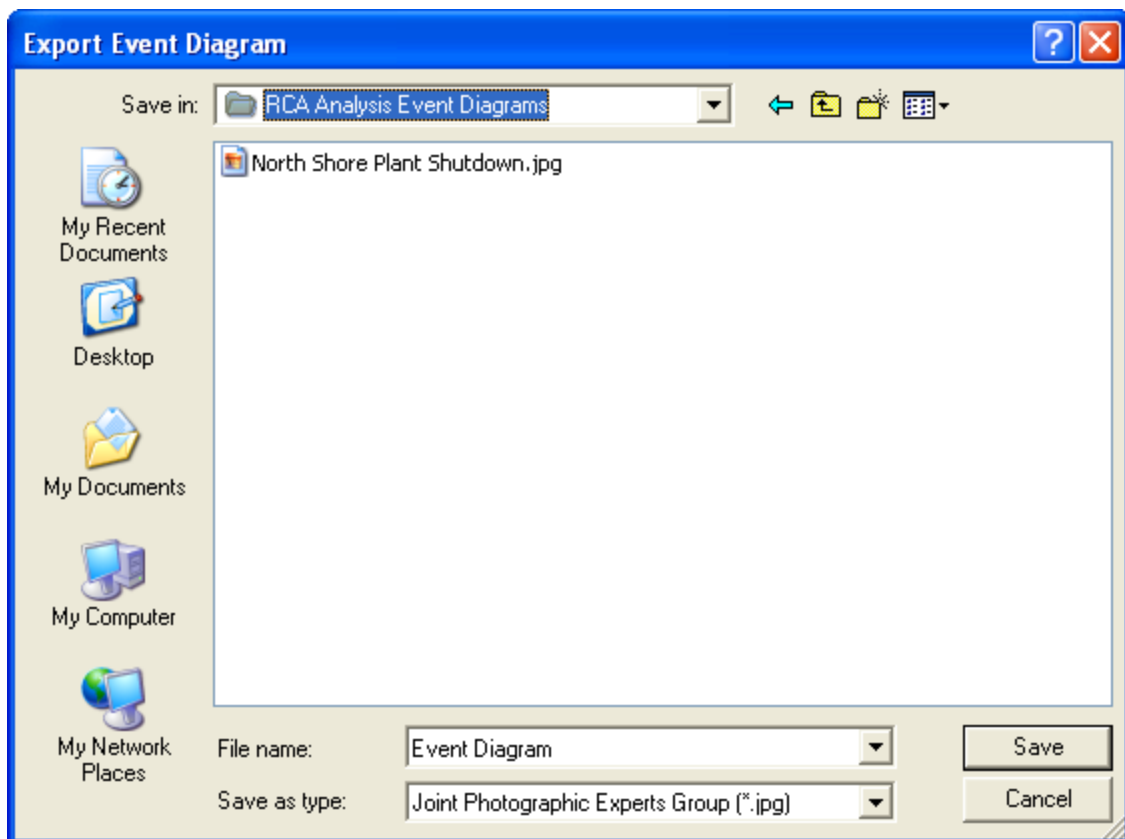

2. Navigate to the location to which you want to save an image of the Event Diagram.

Exporting the Event Diagram

3. In the **File Name** text box, type the desired file name.
4. In the **Save as type** list box, select the desired file type.
5. Click the **Save** button.

The Event Diagram is saved as an image to the specified location.

What is a Logic Tree?

A Logic Tree is an organizational tool that you can use to diagram all the possible causes of a failure event. The structure of the Logic Tree is hierarchical so that you can easily reference which event caused what effect. Each cause or effect is represented by a labeled icon, called a *node*.

There are four types of nodes: Failure Event, Failure Mode, Hypothesis, and Logic Gate. Each node has an associated record, which participates in a predecessor-successor relationship. For example, each Failure Mode node that appears in the Logic Tree has an associated RCA Failure Mode record that is linked to the root RCA Event record. Additionally, for each Hypothesis node that appears in the Logic Tree, an associated RCA Hypothesis record exists that is linked to the predecessor RCA Failure Mode record and the root RCA Event record. Additionally, when you add a node to the Logic Tree, a link is created between the record for that node and the RCA Analysis record.

The following image illustrates the basic structure of the Logic Tree.

What is a Logic Tree?

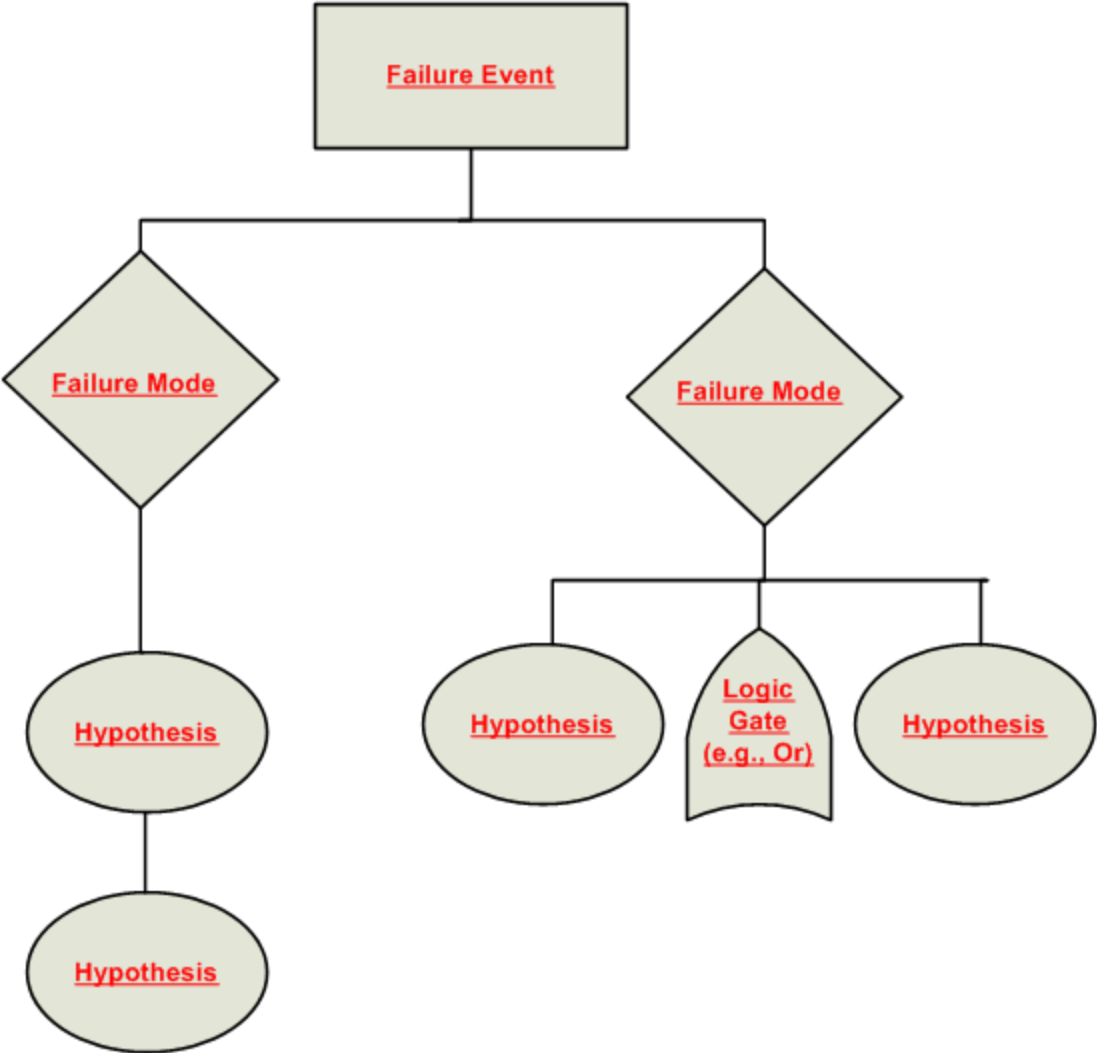

Accessing the Logic Tree Page

You can access the Logic Tree page via the Analyze menu on any of the following pages:

- Analysis page
- [Preserve Failure Data page](#)
- [Preserve Record Details page](#)
- [Critical Success Factors page](#)
- [Event Diagram page](#)
- [Logic Tree page](#)

If an RCA event record has already been created and linked to the current RCA Analysis, the Logic Tree page will appear, displaying the current Logic Tree.

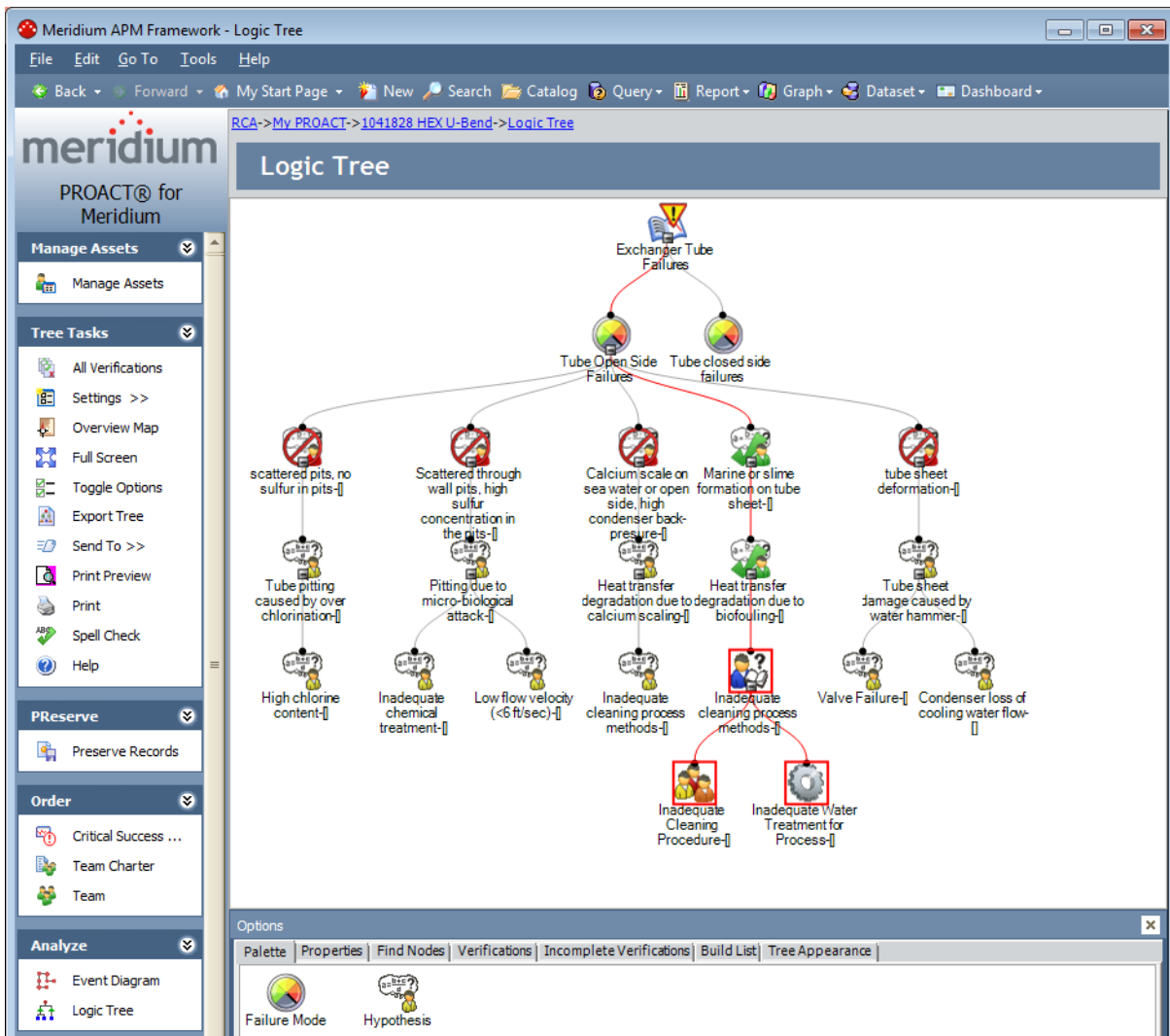

If an RCA Event record has not yet been created for the current RCA Analysis, the **RCA Event** dialog box will appear, prompting you to define the failure event.

The screenshot shows a dialog box titled "RCA Event" with a sub-header "RCA Event Node Data Sheet". Below the header, there is a "Datasheet" dropdown menu set to "RCA Failure Event" and a small icon to its right. Underneath is a tabbed interface with "Event Details" selected. The main area contains a table with the following data:

| | Value(s) |
|------------------|----------------|
| ▶ Label | |
| Long Description | ... |
| Event Start Date | |
| Event ID | RCA-03/03/2011 |
| Event End Date | |

At the bottom right of the dialog box is a "Finish" button.

Note: If the RCA Analysis was created from a Production Event record in the PLA module, several of the fields in the RCA Event record will be populated automatically with values from that Production Event record.

To access the Logic Tree page:

- On the [Analyze menu](#), click the **Logic Tree** link.

The **Logic Tree** page or **RCA Event** dialog box will appear, depending upon whether or not an RCA Event record has been created for the current RCA Analysis.

Aspects of the Logic Tree Page

The **Logic Tree** page consists of the sections shown in the following image. Numbered labels have been added to the image to identify the sections on the page.

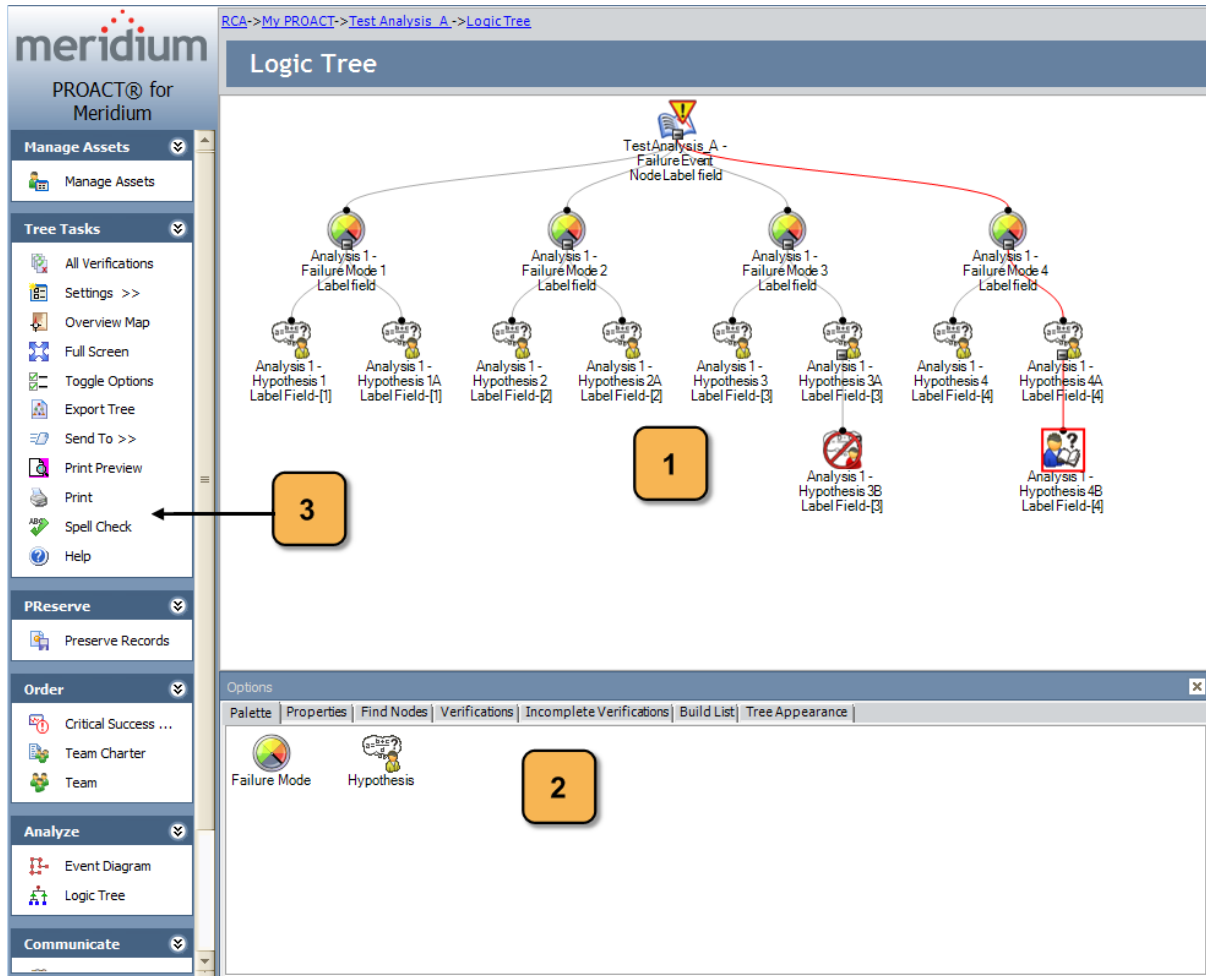

The **Logic Tree** page consists of three sections:

1. **Diagram canvas:** The main display area where you can build the Logic Tree diagram. You can right-click the diagram canvas to display a shortcut menu, containing options that let you modify how the **Logic Tree** page looks.
2. **Options pane:** Contains the following tabs:
 - **Palette:** Contains icons that represent the nodes that you can use to build a Logic Tree.
 - **Properties:** Displays the details of the record for the node that is currently selected in the diagram canvas.

- **Find Nodes:** Lets you search the Logic Tree for a specific node.
 - **Verifications:** Displays a list of the RCA Verification records related to the *hypothesis node* that is currently selected.
 - **Incomplete Verifications:** Displays a list of RCA Hypothesis records that are linked to RCA Verification records for which there is no outcome. You can filter this list to display RCA Hypothesis records that are not linked to RCA Verification records.
 - **Build List:** Displays the current build list, which is a list of *potential* RCA Hypothesis records that you can later select to add to the Logic Tree.
 - **Tree Appearance:** Provides you with options to change the appearance of the Logic Tree.
3. **Task menu pane:** Contains the following task menus that provide options that let you perform tasks associated with the RCA Analysis:
- **Manage Assets**
 - **Tree Tasks**
 - **PReserve**
 - **Order**
 - **Analyze**
 - **Communicate**
 - **Track**

Aspects of the Options Pane

The **Options** pane on the **Logic Tree** page contains tabs, which contain options that you can use to perform tasks associated with the Logic Tree and the Analyze step of the RCA Analysis.

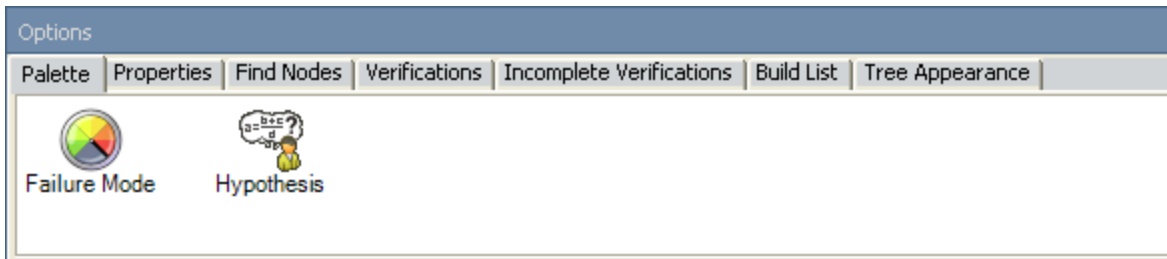

The **Options** pane contains the following tabs:

- **Palette:** Contains icons that represent the nodes that you can use to [build a Logic Tree](#). You can drag icons from the palette and drop them on the diagram canvas to add them to the Logic Tree. The **Palette** tab is displayed by default when you first access the **Logic Tree** page.
- **Properties:** Displays the datasheet for the node that is currently selected in the diagram canvas. You can [view and modify the details for the selected nodes on the datasheet](#). The following image shows an example of a completed datasheet on the **Properties** tab.

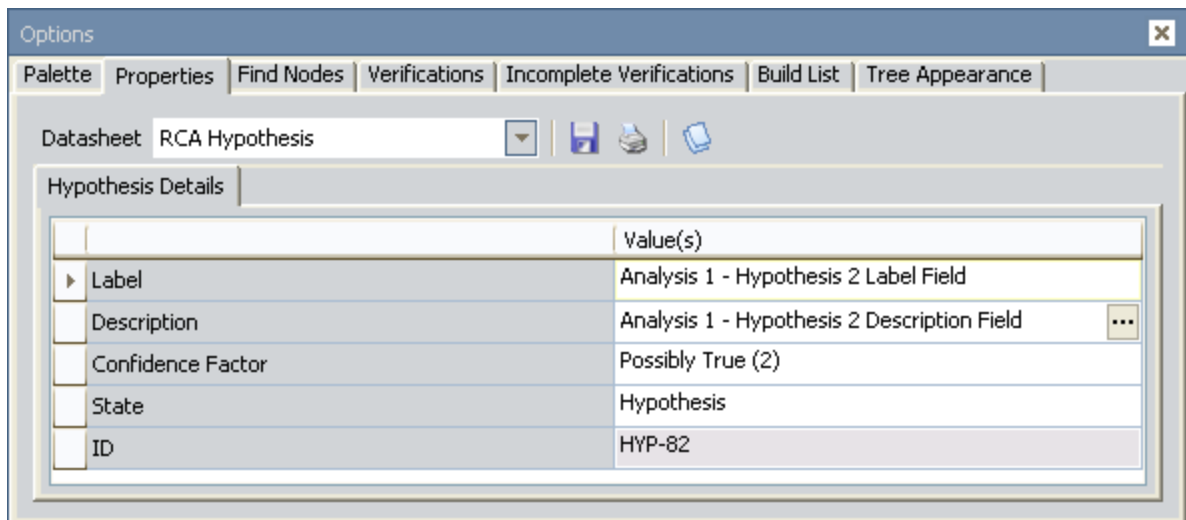

- **Find Nodes:** Lets you [search the Logic Tree for a specific node](#). You can double-click the desired node from the search results, and the Meridium APM system will locate the node in the Logic Tree and select it. The following image shows the **Find Nodes** tab.

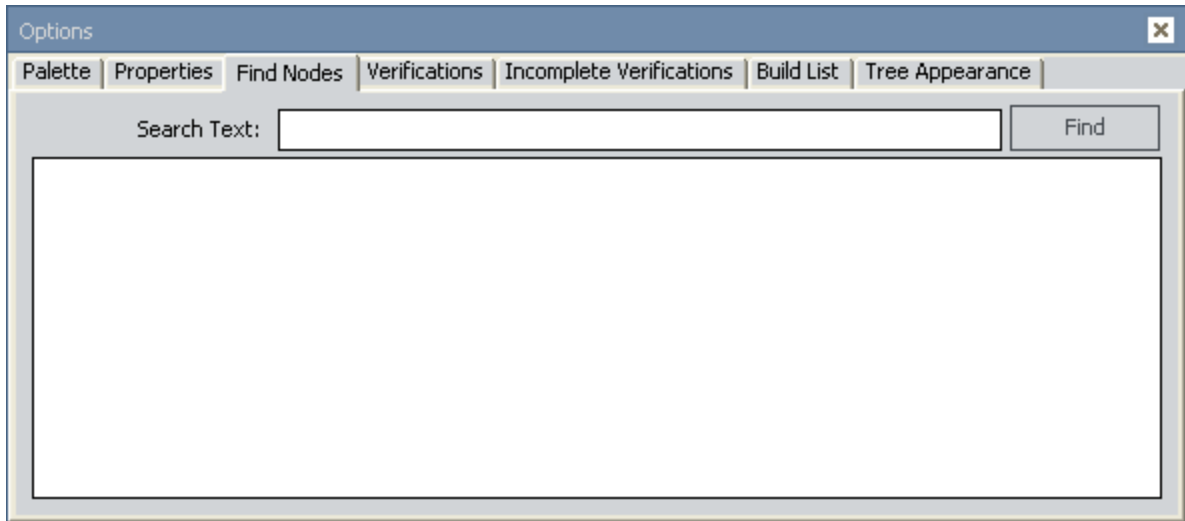

- **Verifications:** Displays a list of the RCA Verification records related to the Hypothesis node that is currently selected. The following image shows the **Verifications** tab.

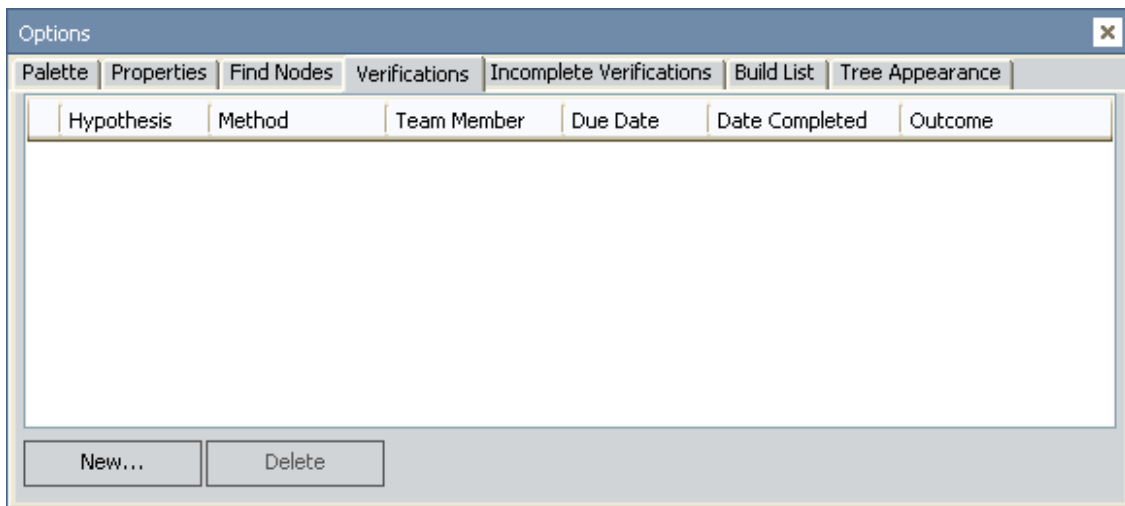

From this tab, you can:

- Select an RCA Verification record to modify.
- [Create a new RCA Verification record](#). The **New** button is enabled only when a Hypothesis node is selected in the diagram canvas.
- Delete an existing RCA Verification record for a selected hypothesis. The **Delete** button is enabled only when a Hypothesis node is selected in the Logic Tree.

Note: RCA Verification records are can be created only for Hypothesis nodes.

- **Incomplete Verifications:** Contains options that you can use to filter the list of RCA Hypothesis records to [locate those that are not linked to RCA Verification records or that are linked to incomplete RCA Verification records](#). The following image

shows an example of the **Incomplete Verifications** tab, where the **Show All** option is selected.

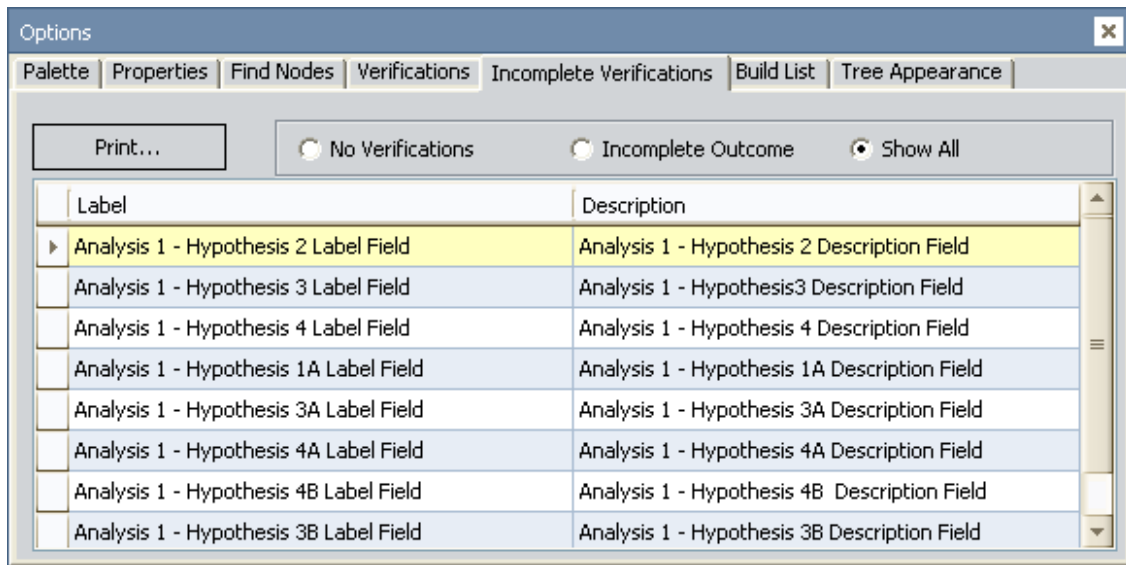

The **Incomplete Verifications** tab contains the following options:

- **No Verifications:** Displays a list of RCA Hypothesis records for which no RCA Verification records exist.
 - **Incomplete Outcome:** Displays a list of RCA Hypothesis records for which RCA Verification records exist but are incomplete (i.e., the Outcome field in the RCA Verification record is empty).
 - **Show All:** Displays a list containing both types of RCA Hypothesis records.
 - **Print button:** Displays the **Preview** window from which you can print the list of RCA Hypothesis records.
- **Build List:** Contains a list of Hypothesis nodes that have not yet been added to the Logic Tree. On the **Build List** tab, [you can add, modify, and delete Hypothesis nodes](#) and [import existing Hypothesis nodes](#) to later [add to the Logic Tree](#). The following image shows an example of the **Build List** tab, which contains a list of Hypothesis nodes.

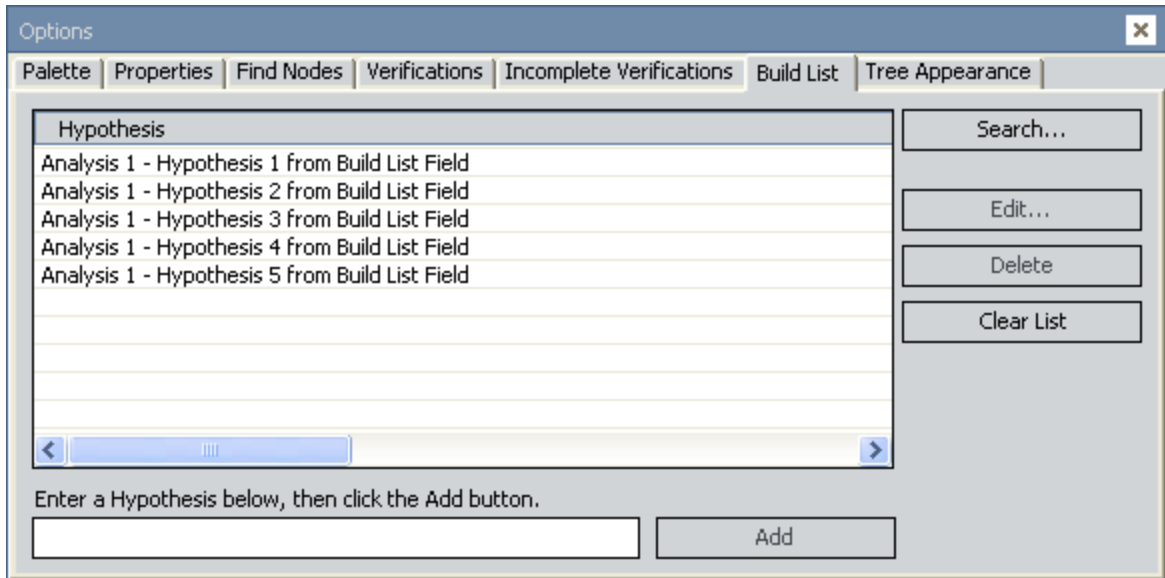

- **Tree Appearance:** Provides you with options that you can use to change the appearance of the Logic Tree. The following image shows the **Tree Appearance** tab.

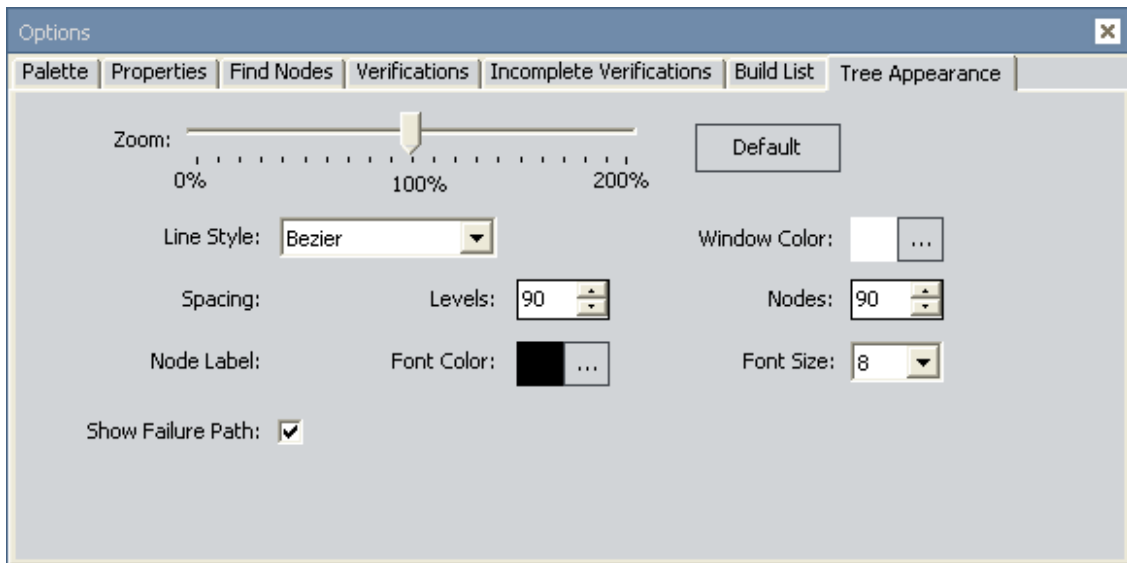

From the **Tree Appearance** tab, you can:

- [Zoom in and zoom out on the Logic Tree.](#)
- [Change the style of the lines that connect the nodes.](#)
- [Change the color of the Logic Tree window.](#)
- [Adjust the number of levels and nodes displayed on the Logic Tree.](#)
- [Change the font color and size of the node labels.](#)

Manage Assets Menu



The **Manage Assets** menu on the **Logic Tree** page contains the following link:

- **Manage Assets:** Displays the **Manage Assets** page, where you can link, view, and unlink Equipment and Functional Location records associated with the current RCA analysis.

Tree Tasks Menu

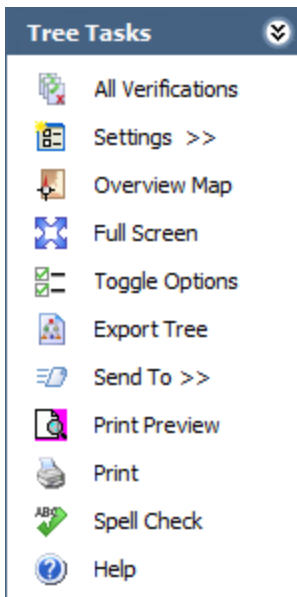

The **Tree Tasks** menu on the **Logic Tree** page contains the following links:

- **All Verifications:** Displays the **All Verifications** dialog box, which displays all verifications (i.e., hypotheses) that belong to the current RCA Analysis. You can use this dialog box to [send records in an email message](#) or print records.
- **Settings:** Displays a submenu that contains the following options:
 - **Show Logic Gates:** Displays on the **Palette** tab in the **Options** section the logic gates that you can use to connect nodes (i.e., *And* and *Or*) and reveals the logic gates that the Meridium APM system adds to the Logic Tree automatically.
 - **Auto Arrange:** Automatically arranges the nodes so that the nodes and the connector lines appear organized as you add nodes and connector lines to the Logic Tree. If this option is selected (as indicated by the check mark to the left of the option), you will not be able to move the nodes manually.
 - **Rearrange:** Rearranges the nodes and the connector lines so that they appear organized after you have manually moved and added nodes and connector lines to the Logic Tree. This option is disabled when the **Auto Arrange** option is selected.

Note: Unlike the other options on the submenu, a check mark does not appear to the left of the **Rearrange** option after you select it.

- **Vertical View:** Displays the Failure Event node at the top of the diagram canvas with the Logic Tree cascading down. This is the default display setting.
- **Horizontal View:** Displays the Failure Event node at the left of the diagram canvas with the Logic Tree cascading across the page to the right.

- **Overview Map:** Displays the **Overview Map** window, which displays the Logic Tree from an overview perspective, where you can [use your pointer to zoom in on specific areas](#). This option is useful when the Logic Tree is larger than the display area.
- **Full Screen:** Maximizes the Meridium APM Framework window, hides the frame around the diagram canvas (including the task menu pane), and displays only the Event Diagram, the **Selected Node Datasheet** pane, and the **Available Nodes Palette**.
- **Toggle Options:** Hides or displays the **Options** section.
- **Spell Check:** Displays the **Spell Check** dialog box, which allows you to perform a [spell check operation](#) on the text and character fields in records belonging to the current RCA Analysis..
- **Export Tree:** Displays the **Export Logic Tree** dialog box, where you can select a location and image file type and then [export the Logic Tree](#).
- **Send To:** Displays a submenu with options that let you provide a link to the current page on your desktop (create shortcut), in an email message, or on a Home Page.
- **Print Preview:** Displays the **Print Preview** window, which shows you a preview of the Logic Tree as it will appear on the printed page.
- **Print:** Displays the **Print** dialog box, where you can specify the printer settings, and then print the Logic Tree.
- **Help:** Displays the context-sensitive Help topic for the current page.

PReserve Menu



The **PReserve** menu on the **Logic Tree** page contains the following link:

- **Preserve Records:** Displays the **Preserve Failure Data** page, which lists the existing RCA Preserve Item records for the current RCA Analysis.

Order Menu

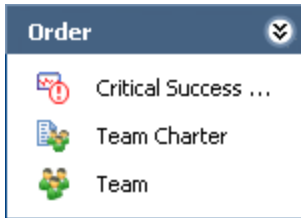

The **Order** menu on the **Logic Tree** page contains the following links:

- **Critical Success Factors:** Displays the **Critical Success Factors** page, which displays the CSFs associated with the selected RCA Analysis.
- **Team Charter:** Displays the **Team Charter** dialog box, which displays the Team Charter that is currently defined for the RCA Analysis. You can modify the Team Charter using this option, and then click the **Save** button.
- **Team:** Displays the **Team** page, which contains a list of Team Members that belong to the current RCA Analysis.

Analyze Menu

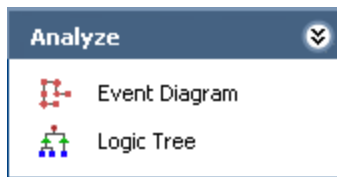

The **Analyze** menu on the **Logic Tree** page contains the following links:

- **Event Diagram:** Displays the **Event Diagram** page for the current RCA Analysis.
- **Logic Tree:** Displays the **Logic Tree** page for the current RCA Analysis.

Communicate Menu



The **Communicate** menu on the **Logic Tree** page contains the following links:

- **Communicate Records:** Displays the **Communicate Records** page, which contains the RCA Communicate datasheet and a list of RCA Recommendation records that are linked to the current RCA Analysis.
- **Reports:** Displays the **Reports List** page, which contains a list of reports that have been configured for use with Root Cause Analysis.

Track Menu



The **Track** menu on the **Logic Tree** page contains the following link:

- **Track:** Displays the **Analysis Tracking Items** page, which contains a list of RCA Tracking Item records that are linked to the current RCA Analysis.

Using the Shortcut Menu in the Diagram Canvas

To access the shortcut menu in the diagram canvas:

- Right-click anywhere in the diagram canvas.

The shortcut menu appears.

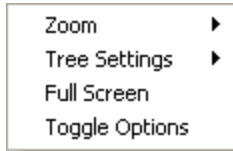

About the options on the shortcut menu:

The following options are available on the shortcut menu in the diagram canvas that let you modify the way the **Logic Tree** page appears.

- **Zoom:** Displays a submenu of options that let you change the magnification at which you are viewing the Event Diagram. When you select a magnification from the submenu, the design canvas refreshes and displays the Event Diagram at the specified magnification.
- **Tree Settings:** Displays a submenu of options that correspond to the options displayed on the submenu for the **Settings** link on the **Tree Tasks** menu. These options include the following.
 - **Show Logic Gates:** Displays on the **Palette** tab in the **Options** section the logic gates that you can use to connect nodes (i.e., *And* and *Or*), and reveals the logic gates that are added automatically to the Logic Tree. The Meridium APM system adds an *Or* node to the Logic Tree by default. If you want to add an *And* node, you will need to do so manually.
 - **Auto Arrange:** Automatically arranges the nodes so that the nodes and the connector lines appear organized as you add nodes and connector lines to the Logic Tree. If this option is selected (as indicated by the check mark to the left of the option), you will not be able to manually move the nodes.
 - **Rearrange:** Rearranges the nodes and the connector lines so that they appear organized after you have manually moved and added nodes and connector lines to the Logic Tree. This option is disabled when the **Auto Arrange** option is selected. A check mark does not appear to the left of the **Rearrange** option after you select it.
 - **Vertical View:** Displays the Logic Tree with the event at the top of the diagram canvas cascading down. This is the default display setting.
 - **Horizontal View:** Displays the Logic Tree with the event to the left of the diagram canvas cascading across the page to the right.
- **Full Screen:** Maximizes the Meridium APM Framework window and hides the frame around the diagram canvas (including the task menu pane), and displays only the Event Diagram, the **Selected Node Datasheet** pane and the **Available**

Nodes Palette. When this option is selected, a check mark appears to the left of the option. To return to the regular view, right-click the diagram canvas and clear the **Full Screen** option.

- **Toggle Options:** Hides the **Selected Node Datasheet** pane and the **Available Nodes Palette**. To hide the panes individually, you can use the **Hide Data Sheet** and **Hide Node Palette** options on the **Event Diagram** task menu.

Workflow for Creating a New Logic Tree

The **Logic Tree** page provides tools that you can use to create a Logic Tree. From the **Logic Tree** page you can view and modify an existing Logic Tree or create a new Logic Tree.

Building the Logic Tree consists of completing the following steps:

1. Defining the Failure Event node.
2. [Adding Failure Mode nodes to the Logic Tree.](#)
3. [Adding Hypothesis nodes to the Logic Tree.](#)
4. [Adding RCA Verification records to Hypothesis nodes.](#)
5. [Adding Logic Gate nodes to the Logic Tree.](#)
6. Setting the [states](#) and [causes](#) of the hypotheses.

What is a Failure Mode?

A *failure mode* is a possible cause associated with the failure event. The failure mode is represented by a node, called the Failure Mode node, which appears below the Failure Event node. When you add a Failure Mode node to the Logic Tree, you are defining the RCA Failure Mode record. When you define an RCA Failure Mode record, a link is created between the RCA Failure Mode record and the root RCA Event record and between the RCA Failure Mode record and the RCA Analysis record.

The following image shows an example of a completed RCA Failure Mode datasheet.

| | Value(s) |
|-------------|---|
| Label | Analysis 1 - Failure Mode 3 Label field |
| Description | Analysis 1 - Failure Mode 3 Description field ... |

The RCA Failure Mode datasheet consists of the following fields:

- **Label:** A description of the failure mode as you want it to appear on the Logic Tree.
- **Description:** A detailed description of the Failure Mode. You can click the  button to display the.

Failure Mode nodes exist on the second level of the tree, under the Failure Event node. Multiple Failure Mode nodes can be linked to the Failure Event node. The following image shows an example of how a Failure Mode node will look in the Logic Tree.

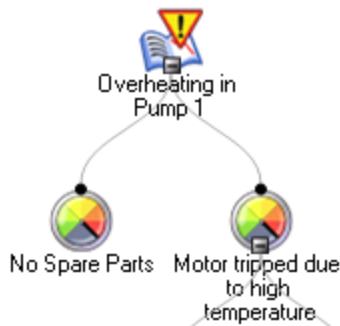

A given failure event can have multiple failure modes. For example, the image shows the failure modes from our Cooling Water Pump failure example. The Failure Event node (i.e., the overheated pump) is associated with the following Failure Mode nodes:

- **No Spare Parts.** There were no spare parts when the pump overheated, which caused the pump to be down for a longer amount of time and a greater loss of production. This failure mode did not cause the failure, so there are no hypotheses associated with it, but it is included as part of the failure event.

What is a Failure Mode?

- **Motor tripped due to high temperature.** This failure was the cause of the overheated pump event. There are additional hypotheses associated with this node so that the cause of the event can be determined.

Adding Failure Mode Nodes to the Logic Tree

To add a Failure Mode node to a Logic Tree, you can either create a new RCA Failure Mode record or [import an existing RCA Failure Mode record](#). The following instructions assume that you want to create a new RCA Failure Mode record.

To add a Failure Mode node to the Logic Tree:

1. In the **Options** pane, on the **Palette** tab, click and drag the **Failure Mode** icon to the **Failure Event** node in the diagram canvas and then release the mouse button to drop the Failure Mode in the desired location. A plus sign appears to indicate when you have chosen a valid location.

-or-

Right-click the Failure Event node in the diagram canvas, and on the shortcut menu, click **Add Failure Mode**.

The **New Logic Tree Item** dialog box appears.

| | Value(s) |
|-------------|----------|
| I Label | |
| Description | ... |

2. Complete the fields on the RCA Failure Mode datasheet as desired.
3. Click **OK** to save your changes.

The RCA Failure Mode record is saved and automatically linked to the RCA Event record and the RCA Analysis record. The Failure Mode node also appears on the Logic Tree below the Failure Event node.

Adding Failure Mode Nodes to the Logic Tree

If necessary, you can add additional Failure Mode nodes by repeating these steps. You can also [modify the RCA Failure Mode record properties on the datasheet](#). After you have finished defining the Failure Mode nodes, the next step in building the Logic Tree is to [define Hypotheses](#).

What is a Hypothesis?

By definition, a *hypothesis* is a tentative assumption intended to explain certain facts or observations. Within the context of an RCA Analysis, a hypothesis represents a theory about the root cause of a failure event.

In the Logic Tree, a hypothesis is represented by a *Hypothesis node*, which is defined in an associated RCA Hypothesis record. Hypothesis nodes can appear below Failure Mode nodes and other Hypothesis nodes in the Logic Tree. When you add a Hypothesis node to the Logic Tree, a link is created between the RCA Hypothesis record and the RCA Analysis record. A link is also created between the RCA Hypothesis record and either the RCA Failure Mode record or the predecessor RCA Hypothesis record.

The following image shows an example of a completed RCA Hypothesis datasheet.

| | Value(s) |
|-------------------|---|
| Label | Analysis 1 - Hypothesis 1 Label Field |
| Description | Analysis 1 - Hypothesis 1 Description Field ... |
| Confidence Factor | Somewhat True (1) |
| State | Hypothesis |
| ID | HYP-82 |

The RCA Hypothesis datasheet contains the following fields:

- **Label:** A description of the hypothesis as you want it to appear on the Logic Tree.
- **Description:** A detailed description of the hypothesis.
- **Confidence Factor:** A value that indicates the probability that the hypothesis is true. The list contains values that range from Not True (0) to True (5). You can choose ONE of the six values. If you select a value in this field, the value that you select will appear in brackets to the right of the hypothesis name in the Logic Tree.
- **State:** The [state of the Hypothesis node](#), which is set to **Hypothesis** by default. You can choose from the following states:
 - **Hypothesis**
 - **Note:** For more information on Hypothesis node states, see the [Hypothesis States](#) section of this Help system.
 - **Hypothesis Not True**

The following image shows an example of how a Hypothesis node and the associated RCA Hypothesis record will look in the Logic Tree when it is first created.

- **Cause Human**
- **Cause Latent**
- **Cause Physical**

What is a Hypothesis?



To the right of the label that you assign to the Hypothesis node, a number appears, indicating the level of confidence that the team has in the hypothesis being true. After a given RCA Hypothesis record has been created, the team can create an RCA Verification record to test the hypothesis. The team will then change [the state of the RCA Hypothesis record](#) according to the results of the RCA Verification record.

You can define multiple Hypothesis nodes for any RCA Failure Mode record or RCA Hypothesis record, meaning that one *cause* could have been caused by something else. For example, a lubrication issue may cause a cooling water pump to overheat, but that lubrication issue was caused by an operator who did not apply enough lubricant, which was caused by inadequate accountability of workers. In this case, the lubrication issue is a physical cause, too little lubrication applied is a human cause, and the latent root cause is the inadequate accountability of workers. The following image shows how this scenario would appear in the Logic Tree.

What is a Hypothesis?

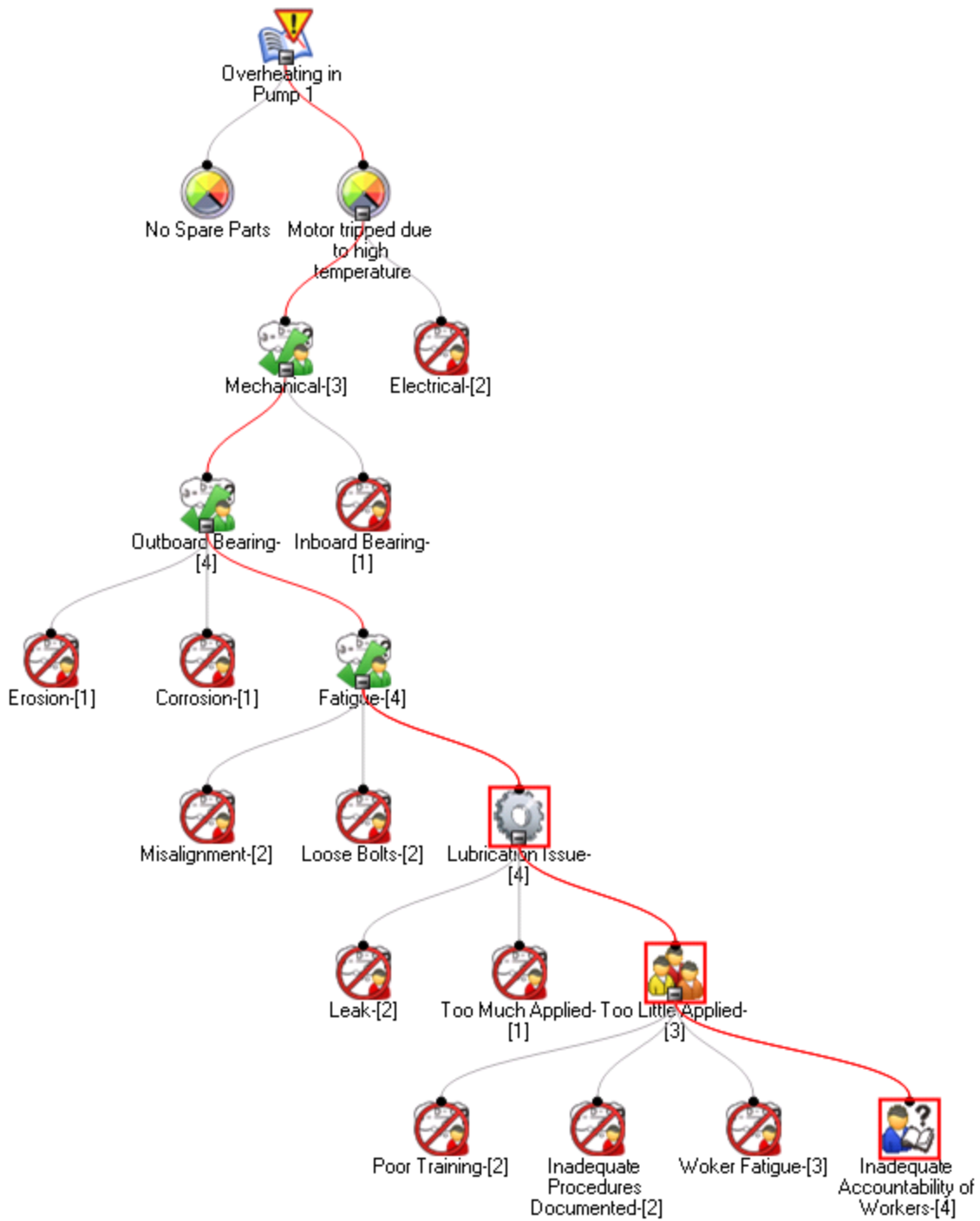



About Hypothesis States



RCA Hypothesis records are assigned a state that indicates the validity of the hypothesis. When a Hypothesis node is first created, it is assigned the *Hypothesis* state by default. After the hypothesis has been tested through the completion of an RCA Verification record, the state of the Hypothesis node can then be changed to *True* or *Not True*. If a hypothesis is proven to be incorrect, after you change the Hypothesis state to *Not True*, you are finished working with that hypothesis. If a hypothesis is proven to be true and you change the Hypothesis State to *True*, you can:

- Create additional RCA Hypothesis records that provide further information on a root cause and link them to the RCA Hypothesis record.
 - Create RCA Verification records to test the additional hypotheses, determine if the hypotheses are true or not true, and then change the state of the associated RCA Hypothesis records accordingly.
- or-
- Create additional RCA Verification records to test the hypothesis to further [identify the root cause as physical, human, or latent](#).

After the root cause has been identified, you can change the state of the associated RCA Hypothesis record to indicate your conclusions (i.e., *Cause Human*, *Cause Latent*, or *Cause Physical*).

When you [change the state of a Hypothesis node](#), the node icon changes to indicate the new state. The following table describes all the possible states of an RCA Hypothesis record and how the associated Hypothesis node will appear in the Logic Tree.

| Hypothesis Node | Hypothesis State | Description | For example, the team may determine that: |
|---|----------------------------|---|--|
|  <Hypothesis label> {3} | Hypothesis | The hypothesis is proposed and no conclusions can be drawn at this point. This is the default state. | The piece of equipment may have failed due to a pressure leak. |
|  <Hypothesis label> {3} | Hypothesis True | The hypothesis has been tested and proven to be <i>correct</i> . Further conclusions can be drawn. | The piece of equipment failed due to a pressure leak. |
|  <Hypothesis label> {3} | Hypothesis Not True | The hypothesis has been tested and proven to be <i>incorrect</i> . No further conclusions can be drawn. | The piece of equipment did not fail due to a pressure leak. |

| Hypothesis Node | Hypothesis State | Description | For example, the team may determine that: |
|---|-----------------------|---|---|
|  | Cause Human | The hypothesis has been proven correct and further testing has revealed that the root cause of the Failure Event was caused by human interaction. | The operator failed to increase the pressure when it reached the critical level, therefore causing a pressure leak and the failure. |
|  | Cause Latent | The hypothesis has been proven correct and further testing has revealed that the root cause of the Failure Event was caused by flaw(s) in procedure or the system that caused incorrect decisions to be made. This is often due to poor data or communication between individuals within the organization. In the vast majority of events, there will be at least one latent cause. | Management failed to adhere to the recommended safety guidelines for the piece of equipment, thus the operator failed to increase the pressure when it reached the critical level, causing the pressure leak and the failure. |
|  | Cause Physical | The hypothesis has been proven correct, and further testing has revealed that the root cause of the Failure Event was caused by a physical piece of equipment. | The seals on the pressure relief valve are worn and require replacement, which caused the pressure leak and the failure. |

Adding Hypothesis Nodes to the Logic Tree

Hypothesis nodes are always on the third level of the tree or later, attached either to a Failure Mode node or another Hypothesis node. After you have created the Failure Event node and the corresponding [Failure Mode node\(s\)](#), you can add Hypothesis nodes to the Failure Mode nodes and Hypothesis nodes as desired to help the team determine the cause of the event.

You can add a Hypothesis node to the Logic Tree by creating a new RCA Hypothesis record or by [importing an existing RCA Hypothesis record and the associated Hypothesis node](#). The following instructions provide details on defining a new Hypothesis node and adding it to the Logic Tree.

To create a new Hypothesis node and add it to the Logic Tree:

1. On the **Logic Tree** page, In the **Options** pane, on the **Palette** tab, click and drag a **Hypothesis** icon to the Failure Mode node or Hypothesis node in the diagram canvas and then release the mouse button to drop the Hypothesis node in the desired location. A plus sign (+) appears to indicate when you have chosen a valid location.

-or-

On the **Logic Tree** page, right-click the Failure Mode node or Hypothesis node in the diagram canvas, and on the shortcut menu, click **Add Hypothesis**.

The **New Logic Tree Item** dialog box appears.

| Label | Value(s) |
|-------------------|------------|
| | |
| Description | |
| Confidence Factor | |
| State | Hypothesis |
| ID | HYP-361 |

Adding Hypothesis Nodes to the Logic Tree

2. Define the RCA Hypothesis record as desired.
3. Click **OK** to save your changes.

The Hypothesis node appears in the Logic Tree and a link is created between the RCA Hypothesis record and the RCA Analysis record and between the RCA Hypothesis record and the RCA Failure Mode record or another RCA Hypothesis record.

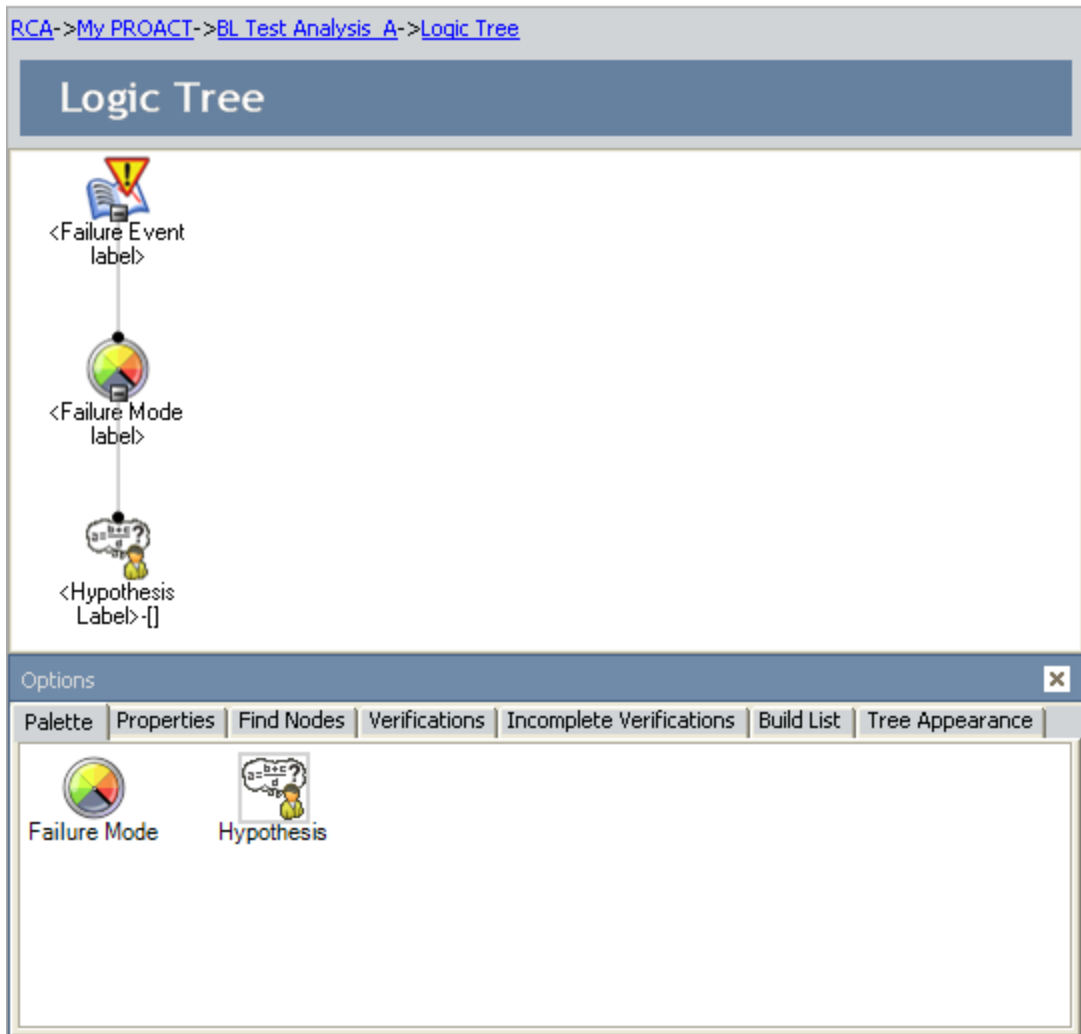

If necessary, you can add additional Hypothesis nodes by repeating these steps. You can also [modify the hypothesis properties via the datasheet](#).

About the Build List Tab

The **Build List** tab appears in the **Options** pane on the [Logic Tree page](#) and contains a list of *potential* Hypothesis nodes that have been defined by an RCA Analysis Team.

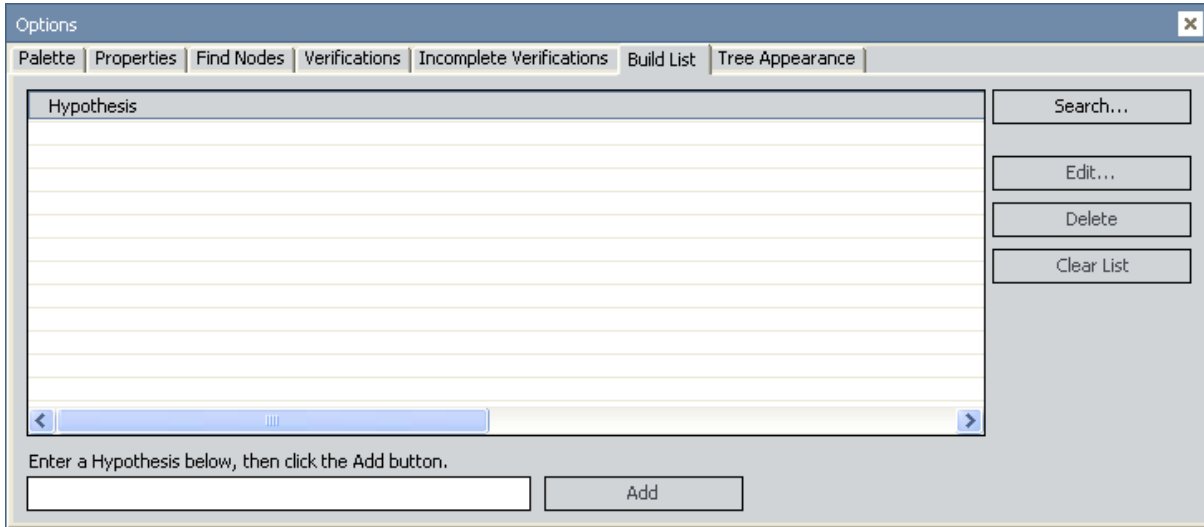

You can create new RCA Hypothesis records and add them to list on the **Build List** tab, and you can select a hypothesis from the **Build List** tab and [add the associated Hypothesis node to the Logic Tree](#).

Adding a New Hypothesis to the Build List Tab

The following instructions provide details on creating a new RCA Hypothesis record and adding it to the **Build List** tab.

To create a new RCA Hypothesis record and add it to the **Build List** tab:

1. On the **Logic Tree** page, In the **Options** pane, click the [Build List tab](#).

The **Build List** tab appears.

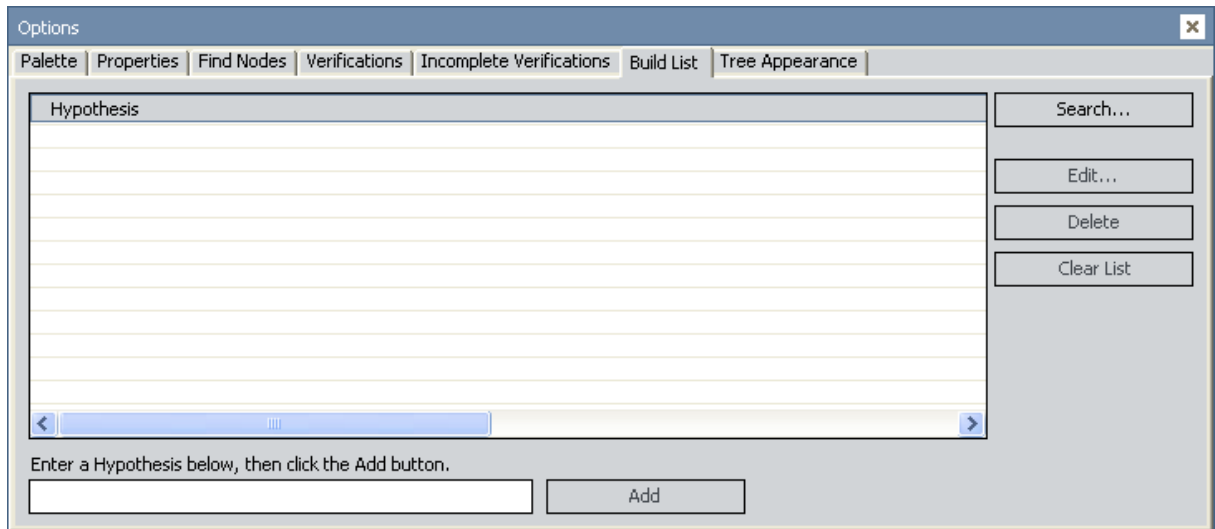

If RCA Hypothesis records exist that are linked to the current RCA Analysis but do not appear in the Logic Tree, they will appear in the list.

2. In the text box below the label **Enter a Hypothesis below, then click the Add button**, type a description of the new Hypothesis node as want it to appear on the Logic Tree.
3. Click the **Add** button.

The description for the new hypothesis appears in the **Build List** of potential hypotheses.

Adding a New Hypothesis to the Build List Tab

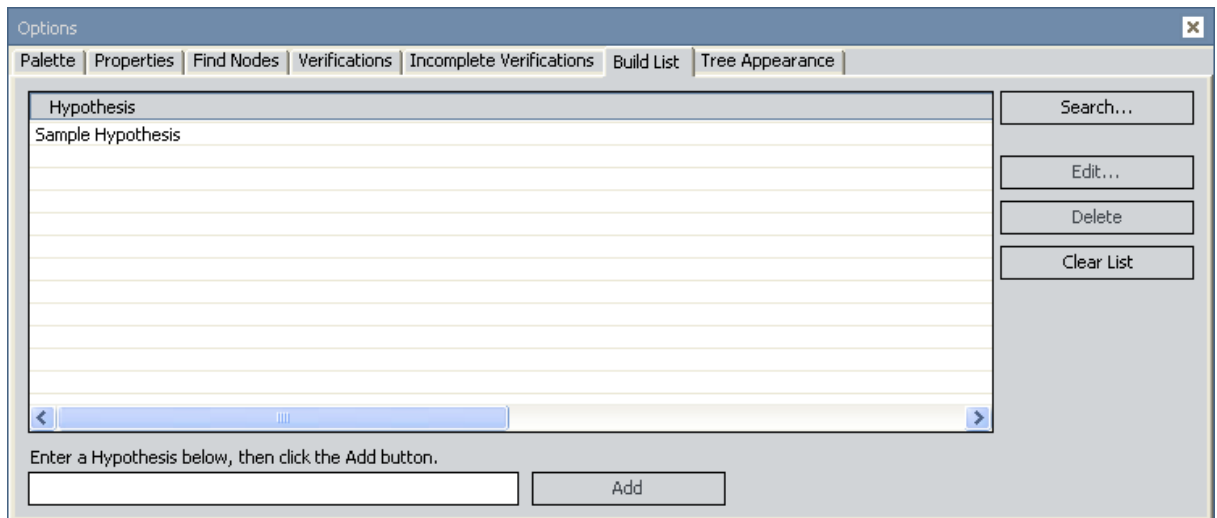

This list will be retained until you add the associated Hypotheses nodes to the Logic Tree.

Importing a Hypothesis and Adding it to the Build List Tab

The following instructions provide details on importing an RCA Hypothesis record from an existing RCA Analysis and adding it the **Build List** tab.

Note: Importing an RCA Hypothesis record in this way adds it *only* to the **Build List** tab. If you want to add the Hypothesis node to the Logic Tree, you will need to [do so manually](#) or [import the Hypothesis node and add it to the Logic Tree](#).

To import a Hypothesis node to the Build List tab:

1. On the **Logic Tree** page, In the **Options** pane, on the [Build List tab](#), click the **Search** button.

The **Search Tool** window appears.

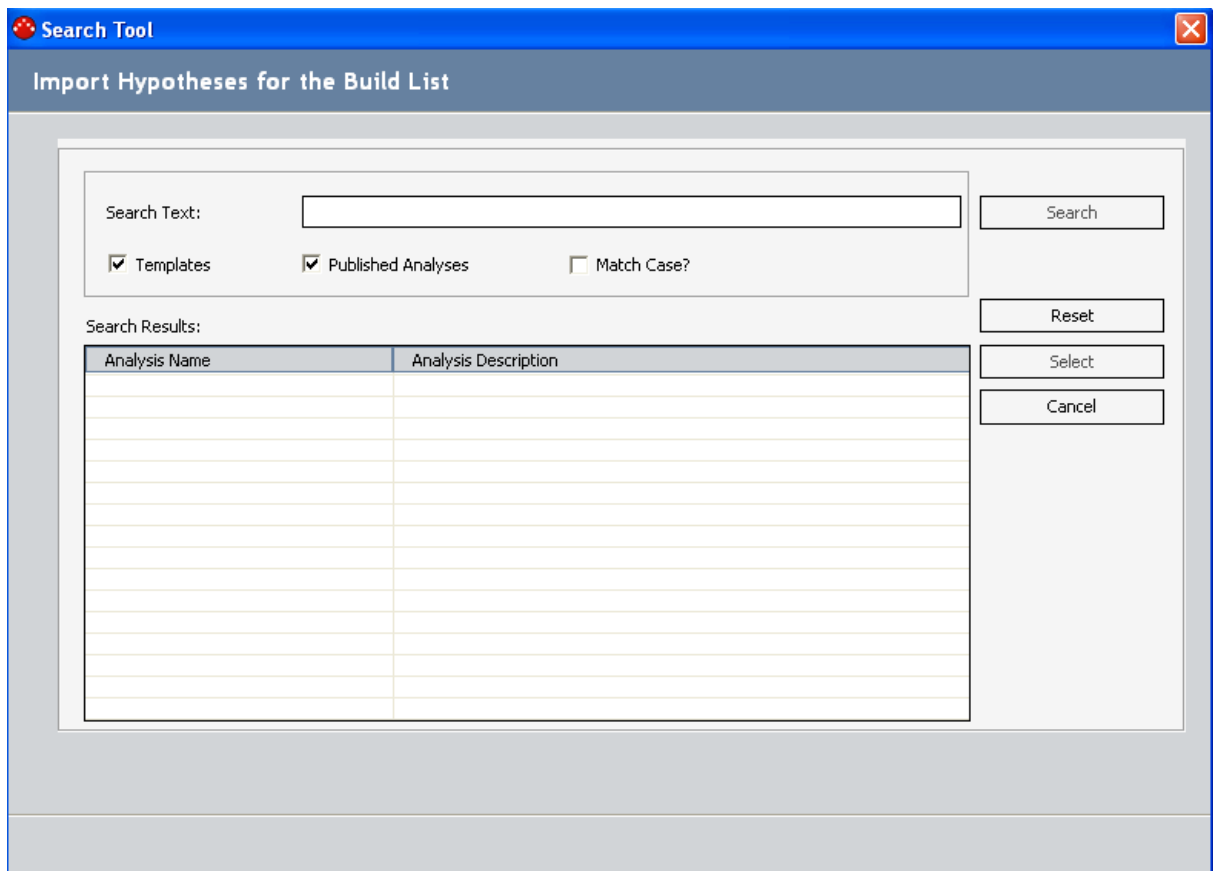

The screenshot shows a window titled "Search Tool" with a subtitle "Import Hypotheses for the Build List". The window contains a search interface with the following elements:

- A "Search Text:" input field.
- Three checkboxes: "Templates" (checked), "Published Analyses" (checked), and "Match Case?" (unchecked).
- A "Search" button.
- A "Search Results:" section containing a table with two columns: "Analysis Name" and "Analysis Description". The table is currently empty.
- Buttons for "Reset", "Select", and "Cancel" on the right side of the window.

2. In the **Search Text** box, type the search criteria for the analysis that is associated with the Hypothesis node that you want to import and add to the **Build List** tab.

CE Hint: You can type the % (percent sign) in the **Search Text** field as a wild card character, allowing you to search on all items stored in the database.

3. Select the check boxes that apply to the type(s) of analysis for which you want to search, **Templates** and/or **Published Analyses**. Note that the **Templates** and **Published Analyses** check boxes are selected by default. If you want search only for Templates or only for Published Analyses, clear the appropriate check box.
4. Select the **Match Case?** check box if you want to return items that match exactly the case of the keyword you entered in the **Search Text** box.

Note: To return all search criteria to their default values, click the **Reset** button. This will clear the **Search Text** box, reselect the **Templates** and **Published Analyses** check boxes, and clear the **Match Case?** check box.

5. Click the **Search** button.

The Meridium APM system searches the database for existing analyses that match the analysis type you selected and whose Label field contains the value that you typed in the **Search Text** box.

The results appear in the grid in the **Search Results** section on the **Search Tool** window.

The screenshot shows the 'Search Tool' window with the title 'Import Hypotheses for the Build List'. It features a search interface with a text box containing '%', three checkboxes for 'Templates', 'Published Analyses', and 'Match Case?', and a grid of search results. The results table has two columns: 'Analysis Name' and 'Analysis Description'.

| Analysis Name | Analysis Description |
|--|---|
| PROACT BL Test Analysis_1 | PROACT BL Test Analysis_1 |
| PROACT BL Test Analysis_2 | PROACT BL Test Analysis_2 |
| PROACT BL Test Analysis_3 | PROACT BL Test Analysis_3 |
| PROACT BL Test Analysis_4 | PROACT BL Test Analysis_4 |
| Template - Analysis 1 - Analysis Name... | Template - Analysis 1 - Analysis Name field |
| Template - BL Test Analysis | Template - BL Test Analysis |
| Template - PMP-4543-5/28/04 | Template - PMP-4543-5/28/04 |
| | |
| | |
| | |
| | |
| | |
| | |
| | |
| | |

6. Select the desired analyses in the list.
7. Click the **Select** button.

The Hypothesis node(s) associated with the selected analyses are imported and appear in the **Build List** tab.

Adding Hypotheses from the Build List Tab to the Logic Tree

The following instructions provide details on adding hypothesis nodes from **Build List** tab to the Logic Tree using the drag-and-drop method.

To add a Hypothesis node from the **Build List** tab to the Logic Tree:

1. On the **Logic Tree** page, in the **Options** pane, on the **Build List** tab, select the row containing the desired hypothesis.
2. Drag the selected hypothesis to the desired location in diagram canvas. A plus sign (+) will appear to indicate that you have selected a valid location. You should only add a Hypothesis node to a Failure Mode node or another Hypothesis node.

Note: If you try to attach a hypothesis to the Failure Event node, the Meridium APM system will create a new *Failure Mode* node instead of a new Hypothesis node.

3. Release your mouse button to drop the hypothesis in the selected location.

The **New Logic Tree Item** dialog box displays the **RCA Hypothesis** datasheet.

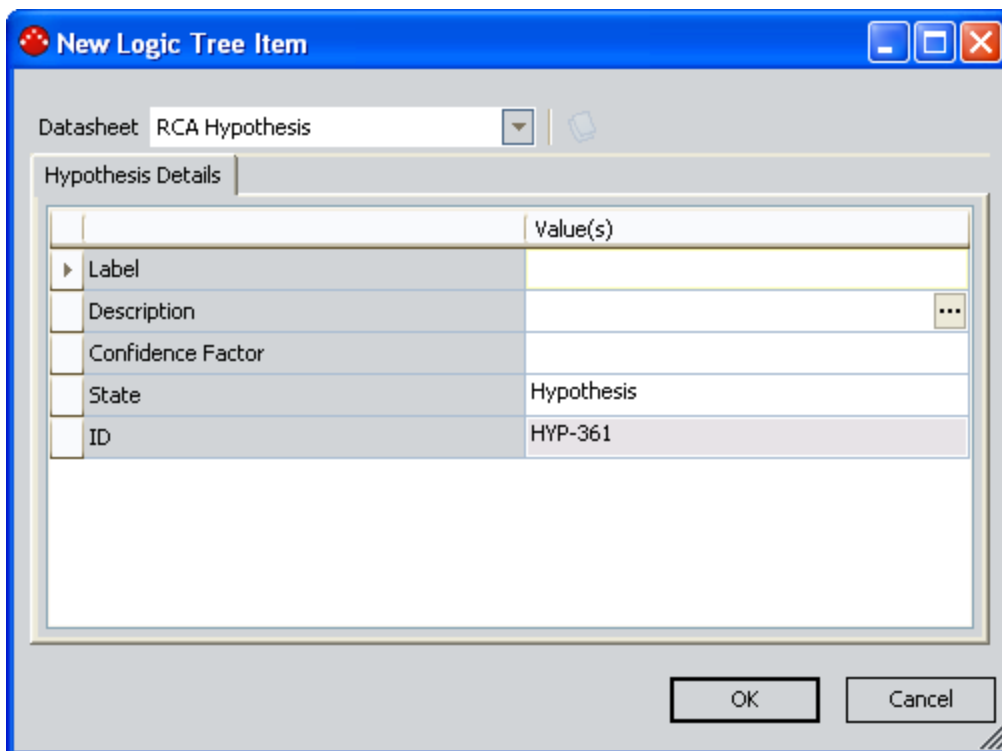

The screenshot shows a dialog box titled "New Logic Tree Item" with a blue header bar. Below the header, there is a "Datasheet" dropdown menu set to "RCA Hypothesis". The main area is labeled "Hypothesis Details" and contains a table with the following fields and values:

| | Value(s) |
|-------------------|------------|
| Label | |
| Description | |
| Confidence Factor | |
| State | Hypothesis |
| ID | HYP-361 |

At the bottom of the dialog box, there are "OK" and "Cancel" buttons.

4. If desired, you can modify the fields on the datasheet.
5. Click **OK** to save your changes.

Adding Hypotheses from the Build List Tab to the Logic Tree

Your changes are saved, and the new Hypothesis node appears on the Logic Tree in the specified location.

Modifying an Existing Hypothesis on the Build List Tab

The following instructions provide details on modifying an existing item on the **Build List** tab in the **Options** pane of the [Logic Tree page](#).

To modify an existing item on the **Build List** tab:

1. On the **Logic Tree** page, in the **Options** pane, on the **Build List** tab, select the row containing the item that you want to edit.
2. Click the **Edit** button.

The **Hypothesis** dialog box appears.

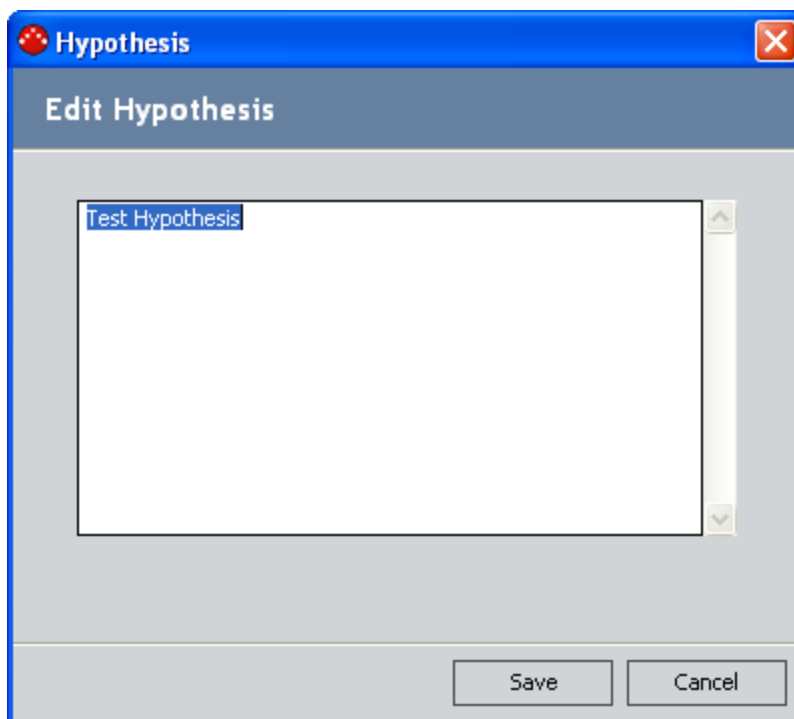

3. Modify the text for the hypothesis as desired.
4. Click the **Save** button.

Your changes are saved and the item in the **Build List** reflects those changes.

Deleting a Hypothesis from the Build List Tab

The following instructions provide details on deleting a hypothesis from the **Build List** tab in the **Options** pane of the [Logic Tree page](#).

To delete a hypothesis from the Build List tab:

1. On the **Logic Tree** page, in the **Options** pane, on the **Build List** tab, select the row containing the item that you want to delete.

2. Click the **Delete** button.

A confirmation message appears, asking if you really want to delete the item.

3. Click the **Yes** button.

The item is removed from the list on the **Build List** tab.

Deleting All Hypotheses from the Build List Tab

The following instructions provide details on deleting all of the hypotheses from the **Build List** tab in the **Options** pane of the [Logic Tree page](#).

To delete all hypotheses from the **Build List** tab:

1. On the **Logic Tree** page, in the **Options** pane, on the **Build List** tab, click the **Clear List** button.

A confirmation message appears, asking if you really want to delete the entire list.

2. Click the **Yes** button.

The list on the **Build List** tab is cleared.

Changing the State of an RCA Hypothesis Record

When an RCA Hypothesis record is created, the state is set to *Hypothesis* by default. Each RCA Hypothesis record can then be tested and proven *True* or *Not True* and the Hypothesis State can be changed accordingly.

To change the state of an RCA Hypothesis record:

1. On the **Logic Tree** page, in the diagram canvas, right-click the Hypothesis node whose state you want to change.

The shortcut menu appears.

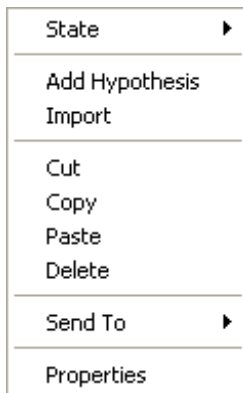

2. On the shortcut menu, point to **State**, and then click the desired state. You can choose:
 - **True** if the hypothesis has been confirmed.
 - **Not True** if the hypothesis has been ruled out.

Note: After you determine a hypothesis to be true, you can [identify the root cause](#).

Identifying the Root Cause for Hypotheses Proven True

After you determine a hypothesis to be true and change its state accordingly, you can continue testing the hypothesis through RCA Verification records to identify the root cause of the Failure Event.

If a hypothesis is proven correct, the RCA Analysis team should continue testing all the other hypotheses before testing further to determine the root cause. For example, the team may find that Hypothesis-A is true and that the cause was physical. If the RCA Analysis is prematurely ended here because the solution seems evident, the team may fail to consider other causes. If other causes are not identified as possibilities, no additional action will occur and the failure event is likely to occur again.

To specify the root cause for a hypothesis:

- On the **Logic Tree** page, in the diagram canvas, right-click the Hypothesis node whose root cause you want to specify, point to **State**, and then click the desired cause. You can choose one of the following causes:
 - **Cause - Physical**
 - **Cause - Human**
 - **Cause - Latent**
- After you select a cause:
 - The hypothesis is outlined in a red square.
 - A red line is drawn to show the path to failure.
 - The icon used to identify the Hypothesis node changes to indicate the specific cause.
- The team can [communicate their findings](#) to the decision makers in your organization.

About Importing Existing Failure Modes and Hypotheses

As you are building out the Logic Tree for an RCA Analysis, you have the option of defining new Failure Mode and Hypothesis nodes from scratch or importing them from the Logic Trees of other RCA Analyses.

You can import existing Failure Mode and Hypothesis nodes via the **Search Tool** window, which allows you to find Failure Mode and Hypothesis nodes that exist in other RCA Analyses.

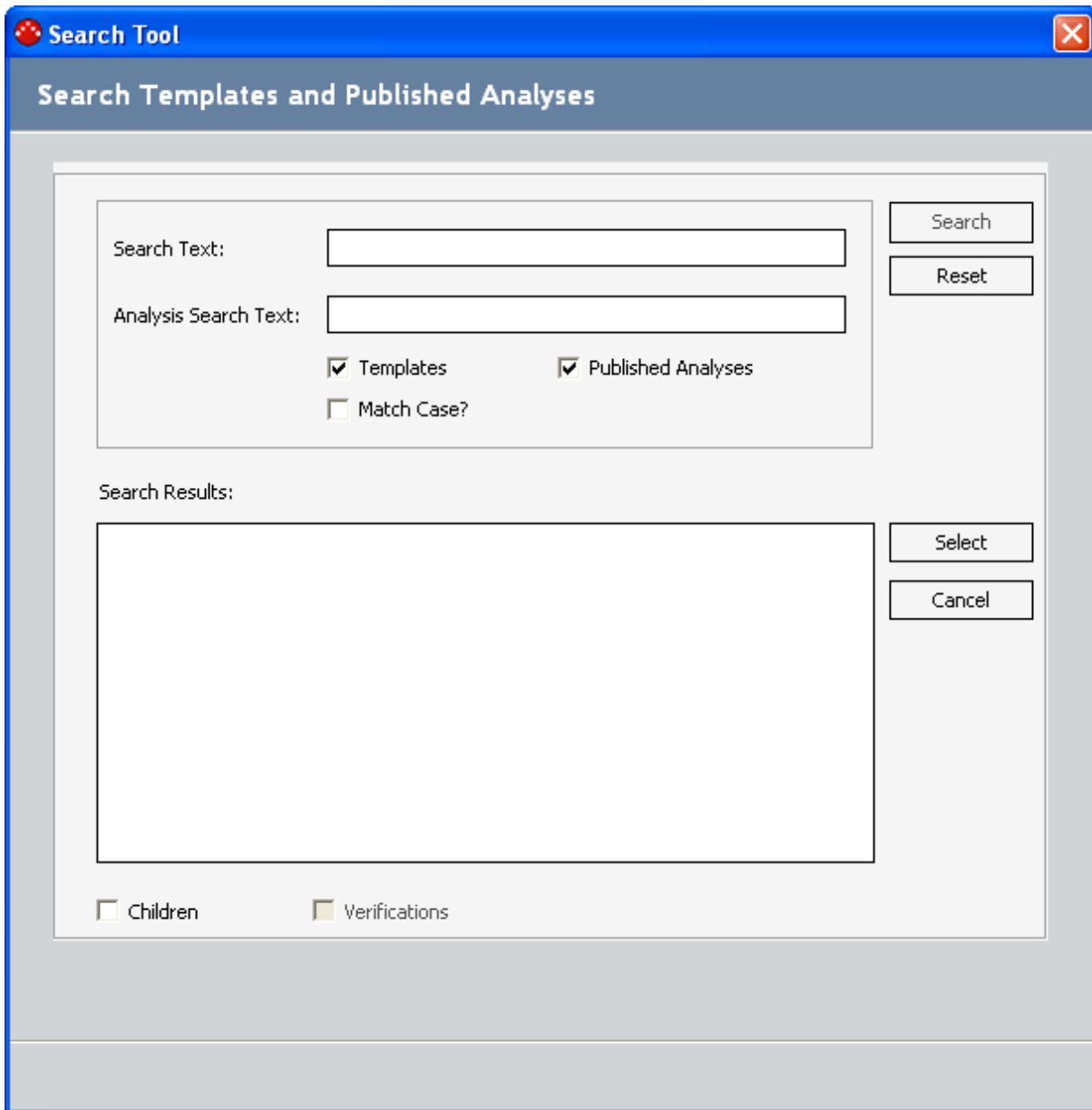

You can use the **Search Tool** window to define [criteria for searching for Failure Mode and Hypothesis nodes](#) to import.

When you import a node into the Logic Tree, any subnodes that belong to it are also added to the Logic Tree. For example, if you import a Failure Mode that is associated with three Hypothesis nodes, the Failure Mode node and ALL of its Hypothesis nodes will be added to your Logic Tree.

Note: Hypothesis nodes can also be added to the **Build List** tab by importing them into the Logic Tree.

Aspects of the Search Tool Window

The **Search Tool** window allows you to [search for existing Failure Mode and Hypothesis nodes](#).

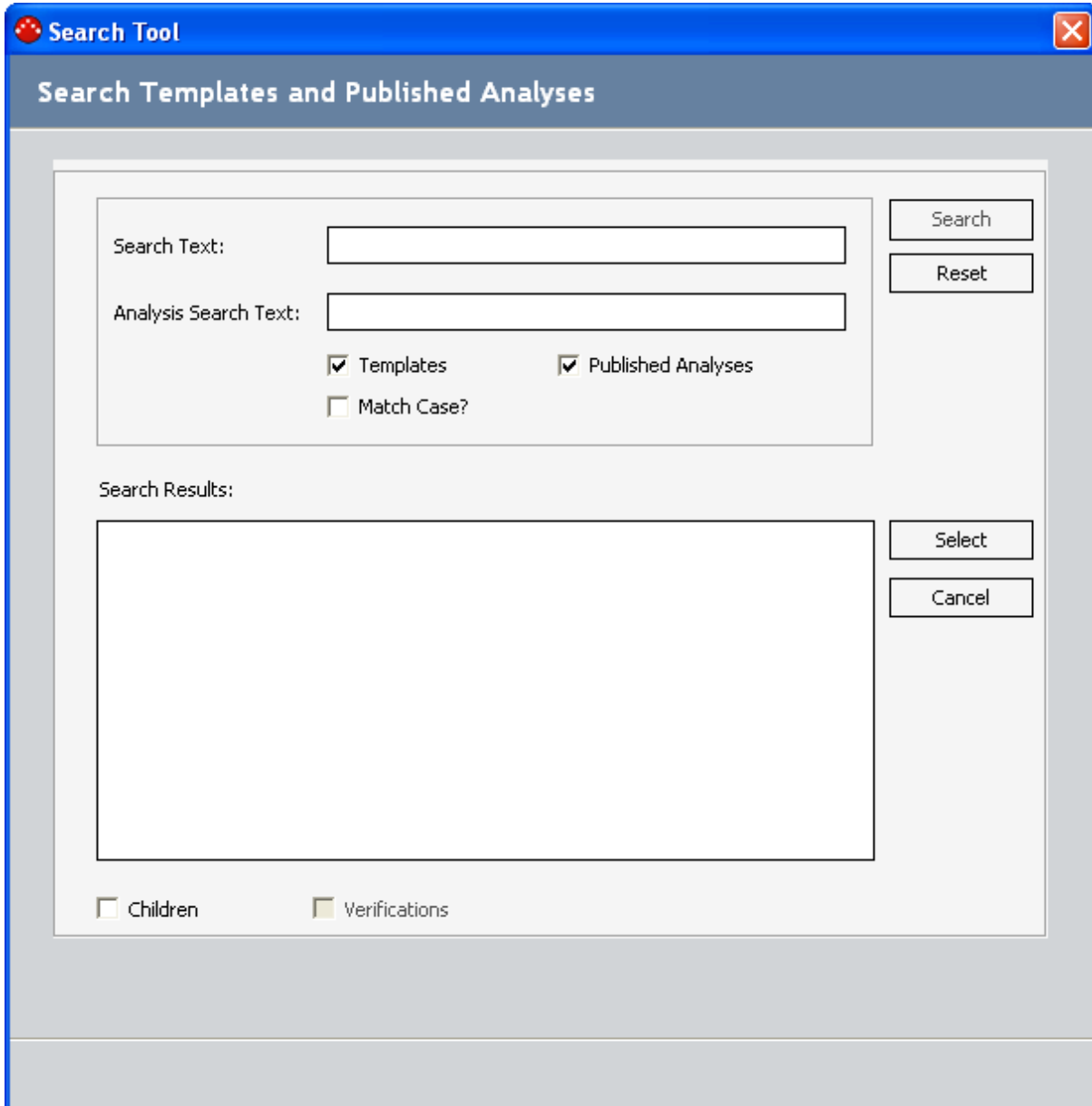

The **Search Tool** window contains the following items:

- **Search Text text box:** Identifies the value that you want to find within the Label field of RCA Event, RCA Failure Mode, and RCA Hypothesis records. For example, if you type *Pump Failure*, the search results will return all RCA Event, RCA Failure Mode, and RCA Hypothesis records with the value *Pump Failure* in the Label field.

- **Analysis Search Text text box:** Identifies the value that you want to find within the Name field of RCA Analyses whose nodes you want to import. For example, if you want to import a Failure Mode node that belongs to an RCA Analysis with the value *Pump Analysis* in the Name field, you would type *Pump Analysis* in this text box.

Note: The **Search Text** text box and **Analysis Search Text** text boxes can be used independently or in conjunction with one another. For example, if you are looking for *Pump Failure* Failure Modes from any analysis, you would type **Pump Failure** in the **Search Text** text box and leave the **Analysis Search Text** text box empty. If you are looking for all the Failure Modes in the *Pump Analysis* RCA Analysis, you would leave the **Search Text** text box empty and type **Pump Analysis** in the **Analysis Search Text** text box. If you are looking for a *Pump Failure* Failure Mode node in the *Pump Analysis* RCA Analysis, you would type **Pump Failure** in the **Search Text** text box and type **Pump Analysis** in the **Analysis Search Text** text box.

- **Templates check box:** Indicates whether or not you want to search the Meridium APM database for RCA Analysis Templates that contain the values that you typed in the **Search Text** text box and **Analysis Search Text** text box. This check box is *selected* by default.
- **Published Analyses check box:** Indicates whether or not you want to search the Meridium APM database for Published RCA Analyses that contain the values that you typed in the **Search Text** text box and **Analysis Search Text** text box. This check box is *selected* by default.
- **Match Case? check box:** Indicates whether or not you want the search to be case-sensitive. This check box is *cleared* by default, meaning that the search will not be case-sensitive.
- **Search button:** Runs the search using the specified criteria.
- **Reset button:** Clears any values in the **Search Text** and **Analysis Search Text** text boxes and resets the check boxes to their default states.
- **Search Results section:** [Displays the search results](#) that are returned for the selected search parameters.
- **Select:** [Imports the search results that are selected in the Search Results section](#) into the Logic Tree.
- **Cancel:** Closes the **Search Tool** window.
- **Children check box:** Indicates whether or not you want the **Search Results** section to display child Hypothesis nodes.

Note: Even if the **Children** check box is selected, you cannot select child nodes independently of their parent nodes.

- **Verifications check box:** Indicates whether or not you want to import RCA Verification records. If you select this check box and then select in the search results a Hypothesis record that is linked to an RCA Verification record, values from the following fields in that RCA Verification record will be copied to a new RCA

Verification record, which is created automatically and linked to the Hypothesis record that is created from the imported Hypothesis node:





- Method
- Send Alert on Due Date?
- Alert Email Text fields

Note: The **Verifications** check box is enabled only if the **Children** check box is selected.

About the Search Results Section

When you use the **Search Tool** window to import a Failure Mode or Hypothesis node into a Logic Tree, the results from the search are displayed in the **Search Results** section. The results are displayed in a hierarchy that contains images and text that identify the items that are returned in the search results. You can select the check boxes to the left of the items in the search results that you want to import into the Logic Tree.

The following table lists the items that appear in the search results, the icons that are used to represent each item, and any additional information about those items.

| Item | Icon | Notes |
|---------------|---|--|
| RCA Analysis |  | RCA Analyses always appear on the first level of the hierarchy. For each RCA Analysis, the label that appears in the search results is the value in the Analysis Name field in the RCA Analysis record for that analysis. The RCA Analysis is displayed in the search results for the purpose of grouping the items that belong to that analysis. While you can select the check box to the left of an RCA Analysis, you cannot import an RCA Analysis into the Logic Tree. If you select the check box to the left of an RCA Analysis, all of the children will be selected automatically and imported into the Logic Tree. |
| Failure Event |  | Failure Events always appear on the second level of the hierarchy, directly below the RCA Analysis to which they belong. For each Failure Event, the label that appears in the search results is the value in the Label field of the RCA Event record for that Failure Event. While you can select the check box to the left of the Failure Event, you cannot import a Failure Event into the Logic Tree. If you select the check box to the left of a Failure Event, nothing will be imported. |
| Failure Mode |  | In the hierarchy, Failure Modes appear below the Failure Event to which they belong. For each Failure Mode, the label that appears in the search results is the value in the Label field of the RCA Failure Mode record for that Failure Mode. If you select the check box to the left of a Failure Mode, it will be imported into the Logic Tree. |
| Hypothesis |  | Hypotheses always appear directly below the Failure Mode to which they belong. For each Hypothesis, the label that appears in the search results is the value in the Label field of the RCA Hypothesis record for that Hypothesis. If you select the check box to the left of a Hypothesis, it will be imported into the Logic Tree. |

Specifying Search Text Only

In the following example, suppose you are building a Logic Tree for an RCA Analysis about a malfunctioning cooling water pump. You are looking for Failure Modes or Hypotheses for a Failure Event where a cooling water pump overheated in a similar way.

To search for a Failure Mode or Hypothesis for a Failure Event that involves overheating, you would search for overheating in the **Search Text** text box. The following image shows what the search results would look like, assuming that the example RCA Analysis has been published and that there are no other published analyses or templates.

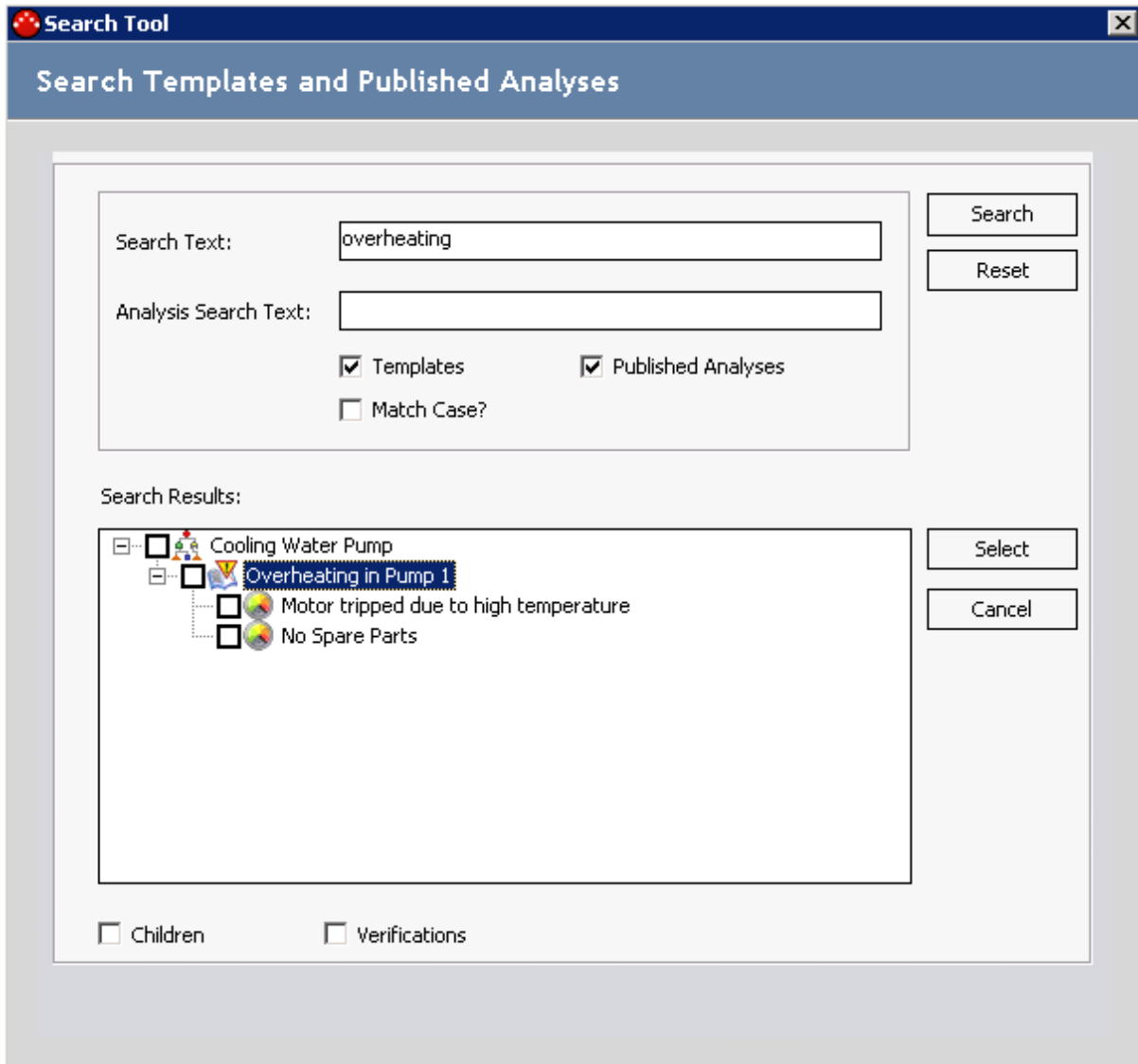

In this image, because the text *overheating* appears in the **Search Text** text box, the search results display the Failure Event *Overheating In Pump 1*. In addition, the hierarchy displays:

Specifying Search Text Only

- The RCA Analysis to which the Failure Event belongs, *Cooling Water Pump*.
- The Failure Modes that belong to the Failure Event. These failure modes are:

Motor tripped due to high temperature.
If you were to select the **Children** check box, the search results would look like this:

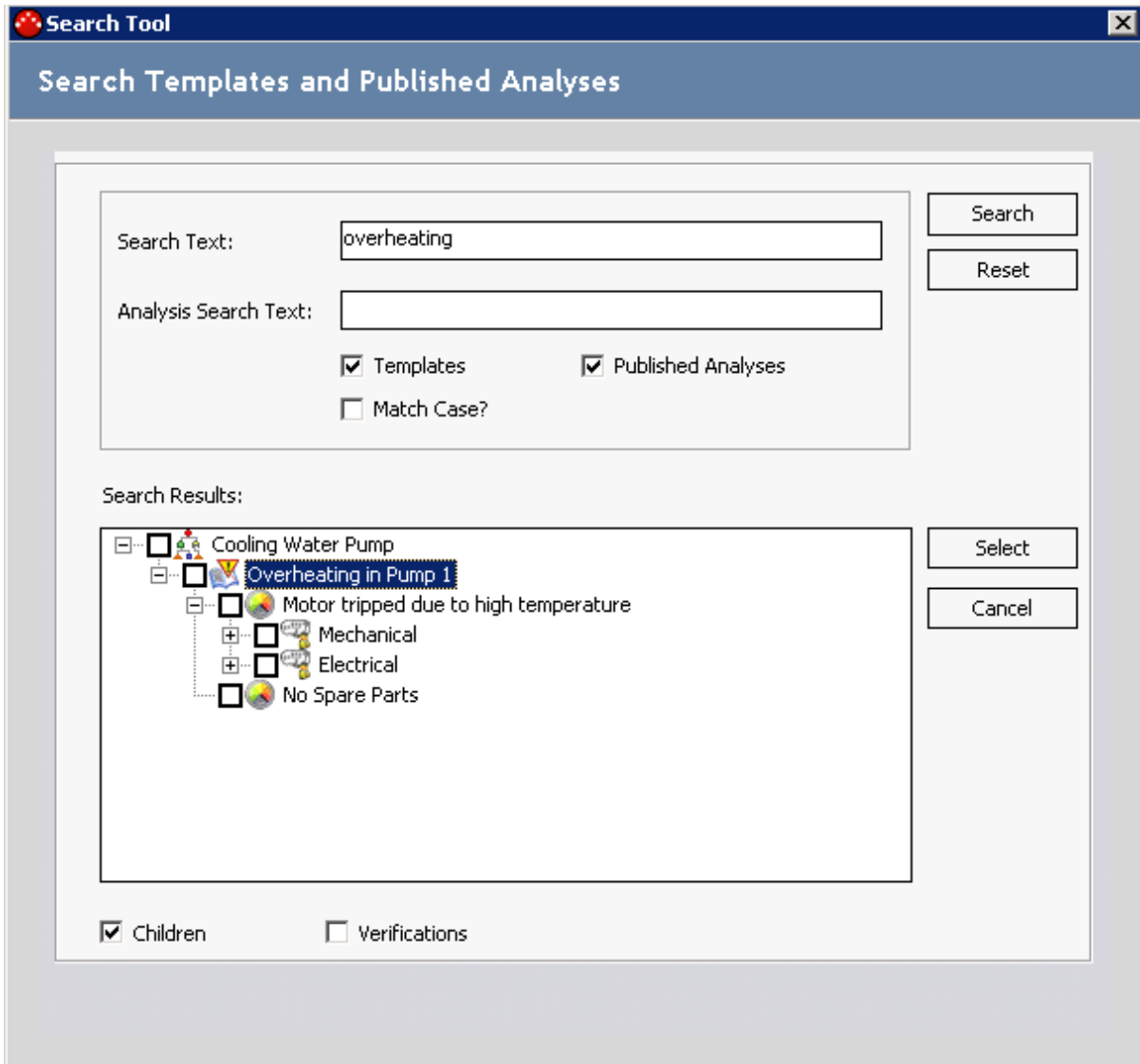

In this image, because the **Children** check box is selected, the following Hypotheses appear:

- Mechanical
- Electrical

Note: You cannot select a child node independent of its parent node.

Specifying Analysis Search Text Only

In the following example, suppose you are building a Logic Tree for an RCA Analysis about a malfunctioning cooling water pump. You are looking for Failure Modes or Hypotheses for a Failure Event where a cooling water pump overheated in a similar way, and you know there has been another RCA Analysis published about a similar malfunction.

In this case, you would use the **Analysis Search Text** text box to search for Failure Modes and Hypotheses that belong to that specific analysis. The following image shows what the search results would look like, assuming that the RCA Analysis *Cooling Water Pump* has been published and that there are no other published analyses or templates.

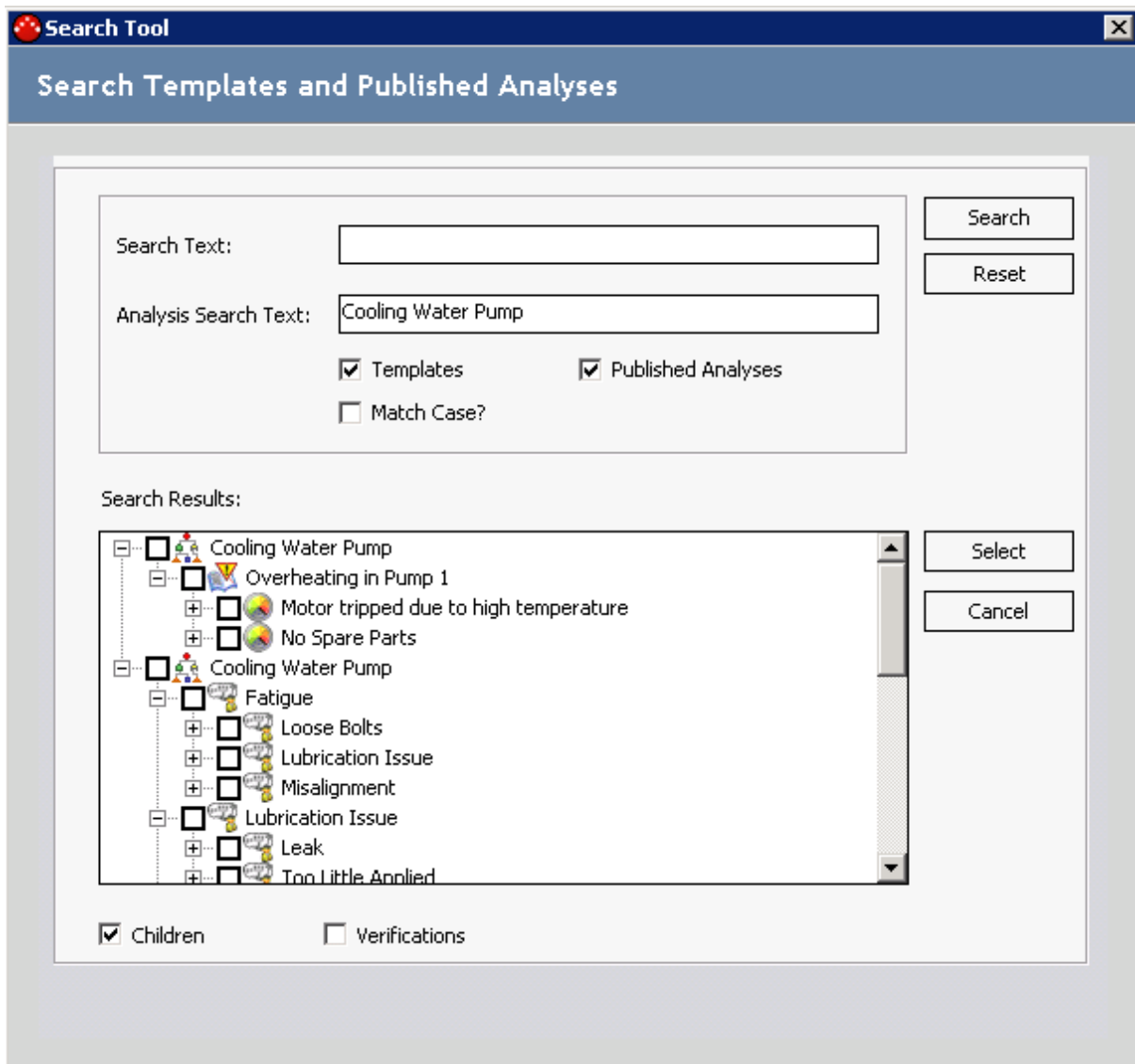

In this image, because the text *Cooling Water Pump* appears in the **Analysis Search Text** text box, the search results display the published RCA Analysis *Cooling Water Pump* and the hierarchy beneath it. The hierarchy displays:

- The Failure Event *Overheating in Pump 1* and Failure Modes that belong to it. These Failure Modes are:
 - No Spare Parts.
 - Motor tripped due to high temperature.
- Each Failure Mode and the Hypotheses that belong to it. The Hypothesis nodes are:
 - Mechanical
 - Electrical
 - Outboard Bearing
 - Inboard Bearing
 - Erosion
 - Corrosion
 - Fatigue
 - Misalignment
 - Loose Bolts
 - Lubrication Issue
 - Leak
 - Too Much Applied
 - Too Little Applied
 - Poor Training
 - Inadequate Procedures Document
 - Worker Fatigue
 - Inadequate Accountability of Workers

Note: In this case, because the entire RCA Analysis was returned in the search results, you can select a child node independent of its parent node.

Specifying Search Text and Analysis Search Text

In the following example, suppose you are building a Logic Tree for an RCA Analysis about a cooling water pump that has malfunctioned due to a lubrication issue. You are looking for Hypotheses for this particular Failure Mode, and you know there has been an RCA Analysis published about a similar malfunction.

In this case, you would use both the **Search Text** text box and the **Analysis Search Text** text box to search for a Hypothesis whose Label field contains the word *Lubrication* and is part of the RCA Analysis *Cooling Water Pump*. The following image shows what the search results would look like, assuming that the RCA Analysis *Cooling Water Pump* has been published and that there are no other published analyses or templates.

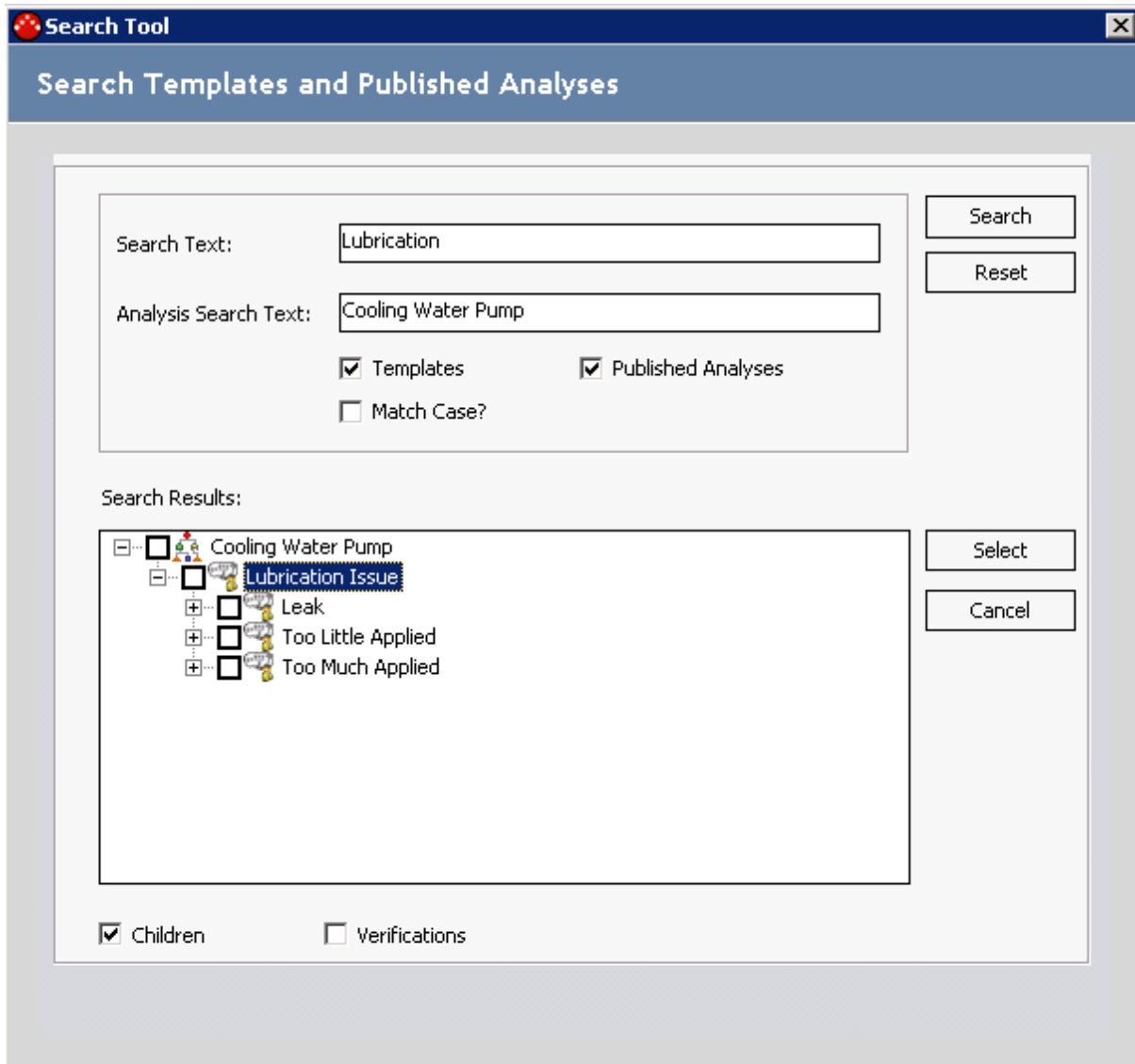

In this image, because the text *Lubrication* appears in the **Search Text** text box, the search results display the Hypothesis node *Lubrication*. In addition, because the text *Cooling Water Pump* appears in the **Analysis Search Text** text box, the search results display only the Failure Modes or Hypotheses that belong to the published RCA Analysis *Cooling Water Pump*. Therefore, the hierarchy displays the Hypotheses node *Lubrication* with the following additional Hypothesis nodes that exist below *Lubrication* in the hierarchy:

- Leak
- Too Much Applied
- Too Little Applied

Performing the Import Operation

To import existing Failure Mode and Hypothesis nodes:

1. On the **Logic Tree** page, in the diagram canvas, right-click the parent node whose child node you want to import, and on the shortcut menu, click **Import**.

The **Search Tool** window appears.

The image shows a software window titled "Search Tool" with a blue header bar. Below the header, the text "Search Templates and Published Analyses" is displayed. The main content area contains a search interface. On the left, there are two text input fields: "Search Text:" containing the word "Leaks" and "Analysis Search Text:" which is empty. Below these fields are three checkboxes: "Templates" (checked), "Published Analyses" (checked), and "Match Case?" (unchecked). To the right of the input fields are two buttons: "Search" and "Reset". Below the search options is a section labeled "Search Results:" followed by a large, empty rectangular box. To the right of this box are two buttons: "Select" and "Cancel". At the bottom of the window, there are two more checkboxes: "Children" (unchecked) and "Verifications" (unchecked).

For the node that you right-clicked, the value that is stored in the Label field in the corresponding record appears in the **Search Text** text box. In the preceding

image, the **Search Tool** window was accessed from the Failure Mode node whose Failure Mode record contains the value *Leaks* in the Label field.

2. If desired, in the **Search Text** text box, type the name of the parent node that contains the child nodes that you want to import.

CEHint: You can use the percent sign (%) as a wild card in the **Search Text** text box, allowing you to search on all items stored in the database.

3. If desired, in the **Analysis Search Text** text box, type the name of the RCA Analysis that contains the nodes that you want to import.
4. If you do not want to search RCA Analysis templates, clear the **Templates** check box.
5. If you do not want to search published analyses, clear the **Published Analyses** check box.
6. If you want the search to be case-sensitive, select the **Match Case?** check box.
7. Click the **Search** button.

The results appear in the **Search Results** section in a hierarchical view of the items that meet the specified criteria.

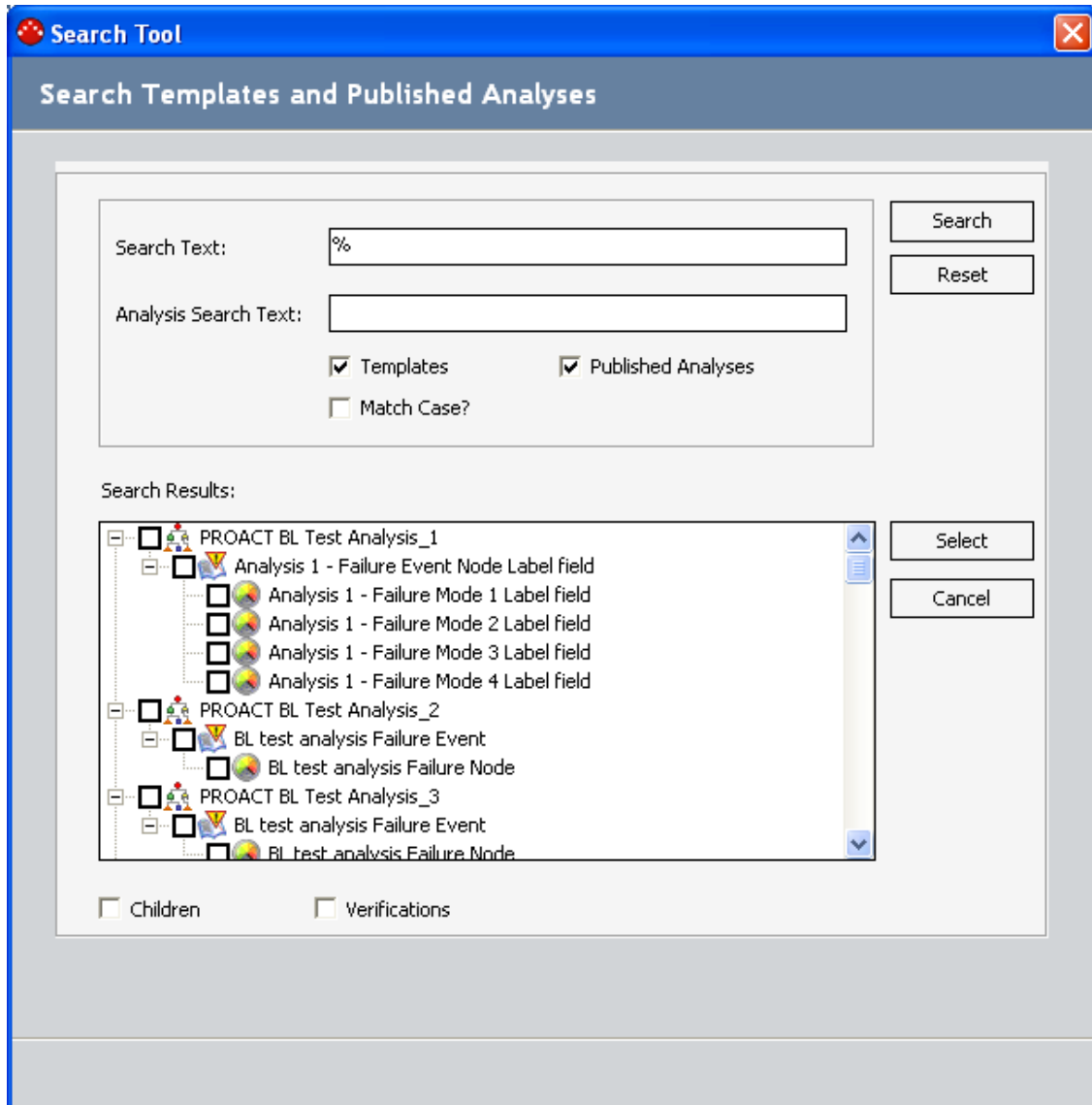

Hint: If desired, you can double-click the name of the item to view the associated datasheet.

8. In the **Search Results** section, select the check boxes next to the nodes that you want to import.
9. If you want to view and import child nodes (e.g., the Hypothesis nodes that exist for a given Failure Mode node), select the **Children** check box at the bottom of the **Search Results** section.

The child nodes appear in the hierarchy, where you can select the check box next to the nodes that you want to import, along with the parent node or nodes.

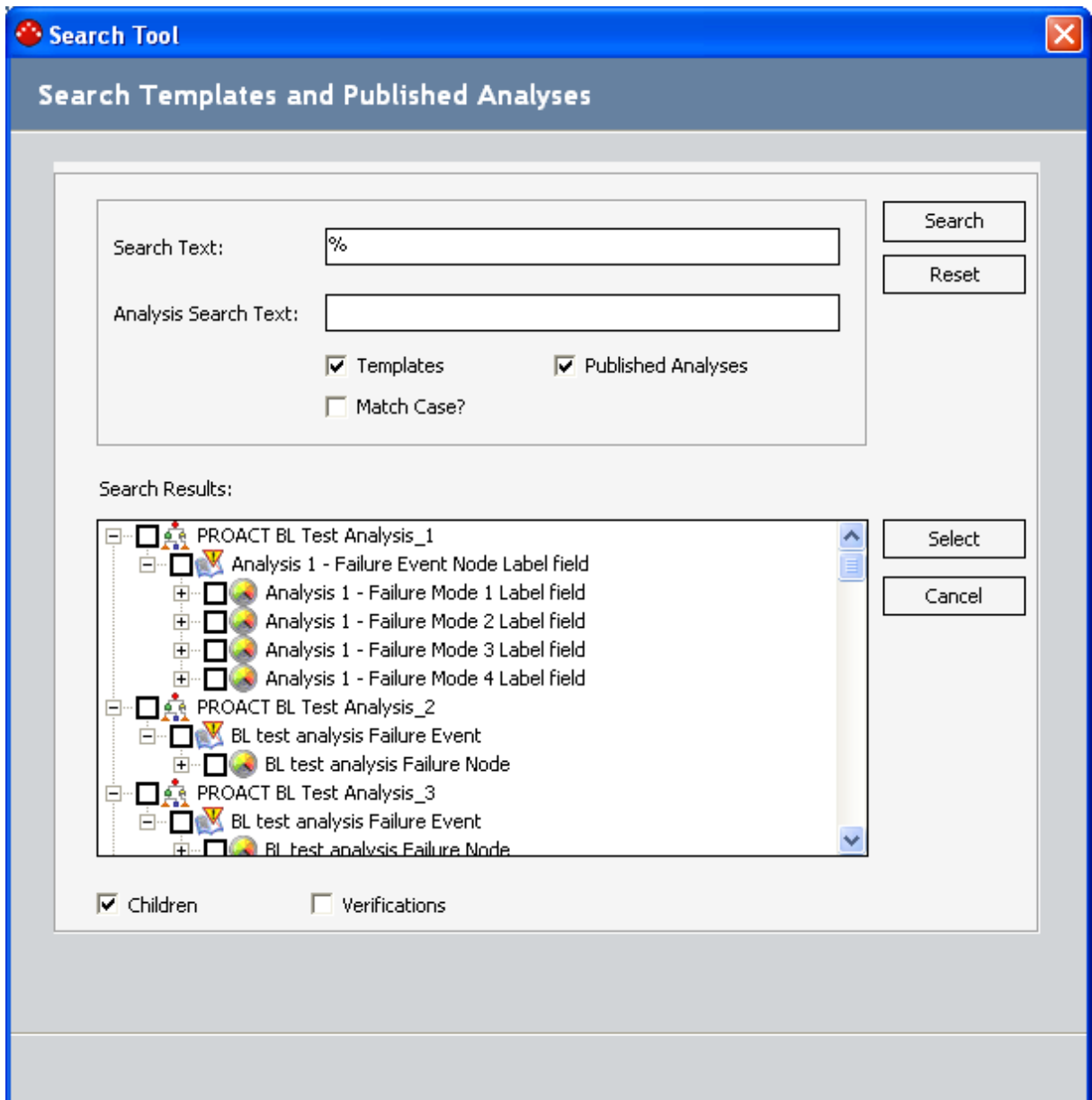

10. If you want to import [RCA Verification records](#), select the **Verifications** check box at the bottom of the display area.
11. When you have made the desired selections, click the **Select** button to import the selected items.

The **Search Tool** window closes, and the selected nodes appear in the diagram canvas and are linked to the selected Failure Event node.

What is a Verification?

A *verification* is a task to prove or disprove a hypothesis. An RCA Verification record contains the task-related information necessary to verify a hypothesis. RCA Verification records are assigned to team members, similarly to the way in which RCA Preserve Item records are assigned. For example, if you wanted to verify whether a pump overheated because of a mechanical or electrical problem, you would need to inspect the pump's wiring. The following image shows an example of an RCA Verification record.

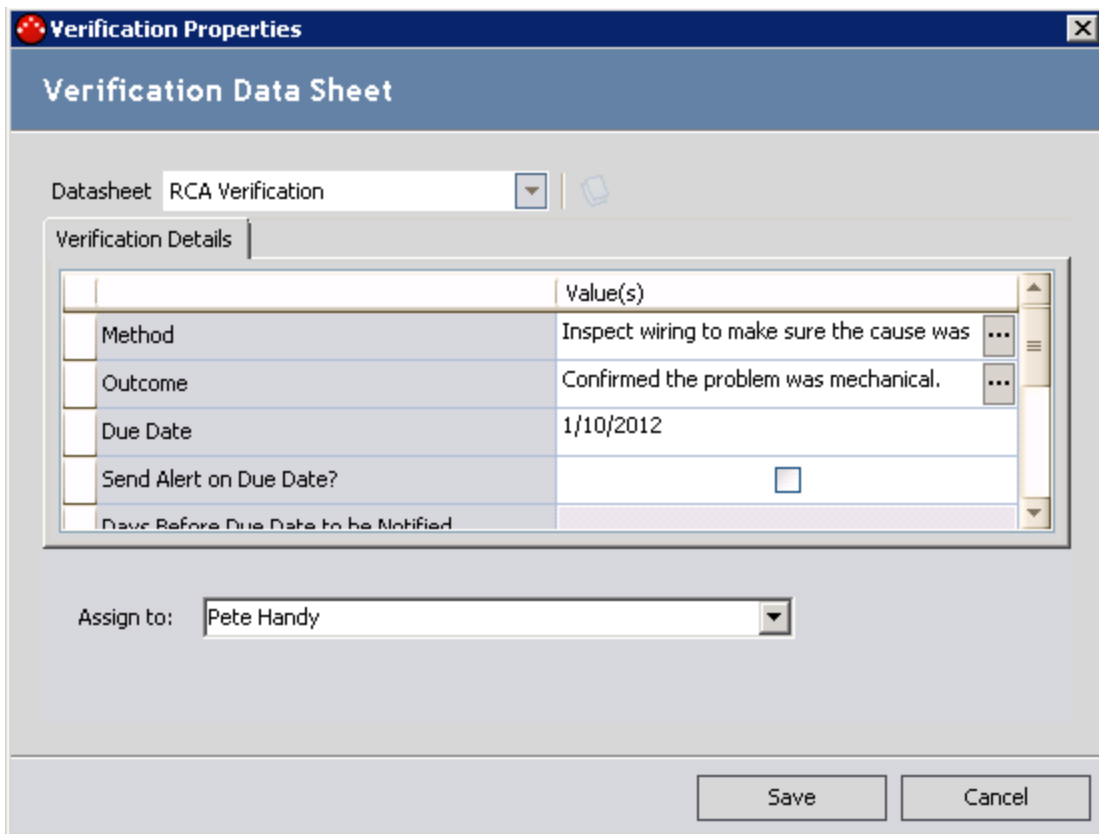

The screenshot shows a software window titled "Verification Properties" with a sub-header "Verification Data Sheet". Below the header, there is a dropdown menu for "Datasheet" set to "RCA Verification". A "Verification Details" tab is active, displaying a table with the following data:

| | Value(s) |
|-------------------------------------|---|
| Method | Inspect wiring to make sure the cause was ... |
| Outcome | Confirmed the problem was mechanical. ... |
| Due Date | 1/10/2012 |
| Send Alert on Due Date? | <input type="checkbox"/> |
| Days Before Due Date to be Notified | |

Below the table, there is an "Assign to:" dropdown menu set to "Pete Handy". At the bottom right, there are "Save" and "Cancel" buttons.

The following fields are available on the RCA Verification datasheet:

- **Method:** The method used to prove that a hypothesis is true or not true (e.g., Data analysis, lube oil analysis, stress analysis, visual inspection, interviews). You can click the button to display the Text Editor.
- **Outcome:** The actual results of the verification method. For instance, an outcome can be a set of lab results or a report to prove or disprove the hypothesis in question. This field is populated when the assigned team member has completed the verification process. You can click the button to display the Text Editor.
- **Due Date:** The date by which the verification of the selected hypothesis should occur. In the **Due Date** cell, type or select the date on which the verification is due.
- **Send Alert on Due Date?:** Select this check box if you want to send to the team

What is a Verification?

member in the Assign To field an email message on the date specified in the Due Date field.

- **Days Before Due Date to be Notified:** The number of days before the date specified in the Due Date field that an alert will be sent to the assigned team member in the Assign To field. If you do not want an alert to be sent to the team member before the due date, enter the value 0.
- **Frequency of Alert After Due Date:** How often you want an alert to be sent to the assigned team member after the date specified in the Due Date field. If you do not want an alert sent to be sent to the team member after the due date, select **Never** from the list.
- **Alert Email Text:** Enabled if you selected the **Send Notification on Due Date?** check box. Type the body of the email message that will be sent to the assigned team member.
- **Completed?:** Defaults to **No** when you create an RCA Verification record. This field can be changed to **Yes** when the assigned team member has completed the verification process.

RCA Verification records are linked to RCA Hypothesis records and the RCA Team Member record for the team member to whom the record is assigned. RCA Verification records do not have an associated node in the Logic Tree. You can [send a link to the RCA Verification record](#) to the team member who is responsible for completing the verification task.

Adding a New Verification to a Hypothesis Node

Each hypothesis is proven true or not true by creating and linking RCA Verification records to that RCA Hypothesis record. A *verification* is a test that you will conduct to prove or disprove (i.e., verify) a hypothesis.

To create a new RCA Verification record for a selected RCA Hypothesis record:

1. In the Logic Tree, select the Hypothesis node that you want to verify.
2. In the **Options** pane, click the **Verifications** tab.

Any existing RCA Verification records that are linked to the selected Hypothesis node appear on the **Verifications** tab.

3. Click the **New** button.

Note: Since RCA Verification records are associated only with RCA Hypothesis records, the **New** button is disabled until you select a Hypothesis node in the Logic Tree.

The **Verification Properties** dialog box appears, displaying the RCA Verification datasheet.

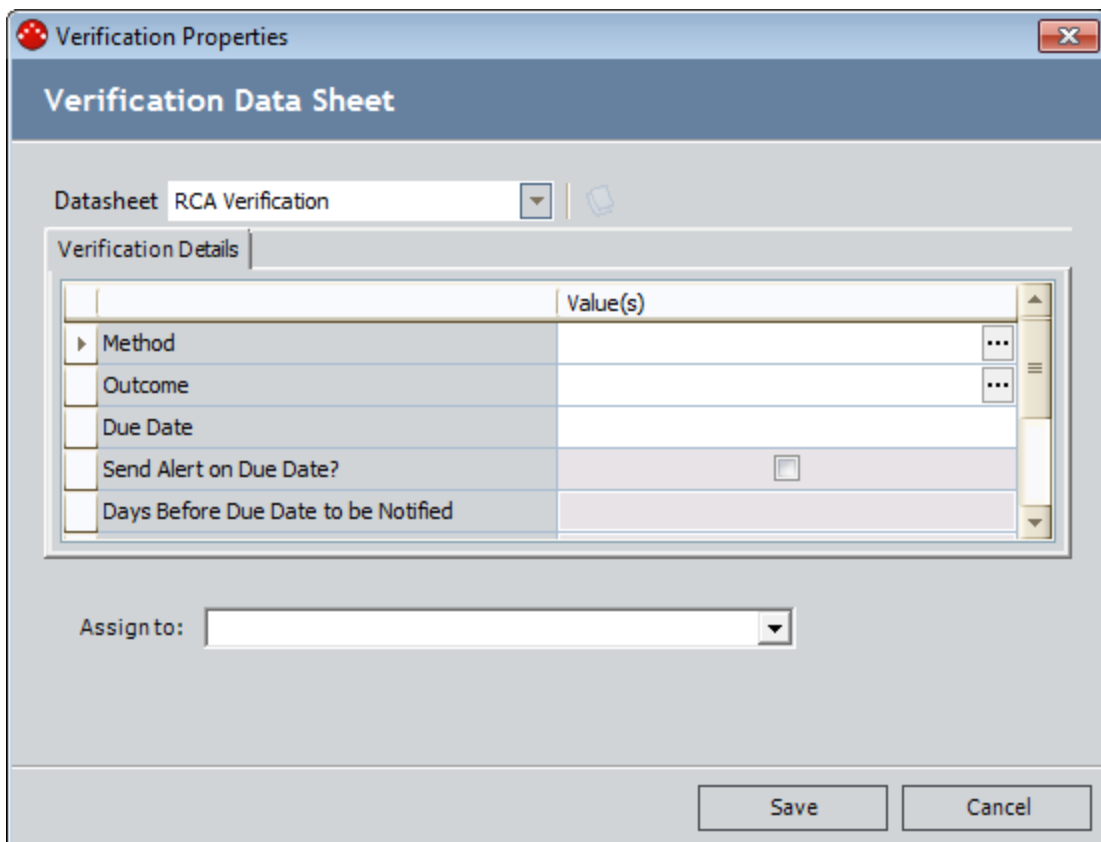

The screenshot shows the "Verification Properties" dialog box with the "Verification Data Sheet" tab selected. The "Datasheet" dropdown is set to "RCA Verification". The "Verification Details" section contains a table with the following fields:

| | Value(s) |
|-------------------------------------|--------------------------|
| Method | |
| Outcome | |
| Due Date | |
| Send Alert on Due Date? | <input type="checkbox"/> |
| Days Before Due Date to be Notified | |

Below the table is an "Assign to:" dropdown menu. At the bottom of the dialog are "Save" and "Cancel" buttons.

4. Complete the fields on the Verification datasheet, as desired.
5. In the **Assign To** list, select a team member to whom you want to assign to the RCA Verification record.
6. Click the **Save** button.

The RCA Verification record is saved and linked to the RCA Analysis record and the RCA Hypothesis record. If you selected the **Send Alert on Due Date** check box, an Alert record that is associated with the RCA Analysis is created automatically. The Alert record then creates a scheduled item in the Schedule Manager, and an email message is sent to the specified recipient on the due date.

Copying and Pasting an RCA Verification Record

You can create a copy of an RCA Verification record and assign the new record to the same Hypothesis node or a different Hypothesis node as the source record.

To copy an RCA Verification record:

1. In the Logic Tree, select the Hypothesis node that is linked to the Verification record you want to copy.
2. In the **Options** pane, click the **Verifications** tab.
3. In the grid, select the RCA Verification record that you want to copy, and click the **Copy** button.
4. To paste the copy of the RCA Verification record to the same Hypothesis node, click the **Paste** button.

-or-

To paste the copy of the RCA Verification record to a different Hypothesis node, select the desired Hypothesis node and click the **Paste** button on the **Verifications** tab for that node.

The **Verification Properties** dialog box appears.

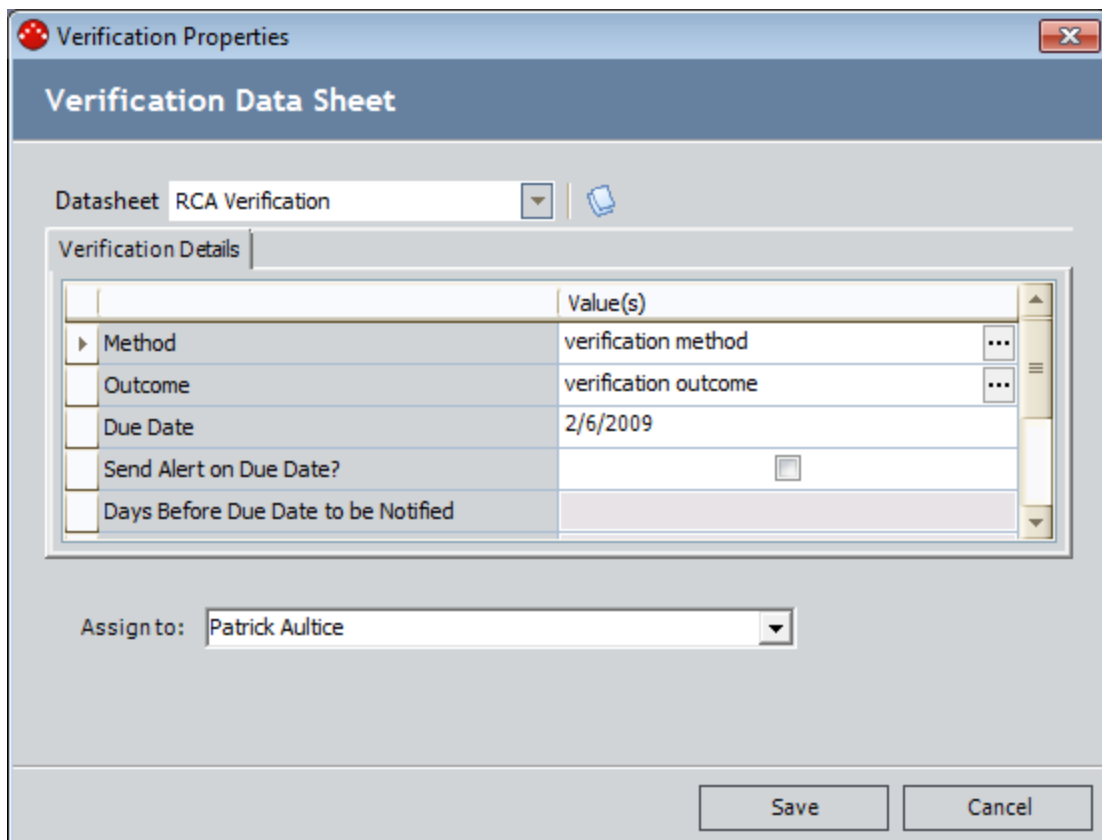

The screenshot shows the 'Verification Properties' dialog box with the 'Verification Data Sheet' tab selected. The 'Datasheet' is set to 'RCA Verification'. The 'Verification Details' section contains a table with the following data:

| | Value(s) |
|-------------------------------------|--------------------------|
| Method | verification method |
| Outcome | verification outcome |
| Due Date | 2/6/2009 |
| Send Alert on Due Date? | <input type="checkbox"/> |
| Days Before Due Date to be Notified | |

Below the table, the 'Assign to:' field is set to 'Patrick Aultice'. At the bottom of the dialog are 'Save' and 'Cancel' buttons.

5. Modify the fields in the **Verification Properties** dialog box as needed.
6. Click the **Save** button.

The copy of the RCA Verification record appears on the **Verifications** tab and is linked to the Hypothesis record.

| Hypothesis | Method | Team Member | Due Date |
|---|-------------------------------------|-----------------|----------|
| ▶ Analysis 1 - Hypothesis 2 Label Fi... | verification method | Patrick Aultice | 2/6/2009 |

New... Copy Paste Delete

Finding Hypothesis Nodes with No Verifications or Incomplete Verifications

RCA Verification records are considered *complete* when the Outcome field is populated with a value. The Meridium APM system keeps a log of all incomplete RCA Verification records that are linked to RCA Hypothesis records in a given RCA Analysis.

On the **Logic Tree** page, in the **Options** pane, on the **Incomplete Verifications** tab, you can view a list of RCA Hypothesis records that are not linked to any RCA Verification record or whose RCA Verification records are incomplete.

To find RCA Hypothesis records without RCA Verification records or with Incomplete RCA Verification records:

1. In the **Options**pane, click the **Incomplete Verifications** tab.

The **Incomplete Verifications** tab appears.

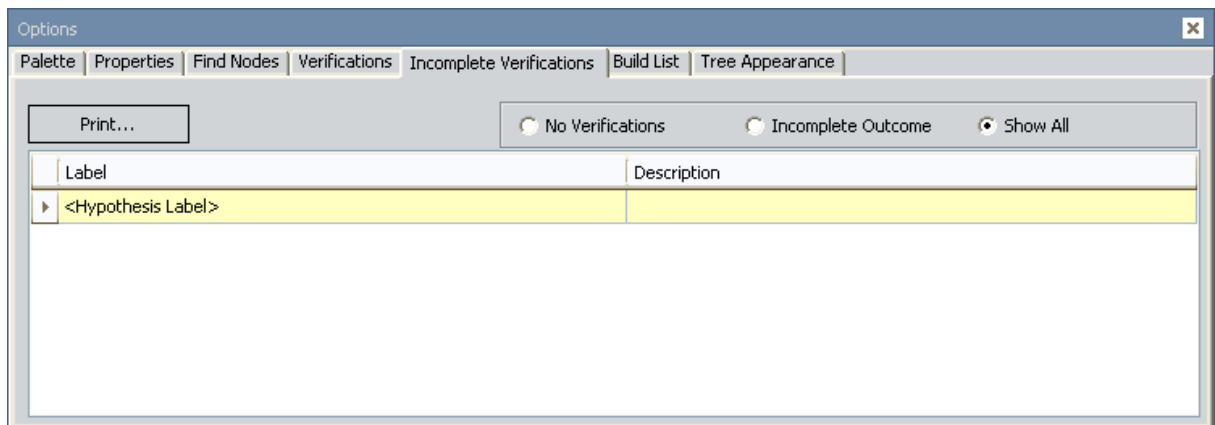



The **Show All** option is selected by default so the list contains RCA Hypothesis records that are not linked to any RCA Verification records or whose RCA Verification records are incomplete.

2. Filter the list to view the desired hypothesis. You can choose one of the following:
 - **No Verifications**
 - **Incomplete Outcome**
 - **Show All**
3. Select the row containing the RCA Hypothesis record that you want to identify in the Logic Tree.

The associated Hypothesis node is outlined in blue in the diagram canvas.

What is a Logic Gate?

Root Cause Analysis provides an option that you can use to add *logic gates* to the Logic Tree to define a connection between nodes. A logic gate is defined in an RCA Logic Gate record and is represented in the Logic Tree by a Logic Gate node. You can use Logic Gate nodes to add Boolean logic between nodes (i.e., AND and OR statements).

The AND Logic Gate is represented by the  symbol in the Logic Tree. The OR Logic Gate is represented by the  symbol in the Logic Tree.

Adding a Logic Gate node between other nodes in the Logic Tree indicates a conditional relationship between the nodes, which you can define in the description fields in the RCA Logic Gate record. These conditional relationships are defined in logical statements (e.g., if B is true, then A is true).

To add a Logic Gate node to the Logic Tree, you will need to [enable logic gates](#) and create an RCA Logic Gate record. There are two types of RCA Logic Gate records: AND and OR. This value is stored in the Gate Type field in the RCA Logic Gate record and determines the text that is displayed on the Logic Gate node (i.e., AND or OR). The default Gate Type value in an RCA Logic Gate record is *OR*.

You can add a Logic Gate node to...

- Failure Mode nodes linked to Hypothesis nodes.
- Hypothesis nodes linked to other Hypothesis nodes.
- Logic Gate nodes linked to other Logic Gate nodes or Hypothesis nodes.

You cannot add a Logic Gate node to the Failure Event node (i.e., between Failure Mode nodes). A given predecessor node can have only one Logic Gate node.

When you add a Logic Gate node to a node in the Logic Tree, a link is created between the RCA Logic Gate record and the record associated with the node to which you added the Logic Gate node and also between the RCA Logic Gate record and the RCA Analysis record. The following fields are available in the RCA Logic Gate record:

- **Short Description:** The connection that the Logic Gate node defines.
- **Long Description:** The logical statement that the Logic Gate node defines.
- **Gate Type:** The type of logic gate: AND or OR.

Example of Logic Gate Nodes

Assume you want to indicate in the Logic Tree that Failure Mode is true only if Hypothesis 1 and Hypothesis 2 or Hypothesis 2A is true.

You would organize the nodes in the Logic Tree as shown in the following image.

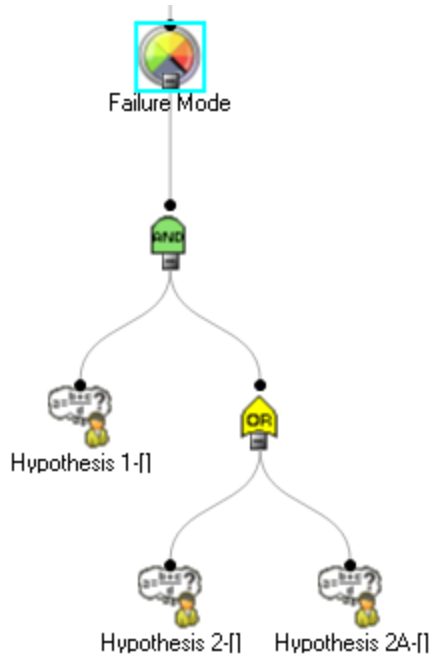

Enabling Logic Gates

To enable the use of Logic Gate nodes within a Logic Tree:

- On the **Tree Tasks** menu, click the **Settings** link, and on the shortcut menu, click the **Show Logic Gates** option.

Note: If the **Show Logic Gates** option is enabled, a check mark will appear to the left of the option.

The Logic Gate nodes appear on the **Palette** tab in the **Options** pane.

Adding a Logic Gate to the Logic Tree

Before you can add a Logic Gate node to the Logic Tree, you will need to [enable logic gates](#).

To add a Logic Gate node to the Logic Tree:

1. On the **Logic Tree** page, In the **Options** pane, on the **Palette** tab, click and drag the **AND** or **OR** icon to the desired node in the diagram canvas. Release the mouse button to drop the node in the desired location. A plus sign appears to indicate when you have chosen a valid location.

-or-

Right-click the node to which you want to add the Logic Gate node, and then on the shortcut menu, click **Add Logic Gate**.

The **New Logic Tree Item** dialog box appears.

| | Value(s) |
|-------------------|----------|
| Short Description | |
| Long Description | ... |
| Gate Type | Or |

2. Complete the fields on the RCA Logic Gate datasheet as desired.
3. Click **OK**.

The Logic Gate node is added to the Logic Tree. A link is created between the RCA Analysis record and the RCA Logic Gate record and between the RCA Logic Gate record and the record associated with the node to which you added the Logic Gate node.

Changing the Gate Type of a Logic Gate

The following instructions provide details on changing the gate type of a Logic Gate in the diagram canvas on the [Logic Tree page](#).

To change the type of a Logic Gate node that appears in the Logic Tree:

1. On the **Logic Tree** page, In the diagram canvas, double-click the Logic Gate node whose gate type you want to change.

The **Properties** tab appears in the **Options** pane, displaying the **RCA Logic Gate** datasheet for the selected Logic Gate node.

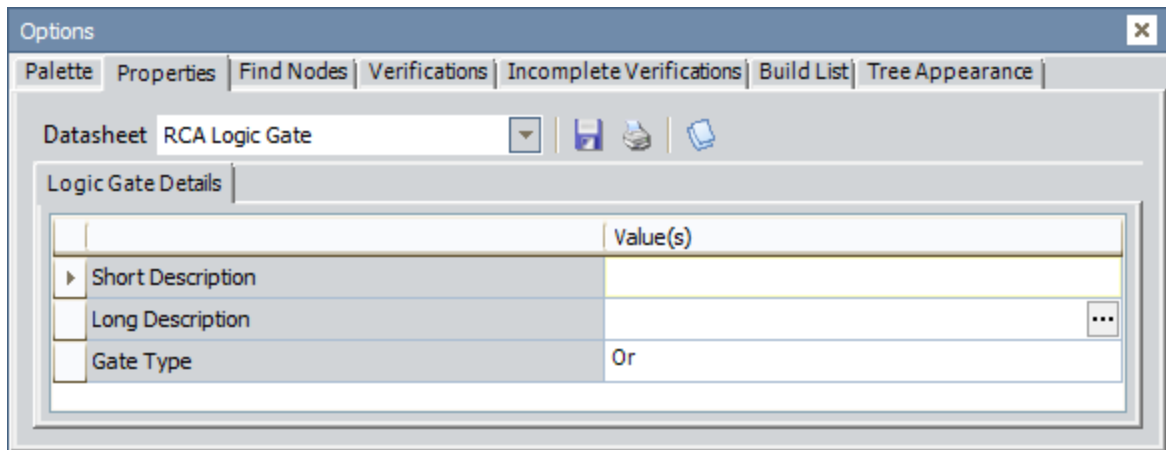

2. Click the **Gate Type** field to expand the **Gate Type** list, and select the desired logic gate.
3. Click the **Save current record** icon. 

CEHint: You can also change the gate type for a Logic Gate node by right-clicking the Logic Gate node whose gate type you want to change (i.e., **OR** to **AND**, or **AND** to **OR**), and on the shortcut menu, point to **State**, and then click the desired type of gate.

Viewing and Modifying Existing Logic Tree Node Records

A node is any object within the Logic Tree. For example, Failure Mode nodes have an associated RCA Failure Mode record that is linked to the RCA Event record. There are several ways to view the record associated with a Logic Tree node, and you can modify the values in the record at any time. Throughout this documentation, we refer to the information contained in the record for a Logic Tree node as its properties.

To view and modify the properties for a Logic Tree node, use any of the following methods:

- On the **Logic Tree** page, in the **Options** pane, click the **Properties** tab, and then click the Logic Tree node whose properties you want to view or modify.
- On the **Logic Tree** page, in the diagram canvas, right-click the Logic Tree node whose properties you want to view or modify, and on the shortcut menu, click **Properties**.
- On the **Logic Tree** page, in the diagram canvas, double-click the Logic Tree node whose properties you want to view or modify.

The datasheet for the selected record appears in the **Options** pane on the **Properties** tab.

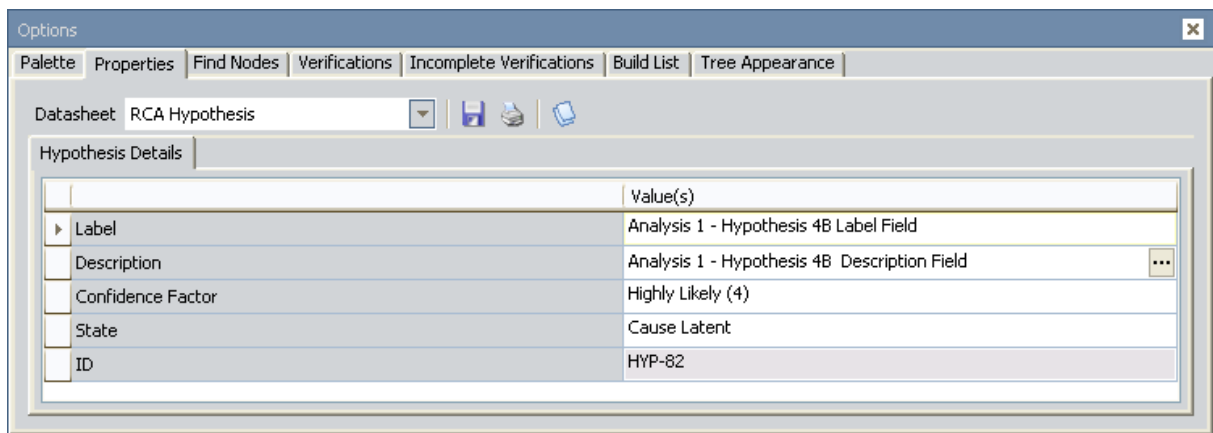

When you are finished modifying the properties of the Logic Tree node, at the top of the datasheet, click the **Save current record** icon,  and your changes will be saved.

Note: In addition to modifying the properties of a node using the previous instructions, you can modify the label of any node by clicking the label on the diagram canvas and making your changes there. If you modify a label in this way, after you navigate off the node label, your changes will be saved *automatically*.

Expanding and Collapsing Logic Tree Nodes

You can collapse or expand nodes in the Logic Tree to hide or reveal related nodes. You can collapse or expand all nodes simultaneously, or you can collapse or expand nodes individually. The following instructions provide details on collapsing and expanding all Logic Tree nodes and individual Logic Tree nodes.

- A minus sign (-) on a Logic Tree node indicates that the node is expanded, revealing its successor nodes.
- A plus sign (+) on a Logic Tree node indicates that the node is collapsed, hiding its successor nodes.
- No plus sign (+) or minus sign (-) on a Logic Tree node indicates that the node has no successors to hide or reveal.

To collapse ALL child Logic Tree nodes that appear after a parent Logic Tree node:

- On a predecessor Logic Tree node (e.g., Failure Mode node or Failure Event node), click the collapse icon as indicated by the minus sign.



The Logic Tree collapses. The minus sign now appears as a plus sign, indicating that the tree is collapsed.



To expand ALL successor Logic Tree nodes that appear after a predecessor Logic Tree node:

- Right-click the desired predecessor Logic Tree node, and on the shortcut menu, click **Expand All**.

Note: If there are no successor nodes associated with a selected node, the **Expand All** option will not appear on the menu.

The Logic Tree expands all the nodes that appear below a predecessor node in the Logic Tree.

To expand Logic Tree nodes individually:

- Select the desired Logic Tree node, and click the plus sign, indicating that the node contains successor nodes.



Expanding and Collapsing Logic Tree Nodes

The next level of the Logic Tree displays the node associated with the selected node. The plus sign now appears as a minus sign, indicating that the Logic Tree node is fully expanded.

Finding Nodes in the Logic Tree

You can locate specific nodes within the Logic Tree by searching for text that matches the label on the node.

To locate nodes in the Logic Tree:

1. On the **Logic Tree** page, in the **Options** pane, select the **Find Nodes** tab.

The **Find Nodes** tab appears, displaying blank search fields.

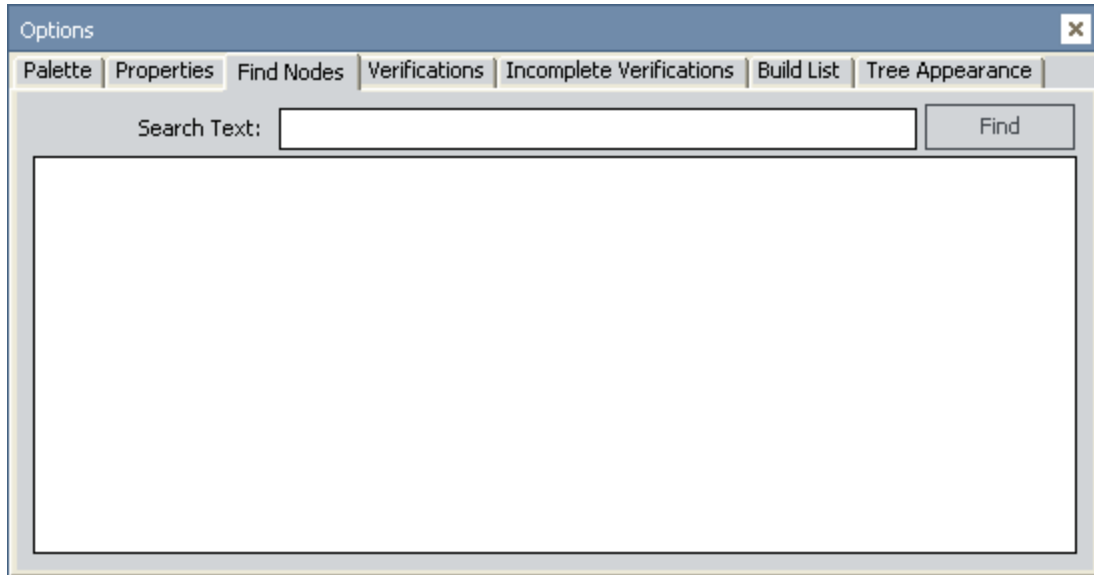

2. In the **Search Text** box, type the text that you want to search for in the records associated with the Logic Tree node.

Note:The search is not case sensitive.

3. Click the **Find** button to display the search results.

The Meridium APM system searches the Label field in the records associated with the Logic Tree nodes for the text that you entered. The results appear in the text box below the **Search Text** box.

Finding Nodes in the Logic Tree

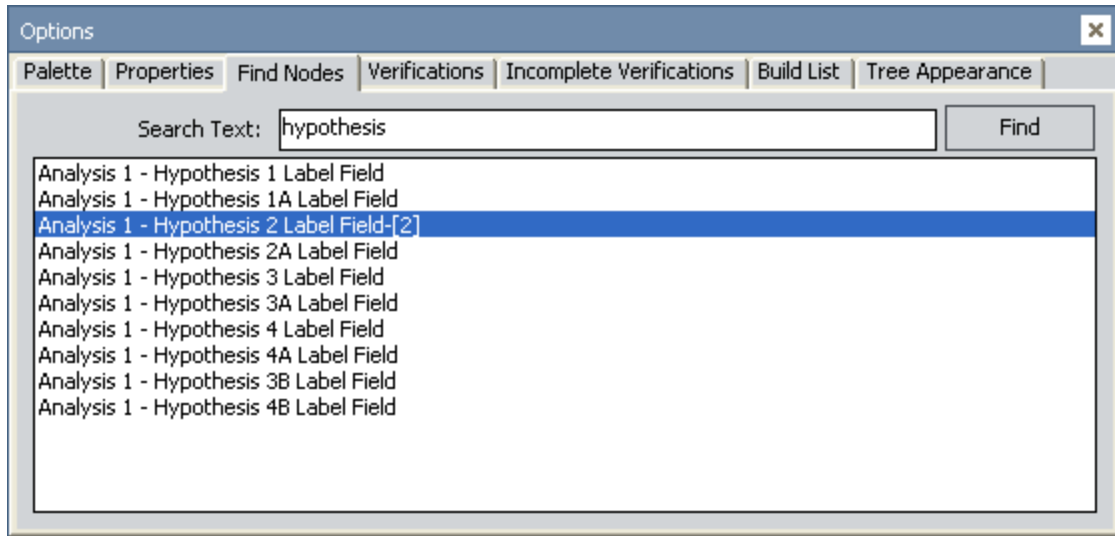

If there are no nodes in the Logic Tree that meet the search criteria, a message appears, indicating that no results match your search criteria. If this message appears, click **OK** to close the message and return to the **Find Nodes** tab.

4. On the **Find Nodes** tab, in the list of results, locate the desired node.
5. Double-click the desired node.

The selected node appears outlined in blue in the diagram canvas.

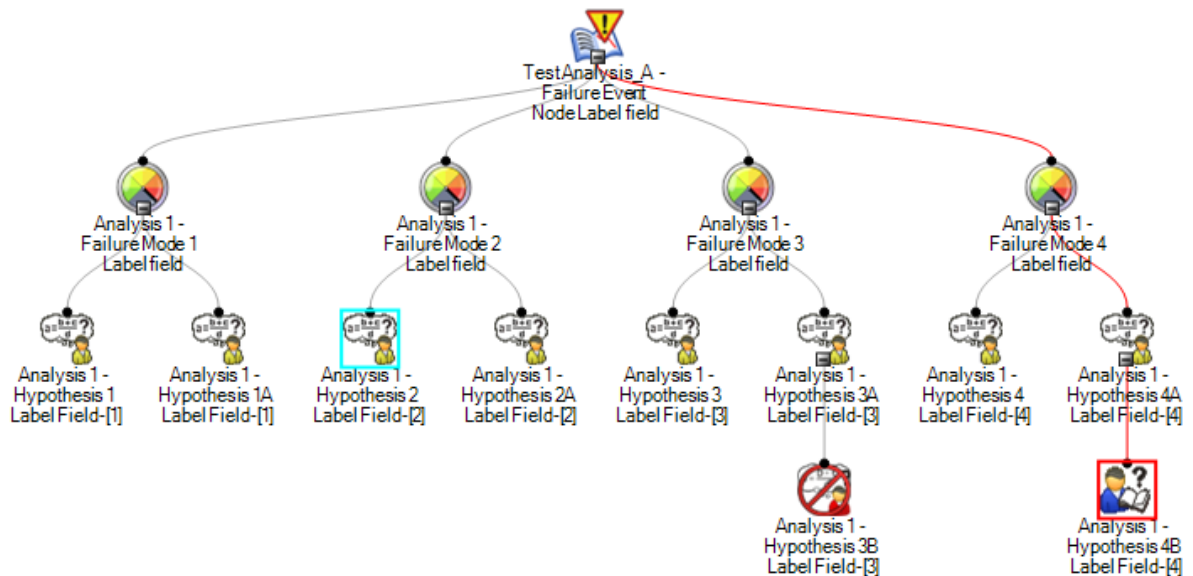

If the selected node is hidden in the diagram canvas (e.g., if its predecessor node is collapsed), the Logic Tree will expand automatically to reveal the selected node.

Manually Arranging Nodes Within the Logic Tree

Disabling Automatic Arrangement

By default, the Meridium APM system automatically arranges the presentation of the nodes on the Logic Tree. You can accept this default setting and allow the Meridium APM system to control the display of the Logic Tree, or you can disable this feature and manually rearrange the location of the nodes.

Before you can begin manually arranging the nodes in the Logic Tree, you will need to disable the **Auto Arrange** option.

To disable this Auto Arrange option:

- On the **Logic Tree** page, on the **Tree Tasks** menu, click the **Settings** link, and on the submenu, click the **Auto Arrange** option to clear the check mark that appears to the left of the option.

Note: If you disable the **Auto Arrange** option, manually change the location of the nodes, and then reselect the **Auto Arrange** option, the system will over-ride all of the manual changes and apply the system defaults to the Logic Tree.

Arranging Nodes Manually

To manually arrange nodes in the Logic Tree:

- On the **Logic Tree** page, on the diagram canvas, click and drag the desired node to the desired location in the Logic Tree.

You can click the plus symbol or minus symbol on a node to [expand and collapse the nodes](#) that appear below the selected node.

Note also, that if you click the **Rearrange** option on the **Settings** menu on the **Tree Tasks** menu, the Logic Tree will display the nodes that you manually arranged in a more logical way. For example, if you arrange the Logic Tree nodes as shown in the following image:

Manually Arranging Nodes Within the Logic Tree

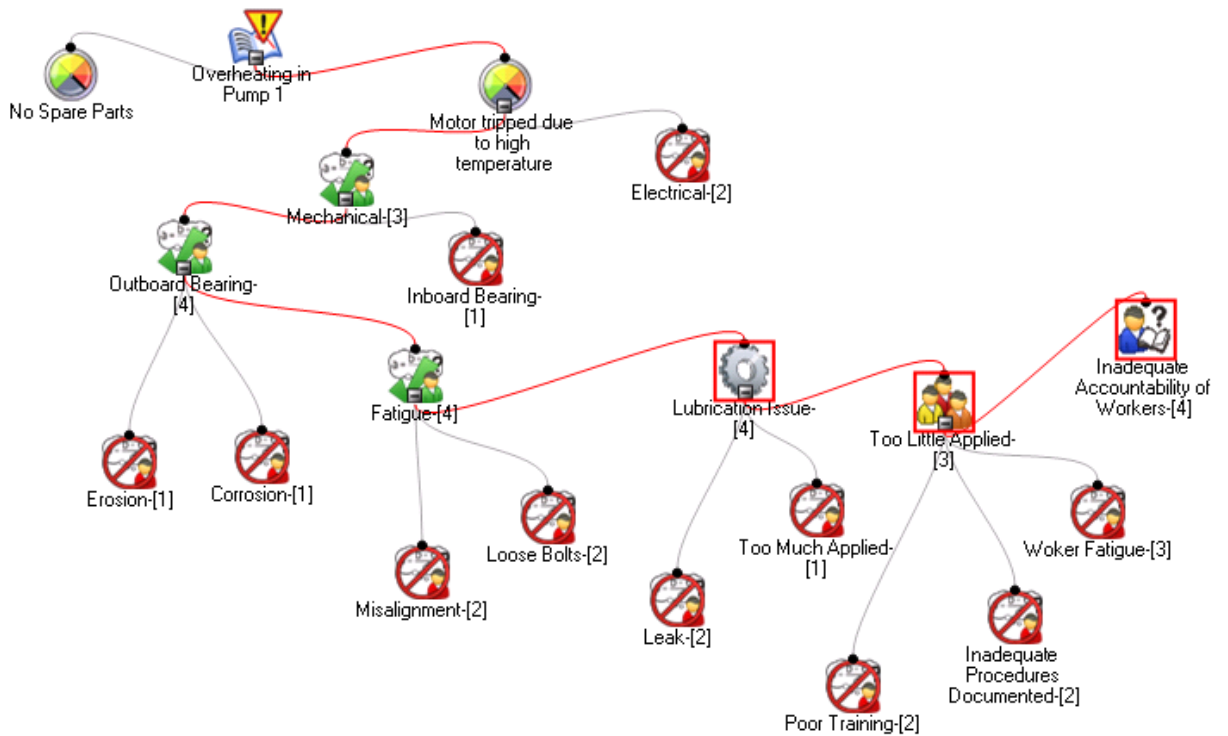

...and then you click the **Rearrange** option, the Logic Tree will be displayed as shown in the following image.

Manually Arranging Nodes Within the Logic Tree

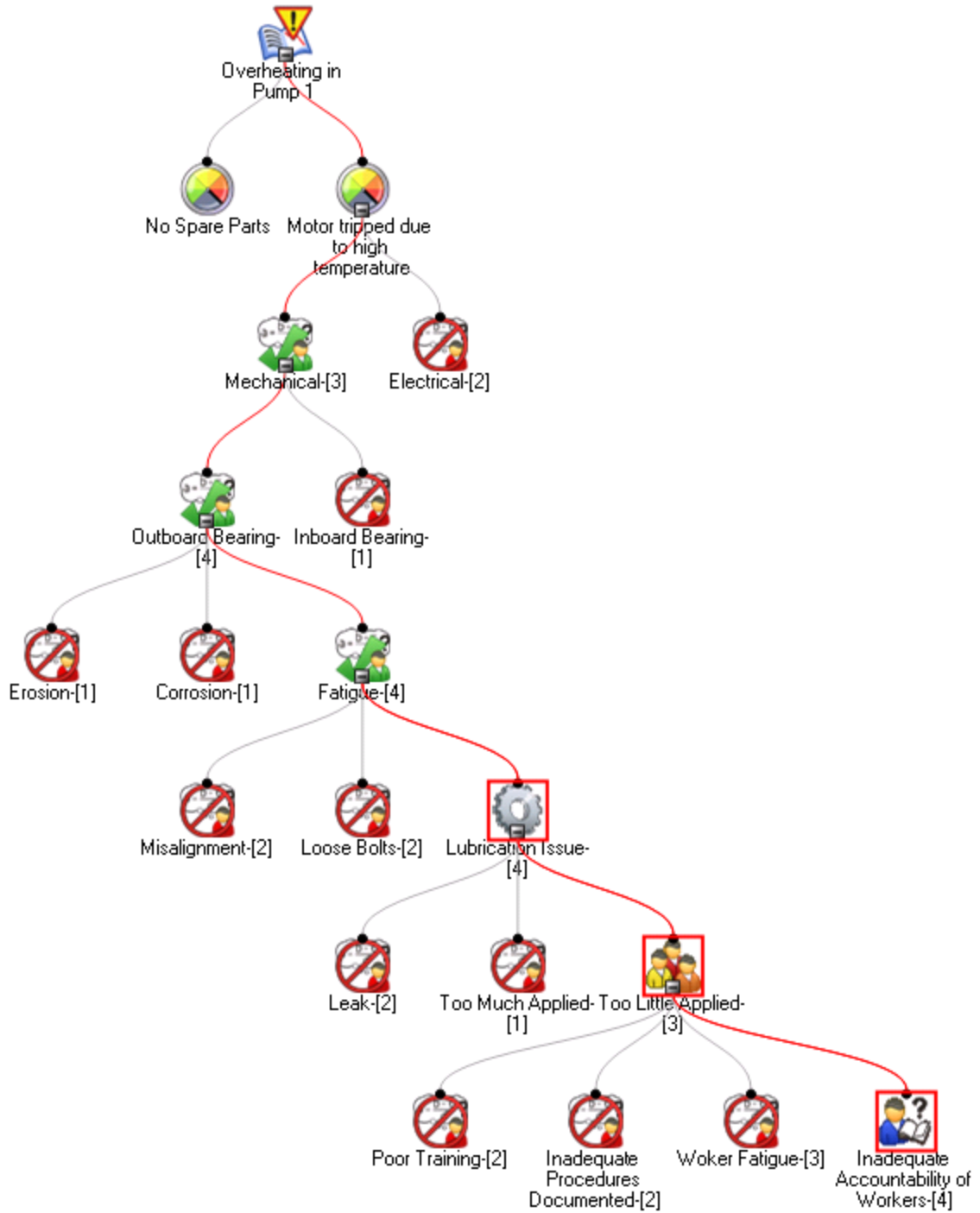

Sending Links to Verification Records to Team Members

On the **Logic Tree** page, you can select and send links to RCA Verification records to multiple analysis team members at the same time. To send links to RCA Verification records to team members, you must be a member of the RCA Analysis Team for the current RCA Analysis, and you must have an email address defined in your Meridium APM Security User record. Additionally, an email address must exist in the *recipient's* Meridium APM Security User record.

To send links to RCA Verification records to team members:

1. On the **Logic Tree** page, on the **Tree Tasks** menu, click the **All Verifications** link.

The **All Verifications** dialog box appears, displaying a list of all existing RCA Verification records associated with the current RCA Analysis.

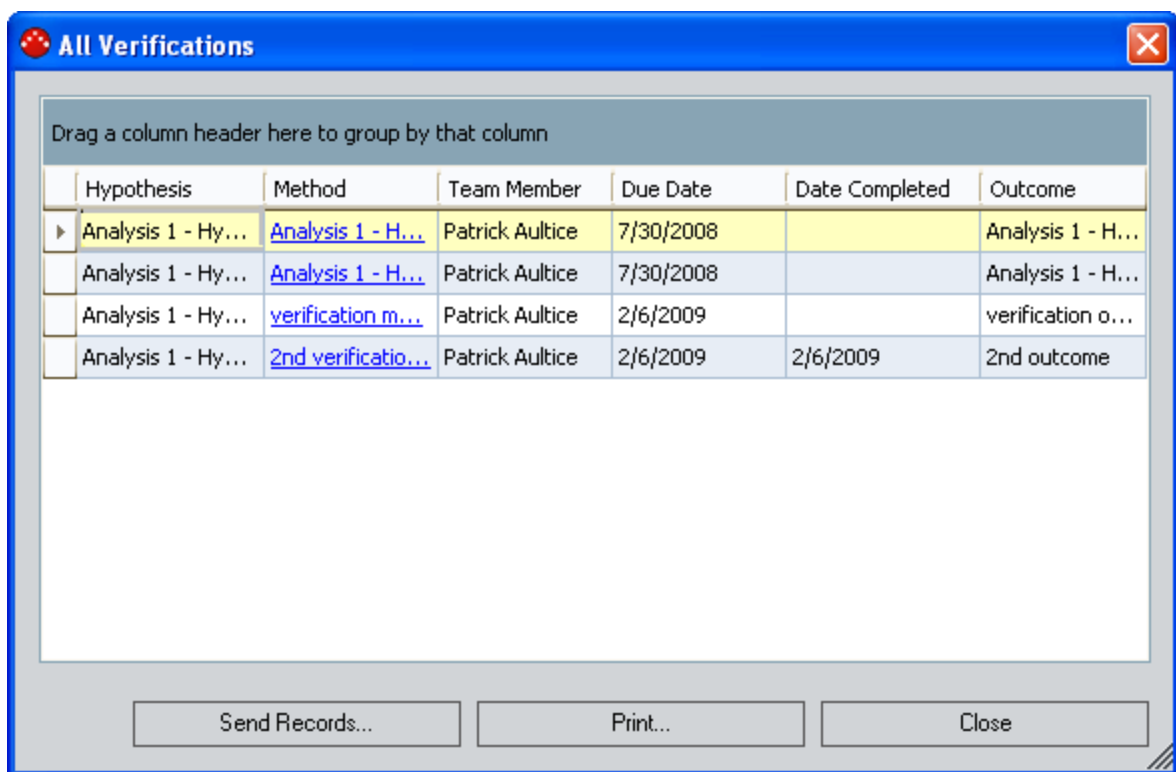

2. On the **All Verifications** dialog box, click the **Send Records** button.

The **Email List of Items** dialog box appears, displaying a list of the existing RCA Verification records in the current RCA analysis.

Note: If you do not currently have an email address defined in your Meridium APM Security User record, a message will appear, indicating that you do not

have an email address. You will need to enter a valid email address in your Meridium APM Security User record before you can continue.

3. Select the RCA Verification record whose link you want to send via email. You can click the **Select All** button to select all the analyses or the **DeselectAll** button to clear all selections.
4. In the **Subject** text box, type the subject of the email message.
5. In the **Message Text** box, type the text of the email message.

Note: The **Person Responsible** field displays the list of team members to whom the message will be sent.

6. Click the **Send** button.

The email message(s) containing a hyperlink to the selected RCA Verification record is sent, and a message appears, indicating that the message has been sent.

Note: If the Security User record for the specified recipient does not contain an email address, a message will appear, indicating that the email could not be sent because the recipient does not have an email address defined. You will need to type a valid email address in the Security User record for the recipient before you can send an email message to that person.

7. Click **OK** to close the confirmation message.
8. Click the **Close** button to close the **Email List of Items** dialog box.

Cutting, Copying, and Pasting Logic Tree Nodes

After you create various nodes in your Logic Tree, you can cut, copy, and paste them as needed throughout the Logic Tree.

To cut or copy a Logic Tree node:

- On the **Logic Tree** page, in the diagram canvas, right-click the Logic Tree node that you want to cut or copy, and on the shortcut menu, click the **Copy** or **Cut** option.
 - If you are copying a Logic Tree node that has successor nodes, a message appears, asking if you also want to copy the successor nodes. Click the **Yes** button to copy the successor nodes, or click the **No** button to copy the predecessor node and leave the successor nodes.

Note: When you copy a Hypothesis node, if the RCA Hypothesis record is linked to RCA Verification records, the verifications for that Hypothesis node will also be copied. When you paste the Hypothesis node, new RCA Hypothesis and RCA Verification records will be created and will contain the same information as the source records.

- If you are cutting a Logic Tree node that has successor nodes, the successor nodes will also be cut.
- If the selected Logic Tree node does not have successor nodes, the selected node is copied to the clipboard.

To paste a copied node:

- On the **Logic Tree** page, in the diagram canvas, right-click the node onto which you want to paste the copied node, and on the shortcut menu, click **Paste**.
 - If the selected node is a valid location to paste the copied or cut node, the nodes that were copied or cut appear in the levels below the selected node.
 - If the selected node is not a valid location to paste the copied or cut node, nothing happens. You will need to select a different location to paste the node(s).

Managing Reference Document Records for Logic Tree Nodes

In some cases it may be necessary to attach additional information to nodes in the Logic Tree. You can do so by creating a Reference Document record and linking it to the record for the desired node.

To manage Reference Document records for nodes in the Logic Tree:

1. On the **Logic Tree** page, in the diagram canvas, double-click the node to which you want to add a reference document.

The associated record appears on the **Properties** tab in the **Options** pane. The following image is an example of an RCA Hypothesis datasheet as it appears on the **Properties** tab when you double-click a Hypothesis node.

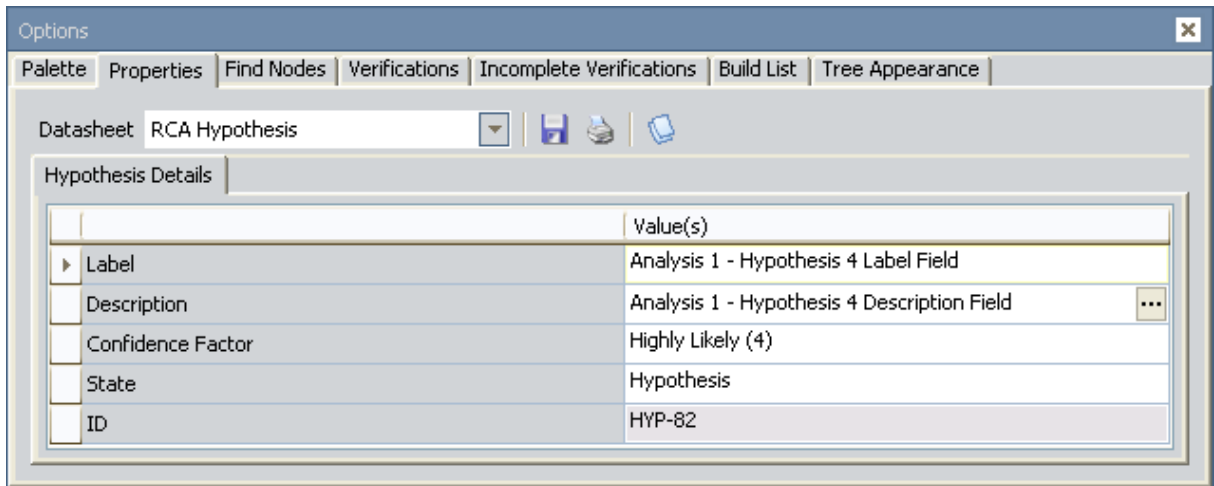

2. At the top of the datasheet, click the reference documents icon. 

The standard **Reference Documents** window appears.

3. Configure reference documents as desired.

Deleting Nodes from the Logic Tree

When you delete a node from the Logic Tree, the associated record is deleted from the database. Any node except the Failure Event Node can be deleted from a Logic Tree.

To delete a node from the Logic Tree:

1. On the **Logic Tree** page, in the diagram canvas, right-click the node that you want to delete.

A highlighted square appears around the node, indicating that the node has been selected, and a shortcut menu appears.

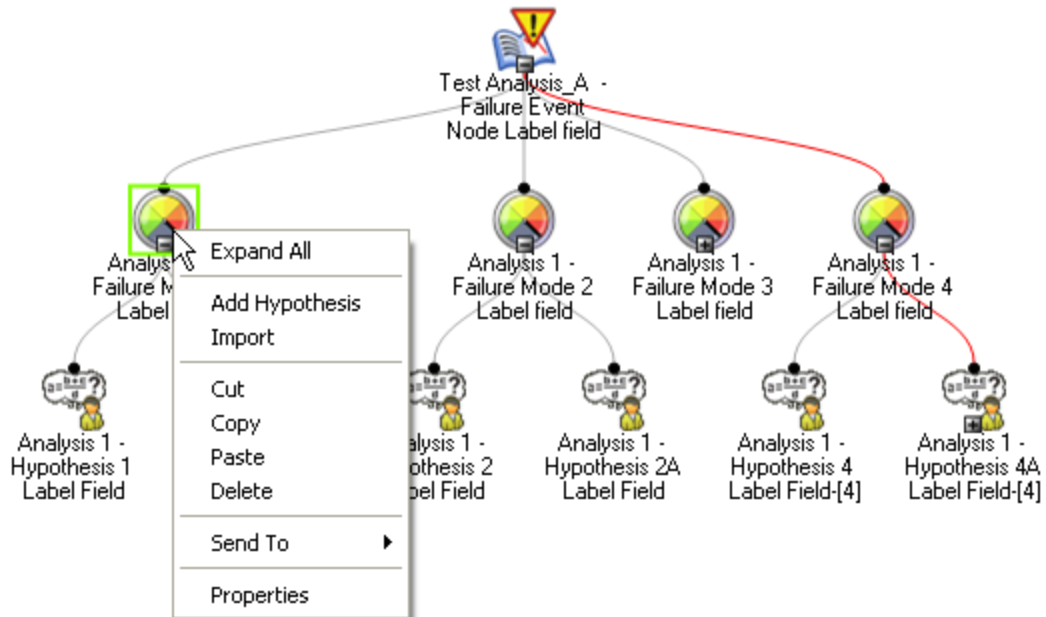

2. On the shortcut menu, click **Delete**.

-OR-

Press the Delete key.

A message appears, asking if you really want to delete the selected node and its successor nodes (if any).

3. Click the **Yes** button to delete the selected node and its successors (if any).

The record associated with the node is deleted from the database, and the node no longer appears in the Logic Tree.

Deleting Nodes from the Logic Tree

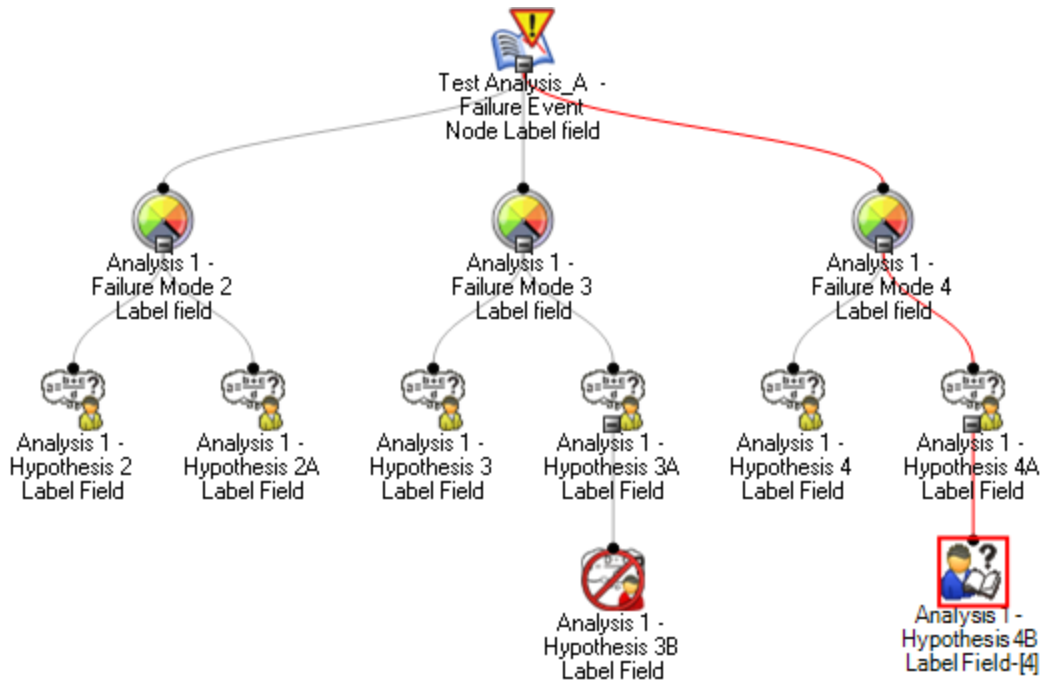

Additionally, the link that existed between the record associated with the deleted node and the node to which it was linked are removed.

Changing the Tree View

When you begin creating a Logic Tree, the tree is displayed vertically by default. If desired, you can view the Logic Tree horizontally. For example, the following image shows a Logic Tree that is displayed using the default setting:

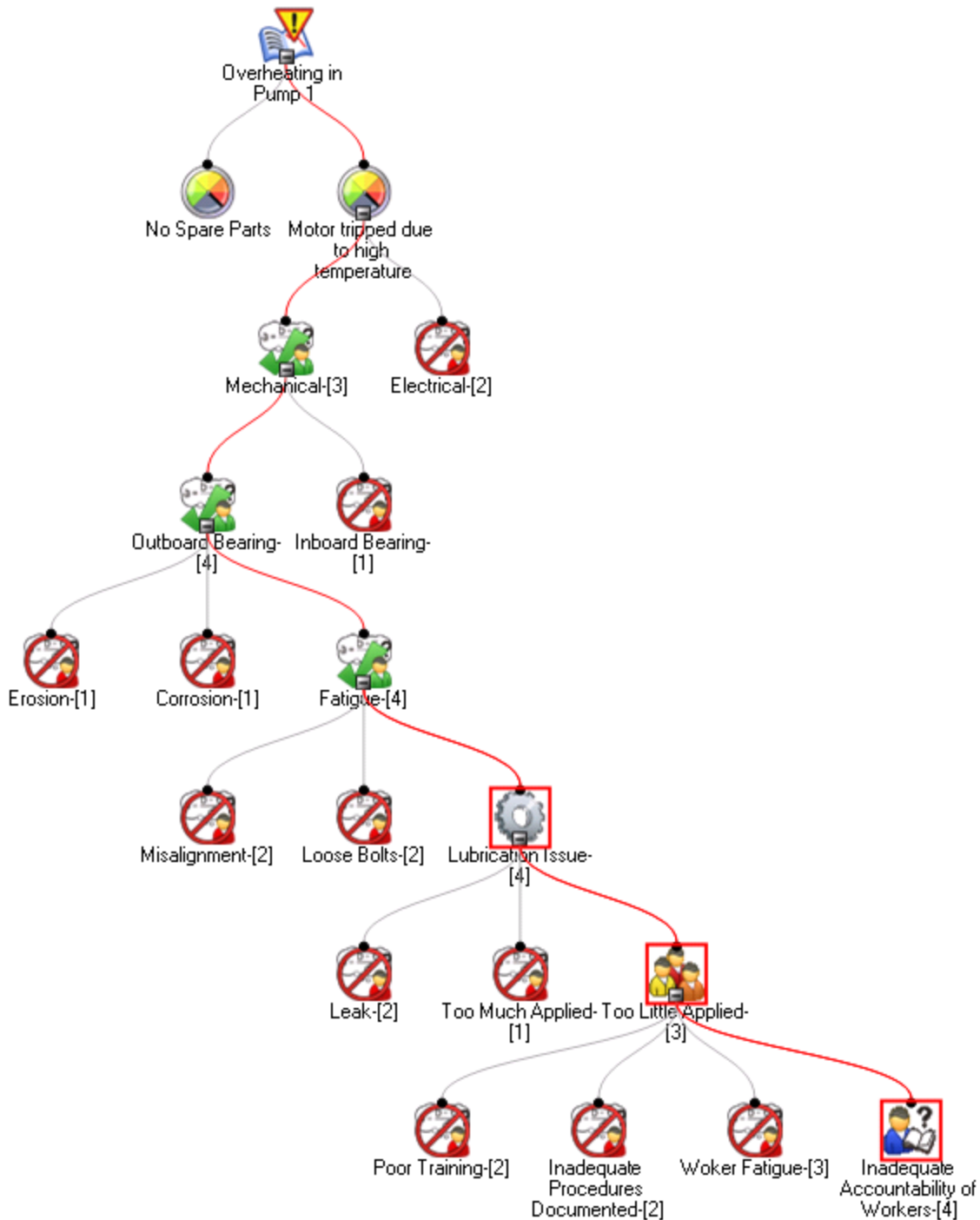

Changing the Tree View

...and this image shows the same Logic Tree after the view has been changed to horizontal:

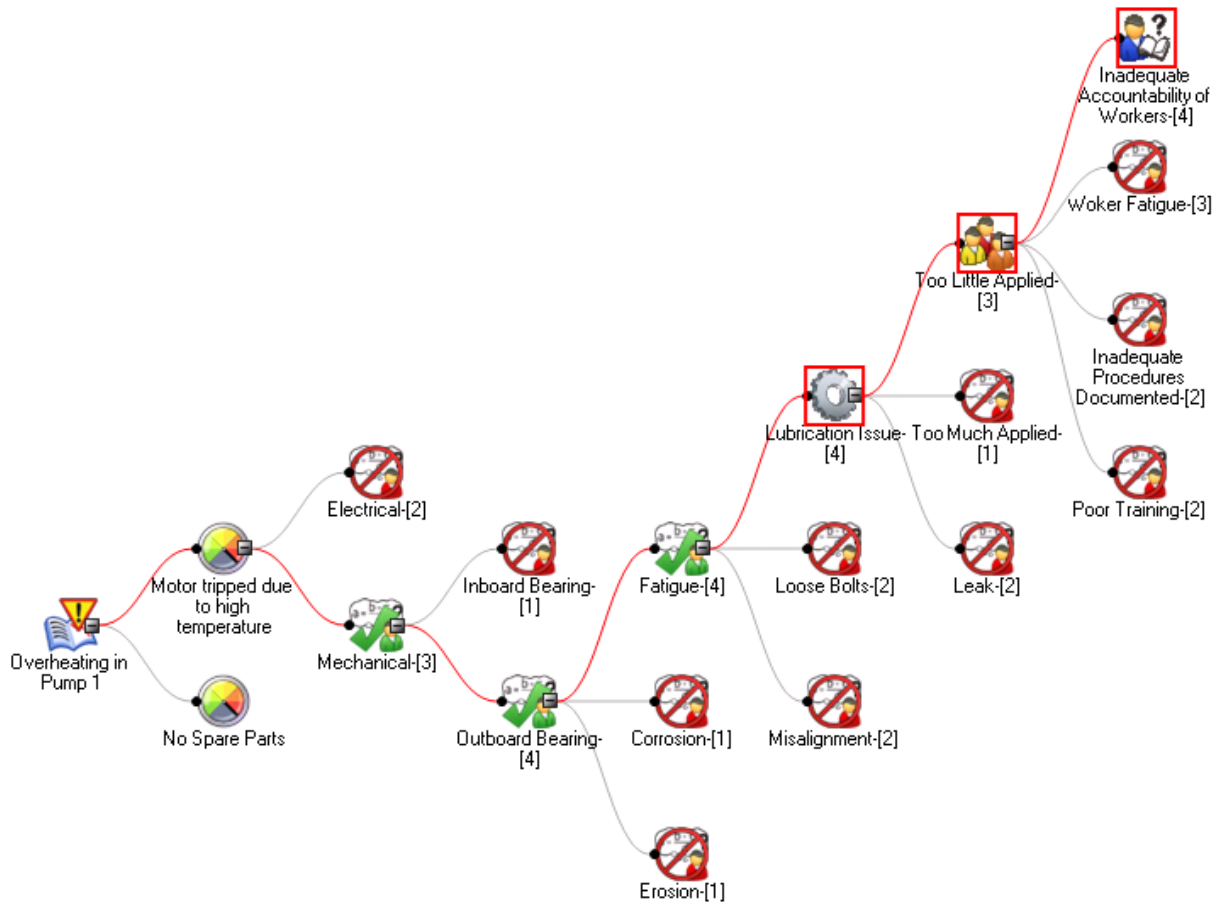

To change the tree view:

1. On the **Logic Tree** page, on the **Tree Tasks** menu, click the **Settings** link.

A submenu appears, displaying a list of options that let you modify the settings on the Logic Tree.

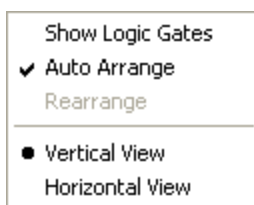

A bullet appears to the left of the **Horizontal View** or **Vertical View** option to indicate the current setting.

2. Click the option that corresponds to the view that you want to apply to the Logic Tree (i.e., Horizontal or Vertical).

The Logic Tree is displayed using the selected view.

Displaying the Logic Tree on a Full Screen

The full screen view of the Logic Tree is useful for showing the Logic Tree in a presentation.

To display the Logic Tree on a full screen:

- On the **Logic Tree** page, on the **Tree Tasks** menu, click the **Full Screen** link.

The Logic Tree appears on a full screen. All of the options available from the right-click menus in normal mode are also available in the full screen mode.

To return to normal mode from the full screen mode:

- Press the Esc key.

-or-

Right-click the Logic Tree diagram, and clear the **Full Screen** option.

Zooming In and Out on the Logic Tree

You can adjust the size of the Logic Tree diagram by zooming in and out on the Logic Tree.

To zoom in and out of the Logic Tree:

1. On the **Logic Tree** page, in the **Options** pane, click the **Tree Appearance** tab.

The **Tree Appearance** tap appears, displaying tree appearance options that can be modified.

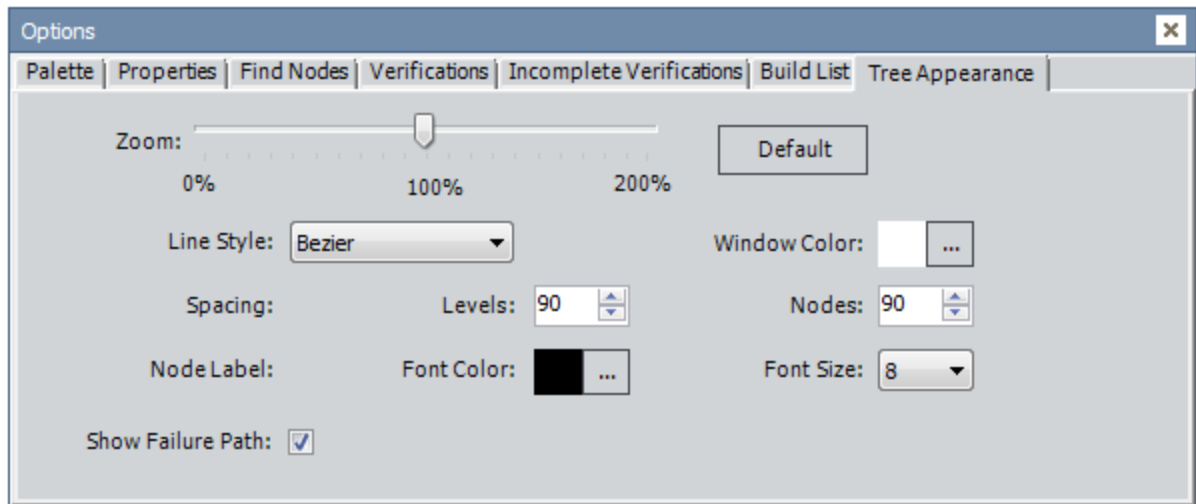

Note: You can also right-click the diagram canvas, point to **Zoom**, and click the desired percentage on the submenu.

2. Click the **Zoom** indicator, and drag it to the right or left to adjust the view size as desired.

The view becomes larger or smaller as appropriate.

Applying a Different Line Style

You can change the style type of the lines that join the nodes on the Logic Tree. The style is set to **Bezier** by default.

To change the line style:

1. On the **Logic Tree** page, in the **Options** pane, click the **Tree Appearance** tab.

The **Tree Appearance** tap appears, displaying tree appearance options that can be modified.

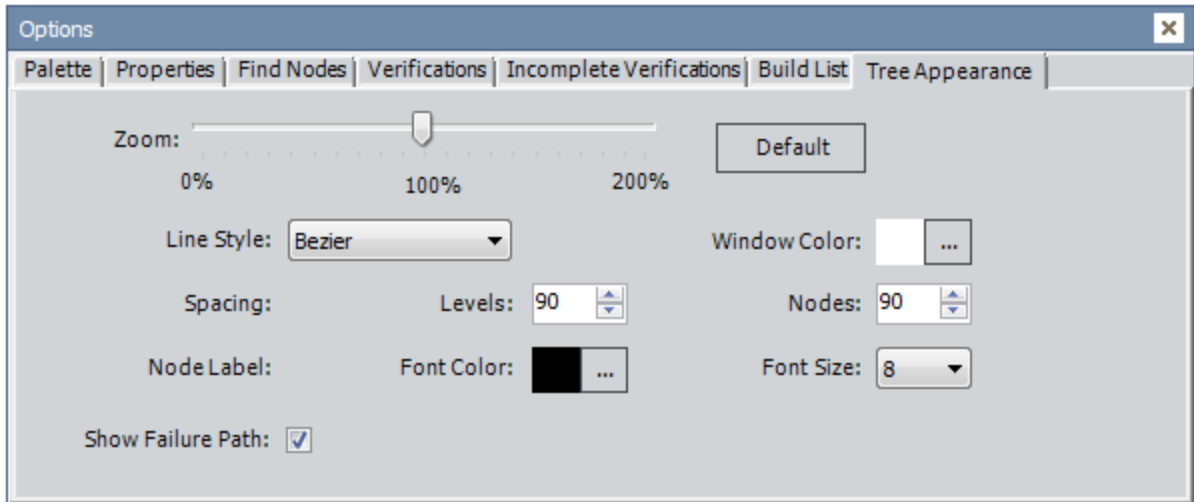

2. Expand the **Line Style** list, and select a different line style. You can select any of the following options:

- Orthogonal
- Rounded
- Straight

The line style is applied to the Logic Tree, and the system saves the Logic Tree with the selected line style. The next time that you view the Logic Tree for the current RCA Analysis, the selected style appears.

Changing the Color of the Logic Tree Section

The default color of the diagram canvas is white. If desired, you can change the color of the diagram canvas.

To change the color of the diagram canvas:

1. On the **Logic Tree** page, in the **Options** pane, click the **Tree Appearance** tab.

The **Tree Appearance** tap appears, displaying tree appearance options that can be modified.

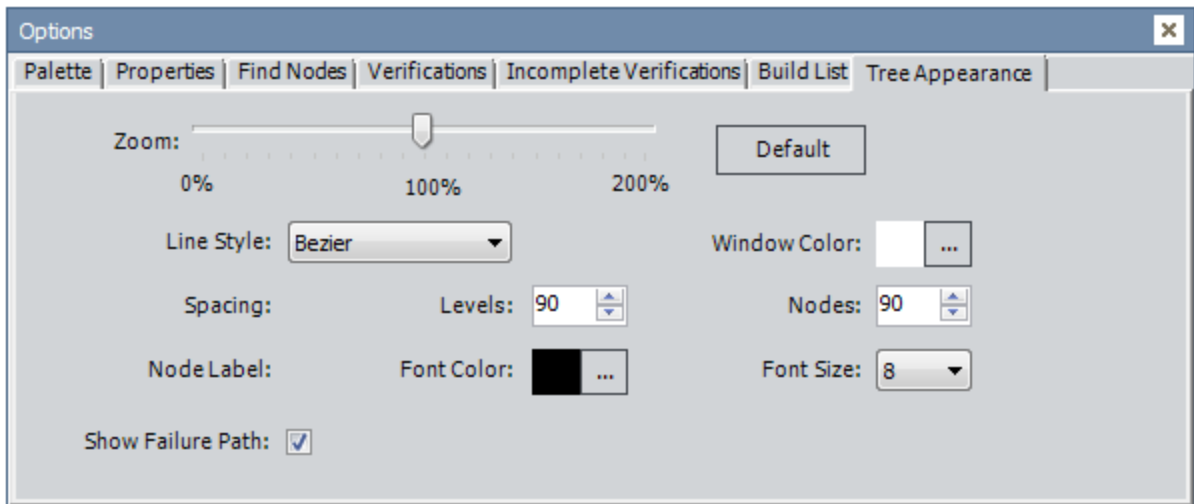

2. In the **Window Color** field, click the  button.

The **Color** dialog box appears.

Changing the Color of the Logic Tree Section

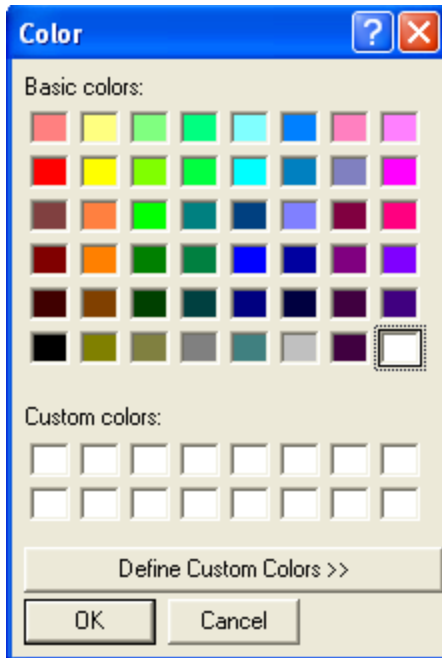

3. Select the color that you want to use for the background from the color palette, or specify a custom color, and click **OK**.

The diagram canvas is displayed using the selected color.

Changing the Spacing for Levels and Nodes



The following instructions provide details on changing the spacing between the levels and individual nodes in the Logic Tree.

To change the spacing for levels and nodes:

1. On the **Logic Tree** page, in the **Options** pane, click the **Tree Appearance** tab.

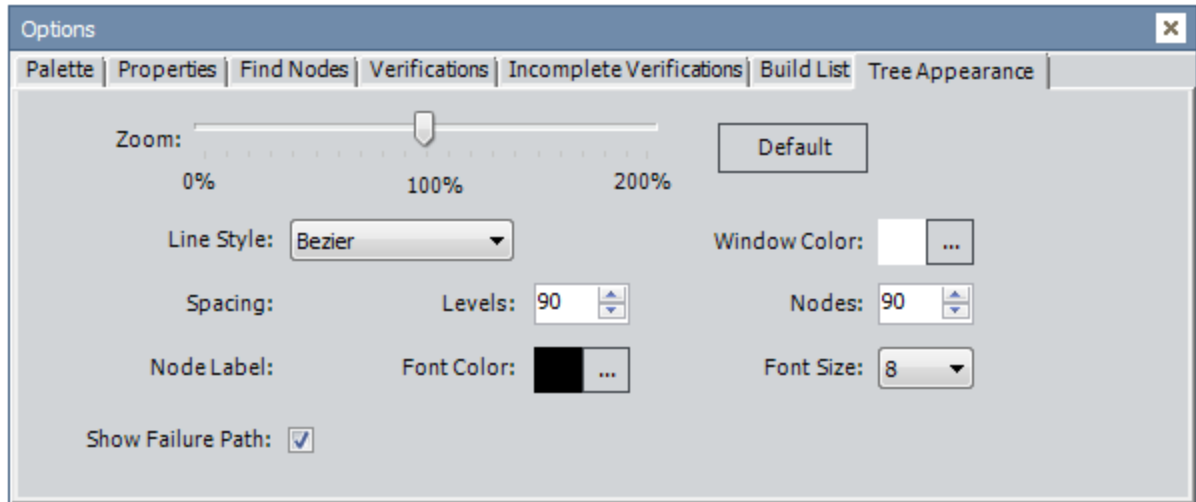
The **Tree Appearance** tap appears, displaying tree appearance options that can be modified.



2. In the **Spacing** section, in the **Levels** field, use the  buttons to select a number. The default setting is *90*.
3. In the **Spacing** section, in the **Nodes** field, use the  buttons to select a number. The default setting is *90*.

Changing the Size and Color of the Font

If desired, you can change the color and size of the text displayed in the Logic Tree.

To change the font color:

1. On the **Logic Tree** page, in the **Options** pane, click the **Tree Appearance** tab.

The **Tree Appearance** tap appears, displaying tree appearance options that can be modified.

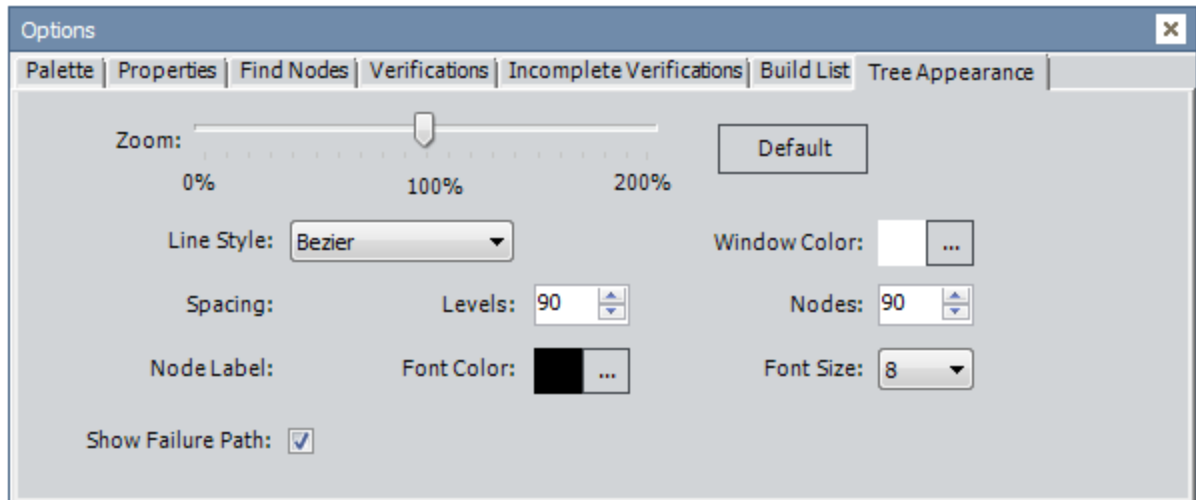

2. In the **Node Label** section, click the **...** button in the **Font Color** field.

The **Color** dialog box appears.



Changing the Size and Color of the Font

3. Select the desired font color from the color palette, or specify a custom color, and click **OK**.

The text is displayed using the selected font color.

To change the font size:

1. On the **Logic Tree** page, in the **Options** pane, click the **Tree Appearance** tab.

The **Tree Appearance** tap appears, displaying tree appearance options that can be modified.

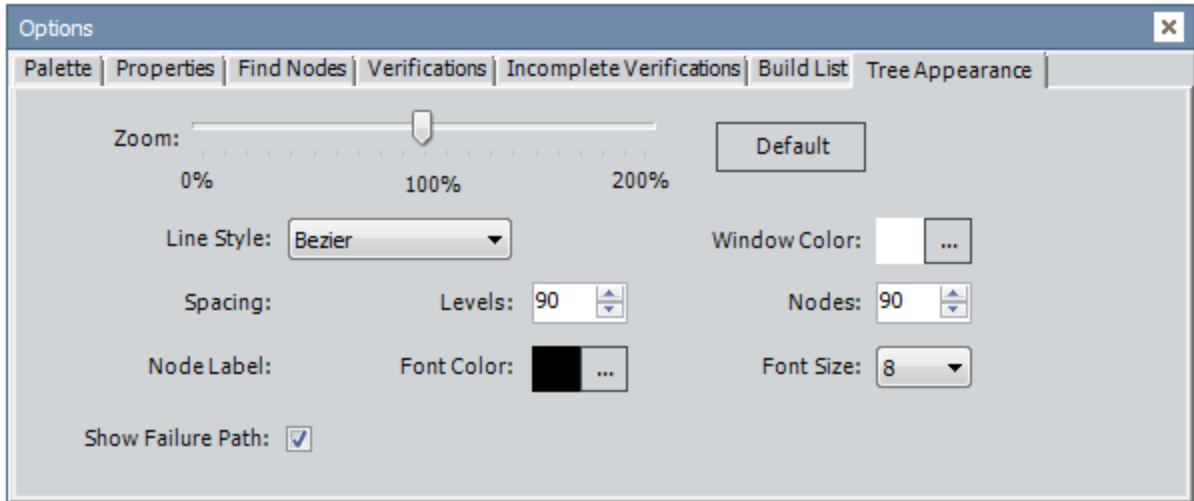

2. In the **Node Label** section, expand the **Font Size** list, and select a number. The default setting is 8.

The text is displayed using the selected font size.

Resetting the Logic Tree to Display Default Settings

If desired, after you have changed the appearance of the Logic Tree, you can reset the Logic Tree and display it using the default settings. The following image shows the default appearance settings for the Logic Tree.

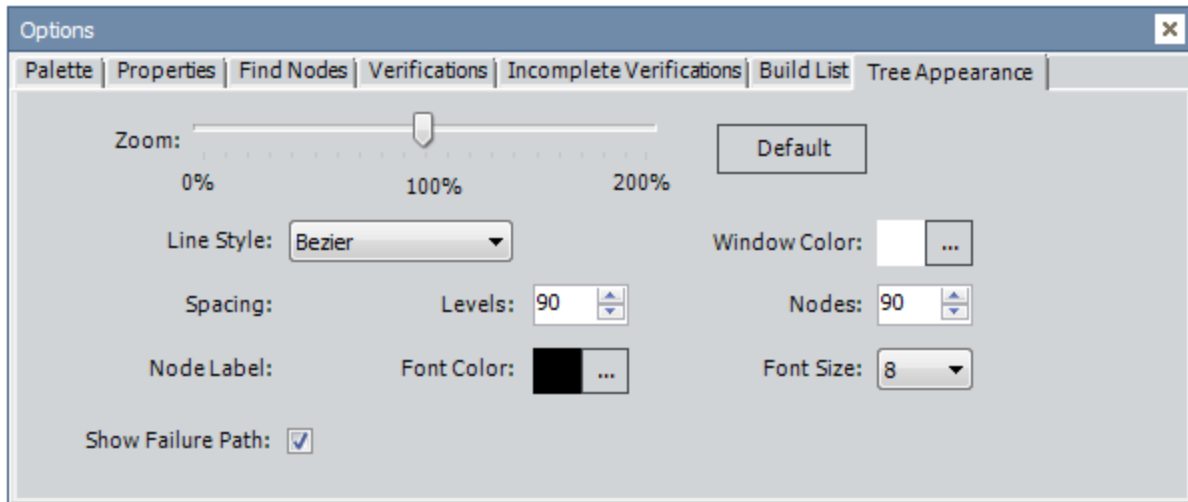

To return the Logic Tree to its default appearance:

1. On the **Logic Tree** page, in the **Options** pane, click the **Tree Appearance** tab.
2. On the **Tree Appearance** tab, click the **Default** button.

A confirmation message appears, asking if you really want to reset the Logic Tree to its default appearance.

3. Click the **Yes** button.

The Logic Tree is displayed using the default appearance settings.

Accessing the Overview Map

The Overview Map is useful when you are working with a large Logic Tree. The Overview Map displays an aerial view of the Logic Tree so that you can quickly locate and zoom in on specific sections of the Logic Tree.

To display the Overview Map window and use it to work with the Logic Tree:

- On the **Logic Tree** page, on the **Tree Tasks** menu, click the **Overview Map** link.

The **Overview Map** window appears.

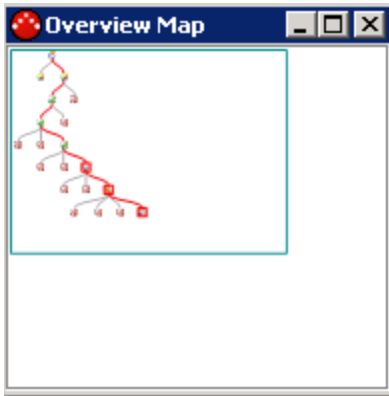

The Logic Tree appears in a box in the upper left corner of the **Overview Map** window. The box that appears around the Logic Tree indicates the scope of the area that is currently magnified in the diagram canvas. You can move the magnifying box to various locations on the tree and the diagram canvas will display that portion of the tree.

You can resize the window by clicking the frame and dragging it to the desired size. To close the **Overview Map** window, click the **X** button in the upper-right corner of the window. After you close the **Overview Map** window, the area that you were magnifying will continue to be displayed in the diagram canvas.

Using the Overview Map

The Overview Map is a tool that you can use to quickly locate specific areas of the Logic Tree, magnify them, and then modify them as desired. You can use your pointer to change the size of the magnifying box to select the areas on the Logic Tree that you want to magnify.

For example, you can change the size of the magnifying box to only display one node at a time, which lets you navigate around the Logic Tree, while seeing only the magnified node in the diagram canvas.

For example, the following image shows the **Overview Map** window when it was first accessed via the **Tree Tasks** menu.

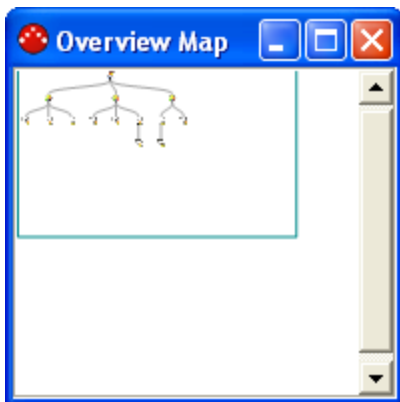

This image shows the **Overview Map** window after it changed the size of the magnifying box:

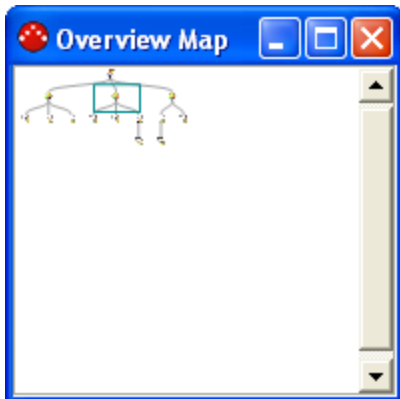

...and this image shows a node that is highlighted in the Overview Map as it appears in the diagram canvas:



Heat Failure

The size of the magnifying box determines the magnification that is applied to the area that appears inside the box. The smaller the box, the greater the magnification level, meaning the image will appear larger in the diagram canvas (taking up more screen space). The larger the box, the lower the magnification level, meaning the image will appear smaller.

Additionally, when you pause on the lines that define the magnifying box, your pointer looks like the following image, which indicates that you can move the magnifying box.



When your pointer looks like the following image, it indicates that you can draw your own magnifying box.



To draw a magnifying box on the Overview Map window:

1. Point to an area on the **Overview Map** window (other than the lines that define the current magnifying box).

Your pointer appears as an arrow. 

2. Press and hold your mouse button, and drag the pointer to the desired size.

As you drag the pointer, a box appears and grows larger or smaller with your movements.

3. Release the mouse button when the magnifying box is the desired size (i.e., magnification).

The magnifying box that you drew appears in the Overview Map. You can move the magnifying box around the Logic Tree in the Overview Map to magnify that

area in the diagram canvas. The diagram canvas displays the selected area at the magnification level that corresponds to the size of the magnifying box.

Note: You cannot re-size a magnifying box after it has been drawn. If you want to change the size of a magnifying box, you will need to draw a new magnifying box.

To select areas on the Logic Tree that you want to magnify:

1. Pause on the magnifying box.

Your pointer appears as a four-way arrow. 

2. Press and hold your mouse button, and drag your pointer until the magnifying box is in the desired location in the Logic Tree.

The diagram canvas displays the selected area at the magnification level that corresponds to the size of the magnifying box.

Exporting Logic Trees

You can export a Logic Tree as an image and save it to another location, such as your local hard drive.

- The exported image will match the current expanded/collapsed state of the Logic Tree. For example, the image will display each node as it is shown in the tree *at the time of the export*. Expanded nodes will be expanded; collapsed nodes will be collapsed.
- Regardless of the zoom factor that is currently applied to the Logic Tree, the *entire* tree will be included in the image, even if it part of the tree is cut off at the time you perform the export. The zoom factor will, however, affect the size of the image that is exported.

To export a Logic Tree:

1. On the **Logic Tree** page, on the **Tree Tasks** menu, click the **Export Tree** link.

The **Export Logic Tree** dialog box appears.

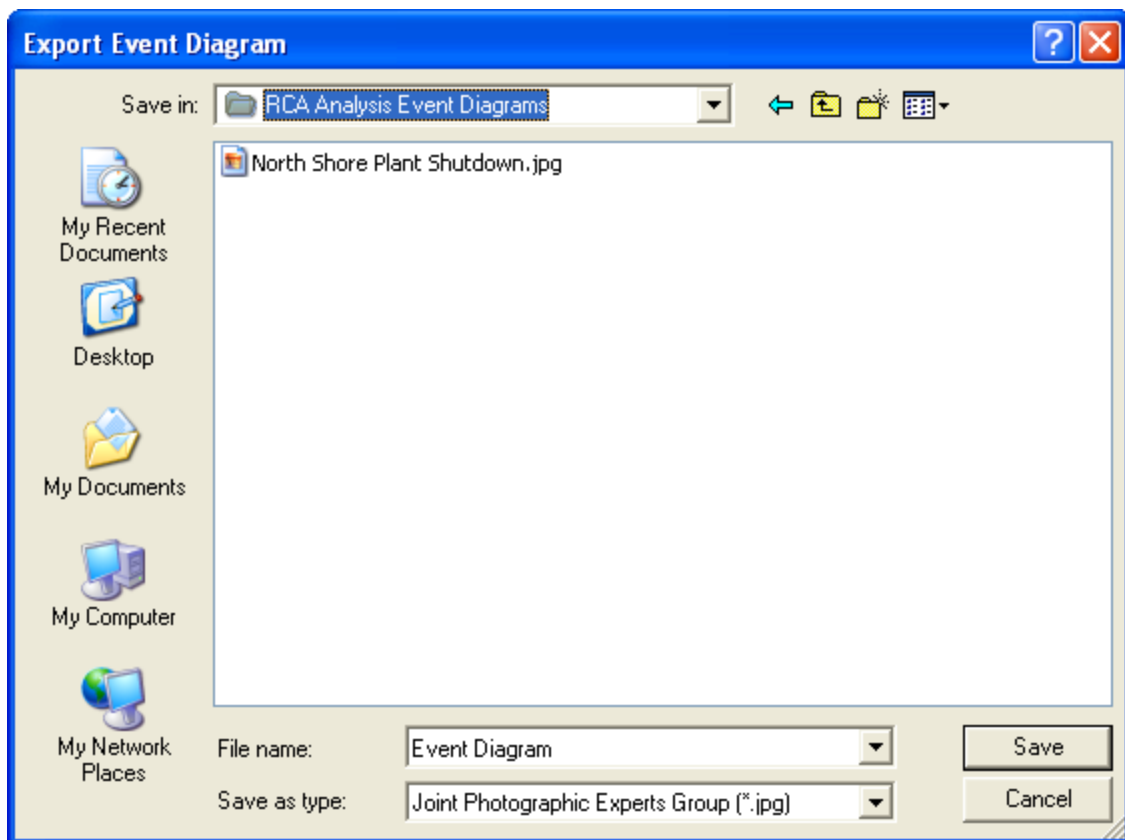

2. Navigate to the location to which you want to save an image of the tree.
3. In the **File Name** text box, type a name for the file.

4. In the **Save as type** list box, select the desired file type. You can choose from:
 - **Bitmap (.BMP)**
 - **Graphics Interchange Format (.GIF)**
 - **Joint Photographic Experts Group (.JPG)**
 - **Portable Network Graphics (.PNG)**
 - **Tag Image File Format (.TIF)**
5. Click the **Save** button.

The Logic Tree is saved to the selected location as the selected image type.

About Communicating Findings and Implementing Recommendations

After the RCA Analysis Team has successfully identified the root cause of the equipment or location failure, the next step involves *communicating* the team's findings and proposing *recommendations* to the appropriate individuals within your organization. To do so, you can use the **Communicate Records** page to:

- [Complete the fields on the RCA Communicate datasheet](#) to define the failure mechanism and acknowledge those who participated in the RCA Analysis but who were not members of the RCA Analysis Team.
- [Create RCA Recommendation records](#) and link them to the RCA Analysis record. RCA Recommendation records contain proposed solutions called *recommendations* that identify the changes in work processes that can be used to avoid or prepare for future failures.
- [Generate reports](#) to communicate the team's findings. These reports can be published and distributed to other members of your organization.

After you have successfully communicated the team's findings and the proposed recommendations have been approved, the recommendations should then be implemented within the organization.

After the recommendations have been implemented, the team should continue to [track the success of the implemented solution through RCA Tracking Item records](#).

Accessing the Communicate Records Page

You can access the **Communicate Records** page via the **Communicate** menu on any of the following pages:

- **Analysis** page.
- **Preserve Failure Data** page.
- **Critical Success Factors** page.
- **Event Diagram** page.
- **Logic Tree** page.

To access the **Communicate Records** page:

- On the **Communicate** menu, click the **Communicate Records** link.

The **Communicate Records** page appears.

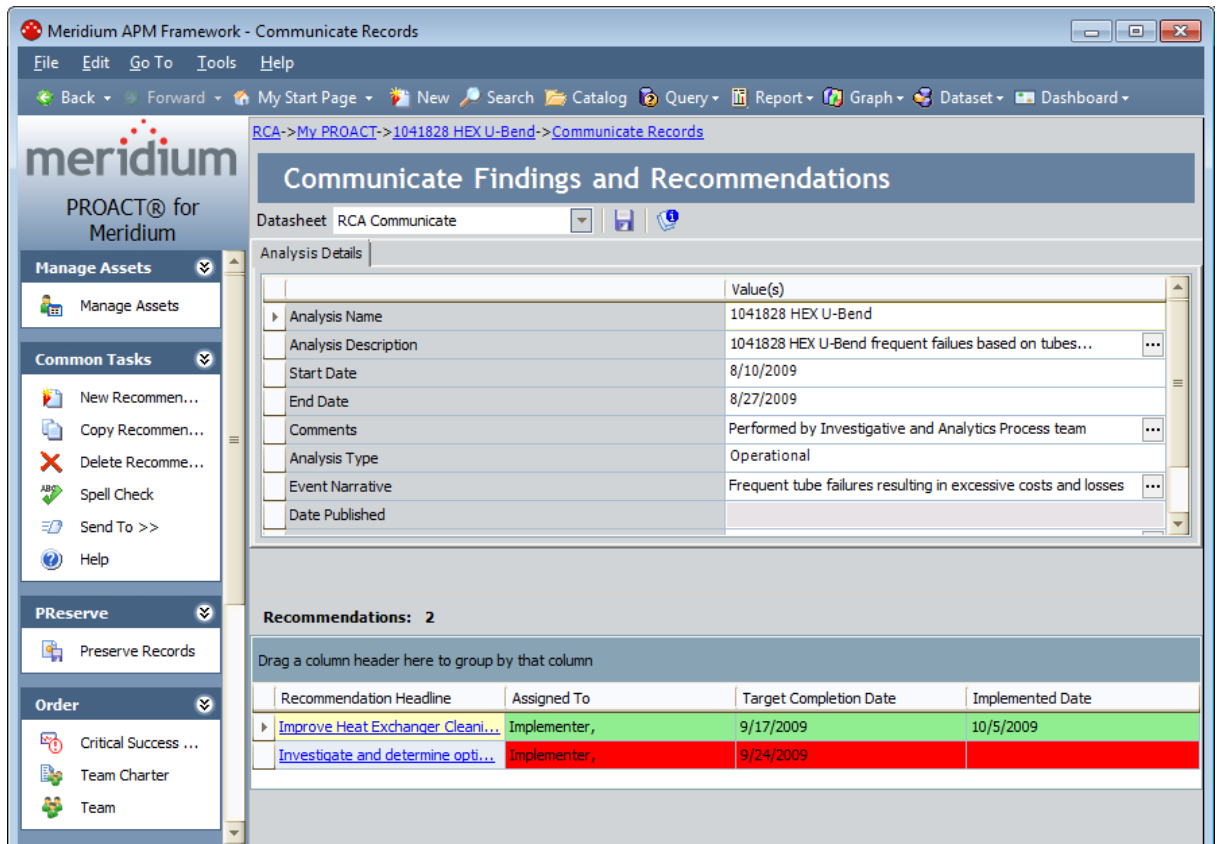

Overview of the Communicate Records Page

The **Communicate Records** page consists of:

- The RCA Communicate datasheet for the RCA Analysis record, as shown in the following image.

The screenshot shows a software interface titled "Datasheet RCA Communicate". Below the title bar is a tab labeled "Analysis Details". The main area contains a table with the following data:

| | Value(s) |
|----------------------|--|
| Analysis Name | Test Analysis_A |
| Analysis Description | Test Analysis_A - Analysis Description field ... |
| Start Date | 7/30/2008 |
| End Date | 8/6/2008 |
| Comments | Test Analysis_A - Comments field ... |
| Analysis Type | Mechanical |
| Event Narrative | Test Analysis_A - Event Narrative field ... |
| Date Published | |

This datasheet appears at the top of the page and contains fields that allow you to complete the RCA Analysis record. The RCA Communicate datasheet contains the same fields as the RCA Analysis datasheet with two exceptions: the Mechanism field and the Acknowledgments field. You should complete these fields on the RCA Communicate datasheet to communicate the results of the RCA Analysis.

- The **Recommendations** section, which appears at the bottom of the page and displays a list of RCA Recommendation records that are associated with the RCA Analysis. The following image shows an example of the **Recommendations** section.

The screenshot shows a section titled "Recommendations: 4". Below the title is a table with the following data:

| Recommendation Headline | Assigned To | Target Completion Date | Implemented Date |
|--|------------------|------------------------|------------------|
| Replace valve on pump 82 | Aultice, Patrick | 6/2/2011 | 6/3/2011 |
| ▶ Replace valve on pump 62 | Aultice, Patrick | 6/9/2011 | |
| Replace valve on pump 67 | Aultice, Patrick | 6/2/2011 | |
| Replace valve on pump 89 | Aultice, Patrick | 6/29/2011 | |

You can use RCA Recommendation records to record and track the progress of recommendations. For each RCA Recommendation record, the following information appears:

- **Recommendation Headline:** A short description of the recommendation.
- **Assigned To:** The name of team member who is responsible for the completing the solution outlined in the RCA Recommendation record.
- **Target Completion Date:** The date by which the recommendation should be implemented.
- **Implemented Date:** The date on which the recommendation was

completed. This field will be populated with a value only for recommendations that have been completed.

Note: You can customize the display of the team member grid in several ways including, adding additional columns, sorting columns, and filtering the list.

For tracking purposes, the **Assigned To**, **Target Completion Date**, and the **Implemented Date** columns are color-coded according to due date:

- **Yellow:** Indicates that the RCA Recommendation record is due in two weeks or less. When the row containing a RCA Recommendation record is colored yellow, the value in the **Target Completion Date** column is within 14 days of the current date.
- **Red:** Indicates that the RCA Recommendation record is overdue. When the row containing the RCA Recommendation record is colored red, the value in the **Target Completion Date** column is on or before the current date.
- **Green:** Indicates that the RCA Recommendation record has been completed.
- **No color:** Indicates that the RCA Recommendation record does not meet any of the conditions described above.

In addition, the **Communicate Records** page provides the following task menus, which give you access to functions associated with the RCA Analysis: [Manage Assets](#), [Common Tasks](#), [PReserve](#), [Order](#), [Analyze](#), [Communicate](#), [Track](#), and **Associated Pages**.

Note: Items appear on the **Associated Pages** menu only if they have been configured for the RCA Analysis family.

Manage Assets Menu



The **Manage Assets** menu on the **Communicate Records** page contains the following link:

- **Manage Assets:** Displays the **Manage Assets** page, where you can link, view, and unlink Equipment and Functional Location records associated with the current RCA analysis.

Common Tasks Menu

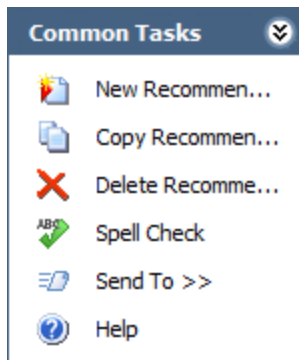

The **Common Tasks** menu on the **Communicate Records** page contains the following links:

- **New Recommendation:** Displays the **Recommendation Details** page, where you can [create a new RCA Recommendation record](#) to link to the current RCA Analysis.
- **Copy Recommendation:** Creates [a copy of the selected record](#) on the **Recommendation Details** page, where you can modify the recommendation and save it to the current RCA Analysis.
- **Delete Recommendation:** After displaying a confirmation message, deletes the selected RCA Recommendation record. This link is enabled only when an RCA Recommendation record is selected in the **Recommendations** section at the bottom of the page.
- **Spell Check:** Displays the **Spell Check** dialog box, which allows you to perform a [spell check operation](#) on the text and character fields in records belonging to the current RCA Analysis.
- **Send To:** Displays a submenu with options that let you provide a link to the current page on your desktop (create shortcut), in an email message, or on a Home Page.
- **Help:** Displays the context-sensitive Help topic for the **Communicate Records** page.

PReserve Menu



The **PReserve** menu on the **Communicate Records** page contains the following link:

- **Preserve Records:** Displays the **Preserve Failure Data** page, which lists existing RCA Preserve Item records for the current RCA Analysis.

Order Menu

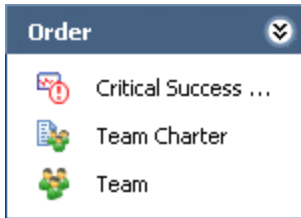

The **Order** menu on the **Communicate Records** page contains the following links:

- **Critical Success Factors:** Displays the [Critical Success Factors page](#), which displays existing RCA Critical Success Factor records that are linked to the current RCA Analysis.
- **Team Charter:** Displays the **Team Charter** dialog box, where you can view and modify the Team Charter for the current RCA Analysis.
- **Team:** Displays the **Team** page, where you can view and modify the RCA Team Members records that are linked to the current RCA Analysis.

Analyze Menu

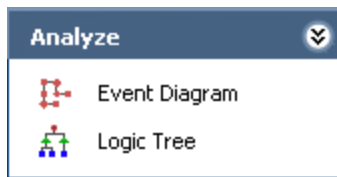

The **Analyze** menu on the **Communicate Records** page contains the following links:

- **Event Diagram:** Displays the **Event Diagram** page, where you can create an Event Diagram for the current RCA Analysis.
- **Logic Tree:** Displays the **Logic Tree** page, where you can create a Logic Tree diagram for the current RCA Analysis.

Communicate Menu



The **Communicate** menu on the **Communicate Records** page contains the following links:

- **Communicate Records:** Displays the **Communicate Records** page for the current RCA Analysis, where you can create RCA Recommendation records that are linked to it.
- **Reports:** Displays the **Reports List** page, where you can view a list of reports that have been configured for Root Cause Analysis.

Track Menu



The **Track** menu on the **Communicate Records** page contains the following link:

- **Track:** Displays the **Analysis Tracking Items** page, where you can view a list of RCA Tracking Item records that are linked to the current RCA Analysis.

Completing the RCA Communicate Datasheet

The **Communicate Records** page displays the RCA Communicate datasheet, which is one of the datasheets available for the RCA Analysis family. The RCA Communicate datasheet lets you record details about a completed RCA Analysis. You will need to complete the RCA Communicate datasheet after a root cause has been determined.

The following fields are unique to the RCA Communicate datasheet and you should complete these fields to communicate the results of the team's analysis:

- **Mechanism:** A brief description of the failure mechanism that was involved in the failure event that was analyzed, including the root causes that were found as a result of the RCA Analysis. This description outlines the "links of the chain" that led to the event.
- **Acknowledgements:** A list of people who are not members of the RCA Analysis Team but who contributed expertise to the RCA Analysis. You may want to include, for example, the company name and the name and position of each person who contributed to the development of the hypotheses, root cause, and recommendations for the pump failure that was analyzed.



To complete the RCA Communicate datasheet:

1. Access the **Communicate Records** page.

The **Communicate Records** page appears, displaying the RCA Communicate datasheet. A red outline has been added to the following image to highlight the RCA Communicate datasheet.

RCA->My PROACT->Test Analysis A->Communicate Records

Communicate Findings and Recommendations

Datasheet RCA Communicate  

Analysis Details

| | Value(s) |
|----------------------|-----------------|
| ▶ Analysis Name | Test Analysis A |
| Analysis Description | ... |
| Start Date | 7/6/2011 |
| End Date | 7/7/2011 |
| Comments | ... |
| Analysis Type | Mechanical |
| Event Narrative | ... |
| Date Published | |

Recommendations: 1

Drag a column header here to group by that column

| Recommendation Headline | Assigned To | Target Completion Date | Implemented Date |
|-------------------------|-------------------------|------------------------|------------------|
| ▶ | Administrator, Meridium | 7/29/2011 | |

2. On the RCA Communicate datasheet, complete the Mechanism and Acknowledgements fields as desired.
3. On the datasheet toolbar, click the **Save current record** icon. 

Your changes are saved.

Viewing and Modifying Values on the RCA Communicate Datasheet

If desired, you can view and modify the values on the RCA Communicate datasheet.



To view and modify values on the RCA Communicate datasheet for an RCA Analysis:

1. Access the **Communicate Records** page.

The **Communicate Records** page appears, displaying the RCA Communicate datasheet at the top of the page. A red outline has been added to the following image to highlight the RCA Communicate datasheet.

[RCA->My PROACT->Test Analysis A->Communicate Records](#)

Communicate Findings and Recommendations

Datasheet: RCA Communicate   

Analysis Details

| | Value(s) |
|----------------------|-----------------|
| Analysis Name | Test Analysis A |
| Analysis Description | ... |
| Start Date | 7/6/2011 |
| End Date | 7/7/2011 |
| Comments | ... |
| Analysis Type | Mechanical |
| Event Narrative | ... |
| Date Published | |

Recommendations: 1

Drag a column header here to group by that column

| Recommendation Headline | Assigned To | Target Completion Date | Implemented Date |
|-------------------------|-------------------------|------------------------|------------------|
| | Administrator, Meridium | 7/29/2011 | |

Note: When you access the **Communicate Records** page, the RCA Communicate datasheet is displayed by default. If desired, you can select a different datasheet in the **Datasheet** list to modify.

2. Modify the values in the fields as desired.
3. At the top of the datasheet, click the **Save current record** icon. 

Your changes are saved.

What is a Recommendation?

A *recommendation* is a suggested solution for preventing or lessening the impact of future failures for the piece of equipment or location that the RCA Analysis Team is analyzing, such as making changes to maintenance schedules or providing additional training to operators. The RCA Analysis Team should develop these solutions based on the evidence that was collected and the conclusions that were drawn in the Preserve and Analyze steps of the RCA Analysis.

RCA Recommendation records store the details of the team's recommendation and provide functionality that lets you send alert emails to the team member responsible for implementing the recommendation. In this way, RCA Recommendation records represent tasks assigned to team members. The following image is an example of a completed RCA Recommendation datasheet, which stores the data that makes up an RCA Recommendation record.

| Datasheet RCA Recommendation | |
|----------------------------------|---|
| General Information Alert | |
| | Value(s) |
| Recommendation ID | REC-81 |
| Recommendation Headline | Improve Heat Exchanger Cleaning and Restoration Program |
| Recommendation Description | Improve Heat Exchanger Cleaning and Restoration Program ... |
| Recommendation Basis | RCA Team Findings |
| ▶ RCA Analysis ID | 1041828 HEX U-Bend |
| Equipment ID | BL0001-108 ~ B-1 MAIN FLAME ~ 00000000001063740 ... |
| Technical Number | BL0001-108 |
| Functional Location ID | MRD-ROA-REFN-RF108-BL0001-108 ~ B-1 MAIN FLAME ... |
| Required Equipment Status | On-Line (ON-LINE) |
| Business Impact | Production (PRODUCTION) |
| Target Completion Date | 9/17/2009 12:00:00 AM |
| Mandatory Date | 30-Sep-2009 |
| Recommendation Priority | Medium (MEDIUM) |
| Status | Created (CREATED) |
| Author Name | Demo, Joe Demo |
| Reviewer Name | Administrator, Meridium MIADMIN |
| Assigned To Name | Implementer, Implementer |
| Final Approver Name | Implementer, Implementer |
| Cause | Inadequate Cleaning Procedure |
| Cause Type | Cause Human |
| Close-Out Comments | ... |
| Implemented Date | 05-Oct-2009 |
| Create Work Request? | <input checked="" type="checkbox"/> |
| Work Request Reference | 000010004233 |
| Work Request Equipment | |
| Work Request Functional Location | |

After the recommendation is completed, the value in the Status field of the RCA Recommendation record can be marked as *Implemented*. The success of the implemented

What is a Recommendation?

recommendation, however, should continue to be tracked. If the piece of equipment or location continues to fail after the recommendation has been implemented, the RCA Recommendation record can be flagged for reevaluation.

About Equipment, Locations, and RCA Recommendations

The details of the recommendations and the progress associated with getting the recommendation approved and implemented can be tracked using fields in RCA Recommendations records. When you create an RCA Recommendation record, a link is created between the RCA Recommendation record and the RCA Analysis record. You can then choose to link the RCA Recommendation record to an Equipment or Functional Location record. Depending on the nature of the recommendation, RCA Recommendation records may or may not be linked to the same Equipment and Functional Location records that are linked to the RCA Analysis record.

For example, suppose you created an RCA Analysis for a piece of equipment called *Pump 1* that was shutting down more frequently than normal. You find that the pump is one of several pumps that are more than 10 years old. You create an RCA Recommendation record to increase inspection rounds for *Pump 1*. Although the RCA Analysis was performed for *Pump 1*, another similar pump, *Pump 2*, is the same age. You can create a new RCA Recommendation record and populate the value in the Equipment ID field to *Pump 2* so that the same recommendation can be applied.

Furthermore, if the Equipment record *Pump 1* is already linked to the Functional Location record *Row 12*, you can change the value in the Functional Location ID field of the RCA Recommendation record from *Row 12* to reflect a higher level Functional Location record, such as *Statesville Plant*. This value can serve as an indicator that pumps located at the Statesville Plant are older than other plants, which is more relevant than the information that *Pump 1* is located in a certain row.

Workflow for Proposing and Implementing Recommendations

RCA Analysis and the fields in the RCA Recommendation record facilitate the following general workflow for proposing and implementing recommendations:

1. After a hypothesis is proven true and a root cause is identified, the RCA Analysis Team discusses possible solutions.
2. After a recommendation has been developed, the analysis team creates an RCA Recommendation record from the analysis. When the RCA Recommendation record is created, the value in the Status field is *Created* by default.
3. The Analysis Team defines the details of the recommendation in the RCA Recommendation record. If the recommendation is specific to a piece of equipment or location, the Analysis Team can define values in the Equipment ID and Functional Location ID fields to link the RCA Recommendation record to the Equipment or Functional Location records that represents that equipment and locations.
4. After the RCA Recommendation record is created to track the progress of the recommendation, an RCA Analysis Team member proposes the recommended solution to the decision makers in your organization using the details stored in the RCA Recommendation record.
5. Your organization make decisions about the recommendation (e.g., approve or reject), and the necessary fields (including the Status field) in the RCA Recommendation record are updated to reflect these decisions.
6. After a recommendation has been approved (i.e., the value in the Status field is changed to *Approved*), it should be implemented within your organization. Alert emails can be scheduled and sent to the team member responsible for implementing the recommendation.
7. In order to implement the recommendation, you can create a work request in a maintenance management system (e.g.,an SAP Notifcation, an Oracle EBS eAM Work Request) by setting the value in the Create Work Request field in the RCA Recommendation record to *True*.
8. After the recommendation is implemented, the value in the Status field in the RCA Recommendation record should be changed to *Implemented*, and the RCA Recommendation record is considered complete.

Note: This step is part of the Tracking and Reevaluating Analysis Results step in an RCA Analysis.

9. If the piece of equipment or location continues to fail, the RCA Recommendation record should be flagged for reevaluation via the **Alert** tab on the RCA Recommendation datasheet.

10. The team should meet to discuss the implemented recommendation, propose new recommendations, amend the original recommendations, and so on until an implemented solution prevents the piece of equipment or location from failing in the same manner that triggered the RCA Analysis.

Creating RCA Recommendation Records

After the RCA Analysis Team has developed a recommended solution for preventing future failures of the piece of equipment or location, a team member should create an RCA Recommendation record to store the details of the recommendation.

To create a new RCA Recommendation record:

1. On the [Communicate Records page](#), on the **Common Tasks** menu, click the **New Recommendation** link.

The **Recommendation Details** page appears, displaying the RCA Recommendation datasheet. The **General Information** tab is selected by default.

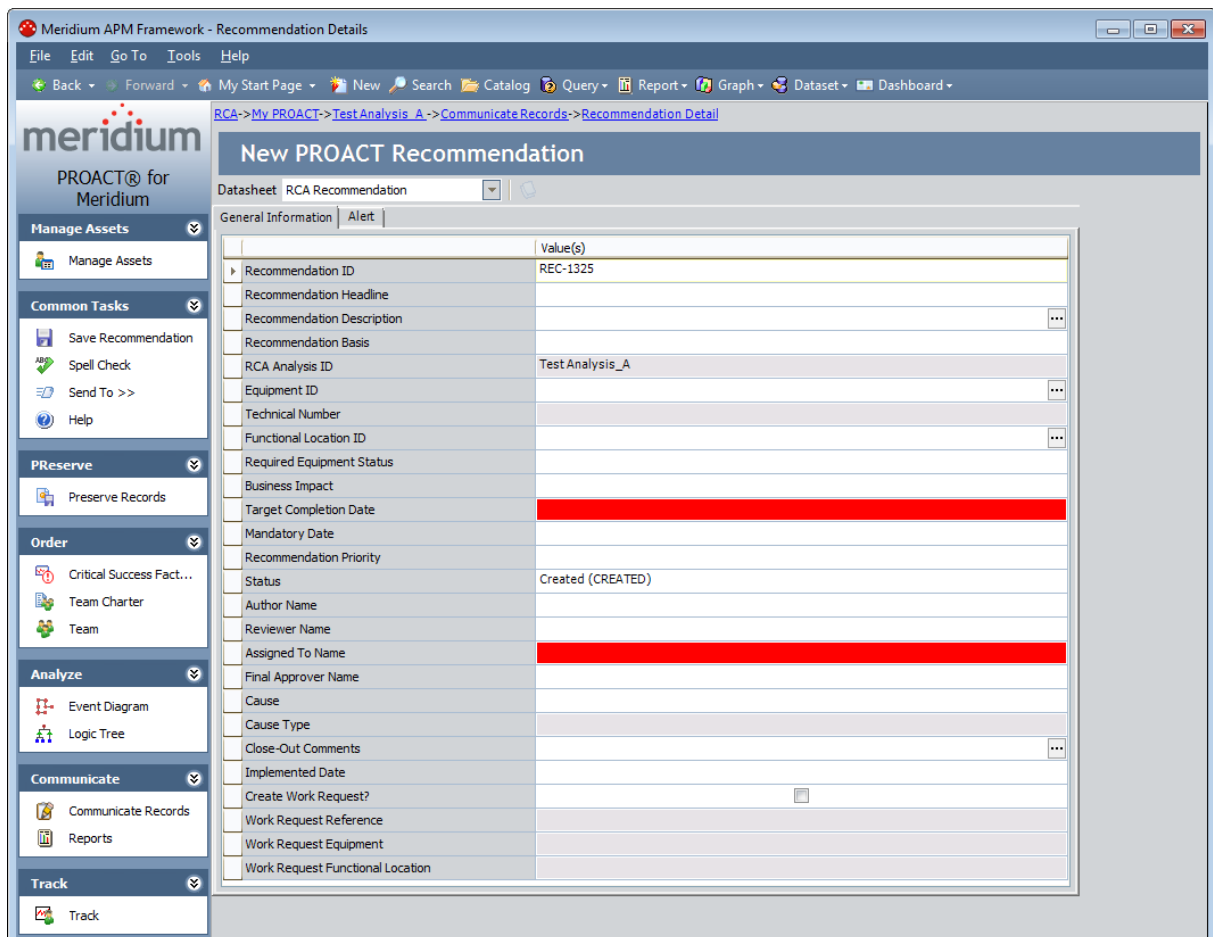

2. On the **General Information** tab, enter the appropriate values into the available fields. The **Target Completion Date** and **Assigned To Name** fields are required.
3. If the recommendation is specific to a piece of equipment or location, define values in the **Equipment ID** and **Functional Location ID** fields to link the RCA Recommendation record to the **Equipment** or **Functional Location** records that represent that piece of equipment or location.

- If a recommendation is specific to an piece of equipment, you should define a value in the Equipment ID field first. If the Equipment record you choose is linked to a Functional Location record, the Functional Location ID field will be populated automatically with the value in the Functional Location field of that Equipment record.
- If the Equipment record is not linked to a Functional Location record or you want to define a different Functional Location record, you can then define a value in the Functional Location ID field.

Note: If you define a value in the Functional Location ID field before you define a value in the Equipment ID field, it may be overwritten when you define a value in the Equipment ID field.

If you want to schedule a recommendation alert email to be sent to a specified recipient, click the **Alert** tab, and enter the appropriate information on the data-sheet.

4. On the **Common Tasks** menu, click the **Save Recommendation** link.

The RCA Recommendation record is saved to the database and linked to the RCA Analysis record for the current RCA Analysis, and the **Communicate Records** page appears.

Meridium APM Framework - Communicate Records

RCA->My PROACT->1041828 HEX U-Bend->Communicate Records

Communicate Findings and Recommendations

Datsheet: RCA Communicate

Analysis Details

| | Value(s) |
|----------------------|--|
| Analysis Name | 1041828 HEX U-Bend |
| Analysis Description | 1041828 HEX U-Bend frequent failues based on tubes... |
| Start Date | 8/10/2009 |
| End Date | 8/27/2009 |
| Comments | Performed by Investigative and Analytics Process team |
| Analysis Type | Operational |
| Event Narrative | Frequent tube failures resulting in excessive costs and losses |
| Date Published | |

Recommendations: 2

Drag a column header here to group by that column

| Recommendation Headline | Assigned To | Target Completion Date | Implemented Date |
|-----------------------------------|--------------|------------------------|------------------|
| Improve Heat Exchanger Cleani... | Implementer, | 9/17/2009 | 10/5/2009 |
| Investigate and determine opti... | Implementer, | 9/24/2009 | |

Copying RCA Recommendation Records

After the RCA Analysis Team has recorded proposed solutions for a piece of equipment or location in an RCA Recommendation record, the RCA Recommendation record can be copied and linked to other Equipment or Functional Location records that identify equipment and locations that require the same actions to be taken. You can also copy an RCA Recommendation record and modify it in order to create a second RCA Recommendation record for the same piece of equipment or location.

To copy an RCA Recommendation record:

1. On the [Communicate Records](#) page, select an RCA Recommendation record that you wish to copy from the **Recommendations** grid.
2. On the **Common Tasks** menu, and click the **Copy Recommendation** link.

The **Recommendation Details** page appears, displaying a copy of the RCA Recommendation record you selected. The values in all fields displayed on the **General Information** and **Alert** tabs are copied except for the Recommendation ID field, which is populated automatically with a unique ID, and the Recommendation Description field.

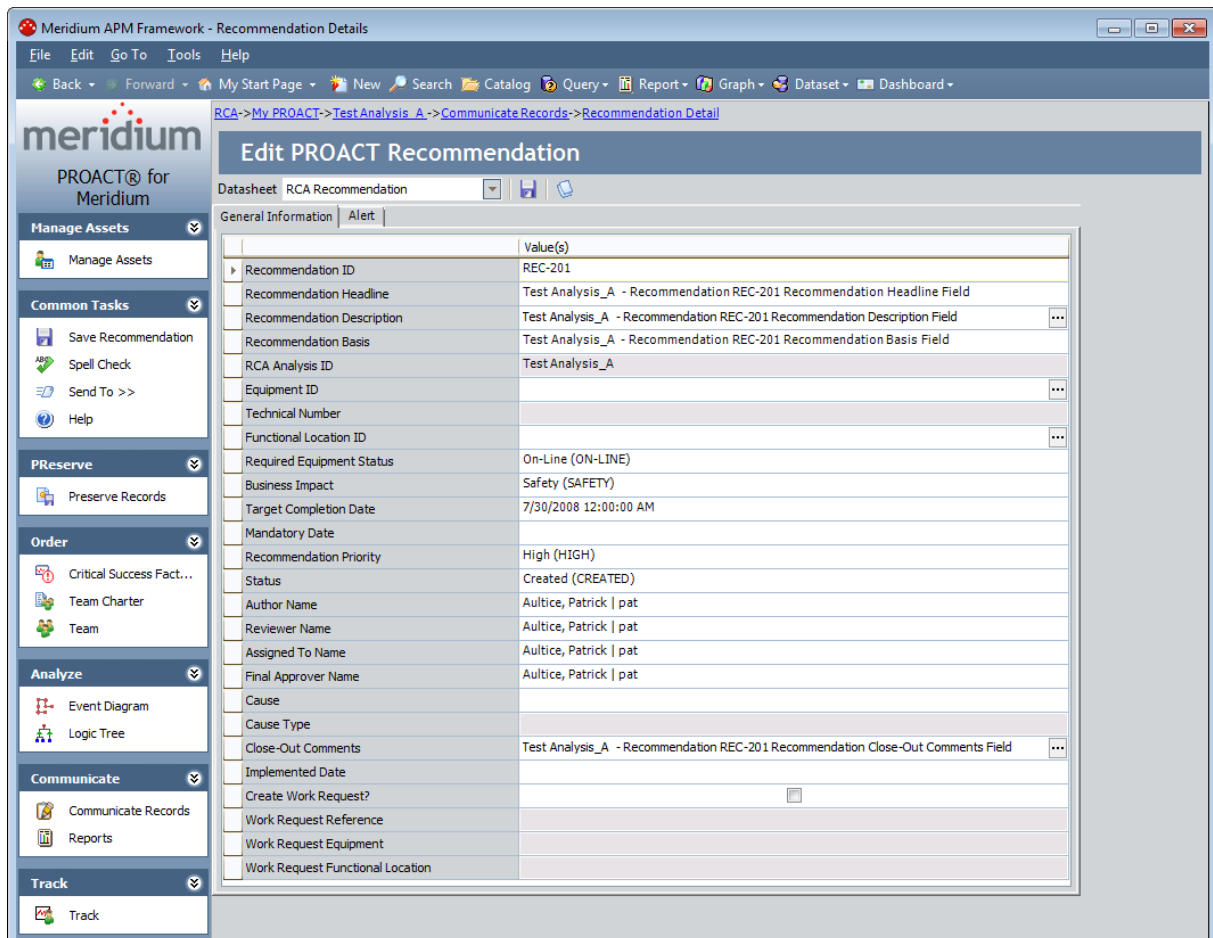

2. Modify the fields on the RCA Recommendation datasheet as needed.
3. If you want to apply the recommendation to another piece of equipment or location, define values in the Equipment ID and Functional Location ID fields to link the RCA Recommendation record to the Equipment or Functional Location records that represent that piece of equipment or location.
 - If a recommendation is specific to a piece of equipment, you should define a value in the Equipment ID field first. If the Equipment record you choose is linked to a Functional Location record, the Functional Location ID field will be populated automatically with the value in the Functional Location field of that Equipment record.
 - If the Equipment record is not linked to a Functional Location record or you want to define a different Functional Location record, you can then define a value in the Functional Location ID field.

Note: If you define a value in the Functional Location ID field before you define a value in the Equipment ID field, it may be overwritten when you define a value in the Equipment ID field.

4. On the **Common Tasks** menu, click the **Save Recommendation** link.

The RCA Recommendation record is saved to the database and linked to the RCA Analysis record for the current RCA Analysis, and the **Communicate Records** page appears.

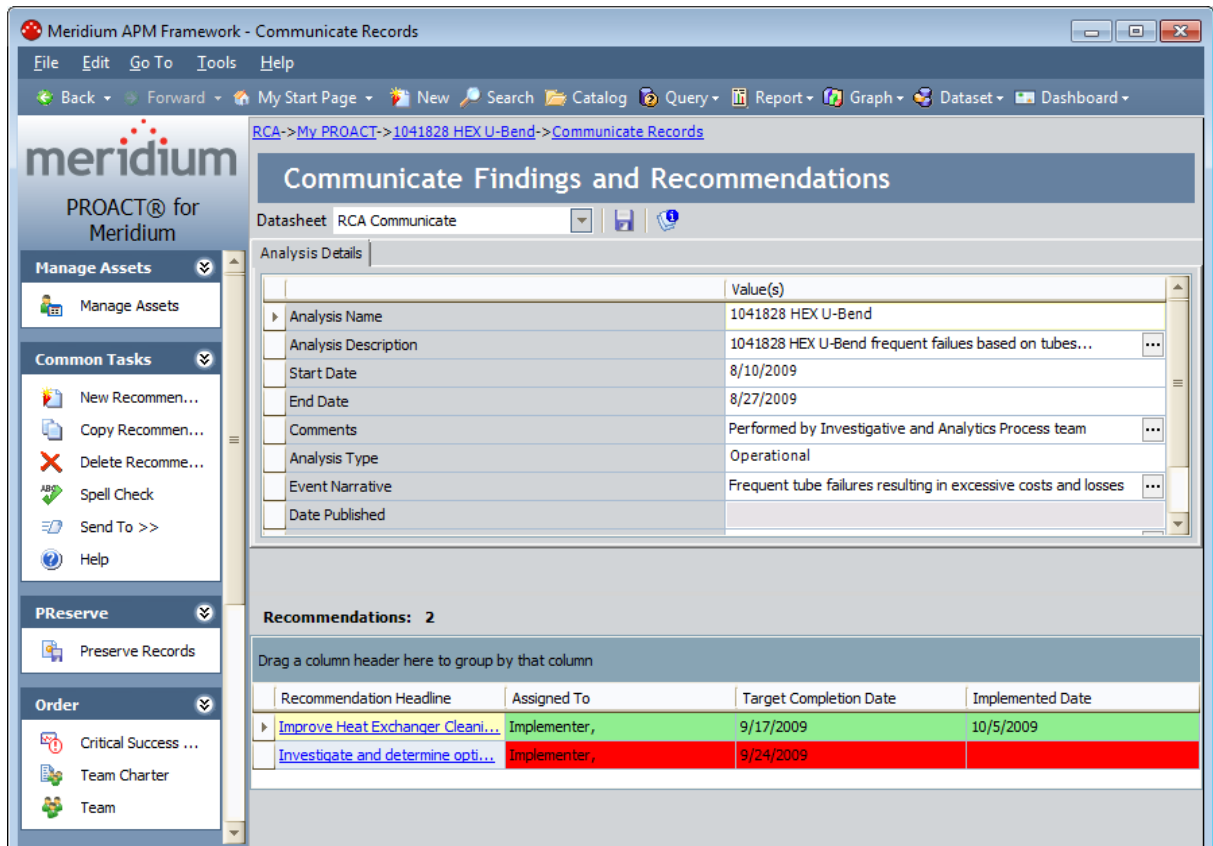

Opening an Existing RCA Recommendation Record

After an RCA Recommendation record has been created, you can open the record to view and modify the contents. At least the team member responsible for implementing the recommendation will need to update the RCA Recommendation record with current information. For example, if a recommendation is rejected by management, the Status field should be updated to reflect this decision.

To open an existing RCA Recommendation record:

- On the [Communicate Records](#) page, in the **Recommendations** section, in the Recommendation Headline column, click the link associated with the RCA Recommendation record that you want to view.

The selected RCA Recommendation record appears on the **Recommendation Details** page, where you can view and modify the record as desired.

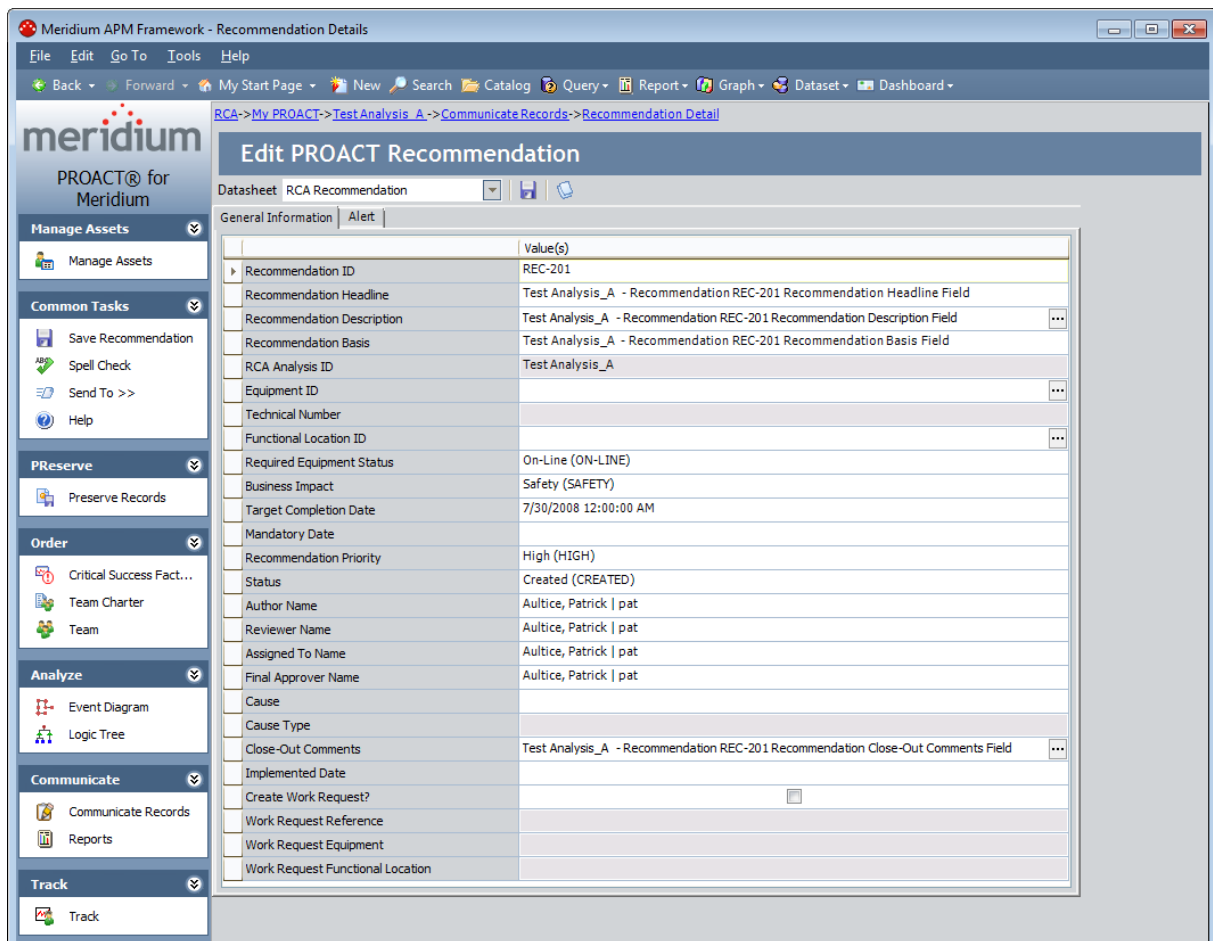

Aspects of the Recommendation Details Page

The **Recommendation Details** page displays the details of an RCA Recommendation record. When you open an existing RCA Recommendation record or create a new RCA Recommendation record, it appears on the **Recommendation Details** page. The main display area contains the RCA Recommendation datasheet, which contains the **General Information** and **Alerts** tabs. You can use the fields in the datasheet to record information associated with the RCA Recommendation record.

| | Value(s) |
|----------------------------------|--|
| Recommendation ID | REC-201 |
| Recommendation Headline | Test Analysis_A - Recommendation REC-201 Recommendation Headline Field |
| Recommendation Description | Test Analysis_A - Recommendation REC-201 Recommendation Description Field |
| Recommendation Basis | Test Analysis_A - Recommendation REC-201 Recommendation Basis Field |
| RCA Analysis ID | Test Analysis_A |
| Equipment ID | |
| Technical Number | |
| Functional Location ID | |
| Required Equipment Status | On-Line (ON-LINE) |
| Business Impact | Safety (SAFETY) |
| Target Completion Date | 7/30/2008 12:00:00 AM |
| Mandatory Date | |
| Recommendation Priority | High (HIGH) |
| Status | Created (CREATED) |
| Author Name | Aultice, Patrick pat |
| Reviewer Name | Aultice, Patrick pat |
| Assigned To Name | Aultice, Patrick pat |
| Final Approver Name | Aultice, Patrick pat |
| Cause | |
| Cause Type | |
| Close-Out Comments | Test Analysis_A - Recommendation REC-201 Recommendation Close-Out Comments Field |
| Implemented Date | |
| Create Work Request? | <input type="checkbox"/> |
| Work Request Reference | |
| Work Request Equipment | |
| Work Request Functional Location | |

The task menu pane on the **Recommendation Details** page contains the same task menus as the **Communicate Records** page:

- [Manage Assets](#)
- [Common Tasks](#)
- [PReserve](#)
- [Order](#)
- [Analyze](#)
- [Communicate](#)

- [Track](#)
- **Associated Pages**

Note: The **Associated Pages** menu on the **Recommendation Details** page displays links only if they have been configured for the RCA Recommendation family via the URL Manager.

Deleting RCA Recommendation Records

To delete a RCA Recommendation record:

1. On the [Communicate Records page](#), in the **Recommendations** area, select the row that contains the RCA Recommendation record that you want to delete.
2. On the **Common Tasks** menu, click the **Delete Recommendation** link.
A confirmation message appears, asking if you really want to delete the record.
3. Click the **Yes** button to delete the selected record.

The selected record is deleted from the database and no longer appears in the **Recommendations** section. Additionally, the link that existed between the RCA Recommendation record and the RCA Analysis record is removed.

About RCA Reports

The RCA baseline module provides a set of baseline reports that display data from RCA Analyses. You can access these reports via the [Reports List page](#). If desired, you can also create your own custom reports and make them available from the **Reports List** page.

Accessing the List of RCA Reports

You can access the list of RCA reports via the **Communicate** menu on any of the following pages:

- Analysis page
- Critical Success Factors page
- Team page
- Preserve Failure Data page
- Event Diagram page
- Logic Tree page
- Analysis Tracking Items page

To access the list of RCA reports:

- On the appropriate page, on the **Communicate** menu, click the **Reports** link.

The **Reports List** page appears, displaying a list of links to all the available RCA reports.

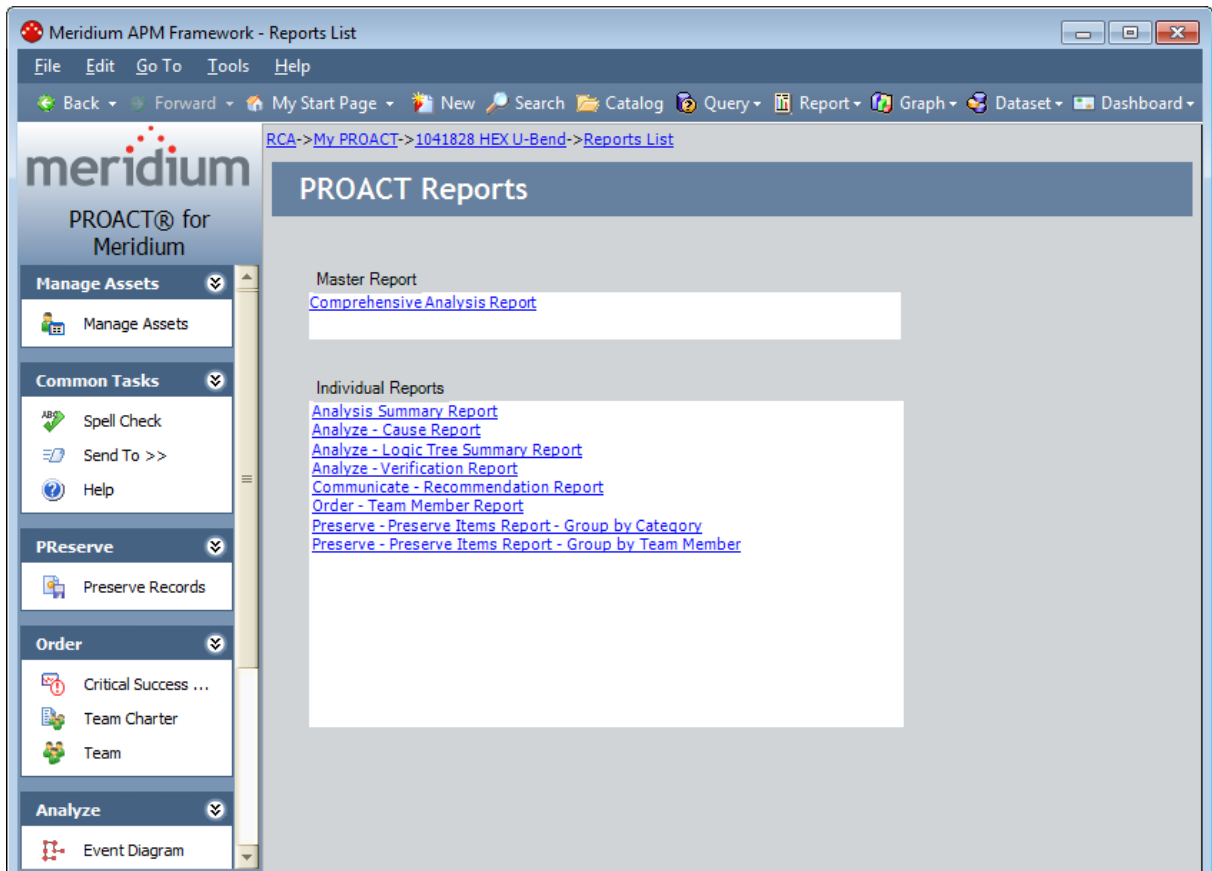

Overview of the Reports List Page

The **Reports List** page is divided into two sections:

- **Master Report:** Displays the Catalog caption, formatted as a hyperlink, of the main report *Comprehensive Analysis Report*. You can click the link to run this report, which is stored in the Catalog folder \\Public\Meridium\Modules\RCA\SSRS along with the subreports that support the main report.



Note: To ensure that you will be able to run the report, you should *not* delete or rename any of the reports or queries that exist by default in the folder \\Public\Meridium\Modules\RCA\SSRS.

- **Individual Reports:** Displays the Catalog captions of *all* reports that exist in the Catalog folder \\Public\Meridium\Modules\RCA as links. This list includes any baseline reports provided with the Root Cause Analysis product and any custom reports that you have saved in this location.



You can click any hyperlink on the **Reports List** page to open the associated report on the **Report Viewer** page, where all standard reporting functionality will be available to you.

The **Reports List** page contains the following task menus:

- [Manage Assets](#)
- [Common Tasks](#)
- [PReserve](#)
- [Order](#)
- [Analyze](#)
- [Communicate](#)
- [Track](#)

Manage Assets Menu



The **Manage Assets** menu on the **Reports List** page contains the following link:

- **Manage Assets:** Displays the **Manage Assets** page, where you can link, view, and unlink Equipment and Functional Location records associated with the current RCA analysis.

Common Tasks Menu

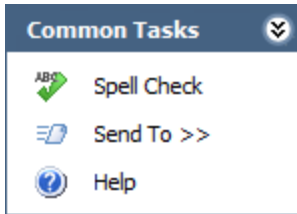

The **Common Tasks** menu on the **Reports List** page contains the following links:

- **Spell Check:** Displays the **Spell Check** dialog box, which allows you to perform a [spell check operation](#) on the text and character fields in records belonging to the current RCA Analysis.
- **Send To:** Displays a submenu with options that let you provide a link to the current page on your desktop (create shortcut), in an email message, or on a Home Page.
- **Help:** Displays the context-sensitive Help topic for the **Reports List** page.

PReserve Menu



The **PReserve** menu on the **Reports List** page contains the following link:

- **Preserve Records:** Displays the **Preserve Failure Data** page, which lists existing RCA Preserve Item records for the current analysis.

Order Menu

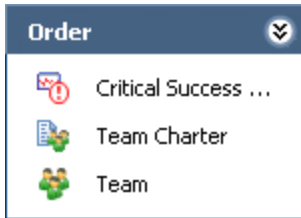

The **Order** menu on the **Reports List** page contains the following links:

- **Critical Success Factors:** Displays the [Critical Success Factors page](#), which displays existing RCA Critical Success Factor record that are linked to the current RCA Analysis.
- **Team Charter:** Displays the **Team Charter** dialog box, which contains the Team Charter for the current RCA Analysis.
- **Team:** Displays the list of **Team** page, where you can view the RCA Team Members records that are linked to the current RCA Analysis.

Analyze Menu

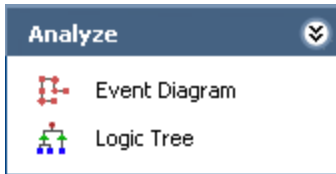

The **Analyze** menu on the **Reports List** page contains the following links:

- **Event Diagram:** Displays the **Event Diagram** page. If this is the first time that you have accessed the **Event Diagram** page for a given RCA Analysis, the **RCA Event** dialog box will appear automatically so that you can [define an RCA Event record](#) and link it to the current RCA Analysis.
- **Logic Tree:** Displays the **Logic Tree** page for the current RCA Analysis, where you can organize the process of analyzing the issue to evaluate the possible causes of the failure being analyzed.

Communicate Menu



The **Communicate** menu on the **Reports List** page contains the following links:

- **Communicate Records:** Displays the **Communicate Records** page for the current RCA Analysis, where you can create RCA Recommendation records that are linked to it.
- **Reports:** Displays the **Reports List** page. This link is available on other pages in Root Cause Analysis that let you navigate to the **Reports List** page.

Track Menu



The **Track** menu on the **Reports List** page contains the following link:

- **Track:** Displays the **Analysis Tracking Items** page. This link is available on other pages in Root Cause Analysis that let you navigate to the **Analysis Tracking Items** page.

About Opening an RCA Report

You can open any of the following RCA reports from the **Report List** page:

- [The baseline comprehensive report.](#)
- [Any baseline topic-specific report.](#)
- [Any customized report that exists in the following Catalog folder: \\Public\Meridium\Modules\RCA.](#)

Opening the Comprehensive Analysis Report

The Comprehensive Analysis Report is comprised of multiple subreports. When you open the report, you can select which subreports you want to display and which ones you do not.

To open the Comprehensive Analysis Report, you must have View privileges to all families included in the underlying queries and datasets. You will must also have View and Update privileges to the RCA Image family.

Note: If this is the first time the Comprehensive Analysis Report has been opened by ANY user, that user must have View, Update, and Insert privileges to the RCA Image family to view the report.

To open the Comprehensive Analysis Report:

1. On the [Reports List page](#), click the hyperlinked caption of the Comprehensive Analysis Report.

The **Comprehensive Analysis Report** dialog box appears.



The **Comprehensive Analysis Report** dialog box contains multiple options, which correspond to subreports that can be included in the Comprehensive Analysis Report. All of the options are selected by default. You can modify these selections as desired. The options that are selected will persist for the current user, which means if you clear any of the check boxes, the next time that you access the report, your previous selections will be retained.

2. Clear the check box next to any item that you want to *exclude* from the report. The following table describes the options that are displayed in the **Com-**

prehensive Analysis Report dialog box and the corresponding section in the report.

| Window Option | Report Section |
|-----------------------------------|---|
| Preserve | A description of the Preserve stage of a Root Cause Analysis. |
| Data Collection | A list of the RCA Preserve Item records that are included in the RCA Analysis. |
| Data Collection File Links | A list of the Reference Document records that are linked to the RCA Preserve Item records that are included in the RCA Analysis. |
| Order | A description of the Order stage of a Root Cause Analysis. |
| Team Member | A list of the RCA Analysis Team members. |
| Critical Success Factors | A description of the analysis Team Charter, a list of the critical success factors that are included in the RCA Analysis, and a list of the important dates associated with the RCA Analysis. |
| Analyze | A description of the Analyze stage of a Root Cause Analysis. |
| Event Diagram | An image of the Event Diagram. |
| Logic Tree | An image of the Logic Tree. |
| Verification Log | A list of the RCA Verification records, which are included in the RCA Analysis. |
| Verification File Links | A list of the Reference Document records that are linked to the RCA Verification records, which are included in the RCA Analysis. |
| Communicate | A description of the Communicate stage of a Root Cause Analysis. |
| Event and Cause Summaries | A description of the event that is being analyzed and a description of the team's findings. These descriptions reflect the values in the Event Narrative and Mechanism fields of the RCA Analysis record. |
| Executive Summary Recommendations | A list of the RCA Recommendation records that are included in the RCA Analysis. |
| Recommendation File Links | A list of the Reference Document records that are linked to the RCA Recommendation records that are included in the RCA Analysis. |

| Window Option | Report Section |
|------------------------|---|
| Acknowledgements | A description of the acknowledgements included in the RCA Analysis. This description reflects the value in the Acknowledgements field, which appears on the RCA Communicate datasheet on the Communicate Records page. |
| Track | A description of the Track stage of a Root Cause Analysis. |
| Tracking Items Summary | A list of the RCA Tracking Item records that are included in the RCA Analysis. |
| Analysis-At-A-Glance | A description of the Overview section of the report. |
| Overview | <p>An overview of the RCA Analysis, including:</p> <ul style="list-style-type: none"> • The name of the RCA Analysis. • The Principal Analyst. • The analysis start date. • The estimated completion date. • The estimated cost of the event. • The number of items that have been created, completed or assigned to RCA Analysis Team Members (e.g., RCA Preserve Item records). |

3. If you want to include Reference Documents in the report, click the **Reference Documents** link.

Note: The check box to the left of the **Reference Documents** link will be selected if one or more reference documents are already included in the report. You can click the **Reference Documents** link to see which ones are already included.

The **Select Reference Documents** dialog box appears.

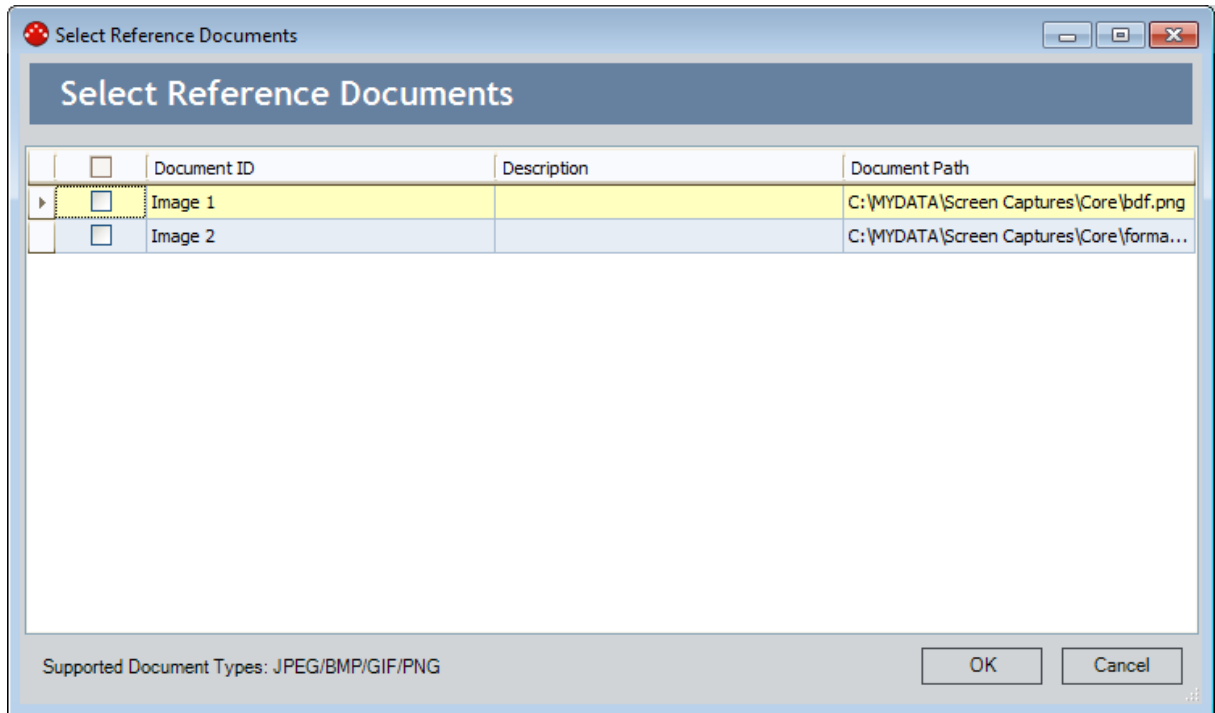

4. In the list of available references documents, select the check box to the left of any reference document that you want to include in the report. If a reference document is already included in the report, the check box to the left of its Document ID will already be selected. You can select the check box in the upper, left corner of the grid to include ALL reference documents. The list contains Reference Document records that are linked to any of the following records in the RCA Analysis:

- RCA Analysis
- RCA Critical Success Factor
- RCA Event
- RCA Failure Mode
- RCA Hypothesis
- RCA Logic Gate
- RCA Preserve Item
- RCA Recommendation
- RCA Team Member
- RCA Tracking Item
- RCA Verification

Note: Only image files with the file extensions JPEG, BMP, GIF, and PNG are supported by the Comprehensive Analysis report. If other types of reference doc-

uments are associated with the analysis, they will not be displayed in the list. Of no reference documents are available, the list will be empty.

5. Click **OK**.

The Select Reference Documents dialog box closes, and the **Comprehensive Analysis** dialog box returns to focus.

6. Click **OK**.

The report is generated and appears in the Report Viewer.

Opening an Individual Report

To open an individual report:

- On the **Reports List** page, in the **Individual Reports** section, click the hyperlinked caption of the desired report.

The report you selected appears in the Report Viewer.

About Available Reports

The baseline RCA module provides the following types of baseline reports for use with the RCA product:

- **Comprehensive:** The [Comprehensive Analysis Report](#) includes information about the entire RCA Analysis. You can customize the data that appears in the report to display data associated with all stages of the RCA Analysis. The Comprehensive Analysis Report is stored in the following folder in the Meridium APM Catalog: \\Public\Meridium\Modules\RCA\SSRS.

IMPORTANT: This report report is built from the queries and reports stored in the SSRS folder. You should not change the name of the SSRS Catalog folder, the name or content of any item within the folder, or *remove* from the folder any item that is being used by the comprehensive report. Modifying or moving any of these items could cause the Comprehensive Analysis Report to stop working.

- **Individual:** Multiple reports that display data associated with specific areas of an RCA Analysis. The individual reports are stored in the Meridium APM Catalog folder \\Public\Meridium\Modules\RCA. Keep in mind that the **Reports List** page displays all reports that are stored in the **RCA** folder.

Note:All items in the Public folder are also available in the corresponding Baseline folder. Throughout this documentation, however, we refer to items in the Public folder.

Components of the Comprehensive Analysis Report

The Comprehensive Analysis Report contains the following components:

- [Cover Page](#)
- [Topics Included in this Report](#)
- [Preserve \(5 P's\)](#)
- [Data Collection](#)
- [Data Collection File Links](#)
- [Order](#)
- [Team Members](#)
- [Charter](#)
- [Critical Success Factors](#)
- [Analyze](#)
- [Event Diagram](#)
- [Logic Tree](#)
- [Verification Logs](#)
- [Verification Log File Links](#)
- [Communicate](#)
- [Event Summary](#)
- [Summary of Findings](#)
- [Executive Summary Recommendations](#)
- [Recommendation File Links](#)
- [Acknowledgements](#)
- [Track](#)
- [Tracking Item Summary](#)
- [Analysis-At-A-Glance](#)
- [PROACT RCA Analysis-At-A-Glance Overview](#)

Cover Page

The cover page of the [Comprehensive Analysis Report](#) displays introductory information for the Comprehensive Analysis Report. The cover page is always included in the Comprehensive Analysis Report. The cover page cannot be excluded from the report.

The following image shows an example of the cover page as it appears in the Comprehensive Analysis Report for the [example RCA Analysis](#). The cover page displays the name of the report, which is always *Comprehensive Analysis Report*, and the following information:

- **Analysis Name:** The name of the RCA Analysis. This value is stored in the Analysis Name field of the RCA Analysis record.
- **Principal Analyst:** The name of the Principal Analyst. This value is stored in the First Name and Last Name fields of the Human Resource record that is linked to the RCA Team Member record that contains the value *Principal Analyst*.
- **Printed:** The date on which the report was generated.

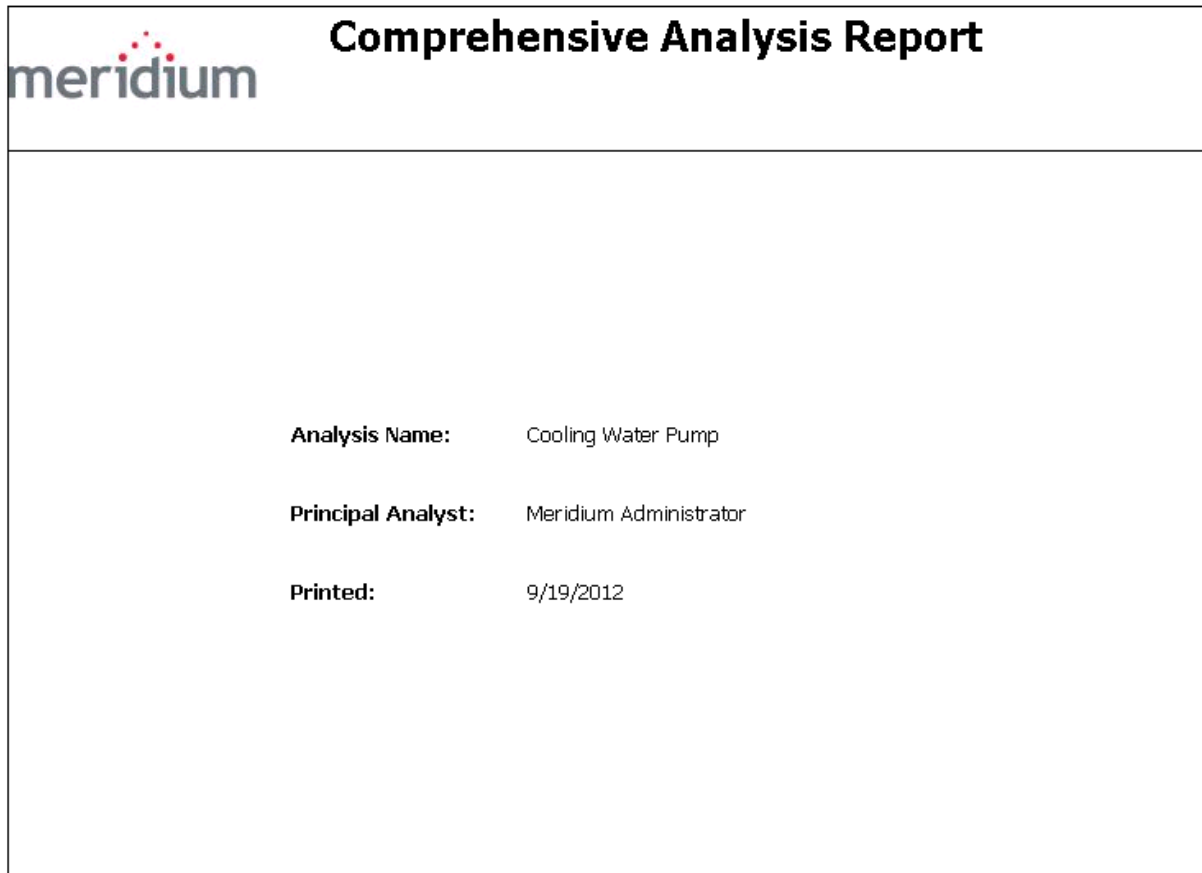

Topics Included in this Report

The **Topics Included in this Report** section of the [Comprehensive Analysis Report](#) displays the titles of the sections that are included in the Comprehensive Analysis Report, much like a table of contents. The titles of the sections correspond to the check boxes that you select on the [Comprehensive Analysis Report](#) dialog box. The **Topics Included in this Report** section will always be included in the Comprehensive Analysis Report and cannot be excluded from the report.

The following image shows an example of the **Topics Included in this Report** section as it appears in the Comprehensive Analysis Report for the [example RCA Analysis](#).

| Topics Included in this Report |
|--|
| PRESERVE |
| <i>Data Collection</i> |
| <i>Data Collection File Links</i> |
| ORDER |
| <i>Team Members</i> |
| <i>Critical Success Factors</i> |
| ANALYZE |
| <i>Event Diagram</i> |
| <i>Logic Tree</i> |
| <i>Verification Logs</i> |
| <i>Verification File Links</i> |
| COMMUNICATE |
| <i>Event and Cause Summaries</i> |
| <i>Executive Summary Recommendations</i> |
| <i>Recommendation File Links</i> |
| <i>Acknowledgements</i> |
| TRACK |
| <i>Tracking Items Summary</i> |
| ANALYSIS-AT-A-GLANCE |
| <i>Overview</i> |

Note: In this image, all possible sections for the Comprehensive Analysis Report appear in the list because ALL the check boxes were selected on the **Comprehensive Analysis Report** dialog box.

Preserve (5P's)

The **Preserve (5P's)** section of the [Comprehensive Analysis Report](#) displays a description of the [PReserve step](#) of a Root Cause Analysis. This section will be included in the report when you select the **Preserve** check box on the [Comprehensive Analysis Report dialog box](#).

The following image shows an example of the **Preserve (5P's)** section as it appears in the Comprehensive Analysis Report for the [example RCA Analysis](#).

PRESERVE (5P's)

Preserve Event Data

As in any investigative occupation, it is a REQUIREMENT that data (evidence) be collected from the scene and preserved in such a fashion as is appropriate for further analysis. As with the detective at a crime scene, the area is roped off and the scene preserved for the professionals who will come in and collect the necessary data.

PROACT® utilizes a data collection technique called the 5-P's. The 5-P's stand for the following five (5) data categories:

1. Parts – Physical or tangible evidence. Examples include process equipment, diagnostic equipment, fluid samples, etc..
2. Paper – Documentation. Examples include procedures, specifications, records, policies, test results, literature searches, etc.
3. Positional - Elements of time and space. Examples include times of occurrences, location of occurrences, frequency of occurrences, etc..
4. People - People sought to be interviewed regarding an event. Examples include management, administration, witnesses, engineers, hourly personnel, purchasing, etc.
5. Paradigms - People's belief systems that contribute to decision errors."Cost reduction is #1","It's the manufacturer's fault","Poor design", etc..

9/19/2012 12:57:53 PM Page 2 of 22

Data Collection

The **Data Collection** section of the [Comprehensive Analysis Report](#) displays information that is stored in each RCA Preserve Item record that is linked to the RCA Analysis record. It also displays information stored in the Human Resource record that is linked to the RCA Team Member record that is linked to each RCA Preserve Item record. This section will be included in the report when you select the **Data Collection** check box on the [Comprehensive Analysis Report dialog box](#).

The following image shows an example of the **Data Collection** section as it appears in the Comprehensive Analysis Report for the [example RCA Analysis](#).

| <i>Data Collection</i> | | | | | |
|-------------------------------|---|---|------------------------|-------------|-------------------|
| Category | Data | Strategy | Team Members | Date | Completed? |
| Parts | The pieces of the cooling water pump that could have caused the pump to overheat. | Document (pictures and observations) the condition of the components of the pump. | Suzie Jones | 1/8/2012 | No |
| Paper | Standard operating procedures and frequent failure information. | Research. | Bob Speck | 1/9/2012 | No |
| People | Operating procedures used by those who maintain the pump. | Interview the floor operators who are assigned to the pump. | Bob Speck | 1/10/2012 | No |
| Paradigms | Common assumptions made when a pump fails. | Research and interview. | Meridium Administrator | 1/10/2012 | No |
| Position | Environment surrounding the pump. | Tools, pictures, diagrams | Bob Speck | 1/10/2012 | No |

9/19/2012 12:58:54 PM Page 3 of 22

The following table lists each item in the **Data Collection** section and the corresponding RCA Preserve Item or Human Resource record field whose data is displayed in the report.

| Report Column | Record Family | Record Field |
|----------------------|----------------------|---------------------|
| Category | RCA Preserve Item | Data Category |
| Data | RCA Preserve Item | Data to Collect |
| Strategy | RCA Preserve Item | Collection Strategy |

| Report Column | Record Family | Record Field |
|---------------|-------------------|-----------------------|
| Team Members | Human Resource | First Name, Last Name |
| Date | RCA Preserve Item | Date Due |
| Completed? | RCA Preserve Item | Completed? |

Data Collection File Links

The **Data Collection File Links** section of the [Comprehensive Analysis Report](#) displays a list of the Reference Document records that are linked to the RCA Preserve Item records that are linked to the RCA Analysis record. This section will be included in the report when you select the **Data Collection File Links** check box on the [Comprehensive Analysis Report dialog box](#).

The following image shows an example of the **Data Collection File Links** section as it would appear in a Comprehensive Analysis Report.

| <i>Data Collection File Links</i> | | | | |
|-----------------------------------|---|--------------|----------------------------------|--------------------------------|
| Category | Data | Team Members | Document Path | ID |
| Paper | Standard operating procedures and frequent failure information. | Jane Doe | C:\MyData\AnalystResearch.txt | Analyst Research |
| People | Operating procedures used by those who maintain the pump. | Jane Doe | C:\MyData\InterviewEmployees.txt | Interviews with pump operators |

9/19/2012 1:23:02 PM Page 4 of 22

The following table lists each item in the **Data Collection File Links** section and the corresponding RCA Preserve Item, Human Resource, or Reference Document record field whose data is displayed in the report.

| Report Column | Record Family | Record Field |
|---------------|--------------------|-----------------------|
| Category | RCA Preserve Item | Data Category |
| Data | RCA Preserve Item | Data to Collect |
| Team Members | Human Resource | First Name, Last Name |
| Document Path | Reference Document | Document Path |
| ID | Reference Document | ID |

Order

The **Order** section of the [Comprehensive Analysis Report](#) displays a description of the [Order step](#) of a Root Cause Analysis. This section will be included in the report when you select the **Order** check box on the [Comprehensive Analysis Report dialog box](#).

The following image shows an example of the **Order** section as it appears in the Comprehensive Analysis Report for the [example RCA Analysis](#).

ORDER

Ordering the Analysis Team

Another prerequisite to the PROACT® RCA approach is that an appropriate team be formed for the analysis at hand. Such an effort involves the following:

1. Providing an unbiased team facilitator - Assigning a person to lead the analysis who has nothing to gain or lose by the outcome; an expert in the facilitation of the PROACT® RCA methodology.
2. Amassing a team of cross-functional members - Ensuring that the team itself is not biased with one perspective; allowing team members to be experts as well as objective observers.
3. Establishing a Team Charter (Terminal Objective) for the analysis - Gaining consensus on a one (1) paragraph statement that outlines the reason the team is together.
4. Establishing Critical Success Factors (CSF's) - Establishing CSF's that outline how the team will know when they have been successful.

9/19/2012 1:23:26 PM Page 5 of 22

Team Members

The **Team Members** section of the [Comprehensive Analysis Report](#) displays information that is stored in Human Resource records that are linked to RCA Team Member records that are linked to the RCA Analysis record. This section will be included in the report when you select the **Team Members** check box on the [Comprehensive Analysis Report dialog box](#).

The following image shows an example of the **Team Members** section as it appears in the Comprehensive Analysis Report for the [example RCA Analysis](#).

| <i>Team Members</i> | | | |
|------------------------------------|-----------------------|--------------------|--------------|
| Principal Analyst: Jane Doe | | | |
| Name | Facility | e-mail | Phone |
| Suzie Jones | Plant 1 | SJones@company.com | 555-5555 |
| Pete Handy | Cooling Systems, Inc. | PHandy@company.com | 555-5555 |
| Bob Speck | Plant 1 | BSpeck@company.com | 555-5555 |
| 9/21/2012 10:20:51 AM | | Page 6 of 22 | |

Note: In order for a team member's information to appear in the Comprehensive Analysis Report, in addition to the Human Resource record, the Team Member must also have a Security User record. Using the Meridium APM Framework, you can promote a Human Resource record to a Security User record.

The following table lists each item in the **Team Members** section and the corresponding Human Resource record field whose data is displayed in the report.

| Report Item | Record Field | Notes |
|-------------------|-----------------------|--|
| Principal Analyst | First Name, Last Name | These values are stored in the Human Resource record that is linked to the RCA Team Member record that contains the value <i>Principal Analyst</i> . |
| Name | First Name, Last Name | None |
| Facility | Facility | None |
| E-mail | Email Address | None |
| Phone | Phone1 | None |

Charter

The **Charter** section of the [Comprehensive Analysis Report](#) displays the value that is stored in the Charter field of the RCA Analysis record. This section will be included in the report when you select the **Critical Success Factors** check box on the [Comprehensive Analysis Report dialog box](#).

The following image shows an example of the **Charter** section as it appears in the Comprehensive Analysis Report for the [example RCA Analysis](#).

Charter

To identify the root cause of the cooling water pump failure. This includes identifying deficiencies in or lack of management systems. Appropriate recommendations for root causes will be communicated to the management for rapid resolutions.

Critical Success Factors

The **Critical Success Factors** section of the [Comprehensive Analysis Report](#) displays information that is stored in RCA Critical Success Factor records and important dates that are stored in the RCA Analysis record (e.g., the start date and publish date). This section will be included in the report when you select the **Critical Success Factors** check box on the [Comprehensive Analysis Report dialog box](#).

The following image shows an example of the **Critical Success Factors** section, outlined in red, as it appears in the Comprehensive Analysis Report for the [example RCA Analysis](#).

Critical Success Factors

A cross-functional section of plant personnel/experts will participate in the analysis.

A disciplined RCFA approach will be utilized.

A measurement process will be used to track the progress of approved recommendations.

All analysis hypothesis will be verified or disproven.

Management agrees to fairly evaluate the analysis team findings and recommendations.

No one will be disciplined for honest mistakes.

Dates

Analysis Start Date: 1/6/2012

Analysis End Date: 1/15/2012

Date Published: 9/19/2012

Comments: Comments

9/20/2012 4:30:13 PM Page 7 of 22

The following table lists each item in the **Critical Success Factors** section and the corresponding RCA Critical Success Factor or RCA Analysis record field whose data is displayed in the report.

| Report Item | Record Family | Record Field |
|--------------------------|-----------------------------|----------------|
| Critical Success Factors | RCA Critical Success Factor | CSF |
| Analysis Start Date | RCA Analysis | Start Date |
| Analysis End Date | RCA Analysis | End Date |
| Date Published | RCA Analysis | Date Published |
| Comments | RCA Analysis | Comments |

Analyze

The **Analyze** section of the [Comprehensive Analysis Report](#) displays a description of the [Analyze step](#) of a Root Cause Analysis. This section will be included in the report when you select the **Analyze** check box on the [Comprehensive Analysis Report dialog box](#).

The following image shows an example of the **Analyze** section as it appears in the Comprehensive Analysis Report for the [example RCA Analysis](#).

ANALYZE

Analyze the Event Data

Any undesirable outcome is a result of a series of "cause-and-effect" relationships. The data collected in the 5-P's section of this report will ultimately serve as proof (evidence) as to what actually did or did not occur.

A logic tree will be used in the PROACT® RCA approach to graphically express the "cause-and-effect" relationships discussed earlier. In this approach, the top two levels of blocks represent the Event (Level 1) and the Modes (Level 2). From level to level represents a "cause-and-effect" relationship. These levels specifically represent the "undesirable outcomes" that did occur (facts only)!

From the MODE level, we do not know why they have occurred, just that they did. From this point we become hypothetical and repeatedly ask the question "How Can?".

As hypotheses are developed in this fashion, we use our 5-P's data to verify what is true and what is not true. In this fashion, facts lead our analyses not assumptions. This process is reiterated until we start to uncover the real root causes; the reasons that people make decision errors that lead to undesirable outcome.

Root causes originate from flawed systems in which people depend on to make informed decisions. We call these Latent Root Causes or Organizational Root Causes. Flawed organizational systems lead to poor decisions being made by well-intentioned individuals. We call these the Human Root Causes. Decision errors lead to Physical Root Causes, or events or conditions that are visible.

Only when we uncover the Latent Roots or Organizational System Roots are we actually conducting a "real" ROOT CAUSE analysis.

9/19/2012 1:25:10 PM Page 8 of 22

Event Diagram

The **Event Diagram** section of the [Comprehensive Analysis Report](#) displays an image of the Event Diagram that exists for the RCA Analysis. This section will be included in the report when you select the **Event Diagram** check box on the [Comprehensive Analysis Report dialog box](#).

The following image shows an example of the **Event Diagram** section as it appears in the Comprehensive Analysis Report for the [example RCA Analysis](#).

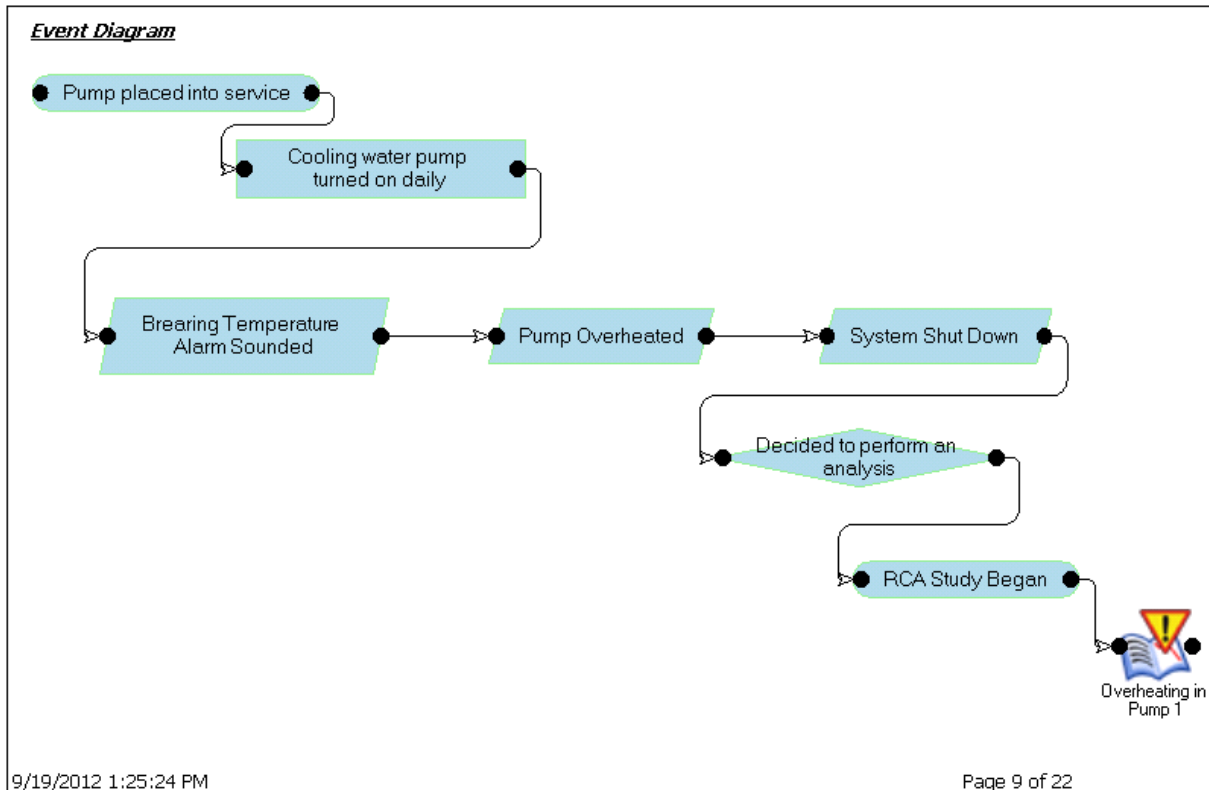

Logic Tree

The **Logic Tree** section of the [Comprehensive Analysis Report](#) displays an image of the Logic Tree that exists for the RCA Analysis. This section will be included in the report when you select the **Logic Tree** check box on the [Comprehensive Analysis Report dialog box](#).

The following image shows an example of the **Logic Tree** section as it appears in the Comprehensive Analysis Report for the [example RCA Analysis](#).

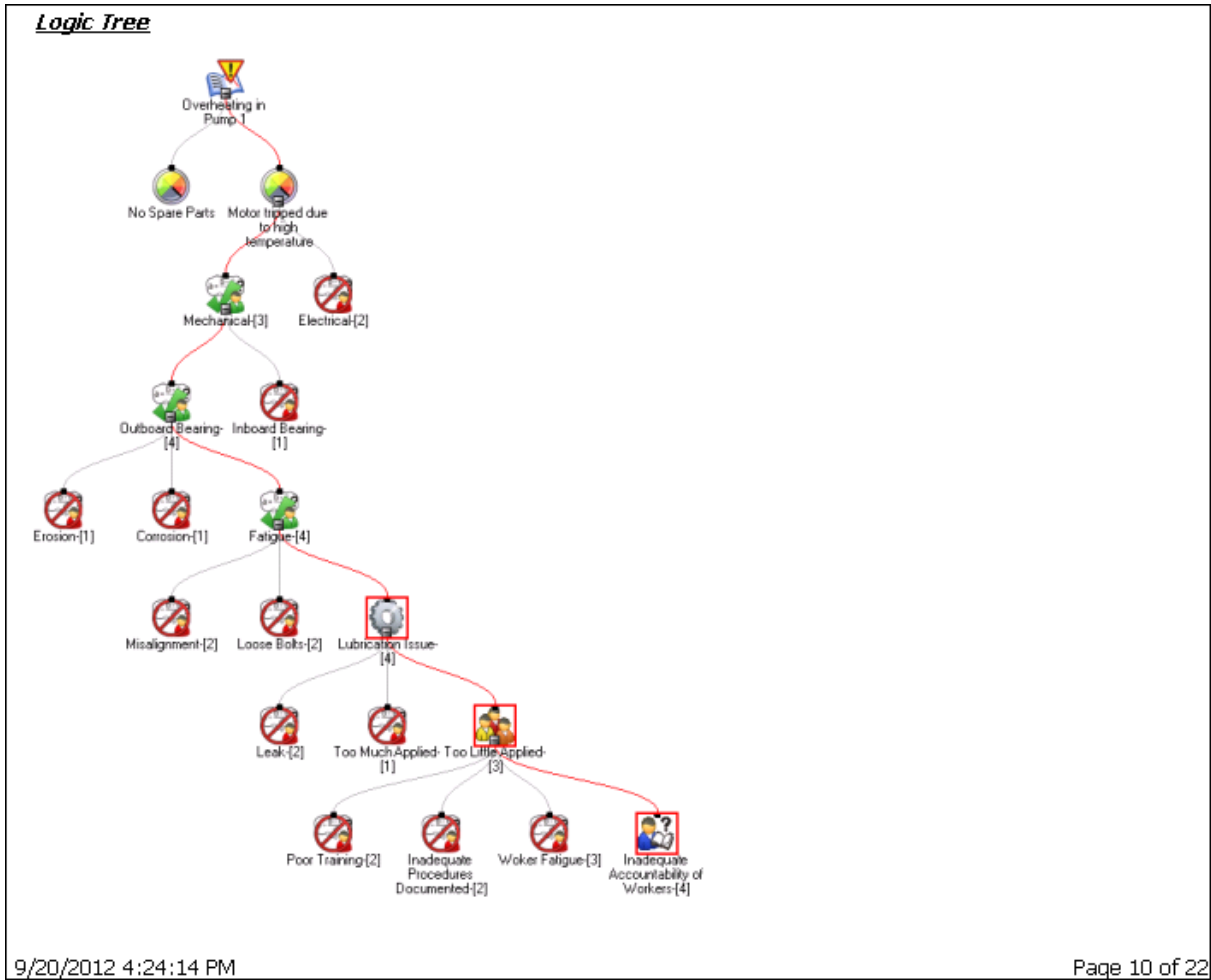

Verification Logs

The **Verification Logs** section of the [Comprehensive Analysis Report](#) displays information that is stored in each RCA Verification record and the RCA Hypothesis record that is linked to an RCA Verification record. It also displays information stored in the Human Resource record that is linked to the RCA Team Member record that is linked to the RCA Verification record. This section will be included in the report when you select the **Verification Logs** check box on the [Comprehensive Analysis Report dialog box](#).

The following image shows an example of the **Verification Logs** section as it appears in the Comprehensive Analysis Report for the [example RCA Analysis](#).

| <i>Verification Logs</i> | | | | |
|---------------------------------|--------------------|---------------------|---|---------------------------------------|
| Hypothesis | Description | Team Members | Verification Method | Outcome |
| Mechanical | | Pete Handy | Inspect wiring to make sure the cause was not electrical. | Confirmed the problem was mechanical. |
| Fatigue | | Bob Speck | Perform a metallurgical analysis to determine why the bearing failed. | The bearing failed due to fatigue. |

9/19/2012 1:25:51 PM Page 11 of 22

The following table lists each item in the **Verification Log** section and the corresponding RCA Verification, RCA Hypothesis, or Human Resource record field whose data is displayed in the report.

| Report Column | Record Family | Record Field |
|---------------------|------------------|-----------------------|
| Hypothesis | RCA Hypothesis | ID |
| Description | RCA Hypothesis | Description |
| Team Member | Human Resource | First Name, Last Name |
| Verification Method | RCA Verification | Method |
| Outcome | RCA Verification | Outcome |

Verification Log File Links

The **Verification Log File Links** section of the Comprehensive Analysis Report contains a list of the Reference Document records that are linked to the RCA Verification records that are linked to the RCA Analysis record. It also displays information stored in the Human Resource record that is linked to the RCA Team Member record that is linked to the RCA Verification record. This section will be included in the report when you select the **Verification Log File Links** check box on the [Comprehensive Analysis Report dialog box](#).

The following image shows an example of the **Verification Log File Links** section as it would appear in a Comprehensive Analysis Report.

| <i>Verification Log File Links</i> | | | |
|---|---------------------|-------------------------------|------------------|
| Method | Team Members | Document Path | ID |
| Perform a metallurgical analysis to determine why the bearing failed. | Bob Speck | C:\MyData\AnalysisResults.txt | Analysis Results |

9/19/2012 1:26:08 PM Page 12 of 22

The following table lists each item in the **Verification Log File Links** section and the corresponding RCA Verification, Human Resource, or Reference Document record field whose data is displayed in the report.

| Report Column | Record Family | Record Field |
|---------------|--------------------|-----------------------|
| Method | RCA Verification | Method |
| Team Members | Human Resource | First Name, Last Name |
| Document Path | Reference Document | Document Path |
| ID | Reference Document | ID |

Communicate

The **Communicate** section of the [Comprehensive Analysis Report](#) displays a description of the [Communicate step](#) of a Root Cause Analysis. This section will be included in the report when you select the **Communicate** check box on the [Comprehensive Analysis Report dialog box](#).

The following image shows an example of the **Communicate** section as it appears in the Comprehensive Analysis Report for the [example RCA Analysis](#).

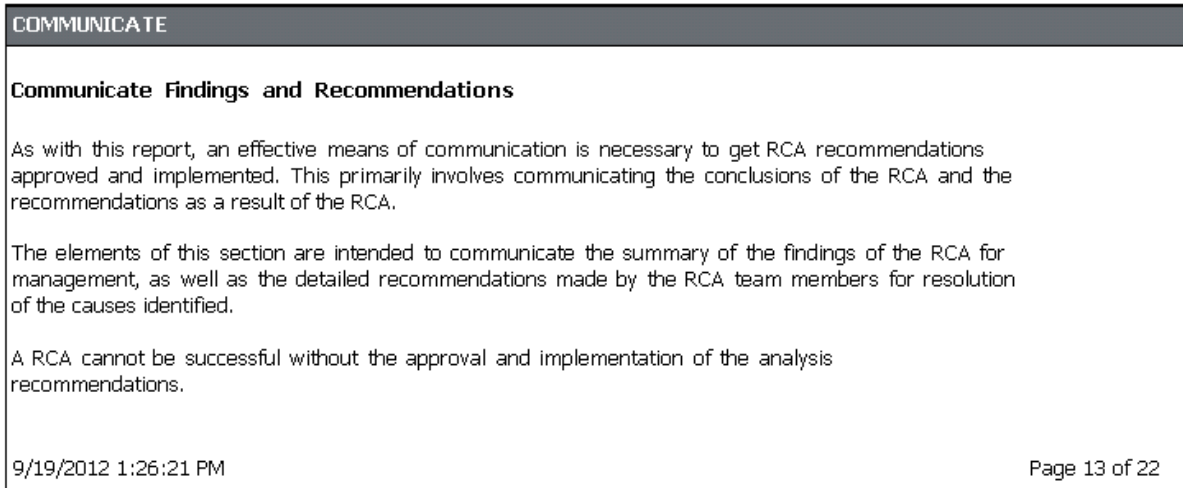

Event Summary

The **Event Summary** section of the [Comprehensive Analysis Report](#) displays the value that is stored in the Event Narrative field in the RCA Analysis record. This section will be included in the report when you select the **Event and Cause Summaries** check box on the [Comprehensive Analysis Report dialog box](#).

The following image shows an example of the **Event Summary** section as it appears in the Comprehensive Analysis Report for the [example RCA Analysis](#).

Event Summary

Investigate what caused the motor temperature in the water pump to increase and overheat.

Summary of Findings

The **Summary of Findings** section of the [Comprehensive Analysis Report](#) displays the value that is stored in the Mechanism field of the RCA Analysis record. This field is labeled *Summary of Findings* on the RCA Communicate datasheet. This section will be included in the report when you select the **Event and Cause Summaries** check box on the [Comprehensive Analysis Report dialog box](#).

The following image shows an example of the **Summary of Findings** section as it appears in the Comprehensive Analysis Report for the [example RCA Analysis](#).

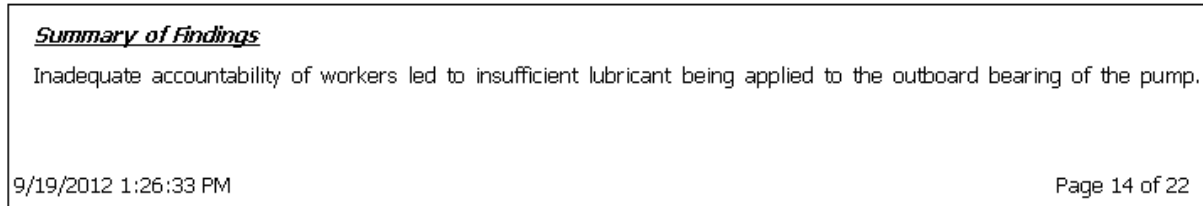

Executive Summary Recommendations

The **Executive Summary Recommendations** section of the [Comprehensive Analysis Report](#) displays information that is stored in RCA Recommendation records that are linked to the RCA Analysis record. This section will be included in the report when you select the **Executive Summary Recommendations** check box on the [Comprehensive Analysis Report dialog box](#).

The following image shows an example of the **Executive Summary Recommendations** section as it appears in the Comprehensive Analysis Report for the [example RCA Analysis](#).

| <i>Executive Summary Recommendations</i> | | | | | |
|--|--------------|--|--------------|------------------------|------------------|
| Root Cause | Type | Recommendation | Team Members | Target Completion Date | Implemented Date |
| Inadequate Accountability of Workers | Cause Latent | Create a new performed maintenance report. | Jones, Suzie | 2/20/2012 | |

9/19/2012 1:27:09 PM Page 15 of 22

The following table lists each item in the **Executive Summary Recommendations** section and the corresponding RCA Recommendation record field whose data is displayed in the report.

| Report Column | Record Field |
|------------------------|---------------------------------------|
| Root Cause | Cause |
| Type | Cause Type |
| Recommendation | Recommendation Headline |
| Team Members | Assigned To Name, Assigned To User ID |
| Target Completion Date | Target Completion Date |
| Implemented Date | Implemented Date |

Recommendation File Links

The **Recommendation File Links** section of the Comprehensive Analysis Report contains a list of the Reference Document records that are linked to the RCA Recommendation records that are linked to the RCA Analysis record. This section will be included in the report when you select the **Recommendation File Links** check box on the [Comprehensive Analysis Report dialog box](#).

The following image shows an example of the **Recommendation File Links** section as it would appear in a Comprehensive Analysis Report.

| <i>Recommendation File Links</i> | | | |
|--------------------------------------|--------------|---------------------------------|---------------------|
| Cause | Team Members | Document Path | ID |
| Inadequate Accountability of Workers | Jones, Suzie | C:\MyData\NewReportTemplate.txt | New Report Template |

9/21/2012 10:07:06 AM Page 16 of 22

The following table lists each item in the **Recommendation File Links** section and the corresponding RCA Recommendation or Reference Document record field whose data is displayed in the report.

| Report Column | Record Family | Record Field |
|---------------|--------------------|---------------------------------------|
| Cause | RCA Recommendation | Cause |
| Team Members | RCA Recommendation | Assigned To Name, Assigned To User ID |
| Document Path | Reference Document | Document Path |
| ID | Reference Document | ID |

Acknowledgements

The **Acknowledgements** section of the [Comprehensive Analysis Report](#) displays the value that is stored in the Acknowledgments field in the RCA Analysis record. This section will be included in the report when you select the **Acknowledgements** check box on the [Comprehensive Analysis Report dialog box](#).

The following image shows an example of the **Acknowledgements** section as it appears in the Comprehensive Analysis Report for the [example RCA Analysis](#).

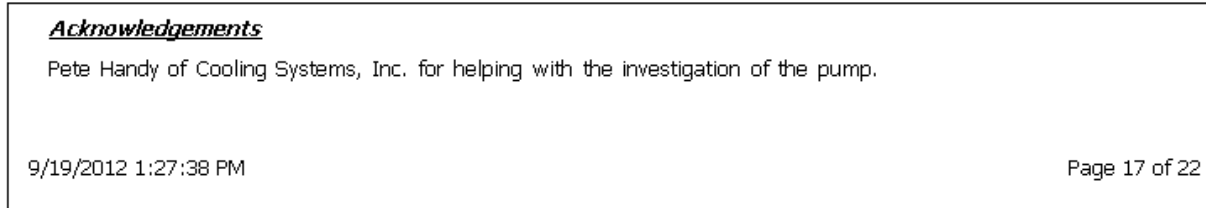

Track

The **Track** section of the [Comprehensive Analysis Report](#) displays a description of the [Track step](#) of a Root Cause Analysis. This section will be included in the report when you select the **Track** check box on the [Comprehensive Analysis Report dialog box](#).

The following image shows an example of the **Track** section as it appears in the Comprehensive Analysis Report for the [example RCA Analysis](#).

TRACK

Tracking For Results

Once you have successfully communicated your finding and your recommendations have been implemented you must now track the effectiveness of those recommendations to ensure that you are getting the results that you have anticipated.

Tracking Evaluations help ensure that the approved PROACT® Recommendations are effective in addressing the underlying issues. During the evaluation process, the PROACT® Principal Analyst specifies a set of conditions (event-based) on which re-evaluation notifications for Tracking Items are based.

Event-based criteria represent a threshold for the number of failure events or the failure cost over a period of time following the implementation of the Recommendation. When the defined thresholds are exceeded, the Tracking Item is updated to a Re-evaluate status, and an e-mail reminder notifies the responsible party to re-examine the defined analysis information. For example, you may specify that a Tracking Item be evaluated if a failure that the analysis was intended to prevent actually occurs.

9/19/2012 1:27:53 PM Page 18 of 22

Tracking Item Summary

The **Tracking Item Summary** section of the Comprehensive Analysis Report contains information that is stored in an RCA Tracking Item record and the Equipment or Functional Location record that is linked to the RCA Tracking Item record. This section will be included in the report when you select the **Tracking Item Summary** check box on the [Comprehensive Analysis Report dialog box](#).

The following image shows an example of the **Tracking Item Summary** section as it would appear in the Comprehensive Analysis Report.

| <i>Tracking Items Summary</i> | | | |
|-------------------------------|------------|-------|-------|
| Related Equipment | Start Date | Count | Cost |
| ~ ~ PUMP | 3/1/2012 | 2 | 10000 |

9/19/2012 1:28:04 PM Page 19 of 22

The following table lists each item in the **Tracking Items Summary** section and the corresponding RCA Tracking Item record whose data is displayed in the report.

| Report Column | Record Family | Record Field |
|-------------------|----------------------------------|--------------|
| Related Equipment | Equipment or Functional Location | Record ID |
| Start Date | RCA Tracking Item | Start Date |
| Count | RCA Tracking Item | Count |
| Cost | RCA Tracking Item | Cost |

Analysis-At-A-Glance

The **Analysis-At-A-Glance** section of the [Comprehensive Analysis Report](#) contains an introduction to the [PROACT RCA Analysis-At-A-Glance Overview section](#), which includes information such as the names of the RCA Analysis Team members and the status of Communicate stage of the RCA Analysis. This section will be included in the report when you select the **Analysis-At-A-Glance** check box on the [Comprehensive Analysis Report dialog box](#).

The following image shows an example of the **Analysis-At-A-Glance** section as it appears in the Comprehensive Analysis Report for the [example RCA Analysis](#).

ANALYSIS-At-A-GLANCE

For the benefit of those that must oversee Root Cause Analysis (RCA) activities from the business perspective, this Analysis-At-A-Glance section provides such information.

In the PROACT® Root Cause Analysis process, there are three points where tasks are assigned to team members, they in:

1. data collection,
2. hypothesis verifications and
3. the development and implementation of recommendations.

Analysis-At-A-Glance is the section where all of this information is brought together in a meaningful fashion.

9/19/2012 1:28:19 PM Page 20 of 22

About the PROACT RCA Analysis-At-A-Glance Overview

The **PROACT RCA Analysis-At-A-Glance Overview** section of the [Comprehensive Analysis Report](#) displays a summary of the RCA Analysis. This section includes the following subsections:

- [Analyze and Team Data](#): Contains summary information about the RCA Analysis.
- [Assets](#): Contains information about the Equipment and Functional Location records that are linked to the RCA Analysis record.
- [Status of Preserve, Status of Analyze, and Status of Communicate](#): Contain the number of items that have been created, completed, or assigned to RCA Analysis Team Members.

The **PROACT RCA Analysis-At-A-Glance Overview** section will be included in the report when you select the **Overview** check box on the [Comprehensive Analysis Report dialog box](#).

Analysis and Team Data Subsection

The following image shows an example of the **Analysis and Team Data** subsection of the **PROACT RCA Analysis-At-A-Glance Overview** section for the [example RCA Analysis](#).

| <u>PROACT® RCA Analysis-At-A-Glance Overview</u> | |
|---|---|
| Analysis and Team Data | |
| Analysis Name: | Cooling Water Pump |
| Principal Analyst: | Jane Doe |
| Team Members: | Suzie Jones Pete Handy Bob Speck |
| Team Charter: | To identify the root cause of the cooling water pump failure. This includes indentifying deficiencies in or lack of management systems. Appropriate recommendations for root causes will be communicated to the management for rapid resolutions. |
| Critical Success Factors: | <p>A cross-functional section of plant personnel/experts will participate in the analysis.</p> <p>A disciplined RCFA approach will be utilized.</p> <p>A measurement process will be used to track the progress of approved recommendations.</p> <p>All analysis hypothesis will be verified or disproven.</p> <p>Management agrees to fairly evaluate the analysis team findings and recommendations.</p> <p>No one will be disciplined for honest mistakes.</p> |
| Start Date: | 1/6/2012 |
| Estimated Completion Date: | 1/15/2012 |
| Estimated Cost of Event: | \$200,000.00 |

The following table lists each item in the **Analysis and Team Data** subsection and the corresponding record field whose data is displayed in the report.

| Report Item | Record Family | Record Field | Notes |
|---------------------------|-----------------------------|-----------------------|--|
| Analysis Name | RCA Analysis | Analysis Name | None |
| Principal Analyst | Human Resource | First Name, Last Name | These values are stored in the Human Resource record that is linked to the RCA Team Member record that contains the value <i>Principal Analyst</i> . |
| Team Members | Human Resource | First Name, Last Name | None |
| Team Charter | RCA Analysis | Charter | None |
| Critical Success Factors | RCA Critical Success Factor | CSF | None |
| Start Date | RCA Analysis | Start Date | None |
| Estimated Completion Date | RCA Analysis | End Date | None |
| Estimated Cost of Event | RCA Analysis | Cost | None |

Assets Subsection

The following image shows an example of the **Assets** subsection of the **PROACT RCA Analysis-At-A-Glance Overview** section for the [example RCA Analysis](#).

| Assets | |
|-----------|-----------|
| Record Id | Family |
| ~ ~ PUMP | Equipment |

The following table lists each item in the **Assets** subsection and the corresponding record field whose data is displayed in the report.

| Report Column | Record Family | Record Field | Notes |
|---------------|----------------------------------|--|--|
| Record ID | Equipment or Functional Location | Equipment ID or Functional Location ID | This column contains the Record ID of each Equipment or Functional Location record that is linked to the RCA Analysis record. |
| Family | None | None | This field is populated automatically with the name of the family to which the piece of equipment or location belongs. If it belongs to the Equipment family, this field will be populated automatically with <i>Equipment</i> . If it belongs to the Functional Location family, this field will be populated automatically with <i>Functional Location</i> . |

Status of Preserve, Analyze, and Communication Subsections

The following image shows an example of the **Status of Preserve**, **Status of Analyze**, and **Status of Communicate** subsections of the **PROACT RCA Analysis-At-A-Glance Overview** section for the [example RCA Analysis](#).

| | |
|---|---------|
| Status of Preserve | |
| Number of Data Collection Tasks Assigned: | 5 |
| Number of Data Collection Tasks Completed: | 0 |
| % of Data Collection Tasks Completed: | 0.00% |
| Status of Analyze | |
| Number of Hypothesis: | 17 |
| Number of Verification Assigned: | 2 |
| Number of Verification Completed: | 2 |
| % of Verifications Completed: | 100.00% |
| Status of Communicate | |
| Number of Root Causes Identified: | 3 |
| Number of Recommendations CREATED | 1 |
| 9/19/2012 1:29:11 PM Page 22 of 22 | |

The following table lists each item in the **Status of Preserve**, **Status of Analyze**, **Status of Communicate** subsections and the corresponding record field whose data is displayed in the report.

| Report Item | Description | Notes |
|---|---|-------|
| Status of Preserve | | |
| Number of Data Collection Tasks Assigned | The total number of RCA Preserve Item records linked to the RCA Analysis record. | None |
| Number of Data Collection Tasks Completed | The number of RCA Preserve Item records that contain the value <i>True</i> in the Completed? field. | None |

Status of Preserve, Analyze, and Communication Subsections

| Report Item | Description | Notes |
|--------------------------------------|---|-------|
| % of Data Collection Tasks Completed | The percentage of RCA Preserve Items records that contain the value <i>True</i> in the Completed? field. | None |
| Status of Analyze | | |
| Number of Hypothesis | The total number of RCA Hypothesis records that are linked to the RCA Analysis record. | None |
| Number of Verification Assigned | The total number of RCA Verification records that are linked to RCA Hypothesis records. | None |
| Number of Verification Completed | The number of RCA Verification records that contain the value <i>True</i> in the Completed? field. | None |
| % of Verification Completed | The percentage of RCA Verification records that contain the value <i>True</i> in the Completed? field. | None |
| Status of Communicate | | |
| Number of Root Causes Identified | The number of RCA Hypothesis records that contain the value <i>Cause - Human, Cause - Latent, or Cause - Physical</i> in the State field. | None |

| Report Item | Description | Notes |
|--|--|---|
| <p>Number of Recommendations</p> <ul style="list-style-type: none"> • Approved • Created • Pending Review • Reviewed • Rejected • Superseded • In Progress • Implemented | <p>The number of RCA Recommendation records that contain a certain value (e.g., <i>Created</i>) in the Status field.</p> | <p>If there are no records that contain a certain value in the Status field, they do not appear in the report. For example, if an RCA Recommendation record contained the value <i>Reviewed</i> in the Status field, the value <i>Reviewed</i> would appear under the Number of Recommendations field, and the number <i>1</i> would appear next to it. If there are no RCA Recommendation records with the value <i>Reviewed</i> in the Status field, the value <i>Reviewed</i> does not appear under the Number of Recommendations field.</p> |

Analysis Summary Report

The **Analysis Summary** report displays summary information that is stored in the RCA Analysis record. The report is divided into the following sections:

- **Analysis Data:** Contains general information about the analysis.
- **Location Data:** Contains information about the location of the piece of equipment being analyzed.
- **Equipment Data:** Contains information about the piece of equipment that is being analyzed.

| | | | |
|---|-------------------------------|--|-----------|
|  | | PROACT® for Meridium Analysis Summary Report | |
| 1041828 HEX U-Bend | | | |
| Analysis Data | | | |
| Analysis Type: | Operational | Analysis Start Date: | 8/10/2009 |
| Cost of Event: | \$250,000.00 | Analysis End Date: | 8/27/2009 |
| Frequency: | 4 | | |
| Acknowledgements: | | | |
| Event Mechanism: | | | |
| Location Data | | | |
| Plant Location: | Roanoke, VA | | |
| Division: | Area 1 | | |
| Functional Location: | MRD-ROA-REFN-RF074-E0011A-074 | | |
| Unit: | 74 | | |
| Equipment Data | | | |
| Asset Category: | Fixed Asset | | |
| Asset Class: | Heat Exchanger | | |
| Asset Type: | Shell and Tube Heat Exchanger | | |
| Asset ID: | 000000000001041828 | | |
| Manufacturer: | HEAT TRANSFER EQUIP | | |

The name of the analysis, which is stored in the Analysis Name field in the RCA Analysis record, is displayed at the top of the **Analysis Summary** report. The following table lists each item in the report and the corresponding RCA Analysis record field whose data is displayed in the report.

Note: The **Location Data** and **Equipment Data** sections exist in the **Analysis Summary** report so that you can view this information in analyses where it existed in previous releases. In the current product, the **Manage Assets** page allows you to link Equipment and Functional Location records to the RCA Analysis record. Asset information is no longer stored in fields in the RCA Analysis record, which are used to populate values in the **Analysis Summary** report. You can view information in Equipment and Functional Location records that are linked to the RCA Analysis record using the **Assets** subsection of the [PROACT RCA Analysis-At-A-Glance Overview section](#) in the Comprehensive Analysis report.

| Report Item | RCA Analysis Field |
|-----------------------|---------------------|
| Analysis Data | |
| Analysis Type | Analysis Type |
| Cost of Event | Cost |
| Frequency | Frequency |
| Acknowledgements | Acknowledgements |
| Event Mechanism | Mechanism |
| Analysis Start Date | Start Date |
| Analysis End Date | End Date |
| Location Data | |
| Plant Location | Plant Location |
| Division | Division |
| Functional Location | Functional Location |
| Unit | Unit |
| Equipment Data | |
| Asset Category | Asset Category |
| Asset Class | Asset Class |
| Asset Type | Asset Type |
| Asset ID | Asset ID |
| Manufacturer | Manufacturer |

Cause Report

The **Cause** report displays information that is stored in RCA Hypothesis records that are linked to the RCA Analysis record and contain a value of [Cause - Physical, Cause - Latent, or Cause - Human in the State field](#). This information is displayed in two different formats:

- The *Types of Causes* graph.
- A table below the graph.

The following image displays the Types of Causes graph. The x-axis displays the types of cause (i.e., human, physical, and latent). The y-axis displays the number of RCA Hypothesis records that contain a cause in the State field and exist in the Logic Tree for the RCA Analysis.

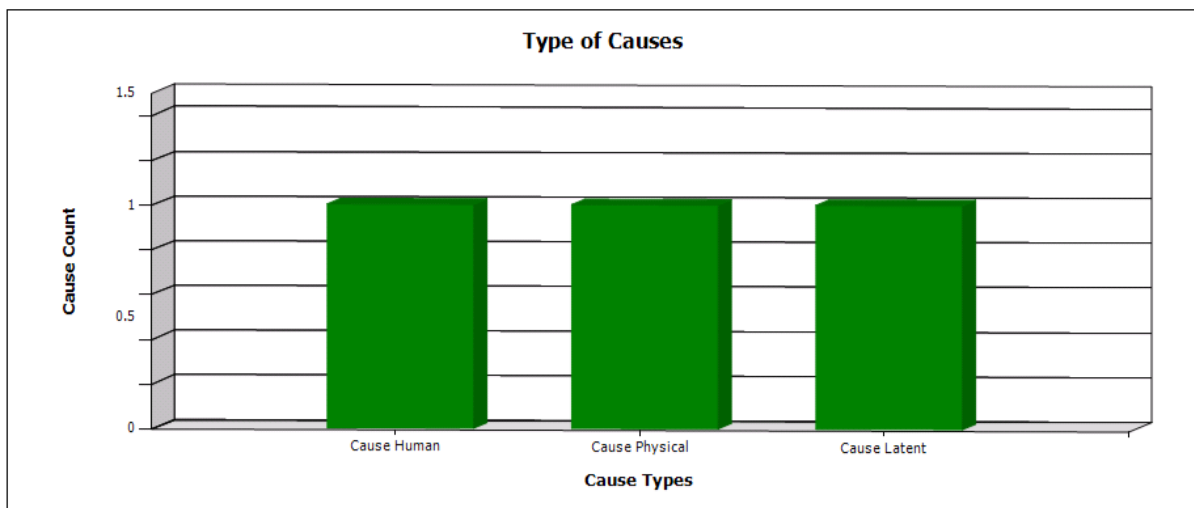

The table below the graph displays information related to each RCA Hypothesis record that is linked to the RCA Analysis record.

| | Hypothesis | Hypothesis Description | Confidence Factor |
|-----------------------|--|--|-------------------|
| Cause Human | | | |
| | Inadequate Cleaning Procedure | Inadequate Cleaning Procedure | Highly Likely (4) |
| Cause Physical | | | |
| | Inadequate Water Treatment for Process | Inadequate Water Treatment for Process | Highly Likely (4) |
| Cause Latent | | | |
| | Inadequate cleaning process methods | Inadequate cleaning process methods | True (5) |

The following table lists each item in the **Cause** report and the corresponding RCA Hypothesis record field whose data is displayed in the report. A row exists for each RCA Hypothesis record and is categorized by the cause state (i.e., physical, latent, or human), which is stored in the State field of the RCA Hypothesis record.

Cause Report

| Report Column | RCA Hypothesis Field |
|------------------------|----------------------|
| Hypothesis | ID |
| Hypothesis Description | Description |
| Confidence Factor | Confidence Factor |

Logic Tree Summary Report

The **Logic Tree Summary** report consists of two parts:

- The *Logic Tree Summary By Node Type* graph.
- A table that displays the information in the graph.

The following image displays the Logic Tree Summary By Node Type graph. The x-axis displays the hypothesis state of the node, which is stored in the State field of each corresponding RCA Hypothesis record. The y-axis displays the number of nodes that exist in the Logic Tree for each [type of state](#).

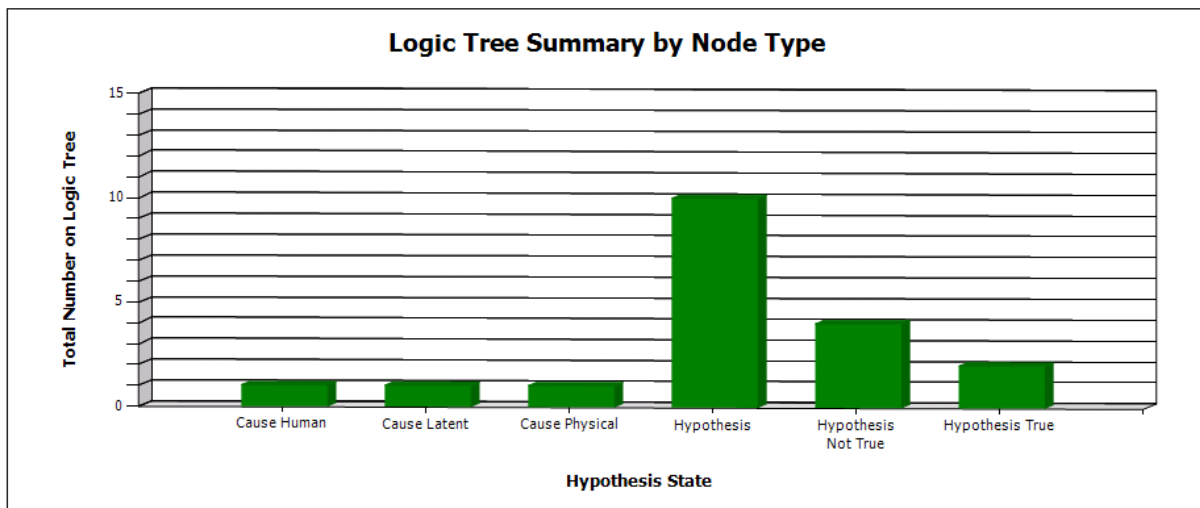

The table below the graph contains the same information in a chart form. In this case, the values in the **Node State** column are equivalent to the Hypothesis State values in the graph, and the values in the **Node Count** column are equivalent to the Total Number on Logic Tree values in the graph. The value in the **Total** row is the total number of nodes that exist in the Logic Tree with a value in the State field in the corresponding RCA Hypothesis record.

| Node State | Node Count |
|---------------------|------------|
| Cause Human | 1 |
| Cause Latent | 1 |
| Cause Physical | 1 |
| Hypothesis | 10 |
| Hypothesis Not True | 4 |
| Hypothesis True | 2 |
| Total : | 19 |

Verification Report

The **Verification** report displays information that is stored in each RCA Verification record and the RCA Hypothesis record that is linked to an RCA Verification record. It also displays information stored in the Human Resource record that is linked to the RCA Team Member record that is linked to the RCA Verification record. The report includes each RCA Verification record that is linked to the RCA Analysis record.

| meridium | | PROACT® for Meridium | | |
|--|--|--|------------------------|--|
| | | Verification Report | | |
| 1041828 HEX U-Bend | | | | |
| Hypothesis | Verification Method | Outcome | Responsible | Due Date |
| Inadequate Water Treatment for Process | Conduct Water Treatment Test | Inconsistent water treatment could cause problems. | Meridium Administrator | 9/17/2009 |
| Inadequate Cleaning Procedure | Investigate various cleaning procedures. | Cleaning process needs to be more thorough. | Meridium Administrator | 9/17/2009 |
| | | | | Total Number of Verifications for this analysis: 2 |

The name of the analysis, which is stored in the Analysis Name field in the RCA Analysis record, is displayed at the top of the **Verification** report. The following table lists each item in the report and the corresponding RCA Verification, RCA Hypothesis, or Human Resource record field whose data is displayed in the report.

| Report Column | RCA Verification or RCA Hypothesis record | Record Field |
|---------------------|---|-----------------------|
| Hypothesis | RCA Hypothesis | ID |
| Verification Method | RCA Verification | Method |
| Outcome | RCA Verification | Outcome |
| Responsible | Human Resource | First Name, Last Name |
| Due Date | RCA Verification | Due Date |

Recommendation Report

The **Recommendation** report displays information that is stored in each RCA Recommendation record that is linked to an RCA Analysis record.

| meridium | | PROACT® for Meridium | | | |
|---|-------------------------------|------------------------|----------------------|------------|-----------------|
| 1041828 HEX U-Bend | | Recommendation Report | | | |
| Recommendation | Assigned To | Target Completion Date | Status | Completed? | Completion Date |
| Improve Heat Exchanger Cleaning and Restoration Program | Implementer, Implementer | 9/17/2009 12:00:00 AM | Created (CREATED) | False | |
| Investigate and determine optimal water treatment for application | Implementer, Implementer | 9/24/2009 12:00:00 AM | Created (CREATED) | False | |

The name of the analysis, which is stored in the Analysis Name field in the RCA Analysis record, is displayed at the top of the **Recommendation** report. The following table lists each item in the report and the corresponding RCA Recommendation record field whose data is displayed in the report.

| Report Column | RCA Recommendation Field |
|------------------------|--------------------------|
| Recommendation | Recommendation Headline |
| Assigned To | Assigned to Name |
| Target Completion Date | Target Completion Date |
| Status | Status |
| Completed? | Completed |
| Completion Date | Implemented Date |

Team Member Report

The **Team Member** report displays information that is stored in an RCA Team Member record and the Human Resource record that is linked to the RCA Team Member record. The report includes each RCA Team Member record that is linked to the RCA Analysis record.

| | | | |
|---|-------------------|---|--|
|  | | PROACT® for Meridium Team Member Report | |
| 1041828 HEX U-Bend | | | |
| Joe Demo - Demo | | | |
| Team Member Type: | Principal Analyst | | |
| Job Title: | Engineer | Address: | 207 Bullitt Ave. |
| Company: | Meridium, Inc. | City: | Roanoke |
| Site: | XXX | State: | Virginia |
| Facility: | Plant 1 | Zip Code: | 24013 |
| Business Unit: | Unit 1 | Email: | mdaniel@meridium.com mdaniel@meridium.com |
| Country: | United States | Phone: | 555-5555 |

The name of the analysis, which is stored in the Analysis Name field in the RCA Analysis record, is displayed at the top of the **Team Member** report. The following table lists each item in the report and the corresponding RCA Team Member or Human Resource record field whose data is displayed in the report.

| Report Field | RCA Team Member or Human Resource record | Record Field |
|------------------|--|---------------|
| Team Member Type | RCA Team Member | Type |
| Job Title | Human Resource | Job Title |
| Company | Human Resource | Company |
| Site | Human Resource | Site Code |
| Facility | Human Resource | Facility |
| Business Unit | Human Resource | Business Unit |
| Country | Human Resource | Country |
| Address | Human Resource | Address1 |

Team Member Report

| Report Field | RCA Team Member or Human Resource record | Record Field |
|--------------|--|---------------|
| City | Human Resource | City |
| State | Human Resource | State |
| Zip Code | Human Resource | Postal Code |
| Email | Human Resource | Email Address |
| Phone | Human Resource | Phone1 |

Preserve Items Report - Group by Category

The **Preserve Items - Group by Category** report displays information that is stored in each RCA Preserve Item record that is linked to an RCA Analysis record and information stored in the Human Resource record that is linked to an RCA Team Member record that is linked to the RCA Preserve Item record. This report displays information for each preserve item in an analysis according to the value in the **Data Category** field (e.g., paper) in the RCA Preserve Item record.

1041828 HEX U-Bend

| Data to Collect | Collection Strategy | Due Date | Completed? | Responsible |
|---|---|-----------|------------|-------------|
| Paper | | | | |
| Paper or electronic failure data | SAP Order / Notification history | 8/13/2009 | Yes | Joe Demo |
| Parts | | | | |
| Pictures or actual segments of failed tubes | Inspection doc pictures and fixed equipment manager | 8/13/2009 | Yes | Analyst |

The name of the analysis, which is stored in the Analysis Name field in the RCA Analysis record, is displayed at the top of the **Preserve Items - Group By Category** report. The following table lists each item in the report and the corresponding RCA Preserve Item or Human Resource record field whose data is displayed in the report.

| Report Item | RCA Preserve Item or Human Resource record | Record Field |
|---------------------|--|-----------------------|
| Data to Collect | RCA Preserve Item | Data to Collect |
| Collection Strategy | RCA Preserve Item | Collection Strategy |
| Due Date | RCA Preserve Item | Date Due |
| Completed? | RCA Preserve Item | Completed? |
| Responsible | Human Resource | First Name, Last Name |

Preserve Items Report - Group by Team Member

The **Preserve Items - Group by Team Member** report displays information that is stored in each RCA Preserve Item record that is linked to an RCA Analysis record. This report displays information for each RCA Preserve Item record according to the RCA Team Member to whom the preserve item is assigned. Each Team Member (e.g., Analyst) is identified in the report by the value stored in the Last Name and First Name fields of the Human Resource record that is linked to the RCA Team Member record that is linked to the RCA Preserve Item record.

1041828 HEX U-Bend

| Data to Collect | Collection Strategy | Due Date | Completed? | Data Category |
|---|---|-----------|------------|---------------|
| Joe Demo | | | | |
| Paper or electronic failure data | SAP Order / Notification history | 8/13/2009 | Yes | Paper |
| Analyst | | | | |
| Pictures or actual segments of failed tubes | Inspection doc pictures and fixed equipment manager | 8/13/2009 | Yes | Parts |

The name of the analysis, which is stored in the Analysis Name field in the RCA Analysis record, is displayed at the top of the **Preserve Items - Group by Team Member** report. The following table lists each item in the report and the corresponding RCA Preserve Item record field whose data is displayed in the report.

| Report Item | RCA Preserve Item Field |
|---------------------|-------------------------|
| Data to Collect | Data to Collect |
| Collection Strategy | Collection Strategy |
| Due Date | Date Due |
| Completed? | Completed? |
| Data Category | Data Category |

About Tracking and Reevaluating Analysis Results

After your team's findings have been communicated successfully to the appropriate individuals in your organization, the next step in the PROACT workflow is to *track* the effectiveness of your recommendations through RCA Tracking Item records. The goal of tracking recommendations is to make sure that the recommendation that was implemented has produced the desired results. Depending on the results, you may need to reevaluate the solution that was implemented to address the underlying issues.

During the *tracking* process, the team should decide on a set of conditions on which reevaluation notifications should be based. The Principal Analyst should specify these conditions in the associated fields in the RCA Tracking Item record. These notifications should be based on event criteria.

Criteria that is event-based includes a number of failure events and/or the failure cost that the piece of equipment or location has incurred after the implementation of a recommendation. When the criteria defined in the RCA Tracking Item record is exceeded, the RCA Tracking Item record will be updated automatically to a *Reevaluate* status, and an email reminder will notify the responsible party to reexamine the recommendation.

Accessing the List of Existing RCA Tracking Item Records

You can access the **Analysis Tracking Items** page via the **Track** menu on any of the following pages:

- **Analysis** page
- **Critical Success Factors** page
- **Team** page
- **Preserve Failure Data** page
- **Event Diagram** page
- **Logic Tree** page
- **Reports List**page

To access the list of existing tracking items:

- On the appropriate page, on the **Track** menu, click the **Track** link.

The **Analysis Tracking Items** page appears, displaying the list of existing RCA Tracking Item records for the current RCA Analysis. If no records exist, a message appears in the workspace instead, indicating that there are no RCA Tracking Item records linked to the current RCA Analysis. The following image shows what the **Analysis Tracking Items** page looks like when it contains RCA Tracking Item records.

Accessing the List of Existing RCA Tracking Item Records

The screenshot shows the Meridium APM Framework interface. The main window title is "Meridium APM Framework - Analysis Tracking Items". The breadcrumb navigation path is "RCA->My PROACT->Test Analysis A->Tracking". The left sidebar contains several sections: "Manage Assets" with a "Manage Assets" button; "Common Tasks" with buttons for "New Item", "Edit Item", "Copy Item", "Delete Item", "Spell Check", "Send To >>", and "Help"; "PReserve" with a "Preserve Records" button; and "Order" with buttons for "Critical Success ...", "Team Charter", and "Team".

The main content area displays a table with the following data:

| Start Date | Is Active? | Count | Cost | Equipment |
|-----------------------|-------------------------------------|-------|------|-----------|
| 7/30/2008 12:00:00 AM | <input checked="" type="checkbox"/> | 10 | 1000 | |
| 2/6/2009 12:00:00 AM | <input checked="" type="checkbox"/> | 56 | 555 | |

Aspects of the Analysis Tracking Items Page

The **Analysis Tracking Items** page displays a list of all the RCA Tracking Item records that are linked to the RCA Analysis record for the current RCA Analysis.

| Start Date | Is Active? | Count | Cost | Equipment |
|---------------------------------------|-------------------------------------|-------|------|----------------------------|
| 6/8/2011 12:00:00 AM | <input checked="" type="checkbox"/> | 0 | 0 | CMP-0221 PROPANE REFRIG. |
| 6/17/2011 12:00:00 AM | <input checked="" type="checkbox"/> | 0 | 0 | AQA PMP-8281 ACID BLOWDOWN |

For each item, the following information appears:

- **Start Date:** The date on which the evaluation will begin. This value appears as a hyperlink, which you can click to view the contents of the corresponding RCA Tracking Item record.
- **Is Active?:** A check box that indicates whether the tracking item is active or inactive. You can select this check box to indicate that the RCA Tracking Item record is active.
- **Count:** The number of failures that can occur before a reevaluation email is sent to the users whose names are selected in the Alert List field in the corresponding RCA Tracking Item record. You can think of this number as the *expected* number of failures that will occur after the associated recommendation has been implemented. Once this number is reached, a notification will be sent to the users whose names appear in the Alert List field.
- **Cost:** The failure cost that must be exceeded for a reevaluation email to be sent to the users whose names are selected in the Alert List field in the corresponding RCA Tracking Item record. You can think of this number as the *expected* cost for maintenance and failure of the piece of equipment that will occur after the associated recommendation has been implemented. Once this number is reached, a notification will be sent to the users whose names appear in the Alert List field.
- **Equipment:** The Equipment ID for the piece of equipment that is being tracked.

The **Analysis Tracking Items** page contains the following task menus:

- [Manage Assets](#)
- [Common Tasks](#)
- [PReserve](#)
- [Order](#)
- [Analyze](#)
- [Communicate](#)
- [Track](#)
- **Associated Pages**

Note: The **Associated Pages** menu will contain links only if they have been defined for the RCA Tracking Item family via the URL Manager.

Manage Assets Menu



The **Manage Assets** menu on the **Analysis Tracking Items** page contains the following link:

- **Manage Assets:** Displays the **Manage Assets** page, where you can link, view, and unlink Equipment and Functional Location records associated with the current RCA analysis.

Common Tasks Menu

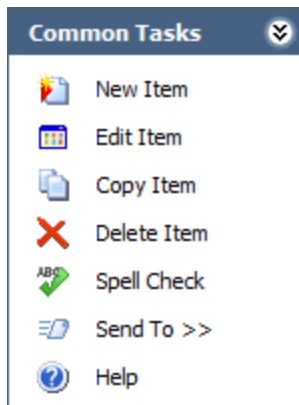

The **Common Tasks** menu on the **Analysis Tracking Items** page contains the following links:

- **New Item:** Displays the **Tracking Item Details** page, which contains a blank data-sheet that you can use to create a new RCA Tracking Item record to link to the RAC Analysis record for the current RCA Analysis.
- **Edit Item:** Opens the selected RCA Tracking Item record on the **Tracking Item Details** page, where you can view and modify its contents.
- **Copy Item:** Creates a copy of the selected RCA Tracking Item record on the **Tracking Item Details** page, where you can modify the RCA Tracking Item record and save it to the current RCA Analysis.
- **Delete Item:** After asking for confirmation, deletes the selected RCA Tracking Item record.
- **Spell Check:** Displays the **Spell Check** dialog box, which allows you to perform a [spell check operation](#) on the text and character fields in records belonging to the current RCA Analysis.
- **Send To:** Displays a submenu with options that let you provide a link to the current page on your desktop (create shortcut), in an email message, or on a Home Page.
- **Help:** Displays the context-sensitive Help topic for the **Analysis Tracking Items** page.

PReserve Menu



The **PReserve** menu on the **Analysis Tracking Items** page contains the following link:

- **Preserve Records:** Displays the **Preserve Failure Data** page, which displays the list of existing RCA Preserve Item records for the current analysis.

Order Menu

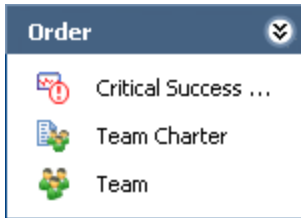

The **Order** menu on the **Analysis Tracking Items** page contains the following links:

- **Critical Success Factors:** Displays the [Critical Success Factors page](#), which displays the list of existing RCA Critical Success Factor records that are linked to the RCA Analysis record for the current RCA Analysis.
- **Team Charter:** Displays the **Team Charter** dialog box, which contains the Team Charter for the current RCA Analysis.
- **Team:** Displays the **Team** page, where you can view the list of RCA Team Members records that are linked to the RCA Analysis record for the current RCA Analysis.

Analyze Menu

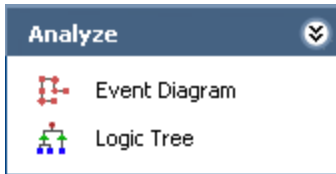

The **Analyze** menu on the **Analysis Tracking Items** page contains the following links:

- **Event Diagram:** Displays the **Event Diagram** page. The first time that you access the **Event Diagram** page for a given RCA Analysis, the **RCA Event** dialog box will appear automatically so that you can [define an RCA Event record](#) and link it to the current RCA Analysis. Otherwise, the **Event Diagram** page appears, displaying the event diagram for the current RCA Analysis.
- **Logic Tree:** Displays the **Logic Tree** page for the current RCA Analysis, where you can create a logic tree diagram to represent the possible causes of the event being analyzed.

Communicate Menu



The **Communicate** menu on the **Analysis Tracking Items** page contains the following links:

- **Communicate Records:** Displays the **Communicate Records** page, where you can create RCA Recommendation records to represent recommendations for the current RCA Analysis.
- **Reports:** Displays the **Reports List** page, where you can view a list of reports that have been configured for the Root Cause Analysis module.

Track Menu



The **Track** menu on the **Analysis Tracking Items** page contains the following link:

- **Track:** Displays the current page. This link is available on other pages in Root Cause Analysis and lets you navigate to the **Analysis Tracking Items** page.

Accessing the Tracking Item Details Page

You can access the **Tracking Item Details** page via the following methods:

- [Create a new RCA Tracking Item record.](#)
- or-
- [Open an existing RCA Tracking record.](#)

Aspects of the Tracking Item Details Page

The **Tracking Item Details** page displays the contents of a single RCA Tracking Item record on the RCA Tracking Item Details datasheet.

Above the datasheet, the **Related Equipment** text box appears, which contains the Record ID of the Equipment or Functional Location record to which the RCA Tracking Item record is linked. If the RCA Tracking Item record is not linked to an Equipment or Functional Location record, this text box will be empty.

To the right of the **Related Equipment** text box, the **Search** button appears, which you can click to search for an Equipment or Functional Location record to link to the current RCA Tracking Item record.

The following image shows what the **Tracking Item Details** page looks like when you create a new RCA Tracking Item record.

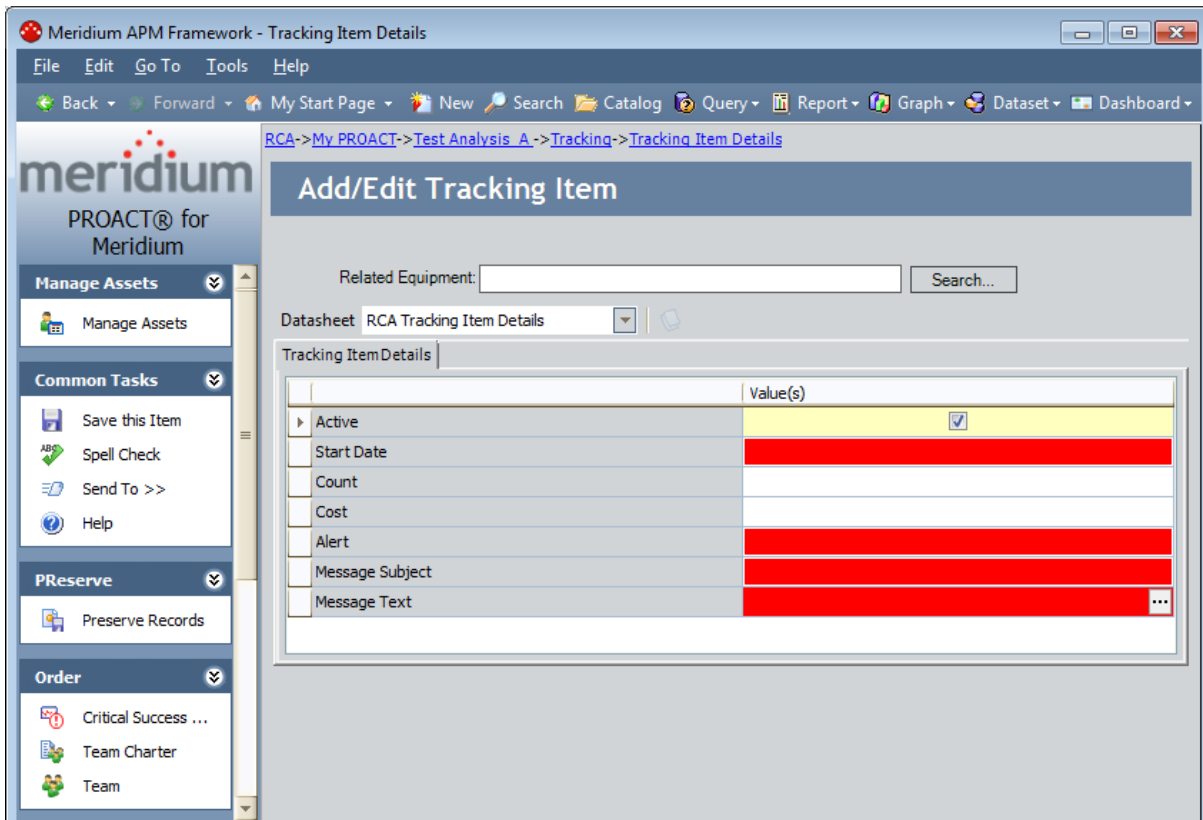

The **Tracking Items Details** page contains the same task menus that appear on the [Analysis Tracking Items page](#).

Note: The **Associated Pages** menu on the **Tracking Item Details** page contains links only if they have been defined for the RCA Tracking Item family and you are viewing an *existing* RCA Tracking Item record.

Creating New RCA Tracking Item Records

You can create RCA Tracking Item records and [set up tracking notifications](#) as a part of the reevaluation process. [In the RCA Tracking Item record](#), you will define the:

- User to whom the notification will be sent.
- Time interval or event-based conditions that should be met *before* the notification can be sent.

Note: For notifications to work properly, an administrative user must create the [Tracking Evaluation scheduled item](#) in the Meridium APM Schedule Manager.

When you create an RCA Tracking Item record, a link is created automatically between the RCA Tracking Item record and the RCA Analysis record. In addition, you will need to specify the Equipment or Functional Location record that represents the piece of equipment or location that you are analyzing. When you do so, a link is created automatically between the RCA Tracking Item record and the specified Equipment or Functional Location record.

To create a new Tracking Item record:

1. On the [Analysis Tracking Items page](#), on the **Common Tasks** menu, click the **New Item** link.

The **Tracking Item Details** page appears, displaying a new RCA Tracking Item record.

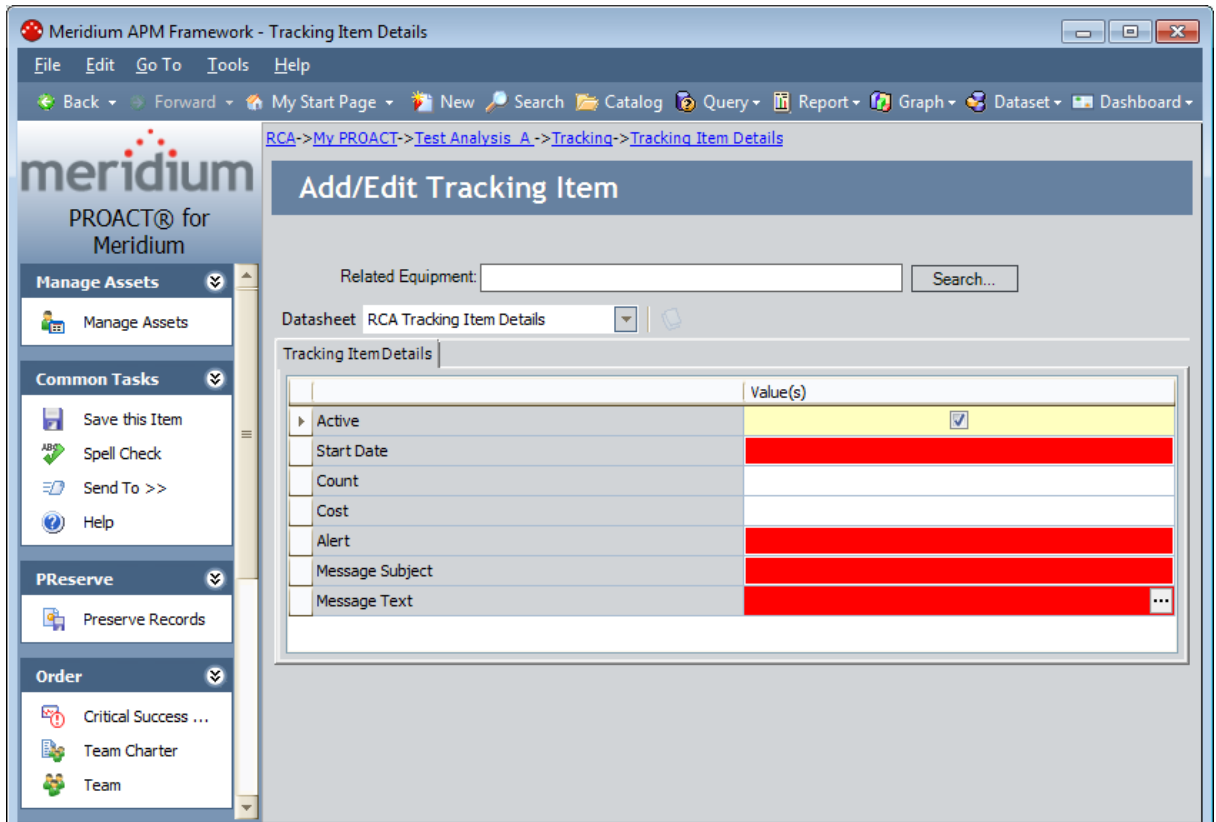

2. On the [RCA Tracking Item Details datasheet](#), complete the fields as desired. The following fields are required:

- Start Date
- Alert
- Message Subject
- Message Text

3. On the **Common Tasks** menu, click the **Save this Item** link.

The RCA Tracking Item record is saved to the database. At this point, [you can link an Equipment or Functional Location record](#) to the RCA Tracking Item record.

Linking Equipment or Functional Location Records to RCA Tracking Item Records

Once you save a RCA Tracking Item record to the database, you can link an Equipment or Functional Location record to that RCA Tracking Item record. Only one Equipment or Functional Location Record can be linked to each RCA Tracking Item record.

To link an Equipment or Functional Location record to an RCA Tracking Item record:

1. [Open the RCA Tracking Item record to which you want to link the Equipment or Functional Location record.](#)

2. Above the datasheet, click the **Search** button.

The **Find Equipment** window appears, and the **Search In** list contains the Equipment and Functional Location families.

3. Perform a search to locate the desired record.

4. In the search results, select row containing the Equipment or Functional Location record that you want to link to the RCA Tracking Item record, and click the **Select** button.

The **Find Equipment** window closes, and the Record ID of the selected record appears in the **Related Equipment** text box, indicating that the RCA Tracking Item record is linked to the record with that Record ID.

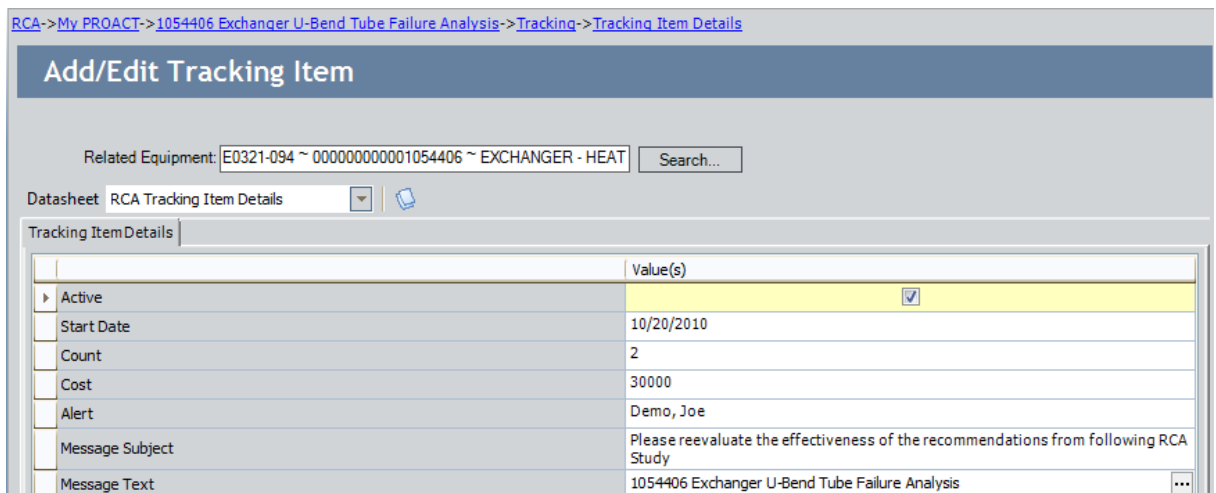

Viewing the Contents of RCA Tracking Item Records

To view the contents of an RCA Tracking Item record:

- On the [Analysis Tracking Items page](#), in the row representing the RCA Tracking Item record whose contents you want to view, in the **Start Date** cell, click the hyper-linked start date.

The **Tracking Item Details** page appears, displaying the contents of the selected record.

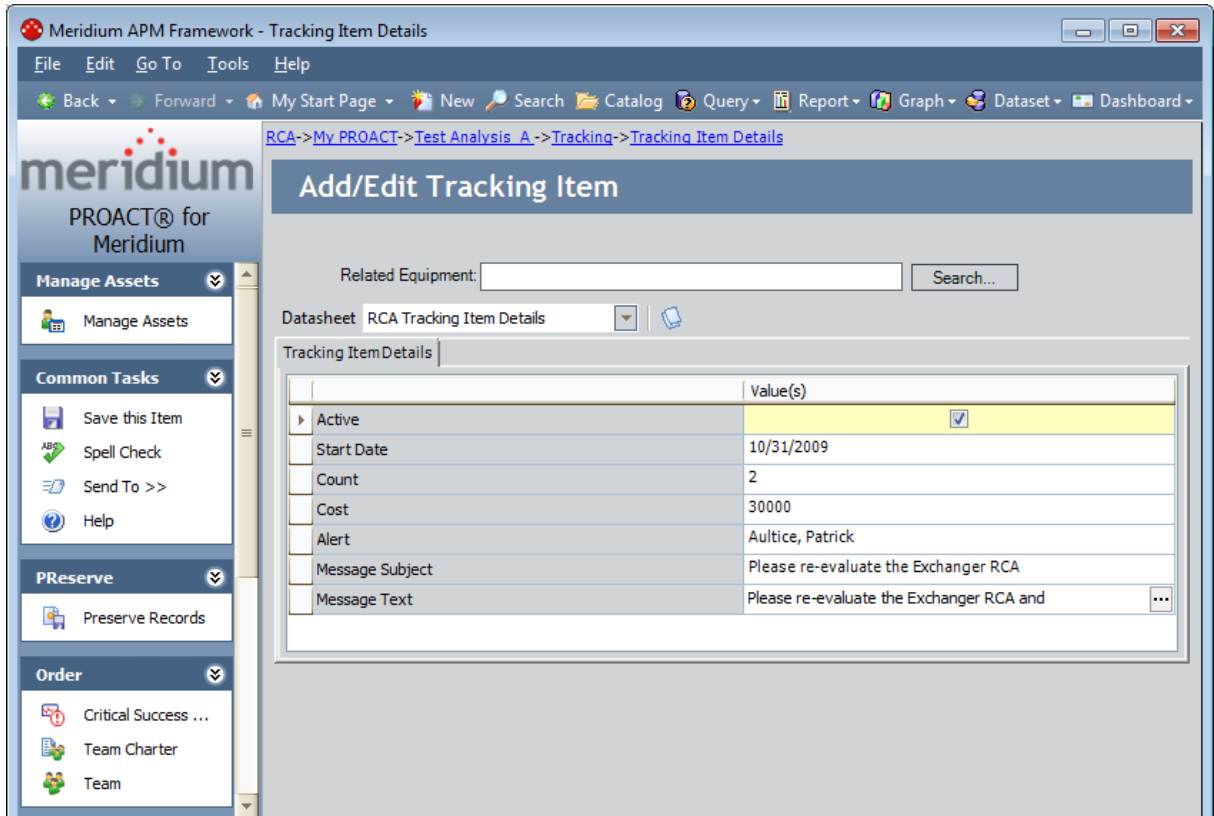

Modifying Existing RCA Tracking Item Records

To modify the RCA Tracking Item record:

1. [Open the RCA Tracking Record whose contents you want to modify.](#)
2. Modify the contents of the record as desired.
3. On the **Common Tasks** menu, click the **Save this Item** link.

Your changes are saved to the database, and the **Analysis Tracking Items** page appears.

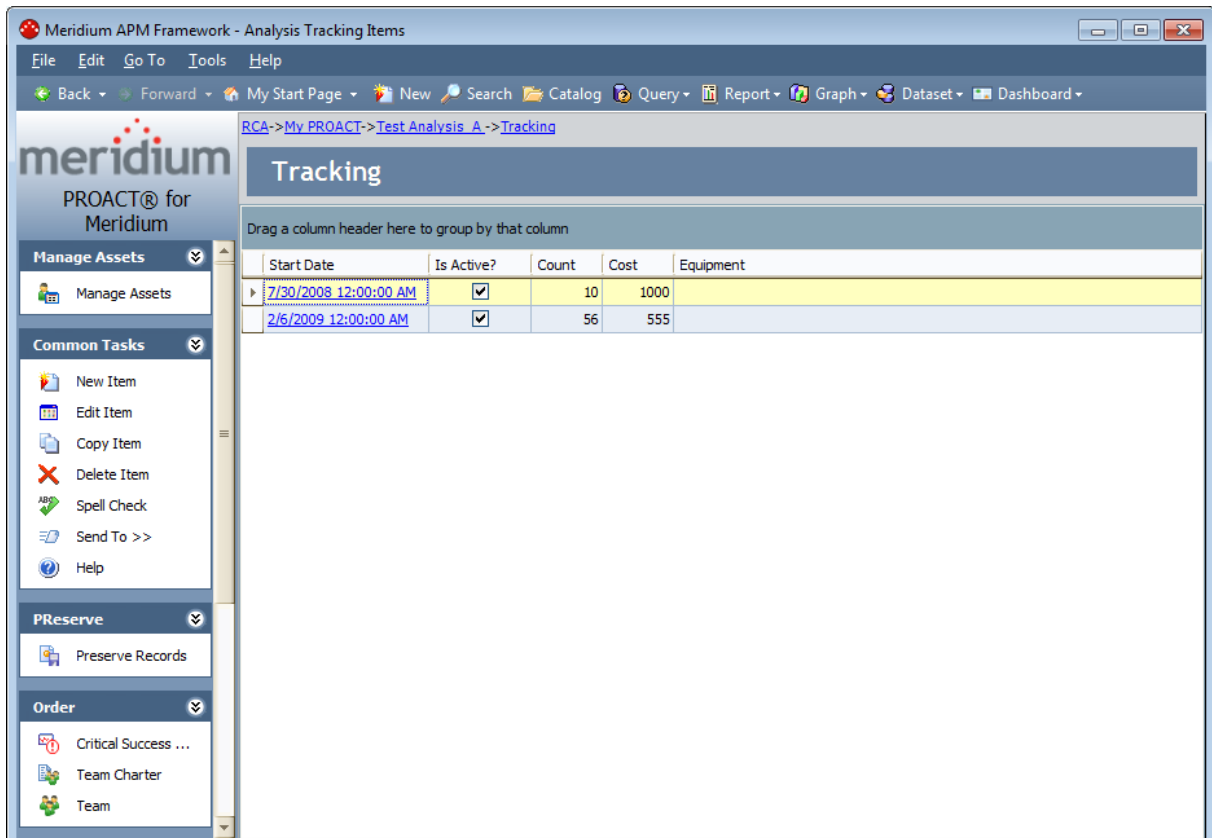

Copying RCA Tracking Item Records

You can copy an RCA Tracking Item record in order to create the same tracking item for similar equipment and locations related to an RCA Analysis.

To copy an RCA Tracking Item record:

1. On the **Analysis Tracking Items** page, select an RCA Tracking Item that you wish to copy from the **Tracking** grid.
2. On the **Common Tasks** menu, click the **Copy Item** link.

The **Tracking Item Details** page appears, displaying a copy of the RCA Tracking Item record you selected. The values in all of the fields on the RCA Tracking Item Details datasheet are copied except for the value in the **Related Equipment** text box.

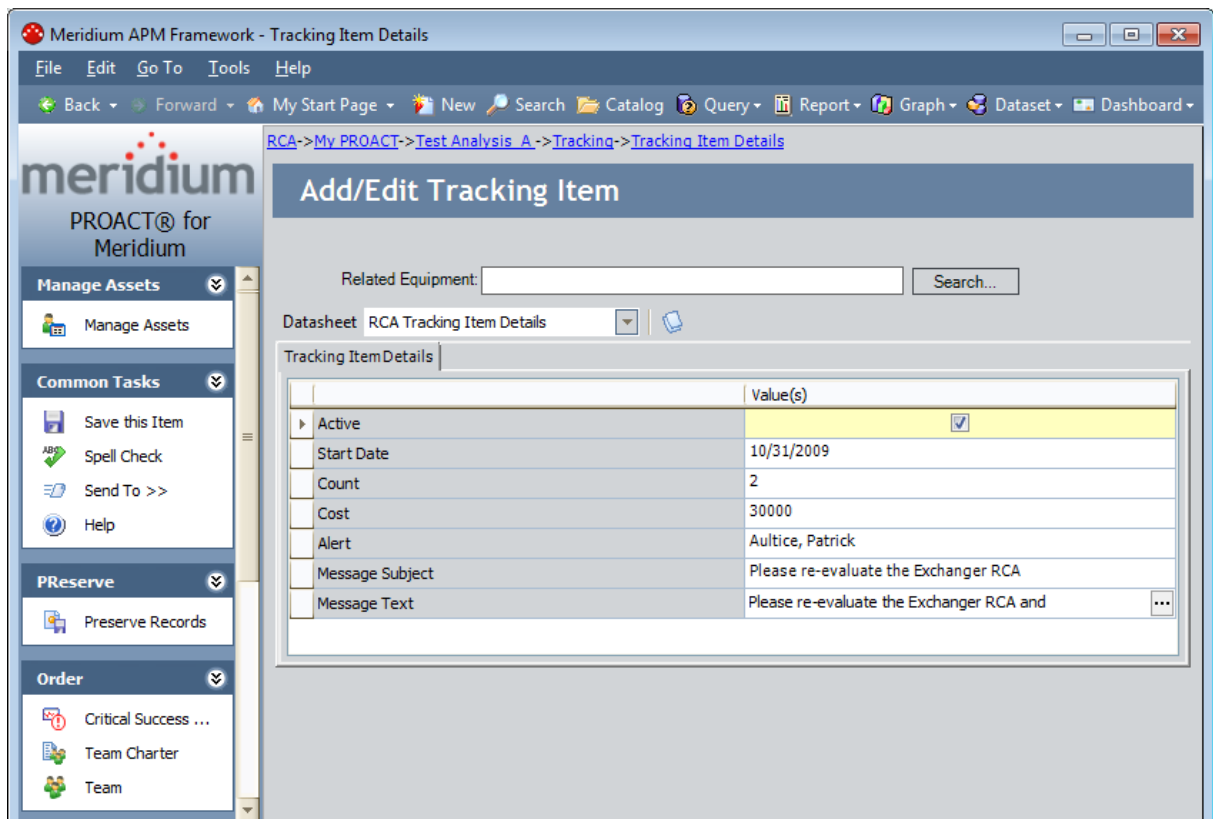

3. [Link an Equipment or Functional Location record to the RCA Tracking Item record.](#)
4. Modify the rest of the contents in the RCA Tracking Item Details datasheet as desired.
5. On the **Common Tasks** menu, click the **Save this Item** link.

Your changes are saved to the database, and the **Analysis Tracking Items** page appears.

Copying RCA Tracking Item Records

The screenshot shows the Meridium APM Framework interface. The main window title is "Meridium APM Framework - Analysis Tracking Items". The breadcrumb navigation path is "RCA->My PROACT->Test Analysis A->Tracking". The left sidebar contains several sections: "Manage Assets" with a "Manage Assets" button; "Common Tasks" with buttons for "New Item", "Edit Item", "Copy Item", "Delete Item", "Spell Check", "Send To >>", and "Help"; "PReserve" with a "Preserve Records" button; and "Order" with buttons for "Critical Success ...", "Team Charter", and "Team".

The main content area displays a table with the following data:

| Start Date | Is Active? | Count | Cost | Equipment |
|-----------------------|-------------------------------------|-------|------|-----------|
| 7/30/2008 12:00:00 AM | <input checked="" type="checkbox"/> | 10 | 1000 | |
| 2/6/2009 12:00:00 AM | <input checked="" type="checkbox"/> | 56 | 555 | |

Deleting RCA Tracking Item Records

To delete an existing RCA Tracking Item record:

1. On the [Analysis Tracking Items page](#), in the list of RCA Tracking Item records, select the row representing the RCA Tracking Item that you want to delete.

| Start Date | Is Active? | Count | Cost | Equipment |
|---|-------------------------------------|-------|------|----------------------------|
| 6/8/2011 12:00:00 AM | <input checked="" type="checkbox"/> | 0 | 0 | CMP-0221 PROPANE REFRIG. |
| ▶ 6/17/2011 12:00:00 AM | <input checked="" type="checkbox"/> | 0 | 0 | AQA PMP-8281 ACID BLOWDOWN |

2. On the **Common Tasks** menu, click the **Delete Item** link.

A confirmation message appears, asking if you really want to delete the item.

3. Click the **Yes** button.

The record is removed from the list of RCA Tracking Item records and deleted from the Meridium APM database.

| Start Date | Is Active? | Count | Cost | Equipment |
|--|-------------------------------------|-------|------|--------------------------|
| ▶ 6/8/2011 12:00:00 AM | <input checked="" type="checkbox"/> | 0 | 0 | CMP-0221 PROPANE REFRIG. |

About the Spell Check Feature

You can use the spell check feature to search for spelling errors in a Root Cause Analysis. When you use the spell check feature, the Meridium APM system checks the spelling of the values in text and character fields of the following records within an RCA Analysis:

- RCA Preserve Item
- RCA Critical Success Factor
- RCA Sequence Node
- RCA Logic Gate
- RCA Failure Mode
- RCA Hypothesis
- RCA Verification
- RCA Build List Item
- RCA Recommendation
- RCA Tracking Item
- RCA Analysis

If a word in a field is misspelled according to the [language specified for the spell check feature](#), the Meridium APM system will display alternative words that you can choose to use in place of the misspelled word.

Note: Fields containing HTML or XML tags will be ignored by the spell check feature.

The Spell Check feature is accessible via the **Spell Check** link, which is located on the **Tree Tasks** menu on the **Logic Tree** page and the **Common Tasks** menu on the following pages:

- **Preserve Failure Data**
- **Critical Success Factors**
- **Team**
- **Event Diagram**
- **Communicate Records**
- **Reports List**
- **Analysis Tracking Items**

Note: For unpublished analyses, the **Spell Check** link is always enabled. For published analyses, it is disabled on all pages except the **Communicate Records** and the **Recommendation Details** pages. It is enabled on these pages for published analyses only if you are a Super User, a member of the MI PROACT Administrator Security Group, or the Principal Analyst for the analysis.

Checking the Spelling in an Analysis

To use the spell check feature:

1. On the **Common Tasks** menu, click the **Spell Check** link.

The **Spell Check** dialog window appears.

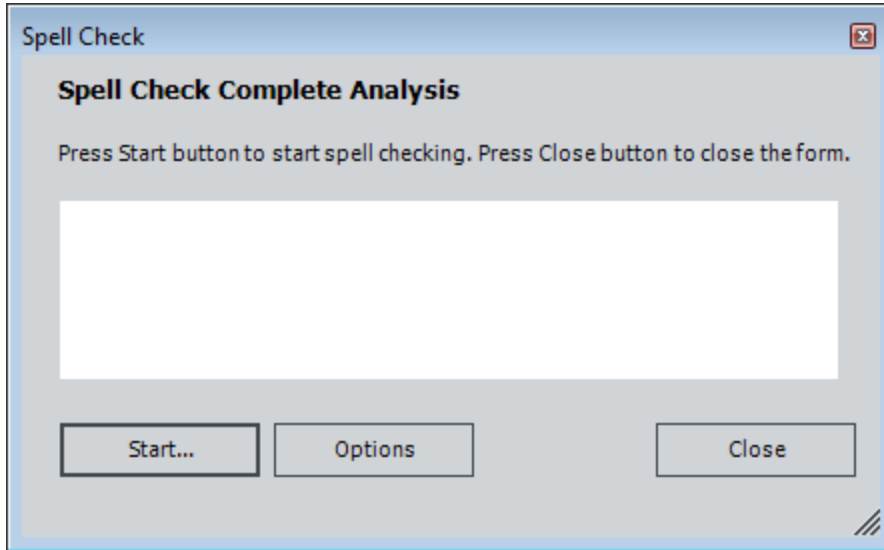

2. To start checking the spelling in the analysis, click the **Start** button.

Note: When you start the spell check operation, the *currently selected* dictionary will be used automatically. If this is the first time you have accessed the spell check feature, the Meridium APM system will automatically select a dictionary that corresponds to your Meridium APM Culture setting, if one is available. If a dictionary is not available for your Meridium APM Culture setting or you do not have a Meridium APM Culture setting defined, the English dictionary will be used. You can [change the language by clicking the Options button](#).

If one or more misspelled words are found, the **Word Not Found** dialog box appears, displaying the misspelled word, the family of the misspelled word, and the number of records that are being checked in the RCA Analysis. If NO misspelled words are found, the **Spelling** dialog box appears, notifying you that the check is complete.

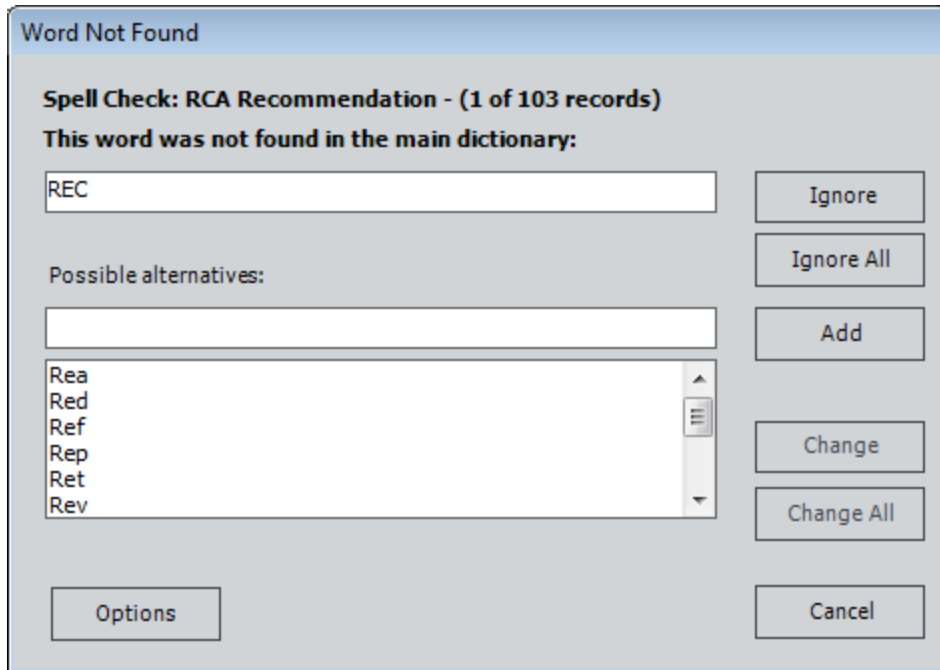

3. If the spell check feature finds misspelled words, click one of the following buttons on the **Word Not Found** dialog box:
- **Ignore:** Ignores the selected word and continues to the next misspelled word.
 - **Ignore All:** Ignores all instances of the selected word in the analysis and continues to the next misspelled word.
 - **Change:** Replaces the selected word with a word you select from the **Possible Alternatives** list.
 - **Change All:** Replaces all instances of this word in the analysis with a word you select from the **Possible Alternatives** list.
 - **Add:** Adds the selected word to the dictionary. After you add the word to the dictionary, it will no longer be considered misspelled, and the spell check feature will continue to the next misspelled record.
 - **Cancel:** Cancels the spell check and closes the **Word Not Found** dialog box.
 - **Options:** Displays the **Spelling Options** dialog box, where you can [specify a new language for the dictionary](#).

When the spell check process is complete, the **Spelling** dialog box appears.

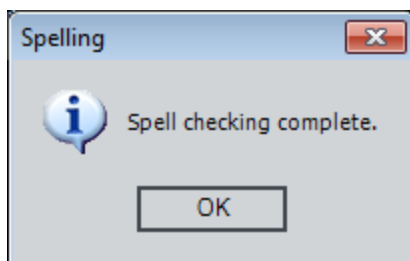

4. Click **OK**. The **Spell Check** dialog box returns to focus. If you are done using the spell check feature, click the **Close** button.

Specifying a Language for the Dictionary

When you initiate the spell check operation, a dictionary will be selected for you by default. The first time you access the spell check feature, the Meridium APM system will automatically select the dictionary associated with your Meridium APM Culture setting (if one is available). If a dictionary is not available for your Meridium APM Culture setting or you do not have a Meridium APM Culture setting defined, the English dictionary will be used. If desired, you can modify the default dictionary selection. If you do so, *that* language will be selected automatically the next time you access the spell check feature.

To specify the language to be used by the spell check feature:

1. On the [Spell Check window](#) or the [Word Not Found window](#), click the **Options** button.

The **Spelling Options** dialog box appears.

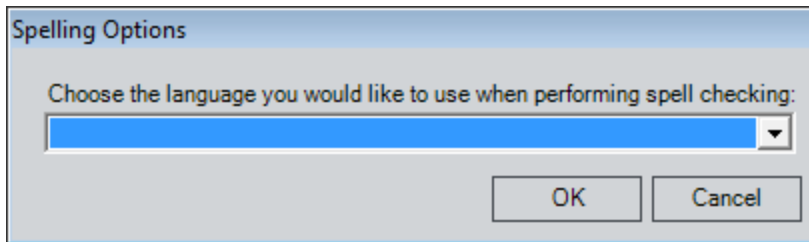

2. Click one of the available options from the **Choose the language you would like to use when performing spell checking**.
3. Click **OK**.

The language you selected will now be used by default each time you access the spell check feature.

Accessing the My PROACT Page

The **My PROACT** page which contains a list of the in-progress (unpublished) RCA Analyses to which you belong and lists of all assigned task items, including RCA Preserve Item records, RCA Verification records, and RCA Recommendation records.

To access the **My PROACT** page:

- On the **Root Cause Analysis Start Page**, click the **My PROACT** link.

The **My PROACT** page appears.

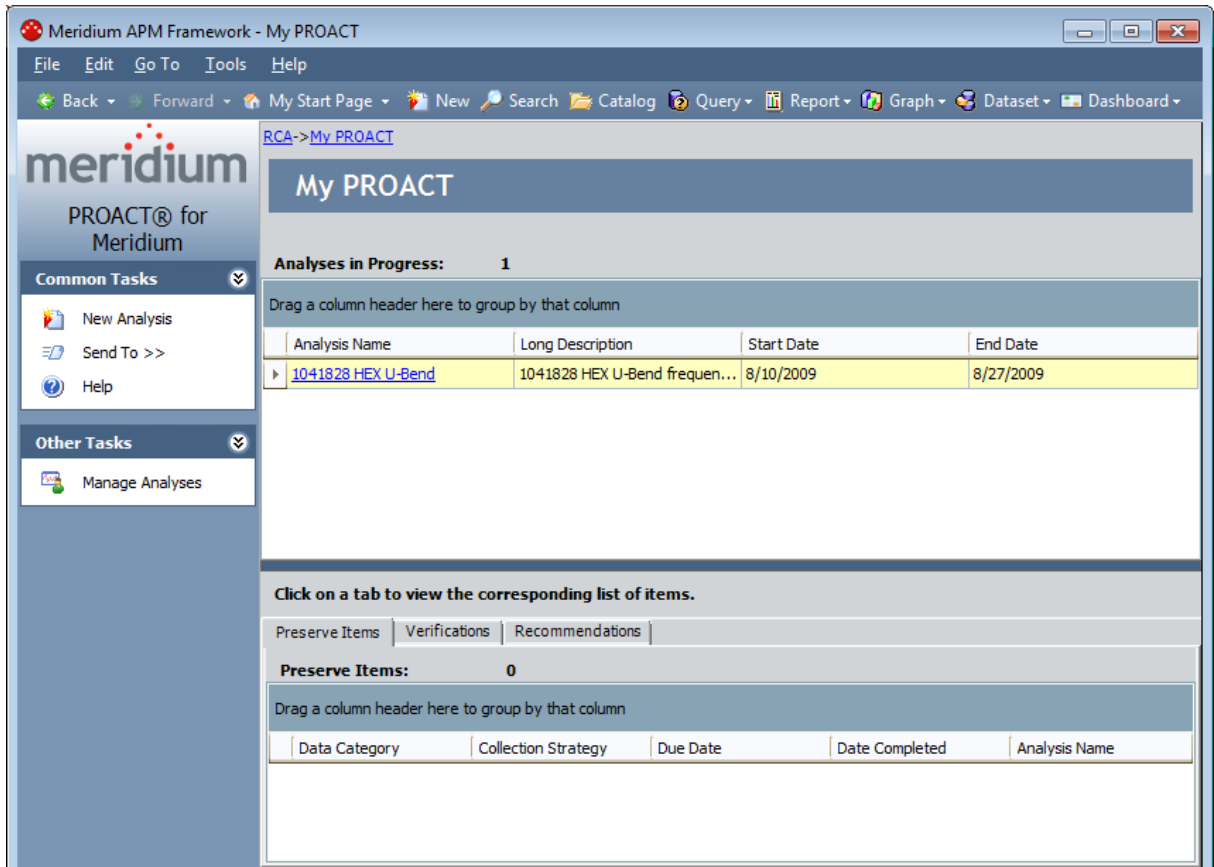

Aspects of the My PROACT Page

The **My PROACT** page displays a list of all of the unpublished RCA Analyses where you are a member of the RCA Analysis Team. It provides you with a central location for viewing the list of the RCA Analyses and the assigned open task items associated with those RCA Analyses. When an RCA Analysis is in progress, only the team members and the Principal Analyst can view the associated data. An example of the **My PROACT** page is shown in the following image.

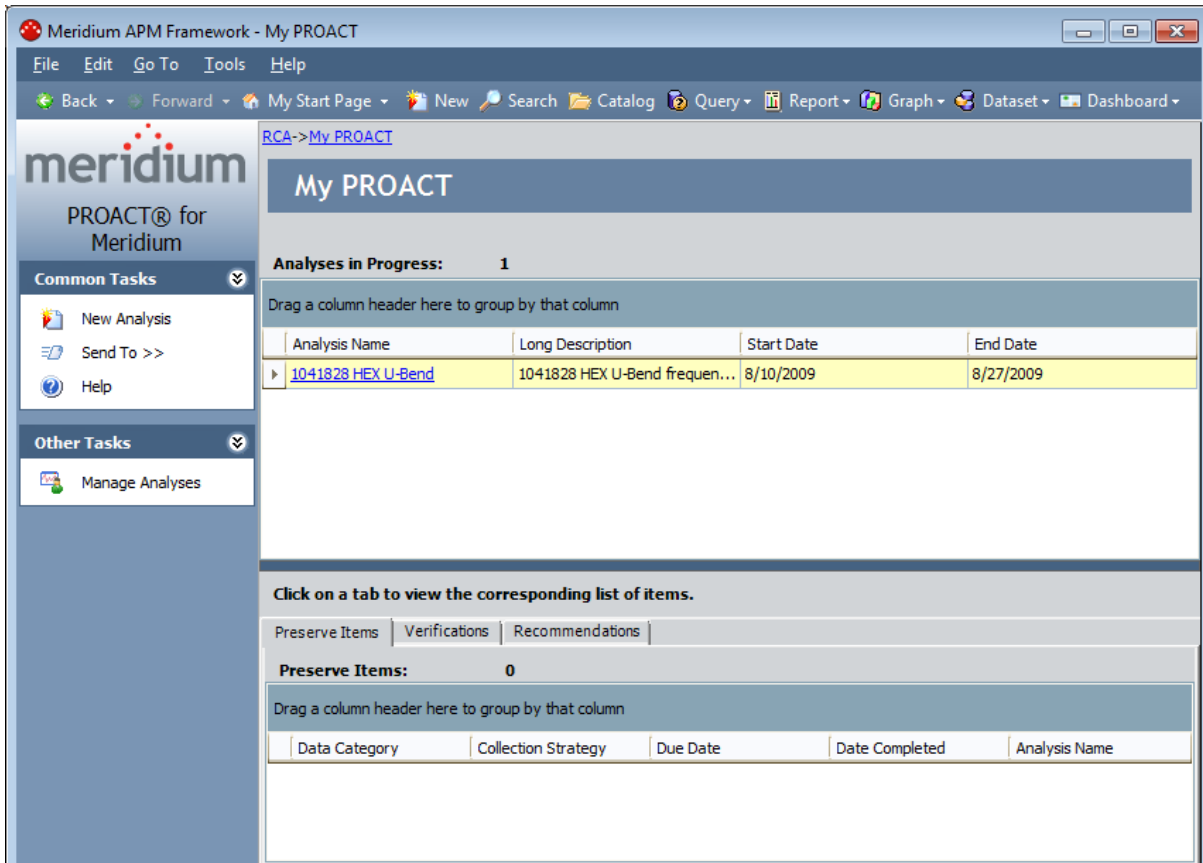

The **My PROACT** page consists of two sections:

- The **Analyses in Progress** section displays following columns of information for each RCA Analysis:

- **Analysis Name:** The name assigned to the RCA Analysis. You can click the hyperlinked analysis name to view the associated RCA Analysis record.

Note: The **Analysis Name** field is locked in the first position on the grid.

- **Long Description:** A description of the RCA Analysis.
- **Start Date:** The start date of the RCA Analysis.
- **End Date:** The date when the RCA Analysis has been completed, if applicable.

You can click the hyperlinked analysis name to [view the details of the RCA Analysis](#).

- The **Preserve Items, Verifications, and Recommendations tabs** section appear at the bottom of the **My PROACT** page to let you view and manage all RCA Preserve Item records, RCA Verification records, and RCA Recommendation records that are assigned to you. To view the details for a particular type of item, click the corresponding tab:
 - **Preserve Items:** Displays a list of all incomplete RCA Preserve Item records for the RCA Analyses to which you belong. RCA Preserve Item records will be displayed as they are created and assigned.
 - **Verifications:** Contains a list of the incomplete RCA Verification records for the RCA Analyses to which you belong. RCA Verification records will be displayed as they are created and assigned.
 - **Recommendations:** Contains a list of the RCA Recommendation records for the RCA Analyses to which you belong. Recommendations will be displayed as they are created and assigned.

Additionally, each tab displays the number of items that appear in the list on that tab. The items in the list on each tab are color-coded according to due date for easy tracking:

- **No color (the default white background):** The item is due two weeks or more from the current date.
- **Yellow:** The item is due within two weeks of the current date.
- **Red:** The item is due today or is overdue.
- **Green:** The item has been completed.

Note: After an RCA Analysis is published, assigned items associated with it are removed from the **Preserve Items, Verifications, and Recommendations** tabs.

The **My PROACT** page contains the following task menus that provide access to Root Cause Analysis functions: [Common Tasks](#) and [Other Tasks](#).

Common Tasks Menu

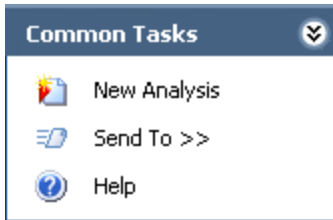

The **Common Tasks** menu on the **My PROACT** page contains the following links:

- **New Analysis:** Displays the **New Analysis Builder**, which will guide you step-by-step through [the initial steps required for a new RCA Analysis](#).
- **Send To:** Displays a submenu with options that let you provide a link to the current page on your desktop (create shortcut), in an email message, or on a Home Page.
- **Help:** Displays the context-sensitive Help topic for the **My PROACT** page.

Other Tasks Menu

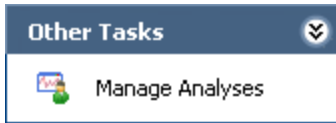

The **Other Tasks** menu on the **My PROACT** page contains the following link:

- **Manage Analyses:** Displays the **Manage Analyses** page, where you can [view all of the analyses of which you are member](#), regardless of the state.

Viewing the Details of an Analysis

From the **My PROACT** page, you can view the details of any RCA Analysis that appears in the list of existing RCA Analyses.

To view the details of an analysis:

- On the **My PROACT** page, in the **Analyses in Progress** list that appears at the top of the page, click the hyperlinked name of the RCA Analysis whose RCA Analysis record you want to view.

The **Analysis** page appears.

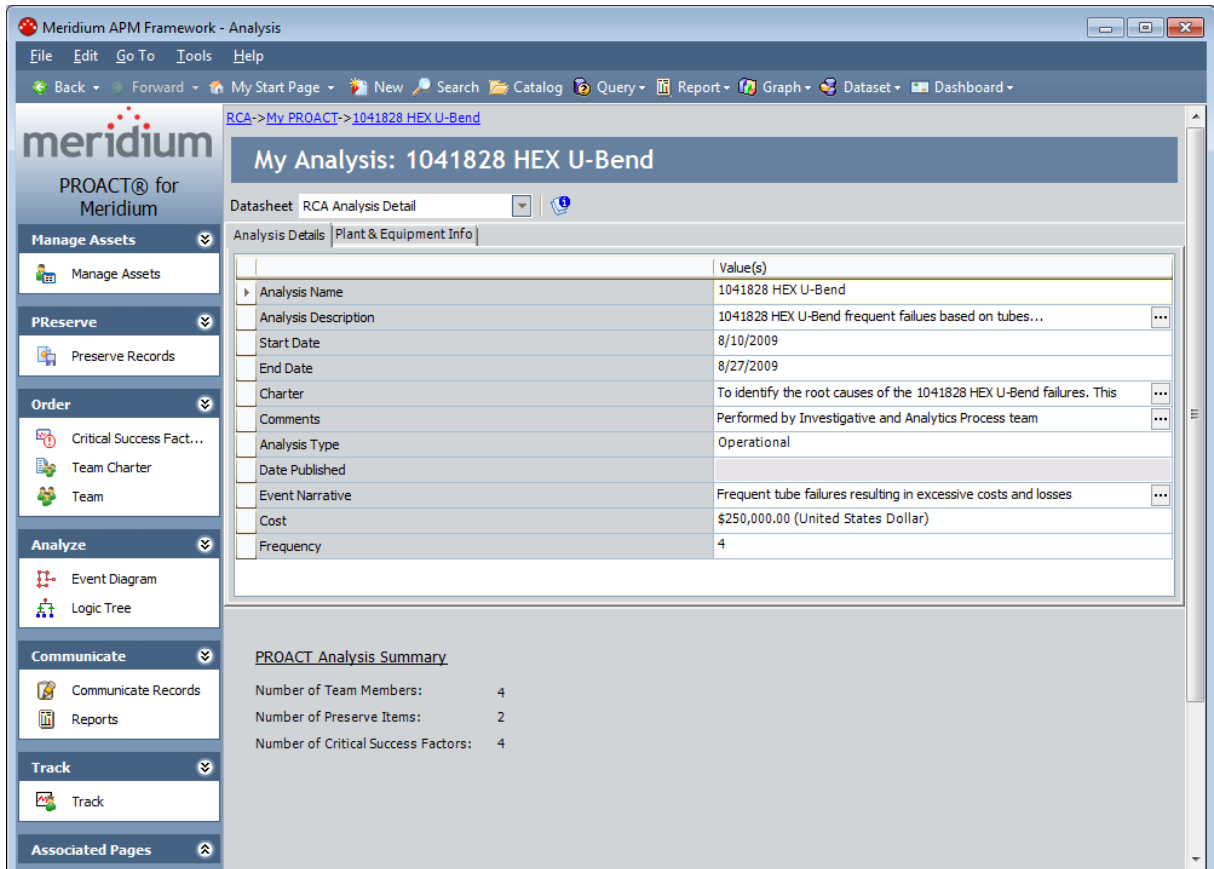

Viewing the Details of a Preserve Item

From the **My PROACT** page, you can view the details for any RCA Preserve Item record that is listed on the **Preserve Items** tab at the bottom of the page.

To view the details of an RCA Preserve Item record:

1. On the **My PROACT** page, in the **Preserve Items, Verifications, and Recommendations** tabs section, click the **Preserve Items** tab to view a list of RCA Preserve Item records.
2. In the list of RCA Preserve Items, in the **Data Category** column, click the hyper-linked value for the record that you want to view.

The **Preserve Record Details** page appears.

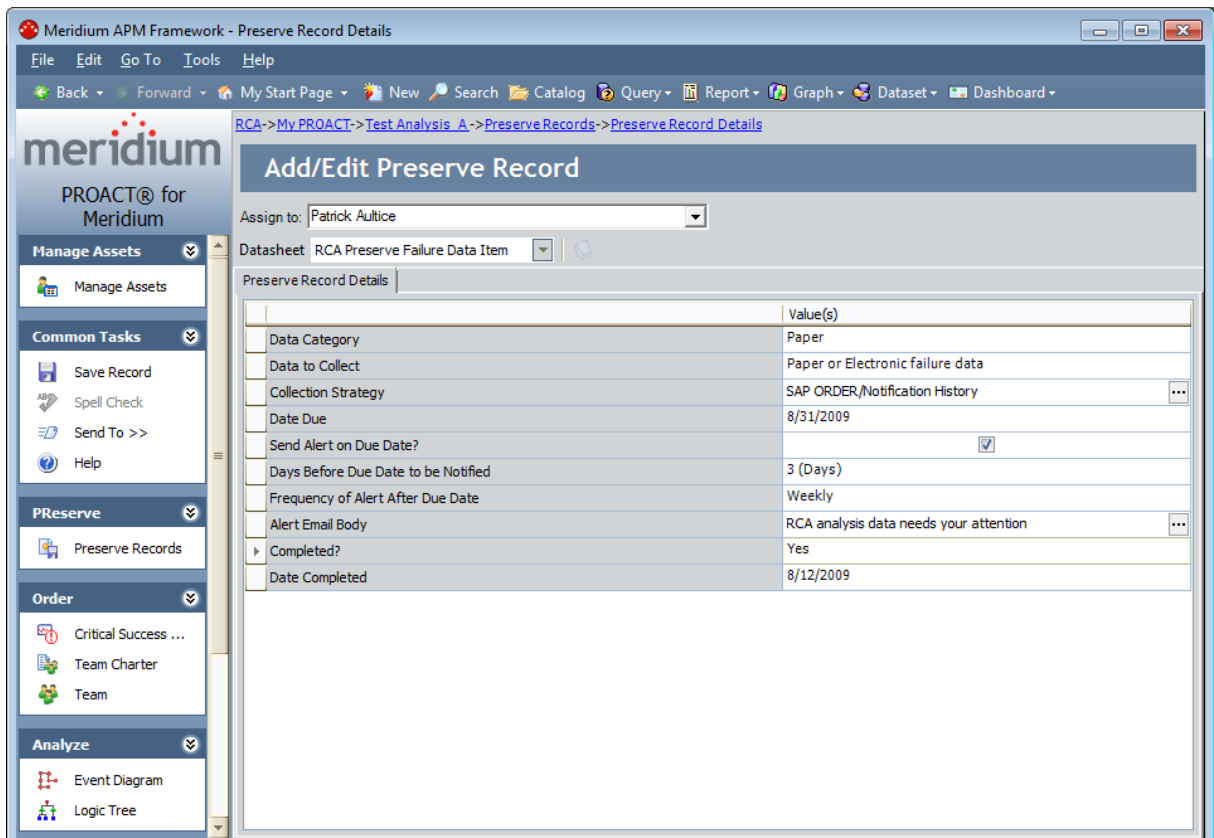

Viewing the Details of an RCA Verification Record

On the **My PROACT** page, you can view the details for any RCA Verification record that is listed on the **Verifications** tab at the bottom of the page. An RCA Verification record will appear on the **Verifications** tab only if it assigned to you.

To view the details of an RCA Verification record:

1. On the **My PROACT** page, in the **Preserve Items, Verification, and Recommendations** tab section, click the **Verifications** tab to view a list of RCA Verification records.
2. In the list of RCA Verification records, in the **Verification Method** column, click the hyperlinked value for the record that you want to view.

The **RCA Verification** dialog box appears.

| | Value(s) |
|-------------------------------------|--------------------------|
| Method | Test Verification |
| Outcome | |
| Due Date | 2/6/2009 |
| Send Alert on Due Date? | <input type="checkbox"/> |
| Days Before Due Date to be Notified | |
| Frequency of Alert After Due Date | |
| Alert Email Text | |

Viewing the Details of an RCA Recommendation Record

On the **My PROACT** page, you can view the details for any RCA Recommendation record that is listed on the **Recommendations** tab at the bottom of the page.

To view the details of an RCA Recommendation record:

1. On the **My PROACT** page, in the **Preserve Items, Verifications, and Recommendations** tabs section, click the **Recommendations** tab to view a list of RCA Recommendation records.
2. In the list of RCA Recommendation records, in the **Description** column, click the hyperlinked value for the record that you want to view.

The **Recommendation Details** page appears.

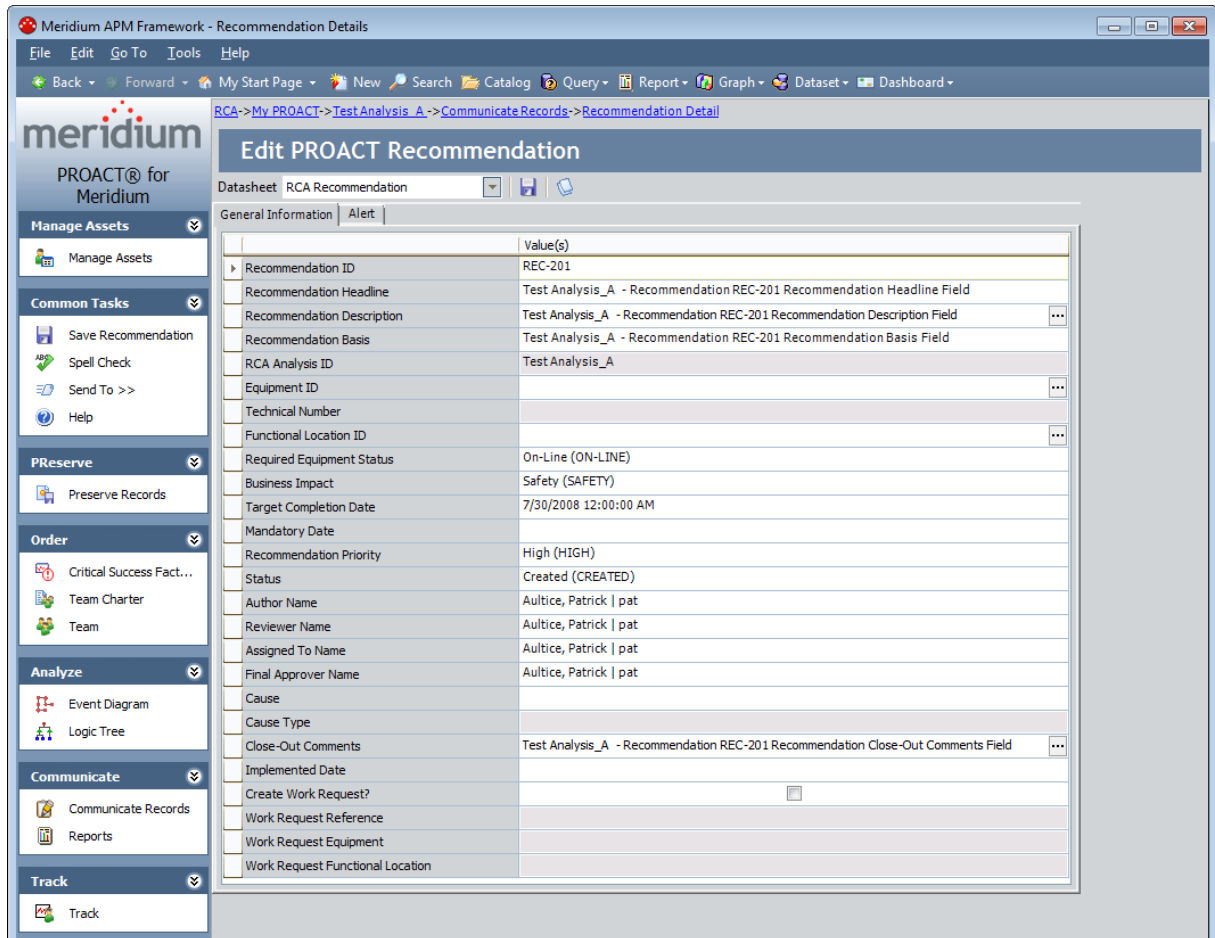

About the Principal Analyst's View

The Principal Analyst facilitates, organizes, and manages the RCA Analysis process. In Root Cause Analysis, when a user completes the initial steps required for an RCA Analysis, that user is designated automatically as the Principal Analyst. Each RCA user has access to the Principal Analyst's view for the RCA Analyses they have initiated via the **New Analysis Builder**. The [PA PROACT page](#) displays the *Principal Analyst's view*.

Via the **PA PROACT** page, you can review all tasks assigned to all team members for any RCA Analysis that you have initialized. If you have not completed the initial steps required for an active RCA Analysis, your **PA PROACT** page will be empty. When you select an RCA Analysis from the list, the open items (e.g., RCA Preserve Item records, RCA Verification records, RCA Recommendation records) associated with the selected RCA Analysis appear on a series of tabs. You can select a items on each tab to view the current status of the item.

In addition, on the **PA PROACT** page, you can create notifications to alert team members of overdue RCA Preserve Item records and RCA Verification records. You can also send notifications to the team member who is responsible for an RCA Recommendation record.

Items with blank assignments will be listed on the **PA PROACT** page to allow you to track the items. If a team member is removed from the RCA Analysis, any item that was previously assigned to the deleted team member (e.g., RCA Verification record) will be displayed on the **PA PROACT** page, where you can reassign those items to another team member.

Accessing the PA PROACT Page

From the PA PROACT page, you can view the list of RCA Analyses for which you are currently serving as the Principal Analyst. In addition, you can view and manage the tasks associated with the RCA Analysis (e.g., RCA Preserve Item records, RCA Verification records, and RCA Recommendation records) and the team members to whom the tasks are assigned.

To access the PA PROACT page:

- On the Root Cause Analysis Start Page, click the **Principal Analyst's View** link.

The PA PROACT page appears.

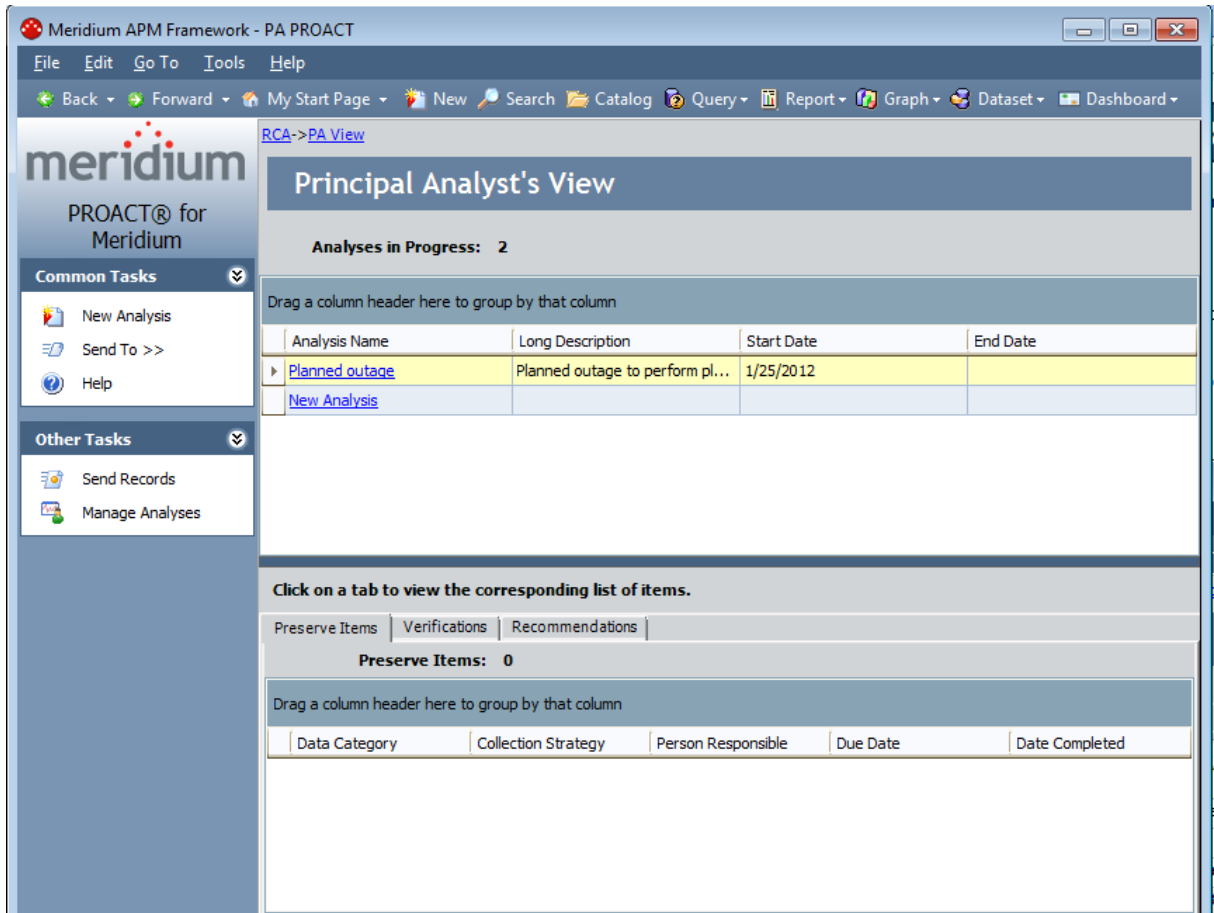

Aspects of the PA PROACT Page

The **PA PROACT** page displays a list of RCA Analyses for which you are currently serving as the Principal Analyst. In addition, on the **PA PROACT** page, you can view and manage the tasks associated with the RCA Analysis (e.g., RCA Preserve Item records, RCA Verification records, and RCA Recommendation records) and the team members to whom the tasks are assigned.

The **PA PROACT** page consists of two sections:

- The **Analyses in Progress** section contains a list of active analysis for which you are currently serving as the Principal Analyst. By default, the following analysis properties are shown for each analysis that appears in the list.
 - **Analysis Name:** The name assigned to this analysis. Click an Analysis Name to view the summary for the selected analysis. The name assigned to this analysis. Click an Analysis Name to view the summary for the selected analysis.
- Note:** This field is locked in the first position on the grid.
- **Long Description:** A description of the analysis.

- **Start Date:** The start date of the analysis and the time are listed in this field.
- **End Date:** The end date of the analysis and the time are listed in this field.
- The **Preserve Items, Verifications, and Recommendations tab** section appears below the list of analyses. Each tab contains a list of items that are linked to the analyses in the **Analyses in Progress** list. Only the unpublished analyses to which the Principal Analyst is assigned will appear in the list.

The following tabs are displayed:

- **Preserve Items:** Displays a list of the RCA Preserve Item records associated with the selected analysis.
- **Verifications:** Displays a list of the RCA Verification records associated with the selected analysis.
- **Recommendations:** Display a list of the RCA Recommendation records associated with the selected analysis.

The items in the list on each tab are color-coded according to due date for easy tracking:

- **No color (the default white background):** The item is due two weeks or more from the current date.
- **Yellow:** The item is due within two weeks of the current date.
- **Red:** The item is due today or is overdue.
- **Green:** The item has been completed.

Items with blank assignments will be listed on the **PA PROACT** page to allow the Principal Analyst to track the items. If a team member is deleted, the analysis task (the RCA Preserve Item Record, RCA Verification Record, or RCA Recommendation record) that was previously assigned to the deleted team member will appear on the **PA PROACT** page. The Principal Analyst can then re-assign those items to another team member.

Common Tasks Menu

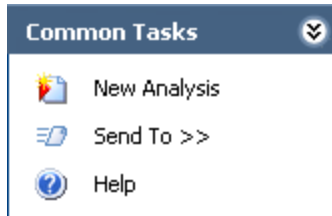

The **Common Tasks** menu on the **PA PROACT** page contains the following links:

- **New Analysis:** Displays the **New Analysis Builder**, which will guide you step-by-step through [the initial steps required for a new RCA Analysis](#).
- **Send To:** Displays a submenu with options that let you provide a link to the current page on your desktop (create shortcut), in an email message, or on a Home Page.
- **Help:** Displays the context-sensitive Help topic for the **PA PROACT** page.

Other Tasks Menu

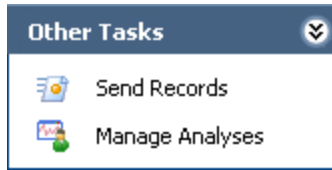

The **Other Tasks** menu on the **PA PROACT** page contains the following links:

- **Send Records:** Allows the Principal Analyst to [send an email message](#) to the RCA Analysis Team member who is responsible for an overdue item (an RCA Preserve Item record or an RCA Verification record) that is being tracked.
- **Manage Analyses:** Displays the **Manage Analyses** page, where you can [view all of the analyses of which you are member](#), regardless of the state.

Viewing the Details of an In-Progress RCA Analysis

To view the details of an in-progress RCA Analysis:

1. On the [PA PROACT page](#), in the **Analyses in Progress** section, select the row containing the RCA Analysis for which you want to display the details.
2. Click the hyperlinked name of the RCA Analysis in the **Analysis Name** column.

The **Analysis** page appears.

The screenshot displays the Meridium APM Framework - Analysis interface. The main content area shows the details for an analysis titled "My Analysis: 1041828 HEX U-Bend". The interface includes a navigation menu on the left with sections like "Manage Assets", "PReserve", "Order", "Analyze", "Communicate", "Track", and "Associated Pages". The main content area is divided into two tabs: "Analysis Details" (selected) and "Plant & Equipment Info". The "Analysis Details" tab contains a table with the following data:

| | Value(s) |
|----------------------|--|
| Analysis Name | 1041828 HEX U-Bend |
| Analysis Description | 1041828 HEX U-Bend frequent failues based on tubes... |
| Start Date | 8/10/2009 |
| End Date | 8/27/2009 |
| Charter | To identify the root causes of the 1041828 HEX U-Bend failures. This |
| Comments | Performed by Investigative and Analytics Process team |
| Analysis Type | Operational |
| Date Published | |
| Event Narrative | Frequent tube failures resulting in excessive costs and losses |
| Cost | \$250,000.00 (United States Dollar) |
| Frequency | 4 |

Below the table, there is a section titled "PROACT Analysis Summary" with the following data:

| | |
|-------------------------------------|---|
| Number of Team Members: | 4 |
| Number of Preserve Items: | 2 |
| Number of Critical Success Factors: | 4 |

Viewing Assigned Incomplete RCA Preserve Item Records

You can view the RCA Preserve Item records assigned for a selected unpublished RCA Analysis for which you are the Principal Analyst.

To view an RCA Preserve Item record:

1. On the [PA PROACT page](#), in the **Analyses in Progress** section, click the row containing the RCA Analysis for which you want to display items.
2. Click the **Preserve Items** tab at the bottom of the page.

All of the RCA Preserve Item records for the selected RCA Analysis appear in the list on the **Preserve Items** tab. A color is assigned to each RCA Preserve Item record according to the due date.

[RCA->PA View](#)

Principal Analyst's View

Analyses in Progress: 2

Drag a column header here to group by that column

| Analysis Name | Long Description | Start Date | End Date |
|---------------------------------|------------------|------------|----------|
| ▶ Test Analysis | | | |
| Sample Analysis | | | |

Click on a tab to view the corresponding list of items.

Preserve Items | Verifications | Recommendations

Preserve Items: 1

Drag a column header here to group by that column

| Data Category | Collection Strategy | Person Respon... | Due Date | Date Completed |
|---------------|--------------------------|------------------|-----------|----------------|
| ▶ Parts | Test Collection Strategy | Rebecca Sweeney | 3/31/2011 | |

The following details are displayed for each Preserve Item in the list.

- **Data Category:** A data collection procedure based on five categories, called the 5

P's, provides a guide for organizing data that is relative to the problem that the RCA Analysis Team wishes to analyze.

- **Collection Strategy:** A description of the exact manner in which the data will be collected. An example of a strategy for collecting data could be acquiring production logs from a line supervisor.
 - **Person Responsible:** The name of the team member to whom this task is assigned.
 - **Due Date:** The deadline for collecting the failure data.
 - **Date Completed:** The date on which the task was completed. This field is automatically populated when the assigned team member has finished collecting the data for the RCA Preserve Item record.
3. Click the hyperlinked value in the Data Category column that corresponds to the record that you want to view or modify.

The RCA Preserve Item record appears on the **Preserve Record Details** page.

4. Modify the record as desired.
5. On the **Common Tasks** menu, click the **Save Record** link.

Your changes are saved to the database and the **PA PROACT** page reappears.

Viewing and Modifying Assigned RCA Verification Records

You can view the RCA Verification records that are linked to a selected unpublished RCA Analysis for which you are the Principal Analyst. From the **Verifications** tab, you can select an RCA Verification record that you want to review.

To view assigned RCA Verification records:

1. On the [PA PROACT page](#), in the **Analyses in Progress** section, click the row containing the RCA Analysis for which you want to display items.
2. In the **Preserve Items, Verifications, and Recommendations tabs** section, click the **Verifications** tab.

All the RCA Verification records for the selected RCA Analysis appear in the list on the **Verifications** tab. A color is assigned to each RCA Verification record according to the due date.

[RCA->My PROACT](#)

My PROACT

Analyses in Progress: 3

Drag a column header here to group by that column

| Analysis Name | Long Description | Start Date | End Date |
|-----------------------------------|--------------------------|------------|----------|
| ▶ Test Analysis_A | Test Analysis_A - Ana... | 7/30/2008 | 8/6/2008 |
| Test Analysis | | | |
| Sample Analysis | | | |

Click on a tab to view the corresponding list of items.

Preserve Items | **Verifications** | Recommendations

Verifications: 1

Drag a column header here to group by that column

| Verification Method | Due Date | Date Completed |
|-------------------------------------|-----------|----------------|
| ▶ Test Verification | 3/31/2011 | |

The following details are displayed for each RCA Verification record in the list:

- **Verification Method:** The method utilized to prove that a hypothesis is true or not

true (e.g., Data analysis, lube oil analysis, stress analysis, visual inspection, interviews).

- **Person Responsible:** The name of the team member to whom this task is assigned.
 - **Due Date:** The deadline when the verification should be completed.
 - **Date Completed:** The date on which the verification is completed. This field is automatically populated when the assigned team member has completed the verification process.
3. Click the hyperlinked value in the **Verification Method** column that corresponds to the record that you want to view or modify.

The **RCA Verification** dialog box appears, displaying the RCA Verification data-sheet.

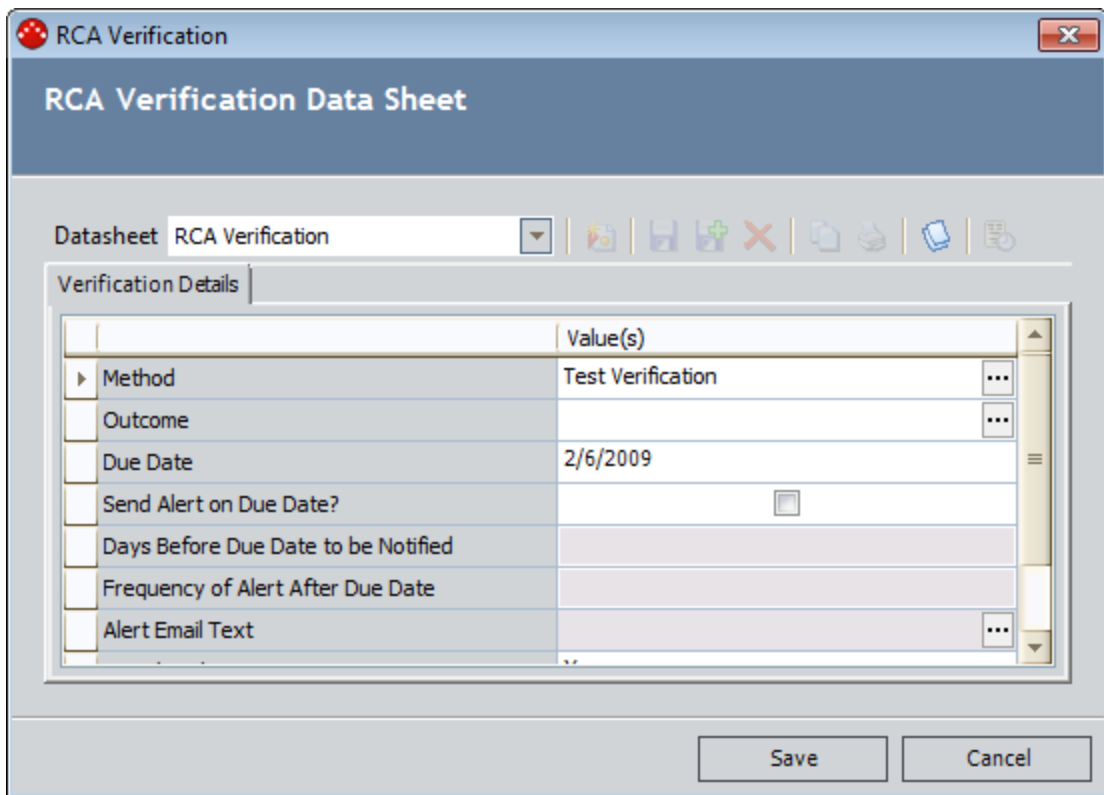

The screenshot shows a dialog box titled "RCA Verification" with a sub-header "RCA Verification Data Sheet". Below the header is a "Datasheet" dropdown menu set to "RCA Verification" and a toolbar with icons for file operations. The main area is a table with the following data:

| | Value(s) |
|-------------------------------------|--------------------------|
| Method | Test Verification |
| Outcome | |
| Due Date | 2/6/2009 |
| Send Alert on Due Date? | <input type="checkbox"/> |
| Days Before Due Date to be Notified | |
| Frequency of Alert After Due Date | |
| Alert Email Text | |

At the bottom of the dialog box are "Save" and "Cancel" buttons.

4. Modify the record as desired.
5. Click the **Save** button to save your changes.

Your changes are saved and the **PA PROACT** page reappears.

Viewing and Modifying Assigned RCA Recommendation Records

You can view the RCA Recommendation records assigned for a selected unpublished RCA Analysis for which you are the Principal Analyst.

To view and modify assigned RCA Recommendation records:

1. On the [PA PROACT page](#), in the **Analyses in Progress** section, click the row containing the RCA Analysis for which you want to display items.
2. Click the **Recommendations** tab to select it.

All of the Recommendations for the selected RCA Analysis appear in the list on the **Recommendations** tab. The system assigns a color to each RCA Recommendation record according to the due date.

[RCA->PA View](#)

Principal Analyst's View

Analyses in Progress: 2

Drag a column header here to group by that column

| Analysis Name | Long Description | Start Date | End Date |
|---------------------------------|------------------|------------|----------|
| ▶ Test Analysis | | | |
| Sample Analysis | | | |

Click on a tab to view the corresponding list of items.

Preserve Items | Verifications | Recommendations |

Recommendations: 1

Drag a column header here to group by that column

| Description | Assigned To | Due Date | Date Completed |
|-------------|------------------|-----------|----------------|
| ▶ | Sweeney, Rebecca | 3/30/2011 | |

The following details are displayed for each RCA Recommendation record in the list:

Viewing and Modifying Assigned RCA Recommendation Records

- **Description:** A brief description of the recommendation.
 - **Person Responsible:** The name of the team member assigned to this record.
 - **Due Date:** The deadline when the recommendation should be implemented.
 - **Date Completed:** Populated when the assigned team member has implemented the recommendation.
3. Click the hyperlinked value in the Description column associated with the record that you want to view or modify.

The **Recommendation Details** page appears, displaying the selected RCA Recommendation record.

| | Value(s) |
|----------------------------------|--|
| Recommendation ID | REC-201 |
| Recommendation Headline | Test Analysis_A - Recommendation REC-201 Recommendation Headline Field |
| Recommendation Description | Test Analysis_A - Recommendation REC-201 Recommendation Description Field ... |
| Recommendation Basis | Test Analysis_A - Recommendation REC-201 Recommendation Basis Field |
| RCA Analysis ID | Test Analysis_A |
| Equipment ID | ... |
| Technical Number | |
| Functional Location ID | ... |
| Required Equipment Status | On-Line (ON-LINE) |
| Business Impact | Safety (SAFETY) |
| Target Completion Date | 7/30/2008 12:00:00 AM |
| Mandatory Date | |
| Recommendation Priority | High (HIGH) |
| Status | Created (CREATED) |
| Author Name | Aultice, Patrick pat |
| Reviewer Name | Aultice, Patrick pat |
| Assigned To Name | Aultice, Patrick pat |
| Final Approver Name | Aultice, Patrick pat |
| Cause | |
| Cause Type | |
| Close-Out Comments | Test Analysis_A - Recommendation REC-201 Recommendation Close-Out Comments Field ... |
| Implemented Date | |
| Create Work Request? | <input type="checkbox"/> |
| Work Request Reference | |
| Work Request Equipment | |
| Work Request Functional Location | |

4. Modify the record as desired.
5. On the **Common Tasks** menu, click the **Save Recommendation** link.
Your changes are saved to the database and the **PA PROACT** page reappears.

About Sending Email to Team Members

Root Cause Analysis provides the Principal Analyst with the ability to send an email message to the RCA Analysis Team member who is responsible for an item, such as an RCA Preserve Item record or an RCA Verification record. The Principal Analyst can select and send email messages about multiple items to multiple RCA Analysis Team members at the same time. Using this feature allows the Principal Analyst to facilitate the participation of team members and manage the administrative responsibilities of collecting the data.

Note: To use this feature, team members must have an email address defined in their Meridium APM Human Resource record. In addition, Microsoft Outlook or the SMTP Server must be configured properly. Additionally, the user who is sending the records and the user who is receiving the records must [belong to the same RCA Analysis Team](#).

Using the **PA PROACT** page, you can:

- [Send email message about RCA Preserve Item records.](#)
- [Send email messages about RCA Verification records.](#)

The Principal Analyst can also send an email message about a recommendation to the RCA Analysis Team member who is responsible for that RCA Recommendation record. The functionality for sending an email message about an RCA Recommendation record is available via the datasheet for the [RCA Recommendation record](#).

Sending Email About RCA Preserve Item Records

To send an email message about an RCA Preserve Item record:

1. On the [PA PROACT page](#), in the **Analyses in Progress** section, select the row containing the desired RCA Analysis.
2. In the **Preserve Items, Verifications, and Recommendations tabs** section, click the **Preserve Items** tab.
3. On the **Other Tasks** menu, click the **Send Records** link.

Note: If you are an RCA Analysis Team member but do not have an email address defined in your Meridium APM Human Resource record, a message will appear, indicating that the current user does not have an email address defined. You can define an email address by [modifying your Human Resource record](#).

The **Email List of Items** dialog box appears, displaying a list of the existing RCA Preserve Item records associated with the selected RCA Analysis.

Email List of Items

List of items

Select items that you want to send. Hold Ctrl or Shift key to select multiple items.

Drag a column header here to group by that column

| Verification Method | Due Date | Date Completed | Person Responsible |
|-----------------------|----------------------|----------------|--------------------|
| ▶ Verification Method | 3/13/2009 1:53:09 PM | | |

Select All Deselect All

Subject:

Message Text:

Send Close

4. Click the rows containing the records about which you want to send an email message.
5. In the **Subject** text box, type the subject of the email message(s).
6. In the **Message Text** text box, type the text of the email message.
7. Click the **Send** button.

The Meridium APM system sends the email messages containing hyperlinks to the selected RCA Preserve Item record(s) and displays a confirmation message.

8. Click **OK** to close the confirmation message.
9. On the **Email List of Items** dialog box, click the **Close** button to close the **Email List of Items** dialog box.

Sending Email about RCA Verification Records

To send an email message about RCA Verification records:

1. On the [PA PROACT page](#), in the **Analyses in Progress** section, click the row containing the desired RCA Analysis.
2. In the **Preserve Items, Verifications, and Recommendations tabs** section, click the **Verifications** tab.
3. On the **Other Tasks** menu, click the **Send Records** link.

The **Email List of Items** dialog box appears, displaying a list of the existing RCA Verification records associated with the selected RCA Analysis.

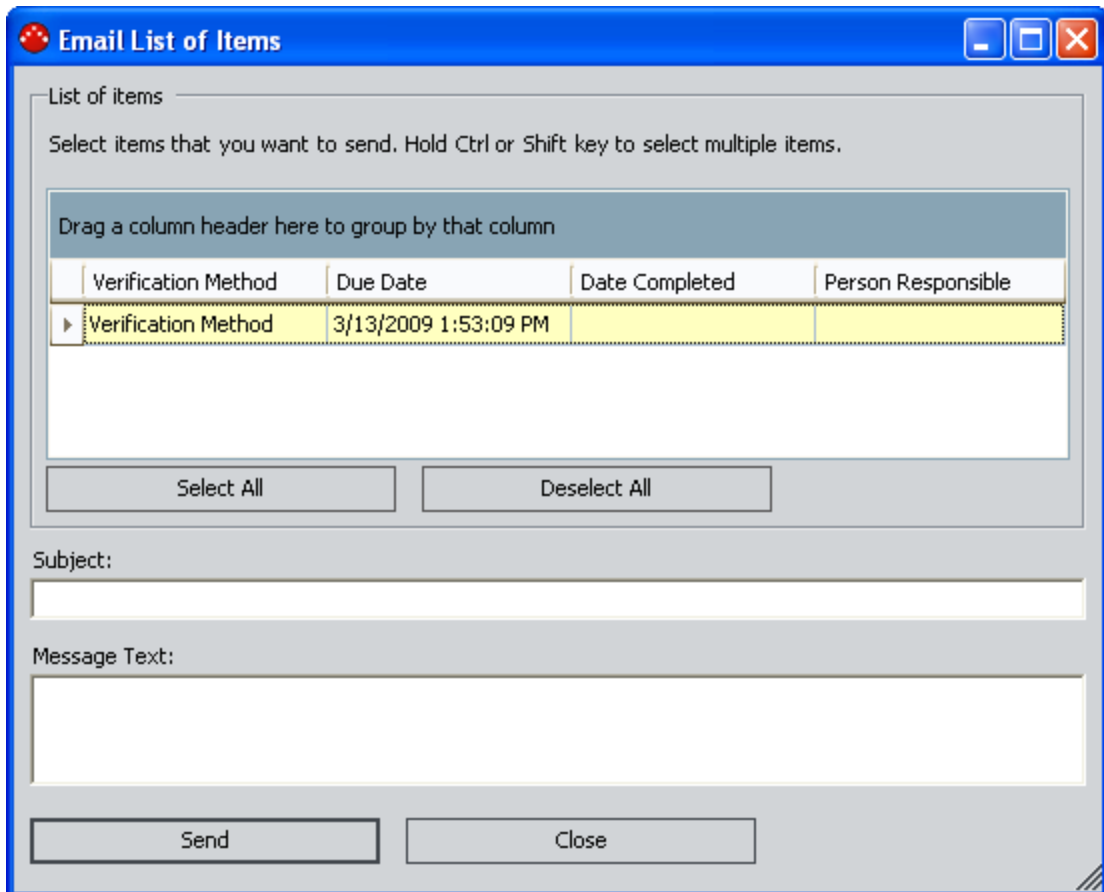

4. Select the rows containing the records about which you want to send an email message.
5. In the **Subject** text box, type the subject of the email message.
6. In the **Message Text** text box, type the text of the email message.
7. Click the **Send** button.

The Meridium APM system sends the email messages containing hyperlinks to the selected RCA Verification record(s) and displays a confirmation message.

8. Click **OK** to close the confirmation message.
9. On the **Email List of Items** dialog box, click the **Close** button to close the **Email List of Items** dialog box.

Accessing the Manage Analyses Page

The **Manage Analyses** page lets you view a list of [unpublished RCA Analyses, RCA Analysis Templates, and published RCA Analyses](#). From the **Manage Analyses** page, you can also view the details of an existing RCA Analysis and perform various tasks associated with RCA Analyses.

The following instructions provide details on accessing the **Manage Analyses** page via the **Root Cause Analysis Start Page**. You can also access the **Manage Analyses** page via the **Other Tasks** menu on any of the following pages:

- My PROACT page
- PA PROACT page
- Analysis page

To access the **Manage Analyses** page:

- On the [Root Cause Analysis Start Page](#), click the **Manage Analyses** link.

The **Manage Analyses** page appears.

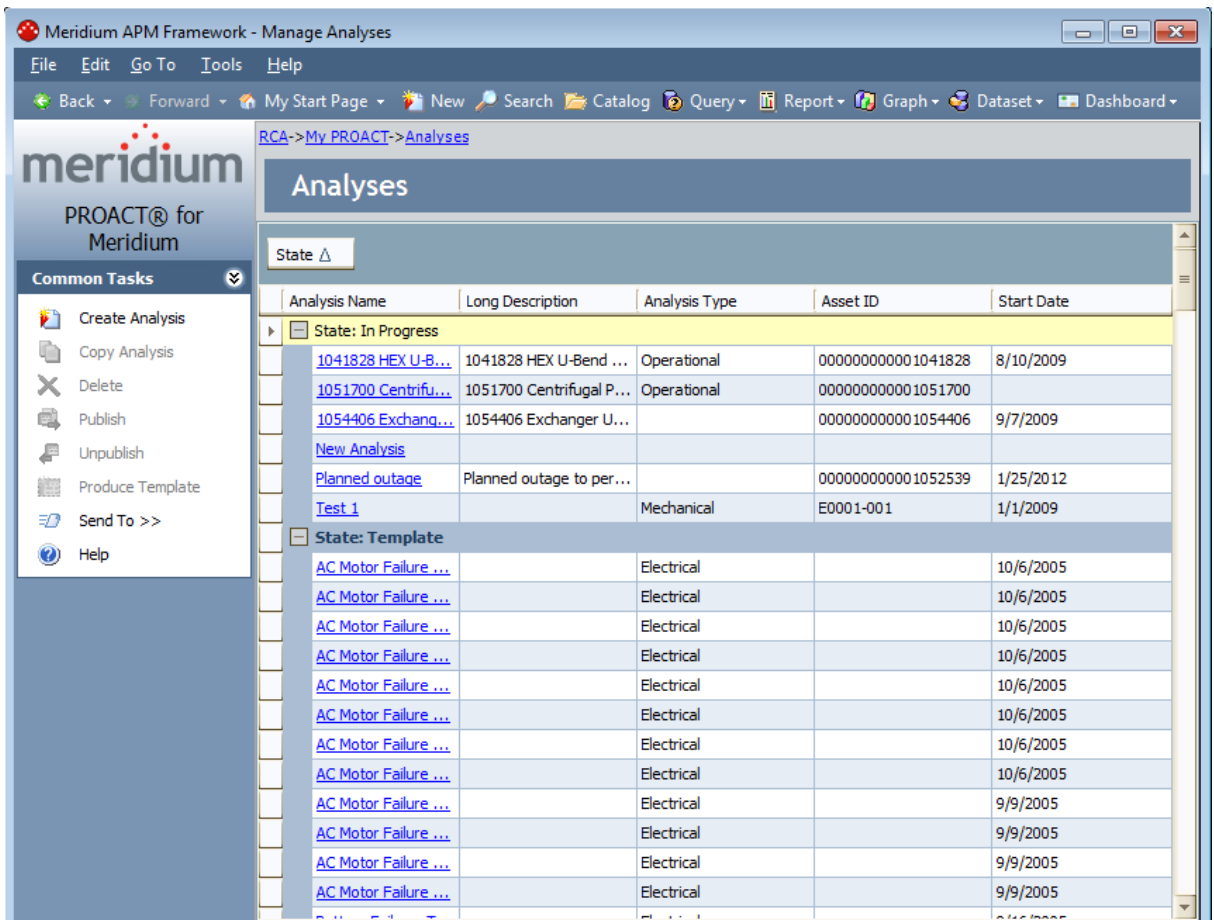

Aspects of the Manage Analyses Page

The **Manage Analyses** page displays [unpublished RCA Analyses](#), [RCA Analysis Templates](#), and [published RCA Analyses](#). By default, the list of existing RCA Analyses is grouped by state so that you can distinguish between analysis states (i.e., In Progress, Published, and Template). You can click any RCA Analysis in the list to [view the details](#) on the **Analysis** page.

| Analysis Name | Long Description | Analysis Type | Asset ID | Start Date |
|--------------------------------------|--------------------------|---------------|--------------------|------------|
| State: In Progress | | | | |
| 1041828 HEX U-B... | 1041828 HEX U-Bend ... | Operational | 000000000001041828 | 8/10/2009 |
| 1051700 Centrifu... | 1051700 Centrifugal P... | Operational | 000000000001051700 | |
| 1054406 Exchang... | 1054406 Exchanger U... | | 000000000001054406 | 9/7/2009 |
| New Analysis | | | | |
| Planned outage | Planned outage to per... | | 000000000001052539 | 1/25/2012 |
| Test 1 | | Mechanical | E0001-001 | 1/1/2009 |
| State: Template | | | | |
| AC Motor Failure ... | | Electrical | | 10/6/2005 |
| AC Motor Failure ... | | Electrical | | 10/6/2005 |
| AC Motor Failure ... | | Electrical | | 10/6/2005 |
| AC Motor Failure ... | | Electrical | | 10/6/2005 |
| AC Motor Failure ... | | Electrical | | 10/6/2005 |
| AC Motor Failure ... | | Electrical | | 10/6/2005 |
| AC Motor Failure ... | | Electrical | | 10/6/2005 |
| AC Motor Failure ... | | Electrical | | 10/6/2005 |
| AC Motor Failure ... | | Electrical | | 9/9/2005 |
| AC Motor Failure ... | | Electrical | | 9/9/2005 |
| AC Motor Failure ... | | Electrical | | 9/9/2005 |
| AC Motor Failure ... | | Electrical | | 9/9/2005 |

For each RCA Analysis in the list, the **Manage Analyses** page displays the following information:

- **Analysis Name:** The name of the RCA Analysis.
- **Long Description:** A description of the RCA Analysis.
- **Analysis Type:** The analysis type: **Mechanical**, **Operational**, **Quality**, or **Safety**.
- **Asset ID:** If you are analyzing equipment, the ID of the selected piece of equipment.
- **Start Date:** The start date of the RCA Analysis.

The **Manage Analyses** page contains one task menu: **Common Tasks**.

Common Tasks Menu

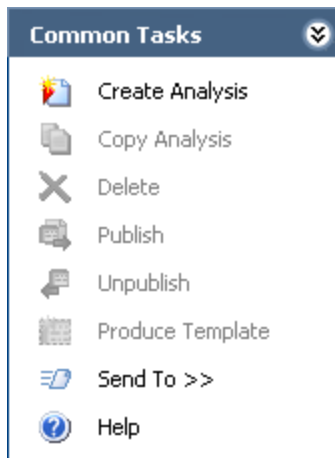

The **Common Tasks** menu on the **Manage Analyses** page contains the following links:

- **Create Analysis:** Displays the **New Analysis Builder**, which will guide you step-by-step through [the initial steps required for a new RCA Analysis](#).
- **Copy Analysis:** Displays a confirmation message, asking if you really want to develop a new RCA Analysis based on the selected RCA Analysis and then copies the RCA Analysis.
- **Delete:** Displays a confirmation message, asking if you really want to delete the selected RCA Analysis and then deletes the RCA Analysis. Only the Principal Analyst or a member of the MI PROACT Administrator Security Group can delete an RCA Analysis.
- **Publish:** Displays a confirmation message, asking if you really want to publish the selected RCA Analysis and then publishes it. Only the Principal Analyst or a member of the MI PROACT Administrator Security Group can publish an RCA Analysis. When an RCA Analysis is published, the system grants all Meridium APM Security users read-only access to the RCA Analysis, regardless of whether they are included on the RCA Analysis Team or not.
- **Unpublish:** Displays a confirmation message, asking if you really want to revoke the publication of the selected RCA Analysis, and then unpublishes a published RCA Analysis. Only the Principal Analyst or a member of the MI PROACT Administrator Security Group can revoke the publication of an RCA Analysis.
- **Produce Template:** Displays a confirmation message, asking if you really want to [create an RCA Analysis Template](#) based on the selected RCA Analysis and then creates a template. This link is enabled only if:
 - You are logged in as a Super User or a member of the MI PROACT Administrator Security Group.
 - or-
 - You are the Principal Analyst of the currently selected RCA Analysis and the [Template Creation Permissions setting](#) has been enabled.

- **Send To:** Displays a submenu with options that let you provide a link to the current page on your desktop (create shortcut), in an email message, or on a Home Page.
- **Help:** Displays the context-sensitive Help topic for the **Manage Analyses** page.

About Copying Existing Analyses

You can make a copy of any existing RCA Analysis to create a new RCA Analysis. This may be useful if you need to conduct multiple RCA Analyses with similar information. For example, another facility may have completed an RCA Analysis on a piece of equipment that you also have in your facility.

You can make a copy of any RCA Analysis regardless of the state of the analysis. This means that you can copy an analysis that is in the In Progress, Published, or Template state.

When you copy an RCA Analysis to develop a new RCA Analysis, [the New Analysis Builder](#) appears, where you can define a new RCA Analysis record. Any of the following items that exist in the original RCA Analysis will be copied to the new RCA Analysis:

- RCA Preserve Item records. The values in the record remain the same except:
 - The value in the Date Due field is set to 30 days after the date the copy is performed.
 - The Completed? field is set to the default value NO.
 - The Date Completed field is disabled and the value is cleared.
- The Logic Tree and any associated records (e.g., Hypothesis, Failure Mode). The values in these records remain the same.
- RCA Verification records. The values in the record remain the same except:
 - The Outcome field is cleared.
 - The Due Date field is set to 30 days after the date the copy is performed.
 - The Completed? field is set to the default value *No*.
 - The Date Completed field is disabled and the value is cleared.
- Event Diagram and any associated records (i.e., RCA Sequence Node records). The values in these records remain the same.

Copying an Existing Analysis to Develop a New Analysis

To create a new analysis based on an existing analysis:

1. On the [Manage Analyses page](#), in the list of existing RCA Analyses, select the row containing the RCA Analysis on which you want to base the new RCA Analysis.
2. On the **Common Tasks** menu, click the **Copy Analysis** link.

A confirmation message appears, asking if you really want to develop a new RCA Analysis based on the selected RCA Analysis.

3. Click the **Yes** button.

The **New Analysis Builder** appears, displaying the RCA Analysis datasheet.

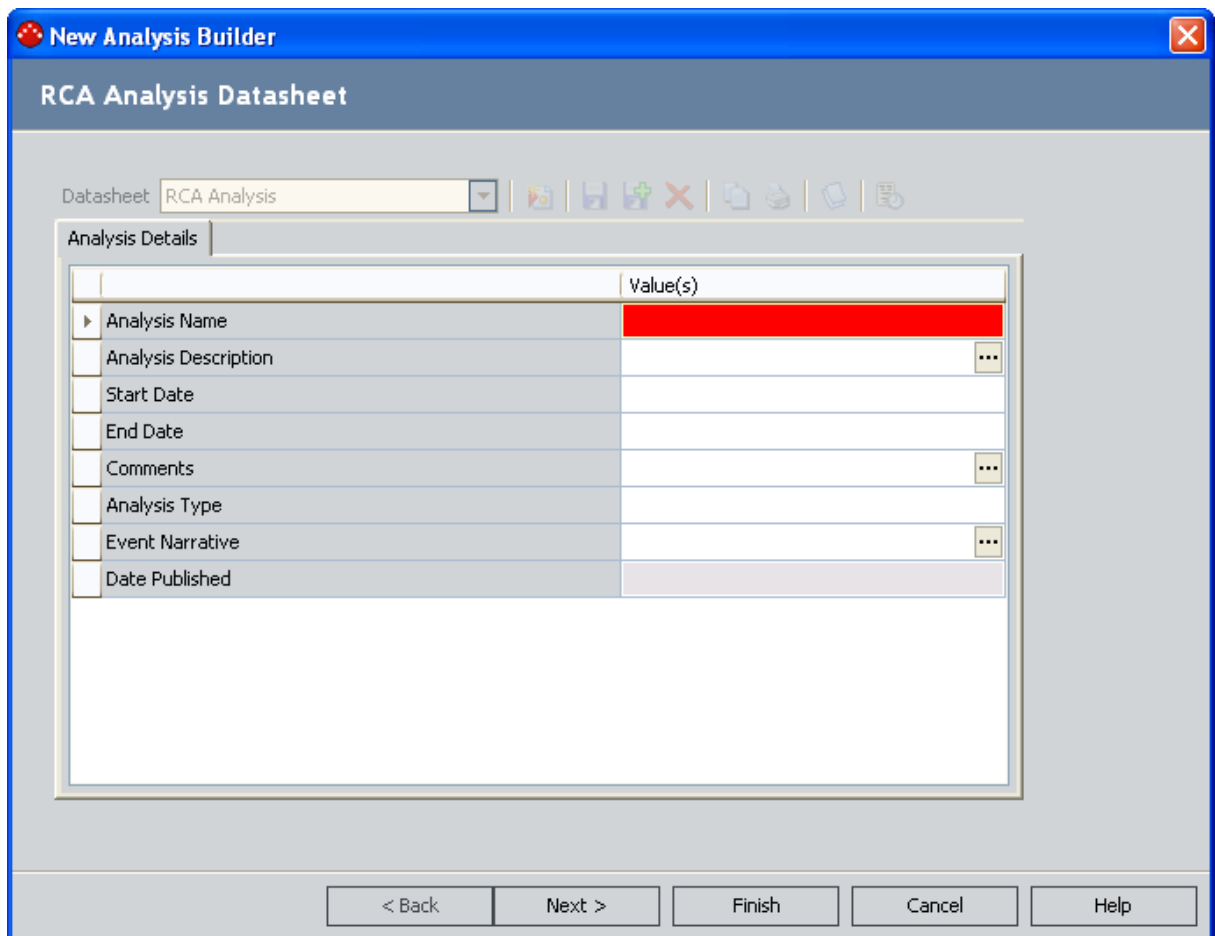

The screenshot shows a window titled "New Analysis Builder" with a sub-header "RCA Analysis Datasheet". Below the header is a "Datasheet" dropdown menu set to "RCA Analysis" and a toolbar with icons for save, delete, copy, and paste. The main area is labeled "Analysis Details" and contains a table with the following fields:

| | Value(s) |
|----------------------|----------|
| ▶ Analysis Name | |
| Analysis Description | ... |
| Start Date | |
| End Date | |
| Comments | ... |
| Analysis Type | |
| Event Narrative | ... |
| Date Published | |

At the bottom of the window are five buttons: "< Back", "Next >", "Finish", "Cancel", and "Help".

4. [Complete the steps in the New Analysis Builder](#). You must at least define a unique Analysis ID for the new RCA Analysis. If you are creating the RCA Analysis based on a template, keep in mind that templates do not have team members defined for

them, so you will also want to set up the RCA Analysis Team.

5. When you have completed all the steps, click the **Finish** button.

The initial steps required for a new RCA Analysis are complete and saved, and the **Preserve Failure Data Records** screen appears. If there were RCA Preserve Item records linked to the original RCA Analysis record, those items will appear in the list.

Linking Reference Document Records to RCA Analysis Records

If desired, you can link existing Reference Document record to the RCA Analysis record or create a new Reference Document record to link to it. The following instructions provide details on linking Reference Document records to an RCA Analysis record.

To link Reference Document records to an RCA Analysis record:

1. On the **Root Cause Analysis Start Page**, click the **Manage Analyses** link.

The **Manage Analyses** page appears.

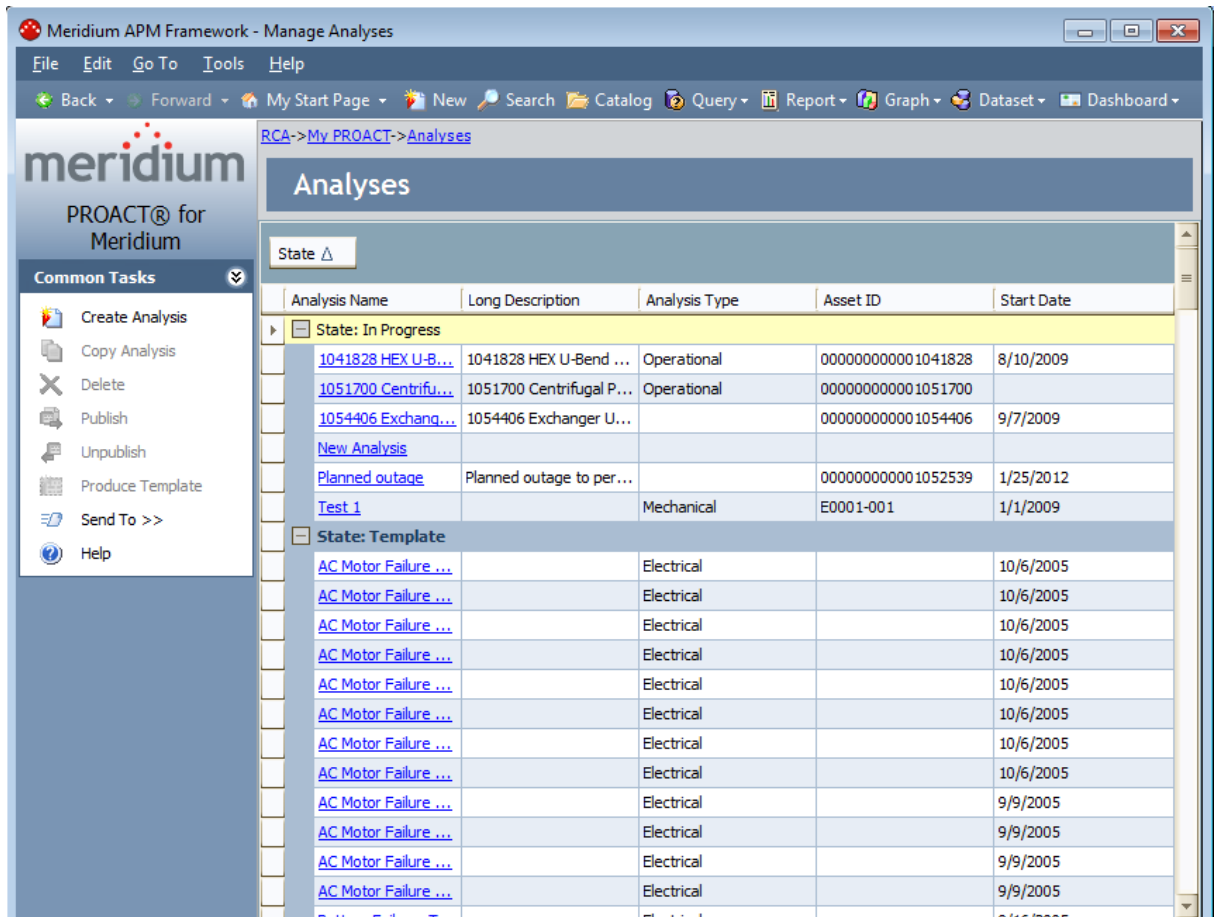

2. Click the hyperlinked name of the RCA Analysis record to which you want to link a Reference Document record.

The **Analysis** page appears, displaying the RCA Analysis Details datasheet for the selected RCA Analysis.

Linking Reference Document Records to RCA Analysis Records

The screenshot shows the Meridium APM Framework - Analysis application. The main window displays the analysis details for '1041828 HEX U-Bend'. The interface includes a navigation menu on the left and a main content area with a table of analysis details.

| | Value(s) |
|----------------------|--|
| Analysis Name | 1041828 HEX U-Bend |
| Analysis Description | 1041828 HEX U-Bend frequent failures based on tubes... |
| Start Date | 8/10/2009 |
| End Date | 8/27/2009 |
| Charter | To identify the root causes of the 1041828 HEX U-Bend failures. This |
| Comments | Performed by Investigative and Analytics Process team |
| Analysis Type | Operational |
| Date Published | |
| Event Narrative | Frequent tube failures resulting in excessive costs and losses |
| Cost | \$250,000.00 (United States Dollar) |
| Frequency | 4 |

PROACT Analysis Summary

| | |
|-------------------------------------|---|
| Number of Team Members: | 4 |
| Number of Preserve Items: | 2 |
| Number of Critical Success Factors: | 4 |

3. At the top of the datasheet, click the reference documents icon. 
The **Reference Documents** window appears.
4. Add the desired Reference Document records to the RCA Analysis record.
Your changes are saved, and the **Analysis** page returns to focus.

Creating RCA Analysis Templates

An *RCA Analysis Template* is an RCA Analysis that is in the [Template state](#). RCA Analysis Templates are the same as other RCA Analyses except that they do not have team members assigned to them and they are always in the Template state (i.e., they never become published). RCA Analysis Templates can be created either from RCA Analyses in either the Published or Unpublished state and can be used for [creating new RCA Analyses](#).

Only certain users can manage RCA Analysis Templates.

- Super Users and members of the MI PROACT Administrator Security Group can create RCA Analysis Templates.
- Additionally, RCA users can create RCA Analysis Templates from the RCA Analysis in which they are the Principal Analyst if the check box **Allow users to create RCA Analysis Templates from the Analyses in which they are the Principal Analyst** is selected on the [Administrative Functions page](#).
- Only Super Users and members of the MI PROACT Administrator Security Group can modify or delete RCA Analysis Templates, regardless of who has created them.

To create an RCA Analysis Template:

1. On the [Manage Analyses page](#), in the list of existing RCA Analyses, select the row containing the RCA Analysis that you want to use to create the template. You can select either a published or an unpublished RCA Analysis.
2. On the **Common Tasks** menu, click the **Produce Template** link.

Note: This link is enabled only if you have permission to create RCA Analysis Templates for the selected RCA Analysis.

A confirmation message appears, asking if you really want to create the template.

3. Click the **Yes** button.

The **New Analysis Name** dialog box appears.

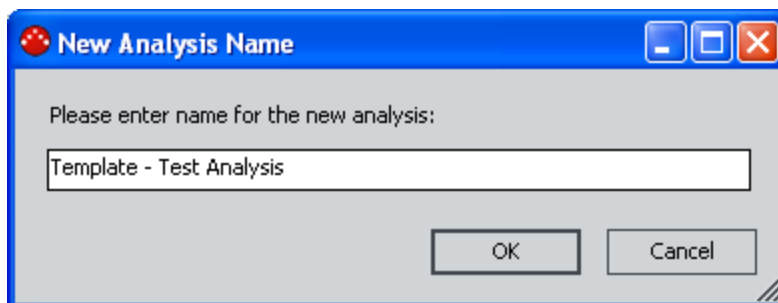

By default, the text box contains the name of the RCA Analysis that you selected along with the prefix *Template*.

4. In the text box, type a name for the RCA Analysis Template to distinguish it from the original RCA Analysis.

Note: If you attempt to save an RCA Analysis Template with a name that is already being used by a RCA Analysis or RCA Analysis Template, an error message will appear, warning you that the name already exists and prompting you to enter another name.

5. Click **OK**.

The **Manage Analyses** page displays the new RCA Analysis Template in the list. You can click the hyperlinked Analysis ID to view or modify the template on the **Analysis** page.

Note: Any Meridium APM user that has View privileges to the RCA Analysis can view RCA Analysis Templates. Only members of the MI PROACT Administrator Security Group and Super Users can modify RCA Analyses in the Template state.

Publishing an Analysis

After an RCA Analysis has been completed, the Principal Analyst can publish it. When an RCA Analysis is in the Published state, it will be read-only to all users, including the team members and the Principal Analyst. If changes must be made to a published analysis, the Principal Analyst can [unpublish it](#), make the necessary changes, and the republish.

Note: While most components of a published analysis cannot be modified, RCA Recommendation records in a published analysis can be edited. Changes are allowed to the RCA Recommendation records because modifications may be necessary to facilitate the implementation of those recommendations.

Published RCA Analyses are useful because they can be viewed by all users, facilitating the transfer of knowledge to other people in your organization.

To publish an unpublished analysis:

1. On the [Manage Analyses page](#), in the list of analyses, select the row containing the RCA Analysis that you want to publish.
2. On the **Common Tasks** menu, click the **Publish** link.

A message appears, asking if you really want to publish the RCA Analysis.

3. Click the **Yes** button.

The state of the RCA Analysis changes from Unpublished (In Progress) to Published and the Date Published field on the RCA Analysis record is populated with the date on which the analysis was published.

Unpublishing an Analysis

After an RCA Analysis has been completed, it can be published so that other users can view it. With the exception of RCA Recommendation records, when an RCA Analysis is in the Published state, the components of that analysis cannot be modified. If you need to make changes to the RCA Analysis after it has been published, or if you decide that you do not want it to be viewed by others, you can unpublish it.

Note: Only a member of the MI PROACT Administrator Security Group, the Principal Analyst, or a Super User can unpublish an RCA Analysis.

To unpublish a published RCA Analysis:

1. On the [Manage Analyses page](#), in the list of existing RCA Analyses, select the row containing the published RCA Analysis that you want to unpublish.

2. On the **Common Tasks** menu, click the **Unpublish** link.

A message appears, asking if you really want to unpublish the RCA Analysis.

3. Click the **Yes** button.

The state of the RCA Analysis changes from Published to Unpublished (In Progress).

Deleting an RCA Analysis or Analysis Template

The following instructions provide details on deleting a published RCA Analysis, an unpublished RCA Analysis, or an RCA Analysis Template. When you delete an RCA Analysis, the RCA Analysis record is deleted along with all the records that are linked to the RCA Analysis record *except* for the:

- RCA Recommendation records.

Note: When you delete an RCA Analysis that has RCA Recommendation records associated with it, a message will appear, providing you with the option to delete the associated RCA Recommendation records or not.

- RCA Tracking Item records that are linked to Equipment or Location records.

To delete an RCA Analysis or RCA Analysis template:

1. On the [Manage Analyses page](#), in the list of existing RCA Analyses, select the row containing the RCA Analysis or RCA Analysis Template that you want to delete.

2. On the **Common Tasks** menu, click the **Delete** link.

A confirmation message appears, asking if you really want to delete the analysis.

3. Click the **Yes** button.

If RCA Recommendation records are associated with the analysis, a message appears, asking if you also want to delete those records.

4. Click the **Yes** or **No** button, as desired.

The selected items are deleted from the database, and the analysis no longer appears in the list on the **Manage Analyses** page.

Accessing the Analysis Page

Individual RCA Analyses appear on the **Analysis** page, where you can manage all the information associated with that specific RCA Analysis. You can access the **Analysis** page from the following main places:

- PA PROACT page
- Manage Analyses page
- My PROACT page

Each page that appears in the previous list is accessible from the **Root Cause Analysis Start Page**.

To access the Analysis page:

- On the [PA PROACT page](#), in the list that appears at the top of the page, click the hyperlinked name of the RCA Analysis that you want to view.

-or-

- On the [Manage Analyses page](#), in the list of analyses, click the hyperlinked analysis name of the RCA Analysis that you want to view.

-or-

- On the [My PROACT page](#), in the list that appears at the top of the page, click the hyperlinked name of the RCA Analysis that you want to view.

The **Analysis** page appears.

The screenshot displays the Meridium APM Framework - Analysis application. The main window title is "Meridium APM Framework - Analysis". The breadcrumb navigation shows "RCA->My PROACT->1041828 HEX U-Bend". The page title is "My Analysis: 1041828 HEX U-Bend". Below the title, there are tabs for "Datasheet" and "RCA Analysis Detail". The "RCA Analysis Detail" tab is active, showing a table with analysis details.

| | Value(s) |
|----------------------|--|
| Analysis Name | 1041828 HEX U-Bend |
| Analysis Description | 1041828 HEX U-Bend frequent failures based on tubes... |
| Start Date | 8/10/2009 |
| End Date | 8/27/2009 |
| Charter | To identify the root causes of the 1041828 HEX U-Bend failures. This includes... |
| Comments | Performed by Investigative and Analytics Process team |
| Analysis Type | Operational |
| Date Published | |
| Event Narrative | Frequent tube failures resulting in excessive costs and losses |
| Cost | \$250,000.00 (United States Dollar) |
| Frequency | 4 |

Below the table, there is a section titled "PROACT Analysis Summary" with the following data:

- Number of Team Members: 4
- Number of Preserve Items: 2
- Number of Critical Success Factors: 4

The left sidebar contains navigation options: Manage Assets, PReserve, Order, Analyze, Communicate, Track, and Associated Pages. The bottom status bar shows: "User Administrator, Meridium Application Server DEVAPP351VM Data Source V351_DEMO_DG_Datestamped".

Aspects of the Analysis Page

The **Analysis** page displays a datasheet that contains all the information associated with a given RCA Analysis. The specific fields that appear will depend on how your system has been configured.

The screenshot shows the Meridium APM Framework - Analysis interface. The main content area displays the 'RCA Analysis Detail' datasheet for the analysis '1041828 HEX U-Bend'. The interface includes a navigation menu on the left with sections like 'Manage Assets', 'Preserve', 'Order', 'Analyze', 'Communicate', 'Track', and 'Associated Pages'. The main window has a menu bar (File, Edit, Go To, Tools, Help) and a toolbar with options like Back, Forward, My Start Page, New, Search, Catalog, Query, Report, Graph, Dataset, and Dashboard. The analysis details are shown in a table format with a 'Value(s)' column.

| | Value(s) |
|----------------------|--|
| Analysis Name | 1041828 HEX U-Bend |
| Analysis Description | 1041828 HEX U-Bend frequent failures based on tubes... |
| Start Date | 8/10/2009 |
| End Date | 8/27/2009 |
| Charter | To identify the root causes of the 1041828 HEX U-Bend failures. This includes... |
| Comments | Performed by Investigative and Analytics Process team |
| Analysis Type | Operational |
| Date Published | |
| Event Narrative | Frequent tube failures resulting in excessive costs and losses |
| Cost | \$250,000.00 (United States Dollar) |
| Frequency | 4 |

Below the table, there is a 'PROACT Analysis Summary' section with the following data:

- Number of Team Members: 4
- Number of Preserve Items: 2
- Number of Critical Success Factors: 4

The status bar at the bottom indicates: User Administrator, Meridium Application Server DEVAPP351VM Data Source V351_DEMO_DG_Datestamped

Note: The RCA Analysis Detail datasheet is set as the default datasheet on the **Analysis** page. While viewing the **Analysis** page, you can select another datasheet by choosing the desired datasheet from the **Datasheet** list. If you select a different datasheet, however, the next time you access the **Analysis** page, the default datasheet will be displayed again.

You can click the **Plant & Equipment Info** tab to view information about the piece of equipment or location that is associated with the RCA Analysis. If desired, you can modify the fields on this datasheet.

Note: If you make any changes to any of the information on the datasheet, you can click the **Save** button on the **Common Tasks** menu to save your changes.

At the bottom of the page, the following read-only information appears:

- **Number of Team Members:** The number of team members assigned to the current RCA Analysis.
- **Number of Preserve Items:** The number of RCA Preserve Item records that are linked to the current RCA Analysis.
- **Number of Critical Success Factors:** The number of CSFs that are associated with the current RCA Analysis.

From the **Analysis** page, you can perform tasks related to the RCA Analysis using the available task menus: [Manage Assets](#), [PReserve](#), [Order](#), [Analyze](#), [Communicate](#), [Track](#), and **Associated Pages**.

Note: Links appear on the **Associated Pages** menu only if they have been configured for the RCA Analysis family via the URL Manager.

Manage Assets Menu



The **Manage Assets** menu on the **Analysis** page contains the following link:

- **Manage Assets:** Displays the **Manage Assets** page, where you can link, view, and unlink Equipment and Functional Location records associated with the current RCA analysis.

PReserve Menu



The **PReserve** menu on the **Analysis** page contains the following link:

- **Preserve Records:** Displays the list of existing RCA Preserve Item records that are linked to the current RCA Analysis.

Order Menu

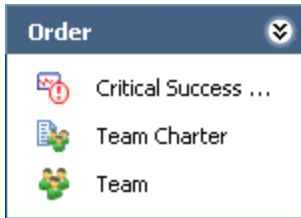

The **Order** menu on the **Analysis** page contains the following links:

- **Critical Success Factors:** Displays the list of existing CSFs that are associated with the current RCA Analysis.
- **Team Charter:** Displays the team charter that is currently defined for the RCA Analysis.
- **Team:** Displays the list of team members that are associated with the current RCA Analysis.

Analyze Menu

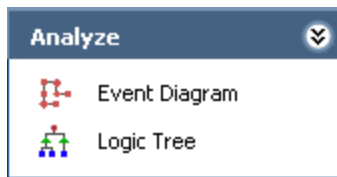

The **Analyze** menu on the **Analysis** page contains the following links:

- **Event Diagram:** Displays the **Event Diagram** page for the current RCA Analysis.
- **Logic Tree:** Displays the **Logic Tree** page for the current RCA Analysis.

Communicate Menu



The **Communicate** menu on the **Analysis** page contains the following links:

- **Communicate Records:** Displays the **Communicate Records** page for the current RCA Analysis, where you can create RCA Recommendation records that are linked to it.
- **Reports:** Displays the **Reports List** page, where you can view a list of reports that contain details about the current RCA Analysis.

Track Menu



The **Track** menu on the **Analysis** page contains the following link:

- **Track:** Displays the [Analysis Tracking Items page](#), where you can view the RCA Tracking Item records that are linked to the current RCA Analysis.

About the Catalog Items Used by PROACT Reports

The Catalog folders \\Public\Meridium\Modules\RCA and \\Public\Meridium\Modules\RCA\SSRS contain items that are used to support RCA reports. The [Catalog items used by the Comprehensive Analysis Report](#) are located in the SSRS folder, and [the catalog items used by the individual reports](#) are located in the RCA folder. The following topics explain the Catalog items that are used by these reports.

Note: A copy of the catalog items used by the individual reports also exists in the SSRS folder, but the Meridium APM systems does not use these items.

Catalog Items Used by the Comprehensive Analysis Report

The following table lists the name and description of the subreports that are used to generate the Comprehensive Analysis Report, any queries that support the subreports, and the Comprehensive Analysis Report sections that the subreports and supporting queries are used to generate.

| Subreport Name | Behavior and Usage | Supporting Query | Comprehensive Analysis Report Section |
|----------------|---|--|--|
| AAAGPage | Provides an introduction to the PROACT RCA Analysis-At-A-Glance Overview section. | None | Analysis-At-A-Glance |
| AAAGReview | Provides a summary of the RCA Analysis, which includes data such as the name of the RCA Analysis, the name of the Principal Analyst, the start date, and the estimated completion date. | <ul style="list-style-type: none"> • HypothesisCount • RecommendationMatrix Query • RootCauseCountTaskAssignedCount Query • TaskAssignedCount Query • TaskCompletedCount Query • VerificationAssignedCount • VerificationCompletedCount | PROACT RCA Analysis-At-A-Glance Overview |

| Subreport Name | Behavior and Usage | Supporting Query | Comprehensive Analysis Report Section |
|----------------------|--|------------------|---------------------------------------|
| Acknowledgements | Displays the value that exists in the Acknowledgments field on the RCA Communicate datasheet of the RCA Analysis record. | None | Acknowledgements |
| AnalyzePage | Provides information about the Analyze step of a Root Cause Analysis. | None | Analyze |
| CommunicatePage | Provides information about the Communicate step of a Root Cause Analysis. | None | Communicate |
| Comprehensive Report | Provides necessary input for the Comprehensive Analysis Report. | None | None |

| Subreport Name | Behavior and Usage | Supporting Query | Comprehensive Analysis Report Section |
|----------------|--|----------------------|---|
| Cover | Provides basic analysis information, such as the Analysis Name, Principal Analyst, and the date on which the report was generated. | Cover Query | Cover Page |
| CSF | Provides a list of the Critical Success Factors that are defined for the RCA Analysis. | CSF Query | Critical Success Factors |
| CSFMain | Provides the charter and the Critical Success Factors that are defined for the RCA Analysis. | CSF Query | <ul style="list-style-type: none"> • Charter • Critical Success Factors |
| DataCollection | Provides a list of the RCA Preserve Item records that are included in the RCA Analysis. | DataCollection Query | Data Collection |

| Subreport Name | Behavior and Usage | Supporting Query | Comprehensive Analysis Report Section |
|------------------------|--|------------------------------|--|
| DataCollectionFileLink | Provides a list of the RCA Preserve Item records that are included in the RCA Analysis. | DataCollectionFileLink Query | Data Collection File Links |
| EventDiagram | Provides an image of the Event Diagram that exists for the RCA Analysis | EventDiagramImage Query | Event Diagram |
| EventSummary | Provides information stored in the Event Narrative and the Mechanism fields of the RCA record. | None | <ul style="list-style-type: none"> • Event Summary • Summary of Findings |
| LogicTree | Provides an image of the Logic Tree that exists for the RCA Analysis. | LogicTreeImage Query | Logic Tree |
| OrderPage | Provides information about the Order step of a Root Cause Analysis. | None | Order |

| Subreport Name | Behavior and Usage | Supporting Query | Comprehensive Analysis Report Section |
|-------------------------|--|-------------------------------|---|
| PreservePage | Provides information about the Preserve step of a Root Cause Analysis. | None | Preserve (5 P's) |
| RecommendationFileLinks | Provides a list of the Reference Document records that are linked to the RCA Recommendation records that are included in the RCA Analysis. | RecommendationFileLinks Query | Recommendation File Links |
| RecommendationSummary | Provides a list of the RCA Recommendation records that are included in the RCA Analysis. | None | Executive Summary Recommendations |
| TableOfContent | Provides a list of the titles of the sections that are included in the Comprehensive Analysis Report. | None | Topics Included in this Report |

| Subreport Name | Behavior and Usage | Supporting Query | Comprehensive Analysis Report Section |
|---------------------|---|---------------------------|---------------------------------------|
| TeamMemberPrincipal | Identifies the Principal Analyst and identifying information from the associated Human Resource record (e.g., name and contact information). | TeamMemberPrincipal Query | Team Members |
| TeamMembers | Provides a list of the team members who belong to the RCA Analysis Team, including various identifying information from the associated Human Resource records (e.g., name and contact information). | TeamMember Query | Team Members |
| TrackingSummary | Provides information from the RCA Tracking Item records that are linked to the RCA Analysis record. | Tracking Query | Tracking Item Summary |

| Subreport Name | Behavior and Usage | Supporting Query | Comprehensive Analysis Report Section |
|-----------------------|--|----------------------------|---|
| TrackPage | Provides information about the Track step of a Root Cause Analysis. | None | Track |
| VerificationFileLinks | Provides a list of the Reference Document records that are linked to the RCA Verification records that are included in the RCA Analysis. | VerificationFileLink Query | Verification Log File Links |
| VerificationLogs | Provides a list of the RCA Verification records that are included in the RCA Analysis. | Verification Query | Verification Logs |

Each supporting query that is listed in this table contains a prompt on the ENTY_KEY field of the RCA Analysis family. When you run a report from the Reports List page, the ENTY_KEY of the RCA Analysis record associated with the current RCA Analysis is passed automatically to the prompt. After the ENTY_KEY is passed, the results for the current RCA Analysis are displayed. If you run an RCA report or query from the Catalog, however, you will need to supply the ENTY_KEY for an RCA Analysis record manually to retrieve results.

Catalog Items Used by the Individual Reports

The following table provides a description of the baseline individual RCA reports. Each report is built upon a supporting query or dataset that is stored in the same folder as the report itself. Each report is a formatted view of the corresponding query or dataset. For additional details on the data that is included in the report, you can run the query itself.

| Report Name | Supporting Query | Behavior and Usage |
|-------------------------------------|------------------------------------|--|
| Analysis Summary Report | Analysis Summary Query | Provides a summary of the information that is stored in a given RCA Analysis record, including information about the piece of equipment or location associated with the RCA Analysis. |
| Analyze - Cause Report | Analyze - Cause Query | For a given RCA Analysis, provides a list of the associated RCA Hypothesis records whose State field contains the value <i>Cause Human</i> , <i>Cause Latent</i> , or <i>Cause Physical</i> . |
| Analyze - Logic Tree Summary Report | Analyze - Logic Tree Summary Query | Provides a summary of the RCA Hypothesis records that exist in the Logic Tree of a given RCA Analysis. This report includes a graph that provides a visual representation of the number of RCA Hypothesis records that are designated as <i>Cause Human</i> , <i>Cause Latent</i> , and <i>Cause Physical</i> and a count of the total number of RCA Hypothesis records not designated as any "cause." |

| Report Name | Supporting Query | Behavior and Usage |
|---|------------------------------------|--|
| Analyze - Verification Report | Analyze - Verification Query | Provides a list of the RCA Verification records that are associated with an RCA Analysis record, including the outcome of each verification and the name of the RCA Hypothesis record to which it is linked. |
| Communicate - Recommendation Report | Communicate - Recommendation Query | Provides a list of the RCA Recommendation records that are associated with an RCA Analysis, including the name of the team member to whom the RCA Recommendation record is assigned and information about the due date and status of the recommendation. |
| Order - Team Member Report | Order - Team Member Query | Provides a list of the team members who belong to an RCA Analysis Team, including various identifying information from the associated Human Resource record (e.g., name and contact information). |
| Preserve - Preserve Items Report - Group by Category | Preserve - Report Query | Provides a list of the RCA Preserve records that are linked to an RCA Analysis, grouped according to the following Data Categories: Parts, Paper, People, Position, Paradigms. |
| Preserve - Preserve Items Report - Group by Team Member | Preserve - Report Query | Provides a list of the RCA Preserve records that are linked to an RCA Analysis record, grouped according to the team member who is responsible for the item. |

Each supporting query contains a prompt on the ENTY_KEY field of the RCA Analysis family. When you run a report from the Reports List page, the ENTY_KEY of the RCA Analysis

record associated with the current RCA Analysis is passed automatically to the prompt. After the ENTY_KEY is passed, the results for the current RCA Analysis are displayed. If you run an RCA report or query from the Catalog, however, you will need to supply the ENTY_KEY for an RCA Analysis record manually to retrieve results.

RCA Analysis

RCA Analysis records store basic information about an RCA Analysis created to track and analyze causes of equipment and location failures. The following table provides an alphabetical list and description of the fields that exist for the RCA Analysis family and appear by default on the RCA Analysis and RCA Analysis Detail datasheets. The information in the table reflects the baseline state and behavior of these fields. This list is not comprehensive.

Note: The fields on the Plant & Equipment Info tab exist on the RCA Analysis Detail datasheet so that you can view this information in analyses where it existed in previous releases. In the current product, the **Manage Assets** page allows you to link Equipment and Functional Location records to the RCA Analysis record, and you no longer need to view equipment and location information on the RCA Analysis Detail datasheet. If you do not want to see the Plant & Equipment Info tab by default, in Meridium APM Configuration Manager you can change the default datasheet for the RCA Analysis family to the RCA Analysis datasheet, which does not contain the Plant & Equipment Information tab.

| Field | Datasheet Caption | Data Type | Description | Behavior and Usage | Datasheets |
|----------------------|-------------------|-----------|---|-------------------------|---|
| Analysis Name | Analysis Name | Character | A value that identifies the Root Cause Analysis record throughout the Meridium APM product. | This field is required. | RCA Analysis; RCA Analysis Detail: Analysis Details Tab |

| Field | Datasheet Caption | Data Type | Description | Behavior and Usage | Datasheets |
|-----------------------|--------------------|-----------|---|---|---|
| Analysis Type | Analysis Type | Character | The type of RCA Analysis you are conducting. | <p>This field contains a list of the following values:</p> <ul style="list-style-type: none"> • Mechanical • Operational • Quality • Safety • Environmental • Electrical • Human <p>You can select the value that defines the type of analysis you are performing.</p> | RCA Analysis; RCA Analysis Detail: Analysis Details Tab |
| Asset Category | Equipment Category | Character | The category of equipment associated with the RCA analysis. | You can type a value in this field to describe the piece of equipment identified in the Asset ID field. | RCA Analysis Detail: Plant & Equipment Tab |
| Asset Class | Equipment Class | Character | The class of equipment associated with the RCA analysis. | You can type a value in this field to describe the piece of equipment identified in the Asset ID field. | RCA Analysis Detail: Plant & Equipment Tab |

| Field | Datasheet Caption | Data Type | Description | Behavior and Usage | Datasheets |
|-------------------|-------------------|-----------|---|--|---|
| Asset ID | Equipment ID | Character | A unique value that identifies the piece of equipment on which the analysis is being performed. | You can type in this field the name of the piece of equipment you are analyzing. Alternatively, you can link Equipment records to the RCA Analysis record via the Manage Assets page. | RCA Analysis Detail: Plant & Equipment Tab |
| Asset Type | Equipment Type | Character | The type of equipment associated with the RCA analysis. | You can type a value in this field to describe the piece of equipment identified in the Asset ID field. | RCA Analysis Detail: Plant & Equipment Tab |
| Charter | Charter | Text | The purpose of and requirements associated with conducting the RCA Analysis. | This value is populated automatically with the charter you entered on the Enter Team Charter screen of the New Analysis Builder . If the full charter does not fit in the field, you can click the <input type="button" value="..."/> button to see the full text. | RCA Analysis; RCA Analysis Detail: Analysis Details Tab |

| Field | Datasheet Caption | Data Type | Description | Behavior and Usage | Datasheets |
|-----------------------|-------------------|-----------|---|--|---|
| Comments | Comments | Text | Any additional information about the current analysis. | You can specify comments by clicking the  button and entering comments in the Comments dialog box. | RCA Analysis; RCA Analysis Detail: Analysis Details Tab |
| Cost | Cost | Number | The estimated cost of the failure event (s) you are analyzing. | You can type a value in this field. | RCA Analysis; RCA Analysis Detail: Analysis Details Tab |
| Date Published | Date Published | Date | The date on which the RCA Analysis was published. | This field is disabled. When the RCA Analysis is published, this field is updated automatically with the published date. | RCA Analysis; RCA Analysis Detail: Analysis Details Tab |
| Division | Division | Character | The division of the equipment on which the RCA Analysis is being performed. | You can type a value in this field to describe the piece of equipment identified in the Asset ID field. | RCA Analysis Detail: Plant & Equipment Tab |
| End Date | End Date | Date | The end date of the analysis, if applicable. | You can select a date using the Calendar tool. | RCA Analysis; RCA Analysis Detail: Analysis Details Tab |

| Field | Datasheet Caption | Data Type | Description | Behavior and Usage | Datasheets |
|----------------------------|----------------------|-----------|--|---|---|
| Event Narrative | Event Narrative | Text | Information about the equipment failure. | You can type a description of the event in this field. | RCA Analysis; RCA Analysis Detail: Analysis Details Tab |
| Frequency | Frequency | Number | The number of times the equipment failure occurred. | You can type a value in this field. | RCA Analysis; RCA Analysis Detail: Analysis Details Tab |
| Functional Location | Functional Location | Character | The location containing the piece of equipment on which you are performing the RCA Analysis. | You can type in this field the name of the location that you are analyzing. Alternatively, you can link Functional Location records to the RCA Analysis record via the Manage Assets page. | RCA Analysis Detail: Plant & Equipment Tab |
| Long Description | Analysis Description | Text | A brief description of the current RCA Analysis. | You can click the  button and enter text in the Analysis Description dialog box. | RCA Analysis; RCA Analysis Detail: Analysis Details Tab |

| Field | Datasheet Caption | Data Type | Description | Behavior and Usage | Datasheets |
|-----------------------|-------------------|-----------|---|---|---|
| Manufacturer | Manufacturer | Character | The manufacturer of the piece of equipment on which you are performing the analysis. | You can type a value in this field to describe the manufacturer of the piece of equipment identified in the Asset ID field. | RCA Analysis Detail: Plant & Equipment Tab |
| Plant Location | Plant Location | Character | The plant where the equipment failure occurred. | You can type a value in this field to describe the plant location of the piece of equipment identified in the Asset ID field. | RCA Analysis Detail: Plant & Equipment Tab |
| Start Date | Start Date | Date | The start date of the analysis. | You can select a date using the Calendar tool. | RCA Analysis; RCA Analysis Detail: Analysis Details Tab |
| Unit | Unit | Character | The ID of the unit where the piece of equipment for which you are conducting the RCA analysis exists. | You can type a value in this field to describe the unit of the piece of equipment identified in the Asset ID field. | RCA Analysis Detail: Plant & Equipment Tab |

RCA Event

RCA Event records store basic information about a failure event. The following table provides an alphabetical list and description of the fields that exist for the RCA Event family and appear by default on the RCA Failure Event datasheet. The information in the table reflects the baseline state and behavior of these fields. This list is not comprehensive.

| Field | Data Type | Description | Behavior and Usage |
|-------------------------|-----------|---|--|
| Event End Date | Date | The end date of the failure event, if applicable. | If the RCA Analysis was created from a Production Event record, this field will be populated automatically with the value in the End Date field of that Production Event record. Otherwise, you can define this value manually when you create the RCA Event record. |
| Event ID | Character | The ID for the failure event. | The Event ID field is populated automatically with <i>RCA-[Current Date]</i> and is disabled. |
| Event Start Date | Date | The start date of the failure event. | If the RCA Analysis was created from a Production Event record, this field will be populated automatically with the value in the Start Date field of that Production Event record. Otherwise, you can define this value manually when you create the RCA Event record. |

| Field | Data Type | Description | Behavior and Usage |
|--------------------------|-----------|---|--|
| Label | Character | The name of the failure event as you want it to appear for the Failure Event node in the diagram. | If the RCA Analysis was created from a Production Event record, this field will be populated automatically with the value in the Headline field of that Production Event record. Otherwise, you can define this value manually when you create the RCA Event record. |
| Long Description | Text | A detailed description of the failure event. | If the RCA Analysis was created from a Production Event record, this field will be populated automatically with the value in the Description field of that Production Event record. Otherwise, you can define this value manually when you create the RCA Event record. |
| Short Description | Character | A brief description of the failure event. | This field does not appear on the RCA Failure Event datasheet by default. |

RCA Preserve Item

RCA Preserve Item records store information about tasks assigned to team members to collect failure data by a certain date. The following table provides an alphabetical list and description of the fields that exist in the RCA Preserve Item family and appear by default on the RCA Preserve Item datasheet. The information in the table reflects the baseline state and behavior of these fields.

| Field | Datasheet Caption | Data Type | Description | Behavior and Usage |
|----------------------------|---------------------|-----------|--|--|
| Collection Strategy | Collection Strategy | Text | A description of the way in which the data should be collected (e.g., acquire production logs from a line supervisor). | On the RCA Preserve Item datasheet, you can click the <input type="button" value="..."/> button to define this value manually via the Collection Strategy dialog box. |
| Completed? | Completed? | Character | A value that specifies whether or not the data collection is completed. | You can choose <i>Yes</i> or <i>No</i> depending on the status of the data collection. When you set this value to <i>Yes</i> , the Date Completed field will be populated automatically with the current date. |

| Field | Datasheet Caption | Data Type | Description | Behavior and Usage |
|------------------------|-------------------|-----------|---|--|
| Data Category | Data Category | Character | The type of data you want a team member to collect. | <p>This field contains a list of the following values representing the 5 P's:</p> <ul style="list-style-type: none"> • People • Parts • Paper • Position • Paradigms <p>You can select the option that defines the type of data that should be collected.</p> |
| Data To Collect | Data To Collect | Character | A description of the data that will be collected for the category that you selected in the Data Category field. | On the Preserve Failure Data page, the text that is specified in this cell will appear as a hyperlink you can click to access the RCA Preserve Item record. |
| Date Completed | Date Completed | Date | The date on which the data-collection was completed. | When the Completed? field is set to <i>True</i> , the Date Completed field will be populated automatically with the current date and time. You can modify the date if necessary. |
| Date Due | Date Due | Date | The deadline for collecting the data. | You can select a date using the Calendar tool. |

| Field | Datasheet Caption | Data Type | Description | Behavior and Usage |
|--|---|-----------|---|--|
| Days Before Due Date to be Notified | Days Before Due Date to be Notified | Number | The number of days prior to the due date that an alert message is sent to the team member to whom the record is assigned. | This field is enabled only when the Send Alert on Due Date? field is set to <i>True</i> . Then this field is required. You must enter a numeric value in this field, or an error message will appear. The units for this field are automatically set to <i>Days</i> . |
| Frequency After Due Date to be Notified | Frequency After Due Date to be Notified | Character | The frequency after the due date that an alert message will be sent to the team member to whom the record is assigned. | This field is enabled only when the Send Alert on Due Date? field is set to <i>True</i> . Then this field is required. This field contains a list of the following values: <ul style="list-style-type: none"> • Never • Daily • Weekly • Monthly • Yearly You can select the option that defines how frequently an alert should be sent after the due date of the RCA Preserve Item record. |

| Field | Datasheet Caption | Data Type | Description | Behavior and Usage |
|---------------------------------------|-------------------------|-----------|--|---|
| Notification Email Body | Alert Email Body | Text | The body of the alert that will be sent via email. | On the RCA Preserve Item datasheet, you can click the <input type="button" value="..."/> button to define this value manually via the Alert Email Body dialog box. |
| Send Notification on Due Date? | Send Alert on Due Date? | Logical | A value that specifies whether or not an alert email message will be sent to the team member to whom the record is assigned. | This field is enabled when there is a value in the Due Date field. When this field is set to <i>True</i> , when you save the RCA Preserve Item record, an Alert record will be created automatically in the Meridium APM database and a Scheduled Item will be created automatically in the Schedule Manager. The Alert record that was created automatically will not be linked automatically to the current RCA Analysis. |

RCA Recommendation

RCA Recommendation records store details of a recommendation and the progress associated with getting the recommendation approved and implemented. The following table provides an alphabetical list and description of the fields that exist for the RCA Recommendation family. The information in the table reflects the baseline state and behavior of these fields. This list is not comprehensive.

| Field | Datasheet Caption | Date Type | Description | Behavior and Usage | Datasheet |
|---------------------------------|-----------------------------------|-----------|--|---|---|
| Alert Assignee When Due? | Alert Responsible Party When Due? | Logical | An option that lets you send an alert to the person responsible for implementing the recommendation. | If this field is set to <i>True</i> , the Meridium APM system will send an alert to the person in the Assigned to Name field on the date defined in the Target Completion Date field. | RCA Recommendation:Alert Tab |
| Analysis ID | RCA Analysis ID | Character | The ID of the RCA Analysis associated with the recommendation. | This field is automatically populated when an RCA Recommendation record is linked to an RCA Analysis record, and is disabled. | RCA Recommendation: General Information Tab |

| Field | Datasheet Caption | Date Type | Description | Behavior and Usage | Datasheet |
|-------------------------|-------------------|-----------|--|---|---|
| Asset ID | Equipment ID | Character | The Record ID for the Equipment Record associated with the recommendation. | You can define this field by clicking the  button and searching for the desired Equipment record, selecting it, then clicking OK to link it to the RCA Recommendation record. | RCA Recommendation: General Information Tab |
| Assigned to Name | Assigned to Name | Character | The name of the person responsible for ensuring the recommendation is implemented. | This field is required. You can select a team member from a list of current RCA Analysis Team Members. | RCA Recommendation: General Information Tab |
| Author Name | Author Name | Character | The name of the person proposing the recommendation. | You can select a team member from a list of current RCA Analysis Team Members. | RCA Recommendation: General Information Tab |

| Field | Datasheet Caption | Date Type | Description | Behavior and Usage | Datasheet |
|------------------------|-------------------|-----------|---|---|---|
| Business Impact | Business Impact | Character | The impact to the manufacturing process during the recommendation implementation. | You can choose this value from a list of the following options: <ul style="list-style-type: none"> • Safety • Environmental • Production • Economic | RCA Recommendation: General Information Tab |
| Cause | Cause | Character | A description of the cause of the problem the recommendation has been created to fix. | You can choose from a list of RCA Hypothesis records that you have identified as causes in the Logic Tree for the RCA Analysis. | RCA Recommendation: General Information Tab |
| Cause Type | Cause Type | Character | The type of cause of the problem the recommendation has been created to fix. | This field is disabled and populated automatically with the value in the State field of the RCA Hypothesis record identified in the Cause field. | RCA Recommendation: General Information Tab |

| Field | Datasheet Caption | Date Type | Description | Behavior and Usage | Datasheet |
|----------------------------|--------------------|-----------|--|--|---|
| Completed | Completed | Logical | Indicates that the recommendation is complete. | You can set this value to <i>True</i> to indicate that this recommendation is complete. | None |
| Completion Comments | Close-Out Comments | Text | Details about the completed recommendation. | This field is required if the value in the Status field is <i>Rejected</i> or <i>Superseded</i> . | RCA Recommendation: General Information Tab |
| Creation Date | Creation Date | Date | The date the recommendation was created. | This field is disabled and populated automatically with the date on which the RCA Recommendation record was created. | RCA Recommendation: General Information Tab |

| Field | Datasheet Caption | Date Type | Description | Behavior and Usage | Datasheet |
|---------------------------------|----------------------|-----------|---|---|---|
| Create SAP Notification? | Create Work Request? | Logical | Creates an SAP Notification for the corresponding recommendation. | If the SAP Interfaces module has been implemented and this field is set to <i>True</i> , when the RCA Recommendation record is saved, a notification will be created in SAP, and the Work Reference Request, Work Request Equipment, and Work Request Functional Location fields will be populated with values from the corresponding notification. | RCA Recommendation: General Information Tab |
| Date Reviewed | Date Reviewed | Date | The date the recommendation status was changed to <i>Reviewed</i> . | This field is populated automatically with the current date when the Status field is updated to <i>Reviewed</i> . | None |

| Field | Datasheet Caption | Date Type | Description | Behavior and Usage | Datasheet |
|--|------------------------------------|-----------|--|---|---|
| Days before Due Date to be Notified | Days before Due Date to be Alerted | Number | The numbers of days prior to the target date that the email message should be sent. | This field is enabled only when the Alert Responsible Part When Due? field is set to <i>True</i> . Then the field is required. | RCA Recommendation-Alert Tab |
| Equipment Technical Number | Technical Number | Character | The technical number of the piece of equipment for which the recommendation is being made. | When you select a value in the Equipment ID field, this field is populated automatically with the value in the Equipment Technical Number field of the associated Equipment record. | RCA Recommendation: General Information Tab |
| Final Action Taken | Final Action Taken | Text | The actions taken to implement the recommendation. | You can define this field manually by typing a description of final actions in this field. | None |

| Field | Datasheet Caption | Date Type | Description | Behavior and Usage | Datasheet |
|--|-----------------------------------|-----------|---|--|---|
| Final Approver Name | Final Approver Name | Character | The name of the person ultimately responsible for approving the recommendation and the associated cost. | You can select a team member from a list of current RCA Analysis Team Members. | RCA Recommendation: General Information Tab |
| Frequency of Alert After Due Date | Frequency of Alert After Due Date | Character | The frequency after the target date that the alert will be resent. | This field is enabled only when the value in the Alert Responsible Part When Due? field is <i>True</i> , in which case this field is required, and you can choose a value from the list of following values: <ul style="list-style-type: none"> • Never • Daily • Weekly • Monthly • Yearly | RCA Recommendation-Alert Tab |

| Field | Datasheet Caption | Date Type | Description | Behavior and Usage | Datasheet |
|-------------------------------|------------------------|-----------|---|--|---|
| Functional Location ID | Functional Location ID | Character | The Record ID of the Functional Location record that is either linked to the Equipment record that appears in the Equipment ID field or linked separately to the RCA Recommendation record. | This value is populated automatically if a Functional Location record exists and is linked to the Equipment record that appears in the Equipment ID field. You can also click the <input type="button" value="..."/> button to search for the desired Functional Location record, select it, then click OK to link it to the RCA Recommendation record. | RCA Recommendation: General Information Tab |
| Hypothesis ID | Hypothesis | Number | The ID of the hypothesis associated with the corresponding RCA Analysis. | This field is populated automatically if the RCA Recommendation record is linked to an RCA Analysis record. | None |

| Field | Datasheet Caption | Date Type | Description | Behavior and Usage | Datasheet |
|----------------------------------|---------------------------|-----------|--|--|---|
| Implementation Alert Text | Implementation Alert Text | Text | Text the user can add that will be sent in the body of the alert to the assignee to remind them the recommendation must be met by the target date. | You can type the text you wish to appear in the Alert email. | RCA Recommendation-Alert Tab |
| Implemented Date | Implemented Date | Date | The date the recommendation was implemented. | This field is populated automatically when the RCA Recommendation record is implemented. When this occurs, the field becomes disabled. | RCA Recommendation: General Information Tab |
| Mandatory Date | Mandatory Date | Date | The date by which the recommendation must be implemented. | You can select a date using the Calendar tool. | RCA Recommendation: General Information Tab |

| Field | Datasheet Caption | Date Type | Description | Behavior and Usage | Datasheet |
|------------------------------------|-----------------------------|-----------|--|--|---|
| Recommendation Basis | Recommendation Basis | Character | Background information about why the recommendation is being made. | You can type any necessary background information in this field. | RCA Recommendation: General Information Tab |
| Recommendation Closure Date | Recommendation Closure Date | Date | The date the recommendation status is changed to Implemented, Rejected, or Superseded. | This field is populated automatically with the current date when the value in the status field is changed to <i>Implemented</i> , <i>Rejected</i> , or <i>Superseded</i> . | None |
| Recommendation Description | Recommendation Description | Text | A detailed description of the recommendation. | You can type a description of the recommendation in this field. | RCA Recommendation: General Information Tab |
| Recommendation Headline | Recommendation Headline | Character | A brief summary of the recommendation. | You can type a brief summary of the recommendation in this field. | RCA Recommendation: General Information Tab |

| Field | Datasheet Caption | Date Type | Description | Behavior and Usage | Datasheet |
|--------------------------------|-------------------------|-----------|---|--|---|
| Recommendation ID | Recommendation ID | Character | The Record ID for the RCA Recommendation record. | This field is populated automatically with a unique name (e.g., REC_888) when the recommendation is created. You can change this value if desired. | RCA Recommendation: General Information Tab |
| Recommendation Priority | Recommendation Priority | Character | A value that represents the priority or criticality level of the recommendation for implementation. | You can chose from a list of the following values: <ul style="list-style-type: none"> • High • Medium • Low | RCA Recommendation: General Information Tab |
| Reevaluate? | Reevaluate? | Logical | Indicates whether team members should evaluate the recommendation again. | If the value is set to <i>True</i> , an alert will be sent to users specified in the Reevaluation Notification List field. | RCA Recommendation-Alert Tab |

| Field | Datasheet Caption | Date Type | Description | Behavior and Usage | Datasheet |
|---------------------------------------|------------------------------|-----------|--|---|------------------------------|
| Re-valuation Alert Body Text | Re-valuation Alert Body Text | Text | The message text in the body of the re-valuation alert, which will be sent to users in the re-valuation notification list. | This field is enabled only when the Re-evaluate? field is set to <i>True</i> . Then the field is required. | RCA Recommendation-Alert Tab |
| Re-valuation Notification List | Re-valuation Alert List | Character | Individuals that will be sent to the re-valuation alert. | This field is enabled only when the Re-evaluate? field is set to <i>True</i> . Then the field is required. You can select from a list of names with Human Resource records. | RCA Recommendation-Alert Tab |
| Re-valuation Date | Re-valuation Date | Date | The date on which an alert is sent out to tell the alert recipient to re-evaluate the recommendation. | This field is enabled only when the Re-evaluate? field is set to <i>True</i> . Then the field is required. You can select a date using the Calendar tool. | RCA Recommendation-Alert Tab |

| Field | Datasheet Caption | Date Type | Description | Behavior and Usage | Datasheet |
|----------------------------------|---------------------------|-----------|---|---|---|
| Required Equipment Status | Required Equipment Status | Character | The operating status the piece of equipment must be under, in order for the recommendation to be implemented. | You can choose from a list of the following values: <ul style="list-style-type: none"> • On-line • Off-line • Not Applicable | RCA Recommendation: General Information Tab |
| Reviewer Name | Reviewer Name | Character | The name of the person responsible for reviewing and endorsing the recommendation. | You can select a team member from a list of current RCA Analysis Team Members. | RCA Recommendation: General Information Tab |
| Status Changed By | Status Changed By | Character | The ID of the user who last changed value in the Status field. | This field is populated automatically when the Status field is updated. | This value does not appear on the datasheet by default. |
| Status Changed by Name | Status Changed by Name | Character | The name of the person who last changed the Status field. | This field is populated automatically when the Status field is updated. | This value does not appear on the datasheet by default. |

| Field | Datasheet Caption | Date Type | Description | Behavior and Usage | Datasheet |
|--------------------|-------------------|-----------|--|---|---|
| Status Date | Status Date | Date | The date the Status field was most recently changed. | This field is populated automatically with the current date when the Status field is updated. | This value does not appear on the datasheet by default. |
| Status | Status | Character | The status of the recommendation. | <p>You can choose from a list of the following values:</p> <ul style="list-style-type: none"> • Created • Pending Review • Reviewed • Rejected • Superseded • In Progress • Implemented <p>When the record is created, the field set populated automatically to <i>Created</i>, but can be modified if needed. This field is required.</p> | RCA Recommendation: General Information Tab |

| Field | Datasheet Caption | Date Type | Description | Behavior and Usage | Datasheet |
|---|----------------------------------|-----------|--|---|---|
| Target Completion Date | Target Completion Date | Date | The date the recommendation is intended to be implemented. | You can select a date using the Calendar tool. This field is required. | RCA Recommendation: General Information Tab |
| Work Order Number | Work Order Number | Character | The ID of the work order arising from the work request. | This field is populated automatically after a notification has been created in SAP. | This value does not appear on the datasheet by default. |
| Work Request Equipment | Work Request Equipment | Character | The Record ID of the Equipment in SAP that is associated with the SAP Notification that was created. | This field is populated automatically after a notification has been created in SAP. | RCA Recommendation: General Information Tab |
| Work Request Functional Location | Work Request Functional Location | Character | The Record ID of the Functional Location in SAP that is associated with the SAP Notification that was created. | This field is populated automatically after a notification has been created in SAP. | RCA Recommendation: General Information Tab |

| Field | Datasheet Caption | Date Type | Description | Behavior and Usage | Datasheet |
|-------------------------------|------------------------|-----------|---------------------------------|---|---|
| Work Request Reference | Work Request Reference | Character | The ID of the SAP Notification. | This field is populated automatically after a notification has been created in SAP. | RCA Recommendation: General Information Tab |

RCA Tracking Item

RCA Tracking Item records store a set of conditions on which reevaluation notifications should be based. The following table provides an alphabetical list and description of the fields that exist for the Tracking Item family and appear by default on the RCA Tracking Item Details datasheet. The information in the table reflects the baseline state and behavior of these fields.

| Field | Datasheet Caption | Data Type | Description | Behavior and Usage |
|---------------|-------------------|-----------|--|---|
| Active | Active | Logical | Indicates whether the RCA Tracking Item record is included in the tracking and reevaluation process (i.e., active). | When you create a new RCA Tracking Item record, the Active field is set to <i>True</i> by default. You set the value to <i>False</i> to indicate that the record is inactive. |
| Cost | Cost | Number | The failure cost that must be met for a reevaluation email to be sent to the user specified in the Alert field. | When you create a new RCA Tracking Item record, you can manually type a value in this field, but the value must be numeric, or an error message will appear when you move to another field. |
| Count | Count | Number | The number of failures that must occur before a reevaluation email is sent to the user specified in the Alert field. | When you create a new RCA Tracking Item record, you can manually type a value in this field, but the value must be numeric, or an error message will appear when you move to another field. |

| Field | Datasheet Caption | Data Type | Description | Behavior and Usage |
|--------------------------|-------------------|-----------|---|--|
| Message Subject | Message Subject | Character | The text that you that want to appear in the subject line of the email message. | You can manually type the subject of the email message in this field. This field is required. |
| Message Text | Message Text | Text | The text that you want to appear in the body of the email message. | On the RCA Tracking Item Details datasheet, you can define this field manually by clicking the  button and entering text in the Message Text dialog box. This field is required. |
| Notification List | Alert | Character | The names of the users to which a notification should be sent when the specified reevaluation criteria is met (i.e., the values stored in the Count and Cost fields). | You can select a team member from a list of current RCA Analysis Team Members. When you select a name in the list, the email address that is stored in the corresponding Security User record appears, and after you navigate away from the Alert field, the user's name appears in the Alert field. This field is required. |
| Start Date | Start Date | Date | The date on which the evaluation will begin. | You can select a date using the Calendar tool. This field is required. |



RCA Verification

RCA Verification records store task-related information necessary to verify a hypothesis. The following table provides an alphabetical list and description of the fields that exist for the RCA Verification family and appear by default on the RCA Verification datasheet. The information in the table reflects the baseline state and behavior of these fields.

| Field | Datasheet Caption | Data Type | Description | Behavior and Usage |
|-----------------------|-------------------|-----------|--|--|
| Completed? | Completed? | Character | A value that specifies whether or not the task is completed. | On the RCA Verification datasheet, you can choose <i>Yes</i> or <i>No</i> from the Completed? list. When you set this value to <i>Yes</i> , the Date Completed field will be populated automatically to the current date. |
| Date Completed | Date Completed | Date | The date on which the task was completed. | This field is populated automatically with the current date when the Completed? field is set to <i>Yes</i> . |

| Field | Datasheet Caption | Data Type | Description | Behavior and Usage |
|--|-------------------------------------|-----------|---|---|
| Days Before Due Date to be Notified | Days Before Due Date to be Notified | Number | The number of days prior to the due date that an alert message is sent to the team member to whom the record is assigned. | This field is enabled only when the Send Alert on Due Date? field is set to <i>True</i> . Then this field is required. You must enter a numeric value in this field, or an error message will appear. The units for this field are automatically set to <i>Days</i> . |
| Due Date | Due Date | Date | The deadline for completing the task. | You can select a date using the Calendar tool. |

| Field | Datasheet Caption | Data Type | Description | Behavior and Usage |
|--|---|-----------|--|---|
| Frequency After Due Date to be Notified | Frequency After Due Date to be Notified | Character | The frequency after the due date that an alert message will be sent to the team member to whom the record is assigned. | <p>This field is enabled only when the Send Alert on Due Date? field is set to <i>True</i>. Then this field is required. This field contains a list of the following values:</p> <ul style="list-style-type: none"> • Never • Daily • Weekly • Monthly • Yearly <p>You can select the option that defines how frequently an alert should be sent after the due date of the RCA Preserve Item record.</p> |
| Method | Method | Text | How the task was completed. | <p>On the RCA Verification datasheet, you can define this field manually by clicking the  button and entering text in the Method dialog box.</p> |

| Field | Datasheet Caption | Data Type | Description | Behavior and Usage |
|--------------------------------|-------------------|-----------|--|---|
| Notification Email Text | Alert Email Text | Text | The body of the alert that will be sent via email. | On the RCA Verification datasheet, you can define this field manually by clicking the  button and entering text in the Alert Email Text dialog box. |
| Outcome | Outcome | Text | The result of completing the task. | On the RCA Verification datasheet, you can define this field manually by clicking the  button and entering text in the Outcome dialog box. |

| Field | Datasheet Caption | Data Type | Description | Behavior and Usage |
|---------------------------------------|-------------------------|-----------|--|--|
| Send Notification on Due Date? | Send Alert on Due Date? | Logical | A value that specifies whether or not an alert email message will be sent to the team member to whom the record is assigned. | This field is enabled when there is a value in the Due Date field. When the Send Notification on Due Date? field is set to <i>True</i> , when you save the RCA Verification record, an Alert record will be created automatically in the Meridium APM database and a Scheduled Item will be created automatically in the Schedule Manager. The Alert record that was created automatically will not be linked automatically to the current RCA Analysis. |

URL Paths for Root Cause Analysis

The following table lists and describes the paths for accessing features in the Meridium Root Cause Analysis module. Note that to construct a valid URL, you must prepend **meridium://** to the path. In some cases, you must define parameters following the path.

| Feature | Path | Description |
|----------------------------------|---------------------|--|
| Root Cause Analysis T Start Page | RCA | Displays the Root Cause Analysis Start Page . This URL does not accept any parameters. |
| RCA Administrative Tools | RCA/AdminTools | Serves as the path for accessing the Administrative Functions page. This path accepts one parameter . |
| Manage Analyses | RCA/AllAnalyses | Displays the Manage Analyses page in RCA. This path does not accept any parameters. |
| RCA Analysis | RCA/Analysis | Serves as the path for accessing RCA Analyses. This path accepts parameters that let you specify which analysis to access. |
| New Analysis Builder | RCA/AnalysisBuilder | Serves as the path for the New Analysis Builder . The path accepts parameters that let you specify how to build the analysis. |
| Communicate Records | RCA/Communicate | Serves as the path for accessing RCA Communicate records. This path accepts parameters that let you specify which records to access. |
| Critical Success Factors | RCA/CSF | Launches the Critical Success Factors page. This path accepts a parameter that lets you specify the analysis whose CSFs you want to view. |
| Event Diagram | RCA/EventDiagram | Serves as the path for accessing an Event Diagram page. This path accepts parameters that let you specify the desired analysis. |
| Logic Tree | RCA/LogicTree | Serves as the path for accessing an Logic Tree page. This path accepts parameters that let you specify the desired analysis. |

| Feature | Path | Description |
|---------------------------------|---------------------|--|
| Manage Assets | RCA/MANAGEASSETS | Serves as the path for accessing the Manage Assets page. This path accepts parameters that let you specify the desired analysis. |
| My PROACT | RCA/MyPROACT | Serves as the path for displaying the My PROACT page. This path requires one parameter . |
| Principal Analyst's View | RCA/PAView | Launches the PA PROACT page. This path does not accept any parameters. |
| Preserve Records | RCA/PreserveRecords | Displays the Preserve Failure Data page. This path accepts one parameter that lets you access the failure data for a specific analysis. |
| RCA Reports | RCA/Reports | Serves as the path for accessing RCA reports. This URL accepts a parameter that lets you specify the analysis for which to access reports. |
| RCA Team | RCA/Team | Serves as the path for accessing the Team page in RCA. This path accepts parameters that let you specify the analysis for which to access the team. |
| Tracking Items | RCA/Track | Displays the Analysis Tracking Items page. This path accepts parameters that let you customize the URL. |

Parameter for the Administrative Functions URL

The URL for accessing a specific RCA Analysis, `meridium://RCA/AdminTools`, accepts the parameter described in the following table.

| Parameter Name | Description | Accepted Value(s) | Notes |
|----------------|--|-------------------|-----------------------------|
| View | Specifies to display the Administrative Functions page. | AdminTools | This parameter is required. |

Examples of the Administrative Functions URL

- `meridium://RCA/AdminTools?View=AdminTools`

Displays the **Administrative Functions** page, where you can perform administrative tasks for RCA.

Parameters for the RCA Analysis URL

The URL for accessing a specific RCA Analysis, `meridium://RCA/Analysis`, accepts the parameters described in the following table.

| Parameter Name | Description | Accepted Value(s) | Notes |
|--------------------|--|---|--|
| AnalysisKey | Specifies which analysis you want to view. | The Entity Key of the desired analysis. | This parameter is required only when View=Template or View=PubAnalysis. If you omit this parameter and use View=Analysis, the link will open a new analysis. |
| View | Specifies which view to display. | Analysis Template PubAnalysis | This parameter is required. |

Examples of the RCA Analysis URL

- **meridium://RCA/Analysis?View=Analysis**
Opens the **Analysis** page, where you can create a new analysis.
- **meridium://RCA/Analysis?View=Analysis&AnalysisKey=2791890**
Opens the **Analysis** page for the RCA Analysis with the Entity Key 2791890.
- **meridium://RCA/Analysis?View=Template&AnalysisKey=2791890**
Opens the analysis with the Entity Key 2791890 in the Analysis Template form.
- **meridium://RCA/Analysis?View=PubAnalysis&AnalysisKey=2791890**
Opens the analysis with the Entity Key 2791890 in the Published Analysis form.

Parameters for the Analysis Builder URL

The URL for accessing the **New Analysis Builder** in RCA, **meridium://RCA/AnalysisBuilder**, accepts the parameters described in the following table.

| Parameter Name | Description | Accepted Value(s) | Notes |
|--------------------|---|---|--|
| Action | Specifies whether to create a brand new analysis or to use an existing analysis as a template to create a new analysis. | BuildAnalysis -OR- CopyAnalysis | This parameter is required. If Action=CopyAnalysis, you must also define the AnalysisKey parameter. |
| AnalysisKey | Specifies which analysis you want to copy to create a new analysis. | The Entity Key of the desired RCA Analysis record. | This parameter is required only when Action=CopyAnalysis. |
| Field ID | Specifies fields in the new RCA Analysis record that you want to populate automatically. | Values that are appropriate for the specified fields. | To use this parameter, the Action parameter value must be set to BuildAnalysis. When you construct a URL to create a new RCA Analysis, you can specify values that will be used to populate fields in that RCA Analysis record automatically. The actual parameter names should correspond to fields that you want to populate. <i>You must use the field ID as the parameter name.</i> The parameter values will vary depending on the values that you want to use to populate the fields, but you should make sure to specify values that are appropriate for the field types (e.g., specify numbers for numeric fields). |

| Parameter Name | Description | Accepted Value(s) | Notes |
|-----------------------|---|--|---|
| AssetEntityKey | Specifies the Equipment or Functional Location record that you want to link to the RCA Analysis record. | The Entity Key of the desired Equipment or Functional Location record. | If you want to link the RCA Analysis to an Equipment or Functional Location record, you must use the AssetEntityKey parameter and the AssetFamilyKey parameter. |
| AssetFamilyKey | Specifies the Equipment or Functional Location family containing the record that you want to link to the RCA Analysis record. | The Family Key of the desired Equipment or Functional Location family. | If you want to link the RCA Analysis to an Equipment or Functional Location record, you will need to use the AssetFamilyKey parameter and the AssetEntityKey parameter. |

Examples of the Analysis Builder URL

- **meridium://RCA/AnalysisBuilder?Action=BuildAnalysis**
Opens the **New Analysis Builder**, where you can create a new RCA Analysis.
- **meridium://RCA/AnalysisBuilder?Action=CopyAnalysis&AnalysisKey=123456**
Opens the **New Analysis Builder** and loads the information from the analysis with the Entity Key 123456, which you can use as the basis for creating a new analysis.
- **meridium://RCA/AnalysisBuilder?Action=BuildAnalysis&MI_AN_ANALY_ID_CHR-R=RCA Analysis Example**
Displays the **RCA Analysis Datasheet** screen of the **New Analysis Builder** with the **Analysis Name** cell populated automatically with the value *RCA Analysis Example*.
- **meridium://RCA/AnalysisBuilder?Action=BuildAnalysis&AssetEntityKey-y=123546&AssetFamilyKey=987654**
Displays the **RCA Analysis Datasheet** screen of the **New Analysis Builder**. If you continue to the **Select an Asset** screen of the **New Analysis Builder**, the **Asset** text box will contain the Record ID of the record with the Entity Key 123456, which belongs to the family with the Family Key 987654.

Parameters for the Recommendation Records URL

The URL for accessing RCA Recommendation records, `meridium://RCA/Communicate`, accepts the parameter described in the following table.

| Parameter Name | Description | Accepted Value(s) | Notes |
|--------------------|---|--|-----------------------------|
| AnalysisKey | Specifies the analysis for which you want to view Recommendation records. | The Entity Key of the desired analysis. | This parameter is required. |
| RecommKey | Specifies the Recommendation record that you want to view. | The Entity Key of the desired Recommendation record. | This parameter is optional. |

Examples of Recommendation Records URLs

- <meridium://RCA/Communicate?AnalysisKey=2860801>

Displays the **Communicate Records** page, which displays the Recommendation records for the analysis with the Entity Key 2860801.

- <meridium://RCA/Communicate?AnalysisKey=2860801&RecommKey=2579812>

Displays the **Communicate Records** page, which displays the Recommendation record with the Entity Key 2579812 for the analysis with the Entity Key 2860801.

Parameters for the Critical Success Factors URL

The URL for accessing Critical Success Factors, `meridium://RCA/CSF`, accepts the parameters described in the following table.

| Parameter Name | Description | Accepted Value(s) | Accepted Value(s) |
|--------------------|--|---|---|
| AnalysisKey | Specifies the analysis for which you want to view Critical Success Factor records. | The Entity Key of the desired analysis. | This parameter is optional. Omitting this parameter, however, will result in a link that opens an empty Critical Success Factors page. |
| CsfKey | Specifies which specific CSF you want to open. | The Entity Key of the desired Critical Success Factor record. | The Critical Success Factor that you specify must be associated with the analysis indicated by the AnalysisKey parameter. |

Examples of the Critical Success Factors URL

- <meridium://RCA/CSF?AnalysisKey=1234567>

Opens the **Critical Success Factors** page, displaying the Critical Success Factors that have been defined for the analysis with the Entity Key 1234567.

- <meridium://RCA/CSF?AnalysisKey=123445&CsfKey=2791902>

Displays the **CSF Details** page for the Critical Success Factor record with the Entity Key 2791902.

Parameters for the Event Diagram URL

The URL for accessing the Event Diagram for an analysis, **meridium://RCA/EventDiagram**, accepts the parameters described in the following table. Both of these parameters are required.

| Parameter Name | Description | Accepted Value (s) | Notes |
|--------------------|--|---|-----------------------------|
| AnalysisKey | Specifies the analysis whose Event Diagram you want to view. | The Entity Key of the desired analysis. | This parameter is required. |
| View | Specifies that you want to display the Event Diagram page for the specified analysis. | EventDiagram | This parameter is required. |

Examples of the Event Diagram URL

- <meridium://RCA/EventDiagram?View=EventDiagram&AnalysisKey=2791890>
Opens the **Event Diagram** page for the analysis with the Entity Key 2791890.

Parameters for the Logic Tree URL

The URL for accessing the RCA Logic Tree, `meridium://RCA/LogicTree`, accepts the parameters described in the following table.

| Parameter Name | Description | Accepted Value(s) | Notes |
|--------------------|---|---|--|
| AnalysisKey | Specifies the analysis for which you want to view the Logic Tree. | The Entity Key of the desired analysis. | This parameter is required. |
| NodeKey | Specifies which node in the Logic Tree that you want to view. | The Entity Key of the desired node. | The node that you specify must belong to the Logic Tree that exists for the analysis defined by the AnalysisKey parameter. |

Examples of the Logic Tree URL

- **meridium://RCA/LogicTree?AnalysisKey=2791890**
Opens the **Logic Tree** page, displaying the Logic Tree for the analysis with the Entity Key 2791890.
- **meridium://RCA/LogicTree?AnalysisKey=2791890&NodeKey=1234567**
Opens the **Logic Tree** page, displaying the Logic Tree for the analysis with the Entity Key 2791890 with the node with the Entity Key 1234567 selected.

Parameters for the Manage Assets URL

The URL for accessing Critical Success Factors, `meridium://RCA/MANAGEASSETS`, accepts the parameters described in the following table.

| Parameter Name | Description | Accepted Value(s) | Notes |
|--------------------|---|---|-----------------------------|
| AnalysisKey | Specifies the analysis for which you want to link and unlink Equipment and Functional Location records. | The Entity Key of the desired analysis. | This parameter is required. |

Examples of the Manage Assets URL

- <meridium://RCA/MANAGEASSETS?AnalysisKey=1234567>

Opens the **Manage Assets** page, displaying the Equipment and Functional Location records that are linked to the analysis with the Entity Key 1234567.

Parameters for the My PROACT URL

The URL for accessing the **My PROACT** page, `meridium://RCA/MyPROACT`, accepts the parameter described in the following table.

| Parameter Name | Description | Accepted Value(s) | Notes |
|----------------|---|-------------------|-----------------------------|
| View | Specifies that you want to display the My PROACT page. | MyPROACT | This parameter is required. |

Examples of the My PROACT URL

- `meridium://RCA/MyPROACT?View=MyPROACT`

Opens the **My PROACT** page, displaying a list of analyses for which the current user is a team member.

Parameters for the Preserve Records URL

The URL for accessing the **Preserve Failure Data** page, `meridium://RCA/PreserveRecords`, accepts the parameters described in the following table.

| Parameter Name | Description | Accepted Value(s) | Notes |
|--------------------|--|--|---|
| AnalysisKey | Specifies the analysis for which you want to view the Preserve Failure Data page. | The Entity Key of the desired analysis. | Omitting this parameter will create a link that displays the Preserve Failure Data page but does not display any Preserve Records. |
| RecordKey | Specifies a particular Preserve Record that you want to view. | The Entity Key of the desired Preserve record. | This parameter is optional. |

Examples of the Preserve Failure Records URL

- <meridium://RCA/PreserveRecords>

Displays the **Preserve Failure Data** page but does not list any Preserve records in the grid.

- <meridium://RCA/PreserveRecords?AnalysisKey=1234567>

Opens the **Preserve Failure Data** page, which displays the Preserve records for the analysis with the Entity Key 1234567.

- <meridium://RCA/PreserveRecords?AnalysisKey=1234567&RecordKey=1234568>

Displays the **Preserve Record Details** page for the Preserve record with the Entity Key 1234568.

Parameters for the RCA Reports URL

The URL for accessing the RCA reports, `meridium://RCA/Reports`, accepts the parameter described in the following table.

| Parameter Name | Description | Accepted Value(s) | Notes |
|--------------------|---|---|--|
| Action | Specifies that action that you want to perform using the URL. | ViewComprehensiveReport | Use this parameter if you want to open the baseline comprehensive RCA report. Note that ALL sections of the report will be displayed when the report appears on the Report Viewer page. |
| AnalysisKey | Specifies the analysis whose report you want to view. | The Entity Key of the desired analysis. | <p>This parameter is required.</p> <p>If you use the AnalysisKey parameter and the Action parameter, the comprehensive report for the associated analysis will be displayed.</p> <p>If you use the AnalysisKey parameter <i>without</i> the Action parameter, the Report List Screen page will be displayed, where you can select the report that you want to open for the analysis specified by the AnalysisKey parameter.</p> |

Examples of the RCA Reports URL

- <meridium://RCA/Reports?AnalysisKey=2791890>

Opens the **Reports List Screen**, displaying the reports associated with the RCA analysis with the Entity Key 2791890.

- <meridium://RCA/Reports?Action=ViewComprehensiveReport&AnalysisKey=2791890>

Opens the baseline comprehensive report for the analysis with the Entity Key 2791890.

Parameters for the RCA Team URL

The URL for accessing the **Team** page for a RCA Analysis, **meridium://RCA/Team**, accepts the parameters described in the following table. Both of these parameters are required.

| Parameter Name | Description | Accepted Value (s) | Notes |
|--------------------|---|---|-----------------------------|
| AnalysisKey | Specifies the analysis for which you want to access the Team page. | The Entity Key of the desired analysis. | This parameter is required. |
| View | Specifies that you want to display the Team page for the specified analysis. | TeamList | This parameter is required. |

Examples of the RCA Team URL

- <meridium://RCA/Team?View=TeamList&AnalysisKey=2791890>

Displays the **Team** page, which displays a list of users who are on the team for the RCA analysis with the Entity Key 2791890.

Parameters for the Tracking Items URL

The URL for accessing the Tracking Items functionality, `meridium://RCA/Track`, accepts the parameters described in the following table.

| Parameter Name | Description | Accepted Value(s) | Notes |
|--------------------|--|---|---|
| AnalysisKey | Specifies the analysis for which you want to view the Analysis Tracking Items page. | The Entity Key of the desired analysis. | Omitting this parameter will create a link that displays the Analysis Tracking Items page but does not display any Tracking Items. |
| ItemKey | Specifies a particular Tracking Item record that you want to view. | The Entity Key of the desired Tracking Item record. | This parameter is optional. |

Examples of the Tracking Items URL

- `meridium://RCA/Track`

Displays the **Analysis Tracking Items** page but does not list any Tracking Items in the grid.

- `meridium://RCA/Track?AnalysisKey=1234567`

Opens the **Analysis Tracking Items** page, which displays the Tracking Items for the analysis with the Entity Key 1234567.

- `meridium://RCA/Track?AnalysisKey=1234567&ItemKey=1234568`

Displays the **Tracking Item Details** page for the Tracking Item with the Entity Key 1234568.

Critical Success Factors

Elements of an RCA Analysis that allow the RCA Analysis Team to evaluate whether or not the analysis effort has been successful. The RCA Analysis effort is considered to be successful if the analysis team adheres to and meets the standards defined by the CSFs.

Event Diagram

A diagram that depicts a chain of events that led to a failure event. The Event Diagram allows you to analyze events that led to a failure event and identify possible work process problems.

Failure Event

The problem that the RCA Analysis Team is analyzing in a Root Cause Analysis. A failure event could be comprised of several failures over a specified period of time (e.g., a pump that overheats several times a month) or one failure (e.g., a fire).

Logic Tree

A diagram that depicts possible causes and hypotheses related to the failure event. The Logic Tree allows you to record discussion points and organize information in order to eliminate hypotheses and determine the root cause of the failure event.

RCA Analysis Team

A group of individuals who will complete the steps required for a comprehensive RCA Analysis. Each RCA Analysis Team is made up of a Principal Analyst, who facilitates and coordinates the RCA Analysis, and analysis team members.

Team Charter

The goal that the RCA Analysis Team wants to achieve by developing an RCA Analysis.