



Meridium APM SIS Management

3.6.1.1.0



Meridium APM SIS Management

3.6.1.1.0

Copyright © Meridium, Inc. 2017

All rights reserved. Printed in the U.S.A.

This software/documentation contains proprietary information of Meridium, Inc.; it is provided under a license agreement containing restrictions on use and disclosure. All rights including reproduction by photographic or electronic process and translation into other languages of this material are fully reserved under copyright laws. Reproduction or use of this material in whole or in part in any manner without written permission from Meridium, Inc. is strictly prohibited.

Meridium is a registered trademark of Meridium, Inc.

All trade names referenced are the service mark, trademark or registered trademark of the respective manufacturer.

About This Document

This file is provided so that you can easily print this section of the Meridium APM Help system.

You should, however, use the Help system instead of a printed document. This is because the Help system provides hyperlinks that will assist you in easily locating the related instructions that you need. Such links are not available in a print document format.

The Meridium APM Help system can be accessed within Meridium APM itself or via the Meridium APM Documentation Website (<https://www.meridium.com/documentation/WebHelp/WebHelpMaster.htm>).

Note: If you do not have access to the Meridium APM Documentation Website, contact [Meridium Global Support Services](#).

Table of Contents

Meridium APM SIS Management	1
Copyright and Legal	2
About This Document	3
Table of Contents	4
Overview of Safety Instrumented System (SIS) Management	15
What is a Safety Instrumented System?	17
SIS Management System Requirements	19
Overview of the SIS Management Data Model	20
Illustration of the SIS Management Data Model	21
Safety Instrumented System Family Is the Predecessor Family	23
Instrumented Function Family Is the Predecessor Family	25
Protective Instrument Loop Family Is the Predecessor	27
Components of an SIL Analysis	28
The SIS Management Workflow	30
SIL Analysis State Configuration	31
Protective Instrument Loop State Configuration	34
SIS Trip Report State Configuration	38
Integration with Hazards Analysis	41
Accessing the SIS Management Start Page	42
Aspects of the SIS Management Start Page	43
First-Time Deployment Workflow	44
Upgrade or Update SIS Management to 3.6.1.1.0	46
SIS Management Security Groups	54
Accessing the SIS Management Administration Page	60
Aspects of the SIS Management Administration Page	61
Common Tasks Menu	63
Specifying a Different Query on SIS Management Administration Page	64
Specifying the Asset Source for ASM Integration	65

About Importing Data from an Exida Project File	66
Accessing the Options Screen	67
Creating a New Analysis for the Imported Data	70
Appending the Imported Data to an Existing Analysis	72
About Exporting Data to an Exida Project File	74
Exporting Data to an Exida Project File	75
About Managing the Types of Independent Layers of Protection	79
About Independent Layer of Protection Types	80
Modifying the Default Values in the Baseline IPL Type Records	82
Defining Additional IPL Types	83
An Example: Defining Additional IPL Types	86
About Navigating SIS Management	88
The Navigation Menu in SIS Management	89
About SIL Analysis Records	90
Accessing the SIL Analysis Search Page	91
Aspects of the SIL Analysis Search Page	92
Common Tasks Menu	93
Searching for SIL Analysis Records	94
Accessing the SIL Analysis Definition Page	95
Aspects of the SIL Analysis Definition Page	96
Common Tasks Menu	97
About Defining SIL Analysis Records	98
Creating SIL Analysis Records	99
Copying SIL Analysis Records	100
Modifying SIL Analysis Records	102
Opening Existing SIL Analysis Records	103
Removing SIL Analysis Records from the SIL Analysis Search Page	104
About Associating SIL Analyses with a Specific Site	105
About the SIL Analysis Team	106
Accessing the SIL Analysis Team Members Page	107

Aspects of the SIL Analysis Team Members Page	108
Common Tasks	109
Creating New Users and Adding Them to the SIL Analysis Team	110
Adding New Team Members Who Already Have A Human Resource Record	112
About SIL Analysis Team Member Roles	114
Assigning Roles to SIL Analysis Team Members	115
Viewing Human Resource Records for Existing Team Members	116
Removing Team Members from the SIL Analysis Team	117
Accessing the Reference Documents Page	118
Aspects of the Reference Documents Page	119
Common Tasks	120
Creating New Reference Document Records and Adding Them to the SIL Analysis	121
Adding Existing Reference Document Records to the SIL Analysis	122
Viewing Reference Documents	123
Opening Reference Document Records	124
Removing Reference Documents from the SIL Analysis	125
About Safety Instrumented System Records	126
Accessing the Safety Instrumented Systems Page	127
Aspects of the Safety Instrumented Systems Page	128
Assessment Tasks	129
Common Tasks	130
Creating New Safety Instrumented System Records	131
Adding Existing Safety Instrumented System Records to the SIL Analysis	133
Copying Existing Safety Instrumented System Records	135
Modifying Safety Instrumented System Records	136
Removing Safety Instrumented System Records from the SIL Analysis	137
About Instrumented Function Records	138
Accessing the Instrumented Functions (IFs) Page	139
Aspects of the Instrumented Functions (IFs) Page	140

Assessment Tasks	142
Common Tasks	144
About Defining Instrumented Function Records	145
Creating New Instrumented Function Records	147
About the Instrumented Function Tab	149
About The Safety Requirement Specification Tab	150
About SIF Common Cause Failure Records	151
Aspects of the Common Cause Failures Tab	153
Creating New Common Cause Failure Records	155
Linking Existing SIF Common Cause Failure Records to Instrumented Function Records	158
Linking Additional Instrumented Function Records to an SIF Common Cause Failure Record	161
Removing SIF Common Cause Failure Records from an Instrumented Function Record	163
About Concurrent Safe State Hazards and Instrumented Function Records	164
Aspects of the Concurrent Safe States Tab in Instrumented Function Records	167
Defining Concurrent Safe State Hazards for Instrumented Functions	169
Removing Instrumented Functions From the Concurrent Safe States Tab	176
Adding Existing Instrumented Function Records to the SIL Analysis	178
Copying Existing Instrumented Function Records	180
Modifying Existing Instrumented Function Records	181
About Assessing the SIL Level for Instrumented Functions	182
SIL Level and Required Probability of Failure	184
About Assessing SIL Values Via the Risk Matrix	187
Accessing the Risk Assessment Interface	188
About Assessing SIL Values via a Hazards Analysis Risk Assessment	189
About Mapping Values from a Hazards Analysis	190
Selecting a Risk Assessment Record from a Hazards Analysis	191
Aspects of the PHA Risk Assessment Window	194
What is a Layer of Protection Analysis (LOPA)?	197

Navigation Menu	198
Common Tasks	199
About LOPA Records	200
Accessing the LOPA Definition Page	201
Aspects of the LOPA Definition Page	202
Creating LOPA Records	203
Opening Existing LOPA Records	204
Adding Existing LOPA Records to the Associated Risk Assessments Grid	205
Copying LOPA Records to Create New Ones	207
Removing LOPA Records from the Associated Risk Assessments Grid	208
About Independent Layer of Protection Records	209
Creating Independent Layer of Protection Records	210
Deleting Independent Layer of Protection Records	212
About Consequence Modifier Records	213
Accessing the Consequence Modifiers Page	214
Aspects of the Consequence Modifiers Page	215
Creating New Consequence Modifier Records	216
Removing Consequence Modifier Records from the Consequence Modifiers Grid	217
About Promoting Instrumented Functions to ASM	218
Promoting Instrumented Functions to ASM	220
Viewing Asset Strategies Created from Instrumented Functions	221
About Proof Testing	222
Common Tasks Menu	224
Accessing the Proof Test Template Definition Page	225
Aspects of the Proof Test Template Definition Page	226
Creating SIS Proof Test Template Records	227
Accessing a List of Existing SIS Proof Test Template Records	229
Aspects of the Proof Test Templates Page	231
Viewing an Existing SIS Proof Test Template Record	232

Adding Existing SIS Proof Test Template Detail Records to the SIS Proof Test Template Record	233
Viewing Existing SIS Proof Test Template Detail Records	235
Removing SIS Proof Test Template Detail Records from the SIS Proof Test Template Record	236
Copying SIS Proof Test Template Records to Create New Ones	237
Removing SIS Proof Test Template Records	238
About SIS Proof Test Records	239
Common Tasks Menu	240
Accessing the Proof Test Definition Page	241
Aspects of the Proof Test Definition Page	242
Creating New SIS Proof Test Records	243
Accessing the List of Existing SIS Proof Test Records	244
Aspects of the Proof Tests Page	246
Opening SIS Proof Test Records	247
Recording Proof Test Results in SIS Proof Test Records	249
About Protective Instrument Loops	251
About the SIL Validation Feature	252
The SIL Validation Workflow	254
The Navigation Menu	255
The SIL Validation Menu	256
The Common Tasks Menu	257
About Creating Protective Instrument Loops	258
Creating New Protective Instrument Loops Manually	259
Creating New Protective Instrument Loops Based on a Template	260
About Opening Existing Protective Instrument Loops	262
Accessing a List of Existing Protective Instrument Loops	263
Aspects of the Protective Loop Search Page	264
Common Tasks	265
Opening an Existing Protective Instrument Loop	266

Opening Protective Instrument Loops Associated with an Instrumented Function in an SIL Analysis	267
Aspects of the Protective Instrument Loop Diagram View Page	268
Adding Elements to the Protective Instrument Loop Diagram	270
Defining Element Properties in the Diagram View	271
Removing Elements from the Protective Instrument Loop Diagram	273
Linking Existing Records to Elements in the Protective Instrument Loop	274
Unlinking Elements from a Protective Instrument Loop	278
Accessing the Protective Instrument Loop Grid View Page	281
Aspects of the Protective Instrument Loop Grid View Page	282
Accessing the Protective Instrument Loop Summary Page	283
Aspects of the Protective Instrument Loop Summary Page	284
Deleting Protective Instrument Loops	285
About Protective Instrument Loop Templates	286
About Creating Protective Instrument Loop Templates	288
Creating Protective Instrument Loop Templates from Scratch	289
Creating Protective Instrument Loop Templates Based on Existing Protective Instrument Loops	290
Copying Protective Instrument Loop Templates to Create New Ones	291
Accessing the Protective Loop Template Search Page	292
Aspects of the Protective Loop Template Search Page	293
The Common Tasks Menu	295
Opening Existing Protective Instrument Loop Templates	296
About Calculating SIL Validation Results	297
Calculating SIL Validation Results for a Protective Instrument Loop	298
Calculating SIL Validation Results for Multiple Protective Instrument Loops	299
About Calculation Details	300
About the Missing Required Values Dialog Box	301
About Protective Instrument Loop Final Element Records	303
About Defining Hazards Associated With Combined Output States	304

Aspects of the Dangerous Combination of Output States Tab in Protective Instrument Loop Final Element Records	307
Defining Combined Output State Hazards for Final Elements	309
Removing Final Elements From the Dangerous Combination of Outputs Tab	317
About the Protective Instrument Loop Report	319
Viewing the Protective Instrument Loop Report	321
Viewing SIL Analysis Graphs	322
Viewing SIL Analysis Reports	324
About the Safety Requirement Specifications Report	325
Accessing the Safety Requirement Specifications Report	326
About Managing Validation Failure Rate Reference Data	328
Navigation	329
Common Tasks	330
Accessing the Sensor Reference Data Search Page	331
Aspects of the Sensor Reference Data Search Page	332
Opening Existing Protective Instrument Loop Sensor Records	333
Aspects of the Sensor Reference Data Page	334
Creating New Protective Instrument Loop Sensor Records from Scratch	335
Creating Protective Instrument Loop Sensor Records as Copies of an Existing One	336
Approving and Revoking Approval for Protective Instrument Loop Sensor Records	339
Accessing the Logic Solver Reference Data Search Page	340
Aspects of the Logic Solver Reference Data Search Page	341
Opening Existing Protective Instrument Loop Logic Solver Records	342
Aspects of the Logic Solver Reference Data Page	343
Creating Protective Instrument Loop Logic Solver Records from Scratch	344
Creating Protective Instrument Loop Logic Solver Records Based on Existing Ones	345
Creating Protective Instrument Loop Logic Solver Records as Copies of an Existing One	347

Linking Protective Instrument Loop Logic Solver Channel Records to Protective Instrument Loop Logic Solver Records 350

Removing Protective Instrument Loop Logic Solver Channel Records from Protective Instrument Loop Logic Solver Records 352

Approving and Revoking Approval for Protective Instrument Loop Logic Solver Records 353

Accessing the Final Element Reference Data Search Page 354

Aspects of the Final Element Reference Data Search Page 355

Opening Existing Protective Instrument Loop Final Element Records 356

Aspects of the Final Element Reference Data Page 357

Creating New Protective Instrument Loop Final Element Records from Scratch .. 358

Creating Protective Instrument Loop Final Element Records as Copies of an Existing One 360

Approving and Revoking Approval for Protective Instrument Loop Final Element Records 362

About SIS Trip Reports 363

Accessing the SIS Trip Report Search Page 364

Aspects of the SIS Trip Report Search Page 365

Opening Existing SIS Trip Report Records 366

Navigation 367

Common Tasks 368

Aspects of the SIS Trip Report Page 369

Creating New SIS Trip Report Records 370

Accessing the SIS Trip Report Details Page 373

Aspects of the SIS Trip Report Details Page 374

Creating New SIS Trip Report Details Records 375

Viewing SIS Trip Report Detail Records 376

Deleting SIS Trip Report Detail Records 377

About Revision History in SIS Management 378

Accessing SIL Analysis Revisions 379

Aspects of the Analysis Revision History Page 380

Common Tasks Menu 382

Viewing the Datasheet for a Revision Record	383
Viewing Changes That Were Made Between Revisions	384
About Risk Assessment Recommendation Records and the SIL Analysis	385
Accessing the Recommendations Dialog Box	386
Aspects of the Recommendations Dialog Box	388
Creating New Risk Assessment Recommendation Records	389
Adding Existing Risk Assessment Recommendation Records to the SIL Analysis ..	391
Removing Risk Assessment Recommendation Records from the SIL Analysis	393
Using the Status Field in Recommendations	394
About Scheduling Risk Assessment Recommendation Alerts	396
Scheduling Alert to Notify an Assignee When a Recommendation is Due	397
Scheduling an Alert to Notify Assignees When a Recommendation is Due for Reevaluation	398
Viewing the List of Risk Assessment Recommendation Records for the Current SIL Analysis	399
Viewing the List of Risk Assessment Recommendation Records for All SIL Ana- lyses	400
About Inspection Tasks Records	401
Creating Inspection Task Records	402
Viewing the List of Inspection Task Records that are Linked to an Individual Record	404
Viewing the List of Inspection Task Records for All SIL Analyses	405
Associated Pages	406
About the SIS Management Catalog Folder Structure	407
Dashboards Folder	409
LOPA Folder	410
PIF Folder	411
Proof Test Template Folder	412
Proof Tests Folder	413
Protective Instrument Loop Folder	414
About The Queries Folder	415

Queries That Support Module-Specific Pages	416
Queries That Support The SRS Report	422
Dashboard Queries Folder	424
SIL Folder	427
SIS Trip Report Folder	429
Consequence Modifier	430
Independent Layer of Protection	431
Instrumented Function	434
Functional Test Detail	462
LOPA	467
Protective Instrument Loop	475
Protective Instrument Loop Final Element	494
Protective Instrument Loop Logic Solver	498
Safety Instrumented System	507
SIF Common Cause Failure	513
SIL Analysis	514
SIS Proof Test	534
SIS Proof Test Template	539
SIS Proof Test Template Detail	541
System Code Tables Used by SIS Management	543
Parameters for the SIS Management URL	544
Examples of SIS Management URLs	561
Instrumented Function	562
Maintenance Capability Index (MCI)	563
Proof Test	564
Protective Instrument Loop	565
SIL Value	566

Overview of Safety Instrumented System (SIS) Management

The *Safety Instrumented System (SIS) Management* module lets you manage the safety instrumented systems that are in place in a facility to monitor and maintain controlled processes and ensure efficiency and safety during those processes.

For example, heating the temperature of a room is a process that has a specific, desired outcome to reach and maintain the desired temperature (e.g., 20 degrees Celsius). If the temperature increases too rapidly, the temperature change could lead to a chain of events that may result in equipment failure or a catastrophic event. To prevent a rapid temperature increase during the heating process, a sensor within the thermometer continually measures the temperature and relays that information to a computer. The computer decides whether the temperature is increasing at intervals that are in line with the specified safe limits for this process. If the data transmitted to the computer indicates that the temperature is increasing too rapidly, it will send a command to the heating element to decrease the temperature.

Together, the sensor within the thermometer, the computer, and the heating element act as a *safety instrumented system* that monitors the process of heating a room to ensure that it is performed safely and efficiently.

Using SIS Management, you can conduct a [Safety Integrity Level \(SIL\) Analysis](#), which you can use to assess the integrity of the safety instrumented systems that are already in place in your facility and to uncover areas that may require further safeguarding. An SIL Analysis (pronounced *S-I-L*) lets you assign a numeric rating to the safety instrumented systems that you are analyzing. This numeric rating represents the level of protection that those systems currently provide, called a safety integrity level (SIL).

For instance, consider the previous example. If the heating element safely and successfully reduces the speed at which the temperature is increasing, this safety instrumented system would be considered to have a higher integrity level than one in which the temperature in the room continues to increase despite the efforts of the system.

To conduct an SIL Analysis in SIS Management, a team of individuals will:

- Define the function of the safety instrumented systems that will be assessed.
- Identify the undesirable consequences that the safety instrumented systems are designed to prevent.
- Test the components of the safety instrumented systems to determine if its performance is meeting the specified requirements and identify failures that may be occurring within those systems.
- Based on the test results, determine where further improvements are needed within the safety instrumented systems.

In addition, the SIS Management module provides the tools necessary for [compliance with the standard IEC 61511](#).

Note: The Meridium APM SIS Management module and supporting documentation are dedicated in memory of Steve Soos IV, Product Manager, whose knowledge, dedication, and vision are realized therein.

What is a Safety Instrumented System?

A *safety instrumented system (SIS)* is a system comprised of instruments that are designed specifically to:

- **Monitor the conditions of a process.** Processes can be executed by an equipment and locations.
- **Recognize conditions that are indicative of failure.** Identifying the initiating events that could lead to a safety instrumented system failure can provide the system with enough time to prevent the failure. The consequences of a safety system failure can lead to a chain of event that causes further equipment failure and even a catastrophic event.
- **Prevent consequences** by reacting to conditions that are indicative of a failure. Safety instrumented systems make adjustments to the process to bring the conditions to a mitigated state or even shut down that process to prevent failures.

A safety instrumented system consists of the following items:

- One or more protective instrument loops (PIL), which is a series of interconnected instruments. Each protective instrument loop (PIL) is designed to maintain a defined condition within the process, meaning that it serves a specific purpose or *instrumented function(IF)*. In other words, for every instrumented function that exists for a safety instrumented system, there is one protective instrument loop in place to fulfill that function.
- One logic solver, which is a computer that interprets readings from the components of the protective instrument loop (PIL) and measures that information against predefined criteria to determine whether that system needs to make adjustments to mitigate the risk associated with the instrumented functions of each protective instrument loop.

For example, assume that Unit A provides steam to Unit B, and SIS-A is in place on Unit A and Unit B to maintain the pressure levels during that process to prevent loss of pressure or excess pressure beyond the defined safe and productive levels. Maintaining safe and productive pressure levels are the instrumented functions of the protective instrument loops within SIS-A. The logic solver within SIS-A receives data from the components of the protective instrument loops and decides whether the pressure levels are normal, exceed, or are lower than the safe and productive pressure levels. If the current pressure levels indicate the possibility of a process failure, which includes scenarios like loss of productivity or explosion, the logic solver tells the components of the SIS to do something to mitigate the current condition. For example, if the current condition of the process indicates that the pressure is too low, the logic solver will tell an element of the protective instrument loop to increase the pressure so the levels are within the safe and productive levels defined for that process.

The following image illustrates a safety instrumented system and the relationships described above.

What is a Safety Instrumented System?

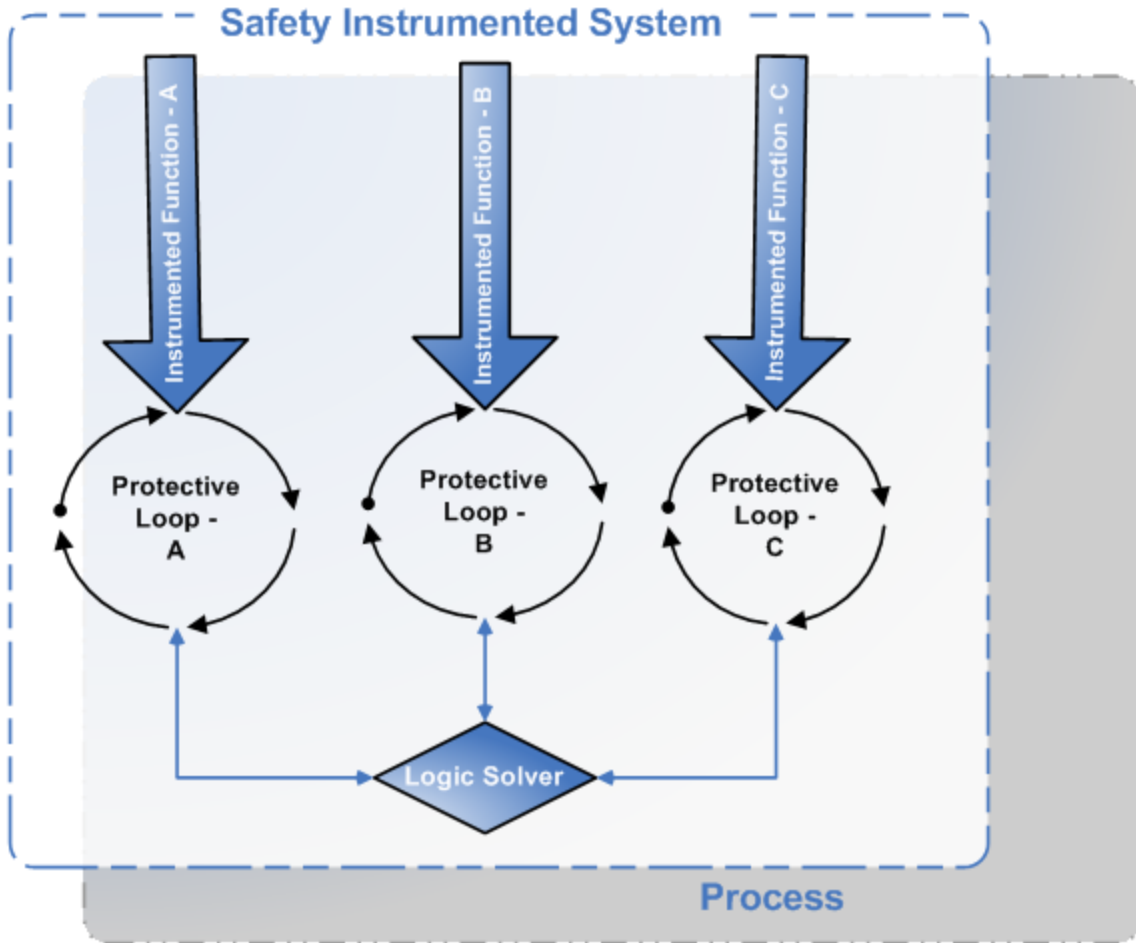

In summary:

- A given process can have more than one safety instrumented system in place to monitor and safeguard its conditions.
- Each safety instrumented system contains one protective instrument loop per instrumented function to fulfill that function within the safety instrumented system.
- Each safety instrumented system contains one logic solver to interpret the readings from the components of the protective instrument loop and instruct those elements to take action if necessary.
- The components of a protective instrument loop provide data in the form of readings to the logic solver.

SIS Management System Requirements

The *SIS Management* license is required to take advantage of SIS Management functionality. In addition, your system must contain the basic Meridium APM system architecture.

In order to use the [integration between SIS Management and Hazards Analysis](#), the *Hazards Analysis* license is also required.

CEHint: Details on the system requirements for the basic Meridium APM system architecture and activating licenses can be found in the Installation, Upgrade, and System Administration section of the Meridium APM Help system.

After you have installed and configured the basic system architecture, you will need to perform some configuration tasks specifically for the SIS Management feature.

Overview of the SIS Management Data Model

The SIS Management data model uses families to represent the various components of an SIL Analysis. Meridium APM leverages its fundamental entity and relationship family infrastructure to store data related to an SIL Analysis. When attempting to understand and make use of the Meridium APM SIS Management functionality, it is helpful to [visualize the SIS Management data model](#).

Because you should already be familiar with the concept of records and viewing records in the Meridium APM Record Manager, as you attempt to get your bearings in SIS Management, it may be useful to remember that SIS Management is simply a customized view of individual records that work together to make up an SIL Analysis.

Note: While SIS Management provides a customized view of individual records that exist in the Meridium APM database, you should not use the Record Manager to manage records for use with SIS Management. You should use the features provided in the Meridium APM SIS Management module only.

All SIL Analyses begin with an *SIL Analysis record*. Each SIL Analysis record will be linked to:

- One Equipment or Functional Location record.
- One or more Human Resource records.
- One or more Reference Document records.
- One or more Instrumented Function records.
- One or more Safety Instrumented System records.

Each Safety Instrumented System record will be linked to:

- One or more Instrumented Function records.
- One or more SIS Proof Test records.
- One or more SIS Proof Test Template records.

Each Instrumented Function records will be linked to:

- One Equipment or Functional Location record.
- One or more Protective Instrument Loop records.
- One or more Inspection Tasks records.
- One Risk Assessment records.
- One or more LOPA records.
- One or more SIS Proof Test records.
- One or more SIS Proof Test Template records.

Illustration of the SIS Management Data Model

The SIS Management data model uses families to represent various components of an SIL Analysis. Meridium APM leverages its fundamental entity and relationship family infrastructure to store data related to an SIL Analysis.

The following diagram illustrates the families that participate in the SIL Analysis. The shaded boxes represent entity families, and the arrows represent relationship families. You can determine the direction of each relationship definition from the direction of the arrow head: the box to the *left* of each arrow head is the *predecessor* in that relationship definition, and the box to the *right* of each arrow head is the *successor* in that relationship definition.

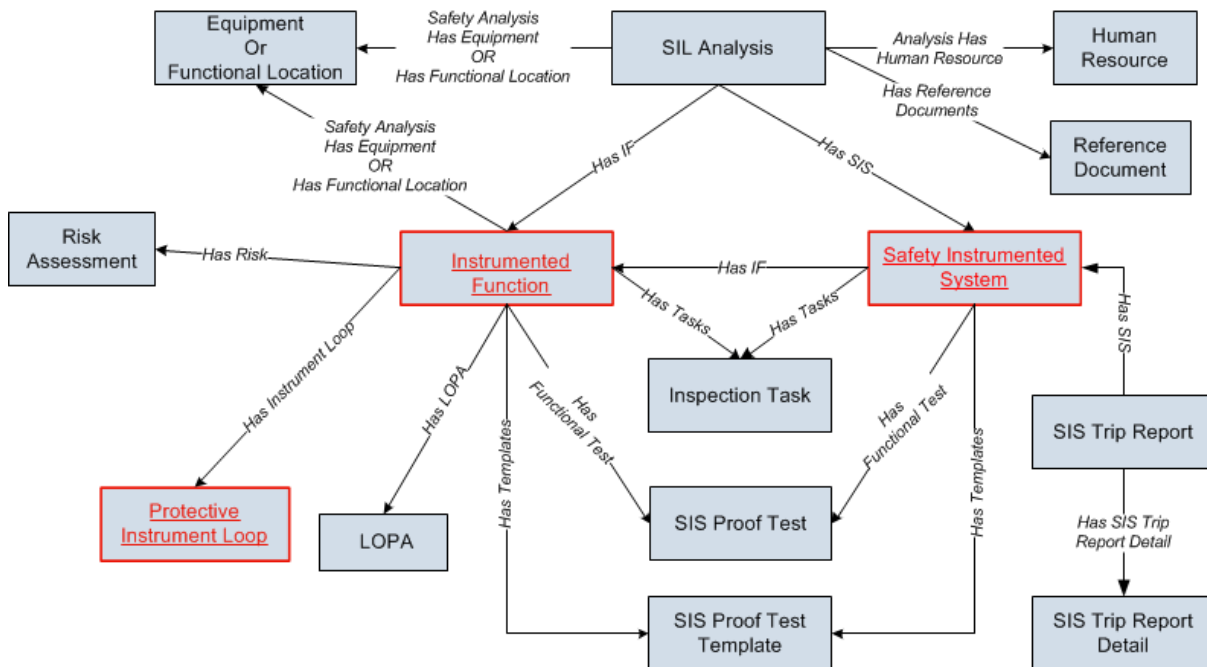

The SIS Management data model is best understood if you view it in portions, and to simplify this image, some relationship and entity families are not included.

This section of the documentation includes images of the portions of the SIS Management data model that are not illustrated in the preceding image. Each image illustrates the portion of the SIS Management data model where the following families participate as the predecessor family in the relationships illustrated in the image:

- [Safety Instrumented System](#)
- [Instrumented Function](#)
- [Protective Instrument Loop](#)

The Reference Document family is a shared family. Meaning that the Reference Document family is used by multiple families within the SIS Management data model. To simplify all the data model images, the Reference Document family is included only in the

preceding image, where the SIL Analysis family is the predecessor. In addition to this relationship, the Reference Document family participates as the successor in the Has Reference Documents relationship definition with the following families:

- SIL Analysis
- SIS Proof Test
- SIS Proof Test Template
- Protective Instrument Loop
- Risk Assessment Recommendation

To simplify the data model images, the following families are not included:

- Risk Assessment Recommendation. Within the SIS Management data model, the Risk Assessment Recommendation family participates as the successor in the Has Recommendations relationship definition with the following families:
 - Instrumented Function
 - Protective Instrument Loop
 - SIS Proof Test
 - SIS Proof Test Template
- IPL Type. This family is not related to any family in the baseline Meridium APM database. The IPL Type family is a subfamily of the Meridium Reference Tables family. IPL Type records store [details about independent layer of protection types](#) and are used to populate Independent Layer of Protection records.
- Hazards Analysis. The Hazards Analysis family participates as the successor in the Has HAZOP Reference relationship definition with the SIL Analysis and Instrumented Function families.

Safety Instrumented System Family Is the Predecessor Family

The following image shows the relationships where the Safety Instrumented System family participates as the predecessor.

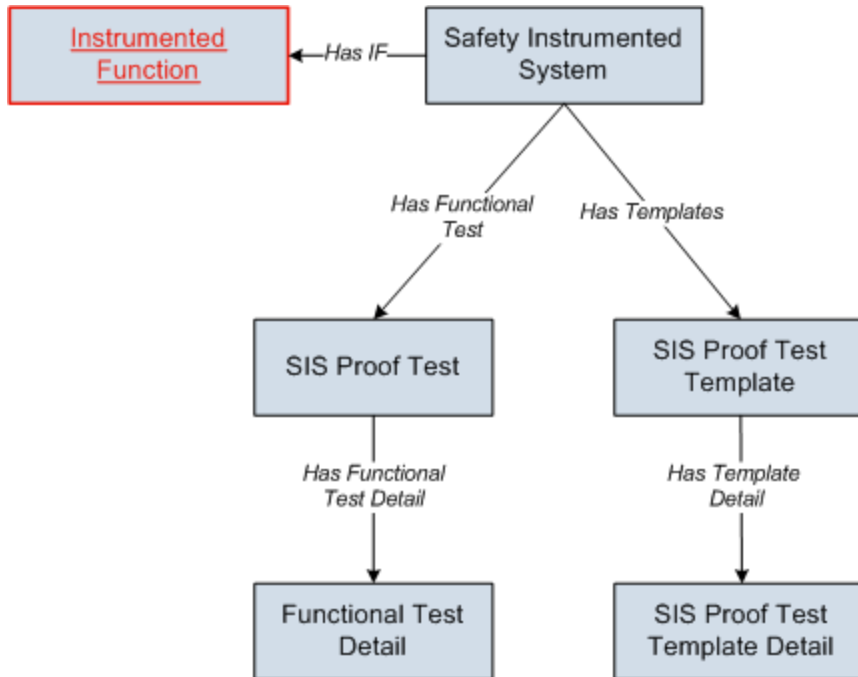

Note: To simplify this image, the relationships between the Instrumented Function family and the SIS Proof Test and SIS Proof Test Template families is not included. This relationship is illustrated in the image that illustrates the relationships in which the [Instrumented Function family participates as the predecessor](#).

The Safety Instrumented System family contains records that store information about the safety instrumented system that you are analyzing. Safety Instrumented System records are linked to Instrumented Function records, which store information about the specific functions associated with the safety instrumented system. Safety Instrumented System records are also linked to records in the following families:

- **SIS Proof Test:** Store details about a proof test that is performed on a safety instrumented system and serves as a record of the proof test event. SIS Proof Test record can be linked to Functional Test Detail records, which store the detailed steps that need to be performed during the proof test.
- **SIS Proof Test Template:** Store details about the steps that should be taken when testing a safety instrumented system. When you create SIS Proof Test record, you can select an SIS Proof Test Template record, and the details from the SIS Proof Test Template record will be populated automatically in the SIS Proof Test record. SIS Proof Test Template records can be linked to SIS Proof Test Template Detail

records, which store details on the steps that need to be performed during the proof test.

The SIS Proof Test, SIS Proof Test Template, and Reference Document families participate as the successor in other relationships within the SIS Management data model. This means that these families appears in another portion of the data model.

Instrumented Function Family Is the Predecessor Family

The following image shows the relationships in which the Instrumented Function family participates as the predecessor.

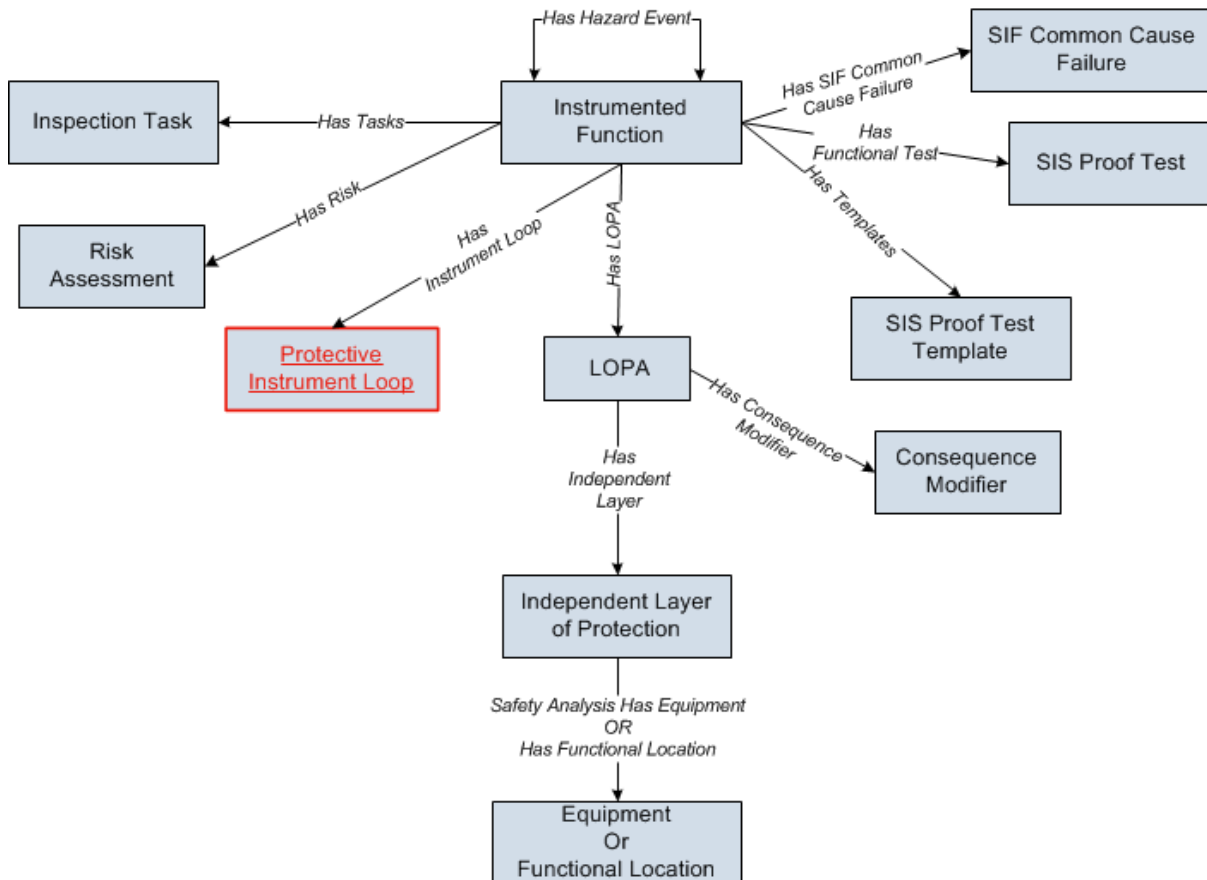

Instrumented Function records store details about a specific function of an SIS. Instrumented Function records are linked directly to records in the following families:

- **Inspection Task:** Stores details on when a task should be performed on the item represented by the record to which the Inspection Task record is linked, including the due date for the task.
- **SIS Proof Test:** Stores details about a test that is taken on a safety instrumented system and serves as a record of the event.
- **SIS Proof Test Template:** Stores details about the steps that should be taken when testing a safety instrumented system. When you create an SIS Proof Test record, you can select an SIS Proof Test Template record, and the details from the SIS Proof Test Template record will be populated automatically in the SIS Proof Test record.
- **Risk Assessment:** Stores the unmitigated risk associated with the item

represented by the record to which the Risk Assessment record is linked.

- **Protective Instrument Loop:** Stores the details of the protective instrument loop and its components, including the calculated results of the proof test associated with the Safety Instrumented System record to which the Protective Instrument Loop record is linked.
- **LOPA:** Stores the details of the Layer of Protection Analysis that you want to conduct, including a description of the initiating event that is indicative of a process failure. LOPA records store details of the risk assessment that is determined after conducting the Layer of Protection Analysis.
- **SIF Common Cause Failure:** Stores the details of a failure that affects the operation of multiple instrumented functions.
- **Instrumented Function:** Indicates that if both the instrumented functions represented by the two records are in their *safe state* at the same time, a hazardous event may occur.

Note: The SIS Proof Test and SIS Proof Test Template families also appear in [other portions of the data model](#).

Protective Instrument Loop Family Is the Predecessor

The following image shows the relationships in which the Protective Instrument Loop family participates as the predecessor.

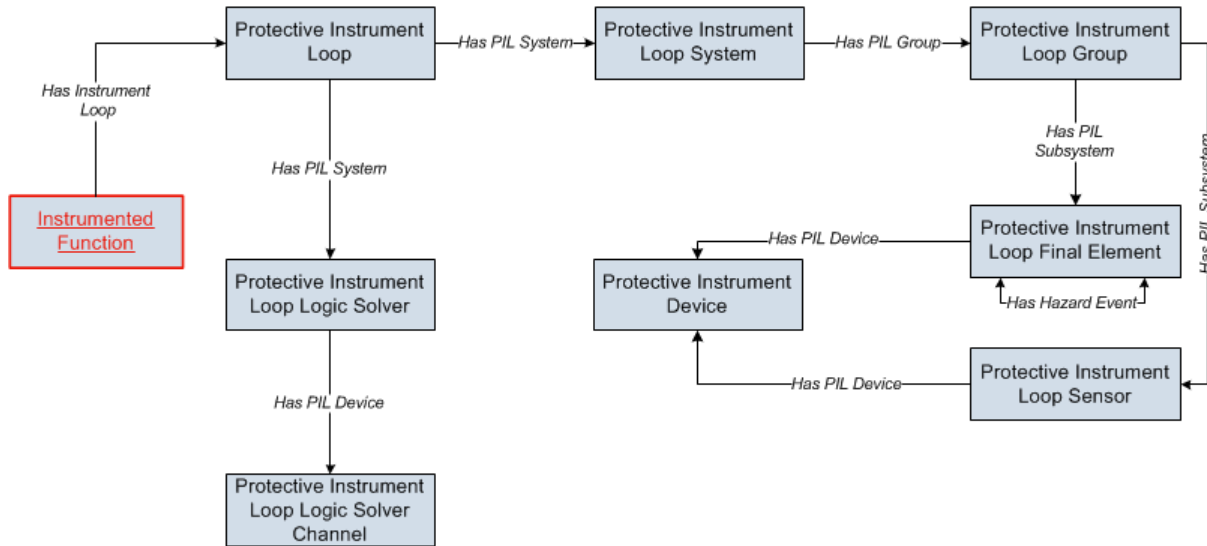

Protective Instrument Loop records store summary information about all the records that are linked to that record. The Protective Instrument Loop record combined with all the records that are linked to that record make up the *protective instrument loop*.

Components of an SIL Analysis

A *Safety Integrity Level (SIL) Analysis* lets you assess the safety instrumented systems in your facility to ensure that they are adequately safeguarding your equipment, locations, and processes. An SIL Analysis consists of an SIL Analysis record and ALL the records that are linked to that record both directly and indirectly. SIL Analysis records store overview information about the analysis that you are conducting, including the start and end dates for the analysis. The following image illustrates the records that are linked *directly* to an SIL Analysis record.

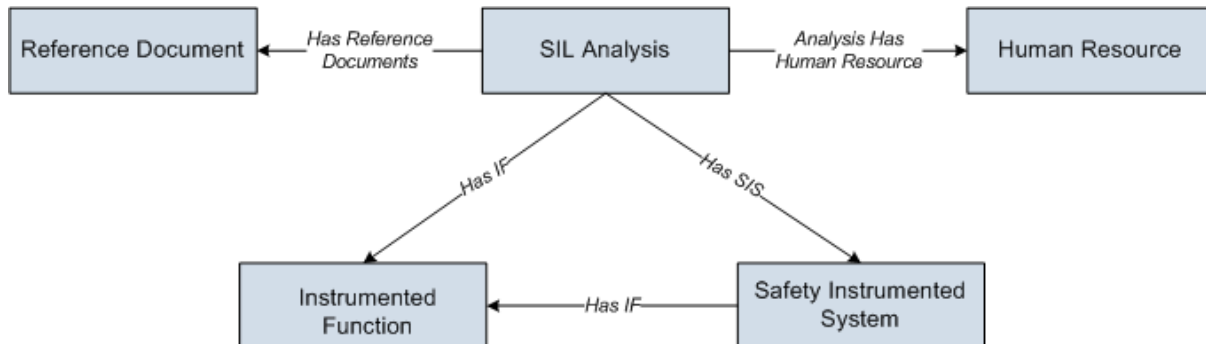

You can see that records in the following families are linked directly to an SIL Analysis record:

- **Human Resource:** Stores information about the people who will participate in the analysis as SIL Analysis team members.
- **Reference Document:** Stores the URL path to a document that is external to Meridium APM and contains reference information related to the SIL Analysis.
- **Instrumented Function:** Stores information about the instrumented functions of the safety instrumented system that you are analyzing.
- **Safety Instrumented System:** Stores information about the safety instrumented systems that you are analyzing.

Additionally, Safety Instrumented System records and Instrumented Function records are linked to one another through the *Has IF* relationship. In addition to the relationships described above, an SIL Analysis includes records in the families that are linked to Safety Instrumented System records and Instrumented Function records. For more information on these records, see the [data model image](#).

When you conduct an SIL Analysis, you will:

- Assess the level of safety integrity per instrumented function, using the Meridium APM Risk Matrix interface or via a Layer of Protection Analysis (LOPA). The overall safety integrity level (SIL) for a safety instrumented system will be calculated automatically by the Meridium APM system based upon the defined risks.
- Validate the safety integrity level (SIL) of a safety instrumented system using the SIL Validation tool, which lets you create a diagram of the protective instrument loops (PIL) that make up the safety instrumented system and calculate the ability

of a protective instrument loop to meet the required safety integrity level (SIL) for that process. The Meridium APM system uses equations defined by IEC 61508 to calculate the probability of failure on Demand average (PFD Avg) or probability of failure per hour (PFH).

- Determine whether further safeguarding is necessary, based upon the safety integrity level maintained by those safety instrumented systems.

The SIS Management Workflow

The first step in creating an SIL Analysis is to create an SIL Analysis record. After you have created the SIL Analysis record on the **SIL Analysis Definition** page, you can complete the SIL Analysis by:

- Defining the SIL Analysis team.
- Managing Reference Document records.
- Defining the Safety Instrumented System records.
- Defining Instrumented Function records.
- Assess risk, which includes:
 - Using a Risk Matrix.
 - Conducting a Layer of Protection Analysis (LOPA)
- Manage Risk Assessment Recommendation records.
- Validate the safety integrity level (SIL) of the safety instrumented systems by managing protective instrument loops (PILs).
- Manage SIS Trip Report records.
- Manage Inspection Task records.
- Manage Validation Failure Rate Reference data.

SIL Analysis State Configuration

This topic describes attributes of the State Configuration that is defined for the SIL Analysis family in the baseline Meridium APM database.

States and Operations

The following State Configuration is defined for the SIL Analysis family. In this image, a box represents a state, and an arrow represents an operation. The state to which an arrow points represents a successor state.

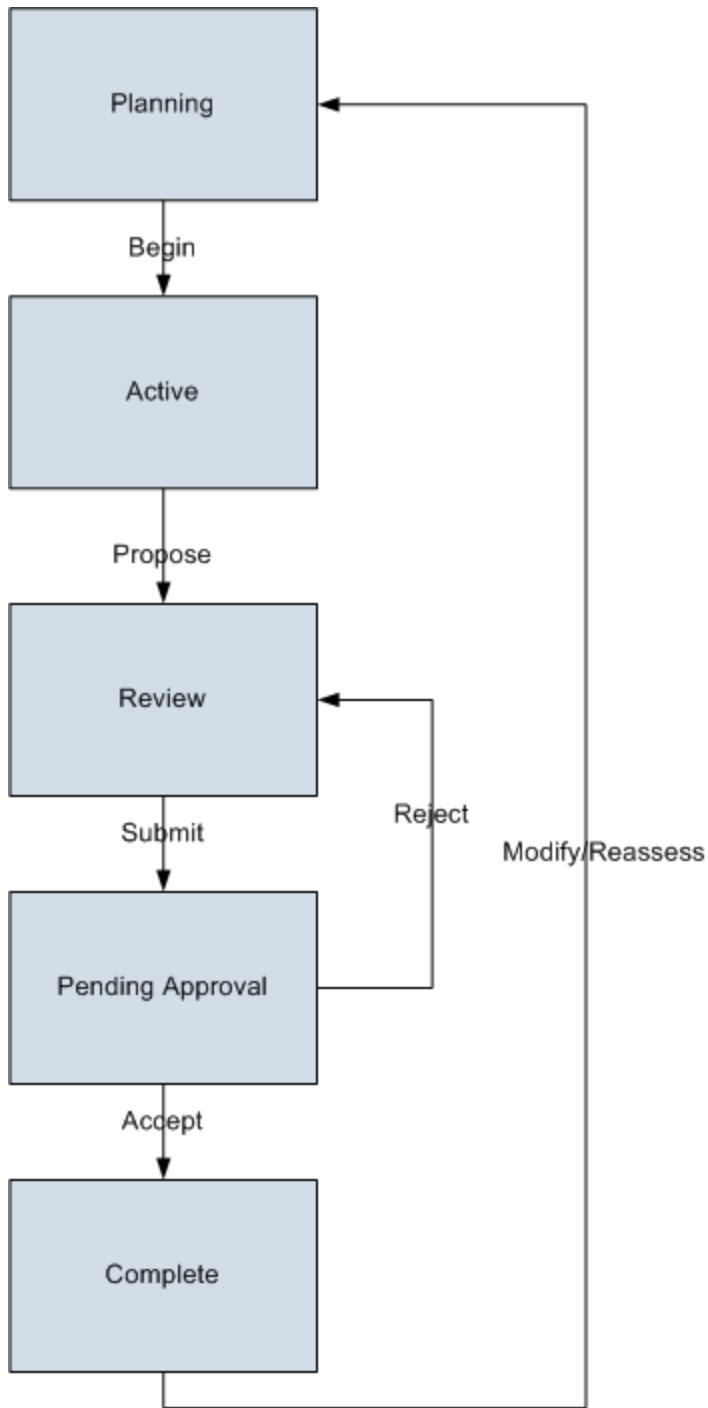

Initial State

The Planning state is the initial state of all new SIL Analysis records.

Datasheet Configuration

By default, states and operations will appear on the datasheet when you are viewing an SIL Analysis record in SIS Management, the Record Manager, or the Bulk Data Form.

Reserved States and Operations

The following table lists the baseline states and operations and indicates which of these states and operations are reserved. You cannot remove or modify reserved states or operation. You can, however, add your own states and operations to the State Configuration.

States	
State	Is Reserved?
Planning	Yes
Active	Yes
Review	Yes
Pending Approval	Yes
Complete	Yes
Operations	
Operation	Is Reserved?
Begin	Yes
Propose	Yes
Submit	Yes
Accept	Yes
Reject	Yes
Modify/Reassess	Yes

State Configuration Roles

By default, the MI SIS Administrator and MI SIS Engineer State Configuration Roles are assigned to all states in the SIL Analysis State Configuration. You can assign State Configuration Roles to any state. In addition, for each state, the **Require a specific user to be assigned to a state** check box is *selected*.

Protective Instrument Loop State Configuration

This topic describes attributes of the State Configuration that is defined for the Protective Instrument Loop family in the baseline Meridium APM database.

States and Operations

The following State Configuration is defined for the Protective Instrument Loop family. In this image, a box represents a state, and an arrow represents an operation. The state to which an arrow points represents a successor state.

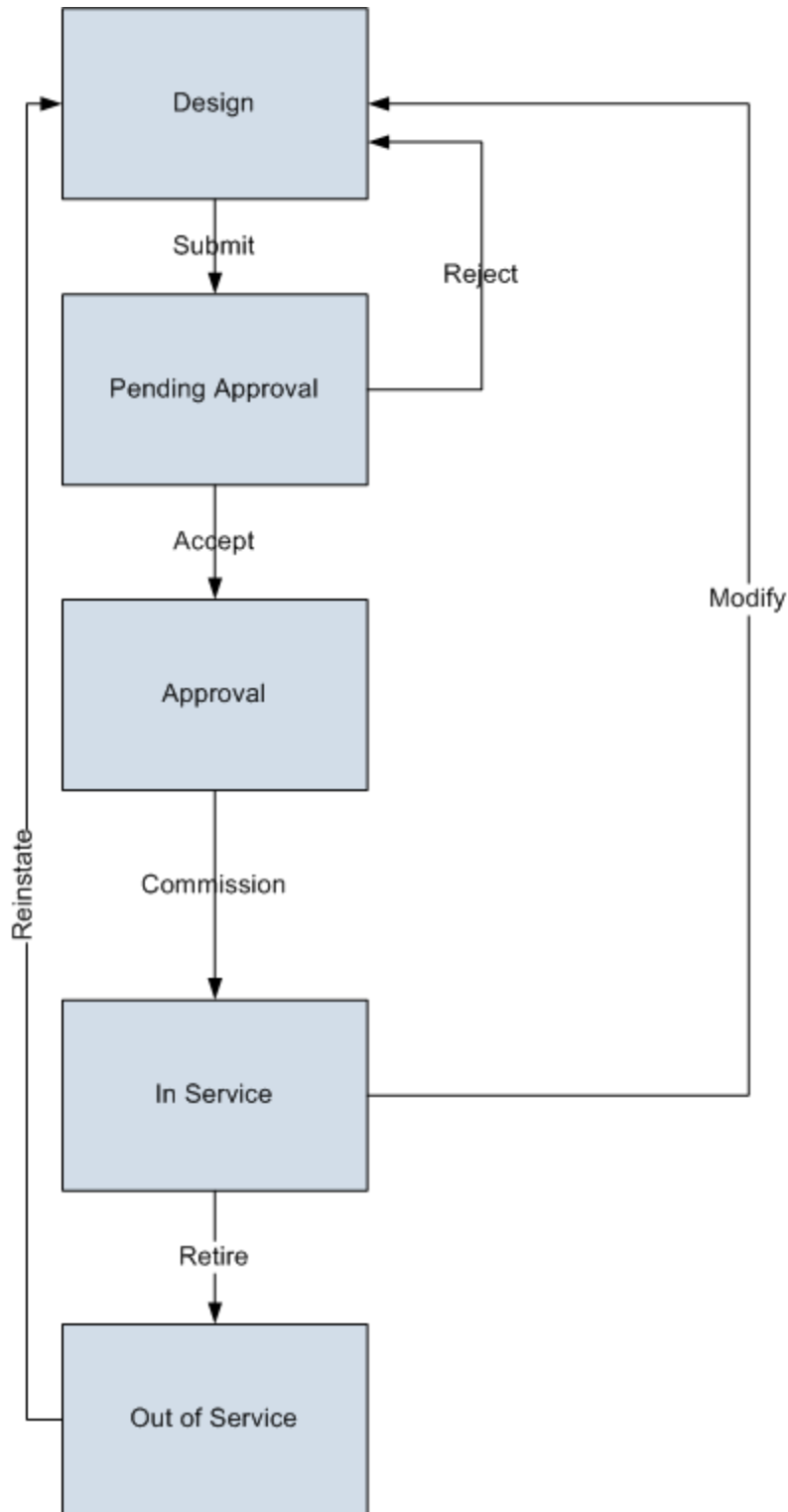

Initial State

The Design state is the initial state of all new Protective Instrument Loop records.

Datasheet Configuration

By default, states and operations will appear on the datasheet when you are viewing a Protective Instrument Loop record in SIS Management, the Record Manager, or the Bulk Data Form.

Reserved States and Operations

The following table lists the baseline states and operations and indicates which of these states and operations are reserved. You cannot remove or modify reserved states or operation. You can, however, add your own states and operations to the State Configuration.

States	
State	Is Reserved?
Design	Yes
Pending Approval	Yes
Approval	Yes
In Service	Yes
Out of Service	Yes
Operations	
Operation	Is Reserved?
Submit	Yes
Accepted	Yes
Rejected	Yes
Commissioned	Yes
Modify	Yes
Resinstate	Yes

State Configuration Roles

The following table lists the baseline states and indicates which State Configuration Roles are assigned to each state.

State	Security Groups
Design	MI SIS Administrator MI SIS Engineer
Pending Approval	MI SIS Administrator MI SIS Engineer
Approval	MI SIS Administrator MI SIS Engineer
In Service	MI SIS Administrator MI SIS Engineer
Out of Service	MI SIS Administrator MI SIS Engineer

In addition, for each state, the **Require a specific user to be assigned to a state** check box is *selected*.

SIS Trip Report State Configuration

This topic describes attributes of the State Configuration that is defined for the SIS Trip Report family in the baseline Meridium APM database.

States and Operations

The following State Configuration is defined for the SI Trip Report family. In this image, a box represents a state, and an arrow represents an operation. The state to which an arrow points represents a successor state.

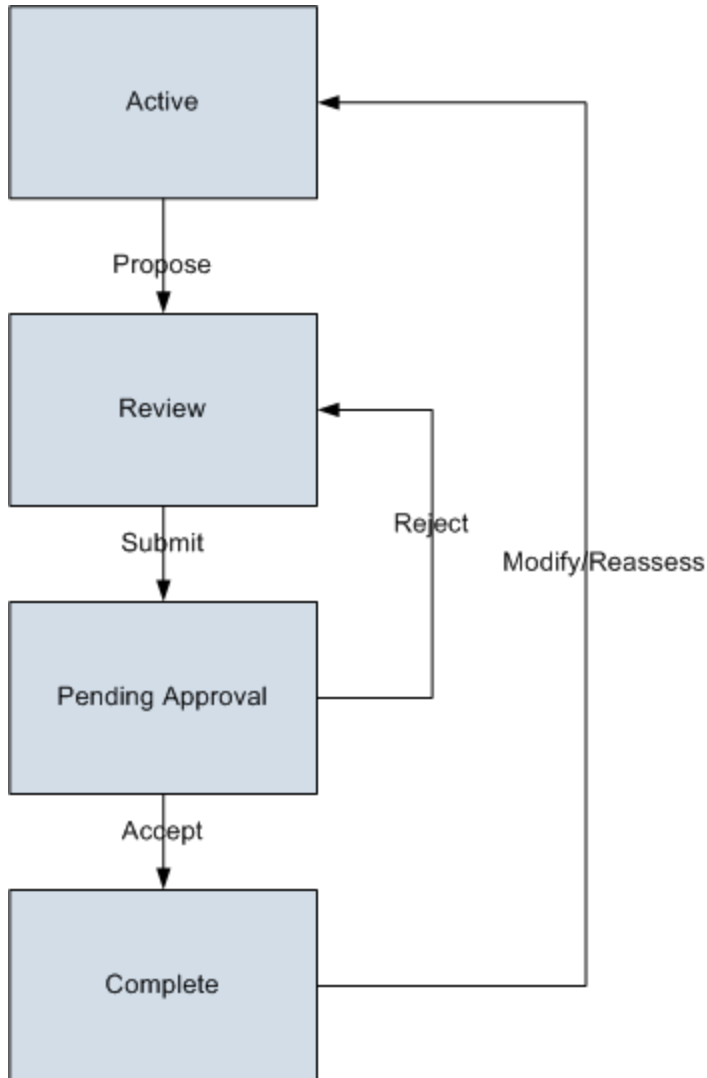

Initial State

The Active state is the initial state of all new SIS Trip Report records.

Datasheet Configuration

By default, states and operations will appear on the datasheet when you are viewing an SIS Trip Report record in SIS Management, the Record Manager, or the Bulk Data Form.

Reserved States and Operations

The following table lists the baseline states and operations and indicates which of these states and operations are reserved. You cannot remove or modify reserved states or operation. You can, however, add your own states and operations to the State Configuration.

States	
State	Is Reserved?
Active	No
Review	No
Pending Approval	No
Complete	No
Operations	
Operation	Is Reserved?
Propose	No
Submit	No
Accept	No
Reject	No
Modify/Reassess	No

State Configuration Roles

The following table lists the baseline states and indicates which State Configuration Roles are assigned to each state.

State	Security Groups
Active	MI SIS Administrator MI SIS Engineer
Review	MI SIS Administrator MI SIS Engineer

State	Security Groups
Pending Approval	MI SIS Administrator MI SIS Engineer
Complete	MI SIS Administrator MI SIS Engineer

In addition, for each state, the **Require a specific user to be assigned to a state** check box is *selected*.

Integration with Hazards Analysis

In the Hazards Analysis module, you can conduct a Hazards Analysis to identify hazards associated with a process, and then assess the risks associated with those hazards. In the SIS Management module, you can use a SIL Analysis to assess the risks associated with the instrumented functions in a safety instrumented system to determine whether it requires additional safeguarding.

After you assess risk in the Hazards Analysis module, you can apply that risk assessment to an Instrumented Function record in an SIL Analysis in the SIS Management module. You can use the Risk Assessment record that you created in a Hazards Analysis to calculate the safety integrity level (SIL) for your Instrumented Function record without having to recreate the assessment in the SIS Management module.

To take advantage of this functionality:

- The *Hazards Analysis* license must be active.
- You must assign at least view permissions to the Hazards Analysis family to any SIS Management Security Groups that should have access to integration with Hazards Analysis.
- You must have full permissions to the Has HAZOP Reference relationship family.

Note: All SIS Management and Hazards Analysis Security Groups have full permissions to the Has HAZOP Reference family by default, with the exception of the MI HA Member Security Group.

Accessing the SIS Management Start Page

To access the SIS Management Start Page:

- On the Meridium APM Framework main menu, click **Go To**, point to **Asset Safety**, and then click **SIS Management**.

The **SIS Management Start Page** appears.

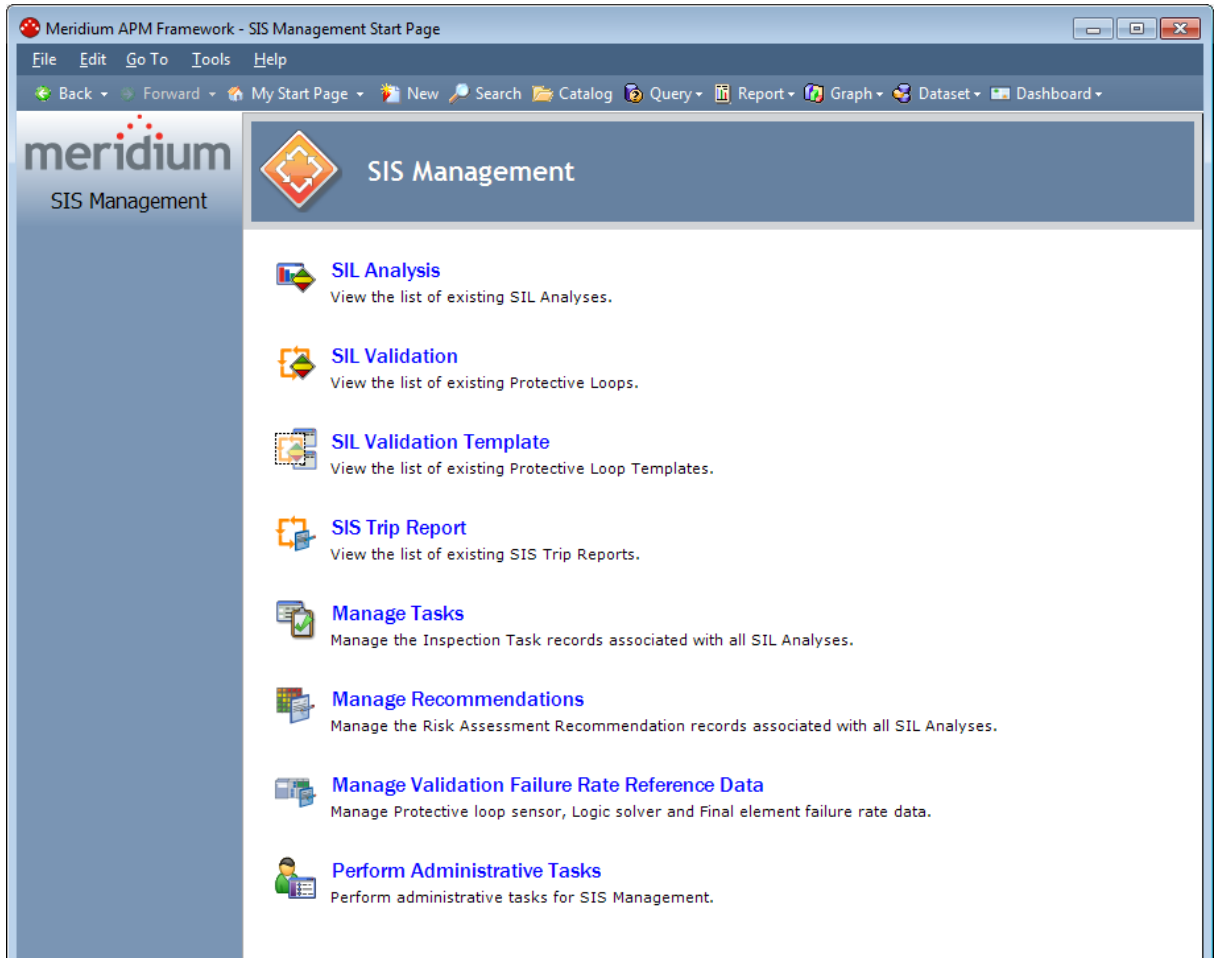

Aspects of the SIS Management Start Page

The **SIS Management Start Page** serves as a starting point for tasks that you can perform using the SIS Management module.

The **SIS Management Start Page** contains the following links:

- **SIL Analysis:** Displays the **SIL Analysis Search** page, where you can create and manage SIL Analysis records.
- **SIL Validation:** Displays the **Protective Loop Search** page, where you can search for and open existing Protective Instrument Loop records.
- **SIL Validation Template:** Displays the **Protective Loop Template Search** page, where you can create and manage Protective Instrument Loop Template records.
- **SIS Trip Report:** Displays the **SIS Trip Report Search** page, where you can create and manage SIS Trip Report records.
- **Manage Tasks:** Displays the **Task List** page, where you can view and manage the Task records that are associated with all SIL Analyses.
- **Manage Recommendations:** Displays the **Recommendation Management** page, where you can view and manage a list of Risk Assessment Recommendation records that are associated with all SIL Analyses.
- **Manage Validation Failure Rate Reference Data:** Displays the **Sensor Reference Data Search** page, where you can create and manage records in the Protective Instrument Loop Element families.
- **Perform Administrative Tasks:** Displays the **SIS Management Administration** page, where you can perform administrative tasks for the SIS Management module. This link appears only if you are logged in as a Super User or a member of the MI SIS Administrator Security Group.

First-Time Deployment Workflow

Deploying and configuring SIS Management for the first time includes completing multiple steps, which are outlined in the table in this topic. The steps in this section of the documentation provide all the information that you need to deploy and configure the SIS Management module on top of the basic Meridium APM system architecture.

Whether a step is required or optional is indicated in the **Required/Optional** cell. Steps are marked as *Required* if you must perform the steps to take advantage of SIS Management functionality.

The person responsible for completing each task may vary within your organization. We recommend, however, that the steps be performed in relatively the same order in which they are listed in the table.

Step	Task	Required/Optional	Notes
1	Review the SIS Management data model to determine which relationship definitions you will need to modify to include your custom equipment or location families. Modify any relationship definitions as needed via Configuration Manager.	Optional	This task is necessary only if you store equipment or location information in families other than the baseline Equipment and Functional Location families.
2	Assign the desired Security Users to one or more SIS Management Security Groups in Configuration Manager.	Required	Users will not be able to access SIS Management unless they have permissions to the SIS Management families.
3	Manage the queries whose results will appear throughout the SIS Management module.	Required	None
4	Specify the whether Equipment or Functional Location records will be used when integrating with the Asset Strategy Management (ASM) module.	Required	None

Step	Task	Required/Optional	Notes
5	Import data from an Exida project file.	Optional	This is necessary only if you want to create SIL Analyses using an Exida project file.
6	Export data from an Exida project file.	Optional	None
7	Manage the types of independent layers of protection that will be used to populate Independent Layer of Protection records.	Required	None
8	Activate the Hazards Analysis license in Configuration Manager.	Optional	This is necessary only if you want to take advantage of the integration between the Hazards Analysis module and SIS Management.
9	Assign at least view permissions to the Hazards Analysis family to SIS Management Security Groups in Configuration Manager.	Optional	This is necessary only for Security Groups that will be used in the integration between the Hazards Analysis module and SIS Management.

Upgrade or Update SIS Management to 3.6.1.1.0

The following tables list the steps that are required to update or upgrade SIS Management to 3.6.1.1.0. These steps assume that you have completed the steps for upgrading the components in the basic Meridium APM system architecture.

Update from version V3.6.1.0.0

This module will be updated to 3.6.1.1.0 automatically when you update the components in the basic Meridium APM system architecture. No additional steps are required.

Upgrade from any version V3.6.0.0.0 through V3.6.0.12.3

Step	Task	Required/Optional	Notes
1	Activate the Hazards Analysis license via Configuration Manager.	Optional	This is necessary only if you want to take advantage of the integration between the Hazards Analysis module and SIS Management.

Step	Task	Required/Optional	Notes
2	Assign at least view permissions to the Hazards Analysis family to SIS Management Security Groups in Configuration Manager.	Optional	This is necessary only for Security Groups that will be used in the integration between the Hazards Analysis module and SIS Management .
3	<p>Verify successful completion of the Protective Loop Utility after you have completed your database upgrade.</p> <p>A. Review the log 93_ProtectiveLoopUtility.cmd.log found in your <code><root>:\Program Files\Meridium\Client\100.0.0.0\DBUpgrade\logs</code> directory.</p> <p>B. You must manually click on Calculate on the Common Tasks Menu for each existing Protective Instrument Loop.</p>	Required	This step is required if you have previously imported data from an exida™ project file.

Upgrade from any version V3.5.1.0.0 through V3.5.1.12.0

Step	Task	Required/Optional	Notes
1	Activate the Hazards Analysis license via Configuration Manager.	Optional	This is necessary only if you want to take advantage of the integration between the Hazards Analysis module and SIS Management.
2	Assign at least view permissions to the Hazards Analysis family to SIS Management Security Groups in Configuration Manager.	Optional	This is necessary only for Security Groups that will be used in the integration between the Hazards Analysis module and SIS Management.

Step	Task	Required/Optional	Notes
3	<p>Verify successful completion of the Protective Loop Utility after you have completed your database upgrade.</p> <p>A. Review the log 93_ProtectiveLoopUtility.cmd.log found in your <root>:\Program Files\Meridium\Client\100.0.0.0\DBUpgrade\logs directory.</p> <p>B. You must manually click on Calculate on the Common Tasks Menu for each existing Protective Instrument Loop.</p>	Required	This step is required if you have previously imported data from an exida™ project file.

Upgrade from any version V3.5.0 SP1 LP through V3.5.0.1.9.0

Step	Task	Required/Optional	Notes
1	<p>Activate the Hazards Analysis license via Configuration Manager.</p>	Optional	<p>This is necessary only if you want to take advantage of the integration between the Hazards Analysis module and SIS Management.</p>

Step	Task	Required/Optional	Notes
2	Assign at least view permissions to the Hazards Analysis family to SIS Management Security Groups in Configuration Manager.	Optional	This is necessary only for Security Groups that will be used in the integration between the Hazards Analysis module and SIS Management .
3	<p>Verify successful completion of the Protective Loop Utility after you have completed your database upgrade.</p> <p>A. Review the log 93_ProtectiveLoopUtility.cmd.log found in your <code><root>:\Program Files\Meridium\Client\100.0.0.0\DBUpgrade\logs</code> directory.</p> <p>B. You must manually click on Calculate on the Common Tasks Menu for each existing Protective Instrument Loop.</p>	Required	This step is required if you have previously imported data from an exida™ project file.

Upgrade from any version V3.5.0 through V3.5.0.0.7.1

Step	Task	Required/Optional	Notes
1	Activate the Hazards Analysis license via Configuration Manager.	Optional	This is necessary only if you want to take advantage of the integration between the Hazards Analysis module and SIS Management.
2	Assign at least view permissions to the Hazards Analysis family to SIS Management Security Groups in Configuration Manager.	Optional	This is necessary only for Security Groups that will be used in the integration between the Hazards Analysis module and SIS Management.

Step	Task	Required/Optional	Notes
3	<p>Verify successful completion of the Protective Loop Utility after you have completed your database upgrade.</p> <p>A. Review the log 93_ProtectiveLoopUtility.cmd.log found in your <code><root>:\Program Files\Meridium\Client\100.0.0.0\DBUpgrade\logs</code> directory.</p> <p>B. You must manually click on Calculate on the Common Tasks Menu for each existing Protective Instrument Loop.</p>	Required	This step is required if you have previously imported data from an exida™ project file.

Upgrade from any version V3.4.5 through V3.4.5.0.1.4

Step	Task	Required/Optional	Notes
1	<p>Activate the Hazards Analysis license via Configuration Manager.</p>	Optional	<p>This is necessary only if you want to take advantage of the integration between the Hazards Analysis module and SIS Management.</p>

Step	Task	Required/Optional	Notes
2	<p>Assign at least view permissions to the Hazards Analysis family to SIS Management Security Groups in Configuration Manager.</p>	Optional	<p>This is necessary only for Security Groups that will be used in the integration between the Hazards Analysis module and SIS Management.</p>
3	<p>Verify successful completion of the Protective Loop Utility after you have completed your database upgrade.</p> <ul style="list-style-type: none"> A. Review the log 93_ProtectiveLoopUtility.cmd.log found in your <code><root>:\Program Files\Meridium\Client\100.0.0.0.0\DBUpgrade\logs</code> directory. B. You must manually click on Calculate on the Common Tasks Menu for each existing Protective Instrument Loop. 	Required	<p>This step is required if you have previously imported data from an exida™ project file.</p>

SIS Management Security Groups

The following Security Groups are provided for use with SIS Management:

- MI SIS Administrator
- MI SIS Engineer
- MI SIS User

These groups are intended to support the three main types of users who will use Hazards Analysis. Each of these groups has privileges assigned to it by default. The baseline family-level privileges are summarized in the following table.

Family	MI SIS Administrator	MI SIS Engineer	MI SIS User
Entity Families			
Asset Criticality Analysis	View	None	None
Asset Criticality Analysis System	View	None	None
Consequence	View, Update, Insert, Delete	View	View
Consequence Modifier	View, Update, Insert, Delete	View, Update, Insert, Delete	View
Equipment	View	View	View
Functional Location	View	View	View
Functional Systems	View, Update, Insert, Delete	View, Update, Insert, Delete	View
Functional Test Detail	View, Update, Insert, Delete	View, Update, Insert, Delete	View, Update, Insert, Delete
Human Resource	View, Update, Insert, Delete	View, Update, Insert, Delete	View
Independent Layer of Protection	View, Update, Insert, Delete	View, Update, Insert, Delete	View
Instrumented Function	View, Update, Insert, Delete	View, Update, Insert, Delete	View
IPL Type	View, Update, Insert, Delete	View, Update, Insert, Delete	View

Family	MI SIS Administrator	MI SIS Engineer	MI SIS User
LOPA	View, Update, Insert, Delete	View, Update, Insert, Delete	View
Notification	View, Update, Insert, Delete	View, Update, Insert, Delete	None
Probability	View, Update, Insert, Delete	View	View
Protection Level	View, Update, Insert, Delete	View, Insert	View
Protective Instrument Loop Element	View, Update, Insert, Delete	View, Update, Insert, Delete	View
Proven In Use Justification	View, Update, Insert, Delete	View, Update, Insert, Delete	View
RBI Components	View, Update, Insert, Delete	View, Update, Insert, Delete	None
Reference Document	View, Update, Insert, Delete	View, Update, Insert, Delete	View
Risk	View, Update, Insert, Delete	View, Update, Insert, Delete	View
Risk Assessment	View, Update, Insert, Delete	View, Update, Insert, Delete	View
Risk Assessment Recommendation	View, Update, Insert, Delete	View, Update, Insert, Delete	View
Risk Category	View, Update, Insert, Delete	View, Update, Insert, Delete	View
Risk Matrix	View, Update, Insert, Delete	View	View
Risk Threshold	View, Update, Insert, Delete	View	View
Safety Instrumented System	View, Update, Insert, Delete	View, Update, Insert, Delete	View
Safety Integrity Level	View, Update, Insert, Delete	View	View

Family	MI SIS Administrator	MI SIS Engineer	MI SIS User
SIF Common Cause Failure	View, Update, Insert, Delete	View, Update, Insert, Delete	View
SIL Analysis	View, Update, Insert, Delete	View, Update, Insert, Delete	View
SIL Threshold	View, Update, Insert, Delete	View	View
SIS Proof Test	View, Update, Insert, Delete	View, Update, Insert, Delete	View, Update, Insert, Delete
SIS Proof Test Template	View, Update, Insert, Delete	View, Update, Insert, Delete	View
SIS Proof Test Template Detail	View, Update, Insert, Delete	View, Update, Insert, Delete	View
SIS Trip Report	View, Update, Insert, Delete	View, Update, Insert, Delete	View
SIS Trip Report Detail	View, Update, Insert, Delete	View, Update, Insert, Delete	View
Site Reference	View	View	View
Task	View, Update, Insert, Delete	View, Update, Insert, Delete	View
Time Based Inspection Interval	View	View	View
Time Based Inspection Setting	View	View	View
Relationship Families			
Analysis Has Human Resource	View, Update, Insert, Delete	View, Update, Insert, Delete	View
Asset Criticality Analysis Has System	View	None	None
Equipment Has Equipment	View	View	View
Functional Location Has Equipment	View	View	View

Family	MI SIS Administrator	MI SIS Engineer	MI SIS User
Functional Location Has Functional Location	View	View	View
Has Consequence Modifier	View, Update, Insert, Delete	View, Update, Insert, Delete	View
Has Equipment	View, Update, Insert, Delete	View, Update, Insert, Delete	View
Has Functional Location	View, Update, Insert, Delete	View, Update, Insert, Delete	View
Has Functional Test	View, Update, Insert, Delete	View, Update, Insert, Delete	View, Update, Insert, Delete
Has Functional Test Detail	View, Update, Insert, Delete	View, Update, Insert, Delete	View, Update, Insert, Delete
Has Hazard Event	View, Update, Insert, Delete	View, Update, Insert, Delete	View
Has HAZOP Reference	View, Update, Insert, Delete	View, Update, Insert, Delete	View, Update, Insert, Delete
Has IF	View, Update, Insert, Delete	View, Update, Insert, Delete	View
Has Independent Protection Layer	View, Update, Insert, Delete	View, Update, Insert, Delete	View
Has Instrumented Function Revision	View, Update, Insert, Delete	View, Update, Insert, Delete	View
Has Instrument Loop	View, Update, Insert, Delete	View, Update, Insert, Delete	View
Has Instrument Loop Revision	View, Update, Insert, Delete	View, Update, Insert, Delete	View
Has LOPA	View, Update, Insert, Delete	View, Update, Insert, Delete	View
Has LOPA Revision	View, Update, Insert, Delete	View, Update, Insert, Delete	View

Family	MI SIS Administrator	MI SIS Engineer	MI SIS User
Has PIL Device	View, Update, Insert, Delete	View, Update, Insert, Delete	View
Has PIL Device Revision	View, Update, Insert, Delete	View, Update, Insert, Delete	View
Has PIL Group	View, Update, Insert, Delete	View, Update, Insert, Delete	View
Has PIL Group Revision	View, Update, Insert, Delete	View, Update, Insert, Delete	View
Has PIL Subsystem	View, Update, Insert, Delete	View, Update, Insert, Delete	View
Has PIL Subsystem Revision	View, Update, Insert, Delete	View, Update, Insert, Delete	View
Has PIL System	View, Update, Insert, Delete	View, Update, Insert, Delete	View
Has PIL System Revision	View, Update, Insert, Delete	View, Update, Insert, Delete	View
Has Proven In Use Justification	View, Update, Insert, Delete	View, Update, Insert, Delete	View
Has RBI Components	View, Update, Insert, Delete	View, Update, Insert, Delete	None
Has Recommendations	View, Update, Insert, Delete	View, Update, Insert, Delete	View
Has Reference Documents	View, Update, Insert, Delete	View, Update, Insert, Delete	View, Insert
Has Reference Values	View, Update, Insert, Delete	View	View
Has Risk	View, Update, Insert, Delete	View, Update, Insert, Delete	View

Family	MI SIS Administrator	MI SIS Engineer	MI SIS User
Has Risk Category	View, Update, Insert, Delete	View, Update, Insert, Delete	View
Has Risk Matrix	View, Update, Insert, Delete	View, Update, Insert, Delete	View
Has SIF Common Cause Failures	View, Update, Insert, Delete	View, Update, Insert, Delete	View
Has SIS Analysis Revision	View, Update, Insert, Delete	View, Update, Insert, Delete	View
Has SIS Revision	View, Update, Insert, Delete	View, Update, Insert, Delete	View
Has SIS Trip Report Detail	View, Update, Insert, Delete	View, Update, Insert, Delete	View
Has Site Reference	View, Update, Insert, Delete	View, Update, Insert, Delete	View
Has Task History	View, Insert	View, Insert	View, Insert
Has Tasks	View, Update, Insert, Delete	View, Update, Insert, Delete	View
Has Task Revision	View	View	View
Has Template Detail	View, Update, Insert, Delete	View, Update, Insert, Delete	View
Has Templates	View, Update, Insert, Delete	View, Update, Insert, Delete	View
Has Time Based Inspection Interval	View	View	View
Mitigates Risk	View, Update, Insert, Delete	View, Update, Insert, Delete	View
Was Promoted to ASM Element	View, Update, Insert, Delete	View, Update, Insert, Delete	View

Accessing the SIS Management Administration Page

Accessing the SIS Management Administration page:

- On the SIS Management Start Page, click the Perform Administrative Tasks link.

The SIS Management Administration page appears.

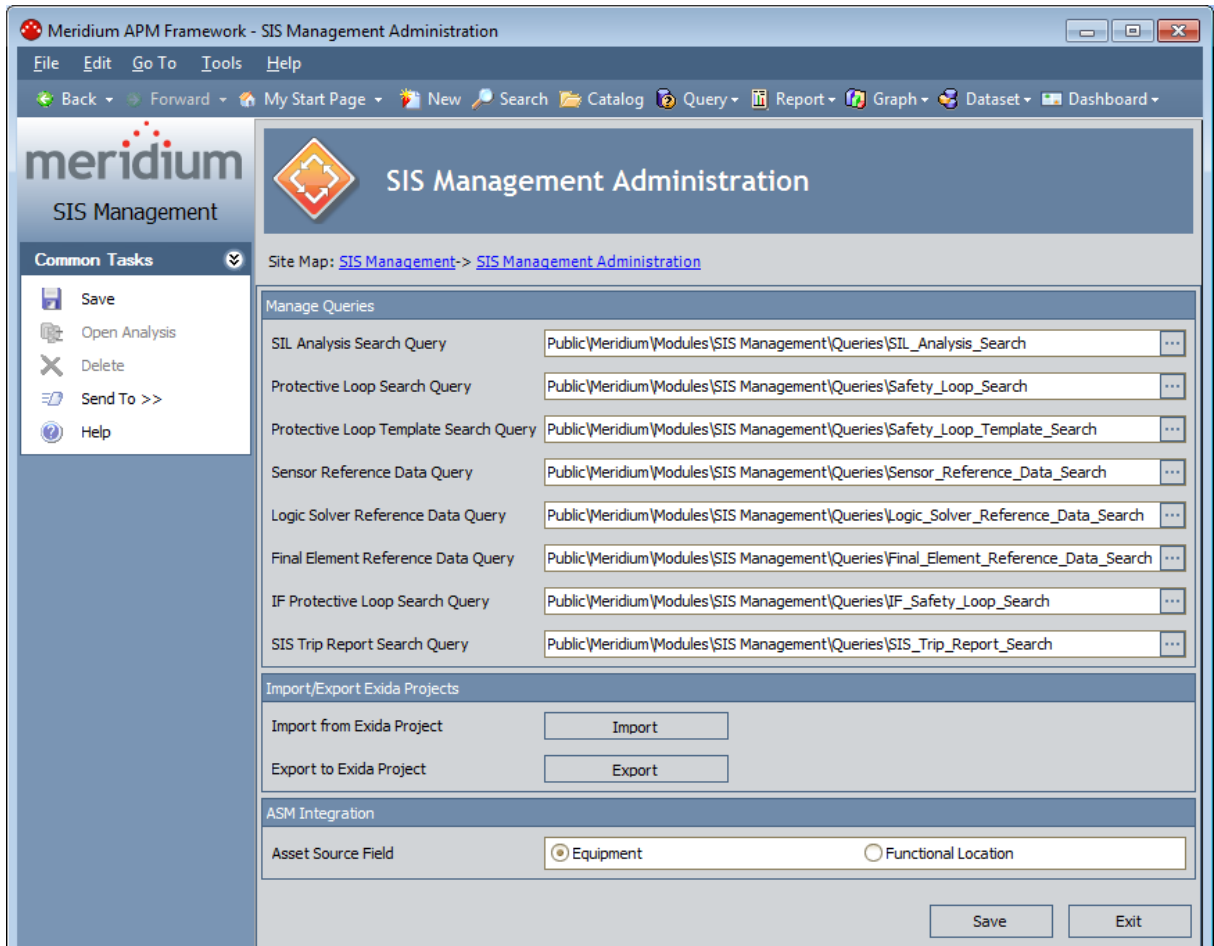

Aspects of the SIS Management Administration Page

The **SIS Management Administration** page contains the following sections:

- **Manage Queries:** Contains the following options:
 - **SIL Analysis Search Query:** Specifies the query whose results will appear on the **SIL Analysis Search** page. The query \\Public\Meridium\Modules\SIS Management\Queries\SIL_Analysis_Search is specified for this setting by default.
 - **Protective Loop Search Query:** Specifies the query whose results will appear on the **Protective Loop Search** page. The query \\Public\Meridium\Modules\SIS Management\Queries\Safety_Loop_Search is specified for this setting by default.
 - **Protective Loop Template Search Query:** Specifies the query whose results will appear on the **Protective Loop Template Search** page. The query \\Public\Meridium\Modules\SIS Management\Queries\Safety_Loop_Template_Search is specified for this setting by default.
 - **Sensor Reference Data Query:** Specifies the query whose results will appear on the **Sensor Reference Data Search** page. The query \\Public\Meridium\Modules\SIS Management\Queries\Sensor_Reference_Data_Search is specified for this setting by default.
 - **Logic Solver Reference Data Query:** Specifies the query whose results will appear on the **Logic Solver Reference Data Search** page. The query \\Public\Meridium\Modules\SIS Management\Queries\Logic_Solver_Reference_Data_Search is specified for this setting by default.
 - **Final Element Reference Data Query:** Specifies the query whose results will appear on the **Final Element Reference Data Search** page. The query \\Public\Meridium\Modules\SIS Management\Queries\Final_Element_Reference_Data_Search is specified for this setting by default.
 - **IF Protective Loop Search Query:** Specifies the query whose results will appear on the **Protective Loop Search** page when you [search for protective instrument loops associated with an instrumented function](#). The query \\Public\Meridium\Modules\SIS Management\Queries\IF_Safety_Loop_Search is specified for this setting by default.
 - **SIS Trip Report Search Query:** Specifies the query whose results will appear on the **SIS Trip Report Search** page. The query \\Public\Meridium\Modules\SIS Management\Queries\SIS_Trip_Report_Search is specified for this setting by default.

For the preceding options, you can specify a different query by clicking the  button that appears to the right of each option. This button displays the **Select Query** dialog box, where you can navigate to the desired query.

- **Import/Export Exida Projects:** Displays the text *Import from Exida Project* and *Export to Exida Project* with corresponding buttons, which appear to the right of

these labels:

- **Import:** Displays the **Import Builder**, which takes you step-by-step through importing data from an Exida project file stored on your computer. When you import data from an Exida project file, that data is transferred into Meridium APM records and creates an SIL Analysis or updates an existing SIL Analysis.
- **Export:** Displays the **Export Builder**, takes you step-by-step through exporting SIL Analysis data from the Meridium APM database to an Exida project file stored on your computer.
- **ASM Integration:** Using SIS Management, you can promote to ASM Instrumented Function records, which contain an Equipment ID and Functional Location ID field. The **ASM Integration** section contains the text **Asset Source Field** and the following options that you can use to specify which field in the Instrumented Function record that the Meridium APM system will use to promote to ASM the corresponding record that represents the equipment or location:
 - **Equipment:** Specifies that the Meridium APM system will promote to ASM the Equipment record that is specified in the Equipment ID field in the Instrumented Function record. This is the default option.
 - **Functional Location:** Specifies that the Meridium APM system will promote to ASM the Functional Location record that is specified in the Functional Location ID field in the Instrumented Function record.

At the bottom of the **SIS Management Administration** page, the following options appear:

- **Save:** Saves the current administrative settings.
- **Exit:** Displays the **SIS Management Start Page**. If you have unsaved changes on the page, a dialog box appears first, asking if you want to save your changes.

The **SIS Management Administration** page contains one task menu [Common Tasks](#).

Common Tasks Menu

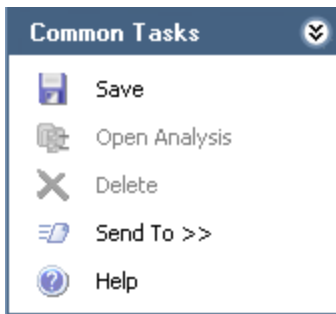

The **Common Tasks** menu on the **SIS Management Administration** page contains the following options:

- **Save:** Saves the current administrative settings.
- **Open Analysis:** This link is disabled.
- **Delete:** This link is disabled.
- **Send To:** Displays a submenu with options that let you provide a link to the current page on your desktop (create shortcut), in an email message, or on a Home Page.
- **Help:** Displays the context-sensitive help topic for the **SIS Management Administration** page.

Specifying a Different Query on SIS Management Administration Page

In the **ManageQueries** section on the **SIS Management Administration** page, you can specify the Catalog path to a query other than the one that is currently displayed.

To specify a different query on the SIS Management Administration Page:

1. Access the [SIS Management Administration page](#).
2. To the right of the text box that corresponds to the query that you want to change, click the  button.

The **Select Query** dialog box appears.

3. Navigate to the desired query.
4. Click the **Open** button.

The **Select Query** dialog box closes, and the name of the query that you selected appears in the corresponding text box.

5. On the **Common Tasks** menu, click the **Save** link.

Your changes are saved.

Specifying the Asset Source for ASM Integration

When you *specify the Asset Source* for ASM integration, you are specifying which relationship family you are using to relate Instrumented Function records representing the desired equipment or location. You will need to specify whether this relationship is *Safety Analysis Has Equipment* or *Has Functional Location*. If you are using both relationships, you will need to specify which one you want to use to promote an asset to ASM when the Instrumented Function to which it is linked is promoted.

To specify the asset source for ASM integration:

1. [Access the SIS Management Administration page.](#)
2. In the **ASM Integration** section, to the right of the Asset Source field label, select the option that corresponds to the relationship family that you are using.
3. Click the **Save** button.

Your changes are saved.

About Importing Data from an Exida Project File

exida™ is a software solution, where you can store information about the systems in a facility. When you *import data from an exida™ project file* on your computer, you are importing information to automatically create Instrumented Function records in the Meridium APM database. Those records are also automatically linked to the SIL Analysis to which they belong. The information in this section of the documentation provides details on using the **Import Builder** on the **SIS Management Administration** page to import data from a file on your computer into the Meridium APM database.

When you use the **Import Builder** to import data from an *exida™* file, you will have two options that you can use to do so:

- Create a new SIL Analysis for the data.
- Append the data to an existing SIL Analysis.

Depending on the method that you select, the screens that you see in the builder will change. This section of the documentation provides instructions for using the **Import Builder** to:

- [Accessing the Options screen](#), where you can select the import method that you want to use.
- [Creating a new SIL Analysis for the imported data.](#)
- [Appending the imported data to an existing SIL Analysis.](#)

Accessing the Options Screen

To import data from an exida™ project file:

1. On the **SIS Management Administration** page, in the **Import/Export Exida Projects** section, click the **Import** button.

The **Import Builder** appears, displaying the **Welcome** screen.

2. Click the **Next** button.

The **Specify exSILentia file** screen appears.

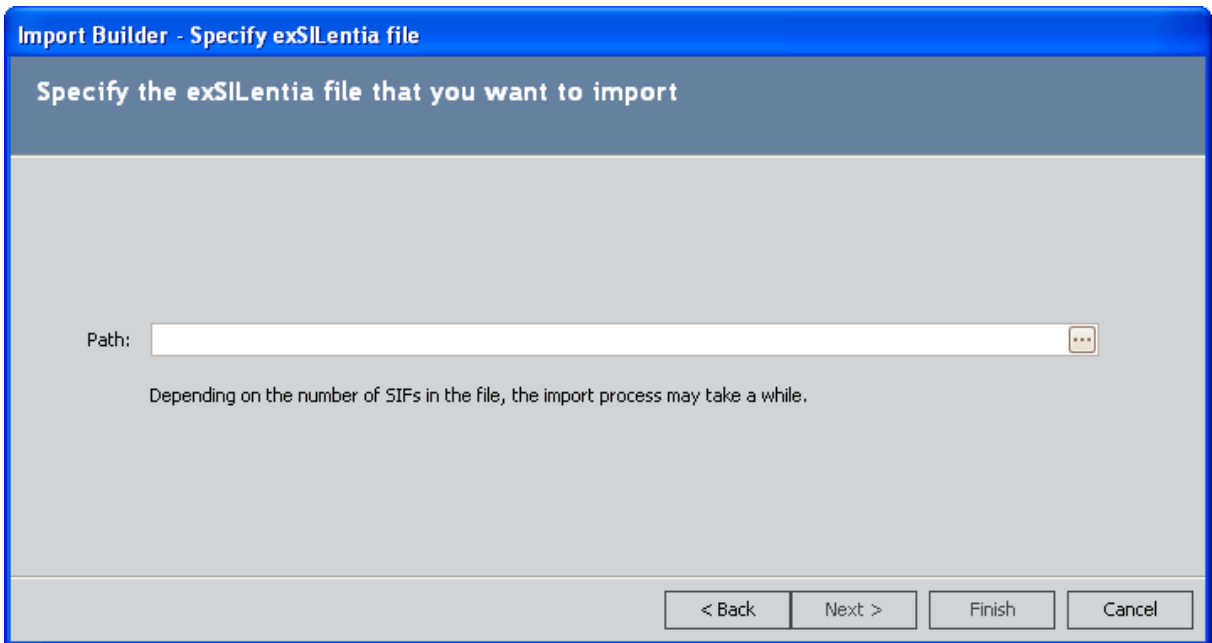

3. In the **Path** text box, type the path to the file that you want to import.

-or-

Click the  button to search for the file on your computer. These instructions assume that you want to search for the file.

The **Import** dialog box appears.

4. Navigate to the desired exSILentia file, and click the **Open** button.

The path to the selected file appears in the **Path** text box.

5. Click the **Next** button.

The **Select Instrumented Functions** screen appears, displaying a list of Instrumented Function records that exist in the specified file.

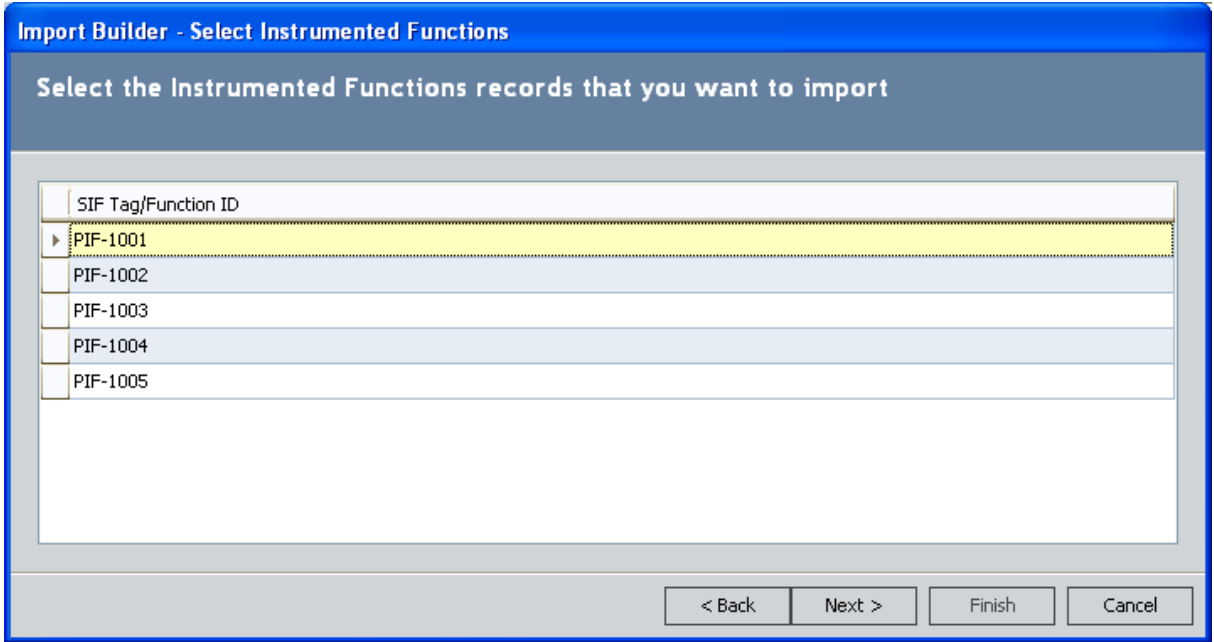

6. Select the rows containing the Instrumented Function records that you want to import.
7. Click the **Next** button.

The **Options** screen appears, displaying the options that you can use to import the Instrumented Functions.

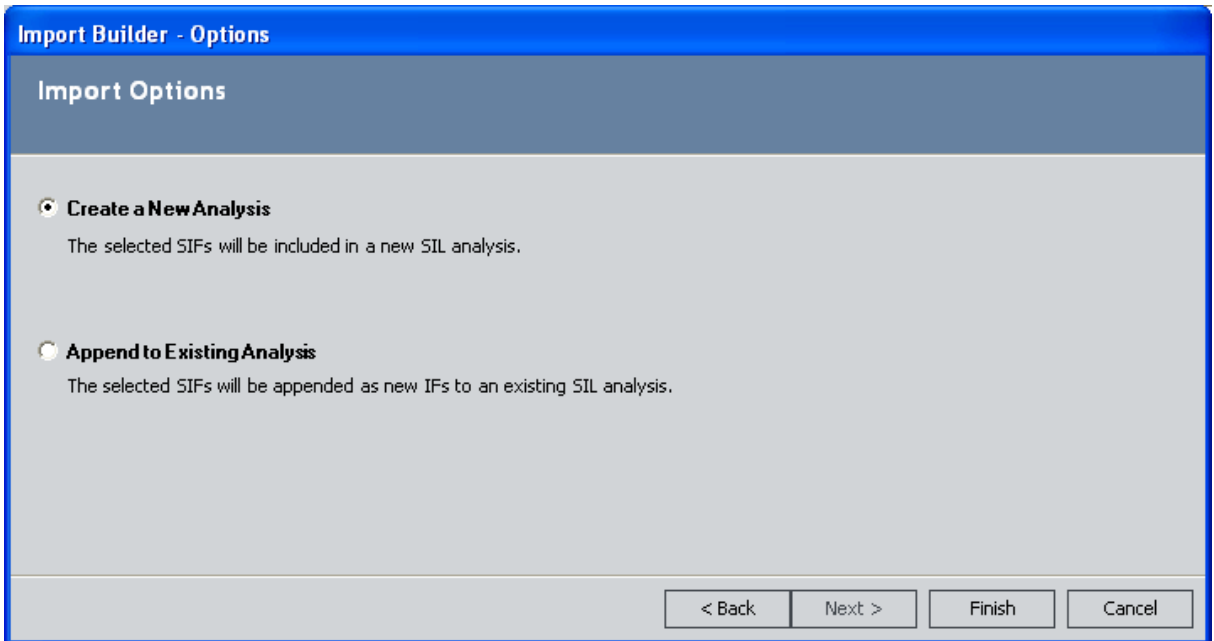

At this point, you can follow the procedure for importing data via the desired method:

Accessing the Options Screen

- [Creating a new analysis for the imported data.](#)
- [Appending the imported data to an existing analysis.](#)

Creating a New Analysis for the Imported Data

The following instructions provide details on using the **Options** screen and successive screens in the **Import Builder** to import data from an exida™ project file and create a new analysis for the data. For details on importing data from an exida™ project file and appending it to an existing analysis, see the [instructions for appending imported data to an existing SIL Analysis](#).

To create a new analysis for the imported data:

1. [Access the Options screen](#) in the **Import Builder**.
2. Select the **Create a New Analysis** option.

The **Next** button is disabled.

3. Click the **Finish** button.

A new blank SIL Analysis record appears in a new window.

The screenshot shows a software window titled "<empty> (new SIL Analysis)". The window contains a toolbar with icons for save, delete, and other actions. Below the toolbar is a form with the following fields:

- Analysis ID:** A red box indicating a required field.
- Analysis Description:** A text input field.
- Long Description:** A text input field with a scroll bar and a menu icon.
- Site ID:** A dropdown menu.
- Unit ID:** A text input field.
- Functional Location ID:** A text input field with a menu icon.
- Equipment ID:** A text input field with a menu icon.
- Hazards Analysis Reference:** A text input field with a menu icon.
- Hazards Analysis Revision:** A text input field.
- Hazards Analysis Date:** A dropdown menu.
- Analysis Re-evaluation:** A text input field followed by the word "Years".
- Owner:** A text input field.
- Analysis Start Date:** A dropdown menu showing "5/26/2010 12:00:00 AM".
- Analysis End Date:** A dropdown menu.
- Last Modified By:** A text input field.
- Last Modified Date:** A dropdown menu.

At the bottom right of the window are "OK" and "Cancel" buttons.

4. Provide values in the fields as desired. Note that the Analysis ID field is required.
5. Click **OK**.

The SIL Analysis record closes, and the **Progress** dialog box appears, displaying the progress of the import process.

When the import is finished, the **Confirmation** dialog box appears, indicating that the selected Instrumented Function records were imported successfully.

Note: If the import process is unsuccessful, a message will appear, indicating that the process was not successful. If you see this message, you will need to correct any issues, and then try again.

6. On the **Confirmation** dialog box, click **OK**.

The **Import Builder** closes, revealing the **SIS Management Administration** page. At this point, you can [view the new SIL Analysis](#).

CEHint: On the **Confirmation** dialog box, you can click the **Detail>>** button to view a list of IDs for the Instrumented Function records that were imported.

Appending the Imported Data to an Existing Analysis

The following instructions provide details on using the **Options** screen and successive screens in the **Import Builder** to import data from an exida™ project file and append that data to an existing SIL Analysis. For details on importing data from an exida™ project file and creating a new analysis for that data, see the [instructions for creating a new SIL Analysis for imported data](#).

To append the imported data to an existing analysis:

1. [Access the Options screen](#) in the **Import Builder**.
2. Select the **Append to Existing Analysis** option.

The **Finish** button is disabled.

3. Click the **Next** button.

The **Select an Analysis** screen appears and displays a query prompt for the record state and SIL Analysis Owner of the desired SIL Analysis record.

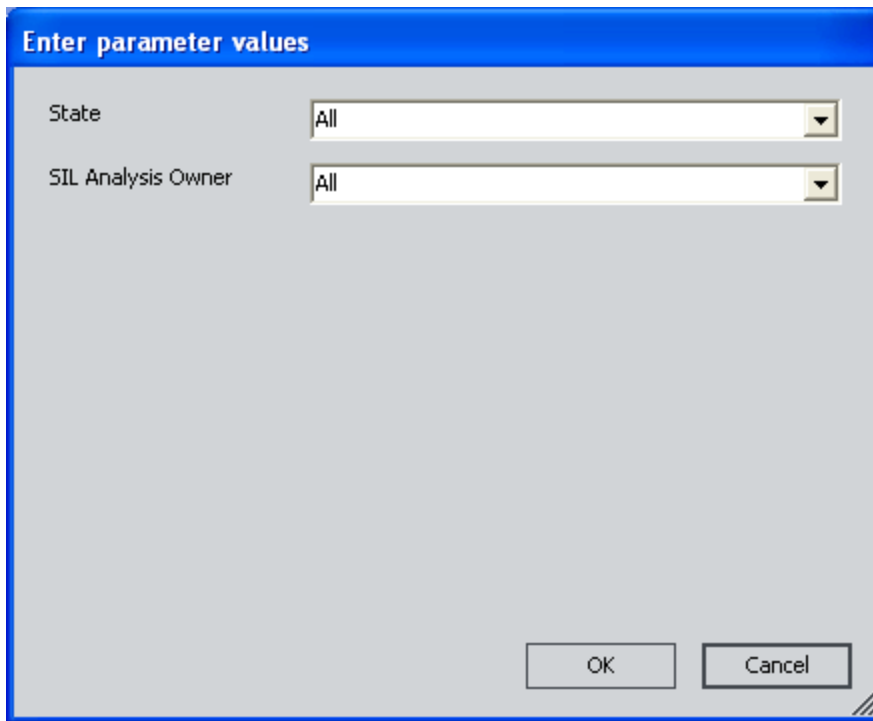

The screenshot shows a dialog box titled "Enter parameter values". It has a blue header bar. Below the header, there are two rows of controls. The first row is labeled "State" and has a dropdown menu with "All" selected. The second row is labeled "SIL Analysis Owner" and also has a dropdown menu with "All" selected. At the bottom right of the dialog, there are two buttons: "OK" and "Cancel".

4. Select the desired search criteria, and then click **OK**.

-or-

Accept the default **All** options, and click **OK**.

The **Select an Analysis** screen is revealed, and the query results are displayed in the grid.

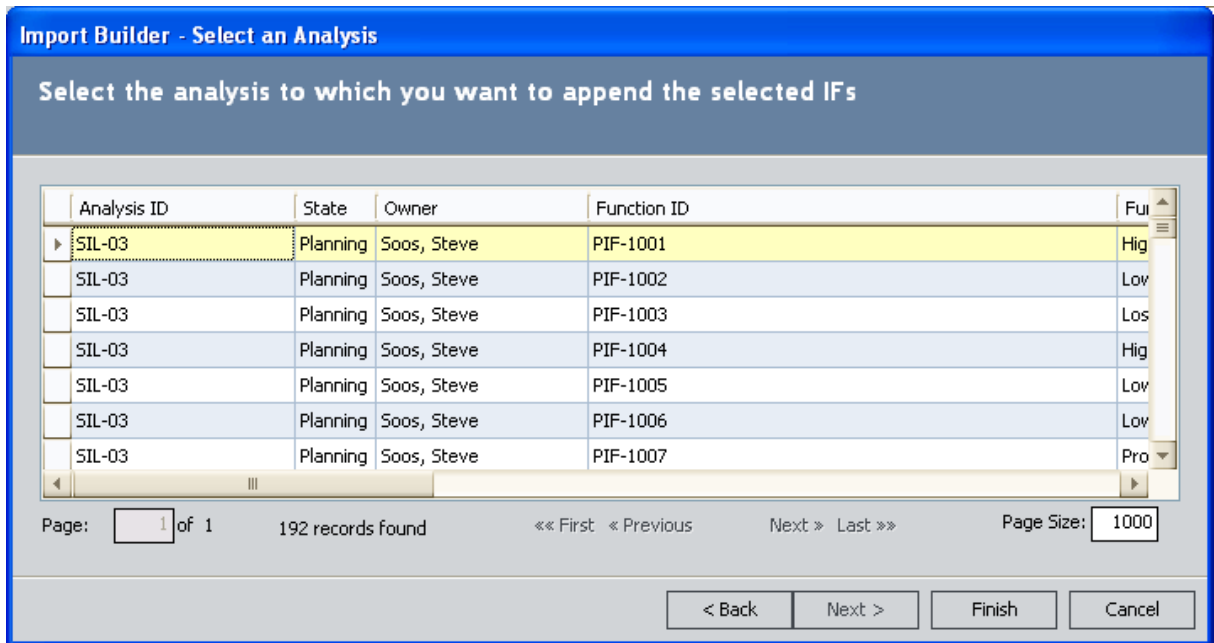

- In the grid, select the row containing the SIL Analysis record to which you want to link the Instrumented Function records.
- Click the **Finish** button.

The **Progress** dialog box appears, displaying the progress of the import process.

When the import is finished, the **Confirmation** dialog box appears, indicating that the selected Instrumented Function records were imported successfully.

Note: If the import process is unsuccessful, a message will appear, indicating that the process was not successful. If you see this message, you will need to correct any issues, and then try again.

- On the **Confirmation** dialog box, click **OK**.

The **Import Builder** closes, revealing the **SIS Management Administration** page. At this point, you can [view the new SIL Analysis](#).

CE Hint: On the **Confirmation** dialog box, you can click the **Detail>>** button to view a list of IDs for the Instrumented Function records that were imported.

About Exporting Data to an Exida Project File

When you export data from the Meridium APM database to a file on your computer, you are exporting information from Instrumented Function records an exida™ project file. The information in this section of the documentation provides details on using the **Export Builder** on the **SIS Management Administration** page to export data from the Meridium APM database to an exida™ project file on your computer.

Exporting Data to an Exida Project File

The following instructions provide details on using the **Export Builder** to export Instrumented Function records and Protective Instrument Loop records to an exida™ project file on your computer.

To export data to an exida project file:

1. On the **SIS Management Administration** page, in the **Import/Export Exida Projects** section, click the **Export** button.

The **Export Builder** appears, displaying the **Welcome** screen.

2. Click the **Next** button.

The **Select SIL Analysis** screen appears and displays a query prompt for the record state of the SIL Analysis whose Instrumented Function records you want to export.

3. In the **State** list, select the state that corresponds to the record state of the SIL Analysis whose Instrumented Function records you want to export.

-or-

Accept the default option, **All**.

4. Click **OK**.

The **Select SIL Analysis** screen appears, and the query results are displayed in the grid.

Export Builder - Select SIL Analysis

Select the SIL Analysis records that you want to export

Analysis ID	Start Date	End Date	Owner	State	Date State Entered	State Owner	User ID	Last L
SIL-03	6/29/2009	8/29/2009	Soos, Steve	Planning	6/29/2009	ssoos	sisadmin	11/18,
SIL-02	7/13/2009		Soos, Steve	Planning	11/18/2009	ssoos	sisadmin	11/18,
SIL-08	7/13/2009		Soos, Steve	Planning	11/18/2009	ssoos	sisadmin	11/18,
SIL-01	11/25/2009		mbj, Secured Super User	Planning	11/25/2009	mbj	mbj	11/25,
SIL-06	3/17/2010		mbj, Secured Super User	Planning	3/17/2010	mbj	mbj	3/17/2,
Exida Imports	4/22/2010		Bulla, Michael J	Planning	4/22/2010	sisadmin	sisadmin	4/22/2,

Page: 1 of 1 6 records found << First < Previous Next > Last >> Page Size: 1000

< Back Next > Finish Cancel

5. In the grid, select the row that contains the SIL Analysis record whose Instrumented Function records you want to export.
6. Click the **Next** button.

The **Select Instrumented Function** screen appears, displaying a list of Instrumented Function records that are linked to the SIL Analysis record that you selected on the **Select SIL Analysis** screen.

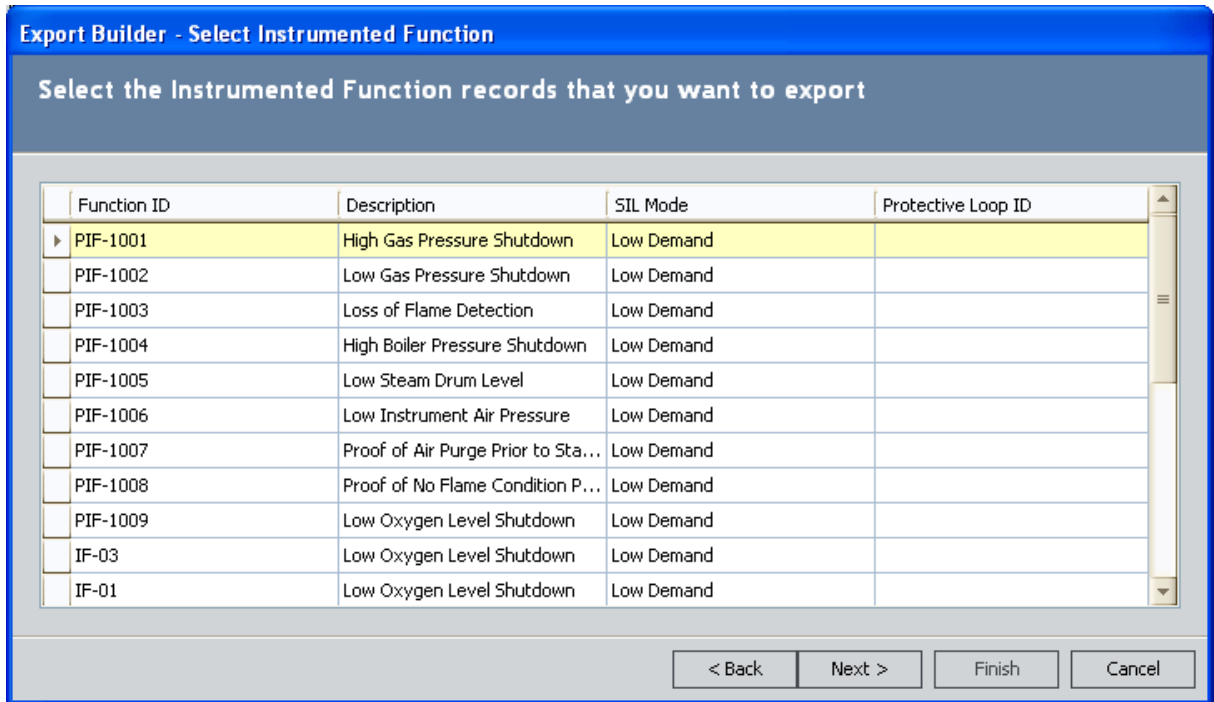

7. In the grid, select the rows that contains the Instrumented Function records that you want to export.
8. Click the **Next** button.

The **Select Protective Instrument Loop** screen appears, displaying the list of Protective Instrument Loop records that are linked to the Instrumented Function records that you selected on the **Select Instrumented Function** screen.

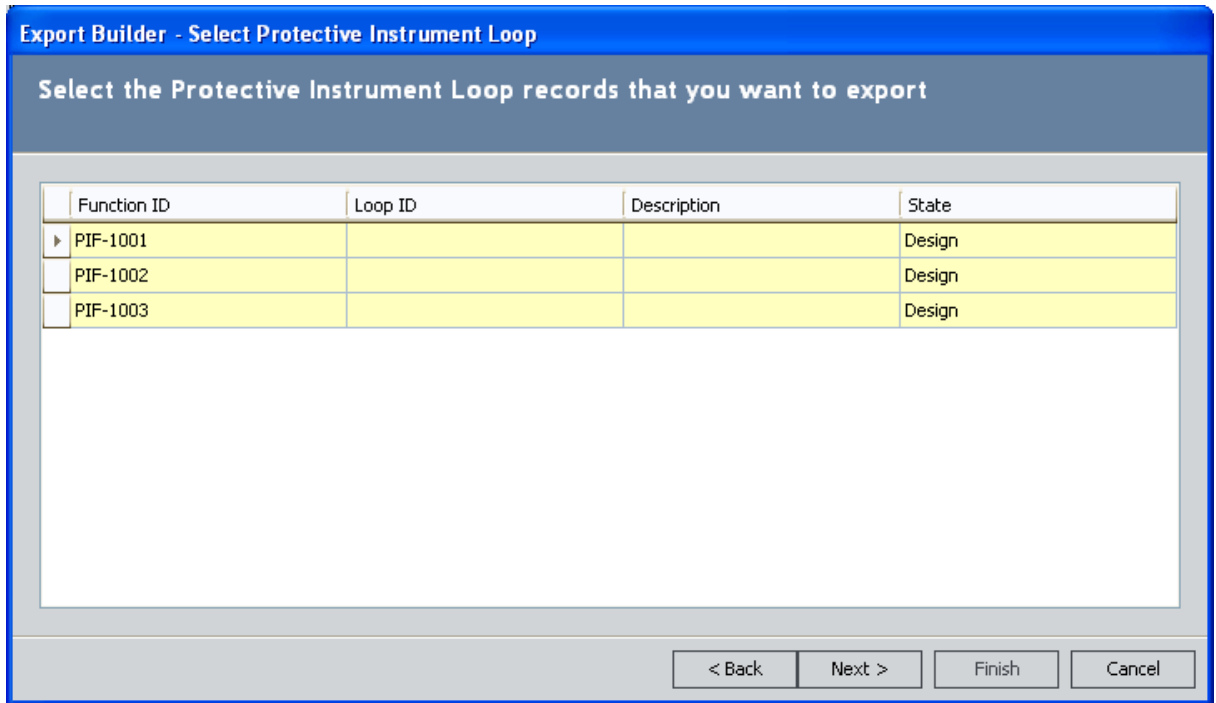

9. In the list, select the rows containing the Protective Instrument Loop records that you want to export.

10. Click the **Next** button.

The **Specify Output File** screen appears.

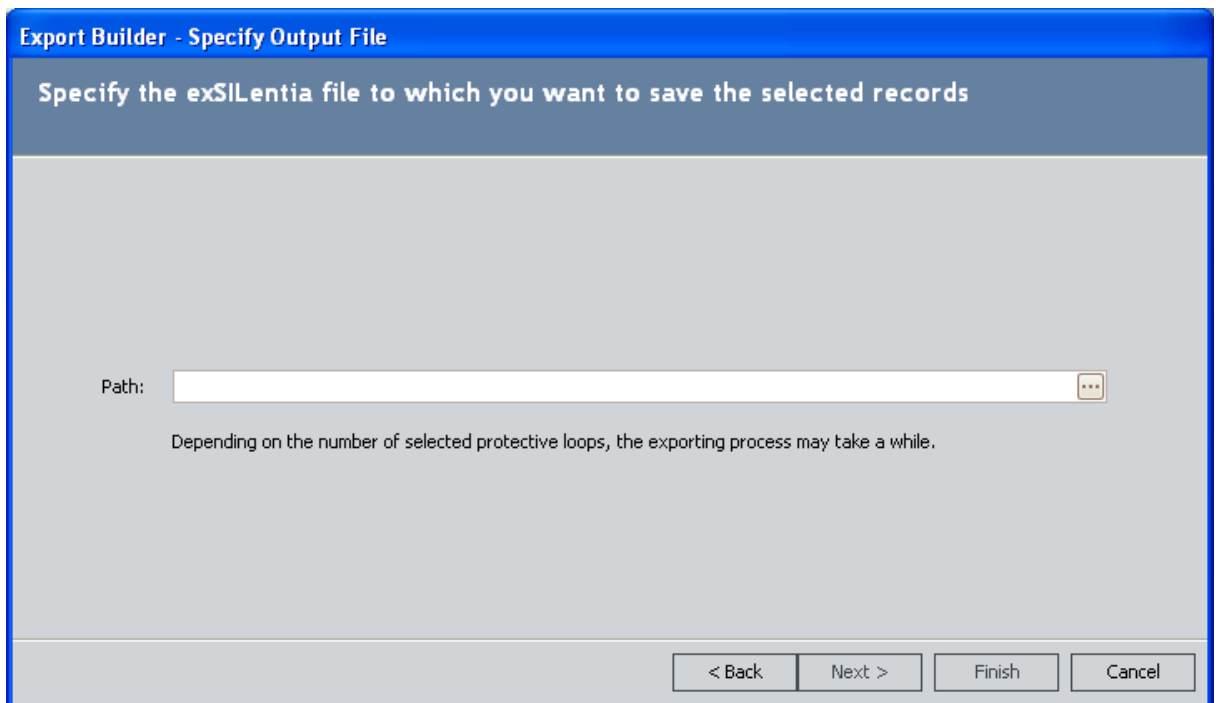

11. In the **Path** text box, type the file path to the desired location.

-or-

Click the  button to search for the desired file. These instructions assume that you want to search for the file.

The **Export** dialog box appears, where you can navigate to the desired exSILential file.

12. Navigate to the desired file on your computer, and then click the **Save** button.

The specified file path appears in the **Path** text box.

13. Click the **Finish** button.

The **Progress** dialog box appears, displaying the progress of the export process.

When the export is finished, the **Confirmation** dialog box appears, indicating that the selected records were exported successfully.

Note: If the export process is unsuccessful, a message will appear, indicating that the process was not successful. If you see this message, you will need to correct any issues, and then try again.

14. On the **Confirmation** dialog box, click **OK**.

The **Progress** dialog box appears, displaying the progress of the import process.

When the import is finished, the **Confirmation** dialog box appears, indicating that the selected Instrumented Function records were imported successfully.

Note: If the import process is unsuccessful, a message will appear, indicating that the process was not successful. If you see this message, you will need to correct any issues, and then try again.

15. On the **Confirmation** dialog box, click **OK**.

The **Import Builder** closes, revealing the **SIS Management Administration** page. At this point, you can [view the new SIL Analysis](#).

CEHint: On the **Confirmation** dialog box, you can click the **Detail>>** button to view a list of IDs for the Instrumented Function records that were imported.

Export Builder closes, revealing the **SIS Management Administration** page.

CEHint: On the **Confirmation** dialog box, you can click the **Detail>>** button to view a list of IDs for the Instrumented Function records that were exported.

About Managing the Types of Independent Layers of Protection

To manage the [types of independent layers of protection](#) that will be used to populate Independent Layer of Protection records, you will need to:

1. [Modify the values in the Default Value fields in the baseline IPL Type records.](#)
2. [Define additional IPL types.](#)

About Independent Layer of Protection Types

An *independent layer of protection* is a system, action, or item that mitigates the risk associated with an instrumented function. In SIS Management, details on independent layers of protection are stored in Independent Layer of Protection records. When you conduct a [Layer of Protection Analysis \(LOPA\) to assess risk for a given instrumented function](#), you will create one [Independent Layer of Protection record](#) per independent layer of protection. When you do so, you will need to select in the **Type** list the *type* of independent layer of protection that the record represents. Throughout the documentation, we refer to the values in the **Type** list as *IPL types*.

The IPL type that you select in the Independent Layer of Protection record is used to determine the probability of failure data (PFD) value that is associated with that type of independent layer of protection. The PFD value is stored in the PFD field in the Independent Layer of Protection record and used to calculate the overall risk associated with a given instrumented function. On the Independent Layer of Protection datasheet, the **Type** list contains the IPL types that are defined in the Meridium APM database in the form of records belonging to the IPL Type family.

The IPL Type family is a subfamily of the Meridium Reference Tables family and is not related to any families in the [SIS Management data model](#). You can think of IPL Type records as templates that you can use to define Independent Layer of Protection records. The following list contains the Record IDs for the baseline IPL Type records that are provided in the Meridium APM database:

- Control loop
- Human performance (trained, no stress)
- Human performance (under stress)
- Operator response to alarms
- Vessel pressure rating above max challenge

The baseline IPL Type records contain a value in the Default Value field. As part of the administrative steps for the SIS Management module, you will need to review and [modify these default values](#). The value in the Default Value field is used to populate the PFD field in the Independent Layer of Protection record.

For each baseline IPL Type record, a corresponding System Code is provided in the LOPA IPL TYPE (MI_IPL_TYPE) System Code Table. You can use these System Codes to translate the baseline IPL types, if desired.

In the **Type** list, the following information is displayed for each IPL type:

<IPL Type ID> (<Default Value or Lower Boundary> - <Upper Boundary>)

...where:

- **<IPL Type ID>** is the value stored in the IPL Type ID field in the corresponding IPL Type record.
- **<Default Value>** is a numeric value that is stored in the Default Value field in the

corresponding IPL Type record.

- **<Lower Boundary>** is a numeric value that is stored in the Lower Boundary field in the corresponding IPL Type record.
- **<Upper Boundary>** is a numeric value that is stored in the Upper Boundary field in the corresponding IPL Type record.

Together, the values stored in the Lower Boundary and Upper Boundary fields define a PFD range for that IPL type.

For example, the baseline IPL type *Control Loop* is displayed in the **Type** list as *Control Loop (.01)*, where *.01* is the value stored in the Default Value field in the corresponding IPL Type record. Likewise, the baseline IPL type *Human performance (trained, no stress)* is displayed in the **Type** list as *Human performance (trained, no stress) (0.0001 - 0.01)*, where *0.0001 - 0.01* is the PFD range defined for that IPL type. Specifically:

- *0.0001* is the value stored in the Lower Boundary field in the corresponding IPL Type record.

-and-

- *0.01* is the value stored in the Upper Boundary field in the corresponding IPL Type record.

In addition to the baseline IPL types, you can [define additional IPL types that will appear in the **Type** list on the Independent Layer of Protection datasheet.](#)

Modifying the Default Values in the Baseline IPL Type Records

The following instructions provide details on modifying the baseline IPL Type records to change the values stored in the Default Value fields in these records.

To modify the value in the Default Value field in a baseline IPL Type record:

1. Open the baseline IPL Type record whose default value you want to modify.
2. In the Default Value field, modify the value as desired.
3. On the datasheet toolbar, click the **Save** button. 

The record is saved.

Defining Additional IPL Types

If desired, you can define additional IPL types that will appear in the **Type** list on the Independent Layer of Protection datasheet. To define additional IPL types, you will need to create a new record in the IPL Type family, using the Record Manager. To do so, you must be logged in as a member of the MI SIS Administrator or MI SIS Engineer Security Group. After you save the record, the IPL type will be available in the **Type** list on the Independent Layer of Protection datasheet.

Remember that the values you enter in the IPL Type record define a [type of independent layer of protection](#) and will be used to determine the PFD value in Independent Layer of Protection records. The following table provides a description of the fields that appear on the IPL Type datasheet and how they effect Independent Layer of Protection records when you select an IPL Type record in the **Type** list. You should use this table to determine how to define additional IPL types, based upon how the values will be used by Independent Layer of Protection records.

IPL Type Field	IPL Type Field Description	Effect on Independent Layer of Protection Records
Default Value	A numeric value representing the PFD value that is associated with the IPL type. This field is required.	The PFD field will be populated automatically with this value.
Description	A description of the IPL type.	The Description field is populated automatically with this value.
IPL Type ID	An ID for the IPL type. This value is used to identify the IPL Type record.	This value will be displayed in the Type list, along with the: <ul style="list-style-type: none"> • Value in the Default Value field. -or- • Range defined by the values in the Lower Boundary and Upper Boundary fields. The value that is displayed here depends upon whether the Is Fixed Value check box is selected in the IPL Type record.

IPL Type Field	IPL Type Field Description	Effect on Independent Layer of Protection Records
<p>Is Fixed Value</p>	<p>A check box that indicates whether the IPL type is associated with a fixed PFD value or a PFD range.</p> <ul style="list-style-type: none"> • If the Is Fixed Value check box is selected, the Lower Boundary and Upper Boundary cells are disabled, and the Default Value cell is required. • If the Is Fixed Value check box is clear, the Default Value cell is disabled, and the Lower Boundary and Upper Boundary cells are required. 	<p>If the Is Fixed Value check box is selected in the IPL Type record:</p> <ul style="list-style-type: none"> • The PFD field will be required, and the value that you enter in the PFD cell must fall within the PFD range defined in the IPL Type record. <p>If the value that you enter in the PFD cell does not fall within the PFD range, a message will appear, indicating that you must enter a value that falls within the specified range.</p> <ul style="list-style-type: none"> • In the Type list, the IPL Type ID will be appended with the values stored in the Lower Boundary and Upper Boundary fields in the IPL Type record, which define the PFD range. <p>If the Is Fixed Value check box is cleared in the IPL Type record:</p> <ul style="list-style-type: none"> • The PFD field will be populated automatically with the value stored in the Default Value field in the IPL Type record. • In the Type list, the IPL Type ID will be appended with the value stored in the Default Value field in the IPL Type record.

IPL Type Field	IPL Type Field Description	Effect on Independent Layer of Protection Records
<p>Lower Boundary</p>	<p>A numeric value representing the lowest value in the PFD range associated with an IPL type.</p> <p>Together, this value and the value in the Upper Boundary field define the PFD range for the IPL type.</p> <p>If the Is Fixed Value check box is selected, this field is disabled.</p>	<p>If the Is Fixed Value check box is selected in the IPL Type record, this value will be displayed in the Type list, along with the following values stored in the IPL Type record:</p> <ul style="list-style-type: none"> • IPL Type ID • Upper Boundary <p>In addition, when you enter a value in the PFD cell, the Meridium APM system will use this value to determine if the PFD value falls within the defined PFD range. If the value does not fall within the PFD range, a message will appear, indicating that you must enter a value that falls within the specified range.</p>
<p>Upper Boundary</p>	<p>A numeric value representing the highest value in the PFD range associated with an IPL type.</p> <p>Together, this value and the value in the Lower Boundary field define the PFD range for the IPL type.</p> <p>If the Is Fixed Value check box is selected, this field is disabled.</p>	<p>If the Is Fixed Value check box is selected in the IPL Type record, this value will be displayed in the Type list, along with the following values stored in the IPL Type record:</p> <ul style="list-style-type: none"> • IPL Type ID • Lower Boundary <p>In addition, when you enter a value in the PFD cell, the Meridium APM system will use this value to determine if the PFD value falls within the defined PFD range. If the value does not fall within the specified range, a message will appear, indicating that you must enter a value that falls within the specified range.</p>

An Example: Defining Additional IPL Types

Assume that you want the IPL type *Vessel pressure rating below minimum challenge* to be available for selection in an Independent Layer of Protection record. In addition, assume that a fixed PFD value of .2 is associated with this IPL type. To define this additional IPL type, you would create the following IPL Type record.

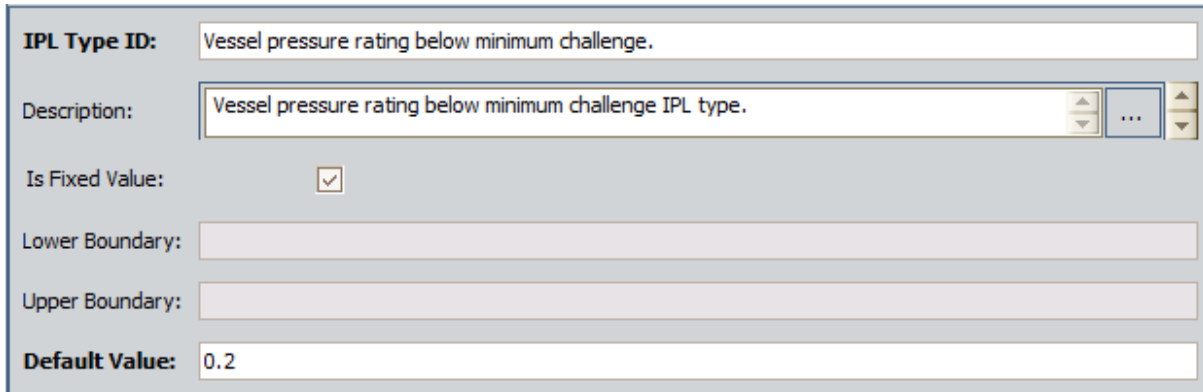

The screenshot shows a form for defining an IPL Type. The fields are as follows:

IPL Type ID:	Vessel pressure rating below minimum challenge.
Description:	Vessel pressure rating below minimum challenge IPL type.
Is Fixed Value:	<input checked="" type="checkbox"/>
Lower Boundary:	
Upper Boundary:	
Default Value:	0.2

If you create a new Independent Layer of Protection record and select the *Vessel pressure rating below minimum challenge* IPL type in the **Type** list, that record would look similar to the following image.

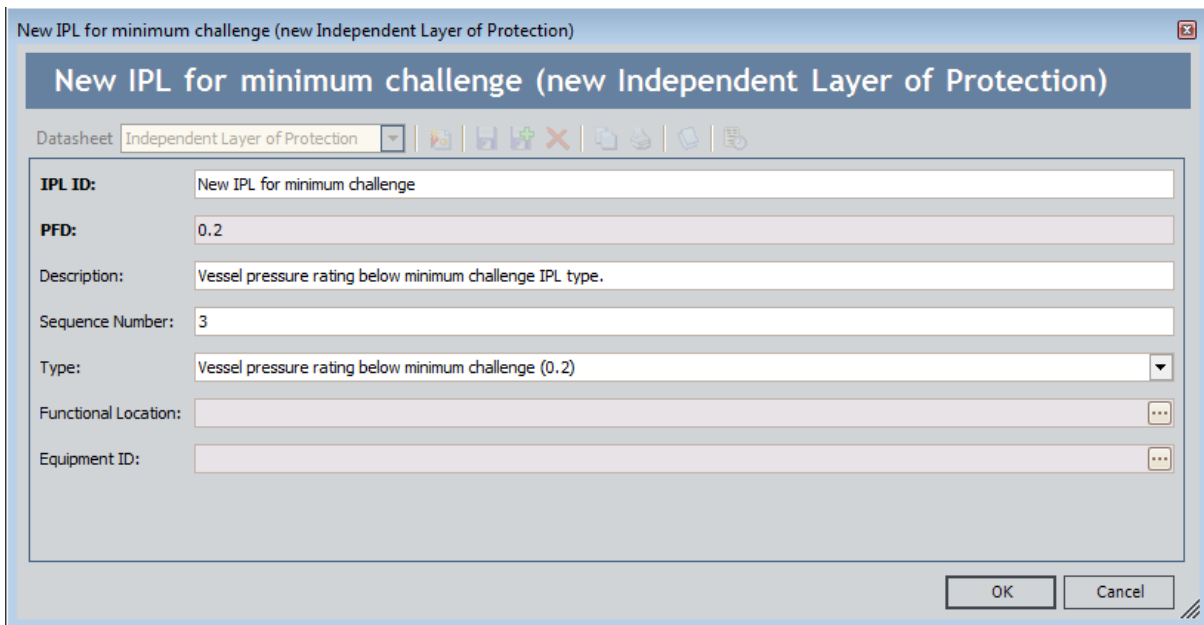

The screenshot shows a dialog box titled "New IPL for minimum challenge (new Independent Layer of Protection)". The fields are as follows:

IPL ID:	New IPL for minimum challenge
PFD:	0.2
Description:	Vessel pressure rating below minimum challenge IPL type.
Sequence Number:	3
Type:	Vessel pressure rating below minimum challenge (0.2)
Functional Location:	
Equipment ID:	

Buttons: OK, Cancel

Alternatively, if you assume that the *Vessel pressure rating below minimum challenge* IPL type is associated with a PFD range of $0.00001 - 0.000001$, you would create the following IPL Type record.

An Example: Defining Additional IPL Types

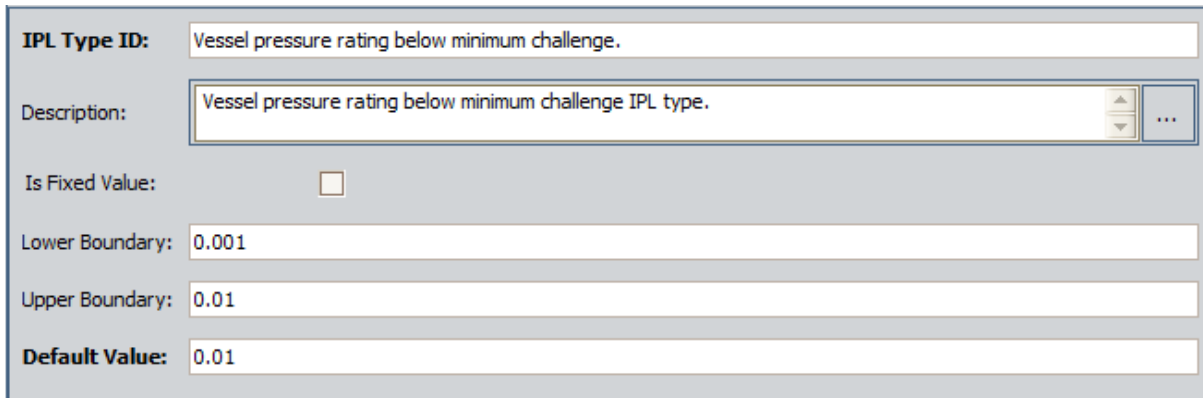

The screenshot shows a configuration form for an IPL Type. The fields are as follows:

IPL Type ID:	Vessel pressure rating below minimum challenge.
Description:	Vessel pressure rating below minimum challenge IPL type.
Is Fixed Value:	<input type="checkbox"/>
Lower Boundary:	0.001
Upper Boundary:	0.01
Default Value:	0.01

If you create a new Independent Layer of Protection record and select the *Vessel pressure rating below minimum challenge* IPL type in the **Type** list, that record would look similar to the following image.

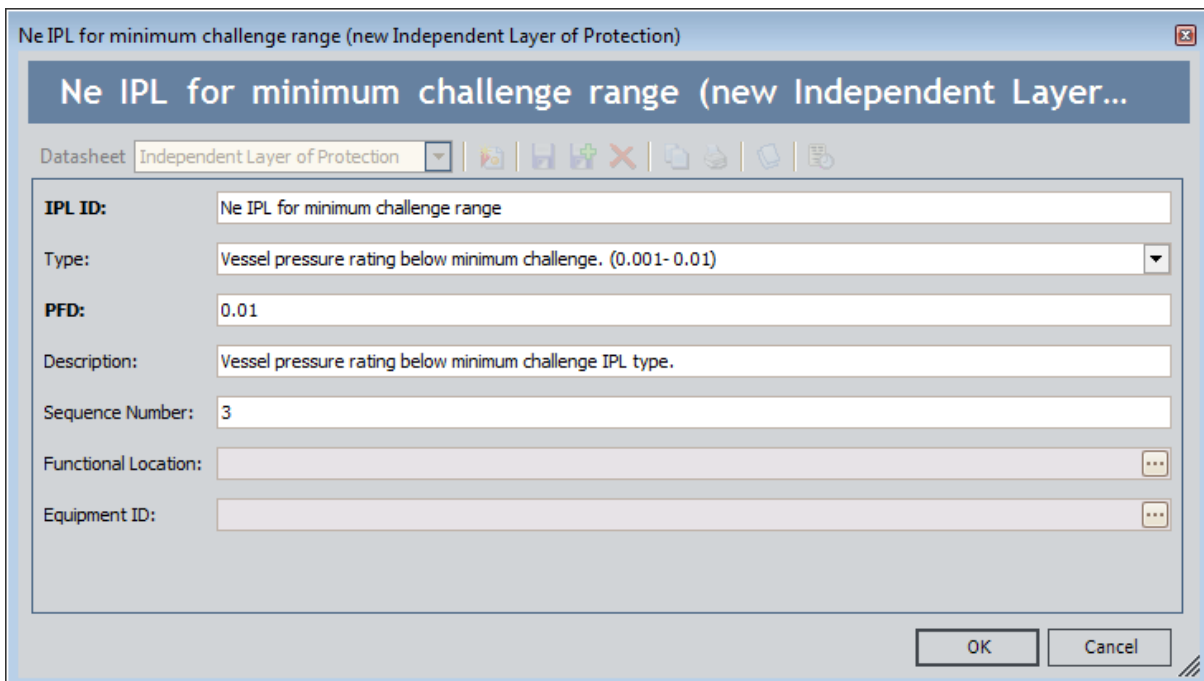

The screenshot shows a record form titled "Ne IPL for minimum challenge range (new Independent Layer of Protection)". The fields are as follows:

IPL ID:	Ne IPL for minimum challenge range
Type:	Vessel pressure rating below minimum challenge. (0.001- 0.01)
PFD:	0.01
Description:	Vessel pressure rating below minimum challenge IPL type.
Sequence Number:	3
Functional Location:	
Equipment ID:	

Buttons: OK, Cancel

At this point, you could modify the PFD value that is populated automatically with the value in the Default Value field in the specified IPL Type record. The PFD value that you type must fall within the PFD range (shown in parenthesis in the **Type** list).

About Navigating SIS Management

SIS Management is context-driven. This means that each page that you view within the module will contain data related only to the SIL Analysis with which you are currently working. After you have opened an SIL Analysis record on the **SIL Analysis Definition** page, the ID of the SIL Analysis will appear on the site map and the title bar on each page within the module, indicating that SIL Analysis with which you are currently working.

The [Navigation](#) menu appears on almost every page in SIS Management and provides access to the pages that contain the features that allow you to create and perform SIL Analyses. After you open an SIL Analysis record on the **SIL Analysis Definition** page, you can use the links on the **Navigation** menu to facilitate a workflow for creating the remaining records that make up the SIL Analysis.

For example, assume that the SIL Analysis record *B0007-009 Steam Boiler SIS* appears on the **SIL Analysis Definition** page. The site map and the title bar will contain the text *B0007-009 Steam Boiler SIS* as shown in the following image.

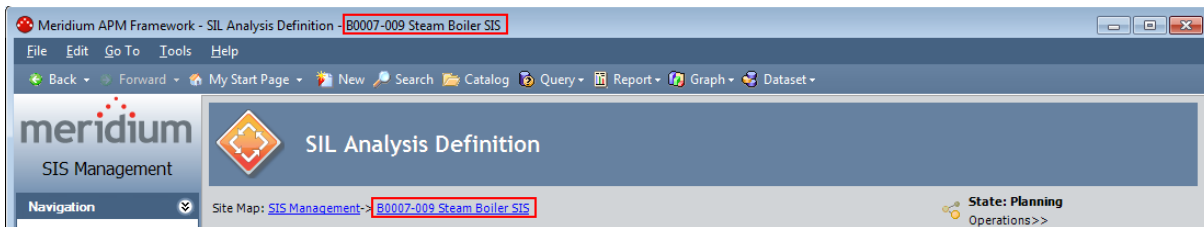

To define the SIL Analysis team for the SIL Analysis *B0007-009 Steam Boiler SIS*, you could click the **Team Members** link on the **Navigation** menu and see that the site map and title bar on the **SIL Analysis Team Members** page still contain the Analysis ID *B0007-009 Steam Boiler SIS*.

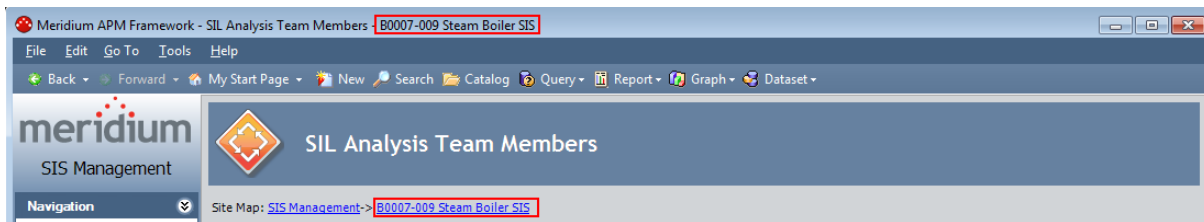

The Navigation Menu in SIS Management

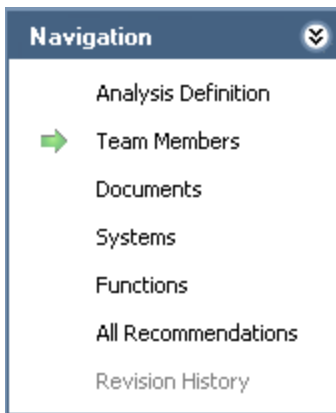

The **Navigation** menu appears on most pages in SIS Management and provides access to the SIS Management features. A green arrow to the left of an option indicates the feature that you are currently viewing. The **Navigation** menu contains the following links:

- **Analysis Definition:** Displays the **SIL Analysis Definition** page, where you can modify an SIL Analysis record or create a new one.
- **Team Members:** Displays the **SIL Analysis Team Members** page.
- **Documents:** Displays the **Reference Documents** page, where you can manage Reference Document records for the current SIL Analysis.
- **Systems:** Displays the **Safety Instrumented Systems** page, where you can manage the Safety Instrumented System records for the current SIL Analysis.
- **Functions:** Displays the **Instrumented Functions (IFs)** page, where you can manage the Instrumented Function records for the current SIL Analysis.
- **All Recommendations:** Displays the **Recommendation Management** page, where you can manage the list of Risk Assessment Recommendation records for the current SIL Analysis.
- **Revision History:** Displays the **Analysis Revision History** page, where you can manage the SIL Analysis Revision records that exist for the analysis. This link is enabled only if the state of the SIL Analysis record with which you are currently working has ever been set to Complete.

About SIL Analysis Records

SIL Analysis records store information about an SIL Analysis. Creating an SIL Analysis record is the first step in creating an SIL Analysis. All other records that you create for the SIL Analysis will be linked directly or indirectly to the SIL Analysis record.

SIL Analysis records are defined via a custom form datasheet that contains the following tabs:

- [SIL Analysis](#)
- Safety Requirement Specifications
- General SIS Requirements
- General SIF Requirements

After you have [created the SIL Analysis record](#), it will appear on the **SIL Analysis Definition** page, from which you can use the links on the **Navigation** menu to:

- [Define the SIL Analysis team.](#)
- [Define Reference Document records.](#)
- [Define the safety instrumented systems that you are analyzing.](#)
- [Define the instrumented functions that make up the safety instrumented system.](#)
- [Manage Risk Assessment Recommendation records](#) that are linked to the SIL Analysis record.

Accessing the SIL Analysis Search Page

The **SIL Analysis Search** page lets you search for existing SIL Analysis records or create new ones. To access this page, you must be a Super User or a member of the MI SIS Administrator, MI SIS Engineer, or MI SIS User Security Group.

To access the **SIL Analysis Search** page:

- On the [SIS Management Start Page](#), click the **SIL Analysis** link.

The **SIL Analysis Search** page appears.

Aspects of the SIL Analysis Search Page

The **SIL Analysis Search** page contains the **SIL Analysis Search** workspace, which displays the results of the query specified in the **SIL Analysis Search Query** text box on the **SIS Management Administration** page. This documentation assumes that you are using the baseline `SIL_Analysis_Search` query, which contains two prompts that appear as lists at the top of the **SIL Analysis Search** Workspace:

- **State:** Contains a list of record states that have been configured for the SIL Analysis family. You can choose from the following baseline states:
 - **Active:** Displays the list of existing SIL Analysis records whose State field contains the value *Active*.
 - **Complete:** Displays the list of existing SIL Analysis records whose State field contains the value *Complete*.
 - **Pending Approval:** Displays the list of existing SIL Analysis records whose State field contains the value *Pending Approval*.
 - **Planning:** Displays the list of existing SIL Analysis records whose State field contains the value *Planning*.
 - **Review:** Displays the list of existing SIL Analysis records whose State field contains the value *Review*.

Selecting the *All* option will cause the query to return all SIL Analysis records in any state.

- **SIL Analysis Owner:** Contains a list of User IDs of the users whose name is stored in the Owner field in any SIL Analysis record.

After you select different criteria, you can click the **Run Query** button to run the `SIL_Analysis_Search` query and displays the results in the grid at the bottom of the page. The query results will include hyperlinked Analysis IDs, which you can use to open the SIL Analysis record on the **SIL Analysis Definition - <Analysis ID>** page, where **<Analysis ID>** is the ID of the SIL Analysis with which you are currently working.

Below the query results, options appear that you can use to navigate the results.

The **SIL Analysis Search** page contains the following task menus:

- [Common Tasks](#)
- [Associated Pages](#)

Common Tasks Menu

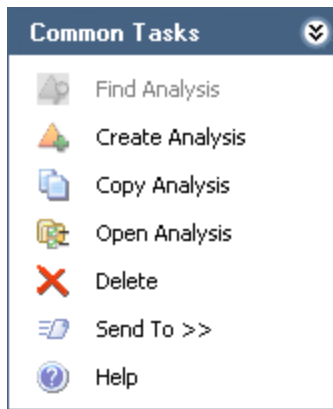

The **Common Tasks** menu on the **SIL Analysis Search** page contains the following options:

- **Find Analysis:** Displays the **SIL Analysis Search** page. This link appears on other pages in SIS Management and is disabled on the **SIL Analysis Search** page.
- **Create Analysis:** Displays a new SIL Analysis record on the **SIL Analysis Definition** page.
- **Copy Analysis:** Displays on the **SIL Analysis Definition** page a new SIL Analysis record, which is populated with information from the SIL Analysis record that is currently selected.
- **Open Analysis:** Displays the selected SIL Analysis record on the **SIL Analysis Definition** page.
- **Delete:** Displays a confirmation message, asking if you want to delete the selected record, and then deletes the selected SIL Analysis record.
- **Send To:** Displays a submenu with options that let you provide a link to the current page on your desktop (create shortcut), in an email message, or on a Home Page.
- **Help:** Displays the context-sensitive Help topic for the **SIL Analysis Search** page.

Searching for SIL Analysis Records

To search for an SIL Analysis record:

1. [Access the SIL Analysis Search page.](#)
2. In the **SIL Analysis Search** workspace, in the **State** list, select the record state by which you want to filter the results.
3. In the **SIL AnalysisOwner** list, select the User ID for the name of the analysis owner by which you want to filter the results.
4. Click the **Run Query** button.

The records that meet your search criteria appear in the query results section.

Accessing the SIL Analysis Definition Page

The SIL Analysis Definition page displays:

- A new blank SIL Analysis datasheet, which you can use to create a new SIL Analysis record.
- or-
- The datasheet for the selected SIL Analysis record, which you can use to modify the SIL Analysis record.

To access the SIL Analysis Definition page:

1. [Access the SIL Analysis Search page.](#)
2. On the **Common Tasks** menu, click the **Create Analysis** link.

-or-

Click the hyperlinked Analysis ID of an existing SIL Analysis record.

The **SIL Analysis Definition** page appears.

Meridium APM Framework - SIL Analysis Definition - SIL-03

File Edit Go To Tools Help

Back Forward My Start Page New Search Catalog Query Report Graph Dataset Dashboard

meridium
SIS Management

Navigation

- Analysis Definition
- Team Members
- Documents
- Systems
- Functions
- All Recommendations
- Revision History

Common Tasks

- Find Analysis
- Create Analysis
- Copy Analysis
- Save
- Open Analysis
- Delete
- Send To >>
- Reports >>
- Graphs >>
- Help

Associated Pages

SIL Analysis Definition

Site Map: SIS Management-> SIL-03

State: Planning
Operations>>

Datasheet: SIL Analysis

SIL Analysis Safety Requirement Specifications General SIS Requirements General SIF Requirements

Analysis ID: SIL-03

Analysis Description: BR-1001 Steam Boiler SIS Analysis

Long Description: Based on results of updated HAZOP conducted on BR-1001 Steam Boiler reassess SIL's and address any recommendations for additional PIF's.

Site ID: Meridium Production Unit ID: Plant Utilities

Functional Location ID:

Equipment ID:

Hazards Analysis Information

Hazards Analysis Reference: HAZOP State:

Hazards Analysis Revision: 1 Hazards Analysis Date: 6/22/2009 12:00:00 AM

Hazards Next Reevaluation Interval: 3 Years HAZOPS Reevaluation Date:

Owner: Soos, Steve

Analysis Start Date: 6/29/2009 12:00:00 AM Analysis End Date: 8/29/2009 12:00:00 AM

Last Modified By: sisadmin Last Modified Date: 1/22/2013 5:01:40 PM

Aspects of the SIL Analysis Definition Page

The SIL Analysis Definition page contains the following items:

- **SIL Analysis Definitionworkspace:** Contains the SIL Analysis record with which you are currently working. Via the **SIL Analysis Definition** workspace, you can [create a new SIL Analysis record](#) or [modify an existing SIL Analysis record](#).
- **Task Menus:** The **SIL Analysis Definition** page contains the following task menus:
 - [Common Tasks](#)
 - [Navigation](#)
 - [Associated Pages](#)

Common Tasks Menu

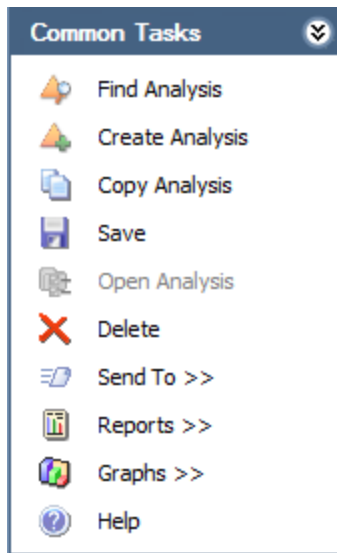

The **Common Tasks** menu on the **SIL Analysis Definition** page contains the following options:

- **Find Analysis:** Displays the **SIL Analysis Search** page.
- **Create Analysis:** Displays a new SIL Analysis record on the **SIL Analysis Definition** page.
- **Copy Analysis:** Displays on the **SIL Analysis Definition** page a new SIL Analysis record, which is populated with information from the SIL Analysis record that is currently selected.
- **Save:** Saves the current SIL Analysis record.
- **Open Analysis:** This link is disabled in the **SIL Analysis Definition** page.
- **Delete:** Displays a confirmation message, and then deletes the current record.
- **Send To:** Displays a submenu with options that let you provide a link to the current page on your desktop (create shortcut), in an email message, or on a Home Page.
- **Reports:** Displays a submenu with the captions of the reports that are stored in the Catalog folder \\Public\Meridium\Modules\SIS Management\SIL\Reports.
- **Graphs:** Displays a submenu with captions of the graphs that are stored in the Catalog folder \\Public\Meridium\Modules\SIS Management\SIL\Graphs.
- **Help:** Displays the context-sensitive Help topic for the **SIL Analysis Definition** page.

About Defining SIL Analysis Records

You can define SIL Analysis records via the SIL Analysis datasheet on the **Analysis Definition** page. The SIL Analysis datasheet is a custom form that contains the following tabs that displays [fields that are configured for the SIL Analysis family](#):

- SIL Analysis
- Safety Requirement Specifications
- General SIS Requirements
- General SIF Requirements

Creating SIL Analysis Records

To create an SIL Analysis record:

1. [Access the SIL Analysis Search page.](#)
2. On the **Common Tasks** menu, click the **Create Analysis** link.
The **SIL Analysis Definition** page appears, displaying a new SIL Analysis record.
3. On the **SIL Analysis** tab, in the Analysis ID field, type a unique name for the SIL Analysis.
4. Provide values in the remaining fields as desired.
5. Click the **Safety Requirement Specifications** tab, and enter values as desired.
6. Click the **General SIS Requirements** tab, and enter values as desired.
7. Click the **General SIF Requirements** tab, and enter values as desired.
8. At the top of the datasheet, click the **Save** button. 

The SIL Analysis record is saved.

Copying SIL Analysis Records

When you copy an existing SIL Analysis record, you are creating a new SIL Analysis record that will be populated with the values from the record that was copied. The values in all the fields from a source record will be copied to the new record with the exception of the following fields:

- Analysis ID
- Analysis End Date
- Analysis Start Date
- Equipment ID
- Functional Location ID
- Hazards Analysis Date
- Hazards Analysis Reference
- Hazards Analysis Reference Key
- Hazards Analysis Revision
- Last Modified By
- Last Modified Date

To copy an SIL Analysis record:

1. [Access the SIL Analysis Definition page](#) for the SIL Analysis record that you want to copy.
2. On the **Common Tasks** menu, click the **Copy Analysis** link.

A new SIL Analysis record appears and is populated automatically with values from the currently selected record.

Copying SIL Analysis Records

The screenshot shows the 'SIL Analysis Definition' web application. At the top left is a logo with a diamond shape containing a cross. The title 'SIL Analysis Definition' is in the top right. Below the title, the 'Site Map' is 'SIS Management' and the 'State' is 'Planning'. The 'Datasheet' is 'SIL Analysis'. The main content area has tabs for 'SIL Analysis', 'Safety Requirement Specifications', 'General SIS Requirements', and 'General SIF Requirements'. The 'SIL Analysis' tab is active. The form contains the following fields:

- Analysis ID:** A redacted field (blacked out).
- Analysis Description:** BR-1001 Steam Boiler SIS Analysis
- Long Description:** Based on results of updated HAZOP conducted on BR-1001 Steam Boiler reassess SIL's and address any recommendations for additional PIF's.
- Site ID:** A dropdown menu.
- Unit ID:** Plant Utilities
- Functional Location ID:** A text box with a search icon.
- Equipment ID:** A text box with a search icon.
- Hazards Analysis Information:**
 - Hazards Analysis Reference:** A text box with a search icon.
 - Hazards Analysis Revision:** A text box.
 - Hazards Next Reevaluation Interval:** 3 Years
 - HAZOP State:** A dropdown menu.
 - Hazards Analysis Date:** A date dropdown menu.
 - HAZOPS Reevaluation Date:** A date dropdown menu.
- Owner:** Soos, Steve
- Analysis Start Date:** 7/29/2013 12:00:00 AM
- Analysis End Date:** A date dropdown menu.
- Last Modified By:** A text box.
- Last Modified Date:** A date dropdown menu.

3. In the **Analysis ID** text box, type a unique name for the SIL Analysis. This field is required.
 4. If needed, modify the values in the remaining fields.
 5. On the **Common Tasks** menu, click the **Save** link.
- The new SIL Analysis record is saved.

Modifying SIL Analysis Records

To modify an SIL Analysis record:

1. [Open the desired SIL Analysis record](#) on the **SIL Analysis Definition** page.
2. On the SIL Analysis datasheet, [modify the fields as desired](#).
3. At the top of the datasheet, click the **Save** icon. 

Your changes are saved.

Opening Existing SIL Analysis Records

To open an existing SIL Analysis record:

1. On the **SIL Analysis Search** page, [search for the desired record](#).
2. In the results, locate the row that contains the desired SIL Analysis record.
3. In the **Analysis ID** column, click the hyperlinked Analysis ID.

The record appears on the **SIL Analysis Definition** page, where you can modify the record and continue working with the SIL Analysis.

Removing SIL Analysis Records from the SIL Analysis Search Page

If you are finished with an SIL Analysis record and no longer want to see that record in the query results on the **SIL Analysis Search** page, you can remove the SIL Analysis record from the query results via the **Delete** option on the **Common Tasks** menu.

Using the **Delete** option does not *delete* the SIL Analysis record from the database. Instead, when you remove an SIL Analysis record:

- The **Is Deleted** check box in the record is selected, and that record will no longer appear in the query results.
- The links between that record and other records associated with the SIL Analysis are deleted.

You can remove an SIL Analysis record from the query results on the **SIL Analysis Search** page regardless of the state of that record. After an SIL Analysis record has been removed from the query results, you can still access the record via a search.

To remove an SIL Analysis record from the SIL Analysis Search page:

1. [On the SIL Analysis Search page](#), select the row containing the SIL Analysis record that you want to delete.
2. On the **Common Tasks** menu, click the **Delete** link.

A confirmation message appears, asking if you really want to delete the SIL Analysis record and all the records linked to that record.

3. Click the **Yes** button.

The SIL Analysis record is removed from the **SIL Analysis Search** page, and the links to all the records that are linked to that record are deleted.

About Associating SIL Analyses with a Specific Site

Some companies that use the Meridium APM software have facilities at multiple sites, or locations, around the world. Each site contains unique equipment and locations.

If desired, you can define these sites and associate equipment and locations with the site to which they belong. You can also associate risk matrices with specific sites. If a risk matrix is associated with a site, you can specify which site you want to associate with an SIL Analysis. You can associate a site with an SIL Analysis by selecting the ID of the desired Site Reference record in the Site ID field in the SIL Analysis record for that SIL Analysis.

After an SIL Analysis is associated with a site, when you create a Risk Assessment record for an Instrumented Function record associated with an SIL Analysis, rather than seeing the default risk matrix, you will see the risk matrix that is associated with the specified site.

About the SIL Analysis Team

The *SIL Analysis team* is a group of individuals who will complete the SIL Analysis. You can add Meridium APM users and non-Meridium APM users to the SIL Analysis team.

- Meridium APM users will have an existing Meridium APM Security User record and an associated Human Resource record that was created automatically when the Security User record was created.
- Non-Meridium APM users will not have a Meridium APM Security User record or a Human Resource record. To add a non-Meridium APM user to the SIL Analysis team, you will need to create a Human Resource record for that user. You can do so via the **SIL Analysis Team Members** page or using Meridium APM Framework Tools.

Note: A Meridium APM Security User record is required for logging in to the Meridium APM Framework application and using SIS Management. SIL Analysis team members who do not have a Security User account may participate in and contribute to the analysis but will not be able to use the application.

Any member of the SIL Analysis team can be assigned a role within the SIL Analysis team, which provides a reference of the tasks for which that team members is responsible.

Accessing the SIL Analysis Team Members Page

On the **SIL Analysis Team Members** page, you can add team members to the SIL Analysis and assign team members the role of Process Owner or Facilitator.

To access the **SIL Analysis Team Members** page:

1. [Open the SIL Analysis record for the desired SIL Analysis.](#)
2. On the **Navigation** menu, click the **Team Members** link.

The **SIL Analysis Team Members** page appears.

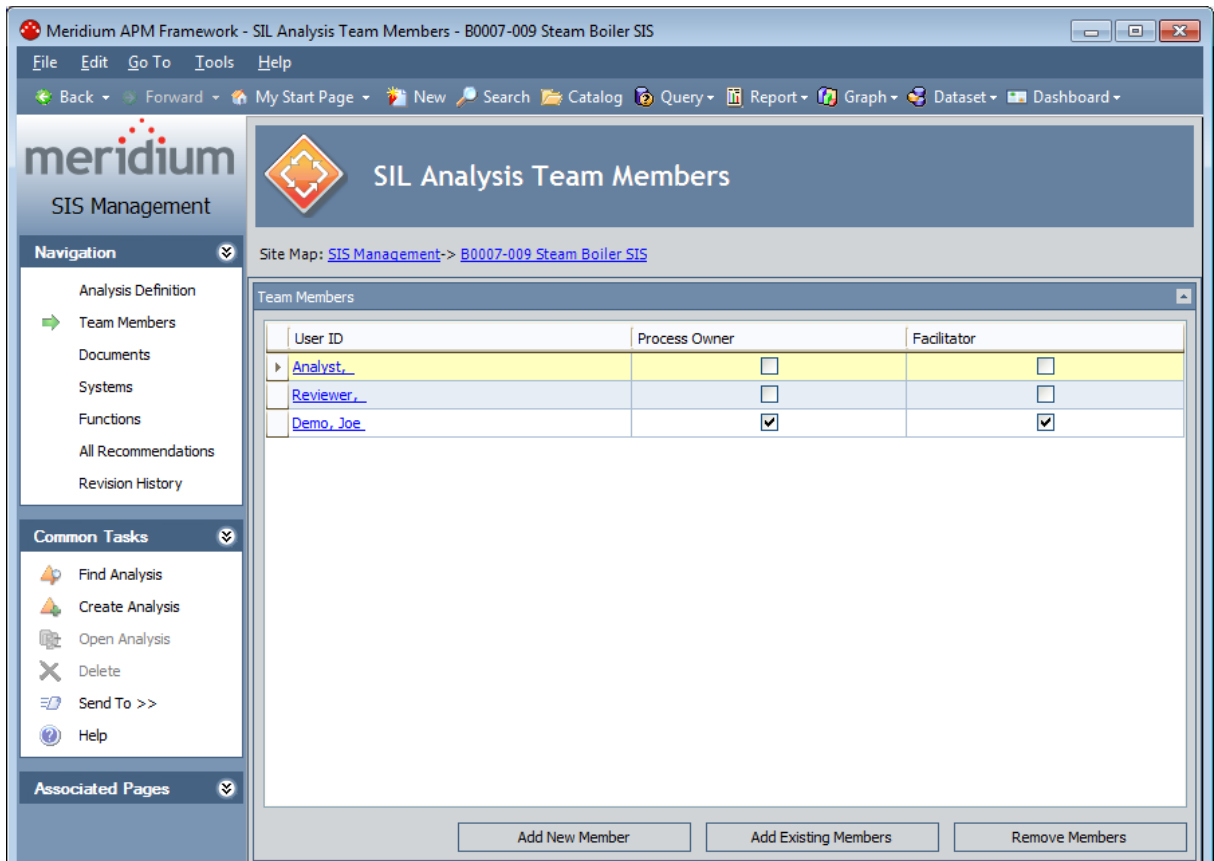

Aspects of the SIL Analysis Team Members Page

The **SIL Analysis Team Members** page displays the **Team Members** workspace, which consists of a grid that displays the names of the SIL Analysis team members. Each row in the grid represents one Human Resource record. For each Human Resource record that appears in the grid, the following information is displayed:

- **User ID:** The name of the team member as it appears in the First Name and Last Name fields in the Human Resource record for that user.
- **Process Owner:** Indicates whether or not the team member has the role of Process Owner. This check box can be selected for only one team member per SIL Analysis team.
- **Facilitator:** Indicates whether or not the team member has the role of Facilitator. This check box can be selected for only one team member per SIL Analysis.

Below the grid, the following buttons appear:

- **Add New Member:** Displays a new Human Resource record that you can define and link to the SIL Analysis record.
- **Add Existing Members:** Displays the **Find Items** window, where you can search for an existing Human Resource record and link it to the SIL Analysis record.
- **Remove Members:** After asking for confirmation, removes the selected user from the team. This button is enabled only when records appear in the grid.

The **SIL Analysis Team Members** page contains the following task menus:

- [Navigation](#)
- [Common Tasks](#)
- [Associated Pages](#)

Common Tasks

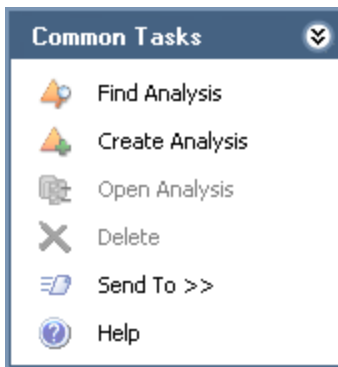

The **Common Tasks** menu on the **SIL Analysis Team Members** page contains the following links:

- **Find Analysis:** Displays the **SIL Analysis Search** page, where you can search for an existing SIL Analysis record.
- **Create Analysis:** Displays a new blank SIL Analysis record on the **SIL Analysis Definition** page.
- **Open Analysis:** This link is disabled.
- **Delete:** This link is disabled.
- **Send To:** Displays a submenu with options that let you provide a link to the current page on your desktop (create shortcut), in an email message, or on a Home Page.
- **Help:** Displays the context-sensitive Help topic for the **SIL Analysis Team Members** page.

Creating New Users and Adding Them to the SIL Analysis Team

When you create new users and add them to the SIL Analysis team, you are creating new *Human Resource records* in the Meridium APM database and linking them to the SIL Analysis record. This option should be used for team members who do not have a Human Resource record. If you want to add a team member who is already has a Human Resource record, see the topic for [adding new team members who already have a Human Resource record](#).

To create a new user and add that user to the SIL Analysis team:

1. [Access the SIL Analysis Team Members page](#).
2. At the bottom of the **Team Members** workspace, click the **Add New Member** button.

A new Human Resource record appears.

The screenshot shows a software window titled "(new Human Resource)". Inside the window, there is a form with the following fields:

- Last Name (highlighted in red)
- First Name
- Middle Initial
- Job Title
- Company
- Address1
- Address2
- City
- State
- Postal Code
- Country
- Phone1
- Phone2
- Fax
- Domain
- Email Address
- Facility
- Site Code
- Business Unit
- Area of Responsibility
- Department
- Comments

At the bottom right of the form, there are three buttons: "Promote to User", "OK", and "Cancel".

3. Enter values in the fields on the datasheet as desired. Note that the Last Name field is required.
4. Click **OK**.

The Human Resource record is saved, and the new SIL Analysis team member appears in the **Team Members** workspace.

Adding New Team Members Who Already Have A Human Resource Record

When you add a new SIL Analysis Team Member who already has a Human Resource record, you are linking an existing Human Resource record to the SIL Analysis record. This option should be used for team members who already have a Human Resource record. If you want to add a new SIL Analysis team member who does not already have a Human Resource record, see the topic for [creating a new user to add to the SIL Analysis team](#).

To add a new team member who already has a Human Resource record:

1. [Access the SIL Analysis Team Members page](#).
2. At the bottom of the **Team Members** workspace, click the **Add Existing Members** button.

The **Find Items** window appears, and the Human Resource family is selected in the **Search In** list by default.

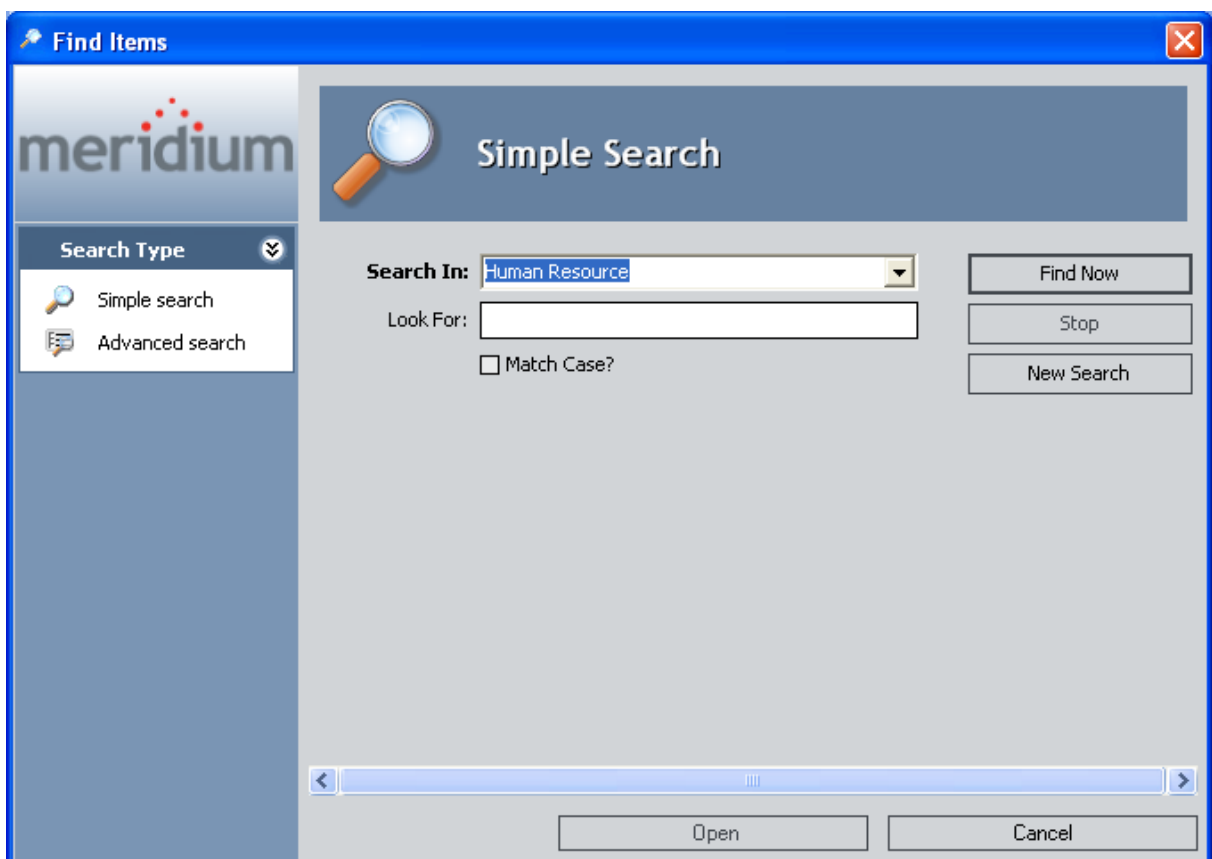

3. If desired, type your search criteria in the **Look For** text box., and then click the **Find Now** button.

The search results appear.

4. Locate the desired Human Resource record, and click the **Open** button.
The new SIL Analysis team member appears in the **Team Members** workspace.

About SIL Analysis Team Member Roles

SIL Analysis team member roles serve as a reference of which SIL Analysis team member is responsible for a given task related to the SIL Analysis. The following roles are available for an SIL Analysis:

- **Process Owner:** The team member who is responsible for the SIL Analysis. After you assign a team member the role of Process Owner, that team member's name will appear in the Owner field in the SIL Analysis record.
- **Facilitator:** The team member who is in charge of conducting the SIL Analysis and organizing the SIL Analysis team.

There can be only one Process Owner and one Facilitator per SIL Analysis. A single team member, however, can be designated as both the Process Owner and Facilitator.

Assigning Roles to SIL Analysis Team Members

The following instructions provide details on designating a team member as the Process Owner or Facilitator. Assigning a team member to a role serves as a reference for the team.

To assign a role to an SIL Analysis team member:

1. [Access the SIL Analysis Team Members page](#).
2. In the **Team Members** workspace, locate the row containing the team member that you want to assign the role of Process Owner or Facilitator.
3. In either the **Process Owner** or **Facilitator** column, select the check box to indicate that the team member is assigned to the corresponding role.

The team member is assigned the specified role, and the Owner field on the [SIL Analysis datasheet](#) is populated with that team member's name.

To assign a role to a different team member, select the **Process Owner** or **Facilitator** check box in the row that represents that team member.

Viewing Human Resource Records for Existing Team Members

To view the Human Resource record for an existing SIL Analysis team member:

1. [Access the SIL Analysis Team Members page.](#)
2. In the **Team Members** workspace, locate the row containing the team member whose Human Resource record you want to view.
3. In the **User ID** column, click the team member's hyperlinked User ID.

The Human Resource record for that team member appears. At this point you can modify the fields if desired.

4. Click **OK**.

Your changes are saved.

Removing Team Members from the SIL Analysis Team

When you remove a team member from an SIL Analysis team, you are deleting the link between the Human Resource record and the SIL Analysis record.

Additionally, if you remove from the SIL Analysis team a team member who is assigned the role of Process Owner, the Owner field in the SIL Analysis record will be cleared.

To remove team members from the SIL Analysis team:

1. [Access the SIL Analysis Team Members page](#).
2. In the **Team Members** workspace, select the rows containing the team member that you want to remove from the SIL Analysis team.
3. At the bottom of the **Team Members** workspace, click the **Remove Members** button.

A confirmation message appears, asking if you really want to remove the selected team members.

4. Click the **Yes** button.

The selected team members are removed from the SIL Analysis team.

Accessing the Reference Documents Page

The **Reference Documents** page lets you create and manage Reference Document records that are linked to the SIL Analysis record for the current SIL Analysis.

To access the Reference Documents page:

1. [Open the SIL Analysis record for the desired SIL Analysis.](#)
2. On the **Navigation** menu, click the **Documents** link.

The **Reference Documents** page appears.

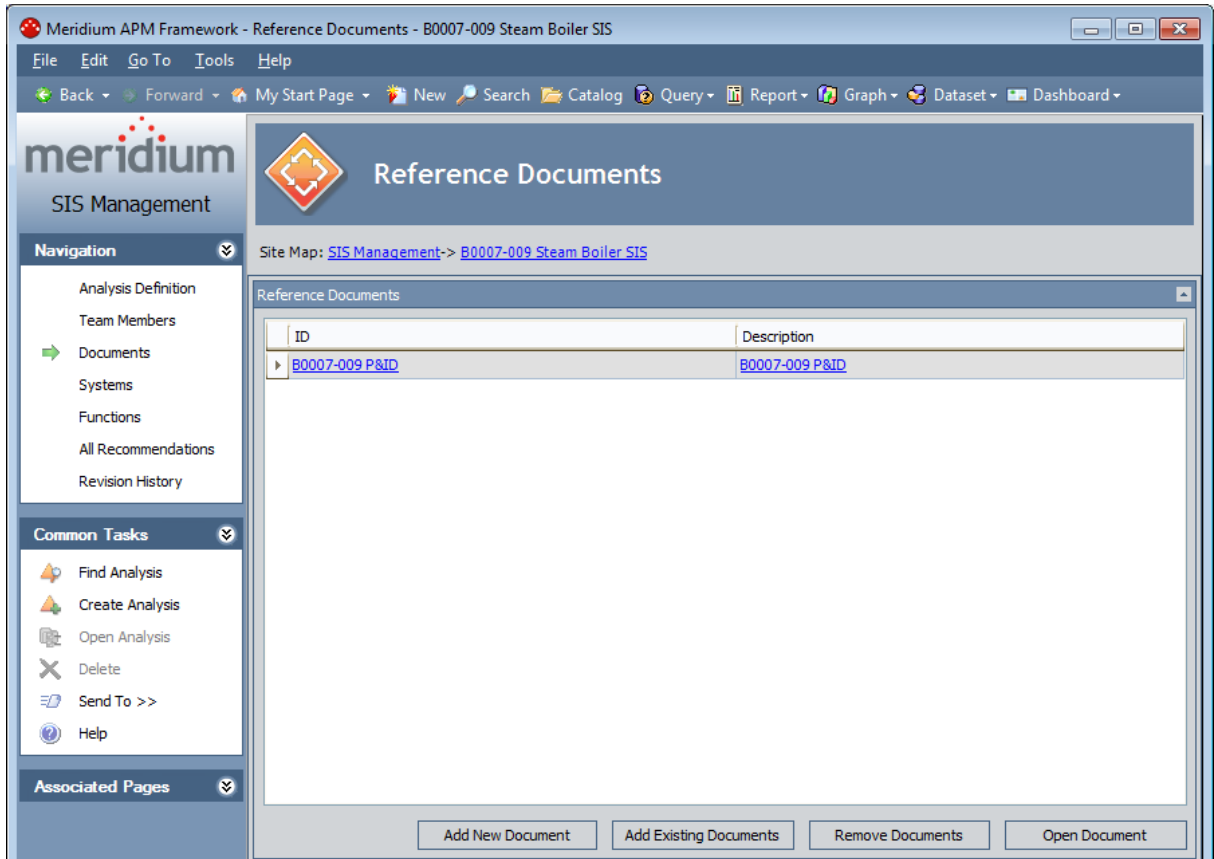

Aspects of the Reference Documents Page

The **Reference Documents** page contains the **Reference Documents** workspace, which consists of a grid that displays a list of Reference Document records that are linked to the current SIL Analysis. Each row in the grid represents one Reference Document record. For each Reference Document record that appears in the grid, the following information is displayed:

- **ID:** The value that exists in the ID field of the associated Reference Document record.
- **Description:** The value that exists in the Description field of the associated Reference Document record.

Below the grid, the following buttons appear:

- **Add New Document:** Displays a new blank Reference Document record in the <empty> (new Reference Document) dialog box.
- **Add Existing Documents:** Displays the **Find Items** window, where you can search for an existing Reference document record to link to the SIL Analysis.
- **Remove Documents:** Displays a confirmation message and then removes the Reference Document record from the SIL Analysis. This button is enabled only when a row in the grid is selected.
- **Open Document:** Opens the file associated with the selected Reference Document record. This button is enabled only when a row in the grid is selected.

The **Reference Documents** page contains the following task menus:

- [Navigation](#)
- [Common Tasks](#)
- [Associated Pages](#)

Common Tasks

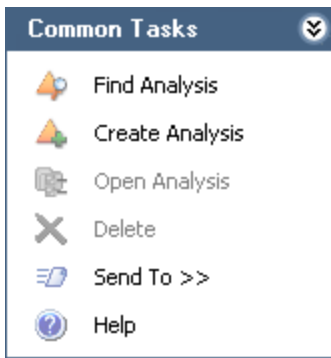

The **Common Tasks** menu on the **Reference Documents** page contains the following links:

- **Find Analysis:** Displays the **SIL Analysis Search** page, where you can search for an existing **SIL Analysis** record.
- **Create Analysis:** Displays a new, blank **SIL Analysis** record on the **SIL Analysis Definition** page.
- **Open Analysis:** This link is disabled.
- **Delete:** This link is disabled.
- **Send To:** Displays a submenu with options that let you provide a link to the current page on your desktop (create shortcut), in an email message, or on a Home Page.
- **Help:** Displays the context-sensitive Help topic for the **SIL Analysis Team Members** page.

Creating New Reference Document Records and Adding Them to the SIL Analysis

When you create a new Reference Document record and add it to the SIL Analysis, you are linking the new Reference Document record to the SIL Analysis record.

To create a new Reference Document record and add it to the SIL Analysis:

1. [Access the Reference Documents page.](#)
2. Below the grid, click the **Add New Document** button.
A new Reference Document record appears.
3. Follow the standard procedure for creating a Reference Document record.
The new Reference Document record is saved and linked to the SIL Analysis record, and the record appears in the **Reference Documents** workspace.

Adding Existing Reference Document Records to the SIL Analysis

When you add an existing Reference Document record to the SIL Analysis, you are linking the Reference Document to the SIL Analysis record.

To add existing Reference Document records to the SIL Analysis:

1. [Access the Reference Documents page.](#)
2. Below the grid, click the **Add Existing Documents** button.
The **Find Items** window appears, and the *Reference Document* family appears in the **Search In** list by default.
3. Provide additional search criteria if desired, and then click the **Find Now** button.
The search results appear.
4. In the search results grid, select the row containing the Reference Document record that you want to link to the SIL Analysis record.
5. Click the **Open** button.
The selected record appears in the **Reference Documents** workspace.

Viewing Reference Documents

When you view a reference document, you are opening the file specified in the Reference Document record. To be able to view a reference document on your computer:

- The file must be saved to a location that can be accessed from your computer.
- The application required to open that document must be installed on your computer.

To view a reference document:

1. [Access the Reference Documents page.](#)
2. In the **Reference Documents** workspace, select the row containing the reference document that you want to view.
3. At the bottom of the **Reference Documents** workspace, click the **Open Document** button.

The reference document file appears in the application required to display it. For example, if the reference document is a word document, it will appear in the Microsoft Word application.

Opening Reference Document Records

To open a Reference Document record:

1. [Access the Reference Documents page.](#)
2. In the **Reference Documents** workspace, locate the row containing the Reference Document record that you want to open.
3. In the **ID** column, click the hyperlinked Record ID of the record.

The Reference Document record appears in a new window. At this point, you can modify the records as desired.

To close the Reference Document record and return to the **Reference Documents** page, click **OK** (to save your changes) or **Cancel**.

Removing Reference Documents from the SIL Analysis

When you remove a reference document from the SIL Analysis, you are deleting the *link* between the Reference Document record and the SIL Analysis record. You are not deleting the Reference Document record from the database.

To remove reference documents from the SIL Analysis:

1. [Access the Reference Documents page.](#)
2. In the **Reference Documents** workspace, select the row containing the reference document that you want to remove from the SIL Analysis.
3. Click the **Remove Documents** button.

A confirmation message appears, asking if you really want to remove the selected record.

4. Click the **Yes** button.

The selected record is removed from the SIL Analysis and is no longer displayed in the grid.

About Safety Instrumented System Records

Safety Instrumented System records store details about safety instrumented systems (SIS) for which you are conducting an SIL Analysis. A safety instrumented system is a system that is equipped with one or more protective instrument loops (PIL), which consist of a series of interconnected instruments that are designed specifically to monitor the process defined by that protective instrument loop's instrumented function and prevent consequences within that process. You should add to the SIL Analysis one Safety Instrumented System record per safety instrumented system that you want to assess via the analysis.

When you add a Safety Instrumented System record to an SIL Analysis, you are linking the Safety Instrumented System record directly to the SIL Analysis record. Additionally, Safety Instrumented System records can be linked to records in the following families:

- **Instrumented Function:** Store details on the specific function of a given protective instrument loop within the safety instrumented system.
- **SIS Proof Test:** Store details on the steps that need to be performed to test each safety instrumented system and the results of that test.
- **SIS Proof Test Template:** Store details on the steps that need to be performed to test an instrumented function. You can use an SIS Proof Test Template record to populate an SIS Proof Test record with data that is common to more than one proof test.

You can add Safety Instrumented System records to the SIL Analysis using the following methods:

- [Create a new one.](#)
- [Add an existing one.](#)
- [Copy an existing one and automatically create a new one.](#)

After you have added to the SIL Analysis the desired Safety Instrumented System records, you can define the specific Instrumented Functions (IFs) of those Safety Instrumented Systems.

Accessing the Safety Instrumented Systems Page

On the **Safety Instrumented Systems** page, you can create new Safety Instrumented System records and modify existing ones.

To access the Safety Instrumented Systems page:

1. [Open the SIL Analysis record for the desired SIL Analysis.](#)
2. On the **Navigation** menu, click the **Systems** link.

The **Safety Instrumented Systems** page appears.

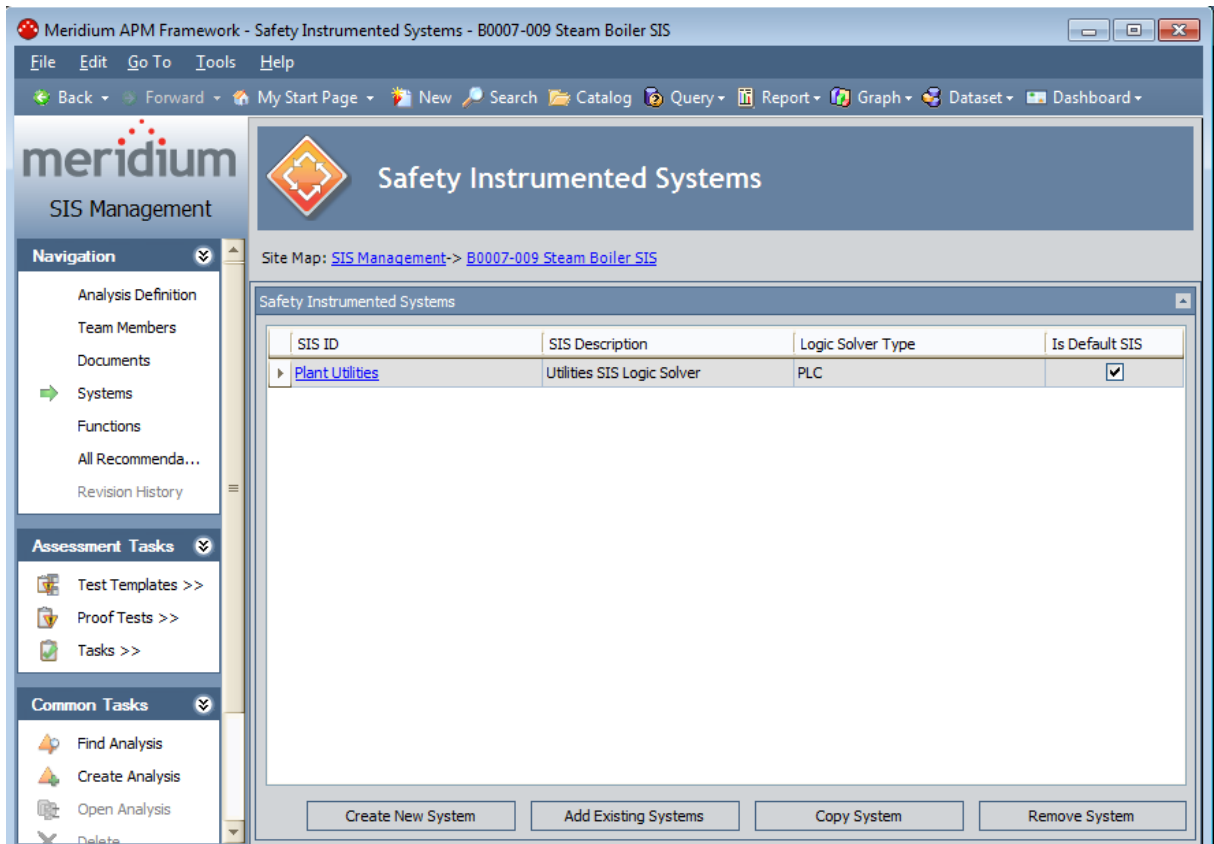

Aspects of the Safety Instrumented Systems Page

The **Safety Instrumented Systems** page contains the **Safety Instrumented Systems** workspace, which consists of a grid that displays a list of [Safety Instrumented System records](#) that are linked to the current SIL Analysis. Each row in the grid represents one Safety Instrumented System record. For each Safety Instrumented System record that appears in the grid, the following information is displayed:

- **System ID:** The value that exists in the SIS ID field in the Safety Instrumented System record.
- **Description:** The value that exists in the SIS Description field in the Safety Instrumented System record.
- **Logic Solver Type:** The value that exists in the Logic Solver Type field in the Safety Instrumented System record.
- **Is Default:** Specifies whether or not the Safety Instrumented System record is the default. If you have more than one safety instrumented systems defined for an SIL Analysis, you will need to specify one as the default.

Below the grid, the following buttons appear:

- **Create New System:** Displays a new blank Safety Instrumented System record in a new window.
- **Add Existing System:** Displays the **Find Items** window, where you can search for an existing Safety Instrumented System record to link to the SIL Analysis record.
- **Copy System:** Displays a new Safety Instrumented System record and populates it automatically with values from the currently selected record. This button is enabled only when a record appears in the grid.
- **Remove System:** After displaying a confirmation message, deletes the link between the selected Safety Instrumented System record and the SIL Analysis record. This button is enabled only when a record appears in the grid.

The **Safety Instrumented Systems** page contains the following task menus:

- [Navigation](#)
- [Assessment Tasks](#)
- [Common Tasks](#)
- [Associated Pages](#)

Assessment Tasks

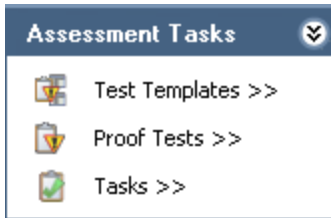

The **Assessment Tasks** menu on the **Safety Instrumented Systems** page contains the following links:

- **Test Templates:** Displays a submenu with the following options:
 - **Create:** Displays the **Proof Test Template Definition** page, where you can create a new Proof Test Template record and link it to the selected Safety Instrumented System record.
 - **View:** Displays the **Proof Test Templates** page, where you can view a list of Proof Test Template records that are linked to the selected Safety Instrumented System record.
- **Proof Tests:** Displays a submenu with the following options:
 - **Create:** Displays the **Proof Test Definition** page, where you can create a new Proof Test record to link to the selected Safety Instrumented System record.
 - **View:** Displays the **Proof Tests** page, where you can view a list of Proof Test records that are linked to the selected Safety Instrumented System record.
- **Tasks:** Displays a submenu with the following options:
 - **Create:** Displays a new Inspection Task record that you can link to the selected Safety Instrumented System record.
 - **View:** Displays the Task List page, where you can view a list of Inspection Tasks records that are linked to the selected Safety Instrumented System record.

The **Assessment Tasks** menu appears on multiple pages throughout SIS Management. The links that are available to you will vary depending on where you are accessing the menu.

Common Tasks

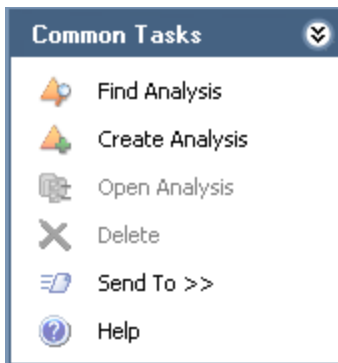

The **Common Tasks** menu on the **Safety Instrumented Systems** page contains the following links:

- **Find Analysis:** Displays the **SIL Analysis Search** page, where you can search for an existing SIL Analysis record.
- **Create Analysis:** Displays a new blank SIL Analysis record on the **SIL Analysis Definition** page.
- **Open Analysis:** This link is disabled.
- **Delete:** This link is disabled.
- **Send To:** Displays a submenu with options that let you provide a link to the current page on your desktop (create shortcut), in an email message, or on a Home Page.
- **Help:** Displays the context-sensitive help topic for the **Safety Instrumented Systems** page.

Creating New Safety Instrumented System Records

When you create a new Safety Instrumented System record, it will be linked automatically to the SIL Analysis record for the current SIL Analysis.

To create a new Safety Instrumented System record:

1. [Access the Safety Instrumented Systems page.](#)
2. At the bottom of the **Safety Instrumented Systems** workspace, click the **Create New System** button.

A new blank Safety Instrumented System record appears in a new window.

The screenshot shows a software window titled "~ (new Safety Instrumented System)". The window contains a form for creating a new Safety Instrumented System record. The form has a "Datasheet" tab selected, showing "Safety Instrumented System". The fields are as follows:

- SIS ID:** A redacted field (indicated by a red bar).
- SIS Description:** A text input field.
- Long Description:** A text input field with a scroll bar and a "..." button.
- Site ID:** A text input field containing "Roanoke, VA".
- Unit ID:** A text input field.
- Logic Solver ID:** A text input field.
- Logic Solver Type:** A dropdown menu.
- Target SIS Test Interval:** A text input field followed by "Months".
- Mission Time:** A text input field followed by "Years".
- Manual Shutdown Description:** A text input field with a scroll bar and a "..." button.
- Reset Procedure:** A text input field with a scroll bar and a "..." button.
- Power Source:** A text input field.
- Communication Links:** A text input field.
- Last Modified By:** A text input field.
- Last Modified Date:** A dropdown menu.
- Plant Operation Mode:** A dropdown menu set to "NORMAL".
- Abnormal State:** A dropdown menu.
- Abnormal Mode Description:** A text input field with a scroll bar and a "..." button.

At the bottom right of the form are "OK" and "Cancel" buttons.

3. In the **SIS ID** text box, type a unique name for the safety instrumented system. This field is required.

4. Provide values for the [remaining fields](#) as desired.
5. Click **OK**.

The record window closes, and the record is created and linked to the SIL Analysis record for the current analysis and appears in the **Safety Instrumented Systems** grid.

Adding Existing Safety Instrumented System Records to the SIL Analysis

When you add an existing Safety Instrumented System record to an SIL Analysis, you are linking that record to the SIL Analysis record for the current SIL Analysis.

To add an existing Safety Instrumented System record to the SIL Analysis:

1. [Access the Safety Instrumented Systems page.](#)
2. At the bottom of the **Safety Instrumented Systems** workspace, click the **Add Existing Systems** button.

The **Find Items** window appears, where you can search for an existing Safety Instrumented System record.

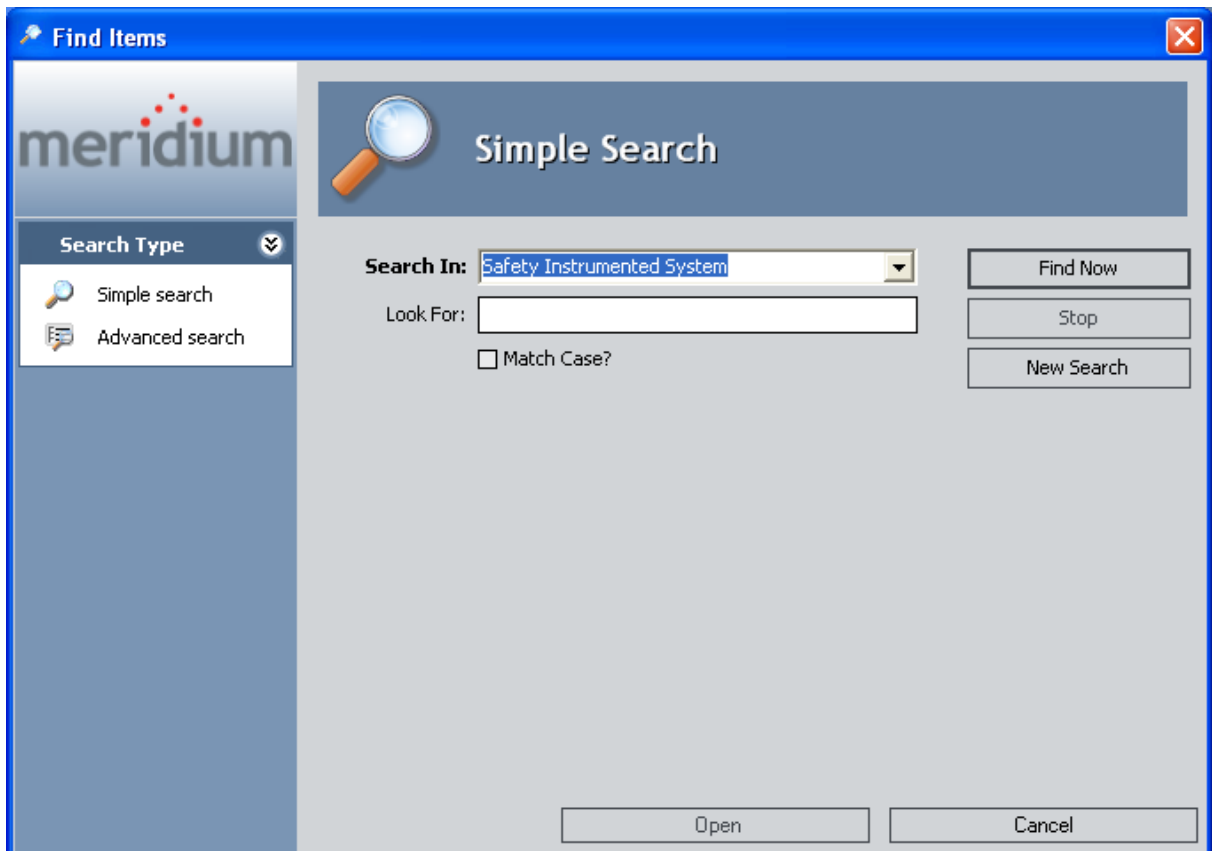

3. If desired, in the **Look For** text box, type the desired search criteria, and click the **Find Now** button.

The search results appear and contain only the Safety Instrumented System records that are not currently linked to an SIL Analysis.

4. In the search results, select the row containing the record that you want to add to the analysis.
5. Click the **Open** button.

The **Find Items** window closes, and the selected record is linked to the SIL Analysis record for the current SIL Analysis and appears in the **Safety Instrumented Systems** grid.

Copying Existing Safety Instrumented System Records

When you copy an existing Safety Instrumented System record, you are creating a new Safety Instrumented System record that will be populated with the values from the record that was copied. The new record will be linked automatically to the SIL Analysis record for the current SIL Analysis. That values in all the fields from a source record will be copied to the new record with the exception of the SIS ID field. Each Safety Instrumented System record should have a unique ID.

To copy a Safety Instrumented System record:

1. [Access the Safety Instrumented Systems page.](#)
2. In the **Safety Instrumented Systems** grid, select the row containing the Safety Instrumented System record that you want to copy.
3. At the bottom of the **Safety Instrumented Systems** workspace, click the **Copy System** button.

A new Safety Instrumented System record appears in a new window and is populated automatically with values from the currently selected record with the exception of the SIS ID field.

4. In the SIS ID field, type a unique name for the safety instrumented system.
5. Modify the values in the remaining fields as desired, and then click **OK**.

The record window closes, and the new record is linked to the SIL Analysis record for the current SIL Analysis and appears in the **Safety Instrumented Systems** grid.

Modifying Safety Instrumented System Records

To modify a Safety Instrumented System record:

1. [Access the Safety Instrumented Systems page.](#)
2. In the **Safety Instrumented Systems** grid, locate the Safety Instrumented System record that you want to modify.
3. In the **System ID** cell, click the hyperlinked Record ID of that record.
The selected record appears in a new window.
4. Modify the values in the fields as desired, and then click **OK**.
Your changes are saved.

Removing Safety Instrumented System Records from the SIL Analysis

When you remove a Safety Instrumented System record from the SIL Analysis, you are deleting the link between the Safety Instrumented System record and the SIL Analysis record for the current SIL Analysis.

To remove a Safety Instrumented System record from the SIL Analysis:

1. [Access the Safety Instrumented Systems page.](#)
2. In the **Safety Instrumented Systems** grid, select the row containing the Safety Instrumented System record that you want to remove from the analysis.
3. At the bottom of the **Safety Instrumented Systems** grid, click the **Remove System** button.

A confirmation message appears, asking if you really want to remove the Safety Instrumented System record from the analysis.

4. Click **OK**.

The link between the selected record and the SIL Analysis record for the current analysis is deleted, and the record is removed from the **Safety Instrumented Systems** grid.

About Instrumented Function Records

Instrumented Function records store details about the specific functions that exist within a safety instrumented system. An instrumented function is a specific need required of a safety instrumented system to monitor the conditions of a process. For each instrumented function defined for a safety instrumented system, one protective instrument loop (PIL) will exist to satisfy that need. A protective instrument loop consists of interconnected safety instruments that monitor aspects of a process and take readings on its condition. You should create one Instrumented Function record per instrumented function on an SIS. An instrumented function may be associated with a particular equipment or location within the process that the SIS exists to safeguard.

When you create an Instrumented Function record, it will be linked automatically to the SIL Analysis record for the current analysis. When you [define the Instrumented Function record](#), in addition to details about the instrumented function, you can specify the:

- Safety Instrumented System record to which the Instrumented Function record is linked.
- Equipment and Functional Location record to which the Instrumented Function record is linked.
- [SIF Common Cause Failure records that are linked to the Instrumented Function record](#).
- [Hazardous events that may occur if the safe state associated with the current instrumented function occurs at the same time as the safe state associated with a different instrumented function](#).

You can add Instrumented Function records to the SIL Analysis using the following methods:

- [Create a new one](#).
- [Add an existing one](#).
- [Copy an existing one and automatically create a new one](#).

After you have defined the desired Instrumented Function records, you can [assess the risk associated with an instrumented function](#) and [define the protective instrument loop](#) that exists for an instrumented function.

Accessing the Instrumented Functions (IFs) Page

The Instrumented Functions (IFs) page lets you manage the Instrumented Function records that are linked to the SIL Analysis record for the current SIL Analysis.

To access the Instrumented Functions (IFs) page:

1. [Open the SIL Analysis record for the desired SIL Analysis.](#)
2. On the **Navigation** menu, click the **Functions** link.

The Instrumented Functions (IFs) page appears.

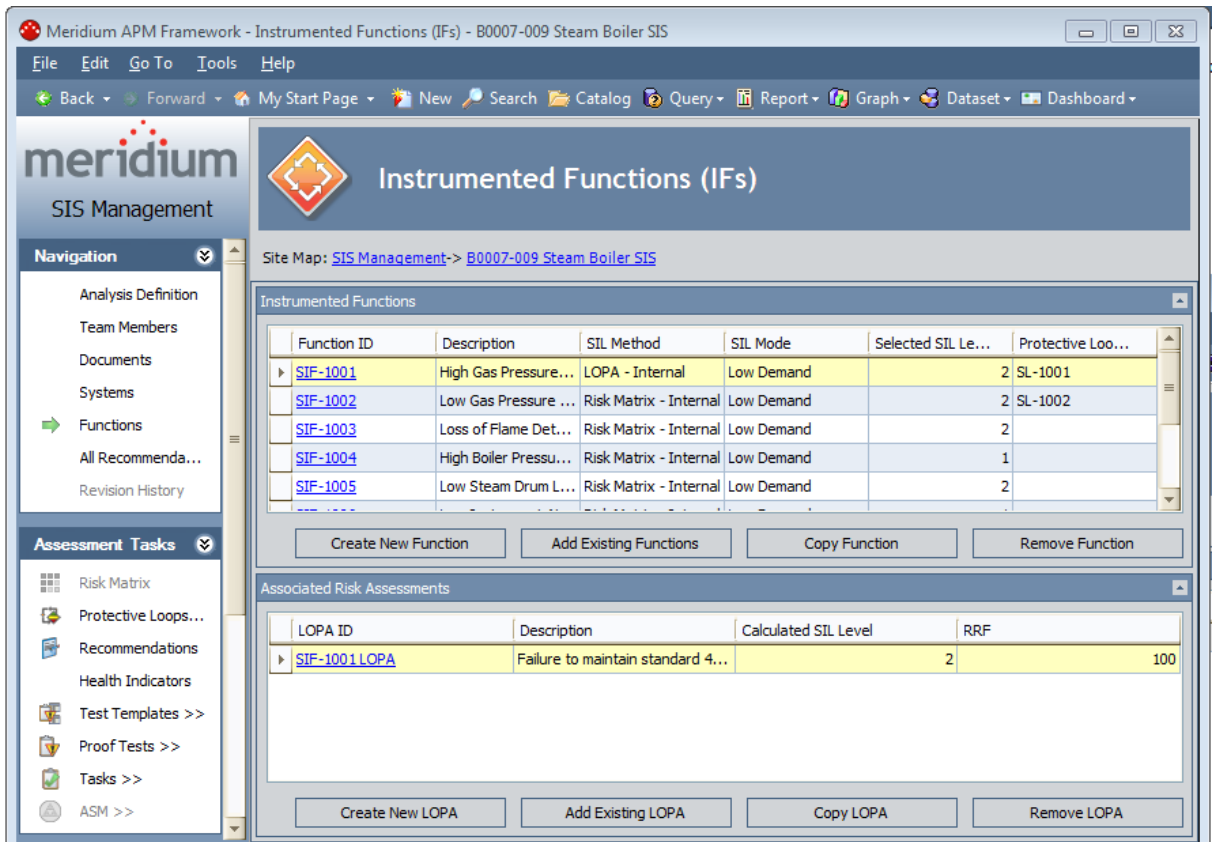

Aspects of the Instrumented Functions (IFs) Page

The **Instrumented Functions (IFs)** page contains the following sections:

- **Instrumented Functions:** Consists of a grid that contains a list of Instrumented Function records that are linked to the SIL Analysis record for the current SIL Analysis and options that you can use to manage those records. Each row in the grid corresponds to one Instrumented Function record. For each Instrumented Function record in the grid, the following information appears:
 - **Function ID:** The value that exists in the IF ID field in the Instrumented Function record. This value appears as a hyperlink, which you can click to view the contents of the Instrumented Function record.
 - **Description:** The value that exists in the IF Description field in the Instrumented Function record.
 - **SIL Method:** The value that exists in the SIL Assessment Method field in the Instrumented Function record.
 - **SIL Mode:** The value that appears in the SIL Mode field in the Instrumented Function record.
 - **Selected SIL Level:** The value that exists in the Selected SIL Level field in the Instrumented Function record. If the Selected SIL Level field is empty (i.e., an SIL Level has not been assessed), the **Selected SIL Level** cell will contain the value 0.
 - **Protective Loop ID:** The ID of the Protective Instrument Loop record that is linked to the Instrumented Function record. If more than one Protective Instrument Loop record is linked to the Instrumented Function, this field contains the ID of the Protective Instrument Loop record that is in the *Approved* state. If a Protective Instrument Loop record that is linked to the Instrumented Function record is not in an *Approved* state, this field contains the ID of the first Protective Instrument Loop record that is linked to the Instrumented Function record.

Below the grid, the following buttons appear:



- **Create New Function:** Displays a new blank Instrumented Function record in a new window.
- **Add Existing Functions:** Displays the **Find Items** window, where you can search for an existing Instrumented Function record to add to the SIL Analysis.
- **Copy Function:** Displays a new Instrumented Function record that is populated automatically with values from the source record. This button is enabled only when a record appears in the grid.
- **Remove Function:** Displays a confirmation message, and then removes the selected Instrumented Function record from the SIL Analysis. This button is enabled only when a record appears in the grid.

- **Associated Risk Assessments:** Consists of a grid that contains a list of [LOPA records](#) that are linked to the Instrumented Function record that is currently selected in the **Instrumented Functions** grid. Each row in the grid represents one LOPA record. For each LOPA record in the grid, the following information appears:
 - **LOPA ID:** The value that exists in the LOPA ID field in the LOPA record.
 - **Description:** The value that exists in the Description field in the LOPA record.
 - **Calculated SIL Level:** The value in the Calculated SIL field in the LOPA record.
 - **RRF:** The value that exists in the Required PIF Risk Reduction Factor field in the LOPA record.

Below the grid, the following buttons appear:

- **Create New LOPA:** Displays the **LOPA Definition** page, where you can create a LOPA record and conduct a Layer of Protection Analysis.
- **Add Existing LOPA:** Displays the **Find Items** window, where you can search for an existing LOPA record to link to the SIL Analysis.
- **Copy LOPA:** Displays on the **LOPA Definition** page a new LOPA record that is automatically populated with values from the currently selected LOPA record.
- **Remove LOPA:** Displays a confirmation message, and then removes the LOPA record from the SIL Analysis.

You can collapse and expand the **Instrumented Functions** and **Associated Risk Assessments** sections using the following buttons, which appear in the top right corner of the sections in turn:

-  : Indicates that the section is expanded. You can click this button to collapse the section.
-  : Indicates that the section is collapsed. You can click this button to expand the section.

The **Instrumented Functions (IFs)** page contains the following task menus:

- [Navigation](#)
- [Assessment Tasks](#)
- [Common Tasks](#)
- [Associated Pages](#)

Assessment Tasks

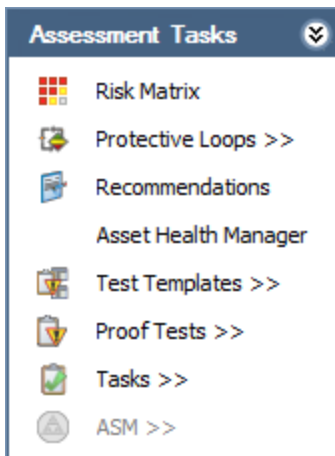

The **Assessment Tasks** menu on the **Instrumented Functions (IFs)** page contains the following links:

- **Risk Matrix:** Displays the Risk Assessment interface from which you can define the unmitigated risk for the selected Instrumented Function record.
- **Protective Loops:** Displays the **Protective Instrument Loop Diagram View** page, where you can manage Protective Instrument Loop records.
- **Recommendations:** Displays the **Recommendations** dialog box, where you can manage Risk Assessment Recommendations records for the selected Instrumented Function record.
- **Asset Health Manager:** Displays the **SIS - Asset Health Manager for <Instrumented Function Record ID> (Instrumented Function)** page, where you can manage the Health Indicator records for the selected Instrumented Function record.

Note: The integration between SIS Management and Asset Health Manager (AHM) is not documented.

- **Test Templates:** Displays a submenu with the following options:
 - **Create:** Displays the **Proof Test Template Definition** page, where you can create a new Proof Test Template record and link it to the selected Instrumented Function record.
 - **View:** Displays the **Proof Test Templates** page, where you can view a list of Proof Test Template records that are linked to the selected Instrumented Function record.
- **Proof Tests:** Displays a submenu with the following options:
 - **Create:** Displays the **Proof Test Definition** page, where you can create a new Proof Test record to link to the selected Instrumented Function record.
 - **View:** Displays the **Proof Tests** page, where you can view a list of Proof Test records that are linked to the selected Instrumented Function record.

- **Tasks:** Displays a submenu with the following options:
 - **Create:** Displays a new Inspection Task record that you can link to the selected Instrumented Function record.
 - **View:** Displays the **Task List** page, where you can view a list of Inspection Tasks records that are linked to the selected Instrumented Function record.
- **ASM:** Displays a submenu with the following options:
 - **Promote:** Promotes the Equipment or Functional Location record that is linked to the selected Instrumented Function record to an ASM and displays on the **ASM - Asset Strategy Overview** page the Asset Strategy for that record.
 - **View:** Displays the Asset Strategy for the Equipment or Functional Location record that is linked to the selected Instrumented Function record. This link is enabled only if that Equipment or Functional Location record has been promoted to ASM and has an existing Asset Strategy.

The **ASM** link is enabled only if the selected Instrumented Function record is linked to an Equipment or Functional Location record and a Risk Assessment record.

The **Assessment Tasks** menu appears on multiple pages throughout SIS Management. The links that are available to you will vary depending on where you are accessing the menu.

Common Tasks

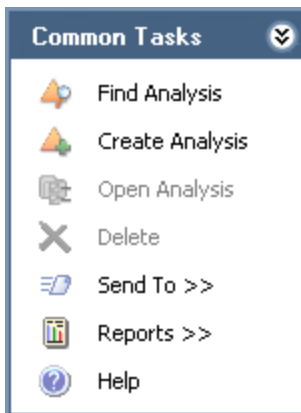

The **Common Tasks** menu on the **Instrumented Functions (IFs)** page contains the following links:

- **Find Analysis:** Displays the **SIL Analysis Search** page, where you can search for an existing SIL Analysis record.
- **Create Analysis:** Displays a new blank SIL Analysis record on the **SIL Analysis Definition** page.
- **Open Analysis:** This link is disabled.
- **Delete:** This link is disabled.
- **Send To:** Displays a submenu with options that let you provide a link to the current page on your desktop (create shortcut), in an email message, or on a Home Page.
- **Reports:** Displays a submenu that contains the captions of the following Catalog items as links:
 - **IF Report:** Displays in the Report Viewer the IF Report for the selected Instrumented Function record.
 - **IF Risk Matrix Result Report:** Displays in the Report Viewer the IF Risk Matrix Result Report for the selected Instrumented Function record.
- **Help:** Displays the context-sensitive help topic for the **Instrumented Functions (IFs)** page.

About Defining Instrumented Function Records

Instrumented Function records are defined via the **<Record ID> (Instrumented Function)** window, where **<Record ID>** is the value stored in the IF ID field in that record. The **<Record ID> (Instrumented Function)** window contains the following tabs:

- **[Instrumented Function](#)**: Displays the Instrumented Function datasheet, which is a custom form and contains fields that store information about the instrumented function that record represents.
- **[Safety Requirement Specification](#)**: Displays the Safety Requirement Specification datasheet, which is a custom form and contains fields that are used by the [Safety Requirement Specifications report](#).
- **[Common Cause Failures](#)**: Contains options you can use to manage the SIF Common Cause Failure records that are linked to Instrumented Function records.
- **[Concurrent Safe States](#)**: Contains options you can use to manage the other Instrumented Function records that are linked to the current Instrumented Function record and specify the hazardous event that can occur when the instrumented functions represented by those records are in safe states at the same time.

The following image shows what an Instrumented Function record looks like in the **<Record ID> (Instrumented Function)** window, where the **Instrumented Function** tab is selected by default.

About Defining Instrumented Function Records

SIF-1002 (Instrumented Function)

Instrumented Function | Safety Requirement Specification | Common Cause Failures | Concurrent Safe States

IF ID: SIF-1002 **Function Type:** Safety

IF Description: Low Gas Pressure Shutdown

Site ID: Roanoke, VA **Unit ID:**

SIS ID: Plant Utilities

Functional Location ID: MRD ~ Meridium International Production Company

Equipment ID: A0001-017 ~ 000000000001008994 MIXER - TANK 824 ~ Mixer ROT MIX MIX

Hazards Analysis Reference: B0007-009 Steam Boiler Analysis

SIL Assessment Method: Risk Matrix - Internal **SIL Mode:** Low Demand

Hazards Analysis Date: 2/17/2011 7:13:17 AM

Initiating Event: Loss of Air Flow

Initiating Event Description: Failed Blower

Frequency of Initiating Event (per yr): 0.3

Hazardous Event:

OK

Creating New Instrumented Function Records

When you create a new Instrumented Function record, it will be linked automatically to the SIL Analysis record for the current SIL Analysis.

To create a new Instrumented Function record:

1. [Access the Instrumented Functions \(IFs\) page.](#)
2. In the **Instrumented Functions** section, below the grid, click the **Create New Function** button.

A new blank Instrumented Function record appears in the **<Record ID> (Instrumented Function)** window, and the **Instrumented Function** tab is selected by default.

The screenshot shows a software window titled "(Instrumented Function)". The window has a tabbed interface with four tabs: "Instrumented Function" (selected), "Safety Requirement Specification", "Common Cause Failures", and "Concurrent Safe States". The main area contains the following fields:

- IF ID:** A redacted field.
- Function Type:** A dropdown menu set to "Safety".
- IF Description:** A text input field.
- Site ID:** A text input field.
- Unit ID:** A text input field.
- SIS ID:** A dropdown menu.
- Functional Location ID:** A text input field with a browse button (...).
- Equipment ID:** A text input field with a browse button (...).
- Hazards Analysis Reference:** A text input field with a browse button (...).
- SIL Assessment Method:** A dropdown menu set to "Risk Matrix - Internal".
- SIL Mode:** A dropdown menu set to "Low Demand".
- Hazards Analysis Date:** A date selection dropdown.
- Initiating Event:** A text input field.
- Initiating Event Description:** A text input field with a browse button (...).
- Frequency of Initiating Event (per yr):** A text input field.
- Hazardous Event:** A text input field.
- Consequence Description:** A text input field with a browse button (...).
- Safe State Description:** A text input field with a browse button (...).
- Process Speed:** A text input field followed by "Seconds".
- Response Time:** A text input field followed by "Seconds".

An "OK" button is located at the bottom right of the window.

3. In the **IF ID** text box, type a unique name for the instrumented function. This field is required.
4. Provide values in the [remaining fields](#) as desired.
5. Click the **Safety Requirement Specification** tab, and then provide values in the fields as desired.
6. Click the **Common Cause Failures** tab, and [define the common cause failures associated with the instrumented function](#).
7. Click the **Concurrent Safe States** tab, and [define the concurrent safe state hazards associated with the instrumented function](#).
8. Click **OK**.

The window closes, and the record is linked to the SIL Analysis record for the current analysis and appears in the **Instrumented Functions** grid.

About the Instrumented Function Tab

The **Instrumented Function** tab on the <Record ID> (**Instrumented Function**) window displays the Instrumented Function datasheet, which is the default datasheet for the Instrumented Function family. This datasheet is a custom form and contains [fields that are used to define the instrumented function that the record represents](#).

The following image shows what the **Instrumented Function** tab looks like in the <Record ID> (**Instrumented Function**) window.

The screenshot shows a software window titled "SIF-1002 (Instrumented Function)". The window has a title bar with standard minimize, maximize, and close buttons. Below the title bar is a header area with the text "SIF-1002 (Instrumented Function)". Underneath the header is a tabbed interface with four tabs: "Instrumented Function" (which is selected), "Safety Requirement Specification", "Common Cause Failures", and "Concurrent Safe States". The main content area is a form with the following fields:

- IF ID:** SIF-1002
- Function Type:** Safety (dropdown menu)
- IF Description:** Low Gas Pressure Shutdown
- Site ID:** Roanoke, VA
- Unit ID:** (empty text box)
- SIS ID:** Plant Utilities (dropdown menu)
- Functional Location ID:** MRD ~ Meridium International Production Company (text box with ellipsis)
- Equipment ID:** A0001-017 ~ 000000000001008994 MIXER - TANK 824 ~ Mixer ROT MIX MIX (text box with ellipsis)
- Hazards Analysis Reference:** B0007-009 Steam Boiler Analysis (text box with ellipsis)
- SIL Assessment Method:** Risk Matrix - Internal (dropdown menu)
- SIL Mode:** Low Demand (dropdown menu)
- Hazards Analysis Date:** 2/17/2011 7:13:17 AM (dropdown menu)
- Initiating Event:** Loss of Air Flow
- Initiating Event Description:** Failed Blower (text box with dropdown arrows and ellipsis)
- Frequency of Initiating Event (per yr):** 0.3
- Hazardous Event:** (empty text box)

An "OK" button is located at the bottom right of the window.

About The Safety Requirement Specification Tab

The **Safety Requirement Specification** tab on the <Record ID> (Instrumented Function) window displays the Safety Requirement Specification datasheet, which is a custom form that [contains fields that store information that is used by the Safety Requirement Specification report](#).

The following image shows what the **Safety Requirement Specification** tab looks like on the <Record ID> (Instrumented Function) window.

The screenshot displays a software window titled "SIF-1003 (Instrumented Function)". The window has a title bar with standard minimize, maximize, and close buttons. Below the title bar is a dark blue header with the text "SIF-1003 (Instrumented Function)". The main content area is divided into four tabs: "Instrumented Function", "Safety Requirement Specification", "Common Cause Failures", and "Concurrent Safe States". The "Safety Requirement Specification" tab is currently selected and active. It contains a form with the following fields and values:

- Operation Modes: NORMAL
- Abnormal States: (empty)
- Operation Mode Description: (empty)
- Required SIF Action: (empty)
- Demand Rate(Source): Low Demand
- Trip Mode: de-energize to trip
- Min Process Variable: (empty) Max Process Variable: (empty)
- Pre Alarm: (empty) Trip Point: (empty)
- UOM: (empty)
- Process Service Description: (empty)
- I/O Functional Relationship Details: (empty)
- Startup And Restart Procedure: Startup and restart procedures as specified by project requirements will be followed.
- Normal Operation Mode: SIF will be in Normal Operating mode when it's performing as per design.
- Maintenance and Test Requirements: Follow prescribed maintenance procedures at defined proof test interval. Contractor to
- Reset Requirement: Good engineering practice entails that trips will be reset by manual action. Trips cannot
- Survival Requirement: The ability of devices to survive a major accident event like a fire or an earthquake,
- Operator Interface Requirement: The Operator Interface shall be required to perform all specifications mentioned in the

An "OK" button is located at the bottom right of the window.

About SIF Common Cause Failure Records

SIF Common Cause Failure records store details about a failure or a condition within a plant that can affect the operation of multiple instrumented functions. Throughout this documentation, we refer to these items as *common cause failures*. SIF Common Cause Failure records must be linked to at least two Instrumented Function records. In other words, for every SIF Common Cause Failure record, there will be at least two Instrumented Function records that represent the instrumented functions that are affected by the common cause failure defined in the SIF Common Cause Failure record.

For example, incorrect maintenance of sensors can affect multiple instrumented functions. In this case, you would first create an SIF Common Cause Failure record to document incorrect maintenance of sensors as a common cause failure and then link that SIF Common Cause Failure record to the Instrumented Function records representing the instrumented functions that would be affected by the incorrect sensor maintenance.

You can manage SIF Common Cause Failure records via the [Common Cause Failures tab](#) on the <Record ID> (Instrumented Function) window for an Instrumented Function record. Using the **Common Cause Failures** tab, you can specify the common cause failures that exist for the current instrumented function and other instrumented functions that are defined in the Meridium APM database. More specifically, to define a common cause failure, you will need to:

- [Link SIF Common Cause Failure records to the current Instrumented Function record.](#)
- [Link additional Instrumented Function records to those SIF Common Cause Failure records.](#)

The following illustration shows the records that will exist for a given common cause failure scenario.

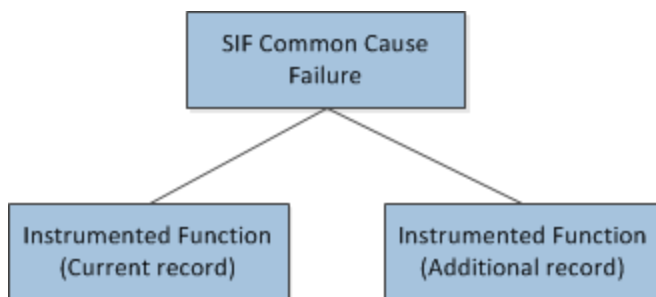

When you are working with records in the SIF Common Cause Failure and Instrumented Function families, it is helpful to refer to the [SIS Management data model in which the Instrumented Function family is the predecessor family](#).

The following image shows what the **Common Cause Failures** tab looks like on the <Record ID> (Instrument Function) window.

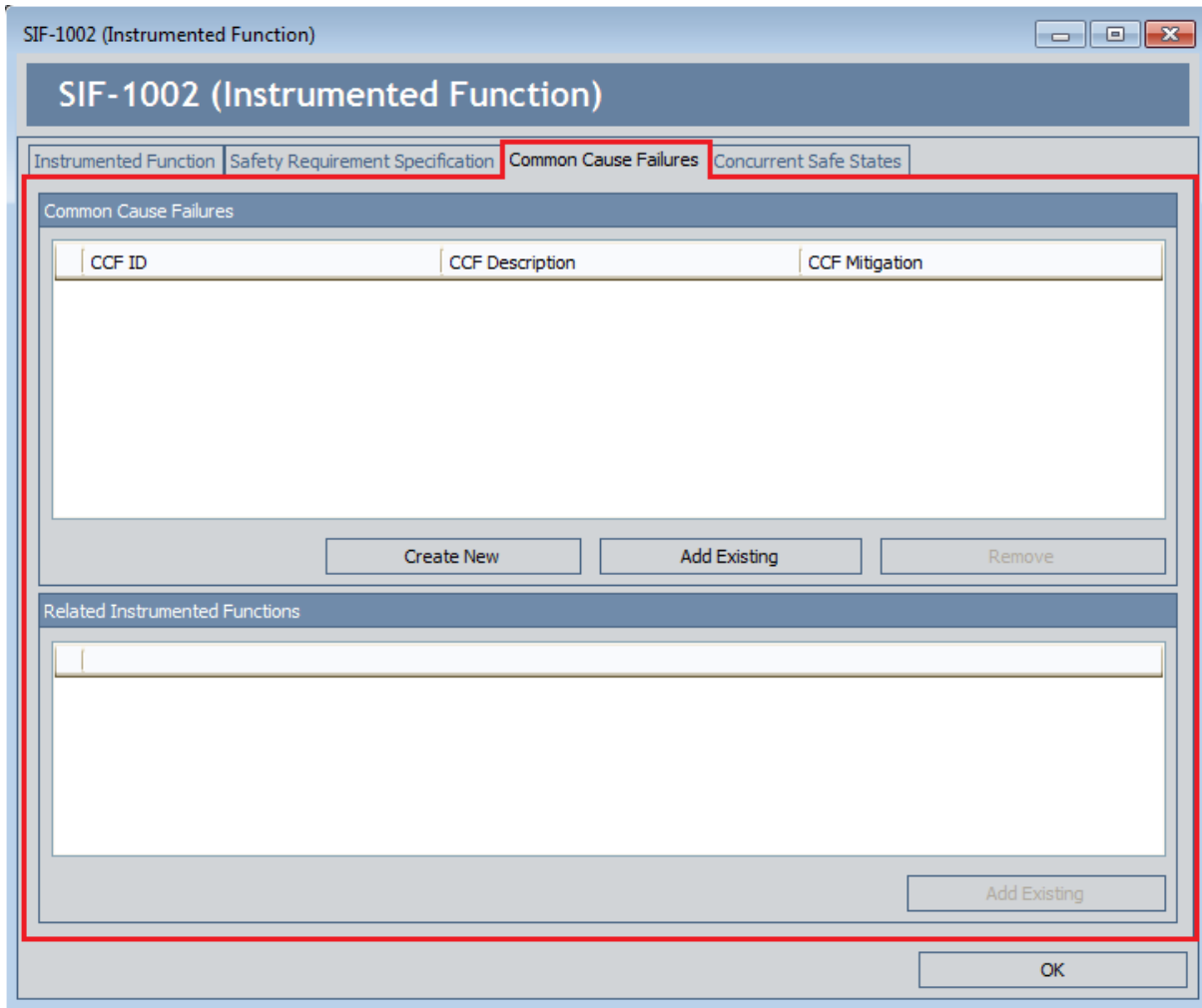

Aspects of the Common Cause Failures Tab

The **Common Cause Failures** tab on the <Record ID> (Instrumented Function) window contains the following sections:

- **Common Cause Failures:** Contains a grid that displays the SIF Common Cause Failure records that are linked to the current Instrumented Function record and the additional Instrumented Function records that appear in the **Related Instrumented Function** grid. Each row in the **Common Cause Failures** grid represents one SIF Common Cause Failure record. For each SIF Common Cause Failure record, the following values that are stored in the corresponding SIF Common Cause Failure record are displayed:
 - **CCF ID:** An ID for the common cause failure. This value appears as a hyperlink, which you can click to view the contents of the corresponding SIF Common Cause Failure record in a new window.
 - **CCF Description:** A description of the common cause failure.
 - **CCF Mitigation:** A description of the way(s) in which you can mitigate the occurrence of the effect of the common cause failure.

Below the grid, the following buttons appear:

- **Create New:** Displays a new SIF Common Cause Failure record in a new window, where you can define a common cause failure and automatically link the SIF Common Cause Failure record to the current Instrumented Function record. After you create an SIF Common Cause Failure record, a new row will appear in the **Related Instrumented Functions** grid to represent the current Instrumented Function, and a message will appear in that section, indicating that you must link at least one more Instrumented Function record to the SIF Common Cause Failure record.
 - **Add Existing:** Displays the **Find Items** window, where you can search for an existing SIF Common Cause Failure record and link it to the current Instrumented Function record. After you link an existing SIF Common Cause Failure record to the Instrumented Function record, a new row will appear in the **Related Instrumented Functions** grid to represent the current Instrumented Function record, and a message will appear in that section, indicating that you must link at least one more Instrumented Function record to the SIF Common Cause Failure record.
 - **Remove:** After displaying a confirmation message, deletes the link between the SIF Common Cause Failure record and the *current* Instrumented Function record. If the SIF Common Cause Failure record is linked to an Instrumented Function record other than the current one, that link will not be removed. This button is disabled until at least one SIF Common Cause Failure record appears in the grid.
- **Related Instrumented Functions:** Contains a grid that displays Instrumented Function records, if at least one SIF Common Cause Failure record appears in the **Common Cause Failures** grid. Specifically, the rows in the **Related Instrumented Functions** grid contain the:

- Current Instrumented Function record. This record always appears in the *first* row.
- Additional Instrumented Function records that are linked to the SIF Common Cause Failure record that is selected in the **Common Cause Failures** grid.

Below the grid, the **Add Existing** button appears, which displays the **Find Items** window, where you can search for an existing Instrumented Function record that you want to link to the selected SIF Common Cause Failure record.

The following image shows what the **Common Cause Failures** tab looks like when ONE SIF Common Cause Failure record is linked to the current Instrumented Function record and two additional Instrumented Function records.

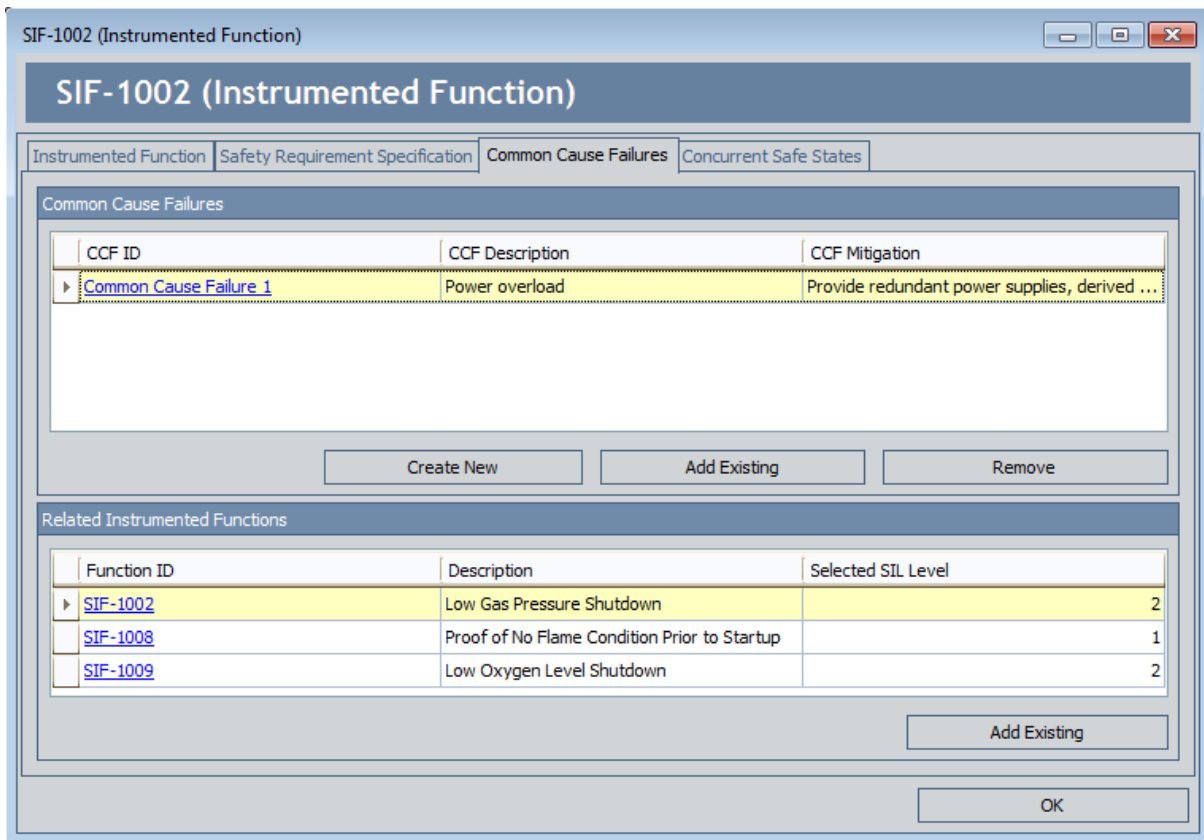

Creating New Common Cause Failure Records

When you create a new SIF Common Cause Failure record, it will be linked automatically to the Instrumented Function record with which you are currently working.

To create a new SIF Common Cause Failure record:

1. [Open the Instrumented Function record](#) to which you want to link a new SIF Common Cause Failure record.
2. Click the **Common Cause Failures** tab.

The **Common Cause Failures** tab appears.

The screenshot shows a software window titled "SIF-1002 (Instrumented Function)". The window has a title bar with standard minimize, maximize, and close buttons. Below the title bar is a header area with the text "SIF-1002 (Instrumented Function)". Underneath the header is a tabbed interface with four tabs: "Instrumented Function", "Safety Requirement Specification", "Common Cause Failures", and "Concurrent Safe States". The "Common Cause Failures" tab is currently selected. This tab contains a table with three columns: "CCF ID", "CCF Description", and "CCF Mitigation". The table is currently empty. Below the table are three buttons: "Create New", "Add Existing", and "Remove". At the bottom of the window, there is a section titled "Related Instrumented Functions" which contains an empty list box and an "Add Existing" button. At the very bottom of the window is an "OK" button.

3. In the **Common Cause Failures** section, click the **Create New** button.
A new SIF Common Cause Failures record appears in a new window.

<empty> (new SIF Common Cause Failure)

Datasheet: SIF Common Cause Failures

CCF ID: [Redacted]

CCF Description: [Redacted]

CCF Mitigation: [Redacted]

OK Cancel

4. Provide values in the fields as desired. *All* the fields are required.
5. Click **OK**.

The SIF Common Cause Failures record closes, and the following rows are added to the **Common Cause Failures** tab:

- One row in the **Common Cause Failures** section that represents the SIF Common Cause Failure record.
- One row in the **Related Instrumented Functions** section that represents the current Instrumented Function record.

In addition, a message appears, indicating that you must link at least one more Instrumented Function record to the SIF Common Cause Failure record. The following image shows an example of how the **Common Cause Failures** tab appears after you create a new SIF Common Cause Failure record.

SIF-1002 (Instrumented Function)

SIF- 1002 (Instrumented Function)

Instrumented Function | Safety Requirement Specification | **Common Cause Failures** | Concurrent Safe States

Common Cause Failures

CCF ID	CCF Description	CCF Mitigation
New CCF	CCF Description	Mitigation description for this CCF

Create New | Add Existing | Remove

Related Instrumented Functions

You must add at least one additional Instrumented Function record.

Function ID	Description	Selected SIL Level
SIF-1002	Low Gas Pressure Shutdown	2

Add Existing

OK

6. [Link the additional Instrumented Function record\(s\) to the SIF Common Cause Failure record.](#)

7. Click **OK**.

The Instrumented Function record closes, and your changes are saved.

Linking Existing SIF Common Cause Failure Records to Instrumented Function Records

To link an existing SIF Common Cause Failure record to an Instrumented Function record:

1. [Open the Instrumented Function record](#) to which you want to link an existing SIF Common Cause Failure record.
2. Click the **Common Cause Failures** tab.

The **Common Cause Failures** tab appears.

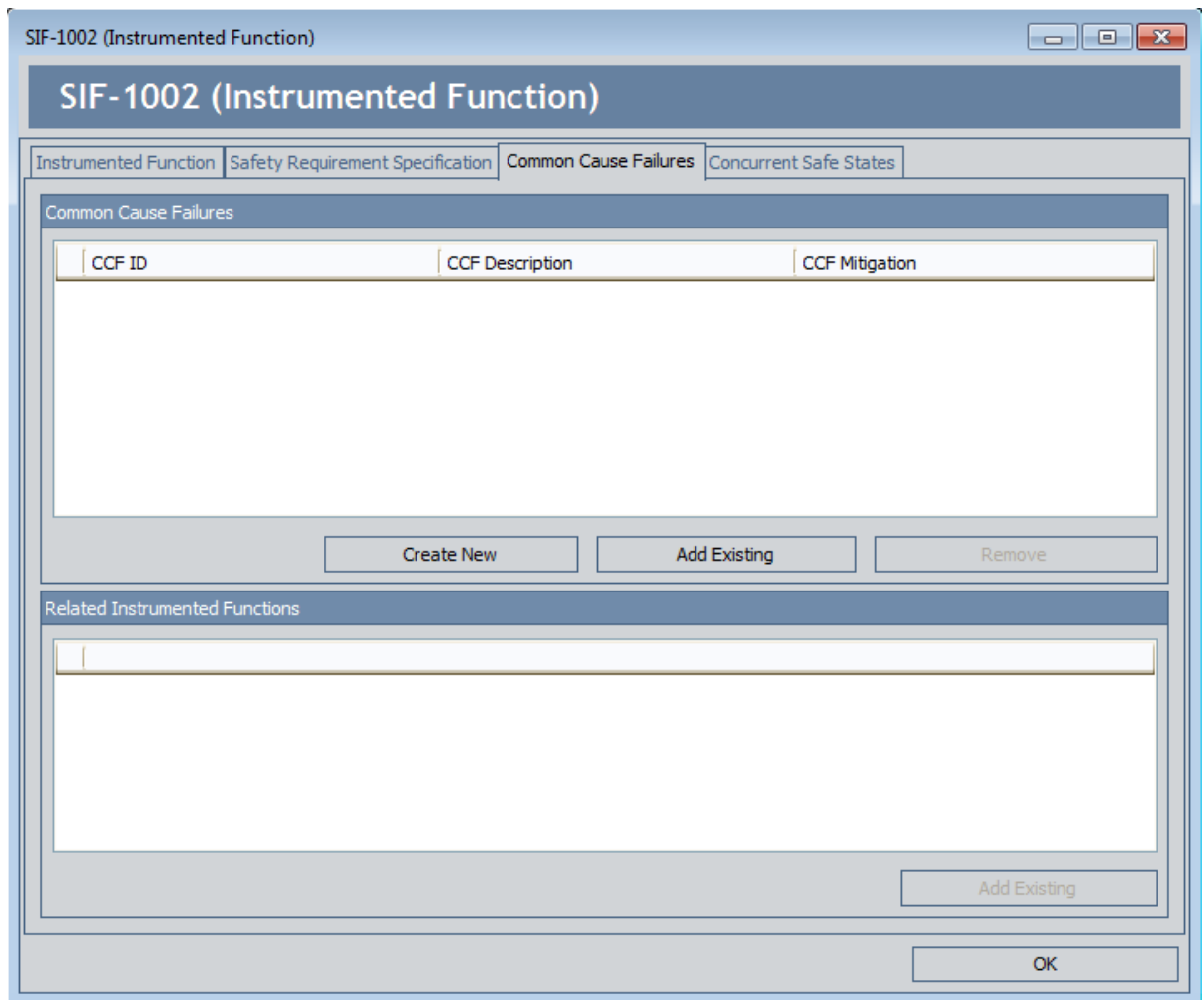

3. In the **Common Cause Failures** section, click the **Add Existing** button.

The **Find Items** window appears.

4. Perform a search for the desired SIF Common Cause Failure record.
5. In the search results, select the row containing the SIF Common Cause Failure record that you want to link to the current Instrumented Function record, and then click the **Open** button.

The **Find Items** window closes, and the following rows are added to the **Common Cause Failures** tab:

- One row in the **Common Cause Failures** section that represents the SIF Common Cause Failure record that you selected.
- One row in the **Related Instrumented Functions** section that represents the current Instrumented Function record.

In addition, a message appears, indicating that you must link at least one more Instrumented Function record to the SIF Common Cause Failure record. The following image shows an example of how the **Common Cause Failures** tab appears after you link an existing SIF Common Cause Failure record to an Instrumented Function record.

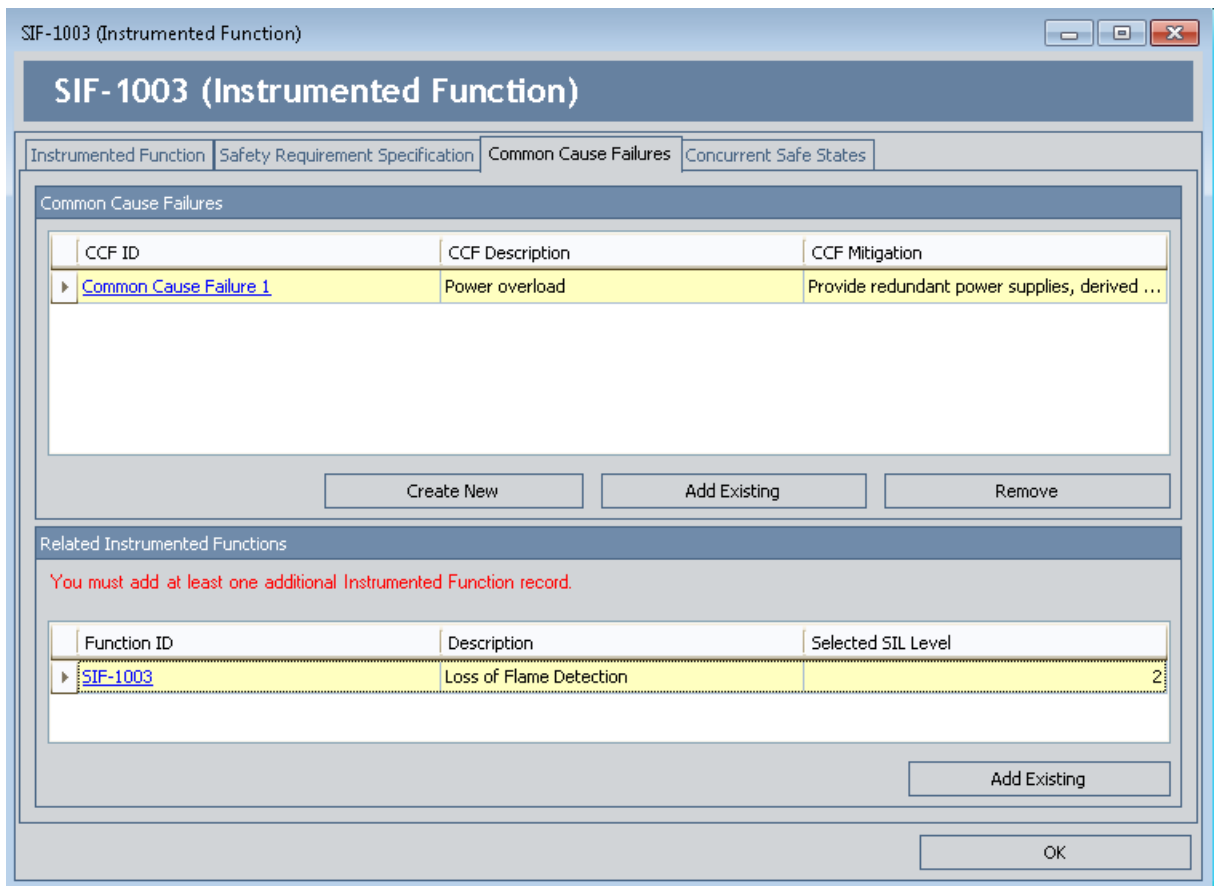

6. [Link the additional Instrumented Function record\(s\) to the SIF Common Cause Failure record.](#)
7. Click **OK**.

The Instrumented Function record closes, and your changes are saved.

Linking Additional Instrumented Function Records to an SIF Common Cause Failure Record

The following instructions assume that you are viewing the [Common Cause Failures tab in an Instrumented Function record](#) that is linked to at least one SIF Common Cause Failure record.

To link an additional Instrumented Function record to an SIF Common Cause Failure record:

1. In the **Common Cause Failures** section, select the row containing the SIF Common Cause Failure record that you want to link to an additional Instrumented Function record.

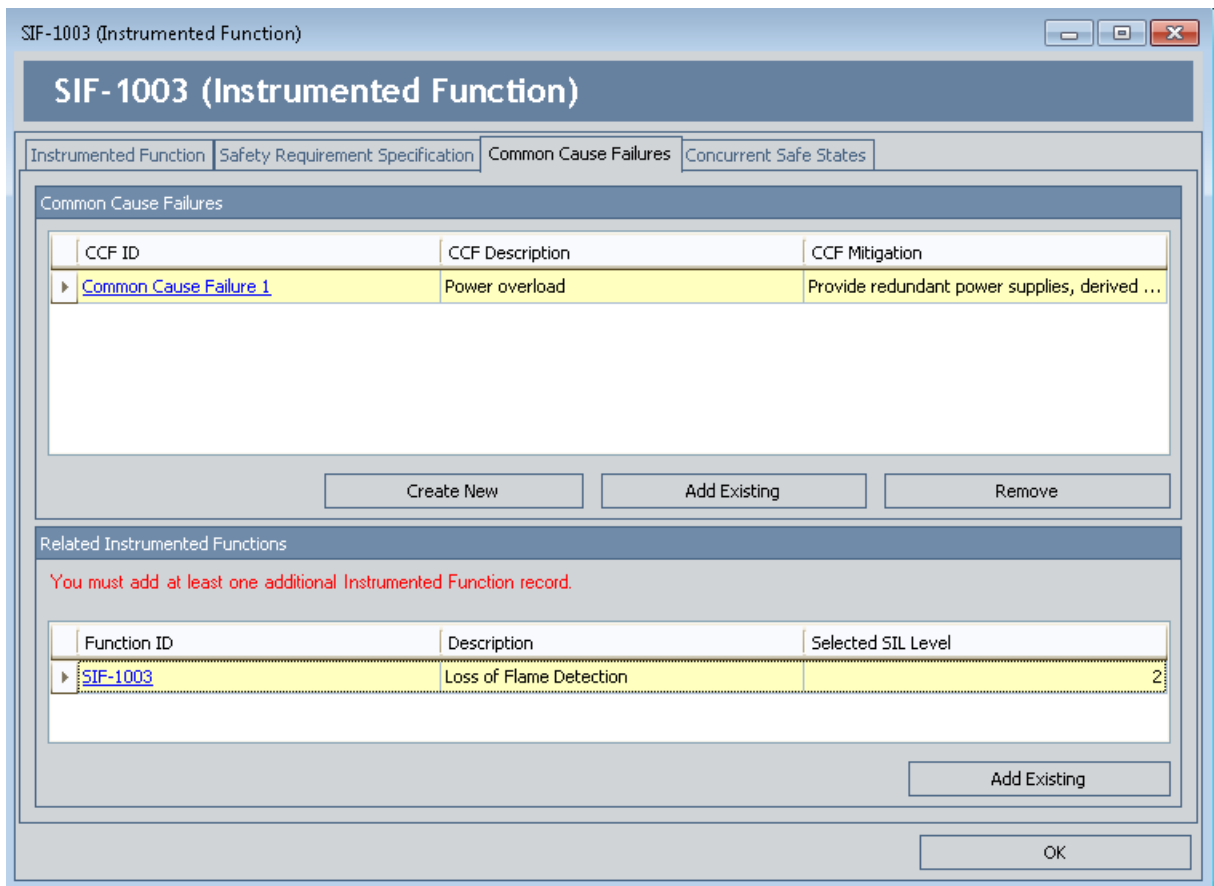

2. In the **Related Instrumented Functions** section, click the **Add Existing** button.
The **Find Items** window appears.
3. Perform a search for the desired Instrumented Function record.
4. In the search results, select the row containing the Instrumented Function record

that you want to link to the SIF Common Cause Failure record, and then click the **Open** button.

The **Find Items** window closes, and the Instrumented Function record appears in a new row in the **Related Instrumented Functions** grid.

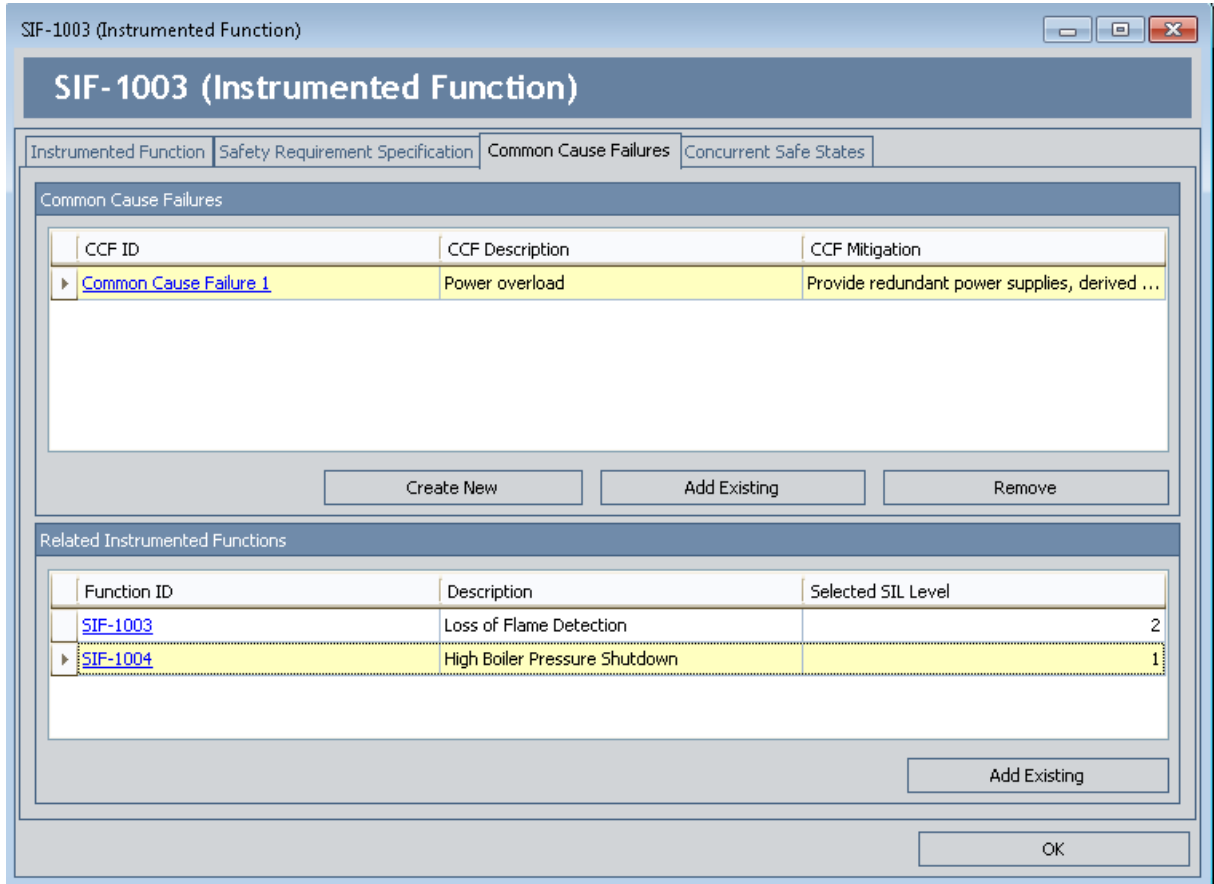

5. Click **OK**.

The Instrumented Function record closes, and your changes are saved. Note that if you view the **Common Cause Failures** tab in the Instrumented Function record that you just added, the SIF Common Cause Failure record will be displayed in the **Common Cause Failures** grid.

Removing SIF Common Cause Failure Records from an Instrumented Function Record

The following instructions provide details on removing an SIF Common Cause Failure record from an Instrumented Function record. When you do so, you are deleting the link between the SIF Common Cause Failure record and the Instrumented Function record.

These instructions assume that you are viewing the [Common Cause Failures tab on the <Record ID> \(Instrumented Function\) window](#) for an Instrumented Function record that is linked to at least one SIF Common Cause Failure record.

To remove an SIF Common Cause Failure record from an Instrumented Function record:

1. In the **Common Cause Failures** section, select the row containing the SIF Common Cause Failure record that you want to remove.

2. Click the **Remove** button.

A confirmation message appears, asking if you really want to remove the SIF Common Cause Failure record from the Instrumented Function record.

3. Click the **Yes** button.

The link between the SIF Common Cause Failure record and the Instrumented Function record is deleted, and the rows in the sections are updated in the following ways:

- The SIF Common Cause Failure record is removed from the **Common Cause Failures** grid.
- The Instrumented Function record(s) that appeared in the **Related Instrumented Functions** section are removed from the grid.

4. Click **OK**.

Your changes are saved, and the Instrumented Function record closes.

About Concurrent Safe State Hazards and Instrumented Function Records

When you [define an Instrumented Function record](#), you will define the *safe state* to the instrumented function is responsible for taking the process in the event that the process is in an unsafe state. In other words, if a given process is approaching an unsafe condition, the instrumented function that monitors that process will take the process to a condition that is specified as the safe for that process. For example, if the temperature reaches an unsafe level, the cooling system will be triggered to bring down the temperature to a safe state.

In some cases, if a given process is in its associated safe state at the same time as a different process, while the individual processes are in a safe state, the combination of these conditions could trigger a hazardous event. For example, assume that to reach a safe state in a Flare system, the steam valve needs to vent. Now assume that two steam valves need to vent at the same time. In this case, the Flare system can become overloaded due to both processes reaching their safe states concurrently.

In Meridium APM, the combinations of safe states that can lead to hazardous events are referred to as *concurrent safe state hazards*. You can document the concurrent safe state hazards that exist for instrumented functions via the Instrumented Function record representing that instrumented function. In other words, for each instrumented function that participates in a potentially hazardous relationship, you will need to define the concurrent safe state hazard(s) for that instrumented function.

The **Concurrent Safe States** tab in the <Record ID> (Instrumented Function) window allows you manage all the concurrent safe state hazards that exist for an instrumented function. To define concurrent safe state hazards for an instrumented function, you will need to:

- Link the Instrumented Function record to the other Instrumented Function record representing the instrumented function whose concurrent safe state can cause a hazard. Instrumented Function records can be linked to one or more other Instrumented Function records through the Has Hazardous Event relationship.
- Describe the hazardous event that can occur when the safe state conditions occur concurrently. Because some instrumented functions can participate in multiple concurrent safe state scenarios, in each Instrumented Function record, you will need to describe the hazardous events that are associated with that instrumented function. In other words, describing the hazardous event in one Instrumented Function record will not automatically populate the linked Instrumented Function record with the same description. You will need to open the linked Instrumented Function record and enter the description of the concurrent safe state hazard.

The following image illustrates the records that participate in a concurrent safe state scenario in which the combination of three concurrent safe states can lead to a hazardous event.

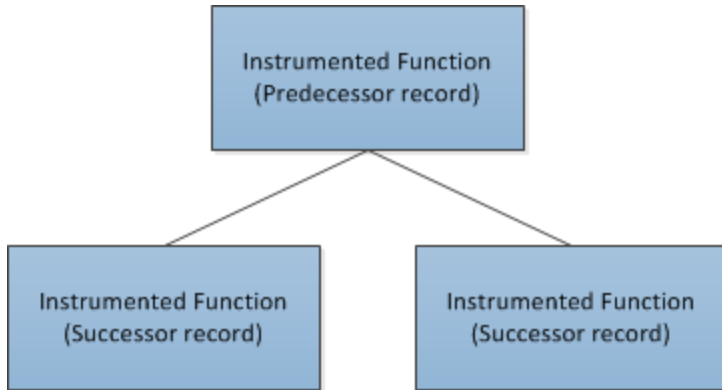

Notice that the Instrumented Function record to which you link other Instrumented Function records is the predecessor in the relationship. When you are working with Instrumented Function records, it is helpful to refer to the [SIS Management data model image in which the Instrumented Function family is the predecessor family](#).

The following image shows what the **Concurrent Safe States** tab looks like in the **<Record ID> (Instrumented Function)** window.

PIF-1001 (Instrumented Function)

Instrumented Function | Safety Requirement Specification | Common Cause Failures | **Concurrent Safe States**

Hazard for Concurrent Safe States?

Individual Safe State Detail

Function ID	Description	Safe States
-------------	-------------	-------------

Add Existing Remove

Potential Concurrent Safe State Hazard

OK

Aspects of the Concurrent Safe States Tab in Instrumented Function Records

The **Concurrent Safe States** tab in the <Record ID> (Instrumented Function) window contains the **Hazard for Concurrent Safe States?** check box, which indicates whether the instrumented function represented by the current Instrumented Function record is associated with any hazards that result from safe states that occur simultaneously. When the **Hazard for Concurrent Safe States?** check box is:

- *Selected*, the remaining options on the **Concurrent Safe States** tab are *enabled*, and a message appears indicating that you must link at least one Instrumented Function record to the current Instrumented Function record. The additional Instrumented Function record represents the instrumented function whose safe state can lead to a hazardous event if it occurs simultaneously with the safe state for the current instrumented function. After you link at least one Instrumented Function record to the current Instrumented Function record, the message is hidden.
- *Cleared*, the remaining options on the **Concurrent Safe States** tab are *disabled*. This indicates that the instrumented function represented by the current Instrumented Function record is not associated with any concurrent safe state hazards.

After at least one Instrumented Function record is linked to the current Instrumented Function record, the **Hazard for Concurrent Safe States?** check box is disabled.

In addition, you can clear this check box only if the **Individual Safe State Detail** grid is empty (i.e., there are no concurrent safe state hazards associated with the instrumented function).

Below the **Hazard for Concurrent Safe States?** check box, the following sections appear:

- **Individual Safe State Detail:** Contains a grid that displays the list of Instrumented Function records that are linked to the current Instrumented Function record. Each row in the grid represents one instrumented function whose safe state can lead to a hazardous event if it occurs simultaneously with the safe state of the current instrumented function. The following [information is displayed for each Instrumented Function record](#) that appears in the grid:
 - **Function ID:** The ID for the instrumented function that is stored in the IF ID field in the corresponding Instrumented Function record. This value appears as a hyperlink, which you can click to view the contents of the corresponding Instrumented Function record.
 - **Description:** The description of the instrumented function that is stored in the IF Description field in the corresponding Instrumented Function record.
 - **Safe States:** The description of the safe state that is associated with the instrumented function, which is stored in the Safe State Description field in the corresponding Instrumented Function record.

Below the grid, the following buttons appear:

- **Add Existing:** Displays the **Find Items** window, which you can use to search for an existing Instrumented Function record and link it to the current Instrumented Function record. After you link an Instrumented Function record to the current Instrumented Function record, a new row will appear in the **Individual Safe State Detail** grid to represent that instrumented function.
- **Remove:** After displaying a confirmation message, deletes the link between the selected Instrumented Function record and the current Instrumented Function record and removes the instrumented function from the grid. This button is disabled until at least one Instrumented Function record appears in the **Individual Safe State Detail** grid.
- **Potential Concurrent Safe State Hazard:** Contains a field, which stores the description for the concurrent safe state hazards that are associated with the current instrumented function. This field is required. If the current instrumented function is associated with multiple concurrent safe state hazards, you should provide a description in this field for each of these hazards.

Defining Concurrent Safe State Hazards for Instrumented Functions

To define a concurrent safe state hazard for instrumented functions, you will need to:

- Link to one another the Instrumented Function records whose associated safe states can cause a hazardous event when they occurs simultaneously.
- Describe in each of the Instrumented Function records the hazardous event that can occur if the safe states associated with the instrumented functions occur simultaneously.

To define a concurrent safe state hazard for an instrumented function:

1. [Open the Instrumented Function record](#) for which you want to define a concurrent safe state.
2. Click the **Concurrent Safe States** tab.

The **Concurrent Safe States** tab appears.

PIF-1001 (Instrumented Function)

PIF-1001 (Instrumented Function)

Instrumented Function | Safety Requirement Specification | Common Cause Failures | **Concurrent Safe States**

Hazard for Concurrent Safe States?

Individual Safe State Detail

Function ID	Description	Safe States
-------------	-------------	-------------

Add Existing Remove

Potential Concurrent Safe State Hazard

OK

3. Select the **Hazard for Concurrent Safe States?** check box.

The remaining options are enabled, and a message appears, indicating that you must link at least one Instrumented Function record to the current Instrumented Function record.

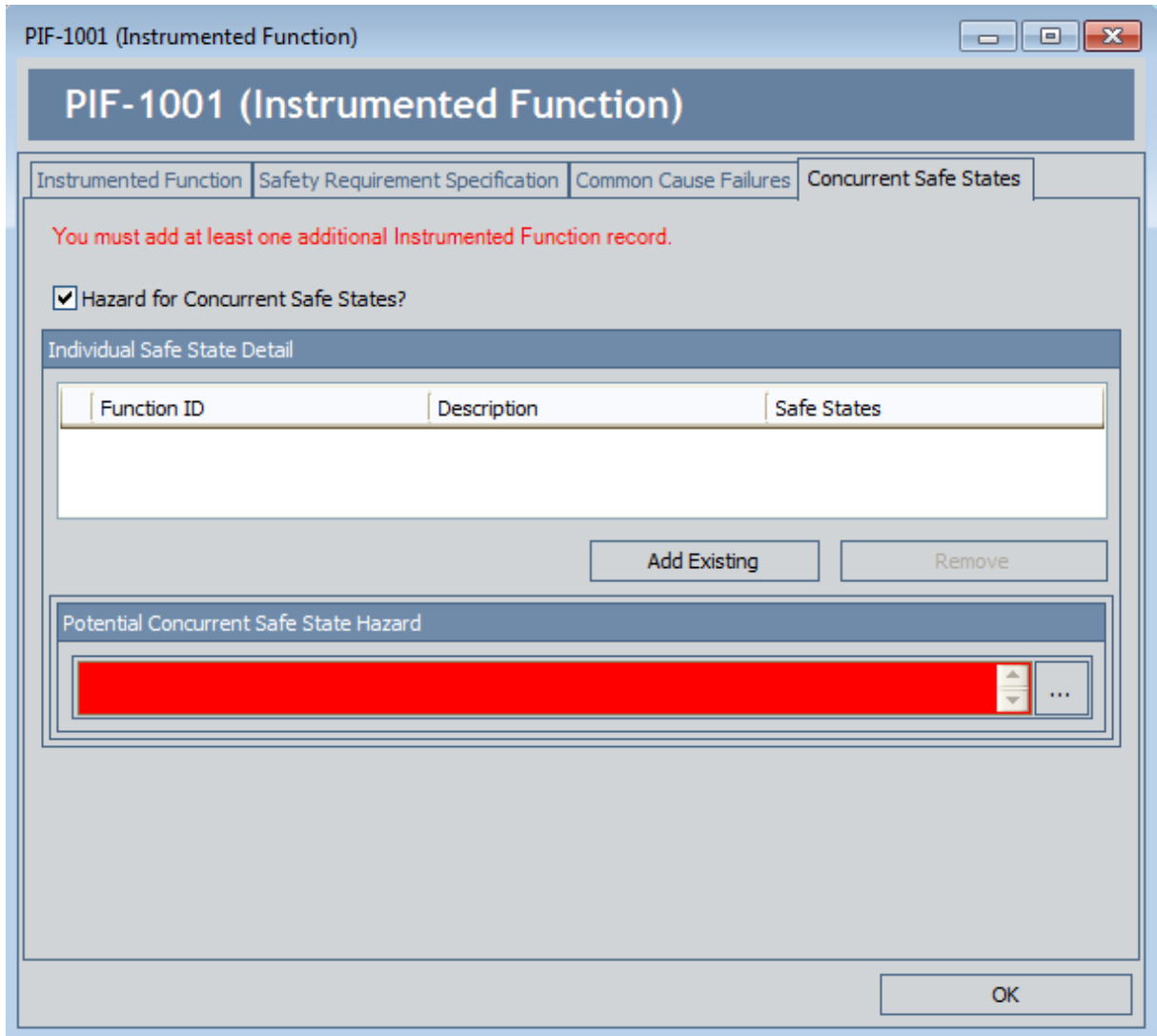

4. In the **Individual Safe State Detail** section, click the **Add Existing** button.
The **Find Items** window appears, and the **Search In** text box contains *Instrumented Function* by default.
5. Perform a search for the desired Instrumented Function record.
6. In the search results, select the rows containing the Instrumented Function records that you want to link to the current Instrumented Function record, and then click the **Open** button. Keep in mind the records you select should represent the instrumented functions whose safe states can lead to a hazardous event if they occur concurrently with the safe state of the current instrumented function.
The **Find Items** window closes, and the Instrumented Function records that you selected appears in the **Individual Safe State Detail** grid.

PIF-1001 (Instrumented Function)

Instrumented Function | Safety Requirement Specification | Common Cause Failures | **Concurrent Safe States**

Hazard for Concurrent Safe States?

Individual Safe State Detail

Function ID	Description	Safe States
1 IM; diverse - SP & FEP - T4.1.3...	SIF used to test Sensor Part Opti...	The safe state for this SIF is...

Add Existing Remove

Potential Concurrent Safe State Hazard

OK

7. In the **Potential Concurrent Safe State Hazard** section, enter a description of the hazardous event that can occur if the safe states for the instrumented functions in the **Individual Safe State Detail** section occur simultaneously with the safe state for the current instrumented function.

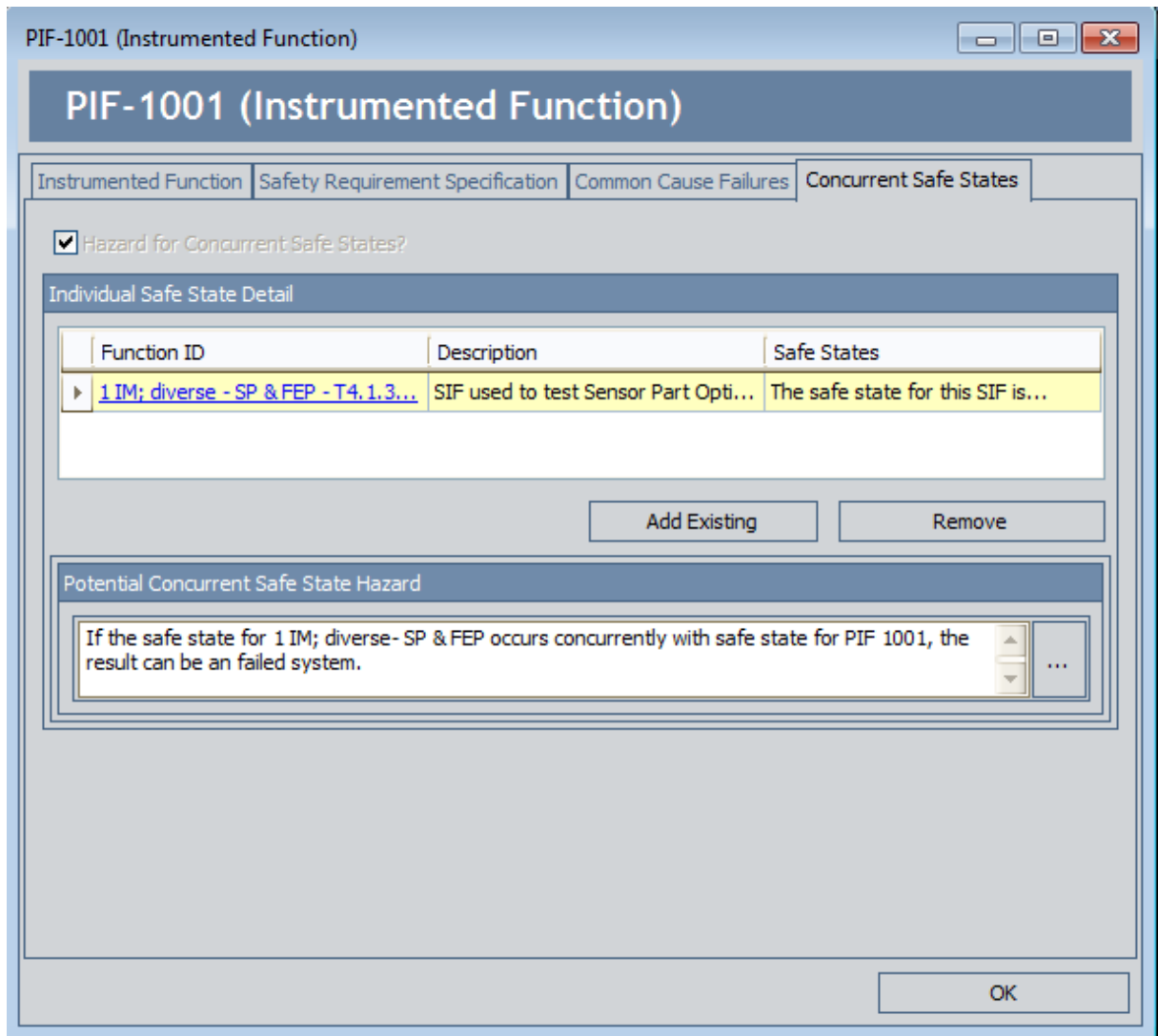

8. In the **Individual Output States** section, in the first row in the grid, click the hyper-linked ID in the **Function ID** cell.

The corresponding Instrumented Function record appears in a new window.

9. Click the **Concurrent Safe States** tab.

The **Concurrent Safe States** tab appears. You can see that the **Hazard for Concurrent Safe States?** check box is selected automatically and the **Individual Safe State Detail** grid contains the Instrumented Function record to which the current record is linked (i.e., the record from which you accessed the current record).

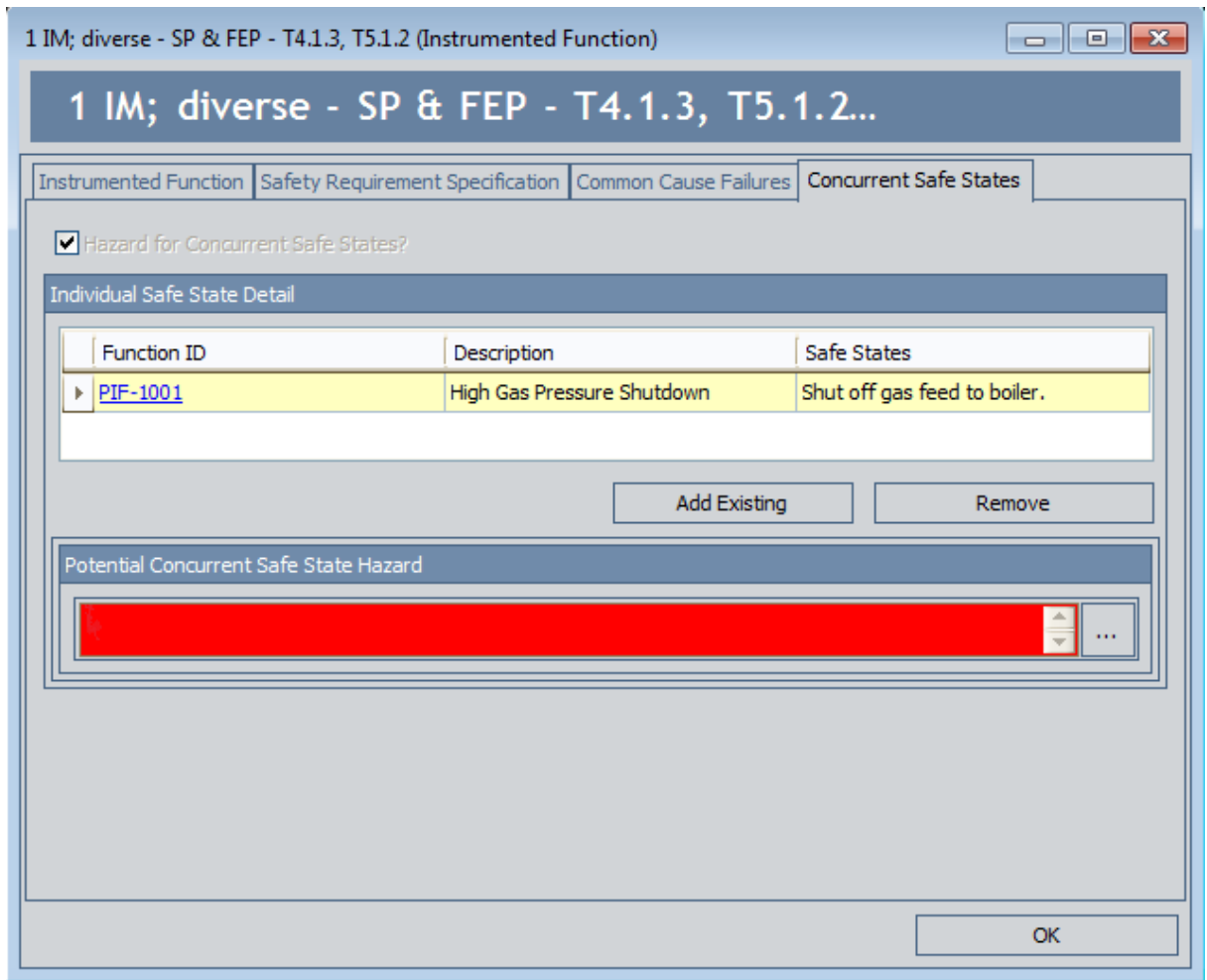

10. In the **Concurrent Hazardous Event** section, enter a description for the hazardous event that can occur if the safe states associated with the instrumented occur simultaneously. This should be the same description that you entered in step 7.

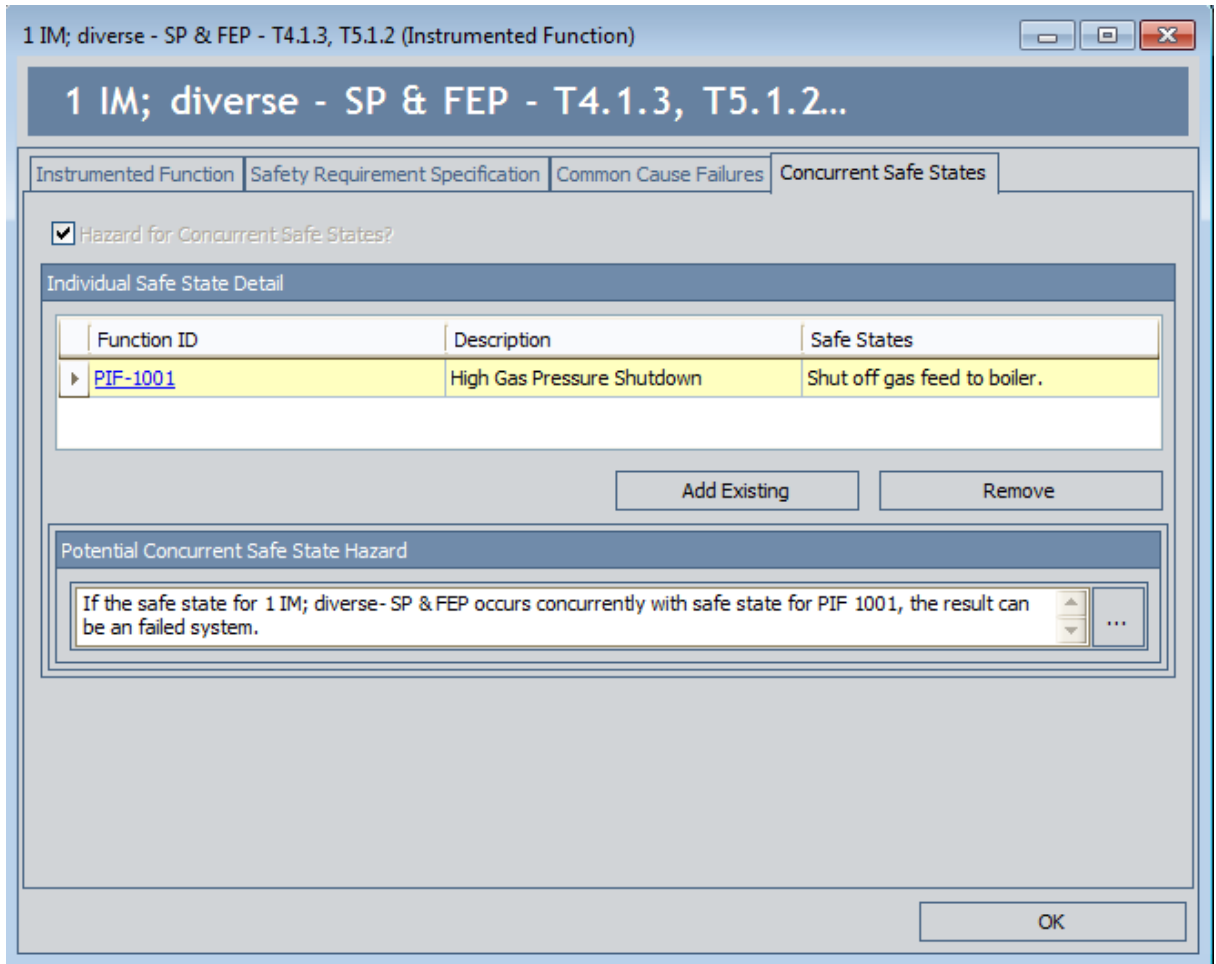

11. Click **OK**.

Your changes are saved, and the Instrumented Function record closes, revealing the previous Instrumented Function record.

12. Repeat steps 8 through 11 for each Instrumented Function record that appears in the **Individual Safe State Detail** grid.

13. Click **OK**.

Your changes are saved, and the Instrumented Function record closes.

Removing Instrumented Functions From the Concurrent Safe States Tab

When you remove an Instrumented Function from the **Concurrent Safe States** tab, you are deleting the link between the Instrumented Function records.

To remove an instrumented function from the **Concurrent Safe States** tab:

1. [Open the Instrumented Function record](#) from which you want to remove a linked Instrumented Function record.
2. Click the **Concurrent Safe States** tab.

The **Concurrent Safe States** tab appears.

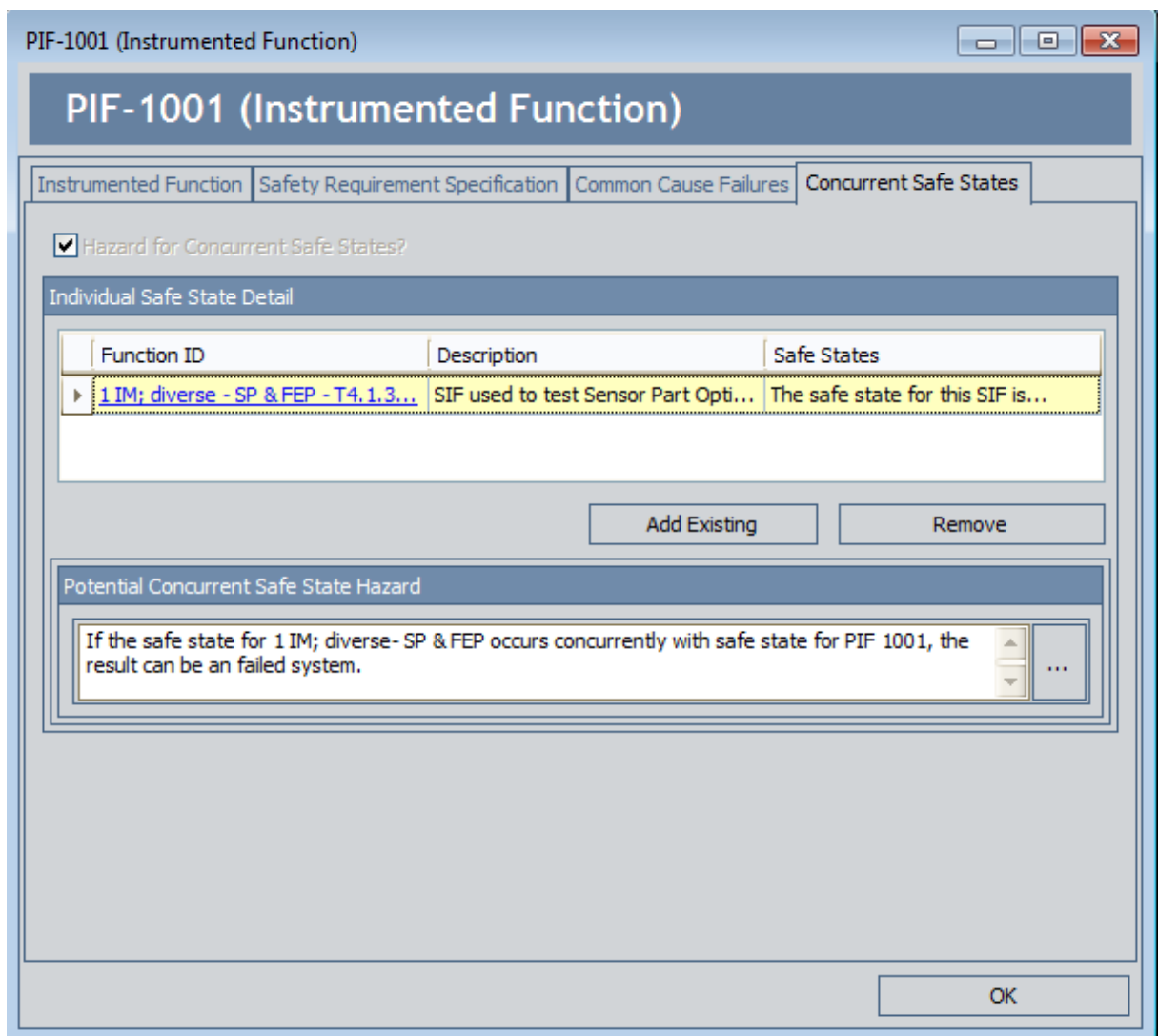

3. In the **Individual Safe State Detail** section, select the row containing the instrumented function that you want to remove.

CEHint: You may want to update the text stored in the **Concurrent Hazardous Event** section in the corresponding Instrumented Function record before you remove it from the current record. To do so, click the hyperlinked value in the **Function ID** cell in that row.

4. Click the **Remove** button.

A confirmation message appears, asking if you really want to remove the selected record.

5. Click the **Yes** button.

The link between the selected Instrumented Function record and the current Instrumented Function record is deleted, and the instrumented function is removed from the **Individual Safe State Detail** grid.

CEHint: You may want to update the text stored in the **Concurrent Hazardous Event** section in the current record.

6. Click **OK**.

Your changes are saved, and the Instrumented Function record closes.

Adding Existing Instrumented Function Records to the SIL Analysis

When you add an existing Instrumented Function record to an SIL Analysis, you are automatically linking that record to the SIL Analysis record for the current SIL Analysis.

To add an existing Instrumented Function record to the SIL Analysis:

1. [Access the Instrumented Functions \(IFs\) page.](#)
2. In the **Instrumented Functions** section, below the grid, click the **Add Existing Functions** button.

The **Find Items** window appears, where you can search for an existing Instrumented Function record.

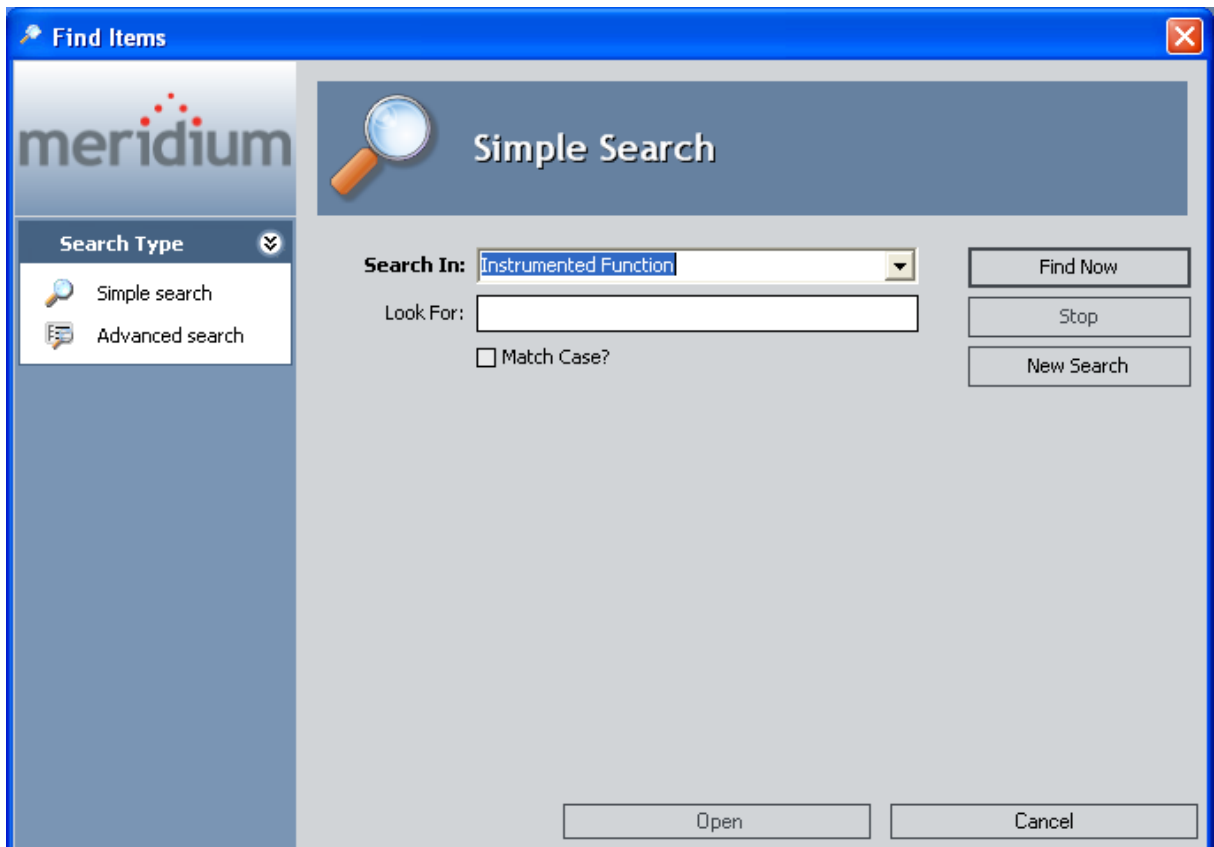

3. If desired, in the **Look For** text box, type the desired search criteria, and click the **Find Now** button.

The search results appear and contain only the Instrumented Function records that are not currently linked to an SIL Analysis.

4. In the search results, select the row containing the record that you want to add to the analysis.
5. Click the **Open** button.

The **Find Items** window closes, and the selected record is linked to the SIL Analysis record for the current SIL Analysis and appears in the **Instrumented Functions** grid.

Copying Existing Instrumented Function Records

When you copy an existing Instrumented Function record, you are creating a new Instrumented Function record that is populated with the values from the record that was copied and automatically linking it to the SIL Analysis record for the current SIL Analysis. The values in all the fields from a selected record will be copied to the new records with the exception of the following fields:

- IF ID
- Hazards Analysis Date
- Hazards Analysis Reference
- Hazards Analysis Reference Key

To copy an Instrumented Function record:

1. [Access the Instrumented Functions page.](#)
2. In the **Instrumented Functions** section, select the row containing the Instrumented Function record that you want to copy.
3. Below the **Instrumented Functions** grid, click the **Copy Function** button.
A new Instrumented Function record appears that is populated with information from the source record.
4. In the IF ID field, type the ID for the instrumented function.
5. Modify the values in the remaining fields as desired.
6. Click **OK**.

The record is saved and appears in the **Instrumented Functions** section.

Modifying Existing Instrumented Function Records

To modify an existing Instrumented Function record:

1. [Access the Instrumented Functions \(IFs\) page.](#)
2. In the **Instrumented Functions** grid, locate the row containing the Instrumented Function record whose contents you want to modify.

The Instrumented Function record appears in a new window.

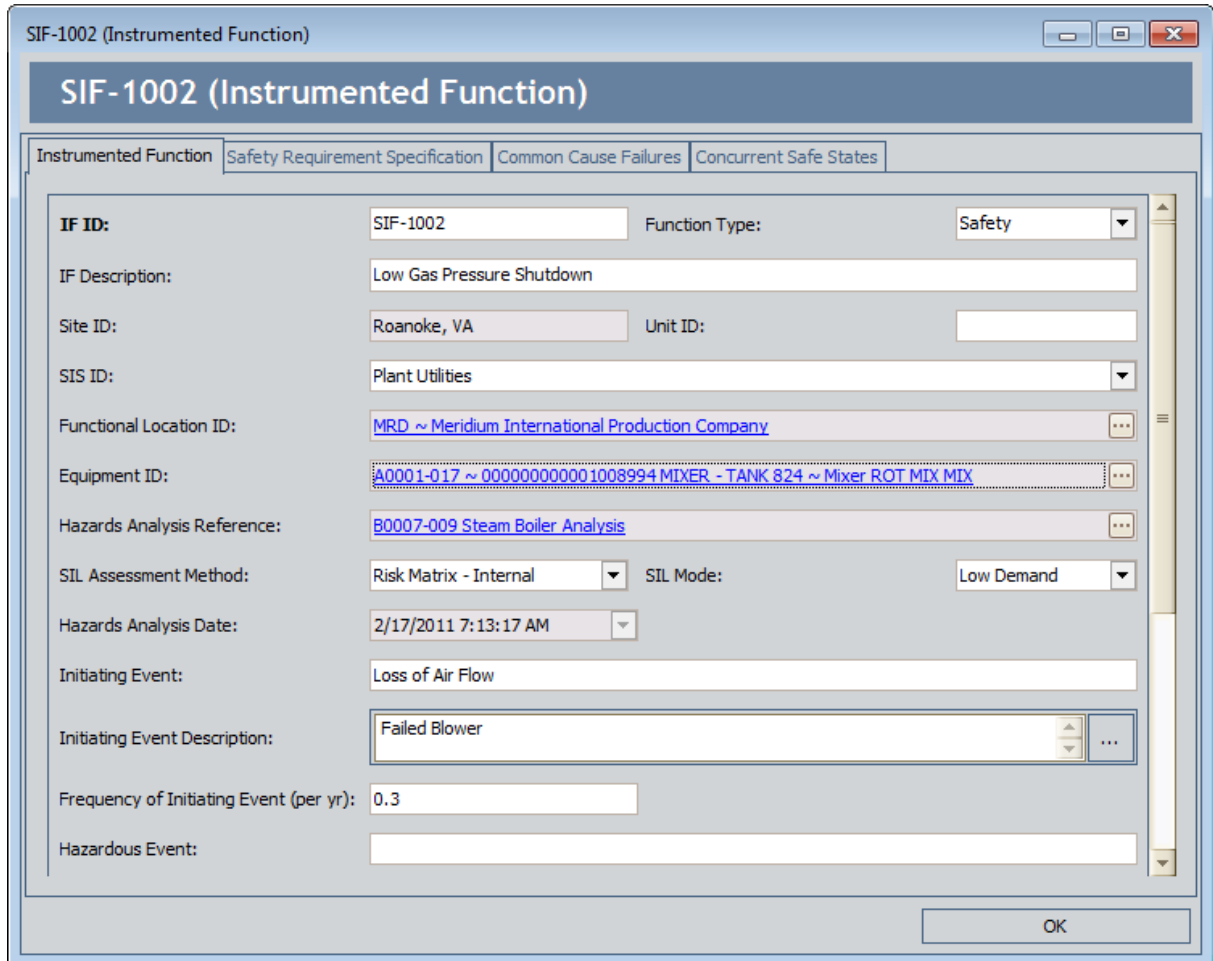

The screenshot shows a software window titled "SIF-1002 (Instrumented Function)". The window has a title bar with standard minimize, maximize, and close buttons. Below the title bar is a header area with the text "SIF-1002 (Instrumented Function)". Underneath the header is a tabbed interface with four tabs: "Instrumented Function" (selected), "Safety Requirement Specification", "Common Cause Failures", and "Concurrent Safe States". The main content area contains a form with the following fields:

- IF ID:** SIF-1002
- Function Type:** Safety (dropdown menu)
- IF Description:** Low Gas Pressure Shutdown
- Site ID:** Roanoke, VA
- Unit ID:** (empty text box)
- SIS ID:** Plant Utilities (dropdown menu)
- Functional Location ID:** MRD ~ Meridium International Production Company (dropdown menu)
- Equipment ID:** A0001-017 ~ 00000000001008994 MIXER - TANK 824 ~ Mixer ROT MIX MIX (dropdown menu)
- Hazards Analysis Reference:** B0007-009 Steam Boiler Analysis (dropdown menu)
- SIL Assessment Method:** Risk Matrix - Internal (dropdown menu)
- SIL Mode:** Low Demand (dropdown menu)
- Hazards Analysis Date:** 2/17/2011 7:13:17 AM (dropdown menu)
- Initiating Event:** Loss of Air Flow
- Initiating Event Description:** Failed Blower (dropdown menu)
- Frequency of Initiating Event (per yr):** 0.3
- Hazardous Event:** (empty text box)

An "OK" button is located at the bottom right of the window.

3. [Modify the record as desired.](#)

4. Click **OK**.

The record closes, and your changes are saved.

About Assessing the SIL Level for Instrumented Functions

Before the SIL Analysis team can make recommendations for actions that should be taken to mitigate risk for a given safety instrumented system, the team must first assign a numeric rating to each instrumented function within that safety instrumented system. The *safety integrity level* (SIL) is a numeric value that represents an overall rating for the instrumented function. This rating tells you to what degree the instrumented function is meeting its requirements to mitigate risk. After you have assigned an SIL value to each instrumented function within a safety instrumented system, the combination of these values indicates overall safety integrity of the safety instrumented system to which the instrumented functions belong.

You can use the following methods to assess the SIL value for an instrumented system:

- **Risk Matrix:** Lets you use the standard Meridium APM Risk Assessment interface to select the risk rank values for specific categories of risk. The *highest* risk rank value that you select in the Risk Matrix is used to determine the SIL value for that instrumented function. You can use the baseline Risk Matrix or a custom Risk Matrix.
- **Layer of Protection Analysis (LOPA):** Lets you evaluate on a granular level the risk value associated with a given risk for the instrumented function to determine the SIL value that is associated with each risk. The *highest* SIL value that is assigned to a given risk is used to determine the SIL value of the instrumented function with which those risks are associated.
- **Hazards Analysis Risk Assessment:** Lets you select an existing Risk Assessment record that is associated with a Hazards Analysis record to which the Instrumented Function record is linked. The existing risk rank values will be used to determine the SIL value for that instrumented function automatically.

You can use *more than one* risk assessment method to determine the SIL value for a given instrumented function and then compare the results of the different methods. If you use *more than one* risk assessment method, however, only one of the resulting SIL values can exist in the Selected SIL Level field in the Instrumented Function record. To indicate whether the SIL value will be determined by the Risk Matrix, LOPA, or Hazards Analysis Risk Assessment method, you can select the corresponding value in the SIL Assessment Method field in the Instrumented Function record. For example, if you select the value *Risk Matrix - Internal* in the SIL Assessment Method field, the SIL value determined by the Risk Matrix assessment method will appear in the Selected SIL Level field.

In addition to the Select SIL Level field, SIL values are also displayed in the **Selected SIL Level** column in the **Instrumented Functions** section on the **Instrumented Functions (IFs)** page. After an SIL value exists for an instrumented function, the SIL Analysis team can make recommendations for actions that should be taken to mitigate the risk associated with that instrumented function, if necessary. They can do so using Risk Assessment Recommendation records.

For example, assume you have conducted a LOPA for the Instrumented Function record *IF - 1001*, and the SIL value is *4*. In this case, your SIL Analysis team might want to create a Risk Assessment Recommendation record that contains a recommendation for adding an additional layer of protection to that instrumented function.

SIL Level and Required Probability of Failure

The *required probability of failure* is a number representing the probability that an instrumented function will fail in a dangerous scenario. This value is represented as a probability value (e.g., .001) and is an indicator of whether the instrumented function is meeting its requirements to mitigate risk.

The required probability of failure is defined in the Required Probability of Failure field in the Instrumented Function record. The required probability of failure value is based upon the following values stored in the Instrumented Function record:

- The SIL value, which is stored in the Selected SIL Level field. The higher the SIL value for an instrumented function, the lower the probability that the instrumented function will fail.
- The method used to determine the SIL value, which is stored in the SIL Assessment Method field (e.g., Risk Matrix).
- The demand rate, which is stored in the SIL Mode field and represents how frequently the instrumented function will be needed to protect the safety instrumented system as a result of a failure (i.e., Low Demand, High Demand, or Continuous).

Depending upon these values in other fields, this field is either disabled and populated automatically *or* enabled so that you can type a value manually. The following sections define how the required probability of failure is calculated for each demand rate.

High Demand and Continuous

In an Instrumented Function record, when the value in the SIL Mode field is *High Demand* or *Continuous* demand, the Meridium APM system assumes that the demand rate of the instrumented function more frequent than once per year. In these cases, the failure rate is measured by the average probability of dangerous failures per hour (PFH). The required probability of failure is defined by an industry standard that is associated with the SIL. The following table contains the standard PFH values for each SIL.

Safety Integrity Level (SIL)	Required Probability of Failure (PFH)
4	$\geq 10^{-9}$ to $< 10^{-8}$
3	$\geq 10^{-8}$ to $< 10^{-7}$
2	$\geq 10^{-7}$ to $< 10^{-6}$
1	$\geq 10^{-6}$ to $< 10^{-5}$

If you use an internal Risk Matrix to determine the SIL value, the value in the Required Probability of Failure field on the Instrumented Function datasheet will be populated

automatically with the lowest (i.e., the most conservative) value as the targeted probability and disabled. For example, if the SIL is 2, the Required Probability of Failure field will be populated automatically with $1E-07$ (i.e., 10^{-7}).

If you use an internal Layer of Protection Analysis to determine the SIL value, the value in the Required Probability of Failure field is disabled and populated automatically with the difference between the values in the Mitigated Consequence Frequency field and the Required Mitigated Consequence Frequency field in the LOPA record.

If you use an SIS Assessment Method *other than* an internal Layer of Protection Analysis or Risk Matrix (e.g., LOPA - External), the Required Probability of Failure field will be enabled, and you can type the probability value manually. In this case:

- If you modify the value in the Selected SIL Level field, the value in the Required Probability of Failure field will be updated automatically to fall within the correct range of values for that level.
- If you type a value that does *not* fall within the range defined in the table, an error message will appear.
- If you type a value in the Required Probability of Failure field without first typing a value in the Selected SIL Level field, an error message will appear.

Low Demand

In an Instrumented Function record, when the value in the SIL Mode field is *Low Demand*, the Meridium APM system assumes that the demand rate of the instrumented function is less frequent than once per year. In this case, the failure rate is measured by the average probability of failure on demand (PFD Avg).

In these cases, a *risk reduction factor* can also be used to indicate the probability of failure for an instrumented function. The risk reduction factor is the inverse of the required probability of failure, which is represented in years in cases of low demand. For example, a required probability of failure value of *.001* would equal a risk reduction factor of *1,000*, meaning that the instrumented function would fail during a dangerous scenario about every 1,000 years.

The required probability of failure is defined by the industry standard that is associated with each SIL. The following table contains the standard PFD Avg values for each SIL.

Safety Integrity Level (SIL)	Required Probability of Failure (PFD Avg)	Target Risk Reduction Factor
4	$\geq 10^{-5}$ to $< 10^{-4}$	$> 10,000$ to $\leq 100,000$
3	$\geq 10^{-4}$ to $< 10^{-3}$	$> 1,000$ to $\leq 10,000$
2	$\geq 10^{-3}$ to $< 10^{-2}$	> 100 to $\leq 1,000$

Safety Integrity Level (SIL)	Required Probability of Failure (PFD Avg)	Target Risk Reduction Factor
1	$\geq 10^{-2}$ to $< 10^{-1}$	> 10 to ≤ 10

If you use an internal Risk Matrix to determine the SIL value, the Required Probability of Failure field on the Instrumented Function datasheet will be disabled and populated automatically with the lowest (i.e., the most conservative) value as the targeted probability. For example, if the SIL is 3, the Required Probability of Failure field will be populated automatically with 0.001 (i.e., 10^{-3}). The value in the Risk Reduction Factor field is the inverse of value in the Required Probability of Failure field, so for an SIL of 3, the Risk Reduction field on the Instrumented Function datasheet will be disabled and populated automatically with 1,000 (i.e., the inverse of 0.001). In other words, for an SIL value of 3, the instrumented function should not fail more than once every 1,000 years.

If you use an internal Layer of Protection Analysis to determine the SIL value, the Required Probability of Failure field is populated automatically in the same way as when the demand rate is *High Demand* or *Continuous*. The value in the Risk Reduction Factor field, however, is now populated automatically with the inverse of value in the Required Probability of Failure field.

For an SIL Assessment Method *other than* an internal Risk Matrix or Layer of Protection Analysis (e.g., LOPA - External), the Required Probability of Failure field and the Risk Reduction field will be enabled, and you can type a value into those fields manually. The same restrictions apply in this case as when the demand rate is *High Demand* or *Continuous* but with the following additional logic:

- If you modify the value in the Required Probability of Failure field, the value in the Risk Reduction Factor field will be populated automatically with the inverse of the value in the Required Probability of Failure field.
- If you modify the value in the Risk Reduction field, the value in the Required Probability of Failure field will be populated automatically with the inverse of the value in the Risk Reduction field.

About Assessing SIL Values Via the Risk Matrix

When you assess a SIL value for an instrumented function via the Risk Matrix, you will use the Risk Assessment interface to create a Risk Assessment record and link it to the Instrumented Function record representing that instrumented function.

Specifically, you will use the Risk Matrix on the Risk Assessment interface to select a risk rank value for each risk category that is defined in that Risk Matrix. After you select risk rank values in the Risk Matrix, the *sum* of the unmitigated risk rank values that you selected (i.e., the overall unmitigated risk rank) is used to determine the SIL value for that instrumented function. This value is stored in the **Unmitigated Risk Rank** text box above Risk Matrix on the Risk Assessment Interface.

SIL values are stored in the SIL Level field in SIL Threshold records. SIL Threshold records also store numeric ranges, which correspond to risk rank values that appear in the Risk Matrix. The Meridium APM baseline database contains SIL Threshold records that you can use for this purpose. The overall unmitigated risk rank value will be compared to the ranges that are defined in the SIL Threshold records. The SIL value that corresponds to the range in which the overall unmitigated risk rank value falls is assigned to the instrumented function.

For example, assume that the following SIL Threshold record exists, where the numeric range is 100 - 1000 with a corresponding SIL value of 2.

2 = 100 - 1000 (SIL Threshold)	
Level	
	Value(s)
SIL Level	2
Lower Boundary	100
Upper Boundary	1000
Mitigated Risk Factor	

In this case, if the overall unmitigated risk rank value is 500, a SIL value of 2 would appear in the Selected SIL Level field in the Instrumented Function record.

Accessing the Risk Assessment Interface

The following instructions provide details on accessing the Risk Assessment interface to select risk rank values. When you select risk rank values via the Risk Assessment interface, you are creating a Risk Assessment record and linking it to the selected Instrumented Function record.

To access the Risk Assessment interface:

1. [Access the Instrumented Functions \(IFs\) page.](#)
2. In the **Instrumented Functions** section, select the row containing the instrumented function whose risk rank values you want to assess.
3. On the **Assessment Tasks** menu, click the **Risk Matrix** link.

The **Risk Analysis** dialog box appears, displaying the Risk Assessment interface.

At this point, you can follow the standard procedure for assessing risk via the Risk Matrix, and then click the **Save** button.

The Risk Assessment record will be linked to the selected Instrumented Function record, and the SIL Level value will be calculated automatically and displayed in the **Selected SIL Level** cell in the currently selected row.

About Assessing SIL Values via a Hazards Analysis Risk Assessment

If you have already performed risk assessments for a Hazards Analysis via the Hazards Analysis module, you can use one of those risk assessments to assess the SIL value for an instrumented function. Before you can use a risk assessment from a Hazards Analysis, you must:

1. Link the Instrumented Function record to the Hazards Analysis record that is associated with the risk assessment that you want to use.
2. In the SIL Assessment Method field in the Instrumented Function record, select *PHA-Internal*.

After you have completed these steps, on the **Assessment Tasks** menu, you can click the **Risk Matrix** link to select which Risk Assessment record you want to use and then view its details on the [PHA Risk Assessment window](#).

About Mapping Values from a Hazards Analysis

When you assess the SIL value for an instrumented function using a Hazards Analysis Risk Assessment, you will select a Risk Assessment record that has been previously defined for a Hazards Analysis and use it to assess risk for that instrumented function.

The risk rank values and Risk Matrix that have been defined for that risk assessment are mapped to corresponding fields on the **PHA Risk Assessment** window. The risk rank values on the **PHA Risk Assessment** window are used to [determine the SIL value in the same way risk rank values from the standard Risk Assessment interface are used to determine the SIL value](#), with the following exceptions:

- The risk rank values on the **PHA Risk Assessment** window are already defined and cannot be modified.
- The overall *unmitigated* risk rank value is not always used to determine the SIL value. The Meridium APM system determines which risk rank values to use based upon the following criteria:
 - If the risk from the Hazards Analysis has *not* been mitigated, the sum of the *unmitigated* risk rank values is used to calculate the SIL value in the same way as the values are calculated using the standard Risk Assessment interface.
 - If the risk from the Hazards Analysis *has* been mitigated, then the sum of the *mitigated* risk rank values from the risk assessment (i.e., the overall mitigated risk rank) is compared to values in SIL Threshold records to determine the SIL value. The overall mitigated risk rank value is displayed in the **Mitigated Risk Rank** text box above the Risk Matrix on the **PHA Risk Assessment** window.

In addition, after you select a Risk Assessment record from a Hazards Analysis, certain values that are stored in fields in Hazards Analysis Cause and Hazards Analysis Consequence records from that Hazard Analysis are copied to corresponding fields in the Instrumented Function record. The following table lists the families and fields in the Hazards Analysis module that store these values and the field in the Instrumented Function record to which they are mapped.

Hazard Analysis Family	Hazard Analysis Field	Instrumented Function Field
Hazard Analysis Cause	Cause Type	Initiating Event
Hazard Analysis Cause	Cause Description	Initiating Event Description
Hazard Analysis Cause	Cause Frequency (per year)	Frequency of Initiating Event (per yr)
Hazard Analysis Consequence	Consequence Type	Hazardous Event
Hazard Analysis Consequence	Consequence Description	Consequence Description

Selecting a Risk Assessment Record from a Hazards Analysis

To use risk ranks that were defined in a Risk Assessment record in a Hazards Analysis, you must access the **PHA Risk Assessment** window instead of the standard [Risk Assessment interface](#). The following instructions assume that the Instrumented Function record for which you are assessing risk is linked to a Hazards Analysis record and contains the value *PHA - Internal* in its SIL Assessment Method field.

To select an existing Risk Assessment record from a Hazards Analysis:

1. On the **Instrumented Functions** page, select the Instrumented Function record for which you want to define risk ranks using an existing Risk Assessment record from a Hazards Analysis.
2. On the **Assessment Tasks** menu, click the **Risk Matrix** link.

The Search Tool appears. The **Search In** list is populated automatically with the *Risk Assessment* family, the **Linked To** list is populated automatically with the *Hazards Analysis Consequence* family, and the **Through** list is disabled and populated automatically with the *Has Risk* family.

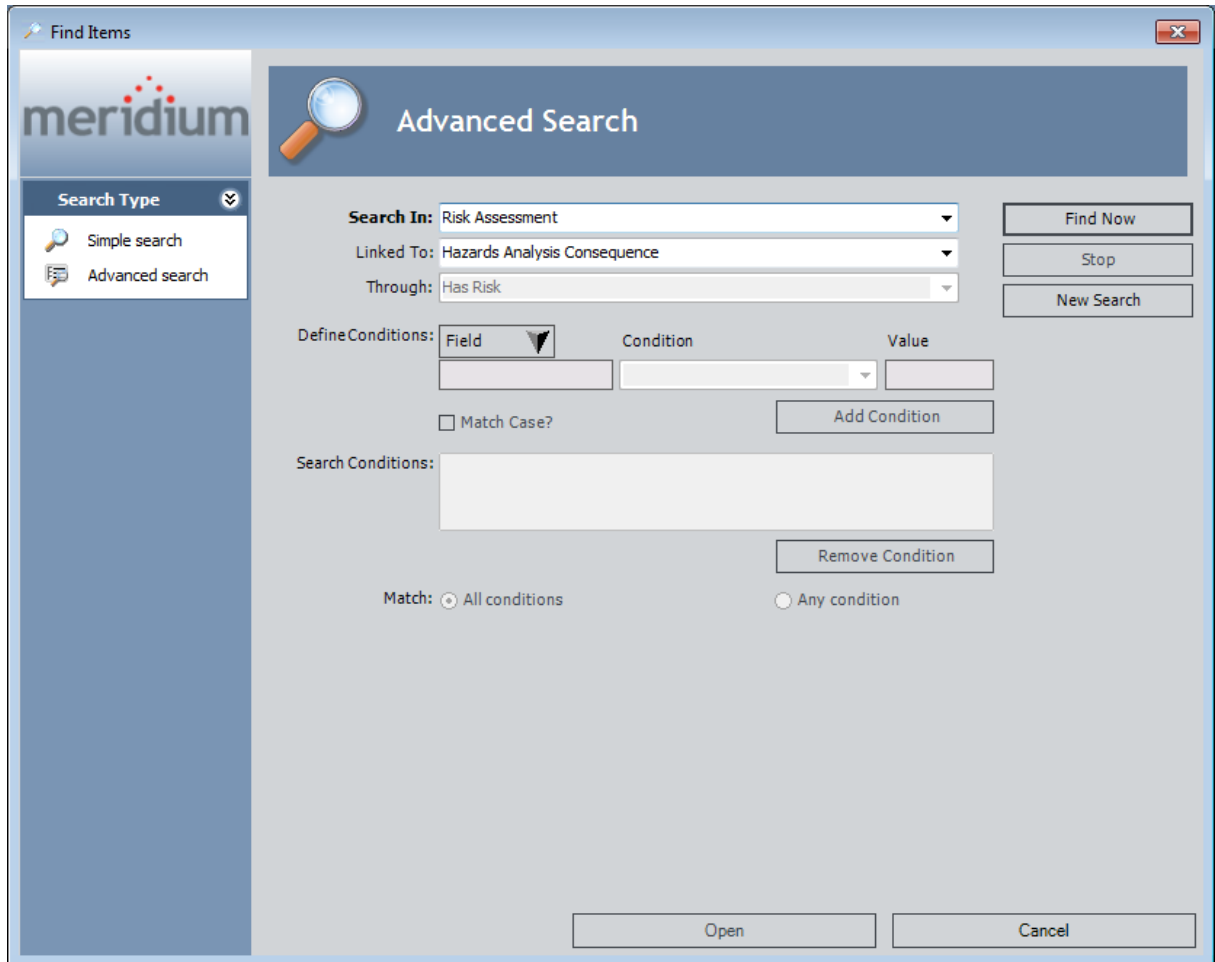

3. Click the **Find Now** button.

The search results display all the Risk Assessment records that are linked to a Hazards Analysis Consequence record through the *Has Risk* relationship family.

Note: Only Risk Assessment records that are associated with the Hazards Analysis record to which the selected Instrumented Function record is linked will appear in the search results.

4. Select the row containing the Risk Assessment record whose risk rank values you want to use, and then click the **Open** button.

The [PHA Risk Assessment window](#) appears, displaying the read-only risk assessment from the Hazards Analysis. In the Instrumented Function record, the values in the following fields are calculated and populated automatically [according to the risk rank values stored in the Risk Assessment record](#):

- Selected SIL Level
- Required Probability of Failure
- Risk Reduction Factor (RRF)

5. Click the  button to close the **PHA Risk Assessment** window.

Aspects of the PHA Risk Assessment Window

The **PHA Risk Assessment** window functions the same as the standard Risk Assessment interface, with some exceptions:

- The Risk Matrix and risk rank values are populated automatically with the corresponding values from the Risk Assessment record that is associated with the Hazards Analysis.
- The Risk Matrix is disabled, and you cannot make changes to the risk rank values. If you want to make changes to the risk rank values, you will need to do so from the source Hazards Analysis, and then select the Risk Assessment record again via the SIS Management module.
- If the Risk Assessment record is linked to a Hazards Analysis Safeguard record that is also an Independent Protection Layer (IPL), the **PHA Risk Assessment** window will contain the **IPL Information** section. Otherwise, this section is hidden.
- The following values are populated automatically from a Risk Assessment record from a Hazards Analysis:
 - Unmitigated Risk Rank
 - Mitigated Risk Rank
 - Risk Matrix
- If you select a Risk Assessment record from a Hazards Analysis that includes safeguards that are independent protection layers (IPLs), the **PHA Risk Assessment** window contains an additional sections: **IPL Information**.

The following items appear on the **PHA Risk Assessment** window:

- **Unmitigated Risk Rank text box:** Displays the unmitigated risk rank value stored in the Risk Assessment record that is linked to the Hazards Analysis record. This text box is disabled.
- **Mitigated Risk Rank text box:** Displays the mitigated risk rank value stored in the Risk Assessment record that is linked to the Hazards Analysis record. This text box is disabled.
- **Risk Matrix:** Displays the Risk Matrix from the Risk Assessment record for the Hazards Analysis as read-only.
- **PIF Information section:** Displays values from the Instrumented Function record for which you are assessing risk. All the fields in this section are disabled and populated automatically with existing values from the corresponding fields in the Instrumented Function record with the following exceptions:
 - The value in the **SIL Level** text box is calculated automatically based on the unmitigated and mitigated risk rank values when you open the **PHA Risk Assessment** window for the first time and then gets copied to the Selected SIL Level field in the Instrumented Function record. After the value is calculated initially, it will be stored in the Instrumented Function record.
 - The **Initiating Event** text box, **Hazardous Description** text box, and

Consequence Description text box are [populated automatically with values that are stored in fields in Hazards Analysis Cause and Hazards Analysis Consequence records from the Hazard Analysis.](#)

- **IPL Information section:** Displays values that are stored in the Independent Protection Layer records and Hazards Analysis Safeguard records that are used to determine the mitigated risk rank in the Hazards Analysis. This section appears on the **PHA Risk Assessment** window *only* if the source Hazards Analysis includes Hazards Analysis Safeguard records that are IPLs. Otherwise, this section is hidden. The **IPL Information** section contains the following items:
 - **IPL List:** Displays the list of Hazards Analysis Safeguard records that are classified as IPLs and linked to the Hazards Analysis Consequence record. You can select one of these records in the list to view its mitigated risk details in the **Risk** grid.
 - **Safeguard ID:** This cell is disabled and populated automatically with the value that is stored in the Safeguard ID field in the Hazards Analysis Safeguard record.
 - **Equipment ID:** This cell is disabled and populated automatically with the value that is stored in the Equipment ID field in the Equipment record to which the Hazards Analysis Safeguard record is linked.
 - **IF ID:** This cell is disabled and populated automatically with the value that is stored in the IF ID field in the Hazards Analysis Safeguard record.
 - **Safeguard Type:** This cell is disabled and populated automatically with the value that is stored in the Safeguard Type field in the Hazards Analysis Safeguard record.
 - **Safeguard Description:** This cell is disabled and populated automatically with the value that is stored in the Safeguard Description field in the Hazards Analysis Safeguard record.
 - **Risk grid:** Displays in grid format the mitigated and unmitigated risk ranks for each Risk Matrix category (e.g., environment) and the overall unmitigated and mitigated risk ranks associated with the IPL that is selected in the **IPL List**.
 - **IPL Credits:** This value is disabled and populated automatically with the value that is stored in the IPL Credits field in the Independent Protection Layer record that is linked to the Hazards Analysis Safeguard record that is selected in the **IPL List**. This number represents the amount by which the risk is reduced because of that IPL.
 - **IPL Type:** This value is disabled and populated automatically with the value that is stored in the IPL Type field in the Independent Protection Layer record that is linked to the Hazards Analysis Safeguard record that is selected in the **IPL List**. This cell can contain one of the following values:
 - **Consequence Reducing IPLs:** Reduce the severity of the failure (e.g., fatality to injury).

- **Frequency Reducing IPLs:** Reduce how often the failures occur (e.g., every 100 years to every 1,000 years).

What is a Layer of Protection Analysis (LOPA)?

A Layer of Protection Analysis (LOPA) is a type of risk assessment, which lets you determine the SIL value that is associated with the protective instruments that exist to mitigate the same risks for which the instrumented function exists. When you use an LOPA to assess the SIL value for an instrumented function, you examine the granular portions of the scenario and assess the risk associated with each portion, and then those individual risk values are used to calculate the SIL value for the instrumented function.

You can conduct one LOPA per risk that is associated with an instrumented function. After you have conducted a LOPA for all the desired risks, the *highest* SIL value will be used to calculate the SIL for that instrumented function.

A LOPA consists of one [LOPA record](#) and all the records that are linked to that record. For more details on how the LOPA family participates in the SIS Management data model, see the [illustration of the data model where the Instrumented Function family is the predecessor](#).

When you conduct an LOPA, you will complete the following steps:

1. Create one LOPA record to define the risk that you are assessing.
2. Create one [Independent Layer of Protection record](#) per independent layer of protection that exists to mitigate the risk defined in the LOPA record.
3. Create one [Consequence Modifier record](#) per consequence modifier that is associated with the risk defined in the LOPA record.

After you complete these steps, the SIL value will be calculated automatically based on the probability values defined in the Independent Layer of Protection records and Consequence Modifier records.

Navigation Menu

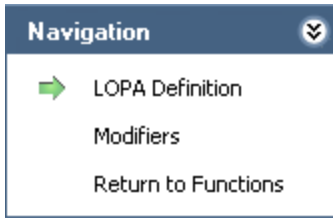

The **Navigation** menu appears on the following pages when you are working with a LOPA:

- [LOPA Definition](#)
- [Consequence Modifiers](#)

In addition to these pages, the **Navigation** menu provides to the **Instrumented Functions (IFs)** page. A green arrow to the left of an option indicates the page that you are currently viewing. The **Navigation** menu contains the following links:

- **LOPA Definition:** Displays the **LOPA Definition** page, where you can manage LOPA records and Independent Layers of Protection records.
- **Modifiers:** Displays the **Consequence Modifiers** page, where you can manage Consequence Modifier records.
- **Return to Functions:** Displays the **Instrumented Functions (IFs)** page, where you can manage Instrumented Function records.

Common Tasks



The **Common Tasks** menu appears on the following pages when you are working with a LOPA:

- [LOPA Definition](#)
- [Consequence Modifiers](#)

The **Common Tasks** menu contains the following links:

- **Send To:** Displays a submenu with options that let you provide a link to the current page on your desktop (create shortcut), in an email message, or on a Home Page.
- **Reports:** Displays a submenu that contains the caption of the Catalog item *LOPA Report* as a link. This link is enabled only if you are viewing an existing LOPA record on the **LOPA Definition** page. This link does not appear on the **Consequence Modifiers** page.
- **Help:** Displays the context-sensitive help topic for the current page.

About LOPA Records

LOPA records store details about the LOPA that you are conducting to determine the SIL value for a risk that is associated with an instrumented function. When you create a LOPA record, it will be linked to the Instrumented Function record that is currently selected on the **Instrumented Functions (IFs)** page.

LOPA records can be linked to records in the following families:

- **Consequence Modifier:** Stores details about the consequences of the risk described in the LOPA record.
- **Independent Layer of Protection:** Stores details about the independent layers of protection that exist to mitigate the risk associated with the consequences described in the Consequence Modifier records. Independent Layer of Protection records can be linked to Equipment and Functional Location records, which store details about the equipment or location with which the independent layers of protection are associated.

These families also store numeric values that present probability and failure rates. These values are used to calculate the SIL value of the Instrumented Function whose risks you are assessing through the LOPA. The calculated SIL value is stored in the Calculated SIL field in the LOPA record.

When you create a LOPA record, you will define the following items in the record:

- The risk for which you are conducting the Layer of Protection Analysis (LOPA).
- The consequences that may occur if that risk is not prevented from proceeding into an undesirable scenario.
- The events or conditions that can initiate the undesirable event.
- How often the event may occur.
- How often it is acceptable for the event to occur.

Accessing the LOPA Definition Page

On the **LOPA Definition** page, you can create the following items:

- One LOPA record.
- One or more Independent Layer of Protection records.

Additionally, via the **LOPA Definition** page, you can access the **Consequence Modifiers** page, where you can create one or more Consequence Modifier records.

The following instruction provide details on accessing the **LOPA Definition** page for a new LOPA record. You can also access the **LOPA Definition** page by [opening an existing LOPA record](#).

To access the LOPA Definition page:

1. [Access the Instrumented Functions \(IFs\) page](#).
2. In the **Instrumented Functions** section, select the row containing the Instrumented Function record for which you want to conduct the LOPA.
3. In the **Associated Risk Assessments** section, click the **Create New LOPA** button.

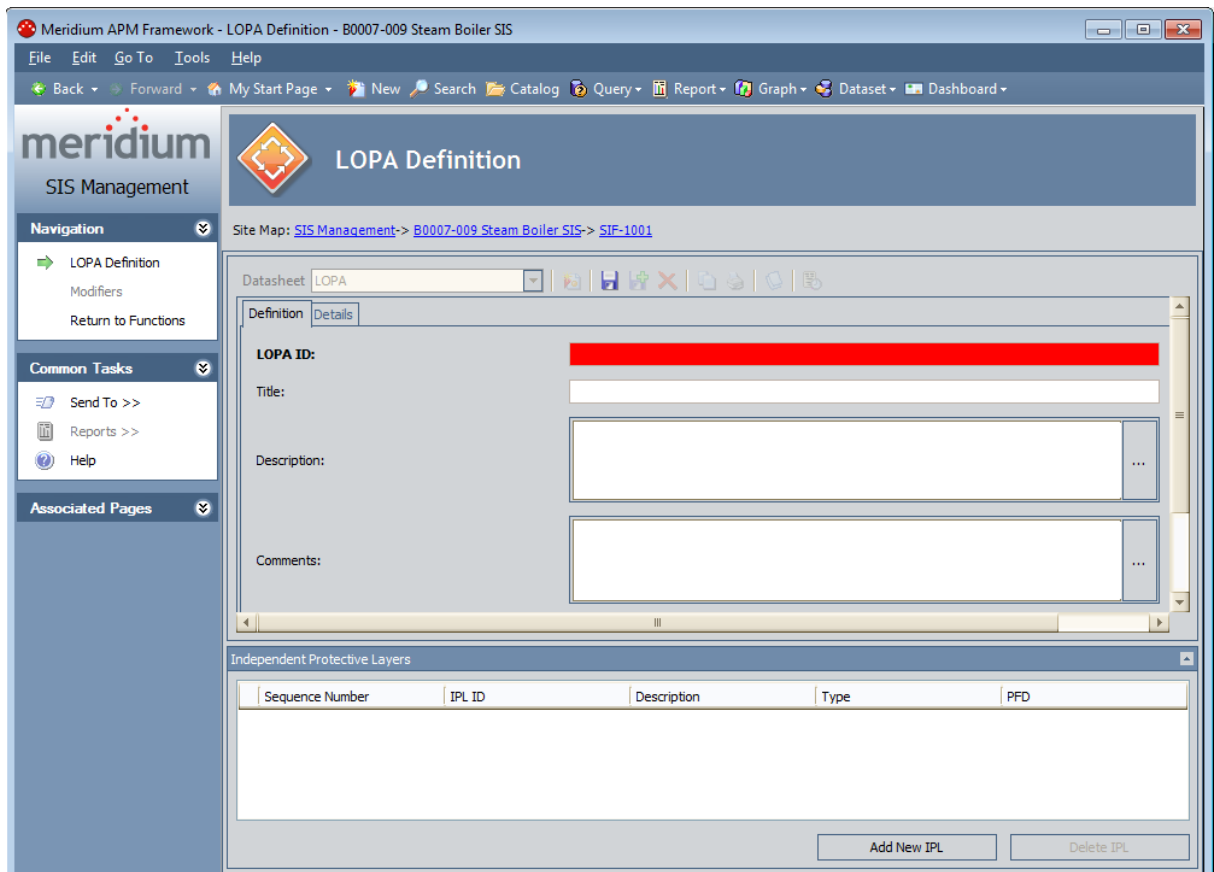

Aspects of the LOPA Definition Page



The **LOPA Definition** page contains the following items:

- **Datasheet area:** Contains the LOPA datasheet for the current LOPA record.
- **Independent Protective Layers section:** Contains a grid that displays a list of Independent Layer of Protection records that are linked to the LOPA record whose datasheet is displayed in the datasheet area. Each row in the grid represents one Layer of Protection record. For each record that appears in the grid, the following information is displayed:
 - **Sequence Number:** The value that exists in the Sequence Number field in the Independent Layer of Protection record.
 - **IPL ID:** The value that exists in the IPL ID field in the Independent Layer of Protection record.
 - **Description:** The value that exists in the Description field in the Independent Layer of Protection record.
 - **Type:** The value that exists in the Type field in the Independent Layer of Protection record.
 - **PFD:** The value that exists in the PFD field in the Independent Layer of Protection record.

Below the grid, the following buttons appear:

- **Add New IPL:** Displays a new blank Independent Layer of Protection record in a new window.
- **Delete IPL:** Displays a confirmation message, and then deletes the selected Independent Layer of Protection record.

You can collapse and expand the **Independent Protective Layers** section using the following buttons, which appear on the top right corner of the section in turn:

-  : Indicates that the section is expanded. You can click this button to collapse the section.
-  : Indicates that the section is collapsed. You can click this button to expand the section.

The **LOPA Definition** page contains the following task menus:

- [Navigation](#)
- [Common Tasks](#)
- [Associated Pages](#)

Creating LOPA Records

To create a LOPA record:

1. [Access the LOPA Definition page.](#)
2. In the datasheet area, on the **Definition** tab, provide values for the fields as desired. Note that the LOPA ID field is required.
3. Click the **Details** tab.
The **Details** tab appears.
4. [Provide values for the fields as desired.](#) Note that the following fields are required:
 - Frequency of Initiating Event
 - Required Mitigated Consequence Frequency
5. Above the datasheet, click the **Save** button. 

The record is saved.

Opening Existing LOPA Records

To open an existing LOPA record:

1. [Access the Instrumented Functions \(IFs\) page.](#)
2. In the **Instrumented Functions** section, select the row containing the Instrumented Function record to which the desired LOPA record is linked.
3. In the **Associated Risk Assessments** section, locate the LOPA record that you want to open.
4. In the **LOPA ID** cell, click the hyperlinked Record ID for the desired record.

The selected LOPA record appears on the **LOPA Definition** page. At this point, you can modify the LOPA record, [create Independent Layer of Protection records](#), and [access the Consequence Modifiers page](#).

Adding Existing LOPA Records to the Associated Risk Assessments Grid

The following instructions provide details on searching for an existing LOPA record to link to an Instrumented Function record. When you search for LOPA records, the search results will contain only LOPA records that are not already linked to an Instrumented Function record.

To add an existing LOPA record to the Associated Risk Assessments grid:

1. Access the Instrumented Functions (IFs) page.
2. In the **Instrumented Functions** section, select the row containing the Instrumented Function record to which you want to link the LOPA record.
3. Below the **Associated Risk Assessments** section, click the **Add Existing LOPA** button.

The **Find Items** window appears.

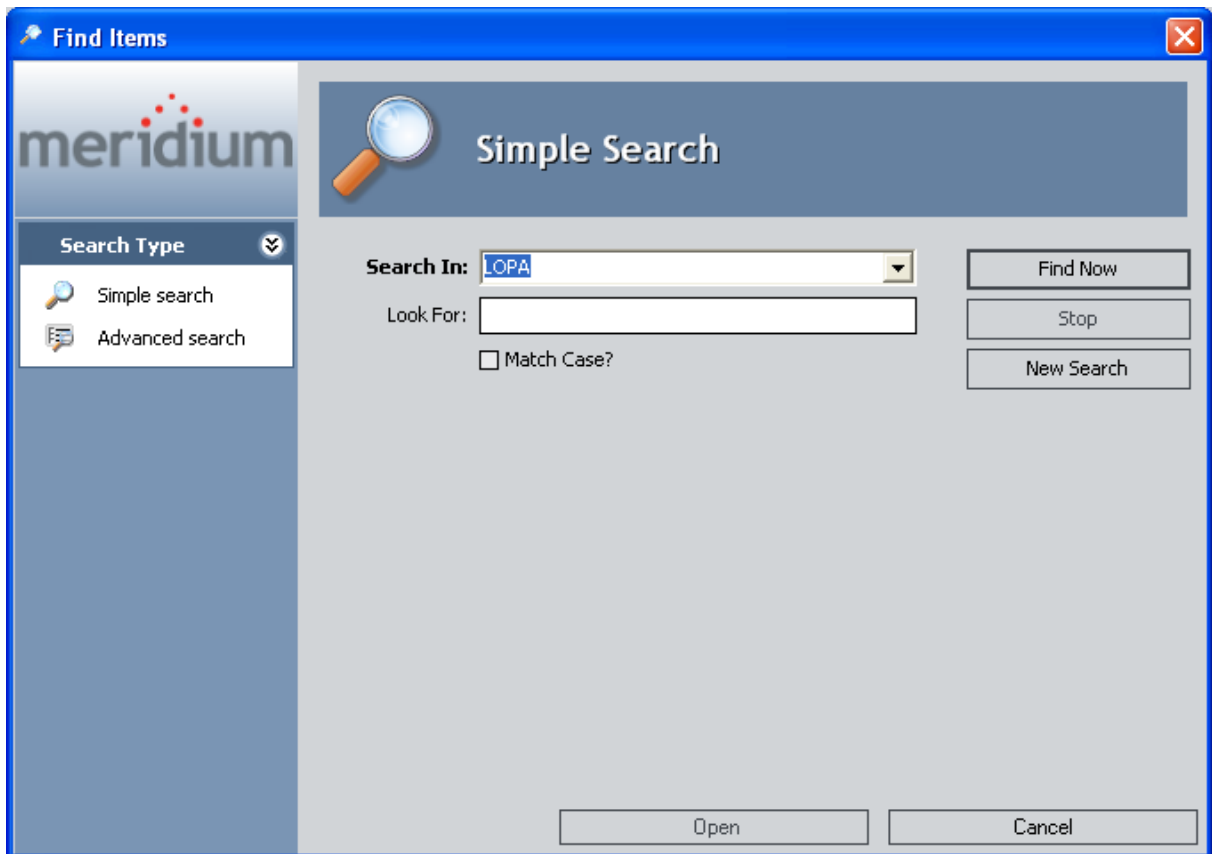

4. Provide the desired search criteria, and then click the **Find Now** button.

The search results appear.

5. In the search results, select the row containing the LOPA record that you want to link to the selected Instrumented Function record, and then click the **Open** button.

The LOPA record is linked to the Instrumented Functions record and appears in the **Associated Risk Assessments** section.

Copying LOPA Records to Create New Ones

When you copy a LOPA record to create a new one, you are creating a new LOPA record that is populated with information from the source record. If the source LOPA record is linked to Independent Layer of Protection records or Consequence Modifier records, those records will not be linked to the new LOPA record.

To copy a LOPA record and create a new one:

1. [Access the Instrumented Functions \(IFs\) page.](#)
2. In the **Instrumented Functions** section, select the row containing the Instrumented Function record to which the desired LOPA record is linked.
3. In the **Associated Risk Assessments** section, select the row containing the LOPA record that you want to copy.
4. Click the **Copy LOPA** button.

A new LOPA record appears on the **LOPA Definition** page and is populated automatically with information from the source record.

5. In the datasheet area, in the LOPA ID field on the **Definition** tab, type an ID for the LOPA. This field is required.
6. Above the datasheet, click the **Save** button. 

The record is saved. At this point you can, link the LOPA record to [Independent Layer of Protection records](#) and [Consequence Modifier records](#).

Removing LOPA Records from the Associated Risk Assessments Grid

When you remove a LOPA record from the **Associated Risk Assessments** grid on the **Instrumented Functions (IFs)** page, you are deleting the link between the Instrumented Function record and the LOPA record, and the LOPA record will no longer be associated with the current SIL Analysis.

To remove a LOPA record from the **Associated Risk Assessments** grid:

1. [Access the Instrumented Functions \(IFs\) page.](#)
2. In the **Instrumented Functions** section, select the row containing the Instrumented Function record to which the desired LOPA record is linked.
3. In the **Associated Risk Assessments** section, select the row containing the LOPA record that you want to remove.
4. Click the **Remove LOPA** button.

A confirmation message appears, asking if you really want to remove the LOPA record from the SIL Analysis.

5. Click the **Yes** button.

The LOPA record is removed from the **Associated Risk Assessments** grid.

About Independent Layer of Protection Records

An *independent layer of protection* is a device, system, or action that exists to prevent a risk and is independent of the event that initiates the scenario. An independent layer of protection is external to any other layer of protection or safety instrumented system. The effectiveness of an independent layer of protection is quantified in terms of its probability of failure data (PFD), which is a numeric value that represents the probability that the independent layer of protection will fail to perform its specified function on demand.

Independent Layer of Protection records store details on probability and failure rate data for an independent layer of protection. When you create an Independent Layer of Protection record, you are defining the item that helps mitigate a risk, which is also mitigated by the instrumented function. By defining these items, you can more accurately assess the SIL value that is associated with a given instrumented function because you are taking into account all the mitigating factors that exist for that risk.

You can use the values in the **Type** list to populate an Independent Layer of Protection record automatically with values from an IPL Type record. [IPL Type records are provided in the baseline database and can be defined by an SIS Administrator or SIS Engineer.](#)

You should create one Independent Layer of Protection record per layer of protection that exists. Via the Independent Layer of Protection datasheet, you can link the Independent Layer of Protection record to the Equipment or Functional Location record that represents the equipment or location for which the layer of protection exists.

You can manage Independent Layer of Protection records via the **Independent Protective Layers** section on the **LOPA Definition** page.

Creating Independent Layer of Protection Records

When you create an Independent Layer of Protection record, you are automatically linking that record to the LOPA record with which you are currently working. The following instructions provide details on creating a new Independent Layer of Protection record. These instructions assume that you are familiar with [the fields in Independent Layer of Protection records](#) and that you want to use a value in the **Type** list to populate the record automatically.

To create an Independent Layer of Protection record:

1. [Open the LOPA record](#) to which you want to link the Independent Layer of Protection record.
2. At the bottom of the **Independent Protective Layers** section, click the **Add New IPL** button.

A new blank Independent Layer of Protection record appears in a new window.

3. In the IPL ID field, type an ID for the record.
4. In the Type list, select the desired IPL type.

The Description field is populated automatically with the value stored in the Description field in the corresponding IPL Type record, and if the IPL type is associated with a:

- Fixed PFD value, the PFD field is disabled and populated automatically with the value stored in the Default Value field in the corresponding IPL Type record.
- PFD range, the PFD field is required.

5. If the PFD field is required, enter a value in the **PFD** cell.

If the value does not fall within the specified PFD range, a message will appear, indicating that the value you entered is not valid, and you will need to specify a value that is within the specified range.

6. In either the Functional Location or Equipment ID field, click the  button.

The **Find Items** window appears, and the **Search In** text box is populated automatically with either *Functional Location* or *Equipment*, depending upon the field from which you accessed the **Find Items** window.

7. Perform a search for the desired Equipment or Functional Location record.

8. Select the desired record, and then click the **Open** button.

The Record ID for the selected record appears in the Functional Location or Equipment ID field, depending upon the family to which the record belongs.

9. Click **OK**.

The record is saved and appears in the **Independent Protective Layers** grid.

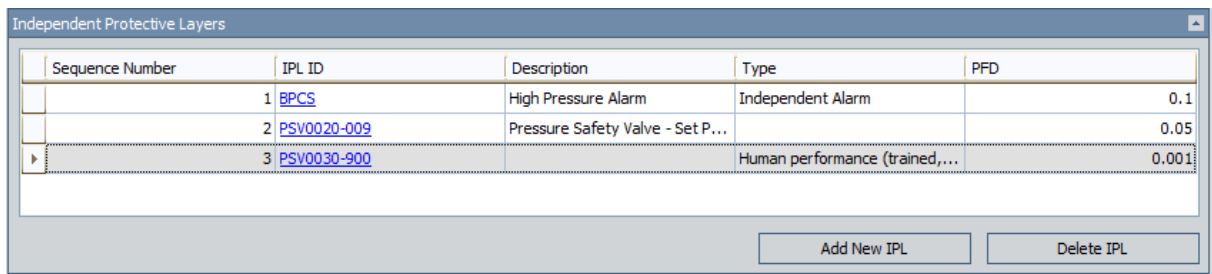

Sequence Number	IPL ID	Description	Type	PFD
1	BPCS	High Pressure Alarm	Independent Alarm	0.1
2	PSV0020-009	Pressure Safety Valve - Set P...		0.05
3	PSV0030-900		Human performance (trained,...	0.001

Deleting Independent Layer of Protection Records

When you delete an Independent Layer of Protection record, you are deleting the link between the Independent Layer of Protection record and the LOPA record to which it is linked *and* deleting the Independent Layer of Protection record from the Meridium APM database.

To delete an Independent Layer of Protection record:

1. [Open the LOPA record](#) that is linked to the Independent Layer of Protection record that you want to delete.
2. In the **Independent Protective Layers** grid, select the row containing the Independent Layer of Protection record that you want to delete.
3. At the bottom of the **Independent Protective Layers** section, click the **Delete IPL** button.

A confirmation message appears, asking if you really want to delete the Independent Layer of Protection record.

4. Click the **Yes** button.

The selected record is deleted and removed from the **Independent Protective Layers** grid.

About Consequence Modifier Records

A *consequence modifier* is an action or event, which can increase the probability that a risk may occur if the action is not mitigated and proceeds into an undesirable event. Details about a consequence modifier are stored in Consequence Modifier records, which are linked to LOPA records. When you define a Consequence Modifier record, you are defining the event or action that exists within a risk scenario and increases the probability or severity of the undesirable outcome that may occur as a result of that scenario.

For example, assume that the SIL Analysis team is conducting an LOPA to investigate the risk scenario, illustrated in the following diagram, where each box represents a portion of the scenario, and each label indicates the family that stores that information:

When Valve A-1001 fails, flammable gas is released into an explosive atmosphere, and if the flame ignites, causing a vapor cloud explosion in the vicinity of the operator, it could cause a fatal injury.

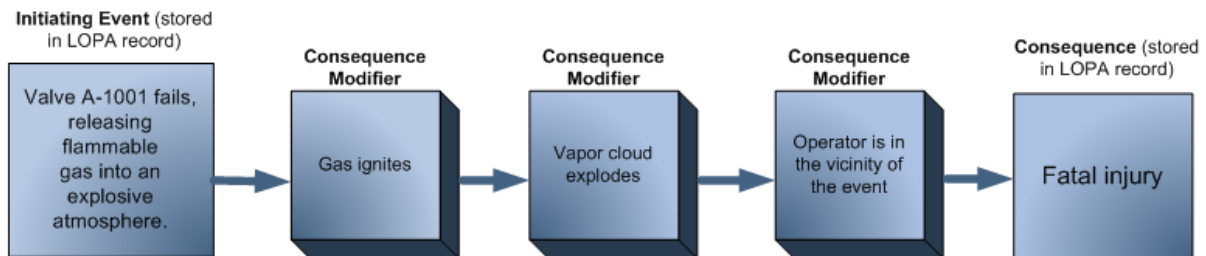

In this risk scenario, the fatal injury is consequence of the valve failure, and the following events or actions are the consequence modifiers:

- The flame igniting
- The vapor cloud exploding
- The operator being in the vicinity of the explosion

Because these actions and events appear within the risk scenario, the probability associated with the consequence occurring is increased exponentially. In other words, if the operator was not in the vicinity of the blast, the probability of fatal injury would be less. By examining the granular events that are associated with a risk, the SIL Analysis team can more accurately assess the SIL value for the instrumented function.

Accessing the Consequence Modifiers Page

The **Consequence Modifiers** page lets you manage the Consequence Modifier records that are linked to a given LOPA record.

To access the **Consequence Modifiers** page:

1. [Open the desired LOPA record](#) on the **LOPA Definition** page.
2. On the **Navigation** menu, click the **Modifiers** link.

The **Consequence Modifiers** page appears.

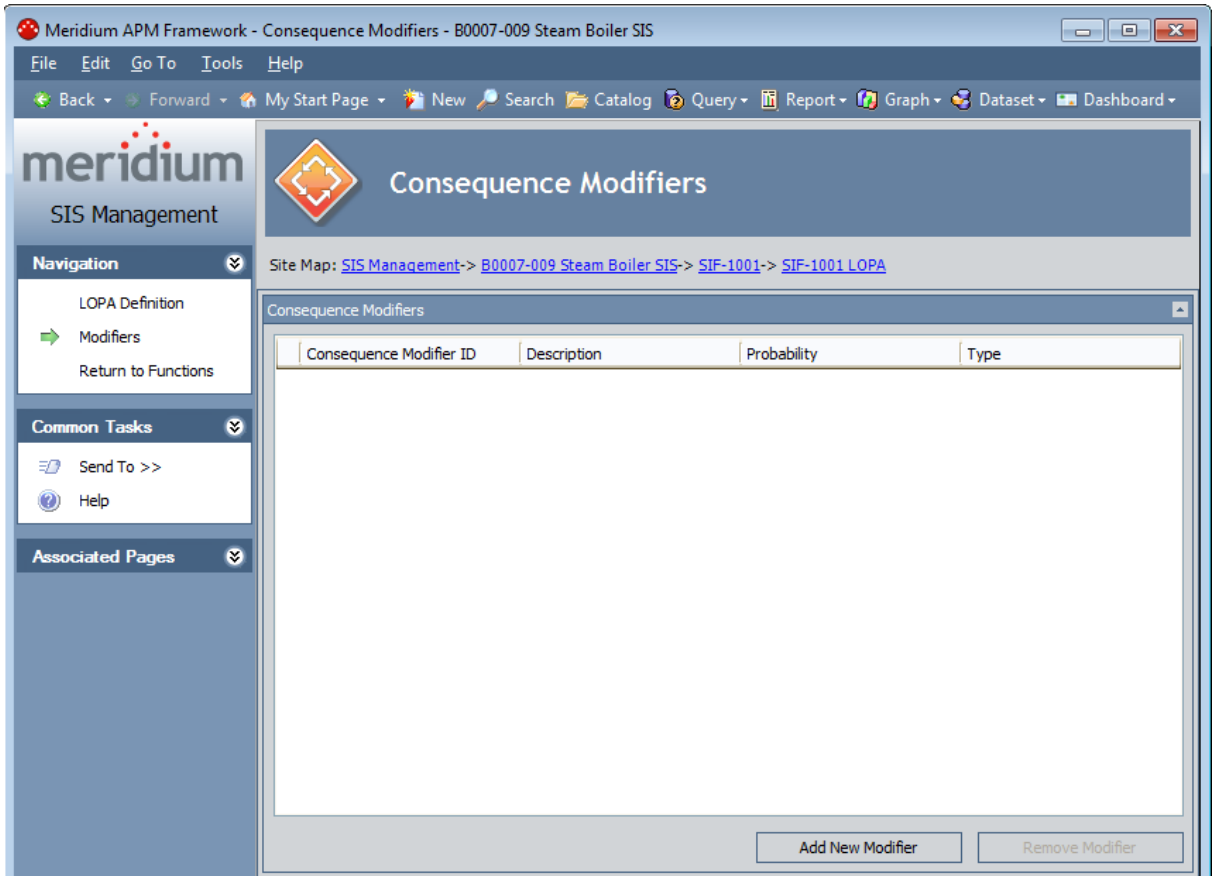

Aspects of the Consequence Modifiers Page

The **Consequence Modifiers** page displays a grid, which contains a list of Consequence Modifier records that are linked to the LOPA record with which you are currently working. Each row in the grid represents one Consequence Modifier record. For each Consequence Modifier record in the grid, the following information is displayed:

- **Consequence Modifier ID:** The value that exists in the Consequence Modifier ID field in the Consequence Modifier record. This value appears as a hyperlink, which you can use to open the Consequence Modifier record.
- **Description:** The value that exists in the Description field in the Consequence Modifier record.
- **Probability:** The value that exists in the Probability field in the Consequence Modifier record.
- **Type:** The value that exists in the Type field in the Consequence Modifier record.

Below the grid, the following buttons appear:

- **Add New Modifier:** Displays a new blank Consequence Modifier record in a new window.
- **Remove Modifier:** Displays a confirmation message, and then removes the Consequence Modifier record from the grid.

The **Consequence Modifier** page contains the following task menus:

- [Navigation](#)
- [Common Tasks](#)
- [Associated Pages](#)

Creating New Consequence Modifier Records

When you create a Consequence Modifier record, you are linking that record to the LOPA record with which you are currently working.

To create a new Consequence Modifier record:

1. [Access the Consequence Modifier page.](#)
2. Below the grid, click the **Add New Modifier** button.

A new blank Consequence Modifier record appears.

	Value(s)
▶ Consequence Modifier ID	
Description	
Type	
Probability	

3. Provide values in the fields as desired. Note that the following fields are required:
 - Consequence Modifier ID
 - Probability
4. Click **OK**.

The record is saved and appears in the grid.

Removing Consequence Modifier Records from the Consequence Modifiers Grid

When you remove a Consequence Modifier record from the **Consequence Modifiers** grid, you are deleting the Consequence Modifier record from the Meridium APM database *and* the link between the Consequence Modifier record and the LOPA record to which it is linked.

To remove a Consequence Modifier record from the Consequence Modifiers grid:

1. Access the Consequence Modifiers page.
2. In the grid, select the row containing the Consequence Modifier record that you want to remove.
3. Below the grid, click the **Remove Modifier** button.

A confirmation message appears, asking if you really want to remove the record from the current LOPA.

4. Click the **Yes** button.

The record is deleted and removed from the grid.

About Promoting Instrumented Functions to ASM

When you promote an Instrumented Function record to ASM, the Meridium APM system will automatically create in ASM one:

- *Asset Strategy* for the Equipment or Functional Location record that is linked to the Instrumented Function record and link that Asset Strategy to the Instrumented Function record through the *Was Promoted to ASM Element* relationship.

Before you promote an Instrumented Function record to ASM, you should specify on the **SIS Management Administration** page whether you want the Meridium APM system to promote the Equipment record that is specified in the Equipment ID field or the Functional Location record that is specified in the Functional Location ID field.

Note: If an Asset Strategy already exists for the record that is linked to the Instrumented Function record, the existing Asset Strategy will be used.

- *Action record* for each Inspection Task record that is linked to the Instrumented Function record and links those Action records to the Instrumented Function record through the *Was Promoted to ASM Element* relationship. The Action records that are created are read-only, meaning that you cannot modify the records.
- *Failure Risk record* for each risk category that exists in the Risk Assessment record that is linked to the Instrumented Function record and links the Failure Risk records to the Instrumented Function records through the *Was Promoted to ASM Element* relationship. The Failure Risk records that are created will be read-only, meaning that you cannot modify the records.

Additionally, if you update in SIS Management the Instrumented Function record or and records that are linked to that record, if you promote that Instrumented Function record *again*, the updates that you made in SIS Management will also saved in ASM. For example, if you link an additional Inspection Task record to the Instrumented Function record that was already promoted to ASM, when you promote that Instrumented Function record again, one additional Action record will be created for the new Inspection Task record and linked to the Asset Strategy that exists for the Instrumented Function record.

Before you can promote an Instrumented Function record to ASM, the Instrumented Function record must be linked to:

- One Equipment or Functional Location record.
- On Risk Assessment record.

Note: You cannot promote to ASM an Instrumented Function record whose risk assessment method is a LOPA.

The **ASM** link on the **Assessment Tasks** menu will be disabled until the preceding criteria are met for an Instrumented Function record that is selected in the **Instrumented**

Functions pane on the **Instrumented Functions (IFs)** page. When you click the **ASM** link, a submenu appears with the following options:

- **Promote:** If the record has not yet been promoted to ASM, the Instrumented Function record will be promoted to ASM, and the **Asset Strategy Overview** page will appear, displaying the Asset Strategy overview for the Instrumented Function record.

-or-

If the record has already been promoted to ASM, the Asset Strategy will be updated with any changes that were made since it was first created, and the **Asset Strategy Overview** page will appear, displaying the Asset Strategy overview for the Instrumented Function record.

- **View:** If the record has not yet been promoted to ASM, this link is disabled.

-or-

If the record has already been promoted to ASM, the **Asset Strategy Overview** page will appear, displaying [the existing Asset Strategy](#).

Promoting Instrumented Functions to ASM

To promote an Instrumented Function record to ASM:

1. [Access the Instrumented Functions \(IFs\) page.](#)
2. In the **Instrumented Functions** pane, select the row containing the Instrumented Function record that you want to promote to ASM.
3. On the **Assessment Tasks** menu, click the **ASM** link.
A submenu appears.
4. On the submenu, click the **Promote** link.

The **Asset Strategy Overview** page appears, displaying the Asset Strategy overview for the Instrumented Function record.

Viewing Asset Strategies Created from Instrumented Functions

To view an Asset Strategy that was created from an Instrumented Function record:

1. [Access the Instrumented Functions \(IFs\) page.](#)
2. In the **Instrumented Functions** pane, select the row containing the Instrumented Function record whose Asset Strategy you want to view.
3. On the **Assessment Tasks** menu, click the **ASM** link.

A submenu appears.

4. On the submenu, click the **View** link.

The **Asset Strategy Overview** page appears, displaying the Asset Strategy overview for the Instrumented Function record.

About Proof Testing

Safety instrumented systems and each instrumented function within that system needs to be tested to ensure that the system is functioning to the standards for which it is designed. A *proof test* consists of a set of steps that you need to perform to test safety instrumented systems and instrumented functions. The conditions under which the test is conducted should represent the normal conditions under which the system is intended to operate.

Depending on the group of equipment or devices that make up a safety instrumented system, you will want to define a set of test steps that apply to a given group equipment or devices. In other words, you will need to define one set of test steps that you can reuse when you test similar systems.

For each proof test that you want to conduct, you should create at least one record in each of the following families:

- **SIS Proof Test Template:** Stores details about a given proof test, including the steps that need to be performed. For each unique set of test steps that exists, you will need to create one SIS Proof Test Template record to store those details.
- **SIS Proof Test Template Detail:** Stores the details on each specific step that needs to be performed for the test. SIS Proof Test Template Detail records are linked to SIS Proof Test Template records through the *Has Template Detail* relationship. You should create one SIS Proof Test Template Detail record for each step that is required for that test.
- **SIS Proof Test:** Stores details about a proof test that you perform, including the test results. When you create an SIS Proof Test record, you will need to specify the SIS Proof Test Template record that contains the details about the proof test you want to perform. When you select the SIS Proof Test Template record, one Functional Test Detail record will be created for each SIS Proof Test Template Detail record that is linked to the SIS Proof Test Template record. For each proof test that you want to perform, you will need to create one SIS Proof Test record. You can, however, reuse SIS Proof Test Template records.

You can think of the SIS Proof Test Template record and SIS Proof Test Template Detail records as the specification for how the test should be performed, and the SIS Proof Test record and Functional Test Details records as a record of the test occurring.

To conduct a proof test, you will need to complete the following steps:

1. **Define the proof test steps** that need to be performed for a given safety instrumented system by creating one Proof Test Template record for each type of test that will need to be performed. Creating an SIS Proof Test Template record includes linking SIS Proof Test Template Detail records to the SIS Proof Test Template record.
2. **Create an SIS Proof Test record**, which serves as a record of the test event and stores the results of that test.

After you have completed a proof test, you can [create Risk Assessment Recommendation records](#) to record recommendations for how a particular proof test can be improved. For example, you may want to suggest adding or removing a particular step from the proof test requirements.

This section of the documentation provides details on managing SIS Proof Test Template and SIS Proof Test records. For details on how these families participate in the SIS Management data model, [see the SIS Management data model image](#).

Common Tasks Menu

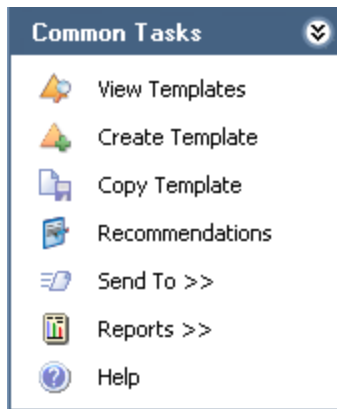

When you are working with SIS Proof Test Template records in SIS Management, the **Common Tasks** menu will appear and contains the following links:

- **View Templates:** Displays the **Proof Test Templates** page, where you can view a list of existing SIS Proof Test Template records that are linked to the Safety Instrumented System record or Instrumented Function record with which you are currently working. This link is disabled on the **Proof Test Templates** page.
- **Create Templates:** Displays a new blank SIS Proof Test Template record on the **Proof Test Template Definition** page.
- **Copy Template:** Displays a new SIS Proof Test Template record on the **Proof Test Template Definition** page that is populated with information from the source SIS Proof Test Template record. This link is enabled only when you are viewing an existing SIS Proof Test Template record.
- **Recommendations:** Displays the **Recommendations** dialog box, where you can manage Risk Assessment Recommendation records that are linked to an SIS Proof Test Template record. This link is enabled only when you are viewing existing SIS Proof Test Template records.
- **Send To:** Displays a submenu with options that let you provide a link to the current page on your desktop (create shortcut), in an email message, or on a Home Page.
- **Reports:** Displays a submenu that displays the caption of the Catalog item *Proof Test Template Report* as a link. The **Reports** link appears only on the **Proof Test Template Definition** page and is enabled only when you are viewing an existing SIS Proof Test Template record.
- **Help:** Displays the context-sensitive help topic for the page that you are currently viewing.

Accessing the Proof Test Template Definition Page

Accessing the Proof Test Template Definition page:

1. [Access the Safety Instrumented Systems page](#) (if you want to link the SIS Proof Test Template record to a Safety Instrumented System record).

-or-

[Access the Instrumented Functions \(IFs\) page](#) (if you want to link the SIS Proof Test Template record to an Instrumented Function record).

2. In the grid, select the record to which you want to link the SIS Proof Test Template record.
3. On the **Assessment Tasks** menu, click the **Test Templates** link, and then click **Create**.

The Proof Test Template Definition page appears.

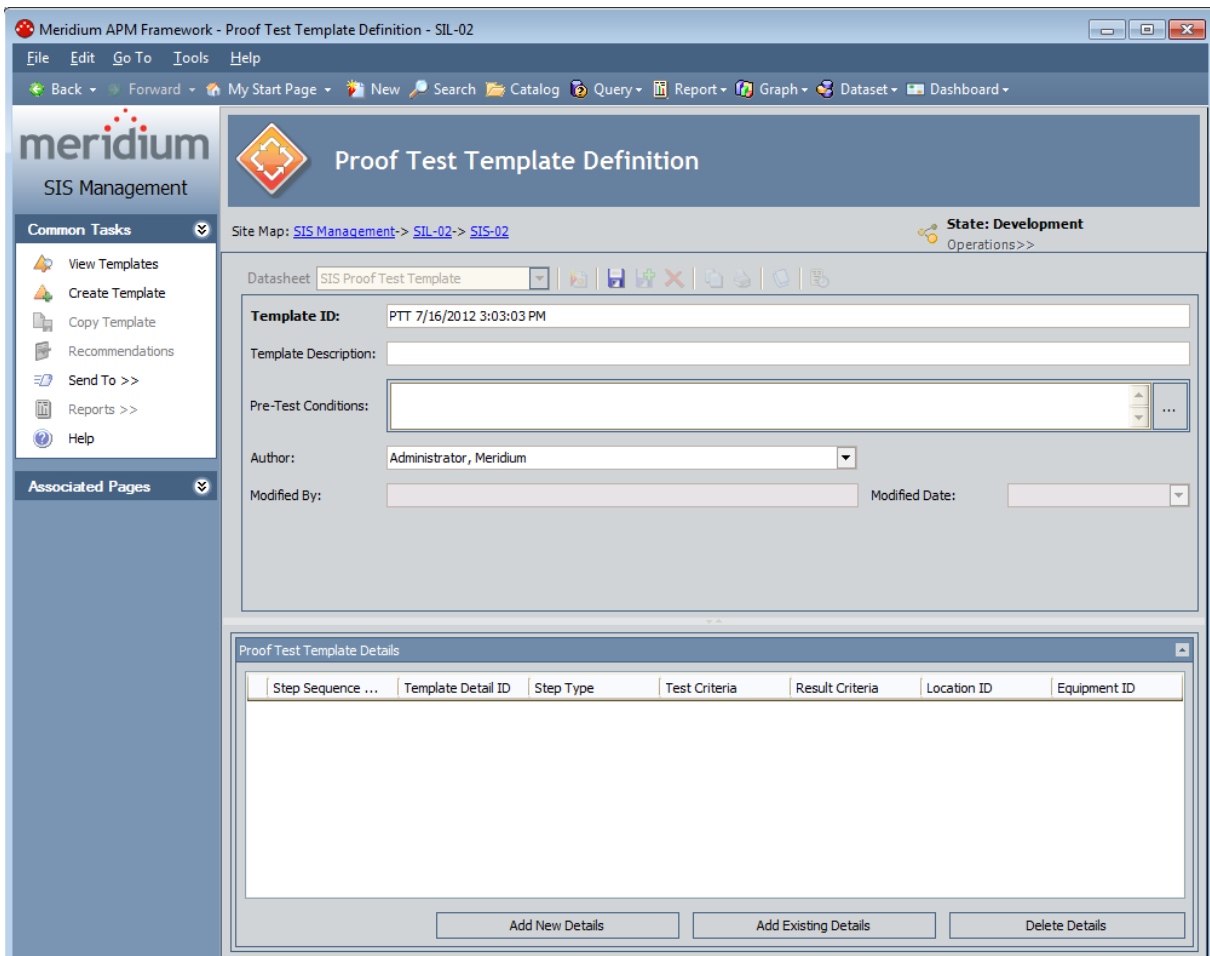

Aspects of the Proof Test Template Definition Page

The **Proof Test Template Definition** page contains the SIS Proof Test Template datasheet, which is a master/detail datasheet that contains two sections:

- **Master record:** Contains fields that you can use to describe the proof test.
- **Proof Test Template Details:** Contains a grid that displays a list of SIS Proof Test Template Detail records, which store details on the individual steps that need to be performed during the proof test. Each row in the grid represents one [SIS Proof Test Template Detail record](#). For each record that appears in the grid, the following information is displayed:
 - Step Sequence Number
 - Template Detail ID
 - Step Type
 - Test Criteria
 - Result Criteria
 - Location ID
 - Equipment ID

Below the grid, the following buttons appear:

- **Add New Details:** Displays a new blank SIS Proof Test Template Detail record.
- **Add Existing Details:** Displays the **Find Items** window, where you can search for an existing SIS Proof Test Template Detail record to link to the SIS Proof Test Template record.
- **Delete Details:** Displays a confirmation message, and then deletes the selected SIS Proof Test Template Detail record.

The **Proof Test Template Definition** page contains the following task menus:

- [Common Tasks](#)
- [Associated Pages](#)

Creating SIS Proof Test Template Records

When you create an SIS Proof Test Template record, you are defining the proof test and related steps that need to be performed when you test a given safety instrumented system or instrumented function within that system. You can create SIS Proof Test Template records and link them to records in the following families:

- Safety Instrumented System
- Instrumented Function

The following instructions provide details on creating an SIS Proof Test Template record that will be linked automatically to a record in the preceding families. The SIS Proof Test Template datasheet is a master/detail datasheet. This means that when you create the SIS Proof Test Template record, you will also need to create SIS Proof Test Template Detail records that will be linked automatically to the SIS Proof Test Template record.

To create an SIS Proof Test Template record:

1. [Access the Proof Test Template Definition page.](#)
2. In the master record, provide values in the fields as desired.
3. In the **Proof Test Template Details** section, click the **Add New Details** button.

A new blank SIS Proof Test Template Detail record appears in a new window.

Note: You can link existing SIS Proof Test Template Detail records to the SIS Proof Test Template record via the **Add Existing Details** button. These instructions assume that you want to create a new SIS Proof Test Template Detail record. For details on adding existing SIS Proof Test Template Detail record to SIS Proof Test Template records, see the topic for [adding existing SIS Proof Test Template Detail Records to the SIS Proof Test Template Detail record](#).

4. [Provide values in the fields as desired](#), and then click **OK**.

The SIS Proof Test Template Detail record is linked to the SIS Proof Test Template record and appears in the **Proof Test Template Details** section.

5. Continue linking SIS Proof Test Template Detail records as desired.
6. Above the datasheet, click the **Save** button. 

The SIS Proof Test Template record is saved.

Accessing a List of Existing SIS Proof Test Template Records

The following instructions provide details on accessing the **Proof Test Templates** page, where you can view a list of SIS Proof Test Template records that are linked to the currently selected Safety Instrumented System record or instrumented function record. You can use this page to view the list of proof tests that have been defined or [define a new proof test that is based on an existing proof test](#).

To access the list of existing SIS Proof Test Template records:

1. [Access the Safety Instrumented Systems page](#) (if you want to view the SIS Proof Test Template records that are linked to a Safety Instrumented System record).

-or-

[Access the Instrumented Functions \(IFs\) page](#) (if you want to view the SIS Proof Test Template records that are linked to an Instrumented Function record).

2. In the grid, select the record whose SIS Proof Test Template records you want to view.
3. On the **Assessment Tasks** menu, click the **Test Templates** link.
A submenu appears.
4. On the submenu, click the **View** link.
The **Proof Test Templates** page appears.

Accessing a List of Existing SIS Proof Test Template Records

The screenshot shows a web browser window titled "Meridium APM Framework - Proof Test Templates - B0007-009 Steam Boiler SIS". The browser's address bar shows the site map path: [SIS Management](#) -> [B0007-009 Steam Boiler SIS](#) -> [SIF-1001](#). The page header includes the Meridium logo and the text "SIS Management" and "Proof Test Templates".

On the left side, there is a sidebar with "Common Tasks" and "Associated Pages". The "Common Tasks" list includes: View Templates, Create Template, Copy Template, Recommendations, Send To >>, and Help.

The main content area is titled "Proof Test Templates" and contains a table with the following data:

Template ID	Template Description	Author	Created On	Modified Date
SIF-1001 Protective L...	Functional test of SIF...	Demo, Joe	2/5/2011	2/5/2011

At the bottom of the page, there are three buttons: "Create Template", "Add Existing Template", and "Remove Template".

Aspects of the Proof Test Templates Page

The **Proof Test Templates** page contains the **Proof Test Templates** grid, which displays the list of SIS Proof Test Template records that are linked to the Safety Instrumented System record or Instrumented Function record with which you are currently working. Each row in the grid represents one SIS Proof Test Template record. For each record in the grid, the following information appears:

- **Template ID:** The value that exists in the Template ID field in the SIS Proof Test Template record.
- **Description:** The value that exists in the Template Description field in the SIS Proof Test Template record.
- **Author:** The value that exists in the Author field in the SIS Proof Test Template record.
- **Created On:** The value that exists in the Created On field in the SIS Proof Test Template record.
- **Modified Date:** The value that exists in the Modified Date field in the SIS Proof Test Template record.

Below the grid, the following buttons appear:

- **Create Template:** Displays a new blank SIS Proof Test Template record on the **Proof Test Template Definition** page.
- **Add Existing Template:** Displays the **Find Items** window, where you can search for an existing SIS Proof Test Template record to link to the Safety Instrumented System record or Instrumented Function record with which you are currently working.
- **Remove Template:** Displays a confirmation message, and then removes the selected SIS Proof Test Template record from the **Proof Test Templates** grid.

The **Proof Test Templates** page contains the following task menus:

- [Common Tasks](#)
- [Associated Pages](#)

Viewing an Existing SIS Proof Test Template Record

When you are viewing the list of proof tests, you can view the details of that proof test. When you do so, you are opening the SIS Proof Test Template record on the **Proof Test Template Definition** page. When you are viewing the details of the record, you can also modify the information that is stored in the record.

To view the details of an existing SIS Proof Test Template record:

1. [Access the Proof Test Templates page](#).
2. In the **Proof Test Templates** grid, locate the row containing the SIS Proof Test Template record whose details you want to view.
3. In the **Template ID** cell in that row, click the hyperlinked Template ID for the desired record.

The selected record appears on the **Proof Test Template Definition** page. At this point, you can modify the record.

Adding Existing SIS Proof Test Template Detail Records to the SIS Proof Test Template Record

When you define a proof test in an SIS Proof Test Template record, you will define the individual steps that should be performed for that test. If desired, you can reuse a step that is associated with a different proof test. To do so, you will need to search for an existing SIS Proof Test Template Detail record to link to the SIS Proof Test Template record.

The following instructions provide details on linking an existing SIS Proof Test Template Detail record to an SIS Proof Test Template record. For details on creating a new SIS Proof Test Template Detail record to link to the SIS Proof Test Template record, see [the instructions for creating SIS Proof Test Template records](#).

To add an existing SIS Proof Test Template Detail record to the SIS Proof Test Template record:

1. [Access the SIS Proof Test Template record](#) to which you want to add an SIS Proof Test Template Detail record.
2. In the **Proof Test Template Details** section, click the **Add Existing Details** button.

The **Find Items** window appears.

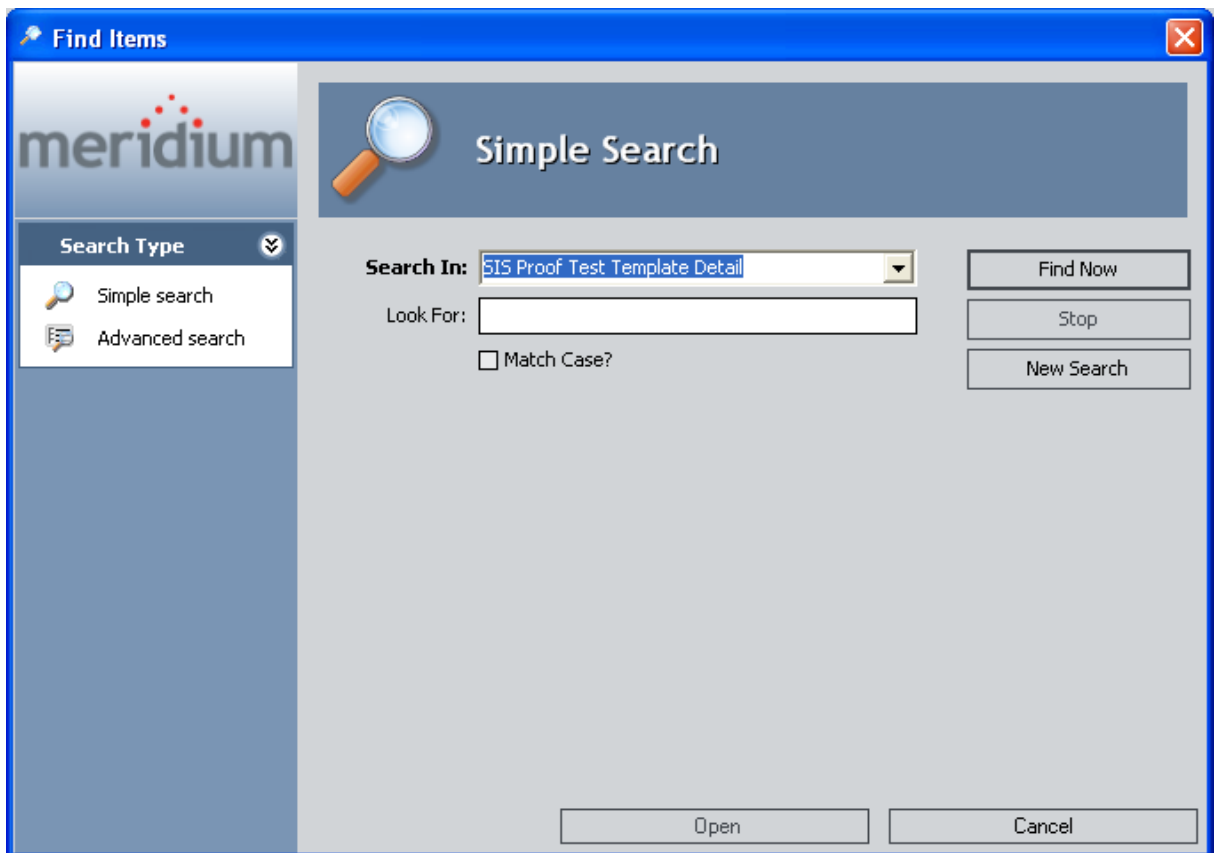

3. Specify the desired search criteria, and then click the **Find Now** button.

The search results appear.

4. In the search results, select the SIS Proof Test Template Detail records that you want to link to the SIS Proof Test Template record.

5. Click the **Open** button.

The selected records are linked to the SIS Proof Test Template record and appears in the **Proof Test Template Details** section.

6. At the top of the datasheet, click the **Save** button. 

Viewing Existing SIS Proof Test Template Detail Records

The following instructions provide details on viewing the contents of an SIS Proof Test Template Detail record that is linked to an SIS Proof Test Template record.

To view an existing SIS Proof Test Template Detail record:

1. [Access the SIS Proof Test Template record](#) whose Detail records you want to view.
2. In the **Proof Test Template Details** section, locate the row containing the SIS Proof Test Template Detail record you want to view.
3. In the **Template Detail ID** cell, click the hyperlinked Template Detail ID.
The selected record appears in a new window.
4. If desired, you can modify the record, and then click **OK**.
Your changes are saved.

Removing SIS Proof Test Template Detail Records from the SIS Proof Test Template Record

If desired, you can remove a step that you previously included in the test steps for a proof test. To do so, you will need to remove the SIS Proof Test Template Detail record from the SIS Proof Test Template record. When you remove an SIS Proof Test Template Detail record from an SIS Proof Test Template record, you are deleting the link between the SIS Proof Test Template record and the SIS Proof Test Template Detail record, and the SIS Proof Test Template record will no longer appear in the **Proof Test Template Detail** section on the SIS Proof Test Template datasheet.

To remove an SIS Proof Test Template Detail record from the SIS Proof Test Template record:

1. [Access the SIS Proof Test Template record](#), which is linked to the SIS Proof Test Template Detail record that you want to remove.
2. In the **Proof Test Template Details** grid, select the row containing the SIS Proof Test Template Detail record you want to remove.
3. Below the grid, click the **Delete Details** button.

A confirmation message appears, asking if you really want to remove the SIS Proof Test Template Detail record from the SIS Proof Test Template record.

4. Click the **Yes** button.

The selected SIS Proof Test Template Detail record is removed from the **Proof Test Template Details** grid.

Copying SIS Proof Test Template Records to Create New Ones

You can use an existing proof test definition to define another similar proof test. To do so, you can copy an existing SIS Proof Test Template record, which will create a new SIS Proof Test Template record that is automatically populated with information from the source record. When you create a new SIS Proof Test Template record in this way, the SIS Proof Test Template Detail records that are linked to the *source* record are also linked the *new* record. These records will not, however, appear in the **Proof Test Template Details** section in the *new* record until after you save the new record.

To copy an SIS Proof Test Template record to create a new one:

1. Access the desired SIS Proof Test Template record.
2. On the **Common Tasks** menu, click the **Copy Template** link.

A new SIS Proof Test Template record appears on the **Proof Test Template Definition** page and is populated automatically with information from the source record.

3. Modify the values in the master record as desired
4. Click the **Save** button. 

The **Proof Test Template Details** section is populated automatically with the SIS Proof Test Template Detail records that are linked to the source record.

5. Modify the values in the detail records as desired, including creating new SIS Proof Test Template Detail records.
6. When you are finished, click the **Save** button. 

The record is saved.

Removing SIS Proof Test Template Records

If an existing proof test is no longer valid, you can remove that proof test from the SIL Analysis. When you do so, you are deleting the link between the SIS Proof Test Template record and the Safety Instrumented System record or Instrumented Function record to which it is linked.

To remove an SIS Proof Test Template record:

1. [Access the Proof Test Templates page](#).
2. In the **Proof Test Templates** grid, select the row containing the SIS Proof Test Template record that you want to remove.
3. Below the grid, click the **Remove Template** button.
A confirmation message appears, asking if you really want to remove the proof test from the SIL Analysis.
4. Click the **Yes** button.

The selected record is removed from the **Proof Test Templates** grid.

About SIS Proof Test Records

SIS Proof Test records store details about a proof test that is executed, including the results of the proof test. Each SIS Proof Test record will be linked to one or more Functional Test Detail records, which store details on the steps that you need to perform during the proof test and the results of each test step.

When you create an SIS Proof Test record, you will need to specify an SIS Proof Test Template record whose details you will use to perform the proof test. When you do so, one Functional Test Detail record will be created for each *SIS Proof Test Template Detail* record that is linked to the SIS Proof Test Template record that you specified in the SIS Proof Test record. The Functional Test Detail records will be populated automatically with information from the source SIS Proof Test Template Detail records.

Common Tasks Menu

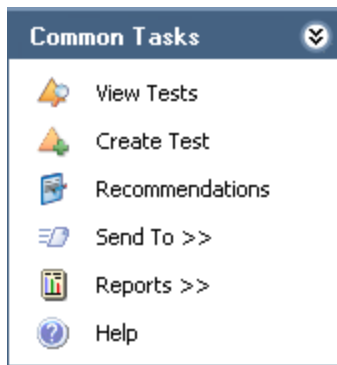

When you are working with SIS Proof Test records in SIS Management, the **Common Tasks** menu will appear and contains the following links:

- **View Tests:** Displays the **Proof Tests** page, where you can view a list of existing SIS Proof Test records that are linked to the Safety Instrumented System record or Instrumented Function record with which you are currently working. This link is disabled on the **Proof Tests** page.
- **Create Test:** Displays a new blank SIS Proof Test record on the **Proof Test Definition** page.
- **Recommendations:** Displays the **Recommendations** dialog box, where you can manage Risk Assessment Recommendation records that are linked to an SIS Proof Test record. This link is enabled only when you are viewing existing SIS Proof Test records.
- **Send To:** Displays a submenu with options that let you provide a link to the current page on your desktop (create shortcut), in an email message, or on a Home Page.
- **Reports:** Displays a submenu that displays the caption of the Catalog item *Proof Test Report* as a link. The **Reports** link appears only on the **Proof Test Definition** page and is enabled only when you are viewing an existing SIS Proof Test record.
- **Help:** Displays the context-sensitive help topic for the page that you are currently viewing.

Accessing the Proof Test Definition Page

Accessing the Proof Test Definition page:

1. [Access the Safety Instrumented Systems page](#) (if you want to link the SIS Proof Test record to a Safety Instrumented System record).

-or-

[Access the Instrumented Functions \(IFs\) page](#) (if you want to link the SIS Proof Test record to an Instrumented Function record).

2. In the grid, select the record to which you want to link the SIS Proof Test record.
3. On the **Assessment Tasks** menu, click the **Proof Tests** link.
A submenu appears.
4. On the submenu, click the **Create** link.

The **Proof Test Definition** page appears.

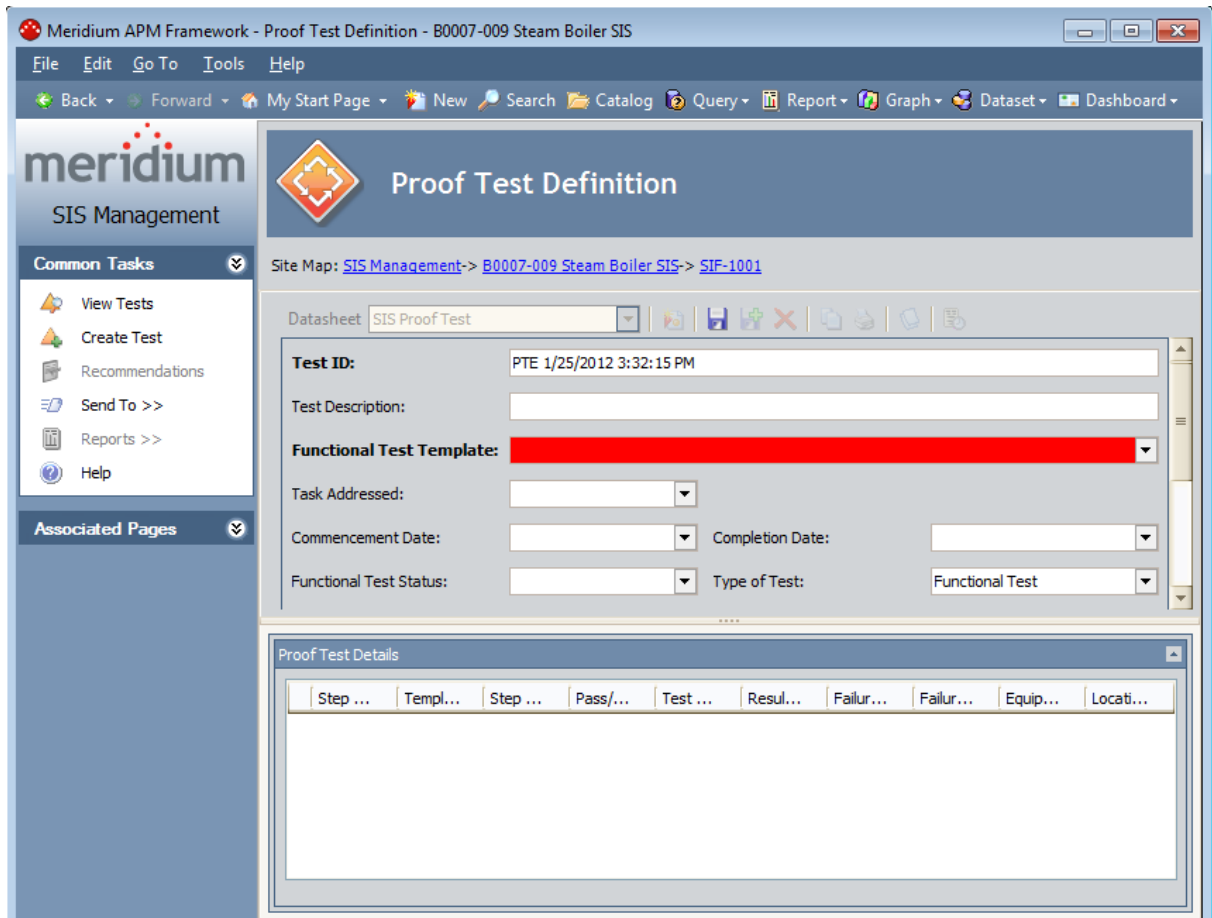

Aspects of the Proof Test Definition Page

The **Proof Test Definition** page contains the SIS Proof Test datasheet, which is a master/detail datasheet that contains two sections:

- **Master record:** Contains fields that you can use to record the status of the proof test and specify the SIS Proof Test Template record whose details you will use to perform the proof test.
- **Proof Test Details:** Contains a grid that displays the list of Functional Test Detail records that are linked to the SIS Proof Test record. Each row in the grid represents one [Functional Test Detail record](#). For each record that appears in the grid, the following information is displayed:
 - Step Sequence Number
 - Template Detail ID
 - Step Type
 - Test Criteria
 - Result Criteria
 - Location ID
 - Equipment ID

If the Proof Test Status field in the SIS Proof Test record contains the value *Closed* or *Complete*, the SIS Proof Test and Functional Test Detail records are disabled on the **Proof Test Definition** page, and you can only view the values stored in these records.

The **Proof Test Definition** page contains the following task menus:

- [Common Tasks](#)
- [Associated Pages](#)

Creating New SIS Proof Test Records

When you create an SIS Proof Test record, you are creating a record of the proof test that takes place in your facility. You can create SIS Proof Test records and link them to records in the following families:

- Safety Instrumented System
- Instrumented Function

The following instructions provide details on creating an SIS Proof Test record that will be linked automatically to a record in the preceding families. The SIS Proof Test data-sheet is a master/detail datasheet. When you create the SIS Proof Test record and specify an SIS Proof Test Template record, Functional Test Detail records will be linked automatically to the SIS Proof Test record that are created based on the SIS Proof Test Template Detail records that are linked to the SIS Proof Test Template record. For details on the relationships that exist between these families, see [the data model image](#).

To create an SIS Proof Test record:

1. [Access the Proof Test Definition page](#).
2. In the master record, in the **Functional Test Template** list, select the Template ID for the SIS Proof Test Template record that contains the test information that you want to use for the proof test. This field is required.
3. Provide values in the remaining fields in the master record as desired.
4. Click the **Save** button. 

The record is saved, and the **Proof Test Details** section is populated automatically with Functional Test Detail records. At this point, you can perform the proof test and [record the results in the SIS Proof Test record](#).

Accessing the List of Existing SIS Proof Test Records

The following instructions provide details on accessing a list of SIS Proof Test records that are currently linked to a given Safety Instrumented System record or Instrumented Function record.

To access the list of existing SIS Proof Test records:

1. [Access the Safety Instrumented Systems page](#) (if you want to view the SIS Proof Test records for a Safety Instrumented System record).

-or-

[Access the Instrumented Functions \(IFs\) page](#) (if you want to view the SIS Proof Test records for an Instrumented Function record).

2. In the grid, select the desired record.
3. On the **Assessment Tasks** menu, click the **Proof Tests** link.
A submenu appears.
4. On the submenu, click the **View** link.
The **Proof Tests** page appears.

Accessing the List of Existing SIS Proof Test Records

The screenshot shows the Meridium APM Framework web application interface. The browser title is "Meridium APM Framework - Proof Tests - B0007-009 Steam Boiler SIS". The application has a menu bar with "File", "Edit", "Go To", "Tools", and "Help". Below the menu bar is a navigation bar with "Back", "Forward", "My Start Page", "New", "Search", "Catalog", "Query", "Report", "Graph", "Dataset", and "Dashboard".

The main content area is titled "Proof Tests" and includes a site map: [SIS Management](#) -> [B0007-009 Steam Boiler SIS](#) -> [SIF-1001](#). Below the site map is a table titled "Proof Tests" with the following data:

Test ID	Test Description	Functional Test Template
SIF-1001 PTE 2/5/2011 10:51:20 PM	SIF-1001 Protective Loop Proof Test	SIF-1001 Protective Loop Test

At the bottom of the page, there are two buttons: "Create Test" and "Delete Test".

Aspects of the Proof Tests Page

The **Proof Tests** page contains the **Proof Test Tests** grid, which displays the list of SIS Proof Test records that are linked to the Safety Instrumented System record or Instrumented Function record with which you are currently working. Each row in the grid represents one SIS Proof Test record. For each record in the grid, the following information appears:

- **Test ID:** The value that exists in the Test ID field in the SIS Proof Test record.
- **Test Description:** The value that exists in the Test Description field in the SIS Proof Test record.
- **Template ID:** The value that exists in the Functional Test Template field in the SIS Proof Test record.

Below the grid, the following buttons appear:

- **Create Test:** Displays a new blank SIS Proof Test record on the **Proof Test Definition** page.
- **Delete Test:** Displays a confirmation message, and then deletes the selected SIS Proof Test record.

The **Proof Test Templates** page contains the following task menus:

- [Common Tasks](#)
- [Associated Pages](#)

Opening SIS Proof Test Records

The following instructions provide details on opening an existing SIS Proof Test record to view its contents.

To open an SIS Proof Test record:

1. [Access the Proof Tests page.](#)
2. In the **Proof Tests** grid, locate the row containing the SIS Proof Test record whose contents you want to view.
3. In the **Test ID** cell, click the hyperlinked ID for the record.

The selected record appears on the **Proof Test Definition** page.

4. If desired, you can modify the values in the fields, and then click the **Save** button.



Opening SIS Proof Test Records

The record is saved.

Recording Proof Test Results in SIS Proof Test Records

When you perform a proof test, you can record the results of each step that is required for that test via the SIS Proof Test record for that proof test.

To record proof test results in an SIS Proof Test record:

1. [Access the SIS Proof Test record for the current proof test.](#)
2. In the **Proof Test Details** section, locate the row containing the Functional Test Detail record, which stores the details of the step for which you want to record the results.
3. In the **Template Detail ID** cell, click the hyperlinked Template Detail ID.

The selected Functional Test Detail record appears in a new window.

<empty> (Functional Test Detail)

Datasheet: Functional Test Detail

Template Detail ID: MI_SISPRFTD 11/18/2009 4:41:42 PM

Step Sequence Number: 1 Step Type: Post Test Procedure

Pass/Fail: Pass

Test Criteria: Post Test Procedure

Result Criteria: Post Test Procedure

Executed By: sisadmin Execution Date: 11/18/2009 4:42:50 PM

Failure Condition: Testing

Failure Type: Dangerous

Equipment ID: ~ AMMONIA COND ~ HXST 165

Location ID: MRD-ROA-REFN-RF001-GM0042-001 ~ MOTOR - NORTH BOILER H2O CIRCULATION

Trip Point: (empty) Trip Point Units: (empty)

Trip Point Direction: (empty) Trip Point Error Limit: (empty)

As Found Trip Point: (empty) As Found Trip Point Error: (empty)

As Left Trip Point: (empty) As Left Trip Point Error: (empty)

OK Cancel

4. Provide values in the fields as desired to indicate the results of the test step.
5. Click **OK**.

The record closes, revealing the **Proof Test Definition** page. You can continue recording test step results in this way.

6. When you are finished, click the **Save** button. 

The record is saved.

About Protective Instrument Loops

A *protective instrument loop* consists of interconnected instruments that work together to serve a function that is defined for the safety instrumented system in which they exist. When you create a protective instrument loop in SIS Management, you are creating a Protective Instrument Loop record, and when you define the components of the protective instrument loop (i.e., the interconnected instruments), you are creating records in the *Protective Instrument Loop Element* family and its subfamilies and linked them to the Protective Instrument Loop record. Throughout this documentation, when we refer to the *protective instrument loop*, we are referring to the Protective Instrument Loop record and all the records that are linked to it, and when we refer to *Protective Instrument Loop Element records*, we are referring to the records that are linked to the Protective Instrument Loop.

When you are working with protective instrument loops in SIS Management, it is helpful to visualize the components of that protective instrument loop as a diagram. For example, the following image shows the baseline protective instrument loop diagram as it appears on the **Protective Instrument Loop Diagram View** page. When you first access the [SIL Validation feature](#) for an SIL Analysis, this diagram will appear by default, and you can use it as a starting point for defining your protective instrument loop.

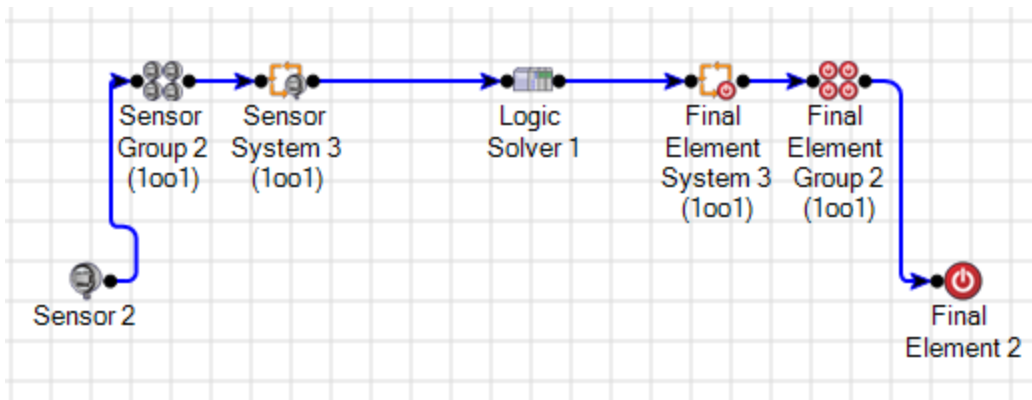

For more details on the components of a protective instrument loop, see the data model image, where the [Protective Instrument Loop family is the predecessor](#).

Additionally, you can create protective instrument loop *templates*, which are protective instrument loops that are specified as a template via the Protective Instrument Loop record for that protective instrument loop. When you are working with protective instrument loop templates in SIS Management, you will use the same features (e.g., the diagram view shown in the preceding image). Within these features, however, the context of the pages will specify that you are working with a template. For more details on the SIL Validation feature, see the topic [about the SIL Validation feature](#).

About the SIL Validation Feature

The *SIL Validation feature* lets you define the various components of [protective instrument loops](#) or [protective instrument loop templates](#) so that you can see how the components will work together to achieve the safety integrity level that was determined based on the risks associated with these components.

Using the SIL Validation feature, you will complete the following steps:

1. Define the components of a protective instrument loop or template.
2. Calculate results.
3. View a summary of these results in graphical format.

The SIL Validation feature includes the following pages, which you can use to complete the preceding steps:

- **Protective Instrument Loop Summary:** Lets you view the Protective Instrument Loop record and graphs, which provide a summary of the calculated data that is stored in Protective Instrument Loop Element records.
- **Protective Instrument Loop Grid View:** Lets you view hierarchically how the Protective Instrument Loop Element records relate to one another in the Meridium APM database.
- **Protective Instrument Loop Diagram View:** Lets you represent visually the physical components of the protective instrument loop or template and how they work together. This is the page that appears by default when you access the SIL Validation feature.

Each page presents a different view of the components of the protective instrument loop and contains the following task menus:

- **Navigation**
- **SIL Validation**
- **Common Tasks**
- [Associated Pages](#)

When you attempt to get your bearings in the SIL Validation feature, keep in mind that each page in the feature displays a custom view of the records that exist in the Meridium APM database.

To begin using the SIL Validation feature, you can:

- [Open an existing protective instrument loop.](#)
- [Create a new protective instrument loop from scratch.](#)
- [Create a new protective instrument loop based on a template.](#)
- [Create a new protective instrument loop template from scratch.](#)
- [Create a new protective instrument loop template based on a protective](#)

[instrument loop](#).

- [Copy an existing protective instrument loop template to create a new one](#).

Throughout this documentation, when we refer to *protective instrument loops*, we are referring to the non-template protective instrument loop. When we discuss templates for protective instrument loops, we refer to them as *protective instrument loop templates*.

The SIL Validation Workflow

When you use the SIL Validation feature, you will complete the following steps:

1. Define the components of the protective instrument loop, using the diagram view.
2. Define the properties of the components, using the grid view.
3. Calculate the values that are defined in the records for the components.
4. View a summary of the data, using the summary view.
5. Define recommendations for the protective instrument loop.

The Navigation Menu

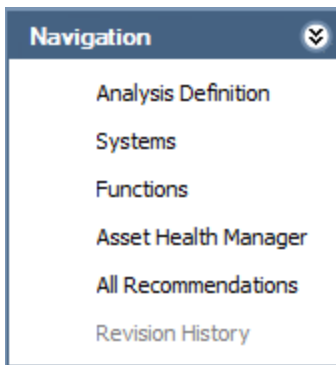

The **Navigation** menu appears on all the pages where you are working with protective instrument loops, but it does not appear when you are working with a protective instrument loop template. This menu contains the following links:

- **Analysis Definition:** Displays the **SIL Analysis Definition** page, where you can modify an SIL Analysis record or create a new one.
- **Systems:** Displays the **Safety Instrumented Systems** page, where you can manage the Safety Instrumented System records for the current SIL Analysis.
- **Functions:** Displays the **Instrumented Functions (IFs)** page, where you can manage the Instrumented Function records for the current SIL Analysis.
- **Asset Health Manager:** Displays the **SIS - Asset Health Manager for <Protective Instrument Loop Record ID> (Protective Instrument Loop)** page, where you can manage Health Indicator records for the current protective instrument loop.

Note: The integration between SIS Management and Asset Health Manager (AHM) is not documented.

- **All Recommendations:** Displays the **Recommendation Management** page, where you can manage the list of Risk Assessment Recommendation records for the current SIL Analysis.
- **Revision History:** Displays the **Analysis Revision History** page, where you can manage the SIL Analysis Revision records that exist for the analysis. This link is enabled only if the state of the SIL Analysis record with which you are currently working has ever been set to Complete.

The SIL Validation Menu

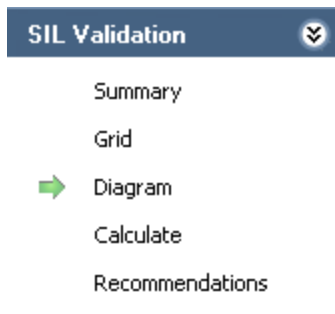

The **SIL Validation** menu appears on all the pages within the SIL Validation feature. A green arrow to the left of an option indicates the feature that you are currently viewing. The **SIL Validation** menu contains the following links:

- **Summary:** Displays the **Protective Instrument Loop Summary** page, where you can view a summary of the protective instrument loop.
- **Grid:** Displays the **Protective Instrument Loop Grid View** page, where you can view the records that make up the protective instrument loop.
- **Diagram:** Displays the **Protective Instrument Loop Diagram View** page, where you can illustrate the protective instrument loop in diagram form.
- **Calculate:** Calculates the values that are stored in the records that make up the protective instrument loop.
- **Recommendations:** Displays the **Recommendations** dialog box, where you can manage Risk Assessment Recommendation records for the protective instrument loop. This link does not appear when you are [working with protective instrument loop templates](#).

The Common Tasks Menu

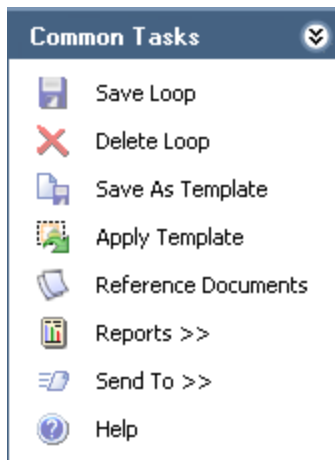

The **Common Tasks** menu appears on all the pages within the SIL Validation features and contains the following links:

- **Save Loop:** Saves the records with which you are currently working.
- **Delete Loop:** Displays a confirmation message and then deletes the Protective Instrument Loop record with which you are currently working.
- **Save As Template:** Displays on the **Protective Instrument Loop Template** page a copy of the selected Protective Instrument Loop record, where the new record is specified as a template.
- **Apply Template:** Displays the **Protective Instrument Loop** dialog box, where you can select the Protective Instrument Loop record whose values you want to use to populate the current Protective Instrument Loop record.
- **Reference Documents:** Displays the **Reference Documents** dialog box, where you can manage Reference Document records that are linked to the Protective Instrument Loop record.
- **Reports:** Displays a submenu that displays the caption of the Catalog item *Protective Instrument Loop Report* as a link, which you can click to [view the Protective Instrument Loop Report](#).
- **Send To:** Displays a submenu with options that let you provide a link to the current page on your desktop (create shortcut), in an email message, or on a Home Page.
- **Help:** Displays the context-sensitive help topic for the current page.

About Creating Protective Instrument Loops

When you create a protective instrument loop, you will need to complete the following steps:

1. Create the Protective Instrument Loop record and the Protective Instrument Loop Element records that are linked to that record. The Meridium APM system will create the Protective Instrument Loop record and the default Protective Instrument Loop Element records automatically when you select to create a new protective instrument loop for an Instrumented Function.
2. Add components to the protective instrument loop in addition to the default components. When you add an element to the protective instrument loop, you are creating a record and linking it to the Protective Instrument Loop record for that protective instrument loop.

To add components to a protective instrument loop, you can use either of the following views:

- [The diagram view](#)
- [The grid view](#)

Note: This documentation assumes that you want to use the diagram view to add components to the protective instrument loop.

3. Define the properties of each element that is included in the protective instrument loop diagram by providing values in the Protective Instrument Loop Element records and the Protective Instrument Loop record. To define the properties of a protective instrument loop, you can use either of the following views:
 - [The diagram view](#)
 - [The grid view](#)

Note: This documentation assumes that you want to use the diagram view to define the properties of the protective instrument loop.

For details on the components of a protective instrument loop, see the data model diagram, where the [Protective Instrument Loop family is the predecessor](#).

Creating New Protective Instrument Loops Manually

The following instructions provide details on creating a new protective instrument loop diagram by adding elements to the default diagram. When you create a protective instrument loop diagram, you are creating a Protective Instrument Loop record. As you add components to the diagram, you are creating a record in the family that represents that element.

To create a new protective instrument loop manually:

1. [Access the Instrumented Functions \(IFs\) page.](#)
2. In the **Instrumented Functions** grid, select the row containing the Instrumented Function record for which you want to create a protective instrument loop diagram.
3. On the **Assessment Tasks** menu, click the **Protective Loops** link.

The **Protective Instrument Loop Diagram View** page appears, displaying the default protective instrument loop diagram, which you can use as a starting point for creating your protective instrument loop.

Note: If a Protective Instrument Loop record is already linked to the selected Instrumented Function record, a submenu appears, displaying options that you can use to create a new Protective Instrument Loop record or view the existing one. These instructions assume that you want to create a new Protective Instrument Loop. In this case, if the submenu appears, click the **Create** link, and the **Protective Instrument Loop Diagram View** page will appear.

4. [Add the desired components to the grid.](#)
5. [Define the properties of the components as desired.](#)
6. On the **Common Tasks** menu, click the **Save Loop** link.

The protective instrument loop is saved.

Creating New Protective Instrument Loops Based on a Template

The following instructions provide details on creating a new protective instrument loop [based on a template](#). When you create a protective instrument loop based on a template, the Meridium APM system will automatically:

- Populate the Protective Instrument Loop record with the information from the Protective Instrument Loop record for the template.
- Create and populate the Protective Instrument Loop Element records that are linked to the Protective Instrument Loop record, using the values in the template.
- Create the diagram.

After you create a protective instrument loop based on a template, you can modify it as desired.

To create a new protective instrument loop based on a template:

1. [Access the Instrumented Functions \(IFs\) page](#).
2. In the **Instrumented Functions** grid, select the row containing the Instrumented Function record for which you want to create a protective instrument loop.
3. On the **Assessment Tasks** menu, click the **Protective Loops** link.

The **Protective Instrument Loop Diagram View** page appears, displaying the default protective instrument loop diagram.

Note: If a Protective Instrument Loop record is already linked to the selected Instrumented Function record, a submenu appears, displaying options that you can use to create a new protective instrument loop or view the existing one. These instructions assume that you want to create a new protective instrument loop. In this case, if the submenu appears, click the **Create** link, and the **Protective Instrument Loop Diagram View** page will appear.

4. On the **Common Tasks** menu, click the **Apply Template** link.

The **Protective Instrument Loop** dialog box appears, displaying a list of Protective Instrument Loop records that are specified as templates.

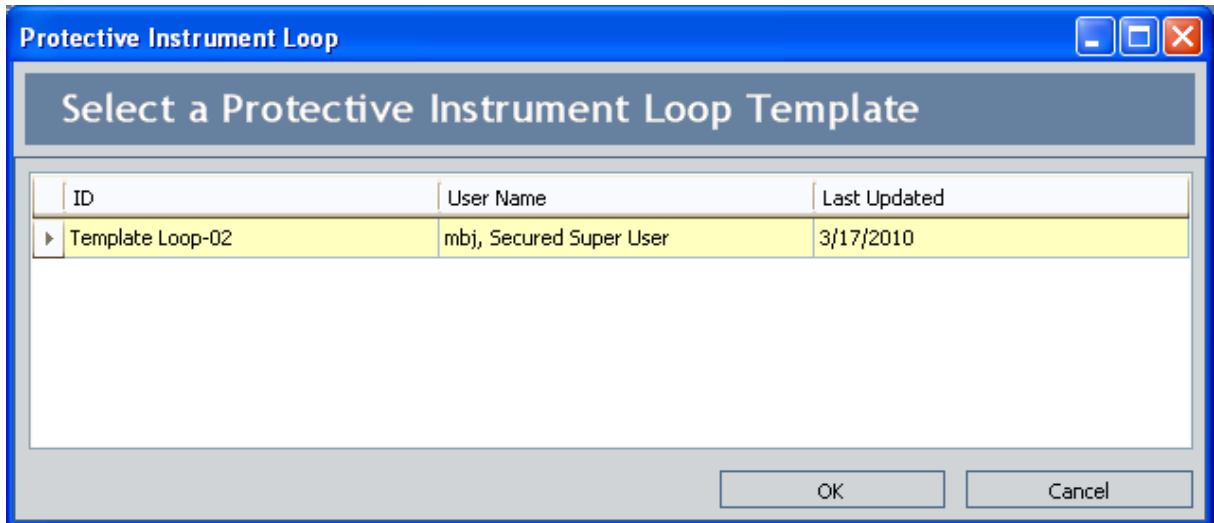

5. In the grid, select the row containing the template that you want to use.
6. Click **OK**.

The **Protective Instrument Loop** dialog box closes, and the **Protective Instrument Loop Diagram View** page refreshes and displays the protective instrument loop that is populated automatically with data from the template.

7. Modify the elements of the protective instrument loop as desired.
8. On the **Common Tasks** menu, click the **Save Loop** link.

The protective instrument loop is saved.

About Opening Existing Protective Instrument Loops

When you open an existing protective instrument loop, you are accessing the Protective Instrument Loop record and the associated records that make up that protective instrument loop.

You can open an existing protective instrument loop from:

- [Search results that return all existing Protective Instrument Loop records.](#)
- [The associated Instrumented Function record in an SIL Analysis.](#)

Accessing a List of Existing Protective Instrument Loops

When you access a list of existing protective instrument loops, you are accessing a list of Protective Instrument Loop records, which represent the protective instrument loop.

To access a list of existing protective instrument loops:

- On the **SIS Management Start Page**, click the **SIL Validation** link.

The **Protective Loop Search** page appears, displaying the list of existing Protective Instrument Loop records.

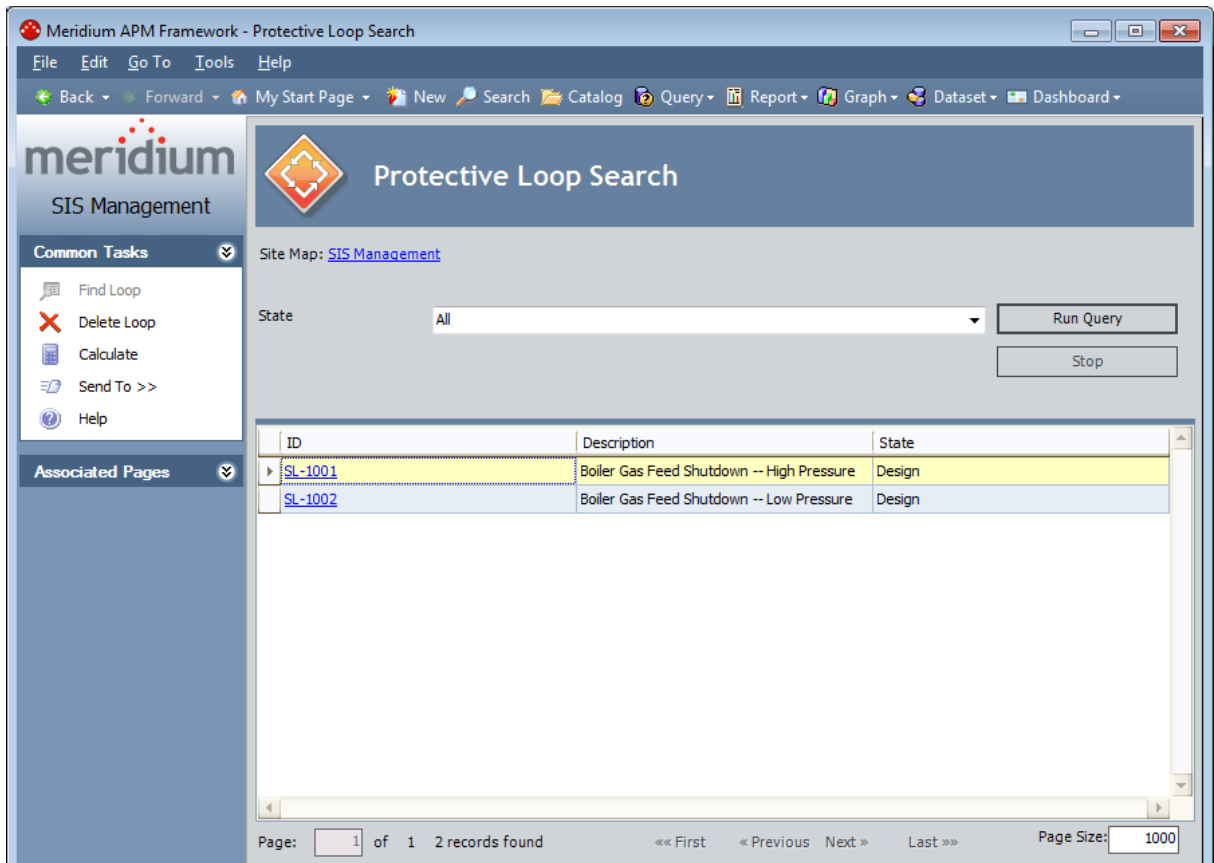

Aspects of the Protective Loop Search Page

The **Protective Loop Search** page contains the **Protective Loop Search** workspace, which displays the results of the query specified in the **Protective Loop Search Query** text box on the **SIS Management Administration** page. This documentation assumes that you are using the baseline `Safety_Loop_Search` query, which contains a **State** prompt that appears a list at the top of the **Protective Loop Analysis Search** workspace. The **State** list contains a list of record states that have been configured for the Protective Instrument Loop family. You can choose from the following baseline states:

- **Approval:** Displays the list of existing Protective Instrument Loop records whose State field contains the value *Approval*.
- **Design:** Displays the list of existing Protective Instrument Loop records whose State field contains the value *Design*.
- **In Service:** Displays the list of existing Protective Instrument Loop records whose State field contains the value *In Service*.
- **Out of Service:** Displays the list of existing Protective Instrument Loop records whose State field contains the value *Out of Service*.
- **Pending Approval:** Displays the list of existing Protective Instrument Loop records whose State field contains the value *Pending Approval*.

Selecting the *All* option displays the list of ALL Protective Instrument Loop records that exist in the Meridium APM database. This is the default option.

After you select the desired state, you can click the **Run Query** button to run the `Safety_Loop_Search` query and display the results in the grid at the bottom of the page. The query results will include hyperlinked Record IDs, which you can click to open the protective instrument loop on the **Protective Instrument Loop Diagram View - <Analysis ID>** page, where **<Analysis ID>** is the value in the Analysis ID field in the SIL Analysis record with which you are currently working.

Below the query results, options appear that you can use to navigate the results.

The **SIL Analysis Search** page contains the following task menus:

- [Common Tasks](#)
- [Associated Pages](#)

Using the **Protective Loop Search** page, you can:

- [Open an existing protective instrument loop.](#)
- [Delete a protective instrument loop.](#)
- [Calculate the SIL Validation results for one or multiple protective instrument loops.](#)

Common Tasks

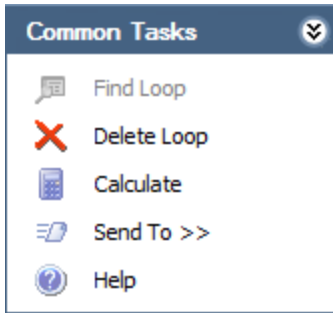

The **Common Tasks** menu on the **Protective Loop Search** page contains the following links:

- **Find Loop:** This link is always disabled.
- **Delete Loop:** Displays a confirmation message, and then deletes the selected record.
- **Calculate:** Calculates the values that are stored in the records that make up the selected protective instrument loop(s).
- **Send To:** Displays a submenu with options that let you provide a link to the current page on your desktop (create shortcut), in an email message, or on a Home Page.
- **Help:** Displays the context-sensitive help topic for the **Protective Loop Search** page.

Opening an Existing Protective Instrument Loop

To open an existing protective instrument loop:

1. [Access the Protective Loop Search page.](#)
2. In the **State** list, select the desired record state, and then click the **Run Query** button.

The results appear in the grid.

3. In the results grid, select the row containing the Protective Instrument Loop record that represents the protective instrument loop that you want to open.
4. In the **ID** cell, click the hyperlinked Record ID.

The protective instrument loop represented by the selected Protective Instrument Loop record appears on the **Protective Instrument Loop Diagram View - <SIL Analysis>** page, where **<SIL Analysis>** is the value in the Analysis ID field in the SIL Analysis record with which the Protective Instrument Loop records is associated.

Opening Protective Instrument Loops Associated with an Instrumented Function in an SIL Analysis

To open a protective instrument loop associated with an instrumented function in an SIL Analysis:

1. [Access the Instrumented Functions \(IFs\) page](#) for the desired SIL Analysis.
2. In the **Instrumented Functions** section, select the row containing the Instrumented Function record that is linked to the Protective Instrument Loop record that you want to open.
3. On the **Assessment Tasks** menu, click the **Protective Loops** link.

A submenu appears with options that let you [create a new protective instrument loop](#) or view the existing protective instrument loop that is associated with the selected Instrumented Function record. These instructions assume that you want to view the existing protective instrument loop.

4. On the submenu, click the **View** link.





The protective instrument loop appears on the **Protective Instrument Loop Diagram View** page.

Note: If the selected Instrumented Function record is associated with more than one protective instrument loop, the **Protective Instrument Loop Search** page appears, where you can [search for the desired Protective Instrument Loop record](#).

Aspects of the Protective Instrument Loop Diagram View Page

When you select to create a new protective instrument loop or open an existing one, the **Protective Instrument Loop Diagram View** page will appear by default. The **Protective Instrument Loop Diagram View** page contains the **Protective Instrument Loop** workspace, which contains the following sections:

- **Explorer pane:** Contains a hierarchical view of the relationships that exist between the records that represent the components of the protective instrument loop. For each level in the hierarchy, an associated element appears in the Diagram grid. When you select a level in the hierarchy, the associated element will be highlighted in green in the Diagram Canvas. You can hide and display the **Explorer** pane, using the  icon.
- **Diagram Canvas:** Serves as an interactive drawing interface where you can build a diagram of the protective instrument loop. Each element represents a record, and each line between the elements represents the relationship that exists between those records. When you first access the Design Canvas, baseline elements appear and serve as a starting point for defining the protective instrument loop. You can double click an element to display the datasheet for the record that is represented by that element. Additionally, you can double click a blank space on the Diagram Canvas to view the Protective Instrument Loop record for that protective instrument loop.
- **Palette pane:** Contains elements that represent components of a protective instrument loop. Each element corresponds to a family whose records can be linked to the Protective Instrument Loop record. You can drag an element to the Diagram Canvas to add that element to the protective instrument loop. The **Palette** pane contains the following elements:

-  Sensor
-  Sensor Group
-  Final Element Group
-  Final Element

The icon for each element in the **Palette** pane includes a connection point to the left, right, or on both sides of the icon, which indicates where that element can be added to the Diagram Canvas. For example, an element with only a connection point to the right can be added to the Diagram Canvas only as the first element. An element with connection points on both sides, however, can be added anywhere in the diagram. You can hide and display the **Palette** pane using the  icon.

Above the **Protective Instrument Loop** workspace, the  button appears, which displays the **State Assignments** dialog box, where you can manage the Security Users that

are assigned to the states that are defined for the Protective Instrument Loop family. To the right of the icon, the following options appear:

- **State indicator:** Displays the current state of the Protective Instrument Loop record.
- **Operations link:** Displays a submenu that lists the available operations for the current record. You can use this option to change the state of the Protective Instrument Loop record.

Using the **Protective Instrument Loop Diagram View** page, you can:

- [Add elements to the protective instrument loop diagram.](#)
- [Define the properties of each element.](#)
- [Delete elements from the protective instrument loop diagram.](#)
- [Link Risk Assessment Recommendation records to the Protective Instrument Loop record](#) that represents the protective instrument loop.

Adding Elements to the Protective Instrument Loop Diagram

When you add an element to the protective instrument loop, you are creating a record and linking it to the Protective Instrument Loop record that represents the protective instrument loop. Note that adding an element to the protective instrument loop diagram does not assign properties to that element. After you add an element to the diagram, you will still need to define its properties by entering values in the fields in the record that it represents.

To add an element to the protective instrument loop diagram:

1. Open the desired Protective Instrument Loop record on the **Protective Instrument Loop Diagram View** page.
2. In the **Palette** pane, select the element that you want to add to the protective instrument loop diagram.
3. Drag the element and drop it in the desired location on the Design Canvas.

The element is added to the diagram. At this point you can [define the properties of that element](#) or [link an existing Element record to the element](#).

Defining Element Properties in the Diagram View

When you define properties for an element via the diagram view, you are entering values into fields in the record represented by that element. The following instructions provide details on defining a new Element record from scratch. Alternatively, you can [link an existing Element record to an element](#).

To define element properties in the diagram view:

1. [Open the desired protective instrument loop](#).

The protective instrument loop appears on the **Protective Instrument Loop Diagram View** page.

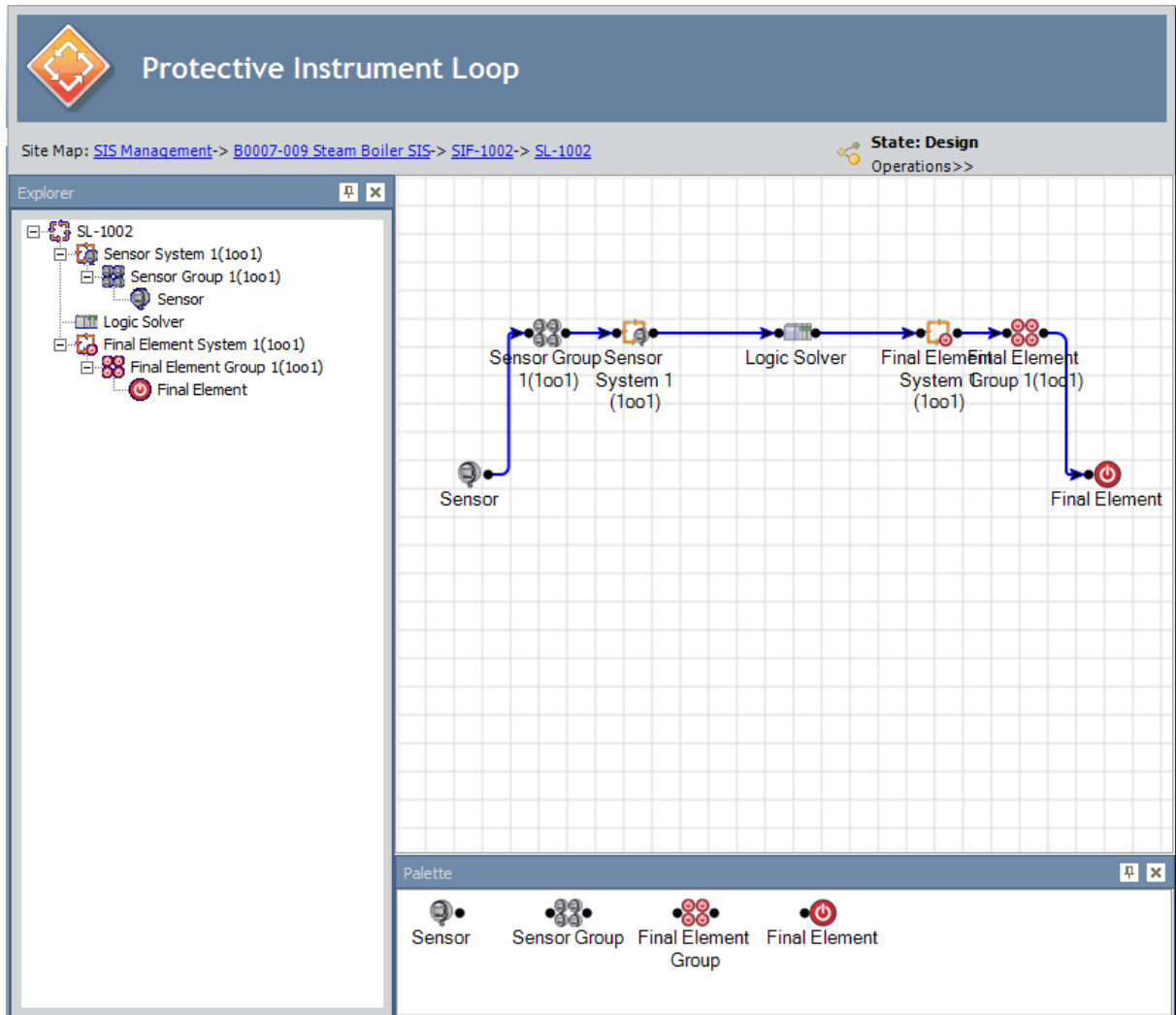

2. In the Diagram Canvas, double-click the element whose properties you want to define.

The record that is represented by that element appears in a new window. For example, the following image shows a Protective Instrument Loop Sensor record.

Sensor 1 (Protective Instrument Loop Sensor)

Sensor Subsystem

Sensor ID: Sensor 1

Description:

Sensor Type*: FireGas Alarm Setting(High/Low):

Analog Trip: Low External Comparison:

Over/Under Range: Alarm Filter:

Alarm Voted as Trip:

Base SFF: PCT SFF: PCT

Approved Custom Device:

Sensor*: NONE Connection: NONE

Interface A: NONE Interface B: NONE

Link Unlink Apply Select

Devices

ID	Device Tag	Dangerous Dete...	Dangerous Unde...	Safe Detected	Safe Undetected
----	------------	-------------------	-------------------	---------------	-----------------

OK Cancel

3. Provide values in the fields on the datasheet as desired.
 4. Click **OK**.
 5. On the **Common Tasks** menu, click the **Save Loop** link.
- Your changes are saved.

Removing Elements from the Protective Instrument Loop Diagram

When you remove an element from the protective instrument loop diagram, you are deleting:

- The link between the Protective Instrument Loop record and the record that is represented by that element.
- The record that is represented by that element.
- The records that are linked to the selected record as successors.

Note: You cannot remove an element that appears in the diagram by default.

To remove elements from the protective instrument loop diagram:

1. Access the desired protective instrument loop on the **Protective Instrument Loop Diagram View** page.
2. On the Diagram Canvas, right-click the element that you want to remove from the diagram.

A shortcut menu appears.

Note: The shortcut menu does not appear if you right-click a element that appears in the diagram by default.

3. Click the **Delete** link.

A confirmation message appears, asking if you really want to delete the selected element.

4. Click the **Yes** button.

The selected element is removed from the protective instrument loop diagram.

Linking Existing Records to Elements in the Protective Instrument Loop

Rather than creating an Element record from scratch and linking it to the element in the protective instrument loop, you can link an existing Element record to an element in the protective instrument loop. Additionally, if an element is already linked to an Element record, you can replace the existing Element record with an existing Element record. When you do so:

- If the current Element record is not linked to any other protective instrument loops, that Element record will be deleted.
- If the current Element record is linked to one or more other protective instrument loops, that Element record will be unlinked from the current protective instrument loop, and will not be deleted.

The following instructions provide details on linking an existing Element record to an element in a protective instrument loop.

To link an existing record to an element in a protective instrument loop:

1. [Open the desired protective instrument loop.](#)

The protective instrument loop appears on the **Protective Instrument Loop Diagram View** page.

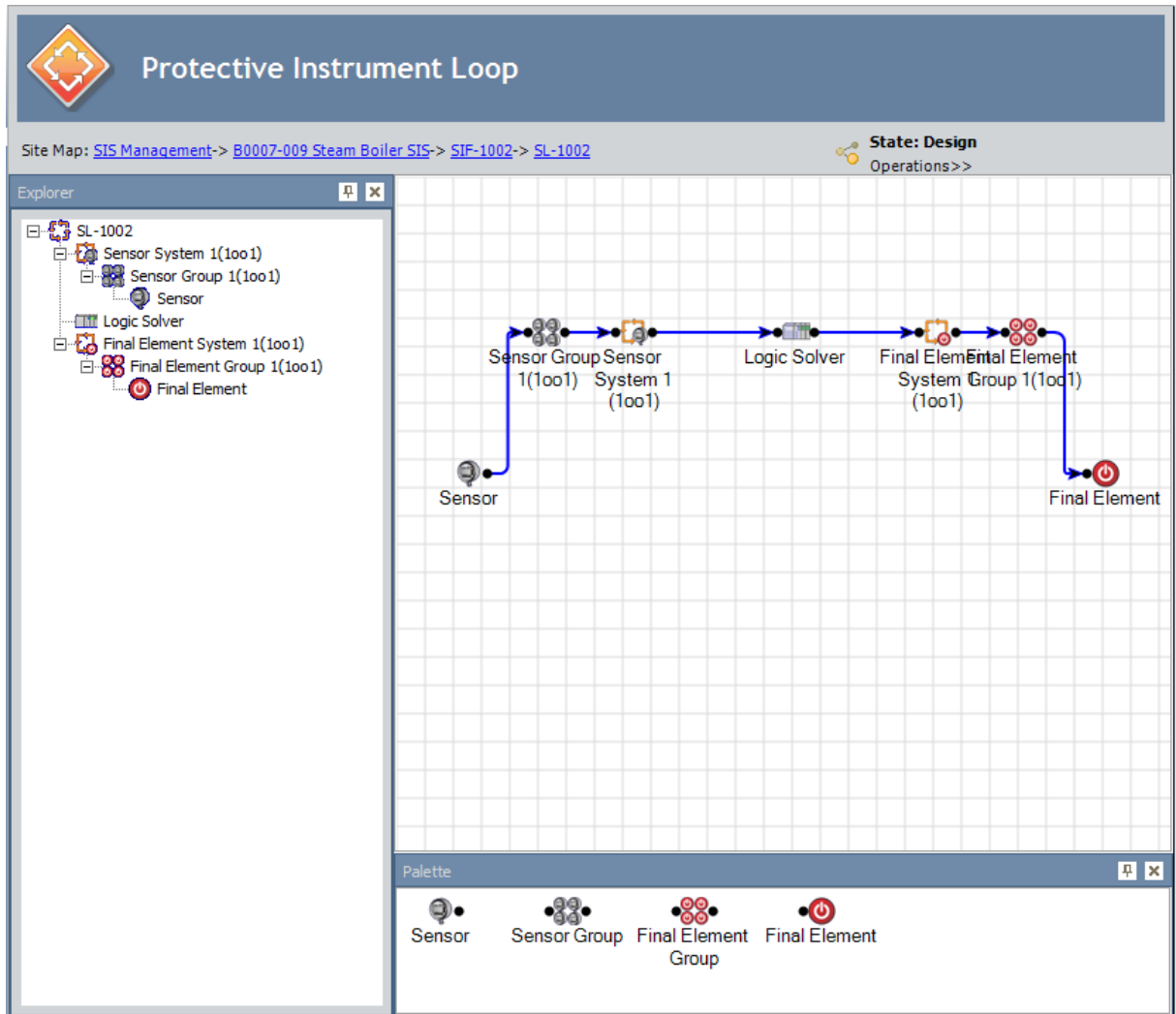

2. In the diagram canvas, double-click the element to which you want to link an existing record.

The record that is represented by that element appears in a new window. For example, the following image shows a Protective Instrument Loop Sensor record.

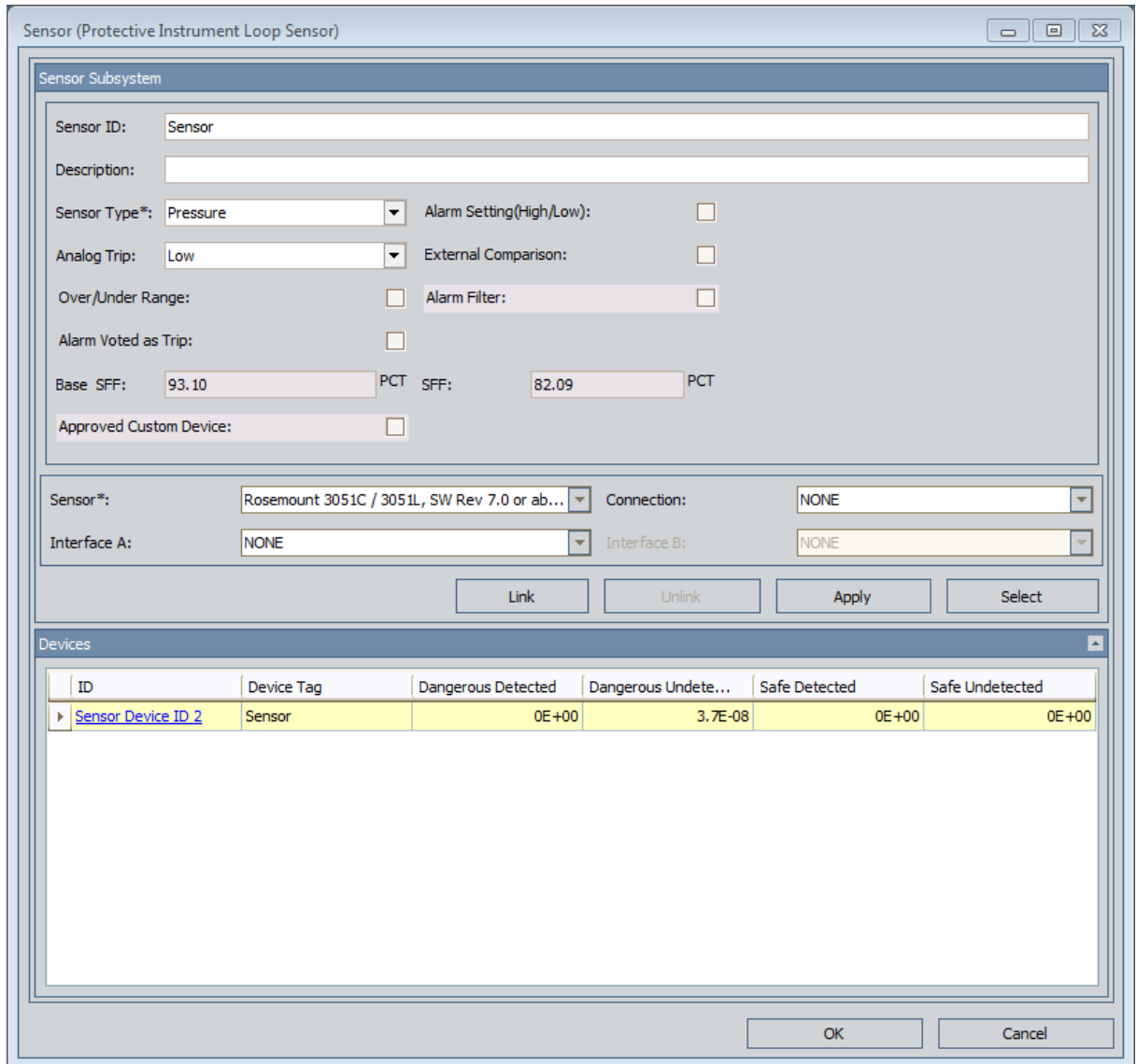

3. Click the **Link** button.

The **Protective Instrument Loop** dialog box appears, displaying a list of existing Element records in the same family. The header on this dialog box indicates the name of the family (e.g., Sensor). For example, the following image shows how the **Protective Instrument Loop** dialog box appears when you access it from a Protective Instrument Loop Sensor record.

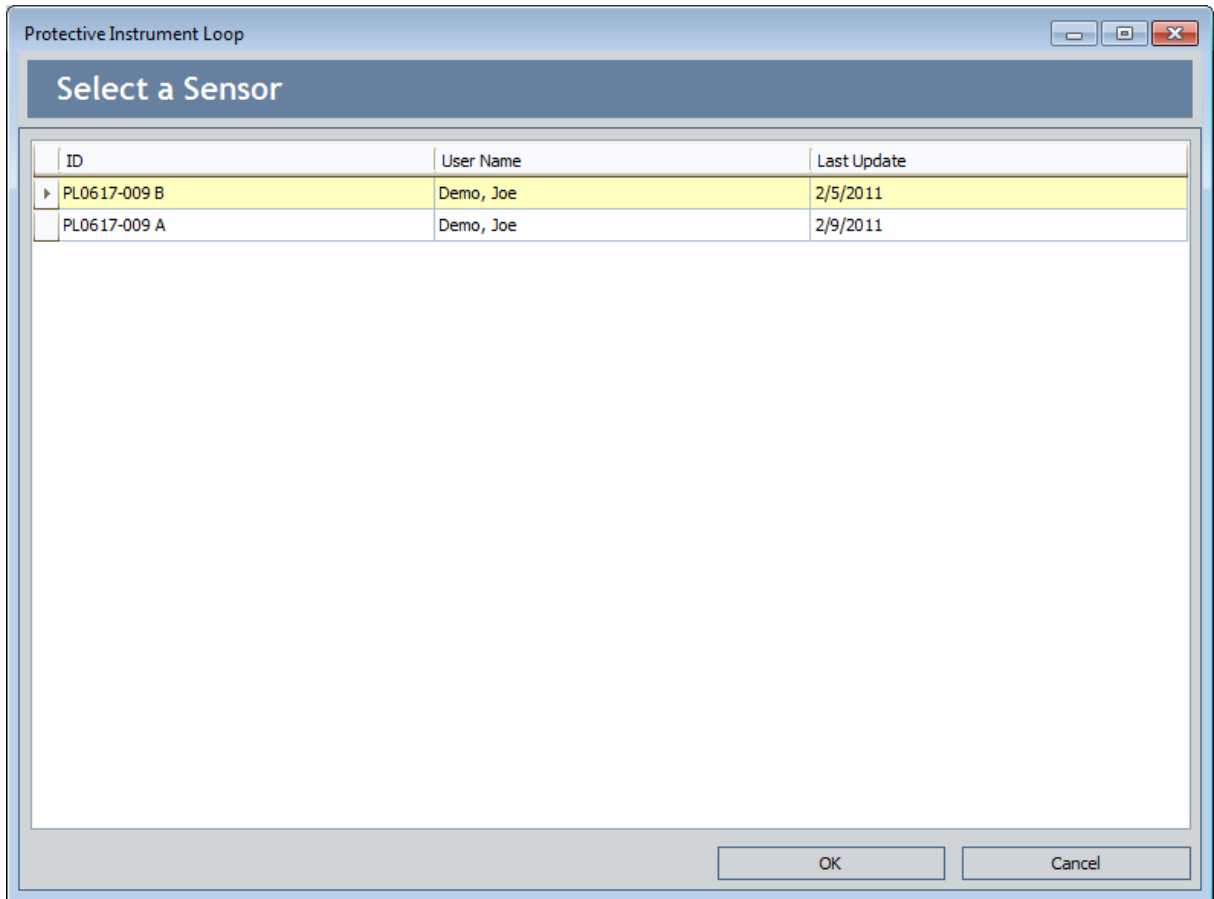

4. Select the row containing the Element record that you want to link to the element, and then click **OK**.

The **Protective Instrument Loop** dialog box closed, and if the element to which you are linking an existing Element record is already linked to an Element record that is:

- Not linked to any other Protective Instrument Loop records, a message appears, indicating that the Element record you selected will replace the current Element record, and then the current Element record will be deleted. Clicking **OK** on this message will delete the current Element record and replace it with the selected Element record.
- Linked to one or more other Protective Instrument Loop records, a message will appear, indicating that the record cannot be deleted until it is unlinked from the current protective instrument loop. Clicking **OK** on this message will unlink the current Element record and link the selected Element record.

5. If the datasheet window is still open, on the datasheet window, click **OK**.

The datasheet window closes.

6. On the **Common Tasks** menu, click the **Save Loop** link.

Your changes are saved.

Unlinking Elements from a Protective Instrument Loop

The following instructions provide details on removing the link between a record representing an element and the Protective Instrument Loop record representing the Protective Instrument Loop. Keep in mind that every Protective Instrument Loop must consist of at least one of ALL the following elements by default:

- Logic Solver
- Sensor System
- Sensor Group
- Sensor
- Final Element System
- Final Element Group
- Final Element

If you remove the link between a Protective Instrument Loop record and the *only* record for a required element type (listed above), the Meridium APM system will automatically create a new, default record of that element type and link it to the Protective Instrument Loop record.

You can remove any element from a Protective Instrument Loop *only* if the record representing that element is linked to more than one Protective Instrument Loop. In this case, the **Unlink** button on the datasheet for that record will be enabled. If, however, a record representing an element is linked to only one Protective Instrument Loop, the **Unlink** button will be disabled. These instructions assume that the **Unlink** button is enabled.

To unlink an element from a Protective Instrument Loop:

1. [Open the Protective Instrument Loop](#) containing the element that you want to remove.

The Protective Instrument Loop appears on the **Protective Instrument Loop Diagram View** page.

Unlinking Elements from a Protective Instrument Loop

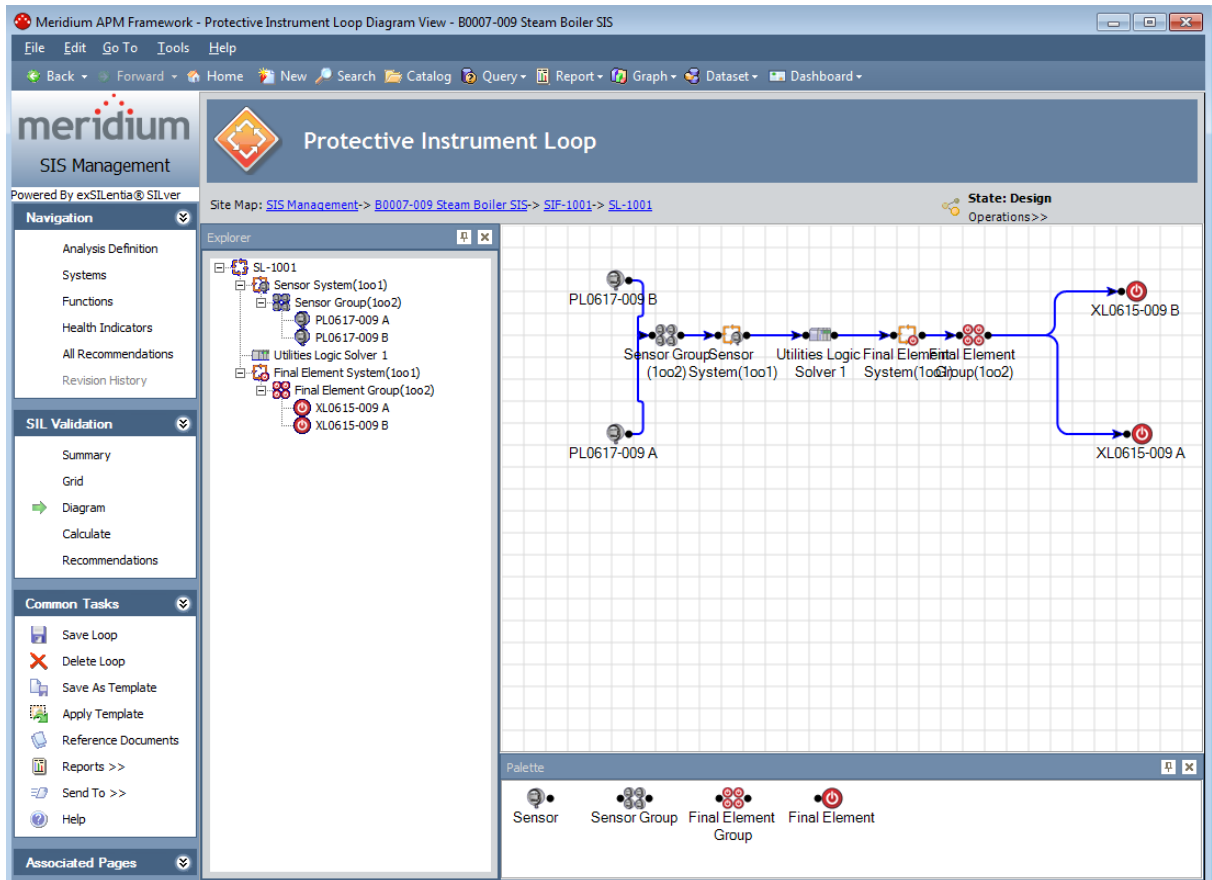

2. [Open the record representing the element](#) that you want to remove from the Protective Instrument Loop.

The record appears. The following image shows an example of a Protective Instrument Loop System record that is linked to more than one Protective Instrument Loop record.

Unlinking Elements from a Protective Instrument Loop

The screenshot shows a software dialog box titled "Sensor System (Protective Instrument Loop System)". The dialog contains the following fields and controls:

- System ID:** A text box containing "Sensor System".
- Voting Between Groups*:** A dropdown menu showing "100 1".
- Number of Groups:** A text box containing "1".
- Common Cause(Beta)*:** A text box containing "PCT".
- Calculated Results:** A section containing several fields:
 - Calculated PFD Avg:** Text box with "3.52E-08".
 - Calculated PFH:** Text box with "NA" and a label "FRPH" to its right.
 - Availability:** Text box with "100.00%".
 - HFT:** Text box with "1".
 - Calculated STR:** Text box with "6.46E-07" and a label "FRPH" to its right.
 - MTTFS:** Text box with "176.74" and a label "Years" to its right.
 - SIL Architectural Constraints:** Text box with "2".
 - SIL Systematic Capability:** Text box with "NA".

At the bottom of the dialog, there are three buttons: "Link", "Unlink", and "Apply". The "Unlink" button is highlighted with a blue border. Below these buttons are "OK" and "Cancel" buttons.

3. Click the **Unlink** button.

The record closes, and the link between the record representing that element and the current Protective Instrument Loop record is removed.

Accessing the Protective Instrument Loop Grid View Page

The **Protective Instrument Loop Grid View** page lets you view the elements of the protective instrument loop by viewing the records that are represented by those elements. Unlike the diagram view, where you can add an element to the *diagram* and then define the field values in the record that is represented by that element, in the grid view, you can add element records to the protective instrument loop using **Link** and **Apply** buttons, which appear on the *datasheet* of some element records.

To access the **Protective Instrument Loop Grid View** page:

1. Access the desired protective instrument loop on the **Protective Instrument Loop Diagram View** page.
2. On the **SIL Validation** menu, click the **Grid** link.

The **Protective Instrument Loop Grid View** page appears.

The screenshot displays the Meridium APM Framework interface for the Protective Instrument Loop Grid View. The window title is "Meridium APM Framework - Protective Instrument Loop Grid View - B0007-009 Steam Boiler SIS". The interface includes a navigation pane on the left with "SIL Validation" selected and "Grid" highlighted. The main area shows a tree view of the loop structure and a detailed configuration panel for "SL-1001".

Protective Instrument Loop Configuration Panel:

- Loop ID: SL-1001
- Description: Boiler Gas Feed Shutdown -- High Pressure
- Loop Class: Safety
- Loop Type: Demand Mode*
- Required SIL: 2
- SIL Validation Method*: Internal Calculat
- Test Architecture Constraints*: IEC 61511
- Startup Time*: 24 Hours
- Mission Time*: Systematic Capability Valid
- Sensr MCI: 1
- Logic Solver MCI:

Systems Table:

Flag	ID	PFD ...	PFD	Avail...	MTTFS	MTTF...	PTI
	Sensor S...	0.00%	3.52E-08	100.00%	176.74	3.71%	12
	Utilities L...	69.47%	1.19E-03	99.88%	7.22	90.74%	12
	Final Ele...	30.52%	5.24E-04	99.95%	118.08	5.55%	12

Aspects of the Protective Instrument Loop Grid View Page

The **Protective Instrument Loop Grid View** page contains the following sections:

- **Datasheet area:** Contains the datasheet for the record that is currently selected in the **Tree** pane. At the top of the datasheet area, the following option appears:
 -  Displays the **State Assignments** dialog box, where you can manage the Security Users that are assigned to the states that are defined for the Protective Instrument Loop family.
- **State indicator:** Displays the current state of the Protective Instrument Loop record.
- **Operations link:** Displays a submenu that lists the available operations for the current record.
- **Tree pane:** Contains a hierarchical view of the records that make up the protective instrument loop. When you select a level in the hierarchy, the corresponding record will appear in the datasheet area.

When you are viewing some datasheets for Protective Instrument Loop Element families, the following buttons may appear:

- **Link:** Displays the **Protective Instrument Loop** dialog box, which contains a list of records that you can link to the currently selected record. To link one of these records to the currently selected record, you can select the row containing the record that you want to link to the currently selected record and then click **OK**.
- **Apply:** Displays the **Protective Instrument Loop** dialog box, which contains a list of records whose contents that you can use to create a new record that is populated automatically with information from the source record and then link that record automatically to the currently selected record. The new record will be linked automatically to the currently selected record. To use an existing record to create a new record and link it automatically to the currently selected record, you can select the row containing the desired record and then click **OK**.
- **Select:** Displays the **Protective Instrument Loop** dialog box, which contains a list of Logic Solver records from which you can select the desired element to link to the protective instrument loop.

Accessing the Protective Instrument Loop Summary Page

The **Protective Instrument Loop Summary** page lets you manage the summarized data that is stored in the records that make up the protective instrument loop that is illustrated in the diagram on the **Protective Instrument Loop Diagram View** page.

To access the **Protective Instrument Loop Summary** page:

1. Access the desired protective instrument loop on the **Protective Instrument Loop Diagram View** page.
2. On the **SIL Validation** menu, click the **Summary** link.

The **Protective Instrument Loop Summary** page appears.

The screenshot displays the 'Protective Instrument Loop Summary' page in the Meridium APM Framework. The page title is 'Meridium APM Framework - Protective Instrument Loop Summary- B0007-009 Steam Boiler SIS'. The main content area shows the following details for Loop ID SL-1001:

- Description:** Boiler Gas Feed Shutdown -- High Pressure
- Required SIL:** 2
- Demand Mode*:** Low Demand
- Test Architecture Constraints*:** IEC 61511
- Systematic Capability Validation:**
- Startup Time*:** 24 Hours
- Mission Time*:** 1
- Sensor MCI:** 1
- Logic Solver MCI:** 1
- Final Element MCI:** 1

Calculated Results Table:

Flag	ID	PFD	Availability	MTTFS	PTI
	Sensor System	3.52E-008	100.00%	176.74	12
	Utilities Logic Solver 1	1.19E-003	99.88%	7.22	12

PFD Contribution Pie Chart:

System	Contribution
Sensor System	69.47%
Utilities Logic Solver 1	30.52%
Final Element System	0.00%

MTTFS Contribution Pie Chart:

System	Contribution
Sensor System	90.74%
Utilities Logic Solver 1	5.55%
Final Element System	3.71%

Aspects of the Protective Instrument Loop Summary Page

The **Protective Instrument Loop Summary** page displays the datasheet for the Protective Instrument Loop record for the protective instrument loop with which you are currently working. Below the datasheet, two graphs appear, which display the following calculated values per element in the protective instrument loop:

- PFD Contribution
- MTTFS Contribution

Deleting Protective Instrument Loops

When you delete a protective instrument loop (or [protective instrument loop template](#)), you are deleting the Protective Instrument Loop record and all the Protective Instrument Loop Element records that are linked to that record. If you try to delete a protective instrument loop that contains an element that is also linked to a different Protective Instrument Loop record, you will need to remove the link between that Protective Instrument Loop Element record and the Protective Instrument Loop record before you can delete the protective instrument loop.

You can delete one or multiple protective instrument loops at one time. These instructions provide details on deleting only ONE protective instrument loop at a time.

To delete a protective instrument loop:

1. [Access the Protective Loop Search page](#) (for non-template protective instrument loops)

-or-

[Access the Protective Instrument Loop Template Search page](#) (for protective instrument loop templates).

2. In the search results, select the row containing the protective instrument loop you want to delete.
3. On the **Common Tasks** menu, click the **Delete Loop** link.

A message appears, asking if you want to delete the selected protective instrument loop.

4. Click the **Yes** button.

The protective instrument loop is deleted.

Note: If the Protective Instrument Loop record is linked to any Element records that are linked to additional Protective Instrument Loop records, a message will appear, indicating that you must remove the link between these Element records and the Protective Instrument Loop record before you can delete the protective instrument loop.

About Protective Instrument Loop Templates

If you create a protective instrument loop that you want to use as a template for [creating additional protective instrument loops in the future](#), you can use that protective instrument loop to create a template, or you can create a protective instrument loop template manually.

A protective instrument loop template is the same as a protective instrument loop, meaning that it consists of a Protective Instrument Loop record and all the records that are linked to that record as elements of the protective instrument loop. Each record that is associated with the protective instrument loop for a template, however, is specified as a template via the Is Template field in the record. Note that the Is Template field value is set by the Meridium APM system automatically when you create a protective instrument loop template. The field does not appear on any datasheet by default and is not meant to be modified manually.

When you save a protective instrument loop as a template, the Meridium APM system will automatically:

- Create a copy of the Protective Instrument Loop record.
- Create a copy of each record that is linked to the Protective Instrument Loop record as an element of the protective instrument loop and link those records to the Protective Instrument Loop record for the template with one exception. When the Meridium APM system copies a Protective Instrument Loop Final Element record, the values stored on the [Dangerous Combination of Outputs](#) tab are not copied to the template record.
- Select the **Is Template** check box in each of the copied records (i.e., setting this value to *true*.), which identifies the protective instrument loop as a template.

After a protective instrument loop template exists:

- As with a non-template protective instrument loop, you can view the records that make up the protective instrument loop in the grid view, diagram view, and summary view.
- As with a non-template protective instrument loop, you can [calculate the SIL Validation results](#).
- It will not appear in the query results on the [Protective Loop Search page](#).
- You can search for it on the [Protective Instrument Loop Template Search page](#).

As with non-template protective instrument loops, when you are working with a protective instrument loop *template*, you will use the following pages to complete the tasks associated with a protective instrument loop:

- **Protective Instrument Loop Diagram View:** Lets you view the components of the protective instrument loop template as a diagram. This is the default view.
- **Protective Instrument Loop Grid View:** Lets you view the components of the protective instrument loop in record form and in a hierarchy, which is similar to the **Record Explorer** pane in the Record Manager.

- **Protective Instrument Loop Summary View:** Lets you view the Protective Instrument Loop record for the template and graphs, which provide a summary of the calculated data that is stored in each Protective Instrument Loop Element record for the template.

Note: Unlike working with these pages for a non-template protective instrument loop, instead of displaying the text **Protective Instrument Loop** in the workspace, the text **Protective Instrument LoopTemplate** will appear, indicating that you are working with a template.

Each page presents a different view of the components of the protective instrument loop template and contains the following task menus:

- [SIL Validation](#)
- [Common Tasks](#)
- [Associated Pages](#)

When you attempt to get your bearings with templates in the SIL Validation feature, keep in mind that each page in the feature displays a custom view of the records that exist in the Meridium APM database.

To begin working with protective instrument loop templates, you can:

- [Create a protective instrument loop template from scratch.](#)
- [Create a protective instrument loop template as a copy of an existing protective instrument loop template.](#)
- [Save an existing protective instrument loop as a template.](#)
- [Open an existing protective instrument loop.](#)

About Creating Protective Instrument Loop Templates

As with non-template protective instrument loops, when you are working with a protective instrument loop *template*, you will complete the following steps:

1. Create the Protective Instrument Loop record for the template and the Protective Instrument Loop Element records that are linked to that record. The Meridium APM system will automatically create these records when you select to create a template:
 - Based on an existing protective instrument loop.
 - From scratch.
 - Based on an existing template.
2. Add elements to the protective instrument loop template in addition to the default elements (for a new template) or existing elements (for a template that is created based on an existing template or non-template protective instrument loop). When you add an element to a protective instrument loop template, you are creating a record in a family and linking that record to the Protective Instrument Loop record for that protective instrument loop template.

To add elements to the protective instrument loop template, you can use either of the following views:

- The diagram view
- The grid view

Note: You can use the same instructions for adding components to a template as adding components to a non-template protective instrument loop.

3. Define the properties of each node that is included in the protective instrument loop template diagram, meaning that you will provide values in the Protective Instrument Loop Element records and the Protective Instrument Loop record for the template.

To define the properties of the protective instrument loop template, you can see the following view:

- The diagram view
- The grid view

Note: You can use the same instructions for defining the properties of nodes for a template as defining the properties of nodes for a non-template protective instrument loop.

For details on the components of a protective instrument loop, see the data model diagram, where the [Protective Instrument Loop family is the predecessor](#).

Creating Protective Instrument Loop Templates from Scratch

To create a protective instrument loop template from scratch:

1. [Access the Protective Loop Template Search page.](#)
2. On the **Common Tasks** menu, click the **Create Template** link.

A new protective instrument loop template appears on the **Protective Instrument Loop Diagram View** page.

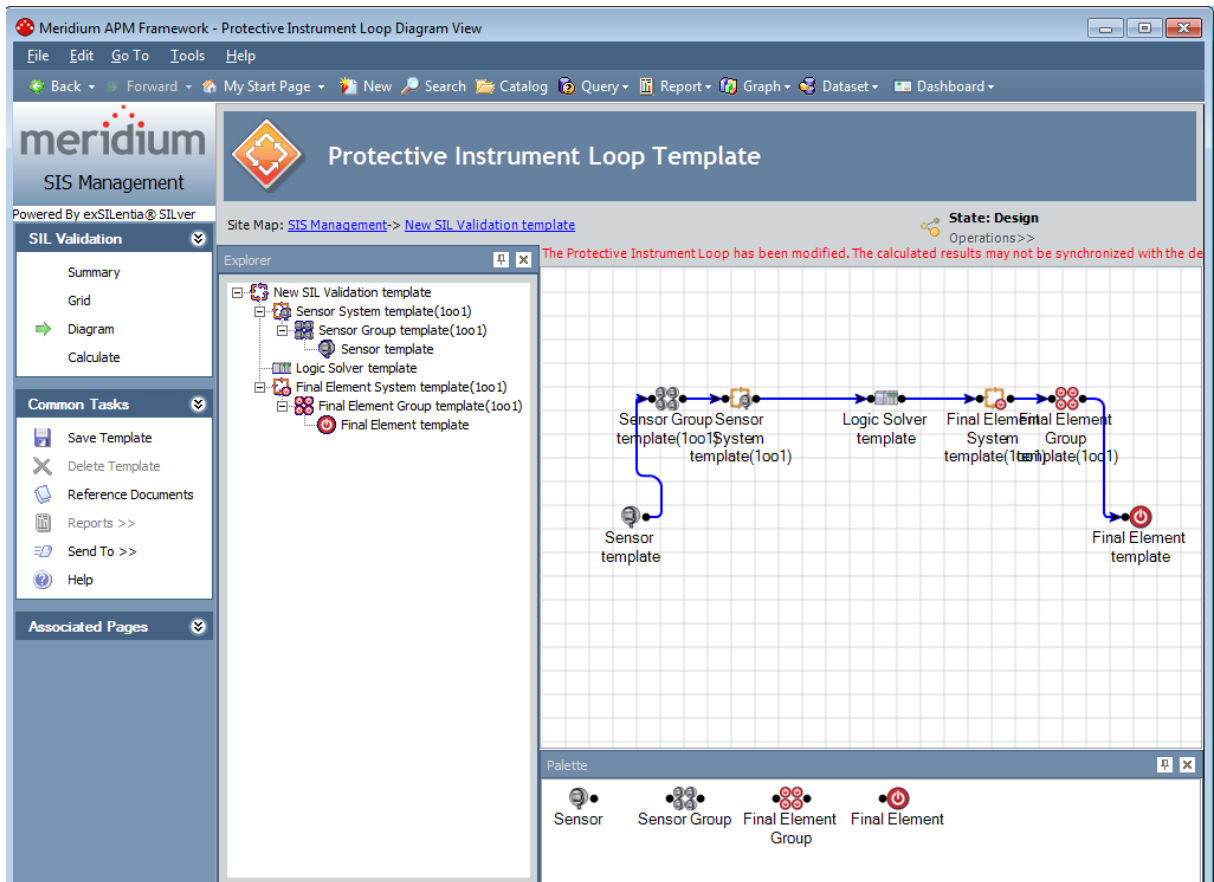

3. [Add the desired components to the grid.](#)
4. [Define the properties of the components as desired.](#)
5. On the **Common Tasks** menu, click the **Save Template** link.

The protective instrument loop template is saved.

Creating Protective Instrument Loop Templates Based on Existing Protective Instrument Loops

If you create a protective instrument loop that you want to use as a template to create additional protective instrument loops in the future, you can save that protective instrument loop as a template.

When you save a protective instrument loop as a template, you are automatically:

- Creating a copy of the source Protective Instrument Loop record and the Protective Instrument Loop Element records that are linked to that record.
- Selecting the **Is Template** check box in the copied records.

In other words, you are creating a protective instrument loop template that is based on a non-template protective instrument loop.

To create a protective instrument loop template based on existing protective instrument loop:

1. Open the protective instrument loop that you want to use as a template.
2. On the **Common Tasks** menu, click the **Save As Template** link.

The page refreshes and displays the protective instrument loop template, which is populated automatically with the information from the source protective instrument loop.

3. [Add the desired components to the grid.](#)
4. [Define the properties of the components as desired.](#)
5. On the **Common Tasks** menu, click the **Save Template** link.

The protective instrument loop template is saved.

Copying Protective Instrument Loop Templates to Create New Ones

When you copy a protective instrument loop template to create a new one, the Meridium APM system will automatically:

- Create a copy of the Protective Instrument Loop record for the template.
- Create a copy of each Protective Instrument Loop Element record that is linked to the Protective Instrument Loop record for the template.
- Append the name of the protective instrument loop with *copy*. For example, if you copy a protective instrument loop template named *Template Loop -02*, the new protective instrument loop template will be named *Template Loop -02 copy*.

To copy a protective instrument loop template to create a new one:

1. [Access the Protective Loop Template Search page.](#)
2. In the search results, select the row containing the protective instrument loop template that you want to copy.
3. On the **Common Tasks** menu, click the **Copy Template** link.

The Protective Instrument Loop Template Search page refreshes, and a new protective instrument loop template appears in a new row in the search results.

Accessing the Protective Loop Template Search Page

On the **Protective Loop Template Search** page, you can search for and manage existing protective instrument loop templates.

To access the **Protective Loop Template Search** page:

1. [Access the SIS Management Start Page.](#)
2. Click the **SIL Validation Template** link.

The **Protective Loop Template Search** page appears.

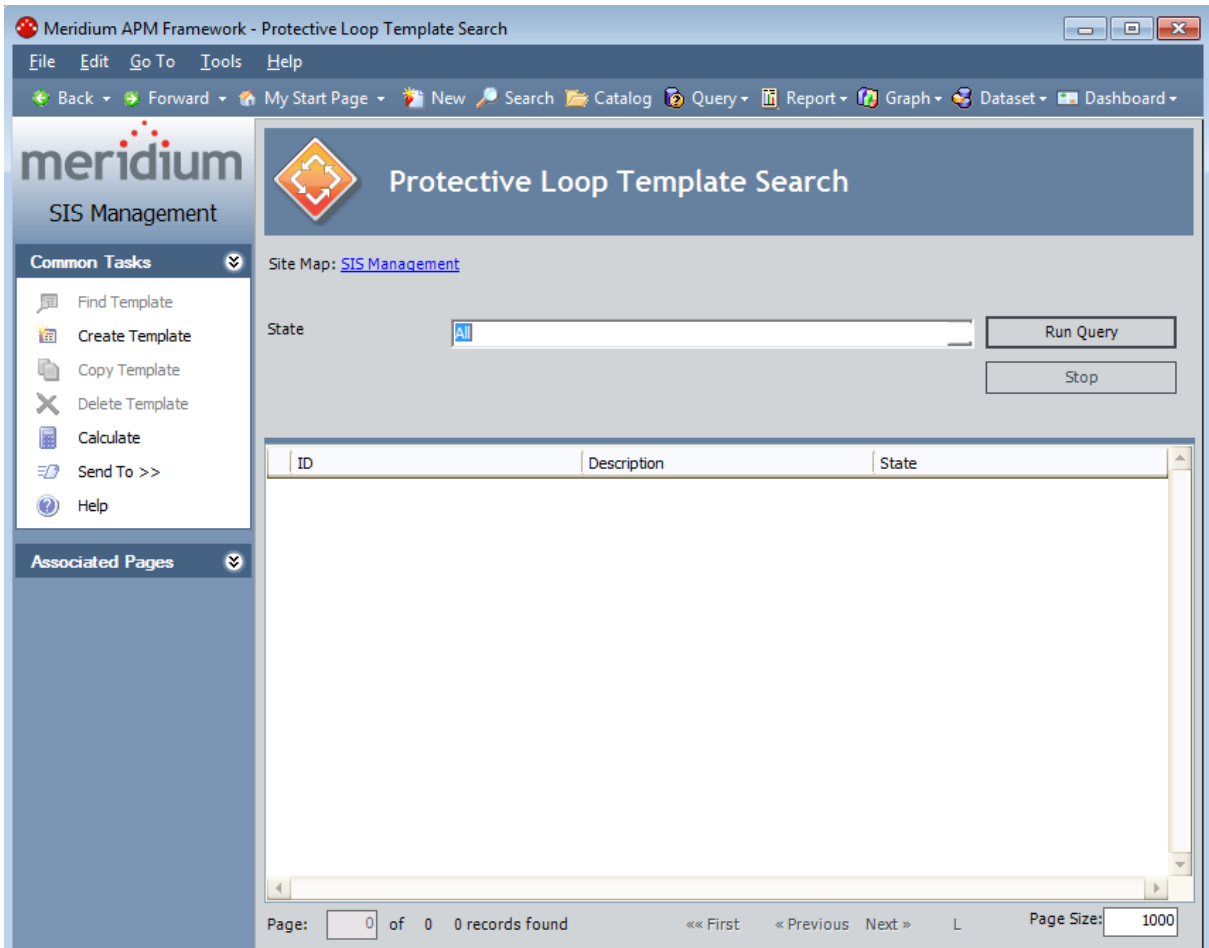

Aspects of the Protective Loop Template Search Page

The **Protective Loop Template Search** page contains the **Protective Loop Template Search** workspace, which displays the results of the query specified in the **Protective Loop Template Search Query** text box on the **SIS Management Administration** page. This documentation assumes that you are using the baseline `Safety_Loop_Template_Search` query, which contains the State prompt that appears as a list at the top of the **Protective Loop Template Search** workspace. The **State** list contains a list of record states that have been configured for the Protective Instrument Loop family. You can choose from the following baseline states:

- **Approval:** Displays the list of existing Protective Instrument Loop records whose State field contains the value *Approval*.
- **Design:** Displays the list of existing Protective Instrument Loop records whose State field contains the value *Design*.
- **In Service:** Displays the list of existing Protective Instrument Loop records whose State field contains the value *In Service*.
- **Out of Service:** Displays the list of existing Protective Instrument Loop records whose State field contains the value *Out of Service*.
- **Pending Approval:** Displays the list of existing Protective Instrument Loop records whose State field contains the value *Pending Approval*.

Selecting the *All* option will cause the query to return all Protective Instrument Loop records in any state.

After you select different criteria, you can click the **Run Query** button to run the `Safety_Loop_Template_Search` query and displays the results in the grid at the bottom of the page. The query results will include hyperlinked Template IDs, which you can use to open the protective instrument loop on the **Protective Instrument Loop Diagram View** page.

Below the query results, options appear that you can use to navigate the results.

The **Protective Loop TemplateSearch** page contains the following task menus:

- [Common Tasks](#)
- [Associated Pages](#)

Using the **Protective Loop Template Search** page, you can:

- [Open an existing protective instrument loop template.](#)
- [Create a new protective instrument loop template from scratch.](#)
- [Create a new protective instrument loop template by copying an existing protective instrument loop template.](#)
- [Delete a protective instrument loop template.](#)

- [Calculate the SIL Validation results for multiple protective instrument loop templates.](#)

The Common Tasks Menu

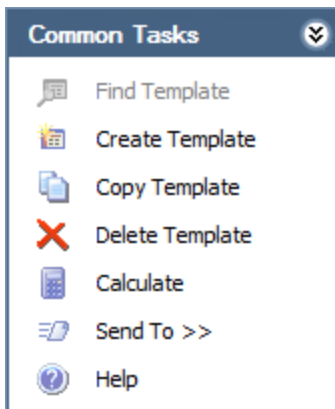

The **Common Tasks** menu on the **Protective Loop Template Search** page contains the following links:

- **Find Template:** This link is disabled.
- **Create Template:** Displays on the **Protective Instrument Loop Diagram View** page the **Protective Instrument Loop Template** screen with a new protective instrument loop template.
- **Copy Template:** Displays in a new row in the grid on the **Protective Loop Template Search** page a new protective instrument loop template with the same name as the source template, appended with *copy*.
- **Delete Template:** Displays a confirmation message, and then deletes the current protective instrument loop.
- **Calculate:** Calculates the values that are stored in the records that make up the selected protective instrument loop template(s).
- **Send To:** Displays a submenu with options that let you provide a link to the current page on your desktop (create shortcut), in an email message, or on a Home Page.
- **Help:** Displays the context sensitive help topic for the **Protective Loop Template Search** page.

Opening Existing Protective Instrument Loop Templates

The following instructions provide details on searching for an existing protective instrument loop templates and opening a protective instrument loop.

To open an existing protective instrument loop template:

1. [Access the Protective Loop Template Search page.](#)
2. In the **State** list, select the state that corresponds to the value in the State field in the Protective Instrument Loop record for the protective instrument loop template that you want to open.
3. Click the **Run Query** button.

The search results appear.

4. In the search results, locate the row containing the protective instrument loop template that you want to open, and in the **ID** cell, click the hyperlinked Template ID for the desired record.

The selected protective instrument loop template appears on the **Protective Instrument Loop Diagram View** page.

About Calculating SIL Validation Results

Note: The details in this section of the documentation can also be used when working with protective instrument loop templates.

The values that are used to calculate SIL Validation results come from the Protective Instrument Loop Element records that are linked to the Protective Instrument Loop record. SIL Validation results for a protective instrument loop can be calculated manually or by the Meridium APM system.

You can specify how you want to calculate the SIL Validation results via the SIL Validation Method field in the Protective Instrument Loop record. On the datasheet, this field appears as a list that contains the following values:

- **Internal Calculation:** Indicates that the results will be calculated by the Meridium APM system. When the SIL Validation Method field contains the value *Internal Calculation*, the **Calculated Results** section on the Protective Instrument Loop datasheet is disabled and populated automatically with the calculation results.
- **External Calculation:** Indicates that the results will be calculated manually. When the SIL Validation Method field contains the value *External Calculation*, the **Calculated Results** section on the Protective Instrument Loop datasheet is enabled. You can use the fields in the **Calculated Results** section to manually calculate SIL Validation results.

The Meridium APM system will calculate SIL Validation results when you click the **Calculate** link, which is available in the following locations:

- **SIL Validation** task menu in the SIL Validation feature. This option lets you [calculate the results for an individual protective instrument loop](#).
- or-
- **Common Tasks** menu on the **Protective Loop Search**. This option lets you [calculate the results for multiple protective instrument loops at one time](#).

Note: You can calculate the results for multiple protective instrument loop templates using this option on the **Protective Loop Template Search** page.

Calculating SIL Validation Results for a Protective Instrument Loop

The following instructions provide details on calculating the SIL Validation results for a single Protective Instrument Loop (or protective instrument loop template). The results of the calculation are stored in the Protective Instrument Loop record and can be viewed via the **Protective Instrument Loop Summary** page.

To calculate SIL Validation results for a Protective Instrument Loop:

- On any page within the SIL Validation feature, on the **SIL Validation** menu, click the **Calculate** link.
- If the results were calculated successfully, a message appears, indicating that the results were calculated successfully.
- If the results were not calculated successfully, a message appears, indicating that the calculation was unsuccessful and that the results have not been updated.
- If the calculation cannot be performed because values required for the calculation have not been provided, [the Missing Required Values dialog box](#) appears, displaying the list of fields that require a value, sorted by the record in which the field exists. You will need to provide the required values and then calculate the results again.

Calculating SIL Validation Results for Multiple Protective Instrument Loops

The following instructions provide details on calculating the SIL Validation results for more than one protective instrument loop at one time. These results are stored in the Protective Instrument Loop record and can be viewed via the **Protective Instrument Loop Summary** page.

These instructions can also be used to calculate the results for more than one protective instrument loop *template*.

To calculate SIL Validation results for multiple Protective Instrument Loops:

1. [Access the Protective Loop Search page](#) (for non-template protective instrument loops).

-or-

[Access the Protective Instrument Loop Template Search page](#) (for protective instrument loop templates).

2. In the search results, select the rows containing the protective instrument loops whose SIL Validation results you want to calculate.
3. On the **Common Tasks** menu, click the **Calculate** link.

The **Calculation** dialog box appears and displays the progress of the calculations. After the results have been calculated, the **Calculation** dialog box displays a message, indicating that the calculation operation is finished, as shown in the following image.

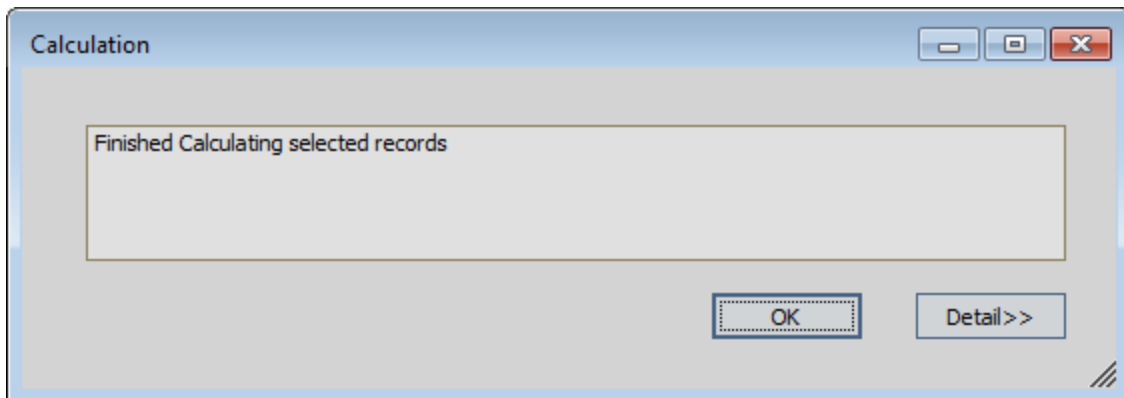

CEHint: To view the list of protective instrument loops that were calculated and [whether the calculation finished successfully or failed](#), click the **Detail>>** button.

4. Click **OK**.

The **Calculation** dialog box closes.

About Calculation Details

After you calculate multiple protective instrument loops, on the **Calculation** dialog box, you can click the **Details>>** button to view the list of protective instrument loops that you selected to calculate and the status of that calculation.

The details of the calculation can contain the following status messages:

- **External Calculation:** This indicates that the value in the SIL Validation Method field in the Protective Instrument Loop record is *External*.
- **Failed:** This indicates that the calculation failed to return results.
- **Succeeded:** This indicates that the calculated results were returned successfully.
- **Unable to calculate:** This indicates that there are some required values missing from the protective instrument loop.

About the Missing Required Values Dialog Box

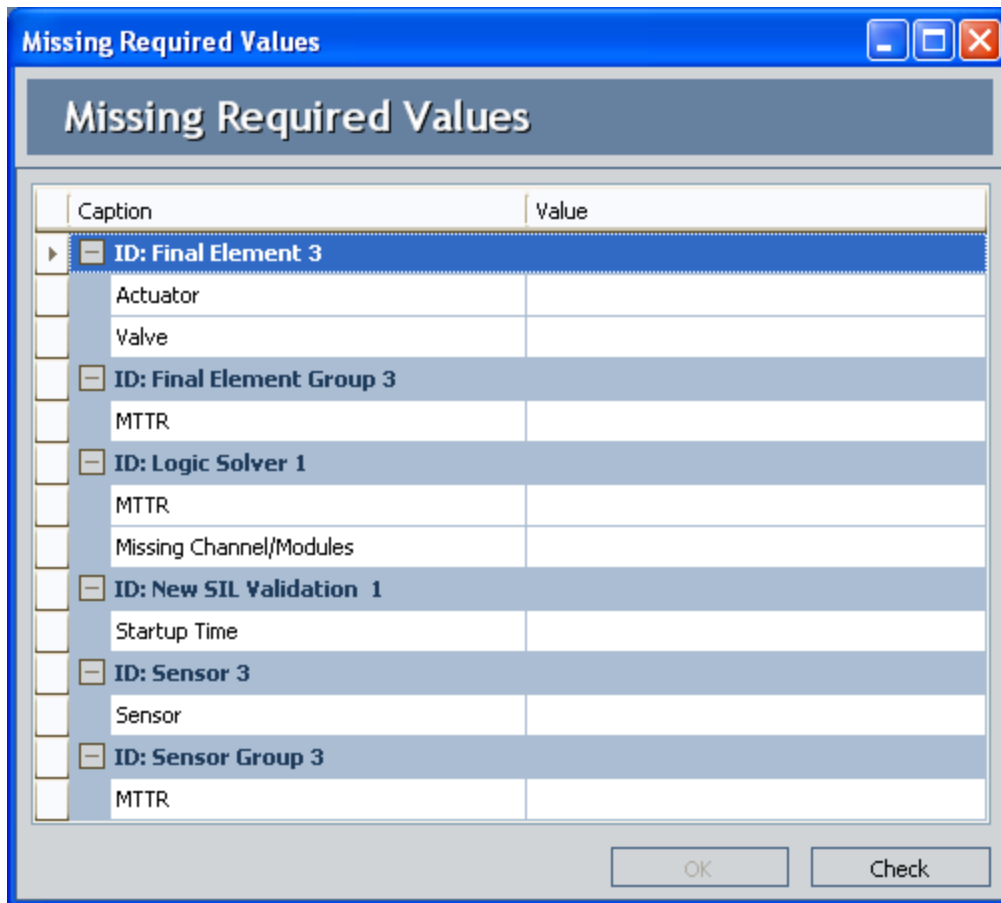

The **Missing Required Values** dialog box will appear if you try to calculate the SIL validation results or save the Protective Instrument Loop record and the values required for the SIL validation calculations have not been provided.

Note: You can save a Protective Instrument Loop record without providing the required values. You cannot, however, successfully calculate SIL Validation results without providing these values.

The **Missing Required Values** dialog box displays a grid that contains a list of fields that are required for the calculation and for which a value has not been provided. These fields are grouped by the Record ID of the record in which they exist. Each row in the grid represents one field. For each field, the following columns are displayed:

- **Caption:** Displays the datasheet caption for that record family.
- **Value:** Displays a text box, where you can provide a value for that field.

In the **Value** cell in the grid, you can type a value for only *some* of the required fields. In some cases, you will need to navigate to the datasheet itself to provide a value. You will know that you can type the value directly in the **Value** cell on the **Missing Required**

Values dialog box if a cursor appears in the **Values** cell when you click the cell. If a cursor does not appear, you will need to navigate to the datasheet. For example, because the Actuator field on a Final Element datasheet contains a list, in order to provide a value in this field, you will need to do so via the datasheet for that family.

Below the grid, the following options appear:

- **OK:** Closes the **Missing Required Values** dialog box.
- **Check:** Refreshes the grid, removing fields for which you have provided a valid value.

About Protective Instrument Loop Final Element Records

Protective Instrument Loop Final Element records can be defined via the <Record ID> (Protective Instrument Loop Final Element) window, which contains the following tabs:

- **Final Element:** Displays the Protective Instrument Loop Final Element datasheet, which is a custom form datasheet that contains [fields that you can use to define the final element](#).
- **[Dangerous Combination of Outputs:](#)** Allows you to [define hazards associated with combined output states for final elements](#).

About Defining Hazards Associated With Combined Output States

When you define a Protective Instrument Loop Final Element record, you will need to define the potential hazards that can occur if the output state associated with the final element is combined with the output state associated with a different final element. While the output state associated with individual final elements is safe, in some cases, when output states associated with multiple final elements are combined, a hazardous event can occur. For example, if the output state associated with Final Element A has the potential to fill a tank half full, and the output state associated with Final Element B has the potential to fill the same tank half full, these combined output states have the potential to overflow the tank. In this way, Final Element A and Final Element B have a *combined output state hazard*.

You can document combined output state hazards that exist for final elements via the **Dangerous Combination of Outputs** tab on the **<Record ID> (Protective Instrument Loop Final Element)** window. In other words, for each final element that participates in a potentially hazardous relationship, you will need to define the combined output state hazard(s) for that final element.

The **Dangerous Combination of Outputs** tab allows you to manage all the combined output state hazards that exist for a final element. To define combined output state hazards for a final element, you will need to:

- Link the Protective Instrument Loop Final Element record to the other Protective Instrument Loop Final Element record representing the final element whose output state can cause a hazard when combined with the output state of the current final element. Protective Instrument Loop Final Element records can be linked to one or more other Protective Instrument Loop Final Element records through the Has Hazardous Event relationship.
- Describe the hazardous event that can occur when the output states are combined. Because some final elements can participate in multiple combined output state hazard scenarios, in each Protective Instrument Loop Final Element record, you will need to describe the hazardous events that are associated with that final element. In other words, describing the hazardous event in one Protective Instrument Loop Final Element record will not automatically populate the linked Protective Instrument Loop Final Element record with the same description.

The following image illustrates the records that participate in a combined output state hazard scenario in which the combination of two output states can lead to a hazardous event.

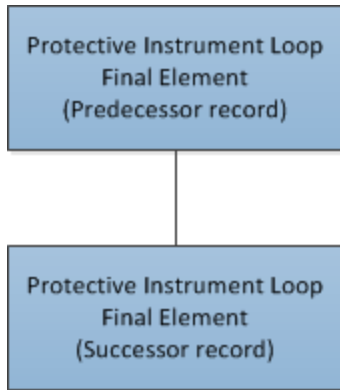

Notice that the Protective Instrument Loop Final Element record to which you link other Protective Instrument Loop Final Element records is the predecessor in the relationship. When you are working with Protective Instrument Loop Final Element records, it is helpful to refer to the [SIS Management data model image where the Protective Instrument Loop family is the predecessor family](#).

The following image shows the **Dangerous Combination of Outputs** tab on the **<Record ID> (Protective Instrument Loop Final Element)** window for the final element with the Record ID *Final Element template 1 2*.

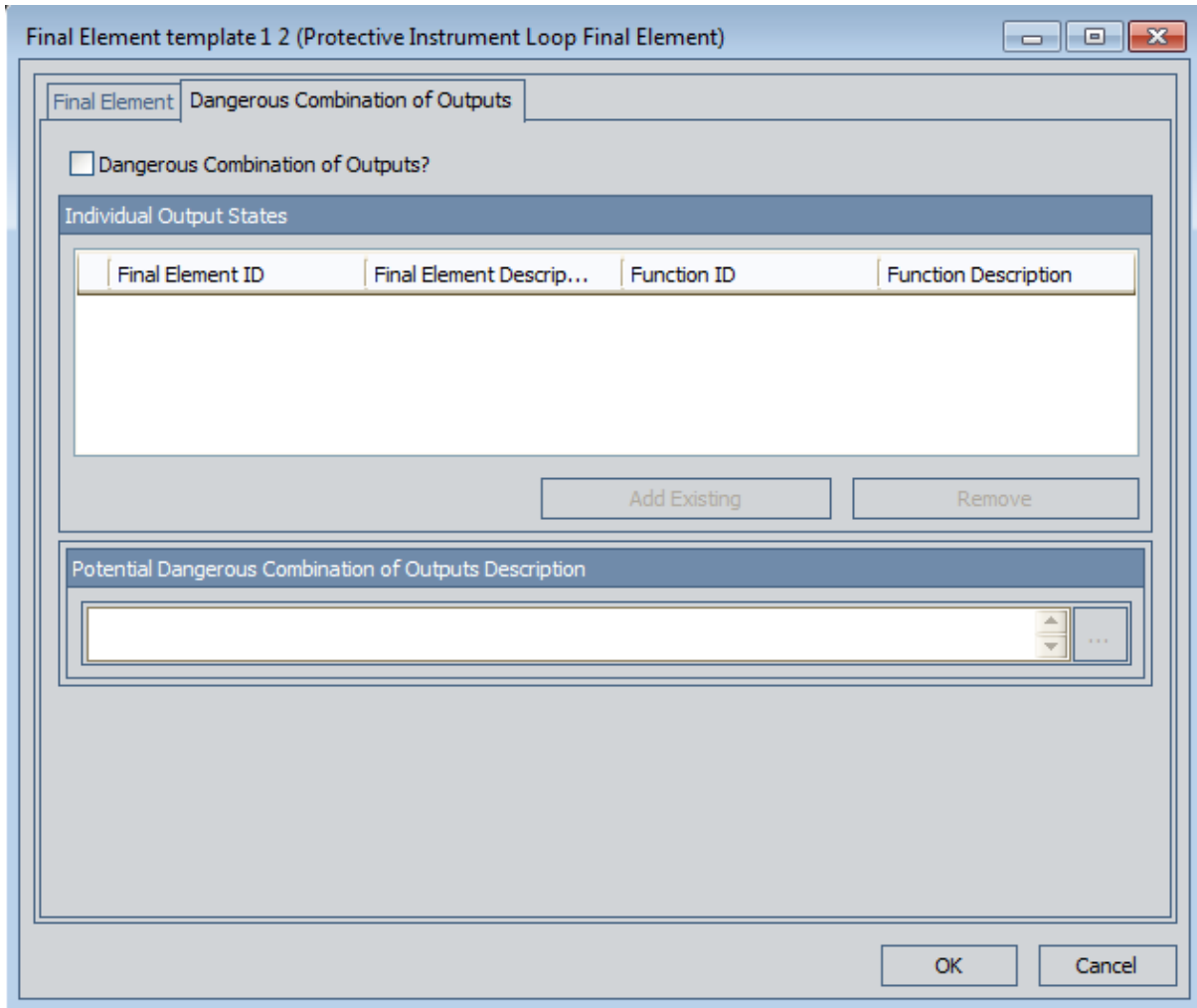

Aspects of the Dangerous Combination of Output States Tab in Protective Instrument Loop Final Element Records

The **Dangerous Combination of Outputs** tab on the <Record ID> (Protective Instrument Loop Final Element) window contains the **Dangerous Combination of Outputs?** check box, which lets you indicate whether the final element represented by the current record is associated with any hazards that result from a combination of output states. When the **Dangerous Combination of Outputs?** check box is:

- *Selected*, the remaining options on the **Dangerous Combination of Outputs** tab are *enabled*, and a message appears, indicating that you must link at least one Protective Instrument Loop Final Element record to the current Protective Instrument Loop Final Element record. The additional Protective Instrument Loop Final Element record represents the final element whose output state combined with the output state of the current final element can lead to a hazardous event. After you link at least one Protective Instrument Loop Final Element record to the current record, the message is hidden.
- *Cleared*, the remaining options on the **Dangerous Combination of Outputs** tab are *disabled*. This indicates that the final element represented by the current Protective Instrument Loop Final Element record is not associated with any combined output state hazards. You will need to open the linked Protective Instrument Loop Final Element record and enter the description of the combined output state hazard.

After at least one Protective Instrument Loop Final Element record is linked to the current Protective Instrument Loop Final Element record, the **Dangerous Combination of Outputs?** check box is disabled. In addition, you can clear this check box only if the **Individual Output States** grid is empty (i.e., there are no combined output state hazards associated with the final element).

Below the **Dangerous Combination of Outputs?** check box, the following sections appear:

- **Individual Output States:** Contains a grid that displays the list of Protective Instrument Loop Final Element records that are linked to the current Protective Instrument Loop Final Element record. Each row in the grid represents one final element whose output state can lead to a hazardous event if it is combined with the output state associated with the output state of the current final element. The following information is displayed for each Protective Instrument Loop Final Element record that appears in the grid:
 - **Final Element ID:** An ID for the final element that is stored in the Final Element ID field in the corresponding Protective Instrument Loop Final Element record.
 - **Final Element Description:** A description for the final element that is stored in the Description field in the corresponding Protective Instrument Loop Final Element record.

- **Function ID:** The value stored in the IF ID field in the Instrumented Function record to which the corresponding Protective Instrument Loop Final Element record is linked.
- **Function Description:** The value stored in the IF Description field in the Instrumented Function record to which the corresponding Instrument Loop Final Element record is linked.

Below the grid, the following buttons appear:

- **Add Existing:** Displays the **Find Items** window, which you can use to search for an existing Protective Instrument Loop Final Element record and link it to the current Protective Instrument Loop Final Element record. After you link a Protective Instrument Loop Final Element record to the current Protective Instrument Loop Final Element record, a new row will appear in the **Individual Output States** grid to represent that final element.
- **Remove:** After displaying a confirmation message, deletes the link between the selection Protective Instrument Loop Final Element record and the current Protective Instrument Loop Final Element record and removes the final element from the grid. This button is disabled until at least one Protective Instrument Loop Final Element record appears in the **Individual Output States** grid.
- **Potential Combination of Outputs Description:** Contains a field, which stores the description of the combined output state hazards that are associated with the current final element. This field is required. If the current final element is associated with multiple combined output state hazards, you should provide a description in this field for each of these hazards.

Defining Combined Output State Hazards for Final Elements

To define a combined output state hazard for final elements, you will need to:

- Link to one another the Protective Instrument Loop Final Element records whose associated output states can cause a hazard if they occur simultaneously.
- Describe in each of the Protective Instrument Loop Final Element records the hazardous event that can occur if the output states associated with the final elements occur simultaneously.

To define a combined output state hazard for final elements:

1. [Open the Protective Instrument Loop](#) record that contains the final element for which you want to define a combined output state hazard.
2. In the Diagram Canvas, double-click the Final Element node representing the final element for which you want to define a combined output state hazard.

The Protective Instrument Loop Final Element record appears in the **<Record> (Protective Instrument Loop Final Element)** window.

Defining Combined Output State Hazards for Final Elements

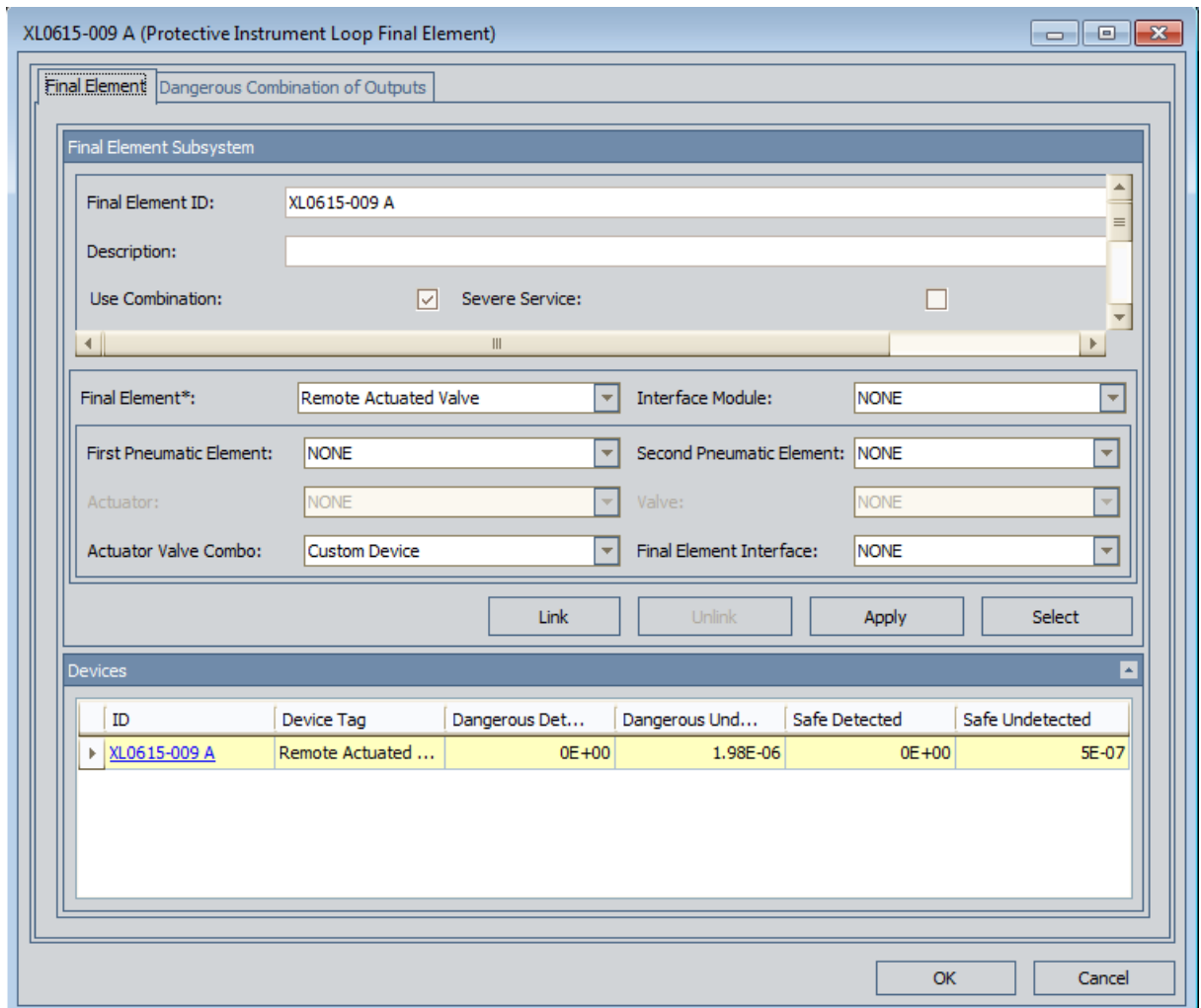

3. Click the **Dangerous Combination of Outputs** tab.
The **Dangerous Combination of Outputs** tab appears.

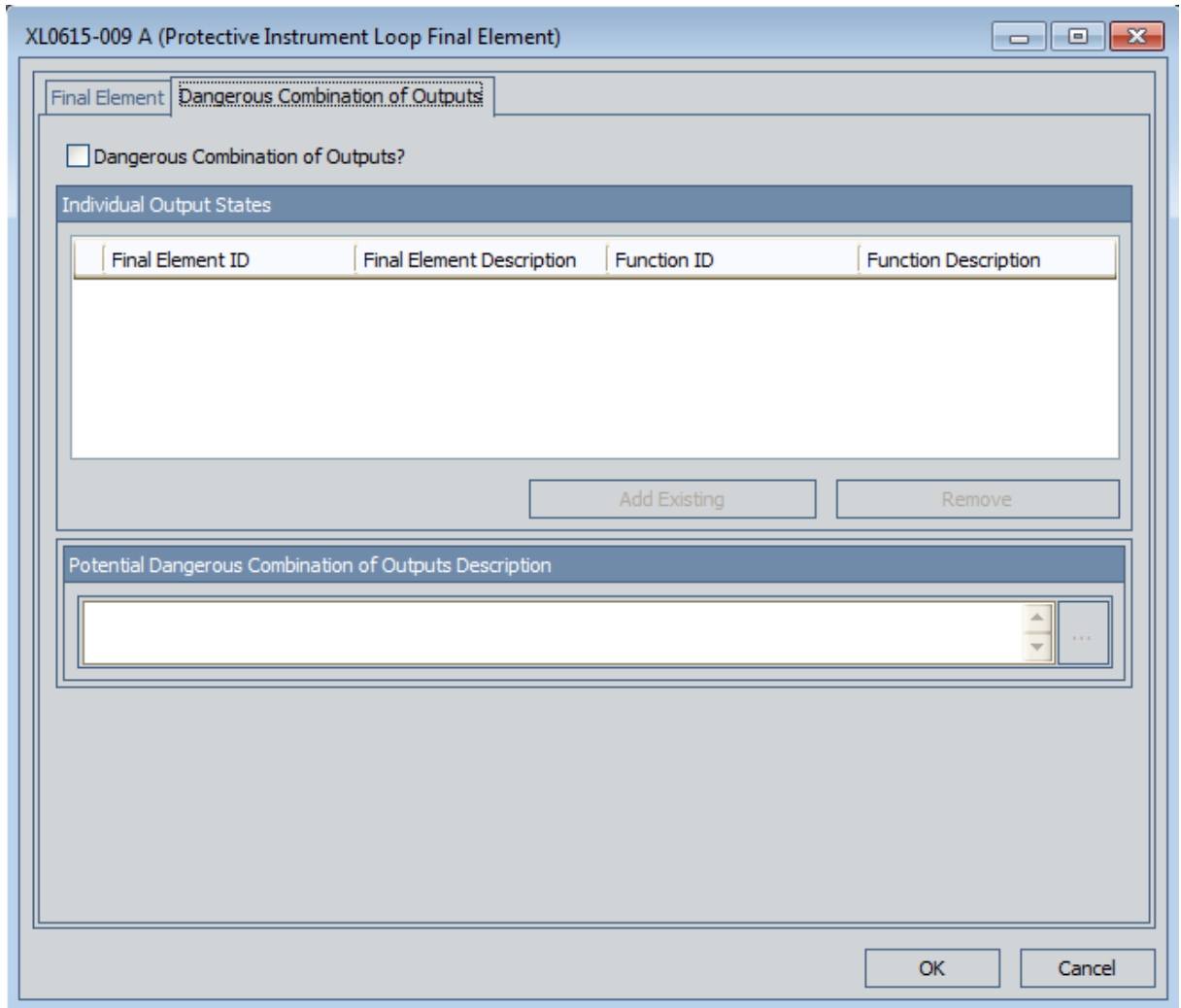

4. Select the **Dangerous Combination of Outputs?** check box.

The remaining options are enabled, and a message appears, indicating that you must link at least one Protective Instrument Loop Final Element record to the current Protective Instrument Loop Final Element record.

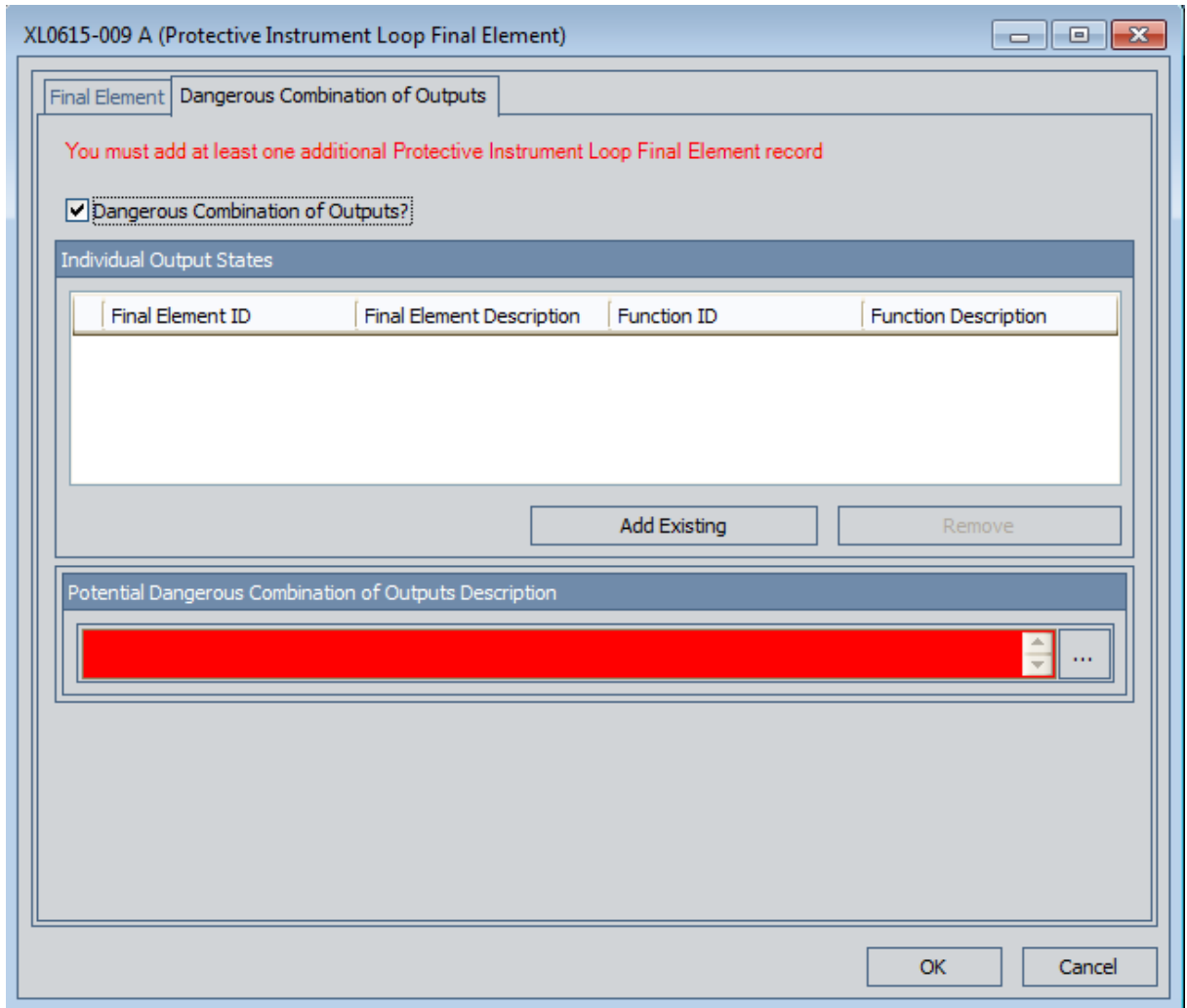

5. In the **Individual Output States** section, click the **Add Existing** button.

The **Search Related Final Element** dialog box appears, displaying the list of existing Protective Instrument Loop Final Element records.

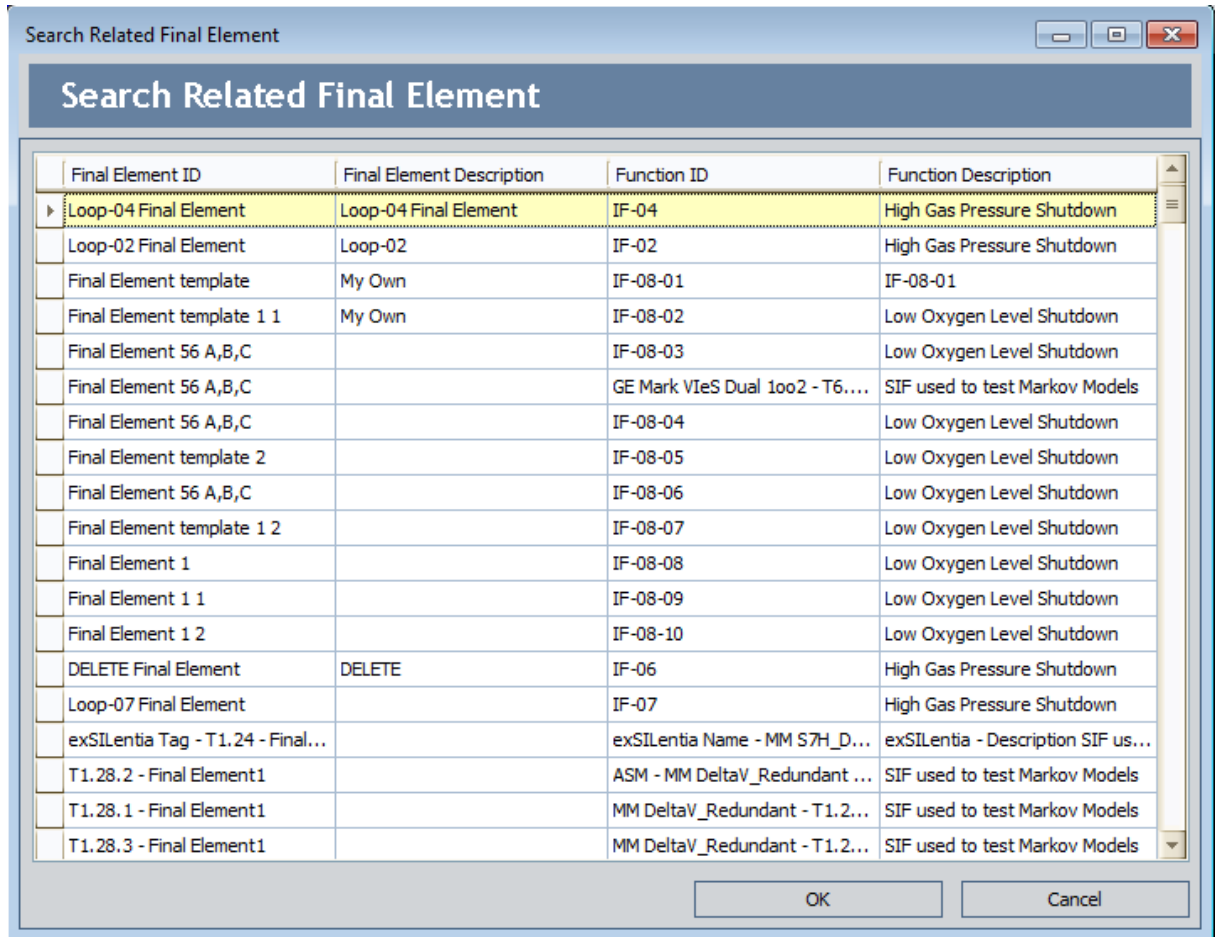

- In the grid, select the rows containing the Protective Instrument Loop Final Element records that you want to link to the current Protective Instrument Loop Final Element record, and then click **OK**. Keep in mind the records you select should represent the final elements whose output states can lead to a hazardous event if they occur simultaneously with the output state of the current final element.

The **Search Related Final Element** dialog box closes, and the record(s) you selected appear in the **Individual Output States** grid. For example, in the following image, you can see that two Protective Instrument Loop Final Element records are linked to the Protective Instrument Loop Final Element record *XL0615-009 A*.

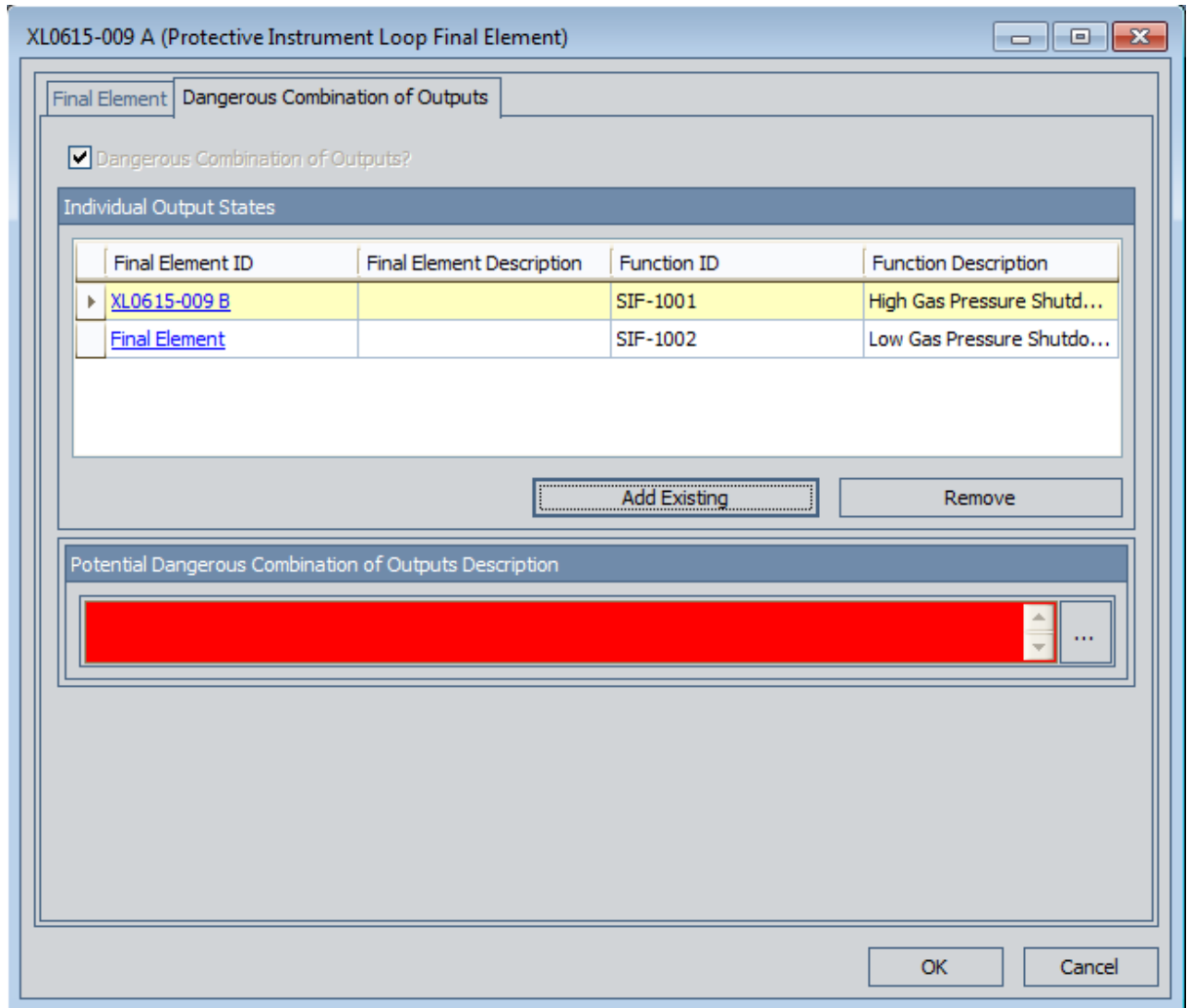

7. In the **Combination Hazardous Event** section, enter a description for the hazardous event that can occur if the output states associated with the final elements occur simultaneously.
8. In the **Individual Output States** section, in the first row in the grid, click the hyper-linked ID in the **Final Element ID** cell.

The corresponding Protective Instrument Loop Final Element record appears in a new <Record ID> (Protective Instrument Loop Final Element) window.

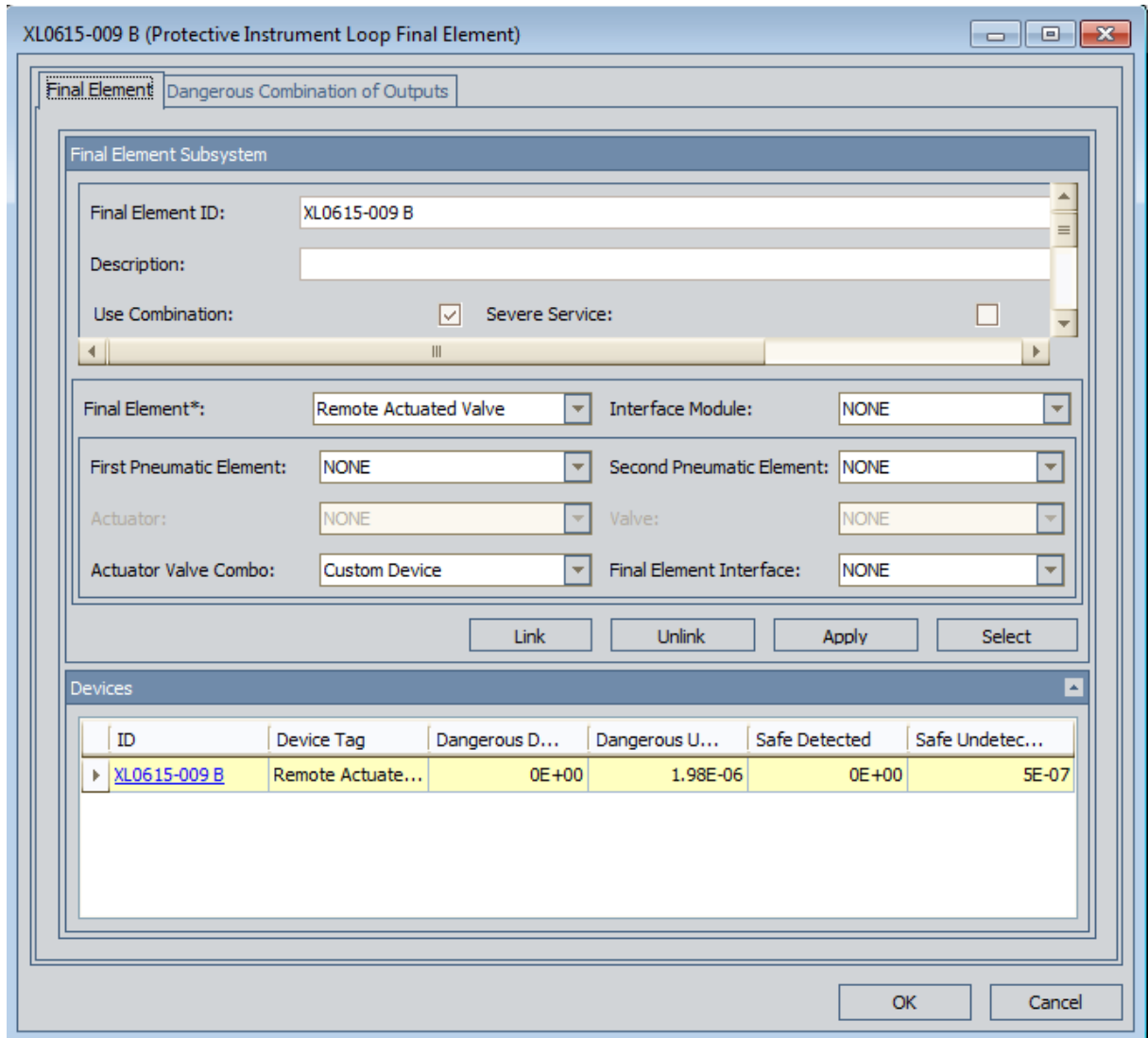

- Click the **Dangerous Combination of Outputs** tab.

The **Dangerous Combination of Outputs** tab appears. In addition, you can see that the **Dangerous Combination of Outputs?** check box is selected automatically and the **Individual Output States** grid contains the Protective Instrument Loop Final Element record to which the current record is linked (i.e., the record from which you accessed the current record).

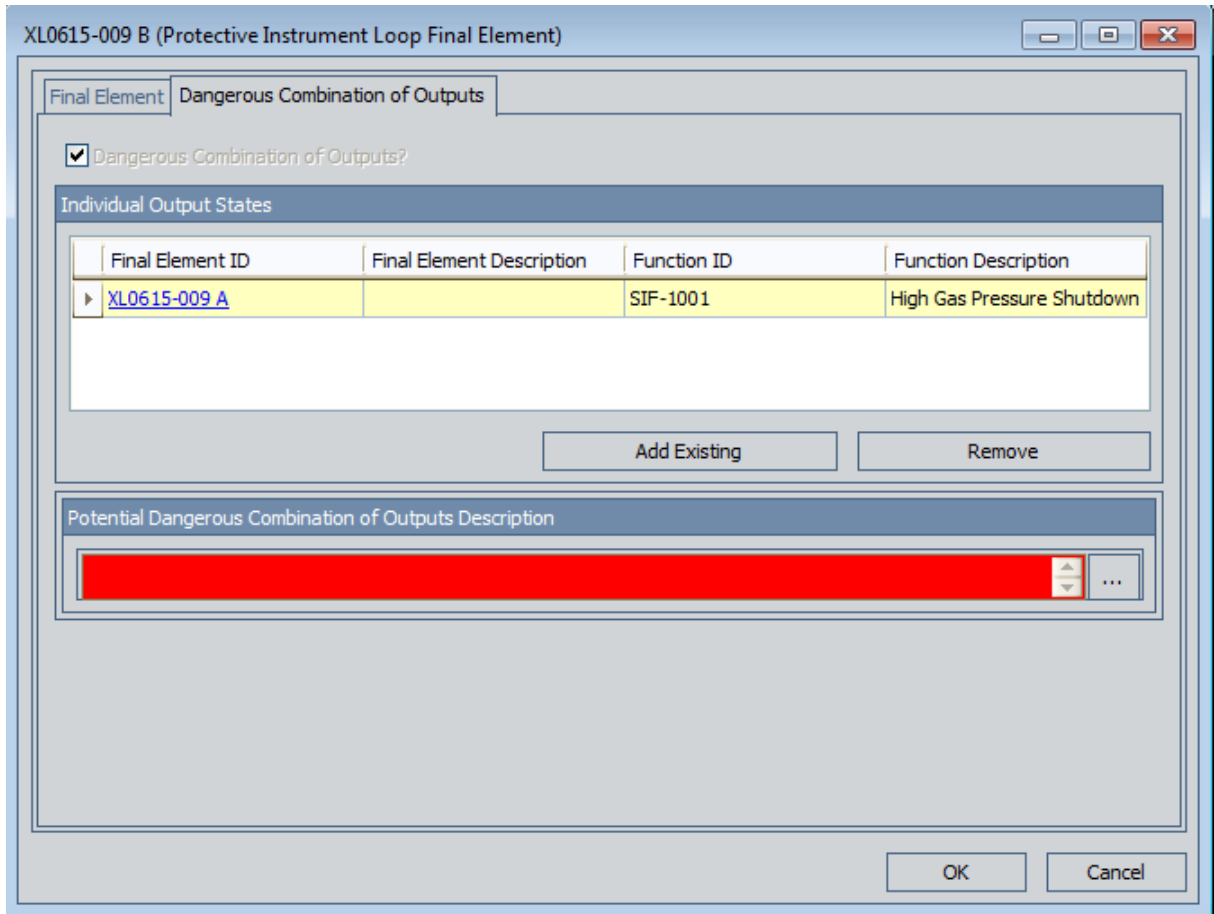

10. In the **Combination Hazardous Event** section, enter a description for the hazardous event that can occur if the output states associated with the final elements occur simultaneously. This should be the same description that you entered in step 7.
11. Click **OK**.
Your changes are saved, and the Protective Instrument Loop Final Element record closes, revealing the previous Protective Instrument Loop Final Element record.
12. Repeat steps 8 through 11 for each Protective Instrument Loop Final Element record that appears in the **Individual Output States** grid.
13. Click **OK**.
Your changes are saved, and the Protective Instrument Loop Final Element record closes.

Removing Final Elements From the Dangerous Combination of Outputs Tab

When you remove a final element from the **Dangerous Combination of Outputs** tab, you are deleting the link between the Protective Instrument Loop Final Element records.

To remove a final element from the **Dangerous Combination of Outputs** tab:

1. [Open the Protective Instrument Loop](#) that contains the final element whose corresponding record you want to modify.
2. In the Diagram Canvas, double-click the Final Element node representing the final element from which you want to remove a different final element.

The Protective Instrument Loop Final Element record appears in a new window.

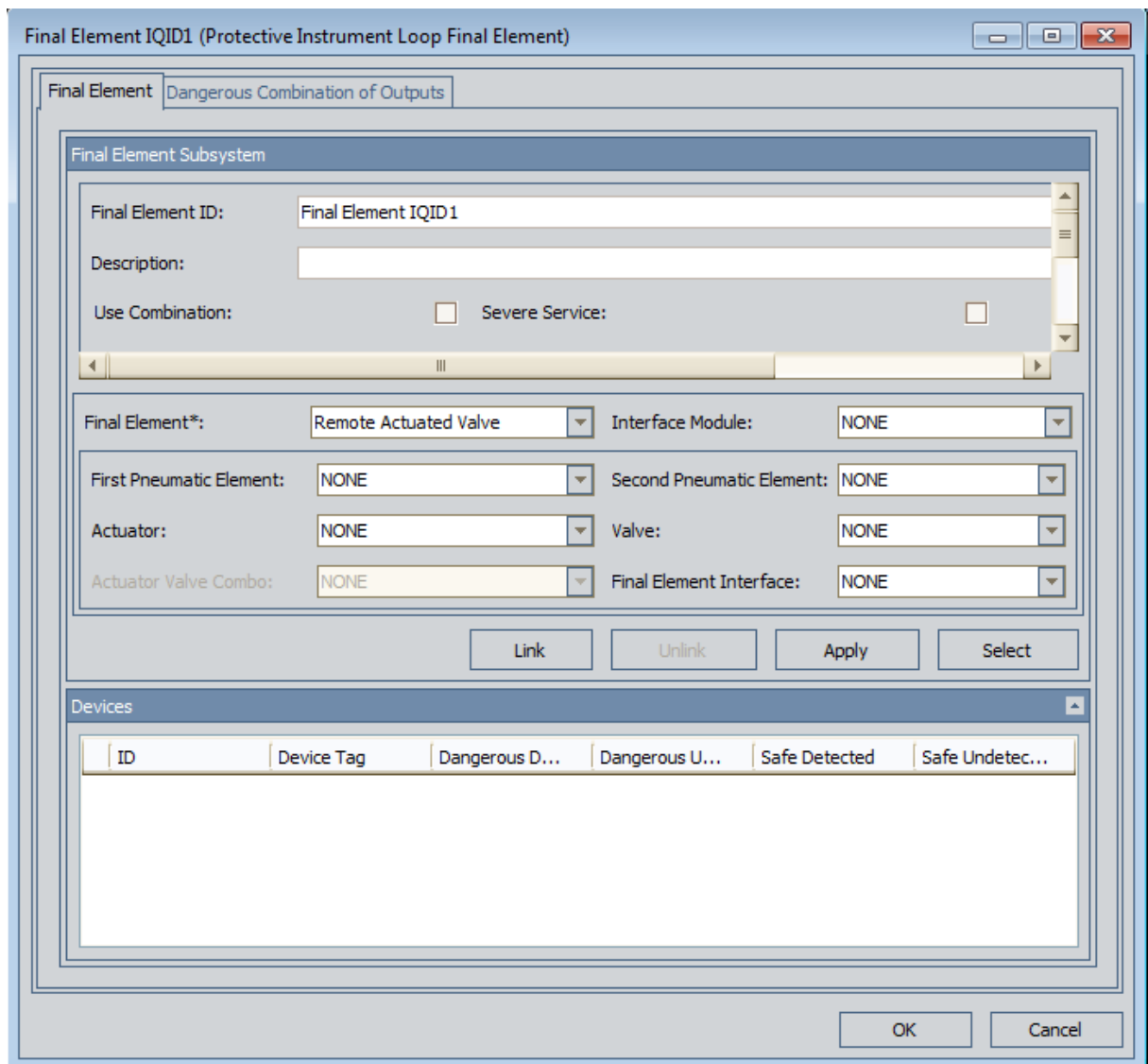

3. Click the **Dangerous Combination of Outputs** tab.

The **Dangerous Combination of Outputs** tab appears.

4. In the **Individual Output States** grid, select the row containing the final element that you want to remove.

CEHint: You may want to update the text stored in the **Combination Hazardous Event** section in the corresponding Protective Instrument Loop Final Element record before you remove it from the current record. To do so, click the hyper-linked value in the **Final Element ID** cell in that row.

5. Click the **Remove** button.

A confirmation message appears, asking if you really want to remove the selected record.

CEHint: You may want to update the text stored in the **Combination Hazardous Event** section in the current record.

6. Click the **Yes** button.

Your changes are saved, and the Protective Instrument Loop Final Element record closes.

About the Protective Instrument Loop Report

The Protective Instrument Loop report provides an overview of the protective instrument loop and displays the following information:

- **Loop ID:** Displays the value that exists in the Loop ID field in the associated Protective Instrument Loop record.
- **Description:** Displays the value that exists in the Description field in the associated Protective Instrument Loop record.
- **Long Description:** Displays the value that exists in the Long Description field in the associated Protective Instrument Loop record.
- **Loop Class:** Displays the value that exists in the Loop Class field in the associated Protective Instrument Loop record.
- **Loop Type:** Displays the value that exists in the Loop Type field in the associated Protective Instrument Loop record.
- **SIL Demand Mode:** Displays the value that exists in the Demand Mode field in the associated Protective Instrument Loop record.
- **Systematic Capability Validation:** Displays the value that exists in the Systematic Capability Validation field in the associated Protective Instrument Loop record.
- **Mission Time:** Displays the value that exists in the Mission Time field in the associated Protective Instrument Loop record.
- **Startup Time:** Displays the value that exists in the Startup Time field in the associated Protective Instrument Loop record.
- **Required SIL:** Displays the value that exists in the Required SIL field in the associated Protective Instrument Loop record.
- **Meets SIL Requirements:** Displays the value that exists in the Meets SIL Requirement? field in the associated Protective Instrument Loop record.
- **Achieved SIL:** Displays the value that exists in the Achieved SIL field in the associated Protective Instrument Loop record.
- **Evaluated Architectural Constraints:** Displays the value that exists in the Meets Architectural Constraints field in the associated Protective Instrument Loop record.
- **Risk Reduction Factor:** Displays the value that exists in the Risk Reduction Factor field in the associated Protective Instrument Loop record.
- **MTTS (years):** Displays the value that exists in the MTTF Years field in the associated Protective Instrument Loop record.
- **Status:** Displays the value that exists in the Status field in the associated Protective Instrument Loop record.
- **Status Changed Date:** Displays the date on which the value in the Status field was updated last.
- **Status Changed By:** Displays the value that exists in the Last Modified By field in

the associated Protective Instrument Loop record.

- **Last Modified By:** Displays the value that exists in the Last Modified By field in the associated Protective Instrument Loop record.
- **Last Modified Date:** Displays the value that exists in the Last Modified Date field in the associated Protective Instrument Loop record.

In addition to the preceding information, the Protective Instrument Loop Report contains a table, which contains various information that is stored in the Protective Instrument Loop Element records that are linked to the Protective Instrument Loop record.

Viewing the Protective Instrument Loop Report

To view the Protective Instrument Loop report:

1. Open the protective instrument loop or protective instrument loop template for which you want to view the Protective Instrument Loop report.
2. On the **Common Tasks** menu, click the **Reports** link.
A submenu appears.
3. On the submenu, click the **Protective Instrument Loop Report** link.

Note: The name of the link is the caption of the Catalog item Protective Instrument Loop Report. This link is called the *Protective Instrument Loop Report* by default.

The Protective Instrument Loop report appears in the Report Viewer.

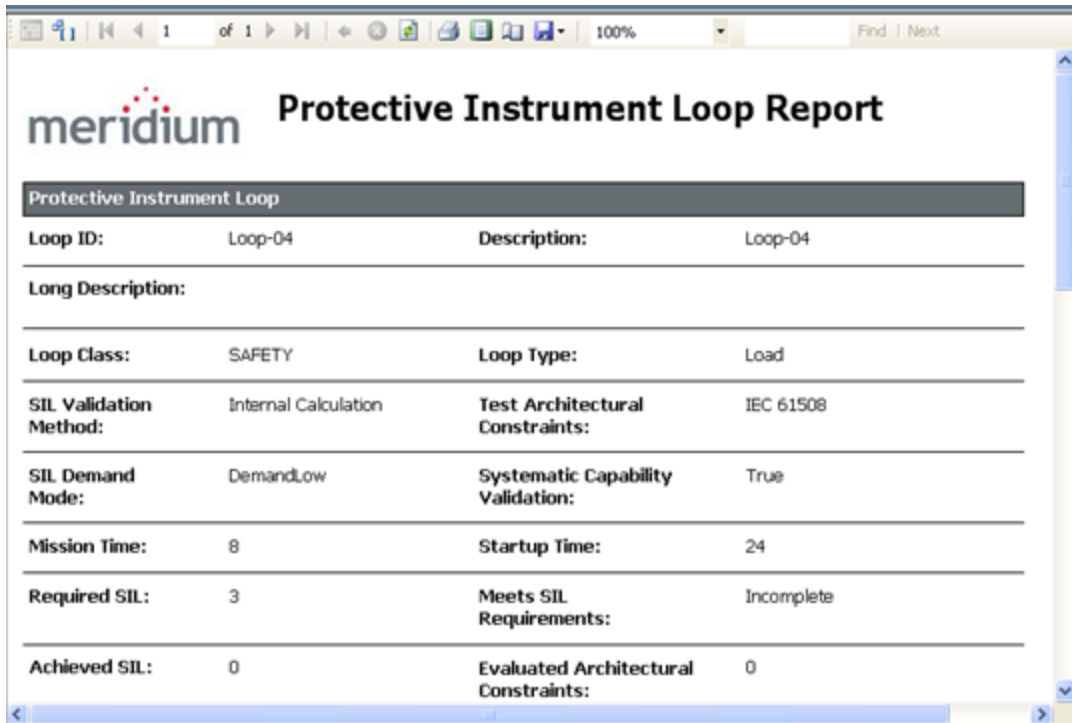

Protective Instrument Loop			
Loop ID:	Loop-04	Description:	Loop-04
Long Description:			
Loop Class:	SAFETY	Loop Type:	Load
SIL Validation Method:	Internal Calculation	Test Architectural Constraints:	IEC 61508
SIL Demand Mode:	DemandLow	Systematic Capability Validation:	True
Mission Time:	8	Startup Time:	24
Required SIL:	3	Meets SIL Requirements:	Incomplete
Achieved SIL:	0	Evaluated Architectural Constraints:	0

Viewing SIL Analysis Graphs

The following instructions provide details on viewing the graphs that appear on the **Graphs** submenu on the **Common Tasks** menu when you are viewing and SIL Analysis record. This submenu displays all the reports that exist in the Catalog folder <\\Public\Meridium\Modules\SIS Management\SIL\Graphs>.

To view an SIL Analysis graph:

1. [Access the SIL Analysis record whose report you want to view.](#)
2. On the **Common Tasks** menu, click the **Graphs** link.
A submenu appears.
3. On the submenu, click the link that corresponds to the caption of the graph that you want to view. For example, click the **SIL Assignment Summary Graph** link.

The selected report appears in the Graph Viewer. The following image shows an example of the baseline SIL Assignment Summary Graph.

Viewing SIL Analysis Graphs

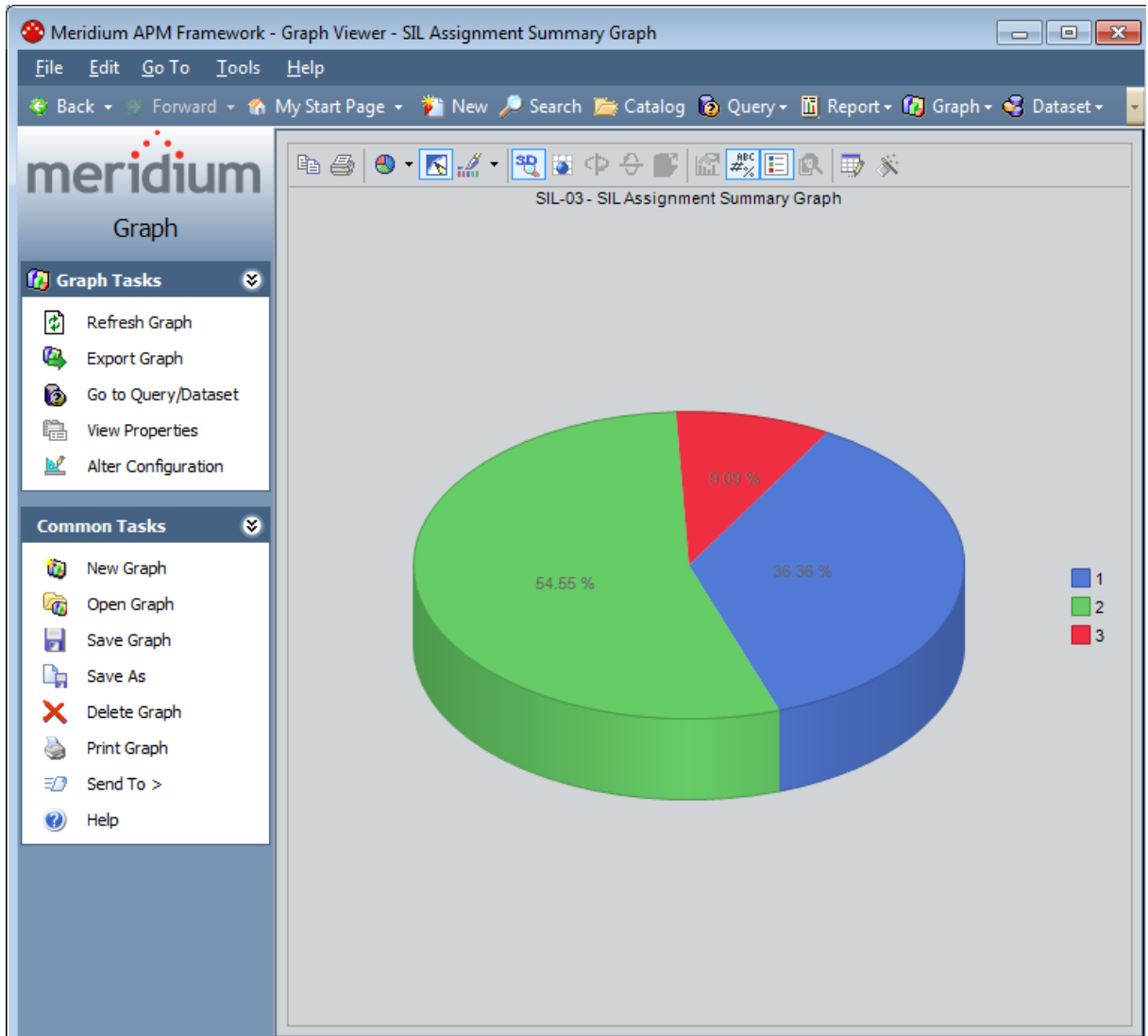

Viewing SIL Analysis Reports

The following instructions provide details on viewing the reports that appear on the **Reports** submenu on the **Common Tasks** menu when you are viewing and SIL Analysis record. This submenu displays the reports that exist in the Catalog folder \\Public\Meridium\Modules\SIS Management\SIL\Reports. By default, this folder contains the SIL Analysis Report.

To view an SIL Analysis report:

1. Access the SIL Analysis record whose report you want to view.
2. On the **Common Tasks** menu, click the **Reports** link.
A submenu appears.
3. On the submenu, click the link that corresponds to the caption of the report that you want to view. For example, click the **SIL Analysis Report** link.

The selected report appears in the Report Viewer.

About the Safety Requirement Specifications Report

The *Safety Requirement Specifications* report contains all the details from an SIL Analysis that are required to meet compliance for IEC standard 61511. You can use this report to:

- Provide proof of compliance with IEC 61511.
- Identify gaps in compliance with IEC 61511.

The Safety Requirement Specifications report displays values that are stored in the [records that make up an SIL Analysis](#).

It is stored in the Catalog folder \\Public\Meridium\Modules\SIS Management\SIL\Reports and titled *SRS Report*. You can [access the report](#) using the **Reports** link on the **Common Tasks** menu on the **SIL Analysis Definition** page. When you access the Safety Requirement Specifications report in this way, the Meridium APM system will automatically pass in the Entity Key for the SIL Analysis record to which all other records that make up and SIL Analysis are linked.

While you can run the Safety Requirement Specifications report directly from the Catalog folder and pass in an Entity Key manually, we recommend that you run the report via the SIL Analysis within the SIS Management module. In addition, you should not modify the report or [any of its supporting queries or subreports](#).

Accessing the Safety Requirement Specifications Report

The following instructions provide details on accessing the Safety Requirement Specifications report for an SIL Analysis. When you run the Safety Requirement Specifications report, the Meridium APM system will automatically pass in the Entity Key of the SIL Analysis record to which all other records that make up the SIL Analysis are linked.

To access the Safety Requirement Specification report:

1. [Open the SIL Analysis](#) for which you want to view the Safety Requirement Specifications report.
2. On the **Common Tasks** menu, click the **Reports** link.

A submenu appears, displaying the captions of the following Catalog items as links:

- SIL Analysis Report
 - SRS Report
3. Click the **SRS Report** link.

The Safety Requirement Specifications report appears in the Report Viewer.

The screenshot shows a PDF viewer window with the Meridium logo and the title 'Safety Requirement Specifications Report'. The document content is as follows:

1 Introduction

1.1 General Project Information:

Project ID:	SIL-03
Project Name:	BR-1001 Steam Boiler SIS Analysis
Project Leader:	Soos, Steve
Project Initiated On:	6/29/2009 12:00:00 AM
Project Description:	Based on results of updated HAZOP conducted on BR-1001 Steam Boiler reassess SIL's and address any recommendations for additional PIF's.
Functional Location:	
Approved By:	SS00S

1.2 Purpose and Scope:

The purpose of this document is to provide details of the functional requirements that are common to the Safety Instrumented System (SIS), the functional requirements that are common to all identified Safety Instrumented Functions (SIF), and the functional and integrity requirements that are unique to each SIF. In this way repetition, conflicting or missing requirements are reduced. The intent is that the information required by the organization responsible for the design of the SIS is presented as clearly, completely and accurately as possible to enable the organization to design the SIS and each SIF to meet the functional requirements.

About Managing Validation Failure Rate Reference Data

Failure rate reference data refers to data that exists to record trends in failure rates for elements that exist in a protective instrument loop. Before you add an element to a protective instrument loop, you can consider the failure rate reference data that is associated with that element and make a decision on whether or not to use that particular element.

SIS Management provides tools that you can use to view Protective Instrument Loop Element records for sensors, logic solvers, and final elements, where the Is Reference Data field in that record is set to *True*. The **Is Reference Data** check box is not included on the datasheet by default. This field is used by the Meridium APM system and is not meant to be modified manually.

When you create a Protective Instrument Loop Element record via the Validation Failure Rate Reference Data feature, the Meridium APM system will automatically select the **Is Reference Data** check box in that record.

You can use the Validation Failure Rate Reference Data feature to determine which elements are approved for use with a protective instrument loop. After you have determined that a given element is approved, you can select **Approve** button below the datasheet. When you do so, the Meridium APM system will automatically select the **Approved Custom Device** check box in that record, and it will be available for selection in the SIL Validation feature. To approve a Protective Instrument Loop Element record, you must be a member of the SIS Administrator or SIS Engineer Security Group.

Navigation

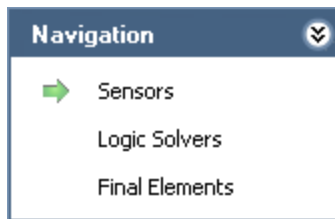

The **Navigation** menu in the Validation Failure Rate Reference Data feature contains the following links:

- **Sensors:** Displays the **Sensor Reference Data Search** page, where you can search for Sensor records.
- **Logic Solvers:** Displays the **Logic Solver Reference Data Search** page, where you can search for Logic Solver records.
- **Final Elements:** Displays the **Final Element Reference Data Search** page, where you can search for Final Element records.

A green arrow to the left of an option indicates the Protective Instrument Loop Element family with which you are currently working.

Common Tasks

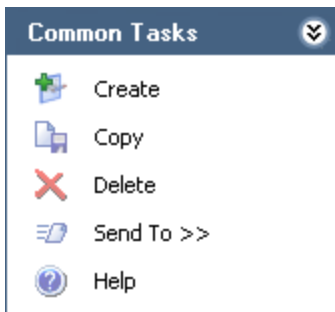

The **Common Tasks** menu in the Validation Failure Rate Reference Data Feature contains the following links, which are context-sensitive, meaning that the family with which you are currently working will determine the specific context of the link:

- **Create:** Displays a new blank record in the family with which you are currently working.
- **Copy:** Displays a new record in the family with which you are currently working that is populated automatically with information from the source record.
- **Delete:** Displays a confirmation message and then deletes the selected record.
- **Send To:** Displays a submenu with options that let you provide a link to the current page on your desktop (create shortcut), in an email message, or on a Home Page.
- **Help:** Displays the context-sensitive Help topic for the current page.

Accessing the Sensor Reference Data Search Page

The **Sensor Reference Data Search** page appears by default when you access the Validation Failure Rate Reference Data feature.

To access the Sensor Reference Data Search page:

1. [Access the SIS Management Start Page](#).
2. Click the **Manage Validation Failure Rate Reference Data** link.

The **Sensor Reference Data Search** page appears.

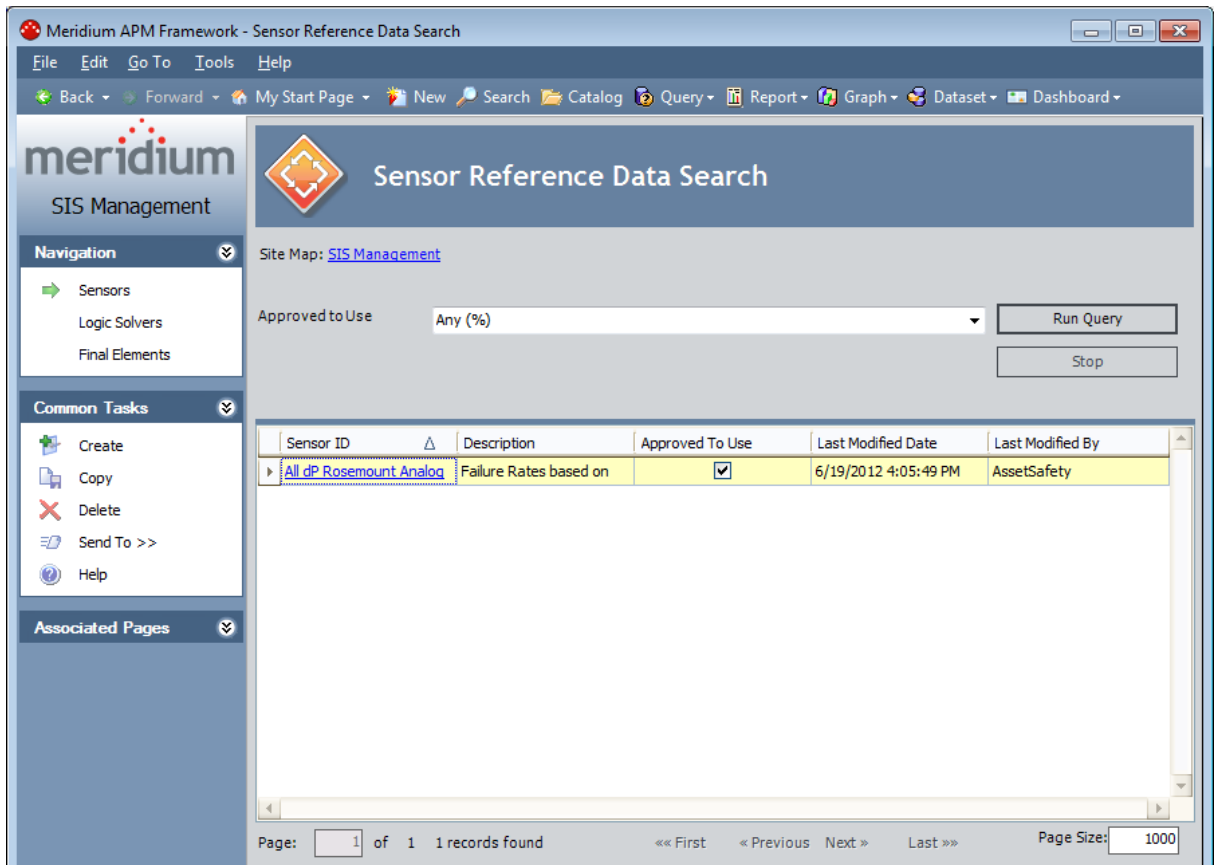

Aspects of the Sensor Reference Data Search Page

The **Sensor Reference Data Search** page contains the results of the `Sensor_Reference_Data_Search` query. This documentation assumes that you are using the baseline query, which contains an **Approved to Use** prompt that appears as a list at the top of the **Sensor Reference Data Search** page. The **Approved to Use** list contains a list of values that correspond to the state of the **Approved Custom Device** field in the Protective Instrument Loop Sensor records. You can choose from the following baseline values:

- **Yes:** Displays all the existing Protective Instrument Loop Sensor records whose **Is Reference Data** field is set to *True* and whose **Approved Custom Device** check box is selected.
- **No:** Displays all the existing Protective Instrument Loop Sensor records whose **Is Reference Data** field is set to *True* and whose **Approved Custom Device** check box is cleared.
- **Any (%):** Displays all the existing Protective Instrument Loop Sensor records whose **Is Reference Data** field is set to *True*.

This query is run automatically using the default prompt value *Any (%)*. If you select different criteria, you can click the **Run Query** button to run the query and display the results in the grid at the bottom of the page. The query results will include hyperlinked Record IDs, which you can use to open the Protective Instrument Loop Sensor record on the **Sensor Reference Data** page.

Below the query results are options that you can use to navigate the results.

The **Sensor Reference Data Search** page contains the following task menus:

- [Navigation](#)
- [Common Tasks](#)
- [Associated Pages](#)

Opening Existing Protective Instrument Loop Sensor Records

To open an existing Protective Instrument Loop Sensor record:

1. [Access the Sensor Reference Data Search page.](#)
2. Provide the desired search criteria, and then click the **Run Query** button.

The results appear in the grid.

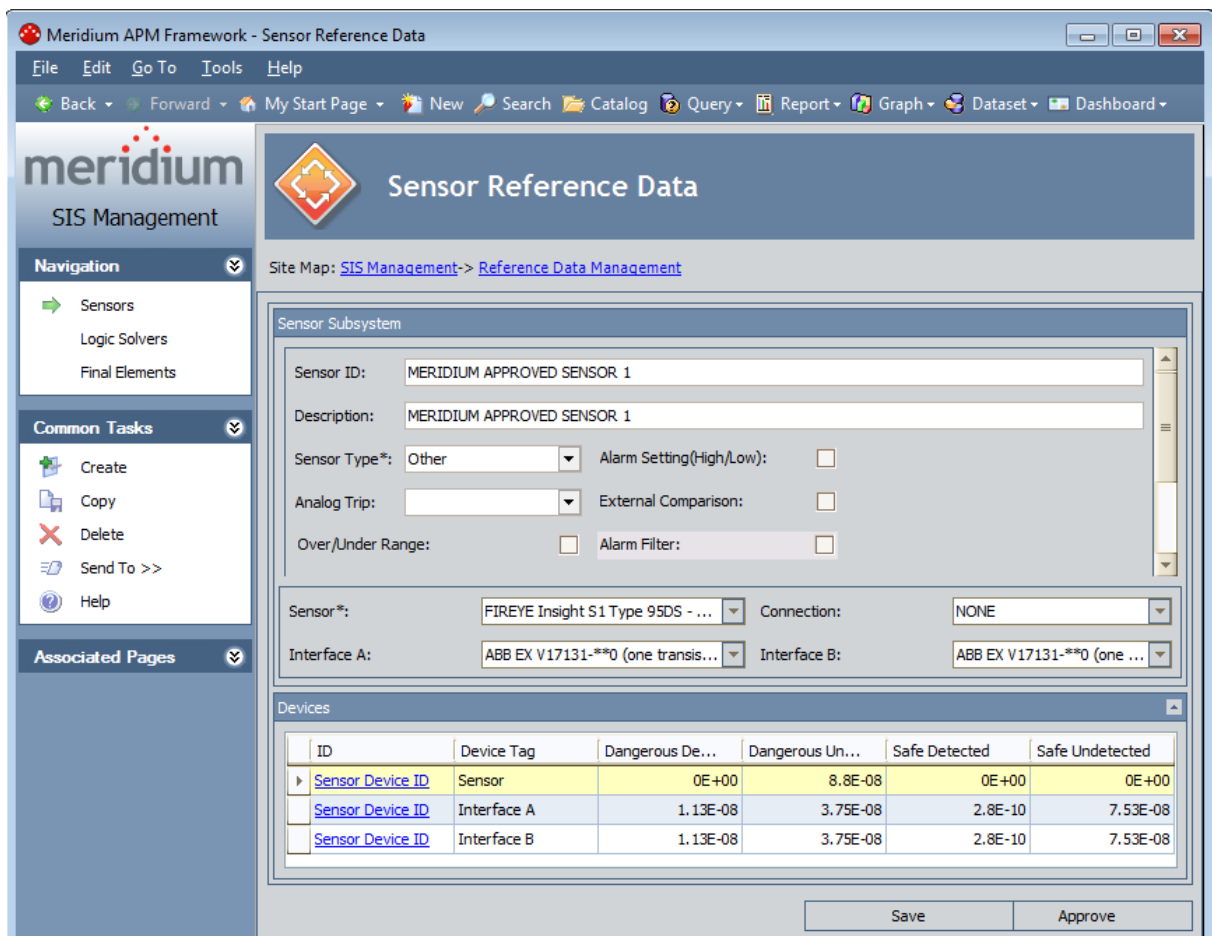

3. In the grid, locate the row containing the Protective Instrument Loop Sensor record whose contents you want to view.
4. In the **Sensor ID** cell, click the hyperlinked Record ID for the desired record.

The selected record appears on the [Sensor Reference Data page.](#)



Aspects of the Sensor Reference Data Page

Note: You can access the **Sensor Reference Data** page by [opening an existing Protective Instrument Loop Sensor record](#) or [creating a new one](#).

The **Sensor Reference Data** page displays the datasheet for a Protective Instrument Loop Sensor record. The Protective Instrument Loop Sensor datasheet is a master/detail datasheet, meaning that below the master record, a **Devices** pane appears, which contains a list of Protective Instrument Device records that are linked to the Protective Instrument Loop Sensor record. The Protective Instrument Device records that appear in this pane will depend on the values that exist in the Sensor field in the master record. You can collapse and expand the **Devices** pane using the  and  buttons that appears in the top right corner of the pane.

Below the datasheet, the following buttons appear:

- **Save:** Saves the Protective Instrument Loop Sensor record.
- **Approve:** Selects the **Approve Custom Device** check box on the Protective Instrument Loop Sensor datasheet. After you click this button, the label changes to **Revoke Approval**.
- **Revoke Approval:** Clears the **Approve Custom Device** check box on the Protective Instrument Loop Sensor datasheet. After you click this button, the label changes to **Approve**.

The **Sensor Reference Data** page contains the following task menus:

- [Navigation](#)
- [Common Tasks](#)
- [Associated Pages](#)

Using the **Sensor Reference Data** page, you can:

- [Create new Protective Instrument Loop Sensor records from scratch.](#)
- [Create new Protective Instrument Loop Sensor records as copies of existing Protective Instrument Loop Sensor records.](#)
- [Approve Protective Instrument Loop Sensor records.](#)
- [Revoke approval for Protective Instrument Loop Sensor records.](#)

Creating New Protective Instrument Loop Sensor Records from Scratch

The following instructions provide details on creating a Protective Instrument Loop Sensor record for the Validation Failure Rate Reference Data feature. You can also create Protective Instrument Loop Sensor records using the [SIL Validation feature](#).

To create a new Protective Instrument Loop Sensor record:

1. [Access the Sensor Reference Data Search page](#).
2. On the **Common Tasks** menu, click the **Create** link.

The **Sensor Reference Data** page appears, displaying a new blank Protective Instrument Loop Sensor record.

The screenshot shows the 'Sensor Reference Data' page in the Meridium APM Framework. The interface includes a sidebar with 'meridium SIS Management' and 'Common Tasks' (Create, Copy, Delete, Send To, Help). The main content area is titled 'Sensor Reference Data' and shows a 'Sensor Subsystem' form with fields for Sensor ID (Sensor 1), Description, Sensor Type* (FireGas), Alarm Setting (High/Low), Analog Trip (Low), External Comparison, Over/Under Range, Alarm Filter, Sensor*, Connection, Interface A, and Interface B. Below the form is a 'Devices' table with columns: ID, Device Tag, Dangerous De..., Dangerous Un..., Safe Detected, and Safe Undetected. At the bottom right are 'Save' and 'Approve' buttons.

3. Provide values in the fields as desired. Note that when you select a value in the **Sensor** list, Protective Instrument Device records will appear in the **Devices** pane.
4. Below the datasheet, click the **Save** button.

The record is saved.

Creating Protective Instrument Loop Sensor Records as Copies of an Existing One

The following instructions provide details on creating a new Protective Instrument Loop Sensor record as a copy of an existing Protective Instrument Loop Sensor record. These instructions assume that you are using the Validation Failure Rate Reference Data feature. You can also create Protective Instrument Loop Sensor records using the [SIL Validation feature](#).

When you create a new Protective Instrument Loop Sensor record as a copy of an existing one, the new Protective Instrument Loop Sensor record will contain the same information as the source record, with the following exceptions:

- The **Approved Custom Device** check box will be clear by default. This setting is clear by default in all new Protective Instrument Loop Sensor records.
- The value in the Sensor ID field will be appended with the number 1 (one). For each subsequent Protective Instrument Loop Sensor record that you create as a copy of the same existing Protective Instrument Loop Sensor record, an additional 1 (one) will be appended to the Sensor ID. For example, if you create three new Protective Instrument Loop Sensor records using the Protective Instrument Loop Sensor record with the Sensor ID *Fire Gas Sensor A*, the Sensor ID values for the new records will be:
 - *Fire Gas Sensor A 1*
 - *Fire Gas Sensor A 1 1*
 - *Fire Gas Sensor A 1 1 1*

You can modify the Sensor ID value, if desired.

If the Protective Instrument Loop Sensor record is linked to Protective Instrument Device records, those record will also be copied and linked to the new record. When a Protective Instrument Device record is copied, the value in the ID field will be appended with the number 1 (one). For each subsequent Protective Instrument Loop Sensor record that you create as a copy of the same source record (i.e., that is linked to the same Protective Instrument Device record), an additional number 1 (one) will be appended to the ID in the new Protective Instrument Device record. You can modify the ID value, if desired.

To create a new Protective Instrument Loop Sensor record as a copy of an existing Protective Instrument Loop Sensor record:

1. [Open the Protective Instrument Loop Sensor record](#) that you want to copy to create a new Protective Instrument Loop Sensor record.

The Protective Instrument Loop Sensor record appears on the **Sensor Reference Data** page.

Creating Protective Instrument Loop Sensor Records as Copies of an Existing One

Meridium APM Framework - Sensor Reference Data

File Edit Go To Tools Help

Back Forward My Start Page New Search Catalog Query Report Graph Dataset Dashboard

meridium
SIS Management

Navigation

- Sensors
- Logic Solvers
- Final Elements

Common Tasks

- Create
- Copy
- Delete
- Send To >>
- Help

Associated Pages

Site Map: [SIS Management](#)-> [Reference Data Management](#)

Sensor Subsystem

Sensor ID: MERIDIUM APPROVED SENSOR 1

Description: MERIDIUM APPROVED SENSOR 1

Sensor Type*: Other Alarm Setting(High/Low):

Analog Trip: External Comparison:

Over/Under Range: Alarm Filter:

Sensor*: FIREYE Insight S1 Type 95DS - ... Connection: NONE

Interface A: ABB EX V17131-**0 (one transis... Interface B: ABB EX V17131-**0 (one ...

Devices

ID	Device Tag	Dangerous De...	Dangerous Un...	Safe Detected	Safe Undetected
Sensor Device ID	Sensor	0E+00	8.8E-08	0E+00	0E+00
Sensor Device ID	Interface A	1.13E-08	3.75E-08	2.8E-10	7.53E-08
Sensor Device ID	Interface B	1.13E-08	3.75E-08	2.8E-10	7.53E-08

Save Approve

2. On the **Common Tasks** menu, click the **Copy** link.

The new Protective Instrument Loop Sensor record appears on the **Sensor Reference Data** page.

Creating Protective Instrument Loop Sensor Records as Copies of an Existing One

Meridium APM Framework - Sensor Reference Data

File Edit Go To Tools Help

Back Forward My Start Page New Search Catalog Query Report Graph Dataset Dashboard

meridium SIS Management

Navigation

- Sensors
- Logic Solvers
- Final Elements

Common Tasks

- Create
- Copy
- Delete
- Send To >>
- Help

Associated Pages

Site Map: [SIS Management](#)-> [Reference Data Management](#)

Sensor Subsystem

Sensor ID: MERIDIUM APPROVED SENSOR 1 1

Description: MERIDIUM APPROVED SENSOR 1

Sensor Type: Other Alarm Setting(High/Low):

Analog Trip: External Comparison:

Over/Under Range: Alarm Filter:

Sensor*: FIREYE Insight S1 Type 95DS - ... Connection: NONE

Interface A: ABB EX V17131-**0 (one transis... Interface B: ABB EX V17131-**0 (one ...)

Devices

ID	Device Tag	Dangerous De...	Dangerous Un...	Safe Detected	Safe Undetected
Sensor Device ID 1	Sensor	0E+00	8.8E-08	0E+00	0E+00
Sensor Device ID 1	Interface A	1.13E-08	3.75E-08	2.8E-10	7.53E-08
Sensor Device ID 1	Interface B	1.13E-08	3.75E-08	2.8E-10	7.53E-08

Save Approve

- If desired, you can modify the record. When you are finished, click the **Save** button.

Your changes are saved.

Approving and Revoking Approval for Protective Instrument Loop Sensor Records

After you have determined that a sensor is approved for use in a protective instrument loop, you can specify that in the Protective Instrument Loop Sensor record. Additionally, if you later determine that a sensor is no longer approved for use in a protective instrument loop, you can revoke that approval in the Protective Instrument Loop Sensor record.

To approve a Protective Instrument Loop Sensor record:

1. [Open the Protective Instrument Loop Sensor record](#) that represents the sensor that you want to approve.
2. Below the datasheet, click the **Approve** button.

The **Approved Custom Device** check box in the Protective Instrument Loop Sensor record is automatically selected, and the label on the **Approve** button changes to **Revoke Approval**.

3. Click the **Save** button.

The record is saved.

To revoke approval for a Protective Instrument Loop Sensor record:

1. [Open the Protective Instrument Loop Sensor record](#) that represents the sensor whose approval status you want to revoke.
2. Below the datasheet, click the **Revoke Approval** button.

The **Approved Custom Device** check box in the Protective Instrument Loop Sensor record is automatically cleared, and the label on the **Revoke Approval** button changes to **Approve**.

3. Click the **Save** button.

The record is saved.

Accessing the Logic Solver Reference Data Search Page

The **Logic Solver Reference Data Search** page lets you search for existing Protective Instrument Loop Logic Solver records that are specified as reference data via the **Is Reference Data** check box in that family.

To access the Logic Solver Reference Data Search page:

1. [Access the SIS Management Start Page](#).
2. Click the **Manage Validation Failure Rate Reference Data** link.

The **Sensor Reference Data Search** page appears.

3. On the **Navigation** menu, click the **Logic Solvers** link.

The **Logic Solver Reference Data Search** page appears.

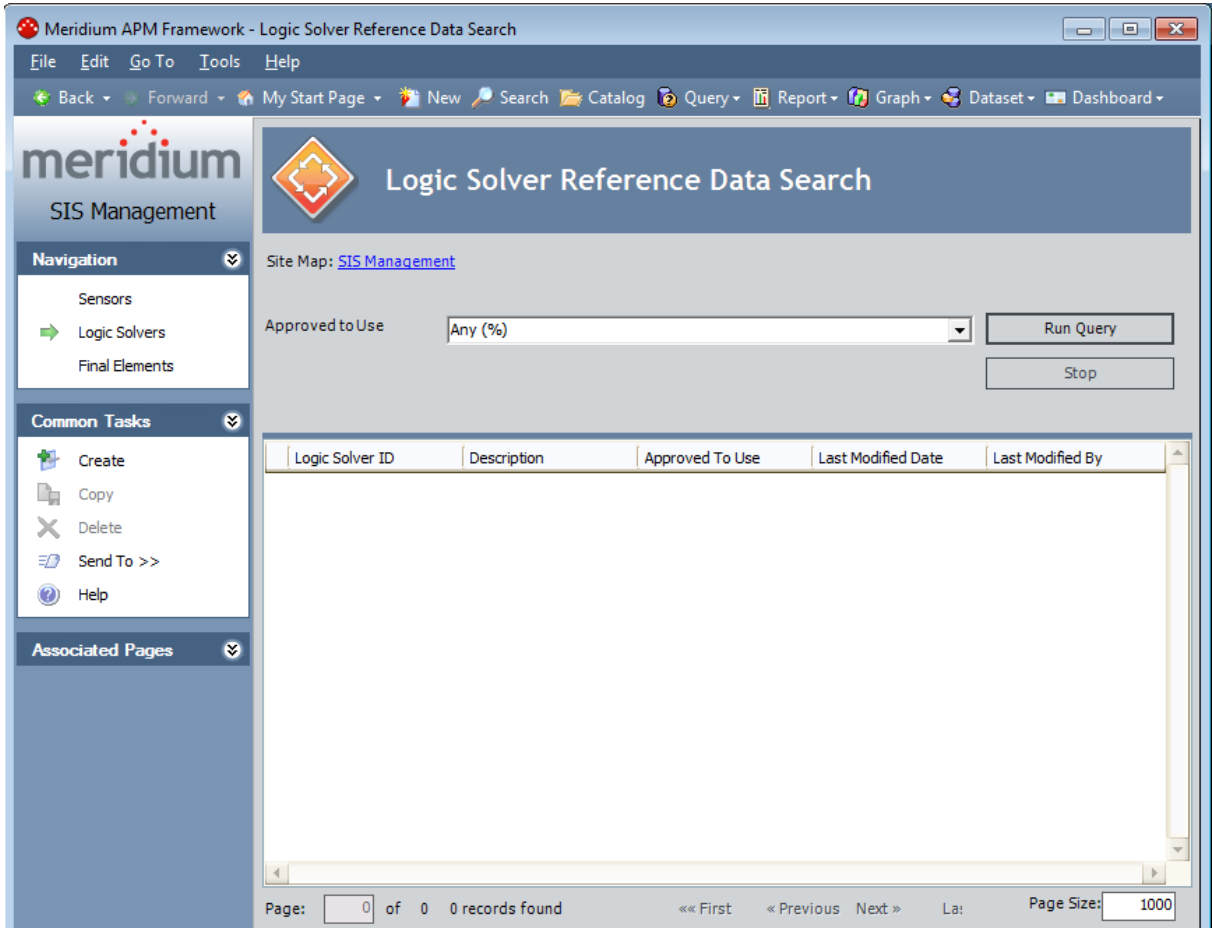

Aspects of the Logic Solver Reference Data Search Page

The **Logic Solver Reference Data Search** page contains the results of the `Logic_Solver_Reference_Data_Search` query. This documentation assumes that you are using the baseline query, which contains an **Approved to Use** prompt that appears as a list at the top of the **Logic Solver Reference Data Search** page. The **Approved to Use** list contains a list of values that correspond to the state of the **Approved Custom Device** field in the Protective Instrument Loop Logic Solver records. You can choose from the following baseline values:

- **Yes:** Displays all the existing Protective Instrument Loop Logic Solver records whose **Is Reference Data** field is set to *True* and whose **Approved Custom Device** check box is selected.
- **No:** Displays all the existing Protective Instrument Loop Logic Solver records whose **Is Reference Data** field is set to *True* and whose **Approved Custom Device** check box is cleared.
- **Any (%):** Displays all the existing Protective Instrument Loop Logic Solver records whose **Is Reference Data** field is set to *True*.

This query is run automatically using the default prompt value *Any (%)*. If you select different criteria, you can click the **Run Query** button to run the query and display the results in the grid at the bottom of the page. The query results will include hyperlinked Record IDs, which you can use to open the Protective Instrument Loop Logic Solver record on the **Sensor Reference Data** page.

Below the query results are options that you can use to navigate the results.

The **Logic Solver Reference Data Search** page contains the following task menus:

- [Navigation](#)
- [Common Tasks](#)
- [Associated Pages](#)

Opening Existing Protective Instrument Loop Logic Solver Records

To open an existing Protective Instrument Loop Logic Solver record:

1. [Access the Logic Solver Reference Data Search page.](#)
2. Provide the desired search criteria, and then click the **Run Query** button.

The results appear in the grid.

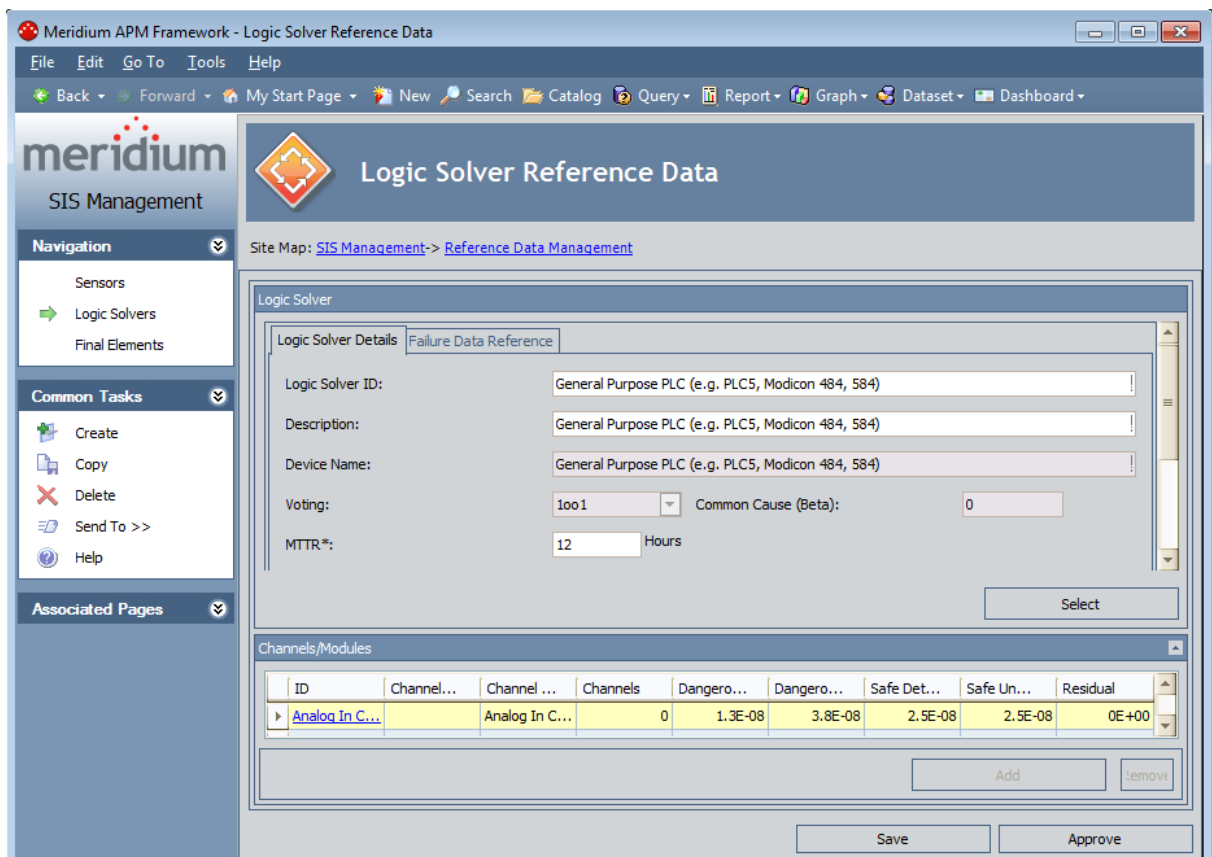

3. In the grid, locate the row containing the Protective Instrument Loop Logic Solver record whose contents you want to view.
4. In the **ID** cell, click the hyperlinked Record ID for the desired record.

The selected record appears on the [Logic Solver Reference Data page.](#)



Aspects of the Logic Solver Reference Data Page

Note: You can access the **Logic Solver Reference Data** page by [opening an existing Protective Instrument Loop Logic Solver record](#) or [creating a new one](#).

The **Logic Solver Reference Data** page displays the datasheet for a Protective Instrument Loop Logic Solver record. The Protective Instrument Loop Logic Solver datasheet is a master/detail datasheet, meaning that below the master record, a **Channels/Modules** pane appears, which contains a list of Protective Instrument Loop Logic Solver Channel records that are linked to the Protective Instrument Loop Logic Solver record. You can link Protective Instrument Loop Logic Solver Channel records to the master record or delete the link between these records using the **Add** and **Remove** options that appears in this pane. You can collapse and expand the **Channels/Modules** pane using the  and  buttons that appears in the top right corner of the pane.

Below the datasheet, the following buttons appear:

- **Save:** Saves the Protective Instrument Loop Logic Solver record.
- **Approve:** Selects the **Approve Custom Device** check box on the Protective Instrument Loop Logic Solver datasheet. After you click this button, the label changes to **Revoke Approval**.
- **Revoke Approval:** Clears the **Approve Custom Device** check box on the Protective Instrument Loop Logic Solver datasheet. After you click this button, the label changes to **Approve**.

The **Sensor Reference Data** page contains the following task menus:

- [Navigation](#)
- [Common Tasks](#)
- [Associated Pages](#)

Using the **Logic Solver Reference Data** page, you can:

- [Create Protective Instrument loop Logic Solver records from scratch.](#)
- [Create Protective Instrument Loop Logic Solver records that are based upon an existing Protective Instrument Loop Logic Solver record.](#)
- [Create Protective Instrument Loop Logic Solver records as copies of an existing Protective Instrument Loop Logic Solver record.](#)
- [Link Protective Instrument Loop Logic Solver Channel records to a Protective Instrument Loop Logic Solver record.](#)
- [Remove the links between a Protective Instrument Loop Logic Solver record and Protective Instrument Loop Logic Solver Channel records.](#)
- [Approve a Protective Instrument Loop Logic Solver record.](#)
- [Revoke approval for a Protective Instrument Loop Logic Solver record.](#)

Creating Protective Instrument Loop Logic Solver Records from Scratch

The following instructions provide details on creating a Protective Instrument Loop Logic Solver record from scratch using the Validation Failure Rate Reference Data feature. You can also create Protective Instrument Loop Logic Solver records using the [SIL Validation feature](#).

To create a new Protective Instrument Loop Logic Solver record from scratch:

1. [Access the Logic Solver Reference Data Search page](#).
2. On the **Common Tasks** menu, click the **Create** link.

The **Logic Solver Reference Data** page appears, displaying a new blank Protective Instrument Loop Logic Solver record.

The screenshot shows the Meridium APM Framework interface for creating a Logic Solver record. The main window is titled "Meridium APM Framework - Logic Solver Reference Data". On the left, there is a navigation pane with "SIS Management" and "Common Tasks" (Create, Copy, Delete, Send To, Help). The main content area is titled "Logic Solver Reference Data" and shows a "Site Map" for "SIS Management -> Reference Data Management". The "Logic Solver" section is active, displaying "Logic Solver Details" and "Failure Data Reference" tabs. The "Logic Solver Details" tab contains the following fields: "Logic Solver ID" (Logic Solver 1), "Description", "Device Name", "Voting" (dropdown), "Common Cause (Beta)", and "MTTR*" (Hours). A "Select" button is located below these fields. The "Failure Data Reference" tab shows a table with columns: ID, Channel/..., Channel ..., Channels, Dangers..., Dangers..., Safe Det..., Safe Und..., Residual. Below the table are "Add" and "Remove" buttons. At the bottom of the window are "Save" and "Approve" buttons.

3. Provide values in the fields as desired.
4. Below the datasheet, click the **Save** button.

The record is saved. At this point, you can [link the desired Protective Instrument Loop Logic Solver Channel records](#) to the Protective Instrument Loop Logic Solver record.

Creating Protective Instrument Loop Logic Solver Records Based on Existing Ones

The following instructions provide details on creating a Protective Instrument Loop Logic Solver record based on an existing one, using the Validation Failure Rate Reference Data feature. You can also create Protective Instrument Loop Logic Solver records using the [SIL Validation feature](#).

To create a new Protective Instrument Loop Logic Solver record based on an existing one:

1. [Access the Logic Solver Reference Data Search page](#).
2. On the **Common Tasks** menu, click the **Create** link.

The **Logic Solver Reference Data** page appears, displaying a new blank Protective Instrument Loop Logic Solver record.

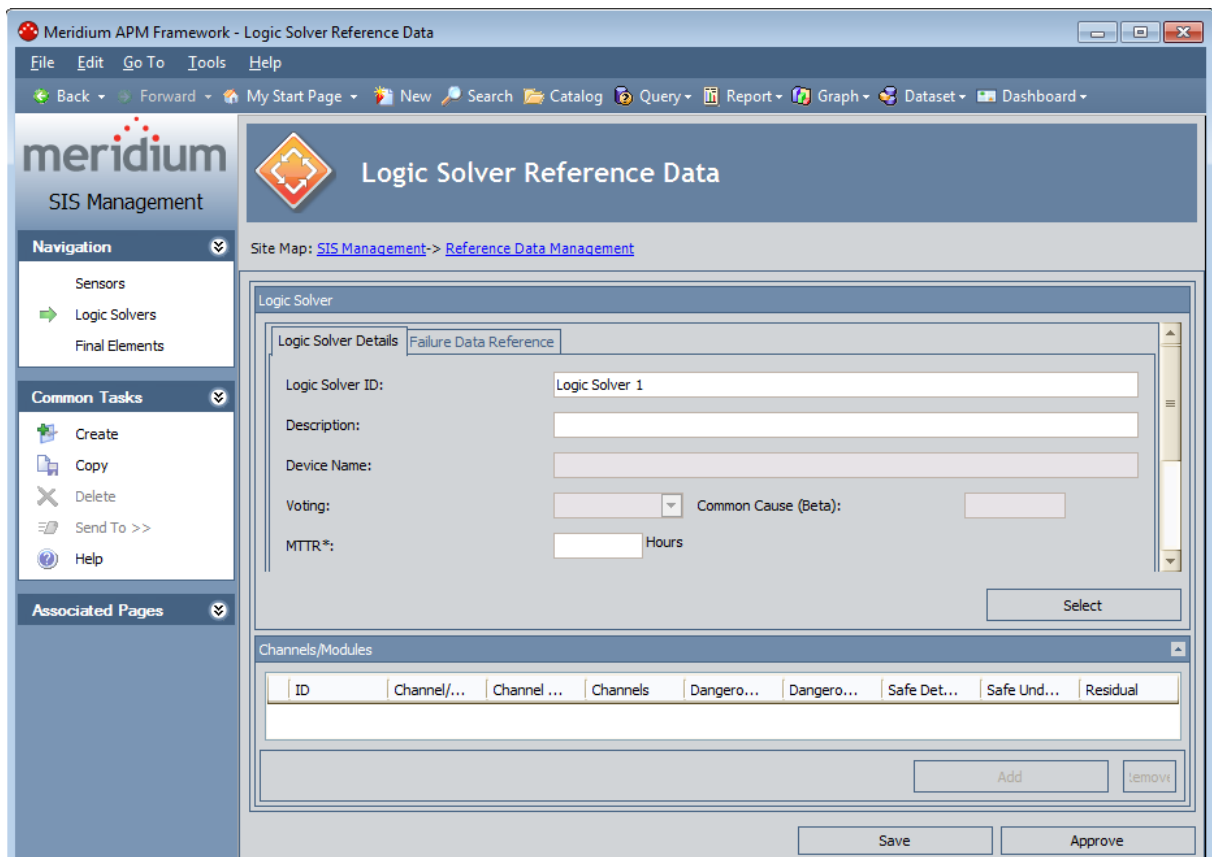

3. In the **MTTR** text box, type the desired numeric value. This field is required before you can apply an existing record.
4. In the **Proof Test Interval** text box, type the desired numeric value. This field is

require before you can apply an existing record.

5. In the **Proof Test Coverage** text box, type the desired numeric value. This field is require before you can apply an existing record.
6. Click the **Select** button.

The **Protective Instrument Loop** dialog box appears, displaying the list of existing Protective Instrument Loop Logic Solver records.

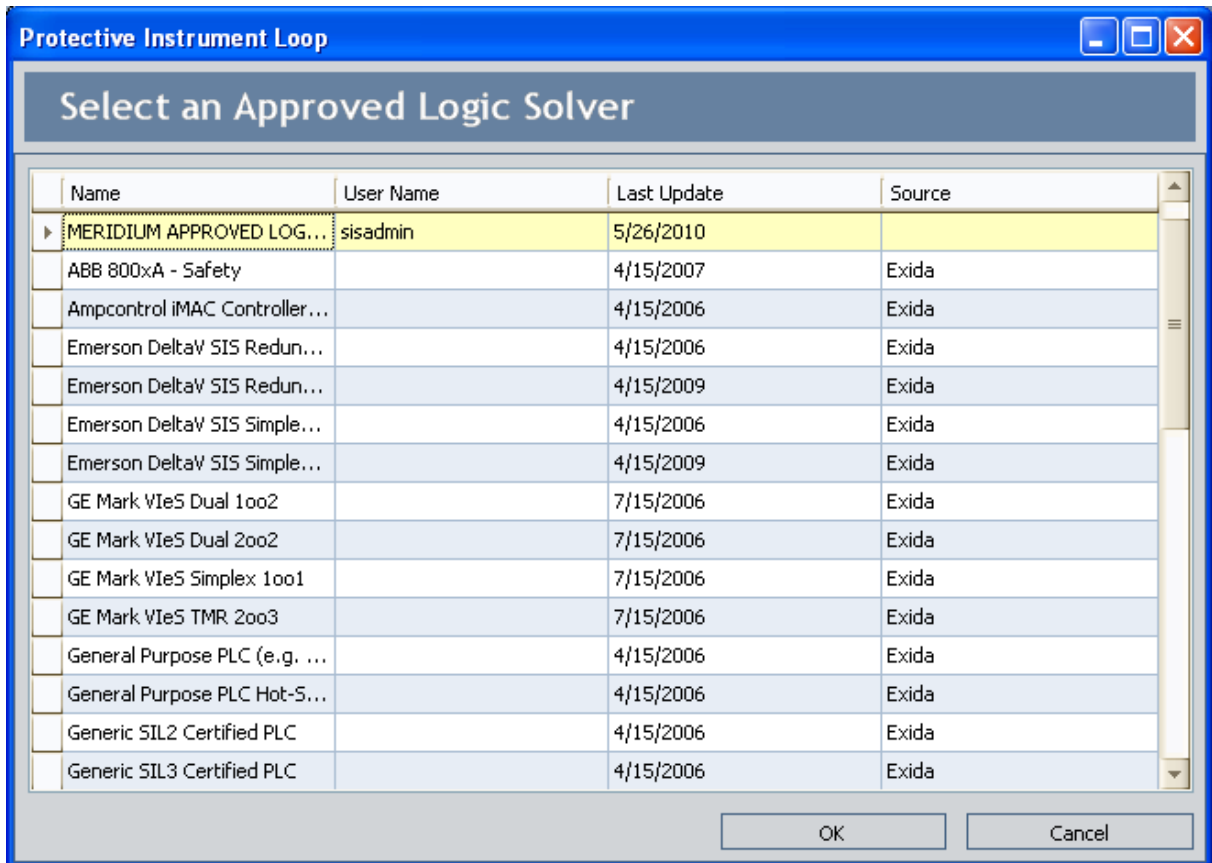

7. In the list, select the row containing the Protective Instrument Loop Logic Solver record whose contents you want to apply to the new Protective Instrument Loop Logic Solver record.
8. Click **OK**.

The new Protective Instrument Loop Logic Solver record is populated automatically with information from the selected record, including the **Channels/Modules** pane.

9. Below the datasheet, click the **Save** button.

The record is saved. At this point, you can [link Protective Instrument Loop Logic Solver Channel records](#) to the Protective Instrument Loop Logic Solver record.

Creating Protective Instrument Loop Logic Solver Records as Copies of an Existing One

The following instructions provide details on creating a new Protective Instrument Loop Logic Solver record as a copy of an existing Protective Instrument Loop Logic Solver record. These instructions assume that you are using the Validation Failure Rate Reference Data feature. You can also create Protective Instrument Loop Logic Solver records using the [SIL Validation feature](#).

When you create a new Protective Instrument Loop Logic Solver record as a copy of an existing one, the new Protective Instrument Loop Logic Solver record will contain the same information as the source record, with the following exceptions:

- The **Approved Custom Device** check box will be clear by default. This setting is clear by default in all new Protective Instrument Loop Logic Solver records.
- The value in the Logic Solver ID field will be appended with a number that is relative to subsequent copies of the same source record, beginning with 1 (one). For each subsequent Protective Instrument Loop Logic Solver record that you create as a copy of the same existing Protective Instrument Loop Logic Solver record, the number that is appended to the Logic Solver ID will increase by one. For example, if you create three new Protective Instrument Loop Logic Solver records using the Protective Instrument Loop Logic Solver record with the Logic Solver ID *Logic Solver A*, the Logic Solver ID values for the new records will be:
 - *Logic Solver A 1*
 - *Logic Solver A 2*
 - *Logic Solver A 3*

You can modify the Logic Solver ID value, if desired.

If the Protective Instrument Loop Logic Solver record is linked to Protective Instrument Loop Logic Solver Channel records, these records will also be copied and linked to the new Protective Instrument Loop Logic Solver record. When a Protective Instrument Loop Logic Solver Channel record is copied, the value in the ID field will be appended with a number that is relative to the subsequent copies of the same source Protective Instrument Loop Logic Solver record, beginning with 1 (one). For each subsequent Protective Instrument Loop Logic Solver record that you create as a copy of the same source record, the value that is appended to the ID in the new Protective Instrument Loop Logic Solver Channel records will increase by one (as explained above).

To create a new Protective Instrument Loop Logic Solver record as a copy of an existing Protective Instrument Loop Logic Solver record:

1. [Open the Protective Instrument Loop Logic Solver record](#) that you want to copy to create a new Protective Instrument Loop Logic Solver record.

The Protective Instrument Loop Logic Solver record appears on the **Logic Solver Reference Data** page.

Creating Protective Instrument Loop Logic Solver Records as Copies of an Existing One

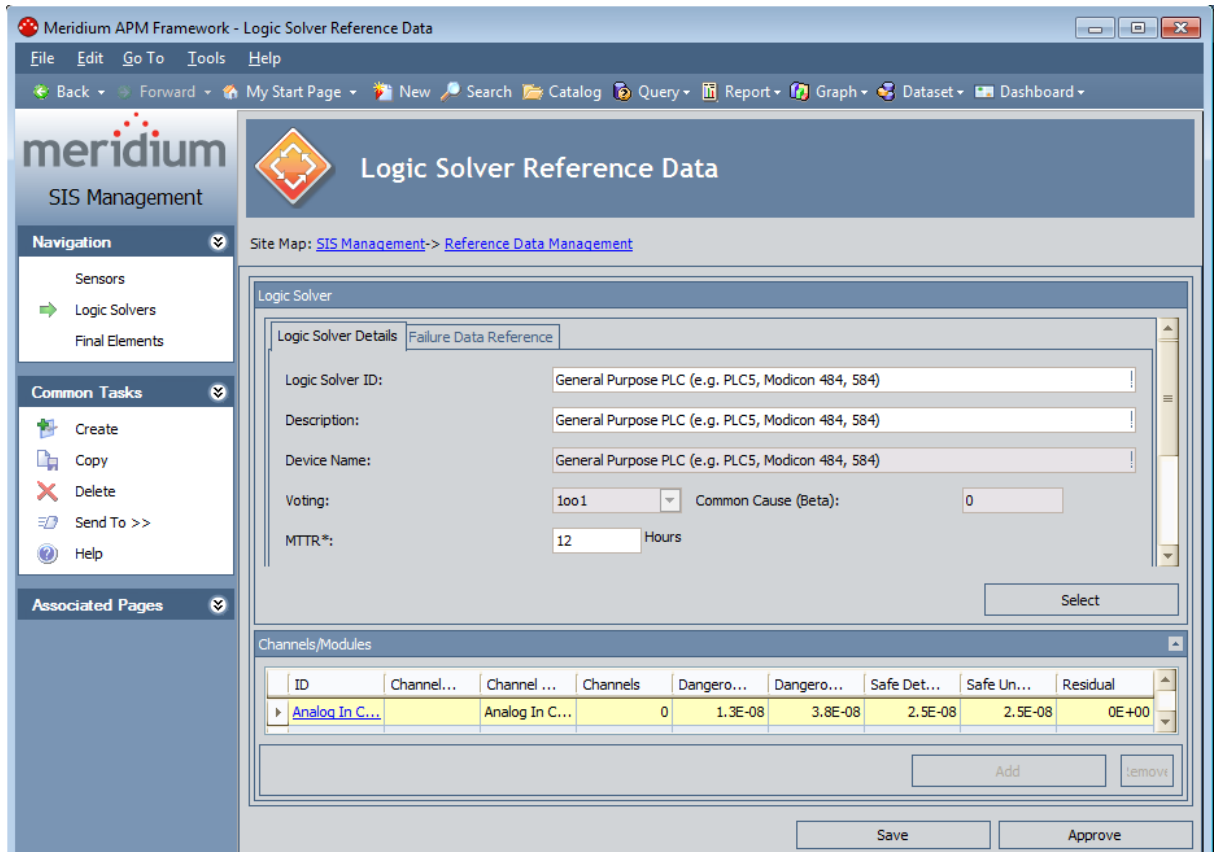

2. On the **Common Tasks** menu, click the **Copy** link.

The new Protective Instrument Loop Logic Solver record appears on the **Logic Solver Reference Data** page.

Creating Protective Instrument Loop Logic Solver Records as Copies of an Existing One

The screenshot displays the Meridium APM Framework - Logic Solver Reference Data application. The interface includes a sidebar with navigation and common tasks, and a main content area with a form for Logic Solver details and a table for Channels/Modules.

Navigation: Sensors, Logic Solvers, Final Elements

Common Tasks: Create, Copy, Delete, Send To >>, Help

Associated Pages:

Logic Solver Reference Data

Site Map: [SIS Management](#) -> [Reference Data Management](#)

Logic Solver

Logic Solver Details | Failure Data Reference

Logic Solver ID: General Purpose PLC (e.g. PLC5, Modicon 484, 584) 1

Description: General Purpose PLC (e.g. PLC5, Modicon 484, 584)

Device Name: General Purpose PLC (e.g. PLC5, Modicon 484, 584)

Voting: 1001 Common Cause (Beta): 0

MTTR*: 12 Hours

Select

Channels/Modules

ID	Channel...	Channel ...	Channels	Dangero...	Dangero...	Safe Det...	Safe Un...	Residual
Analog In C...	Analog In C...	Analog In C...	0	1.3E-08	3.8E-08	2.5E-08	2.5E-08	0E+00

Add Remove

Save Approve

3. If desired, you can modify the record. When you are finished, click the **Save** button.

Your changes are saved.

Linking Protective Instrument Loop Logic Solver Channel Records to Protective Instrument Loop Logic Solver Records

The following instructions provide details on linking Protective Instrument Loop Logic Solver Channel records to existing Protective Instrument Loop Logic Solver records using the Validation Failure Rate Reference Data feature. You can also link these records using the SIL Validation feature. For details on using the SIL Validation feature, see the SIL Validation section of this Help system.

IMPORTANT: Before you can link a Protective Instrument Loop Logic Solver Channel record to a Protective Instrument Loop Logic Solver record, you must select the **Manual Entry** check box in the Protective Instrument Loop Logic Solver record.

To link a Protective Instrument Loop Logic Solver Channel record to a Protective Instrument Loop Logic Solver record:

1. On the Protective Instrument Loop Logic Solver datasheet for the record to which you want to link a Protective Instrument Loop Logic Solver Channel record, in the **Channels/Modules** pane, click the **Add** button.

A new Protective Instrument Loop Logic Solver Channel record appears in a new window.

Custom Channel/Module 1~ (Protective Instrument Loop Logic Solver Channel)

Channel/Module ID: Custom Channel/Module 1

Device Name:

Channel Type:

Description:

Channels: 0

Parameters

Dangerous Detected:	0E+00	FRPH	Dangerous Undetected:	0E+00	FRPH
Safe Detected:	0E+00	FRPH	Safe Undetected:	0E+00	FRPH
Residual:	0E+00	FRPH	Architectural Type:		
Hardware Fault Tolerance:	0		Certified SIL:		
Suggested PTC:	0	PCT			

OK

2. Provide values in the fields on the datasheet as desired, and then click **OK**.

The record is linked to the master record and appears in the grid in the **Channels/Modules** pane.

3. You can continue adding records in this way. When you are finished, below the datasheet, click the **Save** button.

The record is saved.

Removing Protective Instrument Loop Logic Solver Channel Records from Protective Instrument Loop Logic Solver Records

When you remove a Protective Instrument Loop Logic Solver Channel record from a Protective Instrument Loop Logic Solver record, you are deleting the link between the two records and removing the Protective Instrument Loop Logic Solver Channel record from the grid in the **Channels/Modules** pane on the Protective Instrument Loop Logic Solver datasheet.

To remove a Protective Instrument Loop Logic Solver Channel record from a Protective Instrument Loop Logic Solver record:

1. Open the Protective Instrument Loop Logic Solver record that is linked to the Protective Instrument Loop Logic Solver Channel record that you want to remove.
2. In the **Channels/Modules** pane, select the row containing the Protective Instrument Loop Logic Solver Channel record that you want to remove.
3. Below the grid, click the **Remove** button.

A message appears, asking if you are sure you want to remove the selected record.

4. Click the **Yes** button.
The record is removed from the grid.
5. Below the datasheet, click the **Save** button.
The record is saved.

Approving and Revoking Approval for Protective Instrument Loop Logic Solver Records

After you have determined that a logic solver is approved for use in a protective instrument loop, you can specify that in the Protective Instrument Loop Logic Solver record. Additionally, if you later determine that a logic solver is no longer approved for use in a protective instrument loop, you can revoke that approval in the Protective Instrument Loop Logic Solver record.

To approve a Protective Instrument Loop Logic Solver record:

1. [Open the Protective Instrument Loop Logic Solver record](#) that represents the logic solver that you want to approve.
2. Below the datasheet, click the **Approve** button.

The **Approved Custom Device** check box in the Protective Instrument Loop Logic Solver record is automatically selected, and the label on the **Approve** button changes to **Revoke Approval**.

3. Click the **Save** button.

The record is saved.

To revoke approval for a Protective Instrument Loop Logic Solver record:

1. [Open the Protective Instrument Loop Logic Solver record](#) that represents the logic solver whose approval status you want to revoke.
2. Below the datasheet, click the **Revoke Approval** button.

The **Approved Custom Device** check box in the Protective Instrument Loop Logic Solver record is automatically cleared, and the label on the **Revoke Approval** button changes to **Approve**.

3. Click the **Save** button.

The record is saved.

Accessing the Final Element Reference Data Search Page

The **Final Element Reference Data Search** page lets you search for existing Protective Instrument Loop Final Element records that are specified as reference data via the **Is Reference Data** check box in that family.

To access the Final Element Reference Data Search page:

1. [Access the SIS Management Start Page.](#)
2. Click the **Manage Validation Failure Rate Reference Data** link.

The **Sensor Reference Data Search** page appears.

3. On the **Navigation** menu, click the **Final Elements** link.

The **Final Element Reference Data Search** page appears.

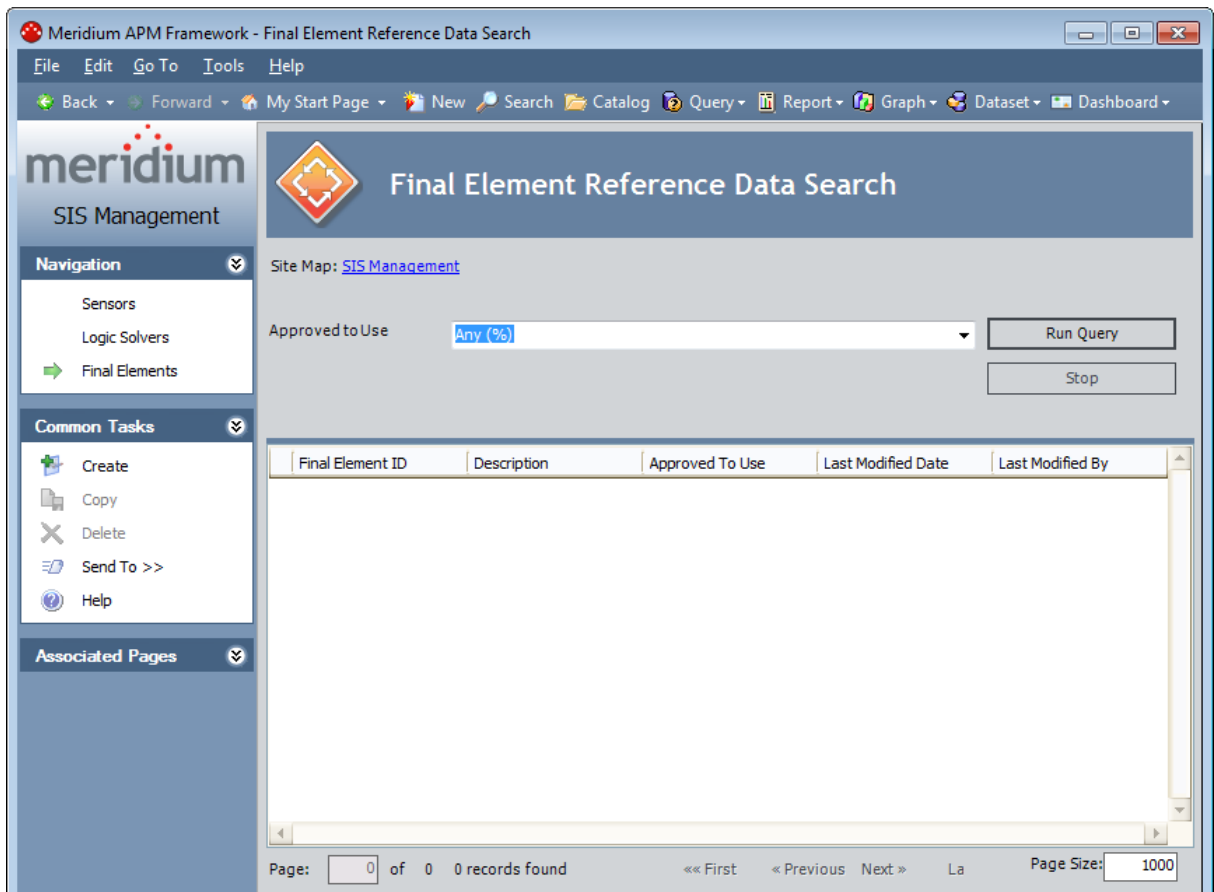

Aspects of the Final Element Reference Data Search Page

The **Final Element Reference Data Search** page contains the results of the `Final_Element_Reference_Data_Search` query. This documentation assumes that you are using the baseline query, which contains an **Approved to Use** prompt that appears as a list at the top of the **Final Element Reference Data Search** page. The **Approved to Use** list contains a list of values that correspond to the state of the **Approved Custom Device** field in the Protective Instrument Loop Final Element records. You can choose from the following baseline values:

- **Yes:** Displays all the existing Protective Instrument Loop Final Element records whose `Is Reference Data` field is set to `True` and whose **Approved Custom Device** check box is selected.
- **No:** Displays all the existing Protective Instrument Loop Final Element records whose `Is Reference Data` field is set to `True` and whose **Approved Custom Device** check box is cleared.
- **Any (%):** Displays all the existing Protective Instrument Loop Final Element records whose `Is Reference Data` field is set to `True`.

This query is run automatically using the default prompt value *Any (%)*. If you select different criteria, you can click the **Run Query** button to run the query and display the results in the grid at the bottom of the page. The query results will include hyperlinked Record IDs, which you can use to open the Protective Instrument Loop Final Element record on the **Sensor Reference Data** page.

Below the query results are options that you can use to navigate the results.

The **Final Element Reference Data Search** page contains the following task menus:

- [Navigation](#)
- [Common Tasks](#)
- [Associated Pages](#)

Opening Existing Protective Instrument Loop Final Element Records

To open an existing Protective Instrument Loop Final Element record:

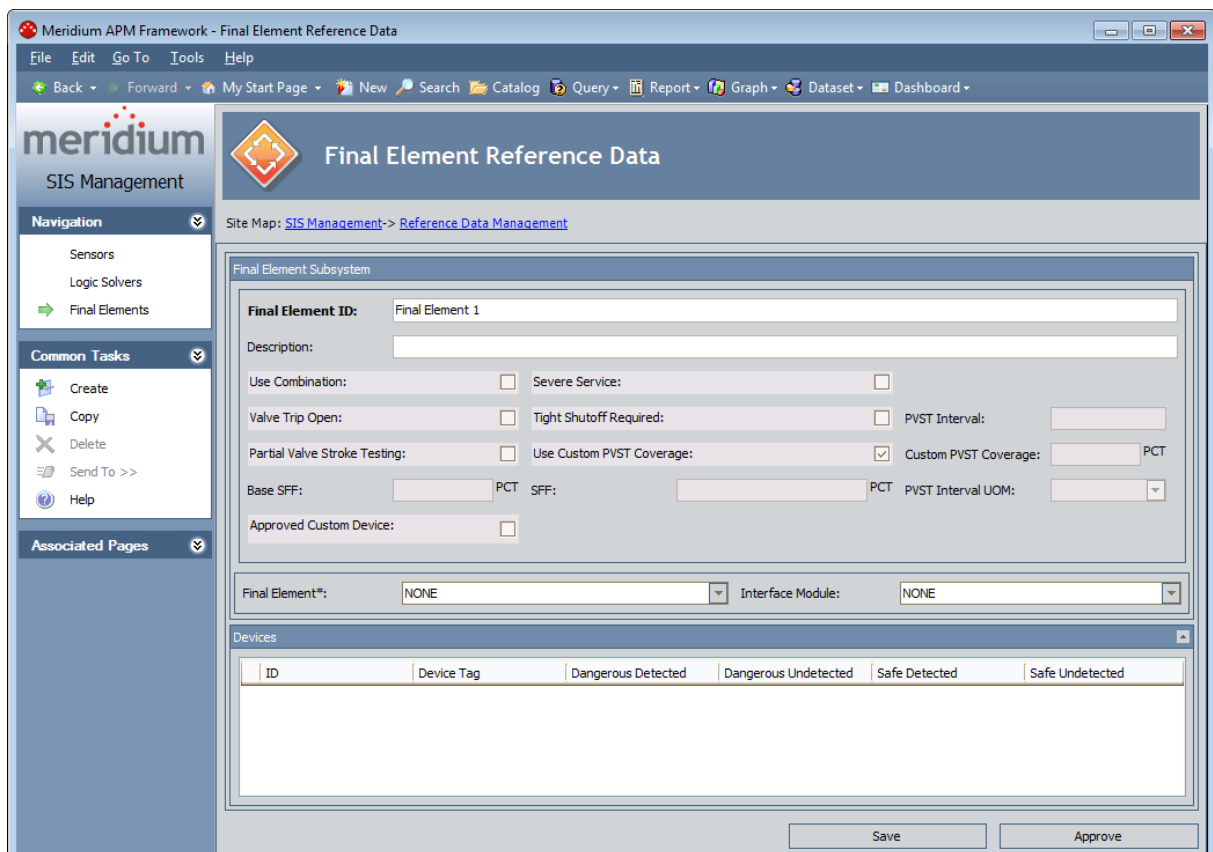

1. [Access the Final Element Reference Data Search page.](#)
2. Provide the desired search criteria, and then click the **Run Query** button.
The results appear in the grid.
3. In the grid, locate the row containing the Protective Instrument Loop Final Element record whose contents you want to view.
4. In the **Final Element ID** cell, click the hyperlinked Record ID for the desired record.

The selected record appears on the [Final Element Reference Data page.](#)



Aspects of the Final Element Reference Data Page

Note: You can access the **Final Element Reference Data** page by [opening an existing Protective Instrument Loop Final Element record](#) or [creating a new one](#).

The **Final Element Reference Data** page displays the datasheet for a Protective Instrument Loop Final Element record. The Protective Instrument Loop Final Element datasheet is a master/detail datasheet, meaning that below the master record, a **Devices** pane appears, which contains a list of Protective Instrument Device records that are linked to the Protective Instrument Loop Final Element record. The Protective Instrument Device records that appear in this pane will depend on the values that exist in the Final Element field in the master record. You can collapse and expand the **Devices** pane using the  and  buttons that appears in the top right corner of the pane.

Below the datasheet, the following buttons appear:

- **Save:** Saves the Protective Instrument Loop Final Element record.
- **Approve:** Selects the **Approve Custom Device** check box on the Protective Instrument Loop Final Element datasheet. After you click this button, the label changes to **Revoke Approval**.
- **Revoke Approval:** Clears the **Approve Custom Device** check box on the Protective Instrument Loop Final Element datasheet. After you click this button, the label changes to **Approve**.

The **Sensor Reference Data** page contains the following task menus:

- [Navigation](#)
- [Common Tasks](#)
- [Associated Pages](#)

Using the **Final Element Reference Data** page, you can:

- [Create new Protective Instrument Loop Final Element records from scratch.](#)
- [Create new Protective Instrument Loop Final Element records as copies of an existing Protective Instrument Loop Final Element record.](#)
- [Approve a Protective Instrument Loop Final Element record.](#)
- [Revoke approval for a Protective Instrument Loop Final Element record.](#)

Creating New Protective Instrument Loop Final Element Records from Scratch

The following instructions provide details on creating a Protective Instrument Loop Final Element record for the Validation Failure Rate Reference Data feature. You can also create Protective Instrument Loop Final Element records using the [SIL Validation feature](#).

To create a new Protective Instrument Loop Final Element record:

1. [Access the Final Element Reference Data Search page](#).
2. On the **Common Tasks** menu, click the **Create** link.

The **Final Element Reference Data** page appears, displaying a new blank Protective Instrument Loop Final Element record.

Meridium APM Framework - Final Element Reference Data

File Edit Go To Tools Help

Back Forward My Start Page New Search Catalog Query Report Graph Dataset Dashboard

meridium SIS Management

Navigation

- Sensors
- Logic Solvers
- Final Elements

Common Tasks

- Create
- Copy
- Delete
- Send To >>
- Help

Associated Pages

Final Element Reference Data

Site Map: [SIS Management](#)-> [Reference Data Management](#)

Final Element Subsystem

Final Element ID: Final Element 2

Description:

Use Combination: Severe Service:

Valve Trip Open: Tight Shutoff Required:

Partial Valve Stroke Testing: Use Custom PVST Coverage: Custom

Final Element*: NONE Interface Module: NONE

Devices

ID	Device Tag	Dangerous D...	Dangerous U...	Safe Detected	Safe Undetected
----	------------	----------------	----------------	---------------	-----------------

Save Approve

3. Provide values in the fields as desired. Note that when you select a value in the **Final Element** list, Protective Instrument Device records will appear in the **Devices** pane.
4. Below the datasheet, click the **Save** button.

The record is saved.

Creating Protective Instrument Loop Final Element Records as Copies of an Existing One

The following instructions provide details on creating a new Protective Instrument Loop Final Element record as a copy of an existing Protective Instrument Loop Final Element record. These instructions assume that you are using the Validation Failure Rate Reference Data feature. You can also create Protective Instrument Loop Final Element records using the [SIL Validation feature](#).

When you create a new Protective Instrument Loop Final Element record as a copy of an existing one, the new Protective Instrument Loop Final Element record will contain the same information as the source record, with the following exceptions:

- The **Approved Custom Device** check box will be clear by default. This setting is clear by default in all new Protective Instrument Loop Final Element records.
- The value in the Final Element ID field will be appended with the number 1 (one). For each subsequent Protective Instrument Loop Final Element record that you create as a copy of the same existing Protective Instrument Loop Final Element record, an additional 1 (one) will be appended to the Final Element ID. For example, if you create three new Protective Instrument Loop Final Element records using the Protective Instrument Loop Final Element record with the Final Element ID *Final Element A*, the Final Element ID values for the new records will be:
 - *Final Element A 1*
 - *Final Element A 1 1*
 - *Final Element A 1 1 1*

You can modify the Final Element ID value, if desired.

If the Protective Instrument Loop Final Element record is linked to Protective Instrument Device records, those record will also be copied and linked to the new record. When a Protective Instrument Device record is copied, the value in the ID field will be appended with the number 1 (one). For each subsequent Protective Instrument Loop Final Element record that you create as a copy of the same source record (i.e., that is linked to the same Protective Instrument Device record), an additional number 1 (one) will be appended to the ID in the new Protective Instrument Device record. You can modify the ID value, if desired.

To create a new Protective Instrument Loop Final Element record as a copy of an existing Protective Instrument Loop Final Element record:

1. [Open the Protective Instrument Loop Final Element record](#) that you want to copy to create a new Protective Instrument Loop Final Element record.

The Protective Instrument Loop Final Element record appears on the **Final Element Reference Data** page.

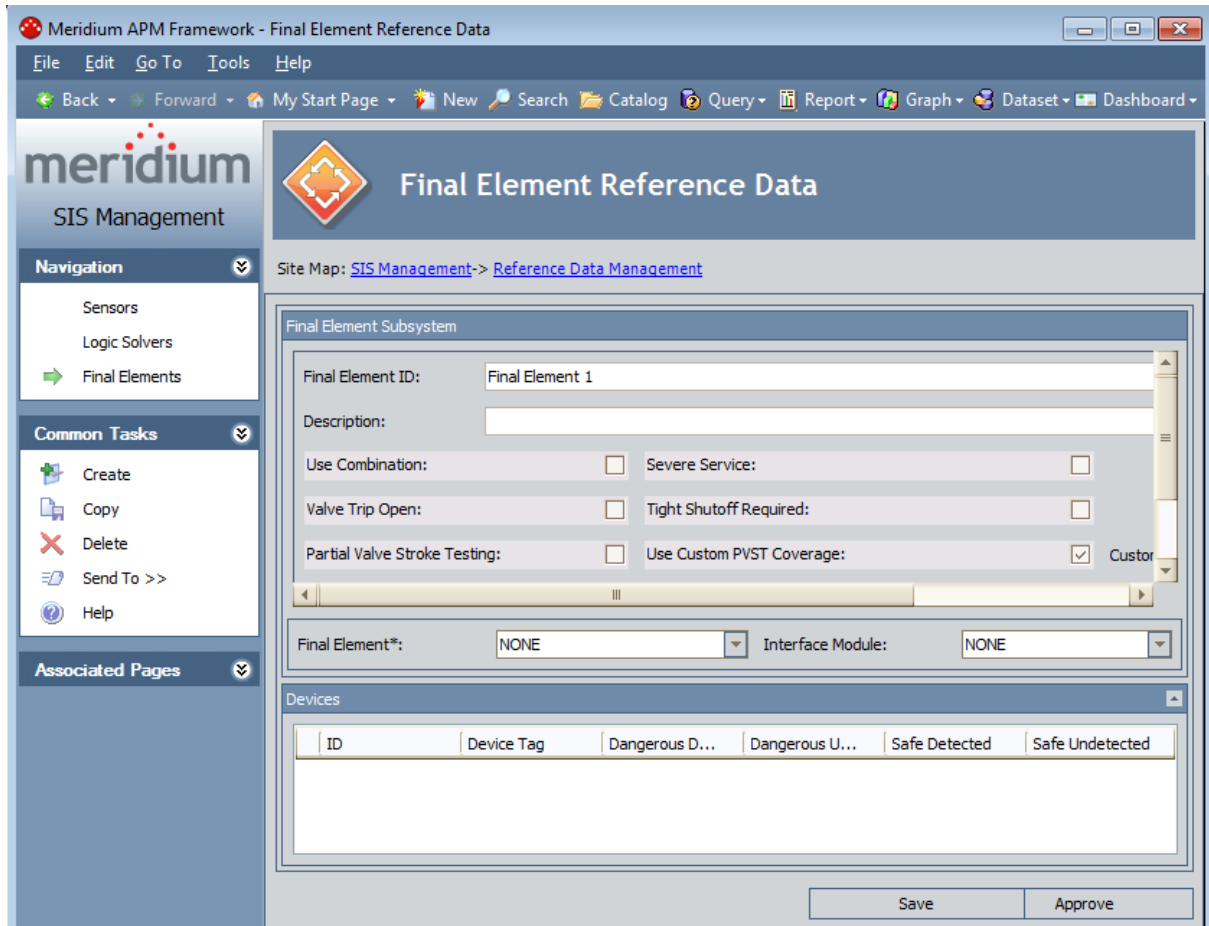

2. On the **Common Tasks** menu, click the **Copy** link.

The new Protective Instrument Loop Logic Solver record appears on the **Logic Solver Reference Data** page.

Approving and Revoking Approval for Protective Instrument Loop Final Element Records

After you have determined that a final element is approved for use in a protective instrument loop, you can specify that in the Protective Instrument Loop Final Element record. Additionally, if you later determine that a final element is no longer approved for use in a protective instrument loop, you can revoke that approval in the Protective Instrument Loop Final Element record.

To approve a Protective Instrument Loop Final Element record:

1. [Open the Protective Instrument Loop Final Element record](#) that represents the final element that you want to approve.
2. Below the datasheet, click the **Approve** button.

The **Approved Custom Device** check box in the Protective Instrument Loop Final Element record is automatically selected, and the label on the **Approve** button changes to **Revoke Approval**.

3. Click the **Save** button.

The record is saved.

To revoke approval for a Protective Instrument Loop Final Element record:

1. [Open the Protective Instrument Loop Final Element record](#) that represents the final element whose approval status you want to revoke.
2. Below the datasheet, click the **Revoke Approval** button.

The **Approved Custom Device** check box in the Protective Instrument Loop Final Element record is automatically cleared, and the label on the **Revoke Approval** button changes to **Approve**.

3. Click the **Save** button.

The record is saved.

About SIS Trip Reports

SIS Trip Reports are records that store details on events, which occurred on a safety instrumented system such as a trip alarm. For example, if during a process, the gas pressure level increased to an unmanageable level and the safety instrumented system turned off the gas feed, you would create one SIS Trip Report record to record the details of that *trip alarm* event.

Using SIS Management, you can manage the SIS Trip Report records that exist for all your safety instrumented systems.

When you create an SIS Trip Report record, you will link the record to a Safety Instrumented System record. When you link the SIS Trip Report record to a Safety Instrumented System record, the list of Instrumented Function records that are linked to the Safety Instrumented System record will automatically appear in the SIS Trip Report record. You can select the Instrumented Function records that you want to associate with the SIS Trip Report record. When you select Instrumented Function records on the SIS Trip Report datasheet, the Meridium APM system will automatically create one SIS Trip Report Detail record for each Instrumented Function record that you select and automatically link the SIS Trip Report Detail record to the SIS Trip Report record.

SIS Trip Report Detail records store details on the Instrumented Function with which it is associated. They also contain the decision that is made around the particular trip event, which is stored in the **Action** text box. For example, you can specify a trip event as *Dangerous* or *Safe*.

Accessing the SIS Trip Report Search Page

The **SIS Trip Report Search** page lets you search for and open an existing SIS Trip Report record. Using this page, you can also access features that you can use to create new SIS Trip Report records.

To access the SIS Trip Report Search page:

1. [Access the SIS Management Start Page.](#)
2. Click the **SIS Trip Report** link.

The **SIS Trip Report Search** page appears.

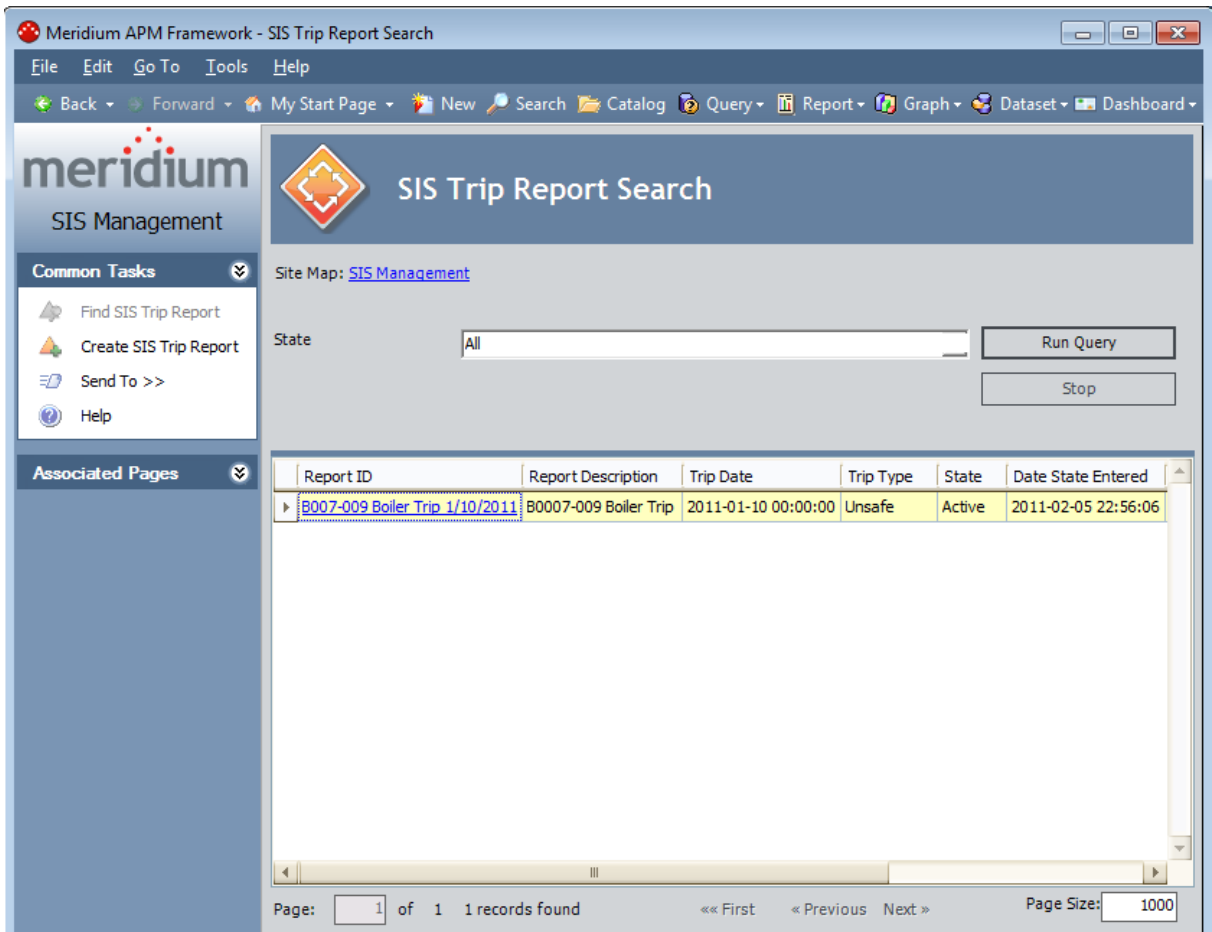

Aspects of the SIS Trip Report Search Page

The **SIS Trip Report Search** page contains the results of the `SIS_Trip_Report_Search` query. This documentation assumes that you are using the baseline query, which contains a **State** prompt that appears as a list at the top of the **SIS Trip Report Search** page. The **State** list contains a list of record states that have been configured for the SIS Trip Report family. You can choose from the following baseline states:

- **All:** Displays all the existing SIS Trip Report records that are in any state.
- **Active:** Displays the SIS Trip Report records that are in the *Active* state.
- **Complete:** Displays the SIS Trip Report records that are in the *Complete* state.
- **Pending Approval:** Displays the SIS Trip Report records that are in the *Pending Approval* state.
- **Review:** Displays the SIS Trip Report records that are in the *Review* state.

This query is run automatically using the default prompt value *All*. If you select different criteria, you can click the **Run Query** button to run the query and display the results in the grid at the bottom of the page. The query results will include hyperlinked Record IDs, which you can use to open the SIS Trip Report record on the [SIS Trip Report page](#).

Below the query results are options that you can use to navigate the results.

The **SIS Trip Report Search** page contains the following task menus:

- **Common Tasks**
- [Associated Pages](#)

Opening Existing SIS Trip Report Records

To open an existing SIS Trip Report record:

1. [Access the SIS Trip Report Search page.](#)
2. In the **State** list, select the record state for the desired SIS Trip Report record, and then click the **Run Query** button.

The search results appear in the grid.

3. In the grid, locate the row containing the SIS Trip Report record that you want to view.
4. In the **Report ID** cell in that row, click the hyperlinked Record ID.

The selected SIS Trip Report record appears on the **SIS Trip Report** page.

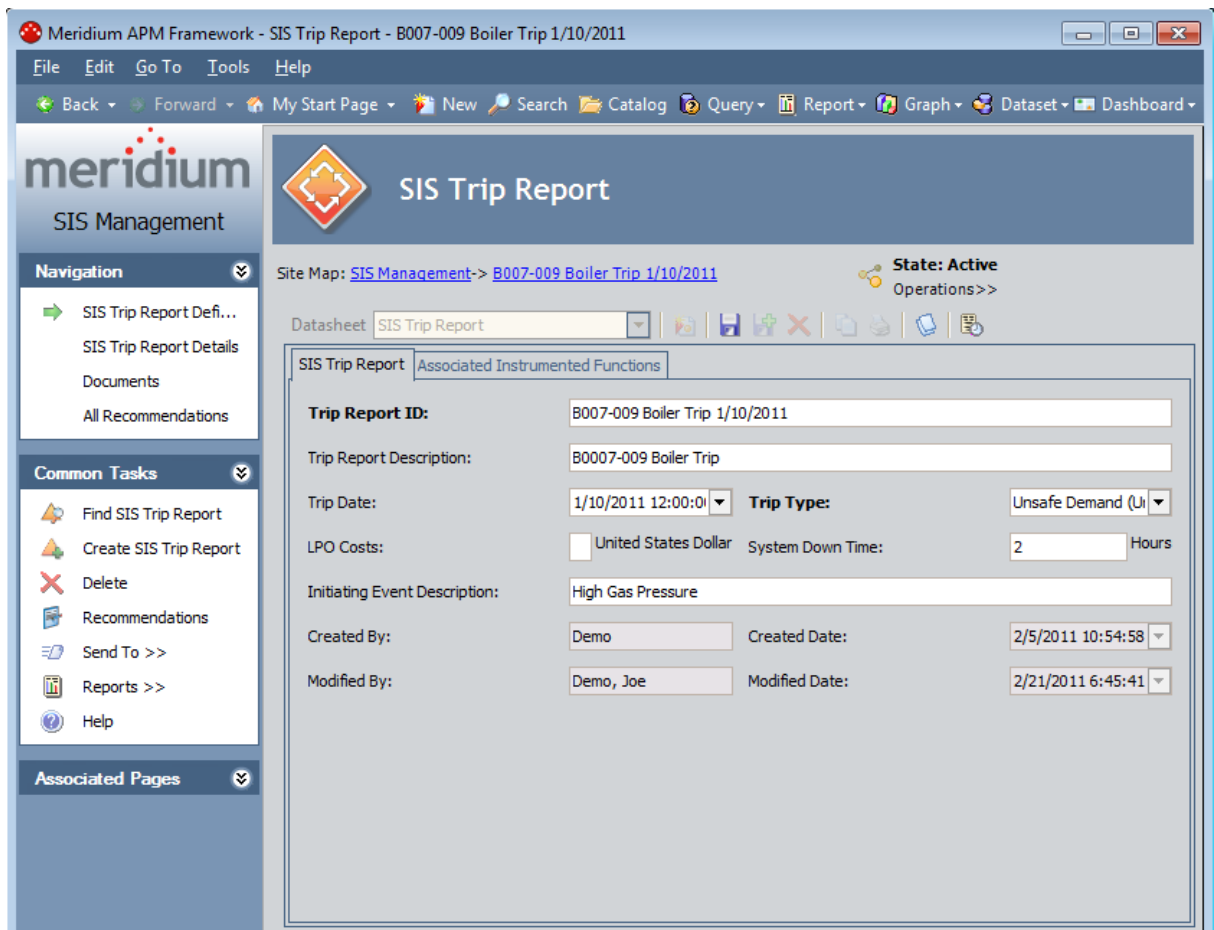

Navigation

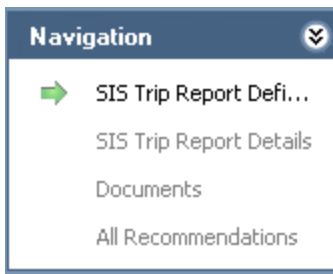

The **Navigation** menu on the **SIS Trip Report** pages contains the following links:

- **SIS Trip Report Definition:** Displays the **SIS Trip Report** page.
- **SIS Trip Report Details:** Displays the **SIS Trip Report Details** page. This link is enabled only when you are viewing an existing SIS Trip Report record.
- **Documents:** Displays the [Reference Documents](#) page. This link is enabled only when you are viewing an existing SIS Trip Report record.
- **All Recommendations:** Displays a list of Risk Assessment Recommendation records on the **Recommendation Management** page. This link is enabled only when you are viewing an existing SIS Trip Report record.

A green arrow to the left of a link indicates the feature that you are currently viewing.

Common Tasks

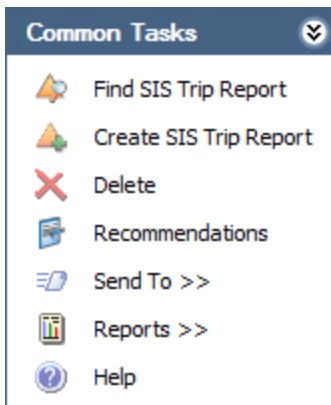

The **Common Tasks** menu on the **SIS Trip Report** pages contains the following links:

- **Find SIS Trip Report:** Displays the **SIS Trip Report Search** page, where you can search for an existing SIS Trip Report record. This link is disabled on the **SIS Trip Report Search** page.
- **Create SIS Trip Report:** Displays a new blank SIS Trip Report record on the **SIS Trip Report** page.
- **Delete:** Displays a confirmation message and then deletes the selected SIS Trip Report record, and the **SIS Trip Report Search** page appears. This link does not appear on the **SIS Trip Report Details** page or the **SIS Trip Report Search** page.
- **Recommendations:** Displays the [Recommendations dialog box](#), where you can manage Risk Assessment Recommendation records that are linked to the SIS Trip Report record. This link is enabled only when you are viewing an existing SIS Trip Report record. This link does not appear on the **SIS Trip Report Details** page or the **SIS Trip Report Search** page.
- **Send To:** Displays a submenu with options that let you provide a link to the current page on your desktop (create shortcut), in an email message, or on a Home Page.
- **Reports:** Displays a submenu that displays the caption of the Catalog item *SIS Trip Report* as a link. This link is enabled only when you are viewing an existing SIS Trip Report record. This link does not appear on the **SIS Trip Report Details** page or the **SIS Trip Report Search** page.
- **Help:** Displays the context-sensitive Help topic for the current page.

Aspects of the SIS Trip Report Page

The **SIS Trip Report** page contains the SIS Trip Report datasheet. You can access the **SIS Trip Report** page by [opening an existing SIS Trip Report record](#) or [creating a new one](#). When you access the **SIS Trip Report** page by creating a new SIS Trip Report record, the Record ID of the SIS Trip Report record will not appear in the page title until after you save the new record.

Above the datasheet, the following options are enabled:



Saves the current SIS Trip Report record.



Displays the **State Assignments** dialog box, where you can manage the Security Users that are assigned to the states that are defined for the SIS Trip Report family. To the right of the icon, the following items appear:



State Indicator: Displays the current state of the SIS Trip Report record.



Operations menu: Displays the operations that are available for selection. You can use this option to change the state of the SIS Trip Report record. This link is enabled only when you are viewing an existing SIS Trip Report record.

The **SIS Trip Report** page contains the following task menus:

- [Navigation](#)
- [Common Tasks](#)
- [Associated Pages](#)

Creating New SIS Trip Report Records

To create a new SIS Trip Report record:

1. [Access the SIS Trip Report Search page.](#)
2. On the **Common Tasks** menu, click the **Create SIS Trip Report** link.

The **SIS Trip Report** page appears, displaying a new blank SIS Trip Report record.

3. In the **Trip Report ID** text box, type a name for the SIS Trip Report record. This field is required.
4. In the **Trip Type** list, select the type of trip event that the SIS Trip Report record represents. This field is required.
5. Provide values in the remaining fields on the **SIS Trip Report** tab as desired.
6. Click the **Associated Instrumented Functions** tab,
The **Associated Instrumented Functions** tab appears.

7. In the **SIS ID** text box, click the  button. This field is required.

The **Find Items** window appears, and the **Search In** list contains the Safety Instrumented System family by default.

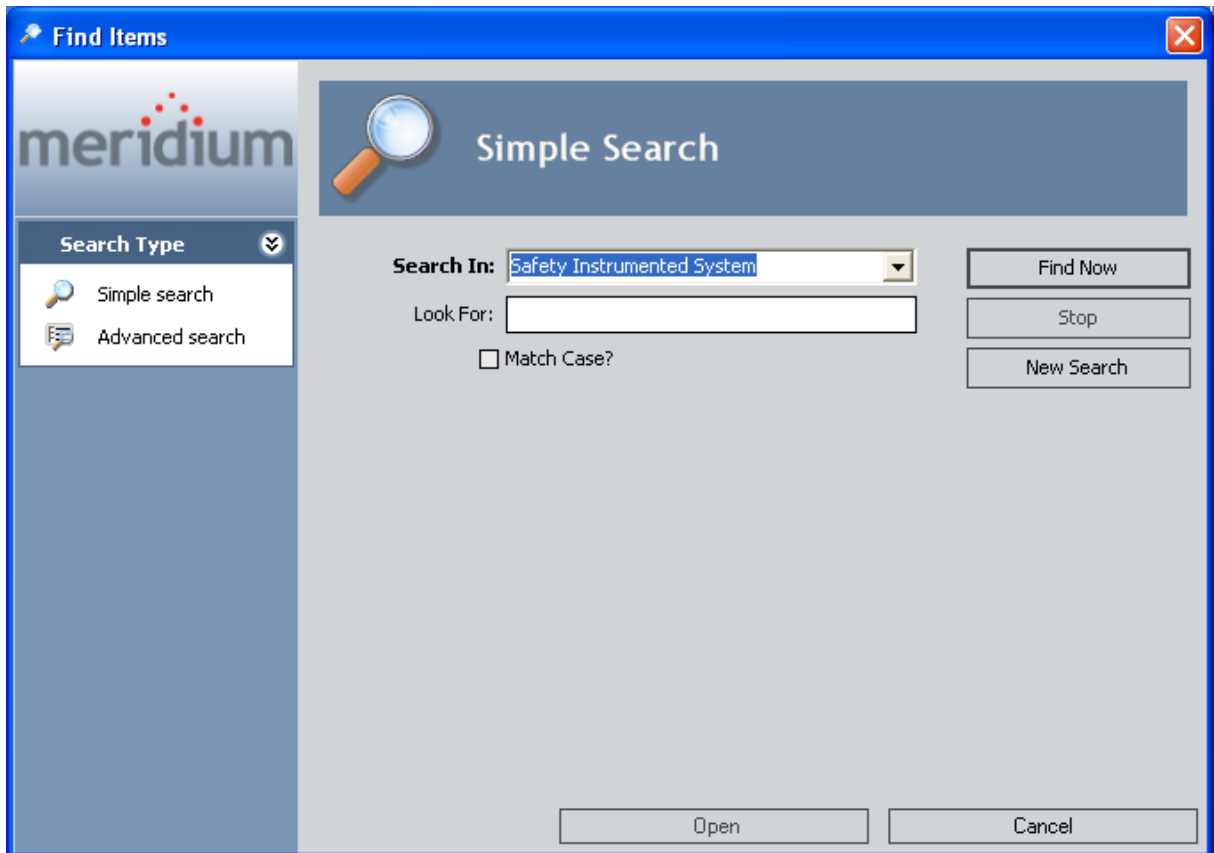

8. Specify the desired search criteria, and then click the **Find Now** button.

The search results appear.

9. In the search results, select the desired Safety Instrumented System record, and then click the **Open** button.

The **Instrumented Functions** dialog box appears, displaying a list of Instrumented Function records that are linked to the selected Safety Instrumented System record. The Instrumented Function records that appear in this list automatically appear in the **Associated Instrumented Functions** list on the **Associated Instrumented Functions** tab.

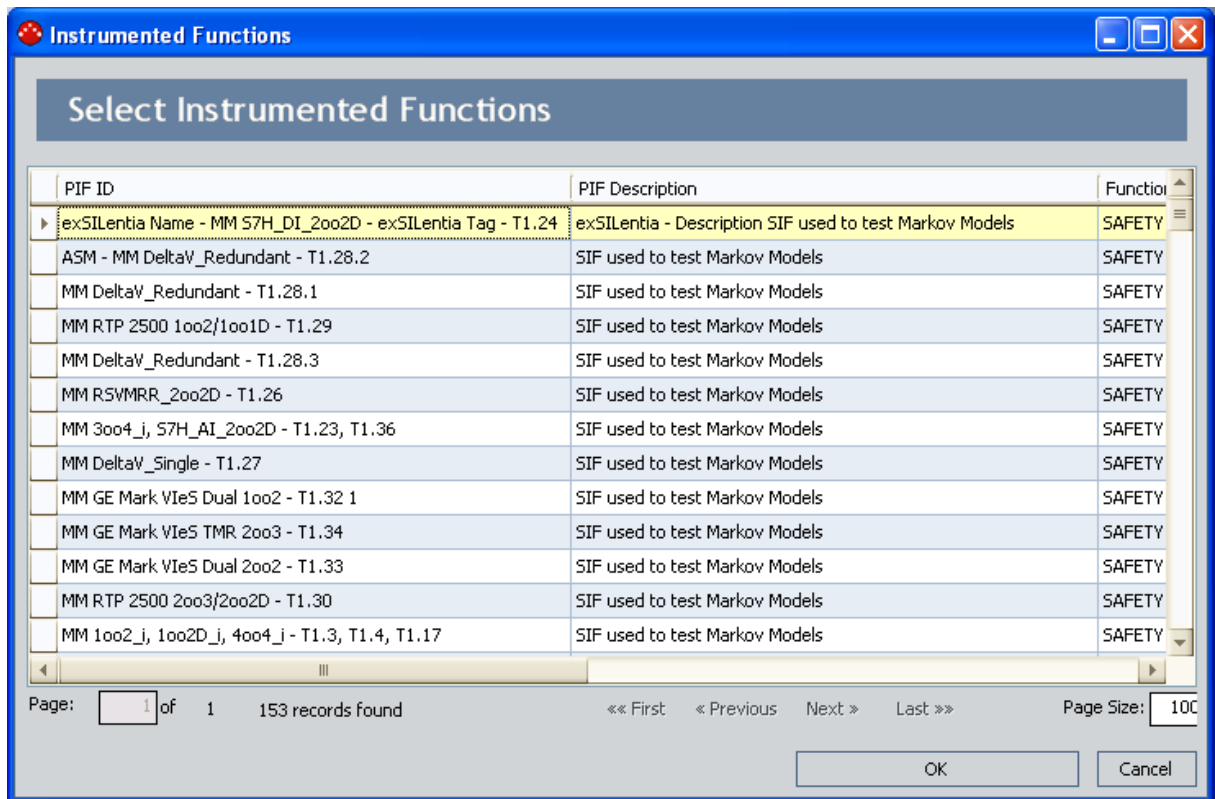

- In the list, select the Instrumented Function records that you want to associated with the SIS Trip Report record, and then click **OK**.

The **Instrumented Functions** dialog box closes, revealing the SIS Trip Report datasheet, where the Record ID of the Safety Instrumented System record appears in the **SIS ID** text box and the Instrumented Function records that you selected on the **Instrumented Functions** dialog box are selected in the **Associated Instrumented Functions** list.

Note: In the **Associated Instrumented** list, if you want to associate additional Instrumented Function records with the SIS Trip Report record, you can select the check box to the left of the desired record.

- Above the datasheet, click the **Save** button. 

The record is saved, and the following links are enabled on the **Navigation** menu:

- **SIS Trip Report Details**
- **Documents**
- **All Recommendations**

Accessing the SIS Trip Report Details Page

The **SIS Trip Report Details** page lets you manage the SIS Trip Report Detail records that were created automatically based on the Instrumented Function records that are specified in the SIS Trip Report record to which the SIS Trip Report Detail records are linked.

To access the SIS Trip Report Details page:

1. [Open on the SIS Trip Report page the SIS Trip Report whose details you want to view.](#)
2. On the **Navigation** menu, click the **SIS Trip Report Details** link.

The **SIS Trip Report Details** page appears, displaying a list of SIS Trip Report Detail records that are linked to the SIS Trip Report record from which you accessed the **SIS Trip Report Details** page.

The screenshot displays the 'SIS Trip Report Details' page within the Meridium APM Framework. The browser title is 'Meridium APM Framework - SIS Trip Report Details - B007-009 Boiler Trip 1/10/2011'. The page features a navigation menu on the left with options like 'SIS Trip Report Details', 'Documents', and 'All Recommendations'. The main content area shows a table of details for the selected trip report.

Trip Report Detail ID	Instrumented Function ID	Action
BR-1001 Boiler Trip - SIF-1001	SIF-1001	As Designed
B007-009 Boiler Trip 1/10/2011 - SIF-1002	SIF-1002	
B007-009 Boiler Trip 1/10/2011 - SIF-1005	SIF-1005	
B007-009 Boiler Trip 1/10/2011 - SIF-1004	SIF-1004	
B007-009 Boiler Trip 1/10/2011 - SIF-1003	SIF-1003	

At the bottom of the page, there are two buttons: 'Add Trip Detail' and 'Remove Trip Detail'.

Aspects of the SIS Trip Report Details Page

The **SIS Trip Report Details** page contains the **SIS Trip Report Details** workspace, which displays a grid with a list of SIS Trip Report Detail records that are linked to the SIS Trip Report from which you accessed the **SIS Trip Report Details** page. Each row in the grid represents one SIS Trip Report Detail record. By default, the grid contains the following columns:

- **Trip Report Detail ID:** Displays the value that exists in the Trip Report Detail ID field in the SIS Trip Report Detail record. This value appears as a hyperlink, which you can click to open the SIS Trip Report Detail record.
- **Instrumented Function ID:** Displays the value that exists in the Instrumented Function ID field in the SIS Trip Report Detail record. This value appears as a hyperlink, which you can use to open the Instrumented Function record.
- **Action:** Displays the value that exists in the Action field in the SIS Trip Report Detail record.

Below the grid, the following buttons appear:

- **Add Trip Detail:** Displays the **Add Trip Details** dialog box, where you can select the Instrumented Function record that you want to use for the SIS Trip Report Detail record.
- **Remove Trip Detail:** Displays a confirmation message, and then deletes the selected SIS Trip Report Detail record.

The **SIS Trip Report Details** page contains the following task menus:

- [Navigation](#)
- [Common Tasks](#)
- [Associated Pages](#)

Using the **SIS Trip Report Details** page, you can:

- [View an existing SIS Trip Report Details record.](#)
- [Create a new SIS Trip Report Details record.](#)
- [Delete an SIS Trip Report Details record.](#)

Creating New SIS Trip Report Details Records

To create a new SIS Trip Report Details record:

1. [Access the SIS Trip Report Details page.](#)
2. In the SIS Trip Report Details workspace, below the grid, click the **Add Trip Detail** button.

The **Add Trip Details** dialog box appears, displaying the list of Instrumented Function records that are linked to the Safety Instrumented System record that is linked to the SIS Trip Report record to which the SIS Trip Report Details record is linked.

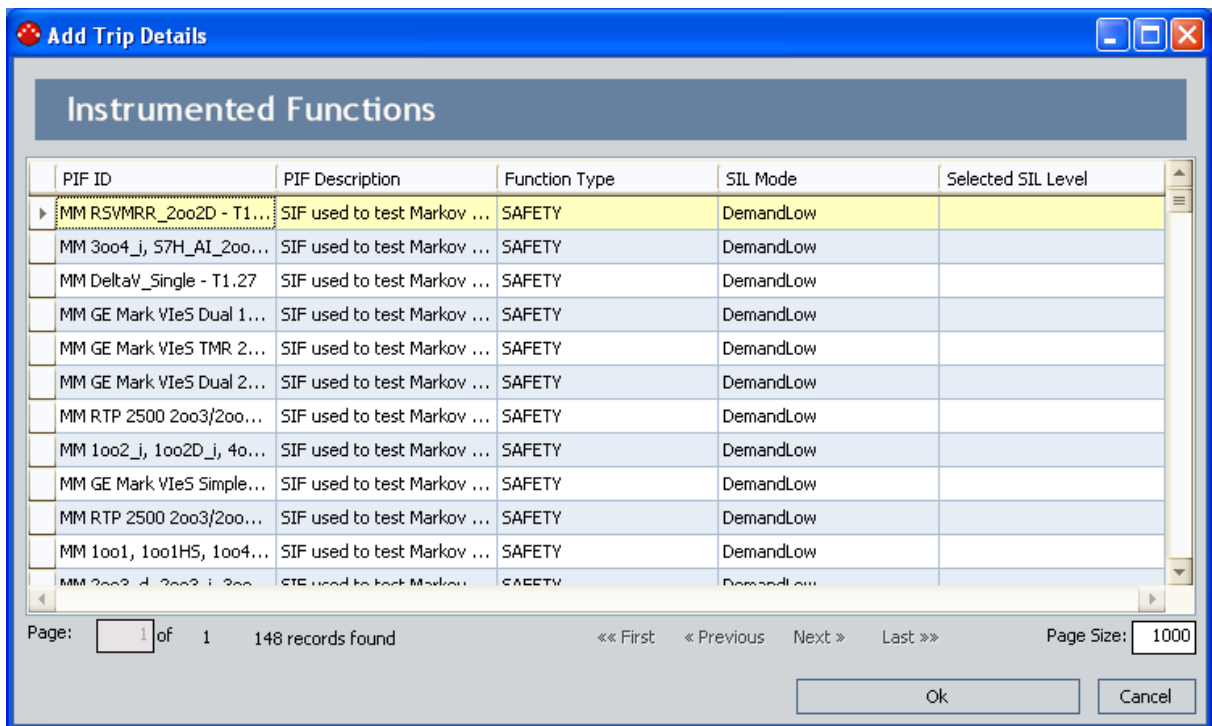

3. In the list, select the Instrumented Function record that you want to use to create the SIS Trip Report Details record, and then click **OK**.

The **Add Trip Details** dialog box closes, the new SIS Trip Report Detail record is created, saved, and appears at the bottom of the list. At this point, you can [open the SIS Trip Report Detail record and modify its contents.](#)

Viewing SIS Trip Report Detail Records

To view an SIS Trip Report Detail record:

1. [Access the SIS Trip Report Details page.](#)
2. In the **SIS Trip Report Details** workspace, locate the row containing the SIS Trip Report Detail record whose contents you want to view.
3. In the **Trip Report Detail ID** cell, click the hyperlinked Record ID for the desired record.

The SIS Trip Report Detail record appears in a new window.

The screenshot shows a window titled "Test - ASM - MM DeltaV_Redundant - T1.28.2 (SIS Trip Report Detail)". The window contains a form with the following fields:

- Trip Report Detail ID:** Test - ASM - MM DeltaV_Redundant - T1.28 Action: [Dropdown]
- Instrumented Function ID:** [ASM - MM DeltaV_Redundant - T1.28.2](#)
- Instrumented Function Description:** SIF used to test Markov Models
- Comments:** [Text Area]
- Failed Component ID:** [Dropdown]
- Failed Component Description:** [Text Area]
- Created By:** lacy
- Created Date:** 6/16/2010 12:16:37 PM

Buttons for "OK" and "Cancel" are located at the bottom right of the window.

4. Modify the values in the fields as desired, and then click **OK**.

Your changes are saved.

Deleting SIS Trip Report Detail Records

When you delete an SIS Trip Report Detail record, the record and all relationships in which it participates will be deleted from the Meridium APM database.

To delete an SIS Trip Report Detail record:

1. [Access the SIS Trip Report Detail page.](#)
2. In the **SIS Trip Report Details** workspace, select the row containing the SIS Trip Report Detail record that you want to delete.
3. Below the grid, click the **Remove Trip Detail** button.

A confirmation message appears, asking if you really want to delete the selected record.

4. Click the **Yes** button.

The selected record is deleted from the Meridium APM database and no longer appears in the grid.

About Revision History in SIS Management

In addition to the Meridium APM Framework Tool that provides revision history for field values, which you can use to manage revisions that are made on individual fields in a family, SIS Management provides a Revision History feature that you can use to manage the revisions made for an entire SIL analysis. When you create an analysis, you link records in multiple families to the SIL Analysis record, which represents the entire analysis. When you complete an analysis, you will change the state of the SIL Analysis record to Complete. When you do so, a snapshot is taken of the SIL Analysis record and each record to which it is linked, either directly or indirectly.

When the SIL Analysis record state is changed to Complete, one record in the associated Revision family for each family that participates in the SIS Management data model will be created. In other words, one Revision record is created for each record that is linked to the SIL Analysis record (with the exception of the Human Resource, Risk Assessment Recommendation, and Risk Assessment families). Each Revision record stores a snapshot of the source record as it appeared when the state of the SIL Analysis record was changed. For details on how these families are related to one another, see the [illustration of the SIS Management data model](#).

If the analysis requires reassessment, after the reassessment takes place, the state of the SIL Analysis record will be changed again to the Complete state and a second set of Revision records will be created, and so on.

You can [access the SIL Analysis Revision records](#) via the **Revision History** link on the **Navigation** menu.

Accessing SIL Analysis Revisions

The following instructions provide details on accessing the **Analysis Revision History** page, where you can view the Revision records that exist for a given SIL Analysis.

To access the **Analysis Revision History** page:

1. Open the desired SIL Analysis.
2. On the **Navigation** menu, click the **Revision History** link.

The **Analysis Revision History** page appears.

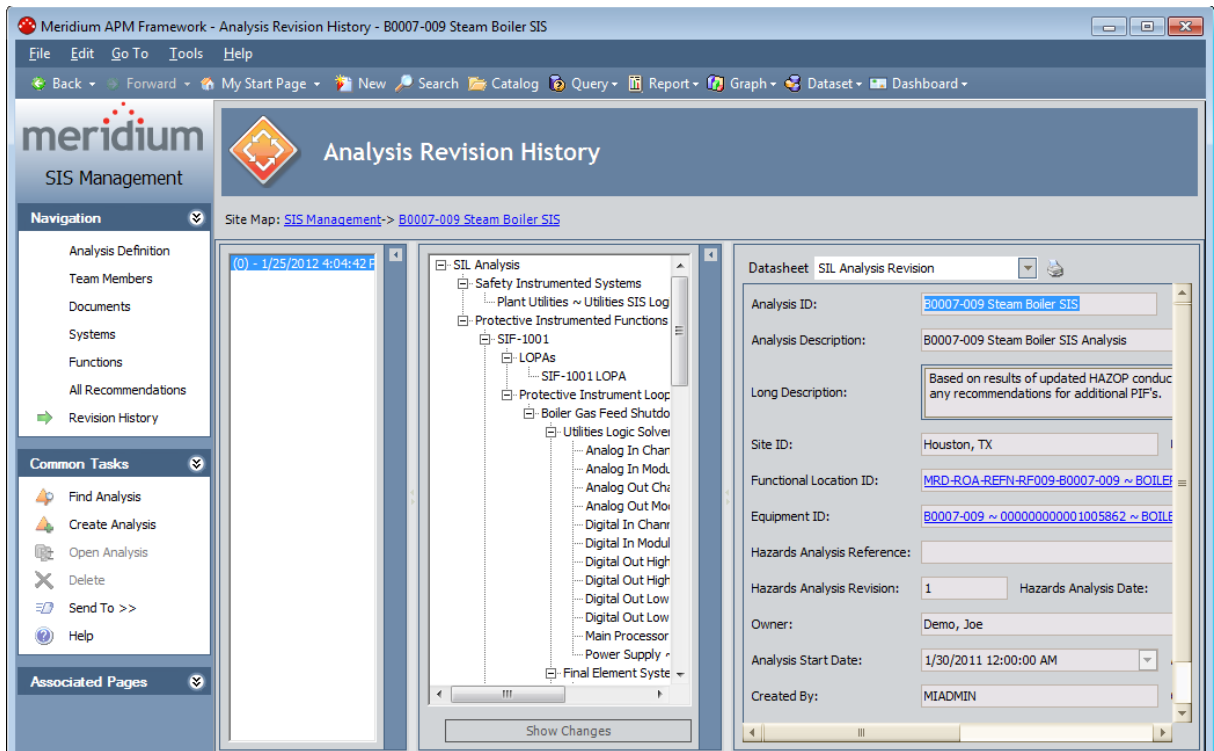

Note: The **Revision History** link is enabled only if the SIL Analysis record for the current analysis has ever been set to the Complete state.

Aspects of the Analysis Revision History Page

The **Analysis Revision History** page contains the following panes:

1. **Revisions pane:** Contains a list of all SIL Analysis Revision records that have been created for the SIL Analysis from which you accessed the **Analysis Revision History** page. Each row in the list represents one SIL Analysis Revision record, and each item in the list is labeled using the value that exists in the Revision Date field in that SIL Analysis Revision record. The rows appear in the reverse order in which they were created and are numbered, starting with 0, where 0 is the first revision. In other words, the most recent revision will appear first in the list. When you select a row in the list:
 - A hierarchical view of the SIL Analysis that existed at the time that revision was created will appear in the **Selected Revision** pane.
 - The corresponding SIL Analysis revision record will be displayed in the **Datasheet** pane.
2. **Selected Revisions pane:** Displays a hierarchical view of the records that belong to the SIL Analysis whose revision is selected in the **Revisions** pane.

At the bottom of this section, the **Show Changes** button appears, which you can click to view the changes that were made to the selected record during this revision. This button is enabled only if the selected record contains values that were changed since the previous revision.

3. **Datasheet pane:** Displays the SIL Analysis Revision record that is currently selected in the **Revisions** pane or the **Selected Revisions** pane. Above the datasheet, the **Print** button  appears, which you can use to print the record that is displayed in the **Datasheet** pane.

The following image shows the **Analysis Revision History** page, where callouts have been provided to identify the numbered panes described above.

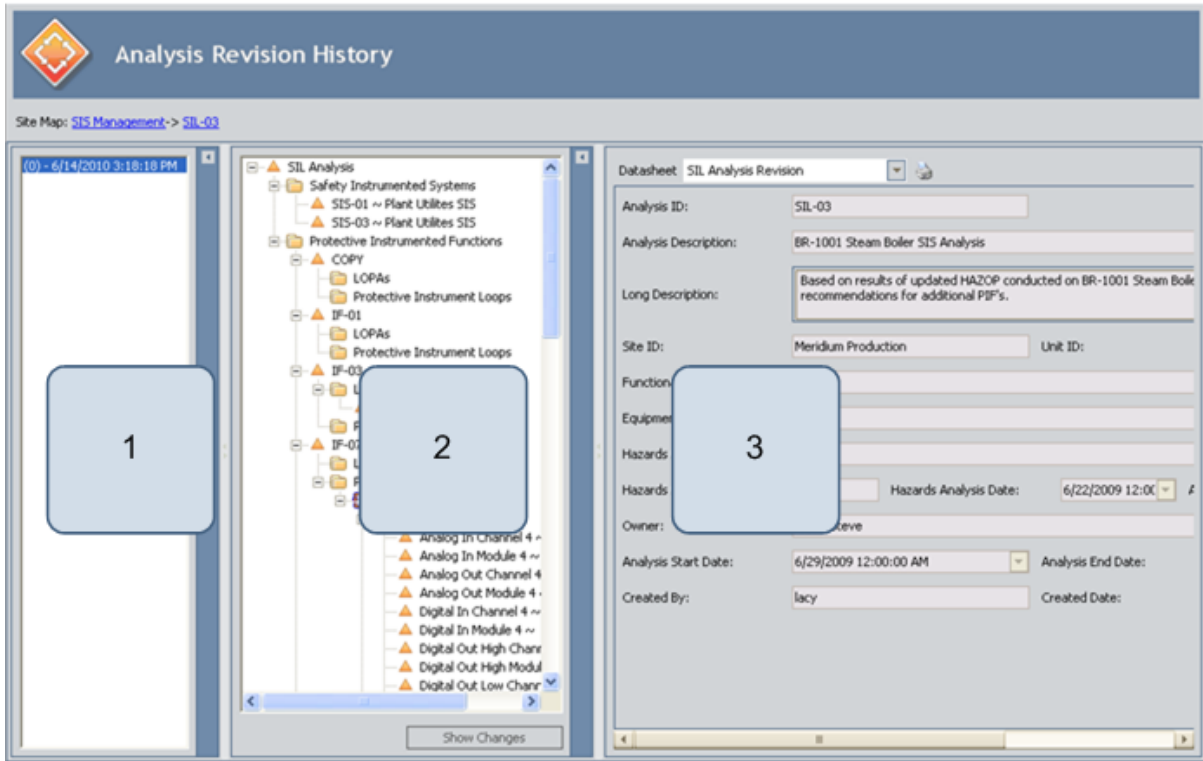

The Analysis Revision History page contains the following task menus:

- [Navigation](#)
- [Common Tasks](#)
- [Associated Pages](#)

The options that appear on these task menus is consistent with the options that appear on that menu when you are viewing it on other pages in SIS Management.

On the Analysis Revision History page, you can:

- [View the Revision record for the desired record.](#)
- [View the specific changes that were made to a given Revision record.](#)

Common Tasks Menu

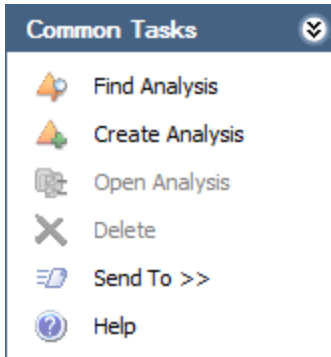

The **Common Tasks** menu on the **Analysis Revision History** page contains the following links:

- **Find Analysis:** Displays the **SIL Analysis Search** page, where you can search for an existing SIL Analysis record.
- **Create Analysis:** Displays a new blank SIL Analysis record on the **SIL Analysis Definition** page.
- **Open Analysis:** This link is disabled.
- **Delete:** This link is disabled.
- **Send To:** Displays a submenu with options that let you provide a link to the current page on your desktop (create shortcut), in an email message, or on a Home Page.
- **Help:** Displays the context-sensitive help topic for the **Analysis Revision History** page.

Viewing the Datasheet for a Revision Record

To view the datasheet for a Revision record:

1. [Access the Analysis Revision History page.](#)
2. In the **Revisions** pane, select the row that represents the revision of the SIL Analysis that you want to view.

The corresponding SIL Analysis Revision record appears in the **Datasheet** pane, and the corresponding revisions appear in the **Selected Revision** pane.

3. In the **Selected Revisions** pane, select the Revision record whose datasheet you want to view.

The Revision record for the selected record appears in the **Datasheet** pane.

Viewing Changes That Were Made Between Revisions

To view changes that were made between revisions:

1. [Access the Analysis Revision History page.](#)
2. In the **Revisions** pane, select the revision for which you want to see the modified values.
3. In the **Selected Revisions** pane, select the record for which you want to see the modified values.
4. At the bottom of the **Selected Revisions** pane, click the **Show Changes** button.

The **Changes** dialog box appears.

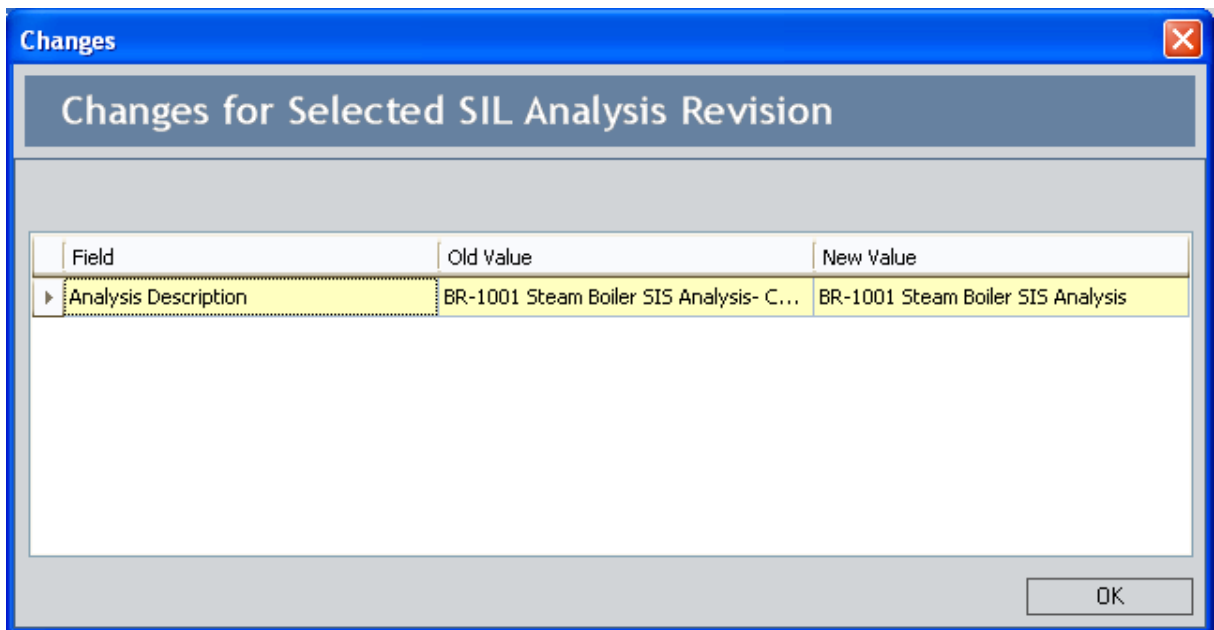

5. Review the changes and click **OK** when you are finished.

The **Changes** dialog box closes.

About Risk Assessment Recommendation Records and the SIL Analysis

Risk Assessment Recommendation Records store recommendations for an action that you should be taken on the item that is represented by the record to which the Risk Assessment Recommendation record is linked. In SIS Management, you can link Risk Assessment Recommendation records to records in the following families:

- Instrumented Function
- Protective Instrument Loop
- SIS Proof Test
- SIS Proof Test Template

You can manage Risk Assessment Recommendation records for individual records within SIS Management via the [Recommendations dialog box](#). Additionally, via Recommendation Management, you can manage Risk Assessment Recommendation records for:

- [One SIL Analysis](#)
- [ALL SIL Analyses](#)

The Risk Assessment Recommendation datasheet contains two tabs:

- **General Information:** Contains fields that you can use to describe the recommendation, assign the recommendation to a Meridium APM user, and specify due dates for the recommendation.
- **Alert:** Contains fields that you can use to [schedule alerts](#) to be sent to specified recipients when a recommendation or reevaluation is due.

After you link a Risk Assessment Recommendation record to an individual record, the Risk Assessment record is part of the SIL Analysis.

Accessing the Recommendations Dialog Box

The **Recommendations** dialog box lets you manage Risk Assessment Recommendation records that [are linked to individual records within the SIL Analysis](#). Using the **Recommendations** dialog box, you can:

- View the Risk Assessment Recommendation records that are currently linked to a record.
- Create new Risk Assessment Recommendation records and link them to a record.
- Link existing Risk Assessment Recommendation records to a record.
- Remove Risk Assessment Recommendation records from the analysis.

The following instructions assume that you are viewing one of the following pages within SIS Management and that the **Recommendations** link is enabled on a task menu on that page:

- [Instrumented Functions \(IFs\)](#)
- [Proof Tests](#)
- [Proof Test Templates](#)
- [Protective Instrument Loop](#)

Note: The **Recommendations** link should not be confused with the **All Recommendations** link, which appears on the **Navigation** menu.

To access the Recommendations dialog box:

- On the appropriate task menu, click the **Recommendations** link.

The **Recommendations** dialog box appears.

Accessing the Recommendations Dialog Box

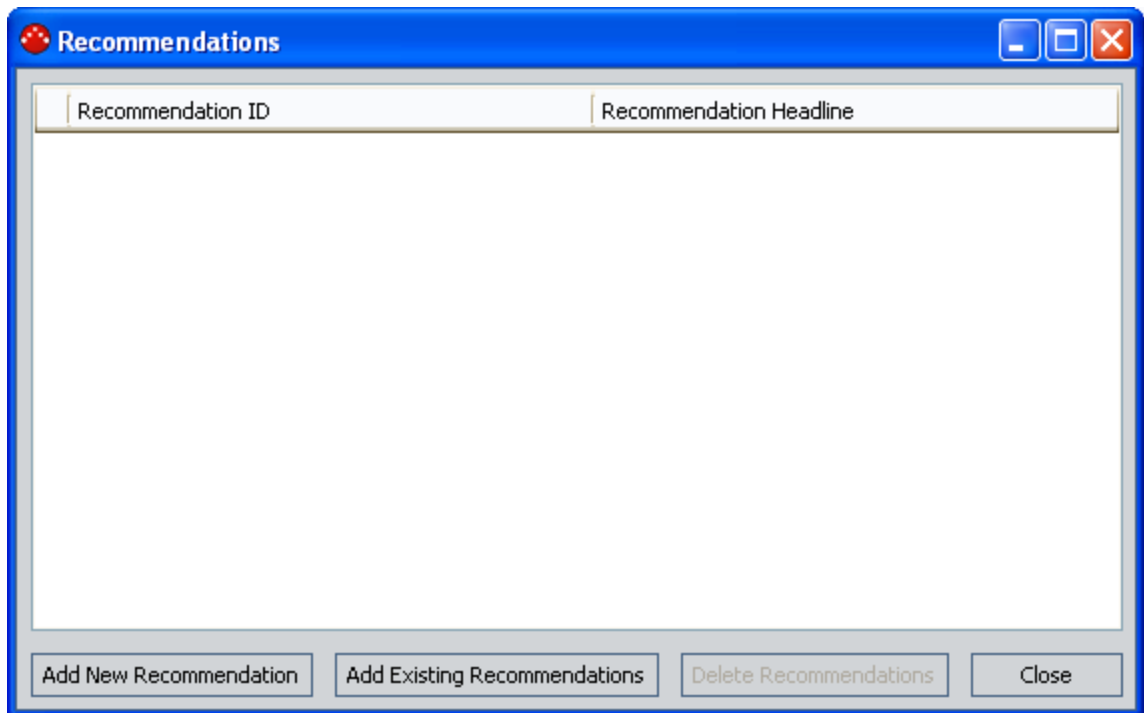

Aspects of the Recommendations Dialog Box

The **Recommendations** dialog box displays a list of Risk Assessment Recommendation records that are linked to the record that is currently selected. Each row in the list represents one Risk Assessment Recommendation records. For each Risk Assessment Recommendation record that appears in the list, the following information is displayed:

- **Recommendation ID:** The ID for the recommendation as it appears in the Recommendation ID field in the Risk Assessment Recommendation record.
- **Recommendation Headline:** The description of the recommendation as it appears in the Recommendation Headline field in the Risk Assessment Recommendation record.

Below the list, the following buttons appear:

- **Add new Recommendation:** Displays a new Risk Assessment Recommendation record in a new window, where you can create a new Risk Assessment Recommendation record. After you save the new record, it will appear in the list on the **Recommendations** dialog box.
- **Add Existing Recommendations:** Displays the **Find Items** window, where you can search for an existing Risk Assessment Recommendation record to link to the selected record.
- **Delete Recommendations:** Displays a confirmation message, and then removes the Risk Assessment Recommendation record from the SIL Analysis. This link is enabled only if a Risk Assessment Recommendation record appears in the list.
- **Close:** Closes the **Recommendations** dialog box, revealing the page from which it was accessed.

Creating New Risk Assessment Recommendation Records

The following instructions provide details on creating a new Risk Assessment Recommendation record via the **Recommendations** dialog box. These instructions assume that you are familiar with the fields in the Risk Assessment Recommendation family.

To create a new Risk Assessment Recommendation record:

1. [Access the Recommendations dialog box.](#)
2. Below the grid, click the **Add New Recommendation** button.

A new Risk Assessment Recommendation record appears in a new window.

The screenshot shows a software dialog box titled "REC-743 (new Risk Assessment Recommendation)". The window has a standard Windows-style title bar and a toolbar with various icons. The main area is divided into a "General Information" tab and an "Alert" tab. The "General Information" tab contains several fields for data entry:

- Recommendation ID:** REC-743
- Recommendation Headline:** (empty text box)
- Recommendation Description:** (empty text box with a scroll bar and a menu icon)
- Recommendation Basis:** (empty text box)
- Functional Location ID:** (empty text box with a menu icon)
- Equipment ID:** (empty text box with a menu icon)
- Required Equipment Status:** (dropdown menu)
- Business Impact:** (dropdown menu)
- Target Completion Date:** (dropdown menu, highlighted in red)
- Mandatory Date:** (dropdown menu)
- Recommendation Priority:** (dropdown menu)
- Status:** Created (CREATED)
- Author Name:** McClure, Lacy | lacy
- Reviewer Name:** (dropdown menu)
- Assigned To Name:** (dropdown menu)
- Final Approver Name:** (dropdown menu)
- Work Request Reference:** (empty text box)
- Work Order Number:** (empty text box)
- Completed Date:** (dropdown menu)

At the bottom right of the dialog box, there are two buttons: "OK" and "Cancel".

3. On the **General Information** tab, in the **Target Completion Date** box, type or select the date that corresponds to the date on which the recommended task should be completed. This field is required.
4. On the **General Information** tab, provide values in the remaining fields as desired.
5. If desired, on the **Alert** tab, provide values in the fields to [schedule an alert to be sent to the assignee when the recommendation is due](#).

Note: On the **Alert** tab, you can also [schedule an alert to be sent to a list of recipients when the recommendation is due for reevaluation](#).

5. Click **OK**.

The selected record appears in the list on the **Recommendations** dialog box and is linked to the record that is currently selected on the page from which you accessed the **Recommendations** dialog box.

Adding Existing Risk Assessment Recommendation Records to the SIL Analysis

The following instructions provide details on searching for an existing Risk Assessment Recommendation record to add to the SIL Analysis. When you add an existing Risk Assessment Recommendation record to the SIL Analysis, you are linking the Risk Assessment Recommendation record to an individual record within the SIL Analysis.

To add an existing Risk Assessment Recommendation record to the SIL Analysis:

1. [Access the Recommendations dialog box.](#)
2. Below the grid, click the **Add Existing Recommendations** button.

The **Find Items** window appears.

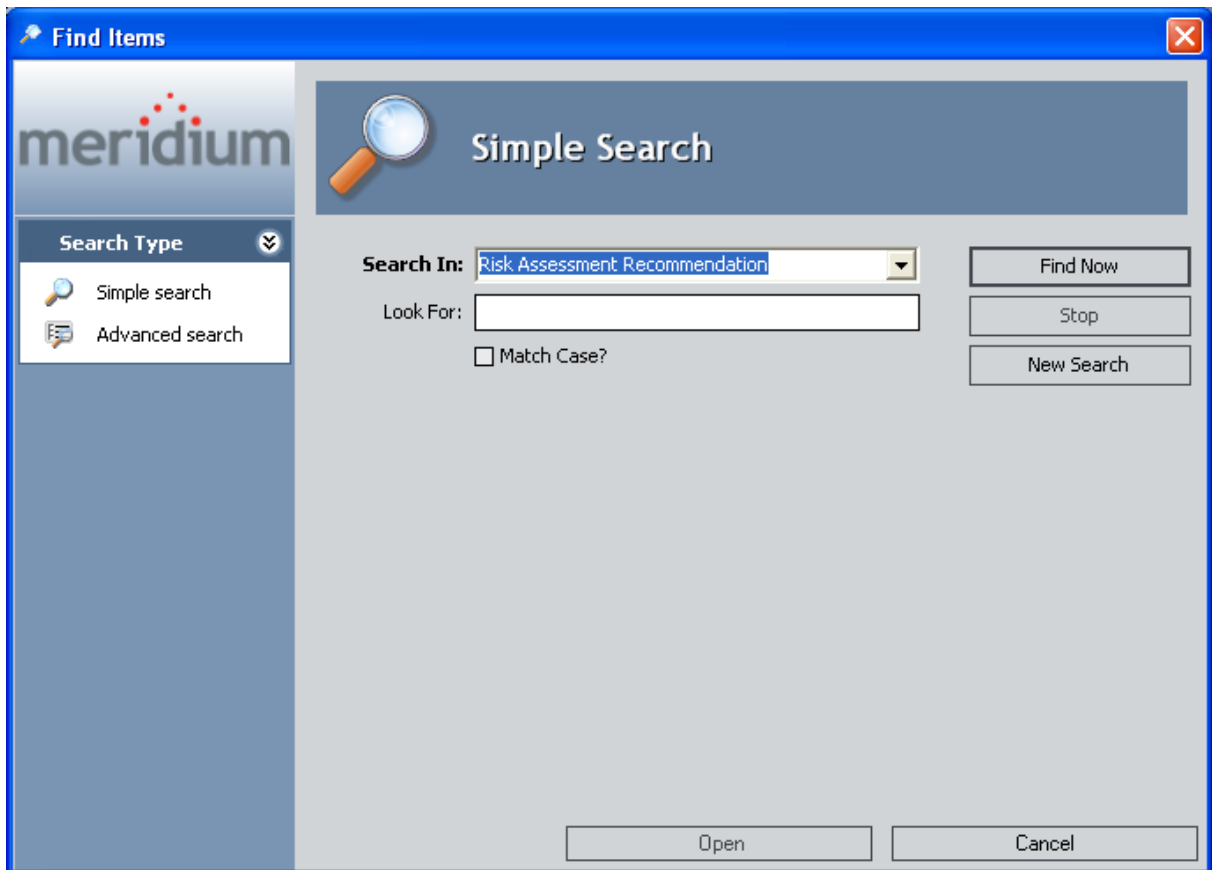

3. If desired, in the **Look For** text box, provide search criteria, and then click the **Find Now** button.

The search results appear.

4. In the search results list, select the desired record, and click the **Open** button.

The selected record appears in the list on the **Recommendations** dialog box and is linked to the record that is currently selected on the page from which you accessed the **Recommendations** dialog box.

Removing Risk Assessment Recommendation Records from the SIL Analysis

When you *remove a Risk Assessment Recommendation record from the SIL Analysis*, you are deleting the link between the Risk Assessment Recommendation record and the record to which it is linked that belongs to the SIL Analysis. After you delete this link, the Risk Assessment Recommendation record is no longer part of the SIL Analysis.

To remove a Risk Assessment Recommendation record from the SIL Analysis:

1. [Access the Recommendations dialog box.](#)
2. In the grid, select the row containing the Risk Assessment Recommendation record that you want to remove from the SIL Analysis.
3. Click the **Delete Recommendations** button.

A confirmation message appears, asking if you really want to remove the link between the Risk Assessment Recommendation record and the record to which it is linked.

4. Click the **Yes** button.

The selected Risk Assessment Recommendation record is removed from the **Recommendations** list and the SIL Analysis.

Using the Status Field in Recommendations

You can use the values in the **Status** list in a Risk Assessment Recommendation record to facilitate a workflow to track the progress of the recommendation.

The **Status** list contains the following values:

- **Approved:** You can use this status to indicate that the recommended action has been approved and can be assigned to someone to implement in your facility.
- **Created:** This status indicates that the Risk Assessment Recommendation record and the associated recommendation are new. This is the default state.
- **Pending Review:** You can use this status to indicate that the recommended action is assigned to someone so that they can review it and obtain approval to implement the suggested action.
- **Reviewed:** You can use this status to indicate that the recommended action has been reviewed and is waiting for approval.
- **Rejected:** You can use this status to indicate that the recommended action has been not been approved.
- **Cancelled:** You can use this status to indicate that the previously approved or reviewed action will no longer be implemented.
- **Superseded:** You can use this status to indicate that the previously approved or reviewed action will no longer be implemented because a different action supersedes it.

Depending on the value that exists in the Status field, you will need to assign the Risk Assessment Recommendation to an analysis team member or the individual within your organization who is responsible for the current task associated with that recommendation. Additionally, when the Status field contains a certain value, in order to change that value, you must be logged in as the user to whom the record is assigned based on the current value in the Status field. For example, only the person whose name appears in the Reviewer Name field can change the value in the Status field to *Reviewed*.

The following diagram illustrates the workflow that you can use when working with the Status field to track the progress of a given recommendation. The boxes represent a Status value that appears in the **Status** field, and the arrows represent actions taken by the current assignee.

Using the Status Field in Recommendations

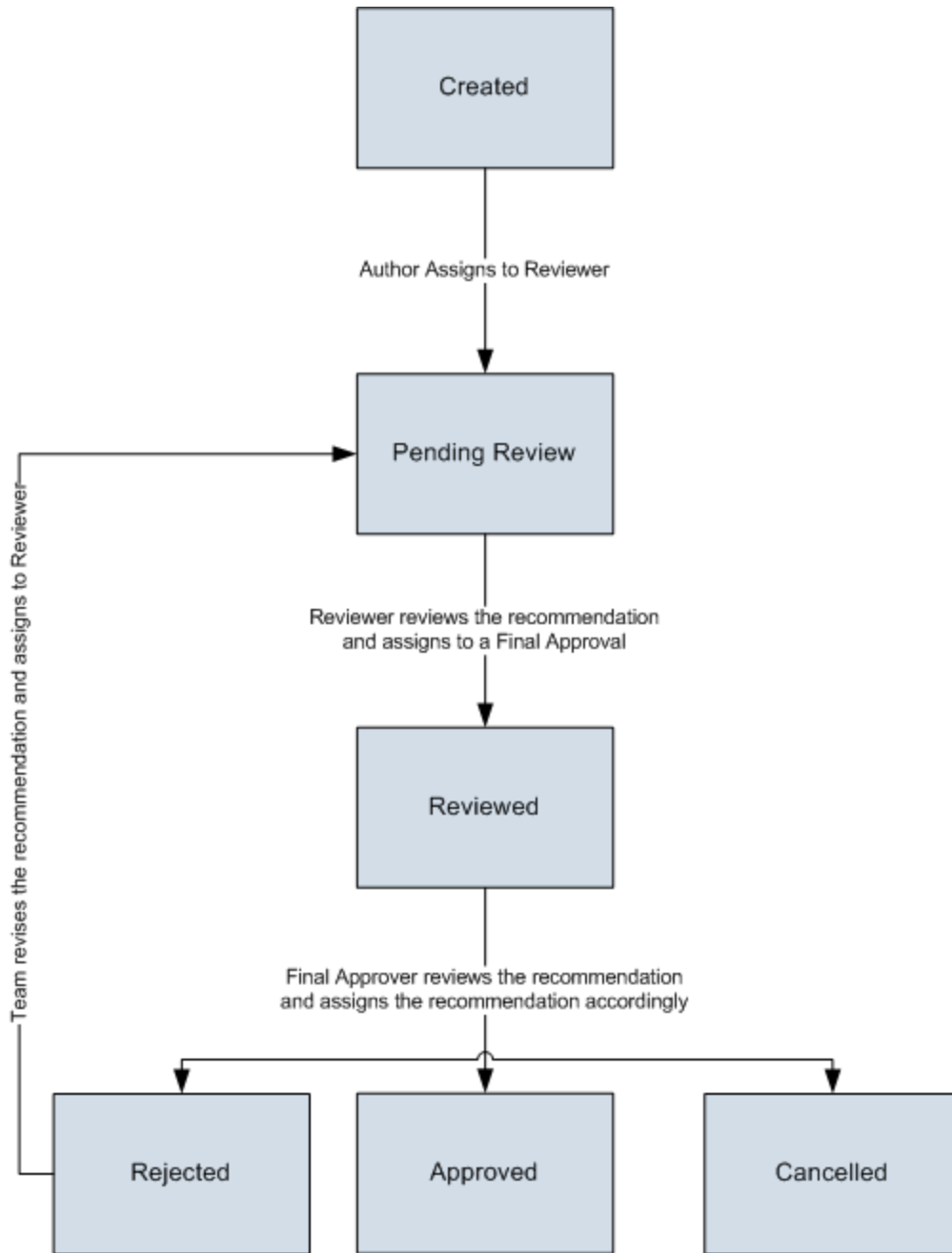

About Scheduling Risk Assessment Recommendation Alerts

The **Alerts** tab on the Risk Assessment Recommendation datasheet contains fields that you can use to schedule an email message to be sent to a Meridium APM user (i.e., a user who has a Human Resource record in the Meridium APM database). You can schedule alerts to be sent when:

- [A recommendation is due.](#)
- [A recommendation is due for reevaluation.](#)

When you save a Risk Assessment Recommendation record that is in the *Approved* or *In Progress* state and whose alert schedule has been defined on the **Alerts** tab, the following items are automatically created in the Meridium APM database:

- One Alert record that is linked to the Risk Assessment Recommendation record.
- One Scheduled Item in the Meridium APM Schedule Manager.

After these items exist, the email message will be sent to the specified recipients according to the schedule that is defined in the Risk Assessment Recommendation record.

Scheduling Alert to Notify an Assignee When a Recommendation is Due

Via the **Alert** tab on the Risk Assessment Recommendation datasheet, you can schedule an alert to be sent to an email address when a recommendation is due or when it is due for reevaluation. The following instructions provide details on using the fields on the **Alert** tab on the Risk Assessment Recommendation datasheet to schedule an alert to be sent to a recipient *when a recommendation is due*.

These instructions assume that you are familiar with [adding Risk Assessment Recommendation records to an SIL Analysis](#).

To schedule an Alert to notify an assignee when a recommendation is due:

1. Open the Risk Assessment Recommendation record for which you want to configure alerts.
2. Click the **Alert** tab.

The **Alert** tab appears.

3. If desired, select the **Alert Assignee When Due?** check box, and then click in a different field.

The following fields are enabled and required:

- Days Before Due Date to be Notified
 - Frequency of Alert After Due Date
4. In the Days Before Due Date to be Notified field, type a numeric value that represents the number of days prior to the due date that the assignee should be notified.
 5. In the **Frequency of Alert After Due Date** list, select the value that represents the frequency by which an assignee should be notified *after* the due date has passed.
 6. In the Implementation Alert Text field, type the message that you want to appear in the alert email message that is sent to the assignee.

Note: These instructions assume that you have specified a Meridium APM user as the assignee on the **General Information** tab and that a valid email address stored in that user's Human Resource record.

7. At the bottom of the Risk Assessment Recommendation datasheet, click **OK**.
The record is saved.

Scheduling an Alert to Notify Assignees When a Recommendation is Due for Reevaluation

Via the **Alert** tab on the Risk Assessment Recommendation datasheet, you can schedule an alert to be sent to an email address when a recommendation is due or when it is due for reevaluation. The following instructions provide details on using the fields on the **Alert** tab on the Risk Assessment Recommendation datasheet to schedule an alert to be sent to a recipient *when a recommendation is due for reevaluation*.

To schedule an alert to notify assignees when a recommendation is due for reevaluation:

1. Open the Risk Assessment Recommendation record for which you want to configure alerts.

2. Click the **Alert** tab.

The **Alert** tab appears.

3. If desired, select the **Reevaluate?** check box, and then click in a different field.

The following fields are enabled and required:

- Reevaluation Date
- Reevaluation Alert Body Text

4. In the **Reevaluation Date** box, type or select the date on which the reevaluation is due.

5. In the **Reevaluation Notification List**, select the check box to the left of the Meridium APM user who will receive the reevaluation alert.

Note: A valid email address must be stored in this user's Human Resource record to receive a reevaluation alert.

6. In the Reevaluation Alert body Text field, type the message that you want to appear in the alert email message that is sent to the assignee.

Viewing the List of Risk Assessment Recommendation Records for the Current SIL Analysis

The following instructions provide details on viewing the list of Risk Assessment Recommendation records that are associated with the current SIL Analysis.

To view the list of all Risk Assessment Recommendation records the current SIL Analysis:

1. Open the desired SIL Analysis record.
2. On the **Navigation** menu, click the **All Recommendations** link.

The **Recommendation Management** page appears, displaying the results of the *SIL Analysis Recommendations* query, which returns a list of all the Risk Assessment Recommendation records that are associated with the SIL Analysis with which you are currently working.

Viewing the List of Risk Assessment Recommendation Records for All SIL Analyses

The following instructions provide details on viewing the list of Risk Assessment Recommendation records that are associated with ALL SIL Analyses in the Meridium APM database.

To view the list of Risk Assessment Recommendation records all SIL Analyses:

- On the [SIS Management Start Page](#), click the **Manage Recommendations** link.

The **Recommendation Management** page appears, displaying the results of the *All SIL Analyses Recommendations* query, which returns the list of Risk Assessment Recommendation records that are currently associated with an SIL Analysis.

About Inspection Tasks Records

Inspection Task records store details on when a task should be performed on the item represented by the record to which the Inspection Task record is linked, including the due date for the task. For example, you can create an Inspection Task to perform a Proof Test.

In SIS Management, you can link Inspection Tasks records to records in the following families:

- Safety Instrumented System
- Instrumented Function

You can manage Inspection Task records for individual records within SIS Management via the **View** option on the **Tasks** submenu. Additionally, you can view a list of the Inspection Task records for ALL SIL Analysis via Task Management. After you link an Inspection Task record to an individual record, the Inspection Task record is part of the SIL Analysis.

Creating Inspection Task Records

When you create an Inspection Task record, you are linking that record to the currently selected record on the page from which you accessed the Inspection Task record. Doing so automatically adds the Inspection Task record to the SIL Analysis. These instructions assume that you are familiar with the fields in the Inspection Task family.

To create an Inspection Task record:

1. [Open the SIL Analysis record for the desired SIL Analysis.](#)
2. Access either the [Instrumented Functions \(IFs\) page](#) or the [Safety Instrumented Systems page](#), depending on the family to which you want to link the Inspection Task record.
3. In the grid, select the row containing the record to which you want to link the Inspection Task record.
4. On the **Assessment Tasks** menu, click the **Tasks** link.

A submenu appears with options that you can use to create a new Inspection Task record or view a list of existing Inspection Task records that are already linked to the currently selected record.

5. On the submenu, click the **Create** link.

A new Inspection Task record appears in the **Task Builder**.

Creating Inspection Task Records

Task Builder - Task Datasheet

Create a new Task

Datasheet: Inspection Task

Details

	Value(s)	UOM
Task Type		
Task ID		
Task Description		...
Task Details		...
Last Date	4/29/2010 12:00:00 AM	
Desired Interval	0	MON
Next Date	4/29/2010 12:00:00 AM	
Next Date Basis		
Coverage	0	
Task Assigned To		
Recurring	<input checked="" type="checkbox"/>	
Modifiable	<input checked="" type="checkbox"/>	
Rejectable	<input checked="" type="checkbox"/>	
Unconstrain Min/Max Dates	<input checked="" type="checkbox"/>	
Min Interval	0	MON
Min Date	1/1/0001 12:00:00 AM	
Max Interval	0	MON
Max Date	1/1/0001 12:00:00 AM	
Source Type	Manual	
Task State	Proposed	

< Back Next > Finish Cancel Help

Note: The **Next** button is disabled on this screen.

6. Provide values in the fields as desired. Note that the Task ID field is required.
7. Click the **Finish** button.

The record is saved.

Viewing the List of Inspection Task Records that are Linked to an Individual Record

The following instructions provide details on viewing the list of all the Inspection Task records that are linked to an individual record.

To view the list of Inspection Task records that are linked to an individual record:

1. [Open the SIL Analysis record for the desired SIL Analysis.](#)
2. Access either the [Instrumented Functions \(IFs\) page](#) or the [Safety Instrumented Systems page](#), where you can locate the record whose Inspection Task records you want to view.
3. In the grid, select the row containing the record to which you want to link the Inspection Task record.

4. On the **Assessment Tasks** menu, click the **Tasks** link.

A submenu appears with options that you can use to create a new Inspection Task record or view a list of existing Inspection Task records that are already linked to the currently selected record.

5. On the submenu, click the **View** link.

The **Task List** page appears, displaying the list of existing Task records that are linked to the currently selected record. At this point you can modify the records as desired by clicking the hyperlinked Task ID in the **Task ID** cell.

Viewing the List of Inspection Task Records for All SIL Analyses

The following instructions provide details on viewing the list of Inspection Task records that are associated with ALL SIL Analyses.

To view the list of Inspection Task Records for all SIL Analyses:

- On the [SIS Management Start Page](#), click the **Manage Tasks** link.

The **Tasks List** page appears, displaying the results of the *All SIL Analyses Tasks* query, which returns a list of Task records that are associated with all existing SIL Analyses. At this point you can modify the Task records by clicking the hyperlinked Task ID in the **Task ID** cell.

Associated Pages

The **Associated Pages** menu appears throughout SIS Management and displays Associated Pages that have been configured for the families that participate in the SIS Management data model. The baseline Meridium APM database does not contain Associated Pages for SIS Management families by default.

About the SIS Management Catalog Folder Structure

The SIS Management Catalog folders contain queries, graphs, and reports that appear throughout SIS Management and display information contained in the records that make up an SIL Analysis. The Catalog folder \\Public\Meridium\Modules\SIS Management contains the following subfolders:

- **Dashboards:** Contains the Asset Safety dashboard.
- **LOPA:** Contains the following subfolders:
 - **Queries:** Contains queries that are used by a Layer of Protection Analysis.
 - **Reports:** Contains the *LOPA Report* and one subfolder, Subreports, which contains the supporting reports for the LOPA Report.
- **PIF:** Contains the following subfolders:
 - **Queries:** Contains queries that support the reports in the Reports folder.
 - **Reports:** Contains the reports that are available when you are viewing Instrumented Function records on the **Instrumented Functions (IFs)** page.
- **Proof Test Templates:** Contains the following subfolders:
 - **Queries:** Contains the Proof Test Template Query, which supports the Proof Test Template Report, which is stored in the **Reports** folder.
 - **Reports:** Contains the Proof Test Template Report.
- **Proof Tests:** Contains the following subfolders:
 - **Queries:** Contains queries that support the Proof Test Report, which is stored in the Reports folder.
 - **Reports:** Contains the Proof Test Report.
- **Protective Instrument Loop:** Contains the following subfolders:
 - **Queries:** Contains queries that support the Protective Instrument Loop Report, which is stored in the Reports folder.
 - **Reports:** Contains the *Protective Instrument Loop Report* and one subfolder, Subreports, which contains a report that supports the Protective Instrument Loop Report.
- **Queries:** Contains queries that appear on various pages throughout SIS Management and are used to display search results for records in an individual family *and* the following subfolder:
 - **Dashboard Queries:** Contains queries that are used to display results on the Asset Safety dashboard.
- **SIL:** Contains the following subfolders:
 - **Graphs:** Contains graphs that are available when you are viewing an SIL Analysis record on the **SIL Analysis Definition** page.

- **Queries:** Contains queries that support baseline SIL Analysis graphs.
- **Reports:** Contains the SIL Analysis Report, which is available when you are viewing an SIL Analysis record on the **SIL Analysis Definition** page.
- **SIS Trip Report:** Contains the following subfolders:
 - **Queries:** Contains queries that support the SIS Trip Report, which is stored in the Reports folder.
 - **Reports:** Contains the SIS Trip Report, which is available when you are viewing an SIS Trip Report record on the **SIS Trip Report** page.

Dashboards Folder

The dashboard that is listed in the following table is stored in the Catalog location \\Public\Meridium\Modules\SIS Management\Dashboards. In this table, the value listed in the **Dashboard** column refers to the dashboard *name*. The baseline caption is the same as the dashboard name.

Dashboard	Behavior and Usage
Asset Safety Dashboard	Displays the Asset Safety dashboard on the Dashboard page.

LOPA Folder

The Catalog folder \\Public\Meridium\Modules\SIS Management\LOPA contains the following subfolders:

- **Queries:** The following table displays the queries that exist in the **Queries** subfolder.

Query Name	Behavior and Usage
LOPA Consequence Modifiers Search	A search that displays a prompt for the Entity Key for a LOPA record and then displays a list of Consequence Modifier records that are linked to the specified LOPA record. The results of this query appear by default on the Consequence Modifiers page.
LOPA ILP Search	A search that displays a prompt for the Entity Key for a LOPA record and then displays a list of Independent Layer of Protection records that are linked to the specified LOPA record. The results of this query appear by default in the Independent Protective Layers pane on the LOPA Definition page.
LOPA_Analysis_Search	A search that displays a prompt for the Entity for a LOPA record and then displays the LOPA records that are linked to a given Instrumented Function record. The result of this query appears by default in the Associated Risk Assessments pane on the Instrumented Functions (IFs) page.

- **Reports:** The following table displays the items that exist in the **Reports** subfolder.

Item Name	Behavior and Usage
LOPA Report	Displays a prompt for the Entity Key for a LOPA record and then displays in the Report Viewer information about the Layer of Protection Analysis that exists in the LOPA record and records that are linked to that LOPA record.
Subreports	A subfolder that contains the reports with the following names: <ul style="list-style-type: none"> ◦ LOPA Consequence Modifiers Report: Supports the LOPA Report. ◦ LOPA ILP Report: Supports the LOPA Report.

PIF Folder

The Catalog folder \\Public\Meridium\Modules\SIS Management\PIF contains the following subfolders:

- **Queries:** The following table displays the queries that exist in the **Queries** subfolder.

Query Name	Behavior and Usage
PIF Query	Displays a prompt for the Entity Key for an Instrumented Function record and then displays information that is stored in the fields in that Instrumented Function record. The results of this query appear by default on the Instrumented Functions (IFs) page.
PIF Risk Matrix Result Query	Displays a prompt for the Entity Key for an Instrumented Function record and then displays the risk rank values that are linked to that Instrumented Function record.

- **Reports:** The following table displays the reports that exist in the **Reports** subfolder.

Report Name	Behavior and Usage
If Report	Displays a prompt for the Entity Key for an Instrumented Function record and then displays in the Report Viewer information about the Instrumented Function that exists in the Instrumented Function record and records that are linked to that Instrumented Function record.
If Risk Matrix Result Report	Supports the IF Report.

Proof Test Template Folder

The Catalog folder \\Public\Meridium\Modules\SIS Management\Proof Test Template contains the following subfolders:

- **Queries:** The following table displays the query that exists in the **Queries** subfolder.

Query Name	Behavior and Usage
Proof Test Template Query	Displays a prompt for the Entity Key for an SIS Proof Test Template record and then displays information that is store in that SIS Proof Test Template record. The results of this query appear by default on the Proof Test Templates page.

- **Reports:** The following table displays the report that exists in the **Reports** subfolder.

Report Name	Behavior and Usage
Proof Test Template Report	Displays a prompt for the Entity Key for an SIS Proof Test Template record and then displays in the Report Viewer summary information that is stored in that SIS Proof Test Template record.

Proof Tests Folder

The Catalog folder \\Public\Meridium\Modules\SIS Management\Proof Tests contains the following subfolders:

- **Queries:** The following table displays the queries that exist in the **Queries** subfolder.

Query Name	Behavior and Usage
SIS Proof Test Query	Displays a prompt for the Entity Key for an SIS Proof Test record and then displays information that is store in that SIS Proof Test record. The results of this query appear by default on the Proof Tests page.
SIS Proof Test Query UNION	Supports the SIS Proof Test Query.

- **Reports:** The following table displays the report that exists in the **Reports** subfolder.

Report Name	Behavior and Usage
Proof Test Report	Displays a prompt for the Entity Key for an SIS Proof Test record and then displays in the Report Viewer summary information that is stored in that SIS Proof Test record.

Protective Instrument Loop Folder

The Catalog folder \\Public\Meridium\Modules\SIS Management\Protective Instrument Loop contains the following subfolders:

- **Queries:** The following table displays the queries that exist in the **Queries** subfolder.

Query Name	Behavior and Usage
Protective Instrument Loop Query	Displays a prompt for the Entity Key for a Protective Instrument Loop record and then displays information that is stored in that Protective Instrument Loop record. This query supports the Protective Instrument Loop Report that is stored in the Reports folder.
Protective Instrument Loop Sensor System Subquery	Displays a prompt for the Entity Key for a Protective Instrument Loop record and then displays information that is stored in the Protective Instrument Loop System records that are linked to the Protective Instrument Loop record. This query supports the Protective Instrument Loop Report that is stored in the Reports folder.

- **Reports:** The following table displays the items that exist in the **Reports** subfolder.

Item Name	Behavior and Usage
Protective Instrument Loop Report	Displays a prompt for the Entity Key for a Protective Instrument Loop record and then displays in the Report Viewer summary information that is stored in that Protective Instrument Loop record.
Subreports	A subfolder that contains the PIL Sensor System Report, which supports the Protective Instrument Loop Report.

About The Queries Folder

The Catalog folder \\Public\Meridium\Modules\SIS Management\Queries contains:

- Queries that support various features with the SIS Management module, *including* those that support the reports that make up the SRS Report.
- A subfolder, *Dashboard Queries*, that contains queries that are used to display content on the Asset Safety dashboard.

To simplify the documentation, the items that are stored in this folder are split up into the following groups:

- [Queries that support modules-specific pages.](#)
- [Queries that support the SRS Report.](#)
- [Dashboard Queries folder.](#)

Queries That Support Module-Specific Pages

The following queries are stored in the Catalog folder \\Public\Meridium\Modules\SIS Management\Queries and support module-specific pages within SIS Management.

Query Name	Behavior and Usage	Notes
Add_SIS_Trip_Report_Detail_Search	A search that displays prompts for the Entity Key for a Safety Instrumented System record and an SIS Trip Report record and then displays information that is stored in both records.	None
ALL SIL Analyses Recommendations	Displays a list of all the Risk Assessment Recommendation records that are linked to any SIL Analysis record.	None
ALL SIL Analyses Tasks	<p>Displays the following prompts and then displays a list of all the Task records that meet the specified criteria.</p> <ul style="list-style-type: none"> ■ Asset ID: The IDs for the Equipment and Functional Location families in the Meridium APM database. ■ Task Family: The names of the Task families that exist in the Meridium APM database. 	The results of this query appear by default on the Task List page when you access it from an SIL Analysis in SIS Management and display only Inspection Task records that are associated with an SIL Analysis.

Query Name	Behavior and Usage	Notes
Export_SIL_Analysis_Search	<p>Displays a prompt for the record state of an SIL Analysis, and then displays a list of SIL Analysis records that meet the specified criteria. The State prompt contains a list of record states that are configured for the SIL Analysis family. By default, this list contains the following baseline values:</p> <ul style="list-style-type: none"> ■ All ■ Active ■ Complete ■ Pending Approval ■ Planning ■ Review 	<p>This query is used by the SIS Management Export Builder.</p>
Final_Element_Reference_Data_Search	<p>A search that displays a prompt and then displays a list of Final Element records whose Is Reference Data field value is set to <i>True</i>.</p>	<p>The results of this query appear by default on the Final Element Reference Data Search page.</p>

Query Name	Behavior and Usage	Notes
IF_Safety_Loop_Search	<p>A search that displays a prompt for the record state of a Protective Instrument Loop record, and then displays a list of Protective Instrument Loop records that are linked to a particular Instrumented Function record. The State prompt contains a list of record states that are configured for the Protective Instrument Loop family. By default, this list contains the following baseline values:</p> <ul style="list-style-type: none"> ■ All ■ Approval ■ Design ■ In Service ■ Out of Service ■ Pending Approval 	<p>The results of this query appear by default on the Protective Loop Search page when you search for protective instrument loops associated with an instrumented function.</p>
Logic_Solver_Reference_Data_Search	<p>A search that displays a prompt and then displays a list of Logic Solver records whose Is Reference Data field value is set to <i>True</i>.</p>	<p>The results of this query appear by default on the Logic Solver Reference Data Search page.</p>

Query Name	Behavior and Usage	Notes
Safety_Loop_Search	<p>A search that displays a prompt for the record state of a Protective Instrument Loop record and then displays a list of Protective Instrument Loop records that meet the specified criteria. The State prompt contains a list of record states that are configured for the Protective Instrument Loop family. By default, the list contains the following baseline values:</p> <ul style="list-style-type: none"> ■ All ■ Approval ■ Design ■ In Service ■ Out of Service ■ Pending Approval 	<p>The results of this query appear by default on the Protective Loop Search page.</p>
Safety_Loop_Template_Search	<p>A search that displays a prompt for the record state of a Protective Instrument Loop record, where the Is Template field value in that record is <i>Yes</i>, and then displays a list of Protective Instrument Loop records that are specified as templates and meet the specified criteria.</p>	<p>The results of this query appear by default on the Protective Loop Template Search page.</p>
Sensor_Reference_Data_Search	<p>A search that displays a prompt and then displays a list of Logic Solver records whose <i>Is Reference Data</i> field value is set to <i>True</i>.</p>	<p>The results of this query appear by default on the Sensor Reference Data Search page.</p>
SIL Analysis Recommendations	<p>Displays a prompt for the Entity Key for an SIL Analysis record and then displays a list of Risk Assessment Recommendation records that are linked to the specified SIL Analysis record.</p>	<p>None</p>

Query Name	Behavior and Usage	Notes
SIL_Analysis_Search	<p>A search that displays the following prompts and then displays a list of SIL Analysis records that meet the specified criteria.</p> <ul style="list-style-type: none"> ■ State: The record states that have been configured from the SIL Analysis family. By default, this list contains the following values: <ul style="list-style-type: none"> ○ All ○ Active ○ Complete ○ Pending Approval ○ Planning ○ Review ■ SIL Analysis Owner: The names of the users whose names appear in the Owner field in a SIL Analysis record. 	<p>By default, this query appears on the SIL Analysis Search page and is used by the SIS Management Import Builder.</p>
SIS Find ASM Actions for IF	<p>Displays a prompt for the Entity Key for an Instrumented Function record and is used to find ASM Actions that were created when the specified Instrumented Function record was promoted to ASM.</p>	None
SIS Find ASM Risk for IF	<p>Displays a prompt for the Entity Key for an Instrumented Function record and is used to find ASM Risks that were created when the specified Instrumented Function record was promoted to ASM.</p>	None
SIS_Trip_Report_IF_Search	<p>A search that displays a prompt for the Entity Key for a Safety Instrumented System record and then displays information that is stored in the SIS Trip Report record that is linked to the specified Safety Instrumented System record.</p>	None

Query Name	Behavior and Usage	Notes
SIS_Trip_Report_Search	<p>A search that displays a prompt for the record state of an SIS Trip Report record and then displays a list of SIS Trip Report records that meet the specified criteria. The State list contains a list of record states that are configured for the SIS Trip Report family. By default, this list contains the following baseline values:</p> <ul style="list-style-type: none"> ■ All ■ Active ■ Complete ■ Pending Approval ■ Review 	<p>The results of this query appear by default on the SIS Trip Report Search page.</p>

Queries That Support The SRS Report

The following queries are stored in the Catalog folder \\Public\Meridium\Modules\SIS Management\Queries and support the [SRS Report and subreports](#) stored in the \SIL\Reports folder.

Query Name	Behavior and Usage
SRS_Report_Query	<p>Displays a prompt for the Entity Key of the SIL Analysis record to which all the records that make up an SIL Analysis are linked and then displays values stored in fields that are required in the following records:</p> <ul style="list-style-type: none"> ■ Instrumented Function ■ Safety Instrumented System ■ SIL Analysis <p>This query supports the main SRS Report.</p>
SIL_Analysis_Doc_Query	<p>Displays a prompt for the Entity Key of the SIL Analysis record to which all the records that make up an SIL Analysis are linked and then displays all the Reference Document records that are linked to that record. This query supports the subreport <i>SIL_Doc_Report</i>.</p>
SRS_SubReport_Query	<p>Displays a prompt for the PIF ID for an Instrumented Function record and then displays values stored in records that make up a protective instrument loop. This query supports the subreport <i>Loop_Report</i>.</p>
SRS_Sensor_Query	<p>Displays a prompt for the PIF ID for an Instrumented Function record and then displays values stored in records that make up a protective instrument loop. This query supports the subreport <i>Loop_Report</i>.</p>
Final_Element_Query	<p>Displays a prompt for the PIF ID for an Instrumented Function record and then displays values stored in records that make up a protective instrument loop. This query supports the subreport <i>Loop_Report</i>.</p>

Query Name	Behavior and Usage
IF_Common_Cause_Failures	<p>Displays a prompt for the PIF ID for an Instrumented Function record to which SIF Common Cause Failure records are linked and then displays the values stored in the following fields in the SIF Common Cause Failure records that are linked to the specified Instrumented Function record.</p> <ul style="list-style-type: none"> ■ CCF ID ■ CCF Description ■ CCF Mitigation <p>This query supports the subreport <i>IF Subreport</i>.</p>
IF_Concurrent_Safe_State	<p>Displays a prompt for the PIF ID for the Instrumented Function record to which Instrumented Function records are linked and then displays the values stored in the following fields in the Instrumented Function record:</p> <ul style="list-style-type: none"> ■ Concurrent Safe State Hazard ■ PIF Description ■ Safe State Description ■ PIF ID <p>This query supports the subreport <i>IF Subreport</i>.</p>
Final_Element_Hazardous_Event_Comb	<p>Displays a prompt for the PIF ID for the Instrumented Function record and then displays values stored in records that make up a protective instrument loop. This query supports the subreport <i>Final_Element_Subreport</i>.</p>

Dashboard Queries Folder

The queries listed in the following table are stored in the Catalog location \\Public\Meridium\Modules\SIS Management\Queries\Dashboard Queries. In this table, the values listed in the **Query** column refer to the query *names*. The baseline query captions are the same as the query names.

Query	Behavior and Usage
Analysis States	Used to return results that are displayed in the Hazards Analysis Schedule section on the Asset Safety dashboard. In the baseline database, this query is configured to return Hazards Analysis records by state.
Calibration Recommendations	Used to return results that are displayed in the Calibration Recommendations section on the Asset Safety dashboard.
Calibration Recommendations - All	Used by the Calibration Recommendations source query to display content on the Asset Safety dashboard.
Calibration Results - Fail	Used by the Calibration Results for Graph source query to display content on the Asset Safety dashboard.
Calibration Results - Pass as Found	Used by the Calibration Results for Graph source query to display content on the Asset Safety dashboard.
Calibration Results - Pass as Left	Used by the Calibration Results for Graph source query to display content on the Asset Safety dashboard.
Calibration Results All	Used by the Calibration Results for Graph source query to display content on the Asset Safety dashboard.
Calibration Results for Graph	Used to return results that are displayed in the Calibration Pass/Fail Results for Last 12 Months section on the Asset Safety dashboard.
Calibration Tasks	Used to return results that are displayed in the Calibration Schedule section on the Asset Safety dashboard.
Calibration Tasks - All	Used by the Calibration Tasks source query to display content on the Asset Safety dashboard.
Filter Widget	Used to return results that are displayed in the Content Filter section on the Asset Safety dashboard.
HAZOP Analyses	Used by one or more source queries to the Asset Safety dashboard.
Last 5 Years	Used by one or more source queries to the Asset Safety dashboard.

Query	Behavior and Usage
Overdue Hazards Analysis	Used to return results that are displayed in the Hazards Analysis Schedule section on the Asset Safety dashboard.
Overdue Proof Test Tasks	Used to return results that are displayed in the Proof Test Schedule section on the Asset Safety dashboard.
Proof Tests States	Used by one or more source queries to the Asset Safety dashboard.
Proof Tests States by State	Used by one or more source queries to the Asset Safety dashboard.
Proof Tests States for Graph	Used by one or more source queries to the Asset Safety dashboard.
Proof Test States with Functional Location	Used by one or more source queries to the Asset Safety dashboard.
Protective Instrument Loop States	Used by the Quantity of Protective Instrumented Loops by State for Graph source query to display content on the Asset Safety dashboard.
Proven In Use Device Types	Used by the Proven In Use Devices by Type for Graph source query to display content on the Asset Safety dashboard.
Proven In Use Devices by Type	Used by the Proven In Use Devices by Type for Graph source query to display content on the Asset Safety dashboard.
Proven In Use Devices by Type for Graph	Used to return results that are displayed in the Proven in Use Devices by Type section on the Asset Safety dashboard.
Quantity of Hazards Analysis	Used by one or more source queries to the Asset Safety dashboard.
Quantity of Protective Instrumented Loops	Used by the Quantity of Protective Instrumented Loops by State for Graph source query to display content on the Asset Safety dashboard.
Quantity of Protective Instrumented Loops by State	Used by the Quantity of Protective Instrumented Loops by State for Graph source query to display content on the Asset Safety dashboard.
Quantity of Protective Instrumented Loops by State for Graph	Used to return results that are displayed in the Quantity of Protective Instrumented Loops section on the Asset Safety dashboard.

Query	Behavior and Usage
Quantity of SIF Trips	Used to display results that are displayed in the Quantity of SIF Trips section on the Asset Safety dashboard.
Quantity of SIL Analysis	Used by one or more source queries to the Asset Safety dashboard.
Quantity of SIL Analysis by State	Used by one or more source queries to the Asset Safety dashboard.
SIF Spurious Trip Reports	Used by one or more source queries to the Asset Safety dashboard.
SIF Trip Report Types	Used by the Quantity of SIF Trips source query to display content on the Asset Safety dashboard.
SIF Unsafe Trip Reports	Used by one or more source queries to the Asset Safety dashboard.
SIL Analysis States	Used by one or more source queries to the Asset Safety dashboard.
SIL Distribution	Used by the SIL Distribution for Graph source query to display content on the Asset Safety dashboard.
SIL Distribution for Graph	Used to return results that are displayed in the View SIL Distribution section on the Asset Safety dashboard.
SIS Proof Test Pass Fail	Used to return results that are displayed in the Proof Tests Pass/Fail section on the Asset Safety dashboard.
SIS Proof Tests Failed	Used by the SIS Proof Test Pass Fail source query to display content on the Asset Safety dashboard.
SIS Proof Tests Passed	Used by the SIS Proof Test Pass Fail source query to display content on the Asset Safety dashboard.
What If Analyses	Used by one or more source queries to the Asset Safety dashboard.

SIL Folder

The Catalog folder \\Public\Meridium\Modules\SIS Management\SIL contains the following subfolders:

- **Graphs:** The following table displays the graphs that exist in the **Graphs** subfolder.

Graph Name	Behavior and Usage	Notes
SIL Analysis Risk Graph	A bar chart that displays a summary of the Risk Rank values that are associated with each Instrumented Function record that is linked to the specified SIL Analysis. When you open this graph from the SIL Analysis Definition page, the value for the SIL Analysis that you are currently viewing is passed in to the ENTY_KEY prompt to return the results for that analysis.	None
SIL Assignment Summary Graph	A pie chart that shows a breakdown of the Selected SIL Level values in the Instrumented Function records that are linked the specified SIL Analysis. This graph is based upon the query <i>SIL Assignment Summary Query</i> , which is stored in the folder \\Public\Meridium\Modules\SIS Management\SIL\Queries and returns a count for each Selected SIL Level value. For example, if five Instrumented Function records that are linked to the SIL Analysis record contain the value 2 in the Selected SIL Level field, the count for level 2 would be 5. Each count is displayed as a percentage in the SIL Assignment Summary Graph.	When you open this graph from the SIL Analysis Definition page, the value for the SIL Analysis that you are currently viewing is passed in to the ENTY_KEY prompt to return the results for that analysis.

- **Queries:** The following table displays the queries that exist in the **Queries** subfolder.

Query Name	Behavior and Usage
SIL Analysis Mitigated Risk Query	Displays risk assessment details that are associated with all SIL Analysis records.
SIL Analysis Query	Displays a prompt for the Entity Key for an SIL Analysis record and then displays information that is stored in the specified SIL Analysis record.
SIL Analysis Risk Query	Displays a prompt for the Entity Key for an SIL Analysis and then displays risk rank details for the Instrumented Functions that are linked to the specified SIL Analysis record.
SIL Assignment Summary Query	Supports the graph <i>SIL Assignment Summary Graph</i> and returns a count for each Selected SIL Level value in the Instrumented Function records that are linked to the specified SIL Analysis.

- **Reports:** The following table displays the items that exist in the **Reports** subfolder.

Report Name	Behavior and Usage
SIL Analysis Report	Displays a prompt for the Entity Key for an SIL Analysis record and then displays in the Report Viewer summary information for the specified SIL Analysis record.
SRS Report	Displays a prompt for the Entity Key for the SIL Analysis record to which all the records that make up an SIL Analysis are linked and then displays in the Report Viewer the Safety Requirement Specifications report for the specified SIL Analysis. While you can run the report from the Catalog and manually enter the Entity Key for the SIL Analysis record, we recommend that you access the report only from within the SIS Management module. You should not modify the SRS Report or any of the supporting queries and subreports.
Subreports	The SubReports folder stores the following reports that support the SRS Report, and are supported by queries stored in the Queries folder : <ul style="list-style-type: none"> ■ Final_Element_Subreport ■ IF Subreport ■ Loop_Report ■ SIL_Doc_Report

SIS Trip Report Folder

The Catalog folder \\Public\Meridium\Modules\SIS Management\SIS Trip Report contains the following subfolders:

- **Queries:** The following table displays the queries that exist in the **Queries** subfolder.

Query Name	Behavior and Usage
SIS Trip Report Recommendations	Displays a prompt for the Entity Key for an SIS Trip Report record and then displays the list of Risk Assessment Recommendation records that are linked to the specified SIS Trip Report record.
SIS Trip Reports Query	Displays a prompt for the Entity Key for an SIS Trip Report record and then displays the list of SIS Trip Report records and information that is stored in each record.

- **Reports:** The following table displays the report that exists in the **Reports** subfolder.

Report Name	Behavior and Usage
SIS Trip Report	Displays a prompt for the Entity Key for an SIS Trip Report record and then displays in the Report Viewer summary information that is associated with the specified SIS Trip Report record and the records that are linked to that SIS Trip Report record.

Consequence Modifier

Consequence Modifier records store information about an event or action that can increase the probability that a risk may occur if the risk is not mitigated and proceeds into an undesirable event. The following table provides an alphabetical list and description of the fields that exist for the Consequence Modifier family and appear on the Consequence Modifier datasheet, unless otherwise specified. The information in the table reflects the baseline state and behavior of these fields. This list is not comprehensive.

Field Caption	Data Type	Description	Behavior and Usage
Consequence Modifier ID	Character	The ID for the consequence modifier.	You must type your own value manually. This value appears in the Consequence Modifier ID cell on the Consequence Modifiers page and is used to distinguish the Consequence Modifier record from other Consequence Modifier records. This field is required.
Description	Character	The description of the consequence modifier.	You can type your own value manually.
Type	Character	The type of consequence modifier.	You can type your own value manually.

Independent Layer of Protection

Independent Layer of Protection records store details about a device, system, or action that exists to prevent a risk and is independent of the event that initiates the scenario. The following table provides an alphabetical list and description of the fields that exist for the Independent Layer of Protection family and appear on the Independent Layer of Protection datasheet, unless otherwise specified. The information in the table reflects the baseline state and behavior of these fields.

Field Caption	Data Type	Description	Behavior and Usage
Description	Character	A description of the independent layer of protection.	On the datasheet, this field appears as a text box labeled Description . When you select a value in the Type list, this field is populated automatically with the value stored in the Description field in the corresponding IPL Type record.
Equipment ID	Character	The ID for the Equipment record that is linked to the Independent Layer of Protection record through the <i>Safety Analysis Has Equipment Relationship</i> family.	On the datasheet, this field is disabled and contains a <input type="button" value="..."/> button, which you can click to search for the Equipment record that you want to link to the Independent Layer of Protection record.
Equipment Entity Key	Number	The Entity Key for the Equipment record that is linked to the Independent Layer of Protection record.	The Meridium APM system uses this value to populate the Equipment ID field in the Independent Layer of Protection record. This field does not appear on the Independent Layer of Protection datasheet by default.
Functional Location	Character	The ID for the Functional Location record that is linked to the Independent Layer of Protection record through the <i>Has Functional Location Relationship</i> family.	On the datasheet, this field is disabled and contains a <input type="button" value="..."/> button, which you can click to search for the Functional Location record that you want to link to the Independent Layer of Protection record.

Field Caption	Data Type	Description	Behavior and Usage
Functional Location Entity Key	Number	The Entity Key for the Functional Location record that is linked to the Independent Layer of Protection record.	The Meridium APM system uses this value to populate the Functional Location field. This field does not appear on the Independent Layer of Protection datasheet by default.
IPL ID	Character	The ID for the independent layer of protection (IPL).	On the datasheet, this field appears as a text box labeled IPL ID , in which you can enter your own value. This value appears in the Independent Protective Layers section on the LOPA Definition page and is used to distinguish the Independent Layer of Protection record from the other Independent Layer of Protection records. This field is required.
PFD	Number	A number representing the probability that the independent layer of protection will fail to mitigate the risk.	<p>On the datasheet, this field appears as a text box labeled PFD. Depending upon the IPL type that you select in the Type list, the PFD field will be:</p> <ul style="list-style-type: none"> • Disabled and populated automatically with a default value. -or- • Required. If the PFD field is required. A rule is applied to this field that checks the value you enter against a range that is defined by the selected IPL type. <p>If you do not select a value in the Type list and type a custom value in the Type text box, the PFD field is required, but the Meridium APM system will be unable to prevent you from entering an invalid PFD value.</p>

Field Caption	Data Type	Description	Behavior and Usage
Sequence Number	Number	A number indicating the order in which the Independent Layer of Protection record must appear in the grid in relation to the other Independent Layers of Protection records.	On the datasheet, this field appears as a text box labeled Sequence Number and is populated automatically with a number relative to the existing Independent Layer of Protection records that are already linked to the same LOPA record. For example, if two Independent Layer of Protection records are already linked to a LOPA record, when you create a third Layer of Protection Analysis record and link it to the same LOPA record, the Sequence Number field will be populated automatically with the value 3. You can modify this value, if desired.
Type	Character	The type of independent layer of protection.	On the datasheet, this field appears as a list labeled Type and contains the IPL Type records that exist in the database. The IPL Type record that you select in this list is used to determine the PFD value that is associated with the independent layer of protection represented by the Independent Layer of Protection record. Alternatively, you can enter a custom value in the Type field.

Instrumented Function

Instrumented Function records store details about a specific function of an SIS. The following table provides an alphabetical list and description of the fields that exist for the Instrumented Function family. The information in this table reflects the baseline state and behavior of these fields. This list is not comprehensive.

Field Caption	Data Type	Description	Behavior and Usage	Datasheet/Tab
Abnormal State	Character	A short description of the specific abnormal state of the operation.	<p>On the datasheet, this field appears as a list labeled Abnormal States and contains the following values:</p> <ul style="list-style-type: none"> • Start-Up • Shutdown • Bypass • Maintenance • Emergency • Other <p>This field is enabled and required only if <i>ABNORMAL</i> is selected in the Operation Modes list. Otherwise, this field is disabled.</p>	Safety Requirement Specification datasheet
Concurrent Safe State Hazard	Text	A description of the hazardous event that could occur if the safe state associated with the instrumented function occurs simultaneously with the safe state of a different instrumented function.	In the UI, this field is displayed without a field caption, and the value is set by default. You can remove this text and enter your own value. This field contains a <input type="button" value="⋮"/> button, which you can click to access the Text Editor.	Potential Concurrent Safe State Hazard section on the Concurrent Safe State tab on the <Record ID> (Instrumented Function) window

Field Caption	Data Type	Description	Behavior and Usage	Datasheet/Tab
Concurrent Safe State Hazard?	Logical	A logical field that stores the value <i>True</i> or <i>False</i> and indicates whether the safe state associated with the instrumented function can cause a hazardous event if it occurs concurrently with a safe state of a different instrumented function. By default, this field contains the value <i>False</i> .	In the UI, this field appears as a check box labeled Hazard for Concurrent Safe States? , which you can select to indicate that the safe state for the instrumented function can lead to a hazardous event if that safe state occurs simultaneously with the safe state of a different instrumented function.	Concurrent Safe States tab on the <Record ID> (Instrumented Function) window

Field Caption	Data Type	Description	Behavior and Usage	Datasheet/Tab
Consequence Description	Text	A description of the risk that is associated with the hazardous event that exists in the Hazardous Event field.	<p>On the Instrumented Function datasheet, this field appears as a text box labeled Consequence Description and contains a <input type="button" value="..."/> button, which you can click to access the Text Editor.</p> <p>If the value in the SIL Assessment Method field is <i>PHA - Internal</i>, after you select a Risk Assessment record from a Hazards Analysis, this field is populated automatically with the value in the Consequence Description field in the Hazards Analysis Consequence record that is linked to the Risk Assessment record you selected.</p>	Instrumented Function datasheet
Demand Rate (Source)	Character	The demand rate (i.e., Low demand or High demand).	On the datasheet, this field contains the text <i>Low Demand</i> by default. You can remove this text and enter your own values.	Safety Requirement Specification datasheet

Field Caption	Data Type	Description	Behavior and Usage	Datasheet/Tab
Equipment ID	Character	The ID of the Equipment record whose Entity ID is stored in the Equipment Key field.	On the datasheet, this field is disabled and contains a  button, which you can click to search for the desired Equipment record. After you select an Equipment record, a link is created between the selected Equipment record and the Instrumented Function record. In addition, the Equipment ID will appear automatically in the Equipment ID field.	Instrumented Function datasheet
Equipment Key	Number	The Entity Key of the Equipment record that is linked to the Instrumented Function record.	The Meridium APM system uses this value to populate the Equipment ID field that appears on the Instrumented Function datasheet.	None

Field Caption	Data Type	Description	Behavior and Usage	Datasheet/Tab
Failure Rate UOM	Character	The unit of measure that is associated with the value in the Required Probability of Failure field.	<p>On the datasheet, this field appears as a list labeled Failure Rate UOM and contains the following values:</p> <ul style="list-style-type: none"> • PFD Avg. • PFH <p>When the value in the SIL Mode field is <i>High Demand</i> or <i>Continuous</i>, this value is disabled and populated automatically with <i>PFH</i>. When the value in the SIL Mode field is <i>Low Demand</i>, this value is disabled and populated automatically with <i>PFH</i>.</p>	Instrumented Function datasheet

Field Caption	Data Type	Description	Behavior and Usage	Datasheet/Tab
Frequency of Initiating Event (Per yr)	Number	The number of times per year that the initiating event occurs.	<p>On the datasheet, this field appears as a text box labeled Frequency of Initiating Event (per yr), in which you can enter your own value.</p> <p>If the value in the SIL Assessment Method field is <i>PHA - Internal</i>, after you select a Risk Assessment record from a Hazards Analysis, this field is populated automatically with the value in the Cause Frequency (per year) field in the Hazards Analysis Cause record that is linked to the Hazards Analysis Consequence record that is linked to the Risk Assessment record you selected.</p>	Instrumented Function datasheet
Function Type	Character	The type of instrumented function.	<p>On the datasheet, this field appears as a list labeled Function Type and contains the following baseline values:</p> <ul style="list-style-type: none"> • Safety • Protective 	Instrumented Function datasheet

Field Caption	Data Type	Description	Behavior and Usage	Datasheet/Tab
Functional Location ID	Character	The ID of the Functional Location record whose Entity Key is stored in the Functional Location Key field.	On the datasheet, this field is disabled and contains a  button, which you can click to search for the desired Functional Location record. After you select a Functional Location record, a link is created between the Functional Location record and the Instrumented Function record. In addition, the Functional Location ID will appear automatically in the Functional Location ID field.	Instrumented Function datasheet
Functional Location Key	Number	The Entity Key of the Functional Location record that is linked to the Instrumented Function record.	The Meridium APM system uses this value to populate the Functional Location ID field.	None

Field Caption	Data Type	Description	Behavior and Usage	Datasheet/Tab
Hazardous Event	Character	A description of the event for which the instrumented function exists to prevent or mitigate risk.	<p>On the datasheet, this field appears as a text box labeled Hazardous Event, in which you can enter your own value.</p> <p>If the value in the SIL Assessment Method field is <i>PHA - Internal</i>, after you select a Risk Assessment record from a Hazards Analysis, this field is populated automatically with the value in the Consequence Type field in the Hazards Analysis Consequence record that is linked to the Risk Assessment record you selected.</p>	Instrumented Function datasheet
Hazards Analysis Date	Date	The date the Hazards Analysis record to which the Instrumented Function record is linked was last modified.	On the datasheet, this field is disabled and populated automatically with the value stored in the Last Modified Date field in the Hazards Analysis record that is linked to the Instrumented Function record and whose ID appears in the Hazards Analysis Reference field.	Instrumented Function datasheet

Field Caption	Data Type	Description	Behavior and Usage	Datasheet/Tab
Hazards Analysis Reference	Character	The Record ID of the Hazards Analysis record that is linked to the Instrumented Function record.	On the datasheet, this field is disabled and populated automatically with the value stored in the Hazards Analysis Reference field in the SIL Analysis record. There must be a value in this field before you select the PHA - Internal option in the SIL Assessment field. Otherwise, an error message will appear.	Instrumented Function datasheet
Hazards Analysis Reference Key	Number	The Entity Key for the Hazards Analysis record that is linked to the Instrumented Function record.	This field is used by the Meridium APM system to populate the Instrumented Function record with information from the Hazards Analysis record that is linked to the Instrumented Function record.	None
I/O Functional Relationship Details	Text	A description of the relationship between the inputs and outputs for the process, including details such as logic and mathematical functions.	On the datasheet, this field appears as a text box labeled I/O Functional Relationship Details and contains a  button, which you can click to access the Text Editor.	Safety Requirement Specification datasheet

Field Caption	Data Type	Description	Behavior and Usage	Datasheet/Tab
Initiating Event	Character	A short description of the initiating event whose description exists in the Initiating Event Description field.	<p>On the datasheet, this field appears as a text box labeled Initiating Event, in which you can enter your own value.</p> <p>If the value in the SIL Assessment Method field is <i>PHA - Internal</i>, after you select a Risk Assessment record from a Hazards Analysis, this field is populated automatically with the value in the Cause Type field in the Hazards Analysis Cause record that is linked to the Hazards Analysis Consequence record that is linked to the Risk Assessment record you selected.</p>	Instrumented Function datasheet

Field Caption	Data Type	Description	Behavior and Usage	Datasheet/Tab
Initiating Event Description	Text	A description of the event which could initiate a series of events that present the risk whose description exists in the Consequence Description field.	<p>On the datasheet, this field appears as a text box labeled Initiating Event Description and contains a  button, which you can click to access the Text Editor.</p> <p>If the value in the SIL Assessment Method field is <i>PHA - Internal</i>, after you select a Risk Assessment record from a Hazards Analysis, this field is populated automatically with the value in the Cause Description field in the Hazards Analysis Cause record that is linked to the Hazards Analysis Consequence record that is linked to the Risk Assessment record you selected.</p>	Instrumented Function datasheet
Last Modified By	Character	The name of the user who last modified the record.	On the datasheet, this field is disabled and updated automatically whenever the record is modified.	Instrumented Function datasheet
Last Modified Date	Date	The date on which the record was last modified.	On the datasheet, this field is disabled and populated automatically.	Instrumented Function datasheet

Field Caption	Data Type	Description	Behavior and Usage	Datasheet/Tab
Maintenance and Test Requirements	Text	A description of the requirements for maintenance and testing procedures for the instrumented function.	On the datasheet, this field appears as a text box labeled Maintenance and Test Requirements , and the value is set by default. You can remove this text and enter your own values. This field contains a  button, which you can click to access the Text Editor.	Safety Requirement Specification datasheet
Maintenance Override	Logical	A logical field that stores the value <i>True</i> or <i>False</i> and indicates whether the process requires override procedures for maintenance activities.	None	None
Manual Shut-down	Logical	A logical field that stores the value <i>True</i> or <i>False</i> and indicates whether the process requires manual shut-down.	None	None

Field Caption	Data Type	Description	Behavior and Usage	Datasheet/Tab
Max Process Variable	Number	A number representing the upper value for the process variable range.	On the datasheet, this field appears as a text box labeled Max Process Variable , in which you can enter your own value. This value combined with the value stored in the Min Process Variable field make up the process variable range.	Safety Requirement Specification datasheet
Min Process Variable	Number	A number representing the lower value for the process variable range.	On the datasheet, this field appears as a text box labeled Min Process Variable , in which you can enter your own value. This value combined with the value stored in the Max Process Variable field make up the process variable range.	Safety Requirement Specification datasheet
Normal Operation Mode	Text	A description of the normal operating mode for the instrumented function.	On the datasheet, this field appears as a text box labeled Normal Operation Mode , and the values is set by default. You can remove this text and enter your own values. This field contains a  button, which you can click to access the Text Editor.	Safety Requirement Specification datasheet

Field Caption	Data Type	Description	Behavior and Usage	Datasheet/Tab
Operation Mode	Character	The mode of operation for the instrumented function.	<p>On the datasheet, this field appears as a list labeled Operation Modes and contains the following values:</p> <ul style="list-style-type: none"> • NORMAL: This is the value that is selected by default. • ABNORMAL: If you select this value, the following fields are enabled: <ul style="list-style-type: none"> ■ Abnormal States ■ Operation Mode Description 	Safety Requirement Specification datasheet
Operator Interface Requirement	Text	A description of the Operator Interface requirements.	<p>On the datasheet, this field appears as a text box labeled Operator Interface Requirement, and the value is set by default. You can remove this text and enter your own values. This field contains a <input type="button" value="..."/> button, which you can click to access the Text Editor.</p>	Safety Requirement Specification datasheet

Field Caption	Data Type	Description	Behavior and Usage	Datasheet/Tab
PIF ID	Character	An ID for the instrumented function.	On the datasheet, this field appears as a text box labeled IF ID , in which you can enter your own value. This value will appear in the list of Instrumented Function records on the Instrumented Functions (IFs) page. This field is required.	Instrumented Function datasheet
PIF Description	Character	Stores a description of the instrumented function. This field is displayed on the Instrumented Function datasheet by default.	On the datasheet, this field appears as a text box labeled IF Description , in which you can enter your own value.	Instrumented Function datasheet
Pre Alarm	Number	A number representing the point on the process variable range at which the pre-alarm should be triggered.	On the datasheet, this field appears as a text box labeled Pre Alarm , in which you can enter your own value.	Safety Requirement Specification datasheet

Field Caption	Data Type	Description	Behavior and Usage	Datasheet/Tab
Process Service Description	Text	A description of the specifications for the process service.	On the datasheet, this field appears as a text box labeled Process Service Description , and the value is set by default. You can remove this text and enter your own values. This field contains a  button, which you can click to access the Text Editor.	Safety Requirement Specification datasheet
Process Speed	Number	A number representing the time in seconds that the process for which the instrumented function exists takes to complete.	On the datasheet, this field appears as a text box labeled Process Speed with an additional label, (Seconds) to the right of the field. You can enter your own value directly in the Process Speed cell.	Instrumented Function datasheet

Field Caption	Data Type	Description	Behavior and Usage	Datasheet/Tab
Required Probability of Failure	Number	A number that represents the target probability that an instrumented function failure will occur.	<p>If the value in the SIS Assessment Method field is <i>Risk Matrix - Internal</i>, this field is disabled and populated automatically based on the SIL requirements from the Risk Matrix.</p> <p>If the value in the SIS Assessment field is <i>Layer of Protection Analysis Internal</i>, this field is disabled and populated automatically with the difference between the values in the Mitigated Consequence Frequency field and the Required Mitigated Consequence Frequency field on the LOPA datasheet.</p> <p>For all other SIS Assessment methods, you can type a value directly into the Required Probability of Failure cell. Note that:</p> <ul style="list-style-type: none"> The value you type must fall within a certain range, which is determined by the value in the Selected SIL Level field. If you modify the value in the Selected SIL Level field, the value in this field will be 	Instrumented Function datasheet

Field Caption	Data Type	Description	Behavior and Usage	Datasheet/Tab
			<p>updated automatically to fall within the correct range of values for that level.</p> <ul style="list-style-type: none">• If you try to type a value into the Required Probability of Failure cell without first selecting a value from the Selected SIL Level list <i>or</i> you type a value that is outside of the acceptable range, an error message will appear.• If the value in the SIL Mode field is <i>Low Demand</i>, when you type a value into the Required Probability of Failure cell, the value in the Risk Reduction Factor field will be populated automatically with the inverse of the value you type. Likewise, if you type a value in the Risk Reduction Factor cell, the value in the Required Probability of Failure field will be populated auto-	

Field Caption	Data Type	Description	Behavior and Usage	Datasheet/Tab
			<p>atically with the inverse of the value that you type.</p> <p>After you type a value in the Required Probability of Failure field, it is converted automatically to scientific notation form (e.g., 1E-07).</p>	

Field Caption	Data Type	Description	Behavior and Usage	Datasheet/Tab
Required SIF Action	Text	A description of the action that the instrumented function performs in response to a triggered alarm.	On the datasheet, this field appears as a text box labeled Required SIF Action and contains a <input type="button" value="..."/> button, which you can click to access the Text Editor.	Safety Requirement Specification datasheet
Reset Requirement	Text	A description of the requirements for resetting a process after it has been tripped.	On the datasheet, this field appears as a text box labeled Reset Requirement , and the value is set by default. You can remove this text and enter your own values. This field contains a <input type="button" value="..."/> button, which you can click to access the Text Editor.	Safety Requirement Specification datasheet
Response Time	Number	A numeric value that represents the time in seconds that it takes for the instrumented function to respond to the initiating event and bring the process to a safe state.	On the datasheet, this field appears as a text box labeled Response Time with an additional label, (Seconds) , to the right of the field. You can enter your own value directly in the Response Time cell.	Instrumented Function datasheet

Field Caption	Data Type	Description	Behavior and Usage	Datasheet/Tab
Risk Reduction Factor (RRF)	Number	A number representing the factor by which the risk should be reduced for the instrumented function.	<p>If the value in the SIL Mode field is <i>Low Demand</i> and the value in the SIS Assessment Method field is <i>Layer of Protection Analysis - Internal</i> or <i>Risk Matrix - Internal</i>, this value is disabled and populated automatically with the inverse of the value in the Required Probability of Failure field.</p> <p>For all other SIS When the value in the SIL Mode field is <i>Low Demand</i> and the value in the SIS Assessment Method field is not <i>Layer of Protection Analysis - Internal</i> or <i>Risk Matrix - Internal</i>, this field is enabled and you can type a value directly into the Risk Reduction Factor cell. Note that:</p> <ul style="list-style-type: none"> The value you type must fall within a certain range, which is determined by the value in the Selected SIL Level field. If you modify the value in the Selected SIL Level field, the value in this field will be updated auto- 	Instrumented Function datasheet



Field Caption	Data Type	Description	Behavior and Usage	Datasheet/Tab
			<p>atically to fall within the correct range of values for that level.</p> <ul style="list-style-type: none"> • If you try to type a value into the Risk Reduction Factor cell without first selecting a value from the Selected SIL Level list <i>or</i> you type a value that is outside of the acceptable range, an error message will appear. • If you type a value into the Risk Reduction Factor cell, the value in the Required Probability of Failure field will be populated automatically with the inverse of the value that you type. Likewise, if you type a value into the Required Probability of Failure cell, the value in the Risk Reduction field will be populated automatically with the inverse of the value that you 	

Field Caption	Data Type	Description	Behavior and Usage	Datasheet/Tab
			<p>type.</p> <p>If the value in the SIL Mode field is <i>High Demand</i> or <i>Continuous</i>, this field is disabled and does not contain a value.</p>	
Safe State Description	Text	A description of the safe state to which the process should be taken via the instrumented function.	On the datasheet, this field appears as a text box labeled Safe State Description and contains a  button, which you can click to access the Text Editor.	Instrumented Function datasheet

Field Caption	Data Type	Description	Behavior and Usage	Datasheet/Tab
Selected SIL Level	Number	A number representing the SIL value that is required for the instrumented function.	<p>On the datasheet, this field is disabled and populated automatically if the value in the SIL Assessment Method field is anything other than <i>External</i>.</p> <p>If the SIL Assessment Method field contains an <i>External</i> value, this field is enabled and appears as a list that is populated with values from the MI_SAFETY_INDEX_LEVEL System Code Table. You can select a value from the list.</p> <p>If a value exists in the Required Probability of Failure field, and you try to delete the value in the Selected SIL Level field, an error message appears, and you will not be able to delete the value.</p>	Instrumented Function datasheet
SIL Analysis Key	Number	The Entity Key of the SIL Analysis record to which the Instrumented Function record is linked.	This field is used internally by the Meridium APM system.	None

Field Caption	Data Type	Description	Behavior and Usage	Datasheet/Tab
SIL Assessment Method	Character	The method used to assess the risk associated with the instrumented function.	<p>On the datasheet, this field appears as a list labeled SIL Assessment Method and contains the following values:</p> <ul style="list-style-type: none"> • Risk Matrix - Internal • Layer of Protection Analysis Internal • PHA - Internal • ALARP - External • Event Tree • Fault Tree • LOPA - External • Risk Graph • Risk Matrix - External <p>If you select the PHA - Internal option, there must be a value in the Hazards Analysis Reference field. Otherwise, an error message will appear.</p>	Instrumented Function datasheet
SIL Mode	Character	The SIL mode that is defined for this instrumented function based on the code IEC-61508.	<p>On the datasheet, this field appears as a list labeled SIL Mode and contains the following baseline values:</p> <ul style="list-style-type: none"> • Low Demand • High Demand • Continuous 	Instrumented Function datasheet

Field Caption	Data Type	Description	Behavior and Usage	Datasheet/Tab
SIS System ID	Character	The ID of the Safety Instrumented System record to which the Instrumented Function record is linked.	On the datasheet, this field appears as a list labeled SIS ID and contains the values that exist in the SIS ID field in the Safety Instrumented System records that are linked to the SIL Analysis record with which you are currently working.	Instrumented Function datasheet
Site Description	Character	A description of the site that is specified in the Site ID field.	None	None
Site ID	Character	The ID of the site that is associated with the instrumented function.	On the datasheet, this field is disabled and populated automatically with the value in the Site ID field of the associated SIL Analysis record .	Instrumented Function datasheet
Spurious Trip Limit (per yr)	Number	A number representing the number of times per year it is acceptable for a spurious trip to occur for this instrumented function.	On the datasheet, this field appears as a text box labeled Spurious Trip Limit (per yr) , in which you can enter your own value. This value is used to determine the value in the Meets STR Limit field in a Protective Instrument Loop record that is linked to the Instrumented Function record.	Instrumented Function datasheet

Field Caption	Data Type	Description	Behavior and Usage	Datasheet/Tab
Startup And Restart Procedure	Text	A detailed description of the startup and restart procedures for the process.	On the datasheet, this field appears as a text box labeled Startup and Restart Procedure , and the value is set by default. You can remove this text and enter your own values. This field contains a  button, which you can click to access the Text Editor.	Safety Requirement Specification datasheet
Survival Requirement	Text	A description of the requirements for the instrumented function to survive a catastrophic event, such as an earthquake.	On the datasheet, this field appears as a text box labeled Survival Requirement , and the value is set by default. You can remove this text and enter your own values. This field contains a  button, which you can click to access the Text Editor.	Safety Requirement Specification datasheet
Trip Mode	Character	A short description of the trip mode (i.e., energize to trip or de-energize to trip).	On the datasheet, this field appears as a text box labeled Trip Mode , and the values is set to <i>de-energize to trip</i> by default. You can remove this text and enter your own value.	Safety Requirement Specification datasheet
Trip Point	Number	A number representing the point on the process variable range at which the trip alarm should be triggered.	On the datasheet, this field appears as a text box labeled Trip Point , in which you can enter your own value.	Safety Requirement Specification datasheet

Instrumented Function

Field Caption	Data Type	Description	Behavior and Usage	Datasheet/Tab
Unit Description	Character	A description of the unit that is specified in the Unit ID field.	None	None
Unit ID	Character	The ID for the unit where the instrumented function exists.	On the datasheet, this field appears as a text box labeled Unit ID , in which you can enter your own value.	Instrumented Function datasheet

Functional Test Detail

The following table provides a list of the fields that exist in the Functional Test Detail family. This list is not comprehensive.

Field Caption	Data Type	Description	Behavior and Usage
As Found Travel Time Limit	Number	The maximum as-found travel time allowed, in seconds. For example, the value might indicate the maximum amount of time it takes a switch to change from open to close.	This field is enabled only in Functional Test Detail records that are linked to records representing final elements.
As Found Trip Point	Number	A value that indicates the performance of the proof test (i.e., the value you found in the field).	You can type a value in this field manually. This field is enabled only in Functional Test Detail records that are linked to records representing sensors, final elements, or logic solvers.
As Found Trip Point Error	Number	The error between the value you found in the field (i.e., As Found Trip Point) and the acceptable range (i.e., Trip Point Error Limit).	This field is enabled only in Functional Test Detail records that are linked to records representing sensors, final elements, or logic solvers.
As Left Travel Time Limit	Number	The maximum as-left travel time allowed, in seconds.	This field is enabled only in Functional Test Detail records that are linked to records representing final elements.

Field Caption	Data Type	Description	Behavior and Usage
As Left Trip Point	Number	A value that indicates the final performance of the proof test. If the value in the As Found Trip Point field is within the Trip Point Error Limit, you might not make adjustments, and the As Left Trip Point will be the same. If the As Found Trip Point is not within the Trip Point Error Limit, you may make adjustments, and will enter the new adjusted trip point as the As Left Trip Point.	You can type a value in this field manually. This field is enabled only in Functional Test Detail records that are linked to records representing sensors, final elements, or logic solver.
As Left Trip Point Error	Number	The error between the value you left in the field (i.e., As Left Trip Point) and the acceptable range (i.e., Trip Point Error Limit).	This field is enabled only in Functional Test Detail records that are linked to records representing sensors, final elements, or logic solvers.
Equipment ID	Character	The Record ID of the Equipment record against which the step should be performed.	You can select the associated Equipment record by clicking the <input type="text" value="..."/> in the Equipment ID field.
Location ID	Character	The Record ID of the Functional Location record against which the step should be performed.	You can select the associated Functional Location record by clicking the <input type="text" value="..."/> in the Location ID field.



Field Caption	Data Type	Description	Behavior and Usage
Pass/Fail	Character	The status of the proof test step.	<p>This value indicates the status of the proof test step identified in the Step Sequence Number and Step Type fields. This field will contain one of the following values: Pass, Fail, Skip, Complete. This field is populated automatically based upon other values in the record. The value in this field will be set automatically to <i>Pass</i> if any of the following conditions is true:</p> <ul style="list-style-type: none"> • The Trip Point, Trip Point Error, and Travel Time Limit fields are empty. • For logic solvers, sensors, and final elements, the value in the As Found Trip Point field is within the range established by the Trip Point Limit field. • For final elements, the value in the As Found Travel Time is within the range established by the Travel Time Limit. • If the Trip Point and Trip Point Error fields are empty but the Travel Time Limit field is not, the pass/fail status will be determined solely by Travel Time Limit. The opposite is true as well.
Result Criteria	Text	A description of an acceptable result of the test.	This field is populated automatically and cannot be modified.

Field Caption	Data Type	Description	Behavior and Usage
Step Sequence Number	Number	A number that represents the order in which the step should be performed, relative to other steps.	This field is populated automatically.
Step Type	Character	The type of step.	This field is populated automatically. When this field contains the value <i>Sensor</i> or <i>Final Element</i> , the following fields will be enabled: Trip Point, Trip Point Direction, Trip Point Error Limit, and Trip Point Units. The Travel Time Units field is also enabled when this field contains the value <i>Final Element</i> .
Test Criteria	Text	The nature of the test.	This field is populated automatically and cannot be modified.
Template Detail ID	Character	An alphanumeric value that identifies the Functional Test Detail record.	This value is generated automatically and cannot be modified.
Travel Time Limit	Number	The maximum acceptable travel time for this step, in seconds.	This field is populated automatically with the value in the Travel Time Limit field in the associated SIS Proof Test Template Detail record and disabled unless the value in the Step Type field is <i>Final Element</i> .
Trip Point	Number	A value that defines when the element will activate an SIS shutdown. For example, a trip point on a water heater might be 140 degrees, a temperature that would scald someone.	This field is populated automatically with the value in the Trip Point field in the associated SIS Proof Test Template Detail record and disabled unless the value in the Step Type field is <i>Final Element</i> .

Field Caption	Data Type	Description	Behavior and Usage
Trip Point Direction	Character	The trend of Trip Point values.	This field is populated automatically with the value in the Trip Point Direction field in the associated SIS Proof Test Template Detail record and disabled unless the value in the Step Type field is <i>Sensor</i> or <i>Final Element</i> .
Trip Point Error Limit	Number	A number identifying the range from the Trip Point, plus or minus, within which the As Found Trip Point value must fall to be acceptable. For example, if the Trip Point is 5, and the Trip Point Error Limit is 3, the As Found Trip Point must fall within plus or minus three of the Trip Point (i.e., from 2 to 8).	This field is populated automatically with the value in the Trip Point Error Limit field in the associated SIS Proof Test Template Detail record and disabled unless the value in the Step Type field is <i>Sensor</i> or <i>Final Element</i> .
Trip Point Units	Character	The unit of measure associated with the value in the Trip Point field.	This field is populated automatically with the value in the Trip Point Units field in the associated SIS Proof Test Template Detail record and disabled unless the value in the Step Type field is <i>Sensor</i> or <i>Final Element</i> .

LOPA

LOPA records store details about the Layer of Protection Analysis they represent. The following table provides an alphabetical list and description of the fields that exist for the LOPA family and appear on the LOPA datasheet, unless otherwise specified. The information in the table reflects the baseline state and behavior of these fields. This list is not comprehensive.

Field Caption	Data Type	Description	Behavior and Usage	Datasheet/Tab
Analysis Type	Character	The type of analysis that you are conducting.	This field does not appear on the datasheet by default and is populated automatically with the value <i>LOPA</i> .	This field does not appear on the LOPA datasheet.
Calculated SIL	Number	The SIL value that is required to mitigate the risk that is associated with the Instrumented Function record to which the LOPA record is linked.	This field is disabled and populated automatically with the SIL value that is associated with the value in the Required PIF PHD field.	This field does not appear on the LOPA datasheet.
Comments	Text	Additional information about the Layer of Protection Analysis.	On the datasheet, this field appears as a text box labeled Comments and contains a  button, which you can click to access the Text Editor.	Definition tab
Description	Text	A description for the Layer of Protection Analysis.	On the datasheet, this field appears as a text box labeled Description and contains a  button, which you can click to access the Text Editor.	Definition tab

Field Caption	Data Type	Description	Behavior and Usage	Datasheet/Tab
Description of Initiating Event	Character	A description of the initiating event that is specified in the Initiating Event field.	This field is populated automatically with the value in the Initiating Event Description field in the associated Instrumented Function record . You can modify this value if needed.	Details tab
Enabling Event/Condition Description	Character	A description of the event that will allow the risk that is associated with the initiating event, which is described in the Initiating Event field, to be mitigated (e.g., the equipment only operates nine months of the year).	You can type your own value manually.	Details tab

Field Caption	Data Type	Description	Behavior and Usage	Datasheet/Tab
Enabling Event/Condition Probability	Number	A number that represents the probability value that is associated with the enabling event <i>and</i> the initiating event. This value is used to determine the probability of an unmitigated event occurring.	<p>You can type your own value manually. The value must be greater than 0 (zero) and less than or equal to 1 (one).</p> <p>This value is multiplied by the value in the Frequency of Initiating Event field to determine the value in Unmitigated Consequence Frequency field. If this field is empty, a default value of 1 will be used in that calculation.</p>	Details tab

Field Caption	Data Type	Description	Behavior and Usage	Datasheet/Tab
Frequency of Initiating Event	Number	A number representing the number of times per year that the initiating event that is specified in the Initiating Event field will occur.	<p>This field is required and is populated automatically with the value in the Frequency of Initiating Event (per yr) field in the associated Instrumented Function record.</p> <p>You can modify this value, but it must be greater than 0 (zero). If you type a value less than 0 (zero), a message will appear, and when you click OK, the modified value will be reverted back to its original value.</p> <p>This value is multiplied by the value in the Enabling Event/Condition Probability field to determine the value in Unmitigated Consequence Frequency field.</p>	Details tab
Initiating Event	Character	A brief description of the event that could cause the risk that is described in the Unacceptable Consequence field to be mitigated.	This field is populated automatically with the value in the Initiating Event field in the associated Instrumented Function record . You can modify this value if needed.	Details tab

Field Caption	Data Type	Description	Behavior and Usage	Datasheet/Tab
LOPA ID	Character	The ID for the Layer of Protection Analysis.	You can type your own value manually. The value will appear on the Instrumented Functions (IFs) page and is used to distinguish the LOPA record from other LOPA records. This field is required.	Definition tab
Mitigated Consequence Frequency	Number	A number representing the mitigated consequence frequency, or the consequence frequency after layers of protection have been added.	This field is disabled and populated automatically. The value is calculated by multiplying the value in the Unmitigated Consequence Frequency field by the value in the Total IPL PFD field.	Definition tab

Field Caption	Data Type	Description	Behavior and Usage	Datasheet/Tab
Required Mitigated Consequence Frequency	Number	The maximum allowable frequency at which the initiating event can occur for the risk that is described in the Unacceptable Consequence field.	<p>This field is required. On the datasheet, this field appears as a list labeled Required Mitigated Consequence Frequency and contains the following hard-coded values:</p> <ul style="list-style-type: none"> • 1E-04 • 1E-05 • 1E-06 <p>You can select a value from the list or type your own value. If you type your own value, it must be greater than 0 (zero). If you modify this value to be less than 0 (zero), a message will appear, and when you click OK, the modified value will revert back to its original value. If you enter a value other than the baseline values in the list, it will then be added to the list.</p>	Definition tab

Field Caption	Data Type	Description	Behavior and Usage	Datasheet/Tab
Required PIF PFD	Number	A number representing the target probability that a failure will occur.	This field is disabled and populated automatically. This value is calculated automatically as the difference between the value in the Mitigated Consequence Frequency field and the value in the Required Mitigated Consequence Frequency Field. This value is used to determine the values in the Required PIF Risk Reduction Factor and Calculated SIL Level fields.	Details tab
Required PIF Risk Reduction Factor	Number	A number representing the factor by which the risk should be reduced.	This field is disabled and populated automatically with the inverse of the value in the Required PIF PHD field.	Details tab
Title	Character	A short description for the Layer of Protection Analysis.	You can type your own value manually.	Definition tab
Total IPL PFD	Number	The PFD value associated with all the IPLs in place for this consequence.	This field is disabled and populated automatically. The value is calculated by multiplying the values in the PFD fields of each Independent Layer of Protection record associated with the LOPA Analysis together.	Details tab

Field Caption	Data Type	Description	Behavior and Usage	Datasheet/Tab
Total CM Probability	Number	The sum of the values that exist in the Probability fields in the Consequence Modifier records that are linked to the LOPA record.	This field is disabled and populated automatically. This field does not appear on the LOPA datasheet by default.	This field does not appear on the LOPA datasheet.
Unacceptable Consequence	Character	A description of the risk for which you are conducting the Layer of Protection Analysis.	This field is populated automatically with the value in the Consequence Description field in the associated Instrumented Function record . You can modify this value if needed.	Details tab
Unmitigated Consequence Frequency	Number	A number representing the unmitigated consequence frequency, or the consequence frequency before layers of protection have been added.	This field is disabled and populated automatically. The value is calculated by multiplying the value in the Frequency of Initiating Event field by the value in the Enabling Event/Condition Probability field.	Details tab

Protective Instrument Loop

Protective Instrument Loop records store details about protective instrument loops for a safety instrumented system. The following table provides an alphabetical list and description of the fields that exist for the Protective Instrument Loop family *and* appear on the Protective Instrument Loop datasheet by default. The information in this table reflects the baseline state and behavior of these fields.

Field	Data Type	Description	Behavior and Usage
Achieved SIL	Number	A number representing the overall SIL value for the protective instrument loop.	<p>This field appears as a list in the Calculated Results section on the datasheet and contains the following options:</p> <ul style="list-style-type: none"> • 0 (zero) • 1 • 2 • 3 • 4 <p>When the value in the SIL Validation Method field is <i>External Calculation</i>, the Achieved SIL field is enabled, and you can select a value from the list.</p> <p>When the value in the SIL Validation Method field is <i>Internal Calculation</i>, the Achieved SIL field is disabled and populated automatically with the <i>lowest</i> value of the values stored in the following fields:</p> <ul style="list-style-type: none"> • Calculated SIL • Calculated SIL Architectural Constraints • Calculated SIL Systematic Capabilities <p>For example, if the value in each of these fields was 2, the value in the Achieved SIL field would be 2. If the value in two of the fields was 2 and the value in one of the fields was 1, the value in the Achieved SIL field would be 1.</p>

Field	Data Type	Description	Behavior and Usage
Availability	Number	A number representing the percentage of time between proof tests that the protective instrument loop is protecting the safety instrumented system.	<p>This field appears as a text box, which is displayed in the Calculated Results section on the datasheet and is enabled or disabled based upon the following criteria:</p> <ul style="list-style-type: none"> • When the value in the SIL Validation Method field is <i>External Calculation</i>, the Availability field is enabled, and you can type a value directly into the Availability cell. • When the value in the SIL Validation Method field is <i>Internal Calculation</i>, the Meridium APM system calculates this value automatically and displays that value as read-only in the Availability field.

Field	Data Type	Description	Behavior and Usage
Calculated SIL	Number	A number representing the SIL value for the protective instrument loop, which is the value stored in the Loop PFD Avg field.	<p>This field appears as a text box, which is displayed in the Calculated Results section on the datasheet and is enabled or disabled based upon the following criteria:</p> <ul style="list-style-type: none"> • When the value in the SIL Validation Method field is <i>External Calculation</i>, the Calculated SIL field is enabled, and you can type a value directly into the Calculated SIL cell. • When the value in the SIL Validation Method field is <i>Internal Calculation</i>, the Meridium APM system calculates this value automatically, based on the value in the Loop PFD Avg field, and displays one of the following values as read-only in the Calculated SIL field: <ul style="list-style-type: none"> ◦ 0 (zero) ◦ 1 ◦ 2 ◦ 3 ◦ 4

Field	Data Type	Description	Behavior and Usage
Calculated SIL Architectural Constraints	Number	The SIL value for the protective instrument loop, which is based on architectural constraints defined in the Test Architecture Constraints field.	<p>This field appears as a text box in the Calculated Results section on the data-sheet and is enabled or disabled based upon the following criteria:</p> <ul style="list-style-type: none"> • When the value in the SIL Validation Method field is <i>External Calculation</i>, the Calculated SIL Architectural Constraints field is enabled, and you can type a value directly into the Calculated SIL Architectural Constraints cell. • When the value in the SIL Validation Method field is <i>Internal Calculation</i>, the Meridium APM system calculates this value automatically, based on the value in the Test Architecture Constraints field, and displays one of the following values as read-only in the Calculated SIL Architectural Constraints field: <ul style="list-style-type: none"> ◦ 0 (zero) ◦ 1 ◦ 2 ◦ 3 ◦ 4

Field	Data Type	Description	Behavior and Usage
Calculated SIL Systematic Capabilities	Number	The SIL value for the protective instrument loop, which is based on systematic capabilities defined in the failure rate data associated with each protective instrument loop element.	<p>This field appears as a text box in the Calculated Results section on the data-sheet and is enabled or disabled based upon the following criteria:</p> <ul style="list-style-type: none"> • When the value in the SIL Validation Method field is <i>External Calculation</i>, the Calculated SIL Systematic Capabilities field is enabled, and you can type a value directly into the Calculated SIL Systematic Capabilities cell. • When the value in the SIL Validation Method field is <i>Internal Calculation</i>, the Meridium APM system calculates this value automatically, based on the systematic capabilities defined in the failure rate data associated with each protective instrument loop element, and displays one of the following values as read-only in the Calculated SIL Systematic Capabilities field: <ul style="list-style-type: none"> ◦ 0 (zero) ◦ 1 ◦ 2 ◦ 3 ◦ 4 <p>If the value in the Systematic Capability Validation field is <i>False</i>, this value is set to <i>NA</i>.</p>

Field	Data Type	Description	Behavior and Usage
Calculated STR	Number	A number representing the spurious trip rate for the protective instrument loop.	<p>This field appears as a text box in the Calculated Results section on the data-sheet and is enabled or disabled based upon the following criteria:</p> <ul style="list-style-type: none"> • When the value in the SIL Validation Method field is <i>External Calculation</i>, the Calculated STR field is enabled, and you can type a value directly into the Calculated STR cell. • When the value in the SIL Validation Method field is <i>Internal Calculation</i>, the Meridium APM system calculates this value automatically and displays that value as read-only in the Calculated STR field.
Demand Mode	Character	A value that indicates how frequently the protective instrument loop will be in demand. In other words, how frequently the protective instrument loop will be needed to protect the safety instrumented system as a result of a failure.	This field is disabled and populated automatically with the value stored in the SIL Mode field in the Instrumented Function record that is linked to the Protective Instrument Loop record.
Description	Character	A brief description of the protective instrument loop.	You can type a value directly into the Description cell.

Field	Data Type	Description	Behavior and Usage
Final Element MCI	Number	A percentage that represents the <i>Main-tenance Cap-ability Index</i> .	<p>This field appears as a list labeled Final Element MCI and contains the following options:</p> <ul style="list-style-type: none"> • MCI 0 (0%): Indicates that repair actions are never performed. • MCI 1 (60%): Indicates that repair actions are effective 60 percent of the time. • MCI 2 (90%): Indicates that repair actions are effective 90 percent of the time. • MCI 3 (99%): Indicates that repair actions are effective 99 percent of the time. • MCI 4 (100%): Indicates that repair actions are always performed perfectly.
ID	Character	The ID of the protective instrument loop.	You can type a value directly into the ID cell. This value is required and must be unique. If you do not type a unique value into the ID cell, you will not be able to save the Protective Instrument Loop record.
Last Modified By	Character	The name of the user who last modified the record.	This field is disabled and populated automatically with the name of the Meridium APM Security User who last modified the Protective Instrument Loop record.
Last Modified Date	Date	The date on which the record was last modified.	This field is disabled and populated automatically with the date on which the Protective Instrument Loop record was last modified.

Field	Data Type	Description	Behavior and Usage
Logic Solver MCI	Number	A percentage that represents the <i>Main-tenance Cap-ability Index</i> .	<p>This field appears as a list labeled Logic Solver MCI and contains the following options:</p> <ul style="list-style-type: none"> • MCI 0 (0%): Indicates that repair actions are never performed. • MCI 1 (60%): Indicates that repair actions are effective 60 percent of the time. • MCI 2 (90%): Indicates that repair actions are effective 90 percent of the time. • MCI 3 (99%): Indicates that repair actions are effective 99 percent of the time. • MCI 4 (100%): Indicates that repair actions are always performed perfectly.
Loop Class	Character	A value that indicates whether the protective instrument loop is designed to mitigate safety risks or commercial risks.	<p>This field appears as a list labeled Loop Class and contains the following options:</p> <ul style="list-style-type: none"> • Safety: Indicates that the protective instrument loop is designed to mitigate risks related to safety. For example, a <i>safety</i> loop might prevent a high motor current from causing a fire. • Protective: Indicates that the protective instrument loop is designed to mitigate commercial risks <i>only</i>. For example, a <i>protective</i> loop might prevent low lube pressure from causing a mechanical failure where there is no safety risk involved.

Field	Data Type	Description	Behavior and Usage
Loop PFD Avg	Number	A number representing the probability that the protective instrument loop will fail.	<p>This field appears as a text box in the Calculated Results section on the data-sheet, which is enabled or disabled based upon the following criteria:</p> <ul style="list-style-type: none"> • When the value in the SIL Validation Method field is <i>External Calculation</i>, the Loop PFD Avg field is enabled, and you can type a value directly into the Loop PFD Avg cell. • When the value in the SIL Validation Method field is <i>Internal Calculation</i>, the Meridium APM system calculates this value automatically and displays that value as read-only in the Loop PFD Avg field.
Loop PFH	Number	A number representing the probability per hour that the protective instrument loop will fail.	<p>This field appears as a text box in the Calculated Results section on the data-sheet, which is enabled or disabled based upon the following criteria:</p> <ul style="list-style-type: none"> • When the value in the SIL Validation Method field is <i>External Calculation</i>, the Loop PFH field is enabled, and you can type a value directly into the Loop PFH field cell. • When the value in the SIL Validation Method field is <i>Internal Calculation</i>, the Meridium APM system calculates this value automatically and displays that value as read-only in the Loop PFH field.

Field	Data Type	Description	Behavior and Usage
Loop Type	Character	A value representing the category of the protective instrument loop, based on the type of data that the sensor is measuring.	<p>This field appears as a list labeled Loop Type and contains the following options:</p> <ul style="list-style-type: none"> • Analysis • Flow • Level • Load • Pressure • Speed • Temperature

Field	Data Type	Description	Behavior and Usage
Meets Architectural Constraints	Character	A value that indicates whether the protective instrument loop's architectural constraints meet the requirement defined by the value in the Required SIL field.	<p>This field appears as a list labeled Meets Architectural Constraints in the Calculated Results section on the data-sheet and contains the following options:</p> <ul style="list-style-type: none"> • Incomplete • Yes • No • NA <p>This value is set to <i>Incomplete</i> by default.</p> <p>When the value in the SIL Validation Method field is <i>External Calculation</i>, the Meets Architectural Constraints field is enabled, and you can select a value from the list.</p> <p>When the value in the SIL Validation Method field is <i>Internal Calculation</i>, the Meets Architectural Constraints field is disabled and populated automatically. After you calculate the SIL Validation results, the Meets Architectural Constraints field is populated using the following logic:</p> <ul style="list-style-type: none"> • If the value in the Calculated SIL Architectural Constraints field is greater than or equal to the value in the Required SIL field, this value is set to <i>Yes</i>. • Otherwise, this value is set to <i>No</i>. <p>If the value in the Test Architectural Constraints field is <i>Not Consider</i>, this value is set to <i>NA</i>.</p>

Field	Data Type	Description	Behavior and Usage
Meets Availability Target	Character	A value that indicates whether the protective instrument loop's availability meets the availability requirement defined in the Instrumented Function record that is linked to the Protective Instrument Loop record.	<p>This field appears as a list labeled Meets Availability Target in the Calculated Results section on the data-sheet and contains the following options:</p> <ul style="list-style-type: none"> • Incomplete • Yes • No • NA <p>This value is set to <i>Incomplete</i> by default.</p> <p>When the value in the SIL Validation Method field is <i>External Calculation</i>, the Meets Availability Target field is enabled, and you can select a value from the list.</p> <p>When the value in the SIL Validation Method field is <i>Internal Calculation</i>, the Meets Availability Target field is disabled and populated automatically. After you calculate the SIL Validation results, the Meets Availability field is populated using the following logic:</p> <ul style="list-style-type: none"> • If the value in the Demand Mode field is <i>Low Demand</i>, and the value in the Availability field is greater than or equal to the value stored in the Availability Target field in the Instrumented Function record that is linked to the Protective Instrument Loop record, this value is set to <i>Yes</i>. • Otherwise, this value is set to <i>No</i>. <p>If the value in the Demand Mode field is <i>High Demand</i> or <i>Continuous</i>, this value is <i>NA</i>.</p>

Field	Data Type	Description	Behavior and Usage
Meets SIL Requirement	Character	A value that indicates whether the protective instrument loop's SIL value meets the SIL requirement defined in the Required SIL field.	<p>This field appears as a list labeled Meets SIL Requirement in the Calculated Results section on the data-sheet and contains the following options:</p> <ul style="list-style-type: none"> • Incomplete • Yes • No • NA <p>This value is set to <i>Incomplete</i> by default.</p> <p>When the value in the SIL Validation Method field is <i>External Calculation</i>, the Meets SIL Requirement field is enabled, and you can select a value from the list.</p> <p>When the value in the SIL Validation Method field is <i>Internal Calculation</i>, the Meets SIL Requirement field is disabled and populated automatically. After you calculate the SIL Validation results, the Meets SIL Requirement field is populated using the following logic:</p> <ul style="list-style-type: none"> • If the value in the Achieved SIL field is greater than or equal to the value in the Required SIL field, this value is set to <i>Yes</i>. • Otherwise, this value is set to <i>No</i>.

Field	Data Type	Description	Behavior and Usage
Meets STR Limit	Character	A value that indicates whether the protective instrument loop's spurious trip rate meets the spurious trip rate requirement defined in the Instrumented Function record that is linked to the Protective Instrument Loop record.	<p>This field appears as a list labeled Meets STR Limit in the Calculated Results section on the datasheet and contains the following options:</p> <ul style="list-style-type: none"> • Incomplete • Yes • No • NA <p>This value is set to <i>Incomplete</i> by default.</p> <p>When the value in the SIL Validation Method field is <i>External Calculation</i>, the Meets STR Limit field is enabled, and you can select a value from the list.</p> <p>When the value in the SIL Validation Method field is <i>Internal Calculation</i>, the Meets STR Limit field is disabled and populated automatically. After you calculate the SIL Validation results, the Meets STR Limit field is populated using the following logic:</p> <ul style="list-style-type: none"> • If the inverse of the value stored in the MTTTS field is <i>greater than or equal to</i> the value stored in the Spurious Trip Limit (per yr) field in the Instrumented Function record that is linked to the Protective Instrument Loop record, the value in the Meets STR Limit field is set to <i>No</i>. • Otherwise, the value in the Meets STR Limit field is set to <i>Yes</i>. <p>If the Protective Instrument Loop record is part of a protective instrument loop template, this value is set to <i>NA</i>.</p>

Field	Data Type	Description	Behavior and Usage
Meets Systematic Capabilities	Character	A value that indicates whether the protective instrument loop's systematic capability meets the systematic capability requirement defined in the Required SIL field.	<p>This field appears as a list labeled Meets Systematic Capabilities in the Calculated Results section on the data-sheet and contains the following options:</p> <ul style="list-style-type: none"> • Incomplete • Yes • No • NA <p>This value is set to <i>Incomplete</i> by default.</p> <p>When the value in the SIL Validation Method field is <i>External Calculation</i>, the Meets Systematic Capabilities field is enabled, and you can select a value from the list.</p> <p>When the value in the SIL Validation Method field is <i>Internal Calculation</i>, the Meets Systematic Capabilities field is disabled and populated automatically. After you calculate the SIL Validation results, the Meets Systematic Capabilities field is populated using the following logic:</p> <ul style="list-style-type: none"> • If the value in the Calculated SIL Systematic Capabilities field is greater than or equal to the value in the Required SIL field, this value is set to <i>Yes</i>. • Otherwise, this value is set to <i>No</i>. <p>If the value in the Systematic Capability Validation field is <i>False</i>, this value is set to <i>NA</i>.</p>

Field	Data Type	Description	Behavior and Usage
Mission Time	Number	A number that represents in years the time that the protective instrument loop will be in use before it is replaced.	You can type a value into this field manually. This value is measured in years.
MTTFS	Number	A number that represents Mean Time To Fail Safe (i.e., the average amount of time between protective instrument loop failures that occur during safe scenarios).	<p>This field appears as a text box in the Calculated Results section on the data-sheet, which is enabled or disabled based upon the following criteria:</p> <ul style="list-style-type: none"> • When the value in the SIL Validation Method field is <i>External Calculation</i>, the MTTFS field is enabled, and you can type a value directly into the MTTFS cell. • When the value in the SIL Validation Method field is <i>Internal Calculation</i>, the Meridium APM system calculates this value automatically and displays that value as read-only in the MTTFS field. <p>This value is measured in years.</p>
Required SIL	Number	A number representing the SIL value that is required for the protective instrument loop.	This field is disabled and populated automatically with the value stored in the Selected SIL Level field in the Instrumented Function record that is linked to the Protective Instrument Loop record.

Field	Data Type	Description	Behavior and Usage
Risk Reduction Factor	Number	A number representing the factor by which the risk should be reduced for the protective instrument loop.	<p>This field appears as a text box in the Calculated Results section on the data-sheet and is enabled or disabled based upon the following criteria:</p> <ul style="list-style-type: none"> • When the value in the SIL Validation Method field is <i>External Calculation</i>, the Risk Reduction Factor field is enabled, and you can type a value directly into the Risk Reduction Factor cell. • When the value in the SIL Validation Method field is <i>Internal Calculation</i>, the Meridium APM system calculates this value automatically and displays that value as read-only in the Risk Reduction Factor field.
Sensor MCI	Number	A value that represents the <i>Maintenance Capability Index</i> .	<p>This field appears as a list labeled Sensor MCI and contains the following options:</p> <ul style="list-style-type: none"> • MCI 0 (0%): Indicates that repair actions are never performed. • MCI 1 (60%): Indicates that repair actions are effective 60 percent of the time. • MCI 2 (90%): Indicates that repair actions are effective 90 percent of the time. • MCI 3 (99%): Indicates that repair actions are effective 99 percent of the time. • MCI 4 (100%): Indicates that repair actions are always performed perfectly.

Field	Data Type	Description	Behavior and Usage
SIL Validation Method	Character	A value that represents the type of method used to calculate the SIL Validation results for the protective instrument loop.	<p>This field appears as a list labeled Loop Class and contains the following options:</p> <ul style="list-style-type: none"> • Internal Calculation: Indicates that the Meridium APM system will calculate the SIL Validation results. When this option is selected, the Meridium APM system calculates the values in all cells in the Calculated Results section automatically and displays them as read-only. • External Calculation: Indicates that you will type SIL Validation results directly into cells on the Protective Instrument Loop data-sheet. When this option is selected, all cells in the Calculated Results section are enabled, and you can type values directly into those cells.
Startup Time	Number	A number representing the amount of time needed for the protective instrument loop to be restored after a failure.	You can type a value into this field manually. This value is measured in hours.

Field	Data Type	Description	Behavior and Usage
Systematic Capability Validation	Logical	A value that indicates whether the SIL value for the protective instrument loop will account for systematic capabilities, which are defined in the failure data for each protective instrument loop element.	If this value is <i>True</i> , the protective instrument loop will use systematic capabilities. If this value is <i>False</i> , the protective instrument loop will <i>not</i> use systematic capabilities.
Test Architecture Constraints	Character	A value that indicates the level of safety certification that is associated with the elements in the protective instrument loop.	This field appears as a list labeled Test Architecture Constraints and contains the following options: <ul style="list-style-type: none"> • IEC 61508: Indicates that the elements in the protective instrument loop have been certified according to the IEC 61508 standard. • IEC 61511: Indicates that the elements in the protective instrument loop have been certified according to the IEC 61511 standard. • Not Consider: Indicates that the architectural constraints will <i>not</i> be considered in the SIL calculation.

Protective Instrument Loop Final Element

Protective Instrument Loop Final Element records store details about final elements for a protective instrument loop. The following table provides an alphabetical list and description of the fields that exist for the Protective Instrument Loop Final Element family. The information in this table reflects the baseline state and behavior of these fields. This list is not comprehensive.

Field Caption	Data Type	Description	Behavior and Usage	Datasheet/Tab
Custom PVST Coverage	Number	A numeric value representing the percentage of possible failures that could be detected by the partial valve stroke test.	On the data-sheet, this field appears as a text box labeled Custom PVST Coverage , in which you can enter your own value.	Final Element data-sheet
Description	Character	A description for the final element.	On the data-sheet, this field appears as a text box labeled Description , in which you can enter your own value.	Final Element data-sheet

Field Caption	Data Type	Description	Behavior and Usage	Datasheet/Tab
Dangerous combination of outputs?	Logical	Stores the value <i>True</i> or <i>False</i> indicating whether the output associated with the final element can lead to a hazardous event if it occurs simultaneously with the output associated with a different final element.	In the UI, this field appears as a check box labeled Dangerous Combination of Outputs? , which you can select to indicate that the final element is associated with a combination of outputs hazard. This check box is clear by default. When you select this check box, the Hazardous Events field is enabled and required.	Dangerous Combination of Outputs tab on the <Record ID> (Protective Instrument Loop Final Element) window
Final Element ID	Character	An ID for the final element.	On the datasheet, this field appears as a text box labeled Final Element ID , in which you can enter your own value. This value is displayed in the diagram to identify the final element. This field is required.	Final Element datasheet

Field Caption	Data Type	Description	Behavior and Usage	Datasheet/Tab
Hazardous Events	Text	A description of the hazardous event that can occur if the output associated with the final element occurs simultaneously with the output of a different final element.	In the UI, this field appears as a text box without a caption and contains a  button, which you can click to access the Text Editor. When the Dangerous Combination of Outputs? check box is selected, this field is enabled and required. Otherwise, this field is disabled.	Potential Dangerous Combination of Outputs Description section on the Dangerous Combination of Outputs tab on the <Record ID> (Protective Instrument Loop Final Element) window
PVST Interval	Number	A numeric value representing the frequency at which the partial valve stroke test should be performed.	On the datasheet, this field appears as a text box labeled PVST Interval , in which you can enter your own value. This field is enabled only if the Partial Valve Stroke Testing check box is selected.	Final Element datasheet

Field Caption	Data Type	Description	Behavior and Usage	Datasheet/Tab
PVST Interval UOM	Character	The unit of measure associated with the value stored in the PVST Interval field.	On the datasheet, this field appears as a list labeled PVST Interval UOM . You can select a value in this list. This field is enabled only if the Partial Valve Stroke Testing check box is selected.	Final Element datasheet

Protective Instrument Loop Logic Solver

Protective Instrument Loop Final Element records store details about logic solvers for a protective instrument loop. The following table provides an alphabetical list and description of the fields that exist for the Protective Instrument Loop Logic Solver family and appear on the Protective Instrument Loop Logic Solver datasheet. The information in this table reflects the baseline state and behavior of these fields. This list is not comprehensive.

Field Caption	Data Type	Description	Behavior and Usage	Datasheet Tab
Approved Custom Device	Logical	Indicates whether or not the logic solver that is identified in the Exida Name field is approved for use in the protective instrument loop.	<p>This field appears as a check box labeled Approved Custom Device. This value is disabled and populated automatically by the Meridium APM system with one of the following values:</p> <ul style="list-style-type: none"> • If this value is <i>True</i>, it indicates the device is an approved device. • If this value is <i>False</i>, it indicates that the device is <i>not</i> an approved device. 	Logic Solver Details tab

Field Caption	Data Type	Description	Behavior and Usage	Datasheet Tab
Architectural Type	Character	Indicates the level of safety certification of the logic solver based on compliance with standard IEC 61508.	<p>If the value in the Manual Entry field is <i>False</i>, this value is disabled and populated automatically with one of the following values based on the device identified in the Exida Name field:</p> <ul style="list-style-type: none"> • A • B <p>If the value in the Manual Entry field is <i>True</i>, this field is enabled, and you can type a value directly into the Architectural Type cell.</p>	Logic Solver Details tab
Availability	Number	A number representing the percentage of time between proof tests that the logic solver is operating in the protective instrument loop.	This field appears as a text box labeled Availability . The Meridium APM system calculates this number automatically and displays it as read-only in the Availability text box.	Calculated Results section on the Logic Solver Details tab
Calculated PFD Avg	Number	A number representing the probability that the logic solver will fail.	This field appears as a text box labeled Calculated PFD Avg . The Meridium APM system calculates this number automatically and displays it as read-only in this cell.	Calculated Results section on the Logic Solver Details tab

Field Caption	Data Type	Description	Behavior and Usage	Datasheet Tab
Calculated PHF	Number	A number representing the calculated probability of failure per hour for the logic solver.	This field appears as a text box labeled Calculated PHF . The Meridium APM system calculates this number automatically and displays it as read-only in this cell.	Calculated Results section on the Logic Solver Details tab
Calculated STR	Number	A number representing the spurious trip rate for the logic solver.	This field appears as a text box labeled Calculated STR . The Meridium APM system calculates this number automatically and displays it as read-only in this cell.	Calculated Results section on the Logic Solver Details tab
Description	Character	A brief description of the logic solver.	You can type a value directly into the Description cell.	Logic Solver Details tab
Equipment	Character	The Record ID of the Equipment record to which the Protective Instrument Loop Logic Solver record is linked.	This field contains an  button, which you can click to search for the desired Equipment record.	Logic Solver Details tab
Exida Name	Character	The name of the logic solver device.	This field appears as a text box labeled Device Name and is disabled. This value is populated automatically.	Logic Solver Details tab

Field Caption	Data Type	Description	Behavior and Usage	Datasheet Tab
Functional Location	Character	The Record ID of the Functional Location record to which the Protective Instrument Loop Logic Solver record is linked.	This field contains an  button, which you can click to search for the desired Functional Location record.	Logic Solver Details tab
Logic Solver ID	Character	An ID for the logic solver.	You can type a value directly into the Logic SolverID cell. This value is required and must be unique.	Logic Solver Details tab
Manual Entry	Logical	Indicates whether you will enter data in a Protective Instrument Loop Logic Solver Channel record manually or the Meridium APM system will populate this value automatically.	This field appears as a check box labeled Manual Entry . If this value is <i>True</i> , the Add button in the Channels/Modules section on the Protective Instrument Loop page is enabled. You can use the Add button to add a Protective Instrument Logic Solver Channel record to the Protective Instrument Loop. If this value is <i>False</i> , the Add button is disabled.	Logic Solver Details tab

Field Caption	Data Type	Description	Behavior and Usage	Datasheet Tab
MTTFS	Number	A number representing <i>Mean Time To Fail Safe</i> for a logic solver (i.e., the average amount of time between logic solver failures that occur during safe scenarios).	This field appears as a text box labeled MTTFS . The Meridium APM system calculates this number automatically and displays it as read-only in this cell. This value is measured in years.	Calculated Results section on the Logic Solver Details tab
MTTR	Number	A number representing <i>Mean Time To Repair</i> , or the time it takes to repair the logic solver after a failure is detected.	You can type a number directly into the MTTR cell. The value that you enter must be between 4 and 336. Otherwise, an error message will appear. This value is required.	Logic Solver Details tab
Proof Test Coverage	Number	A number representing the percentage of failures that are detected by the proof test (i.e., how effectively the proof test identifies failures). For example, 100% proof test coverage indicates that the proof test would identify 100% of the failures that occurred.	You can type a number directly into the Proof Test Coverage cell. The number that you enter must be between 0 and 100. Otherwise, an error message will appear. This value is required.	Logic Solver Details tab

Field Caption	Data Type	Description	Behavior and Usage	Datasheet Tab
Proof Test Interval	Number	A number representing the monthly intervals at which the proof test should be performed.	You can type a number directly into the Proof Test Interval cell. The number that you enter must be between <i>1</i> and <i>360</i> , or an error message will appear. This value is required.	Logic Solver Details tab
Reference Data Date	Date	The date on which that the reference data was published for the device that is identified in the Exida Name field.	<p>This field appears as a text box labeled Reference Data Date and displays the Calendar feature.</p> <p>When the value in the Manual Entry field is <i>True</i>, this field is enabled, and you can select a date manually. When the value in the Manual Entry field is <i>False</i>, this value is disabled and populated automatically with the date on which the reference data was published for the device that is identified in the Exida Name field.</p>	Failure Data Reference tab

Field Caption	Data Type	Description	Behavior and Usage	Datasheet Tab
Reference Data Reference	Character	The specific failure data reference as it appears in the Exida data source that is identified in the Reference Data Source field.	<p>This field appears as a text box labeled Reference Data Reference.</p> <p>When the value in the Manual Entry field is <i>True</i>, this value is enabled, and you can type a value directly into the Reference Data Reference cell.</p> <p>When the value in the Manual Entry field is <i>False</i>, this field is populated automatically with the data reference for the device that is identified in the Exida Name field and displayed as read-only in this cell.</p>	Failure Data Reference tab
Reference Data Revision	Character	A number that represents the number of times the reference data has been revised in the Exida database.	<p>This field appears as a text box labeled Reference Data Revision.</p> <p>When the value in the Manual Entry field is <i>True</i>, this value is enabled, and you can type a value directly into the Reference Data Revision cell.</p> <p>When the value in the Manual Entry field is <i>False</i>, this field is populated automatically with the data revision for the device identified in the Exida Name field and is displayed as read-only in this cell.</p>	Failure Data Reference tab

Field Caption	Data Type	Description	Behavior and Usage	Datasheet Tab
Reference Data Source	Character	The source of the reference data (e.g., Exida).	<p>This field appears as a text box labeled Reference Data Source.</p> <p>When the value in the Manual Entry field is <i>True</i>, this value is enabled, and you can type a value directly into the Reference Data Source cell.</p> <p>When the value in the Manual Entry field is <i>False</i>, this field is populated automatically with the data source for the device identified in the Exida Name field and is displayed as read-only in this cell.</p>	Failure Data Reference tab
SIL Architectural Constraints	Number	A number that represents the SIL value for the logic solver, which is based on the architectural constraints that are defined in the Test Architecture Constraints field.	This field appears as a text box labeled SIL Architectural Constraints . The Meridium APM system calculates this number automatically and displays it as read-only in this cell.	Calculated Results section on the Logic Solver Details tab



Field Caption	Data Type	Description	Behavior and Usage	Datasheet Tab
SIL Systematic Capability	Number	A number that represents the SIL value for the logic solver which is based on the systematic capabilities that are defined in the failure rate data.	<p>This field appears as a text box labeled SIL Systematic Capabilities and is enabled or disabled based upon the following criteria:</p> <ul style="list-style-type: none"> • When the value in the Manual Entry field is <i>True</i>, the SIL Systematic Capabilities field is enabled, and you can't type a value directly into the SIL Systematic Capabilities cell. • When the value in the Manual Entry field is <i>False</i>, the Meridium APM system calculates the number automatically, based on the systematic capabilities that are defined in the failure rate data associated with the logic solver device, and displays one of the following values as read-only in the SIL Systematic Capability field: <ul style="list-style-type: none"> ◦ 0 (zero) ◦ 1 ◦ 2 ◦ 3 ◦ 4 	Calculated Results section on the Logic Solver Details tab

Safety Instrumented System

Safety Instrumented System records store details about the safety instrumented system they represent. The following table provides an alphabetical list and description of the fields that exist for the Safety Instrumented System family and appear on the Safety Instrumented System datasheet, unless otherwise specified. The information in this table reflects the baseline state and behavior of these fields. This list is not comprehensive.

Field Caption	Data Type	Description	Behavior and Usage
Abnormal Mode Description	Text	A detailed description of the abnormal mode of operation.	On the datasheet, this field appears as a text box labeled Abnormal Mode Description and contains a <input type="button" value="..."/> button, which you can click to access the Text Editor. This field is enabled only if ABNORMAL is selected in the Operation Modes list. Otherwise, this field is disabled.
Abnormal State	Character	A short description of the specific abnormal state of the operation.	On the datasheet, this field appears as a list labeled Abnormal State and contains the following values: <ul style="list-style-type: none"> • Start-Up • Shutdown • Bypass • Maintenance • Emergency • Other This field is enabled and required only if ABNORMAL is selected in the Plant Operation Mode list. Otherwise, this field is disabled.

Field Caption	Data Type	Description	Behavior and Usage
Communication Links	Character	The type of communication link that exists between components within the logic solver and any other network device. For example, <i>Ethernet</i> .	On the datasheet, this field appears as a text box labeled Communication Links , in which you can enter your own value.
Is Default SIS	Logical	Indicates whether the Safety Instrumented System record is the default.	This field does not appear on the datasheet by default.
Last Modified By	Character	The name of the user who last modified the record.	On the datasheet, this field is disabled and updated automatically whenever the record is modified.
Last Modified Date	Date	The date on which the record was last modified.	On the datasheet, this field is disabled and populated automatically.
Logic Solver ID	Character	The ID for the logic solver that is associated with the safety instrumented system.	On the datasheet, this field appears as a text box labeled Logic Solver ID , in which you can type your own value. This value should correspond to the value stored in the Logic Solver ID field in the Protective Instrument Loop Logic Solver record that represents the desired logic solver.

Field Caption	Data Type	Description	Behavior and Usage
Logic Solver Type	Character	The type of logic solver.	<p>On the datasheet, this field appears as a list labeled Logic Solver Type and contains the following baseline System Codes in the MI_LOGIC_SOLVER_TYPE System Code Table :</p> <ul style="list-style-type: none"> • PLC • BPCS • Relay
Long Description	Text	A statement describing the purpose of the safety instrumented system.	<p>On the datasheet, this field appears as a text box labeled Long Description and contains a  button, which you can click to access the Text Editor.</p>
Manual Shut-down Description	Text	A description of the method by which the safety instrumented system can be manually shut down.	<p>On the datasheet, this field appears as a text box labeled Manual Shut-down Description and contains a  button, which you can click to access the Text Editor.</p>
Mission Time	Number	A numeric value in years that represents the time that the safety instrumented system will be in use before it is replaced or remanufactured.	<p>On the datasheet, this field appears as a text box labeled Mission Time with an additional label, Years, to the right of the text box. You can enter your own value directly in the Mission Time cell. This value should be equal to or greater than the length of time specified in the Target SIS Test Interval field.</p>



Field Caption	Data Type	Description	Behavior and Usage
Operation Mode	Character	The mode of operation for the safety instrumented system.	<p>On the datasheet ,this field appears as a list labeled Plant Operation Mode and contains the following values:</p> <ul style="list-style-type: none"> • NORMAL: This is the value that is selected by default. • ABNORMAL: If you select this value, the following fields are enabled: <ul style="list-style-type: none"> • Abnormal State • Abnormal Mode Description
Plant ID	Character	The ID of the plant in which the safety instrumented system exists.	This field does not appear on the datasheet by default.
Power Source	Character	A description of the power supply to the safety instrumented system.	On the datasheet, this field appears as a text box labeled Power Source , in which you can enter your own value.
Reset Procedure	Text	A description of the method by which the safety instrumented system can be reset.	On the datasheet, this field appears as a text box labeled Reset Procedure and contains a  button, which you can click to access the Text Editor.
SIS Description	Character	A description for the safety instrumented system.	On the datasheet, this field appears as a text box labeled SIS Description , in which you can enter your own value.

Field Caption	Data Type	Description	Behavior and Usage
SIS ID	Character	A name for the safety instrumented system.	On the datasheet, this field appears as a text box labeled SIS ID , in which you can enter your own value. This field is required, and a rule exists on the field that checks to see if the value that you enter is unique. If the value that you enter is already specified for an existing Safety Instrumented System record, a message will appear, indicating that the value is already in use. You will need to specify a different value before you can save the record.
Site Description	Character	A description of the site that is specified in the Site ID field.	This field does not appear on the datasheet by default.
Site ID	Character	The ID of the Site record associated with the safety instrumented system.	On the datasheet, this field is disabled and populated automatically with the value stored in the Site ID field in the associated SIL Analysis record. You should not modify this value.
Target SIS Test Interval	Number	A number that represents the interval in months by which regular testing will be performed on the safety instrumented system.	On the datasheet, this field appears as a text box labeled Target SIS Test Interval , in which you can enter your own value.
Unit Description	Character	A description of the unit specified in the Unit ID field.	This field does not appear on the datasheet by default.

Field Caption	Data Type	Description	Behavior and Usage
Unit ID	Character	A description of the area in which the safety instrumented system exists.	On the datasheet, this field appears as a text box labeled Unit ID , in which you can enter your own value.

SIF Common Cause Failure

SIF Common Cause Failure records store details about a failure or a condition within a plant that can affect the operation of multiple instrumented functions (i.e., common cause failures). The following table provides an alphabetical list and description of the fields that exist for the SIF Common Cause Failure family and appear on the SIF Common Cause Failures datasheet. The information in the table reflects the baseline state and behavior of these fields.

Field Caption	Data Type	Description	Behavior and Usage
CCF Description	Text	The description of the common cause failure.	This field is required. On the SIF Common Cause Failure datasheet, you can click the  button to define this value manually via the CCF Description dialog box.
CCF ID	Character	The ID for the common cause failure.	This field is required. On the Common Cause Failures tab on the <Record ID> (Instrumented Function) window, this value appears as a hyperlink, which you can click to view the contents of the corresponding SIF Common Cause Failure record in a new window.
CCF Mitigation	Text	A brief description of ways to mitigate the effect of the common cause failure.	This field is required. On the SIF Common Cause Failure datasheet, you can click the  button to define this value manually via the CCF Mitigation dialog box.

SIL Analysis

SIL Analysis records store details about an SIL Analysis. The following table provides an alphabetical list and description of the fields that exist for the SIL Analysis family. The information in this table reflects the baseline state and behavior of these fields. This list is not comprehensive.

Note: The field captions that are displayed in the following table may differ from the datasheet captions.

Field Caption	Data Type	Description	Behavior and Usage	Datasheet/Tab
Analysis Description	Character	A brief description for the SIL Analysis.	You can type your own value manually.	SIL Analysis tab on the SIL Analysis datasheet
Analysis End Date	Date	The date on which the SIL Analysis will end.	You can type or select the desired date. The start date must be later than the date in the Analysis Start Date field, or an error message will appear. When you copy a SIL Analysis record, the value in this field is not copied to the new record.	SIL Analysis tab on the SIL Analysis datasheet

Field Caption	Data Type	Description	Behavior and Usage	Datasheet/Tab
Analysis ID	Character	The ID for the SIL Analysis.	You can type your own value manually. This field is required, and the value you enter must be unique with respect to the Analysis ID in other SIL Analysis records. Note that if you open an existing SIL Analysis record and delete the value in the Analysis ID field, if you then retype that same value and try to save the record, an error message will appear indicating that the Analysis ID already exists.	SIL Analysis tab on the SIL Analysis datasheet

Field Caption	Data Type	Description	Behavior and Usage	Datasheet/Tab
Analysis Re-evaluation	Number	A number indicating how many years after the completion of the Hazards Analysis that is associated with the SIL Analysis that the Hazards Analysis should be re-evaluated.	<p>On the datasheet, this field appears as a text box that is labeled Hazards Next Reevaluation Interval with an additional label, Years, to the right of the text box. If the SIL Analysis record <i>is</i> linked to a Hazards Analysis record, this field is populated automatically with the value in the Reevaluation Interval field in the Hazards Analysis record that is linked to the SIL Analysis record.</p> <p>If the SIL Analysis record is <i>not</i> linked to a Hazards Analysis record, this field is enabled and you can populate it <i>manually</i>.</p>	SIL Analysis tab on the SIL Analysis datasheet
Analysis Start Date	Date	The date on which the SIL Analysis will begin.	<p>You can type or select the desired date. The analysis end date must be earlier than the date in the Analysis Start Date field, or an error message will appear.</p> <p>When you copy an SIL Analysis record, this field is populated automatically with the current date.</p>	SIL Analysis tab on the SIL Analysis datasheet

Field Caption	Data Type	Description	Behavior and Usage	Datasheet/Tab
Equipment ID	Character	The ID for the Equipment record that is linked to the SIL Analysis.	<p>On the datasheet, this field is disabled and contains a  button, which you can click to search for an existing Equipment record to link to the SIL Analysis record. After you select an Equipment record, the Equipment ID field is populated automatically with the ID stored in the corresponding Equipment record.</p> <p>The Equipment ID value appears as a hyperlink, which displays in a new window the Equipment record with that ID. The selected Equipment record should represent the equipment for which the SIS exists to mitigate the risk of failure on that equipment.</p> <p>When you copy an SIL Analysis record, the value in this field is <i>not</i> copied.</p>	SIL Analysis tab on the SIL Analysis datasheet
EquipmentKey	Number	The Entity Key of the Equipment record that is linked to the SIL Analysis record.	This field does not appear on the SIL Analysis datasheet by default.	None

Field Caption	Data Type	Description	Behavior and Usage	Datasheet/Tab
Facilitator	Character	The name of the SIL Analysis team member who is specified as the Facilitator on the SIL Analysis Team page.	This field does not appear on the SIL Analysis datasheet by default.	None



Field Caption	Data Type	Description	Behavior and Usage	Datasheet/Tab
Functional Location ID	Character	The ID for the Functional Location record that is linked to the SIL Analysis record.	<p>On the datasheet, this field is disabled and contains a  button, which you can click to search for an existing Functional Location record to link to the SIL Analysis record. After you select a Functional Location record, the Functional Location ID field is populated automatically with the ID from the corresponding Functional Location record.</p> <p>The Functional Location ID appears as a hyperlink, which displays in a new window the Functional Location record with that ID. The selected Functional Location record should represent the location for which the SIS exists to mitigate the risk of failure on that location.</p> <p>When you copy an SIL Analysis record, the value in this field is <i>not</i> copied.</p>	SIL Analysis tab on the SIL Analysis datasheet



Field Caption	Data Type	Description	Behavior and Usage	Datasheet/Tab
Functional Location Key	Number	The Entity Key of the Functional Location record that is linked to the SIL Analysis record.	This field does not appear on the SIL Analysis datasheet by default.	None
Hazards Analysis Date	Date	The value that exists in the Last Modified Date field in the Hazards Analysis record whose record ID appears in the Hazards Analysis Reference field.	If the SIL Analysis record <i>is</i> linked to a Hazards Analysis record, this field is populated automatically with the value in the Last Modified Date field in that Hazards Analysis record. If the SIL Analysis record is <i>not</i> linked to a Hazards Analysis record, this field is enabled, and you can populate it <i>manually</i> .	SIL Analysis tab on the SIL Analysis datasheet





Field Caption	Data Type	Description	Behavior and Usage	Datasheet/Tab
Hazards Analysis Reference	Character	The ID of the Hazards Analysis record that is linked to the SIL Analysis record.	<p>On the datasheet, this field is disabled and contains a  button, which you can click to search for an existing Hazards Analysis record to link to the SIL Analysis record. After you select the Hazards Analysis record, the Hazards Analysis Reference field is populated automatically with the Record ID from the corresponding Hazards Analysis record.</p> <p>The Hazards Analysis ID appears as a hyperlink, which opens in a new window the Hazards Analysis record with that ID.</p> <div style="border: 1px solid yellow; padding: 5px; margin-top: 10px;"> <p>Note: In order to link a Hazards Analysis record to an SIL Analysis record, you must have at least View privileges to the Hazards Analysis family.</p> </div>	SIL Analysis tab on the SIL Analysis datasheet
Hazards Analysis Reference Key	Number	The Entity Key for the Hazards Analysis record that is linked to the SIL Analysis record.	This field does not appear on the SIL Analysis datasheet by default.	None



Field Caption	Data Type	Description	Behavior and Usage	Datasheet/Tab
Hazards Analysis Revision	Character	The numeric value that exists in the Revision Number field in the Hazards Analysis record whose Record ID appears in the Hazards Analysis Reference field.	If the SIL Analysis <i>is</i> linked to a Hazards Analysis record, this field is populated automatically with the value in the Revision Number field in that Hazards Analysis record. If the SIL Analysis record is <i>not</i> linked to a Hazards Analysis record, this field is enabled, and you can populate it <i>manually</i> .	SIL Analysis tab on the SIL Analysis datasheet
Hazards Re-evaluation Date	Date	The date on which the Hazards Analysis that is associated with the SIL Analysis should be re-evaluated.	<p>This field is populated automatically with the output of the following calculation:</p> <p>Hazards Re-evaluation Date = Hazards Analysis Date + Analysis Re-evaluation</p> <p>If the SIL Analysis record is <i>not</i> linked to a Hazards Analysis record (i.e., the record from which the values in the calculation shown above are mapped), this field is enabled, and you can populate it <i>manually</i>.</p> <p>On the datasheet, this field is labeled HAZOPS Re-evaluation Date.</p>	SIL Analysis tab on the SIL Analysis datasheet





Field Caption	Data Type	Description	Behavior and Usage	Datasheet/Tab
HAZOP State	Character	The current state of the Hazards Analysis record that is linked to the SIL Analysis record.	If the SIL Analysis record <i>is</i> linked to a Hazards Analysis record, this field is populated automatically with the state of that Hazards Analysis record. If the SIL Analysis record is <i>not</i> linked to a Hazards Analysis record, this field is enabled, and you can populate it <i>manually</i> .	SIL Analysis tab on the SIL Analysis datasheet
Is Deleted	Logical	Specifies whether the SIL Analysis record has been removed from the SIL Analysis Search page .	The value in this field is used by the Meridium APM system. You should not modify this value. This field does not appear on the SIL Analysis datasheet by default.	None
Last Modified By	Character	The name of the Meridium APM Security User who last modified the record.	This field is disabled and populated automatically with the name of the user who was logged in when the record was last modified. When you copy an SIL Analysis record, the value in this field is <i>not</i> copied.	SIL Analysis tab on the SIL Analysis datasheet
Last Modified Date	Date	The date on which the record was last modified.	This field is disabled and populated automatically. When you copy an SIL Analysis record, the value in this field is <i>not</i> copied.	SIL Analysis tab on the SIL Analysis datasheet





Field Caption	Data Type	Description	Behavior and Usage	Datasheet/Tab
Long Description	Text	A detailed explanation of the SIL Analysis that you want to conduct.	On the datasheet, this field contains a  button, which you can click to access the Text Editor.	SIL Analysis tab on the SIL Analysis datasheet
Loss of SIS Energy Sources	Text	A description of how the safety instrumented system responds to a loss of energy.	On the datasheet, the field appears as a text box labeled Loss of Energy Sources , and the value is set by default. You can remove the default text and type your own values. This field contains a  button, which you can click to view the Text Editor.	General SIS Requirements tab on the SIL Analysis datasheet
Normal Operation Requirement	Text	A description of the requirements for the normal mode of the instrumented function.	The value in this field is set by default. You can remove the default value and type your own values. This field contains a  button, which you can click to view the Text Editor.	Safety Requirement Specifications tab on the SIL Analysis datasheet
Owner	Character	The name of the SIL Analysis team member who is specified as the Process Owner on the SIL Analysis Team Members page.	This field is disabled and populated automatically with the first and last name of the team member as it appears in the First Name and Last Name fields in the user's Human Resource record.	SIL Analysis tab on the SIL Analysis datasheet



Field Caption	Data Type	Description	Behavior and Usage	Datasheet/Tab
Process Owner	Character	The name of the SIL Analysis team member who is specified as the Process Owner on the SIL Analysis Team Members page.	This value is used to populate the Owner field and does not appear on the SIL Analysis datasheet by default.	None
Requirement for SRS Review	Text	A description of the requirement for the safety requirement review.	The value in this field is set by default. You can remove the default value and type your own values. This field contains a  button, which you can click to view the Text Editor.	Safety Requirement Specifications tab on the SIL Analysis datasheet
SIF Bypass Requirements	Text	A description of the bypass requirements for the instrumented function.	The value in this field is set by default. You can remove the default value and type your own values. This field contains a  button, which you can click to access the Text Editor.	General SIF Requirements tab on the SIL Analysis datasheet
SIF Common Cause Sources	Text	A description of the sources for common cause failures in instrumented functions.	The value in this field is set by default. You can remove the default value and type your own values. This field contains a  button, which you can click to access the Text Editor.	General SIF Requirements tab on the SIL Analysis datasheet

Field Caption	Data Type	Description	Behavior and Usage	Datasheet/Tab
SIF Demand Mode of operation	Text	A description of the demand mode associated with an instrumented function.	The value in this field is set by default. You can remove the default value and type your own values. This field contains a  button, which you can click to access the Text Editor.	General SIF Requirements tab on the SIL Analysis datasheet
SIF Diagnostics	Text	A description of component diagnostics for an instrumented function.	The value in this field is set by default. You can remove the default value and type your own values. This field contains a  button, which you can click to access the Text Editor.	General SIF Requirements tab on the SIL Analysis datasheet
Emergency Requirement	Text	A description of the requirement for an instrumented function in the case of emergency.	The value in this field is set by default. You can remove the default value and type your own values. This field contains a  button, which you can click to access the Text Editor.	General SIF Requirements tab on the SIL Analysis datasheet
SIF Failure Modes	Text	A description of the configuration of instrumented function failure modes.	The value in this field is set by default. You can remove the default value and type your own values. This field contains a  button, which you can click to access the Text Editor.	General SIF Requirements tab on the SIL Analysis datasheet





Field Caption	Data Type	Description	Behavior and Usage	Datasheet/Tab
SIF Manual Shutdown	Text	A description of the manual shutdown operation for an instrumented function.	The value in this field is set by default. You can remove the default value and type your own values. This field contains a  button, which you can click to access the Text Editor.	General SIF Requirements tab on the SIL Analysis datasheet
SIF Maintenance Overrides	Text	A description of the manual override procedures needed for maintenance on an instrumented function.	The value in this field is set by default. You can remove the default value and type your own values. This field contains a  button, which you can click to access the Text Editor.	General SIF Requirements tab on the SIL Analysis datasheet
SIF Pre-Alarms	Text	A description of the pre-alarms for an instrumented function.	The value in this field is set by default. You can remove the default value and type your own values. This field contains a  button, which you can click to access the Text Editor.	General SIF Requirements tab on the SIL Analysis datasheet
SIF Process Interfaces	Text	A description of process interfaces for instrumented functions.	The value in this field is set by default. You can remove the default value and type your own values. This field contains a  button, which you can click to access the Text Editor.	General SIF Requirements tab on the SIL Analysis datasheet

Field Caption	Data Type	Description	Behavior and Usage	Datasheet/Tab
SIF Proof Test Procedures	Text	A detailed description of the proof test procedures associated with an instrumented function.	The value in this field is set by default. You can remove the default value and type your own values. This field contains a  button, which you can click to access the Text Editor.	General SIF Requirements tab on the SIL Analysis datasheet
SIF Protection Mode	Text	A description of the way in which the instrumented function will respond in protection mode.	The value in this field is set by default. You can remove the default value and type your own values. This field contains a  button, which you can click to access the Text Editor.	General SIF Requirements tab on the SIL Analysis datasheet
SIF Regulations and Standards	Text	A description of all the regulations and standards associated with an instrumented function.	The value in this field is set by default. You can remove the default value and type your own values. This field contains a  button, which you can click to access the Text Editor.	General SIF Requirements tab on the SIL Analysis datasheet
SIF Spurious Trip Rate	Txt	A description of the acceptable spurious trip rate for an instrumented function.	The value in this field is set by default. You can remove the default value and type your own values. This field contains a  button, which you can click to access the Text Editor.	General SIF Requirements tab on the SIL Analysis datasheet

Field Caption	Data Type	Description	Behavior and Usage	Datasheet/Tab
SIF Trip Reset	Text	A description of the reset procedures in the case of a tripped instrumented function.	The value in this field is set by default. You can remove the default value and type your own values. This field contains a  button, which you can click to access the Text Editor.	General SIF Requirements tab on the SIL Analysis datasheet
SIS Design Requirements	Text	A description of the design requirements for the safety instrumented system.	The value in this field is set by default. You can remove the default value and type your own values. This field contains a  button, which you can click to access the Text Editor.	General SIF Requirements tab on the SIL Analysis datasheet
SIS Electrical Power	Text	A description of the specific electrical requirements for the safety instrumented system.	The value in this field is set by default. You can remove the default value and type your own values. This field contains a  button, which you can click to access the Text Editor.	General SIF Requirements tab on the SIL Analysis datasheet
SIS Environmental Conditions	Text	A description of the environmental operating conditions of the safety instrumented system.	The value in this field is set by default. You can remove the default value and type your own values. This field contains a  button, which you can click to access the Text Editor.	General SIF Requirements tab on the SIL Analysis datasheet

Field Caption	Data Type	Description	Behavior and Usage	Datasheet/Tab
SIS Interfaces	Text	A description of the interfaces for the safety instrumented system.	The value in this field is set by default. You can remove the default value and type your own values. This field contains a  button, which you can click to access the Text Editor.	General SIF Requirements tab on the SIL Analysis datasheet
Logic Solver Failure Response	Text	A description of how the logic solver responds to a failure.	The value in this field is set by default. You can remove the default value and type your own values. This field contains a  button, which you can click to access the Text Editor.	General SIF Requirements tab on the SIL Analysis datasheet
SIS Sequence of Events Recording	Text	A description of sequence of event recordings that exist for the safety instrumented system.	This field is populated automatically. You can remove the default value and type your own values if needed. On the datasheet, the SIS Sequence of Events Recording text box contains a  button, which you can click to access the Text Editor.	General SIF Requirements tab on the SIL Analysis datasheet

Field Caption	Data Type	Description	Behavior and Usage	Datasheet/Tab
SIS Software Requirements	Text	A description of the software programming languages that are permitted for use.	This field is populated automatically. You can remove the default value and type your own values if needed. On the datasheet, the SIS Software Requirements text box contains a <input type="button" value="..."/> button, which you can click to access the Text Editor.	General SIF Requirements tab on the SIL Analysis datasheet
Site Description	Character	A description of the site specified in the Site ID field.	This field does not appear on the SIL Analysis datasheet by default.	None
Site ID	Character	The ID of the site associated with the SIL Analysis.	On the datasheet, this field appears as a list labeled Site ID and contains IDs for existing Site Reference records as they appear in the Name field in the associated Site Reference record. The record that you select here is used to identify which risk matrix to display when you create Risk Assessment records in SIS Management. If this field is empty, the default risk matrix will be used.	SIL Analysis tab on the SIL Analysis datasheet

Field Caption	Data Type	Description	Behavior and Usage	Datasheet/Tab
SRS Methodology	Text	A long description of the methodology for the Safety Requirement Specification report.	The value in this field is set by default. You can remove the default value and type your own values. This field contains a  button, which you can click to access the Text Editor.	Safety Requirement Specifications tab on the SIL Analysis datasheet
SRS Purpose and Scope	Text	A long description of the purpose and scope of the Safety Requirement Specification report for the SIL Analysis.	The value in this field is set by default. You can remove the default value and type your own values. This field contains a  button, which you can click to access the Text Editor.	Safety Requirement Specifications tab on the SIL Analysis datasheet
SRS Standards Use	Text	A description of the standards that are used within the Safety Requirement Specification report.	The value in this field is set by default. You can remove the default value and type your own values. This field contains a  button, which you can click to access the Text Editor.	Safety Requirement Specifications tab on the SIL Analysis datasheet
System Definition	Text	A description of the safety instrumented system.	The value in this field is set by default. You can remove the default value and type your own values. This field contains a  button, which you can click to access the Text Editor.	General SIF Requirements tab on the SIL Analysis datasheet
Unit Description	Character	A description of the unit that is specified in the Unit ID field.	This field does not appear on the SIL Analysis datasheet by default.	None

Field Caption	Data Type	Description	Behavior and Usage	Datasheet/Tab
Unit ID	Character	The ID for the unit where the safety instrumented system for which you are conducting the SIL Analysis exists.	On the datasheet, this field appears as a text box labeled Unit ID , in which you can type your own value.	SIL Analysis tab on the SIL Analysis datasheet

SIS Proof Test

SIS Proof Test records store details about a proof test that is executed, including the results of the proof test. The following table provides an alphabetical list and description of the fields that exist for the SIS Proof Test family and appear on the SIS Proof Test datasheet, unless otherwise specified. The information in the table reflects the baseline state and behavior of these fields.

Field Caption	Data Type	Description	Behavior and Usage
Cleared All Bypasses and Forced Logic	Logical	Indicates whether or not you have cleared all bypasses and forced logic while performing the proof test.	On the datasheet, this field appears as a check box labeled Cleared All Bypasses and Forced Logic , which you can <i>select</i> to specify that you have cleared all bypasses and forced logic while performing the proof test.
Commencement Date	Date	The date on which you began performing the proof test.	On the datasheet, this field appears as a text box, where you can type or select the desired date and time.
Completion Date	Date	The date on which you completed the proof test.	On the datasheet, this field appears as a text box, where you can type or select the desired date and time.

Field Caption	Data Type	Description	Behavior and Usage
Equipment Operating State	Character	The current state of the equipment that you are testing.	<p>On the datasheet, this field appears as a list labeled Equipment Operating State and contains the System Codes that exist in the MI_EQUIP_OP_STATE System Code Table. You can choose from the following baseline values:</p> <ul style="list-style-type: none"> • On-Line (ON-LINE) • Off-Line (OFF-LINE) • Not Applicable (NA)
Functional Test Closed	Logical	A value that indicates whether or not the proof test has been completed.	<p>On the datasheet, this field appears as a check box labeled Functional Test Closed, which you can <i>select</i> to specify that you are finished with the proof test, meaning it is closed. When you select this check box, all fields on the SIS Proof Test datasheet become disabled automatically.</p>

Field Caption	Data Type	Description	Behavior and Usage
Functional Test Status	Character	Stores the current status of the proof test.	<p>On the datasheet, this field appears as a list labeled Functional Test Status and contains the System Codes that exist in the MI_FUNCTIONAL_TEST_STATUS System Code Table. You can choose from the following baseline values:</p> <ul style="list-style-type: none"> • Active • Complete • Closed
Functional Test Template	Character	The Record ID of the SIS Proof Test Template record that was used to create the SIS Proof Test record.	<p>On the datasheet, this field appears as a list labeled Functional Test Template and contains a list of Record IDs for the existing SIS Proof Test Template records. When you create an SIS Proof Test record, this field is required. After you select an SIS Proof Test record in the list and save the record, the field is disabled.</p>

Field Caption	Data Type	Description	Behavior and Usage
SIS Tester Name	Character	The name of the user who is responsible for performing the proof test.	<p>On the datasheet, this field appears as a list labeled SIS Tester Name and contains the names of the:</p> <ul style="list-style-type: none"> • Security User who created the SIS Proof Test record. <p>-and-</p> <ul style="list-style-type: none"> • Members of the MI SIS Administrator, MI SIS Engineer, or MI SIS User Security Groups.
Task Addressed	Number	The Record ID of the Inspection Task record that is addressed by the proof test.	<p>On the datasheet, this field appears as a list labeled Task Addressed and contains the Record IDs of the Inspection Task records that are linked to the Instrumented Function record or Safety Instrumented System record to which the SIS Proof Test record is linked.</p>
Test Description	Character	A description of the proof test.	<p>On the datasheet, this field appears as a text box labeled Test Description, in which you can enter your own value.</p>

Field Caption	Data Type	Description	Behavior and Usage
Test ID	Character	The ID for the proof test.	On the datasheet, this field appears as a text box labeled Test ID , in which you can enter your own value.
Test Summary	Text	A summary of the proof test that was performed.	On the datasheet, this field appears as a text box labeled Test Summary and contains a  button, which you can click to access the Text Editor.
Type of Test	Character	The type of proof test that you performed.	On the datasheet, this field appears as a list labeled Type of Test and contains the following baseline values: <ul style="list-style-type: none"> • Functional Test • System Validation
SIS Or PIF Key	Number	The Entity Key of the Instrumented Function record or Safety Instrumented System record to which the SIS Proof Test record is linked.	This field does not appear on the datasheet by default.

SIS Proof Test Template

The following table provides a list of the fields that exist in the SIS Proof Test Template family.

Field Caption	Data Type	Description	Behavior and Usage
Author	Character	The name of the user who defined the proof test.	On the datasheet, this field appears as a list labeled Author and contains the names of users who have an associated Human Resource record in the Meridium APM database. When you create an SIS Proof Test Template record, by default, this field contains the name of the user who is currently logged.
Modified By	Character	The name of the user who was logged in when the SIS Proof Test Template record was last modified.	On the datasheet, this field is disabled and populated automatically.
Modified Date	Date	The date on which the SIS Proof Test Template record was last modified.	On the datasheet, this field is disabled and populated automatically.
Pre-Test Conditions	Text	A description of the required conditions of the equipment or system on which the proof test will be performed.	On the datasheet, this field appears as a text box labeled Pre-Test Conditions and contains a  button, which you can click to access the Text Editor.
Template Description	Character	A brief description of the proof test.	On the datasheet, this field appears as a text box labeled Template Description , in which you can enter your own value.

Field Caption	Data Type	Description	Behavior and Usage
Template ID	Character	The ID for the proof test template.	On the datasheet, this field appears as a text box labeled Template ID , in which you can enter your own value. When you create an SIS Proof Test Template record, this field is populated automatically with <i>PPT</i> and the current date and time. You can remove the default value and enter your own value directly in the Template ID cell.

SIS Proof Test Template Detail

The following table provides a list of the fields that exist in the SIS Proof Test Template Detail family. This list is not comprehensive.

Field Caption	Data Type	Description	Behavior and Usage
Equipment ID	Character	The Record ID of the Equipment record against which the step should be performed.	You can select the associated Equipment record by clicking the <input type="text" value="..."/> in the Equipment ID field.
Location ID	Character	The Record ID of the Functional Location record against which the step should be performed.	You can select the associated Functional Location record by clicking the <input type="text" value="..."/> in the Location ID field.
Result Criteria	Text	A description of what is considered to be an acceptable result of the step.	None
Step Sequence Number	Number	A number that represents the order in which the step should be performed, relative to other steps.	When you create a new SIS Proof Test Template Detail record this value is set automatically based upon the values in existing SIS Proof Test Template Detail records. You can modify this value manually in both new and existing records.
Step Type	Character	The type of step.	On the datasheet, you can select the step type from a list of the following options: <ul style="list-style-type: none"> • Pretest Setup • Sensor • Logic Solver • Final Element • Post Test Procedure

Field Caption	Data Type	Description	Behavior and Usage
Template Detail ID	Character	An alphanumeric value that identifies the SIS Proof Test Template Detail record.	None
Travel Time Limit	Number	A number that quantifies the maximum acceptable travel time for this step, in seconds.	This field is enabled only in SIS Proof Test Template Detail records that are linked to records representing final elements.
Trip Point	Number	A number that defines when the element will activate an SIS shutdown.	This field is enabled only in SIS Proof Test Template Detail records that are linked to records representing sensors, final elements, or logic solvers.
Trip Point Direction	Character	The trend of Trip Point values.	This field is enabled only in SIS Proof Test Template Detail records that are linked to records representing sensors, final elements, or logic solvers.
Trip Point Error Limit	Number	A value that defines the range, plus or minus, within which the Trip Point value must fall to be acceptable.	This field is enabled only in SIS Proof Test Template Detail records that are linked to records representing sensors, final elements, or logic solvers.
Trip Point Units	Character	The unit of measure associated with the value in the Trip Point field.	This field is populated with a list of System Codes that exist in the UOME System Code table. This field is enabled only in SIS Proof Test Template Detail records that are linked to records representing sensors, final elements, or logic solvers.

System Code Tables Used by SIS Management

The following table provides an alphabetical list and description of the System Code Tables that are used by the SIS Management module. This list is not comprehensive.

System Code Table Description	System Code Table ID	Notes
LOPA IPL TYPE	MI_IPL_TYPE	Used to populate the Type field in Independent Layer of Protection records.
SIL Assessment Method	MI_SIL_ASSESSMENT_METHOD	Used to populate the SIL Assessment Method field in Instrumented Function records.
SIL FinalElement Vote	MI_SIL_FINAL_ELEMVOTE	Used to populate the Voting field in Protective Instrument Loop Group records when the group type is Final Element.
SIL Sensor Vote	MI_SIL_SENSORVOTE	Used to populate the Voting field in Protective Instrument Loop Group records when the group type is Sensor.
Unit of Measure	UOME	Used to populate Trip Point Units field in SIS Proof Test Template Detail record.

Parameters for the SIS Management URL

There is one root URL associated with SIS Management: **meridium://SIS**. A link constructed from the path alone will open the **SIS Management Start Page**. In addition, you can use any of the parameters described in the following table.

Parameter Name	Description	Accepted Value(s)	Notes
Page	Specifies the page that you want to view.	Search Definition Team Documents SIS PIF SILValidation SILValidationView LopaDefinition LopaModifiers HealthIndicator PTemplateList ProofTestList ReferenceDataList ReferenceData Admin	<p>The Page parameter is required.</p> <p>Displays the <Family> Search page, where <Family> specifies the family of the records for which you can search using the page (e.g., Protective Loop Search page). The family is determined by the Module or AnalysisType parameter value.</p> <p>If no Module or AnalysisType parameter is provided in the URL, SIL Analysis Search page will be displayed.</p> <p>Displays a new or existing record on the <Family> Definition page, where <Family> specifies the family to which the record belongs. The family is determined by the Module or AnalysisType parameter.</p> <p>If the EntyKey parameter is included in the URL, the page will display the existing record with the specified Entity Key. If, however, the EntyKey parameter is omitted from the URL, the page will display a <i>new</i> record in the family identified by the Module or AnalysisType parameter value.²</p> <p>If no Module or AnalysisType parameter is provided in the URL, you will need to provide additional parameters to...</p> <ul style="list-style-type: none"> Specify to relationship

Parameter Name	Description	Accepted Value(s)	Notes
			<p>between the record you are creating and the record to which it will be linked.</p> <ul style="list-style-type: none"> Specify the record that you want to modify by identifying the record to which it is linked. <p>For details on these parameters, see the notes for the Module and AnalysisType parameters.</p> <p>Displays the Team Members page for the SIL Analysis that is specified by the EntyKey parameter. If the Team parameter is included, the EntyKey parameter is required.</p> <p>Displays the Reference Documents page for the SIL Analysis specified by the EntyKey parameter. If the Documents parameter is included, the EntyKey parameter is required.</p> <p>Displays the Safety Instrumented Systems page for the SIL Analysis that is specified by the EntyKey parameter. If the SIS parameter is included, the EntyKey parameter is required.</p> <p>Displays the Instrumented Functions page for the SIL Analysis that is specified by the EntyKey parameter. If the PIF parameter is included, the EntyKey parameter is required.</p>

Parameter Name	Description	Accepted Value(s)	Notes
			<p>Displays on the Protective Instrument Loop Diagram View page the Protective Instrument Loop record that is linked to an Instrumented Function record for an SIL Analysis.</p> <p>When Page=SILValidation, the following parameters are required:</p> <ul style="list-style-type: none"> • EntyKey: Specifies the EntityKey of the Protective Instrument Loop record that is displayed. • AnalKey: Specifies the Entity Key of the SIL Analysis record to which the Instrumented Function record is linked. • PIFKey: Specifies the Entity Key of the Instrumented Function record to which the Protective Instrument Loop record is linked. <p>Displays on the Protective Instrument Loop Grid View page the Protective Instrument Loop record that is linked to an Instrumented Function record for an SIL Analysis.</p> <p>When Page=SILValidationView, the following parameters are required:</p> <ul style="list-style-type: none"> • EntyKey: Specifies the Entity Key of the Pro-

Parameter Name	Description	Accepted Value(s)	Notes
			<p>protective Instrument Loop record that is displayed.</p> <ul style="list-style-type: none"> • AnalKey: Specifies the Entity Key of the SIL Analysis record to which the Instrumented Function record is linked. • PIFKey: Specifies the Entity Key of the Instrumented Function record to which the Protective Instrument Loop record is linked. <p>Displays on the LOPA Definition page the LOPA record that is linked to an Instrumented Function record for an SIL Analysis.</p> <p>When Page=LopaDefinition, the following parameters are required:</p> <ul style="list-style-type: none"> • LopaKey: Specifies the Entity Key of the LOPA record that is displayed. • AnalysisKey: Specifies the Entity Key of the SIL Analysis record to which the Instrumented Function record is linked. • PIFKey: Specifies the Entity Key of the Instrumented Function record to which the LOPA record is linked. <p>Displays on the Con-</p>

Parameter Name	Description	Accepted Value(s)	Notes
			<p>sequence Modifiers page the Consequence Modifier records that are linked to a LOPA record that is linked to an Instrumented Function for an SIL Analysis.</p> <p>When Page=LopaModifiers, the following parameters are required:</p> <ul style="list-style-type: none"> • LopaKey: Specifies the Entity Key of the LOPA record that is displayed. • AnalysisKey: Specifies the Entity Key of the SIL Analysis record to which the Instrumented Function record is linked. • PIFKey: Specifies the Entity Key of the Instrumented Function record to which the LOPA record is linked. <p>Displays on the SIS - Asset Health Manager page the Health Indicator record for an SIL Analysis.</p> <p>When Page=HealthIndicators, the following parameters are required:</p> <ul style="list-style-type: none"> • EntyKey: The Entity Key of the Health Indicator record that is displayed. • AnalysisKey: The Entity Key of the SIL Analysis record to which the Health Indicator record

Parameter Name	Description	Accepted Value(s)	Notes
			<p>is linked.</p> <p>Displays on the Proof Test Templates page the SIS Proof Test Template records that are linked to a Safety Instrumented System record or Instrumented Function record for an SIL Analysis.</p> <p>When Page=PTTemplateList, the following parameters are required:</p> <ul style="list-style-type: none"> • AnalysisKey: Specifies the Entity Key of the SIL Analysis record to which the Safety Instrumented System record or Instrumented Function record is linked. • SISKey: Specifies the Entity Key of the Safety Instrumented System record to which the SIS Proof Test Template records are linked. <p>-OR-</p> <p>PIFKey: Specifies the Entity Key of the Instrumented Function record to which the SIS Proof Test Template records are linked.</p> <p>Displays on the Proof Tests page the SIS Proof Test records that are linked to a Safety Instrumented System record or Instrumented Function record for an SIL Analysis.</p> <p>When Page=ProofTestList,</p>

Parameter Name	Description	Accepted Value(s)	Notes
			<p>the following parameters are required:</p> <ul style="list-style-type: none"> • AnalysisKey: Specifies the Entity Key of the SIL Analysis record to which the Safety Instrumented System record or Instrumented Function record is linked. • SISKey: Specifies the Entity Key of the Safety Instrumented System record to which the SIS Proof Test records are linked. <p>-OR-</p> <p>PIFKey: Specifies the Entity Key of the Instrumented Function record to which the SIS Proof Test records are linked.</p> <p>Displays the <Family> Reference Data Search page, where <Family> specifies the family of the Reference Data records for which you can search using the page (e.g., Logic Solver Reference Data Search page). The family is determined by the Type parameter value.</p> <p>When Page=e=ReferenceDateList, the Type parameter is required.</p> <p>Displays a new or existing record on the <Family> Reference Data page, where <Family> specifies the family to which the record belongs.</p>

Parameters for the SIS Management URL

Parameter Name	Description	Accepted Value(s)	Notes
			<p>The family is determined by the Type parameter value.</p> <p>If the EntyKey parameter is included in the URL, the page will display the existing record with the specified Entity Key. If, however, the EntyKey parameter is omitted from the URL, the page will display a <i>new</i> record in the family identified by the Type parameter value.</p> <p>If no Type is provided in the URL, the Sensor Reference Data page will be displayed.</p> <p>Displays the SIS Management Administration page.</p> <p>To see examples of URLs that include these parameters, see the topic Examples of SIS Management URLs.</p>

Parameter Name	Description	Accepted Value(s)	Notes
Module	Specifies the family of the records that you want to view on the page specified by the Page parameter.	SA SV SVTP PTTemplate ProofTest	<p>Displays SIL Analysis records on the page specified by the Page parameter value.</p> <p>Displays Protective Instrument Loop records on the page specified by the Page parameter value.</p> <p>Displays Protective Instrument Loop records that are specified as templates on the page specified by the Page parameter value.</p> <p>Displays on the Proof Test Template Definition page a new SIS Proof Test Template record that will be linked to the Instrumented Function record or Safety Instrumented System record for the SIL Analysis.</p> <p>When Page=Definition and Module=PTTemplate, the following parameters are required:</p> <ul style="list-style-type: none"> • AnalysisKey: Specifies the Entity Key of the SIL Analysis record to which the Instrumented Function record or Safety Instrumented System record is linked. • PIFKey: Specifies the Entity Key of the Instrumented Function record to which the SIS Proof Test Template record will be linked. <p>-OR-</p>

Parameter Name	Description	Accepted Value(s)	Notes
			<p>SISKey: Specifies the Entity Key of the Safety Instrumented System record to which the SIS Proof Test Template record will be linked.</p> <p>Displays on the Proof Test Definition page a new SIS Proof Test record that will be linked to the Instrumented Function record or Safety Instrumented System record for an SIL Analysis.</p> <p>When Page=Definition and Module=ProofTest, the following parameters are required:</p> <ul style="list-style-type: none"> • AnalysisKey: Specifies the Entity Key of the SIL Analysis record to which the Instrumented Function or Safety Instrumented System is linked. • PIFKey: Specifies the Entity Key of the Instrumented Function record to which the SIS Proof Test record will be linked. <p>-OR-</p> <p>SISKey: Specifies the Entity Key of the Safety Instrumented System record to which the SIS Proof Test record will be linked.</p> <p>To see examples of URLs that include these parameters, see the topic Examples of SIS</p>

Parameters for the SIS Management URL

Parameter Name	Description	Accepted Value(s)	Notes
			Management URLs.
AnalysisType	Specifies that you want to view records in the SIS Trip Report family rather than records in the SIL Analysis family.	SISTripReport	<p>The AnalysisType parameter Lets you view records in the SIS Trip Report family instead of the default SIL Analysis family.</p> <p>You can use the AnalysisType parameter with any of the following Page parameter values to specify that SIS Trip Report records should be displayed on those pages instead of SIL Analysis records:</p> <ul style="list-style-type: none"> • Search • Definition

Parameter Name	Description	Accepted Value(s)	Notes
EntyKey	Specifies the specific record that you want to view.	A numeric Entity Key	<p>This parameter is required if:</p> <ul style="list-style-type: none"> • Page=Definition and you want to view a specific record. You can use the Module parameter, EntyKey parameter or AnalysisType parameter. If you do not use the EntyKey parameter in this case, a new record will appear according to the Module parameter value. If you do not use one of these parameters, a new SIL Analysis record will appear on the SIL Analysis Definition page by default. • Page=Team • Page=Documents • Page=SIS • Page=PIF • Page=SILValidation • Page=SILValidationView • Page=HealthIndicator • Page=ReferenceDate

Parameters for the SIS Management URL

Parameter Name	Description	Accepted Value(s)	Notes
AnalysisKey	Specifies the SIL Analysis record that is linked to the records that you want to view.	A numeric Entity Key	This parameter is required if: <ul style="list-style-type: none"> • Page=LopaDefinition • Page=LopaModifiers • Page=HealthIndicator • Page=PTTemplateList • Page=ProofTestList • Module=ProofTest
PIF Key	Specifies the Instrumented Function record that is linked to the record that you want to view.	A numeric Entity Key	This parameter is required if you want to view a specific Instrumented Function record that is linked to another record specified in the URL. This parameter can be used with the AnalysisKey, AnalKey, or EntyKey parameters. If Module=PTTemplate or Module=ProofTest, the EntyKey, AnalysisKey, and PIF Key parameters are required.

Parameters for the SIS Management URL

Parameter Name	Description	Accepted Value(s)	Notes
AnalKey	Specifies the SIL Analysis record that is linked to the records that you want to view.	A numeric Entity Key	<p>The AnalKey parameter is required if:</p> <ul style="list-style-type: none"> • Page=SILValdiation • Page=SILValidationView and EntyKey=<Entity Key value> <p>When you use the AnalKey parameter, the PIFKey or SISKey parameter is required. You can use the PIFKey parameter with the AnalysisKey parameter, AnalKey parameter, or EntyKey parameter. Where you use the PIFKey parameter depends upon the URL that you want to construct.</p>
SISKey	Specifies the Safety Instrumented System record that is linked to the record that you want to view.	A numeric EntityKey value for an SIL Analysis record.	This parameter is required if you want to view a specific record that is linked to a Safety Instrumented System record and can be used with the AnalysisKey, AnalKey, or EntyKey parameters.

Parameters for the SIS Management URL

Parameter Name	Description	Accepted Value(s)	Notes
LopaKey	Specifies the LOPA record that you want to view.	A numeric Entity Key	<p>This parameter is required if:</p> <ul style="list-style-type: none"> • Page=LopaDefinition • Page=LopaModifiers <p>When you use the LopaKey parameter, the AnalysisKey and PIFKey parameters are required. You can use the PIFKey parameter with the AnalysisKey parameter, AnalKey parameter, or EntyKey parameter. Where you use the PIFKey parameter depends upon the URL that you want to construct.</p>

Parameter Name	Description	Accepted Value(s)	Notes
Type	Specifies the records that you want to view in the Validation Reference Data feature.	FinalElement LogicSolver Sensor	<p>The Type parameter is required if Page=ReferenceDataList.</p> <p>If Page=ReferenceData, you can optionally use the following Type parameter values to view a record in a family other than the default Sensor family:</p> <ul style="list-style-type: none"> • Final Element: Displays Final Element records. • Logic Solver: Displays Logic Solver records. • Sensor: Displays Sensor records. <p>If Page=ReferenceData and you omit the Type parameter, a Sensor record will be displayed by default. If you include it, the value can be set to either FinalElement or LogicSolver.</p> <p>In other words, omitting the Type parameter when Page=ReferenceDate has the same effect as setting it to Sensor.</p> <p>Note that if Page=ReferenceData and the Type parameter is included, the EntyKey parameter is required.</p>

Examples of SIS Management URLs

- **meridium://SIS**
Displays the **SIS Management Start Page**.
- **meridium://SIS?Page=Search**
Displays the **SIL Analysis Search** page.
- **meridium://SIS?Page=Search & Module=SV**
Displays the **Protective Loop Search** page.
- **meridium://SIS?Page=Search & AnalysisType=SIS Trip Report**
Displays the **SIS Trip Report Search** page.
- **meridium://SIS? Page=Definition**
Displays a new SIL Analysis record on the **SIL Analysis Definition** page.
- **meridium://SIS?Page=Definition&Module=PTTemplate&AnalysisKey=123456&SISKey=789101**
Displays on the **Proof Test Template Definition** page a new SIS Proof Test Template record that will be linked to the Safety Instrumented System record with the Entity Key 123456 that is linked to the SIL Analysis record with the Entity Key 789101.
- **meridium://SIS?Page=LopaModifiers&LopaKey=123456&AnalysisKey=789101&PIFKey=111213**
Displays in the **Consequence Modifiers** page list of Consequence Modifier records that are linked to the Instrumented Function record with the Entity Key 111213 that is linked to the SIL Analysis record 789101.
- **meridium://SIS?Page=e=SILValidation&EntityKey=123456&AnalKey=789101&PIFKey=111213**
Displays the Protective Instrument Loop record with the Entity Key 123456 that is linked to the Instrumented Function record with the Entity Key 111213, which is linked to the SIL Analysis record with the Entity Key 789101.
- **meridium://SIS?Page=ReferenceDataList & Type=Logic Solver**
Displays the **Logic Solver Reference Data Search** page.

Instrumented Function

A specific need required of a safety instrumented system to monitor the conditions of a process.

Maintenance Capability Index (MCI)

A value 0 through 4 that measures the effectiveness of the repair processes for an element in a protective instrument loop. The following list defines each MCI value:

- **MCI 0:** Indicates that repair actions are never performed.
- **MCI 1:** Indicates that repair actions are effective 60 percent of the time.
- **MCI 2:** Indicates that repair actions are effective 90 percent of the time.
- **MCI 3:** Indicates that repair actions are effective 99 percent of the time.
- **MCI 4:** Indicates that repair actions are always performed perfectly.

Proof Test

A test that consists of a set of steps that you need to perform to test safety instrumented systems and instrumented functions. The conditions under which the test is conducted should represent the normal conditions under which the system is intended to operate.

Protective Instrument Loop

A set of interconnected instruments that work together to serve a function that is defined for the safety instrumented system in which they exist.

SIL Value

A numeric rating representing the overall level of protection that a safety instrumented system provides.