



Proficiency CIMPPLICITY 11.1

Addons and Options



Proprietary Notice

The information contained in this publication is believed to be accurate and reliable. However, General Electric Company assumes no responsibilities for any errors, omissions or inaccuracies. Information contained in the publication is subject to change without notice.

No part of this publication may be reproduced in any form, or stored in a database or retrieval system, or transmitted or distributed in any form by any means, electronic, mechanical photocopying, recording or otherwise, without the prior written permission of General Electric Company. Information contained herein is subject to change without notice.

© 2021, General Electric Company. All rights reserved.

Trademark Notices

GE, the GE Monogram, and Predix are either registered trademarks or trademarks of General Electric Company.

Microsoft® is a registered trademark of Microsoft Corporation, in the United States and/or other countries.

All other trademarks are the property of their respective owners.

We want to hear from you. If you have any comments, questions, or suggestions about our documentation, send them to the following email address:

doc@ge.com

Chapter 1. .NET Component Hosting.....	14
About CIMPLICITY .NET Component Hosting.....	14
.NET Control: Configuration.....	15
.NET Control: Configuration Guidelines.....	15
.NET Control: Insert into a CimEdit Screen.....	15
.NET Control: Color and Font Properties.....	20
.Net Control: Configuration for new .Net components.....	28
.NET Control: Additional CimEdit Configuration.....	29
.NET Control: Technical Reference.....	49
.NET Control: Technical Reference.....	49
.NET Components: General Information.....	49
.NET Control: Create new Components.....	51
.NET Component Browser: Modifications.....	54
.NET Components: On other CIMPLICITY Systems.....	59
.NET Files: Location.....	61
.NET Data: Conversion Rules.....	62
.NET Error: Logging.....	67
.NET: Glossary.....	68
Chapter 2. Change Management.....	70
About Change Management.....	70
Entities Overview in Change Management.....	71
Entities Overview in Change Management.....	71
CIMPLICITY Project in the Workbench: Managed Files Overview.....	74
Computer Project in the Workbench: Managed Files Overview.....	75
Enable Computer Management.....	76
Enable Project Management.....	81
Change Management Procedures.....	89
Change Management Procedures.....	89

1. Log On.....	89
2. Log Off.....	92
3. Get Latest Version.....	92
4. Check Out.....	93
5. Check In.....	96
6. Undo Check Out.....	97
7. Refresh.....	98
8. Label.....	100
9. Show History.....	101
10. Show Master Label History.....	108
11. Add.....	118
12. Destroy.....	121
13. Check out Status.....	122
14. Fetch Project.....	122
Change Management Client.....	126
Change Management Client.....	126
Step 1. Install the Change Management Client on the Local Server.....	127
Step 2. Open the Machine Edition InfoViewer Window.....	128
Step 3. Configure and Use the Scheduler.....	130
Step 4. Enable Auto Login.....	131
Change Management Best Practices.....	133
Change Management Best Practices.....	133
1. Best Practices: Initial Development.....	133
2. Best Practices: Change Management Project Management.....	137

3. Best Practices: Test Bed to Production.....	138
4. Best Practices: CIMPLICITY Version Changes.....	141
Change Management Technical Reference.....	142
Change Management Technical Reference.....	142
File and Folder Names.....	142
Server Redundancy Guidelines.....	143
Computer Level Files: Management Categories.....	144
Project Level Files: Management Categories.....	149
Managed Enterprise Server Project Guidelines.....	152
Pager Data Files Management.....	153
Change Management Licensing.....	153
Chapter 3. HMI for CNC.....	154
Overview.....	154
Required and Supported Hardware and Software.....	155
Upgrading from Previous Releases.....	156
Licensing Requirements.....	157
Interface Requirements.....	157
Interface Requirements.....	157
HSSB Interface Requirements.....	157
Ethernet Interface Requirements.....	159
Hardware and Optional Software Supplied by FANUC.....	159
Software Installation.....	159
Software Installation.....	159
Step 1. Install HSSB Interface Hardware.....	160
Step 2. Install CIMPLICITY Software.....	160
Step 3. Install the HSSB Driver.....	160
Step 4. Configure the HSSB Card.....	165

Step 5. Copy FOCAS Libraries to your System.....	166
Step 6. Install HMI for CNC Software.....	167
Step 7. Verify Successful Communications.....	169
Project Creation.....	172
Project Creation.....	172
Step 1. Create a new HMI for CNC Project.....	173
Step 2. Set HMI for CNC Project Properties.....	175
Step 3. Configure Ports.....	178
Step 4. Configure Devices.....	181
Step 5. Configure Points.....	187
Step 6. Configure Screens.....	250
Step 7. Configure and View Alarms.....	262
CNC Dynamic Link Library.....	265
CNC Dynamic Link Library.....	265
CNC DLL Entry Point Interfaces for FOCAS/HSSB.....	266
CNC DLL Entry Point Interfaces for FOCAS/Ethernet.....	288
CNC DLL Sample Application Script and Screens.....	316
CNC Part Program.....	321
CNC Part Program.....	321
Part Program Parameters.....	322
Use the CNC Part Program Application.....	325
CNC Command Line Utilities.....	346
CNC Command Line Utilities.....	346

CNC Dynamic Link Library Graphic Overview.....	347
CNC Part Program Command Line Utilities for FOCAS/HSSB.....	348
CNC Part Program Command Line Utilities for FOCAS/Ethernet.....	355
CNC File Data Command Line Utilities for FOCAS/HSSB.....	362
CNC File Data Command Line Utilities for FOCAS/Ethernet.....	366
Error Handling.....	370
Error Handling.....	370
Connection Error Handling.....	371
CNC Data Window Error Handling.....	372
Ethernet Version Only Error Handling.....	374
PMC Data Window Error Handling.....	377
CNC Dynamic Link Library Error Codes and Messages.....	379
Software Removal and Driver Deletion.....	381
Software Removal and Driver Deletion.....	381
Software Removal.....	381
HSSB Driver Deletion.....	382
Chapter 4. Machine Edition Integration with CIMPLICITY.....	383
About Machine Edition Integration with CIMPLICITY.....	383
Machine Integration Architecture.....	383
Machine Edition Variables in CIMPLICITY.....	385
Machine Edition Variables in CIMPLICITY.....	385
Step 1. Configure the Machine Edition Project for CIMPLICITY.....	385
Step 2. (Optional) Configure CIMPLICITY Points to Access Machine Edition Points....	388
Step 3. View/Set/Log Machine Edition Variable Data through CIMPLICITY.....	401
Machine Edition to CIMPLICITY Technical Reference.....	413
Machine Edition to CIMPLICITY Technical Reference.....	413
Point Data Integration Technical Notes.....	413
Machine Edition Variable Data Types Defined as CIMPLICITY Point Data Types.....	414
Chapter 5. Recipes Configuration.....	416

About Recipes.....	416
Open a RecipeConfig Window.....	417
Open a RecipeConfig Window.....	417
Option 1. Open a new RecipeConfig Window.....	417
Option 2. Open an existing Recipe Group Window.....	418
RecipeConfig Window Overview.....	419
RecipeConfig Window Overview.....	419
1. RecipeConfig Window: Left Pane.....	420
2. RecipeConfig Window: Right Pane.....	422
3. RecipeConfig Window: Toolbar Buttons.....	422
4. RecipeConfig Window: Menu Items.....	423
5. RecipeConfig Window: Mouse Operations.....	426
6. RecipeConfig Window: Keyboard Operations.....	428
Recipe Group Configuration.....	429
Recipe Group Configuration.....	429
Step 1. Select a Recipe Group.....	430
Step 2. Define Parameter Attributes for a Recipe Group.....	435
Step 3. Configure Recipes.....	441
Step 4. Configure Recipe Maps.....	454
Step 5. Upload/Download Recipes and Maps.....	460
Step 6. Administer Recipe Groups.....	471
Recipe Control Configuration.....	477
Recipe Control Configuration.....	477
Step 1. Place a Recipe Control on a CimEdit Screen.....	477
Step 2. Open a CIMPLICITY Recipe Control Properties Dialog Box.....	478
Step 3. Define General Recipe Control Properties.....	479

Step 4. Specify Recipe Control Batch ID Properties.....	481
Step 5. Upload or Download Recipes during Runtime.....	482
Technical Reference.....	485
Technical Reference.....	485
1. CSV File Format for Import/Export.....	485
2. Basic Control Engine Extensions for Recipes.....	487
Chapter 6. Statistical Process Control.....	488
About Statistical Process Control.....	488
SPC Administration Alarms.....	490
SPC Preparation.....	491
SPC Preparation.....	491
1. SPC Preparation: Enable SPC.....	491
2. SPC Preparation: Security.....	492
3. SPC Preparation: Points.....	493
4. SPC Preparation: Database Logger.....	495
5. SPC Preparation: PKCS #7 Certificate.....	497
SPC Products: Configuration.....	500
SPC Products: Configuration.....	500
1. SPC Products: Open the SPC Configuration Window.....	502
2. SPC Products: Document Properties.....	509
3. SPC Products: File Menu/Toolbar/Quick Keys.....	511
4. SPC Products: Product Properties.....	518
5. SPC Products: Variable Quality Characteristics.....	520
6. SPC Products: Attribute Quality Characteristics.....	542
7. SPC Products: Defect Properties.....	564
SPC Control: Configuration.....	574
SPC Control: Configuration.....	574

1. SPC Control: Insert in CimEdit.....	575
2. SPC Control: Open an SPC Control Properties Dialog Box.....	576
3. SPC Control: General Properties.....	577
4. SPC Control: Chart Properties.....	580
5. SPC Control: Line Display.....	580
6. SPC Control: Axis Display.....	581
7. SPC Control: Bar Chart.....	582
8. SPC Control: Report.....	585
9. SPC Control: Annotation.....	588
SPC Runtime.....	590
SPC Runtime.....	590
1. SPC Runtime: Update.....	591
2. SPC Runtime: Manual Data Entry.....	592
3. SPC Runtime: Print.....	594
4. SPC Runtime: Exclusion Mode.....	595
5. SPC Runtime: Annotation.....	598
6. SPC Runtime: Properties.....	607
7. SPC Runtime: Ambient Properties.....	607
8. SPC Runtime: About SPC.....	608
SPC Technical Reference.....	609
SPC Technical Reference.....	609
SPC Charts.....	609
ActiveX Methods.....	620
ActiveX Properties.....	620
Chapter 7. System Sentry.....	622
About System Sentry.....	622

System Sentry at a Glance.....	623
Activate the System Sentry.....	624
System Sentry Screens.....	624
System Sentry Screens.....	624
Open System Sentry Screens.....	625
System Sentry Overview Screen.....	628
System Sentry Processes Screen.....	630
System Sentry CimView Screen.....	632
System Sentry Point Manager Screen.....	633
System Sentry Alarm Manager Screen.....	634
System Sentry Logging Screen.....	635
System Sentry Point Logging Screen.....	636
System Sentry Data Logger Screen.....	637
System Sentry Event Manager Screen.....	638
System Sentry Derived Points Screen.....	640
System Sentry User Registration Screen.....	641
System Sentry Router Screen.....	642
System Sentry Devices Screen.....	644
System Sentry Ports (Devcom) Screen.....	645
Frequently Used Features on System Sentry Screens.....	645

System Sentry Screen Viewing and Navigation Tools.....	647
System Sentry Power Tools.....	652
System Sentry Power Tools.....	652
Power Tools Using System Sentry Device Points.....	654
CimView Screens Using System Sentry Points by Address.....	663
CIMPLICITY Counters.....	669
CIMPLICITY Counters.....	669
Levels in a System in which Counters Operate.....	670
CIMPLICITY Objects with Counters.....	670
CIMPLICITY Counters' Log Files.....	682
CIMPLICITY Counters' Log Files.....	682
Configuration File for the Counter Log Files.....	683
System Sentry Privileges from Other Nodes.....	685
System Sentry Privileges from Other Nodes.....	685
Step 1. Make CIMPLICITY a Domain User.....	686
Step 2. Change Local Machine Key Privileges in the Windows Registry.....	688
Chapter 8. Pager.....	691
CIMPLICITY Marquee Manager Administrator.....	691
About CIMPLICITY Marquee Manager Administrator.....	691
Marquee Manager Administrator: Key Features.....	691
Marquee Manager Administrator: How it Works.....	692
Marquee Manager Administrator: Available Object Types.....	693
Marquee Manager Administrator Pre-configuration.....	695

Marquee Manager Administrator Configuration.....	699
Marquee Manager Administrator Tools: Users.....	743
Marquee Manager Administrator Other Tools.....	745
Marquee Manager Administrator Technical Reference.....	750
Marquee Manager Administrator Glossary.....	757
Marquee Manager Gateway.....	760
About Marquee Manager Gateway.....	760
Marquee Manager Gateway: Key Features.....	760
Marquee Manager Gateway: How it Works.....	761
Marquee Manager Gateway Components.....	762
Marquee Manager Gateway Tools: Users.....	781
Marquee Manager Gateway for CIMPLICITY Other Tools.....	782
Marquee Manager Gateway Insertion Tag List.....	786
Marquee Manager Gateway Glossary.....	787
Marquee Manager Client.....	789
About CIMPLICITY Marquee Manager Client.....	789
Marquee Manager Client: Key Features.....	789
Marquee Manager Client: How it Works.....	790
Marquee Manager Client Components.....	791
Marquee Manager Client Tools.....	806
Marquee Manager Client Sign Properties.....	809
Marquee Manager Client Glossary.....	814
Alarm Cast Administrator.....	815
About Alarm Cast Administrator.....	815
Alarm Cast Administrator - Key Features.....	816
Alarm Cast Administrator: How it Works.....	817
Alarm Cast Administrator Pre-configuration.....	818
Alarm Cast Administrator Components.....	826
Alarm Cast Administrator Tools.....	875
Alarm Cast Administrator Other Tools.....	887
Alarm Cast Redundancy.....	892
Alarm Cast Administrator Glossary.....	904

Alarm Cast Alarm Administrator.....	909
About Alarm Cast Alarm Administrator.....	909
Alarm Cast Alarm Administrator: Key Features.....	910
Alarm Cast Alarm Administrator: How it Works.....	911
Alarm Cast Alarm Administrator Pre-configuration.....	912
Alarm Cast Alarm Administrator Components.....	918
Alarm Cast Alarm Administrator Tools.....	940
Alarm Cast Alarm Administrator Other Tools.....	943
Alarm Cast Alarm Administrator Glossary.....	947
Alarm Cast Gateway for CIMPLICITY.....	950
About Alarm Cast Gateway for CIMPLICITY.....	950
Alarm Cast Gateway for CIMPLICITY: Key Features.....	950
Alarm Cast Gateway for CIMPLICITY: How it Works.....	951
Alarm Cast Gateway for CIMPLICITY Components.....	951
Alarm Cast Gateway for CIMPLICITY Tools: Users.....	959
Alarm Cast Gateway for CIMPLICITY Other Tools.....	960
Alarm Cast Gateway for CIMPLICITY Glossary.....	962
Alarm Cast Client.....	964
About Alarm Cast Client.....	964
Alarm Cast Client: Key Features.....	964
Alarm Cast Client: How it Works.....	965
Alarm Cast Client Components.....	965
Alarm Cast Client Tools.....	974
Alarm Cast Client Glossary.....	983

Chapter 1. .NET Component Hosting

About CIMPLICITY .NET Component Hosting

Component Hosting v1.0 enables you to take advantage of .NET technology by seamlessly supporting hosting .NET components in CIMPLICITY screens.

- .NET Control: Configuration guidelines.
- .NET Control: Technical reference.

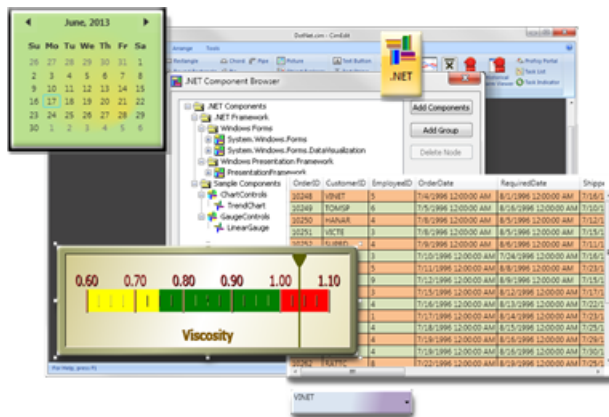

Install and System Requirements

Installed features and requirements for .NET components include:

- The .NET Component Hosting 1.0 package is automatically installed with the CIMPLICITY v8.2 SIM 10 or higher.
- Component Hosting 1.0 requires that Microsoft .NET Framework 4.0 be installed with the target system.

This was installed when CIMPLICITY v8.2 was installed.

- Two additional modules, specifically tailored for interfacing with CIMPLICITY screen editing and runtime views, are also installed without user interactions.

The modules, which are demo and sample components, are installed into the following folder.

..\<CIMPLICITY Installation>\exe\DotNet Components.

.NET Control: Configuration

.NET Control: Configuration Guidelines

.NET Component Hosting, .NET control makes configuration available to different degrees in both the control's Properties - Object dialog box>Control Properties list and using CimEdit's properties, such as events, procedures/methods and scripts.

Similar to other ActiveX controls, because there are so many varieties of .NET controls, the available and appropriate configuration depends on the selected control.

.NET Configuration Guidelines

- .NET Control: Insert into a CimEdit screen.
- .NET Control: Color and font properties.
- .NET Control: Additional CimEdit configuration.

.NET Control: Insert into a CimEdit Screen

.NET controls can be easily found and placed onto a CimEdit screen using the Ribbon bar .NET button.

1 (page 15)	Open the .NET Component Browser.
2 (page 16)	Select a .NET control to insert.
3 (page 17)	Adjust the control on the screen.

1. Open the .NET Component Browser

1. Click the .NET button in the Drawing>Objects group on the CimEdit Ribbon bar.



The ActiveX placement cursor  displays on the screen.

1. Place the cursor where the component will be placed initially.
2. Click the left-mouse button.

A .NET Component Browser opens; the browser (initially) includes the following categories of .NET components.

 **Note:** You can modify the list by [adding and/or removing \(page 54\)](#) components.

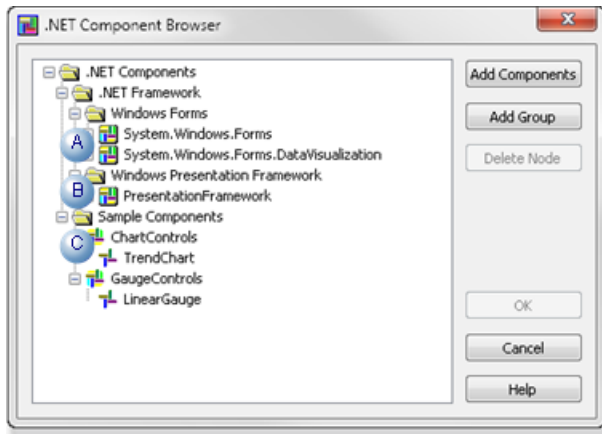

A	System.Windows.Forms (Forms-based controls)
B	Windows Presentation Framework (WPF controls)
C	<p>Sample Components Note: CIMPLICITY provides two sample controls</p> <ul style="list-style-type: none"> • TrendChart • LinearGauge (page 29)

1. Select a .NET Control to Insert

Do the following.

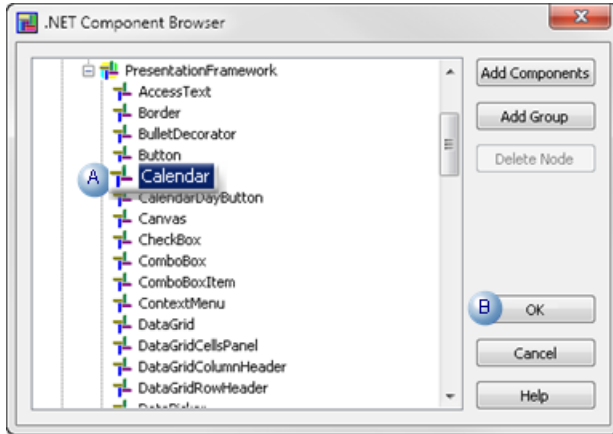

A	Select a component in the .NET Component browser's expanded tree.
B	Click OK.

Result: The component displays on the CimEdit screen.

1. Adjust the Component on the Screen

Screen editing actions and configuration actions with the Properties dialog box on a screen that contains hosted .NET components all work essentially the same as on a screen that contains only OLE and CIMPLICITY native objects.

Actions include, but are not limited to:

• Copy	• Paste	• Undo
• Delete	• Resize	• Save
• Move	• Select	• Load

Note: For most actions, the control will have to be in configuration mode.

- .NET Control: Display modes.
- .NET Control: Resize.
- .NET Control: Move.

.NET Control: Display Modes

When .NET controls are placed initially on the CimEdit screen they are in configuration mode, which displays as follows.

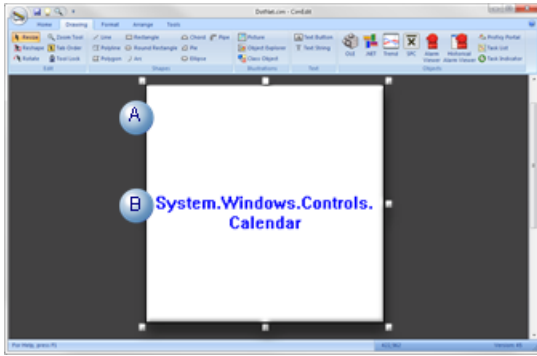

A	The initial object size is the same regardless of what control is selected.
B	Text identifies the selected component.

The control display when you double-click it depends on the default control configuration and properties.

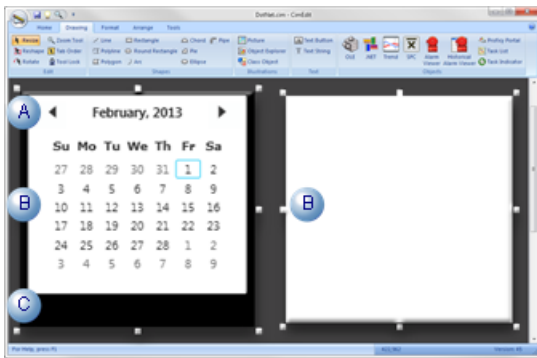

A	The initial object size is the same regardless of what component is selected.
B	Possible displays include: <ul style="list-style-type: none"> • A representation of the runtime image. (e.g. Calendar). • A blank box.
C	Area surrounding control display, if there is one, standardizes the initial insert size.

! **Important:** Because these components come from different sources, the display may require additional scripting or configuration for anything to display. If the image is blank or not what you expect, consult the documentation from the component's source to learn what is required.

.NET Control: Resize

You can resize the .NET component using the same methods as you use for any CimEdit object.

Note: The:

- Resize process may require some toggling between the configuration mode image and the runtime (or blank) representation.
- Actual runtime display may or may not resize, depending on the control. However the area around it can be increased or decreased.

Examples



- The initial size of a checkbox control is the same as any other control. The checkbox itself cannot be resized; the area around the checkbox can be reduced so only the checkbox displays.
- The actual text box in a Rich Text box control can be larger or smaller, as required.

1. Select the handle that will resize the object in the appropriate direction
2. Drag the handle in the direction that will correctly resize the object.
3. (If necessary) Click the left mouse button outside of the component.

The display will toggle to the view that does not currently display.

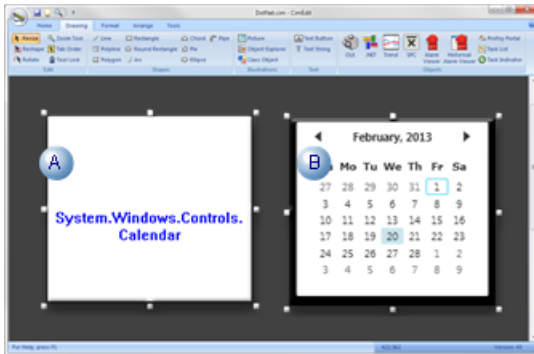
4. Toggle back and forth until the image is the appropriate size.



	Display Mode	Guidelines
A	Configuration	Resize the .NET component object the same way you resize any CimEdit object. <ul style="list-style-type: none"> • Select a handle and move it. • Enter new Geometry specifications in the object's Properties dialog box. <p> Note: If the component size is reduced, the identification label may no longer display when the control is in configuration mode.</p> 

	Display Mode	Guidelines
B	Runtime	<ul style="list-style-type: none"> • If the component has enough information to display a runtime representation, this display will guide the resizing. • If the runtime image is blank, you can estimate the size and modify it when your configuration produces an image.

guide: Guideline: Component Identification

Naming the component will enable you to identify it easily. Instances when entering a unique name will help include:

- The size is reduced so the configuration mode no longer displays the name.
- The runtime mode is blank.
- More than one of the same component is required.
- A CIMPLICITY procedure that requires the control name is being configured.
 - a. Right-click the component; select Properties on the Popup menu.

The component's Properties dialog box opens.

- a. Select **General**.
- b. Enter a unique name in the **Object Name** field.

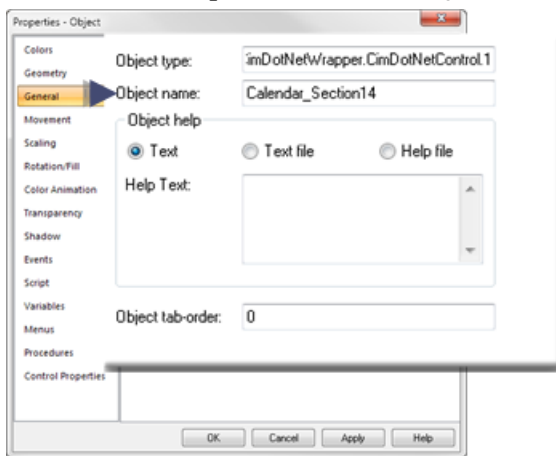

.NET Control: Move

Move the .NET component object the same way you move other CimEdit objects.

 **Note:** The object must be in the configuration mode to move it.

- Select the object and move it.
- Enter new **Geometry** specifications in the object's Properties dialog box.

.NET Control: Color and Font Properties

Many .NET control properties are unique to the selected control. However, in most cases colors/brush types and fonts that are included in the control can be changed in the Properties - Object dialog box>**Control Properties**.

- .NET Control: Select colors and brush types.
- .NET Control: Select fonts.

.NET Control: Select Colors and Brush Types

When using Component Hosting, the Windows Forms color (System.Drawing.Color) and WPF color (System.Windows.Media.Color) types are converted to the COM color type (OLE_COLOR) so the two .NET color types can be configured with the standard Windows palette.

- Color: Color
- Color: Brush types.

Color: Color

1. Right-click a .NET control>select **Properties** on the Popup menu.

The Properties - Object dialog box opens.

2. Select **Control Properties**.

3. Click the Palette button to the right of the control color you want to change.

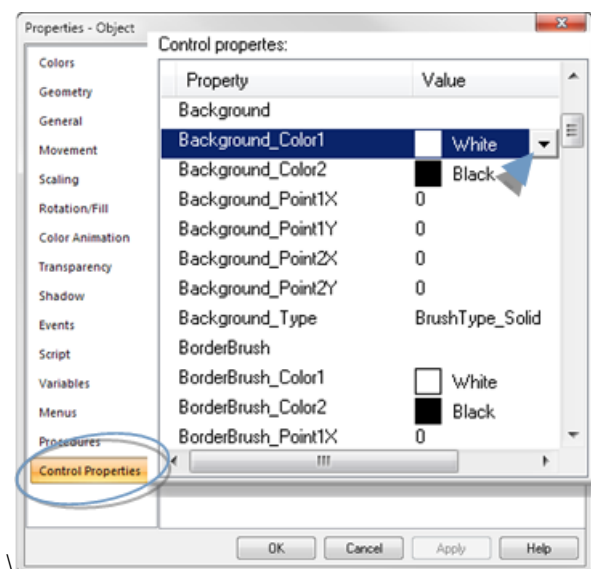

A standard Windows color palette opens.

- BrushType_Linear
- BrushType_Radial

BrushType_Solid

Select one color.

Select BrushType_Solid for the selected color area, e.g. Background_Type.

Result: The selected color area will display one solid color.



BrushType_Linear

A linear brush provides a "straight line" gradation in which one color gradually changes to another. You can select where in the gradation, each color will begin and end.

Select BrushType_Linear in the **...Type** field for the selected area.

Required configuration entries include the following.

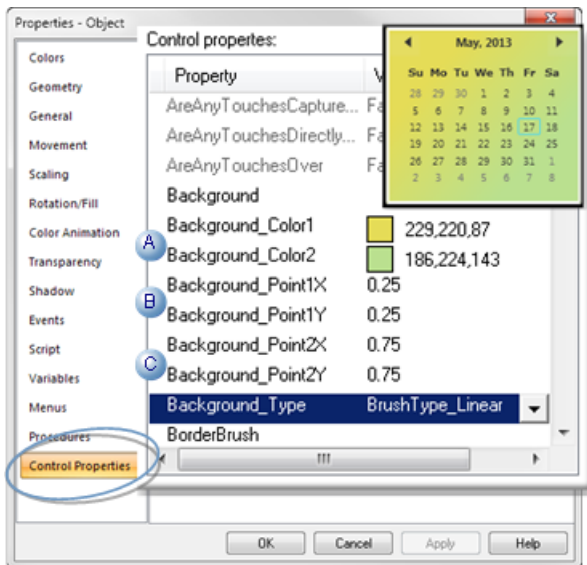

	Field	Description
A	...Color1/...Color2	Two colors are required for a Linear brush type.
B	...Point1X/Point1Y	X and Y coordinates of the gradient starting position

	Field	Description
C	...Point2X/Point2Y	X and Y coordinates of the gradient ending position

BrushType_Radial

A radial brush provides a circular gradation in which one color starts at a center point and gradually changes to another. You can select where in the gradation, each color will begin and end.

Select BrushType_Radial in the **...Type** field for the selected area.

Required configuration entries include the following.

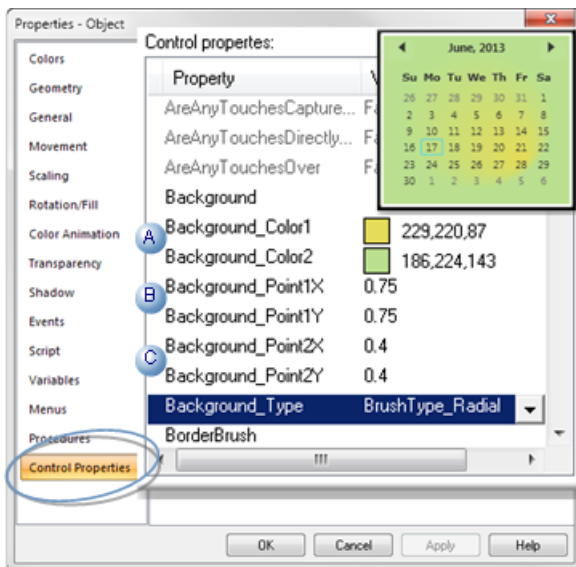

	Fields	Description	
A	...Color1/...Color2	Two colors are required for a Linear brush type.	
B	...Point1X/Point1Y	Color1 color position.	Coordinates of the gradient center.
C	...Point2X/Point2Y	Color2 color position	X and Y radii of the gradient ending ellipse

.NET Control: Select Fonts

Font configuration options are based on the control type.

- Fonts: Windows forms-based controls.
- Fonts: .NET WPF controls

Fonts: Windows Forms-based Controls

Windows Forms-based controls use the standard Font dialog box to configure font.

5. Open a Properties dialog box for a Windows Forms-based control.
6. Select Control Properties.
7. Click the Font button to the right of the field.

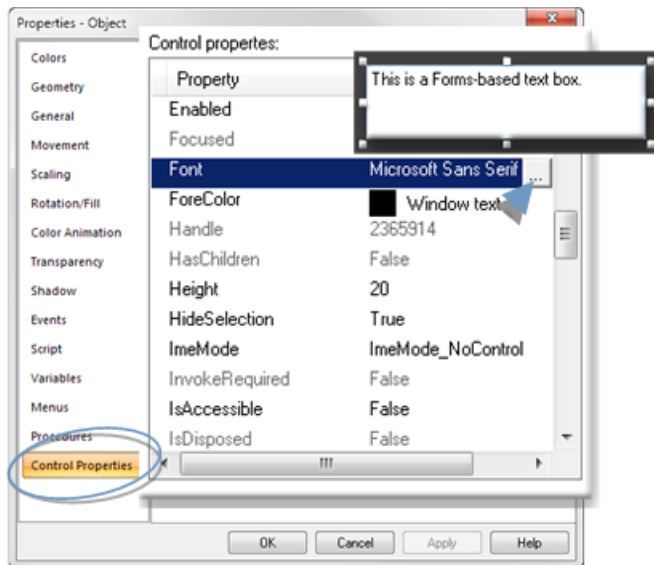

A Font dialog box opens.

8. Select the font properties: **font**, **Font style**, **Size** and **Effects**.

Note: **Script** does not work for standard WinForm controls.

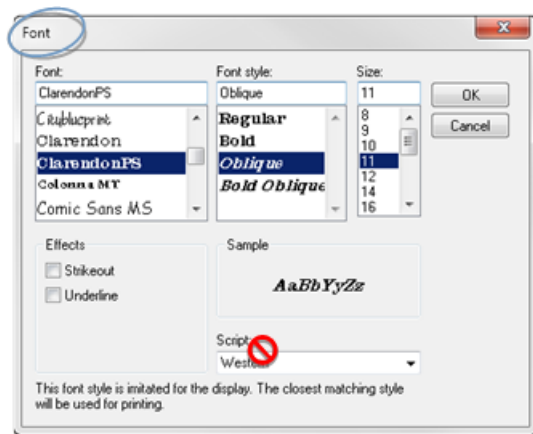

9. Click OK.

Result: The selected font displays in the Font field; the text in the control displays the new font selections.

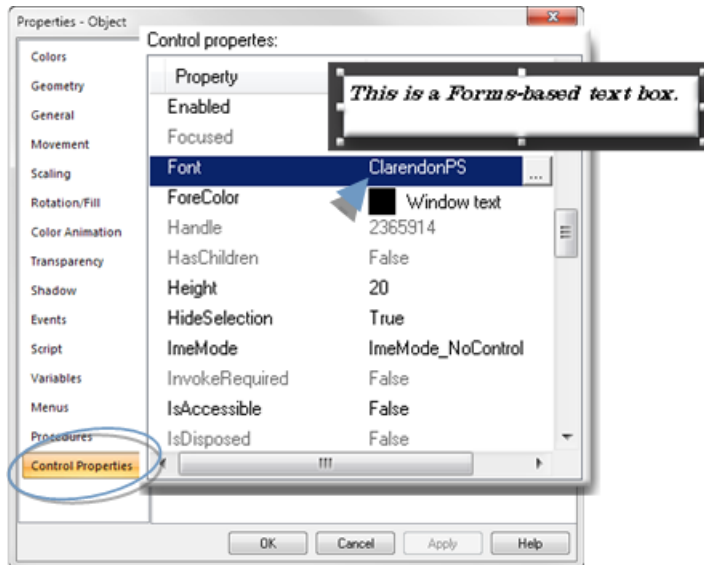

Note:

- In most instances, you can change the font color in the **FontColor** field. Select a solid color the same way you select a color for any control feature that enables color selection.
- A Windows Forms-based control plain text box does not word wrap. The text that goes beyond the width of the box will not display.

Fonts: .NET WPF Controls

.NET WPF control font configuration is primarily located in the Control Properties list rather than in a separate Font dialog box. However, the Font dialog box is still available in order to select a font. The new configuration enables you to apply more granulated configuration to the font, both in style and color.

10. Open a Properties dialog box for a .NET WPF control.
11. Select Control Properties.
12. Click the Font button to the right a **Font Family** field.

A Font dialog box opens.

13. Select the font that should display.

Note: Only Font is applied to the control; all other font related properties in the Font dialog box are not applied

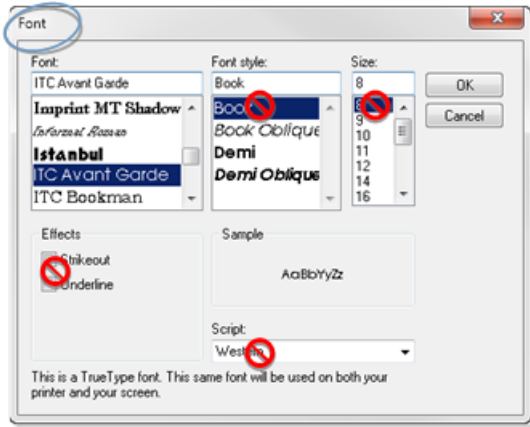

14. Click OK.

The Font dialog box closes.

15. Select values for other Font properties, including the following.

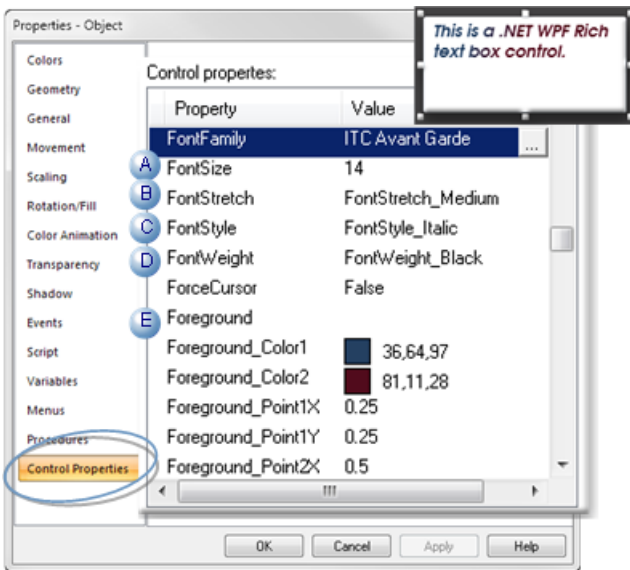

	Field	Description
A	Font Size	The text display size in the Rich text box. Note: The size entered in this Font Size field is the size that is used, not the size that appears to be selected in the Font dialog box.
B	FontStretch	Expands or contracts the text width, based on the selection. Selections can include, but are not limited to: FontStretch_Condensed FontStretch_Expanded FontStretch_ExtraCondensed FontStretch_ExtraExpanded FontStretch_Medium FontStretch_Normal FontStretch_SemiCondensed FontStretch_SemiExpanded FontStretch_UltraCondensed FontStretch_UltraExpanded
C	FontStyle	Common styles (if the selected font includes them). Selections can include: FontStyle_Italic FontStyle_Normal FontStyle_Oblique

	Field	Description
D	FontWeight	The weight applied to each character. Note: Results can also depend on the selected font configuration capabilities. Selections can include, but are not limited to: FontWeight_Black FontWeight_Bold FontWeight_DemiBold FontWeight_ExtraBlack FontWeight_ExtraBold FontWeight_ExtraLight FontWeight_Heavy FontWeight_Light FontWeight_Medium FontWeight_Normal FontWeight_Regular FontWeight_SemiBold FontWeight_Thin FontWeight_UltraBlack FontWeight_UltraBold FontWeight_UltraLight
E	Foreground	Both color and brush types can be applied to .NET WPF control fonts.

.Net Control: Configuration for new .Net components

The following properties enable you to view or hide the base members or newly added members/controls. You can modify the following properties as per your requirement in the GEIP.Orion.ComponentBuilder.config located at <installation_location>\Proficy\Proficy CIMPLICITY\exe:

Property	Default Values	Values
IncludeBaseMembers	<code><IncludeBaseMembers>>false</IncludeBaseMembers></code>	<p>The base members are not included to object properties in CimEdit.</p> <p>Set to True if you want to include base members to object properties in CimEdit.</p>
IncludeNewMembers	<code><IncludeNewMembers>>false</IncludeNewMembers></code>	<p>When you upgrade .Net components version the, the new members introduced in the version, will not appear in object properties in CimEdit.</p> <p>Set to True if you want to include newly introduced members to object properties in CimEdit.</p>
IncludeNewControls	<code><IncludeNewControls>>true</IncludeNewControls></code>	<p>When you upgrade .Net components version the, the new controls introduced in the version, will appear in the .Net Component Browser in CimEdit.</p> <p>Set to False if you do not want to include the newly introduced controls to the .Net Component Browser in CimEdit.</p>

.NET Control: Additional CimEdit Configuration

.NET Control: Additional CimEdit Configuration

Properties that are available to the .NET controls in their Control Properties lists vary widely. Some .NET controls can be completely customized for your system by simply entering and/or selecting values in the Control Properties list. More often some additional configuration will be required.

CimEdit provides extensive additional configuration options for the .NET control when more than the data types in the control's Properties - Object dialog box>**Control Properties** list is required.

CimEdit enables you to:

- Get or set properties of the primitive and complex data types;
- Call methods.
- Handle events.

Because .NET Component Hosting exposes all of the properties, methods and events of the underlying .NET component with appropriate data conversions, the underlying component can be fully manipulated with CimEdit scripting.

Examples that Demonstrate Simple to more Complex .NET Control Configuration

- [.NET Example: Control Properties/Simple Event and Script \(page 29\)](#)
- [.NET Example: Complex Properties and Methods \(page 35\)](#)
- [.NET Example: Parameters Not Fully Converted \(page 42\)](#)

.NET Example: Control Properties/Simple Event and Script

Some .NET controls can be almost completely configured, if not completely, using the properties in the control's Properties - Object dialog box>Control Properties.

A linear gauge, which is available in the .NET Component Browser, is one of these controls. With Control Properties configuration, a Periodic event and simple script, the gauge can display a selected point's values.

 **Note:** The gauge will be configured to report the value of a point PROCESS_VISCOSITY.

Point attributes include the following.

Point Attributes Description

Point Type	REAL
Decimal places	2
Maximum value	1.10
Minimum value	0.60

Linear Gauge: Place on the CimEdit Screen.

1. Open the .NET Component browser.
2. Place the LinearGauge on the CimEdit screen, as follows.

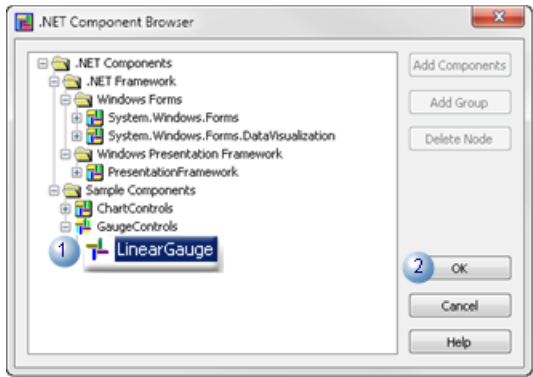

3. Select .NET Components>Sample Components>GaugeControls>LinearGauge.
4. Click OK.

The linear gauge control is placed on the CimEdit screen.

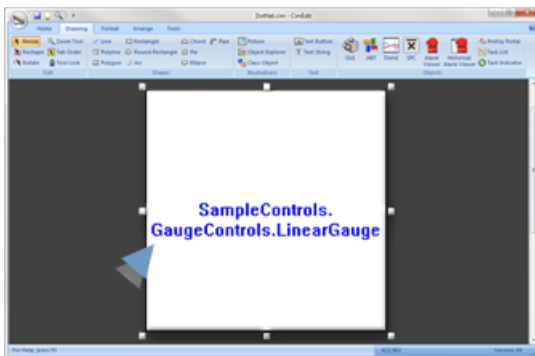

Resize/move the linear gauge to accommodate the display.

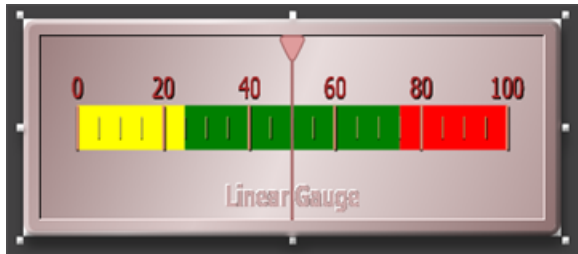

Linear Gauge: Apply Basic Control Properties

The linear gauge's basic display properties can be selected in the control's Properties - Object dialog box>Control Properties list.

- (Optional) Change the color and/or fonts.

 **Note:** The linear control also has a `BlinkSeconds` property that causes a region to blink if the value is in its range. `BlinkSecond` indicates the number of times the region should blink per second. `Blink = 1` per second or higher. `No Blink = 0`.

- Revise some basic values in the control's Properties dialog box>Control Properties list to customize the control for the selected point.

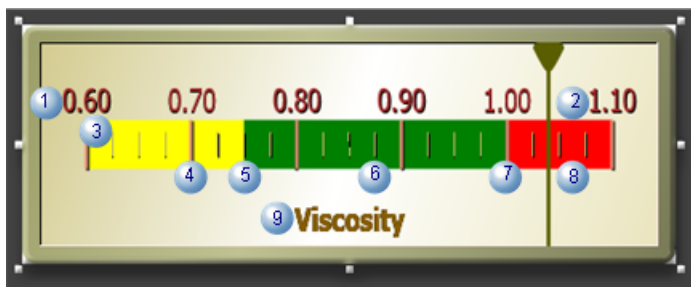

	Field	Description	Example Value
1	MinReading	Lowest reading on the gauge.	0.6
2	MaxReading	Highest reading on the gauge.	1.1
3	DecimalPlaces	Number of decimal places in the value display.	2
4	MajorTicks	Prominent ticks on the gauge. Note: The value excludes the starting point.	5
5	Range1Color	Color for the lowest range on the gauge	Yellow
	Range1High	Highest value for Range1. Note: The Range1 color ends at this value.	.75

	Field	Description	Example Value
6	MinorTicks	Small ticks going from one major tick to the next.	4
7	Range 2Color	Color for the middle range	Green
	Range2High	Highest value for Range2. Note: The Range2 color ends at this value.	1
8	Range3Color	Color for the highest range.	Red.
9	Title	Identifies the linear gauge	Viscosity

Result: The linear gauge display is ready to report point values (e.g. PROCESS_VISCOSITY). A simple script will pull the data into the gauge; the script will be triggered by an event.

Linear Gauge: Configure an Event and Simple Script

Although the linear gauge has many properties that can be easily configured in the control properties list, an event and script are required to connect a selected point's data to the gauge.

For this control a simple event and script are all that is required:

1. Select Events in the Linear Gauge control's Properties - Object dialog box.
2. Open a new Edit Script window for a Periodic event.

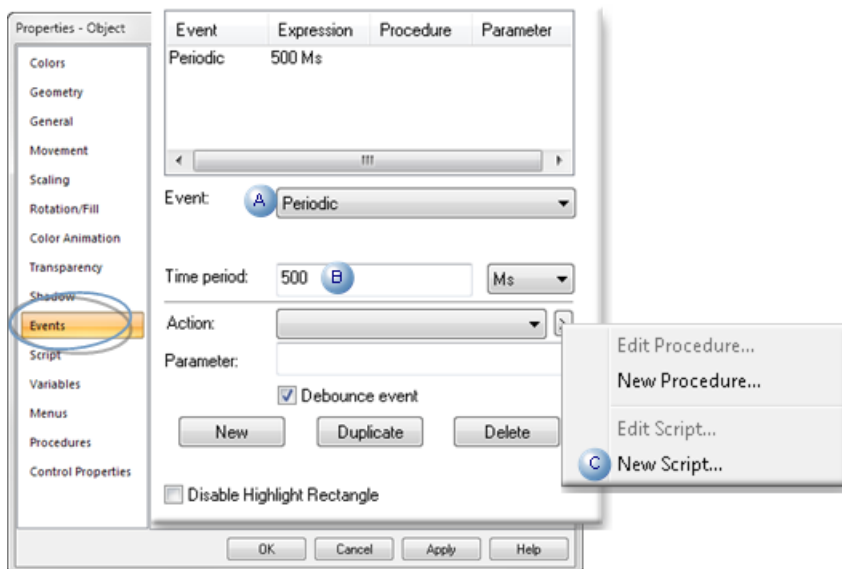

A Event Select Periodic.

B Time period
500 Ms

Note: Specifies the period between the time the event's procedure ends and the time it is re-triggered.

C Action

1. Click the Popup button to the right of the Action field.
2. Select New Script on the Popup menu.

An Edit Script window opens for the control's periodic event:

1. Right-click the mouse under Sub OnTimer().
2. Select ActiveX Properties>Value of>Reading on the extended Popup menu.

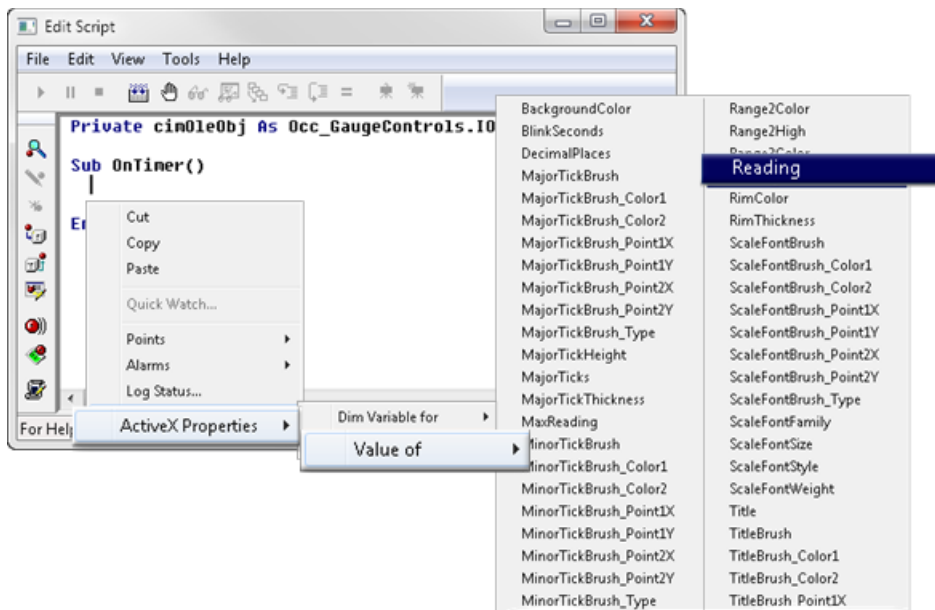

CimOleObj.Reading is inserted into the script:

1. Enter an Equals sign (=) after CimOleObj.Reading.
2. Right-click the Edit Script window after the Equals sign.
3. Select Points>Get on the Popup menu.

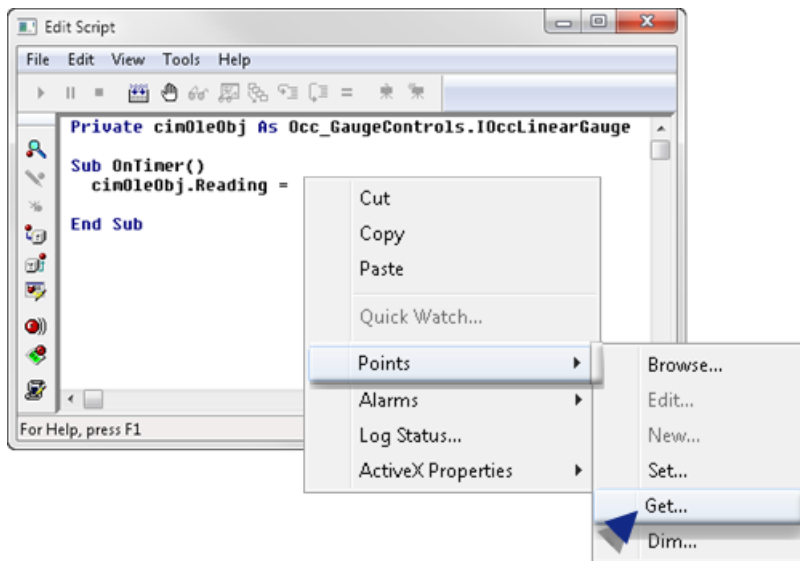

A Get Point dialog box opens:

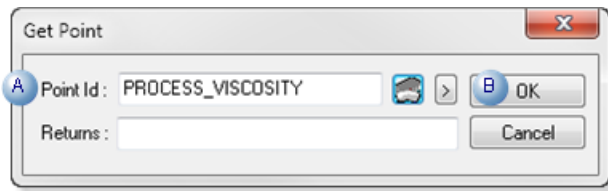

A Enter a point ID (e.g.PROCESS_VISCOSITY) in the Point Id field.

B Click OK.

The script is now ready to be compiled.

```
Private cimOleObj As Occ_System_Windows_Forms_DataVisualization.IOccChart
Sub OnTimer()
  cimOleObj.Reading = PointGet("PROCESS_VISCOSITY")
End Sub
```

Compile the script; close the Edit Script window.

Close the linear gauge's Properties - Object dialog box.

Result: The linear gauge is ready to be tested.

Linear Gauge: Runtime Test

If the configuration is correct, the Gauge needle position will report the point value, and the Region the value is in will blink if blinking is enabled.

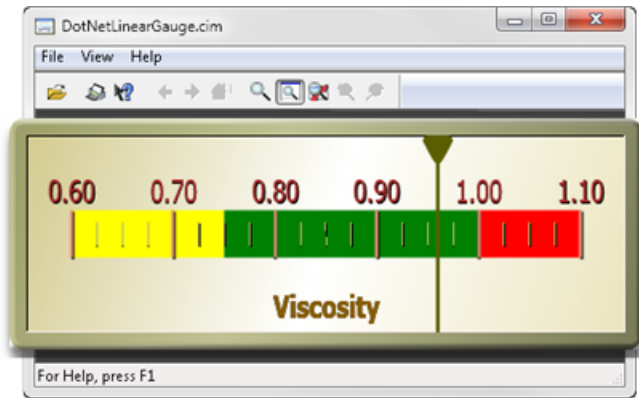

.NET Example: Complex Properties and Methods

1. Click the Popup button to the right of the Action field.
2. Select **New Script** on the Popup menu.
3. Right-click the Edit Script window in the location where the method should be inserted.

Note: In this script, the method is entered under the rs.Open line.

4. Select **ActiveX Methods>Call** on the extended Popup menu.

An Edit Method dialog box opens.

5. Select and enter the following.

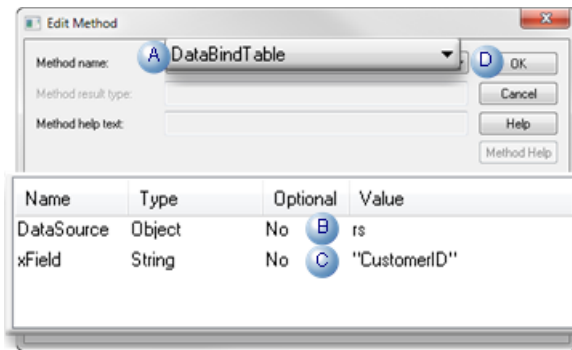

	Field	Select/Enter
A	Method name	DataBindTable. Note: Select the method from a dropdown list of methods.
B	DataSource	rs (Recordset variable name in the script)
C	xField	String column in the selected table. Example "CustomerID"
D	Click OK.	

Field	Select/Enter
Result. The Edit Method dialog box closes; the line created from your selections and entries is entered into the script where you opened the Popup menu.	

- a. Chart: Test the Script - Part 1
- a. Compile the script; close the Edit Script window.
- b. Close the control's Properties - Object dialog box.
- c. Click the Test Button on the CimEdit Ribbon bar.

If the configuration is correct .NET Chart displays as a bar chart with data pulled from SQL Server.

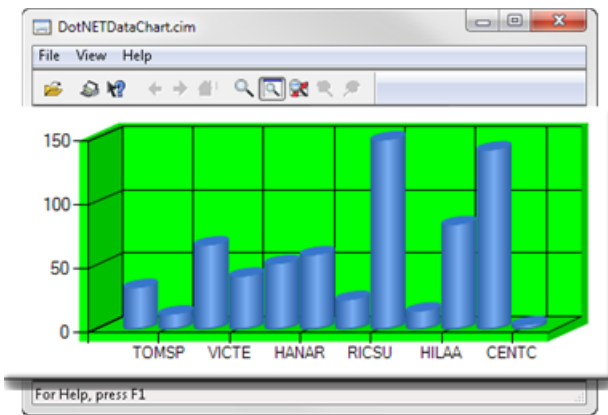

Chart: Script - Part 2

Since the Generic ActiveX Wrapper exposes component events defined by an underlying .NET control as ActiveX events, they can be handled with CimEdit scripting.

1 (page 36)	Chart: Add three mouse events.
2 (page 38)	Chart: Complete (sample) script: Parts 1 and 2.
3 (page 39)	Chart: Test the Script - Parts 1 and 2.

1. Chart: Add Three Mouse Events

Note:

- This configuration that demonstrates rotating the chart using `MouseMove` handler logic is simplified to emphasize the main points of event handling.
- The mouse event handlers that will be used are converted by the Data Conversion module from the corresponding .NET mouse event handlers.

Key event handlers are also converted to the forms similar to their respective Win32 key messages.

1. Re-opt the control chart's Properties - Object dialog box.
2. Select **Events**.
3. Add events and create new scripts as follows.

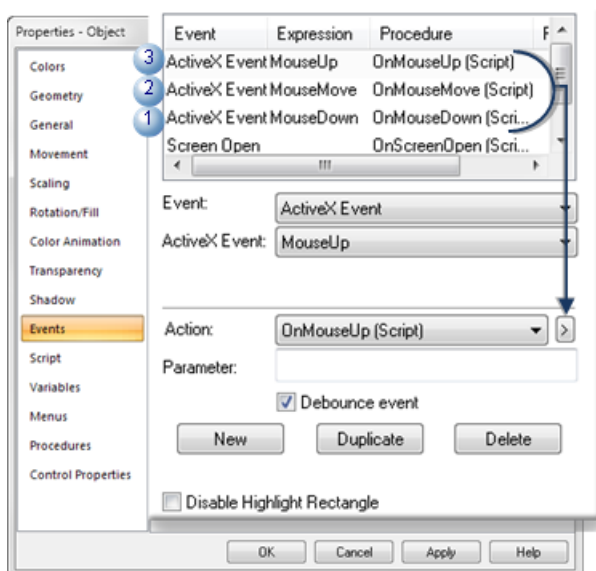

1	Add a <code>MouseDown</code> event.	Create a new script.
2	Add a <code>MouseMove</code> event.	Create a new script
3	Add a <code>MouseDown</code> event.	Create a new script.

The chart's script will now include three additional event handlers.

```
Sub OnMouseDown(state As Long, x As Long, y As Long)
End Sub

Sub OnMouseMove(state As Long, x As Long, y As Long)
End Sub

Sub OnMouseUp(state As Long, x As Long, y As Long)
End Sub
```

Note:

- The .NET control events have the conventional two-parameter signature,
- Sender (Object)
- e (EventArgs)

However, the Data Conversion module has converted these mouse events into those with Win32-style parameters.

- The x and y values are the x and y coordinates of the mouse pointer
- The state value is the mouse button state (not used here).

1. Add a mouse down state variable and some simple handling code.

```
Sub OnMouseDown(state As Long, x As Long, y As Long)
    mouseDown = True
End Sub
Sub OnMouseMove(state As Long, x As Long, y As Long)
    If mouseDown = True Then
        area.Area3DStyle.Inclination = (x Mod 90) / 2
        area.Area3DStyle.Rotation = (y Mod 180) / 2
    End If
End Sub
Sub OnMouseUp(state As Long, x As Long, y As Long)
    mouseDown = False
End Sub

Private Sub Chart1_MouseUp(ByVal state As Long, ByVal x As Long, ByVal y As Long)
    mouseDown = False
End Sub
```

1. Add `Private mouseDown As Boolean` to the beginning of the script.

```
Private cimOleObj As Occ_System_Windows_Forms_DataVisualization.IOccChart
Private area As Object
Private mouseDown As Boolean
```

1. Compile the script; close the Edit Script window and Properties - Object dialog box.

1. Chart: Complete (Sample) Script: Parts 1 and 2

This is the complete (sample) script (Parts 1 and 2) that includes pulling data from SQL server and using mouse events to rotate the chart.

```

Private cimOleObj As Occ_System_Windows_Forms_DataVisualization.IOccChart
Private area As Object
Private mouseDown As Boolean

Sub OnScreenOpen()
    Dim conn As Object
    Dim rs As Object
    Dim series As Object

    Set area = cimOleObj.ChartAreas.Add("areal")
    area.BackColor = &H8000FF00
    area.Area3DStyle.Enable3D = True

    Set conn = CreateObject("ADODB.Connection")
    Set rs = CreateObject("ADODB.Recordset")
    conn.ConnectionString = "Provider=SQLNCLI10;Data Source=.\\sqlexpress;" _
        & "AttachDbFilename=C:\\SQLSampleDatabases\\NORTHWND.MDF;Integrated Security=SSPI;"

    conn.Open
    rs.Open "Select Top 12 CustomerID, Freight from Orders", conn
    cimOleObj.DataBindTable rs, "CustomerID"
    rs.Close
    conn.Close
    Set series = cimOleObj.Series.Item(0)
    series.ChartType = SeriesChartType_Column
    series.SetCustomProperty "DrawingStyle", "Cylinder"
End Sub
Sub OnMouseDown(state As Long, x As Long, y As Long)
    mouseDown = True
End Sub
Sub OnMouseMove(state As Long, x As Long, y As Long)
    If mouseDown = True Then
        area.Area3DStyle.Inclination = (x Mod 90) / 2
        area.Area3DStyle.Rotation = (y Mod 180) / 2
    End If
End Sub
Sub OnMouseUp(state As Long, x As Long, y As Long)
    mouseDown = False
End Sub

Private Sub Chart1_MouseUp(ByVal state As Long, ByVal x As Long, ByVal y As Long)
    mouseDown = False
End Sub

```

1. Chart: Test the Script - Parts 1 and 2

The chart should rotate as you hold the mouse button down and move it.

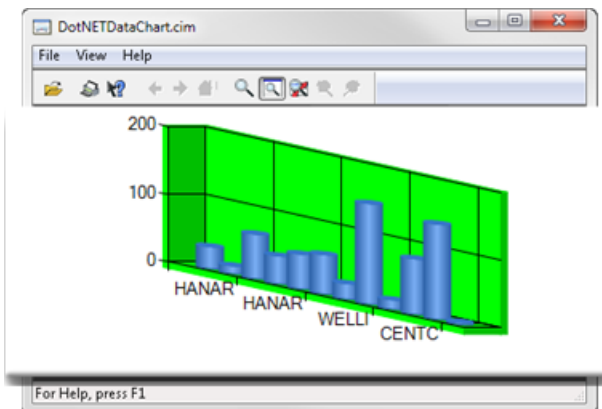

Chart: Script: Part - 3

More sophisticated code than the mouse handling logic used in Sample Script 1 is needed to make the graph move more smoothly in rotation and inclination.

1 (page 40)	Chart: Complete (sample) script: Parts 1 and 3.
2 (page 41)	Chart: Test the script - Parts 1 and 3

1. Chart: Complete (Sample) Script: Parts 1 and 3

The following chart graph uses the same event handling script used in Sample Script 1, but selects two numeric columns from another table.

Replace the code in Sample Script - Parts 1 and 2 from the `conn.Open` line in the `OnScreenOpen()` subroutine to the `End Sub` with the code that is now in that location.

```

Private cimOleObj As Occ_System_Windows_Forms_DataVisualization.IOccChart
Private area As Object
Private mouseDown As Boolean
Sub OnScreenOpen()
    Dim conn As Object
    Dim rs As Object
    Dim series As Object
    '
    Set area = cimOleObj.ChartAreas.Add("area1")
    area.BackColor = &H8000FF00
    area.Area3DStyle.Enable3D = True
    '
    Set conn = CreateObject("ADODB.Connection")
    Set rs = CreateObject("ADODB.Recordset")
    conn.ConnectionString = "Provider=SQLNCLI10;Data Source=.\sqlexpress;" _
        & "AttachDbFilename=C:\SQLSampleDatabases\NORTHWND.MDF;Integrated Security=SSPI;"
    '
    conn.Open
    rs.Open "select Top 50 OrderID, UnitPrice, Quantity from [Order Details]", conn
    cimOleObj.DataBindTable rs, "OrderID"
    rs.Close
    conn.Close
    Set series = cimOleObj.Series.Item(0)
    series.ChartType = SeriesChartType_Column
    series.SetCustomProperty "DrawingStyle", "Cylinder"
    Set series = cimOleObj.Series.Item(1)
    series.ChartType = SeriesChartType_Column
    series.SetCustomProperty "DrawingStyle", "Cylinder"
End Sub
Sub OnMouseDown(state As Long, x As Long, y As Long)
    mouseDown = True
End Sub
Sub OnMouseMove(state As Long, x As Long, y As Long)
    If mouseDown = True Then
        area.Area3DStyle.Inclination = (x Mod 90) / 2
        area.Area3DStyle.Rotation = (y Mod 180) / 2
    End If
End Sub
Sub OnMouseUp(state As Long, x As Long, y As Long)
    mouseDown = False
End Sub

Private Sub Chart1_MouseUp(ByVal state As Long, ByVal x As Long, ByVal y As Long)
    mouseDown = False
End Sub

```

1. Chart: Test the Script - Parts 1 and 3

If the script details have been entered correctly two columns will display. The chart should also rotate more smoothly.

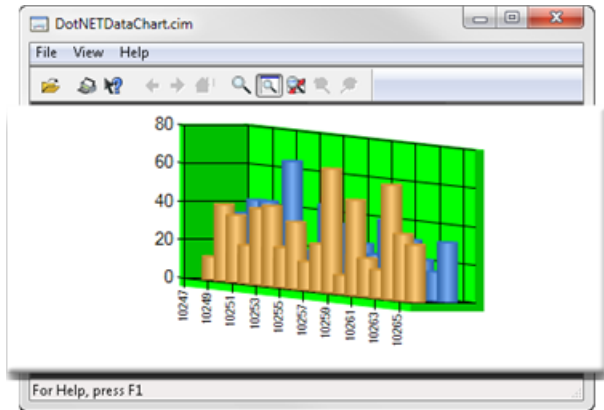

.NET Example: Parameters Not Fully Converted

Because there are endless .NET event argument types, the common and most useful types will be converted first for the .NET Component Host; additional .NET argument types will be converted in future CIMPLICITY releases.

However, when parameters are not fully converted, the controls can be configured using CimEdit features, such as events, scripts and procedures.

A **DataGrid** and **ComboBox**, which are available in the .NET Component Browser, have properties of not fully converted data types that have these requirements.

 **Note:** The **DataGrid** and **ComboBox** example:

- Will be configured to display logged data in the DataGrid whose category can be selected in the ComboBox.
- Uses the Microsoft SQL Server sample database Northwind.mdf/Mothwind.ldf files, which can be downloaded from the Microsoft Website.

 **Important:** Before you work with or apply this example make sure that a **Virtual integer point** is available for the script.

The sample uses a point named SEL_INDEX.

- Controls: Script - Part 1
- Controls: Script - Part 2

Controls: Script - Part 1

Once a chart is placed on the screen, scripting can be started that will pull data into the control from SQL Server.

1 (page 43)	Controls: Place and resize on the CimEdit screen.
2 (page 44)	Controls: Create a new script.
3 (page 46)	Controls: Test the script - Part 1.

1. Controls: Place and Resize on the CimEdit Screen

DataGrid: Place on the CimEdit screen.

1. Open the .NET Components Browser.
2. Select .NET Components>.NET Framework>Windows Presentation Framework>Presentation Framework>DataGrid.
3. Close the .NET Components Browser.
4. Resize the DataGrid.

Note: Since the DataGrid runtime representation is blank, approximate its size. You can modify the size later.

5. Open the DataGrid's Properties - Object dialog box.
6. Select **General**.
7. Name the DataGrid in the **Object name** field (e.g. Data Grid1).
8. Close the Properties - Object dialog box.

ComboBox: Place and Resize on the CimEdit screen.

9. Open the .NET Components Browser.
10. Select .NET Components>.NET Framework>Windows Presentation Framework>Presentation Framework>ComboBox.
11. Close the .NET Components Browser.
12. Resize the ComboBox.

Since the ComboBox runtime representation displays a drop list arrow aiding you to approximate its size. You can modify the size later.

13. Open the ComboBox's Properties - Object dialog box.
14. Select **General**.
15. Name the ComboBox in the **Object name** field (e.g. Combo Box1).
16. Close the Properties - Object dialog box.

The controls

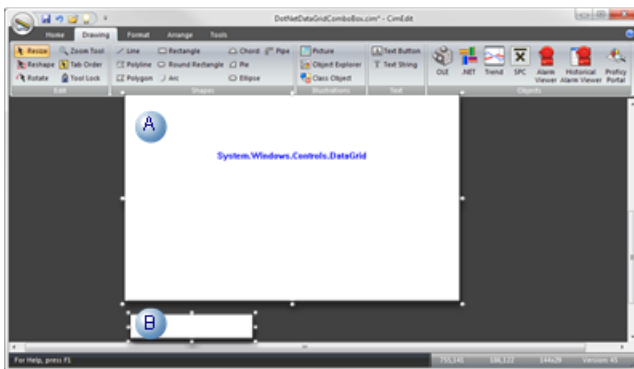

Note: [Colors \(page 21\)](#) and [fonts \(page 24\)](#) that are different from the default colors and fonts can be selected at anytime in the control's Properties - Object dialog box>**Control Properties** list.

Solid colors can be selected for the DataGrid rows.

Example

The following colors are selected for the DataGrid rows.

Row	RGB Color
AlternatingRowBackground_Color1	218,227,188
RowBackground_Color1	250,192,143

The DataGrid rows will alternate these colors during runtime.

- a. Controls: Create a New Script

Scripts that will populate the DataGrid and ComboBox are based on a `Screen Open` event.

- DataGrid: Create a Script - Part 1
- ComboBox: Create a Script - Part 1

DataGrid: Create a Script - Part 1

- Add a `Screen Open` event to the DataGrid control.
- Create a new script.
- Add the following code to the script.

Important: Change the information, if necessary, to match your database specifications.

```
Private cimOleObj As Occ_PresentationFramework.IOccDataGrid
Sub OnScreenOpen()
    Dim conn As Object
    Dim rs As Object

    Set conn = CreateObject("ADODB.Connection")
    Set rs = CreateObject("ADODB.Recordset")
    conn.ConnectionString = "Provider=SQLNCLI10;Data Source=.\sqlexpress;" _
        & "AttachDbFilename=C:\SQLSampleDatabases\NORTHWND.MDF;Integrated Security=SSPI;"

    conn.Open
    rs.Open "Select Top 20 * from Orders", conn
    Set cimOleObj.ItemsSource = rs

    rs.Close
    conn.Close
End Sub
```

- Compile the script; close the Edit Script window.
- Close the DataGrid's Properties - Object dialog box.

ComboBox: Create a Script - Part 1

- Add a `Screen Open` event to the ComboBox control
- Create a new script.
- Add the following code to the script.

Important: Change the information, if necessary, to match your database specifications.

```
Private cimOleObj As Occ_PresentationFramework.IOccComboBox
Sub OnScreenOpen()
    Dim conn As Object
    Dim rs As Object

    Set conn = CreateObject("ADODB.Connection")
    Set rs = CreateObject("ADODB.Recordset")
    conn.ConnectionString = "Provider=SQLNCLI10;Data Source=.\sqlexpress;" _
        & "AttachDbFilename=C:\SQLSampleDatabases\NORTHWND.MDF;Integrated Security=SSPI;"

    conn.Open
    rs.Open "Select Top 20 * from Orders", conn

    Do While Not rs.EOF
        cimOleObj.Items.Add CStr(rs("CustomerID"))
        rs.MoveNext
    Loop
    cimOleObj.SelectedIndex = 0

    rs.Close
    conn.Close
End Sub
```

- Compile the script; close the Edit Script window.
- Close the ComboBox's Properties - Object dialog box.

a. Controls: Test the Script - Part 1

The controls should now display data from the selected database (e.g. Northwind).

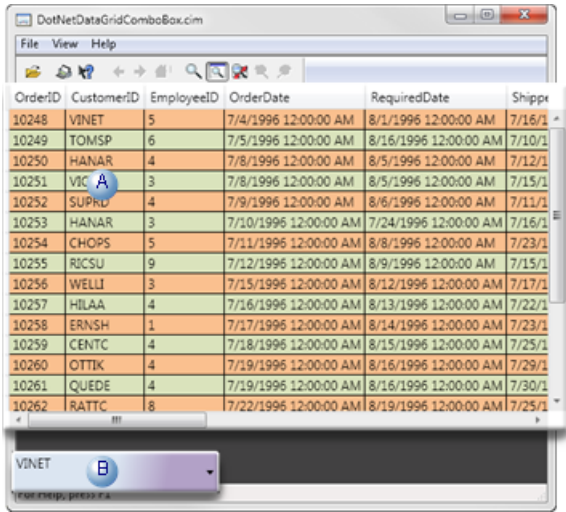

A user can:

A	Scroll up and down the DataGrid to review data.
B	Select different items on the ComboBox drop down list.

There is currently no connection between the DataGrid and the ComboBox.

Controls: Script - Part 2

When two additional scripts are applied to a procedure, they will connect the two .NET controls and cause the ComboBox selection to drive the DataGrid display.

1 (page 46)	Controls: Add subroutines- Part 2
2 (page 47)	Controls: Create a procedure to invoke the scripts.
3 (page 48)	Controls: Test scripts and procedures.

a. Controls: Add Subroutines - Part 2

The .NET controls subroutines get and set the Virtual point that you created or selected for use before placing the controls on the CimEdit screen.

ComboBox: Add a Subroutine

A ComboBox subroutine sets the point (e.g. SEL_INDEX).

This is the companion to the DataGrid subroutine that will get the point.

```
Sub GetSelection()
PointSet "SEL_INDEX", cimOleObj.SelectedIndex
End Sub
```

DataGrid: Add a Subroutine

A DataGrid subroutine gets the point (e.g. SEL_INDEX).

This is the companion to the ComboBox subroutine that will set the point.

```
Sub SetSelection()
cimOleObj.SelectedIndex = PointGet("SEL_INDEX")
End Sub
```

a. Controls: Create a Procedure to Invoke the Scripts

Note:

Because the two parameters are of the COM Variant type, it's not as straightforward to use a handler routine as, for example, `Mouse` events.

However, because both the DataGrid and ComboBox each have the `SelectionIndex` property, the selection in the ComboBox drop down list can be determined and the corresponding row selection of the DataGrid component can be set by accessing their `SelectionIndex` properties.

A straightforward way to configure the parameters is through an ActiveX `Event>SelectionChanged` event and a procedure that uses `InvokeScript` actions.

- ComboBox: Configure `SetChangedProc`
- DataGrid: Configure `SetChangedProc`

ComboBox: Configure `SetChangedProc`

- Open the ComboBox Properties - Object dialog box.
- Select **Events**.
- Create an ActiveX `Event>SelectionChanged` event.
- Create a new procedure for the event.

The procedure Includes two `Invoke script` actions.

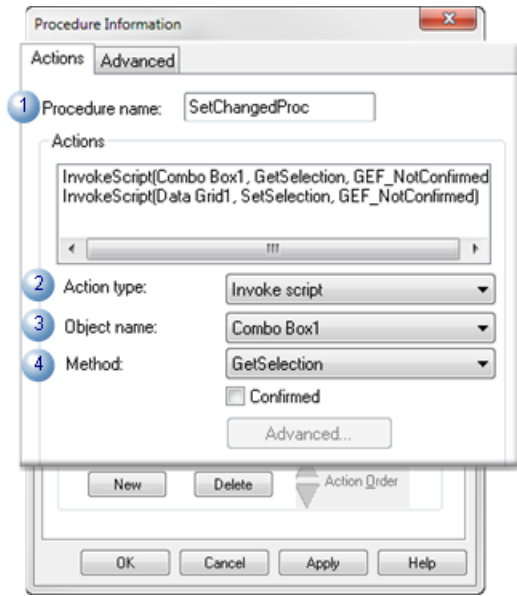

1	Procedure name	Name to clearly identify the procedure. Example SetChangedProc
2	Action type 1	Invoke script
3	Object name1	Select the name that was entered in the ComboBox's Properties - Object dialog box>General> Object name field. Example Combo Box1
4	Method1	<code>GetSelection</code>
2	Action type 2	Invoke script
3	Object name2	Select the name that was entered in the DataGrid's Properties - Object dialog box>General> Object name field Example DataGrid1
4	Method	<code>SetSelection</code>

a. Click Apply; close the ComboBox control's Properties - Object dialog box.

DataGrid: Configure SetChangedProc

Configure the same ActiveX Event>Selection Changed event with the same SetChangedProc in the DataGrid control's Properties - Object dialog box.

a. Controls: Test Scripts and Procedures -

If the scripts and configuration are completed correctly the DataGrid control now automatically highlights the data row based on the selection made in the ComboBox control.

OrderID	CustomerID	EmployeeID	OrderDate	RequiredDate	ShipDate
10248	VINET	5	7/4/1996 12:00:00 AM	8/1/1996 12:00:00 AM	7/16/1996
10249	TOMSP	6	7/5/1996 12:00:00 AM	8/16/1996 12:00:00 AM	7/10/1996
10250	HANAR	4	7/8/1996 12:00:00 AM	8/5/1996 12:00:00 AM	7/12/1996
10251	VICTE	3	7/8/1996 12:00:00 AM	8/5/1996 12:00:00 AM	7/15/1996
10252	SUPRD	4	7/9/1996 12:00:00 AM	8/6/1996 12:00:00 AM	7/11/1996
10253	HANAR	3	7/10/1996 12:00:00 AM	7/24/1996 12:00:00 AM	7/16/1996
10254	CHOPS	5	7/11/1996 12:00:00 AM	8/8/1996 12:00:00 AM	7/23/1996
10255	RCSU	9	7/12/1996 12:00:00 AM	8/9/1996 12:00:00 AM	7/15/1996
10256	WELLI	3	7/15/1996 12:00:00 AM	8/12/1996 12:00:00 AM	7/17/1996
10257	HILAA	4	7/16/1996 12:00:00 AM	8/13/1996 12:00:00 AM	7/22/1996
10258	ERNSH	1	7/17/1996 12:00:00 AM	8/14/1996 12:00:00 AM	7/23/1996
10259	CENTC	4	7/18/1996 12:00:00 AM	8/15/1996 12:00:00 AM	7/25/1996
10260	OTTIK	4	7/19/1996 12:00:00 AM	8/16/1996 12:00:00 AM	7/29/1996
10261	QUEDE	4	7/19/1996 12:00:00 AM	8/16/1996 12:00:00 AM	7/30/1996
10262	RATTC	8	7/22/1996 12:00:00 AM	8/19/1996 12:00:00 AM	7/25/1996

.NET Control: Technical Reference

.NET Control: Technical Reference

- .NET Components: General information.
- .NET Control: Create new components.
- .NET Component Browser: Modifications.
- .NET Components: On other CIMPLICITY systems.
- .NET Files: Location.
- .NET Data: Conversion rules.
- .NET Error: Logging.
- .NET: Glossary.

.NET Components: General Information

- Component supporting files.
- Unique NET Control Assembly names.
- Supported .NET Control types.
- Remote use: WebSpace.

Component Supporting Files

Component supporting files are [automatically created \(page 57\)](#) from the original .NET source assembly (e.g. ChartControls.dll).

Assemblies referenced by the source assembly and not installed in the assembly cache must be put in the same folder.

The component creation process creates the following essential files for a .NET source assembly to support hosting and communicating with all the components created from the selected controls in the source assembly:

File	Description
<Occ><ordinal number>_<source assembly name>.dll:	Component assembly
<Occ><the same ordinal number>_<source assembly name>.tlb	Component type library

Note:

- `Occ` is short for Orion COM Component (Orion is the original name of Component Client.).
- Do not manually delete the essential supporting files.
- Some temporary or debugging files may be created; they are not essential for the components to function.
- If the same source assembly is selected to the Add Components process the second time, the ordinal number will increase.

Unique NET Control Assembly Names

A [control assembly \(page 56\)](#) name (e.g. ChartControls) must be unique among all .NET control assemblies that are used to build CIMPLICITY containable components.

If a name is not unique unexpected results may happen as the .NET runtime will use the first loaded control assembly for all same named assemblies.

Note:

- .NET has provisions to support loading assemblies with the same name but different versions.

However, that requires the versioned assemblies be signed and installed into the system assembly cache; this scenario is not appropriate to the current case and thus is not supported.

- The full name (namespace and class name) of any .NET control must be unique.

Supported .NET Control Types

Component Hosting Release 1.0 supports following two .NET control types.

These types basically cover all .NET controls used for non-web-based applications.

Specifically, custom or third-party controls that are derived from the following .NET Framework 4.0 classes can be hosted:

WPF	<ul style="list-style-type: none"> • System.Windows.UIElement • System.Windows.FrameworkElement • Any of the over 100 control classes in the System.Windows.Controls namespace
WinForms	<ul style="list-style-type: none"> • System.Windows.Forms.Control • Any of the over 60 control classes in the System.Windows.Forms namespace.

 **Note:** All custom controls must define a parameter-less constructor or no constructors at all (so the compiler will add a parameter-less one) in order for them to be created in an environment that no parameters may be passed to. This is the same requirement for all ActiveX controls working with a COM client and all .NET controls used by a user-interface configurable .NET environment.

Remote Use: WebSpace

If you are working remotely with CimView screens that include .NET components, use WebSpace to insure that the components, which are ActiveX controls display and perform correctly.

.NET Control: Create new Components

The Generic ActiveX Wrapper and other modules in the CimEdit .NET feature support hosting and interfacing with any WPF and WinForms controls, As a result, you can use third-party controls or create your own controls based on any .NET Framework WPF or WinForms control types.

 **Note:** If you are using a third party control this procedure can be omitted.

1. Create a folder in the..\<<CIMPLICITY Installation>\exe\DotNet Components directory.

Example

..\Proficy\Proficy CIMPLICITY\exe\DotNet Components\My Samples

2. Do the following.
 - a. Use a text editor (e.g. Notepad) to write following code as a C# source file.
 - b. Name the file TrendChart.cs.
 - c. Save the file in your My Samples folder.

```

using System;
using System.Drawing;
using System.Windows.Forms.DataVisualization.Charting;
namespace ChartControls
{
    public class TrendChart : Chart
    {
        private double _value;
        private ChartArea _area;
        private Series _series;
        private Title _title;
        public TrendChart()
        {
            BackColor = Color.Silver;
            BorderSkin.SkinStyle = BorderSkinStyle.FrameThin5;
            _title = Titles.Add("Trend Chart");
            _title.Font = new Font("Arial", 10, FontStyle.Bold);
            _area = ChartAreas.Add("area0");
            _area.AxisX.LabelStyle.Format = "hh:mm:ss";
            _area.AxisX.LabelStyle.Interval = 5;
            _area.AxisX.LabelStyle.IntervalType = DateTimeIntervalType.Seconds;
            _area.AxisX.MajorGrid.Interval = 5;
            _area.AxisX.MajorGrid.IntervalType = DateTimeIntervalType.Seconds;
            _area.BackColor = Color.Orange;
            _area.BackGradientStyle = GradientStyle.TopBottom;
            _series = Series.Add("series0");
            _series.ChartType = SeriesChartType.Line;
            _series.ShadowOffset = 1;
        }
        public string Title
        {
            get { return _title.Text; }
            set { _title.Text = value; }
        }
        public double Value
        {
            get { return _value; }
            set
            {
                _value = value;
                DateTime current = DateTime.Now;
                _series.Points.AddXY(current.ToOADate(), _value);
                double removeBefore = current.AddSeconds(-25).ToOADate();
                while (_series.Points[0].XValue < removeBefore)
                    _series.Points.RemoveAt(0);
                _area.AxisX.Minimum = _series.Points[0].XValue;
                _area.AxisX.Maximum
                    = DateTime.FromOADate(_series.Points[0].XValue).AddSeconds(30).ToOADate();
            }
        }
    }
}

```

 **Note:** The TrendChart class is derived from the Framework 4.0 Chart class.

3. In the constructor, a `ChartArea` and a `Series` are added to the chart control,
4. The control is then configured by setting some `ChartArea` and `Series` properties.
5. Two properties are defined:

Title	Sets a chart title
Value	Binds to a data source

6. When the data value changes, the set action of the `value` property adds a new data point to the chart.
7. When the number of data points exceeds a preset limit, the oldest points are removed.
8. Open a Command Prompt window.
9. Change the directory to the path to your new DotNet component folder.

Example

C:\Program Files (x86)\Proficy\Proficy CIMPLICITY\exe\DotNet Components\My Samples

10. Enter the following command.

```
C:\WINDOWS\Microsoft.NET\Framework\v4.0.30319\csc /t:library /out:ChartControls.dll /
r:System.dll;System.Windows.Forms.dll;System.Windows.Forms.DataVisualization.dll TrendChart.cs
```

A ChartControls.dll is now included in your DotNet components folder.

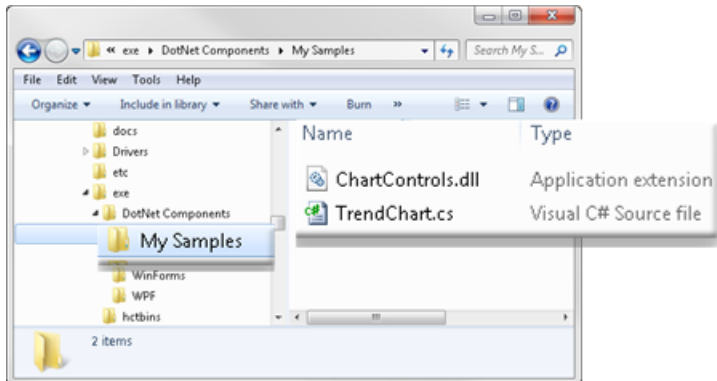

Note: This TrendChart control can also be built with Visual Studio 11.0. A project for this is included in the folder

..\<CIMPLICITY Install>\exe\DotNet Components\Sample Components\VS2010SampleProjects.

! **Important:** Make sure that the .dll files you use to add new components are unblocked.

1. Right-click the file in Windows Explorer.

The Properties dialog box opens.

1. Select the General tab.
2. Click Unblock.

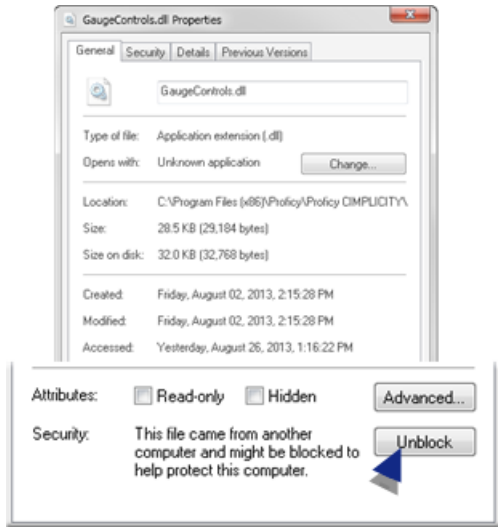

.NET Component Browser: Modifications

The .NET Component Browser can be modified to accommodate your system's .NET requirements.

- Add a group.
- Add components to a group.
- Delete nodes.
- Delete .NET Components.

Add a Group

1. Open the .NET Component Browser.
2. Do the following.

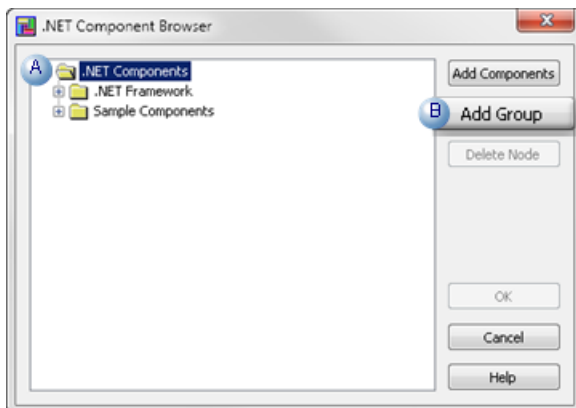

A Select the folder that will include the new group.

B	Click Add Group.
---	------------------

3. Enter the following.

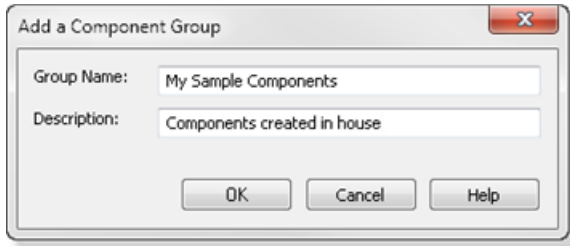

Group Name	Name that will clearly identify the group of .NET controls that will be added.
Description	(Optional) Additional information to help users know what controls are in the group. Note: The description will display as the tooltip of the group name.

4. Click OK.

Result: A group folder is added to the .NET Component Browser at the level in which it was inserted.

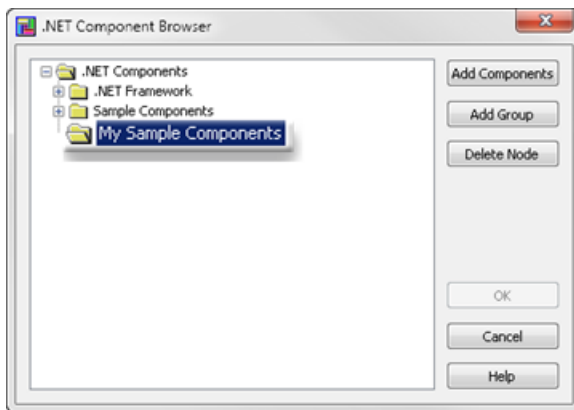

Add Components to a Group

5. Open the .NET Component Browser.

6. Do the following.

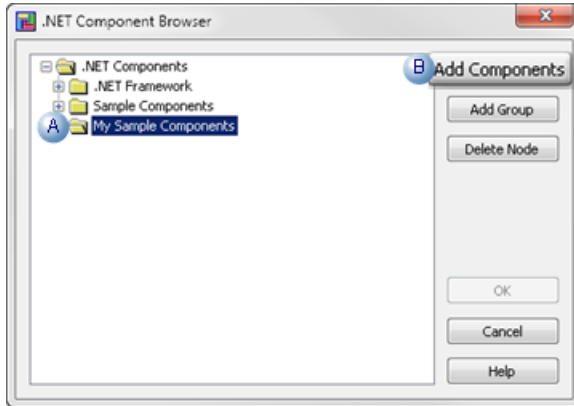

A	Select the folder that will include the added component.
B	Click Add Components.

An Add .NET Components dialog box opens.

7. Do the following.

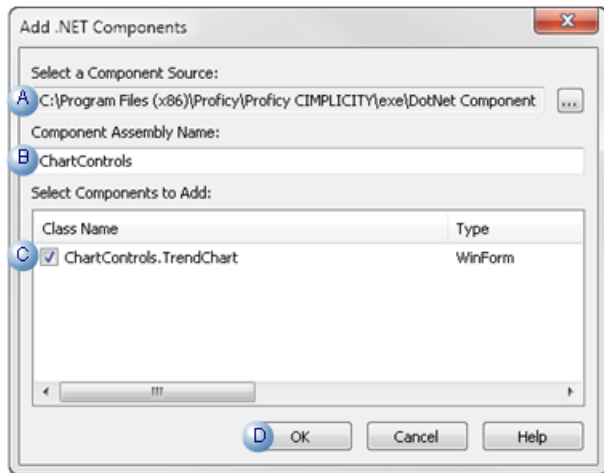

A	Select a Component Source	<p>a. Click the Browse button to the right of the field to open the folder that contains the appropriate Control file.</p> <p>b. Select the ChartControls.dll file in the selected folder.</p> <p>Example C:\Program Files (x86)\Proficy\Proficy CIMPLICITY\exe\DotNet Components\My Samples\ChartControls.dll</p>
B	Component Assembly Name	The assembly name, which is the name of the selected .dll, will be entered automatically.
C	Select Components to Add	Check the components, located in the selected assembly, which will be added to the .NET Components Browser.
D	Click OK.	

The .NET Components Browser now lists the selected components in the selected folder.

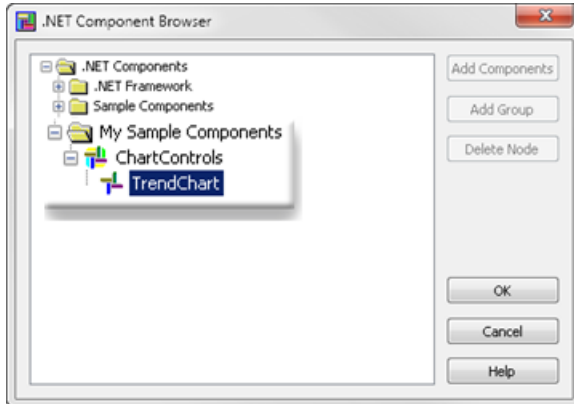

Result: [Two additional files \(page 49\)](#) are added to the new directory.

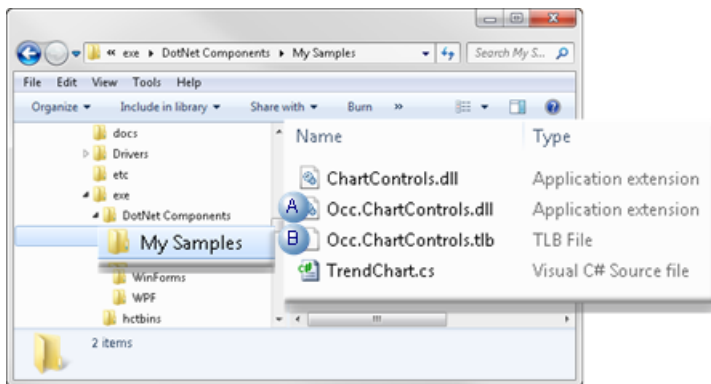

A	Occ.ChartControls.dll	Component assembly
B	Occ.ChartControls.tlb	Component type library

.NET Controls with Non-System References

This example (depends on) only system assemblies (as listed for the `/r` command option).

They are:

- System.dll
- System.Windows.Forms.dll
- System.Windows.Forms.DataVisualization.dll.

Third-party controls, however, usually reference their own supporting assemblies. When a control assembly is compiled, the compiler copies all non-system reference assemblies to the output folder.

The control assembly and its supporting reference assemblies should be copied to a specific folder under the `..\<CIMPPLICITY Installation>\exe\DotNet Components` folder. However, some third-party common assemblies may need to be installed into the system assembly cache or be copied to the `..\<CIMPPLICITY Installation>\exe` folder.

Delete Nodes

You can delete a group or an assembly node from the .NET Component Browser.

Do the following.

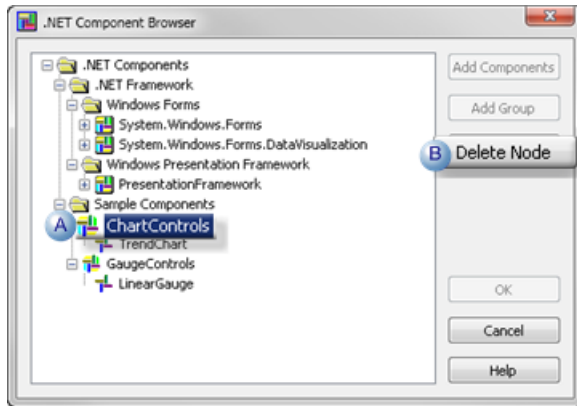

A	Select the node to delete.
B	Click Delete Node.

guide: Delete Node Guidelines

The Delete feature can help to keep the browser clean and well organized. However, be very cautious when deleting components such as the **ChartControls** node. A CIMPLICITY screen will fail to load if it contains any control objects created from the components of the deleted assembly.

The deletion action includes the following safeguards.

- Custom nodes that are deleted can be recovered by adding their assemblies ([Add Components \(page 55\)](#)).
- If any node under .NET Framework is deleted, the .NET Component feature will have to be reinstalled to recover the deleted node.
- The root Group node (.NET Components) cannot be deleted;
- A Group node cannot be deleted if it contains child nodes.
- An Assembly node cannot be deleted if any opened CIMPLICITY screens contain control objects created from its components.
- An assembly node added in the current session cannot be deleted.

Note: The generated supporting assembly is loaded when performing an Add Components action; it cannot be deleted unless it is unloaded at the session's end. If you are certain that the assembly entry should no longer be available it can be deleted by closing and reopening CimEdit.

Problems with deletion arise if a closed picture that contains components from the deleted assembly is then opened, because CimEdit cannot check references in closed screens. This is the same behavior as that of CIMPLICITY ActiveX controls in case that they are unregistered.

Delete .NET Components

Deleting a component entry is a serious action and is a rarely used feature.

However, if it is necessary to delete a .NET component,

8. Click the Browse button to the right of the field to open the folder that contains the appropriate Control file.
9. Select the ChartControls.dll file in the selected folder.
ExampleC:\Program Files (x86)\Proficy\Proficy CIMPLICITY\exe\DotNet Components\My Samples\ChartControls.dll
10. All of the .NET component's children (e.g. groups, assembly nodes, etc.) must be deleted first.
11. CimEdit must be closed and re-opened.

.NET Components: On other CIMPLICITY Systems

- Component files copied to other systems.
- Components added to the component browser of another CIMPLICITY system.

Component Files Copied to Other Systems

If new components are created and inserted into CIMPLICITY screens on one CIMPLICITY system, and the saved screens are opened on another CIMPLICITY system, the screens will not load with the new components if they do not exist on the new system. This is the same situation as ActiveX controls if they are not installed (copied and registered) on a new target system.

There is no need to register the new components: neither the component assembly nor the component type library files.

Copy the same directory hierarchy relative to the ..\<CIMPLICITY Installation>\exe folder to other systems in the same hierarchy.

Example

If the ChartControls.dll, Occ.ChartControls.dll and Occ.ChartControls.tlb files are copied to the .. \<CIMPLICITY Installation>\exe\DotNet Components\My Sample Components folder of another CIMPLICITY system, the TrendChart objects configured on the original system will then load and function on the new system.

Any custom or third-party supporting assemblies in the <CIMPPLICITY Install>\exe folder must also be copied to the <CIMPPLICITY Install>\exe folder of other systems.

Components Added to the Component Browser of another CIMPPLICITY System

A suitable entry needs to be on the Component Browser's tree view to insert objects of a new component into a CIMPPLICITY screen on another system,

Options include the following.

Keep all the created components synchronized across all systems.

1. Keep the folder hierarchy and file contents synchronized from < CIMPPLICITY Installation>\exe \DotNet Components (inclusive) on all systems using a main copy.
2. Overwrite the Component Browser content files: <CIMPPLICITY Installation>\exe \GEIP.Orion.Components.dat on all systems using a main copy.

Add Entries to the .NET Component Browser

Browsing entries for a group of new components may be easily added to the .NET Component Browser, especially if different complexity and usefulness levels are desired across the involved systems.

Example

A Trend .NET control will be made available to other browser.

3. Open the .NET Component Browser.
4. Add a new group (e.g. My Sample Components).
5. Do the following.

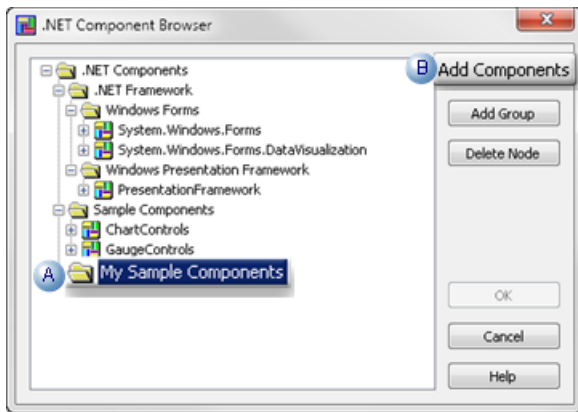

A	Select the new folder (e.g. My Sample Components).
---	--

B Click Add Components.

An Add .NET Components dialog box opens.

6. Do the following.

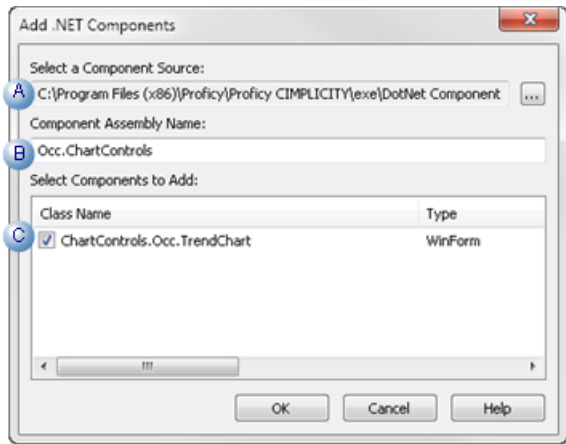

A	Select a Component Source	<p>a. Click the Browse button to the right of the field to open the folder that contains the appropriate Control file.</p> <p>b. Select the Occ.ChartControls.dll file in the selected folder.</p> <p>! Important: Do not select chartControls.dll.</p> <p>Example C:\Program Files (x86)\Proficy\Proficy CIMPLICITY\exe\DotNet Components\My Samples\Occ.ChartControls.dll.</p>
B	Component Assembly Name	The assembly name, which is the name of the selected .dll, will be entered automatically.
C	Select Components to Add	Check the components, located in the selected assembly that will be added to the .NET Components Browser. Note; The class name is <code>ChartControls.Occ.TrendChart</code> .
D	Click OK.	

7. Click the Browse button to the right of the field to open the folder that contains the appropriate Control file.

8. Select the Occ.ChartControls.dll file in the selected folder.

! **Important:** Do not select chartControls.dll.

Example C:\Program Files (x86)\Proficy\Proficy CIMPLICITY\exe\DotNet Components\My Samples\Occ.ChartControls.dll.

.NET Files: Location

All .NET components must be located in the following directory (or subfolders in the following directory).

..\<CIMPLICITY Installation>\exe\DotNet Components

! Important:

- All original .NET control assemblies must be stored under the root component directory.
- Network shared folders for component storage are not supported due to .NET security implementations

Default subfolders and files include the following.

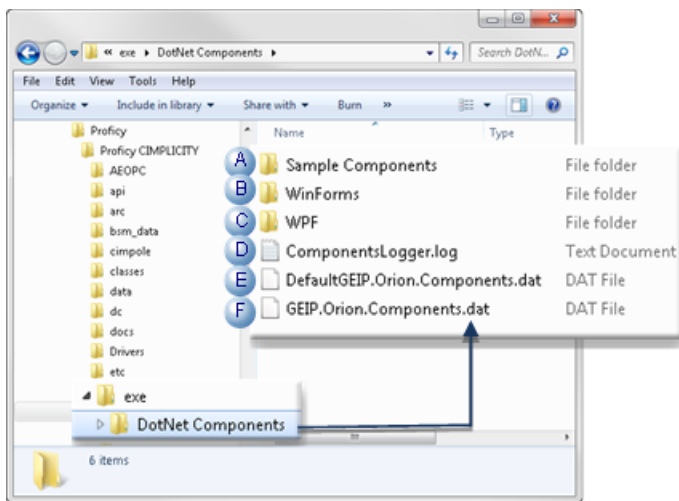

	Folder/File	Description
A	Sample Components	CimEdit sample controls.
B	WinForms	Windows-Forms-based controls
C	WPF	.NET WPF controls
D (page 67)	ComponentsLogger.log	Error logging file.
E	DefaultGEIP.Orion.Components.dat	
F	GEIP.Orion.Components.dat	

.NET Data: Conversion Rules

- Properties and methods.
- Events.

- Complex data types.
- Strategies for parameter types that cannot be converted.

Properties and Methods

If a custom or third-party .NET control is one of the supported .NET control types, any public property or method defined in the control class will be exposed if the data type of the property or the type of each parameter of the method is one of the following types:

Type	Description
Primitive	Including integral and floating numeric
COM recognizable	Including: <ul style="list-style-type: none"> • String • DateTime • System.Drawing.Color (WinForms Color)
COM visible	Such as: <ul style="list-style-type: none"> • System.Collections.ArrayList • System.Collections.IList • System.Object
NET generic list	<ul style="list-style-type: none"> • List<short> • List<int> • List<float> • List<double> • List<string> • (All of the System.Collections.Generic namespace).
DataTable and DataView classes	<ul style="list-style-type: none"> • (All of the System.Data namespace) • System.Windows.Media.Brush class • System.Collections.IEnumerable interface • System.Windows.Control.ItemCollection class.
Windows Forms Font	<ul style="list-style-type: none"> • System.Drawing.Font • WPF FontFamily (System.Windows.Media.FontFamily) classes • FontStretch • FontStyle • FontWeight structures • (All of the System.Windows namespace).

Note:

- The property or method in the exposed COM interface will have the corresponding COM types converted from the original .NET types.

- If a property or method does not meet the above condition, it will be ignored in the component building process and will not be available in the component COM interface.

Events

All the public events defined in the control class are exposed as COM connection point handlers, according to the following rules:

1. If all the parameter types of a .NET event delegate are convertible according to the conditions listed in the Properties and Methods section, the .NET event delegate will be converted to a COM event handler with the same number of parameters of the corresponding COM types.
2. Some common .NET delegate types are converted to specifically defined COM event handlers.

These include the:

- Mouse events.
 - WPF MouseEventHandler
 - MouseButtonEventHandler
 - MouseWheelEventHandler
 - WinForms MouseEventHandler delegates
- Key events
 - WPF KeyEventHandler
 - KeyboardEventHandler
 - WinForms KeyEventHandler
 - KeyPressEventHandler delegates
- Selection events
 - SelectionChangedEventHandler
 - EventHandler<SelectionChangedEventArgs> delegates.

3. The converted COM mouse event handlers are defined to have three parameters:
 - Mouse button state.
 - X and Y positions

Refer to the Win32 documents for the definitions of the mouse button state.

4. The COM key event handlers are defined to have two parameters
 - Key state
 - Key code

Refer to the Win32 documents for the definitions of the key state.

5. The converted COM selection event handler has two parameters of the COM Variant type with an array subtype:
 - AddedItems, for items newly added to the selected items collection.
 - RemovedItems, for items newly removed from the selected items collection.

Note: To avoid array indexing problems (the items arrays might be empty), check with the VBA function `UBound`.

- All other delegates that follow the .NET convention (two parameters: sender of the Object type and e of an EventArgs derived type) are converted to a COM handler of two parameters of the String type.

Complex Data Types

The data conversion module supports passing complex data types such as arrays (lists) and data tables. The supported .NET types are exposed as common COM types or specific interfaces and types implemented by the conversion module. The supported COM types may be passed to or returned from the methods and properties of .NET controls, to which, as a result of data conversion, these data types appear as the corresponding .NET types.

- `DataTable`, `DataRowView` (both of System.Data) and `IEnumerable` (of System.Collection).
- These types appear as `ADODB.Recordset` and are used to pass data tables with columns and rows.

`IEnumerable` is converted to `Recordset` because many .NET controls use the `IEnumerable` interface to pass `DataTable` objects.

- Add the Microsoft ActiveX Data Objects Library (2.7 or higher) reference when scripting with these data types.

Refer to `ADODB` documents for the usage of the `Recordset` interface.

- `List<short>`, `List<int>`, `List<float>`, `List<double>`, and `List<string>` (all of System.Collections.Generic).

These types, implemented in the data conversion module, appear as:

- `ShortList`
- `IntList`
- `FloatList`
- `DoubleList`
- `StringList`

Add the `GEIP_Orion_Dataconversion` reference when scripting with these data types.

The `ShortList` list implements the following interface:

```

interface IShortList : IDispatch
{
    [id(0x60020000), propget]
    HRESULT Count([out, retval] long* pRetVal);
    [id(0x60020001)]
    HRESULT Add([in] short item);
    [id(0x60020002)]
    HRESULT Clear();
    [id(00000000), propget]
    HRESULT item(
        [in] long index,
        [out, retval] short* pRetVal);
    [id(00000000), propput]
    HRESULT item(
        [in] long index,
        [in] short pRetVal);
    [id(0x60020005)]
    HRESULT Insert(
        [in] long index,
        [in] short item);
    [id(0x60020006)]
    HRESULT RemoveAt([in] long index);
};

```

All the rest implement basically the same interface, but with different data types (`long` for `IntList`, etc.) for the item parameter.

- `ArrayList` (of `System.Collections`).

This displays as `ObjectList`, which implements the following interface:

```

interface IObjectList : IDispatch
{
    [id(0x60020000), propget]
    HRESULT Count([out, retval] long* pRetVal);
    [id(0x60020001)]
    HRESULT Add(
        [in] VARIANT item,
        [out, retval] long* pRetVal);
    [id(0x60020002)]
    HRESULT Clear();
    [id(00000000), propget]
    HRESULT item(
        [in] long index,
        [out, retval] VARIANT* pRetVal);
    [id(00000000), propputref]
    HRESULT item(
        [in] long index,
        [in] VARIANT pRetVal);
    [id(0x60020005)]
    HRESULT Insert(
        [in] long index,
        [in] VARIANT item);
    [id(0x60020006)]
    HRESULT RemoveAt([in] long index);
};

```

As the item type here is `VARIANT`, this list can pass any convertible types supported by the data conversion module.

For example, list objects can be added to an `ObjectList` as list items, resulting a multi-dimensional array.

Add the `GEIP_Orion_Dataconversion` reference when scripting with this date type.

Strategies for Parameter Types that Cannot Be Converted

Most commonly used parameter types are converted, so CIMPLICITY screens host and also communicate with the .NET controls through primitive data types and converted parameter types.

However, there will be parameter types that cannot be converted and thus ignored by the current release because the authors of custom .NET controls may use any Framework types and create and use their own types.

In order to avoid the essential properties, methods and events of a .NET control not being exposed, the control author may do the following.

- Rewrite a desired property using the convertible types listed above.
- Separate a desired property into multiple properties of the convertible type.
- Rewrite a method with the convertible types or with more parameters so that each parameter can be converted.
- Define a new event type (delegate) with all parameters convertible and reroute the original event with the new delegate.

.NET Error: Logging

The error logging module is designed to log information and error messages to a file, so that error causes may be analyzed for rather complicated processes, such as the process to build a component that can be hosted with the CIMPLICITY environment.

The logging process is controlled by a logging configuration file named `GEIP.Orion.ComponentsLogger.config` in the `..\<CIMPLICITY Installation>\exe` folder.

`GEIP.Orion.ComponentsLogger.config` has the following typical content:

```
<?xml version="1.0" encoding="utf-8" ?>
<log4net debug="true">
  <appender name="RollingLogFileAppender"
    type="log4net.Appender.RollingFileAppender">
    <file value=".\DotNet Components\ComponentsLogger.log" />
    <appendToFile value="true" />
    <rollingStyle value="Size" />
    <maxSizeRollBackups value="10" />
    <maximumFileSize value="10MB" />
    <staticLogFileName value="true" />
    <layout type="log4net.Layout.PatternLayout">
      <conversionPattern value="%d [%t] %-5p %logger %method%n%m%n" />
    </layout>
  </appender>
</root>
```

```

<level value="WARN" />
<appender-ref ref="RollingLogFileAppender" />
</root>
</log4net>

```

- Items may be easily changed are the:
- Logging file path.
- Logging level.
- The content above sets the path to ..\<CIMPLICITY Installation>\exe\DotNet Components \ComponentsLogger.log.
- Levels include:

• DEBUG	Logs everything
• INFO • WARN • ERROR • FATAL	Log successively fewer messages

Refer to the log4net document for more details.

- The logging actions are mostly performed at the configuration mode and have no significant performance panalties even if the logging level is set to DEBUG.

.NET: Glossary

.NET terms include the following.

Term	Definition
ActiveX	ActiveX is a framework for defining reusable software components in a programming language independent way. This technology is often used to develop user interface controls, and the controls so developed are therefore called ActiveX controls, or OLE controls after the older terminology.
CCW	COM Callable Wrapper is a proxy that enables you to use .NET code from a COM client.
CLR	Common Language Runtime "brings to the table" cross-language integration, security and versioning support, and garbage collection (MSDN)
COM	The Microsoft Component Object Model is a binary interface standard to allow for reuse of objects with no knowledge of their internal implementation in environments different from the one they were created in.
Managed Code	Code that operates within the .NET CLR.

Term	Definition
.NET	The Microsoft .NET Framework is a software framework that includes a large library of coded solutions to common programming problems and a virtual machine that manages the execution of programs written specifically for the framework.
.NET component	A component is a special type of executable built from a .NET project. typically referenced by applications needing the services provided by the component. (MSDN)
Unmanaged Code	Code that operates outside the .NET CLR. All COM code is unmanaged code.
Win32	The 32-bit Windows of Application Programming Interfaces. This is Microsoft's core set of APIs available in the Microsoft Windows operating systems.
Windows Forms	Windows Forms, or shortly WinForms, is the graphical API included as a part of the Microsoft .NET Framework, providing access to native Windows interface elements and controls. The .NET Framework 4 now includes sophisticated charting features that are based on Windows Forms.
WPF	The Windows Presentation Foundation is a graphical subsystem for rendering user interfaces in Windows-based applications. WPF, initially released as part of .NET Framework 3.0, provides a consistent programming model for building applications with a clear separation between the user interface and the business logic.

Chapter 2. Change Management

About Change Management

- About Change Management overview.
- Change Management topics.
- CIMPLICITY options not supported in Change Management.

About Change Management Overview

Beginning with CIMPLICITY 7.0, several versions of configuration and files that apply to a single CIMPLICITY projector computer level configuration can be stored and retrieved on a Change Management (PCM) server.

- More than one local server can hold copies of the same CIMPLICITY project and maintain the project's integrity through the PCM.
- Each local server can store versions of the computer-based files.

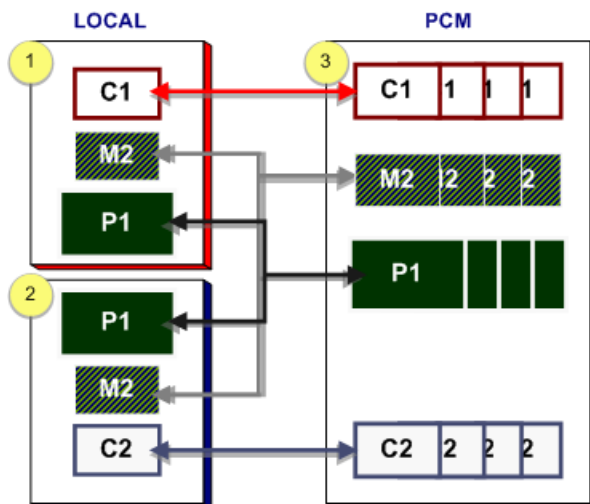

1	Local Server 1 holds the following projects: C1, M2, P1.
2	Local Server 2 holds the following projects: P1, M2, C2.
3	Change Management Server holds several versions of the following: C1, M2, P1, C2.

Change Management Topics

- Entities Overview in Change Management.
- Enable computer management.
- Enable project management.
- Change Management procedures.
- Change Management client.
- Change Management best practices.
- Change Management technical reference.

CIMPLICITY Options not Supported in Change Management

The following are not supported in Change Management.

- Microsoft Cluster.
- Tracker.
- Order Execution Management.

Entities Overview in Change Management

Entities Overview in Change Management

There are two types of Change Management projects.

- CIMPLICITY project.
- Computer project.

There are two classes of entities that can be added to Change Management for each project type.

Entity Class	Description
Base Configuration	A collection of interrelated files that must remain interrelated and, thus, must be managed as a single unit.
Individually managed files	Files that can be managed as individual units.

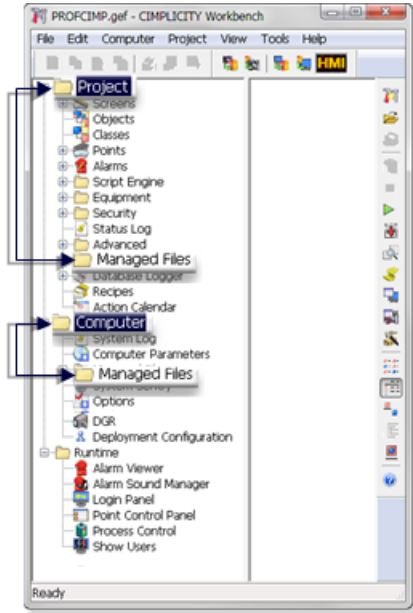

Field	Description
CIMPLICITY Project	
Project	<p>All user configurable configuration files in the CIMPLICITY project can be added to Change Management. Project configuration includes:</p> <ul style="list-style-type: none"> • Base configuration. • Individually managed files.
Base Configuration	<p>Files that make up the project's basic configuration, e.g. points, alarms, configuration files, are required for the project processes to run. Note: The processes start when the project starts. Base configuration files:</p> <ul style="list-style-type: none"> • Are automatically added to Change Management the next time the base configuration (or project) is checked in. • Are checked in whenever any base configuration entity is selected to be checked in. <p> Important: Base configuration must be added once to be managed.</p>

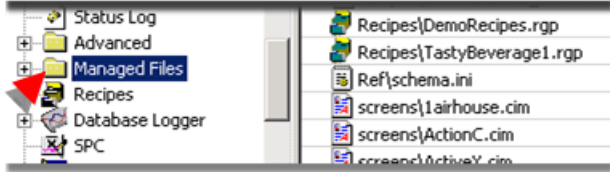
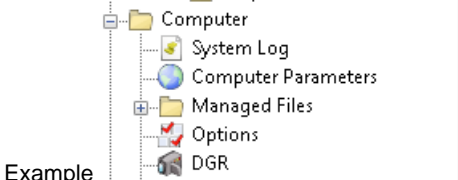
Field	Description
Individually managed files	<p>Single files that are listed in the CIMPLICITY project's Managed files folder can be added separately to Change Management. These files, e.g. CimView screens and scripts, are individually controlled. Individually managed files:</p> <ul style="list-style-type: none"> • Are added to Change Management when the project is added. <p>Note: The project can be added more than once: each time it is added any individually managed files that have not already been added will be added to Change Management.</p> <ul style="list-style-type: none"> • Can be added individually. • Must be added in order to be managed; they are not automatically added when the project is checked in. <p>Example</p> 
Computer Project	
Computer	<p>All files in the computer project can be added to Changed Management. Computer files include:</p> <ul style="list-style-type: none"> • Computer base configuration. • Managed files.
Base Configuration	<p>Files included in the system's basic configuration, e.g. globals.ini, cimhosts.txt. These files are required for the Computer project system's processes to run.</p>
Managed files	<p>Single files that are listed in the Computer project's Managed files folder can be added separately to Change Management. These files are individually controlled and are not required for the Computer project's processes to run. These files, e.g. CimView screens and scripts, are individually controlled. Individually managed files:</p> <ul style="list-style-type: none"> • Are added to Change Management when the project is added. <p>Note: The project can be added more than once; each time it is added any individually managed files that have not already been added will be added to Change Management.</p> <ul style="list-style-type: none"> • Can be added individually. • Must be added in order to be managed; they are not automatically added when the project is checked in. <p>Example</p> 

CIMPLICITY Project in the Workbench: Managed Files Overview

When a CIMPLICITY project is managed, the Workbench entities can be added, checked in or checked out as part of the base configuration or as individually managed files.

The following table identifies the [category \(page 75\)](#) when an icon is right-clicked in the Workbench left pane.

Icon		Base	Individual	NM
Screens	Screens		X	
Objects	Objects	X		
Classes	Classes	X		
Points	Points	X		
	Attribute Sets	X		
	Point Enumerations	X		
	Cross Reference			X
Alarms	Alarms	X		
	Alarm Classes	X		
	Alarm Strings	X		
	Alarm Printer	X		
	Alarm OPC Client	X		
	Alarm Blocking	X		
	Alarm Translator		X	
	Alarm Paging	X		
Basic Control Engine	Event Editor	X		
	Scripts		X	
	BCE User Interface			X
Equipment	Devices			
	Ports			
	Diagnostics			X
	Marquee	X		
Security	Users	X		
	Roles	X		

Icon		Base	Individual	NM
	Resources	X		
	Advanced	X		
Status Log				X
Advanced	Project Parameters	X		
	Measurement Units	X		
	Process Health Parameters	X		
Managed Files	Managed Files		X	
Recipes	Recipe Files		X	
Database Logger	Database Logger configuration	X		
	Archive			X
SPC	SPC files		X	
Document Delivery	Base	X		
	Object	X		
Action Calendar		X		

Table headings are:

Base	Base configuration.
Individual	Files in the selected node's right pane are individually managed
NM	Not managed.

- Other files, e.g. Class export files, *.soc, are not listed in the Workbench so they are not included in this table.
- View a complete list of individually project managed files.
- Files that are individually managed in your system configuration are listed (and available) in the project's [Managed Files folder \(page 73\)](#).

Computer Project in the Workbench: Managed Files Overview

When a Computer project is managed, the Workbench entities can be added, checked in or checked out as part of the base configuration or as individually managed files, as follows.

The following table identifies the [category \(page 76\)](#) when an icon is right-clicked in the Workbench left pane.

Entity		Base	Individual	NM
System Log				X
Computer Parameters	Computer Parameters	X		
Managed Files	Managed Files		X	
System Sentry	System Sentry			X
Options	Options	X		
DGR				X
(ME) Change Management				X
FirstPAGE Administrator	FirstPAGE Administrator		X	

Table headings are:

Base	Base configuration.
Individual	Files in the selected node's right pane are individually managed
NM	Not managed.

- Other files, e.g. Class export files, *.soc, are not listed in the Workbench so they are not included in this table.
- Files that are individually managed in your system configuration are listed (and available) in the project's Managed Files folder .

Enable Computer Management

1. Do one of the following.
 - Click Computer>Properties on the Workbench menu bar.
 - Click the Computer Properties button  on the Workbench toolbar.

The Computer Properties dialog box opens.

2. Enter specifications as follows.

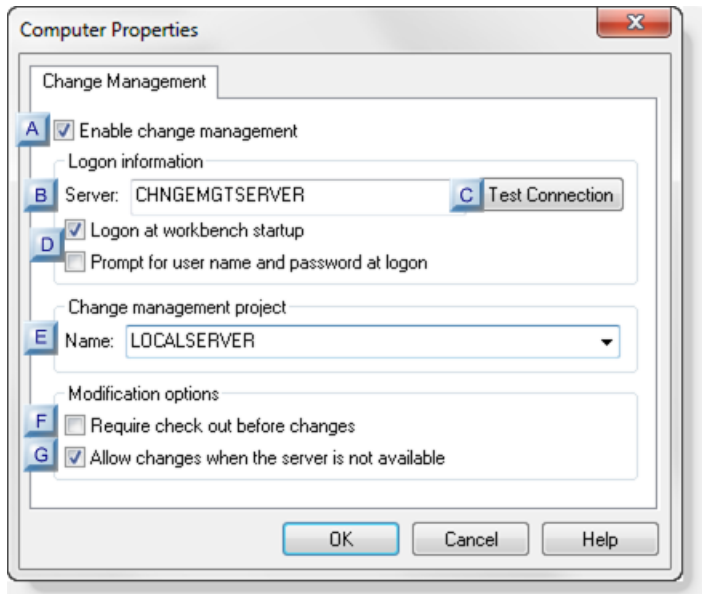

rect 2, 66, 30, 92 ([page 78](#))

rect 5, 103, 36, 130 ([page 78](#))

rect 272, 106, 309, 133 ([page 78](#))

rect 11, 138, 39, 160 ([page 79](#))

rect 7, 197, 32, 217 ([page 79](#))

rect 8, 246, 36, 270 ([page 79](#))

rect 8, 270, 37, 290 ([page 80](#))

A (page 78)	Enable Change Management.
B (page 78)	Server.
C (page 78)	Test Connection
D (page 79)	Logon at Workbench startup/Prompt for username and password at startup.
E (page 79)	Name (Change Management project).
F (page 79)	Require checkout before changes
G (page 80)	Allow changes when the server is not available.

A	Enable Change Management
---	--------------------------

Do one of the following.

Check	Enables Change Management for the computer. This will apply to every open Workbench on the computer.
Clear	Change Management is not enabled for the computer. Note: This does not affect enabling Change Management for a CIMPLICITY project.

B	Server
---	--------

Name of the Change Management server.

C	Test connection
---	-----------------

Click to confirm that the Change Management server is available and can connect to the project.

- Click Test connection to confirm that the Change Management server is available and can connect to the project.

A Change Management [Logon \(page 89\)](#) dialog box opens.

- Enter an authorized user name and password.

Results:

One of the following will occur depending on the project/Change Management Server status.

- The connection is successful

A message opens and reports:

The change management server connection test succeeded.

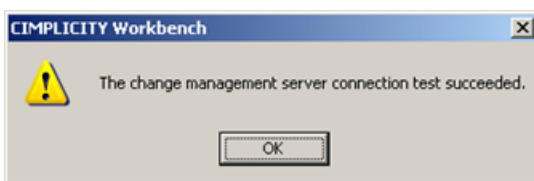

- The connection fails.

A message opens and reports:

Unable to connect to change management server <Change Management server> with user <User Name>. Server unreachable or not found.

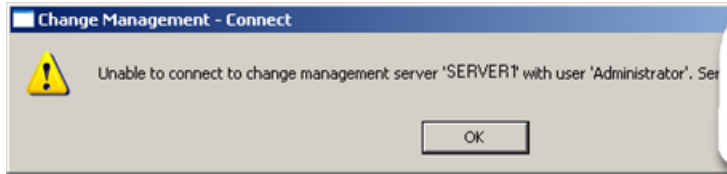

If the connection failed, check with the Change Management system administrator to correct the problem.

D	Logon at Workbench startup/Prompt for username and password at startup
---	--

Checking either or both Logon at Workbench startup/Prompt for username and password at startup determines the following.

Logon at Workbench startup	Prompt for username and password	Result
X		If the CIMPLICITY log on credentials are the same as the Change Management credentials, the computer project is automatically logged onto the Change Management server when the Workbench opens. Note: If Allow Configuration Auto Logonis checked in the Windows Authentication window, a user who is allowed to log on using Windows Authentication is also automatically logged onto Change Management for the computer project when the Workbench opens.
X	X	<ul style="list-style-type: none"> A Change Management Logon dialog box for the computer project opens when the Workbench opens. If an authorized username and password are entered, the project is logged into the Change Management server.
	X	<ul style="list-style-type: none"> The computer project is not logged onto the Change Management server when the Workbench opens. When a logon is attempted a Change Manage Logon dialog box for the computer project opens. If an authorized username and password are entered, the project is logged into the Change Management server.
		<ul style="list-style-type: none"> The computer project is not logged onto the Change Management server when the Workbench opens. Change Management will attempt to log you into the PCM server using CIMPLICITY login credentials. If the CIMPLICITY credentials do not match the PCM credentials, a Change Management Logon dialog box will open.

E	Name (Change Management Project)
---	----------------------------------

The project name used on the Change Management server.

The default name is the name of the local server.

! **Important:** It is strongly recommended that this name be the same as the local server name.

F	Require checkout before changes
---	---------------------------------

Check to require that an item be checked out of Change Management before it can be edited.

 **Note:**

- If an item is not checked out a Check out dialog box will open when a user attempts to edit an entity.

If Require checkout before changes is:

Checked (page 93)	An authorized user must enter a valid Change Management ID/password in order to edit (or save) the selected item.
Clear	An authorized Change Management user can cancel the checkout and edit the selected item.

- Enabling this feature provides the highest level of integration with Change Management.
- If the checkout is cancelled a message opens reporting that:

You are required to check out the configuration before you can modify it.

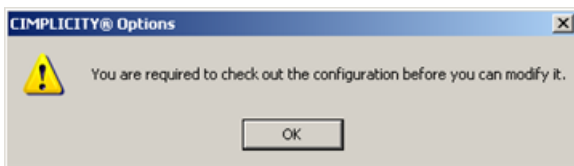

G	Allow changes when the server is not available
---	--

Check to allow changes when the Change Management server is not available.

 **Important:** If this feature is checked make sure a Project Compare is performed when the Change Management server is available. The report will aid you to check modified entities into the Change Management server so they will not be lost.

5. Click OK.

Result

- If the Computer project has already been added to the Change Management server:

A message opens and reports:

Change Management project <project name> already exists on the Server <Change Management server>. Do you want to replace the project?

Click one of the following.

Button	Description
Yes	<ul style="list-style-type: none"> • Change Management maps your CIMPLICITY project to the existing Change Management project. • The local project is now managed. <p>Note: The project (version) that was replaced is still on the Change Management server and can be retrieved, if necessary.</p>
No	<p>The local project is</p> <ul style="list-style-type: none"> • Not added to the Change Management server. • Not managed.

- If the project is new on the Change Management server:
- The Change Management server maps a place for the Change Management project.
- The project is now managed.

Note: The project or entities in the project that should be managed still need to be [added \(page 118\)](#) to the Change Management server.

Enable Project Management

Access Change Management Dialog Box

1. Click Project>Properties on the Workbench menu bar, or click the Project Properties button  on the Workbench toolbar. The Project Properties dialog box opens.
2. Select the Change Management tab. Change Management options are as follows.

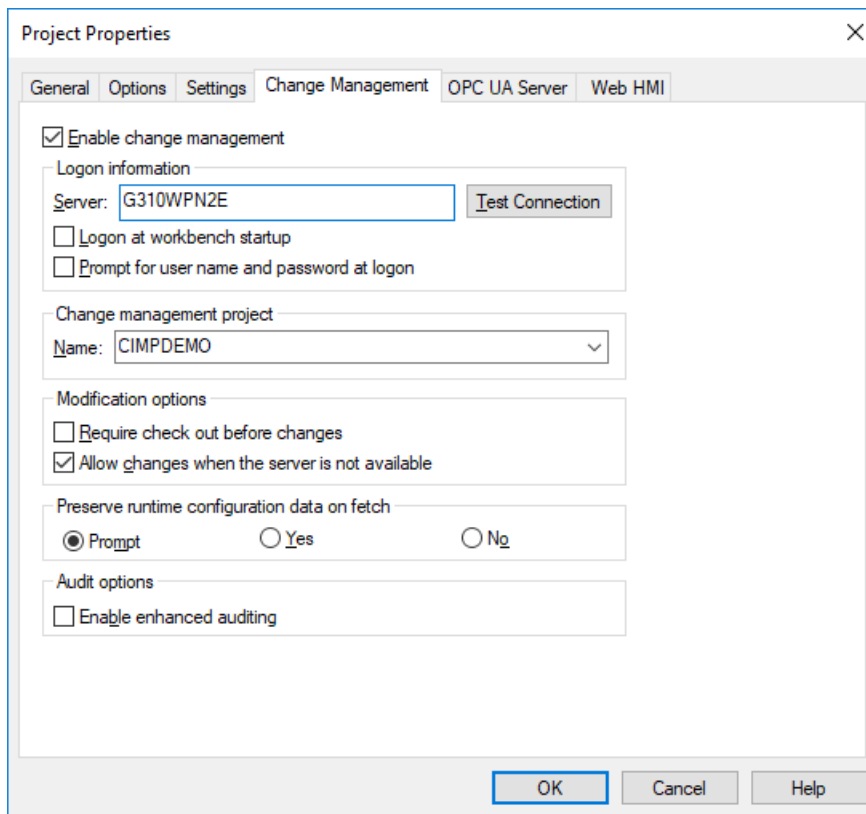

Enable Change Management

Do one of the following:

Check	Enables Change Management for the active CIMPLICITY project.
Clear	Change Management is not enabled for the active CIMPLICITY project. This does not affect enabling Change Management for the computer project.

- When Change Management is enabled for a CIMPLICITY project, the project's Configuration Security on the Options tab is automatically checked and made read-only.
- Change Management can be enabled for both a running and a stopped project.

Configure Server

Name of Change Management server that the user will be using to authenticate/log in to Change management.

Test Connection

1. Click Test connection to confirm that the selected Change Management server is available and can connect to the project. A Change Management [Logon \(page 89\)](#) dialog box opens.

2. Enter an authorized user name and password.

Results: One of the following will occur depending on the project/Change Management Server status.

- The connection is successful. A message opens and reports. The change management server connection test succeeded.

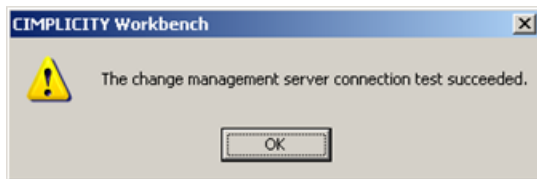

- The connection fails.

A message opens and reports: Unable to connect to change management server <Change Management server> with user <User Name>. Server unreachable or not found.

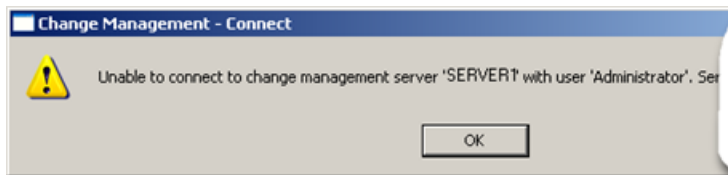

If the connection failed, check with the Change Management system administrator to correct the problem.

Requirement for logging into the Change Management server depends on the following.

Log on at Workbench startup/Prompt for user name and password at logon

If Change Management is enabled for the CIMPPLICITY project, configuration security is enabled.

Other factors that determine if and when a user needs to log onto PCM include whether or not: the following are checked Yes or No:

- Allow Configuration Auto Logon in the Windows Authentication dialog box. If Allow Configuration Auto Logon is not checked, logging in options/requirements are the same as if the Windows Authentication login is invalid.
- Prompt Username/password.
- PCM Workbench Start.

If Allow Configuration Auto Logon is checked in the Windows Authentication window options and requirements for Change Management logon are as follows.

1	Windows Logon for CIMPLICITY	Windows Logon for PCM
	Valid	Valid

Windows Logon for CIMPLICITY		Windows Logon for PCM	
VALID		VALID	
THEN	IF	TYPE	WHEN
CIMPLICITY Logon			
Configuration Security	Yes	Auto	Workbench Start
PCM Logon			
Prompt Username/Password	Yes / No	Manual / Auto	
PCM Workbench Start	Yes / No		Workbench Start / PCM Open

Windows Logon for CIMPLICITY		Windows Logon for PCM	
VALID		INVALID	
	IF	TYPE	WHEN
CIMPLICITY Logon			
Configuration Security	Yes	Auto	Workbench Start
PCM Logon			
Prompt Username/Password	Yes / No	Manual / Manual	
PCM Workbench Start	Yes / No		Workbench Start / PCM Open

Windows Logon for CIMPLICITY		Windows Logon for PCM	
Invalid		Valid	
	IF	TYPE	WHEN
CIMPLICITY Logon			
Configuration Security	Yes	Manual	Workbench Start
PCM Logon			
CIMPLICITY Login is Valid PCM Login			
Prompt Username/Password	Yes / No	Manual / Auto	
PCM Workbench Start	Yes / No		Workbench Start / PCM Open
CIMPLICITY Login is Invalid PCM Login			

Windows Logon for CIMPLICITY		Windows Logon for PCM	
Invalid		Valid	
	IF	TYPE	WHEN
Prompt Username/Password	Yes / No	Manual / Manual	
PCM Workbench Start	Yes / No		Workbench Start / PCM Open

Windows Logon for CIMPLICITY		Windows Logon for PCM	
Invalid		Invalid	
	IF	TYPE	WHEN
CIMPLICITY Logon			
Configuration Security	Yes	Manual	Workbench Start
PCM Logon			
CIMPLICITY Login is Valid PCM Login			
Prompt Username/Password	Yes / No	Manual / Auto	
PCM Workbench Start	Yes / No		Workbench Start / PCM Open
CIMPLICITY Login is Invalid PCM Login			
Prompt Username/Password	Yes / No	Manual / Manual	
PCM Workbench Start	Yes / No		Workbench Start / PCM Open

Enter a Change Management Project Name

It is strongly recommended that this name be the same as the CIMPLICITY project name. The default name is the name of the local project. When the user first logs in, if the project does not exist in Change Management, the project is created. No files are added to the project except when specifically requested by the user.

Require Checkout Before Changes

Do one of the following.

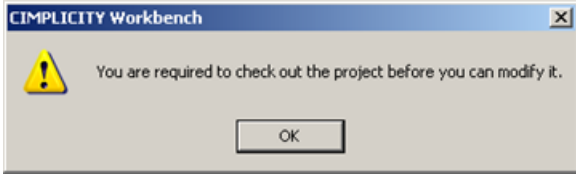
Check	<p>Require that an entity be checked out of Change Management before it can be edited. A message reminds a user that: You are required to check out the project before you can modify it.</p>  <ul style="list-style-type: none"> • If a project is being managed a user must add the entity and check out the entity before making any changes. • Enabling this feature provides the highest level of integration with Change Management. • If the project is not checked out, a user cannot do a configuration update when trying to start the project. • Certain managed files, e.g. CimEdit screens (*.cim) and scripts (*.bcl), may be edited even when Require checkout before changes is checked and the files are not checked out. However, the edited file can only be saved using the File>Save as option either: <ul style="list-style-type: none"> ◦ To an unmanaged folder. ◦ With a different name than the managed entity in the managed folder. (File> Save as the managed entity name to a managed folder is not allowed.) <p>The new saved as version will not be managed. The managed version will be the original version before it was edited. When a new file is created, it is not managed until it is added. The unmanaged file can be edited no matter where it is located until it is added.</p>
Clear	An entity does not have to be checked out of Change Management to be edited and saved.

Allow changes when the server is not available

Do one of the following.

Check	Allow changes when the Change Management server is not available.
Clear	Do not allow changes when the Change Management server is not available. Important: If Require Checkout before changes is checked, configuration changes will not be possible if the Change Management Server is not available.

! **Important:** If this feature is checked make sure a Project Compare is performed when the Change Management server is available. The report will aid you to check modified entities into the Change Management server so they will not be lost.

Example:

1. Allow changes when the server is not available is checked.
2. A CimEdit screen, TANK750, is not checked out.
3. TANK750 is enhanced with new graphic and text objects reporting additional point values.
4. The following is done so these changes will be preserved.
 - a. TANK750 is checked out. **IMPORTANT:** Don't overwrite local files with managed copy is **checked**.
 - b. TANK750 is checked in.

Preserve runtime configuration data on fetch (passwords and alarm setups)

Prompt

The Preserve runtime configuration data on Fetch options dictate how the runtime data will be handled.

A Save Configuration Data dialog box opens with check box entries for each of the configuration data that has changed. The dialog box opens before any of the following processes are completed:

- Fetch.
- Check out.
- Get latest version.

 **Note:** Currently the configuration data includes passwords and alarm setups.

Check the configuration data that you want to preserve:

- Passwords that were specified as valid after the checkout continue to be valid. A user who is logged in with a new password can continue configuration with no interruptions.
- New or modified alarm setups are preserved.

Click one more than one of the following:

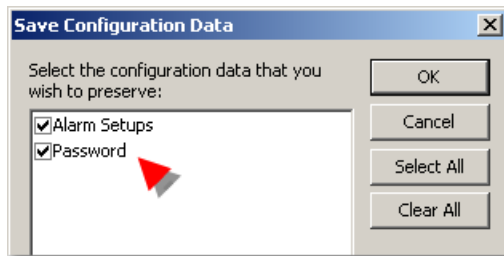

- OK - Preserves or overwrites the configuration data based on your selection.
- Cancel - Cancels the retrieval.
- Select All - Checks all listed data check boxes. All listed data will be preserved.
- Clear All - Clears all the check boxes. All listed data will be overwritten.

Yes

- Passwords that were specified as valid after the checkout continue to be valid. A user who is logged in with a new password can continue configuration with no interruptions.
- New or modified alarm setups are preserved.
- When the base configuration is checked into Change Management, the file will be checked in with the current valid passwords.

No

- The file with the old passwords is fetched from Change Management and overwrites the file with the new passwords.
- The new passwords are no longer valid.
- A user will have to re-enter the old password and, in instances where a new password is required, the new password in order to continue configuration.
- When the base configuration is checked into Change Management, the file will be checked in with the passwords that were specified as valid after the checkout.

If the project has already been added to the Change Management server: a message opens and reports: Change Management project <project name> already exists on the Server <Change Management server>. Do you want to replace the project?

Click one of the following:

- Yes - Change Management maps your CIMPLICITY project to the existing Change Management project. The local project is now managed. The project (version) that was replaced is still on the Change Management server and can be retrieved, if necessary.
- No - The local project is Not added to the Change Management server. Not managed.

If the project is new on the Change Management server, the Change Management server maps a place for the Change Management project. The project is now managed.

 **Note:** The project or entities in the project that should be managed still need to be added to the Change Management server.

Enable enhanced auditing

When the enhanced auditing check box is checked CIMPLICITY will put entries in the Change Management audit log when a point is added, modified or deleted.

The audit entries include the:

- Point.
- Action.
- User who performed the action.

 **Important:** This feature will have a performance impact when bulk operations are performed on large numbers of points so it is best to enable it after the main provisioning stage of the project and more in the maintenance stage. A global parameter, PCM_ENH_AUDIT, is added when you check Enable Enhanced Auditing. Perform a Workbench configuration update after you check/clear the check box.

Change Management Procedures

Change Management Procedures

1. Right-click Project or Computer in the Workbench left pane.
2. Select Manage on the Popup menu.
3. Select one of the following in the Workbench left1 pane.
 - Project>Managed files
 - Computer>Managed files
4. Right-click a file in the Workbench right pane.

1. Log On

The Logon options are enabled for a CIMPLICITY project and a computer project, if the user was not logged in when the Workbench started up.

Logon opens a Change Management Logon dialog box to log a CIMPLICITY project or computer project onto the Change Management server.

 **Tip:** If a logged in CIMPLICITY project user name and password are the same as an authorized Change Management user name and password, you can avoid logging in twice (*page*), if you select to.

Specifications in a Change Management Logon dialog box are as follows.

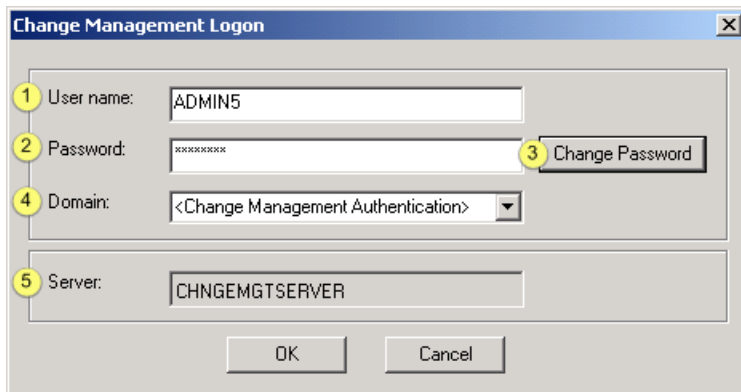

- rect 3, 45, 337, 75 [\(page 90\)](#)
- rect 4, 76, 321, 105 [\(page 91\)](#)
- rect 319, 78, 443, 106 [\(page 91\)](#)
- rect 4, 107, 325, 139 [\(page 91\)](#)
- rect 4, 152, 336, 195 [\(page 92\)](#)

1 (page 90)	User name
2 (page 91)	Password
3 (page 91)	Change Password
4 (page 91)	Domain
5 (page 92)	Server

1	User name
---	-----------

Authorized Change Management user.

Note: The privileges that a user has are set by the Change Management server administrator.

Therefore, it is possible for a PCM server user to be able to log into the PCM server, but not be able to modify or check in files even if the user has administrative permissions on the CIMPLICITY server.

 **Note:** CIMPLICITY User names can be 32 characters, however, Change Management limits user names to 20 characters. If the same user names will be used for CIMPLICITY and Change Management, limit the length to 20 characters.

2	Password.
---	-----------

Valid password for specified Change Management user.

3	Change Password
---	-----------------

1. Click Change Password to open the Change Management - Change Password dialog box.

Fields are as follows.

Field	Description
User	(Read only) User logged into the Change Management server.
Authority	(Read only) Selected Domain authentication.
Existing password	User's current valid password.
New password	Password the user will use for the next and future log ins.
Confirm new password	New password repeated.
Server	(Read only) Change Management server.

1. Click OK.

The Change Management - Change Password dialog box closes.

The password is changed.

1. Confirm that the new password is entered in the **Password** field.

4	Domain
---	--------

Change Management provides the capability to log in to the Change Management server using either of the following.

- Change Management authentication.
- Windows authentication.

 **Note:** The feature used to authenticate the Domain log on is based on how the Change Manager access control was set up.

Consult Change Management documentation for details about setting up access control.

5	Server
---	--------

(Read-only)

The Change Management server is identified for the project or computer as follows.

Project	Server entered on the Change Management tab in the Project Properties dialog box.
Computer	Server entered in the Computer Properties dialog box.

 **Note:** If the computer project requires a log on in order to make changes and a user tries to open a CIMPLICITY application e.g. the Options dialog box, a Change Management Logon dialog box will open for the user to log onto the PCM server. Even though the user is then logged onto the PCM Server, the Workbench [status bar \(page 98\)](#) will continue to report that the user is not logged on. The Workbench status bar only reports a log on when the user logs on by right-clicking an icon in the Workbench and selecting Log On in the Popup menu.

2. Log Off

Log off logs the CIMPLICITY project or computer project user off of the Change Management server.

Your ability to work with managed entities will depend on whether you checked Allow changes when the server is not available when configuring the Change Management properties for the project ([page 80](#)) or [computer \(page 80\)](#).

 **Important:** Close the [Show History \(page 101\)](#) window after logging out of the Change management server

3. Get Latest Version

Get Latest Version copies the latest version of the selected entity (computer, project or managed file(s)) that are on the Change Management server into the CIMPLICITY project or computer project.

When Get Latest Version of the base configuration is selected, Change Management first compares the local files with the files on the Change Management server. If there are differences a Changed Files dialog box opens.

Note: The Changed Files dialog box also lists files that are different before performing a [checkout \(page 93\)](#) of the project or base configuration, where the selection is to get the latest copy from the Change Management server.

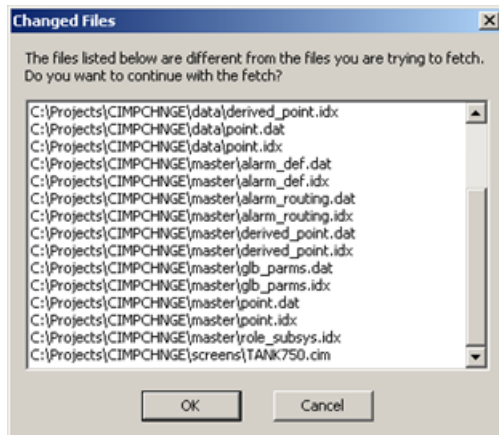

Click one of the following.

Ok	All files that are on the Change Management server are copied to the local server. Files that were on the local server are overwritten.
Cancel	Cancels the check out.



! Important:

- If the project is running, you cannot get the project base configuration. You must work with the local copy until you stop the project.
- It is strongly recommended that you compare the local project version with the project version on the Change Management server before performing a Get Latest Version, in order to check in any file versions that you do not want to have overwritten.
- Get Latest Version does not check out the files.

4. Check Out

Check out prohibits another user from adding or checking in another version of the entity on the PCM server if Require check out before changes is checked for the project in which the checkout was made, the CIMPLICITY (page) or [computer \(page 79\)](#) project.

 **Note:** Workbench Check Out toolbar buttons are available as follows:

	Project Check Out
	Computer Check Out

A Check Out dialog box opens when you check out a selected entity.

- Check Out dialog box options.
- Check Out guidelines.

Check Out Dialog Box Options

! Important: If the project is running, you cannot get a copy of a base configuration entity from Change Management. You must work with the local copy until you stop the project.

Options are as follows.

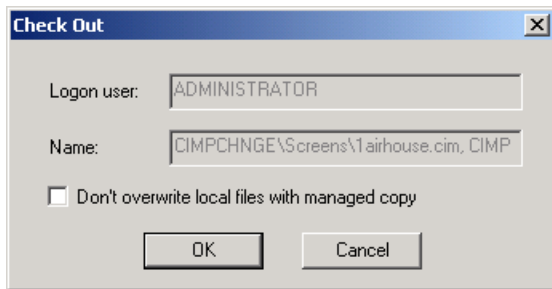

Field	Description
Logon User	(Read only) Name of the logged on user who is checking out the entity. Note: If a user is not logged in a Change Management Logon dialog box opens, requiring an authorized user/ password.
Name	(Read only) Name of the entity being checked out.
Don't overwrite local files with managed copy	Do one of the following: Check, Clear, Default
	<p>! Important: It is highly recommended that when you:</p> <ul style="list-style-type: none"> • Begin working on a file or set up files, always overwrite the local files with the managed copies (Leave the checkbox clear.) • Take a break or are done for the day, always check in any work that is either an in-progress or finished project. <p>This enables you to back-track if that is required and is particularly useful if more than one person is working with the project.</p>

Check out Guidelines

- If you select the project or base configuration to check out and/or get the latest copy from Change Management, this may affect more than one file in your project. Change Management determines if there are differences between the Change Management latest copy and the local copy for all effected files. If there are differences a message box reports what files are different.

Note: The Changed Files dialog box also lists files that are different before performing a [get latest version \(page 92\)](#).

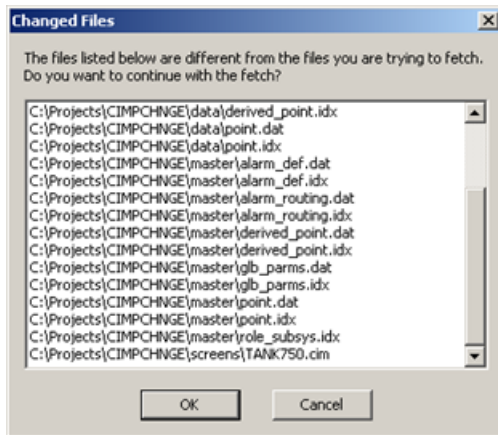

Click one of the following.

Ok	Continues the check out.
Cancel	Cancels the check out.

- If Require checkout before changes is checked in the Project Properties or Computer Properties tabs in dialog boxes are disabled to prevent configuration.

Note: Some managed files, e.g. scripts and CimEdit screens, can be opened. However, any changes made to the screen cannot be saved until it is checked out or [saved as \(page 79\)](#) an unmanaged file.

Example

1. A CimEdit screen is created and added to the PCM server.
2. The CimEdit screen is not checked out.
3. A user attempts to open it to edit.
4. A Check Out dialog box opens.
5. The user clicks Cancel.

A CimEdit Message box opens reporting:

You are required to check out the file before you can modify it.

6. The user
 - a. Clicks OK to close the message box.
 - b. Edits the CimEdit screen.
 - c. Clicks the Save button.

A Check Out dialog box opens again.

7. The user clicks Cancel.



The CimEdit message box opens again reporting that check out is required.

The user will not be able to save the screen as a managed file until it is checked out.

5. *Check In*

Check In copies the local version of the selected entity onto the Change Management server.

 **Note:** Workbench Check In toolbar buttons are available as follows:

	Project Check In
	Computer Check In

A Check In dialog box opens when you check in a selected entity.

 **Important:** If the project is running, you cannot get a copy of a base configuration entity from Change Management. You must work with the local copy until you stop the project.

Options are as follows.

Field	Description
Logon User	(Read only) Name of the logged on user who is checking out the entity. Note: If a user is not logged in a Change Management Logon dialog box opens, requiring an authorized user/password.
Name	(Read only) Name of the entity being checked out.
Keep local copy	(Read only) Retains copy of the checked in entity on the local computer.
Keep check out	Do one of the following: Check or Clear
Comment	Description for a user to distinguish the entity version being checked in from other versions. Max Length

 **Note:** An [Apply Label \(page 100\)](#) dialog box will open before the entity is checked in if it is a project or core configuration.

6. Undo Check Out

Undo checkout removes the check out status of an entity that was checked out of Change Management and identifies it as checked in on the Change Management Server.

If the file has been edited while it was checked out, the edited version that is on the local computer can remain on the local computer and not be overwritten by the managed copy.

Options in an Undo Check Out dialog box that opens when Undo checkout is selected are as follows.

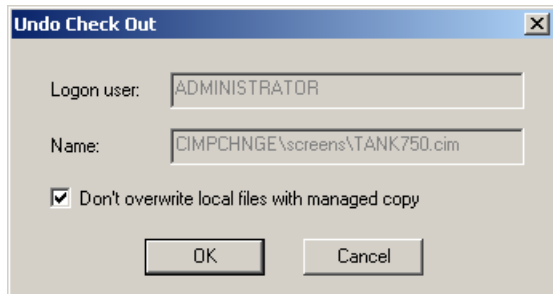

Field	Description
Logon User	User who is logged into Change Management.
Name	Name of the entity that will have it
Don't overwrite local files with managed copy	Do one of the following: Check, Clear, or Default.

7. Refresh

Refresh the Workbench updates icons and Workbench right pane details columns (that are available for selected nodes) that report the status of a managed entity.

 **Note:** The Workbench status bar reports if the project is connected to the Change Management server and the Change Management server name. When you select Refresh the Workbench determines and then displays the status for the selected entity.



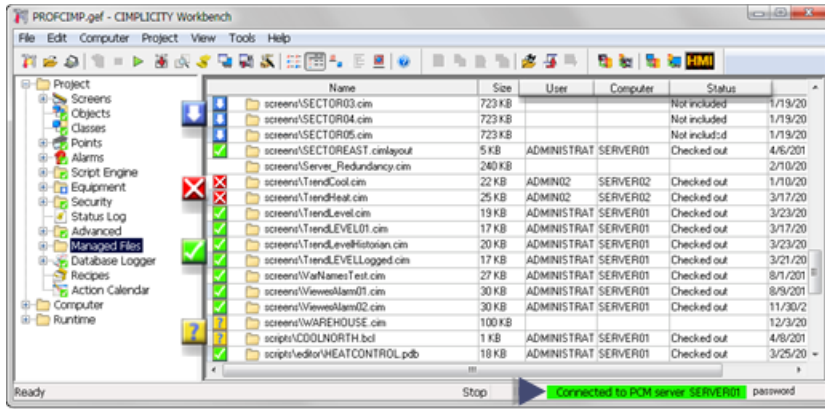

Example

If you select Computer>Managed Files>Manage>Refresh, the Workbench refreshes the status for the Managed files only. The status for other entities in the Computer project may still be unknown.

Status icons include the following.



- rect 418, 44, 477, 60 ([page 99](#))
- rect 363, 46, 417, 62 ([page 99](#))
- rect 322, 45, 363, 61 ([page 99](#))
- rect 294, 229, 508, 254 ([page 100](#))
- rect 107, 60, 127, 76 ([page 99](#))
- rect 108, 106, 128, 122 ([page 99](#))
- rect 107, 144, 127, 166 ([page 99](#))
- rect 106, 195, 126, 211 ([page 99](#))

Icon/ Detail	Description
	Not yet on the Change Management server; the entity is not currently being managed. Example A computer project is enabled for Change Management. However, only selected files have been added. Icons for other computer files that could be managed display a down arrow.
	The entity is checked out to another user or computer. It cannot be checked out on the local computer. The entity can be available only if the user name/password that checked it out logs in, checks the entity in or an authorized user undoes the checkout. Tip: Use the Check out Status option to see what user has the entity checked out.
	Unknown.
	Checked out.
No icon	No icon indicates one of the following. The entity: <ul style="list-style-type: none"> • Is in Change Management and not currently checked out. • Cannot be managed.
Status	Entity status
User	User who has the entity checked out, if it is checked out.
Computer	Computer on which the entity is checked out, if it is checked out.

Note: The status bar reports if the selected project, CIMPPLICITY or Computer, is connected ([logged onto \(page 89\)](#)) the PCM Server and the user who logged in. The status changes only when a user right-clicks an icon in the Workbench and selects Log on in the Popup menu.

8. Label

Labels enable you to create a set of easily identifiable managed entities that can be retrieved from Change Management.

Checking out or getting a labelled set retrieves the file versions that were included when the entity was labelled.

Managed entities that:	Include:
Can be labelled.	<ul style="list-style-type: none"> • CIMPPLICITY project. • Computer project • Primary folders and icons in the Workbench left pane. <p>Examples</p> <ul style="list-style-type: none"> • Screens • Ports • Resources
Cannot be labelled.	<ul style="list-style-type: none"> • Individual files. • Managed Files folders in the Workbench left pane. <p>Note: The Managed Files folders are not actual directories. They only exist in the Workbench to contain all of the individually managed files.</p>

Label options include the following.

The screenshot shows a dialog box titled "Apply Label" with a close button (X) in the top right corner. The dialog contains the following fields and values:

- Logon User: ADMINISTRATOR
- Name: GEF_CIMPCHNGE
- Version: N/A
- Date: N/A
- Label: TANKS1

At the bottom of the dialog are two buttons: "OK" and "Cancel".

Field	Description
Logon User	(Read only) Name of the logged on user who is checking out the entity. Note: If a user is not logged in a Change Management Logon dialog box opens, requiring an authorized user/password.
Name	(Read only) Name of the entity being labeled.
Version	(Read only) N/A
Date	(Read only) N/A
Label	Label that clearly identifies the entity version being added.  Note: Make sure that a label is entered if you want to view the version in the PCM History window (page 101) and retrieve it.

 **Note:** The Apply Label dialog box opens after a project or the base configuration is added or checked into the PCM server.

9. Show History

9. Show History

Show History opens the PCM History window that lists the versions and data history of the selected entity that are on the Change Management server, e.g. if the project is selected, the PCM history window displays the history of the project; if a screen is selected, the PCM History window displays the history of the selected screen.

 **Important:** Make sure the PCM History window is closed after logging out of Change Management through the Workbench.

Automatically generated short point IDs replace their corresponding long point IDs to display in History report lists.

 **Tip:** You can list (and sort) the short point IDs in the Workbench right-pane next to their associated long point IDs.

Use the Field Chooser to select and position the field.

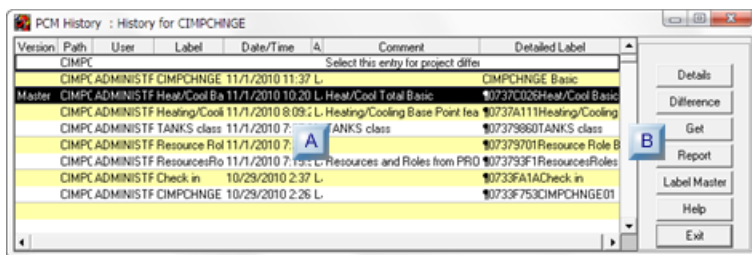

rect 387, 70, 413, 94 ([page 102](#))

rect 177, 70, 203, 94 ([page 102](#))

A (page 102)	PCM History window overview.
B (page 102)	PCM History window components.

1. PCM History Window Columns

Version	Path	User	Label	Date/Time	Action	Comment	Detailed Label
	CIMPCHN ADMINISTR	TANKS class	11/1/2010 7:3: Labeled	TANKS class			¶07379860TANKS c
	CIMPCHN ADMINISTR	CIMPCHNGE	11/1/2010 11: Labeled	CIMPCHNGE Basic			
Master	CIMPCHN ADMINISTR	Heat/Cool Ba	11/1/2010 10: Labeled	Heat/Cool T total Basic			¶0737C026Heat/Co
	CIMPCHN ADMINISTR	Heating/Cooli	11/1/2010 8:0: Labeled	Heating/Cooling Base Point feat			¶0737A111Heating/
	CIMPCHN ADMINISTR	CIMPCHNGE	10/29/2010 2: Labeled				¶0733F753CIMPCH
	CIMPCHN ADMINISTR	Resource Rol	11/1/2010 7:2: Labeled				¶07379701Resource
	CIMPCHN ADMINISTR	ResourcesRol	11/1/2010 7:1: Labeled	Resources and Roles from PRD			¶073793F1Resource
	CIMPCHN ADMINISTR	Check in	10/29/2010 2: Labeled				¶0733FA1ACheck in
	CIMPCHN					Select this entry for project differ	

Information	Description
Version	Number that defines when the selected entity was checked in static to other check-ins. Note: Folders, e.g. projects, do not have version numbers; a file, e.g. a screen is assigned a version number each time a new version is added, then checked into the Change Management server.
Path	PCM server path (starts with the project root).
User	User who performed an action (e.g. check in, add) on the entity.
Label	Label, if there is one, that is applied to the added or checked in entity (page 100) .
Date/Time	The date and time the action occurred on the Change Management server.
Action	The type of action performed on the file or folder in the Change Management product. Some actions include (but are not limited to): <ul style="list-style-type: none"> • Add • Label • Get Latest • Get • Check Out • Check In • Undo Check Out.
Comment	Comment that was entered in the Check In (page 96) or Add (page 118) dialog box.

1. PCM History Window Components

9.1 (page 103)	Details
--------------------------------	---------

9.2 (page 104)	Difference
9.3 (page 107)	Get
9.4 (page 107)	Report

9.1 Details

The Details button opens a Details screen that provides the following read-only information about the selected version.

 **Note:** You can double-click a version to open its Details screen.

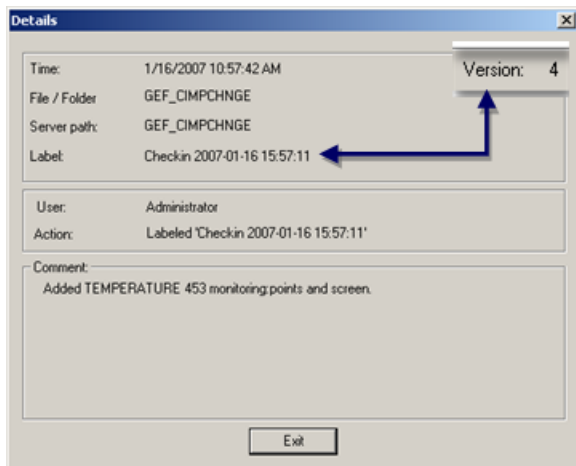

Topic	Description
Time	Time the action was performed on the entity on the Change Management server.
File / Folder	Folder on the Change Management server where the entity is located. Note: The Change Management server adds a GEF_ prefix to the local checked in CIMPLICITY project folder and COM_ to a computer project folder.
ServerPath	ServerPath Path to the entity on the Change Management server.
Label/ Version	<ul style="list-style-type: none"> • A version is assigned to files. • A label is assigned to folders.
User	User who performed an action on the entity.

Topic	Description
Action	Action that was taken on the entity. Example A screen is created and added to the Change Management server. The action is Created. <div data-bbox="344 352 750 499" style="border: 1px solid gray; padding: 5px; margin: 10px 0;"> User: ADMINISTRATOR Action: Created Comment: Start Screen for TANK905 Backup </div>
Comment	Comment entered in the Check In or Add dialog box Comment field.

9.2. Difference

The Difference button provides the ability to compare a selected entity version on the PCM server vs. the local server entity by running either of the following.

! **Important:** Automatically generated short point IDs replace their corresponding long point IDs to display in History difference report lists.

Tip: Use the pt_name_map.idtfile to look up what long point ID is associated with any automatically generated short point ID.

- Binary compare
- Text compare (available for selected entities)

Binary Compare

Binary compare that identifies the files that are different in the selected entity version vs. the entity's files on the local server.

1. Click the Difference button to begin the comparison process.

When Change Management has completed comparing the local entity version vs. the select PCM version, a Web Browser opens displaying the report.

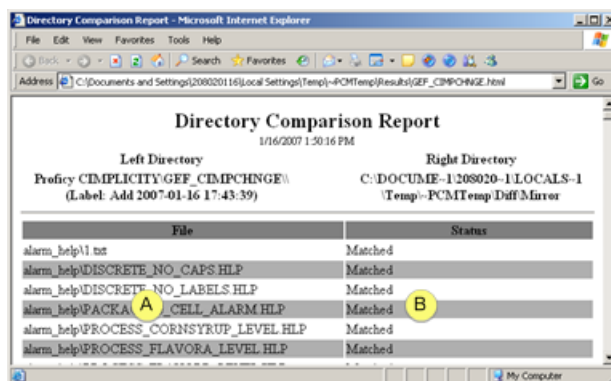

	Prev	Click to go to the previous line that is different. Note: If you click Prev when the selected line is the first different line in the files, the Directory Comparison Report list will display.
	Next	Click to go to the next line that is different.
C	Left column	Rows in the Change Management server file.
	Right column	Rows in the local file.
D	A row highlighted in red is the selected line.	
E	Rows highlighted in yellow lines are different.	
F	Rows with a white background are the same.	

Text Compare (available for selected entities)

A Text Compare check box is available for selected managed files, including:

- CimEdit screens
- Scripts
- Recipes

Text Compare displays the details of the changes in the selected file when Difference is clicked.

4. Check Text Compare.

5. Click Difference.

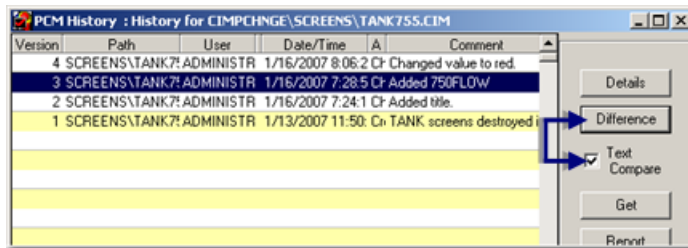

A Comparison report opens identifying the details of the changes.

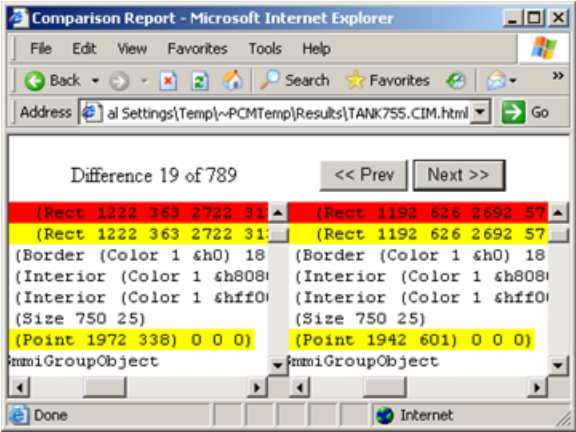

9.3. Get

The Get button fetches the selected entity version and overwrites the corresponding files on the local server.

! Important: It is strongly recommended that you compare the difference between the selected entity version and the entity on the local server before getting the file.

1. Click Get.

A message box opens asking you to confirm that you want to get the selected PCM entity version.

2. Click one of the following.

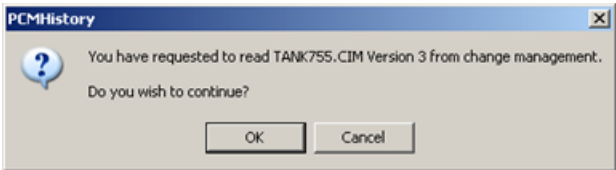

OK	The selected entity on the PCM server overwrites the local copy.
Cancel	Cancels the Get.

9.4. Report

The Report button opens a Save As dialog box to save the data in the PCM History window.

1. Click Report.

A Save As dialog box opens.

2. Select the file format in the **Save as type** drop down box.

Options are:

- HTML
- XML
- CSV
- TXT

3. Enter a **File name** for the report file.

Note: When you select HTML, the file is automatically saved as an HTM file unless you enter .html when you enter the file name.

If you let the file be saved as an .htm file, it will not automatically display when you select the HTML type the next time you save a report.

Enter *.htm in the **File name** field to display the existing .htm files.

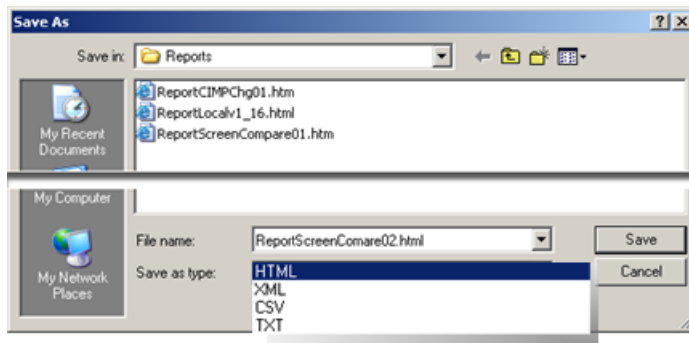

4. Click Save.

The report is saved in the selected format.

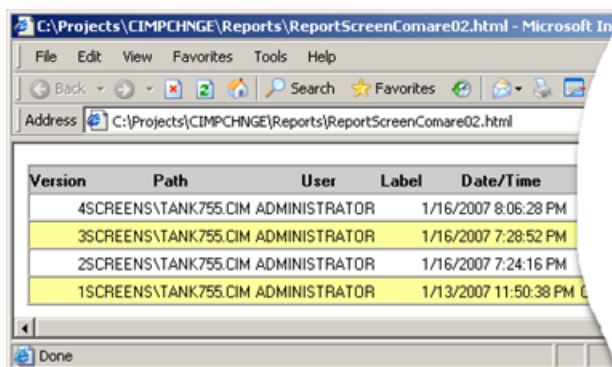

10. Show Master Label History

A Change Management Master Label project version enables:

- Users to select any version of a project and/or computer (system) as its Master label.
- The Change Management Scheduler to compare the current local version against the Master version.

 **Note:**

- Only one version at a time can be selected as the Master for the project and one version for the computer.
- Before this enhancement the Change Management Scheduler could only compare (and optionally backup) the current version of a local project/computer against the last checked in project/computer version.
- Local computer: New Master Label features.
- Change Management Server: Required Master Label configuration.

Local Computer: New Master Label Features

The following new and enhanced Change Management features enable you to select and work with the Master Label.

- Project/Computer New and Enhanced Manage Menu Items
- Show History: Enhanced PCM History Window
- Show Master Label History: New PCM (Master Label) History Window

Project/Computer New and Enhanced Manage Menu Items

Do the following to display either the Project or the Computer Manage menus.

1. Select the **Project** or **Computer** folder in the Workbench left-pane.
2. Do one of the following.
 - Right-click the selection; select Manage on the Popup menu.
 - Click Project or Computer (corresponding to your selection) on the Workbench Menu bar; select Manage.

Result: Items on the extended menus provide access to the following.

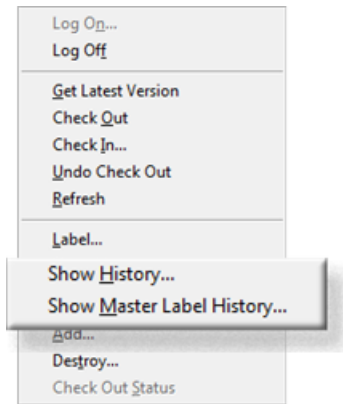



rect 18, 156, 100, 178 [9. Show History \(page 101\)](#)

Show History: Enhanced PCM History Window

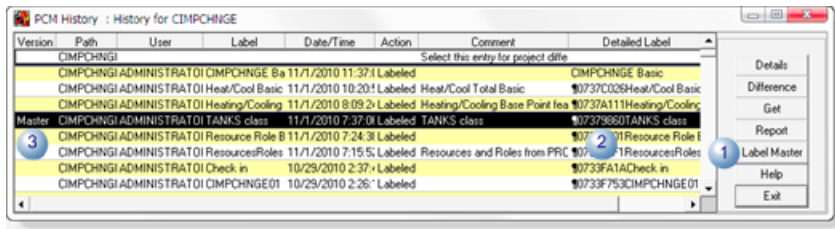
The Show History window for the project or computer provides the following new and enhanced features.

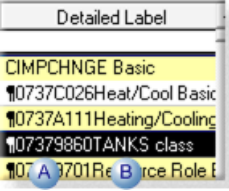

1	Label Master button	<p>A Label Master button has been added; when it is clicked the selected row is:</p> <ul style="list-style-type: none"> Identified as the Master version. Used by the Change Management Scheduler when it does comparisons. <p></p>
2	Selected Row/Detailed Label Column	<ul style="list-style-type: none"> One row only must be selected in order to enable the Label Master button. <p>Note: If more than one row is highlighted, click the rows that should not be highlighted to deselect them</p> <ul style="list-style-type: none"> A new Detailed Label column displays the following. <p></p>

3	Master Version	<p>The Master Version row is identified as Master in the Version column.</p> 
---	----------------	---

Show Master Label History: New PCM (Master Label) History Window

Master Label versions are tracked as follows.

- `_config.ini` file.
- PCM (Master Label) History window columns.
- Master version details and differences.

`_Config.ini` File

Change Management internally updates a `_config.ini` file as it keeps track of which project/computer version is currently selected as the Master version. Each time a different version is selected, the `_config.ini` file is updated.

The Master Label identification for the Master version in the `_config.ini` is the same as the value that displays in the project/computer PCM History window's **Detailed Label** column.

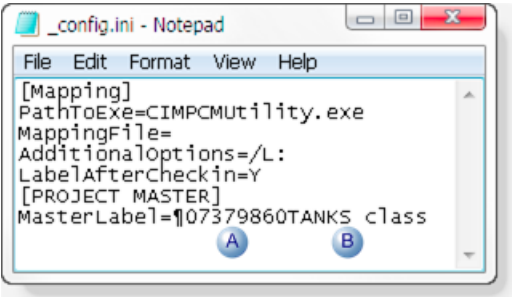

A	Master Label string
B	Version label entered manually or by default.

CAUTION: This file is updated internally. Do not change it manually.

PCM (Master Label) History Window Columns

The PCM (Master Label) History window displays the history of the Master Label `config.ini` file updates.

Columns in the PCM (Master Label) History window provide details about the `_config.ini` file, as follows.

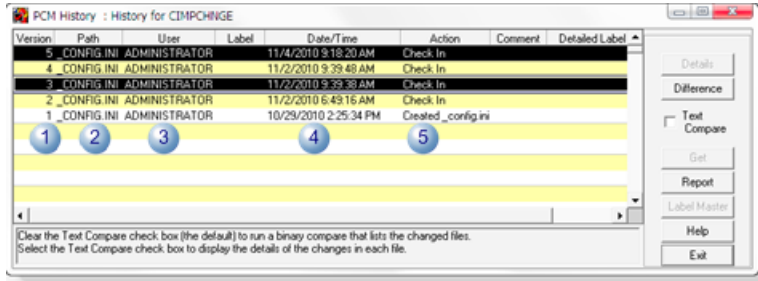

	Column	Identifies
1	Version	Each time the _config.ini file was updated.
2	Path	_config.ini.
3	User	Person who selected the project/computer version to be the Master for that instance.
4	Date/Time	When the _config.ini file was updated.
5	Action	The action performed on the _config.ini file.

Master Version Details and Differences

Master version details and differences can be reviewed through the PCM (Master Label) History window.

Select two _config.ini file versions; click Difference.

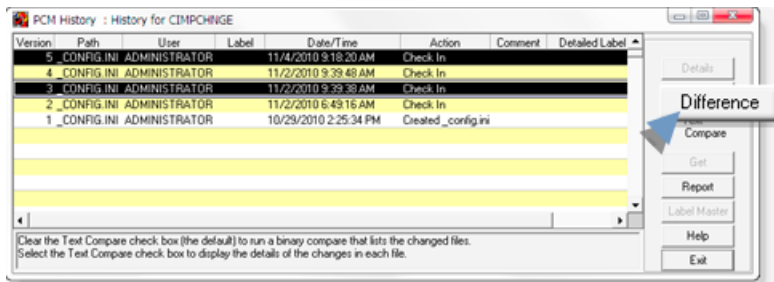

Result: An HTML page opens that displays the details and differences between the two versions.

The Master Label identification for the Master version is the same as the value that displays in the project/computer PCM History window's **Detailed Label** column.

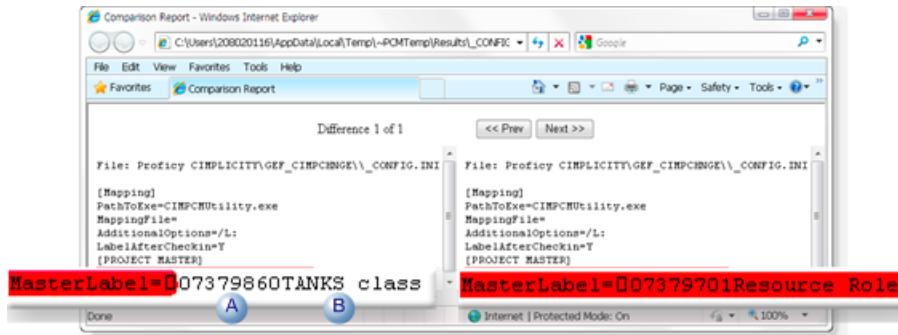

A	Master Label string.
B	Version label entered manually or by default.

Change Management Server: Required Master Label Configuration

Change Management Server script updates are included in CIMPLICITY v8.1-000004. These updates need to be copied and pasted on the Change Management Server; once copied some minor configuration is required.

The procedures to copy/paste the updates and required configuration are as follows.

- Change Management Server Script File Updates
- Change Management Scheduled Event
- Permissions to select the Master Label

Change Management Server Script File Updates

Scripts on the Change Management server must be updated in order for the server to recognize the new Master Label feature.

The updated scripts are included in the SIM and will be placed in the ..Proficy\CIMPLICITY\Extras folder.

Do the following to update the scripts on the Change Management server.

3. Log on to the desired Change Management server.
4. Open Machine Edition.
5. Right-click the Custom Project Settings>**Scheduler Scripts** folder.
6. Select Check Out on the Popup menu.

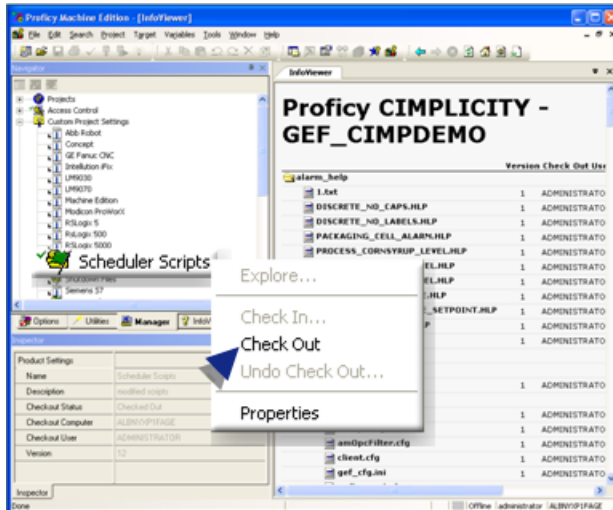

7. Right-click **Scheduler Scripts** again.

8. Select Explore on the Popup menu.



A Windows Explorer window opens with the Scheduler Scripts folder selected.

9. Paste the updated script files in this location.

The files are:

- In the ..\Proficy CIMPLICITY\Extras folder on the computer where you just installed CIMPLICITY v8.1-000004.
- Named:
 - APICompare_functions.vb
 - Cimplicity_Compare_Master.vb
 - Cimplicity_Compare_MasterLabel.vb
 - scriptdef.ini

A message will ask if you want to overwrite the existing files.

10. Click Yes.

11. Right-click **Scheduler Scripts** again.

12. Select Check In on the Popup menu.



Change Management Scheduled Event

Master Label configuration includes creating one or more scheduled event that

13. Right-click **Select Scheduler Event List** in the Machine Edition window.

14. Select Check Out Scheduler Settings on the Popup menu.

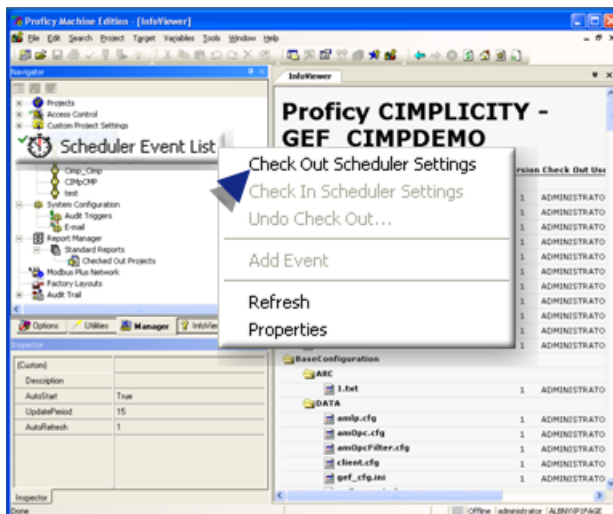

15. Right-click **Select Scheduler Event List** again.

16. Select Add Event on the Popup menu.

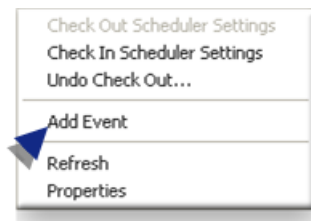

A new event is added to the Scheduler Event List tree.

17. Name the event, e.g. CIMPChnge.

18. Select the event.

19. Configure the following in the Inspector.

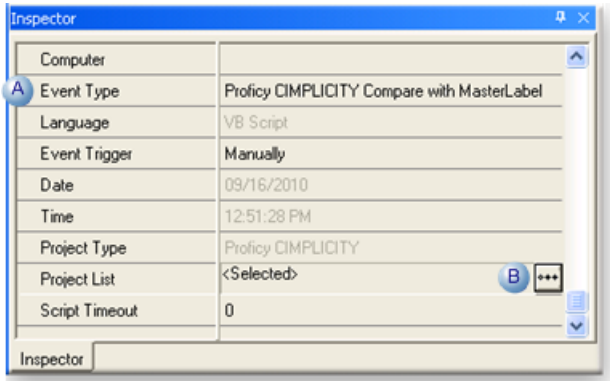

A	Event Type	Select CIMPLICITY Compare with MasterLabel.				
B	Project List	Click the button on the Project List line; Result: A Project List for <event name> dialog box opens. Associate a project with the event, as follows.				
		<p>The Project List for CIMPChange dialog box shows the following configuration:</p> <ul style="list-style-type: none"> Product Type: Proficy CIMPLICITY Available Projects list (2): <ul style="list-style-type: none"> COM_ALBMUSSET COM_ES_8PTGSH1 COM_ES_8PTGSH1_COMPUTER GEF_CIMPDEMO GEF_NEWTEST GEF_PROF_CIMP18175 GEF_SHOBI_TEST GEF_TEST_PROJECT_8_2 Buttons: Add All (1), Add (3), Remove, Remove All Project List table (4, 5): <table border="1"> <thead> <tr><th>Project</th><th>Address</th></tr> </thead> <tbody> <tr><td>GEF_CIMPCHNGE</td><td>C:\Projects</td></tr> </tbody> </table> 	Project	Address	GEF_CIMPCHNGE	C:\Projects
Project	Address					
GEF_CIMPCHNGE	C:\Projects					

20. Right-click **Select Scheduler Event List** again.

21. Select **Check In Scheduler Settings** on the Popup menu.

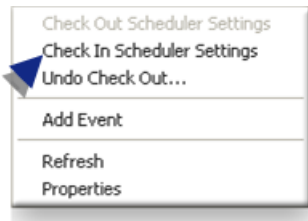

22. Select **..>Machine Edition>Scheduler Engine** on the Windows Start menu.

A Scheduler icon displays on the Windows Task bar, indicating that the Scheduler has been started.



23. Right-click the **Scheduler** icon.

24. Select Maximize Scheduler on the Popup menu.

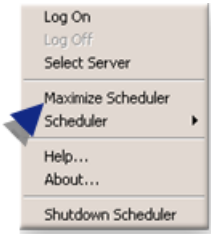

The Change Management Scheduler dialog box opens.

25. Do the following.

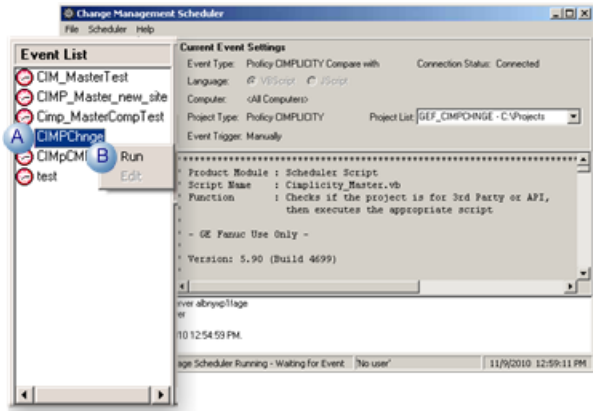

A	Right-click the event that should be started.
B	Select Run on the Popup menu.

The Scheduler will now run the script to compare the Master Label project with the current project version.

Note: If the Master Label is not set through the Project List for <event name> dialog box, the script will fall back to comparing the latest version on the Change Management server with the current version.

Permissions to select the Master Label

CIMPLICITY Change Management users can select project versions as the Master version only if the feature is set to True on the Change Management Server.

Do the following.

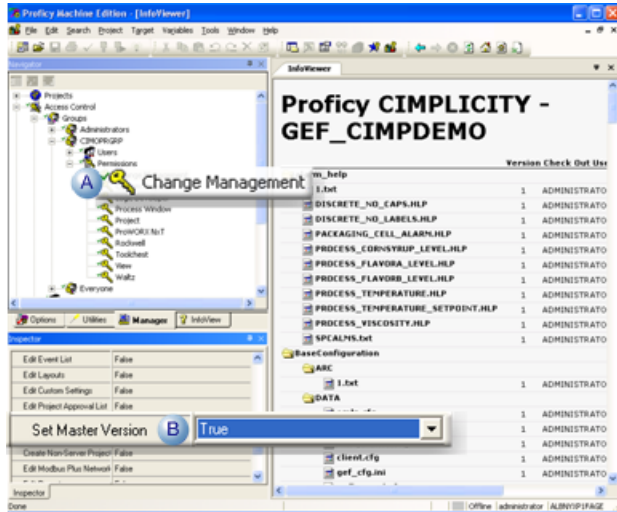

A	Select Access Control>Groups>CIMOPRGRP>Permissions> Change Management in the Machine Edition Navigator.
B	Select True for Set Master Version in the Inspector.

11. Add

- Add procedure.
- Important.

Add Procedure

Adds the selected entity to Change Management.

1. Select a project folder, base configuration icon or managed file that is or belongs to the entity that will be added.
2. Do one of the following.

Entity	Do one of the following.	Adds
<ul style="list-style-type: none"> • Computer project folder 	<ul style="list-style-type: none"> • Right-click; select Add on the Popup menu. • Click Computer>Manage>Add on the Workbench menu bar. 	Computer project
<ul style="list-style-type: none"> • Proficy CIMPLICITY Project folder • Managed project file 	Right-click; select Add on the Popup menu.	Selected entity.
<ul style="list-style-type: none"> • Proficy CIMPLICITY Project folder • CIMPLICITY project base configuration entity • Managed project file 	Click Project>Manage>Add on the Workbench menu bar.	The CIMPLICITY project.

An Add or Add Files dialog box opens, based on the selected entity.

- 3. Enter specifications as follows.
 - Project or base configuration
 - Managed files

Project or Base Configuration

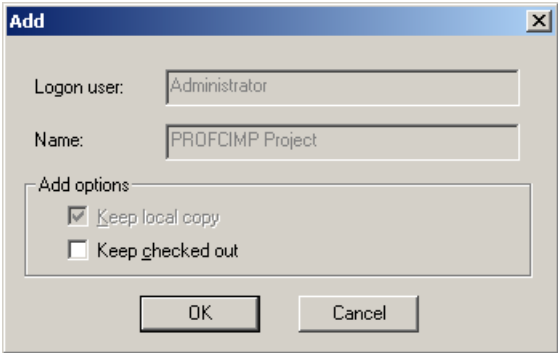

Field	Description
Logon User	(Read-only) Displays the Change Management user name.
Name	(Read-only) Selected entity name.
Keep Local copy	(Read-only) A copy of the entity being added is maintained on the local computer.
Keep check out	Checked

Managed Files

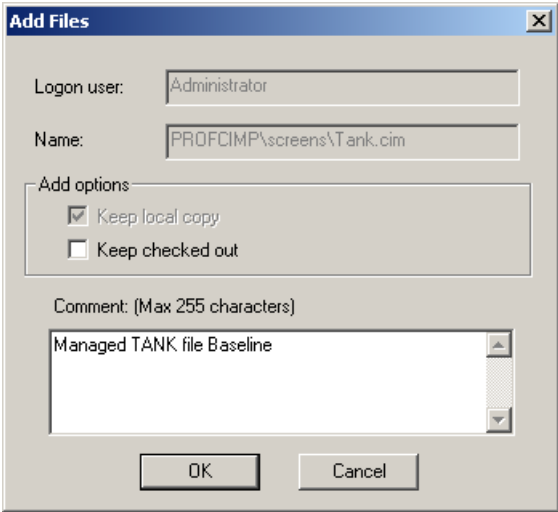

Field	Description
Logon User	(Read-only) Displays the Change Management user name.
Name	(Read0only) Selected entity name.
Keep Local copy	(Read-only) A copy of the entity being adds is maintained on the local computer.
Keep check out	Checked
Comment	Description for a user to distinguish the entity version being checked in from other versions. Max Length.

4. Click OK.

The selected entity is added to Change Management.

Results

- a. If an entity that can be [labelled \(page 100\)](#) is added:

An Apply Label dialog box opens.

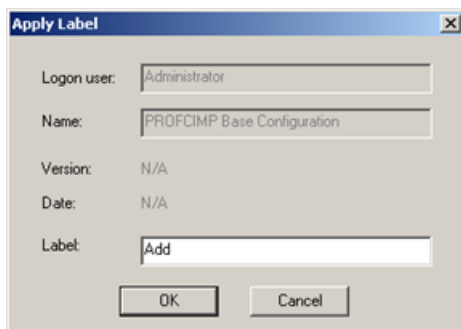

5. (Optional) Enter a Label to conform to your system standards.

6. Click either:

OK	<ul style="list-style-type: none"> • Saves the label. • Closes the Apply Label dialog box.
Cancel	<ul style="list-style-type: none"> • Cancels applying a label. • Closes the Apply Label dialog box.

- a. The entity is added to the Change Management server.
 b. If Keep checked out was checked, **Checkout** icons display to the left of the added entities in the Workbench.

! Important:

- An entity is not managed until it is added to Change Management; this includes the base configuration. If you create a managed file, e.g. a new CimEdit screen or a new alarm

setup, remember to add it separately or in a full project add so it will be included in the managed set.

- If two projects (which would be on different computers) have the same name, the first project's .gef file that is added to Change Management has precedence over the second.

Example

Two computers add the .gef file for projects with the same name to Change Management.

Computer	Project Name	When the .gef file was Added
Comp1	Project A	July 9, 2008
Comp2	Project A	August 2, 2008

Since Comp1 added Project A's .gef file first, Change Management gives Comp1's Project A .gef file precedence over Comp2's Project A .gef file..

Use Case

7. A production version of a project is running on a production server.
8. The project is checked out to a test project running on a test server.
9. Once tested, the tested project is returned to Change Management where the production project can get the latest version at a break in production, e.g. the weekend.
10. The .gef file is the file from the production version.

12. Destroy

Destroy destroys the selected managed entity on the Change Management server.

The project can be either checked in or out.

 **Warning:** This is not a delete function. Destroy literally destroys all traces of the selected entity on the Change Management server.

A Destroy message box will open to warn you.

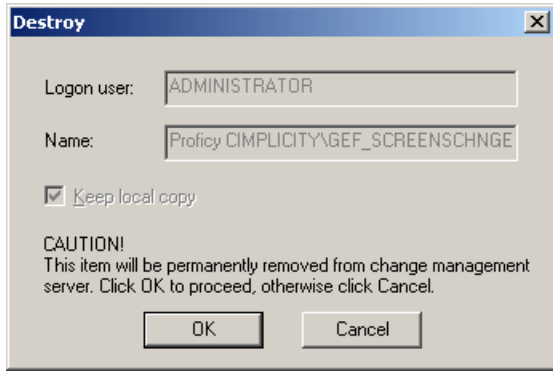

13. Check out Status

Check out Status opens a Check Out Status dialog box that provides details about the status of the selected entity.

Information in the dialog box includes the following.

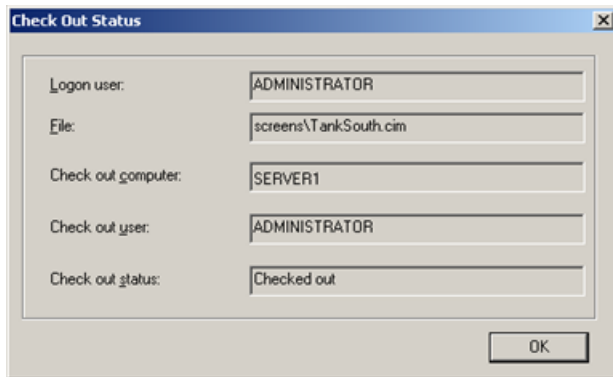

Field	Description
Logon user	(Read-only) User who logged onto the Change Management server.
File	(Read-only) File (or entity) that is being reported on.
Check out computer	(Read-only) Either: Entity is checked out or Entity is checked in.
Check out user	(Read-only) Either: Entity is checked out or Entity is checked in.
Check out status	(Read-only) Either: Entity is checked out or Entity is checked in.

14. Fetch Project

Fetch Project enables you to fetch any project that is available on the Change Management server and copy it to a selected destination directory.

- Fetch project procedure.
- Fetch project notes.

Fetch Project Procedure

1. Open a Workbench on the target computer.

Note: The Workbench can either be blank or can contain an existing project.

2. Click File>Fetch Project on the Workbench menu bar.

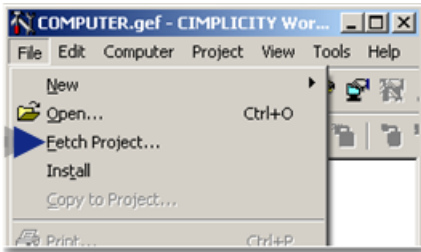

A Fetch Project Dialog box opens.

3. Enter or select the following.

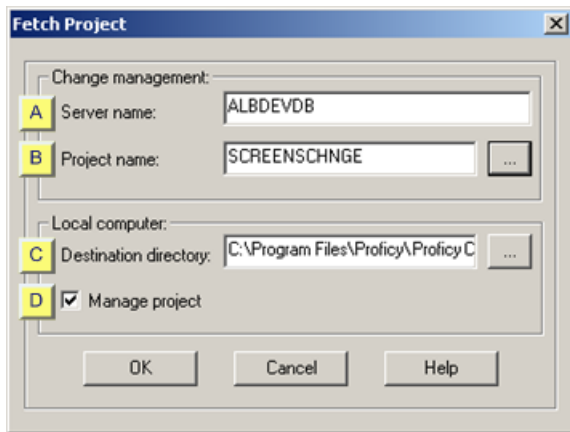

rect 5, 45, 43, 82 ([page 124](#))

rect 4, 80, 40, 117 ([page 124](#))

rect 5, 142, 35, 169 ([page 125](#))

rect 4, 169, 36, 202 ([page 125](#))

A (page 124)	Server name.
B (page 124)	Project name.

C (page 125)	Destination directory.
D (page 125)	Manage project.

A	Server name
---	-------------

Name of the Change Management server that has the project to be fetched.

B	Project name
---	--------------

Name of the project to be fetched.

Find and add the project as follows, if you do not know the exact name.

- Click the Browse button to the right of the Project name field.

A Change Management Logon dialog box opens.

- Enter an authorized user name and password.

- Click OK.

A Select Project Browser opens with a listing of projects on the Change Management Server; the listed project may include either the entire project or selected managed files. However, only entire projects can be fetched.

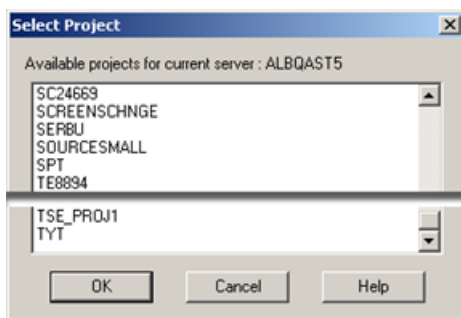

- Select the project to be fetched.

- Click OK.

Result: The Select Project browser closes and the selected project displays in the Project name field.

Note: If you selected a partial project a message box will open to report:

Item not be found.



C	Destination directory
---	-----------------------

Directory the project directory will be fetched to.

Default	...\\Program Files\\Proficy\\Proficy CIMPPLICITY\\Projects Where ...\\Program Files\\Proficy\\Proficy CIMPPLICITY is the root directory.
---------	--

 **Note:**

- If the project already exists on the target computer, the destination directory must be in a different location from the local project.
- UNC paths are not supported.

e.g. \\computer\share

D	Manage project
---	----------------

Do one of the following.

Check	The project will be managed by Change Management.
Clear	The project will be copied to the destination directory; however, Enable Change Management (<i>page</i>) will not be checked in the Project Properties dialog box.

9. Click OK.

Result:

10. If you are not already logged onto the Change Management server, a Change Management Logon dialog box opens.

- Enter an authorized user name and password.
- Click OK.

11. The selected project is fetched to the selected destination directory.

Fetch Project Notes

- If the PCM project name is not the same as the CIMPPLICITY project name:
- The folder for the fetched project has the Change Management project name.
- The project name is the local project name.

Example

- A local project is named PCMLOCAL.
- The project is named PCMSERVER on the Change Management server.
- The project PCMSERVER is fetched to another computer.
- The names are as follows.

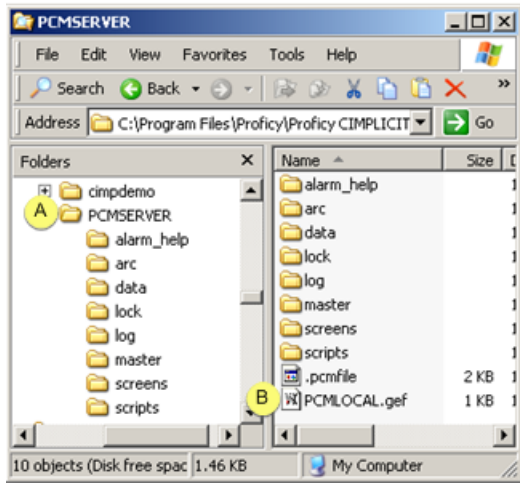

A	The fetched project folder name is PCMSERVER.
B	The fetched project name is PCMLOCAL.

- If you immediately open a Directory Comparison report it will report that there are differences.

However, if you run the report to discover what the differences are, the report may declare there are no differences.

The initial notification that there are differences is based on time stamps of actual file creation vs. Fetch creation.

Note: If there actually were differences when the project was added or checked into the PCM server, those differences will be reported.

Change Management Client

Change Management Client

The Change Management client:

- Can be installed when Machine Edition is installed.

- Includes a Scheduler that enables you to schedule events to perform either a - CIMPPLICITY compare or CIMPPLICITY compare and back up.

Important: Change Management client requires Machine Edition Change Management Client v. 5.6 SIM2 or higher.

Step 1 (page 127)	Install the Change Management Client on the Local Server.
Step 2 (page 128)	Open the Machine Edition InfoViewer window.
Step 3 (page 130)	Configure and Use the Scheduler
Step 4 (page 131)	Enable Auto Login

 **Note:** You can also look at the status of your projects; computer projects, site root project; you can see who has items checked out.

Step 1. Install the Change Management Client on the Local Server

1. Start the Machine Edition installation.

The Machine Edition Splash screen opens..

2. Click Change Management.



3. Continue with the installation until the Machine Edition Setup screen opens.

Consult Machine Edition documentation for details.

4. (If a list of support product modules displays that includes CIMPLICITY HMI) Make sure that CIMPLICITY HMI is not selected.

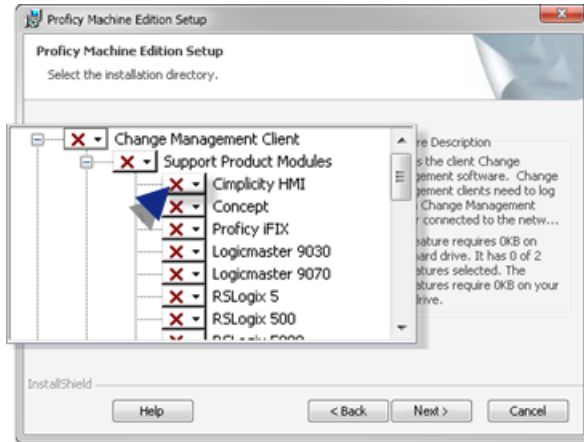

5. Continue with the Change Management client installation.

Consult Machine Edition documentation for details.

When the installation is complete:

- A **Change Management client** icon will display in the Workbench left pane.
- Machine Edition and Scheduler will be listed on the Windows Start menu.

Step 2. Open the Machine Edition InfoViewer Window

1. Make sure your project is checked into the Change Management server.
2. Do one of the following.
 - Workbench Log On

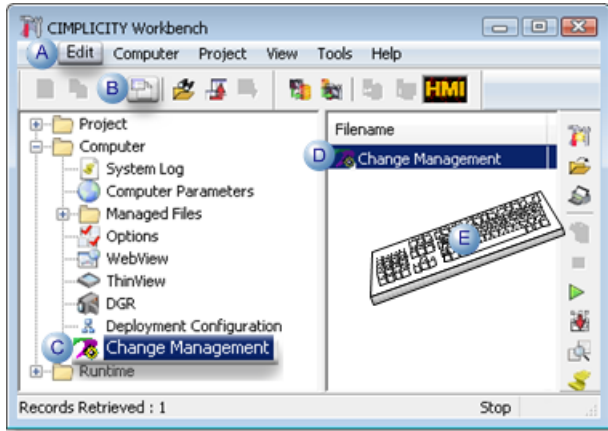

A	Click Edit>Properties on the Workbench menu bar.
B	Click the Properties button on the Workbench toolbar.
C	In the Workbench left pane: a. Right-click Change Management . b. Select Properties on the Popup menu.
D	In the Workbench right pane, double click Change Management .
E	Press Alt+Enter on the keyboard.

- Windows Start Menu
 - a. Click Start on the Workbench task bar.
 - b. Machine Edition on the Start menu.

Example

(Windows 7) The selection is Proficy>Machine Edition.

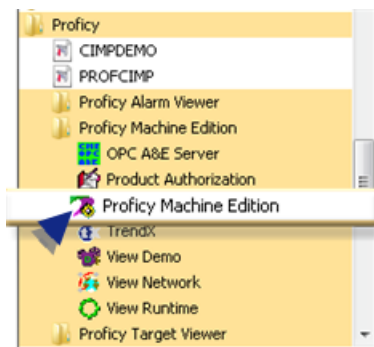

Result: A Change Management Log On dialog box opens when you use either method.

3. Right-click **Change Management**.
4. Select Properties on the Popup menu.
5. Enter the following.

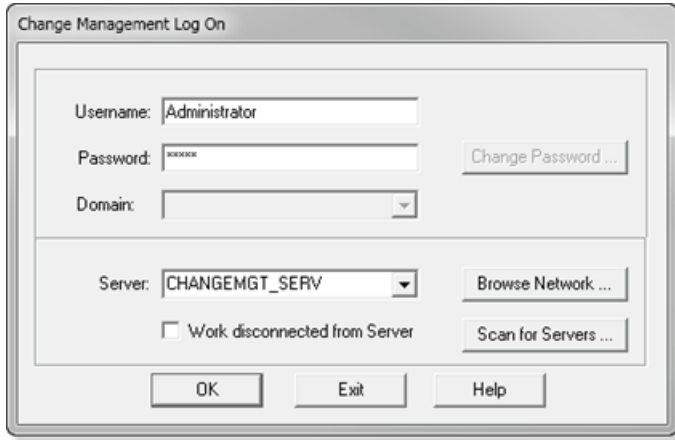

Field	Description
Username	Authorized Change Management server user name.
Password	Valid password for authorized user.
Server	Change Management server. Note: The server name can be typed in or selected from the drop-down list.

6. Click OK.

A Machine Edition InfoViewer window opens.

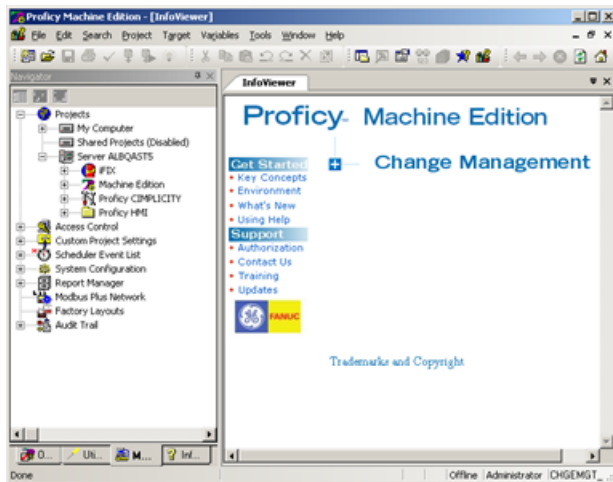

Step 3. Configure and Use the Scheduler

1. Compare a local project to a project in Change Management
2. Indicate if they are different.

3. Compare a local project to a project in Change Management
4. (If the projects are different) the local project will be automatically checked out and checked back in.

Notes

- During the checkout, the local project will not be overwritten.
- The items do not remain checked out when they are checked back in.
- No entities can be checked out for the compare and backup to work.

Step 4. Enable Auto Login

If you had selected to allow users to log in automatically to Change Management in the Windows Authentication window and Project Properties (page) dialog box, the Change Management Client also must be configured to recognize the auto login feature.

1 (page 131)	Check out the Access Control Database
2 (page 132)	Select Auto Login
3 (page 132)	Check in the Access Control Database

Check out the Access Control Database

1. Right-click Access Control in the Machine Edition Navigator.
2. Select Check Out Access Control on the Popup menu.

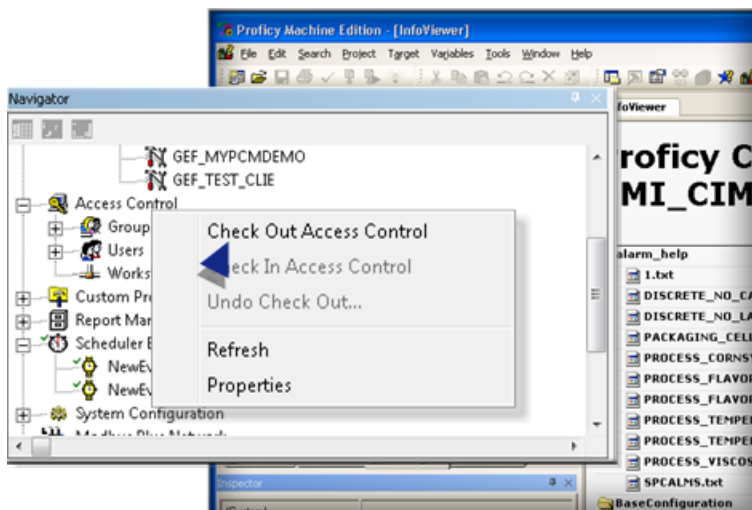

Select Auto Login

1. Select the Auto Login field in the Inspector.
2. Select True in the drop down menu.

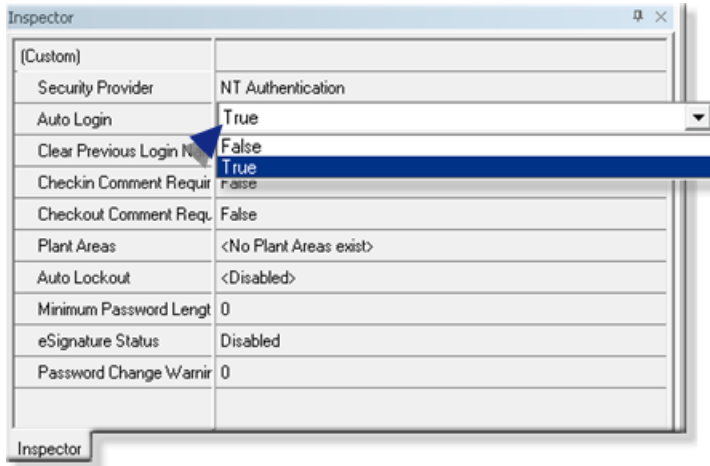

Check in the Access Control Database

1. Right-click Access Control in the Machine Edition Navigator.
2. Select Check In Access Control on the Popup menu.

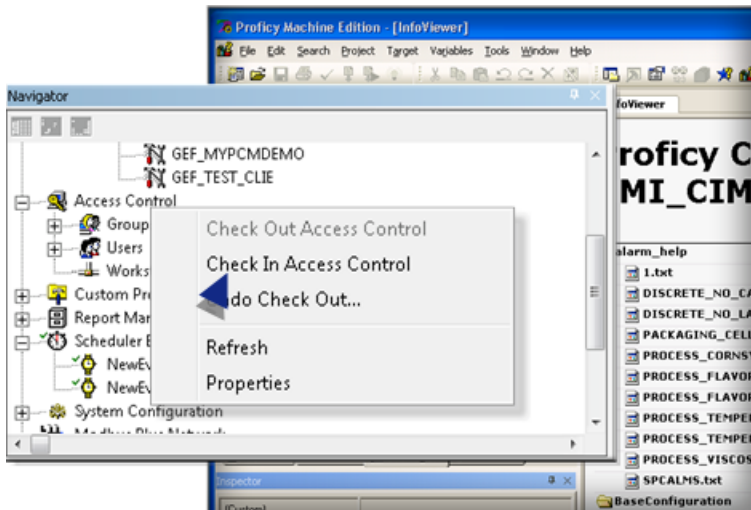

Result: The Change Management Client will now recognize the auto login feature.

Change Management Best Practices

Change Management Best Practices

Several best practices are provided as guidelines to help insure that Change Management keeps your system accurate and up-to-date.

1 (page 133)	Best practices: Initial development.
2 (page 137)	Best practices: Change Management Project Management.
3 (page 138)	Best practices: Test bed to production.
4 (page 141)	Best practices: CIMPLICITY version changes.

1. Best Practices: Initial Development

1. Best Practices Initial Development

The following cases describe best project management practices to use when setting up or making configuration changes for a managed project.

Case 1.1 (page 133)	Multiple users, non-shared drives.
Case 1.2 (page 136)	Multiple users, shared drive.

Case 1.1. Multiple Users, Non-shared Drives

1 (page 134)	Case description.
2 (page 134)	CIMPLICITY project configuration.

3 (page 134)	Managed characteristics configuration.
4 (page 135)	User setup.
5 (page 135)	Configuration changes guidelines.
6 (page 136)	Exceptions

Case Description

- Multiple users use Change Management.
- Users do not use shared drives.
- Users use separate local copies of the project.

CIMPLICITY Project Configuration

1. Create a project in CIMPLICITY.
2. Add all of the users who will need access to CIMPLICITY and/or Change Management to the new project.
3. Configure the CIMPLICITY project to perform according to your system specifications.

Managed Characteristics Configuration

1. Select the Change Management tab in the Project Properties dialog box.
2. Do the following.

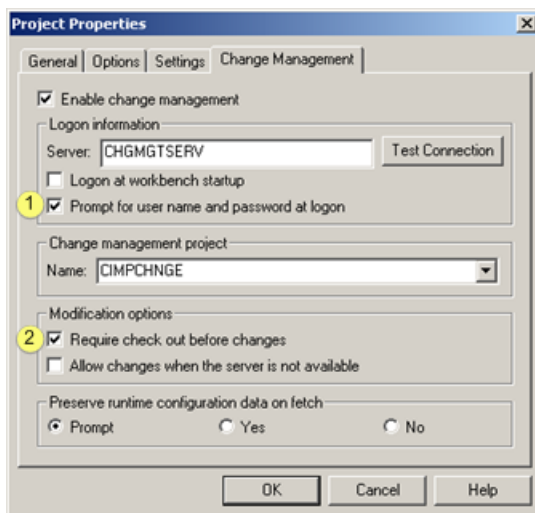

1	PCM user names and passwords vs. CIMPLICITY user names and passwords. CIMPLICITY/PCM user names and passwords are not the same.
2	Check Require check out before changes.

1. Add the CIMPLICITY project to the Change Management server.

User Setup

- For Computer level projects
- On the same computer:

The computer level project is the same.

- On different computers:

1. Click Computer>Properties>Manage>Logon on the Workbench menu bar.
2. Configure the characteristics to match those specified on the original project log in as a unique PCM user.
3. Right-click the entity.
4. Select Manage>Get Latest Version on the Popup menu.

Note: This will impact other computer project on the computer to which these files were fetched.

- For CIMPLICITY projects

1. Click File>Fetch Project on the Workbench menu bar.

The Fetch Project dialog box opens.

1. Enter the PCM Server name and name of the project to be fetched.
2. Select a unique directory location for the project.
3. Configure the characteristics to match those specified on the original project.

Configuration Changes Guidelines

Always follow these guidelines when performing configuration changes:

- Always close all configuration applications before performing a check in operation, when performing configuration transactions.
- Perform a check out of the item(s) before beginning application changes.
- Never check [Don't overwrite local files with managed copy \(page 93\)](#) when performing a check out operation.
- Never check [Don't overwrite local files with managed copy \(page 97\)](#) when performing an undo check out.

- Never share PCM user names with different users.

Exceptions

Failure to follow these instructions can result in one user overwriting another user's changes or an incoherent project as a result of concurrent changes.

Case 1.2. Multiple users, Shared Drive

1 <i>(page 136)</i>	Case description.
2 <i>(page 136)</i>	CIMPLICITY project configuration.
3 <i>(page 136)</i>	Managed characteristics configuration.
4 <i>(page 137)</i>	Configuration changes guidelines.
5 <i>(page 137)</i>	Exceptions.

Case Description

- Multiple users use Change Management.
- Users are using the same copy of the project on a shared drive.

CIMPLICITY Project Configuration

1. Create a project in CIMPLICITY.
2. Add all of the users who will need access to CIMPLICITY and/or Change Management to the new project.
3. Configure the CIMPLICITY project to perform according to your system specifications.

Managed Characteristics Configuration

1. Select the Change Management tab in the Project Properties dialog box.
2. Do the following.

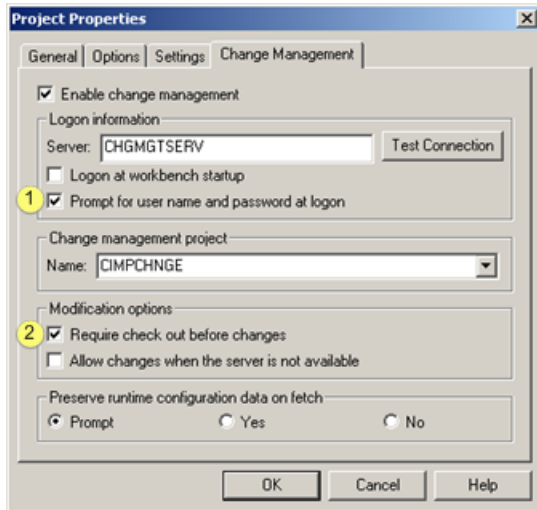

1	PCM user names and passwords vs. CIMPLICITY user names and passwords.
2	Check Require check out before changes.

1. Add the CIMPLICITY project to the Change Management server.

Configuration Changes Guidelines

Always follow these guidelines when performing configuration changes:

- Always close all configuration applications before performing a check in operation, when performing configuration transactions.
- Perform a check out of the item(s) before beginning application changes
- Never check [Don't overwrite local files with managed copy \(page 93\)](#) when performing a check out operation,
- Never check [Don't overwrite local files with managed copy \(page 97\)](#) when performing an undo check out.
- Never share PCM user names with different users.

Exceptions

Failure to follow these instructions can result in one user overwriting another user's changes or an incoherent project as a result of concurrent changes.

2. Best Practices: Change Management Project Management

1 (page 138)	Case description.
------------------------------	-------------------

2 <i>(page 138)</i>	Recommended procedure.
--	------------------------

Case Description

- The existing project is running correctly.
- Insure that it can be recovered from PCM.

Recommended Procedure

The following procedure helps to insure that local and managed projects are properly managed and can be correctly recovered from the PCM Server.

Use this procedure consistently whenever making configuration changes to a managed CIMPLICITY project:

1. Verify that all configuration applications are closed and remain closed throughout this process.
2. Check in all checked out files
3. Add project that will add in any missing files
4. Check out project without get (to get all files that were modified without checking out)
5. Check in project to update the managed project.
6. Label Project

3. Best Practices: Test Bed to Production

3. Best Practices: Test Bed to Production

The following cases provide best practices to help insure a smooth transition from a test bed managed project to production.

Case 3.1 <i>(page 138)</i>	CIMPLICITY test bed project deployed to production system.
Case 3.2 <i>(page 140)</i>	Project not acceptable after configuration changes.

Case 3.1. CIMPLICITY Test Bed Project Deployed to Production System

1 <i>(page 139)</i>	Case description.
--	-------------------

2 (page 139)	Recommended procedure
3 (page 140)	Notes and issues.

Case Description

A Project is developed in the test bed and deployed in production.

Recommended Procedure

Important:

- Use a managed project for the test bed and the deployed project.
- Make sure that no configuration applications are open through the process except where specifically noted.
- Make sure that change management operations are not performed on either system except as specified in this use case
- For the test bed and production system, use [project management \(page 137\)](#) recommended procedure to ensure that managed data is up-to-date.

Procedure

1. Modify the managed characteristics of the test bed local project to point to the production project in Change Management.
2. Compare latest test bed project with the current production project in Change Management.
 1. Identify independently managed files that are in the current production project, but not in the test bed version.
 2. Confirm that all differences are acceptable.
 3. Re-configure the managed characteristics of the test bed project to point to the test bed project.
 4. Shutdown the production system.
 5. Make a backup copy of the local production project directory.
 6. Modify the managed characteristics of the production local project to point to the test bed project in Change Management.
 7. Right-click **Project** in the Workbench.
 8. Select Manage>Get Latest on the Popup menu.

Note: This method is used so that runtime data that is not managed remains in the production project. If this is not desired do a [Fetch Project \(page 122\)](#) instead of following this procedure.

1. Delete any files that were not in the test bed project.
2. Modify any non-CIMPLICITY configuration changes that were made to support the requirements change.

3. Modify the managed characteristics of the local production project to point to the production project in Change Management.
4. Check out the production project from Change Management.

Important: Do not overwrite the local copy.

1. Check in the production project.
2. Start the production project.
3. Perform a configuration update.
4. Start the production project to resume production

Notes and Issues

- Must manually perform any configuration changes not related to CIMPLICITY
- Must be careful about runtime data that is stored with configuration

Case 3.2. Project not Acceptable after Configuration Changes

1 <i>(page 140)</i>	Case description.
2 <i>(page 140)</i>	Recommended procedure

Case Description

- The project is developed on a test bed and deployed in production.
- Requirements are revised.
- Change Management [project management \(page 137\)](#) recommended procedure are followed to ensure all data is always on the Change Management server.
- Production starts.
- Problems are noted

Recommended Procedure

Important:

Make sure that all configuration applications are closed and remain closed through this process.

Procedure

1. Stop the production project.
2. Right-click **Project** in the Workbench.

3. Select Manage>Show History on the Popup menu.
4. Select the labeled version of the project that was running successfully
5. Click Get to get that version
6. Delete any files that were added from the local project.
7. Modify any non-CIMPLICITY configuration changes that were made to support the requirements change.

Note: You may need to delete saved runtime information (e.g. SAVED_POINT files).

1. Use [project management best practices \(page 137\)](#) to ensure that the current version of the managed project matches the production system project.
2. Start the production project.

4. Best Practices: CIMPLICITY Version Changes

1 (page 141)	CIMPLICITY version upgrade.
2 (page 141)	CIMPLICITY version downgrade.

CIMPLICITY Version Upgrade

1. Follow the Change Management [project management \(page 137\)](#) recommended procedure to ensure the managed project is up to date.
2. Apply the CIMPLICITY upgrade.
3. Follow the Change Management [project management \(page 137\)](#) recommended procedure to ensure the managed project is up to date.

CIMPLICITY Version Downgrade

Important:

Make sure that all configuration applications are closed and remain closed through this process.

Procedure

1. Follow the Change Management [project management \(page 137\)](#) recommended procedure to ensure the managed project is up to date on the Change Management server.
2. Right-click Project in the Workbench.
3. Select Manage>Show History on the Popup menu.
4. Select the current project and the labeled project that corresponds to the previous version of CIMPLICITY.
5. Identify the configuration changes.

6. Stop the project.
7. Right-click Project in the Workbench.
8. Click Manage>Show History on the Popup menu.
9. Select the labeled version of the project that was running successfully.
10. Click Get to get that version.
11. Delete any files that were added from the local project.
12. Modify any non-CIMPLICITY configuration changes that were made to support the requirements change

Note: You may need to delete saved runtime information (e.g. SAVED_POINT files).

1. Apply any desired/application configuration changes from the new project
2. Use [project management best practices \(page 133\)](#) to ensure that the current version of the managed project matches the production system project.

Change Management Technical Reference

Change Management Technical Reference

- File and folder names.
- Server Redundancy guidelines.
- Computer level files: Management categories.
- Project level files: Management categories.
- Managed Enterprise Server project guidelines.
- Pager data files management.
- Change Management licensing.

File and Folder Names

File and folder names that include following characters cannot be added to Change Management Server.

Note: In the rare cases, if an invalid character is in a file or folder name, the character will be replaced with a correspondent string. The modified file or folder name will be saved to Change Management Server.

Users will see different file or folder names on the Server side if they choose to use the Change Management client.

Example

Invalid Character Name	Name with Replacement String
\$Filename	$Filename

Invalid characters and, in rare cases, replacement strings are as follows.

Invalid Characters	Replacement Strings
&	&
\$	$
@	@
[[
]]
((
))
=	=
^	^
!	!
%	%
,	,
;	;

 **Important:** Do not use replacement strings a file or folder name.

Server Redundancy Guidelines

- A Host redundant system is managed from the Primary node only.
- Only the files on the primary are protected.
- The secondary server does not know the project is managed.
- To use project restoration on a redundant system

1. Recover the primary while the project is not running.
2. Do a configuration update.
3. Start the project start

! **Important:** The secondary and the primary server must have the same configuration.

Change management has no way to ensure this because of dynamic configuration and the possibility that the last changes were not checked in. So the only support we have requires that the project not be running on the redundant pair.

- Screens that are copied to the secondary server cannot be change managed.
- The following files are not managed.
- Alarm comments file.
- Files used to sync up data base logging.

Note: These files have the prefix ptnr_.

- The secondary server can be managed as a computer project.
- When fetching a redundant primary project to a different physical node than the one it came from, do the following:

4. Copy the gefconfig.ini file from the windows directory of the secondary node to the local one.
5. Create a Redundancy share drive with the same drive letter as the original primary node.
6. Change the local node's node name to be the same as the original primary node.

Computer Level Files: Management Categories

The following table lists the categories of files that are:

- Excluded from the Base Configuration.
- Individually Managed. Individually managed files are included in both the Excluded from Base Configuration list and Individually Managed lists.
- Base Configuration. Essentially the base configuration files are all files not included in the Excluded from Base Configuration list.

Excluded from Base Configuration	Individually Managed	Included Base Configuration
\.PCMFIL		
_CONFIG.INI		

Excluded from Base Configuration	Individually Managed	Included Base Configuration
\CNC_README.CHM		
\COMPUTER.GEF		
\README.CHM		
*.AMV	*.AMV	
*.ASC	*.ASC	
*.BACKUP		
*.BCD	*.BCD	
*.BCL	*.BCL (Except, see below (page 149))	
*.BCLRT	*.BCLRT	
*.CIM	*.CIM (Except, see below (page 149))	
*.CIMRT	*.CIMRT	
*.CLG		
*.CLM	*.CLM	
*.CMS	*.CMS	
*.CMSRT	*.CMSRT	
*.CTX	*.CTX	
*.ERR		
*.INI (That are not in Base Config)	*.INI (Except, see below (page 149) and not in Base Config.)	DATA\GLOBALS.INI
		DATA\master_pos_0.ini
		DATA\MASTER_POS_63.ini
		DATA\S90TRIO.ini
	*.HTM	
	*.HTML (Except, see below (page 149))	
*.LOCK		
*.OCX		
*.PP	*.PP	
*.PPL	*.PPL	
*.PRO	*.PRO	
*.QTR	*.QTR	
*.REG		

Excluded from Base Configuration	Individually Managed	Included Base Configuration
*.RGP	*.RGP	
*.RTF		
*.SOC	*.SOC	
*.SPC	*.SPC	
*.STG		
*.TXT (That are not in Base Config)	PERFSERV\DEFAULTCOUNTERS.TXT	ETC\CIMHOSTS.TXT
*.XLS		
*.XML (That are not in Base Config)	DATA\PCIM.XML	DATA \CIMOPCSERVER.XML
AEOPC**		
API**		
ARC*.MDB		
BSM_DATA**		
CIMPOLE**		
CLASSES**		
CNC**	CNC**	
CNC_SETUP**		
DATA*.CACHE		
DATA*.DAT	DATA\RGB.DAT	
DATA*.FAV		
DATA*.IDX		
DATA*.IDT		DATA \CIMVIEWSESSIONS.IDT
DATA\AML.P.CFG		
DATA\CIMCMSAFE.CFG	DATA\CIMCMSAFE.CFG, DATA \CIMVIEW.CFG	
DATA\CIM_CONFIG_SERVICE.JSON	DATA\CIM_CONFIG_SERVICE.JSON	
DATA\DATALOG.DAT		
DATA\GEFDEPL.DPLCFG	DATA\GEFDEPL.DPLCFG	
DATA\GEFKEYPAD.CFG	DATA\GEFKEYPAD.CFG	
DATA \HISTMGR_CONNECTION_CONFIG.XML	DATA \HISTMGR_CONNECTION_CONFIG.XML	

Excluded from Base Configuration	Individually Managed	Included Base Configuration
DATA\LOGPROC.DAT		
DATA\NODE.DAT		
DATA\OPCINISETTINGS.CFG	DATA\OPCINISETTINGS.CFG	
DATA\OPCUA-BROWSE-CONFIG.JSON	DATA\OPCUA-BROWSE-CONFIG.JSON	
DATA\PROJECTS.JSON	DATA\PROJECTS.JSON	
DATA\PROJSHARES.DAT		
DATA\PTMGMT.DAT		
DATA\SERVICE.DAT		
DC*.*		
DOCS*.*		
DRIVERS\GENIUS\SETUP.EXE		
ETC*.TXT		
EXE*.*		
EXTRAS*.*		
FIREWALL\SP2MANAGER.DLL		
FIREWALL\SP2MANAGEREXE.EXE		
FONTS*.*		
GEFVCR*.*		
HELP*.*		
LOG*.*		
MDAC*.*		
MSSQL**.*		
OPCSERVER*.*		
OPENSLL*.*		
OPT*.*		
PAGER\INSTALL.LOG		
PAGER\UNWISE.ENG		
PAGER\UNWISE32.EXE		
PAGER\BACKUP\		
PAGER\DATA\FPADMIN.MDB	PAGER\DATA\FPADMIN.MDB	

Excluded from Base Configuration	Individually Managed	Included Base Configuration
PAGER\DATA\FPSERVER.MDB	PAGER\DATA\FPSERVER.MDB	
PAGER\DBSCRIPTS*.*		
PAGER\EXAMPLES*.*		
PAGER\EXE*.*		
PAGER\LIBS*.*		
PAGER\LOGS*.*		
PAGER\MANUALS*.*		
PAGER\REPORTS*.*		
PERFSERV*.*		
POMS*.*		
PROJECTS*.*		
DATA\TOPC_CONFIG.XML	DATA\TOPC_CONFIG.XML	
PUBLISHSUBSCRIBEDELIVERY*.*		
RCO*.*		
REPORT*.*		
SCRIPTS*.*		
SERIES90*.*		
SETUP*.*		
SYMBOLS*.*	SYMBOLS*.*	
SYSTEMSENTRY*.*	SYSTEMSENTRY*.*	
TADB*.*		
TQE*.*		
TRACKER*.*		
UNINSTALL*.*		
WEB*.*	WEB\EXE\CONF\NGINX.CONF	
WEBPAGES*.*		
		All other files not listed in this table or as exceptions.

Files that are Exceptions to the Rule

The following files may be types that are individually managed. However, these specific files are excluded from computer project management.

_CONFIG.INI

API\REDUNDANT_API[_A-Z0-9].*\BCL

BSM_DATA\[_A-Z0-9].*\BCL

BSM_DATA\[_A-Z0-9].*\INI

DATA\GLOBALS.INI

EXE\[_A-Z0-9].*\INI

\FIREWALL.*

PAGER\EXAMPLES\[_A-Z0-9].*\BCL

PERFSERV\[_A-Z0-9].*\H

PERFSERV\MACROS.IDT

PERFSERV\[_A-Z0-9].*\INI

SERIES90\[_A-Z0-9].*\CIM

WEB\EXE\DOCS*.*

WEB\EXE\LOGS*.*

WEB\EXE\TEMP*.*

WEB\HTML*.*

Project Level Files: Management Categories

The following table lists the categories of files that are:

- Excluded from the Base Configuration.
- Individually Managed

Individually managed files are included in both the Excluded from Base Configuration list and Individually Managed lists.

- Base Configuration

Essentially the base configuration files are all files not included in the Excluded from Base Configuration list.

Excluded from Base Configuration	Individually Managed	Included Base Configuration
\.PCMFIL		
_CONFIG.INI		
*.AMV	*.AMV	
*.ASC	*.ASC	
*.BCD	*.BCD	
*.BCL	*.BCL	
*.BCLRT	*.BCLRT	
*.CIM	*.CIM	
*.CIMRT	*.CIMRT	
*.CLG		
*.CLM	*.CLM	
*.CMS	*.CMS	
*.CMSRT	*.CMSRT	
*.CTX	*.CTX	
*.EXE	*.EXE	
*.INI (That are not in Base Config)	*.INI (That are not in Base Config)	\ABRFID.INI
		DATA\CIMPAGER.DAT
		DATA\GEF_CFG.INI
		DATA\HWABC.INI
		DATA\MASTER_COM[0-9]*.INI
		DATA\MASTER_OPC_*.INI
		DATA\MASTER_POS_*.INI
		DATA\MBPLUS.INI
		DATA\NSC.INI
		DATA\OPCAESERVER.INI

Excluded from Base Configuration	Individually Managed	Included Base Configuration
		DATA\PAGERDIS.DAT
		DATA\PAGERDL.DAT
		DATA\[_A-Z0-9].*_FS*.INI
		DATA\SPCACTIVELIST
		DATA\TRIPLEX_PASSWORD.INI
		DATA*.XML
		MASTER \TRIPLEX_PASSWORD.INI
*.PP	*.PP	
*.PPL	*.PPL	
*.PRO	*.PRO	
*.QTR	*.QTR	
*.RGP	*.RGP	
*.SOC	*.SOC	
Alarm_Help*.*	Alarm Help*.* (Except *.cmt)	
ARC*.CSV		
CNC*.*	CNC*.*	
DATA*.IDT		
DATA*.IDX		
DATA\ALARMSETUPMERGE		
DATA\DYN_CFG.CFG		
DATA\FPAGECIM.CSV		
DATA\PTX_POINTS.CFG		
DATA\USER.TXT		
DATA\WARMDATA.SAV		
GATHERFILES*.*		
LOCK*.*		
LOG*.ERR		
LOG*.LOG		
LOG*.OUT		
LOG\AMRP_TRANSLATED.TXT		

Excluded from Base Configuration	Individually Managed	Included Base Configuration
LOG\SAVED_POINT.STG		
MASTER*.IDT		
MASTER*.IDX		
MASTER\USER.TXT		
PXR*.*		
SCREENS*.*	SCREENS*.*	
SCRIPTS*.*	SCRIPTS*.*	
RECIPES*.*	RECIPES*.*	
XREF*.*		
		All other files not listed in this table.

Managed Enterprise Server Project Guidelines

When a managed project is an Enterprise Server, the Enterprise Server files, ES_*, are included in the managed base configuration.

However, the files will change when the Enterprise project synchronizes with source projects at startup, regardless of its checkout status.

Because of the synchronization, it can take a long time to startup an Enterprise project. Therefore, it is recommended that the changes made by the startup synchronization between the projects get checked into the PCM server.

A recommended approach is as follows.

After points that are marked as Enterprise points have been changed in a source project.

1. Checkout the Enterprise project's base configuration.
2. Start the Enterprise project
3. Wait for synchronization to complete.
4. Check in the Enterprise project's base configuration so that the ES_* file changes are captured.

 **Note:** This procedure is not critical to success. However, it will help insure that the next time the project is fetched from the PCM server that there are no conflicts to be resolved between the checked in ES_* files and the points configured in the source projects.

These conflicts are resolved by sending out dynamic configuration messages for every point that is new or that has been modified.

Pager Data Files Management

Beginning in CIMPLICITY 7.0, Pager configuration data is stored in two .mdb files that are located in the directory:

...\Program Files\Proficy\Proficy CIMPLICITY\PAGER\DATA.

The files are:

- FPADMIN.MDB
- FPSERVER.MDB

In the Workbench the files are in the **Computer>Managed Files** folder.

A user may manually check these files in and out and trigger manual PCM checks. However, the PCM server will not do any automatic check in and check out validation

Change Management Licensing

Change Management licensing is as follows.

- Each physical PC that is connected to the PCM server consumes a single PCM client license, regardless of how many actual connections are made from that machine.
- Each Terminal Services client that connects to the PCM server will consume one license.

 **Note:** Projects that do not include configuration privileges can be Change Managed. In this situation Change Management:

- Can act as a place for safe keeping and deployment.
- Adds the ability for password changes, alarm setups, and other runtime configuration information to be managed.

Chapter 3. HMI for CNC

Overview

HMI for CNC is a product option release of HMI/SCADA CIMPLICITY. If you purchased a licensed system, the following is included:

- CIMPLICITY software license agreement.
- Licenses for the CIMPLICITY Base System, HMI for CNC option, HMI for CNC additional connections, and other options you purchased.
- Install media containing the software you need to install and use HMI for CNC.
- Associated documentation.

Note the following important information regarding HMI for CNC:

Item	Description
HMI for CNC is not cluster-aware.	Due to protocol limitations, HMI for CNC is not currently supported in a cluster environment.
Retry method for down devices.	When communicating with multiple FOCAS Ethernet CNCs, it's recommended that the global parameter DC_RETRY_ONE_DEVICE be set to TRUE for the project. For information on global parameters, see Global Parameters in CIMPLICITY Help.
Count licenses by CNCs rather than paths.	HMI for CNC licensing now counts the Host, IP, or HSSB address of the CNC; it does not count each path. This is of particular value to users who use a CNC such as the Series 30i/31i/32i, which supports up to ten (10) paths per CNC.
Handling multiple devices.	If multiple devices are configured to use the same physical CNC, only one of the available HMI for CNC licenses will be used.
Licensing.	If you don't have a license for CIMPLICITY for CNC v10.0, the product will run in 2-hour demo mode. In addition to that time limit, actual device communications and the CNC alarm process are disabled.

Item	Description
Converting CimEdit screens with embedded FANUC ActiveX controls.	<p>If you created CimEdit screens under HMI for CNC version 4.0 or earlier, with embedded FANUC ActiveX controls, and have not performed the following steps, complete the steps now so the screens can be upgraded to work with HMI for CNC 10.0.</p> <ol style="list-style-type: none"> 1. Ensure all CIMPLICITY projects are shut down. 2. For each project with a screen or multiple screens that have embedded FANUC ActiveX controls, do the following. <ol style="list-style-type: none"> 1. Open Workbench. 2. Click Tools>Command Prompt on the Workbench menu bar. <p>The Command window opens. The command prompt displays as: c:\<project name> Where c:\<project name> represents the drive that the project is on and the project name.</p> <ol style="list-style-type: none"> 1. Type the following: <pre>cd screens</pre> <p>The prompt changes to c:\<project name>\screens></p> <ol style="list-style-type: none"> 1. Type the following: <pre>convert_screen "screen name" Or convert_screen *</pre>
Obsolete interface boards.	Because only the PCI HSSB Interface Board is supported in Windows XP and subsequent versions of Windows, ISA HSSB Interface Boards

Required and Supported Hardware and Software

CIMPLICITY v10.0 must be installed before installing HMI for CNC v10.0.

FANUC Open CNC API Specification (FOCAS) 1/2 libraries (available from the CNC Application Development Kt 1.5 Edition) are required, but are no longer included with the HMI for CNC distribution. You must acquire them directly from FANUC (Part number A08B-9010-J555#ZZ12).

Note: Consult your FANUC representative for more information about the FOCAS libraries and hardware.

Supported Hardware

HMI for CNC v10.0 supports the following models of FANUC CNC's using:

FOCAS HSSB

Series 0iMA, 0iMB, 0iMC, 0iTA, 0iTB, 0iTC

Series 150MB, 150TB, 150MBMA (up to 15 axis), 150MBMA2 (up to 24 axis)

Series 150iMA (up to 24 axis), Series 150iMB (up to 24 axis)

Series 160MB, 160TB, 160MC, 160TC

Series 180MB, 180TB, 180MC, 180TC

Series 210MB, 210TB

Series 160iMA, 160iTA, 160iMB, 160iTB, 160iMP, 160iTP

Series 160iLA, 160iWA, 160iLB, 160iWB, 160iLP, 160iWP

Series 180iMA, 180iTA, 180iMB, 180iTB, 180iMP, 180iTP

Series 180iWA, 180iWB, 180iWP

Series 210iMA, 210iTA, 210iMB, 210iTB

Series 300iA, 310iA, 320iA

Power Mate H, i-H, i-D

FOCAS Ethernet

Series 150iMA (up to 24 axis), Series 150iMB (up to 24 axis)

Series 160iMA, 160iTA, 160iMB, 160iTB, 160iMP, 160iTP

Series 160iLA, 160iWA, 160iLB, 160iWB, 160iLP, 160iWP

Series 180iMA, 180iTA, 180iMB, 180iTB, 180iMP, 180iTP

Series 180iWA, 180iWB, 180iWP

Series 210iMA, 210iTA, 210iMB, 210iTB

Series 300iA, 310iA, 320iA

Power Mate i-H, i-D

Upgrading from Previous Releases

Before upgrading from a previous release of HMI for CNC:

If you want to retain and upgrade your projects, save them in a directory outside of the CIMPLICITY path. **Once upgraded, the projects will not work with earlier CIMPLICITY software versions.**

- a. Shut down all CIMPLICITY and FOCAS software.

- b. Start the CIMPLICITY v10.0 installation and follow the prompts.
- c. After the installation finishes, reboot your computer.
- d. Start the HMI for CNC v10.0 installation and follow the prompts.

Licensing Requirements

The following scenarios describe the behavior of HMI for CNC device communications and the CNC Alarm process with and without licensing:

- If the base product, HMI/SCADA CIMPLICITY, is not licensed, HMI for CNC is also not licensed. CIMPLICITY will run in a two hour demonstration mode; however, the Router will shut down any HMI for CNC device communications and the HMI for CNC Alarm process.
- If the base product, HMI/SCADA CIMPLICITY, is licensed, but HMI for CNC is not licensed, HMI for CNC device communications and the HMI for CNC Alarm process will shut down immediately.
- If the base product, HMI/SCADA CIMPLICITY, is licensed and HMI for CNC is also licensed, HMI for CNC will run for the number of purchased licenses.

Consult your GE representative for detailed information about HMI for CNC software licensing.

Consult your FANUC representative for detailed information about hardware.

Interface Requirements

Interface Requirements

Depending on the protocol you choose to use, you may need to purchase some required hardware and software to optimize your system.

- HSSB interface requirements.
- Ethernet interface requirements.
- Hardware supplied by FANUC.

HSSB Interface Requirements

- HSSB card configuration
- HSSB card set

HSSB card configuration

HMI for CNC supports communication through the following High Speed Serial Bus (HSSB) interfaces:

- Type 2
- Type 3 (30i/31i/32i) (Formerly Series 300i/310i/320i)

You can configure your system to support a:

- Single HSSB-card per PC or
- Multiple HSSB-cards per PC, up to 8 total CNC connections. This can be any of the following:
 - 8 single channel boards.
 - 4 dual channel boards.
 - A combination of single channel boards and dual channel boards

The following diagram illustrates a multiple HSSB card configuration:

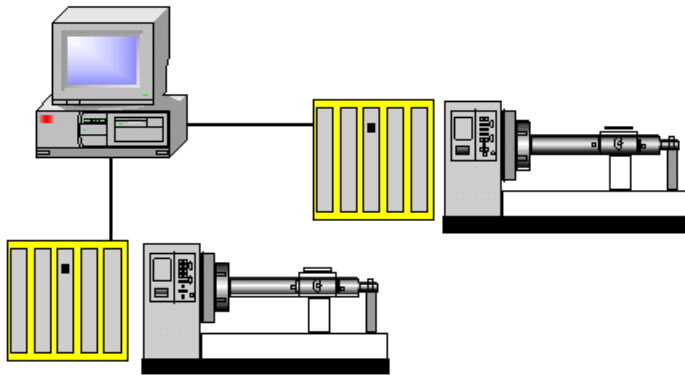

HSSB card set

The HSSB card set can have a PC PCI or PCI Express card, plus a fiber optic cable, and a CNC card. Each connection requires a card set.

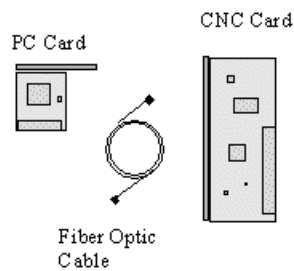

 **Note:** DISA HSSB Interface Boards are obsolete.

Ethernet Interface Requirements

CNC to port configuration

HMI for CNC supports communication through an Ethernet connection on your network.

You can configure your system to support 10 CNC's per CIMPLICITY port, with a maximum of 10 ports, to a total of 100 CNC's.

The following diagram illustrates multiple CNC's to port configuration:

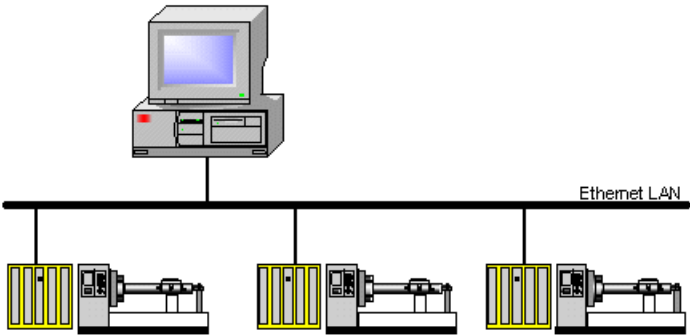

Ethernet card set

The Ethernet card set consists of a standard network adapter, network cable, and a CNC card. A CNC card is required for every CNC.

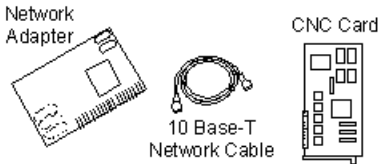

Hardware and Optional Software Supplied by FANUC

Contact your FANUC sales representative for details about CNC hardware.

Software Installation

Software Installation

Steps for installing HMI for CNC are as follows.

Step 1 (page 160)	(HSSB only) Install HSSB interface hardware.
Step 2 (page 160)	Install CIMPLICITY software.
Step 3 (page 160)	Install FOCAS HSSB driver if HSSB card is used.
Step 4 (page 165)	Configure the HSSB Card.
Step 5 (page 166)	Copy FOCAS Libraries to your system.
Step 6 (page 167)	Install HMI for CNC software.
Step 7 (page 169)	Verify successful communications.

 **Note:** HMI for CNC licensing is included in the licensing hardware key. Consult your GE sales representative for details.

Step 1. Install HSSB Interface Hardware

Contact FANUC for HSSB interface parts (hardware and the driver) and installation instructions if you are going to use the HSSB.

 **Important:** HSSB hardware and the driver must be installed before you install HMI for CNC.

Step 2. Install CIMPLICITY Software

Install the latest CIMPLICITY SIM.

For more information, refer to the CIMPLICITY installation documentation.

Step 3. Install the HSSB Driver

 **Note:** : Make sure your CNC supports HSSB cards if you plan to use one.

The PCI HSSB interface board and the HSSB interface board for PCI Express are supported. When two or more PCI HSSB interface boards are installed, the nodes are first allotted from the PCI HSSB interface board inserted in the lower PCI slot number.

Either of two procedures can be used to install the driver.

Note: This procedure describes installation on Windows 7.

- Automatic HSSB Driver Detection by Windows Installation
- Manual HSSB Driver Installation

Automatic HSSB Driver Detection by Windows Installation

When Windows is started, the PCI HSSB interface board is detected as PCI Simple Communications Controller in the Found New Hardware wizard.

1. Make sure your FANUC CNC Application Development Kit 1.5 Edition distribution is inserted into the DVD drive.
2. Check Select Locate and Install driver software (recommended).
3. Click Next.

A Please choose your search and installation options screen opens.

Note: If **User Account Control** is configured and you are not an Administrative user, a User Account Control Window opens.

Click Continue to proceed with the driver installation.

A Found New Hardware – PCI Simple Communications Controller opens.

4. Check Don't search online.

An Insert the disk that came with your PCI Simple Communications Controller message displays.

5. Check I don't have the disc. Show me other options.

A Windows couldn't find driver software for your device message displays.

6. Check Browse my computer for driver software (advanced).

Windows 7	Enter or Browse to:
32-bit edition	<DVD drive>:\FOCAS2 Library\Hssb\Vista Note: A message will display: Windows can't verify the publisher of this driver software. Check Install this driver software anyway. The installation will continue.
64-bit edition	<DVD drive>:\FOCAS2 Library\hssb\win7_64

The driver software will automatically be installed.

When the hardware has been successfully installed, a message reports:

Found New Hardware – FANUC HSSB xxxxx.

Where

xxxxx indicates the board type.

7. Click Close to finish the installation.

 **Note:** This procedure installs the driver for all HSSB cards in the PC.

Manual HSSB Driver Installation

8. Open the Windows Device Manager.

Note: Methods for Windows 7 include the following.

- Click Start on the Windows Task Bar; select Control Panel>Device Manager.
- Display the Command prompt; enter devmgmt.msc.

9. Expand Other devices if it is not expanded.

10. Right-click PCI Simple Communications Controller.

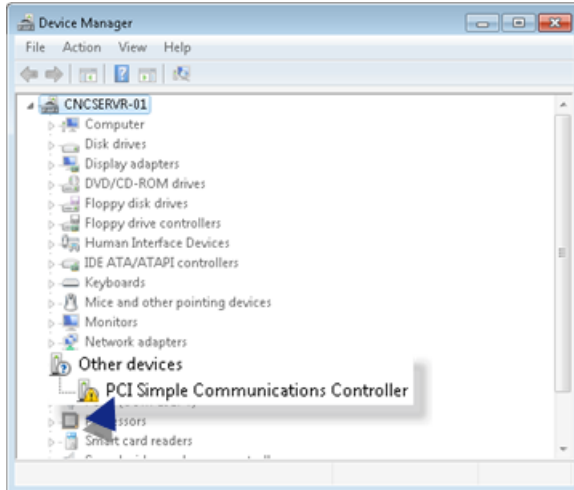

11. Select Update Driver Software on the Popup menu.

A How do you want to search for driver software screen opens.

12. Click Browse my computer for driver software.

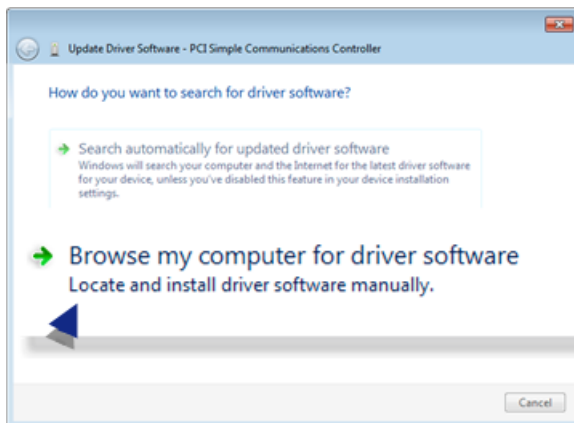

A Browse for driver software on your computer screen opens.

13. Do the following in the Search for driver software in this location section.

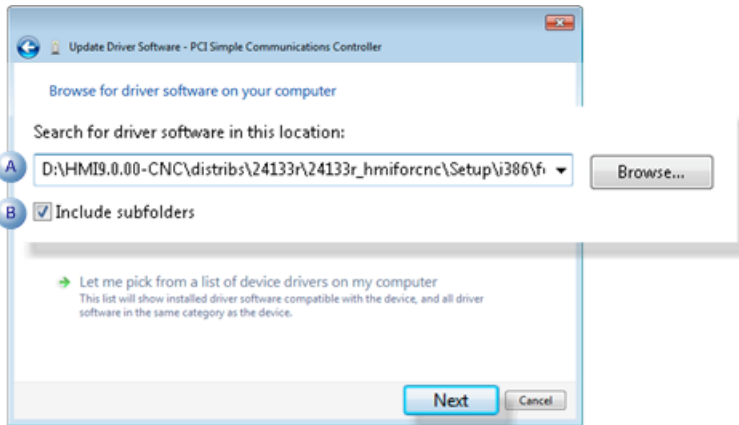

A	Enter or browse for the software. The selected folder depends on whether the system is 32-bit or 64-bit.	
	Windows 7	Enter or Browse to:
	32-bit edition	<DVD drive>:\FOCAS2 Library\Hssb\Vista Note: A message will display: Windows can't verify the publisher of this driver software. Check Install this driver software anyway. The installation will continue.
	64-bit edition	<DVD drive>:\FOCAS2 Library\hssb\win7_64
B	Check Include subfolders.	

14. Click Next.

The driver software will be installed.

A screen reports when the driver has been successfully installed.

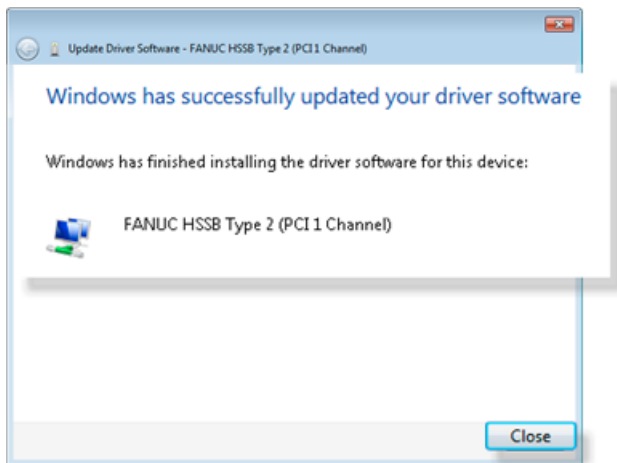

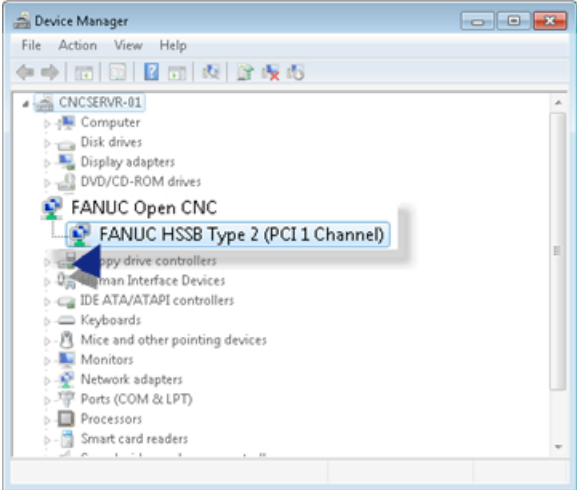

15. Select Close to finish the installation.

The installed HSSB driver is now listed in the Device Manager.



Step 4. Configure the HSSB Card

- 1. Click Start on the Windows task bar.
- 2. Select Settings>Control Panel.
- 3. Do one of the following.

- Double-click the **HSSB** icon  in the Control Panel.
- Click the **HSSB** icon  on the Control Panel menu.

The HSSB dialog box opens.

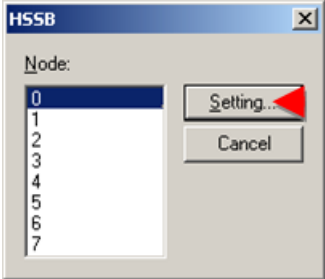

- 4. Select a node and click Setting. The HSSB: Node n dialog box opens.
- 5. Fill in the fields as follows.

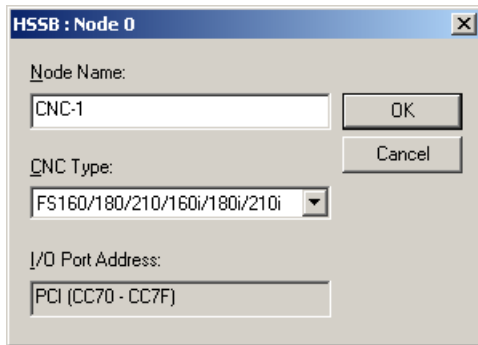

Field	Description
Node Name	Name for the machine connected to the HSSB card.
CNC Type	Select the appropriate CNC type from the drop-down list.
I/O Port Address	a. When the HSSB dialog box is first opened, select Use PCI from a drop-down list. b. The field changes to read-only with an assigned port address after you reboot the computer.

6. When the HSSB dialog box is first opened, select Use PCI from a drop-down list.
7. The field changes to read-only with an assigned port address after you reboot the computer.
8. Click **OK**.

The HSSB dialog box re-displays.

9. (Optional) Select a new node number and repeat the procedure to configure additional hardware.
10. Click **Cancel** in the HSSB dialog box when all of the hardware has been configured.

(For CIMPLICITY supported operating systems) The settings are immediately changed. No further action is needed.

Step 5. Copy FOCAS Libraries to your System

The FOCAS libraries used by HMI for CNC are no longer included with the HMI for CNC distribution. Therefore, you will need to manually copy these files from the FANUC CNC Application Development Kit 1.5 Edition DVD to your hard drive.

For example:

```
copy "F:\FOCAS2 Library\Fwlib\*.dll" "C:\Windows\SysWOW64"
```

- Software installation.

Step 6. Install HMI for CNC Software

Step 6. Install HMI for CNC Software

! **Important:** Before you begin to install HMI for CNC make sure you have:

- Installed CIMPPLICITY software on your PC. If you do not have the correct version, the installation process will stop and inform you that you must install the correct version.
- [Removed \(page 381\)](#) any previous version of HMI for CNC.

HMI for CNC installation steps are as follows.

Step 6.1 (page 167)	Begin the HMI for CNC installation.
Step 6.2 (page 168)	Complete HMI for CNC installation.

Step 6.1. Begin the HMI for CNC Installation

1. Start the installer.
 - a. Click Start>Run on the Windows desktop.
 - b. Type **D:\InstallFrontEnd.exe** (where **D** is the drive where your install media is located)
 - c. Click **OK**.

The HMI/SCADA - CIMPPLICITY® Setup screen opens.

2. Click **Install HMI for CNC 10**.

The Welcome screen displays.

HMI for CNC setup will analyze your system. If an older or unknown version of this software exists, you will be instructed to remove it from your system to avoid conflicts with the newer version of the software.

3. Click **Next**.

The License Agreement screen displays.

4. Check I accept the terms of the license agreement.

5. Click **Next** to accept all the terms of the license agreement.

The Important Product Information screen displays.

Recommendation: Read all the information on this screen as it contains important information about the HMI for CNC software.

Note: You can access a complete list of release notes through the HMI/SCADA - CIMPLICITY® Setup screen>View README option.

6. Click **Yes**.

The Ready to Install the Program screen displays.

7. Click **Install**.

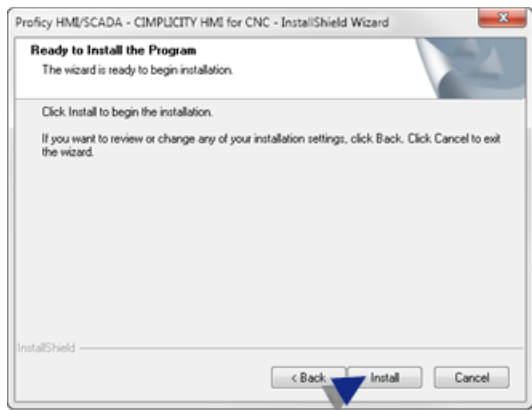

The InstallShield Wizard begins to install HMI for CNC. Follow the installation prompts.

Step 6.2. Complete the HMI for CNC Installation

When HMI for CNC and all of the selected components are installed the InstallShield Wizard Complete screen displays.

Click Finish.

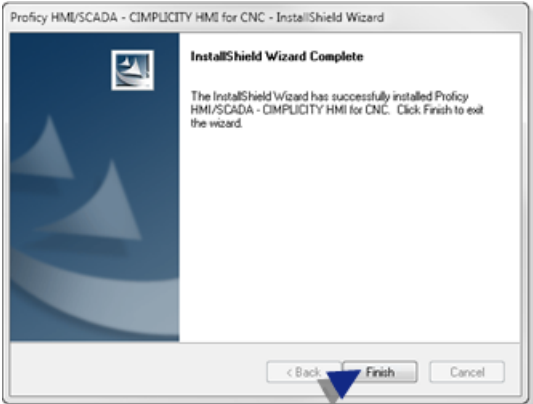

! **Important:** Reboot your machine after you click Finish.

Result: After reboot, HMI for CNC and all selected components are installed and ready for configuration.

Step 7. Verify Successful Communications

- Command prompt commands.
- Communication verification.

Command Prompt Commands

Ethernet

```
Type test_cnc Address Portnum timeout
```

where:

Address=	CNC's IP Address or host name to connect. (e.g. 192.168.0.1 or CNCBRASSTAG)
Portnum=	Port number of the DNC1/Ethernet (TCP) function. Important: The port number cannot be less than 5001.
Timeout=	Time out in seconds. The best time out value is different depending on the system. For example, in the case of a hi-speed network, 10 seconds is sufficient for time out. But, in the case of a low-speed telephone line, more than 60 seconds is better for time out. So you must specify the timeout value after the measurement of the system.

HSSB

Type TEST_CNC without parameters to display all the currently configured FOCAS/HSSB node(s).

Communication Verification

1. Click Start on the Windows task bar.

2. Select (All) Programs> HMI SCADA - CIMPLICITY 10 >CNC QuikStart project.
3. Click Tools>Command prompt on the CNC QuikStart Workbench toolbar.
4. Test the CNC connections.
 - Verify FOCAS/Ethernet.
 - Verify FOCAS/HSSB.

Verify FOCAS/Ethernet

- a. Type the following command at the command prompt.

```
test_cnc Address Portnum timeout
```

- a. Press Enter.

The status of the CNC connection is reported.

Ethernet Successful

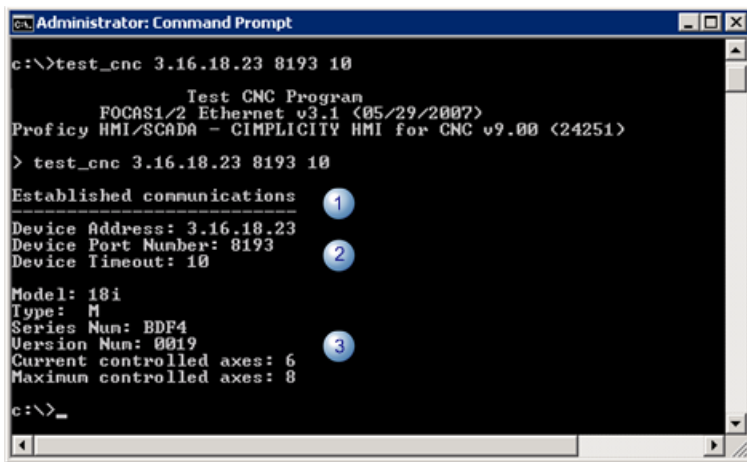

1	When a connection is successful, a line displays:
	Established communications.
2	Device details.
3	CNC Ethernet details.

Ethernet Failed

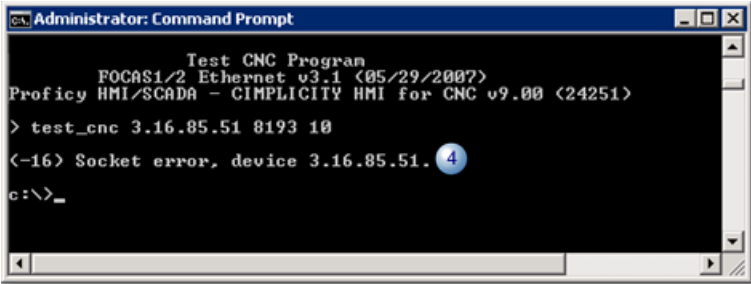

4	If the Ethernet connection fails, a message line (page 372) displays explaining the problem.
	Example: (-16) Investigate address power/cable/board.

Verify FOCAS/HSSB

- 1. Type the following command at the command prompt:

```
test_cnc
```

- 1. Press Enter.

The status of CNC connections is reported.

HSSB Successful

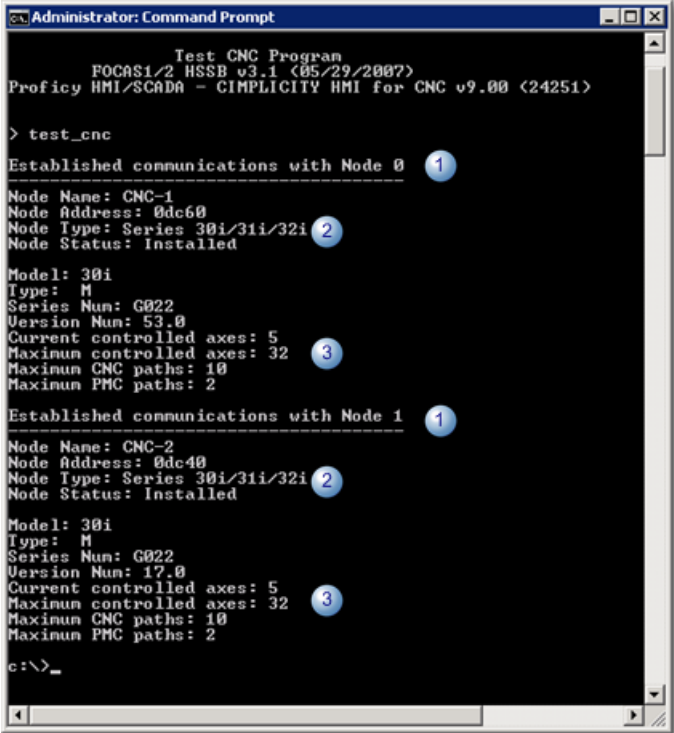

1	When a connection is successful, a line displays:
	Established communications with Node n.
2	CNC node details.
3	CNC HSSB details.

HSSB failed

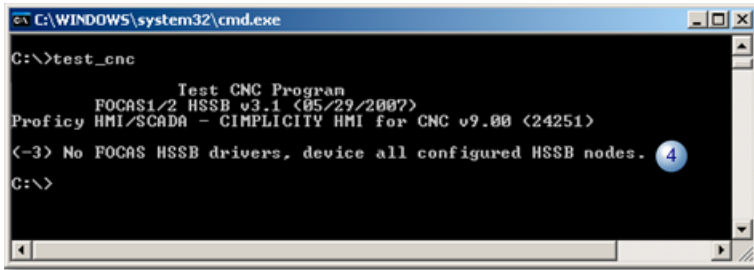

4	If the HSSB connection fails, a message line (page 372) displays explaining the problem.
	Example: (-3) No FOCAS HSSB drivers, device all configured HSSB nodes.

[Up \(page 169\)](#)

! **Important:** You must be able to run the test_cnc program successfully before continuing.

Project Creation

Project Creation

CIMPLICITY software features are available for your HMI for CNC project.

These features can be created when you create a new project, modified or added to an existing project.

Steps to create or configure a HMI for CNC project are:

Step 1 (page 173)	Create a new HMI for CNC project.
Step 2 (page 175)	Set HMI for CNC Project Properties.
Step 3 (page 178)	Configure ports.

Step 4 (page 181)	Configure devices.
Step 5 (page 187)	Configure points.
	o (page 189) Supported data types.
Step 6 (page 250)	Configure screens.
Step 7 (page 262)	Configure and view alarms.

Step 1. Create a new HMI for CNC Project

Step 1. Create a new HMI for CNC Project

Option 1.1 (page 173)	Create a totally new HMI for CNC Project.
Option 1.2 (page 174)	Copy the CNC QuikStart Project to a New Project.

Option 1.1. Create a totally new HMI for CNC Project

1. Open a CIMPLICITY Workbench.
 - a. Click **Start** on the Windows task bar.
 - b. Select (All) Programs>HMI SCADA - CIMPLICITY 10>Workbench.

A blank CIMPLICITY Workbench opens.

2. Click the New Project button  on the Workbench toolbar.

A New Project dialog box opens.

3. Select the features that apply to your HMI for CNC project.

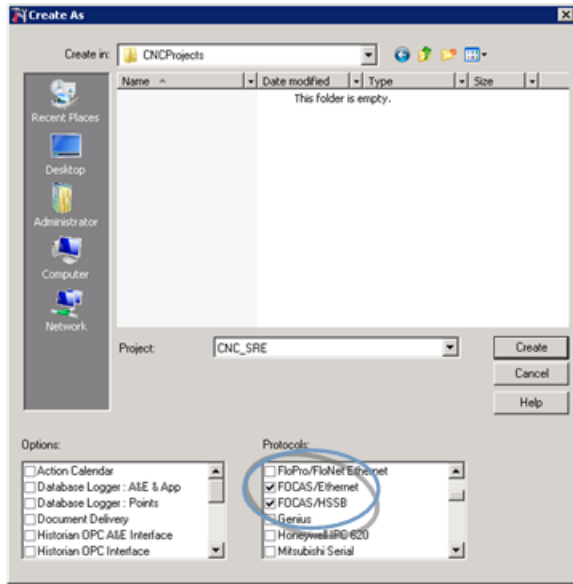

Feature	Description
Create (field)	Directory in which the project directory should be created.
Project	(Required) A unique name for the HMI for CNC project.
Options	CIMPLICITY options that should be enabled for the HMI for CNC project.
Protocols	Available CNC protocols can include: <ul style="list-style-type: none"> • FOCAS/Ethernet • FOCAS/HSSB
Create (button)	Click to begin project creation.

Option 1.2. Copy the CNC QuikStart Project to a New Project

 **Note:** The CNC QuikStart project is an HMI for CNC installation option.

1. Click Start on the Windows taskbar.
2. Select (All) Programs>HMI SCADA - CIMPLICITY 10>**CNC QuikStart Project**.

The CNC QuikStart project opens in the CIMPLICITY Workbench.

3. Click File>Copy to Project on the Workbench menu bar.

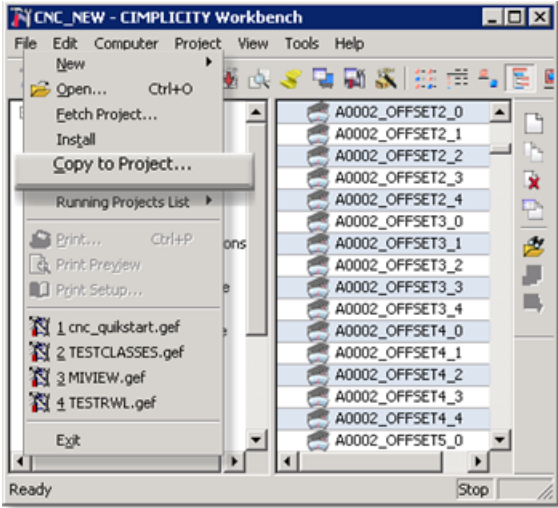

The Copy Project to New Project dialog box opens.

4. Do the following.

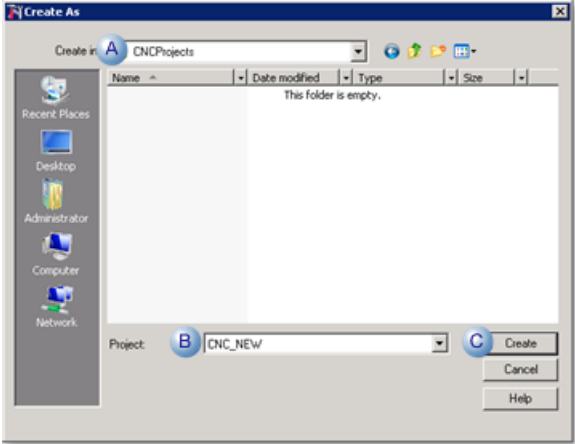

A	Select a directory for the project to be copied to.
B	Enter a project name in the Project field.
C	Click Create.

The new project is created with the CNC QuikStart project configuration.

5. Click Project>Properties on the Workbench menu bar.

The Project Properties dialog box opens.

Step 2. Set HMI for CNC Project Properties

A (page 176)	General tab in the Project Properties dialog box.
B (page 176)	Options tab in the Project Properties dialog box.

1. General tab in the Project Properties dialog box

1. Select the General tab on the Project Properties dialog box.
2. Check options you want enabled in the project that are not already checked.
3. Check either or both of the FOCAS protocols.

Clear either protocol that you do not want enabled. One must be checked.

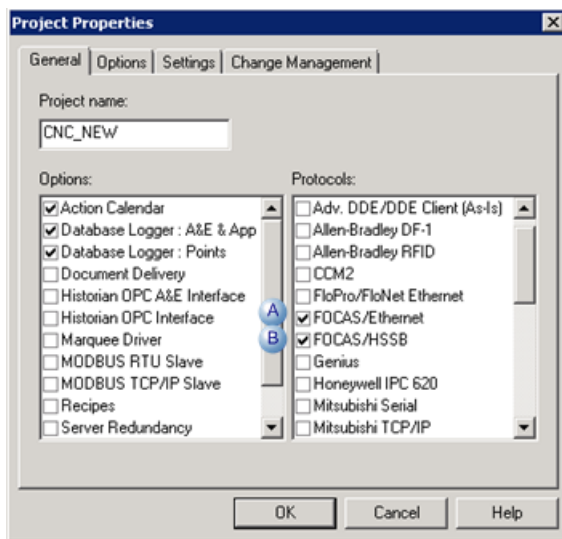

A	FOCAS/Ethernet
B	FOCAS/HSSB

a. Options tab in the Project Properties dialog box

4. Select the Options tab on the Project Properties dialog box.
5. Enter the following.



	Feature	Description
A	Description	Description that identifies the project.
B	Enable project broadcast	Allow the project data to be "seen" over the network.
C	Use this IP address	(Enabled if either Enable project broadcast or multicast is checked) The IP address that will be used in project broadcast/multicast can be entered in this field; this is used if you want to restrict the project announcements to only one IP address.
		Note: The drop-down list contains IP addresses that are selected for use on the Network tab in the CIMPLICITY® Options dialog box. The field is writable; an IP address that is not in the list can be entered manually.
D	Computer name	Server on which the project is set up.
		Note: The computer name defaults to the computer you are setting the project up on.
E	Startup timeout	Number of minutes that CIMPLICITY should wait for the project to start before it times out. The default is 10 minutes. The project will continue to try and start up until the timer expires.

Note: Other configuration features on the Options tab are optional for the HMI for CNC project.

6. Select the Settings tab.
7. Configure settings, as needed.
8. Click **OK** in the Project Properties dialog box.

For a project created:

1. The properties are set.
2. The Workbench re-displays.

Step 3. Configure Ports

Create CNC ports for:

- Completely new projects.
- Projects created by copying the CNC QuikStart project.

CNC Ports for Completely new projects

1. Right-click **Ports** in the Workbench left pane and select New on the Popup menu.

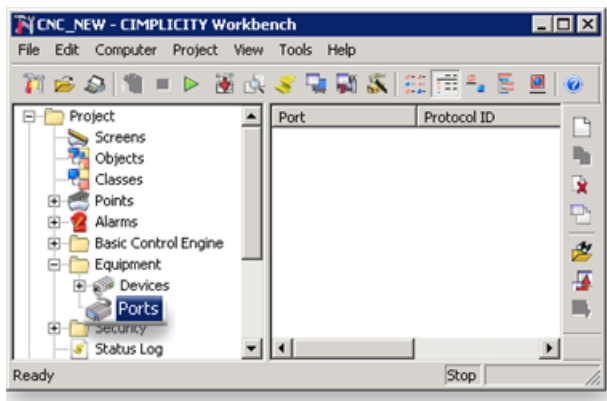

A New Port dialog box opens.

2. Create either of the following.

Ethernet
HSSB

Ethernet

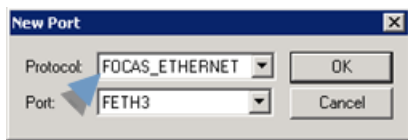

Field	Select
Protocol	FOCAS_ETHERNET
Port	One of the available FETHn ports.

Ethernet Port Guidelines

Each port that uses the Ethernet protocol can provide communication for up to **10** devices or a total of **100** devices.

Each PC generally has a network adapter on which you can configure 10 Ethernet ports numbered 0 – 9.

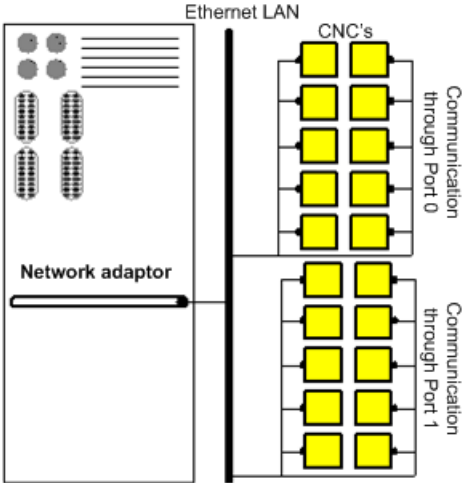

HSSB

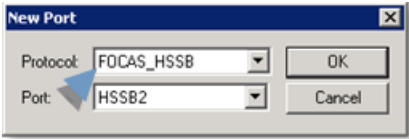

Field	Select
Protocol	FOCAS_HSSB
Port	One of the available HSSBn ports.

HSSB Port Guidelines

Each port that uses the HSSB protocol can provide communication to only **1** physical device.

Each PC can have a maximum of **8** HSSB cards, or 4 dual-port HSSB cards, on which you can configure **8** HSSB ports numbered 0 – 7.

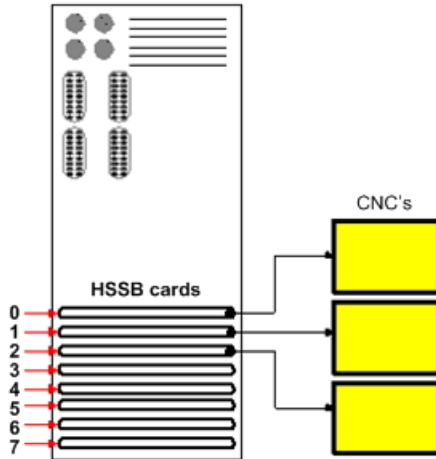

3. Click OK.

A Port Properties dialog box opens.

Options for the port's general properties are the same as for other ports.

4. Click **OK**.

The port is added to the list in the Workbench right pane.

CNC Ports for Projects created by copying the CNC QuikStart project

If you created the project by copying the CNC QuikStart project, this step may not be necessary.

The following ports are already added to the project.

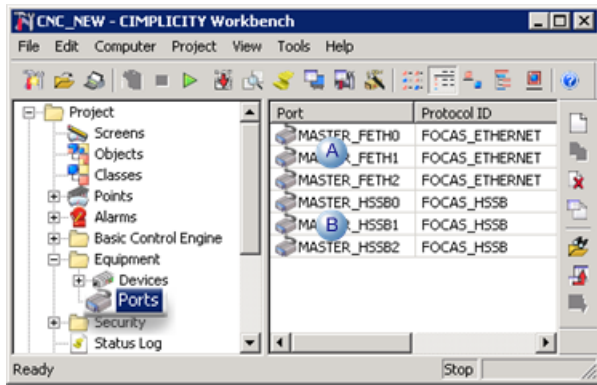

	Protocol ID	Port
A	FOCAS_ETHERNET (page 178)	MASTER_FETH<n>

	Protocol ID	Port
B	FOCAS_HSSB <i>(page 179)</i>	MASTER_HSSB<n>

Step 4. Configure Devices

Step 4. Configure Devices

Step 4.1 <i>(page 181)</i>	Open a Device Properties dialog box.
Step 4.2 <i>(page 182)</i>	Enter CNC Device General Properties.
Step 4.3 <i>(page 185)</i>	Enter CNC Device Specific Properties.

Step 4.1. Open a Device Properties Dialog Box

Open the Device Properties dialog box for:

- A new device.
- An existing CNC device.

New device

1. Right-click **Devices** in the Workbench left pane and select New.

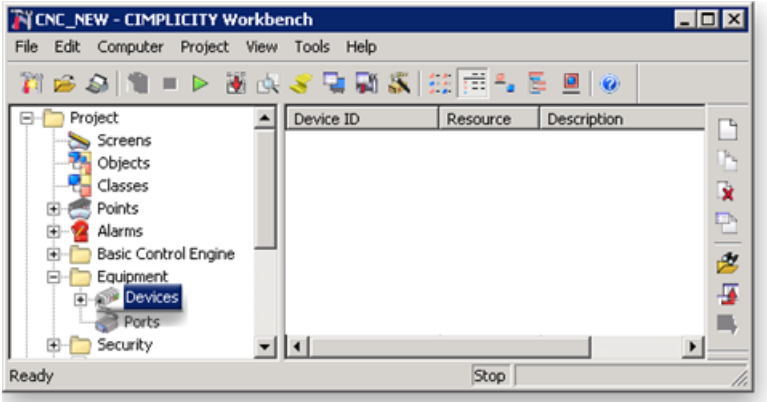

A New Device dialog box opens.



2. Enter the following information.

Field	Description
Device	Enter a unique name.
Port	Select one of the available ports for:
	FOCAS/Ethernet MASTER_FETHn
	FOCAS/HSSB MASTER_HSSBn

3. Click OK.

Result: A Device Properties dialog box of for the selected port/protocol opens.

Existing CNC device

4. Click **Devices** in the Workbench left pane.

The existing devices are displayed in the Workbench right pane.

5. Double-click a device in the Workbench right pane.

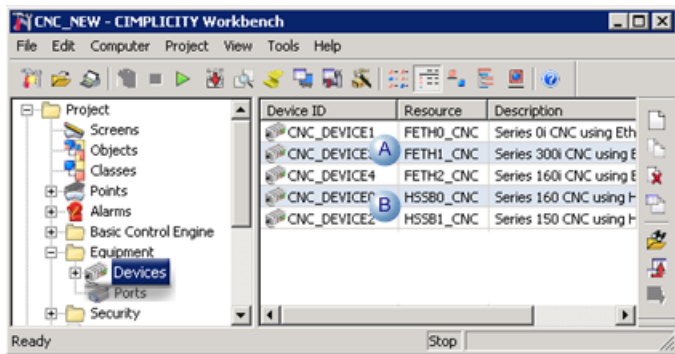

	Device	Opens a Devices Properties dialog box for:
A	Ethernet	FOCAS/Ethernet
B	HSSB	FOCAS/HSSB

The Device Properties dialog box opens for the selected device.

Step 4.2. Enter CNC Device General Properties

Enter or modify general CNC device specifications as follows.

- HSSB devices.
- Ethernet devices.

HSSB devices

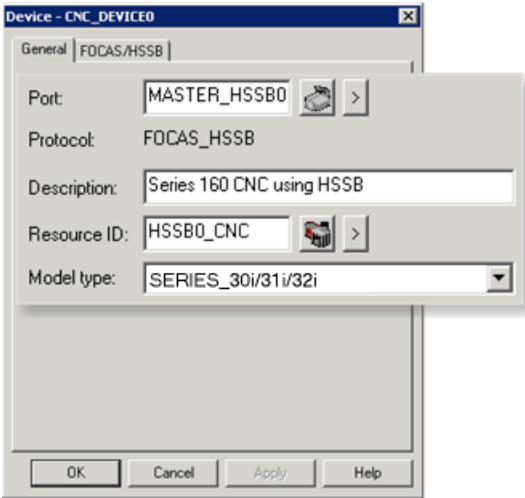

Field	Description
Port	The selected port can be changed. CNC HSSB port guidelines
Protocol	FOCAS_HSSB
Description	Unique description that will display when the device description is available, e.g. in the Workbench right-pane.
Resource ID	The resource you want to associate with the device. ! Important: Because the device ID is not displayed in the Alarm Viewer, we strongly recommend that you create a meaningful and unique resource ID for each device. This ensures that you can identify alarm, operator, and macro messages for your devices in the Resource ID column in the Alarm Viewer. For detailed information about creating resources, refer to About Resources.

Field	Description
Model type	Available HSSB model types include: <ul style="list-style-type: none"> • POWER_MATE_H • POWER_MATEi_D • POWER_MATEi_H • SERIES_0i_M • SERIES_0i_T • SERIES_150_M • SERIES_150_T • SERIES_150_TT • SERIES_150i_M • SERIES_160/180/210_M • SERIES_160/180/210_T • SERIES_160/180_TT • SERIES_160_MM • SERIES_160i/180i/210i_M • SERIES_160i/180i/210i_T • SERIES_160/180i_P • SERIES_160i/180i_TT • SERIES_160i/180i_W • SERIES_160i_L • SERIES_160i_MM • SERIES_160i_TTT • SERIES_30i/31i/32i

Click Apply.

Result: The specifications are applied to the selected or new device.

Ethernet devices

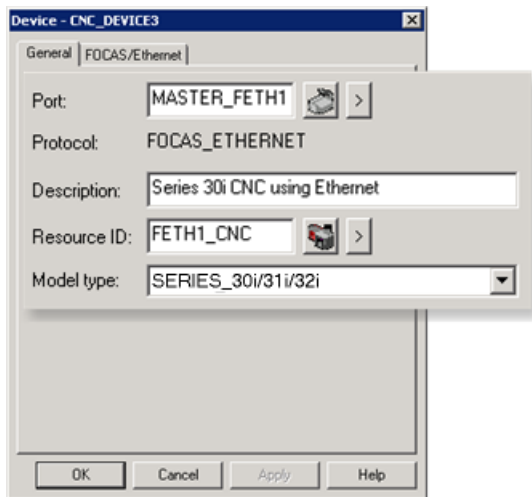

Field	Description
Port	The selected port can be changed.
	CNC Ethernet port guidelines

Protocol	FOCAS_ETHERNET
Description	Unique description that will display when the device description is available, e.g. in the Workbench right-pane.
Resource ID	The resource you want to associate with the device.  Important: Because the device ID is not displayed in the Alarm Viewer, we strongly recommend that you create a meaningful and unique resource ID for each device. This ensures that you can identify alarm, operator, and macro messages for your devices in the Resource ID column in the Alarm Viewer. For detailed information about creating resources, refer to About Resources.
Model type	Available Ethernet model types include: <ul style="list-style-type: none"> • POWER_MATEi_D • POWER_MATEi_H • SERIES_0i_M • SERIES_0i_T • SERIES_150i_M • SERIES_160i/180i/210i_M • SERIES_160i/180i/210i_T • SERIES_160i/180i_P • SERIES_160i/180i_TT • SERIES_160i/180i_W • SERIES_160i_L • SERIES_160i_MM • SERIES_160i_TTT • SERIES_30i/31i/32i

Click Apply.

Result: The specifications are applied to the selected or new device.

Step 4.3. Enter CNC Device Specific Properties

The tab in the dialog box depends on the device's protocol.

- FOCAS/HSSB tab.
- FOCAS/Ethernet tab.

FOCAS/HSSB tab

1. Select the FOCAS/HSSB tab.

Selections on the tab depend on the Model type selected.

2. Enter the following.

Field	Description	
CNC Path	* For all models except: <ul style="list-style-type: none"> • POWER_MATE_H • POWER_MATEi_D • POWER_MATEi_H 	
PMC Path	** For SERIES_30i/31i/32i only.	
Enable Device	Controls communications capability.	
	Checked	Enables communication.
	Clear	Disables communication.

3. Click OK.

Result: The device is configured and, if new, added to the list in the Workbench right-pane.

FOCAS/ETHERNET tab

! **Important:** The IP address or Host name and Port Number must match the CNC from which data is to be collected. Communications will fail if either field is entered incorrectly.

4. Select the FOCAS/Ethernet tab.

Selections on the tab depend on the Model type selected.

5. Enter the following.

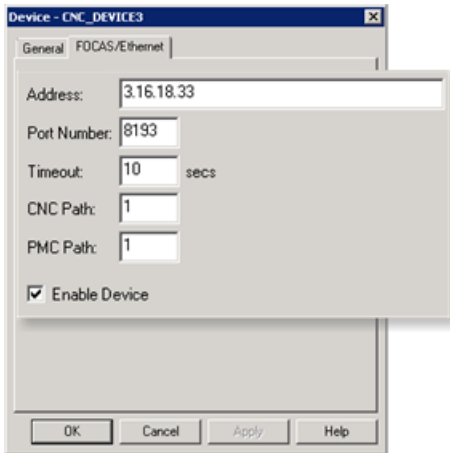

Field	Description
IP Address	IP address or Host name for the CNC from which data and alarms are to be collected.
Port Number	Port number for the CNC.
Timeout	CIMPLICITY attempts to connect with the device until the timer expires.

Field	Description	
	Unit	Seconds
CNC Path	* For all models except: <ul style="list-style-type: none">• POWER_MATEi_D• POWER_MATEi_H	
PMC Path	** For SERIES_ 30i/31i/32i only	
Enable Device	Controls communications capability.	
	Checked	Enables communication.
	Clear	Disables communication.

6. Click OK.

Step 5. Configure Points

Step 5. Configure Points

1. Do one of the following to open a Point Properties dialog box for a CNC device point.
 - A new point.
 - An existing CNC point.

New point for a CNC device

 **Note:** : Review [supported \(page 189\)](#) data types before you configure points for a CNC device.

Using the correct data types is essential for making your project communicate with the device.

- a. Right-click **Points** in the Workbench left pane; select New on the Popup menu.

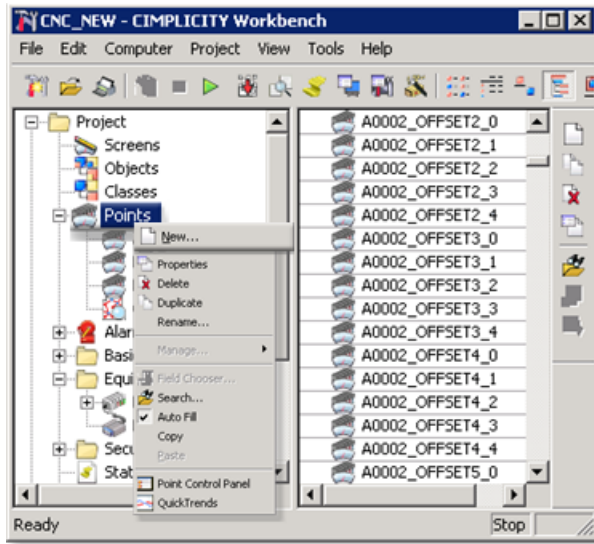

A New Point dialog box opens.

- a. Create a new CNC device point.

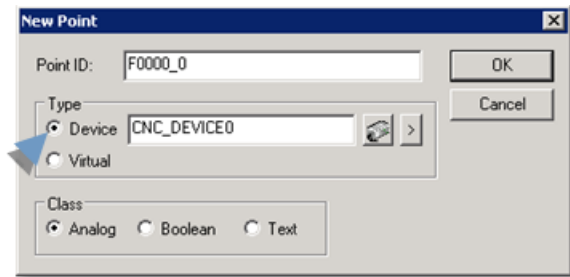

The Point Properties dialog box opens for the new point.

Existing CNC point

- a. Click **Points** in the Workbench left pane.
- b. Double-click a point connected to a CNC device in the Workbench right pane.

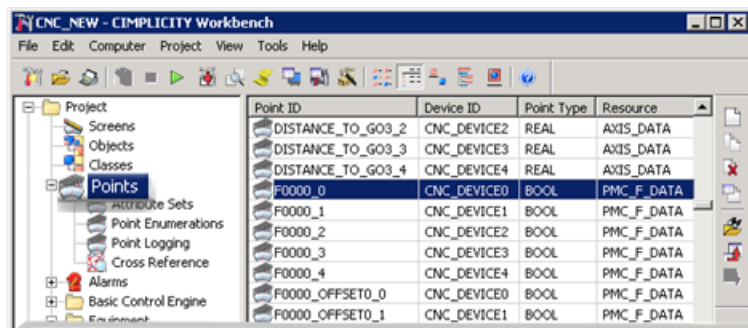

The Point Properties dialog box for the selected point opens.

 **Note:** The CNC QuikStart project contains more than 1500 pre-configured points.

If you use this project or copied it to a new HMI for CNC project, the points will be available for use.

2. Enter or make any required modifications to the CNC device point.

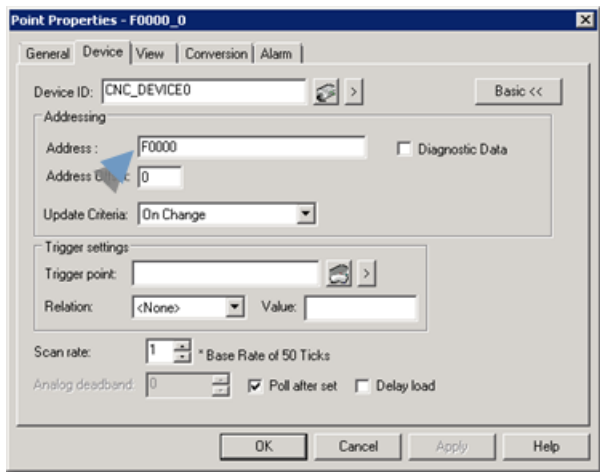

3. Click OK when you have completed configuration.

The Point Properties dialog box closes.

4. Click the Configuration Update button  on the Workbench menu bar.

The point is available for the project.

Supported Data Types

Supported Data Types

Descriptions of pre-configured and configured points for each of the CNC data types are as follows.

- Floating data.
- CNC data types.

Floating data

All floating point data is actually stored on the CNC in two separate memory locations.

The two memory locations are:

1. A long integer that specifies the value.

2. A short integer that specifies the number of decimal places (for example, the precision).

Within CIMPLICITY software, these two integers are:

- Converted into a single 8-byte, double precision, floating point number and
- Stored in a REAL point.

! **Important:** The nature of floating point data is such that imprecision is likely in the least significant digits.

Therefore, when dealing with REAL points, it is not appropriate to use these points in conditions that involve EQUALS or NOT EQUALS.

Example

- It is not appropriate to test if REAL point A = 5 since the exact representation stored in A might be 5.000000000000001.
- It is appropriate to use the **Less than or equal to** or **Greater than or equal to** operators.

CNC data types

Use any combination of pre-configured and configured points for each of the following CNC data types in your CIMPLICITY project.

- Active program numbers.
- Actual axis feedrate / actual spindle speed.
- Axis position data (static, absolute, machine, and distance-to-go).
- Custom macro variable data.
- Diagnosis data.
- P Code macro variable data.
- Parameter data.
- Pitch error compensation data.
- PMC BMI bits.
- Skip data.
- Tool offset data.
- Work zero offset data.
- Tool Life Management data.
- Tool Management data.

Active Program Numbers

- Active main program number.
- Active program number.
- Active program sequence number.

Active Main Program Number

Point Class	ANALOG
Type	DINT
Access	READ
Valid Addresses	PM
Address Offset	None

Active Program Number

Point Class	ANALOG
Type	DINT
Access	READ
Valid Addresses	PN
Address Offset	None

Active Program Sequence Number

Point Class	ANALOG
Type	DINT
Access	READ
Valid Addresses	SN
Address Offset	None

Actual Axis Feedrate / Actual Spindle Speed

- Actual axis feed rate.
- Actual spindle speed.

Actual axis feed rate

Point Class	ANALOG
Type	REAL
Access	READ
Valid Addresses	AF
Address Offset	None

Actual spindle speed

 **Note:** The Power Mate H and i-H CNC's do not support the actual spindle speed. The Power Mate i-D control does support the actual spindle speed.

Point Class	ANALOG
Type	DINT
Access	READ
CNC	Valid Addresses
Series 150, 160/180/210, 0i-A	SS
Series 150i, 160i/180i/210i, 0i-B, 0i-C	SS, SS1-SS4
Series 30i/31i/32i, 0i-D	SS, SS1-SS8
Power Mate i-D	SS
Address Offset	None

 **Note:** The retrieval of actual spindle speed data is related to the following.

CNC Option	Spindle Speed Data Related to:
M series of Series 160/180/210, 160i/180i/210i, 30i/31i/32i, 0i, Power Mate i	Thread cutting, synchronous cutting
CNC Parameter	Spindle Speed Data Related to:
Series 150	7613#0=1, 7613#2=1 (must be set)
Series 160/180/210, 160i/180i/210i, 0i A/B/C, Power Mate i	3118#0,#1,#2,#3 (influenced by setting) 4001#2 (influenced by setting)
Series 30i/31i/32i, 0i-D	3799#2 (influenced by setting) 4001#2 (influenced by setting)

Axis Position Data

Axis Position Data

Axis Position data points	Are read-only.
---------------------------	----------------

- Points for axis positions attributes.
- Address specifications.
- Support for obtaining data.

Points for axis positions attributes

When configuring these points, you must specify the following attributes.

- Static axis positions.
- Absolute axis positions.
- Distance-to-go axis positions.
- Machine axis positions.

Address specifications

Address specifications for axis positions include the following.

Address specification	Indicates
Two-letter prefix	Position type
Number following the prefix	Particular axis.

Example

DA6 specifies Distance-to-Go axis number 6.

Support for obtaining data

Support is provided for obtaining data from up to:

Axes	CNC
24 axes	Series 150/150i
8 axes	Series 160/180/210, 160i/180i/210i, 0i-A/B/C
32 axes	Series 30i/31i/32i.
4 axes	Series 0i-D
2 axes	PowerMatei-D
6 axes	PowermateH, iH

You will only be able to obtain data for the number of controlled axes that are configured in your CNC.

Example

If your CNC is currently configured for 3 controlled axes, you can define points for Machine Axis Positions MA1 - MA8. However, only points MA1, MA2, and MA3 will have values.

Relative Axis Positions

Point Class	ANALOG
Type	REAL
Access	READ
CNC	Valid Addresses
Series 150/150i	RA1-RA24
Series 160/180/210, 160i/180i/210i, 0i-A/B/C	RA1-RA8
Series 30i/31i,32i	RA1-RA32
Series 0i-D	RA1-RA4
Power Mate i-D	RA1, RA2
Power Mate H, i-H	RA1-RA6
Address Offset	None

Absolute Axis Positions

Point Class	ANALOG
Type	REAL
Access	READ
CNC	Valid Addresses
Series 150/150i	AA1-AA24
Series 160/180/210, 160i/180i/210i, 0i-A/B/C	AA1-AA8
Series 30i/31i,32i	AA1-AA32
Series 0i-D	AA1-AA4
Power Mate i-D	AA1, AA2
Power Mate H, i-H	AA1-AA6
Address Offset	None

Distance-to-Go Axis Positions

Point Class	ANALOG
Type	REAL
Access	READ
CNC	Valid Addresses

Series 150/150i	DA1-DA24
Series 160/180/210, 160i/180i/210i, 0i-A/B/C	DA1-DA8
Series 30i/31i,32i	DA1-DA32
Series 0i-D	DA1-DA4
Power Mate i-D	DA1, DA2
Power Mate H, i-H	DA1-DA6
Address Offset	None

Machine Axis Positions

Point Class	ANALOG
Type	REAL
Access	READ
CNC	Valid Addresses
Series 150/150i	MA1-MA24
Series 160/180/210, 160i/180i/210i, 0i-A/B/C	MA1-MA8
Series 30i/31i,32i	MA1-MA32
Series 0i-D	MA1-MA4
Power Mate i-D	MA1, MA2
Power Mate H, i-H	MA1-MA6
Address Offset	None

Custom Macro Variable Data

 **Note:** Bits for Custom Macro variables are purchase options.

- Custom Macro Variable guidelines.
- Custom Macro Variable attributes.
- Custom Macro Variable restrictions.

Custom Macro Variable guidelines

Variable Type	Guidelines
Local	You cannot write Local common variables (CMV1-CMV33).

Variable Type	Guidelines
Vacant	Individual custom macro variables may be vacant on the CNC. Vacant macro variables are not currently assigned a value. A point that is reading a vacant custom macro variable will have a value of 0.

Custom Macro Variable attributes

When configuring points for Custom Macro Variable Data, specify the following attributes:

Point Class	ANALOG	
Type	REAL	
Access	READ or READ/WRITE	
CNC	Valid Addresses	Variable Types
Series 150 M/T	CMV1-CMV33	Local Macro Variables
	CMV100-CMV149, CMV500-CMV531	Macro Variable
	CMV100 - CMV149, CMV500 - CMV549 or	
	CMV100 - CMV199, CMV500 - CMV599 or	
	CMV100 - CMV199, CMV500 - CMV699 or	
	CMV100 - CMV199, CMV500 - CMV999 or	
	CMV1000-CMV9999	System Macro Variables
Series 150i	CMV1 - CMV33	Local Macro Variables
	CMV100 - CMV199, CMV500 - CMV999 or	Macro Variables
	CMV100 - CMV199, CMV200 - CMV999 or	
	CMV1000-CMV9999	System Macro Variables
Series 15TT	CMV1 - CMV33	Local Macro Variables
	CMV100 - CMV149, CMV500 - CMV524 or	Macro Variables
	CMV100 - CMV149, CMV500 - CMV549 or	
	CMV100 - CMV149, CMV500 - CMV599 or	
	CMV100 - CMV149, CMV500 - CMV749 or	
	CMV1000-CMV9999	System Macro Variables
Series 160/180, 160i/180i, 0i	CMV1 - CMV33	Local Macro Variables
	CMV100 - CMV149, CMV500 - CMV531 or	Macro Variables
	CMV100 - CMV199, CMV500 - CMV999 or	
	CMV100 - CMV199, CMV500 - CMV599 or	

	CMV1000-CMV9999	System Macro Variables
Series 160i/180i W	CMV1 - CMV33	Local Macro Variables
	CMV100 - CMV149, CMV500 - CMV531 or	Macro Variables
	CMV100 - CMV314, CMV500 - CMV699 or	
	CMV100 - CMV149, CMV500 - CMV699 or	
	CMV100 - CMV314, CMV500 - CMV531 or	
	CMV100 - CMV149, CMV500 - CMV999 or	
	CMV100 - CMV314, CMV500 - CMV999 or	
	CMV1000-CMV9999	System Macro Variables
Series 30i/31i/32i	CMV1 - CMV33	Local Macro Variables
	CMV100 - CMV149, CMV500 - CMV549 or	Macro Variables
	CMV100 - CMV199, CMV500 - CMV999 or	
	CMV100 - CMV149, CMV200 - CMV499, CMV500 - CMV549 or	
	CMV100 - CMV199, CMV200 - CMV499, CMV500 - CMV999 or	
	CMV1000-CMV9999	System Macro Variables
Power Mate, Power Mate i-D/H	CMV1 - CMV33	Local Macro Variables
	CMV100 - CMV149, CMV500 - CMV549 or	Macro Variables
	CMV100 - CMV199, CMV500 - CMV999 or	CMV100 - CMV149, CMV200 - CMV499, CMV500 - CMV549 or
	CMV100 - CMV199, CMV200 - CMV499, CMV500 - CMV999 or	
	CMV1000-CMV9999	System Macro Variables
Address Offset	None	

 **Note:** CIMPLICITY supports the system macro variable range of 1000-9999. However each CNC configuration may not support this range of address; that support depends on your physical devices and configuration.

Custom Macro Variable restrictions

 **guide: Guidelines**

When writing P Code Macro Variables that support the real (floating-point) data type, please be aware that the available range is 999999999,....,-999999999.

Diagnosis Data

Diagnosis Data

- Diagnosis information for point configuration.
- Control manual required information for point configuration.
- Restrictions for configuring points as diagnosis.

Diagnosis information for point configuration

After you have determined this information, you may configure points using the following information:

- Bit Diagnosis (no axis).
- Bit Diagnosis (with axis).
- Byte Diagnosis (no axis).
- Byte Diagnosis (with axis).
- Word Diagnosis (no axis).
- Word Diagnosis (with axis).
- Longword (2-word) Diagnosis (no axis).
- Longword (2-word) Diagnosis (with axis).
- Real (4-word) Diagnosis (no axis).
- Real (4-word) Diagnosis (with axis).

Control manual required information for point configuration

Before configuring a point, refer to the Maintenance Manual for your control type (Series 15, Series 16 or Power Mate) to determine the following information.

- Is the CNC diagnosis a bit, byte, word, longword (2-word) or real (4-word) data?
- Does the CNC diagnosis contain signed or unsigned data?
- Does the CNC diagnosis have data for every axis or is there just a single value?

Restrictions for configuring points as diagnosis

When configuring points as diagnosis, be aware of the following restrictions:

- You cannot configure points as array points for diagnosis data.
- You cannot write to diagnosis data.
- In general, most CNC diagnosis data contain "SIGNED" data, so you should use the equivalent signed point type (SINT, INT, or DINT).
- Valid diagnosis addresses are 0 – 6,200.

! **Important:** CIMPLICITY HSSB and Ethernet device points for diagnosis data should be configured according to the instructions in the appropriate CNC Controller Maintenance Manual.

Bit Diagnosis (no axis)

Point Class	DIGITAL
Type	BOOL
Access	READ
Valid Addresses	DNx, where x is a valid diagnosis number for a bit diagnosis
Address Offset	0-7, depending upon which bit you want to access

Bit Diagnosis (with axis)

Point Class	DIGITAL
Type	BOOL
Access	READ
Valid Addresses	DNxAy, where x is a valid diagnosis number for a bit diagnosis, and y is the particular axis number
Address Offset	0-7, depending upon which bit you want to access

Byte Diagnosis (no axis)

Point Class	ANALOG
Type	SINT for signed data; USINT for unsigned data
Access	READ
Valid Addresses	DNx, where x is a valid diagnosis number for a byte diagnosis
Address Offset	N/A

Byte Diagnosis (with axis)

Point Class	ANALOG
Type	SINT for signed data; USINT for unsigned data
Access	READ
Valid Addresses	DNxAy, where x is a valid diagnosis number for a byte diagnosis, and y is the particular axis number
Address Offset	N/A

Word Diagnosis (no axis)

Point Class	ANALOG
-------------	--------

Type	INT for signed data; UINT for unsigned data
Access	READ
Valid Addresses	DNx, where x is a valid diagnosis number for a word diagnosis
Address Offset	N/A

Word Diagnosis (with axis)

Point Class	ANALOG
Type	INT for signed data; UINT for unsigned data
Access	READ
Valid Addresses	DNxAy, where x is a valid diagnosis number for a word diagnosis, and y is the particular axis number
Address Offset	N/A

Longword (2-word) Diagnosis (no axis)

Point Class	ANALOG
Type	DINT for signed data; UDINT for unsigned data
Access	READ
Valid Addresses	DNx, where x is a valid diagnosis number for a longword diagnosis
Address Offset	N/A

Longword (2-word) Diagnosis (with axis)

Point Class	ANALOG
Type	DINT for signed data; UDINT for unsigned data
Access	READ
Valid Addresses	DNxAy, where x is a valid diagnosis number for a longword diagnosis, and y is the particular axis number
Address Offset	N/A

Real (4-word) Diagnosis (no axis)

Point Class	ANALOG
Type	REAL
Access	READ
Valid Addresses	DNx, where x is a valid diagnosis number for a real word diagnosis
Address Offset	N/A

Real (4-word) Diagnosis (with axis)

Point Class	ANALOG
Type	REAL
Access	READ
Valid Addresses	DNxAy, where x is a valid diagnosis number for a real diagnosis, and y is the particular axis number
Address Offset	N/A

*P Code Macro Variable Data**P Code Macro Variable Data***! Important:**

- Before you configure P Code Macro variable data, please review the Macro Compiler/Macro Executor Programming Manual for details on how to configure your CNC.
- Series 150i and Power Mate are not supported for P Code macro variable data.

Points for P code macro variable data	Are read and write in the P Code Macro variable table.
---------------------------------------	--

On the CNC, individual P code macro variables may be vacant (i.e. they are not currently assigned a value).

A point that is reading a vacant P code macro variable has a value of 0.

When configuring these points, you must specify the following attributes:

- P Code Macro Variable 10000-Type A
- P Code Macro Variable 10000-Type B
- P Code Macro Variable 20000-Type A
- P Code Macro Variable 20000-Type B
- P Code Macro Variable 20000-Type C
- P Code Macro Variable 20000-Type D.
- P Code Macro Variable 30000-Type A
- P Code Macro Variable 30000-Type B.
- P Code Macro Variable 40000-Type A
- P Code Macro Variable 40000-Type B.

📖 guide: Guidelines

When writing P Code Macro Variables that support the real (floating-point) data type, please be aware that the available range is 999999999,....,-999999999.

P Code Macro Variable 10000-Type A

Point Class	ANALOG
Type	REAL (8 bytes)
Access	READ or READ/WRITE
CNC	Valid Addresses
Series 160/180/210, 160i/180i/210i, 0i-A/B/C	PMV10000-PMV75535
Series 30i/31i/32i, 0i-D	PMV10000-PMV19999
Power Mate i	PMV10000-PMV75535
Address Offset	None

P Code Macro Variable 10000-Type B

Point Class	ANALOG
Type	INT (2 bytes)
Access	READ or READ/WRITE
CNC	Valid Addresses
Series 30i/31i/32i, 0i-D	PMV20000-PMV89999
Address Offset	None

P Code Macro Variable 20000-Type A

Point Class	ANALOG
Type	REAL (8 bytes)
Access	READ or READ/WRITE
CNC	Valid Addresses
Series 160/180/210, 160i/180i/210i, 0i	PMV20000-PMV85535
Power Mate i	PMV20000-PMV85535
Address Offset	None

P Code Macro Variable 20000-Type B

Point Class	ANALOG
Type	INT (2 bytes)
Access	READ or READ/WRITE

CNC	Valid Addresses
Series 160/180/210, 160i/180i/210i, 0i	PMV20000-PMV85535
PMV20000-PMV85535	PMV20000-PMV85535
Power Mate i	PMV20000-PMV85535
Address Offset	None

P Code Macro Variable 20000-Type C

Point Class	ANALOG
Type	INT (2 bytes)
Access:	READ or READ/WRITE
CNC	Valid Addresses
Series 160/180, 160i/180i	PMV20000-PMV85535
Address Offset	None

P Code Macro Variable 20000-Type D

Point Class	ANALOG
Type	INT (2 bytes)
Access	READ or READ/WRITE
CNC	Valid Addresses
Series 160/180, 160i/180i	PMV20000-PMV85535
Address Offset	None

P Code Macro Variable 30000-Type A

Point Class	ANALOG
Type	INT (2 bytes)
Access	READ or READ/WRITE
CNC	Valid Addresses
Series 150	PMV30000-PMV95535
Address Offset	None

P Code Macro Variable 30000-Type B

Point Class	ANALOG
-------------	--------

Type	INT (2 bytes)
Access	READ or READ/WRITE
CNC	Valid Addresses
Series 150	PMV30000-PMV95535
Address Offset	None

P Code Macro Variable 40000-Type A

Point Class	ANALOG
Type	REAL (8 bytes)
Access	READ or READ/WRITE
CNC	Valid Addresses
Series 150	PMV40000-PMV105535
Address Offset	None

P Code Macro Variable 40000-Type B

Point Class	ANALOG
Type	INT (2 bytes)
Access	READ or READ/WRITE
CNC	Valid Addresses
Series 150	PMV40000-PMV105535
Address Offset	None

Parameter Data

Parameter Data

You can configure points to read and write parameters in the parameter table.

- Parameter information for point configuration.
- Control manual required information for point configuration.
- Restrictions for configuring points as parameters.
- Write Enable Bit Parameter.

Parameter information for point configuration

Use the control manual and following parameter information to configure points.

- Bit Parameters (no axis).
- Bit Parameters (with axis).
- Byte Parameters (no axis).
- Byte Parameters (with axis).
- Word Parameters (no axis).
- Word Parameters (with axis).
- Longword (2-word) Parameters (no axis).
- Longword (2-word) Parameters (with axis).
- Real (4-word) Parameters (no axis).
- Real (4-word) Parameters (with axis).

Control manual required information for point configuration

Before configuring a point, refer to the Parameter Manual for your CNC to determine the following information:

- Is the CNC parameter a bit, byte, word, longword (2-word) or real (4-word) parameter?
- Does the CNC parameter contain signed or unsigned data?
- Does the CNC parameter have data for every axis (an **axis** parameter), or is there just a single value?

Restrictions for configuring points as parameters

When configuring points as parameters, be aware of the following restrictions:

- Points cannot be configured as array points for parameters.
- The default behavior of the HMI for CNC product is to check the Parameter Write Enable bit (the "PWE" bit) before writing any parameter data. Thus, if the Parameter Write Enable bit is not set, any setpoints for parameters will fail. You can override the default behavior by forcing CIMPLICITY software to ignore the [Parameter Write Enabler bit \(page 205\)](#).
- In general, most CNC parameters contain **SIGNED** data, so you should use the equivalent signed point type (SINT, INT, or DINT).
- Valid parameter addresses are 0 – 16,000.

 **Note:** CIMPLICITY HSSB and Ethernet device points for parameter data should be configured according to the instructions in the appropriate CNC Controller Parameter Manual.

Write Enable Bit Parameter

The default behavior of the HMI for CNC product is to check the Parameter Write Enable (**PWE**) bit before allowing CIMPLICITY to write any points that are configured to access the CNC parameter table.

You can override the default behavior and allow CIMPLICITY software to always write to the parameter table through the global parameter DC_CHECK_PWE.

1. Stop the CIMPLICITY project if it is running.
2. Do the following.

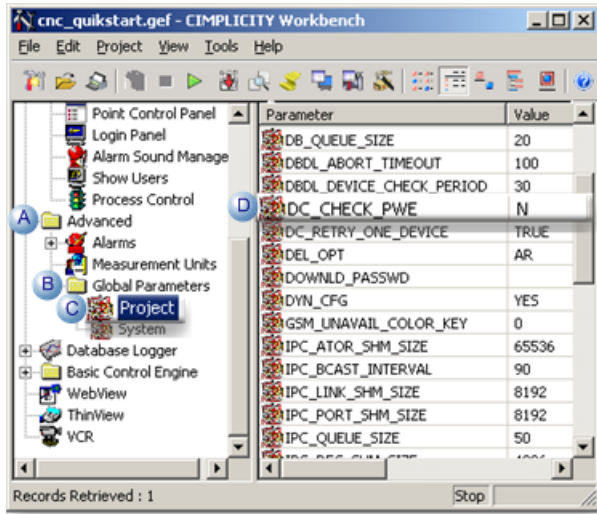

A	Expand the Advanced folder in the Workbench left pane.	
B	Expand the Global Parameters folder.	
C	Select Project	
D	Change the value of the appropriate global parameter to N as follows	
	Single controllers	DC_CHECK_PWE
	Dual path controllers	One of the following: <ul style="list-style-type: none"> • DC_CHECK_PWE • DC_CHECK_PWE2
	Multi-path controllers	One of the following: <ul style="list-style-type: none"> • DC_CHECK_PWE • DC_CHECK_PWE2 • DC_CHECK_PWE<n> Where n = 3, 4, 5, 6, 7, 8, 9, or 10

3. Click the Run button  on the Workbench toolbar to restart the project.
4. Update the project configuration files when prompted.

Bit Parameters (no axis)

Point Class	DIGITAL
Type	BOOL

Access	READ or READ/WRITE
Valid Addresses	PAX, where x is a valid parameter number for a bit parameter.
Address Offset	0-7, depending upon which bit you want to access

Bit Parameters (with axis)

Point Class	DIGITAL
Type	BOOL
Access	READ or READ/WRITE
Valid Addresses	PAXAy, where x is a valid parameter number for a bit parameter, and y is the particular axis number
Address Offset	0-7, depending upon which bit you want to access

Byte Parameters (no axis)

Point Class	ANALOG
Type	SINT for signed data; USINT for unsigned data
Access	READ or READ/WRITE
Valid Addresses	PAX, where x is a valid parameter number for a byte parameter
Address Offset	N/A

Byte Parameters (with axis)

Point Class	ANALOG
Type	SINT for signed data; USINT for unsigned data
Access	READ or READ/WRITE
Valid Addresses	PAXAy, where x is a valid parameter number for a byte parameter, and y is the particular axis number
Address Offset	N/A

Word Parameters (no axis)

Point Class	ANALOG
Type	INT for signed data; UINT for unsigned data
Access	READ or READ/WRITE
Valid Addresses	PAX, where x is a valid parameter number for a word parameter
Address Offset	N/A

Word Parameters (with axis)

Point Class	ANALOG
Type	INT for signed data; UINT for unsigned data
Access	READ or READ/WRITE
Valid Addresses	PxAy, where x is a valid parameter number for a word parameter, and y is the particular axis number
Address Offset	N/A

Longword (2-word) Parameters (no axis)

Point Class	ANALOG
Type	DINT for signed data; UDINT for unsigned data
Access	READ or READ/WRITE
Valid Addresses	PxA, where x is a valid parameter number for a longword parameter
Address Offset	N/A

Longword (2-word) Parameters (with axis)

Point Class	ANALOG
Type	DINT for signed data; UDINT for unsigned data
Access	READ or READ/WRITE
Valid Addresses	PxAy, where x is a valid parameter number for a longword parameter, and y is the particular axis number
Address Offset	N/A

Real (4-word) Parameters (no axis)

Point Class	ANALOG
Type	REAL
Access	READ or READ/WRITE
Valid Addresses	PxA, where x is a valid parameter number for a real parameter
Address Offset	N/A

Real (4-word) Parameters (with axis)

Point Class	ANALOG
-------------	--------

Type	REAL
Access	READ or READ/WRITE
Valid Addresses	PxAy, where x is a valid parameter number for a real parameter, and y is the particular axis number
Address Offset	N/A

Pitch Error Compensation Data

 **Note:** The pitch error compensation is a purchase option.

- Pitch Error Compensation entry numbers and values.
- Pitch Error Compensation attributes.

Pitch Error Compensation entry numbers and values

Each entry in the Pitch Error Compensation table has the following.

Entry for CNC	Has a unique number between	Has an allowed assigned value between
Series 150	0 and 1279	-7 and 7
Series 150i	0 and 1279	-128 and 127
Series 160/180/210, 160i/180i/210i, 0i-A/B/C	0 and 1023	-7 and 7
Series 30i/31i/32i	0 and 1535	-128 and 127
Series 0i-D	0 and 1023	-7 and 7
Power Mate i-D	0 and 1023	-7 and 7

Pitch Error Compensation attributes

When configuring points for Pitch Error Compensation, specify the following attributes.

 **Note:** The Power Mate H and Power Mate i-H CNC's do not support pitch error compensation attributes.

Point Class:	ANALOG
Type:	SINT
Access:	READ or READ/WRITE
CNC	Valid Addresses
Series 150	PEC0000 - PEC1279
Series 150i	PEC0000 - PEC1279

Series 160/180/210, 160i/180i/210i, 0i	PEC0000 - PEC1023
Series 30i/31i/32i	PEC0000 - PEC1535
Power Mate i-D	PEC0000 - PEC1023

PMC BMI Bits

PMC BMI Bits

PMC data is frequently referred to as BMI Bits.

- Details about PMC BMI Bits.
- Guidelines for PMC BMI Bits points.
- Series 150 CNC's and Motorola vs. Intel standards.

Details about PMC BMI Bits

G (page 211)	G Data
F (page 213)	F Data
X (page 217)	X Data
Y (page 215)	Y Data
R (page 220)	R Data
A (page 218)	A Data
I (page 222)	T Data
K (page 223)	K Data
C (page 225)	C Data
D (page 227)	D Data

E (page 228)	E Data
------------------------------	--------

Guidelines for PMC BMI Bits points

You can configure:

- Points that read and write individual bits of data using digital points.
- Analog points that access PMC data locations as individual bytes, words (2 bytes), or longwords (4 bytes) of data at a time.
- Digital points to access bits of data.

CIMPLICITY accesses the memory location as a byte.

In order to specify the particular bit, set the **Address Offset** field to a value between 0 and 7,

Where

0 specifies the least significant bit and

7 specifies the most significant bit.

- Analog points to access 1, 2, or 4 bytes of data at a time.

Do not set the **Address Offset** field.

Series 150 CNC's and Motorola vs. Intel Standards

! **Important:** Due to the different standards between Motorola and Intel, Series 150 CNC's that use PMC type NA will swap the high and low order bytes of each word. This issue was resolved in a previous HMI for CNC software release. All analog points configured to reference PMC BMI Bits data locations as words (2 bytes) or longwords (4 bytes) are converted as follows:

Data Type	Data that looks like this on the CNC...	Is swapped and looks like this in CIMPLICITY
UINT OR INT	00000010 00000001	00000001 00000010
UDINT OR DINT	00001000 00000100 000000010 00000001	00000001 000000010 00000100 00001000

G Data

- G Data definition.
- Digital points to reference individual bits configuration.
- Analog points to reference individual bytes, words, or longwords configuration.

- Supported addresses

G Data definition

G Data	Is information sent:	
	From	PMC
	To	CNC
G data points	Are read and write	

Digital points to reference individual bits

Point Class	DIGITAL
Type	BOOL
Access	READ or READ/WRITE
Valid Addresses	Gxxxx, where xxxx is a valid address for your PMC type
Address Offset	0-7, for the particular bit you want to reference

Analog points to reference individual bytes, words, or longwords

Point Class	ANALOG
Type	SINT, INT, or DINT (1, 2, or 4 bytes)
Access	READ or READ/WRITE
Valid Addresses	Gxxxx, where xxxx is a valid address for your PMC type
Address Offset	none

Supported addresses

CNC	PMC Type	Valid Address Range
Series 150	NA/NB/NB2	G0000-G0511
Series 150i	NB6	G0000-G0511 G1000-G1511
Series 160/180-B/C	SA1/SB3/SB5/SC3	G0000-G0255 G1000-G1255
	SB4/SB6/SC4	G0000-G0511 G1000-G1511 G2000-G2511
Series 210-B, 0i-A	SA1/SA3	G0000-G0255 G1000-G1255

CNC	PMC Type	Valid Address Range		
Series 160i/180i, 0i-B(SB7)	SB5	G0000-G0255 G1000-G1255		
	SB6	G0000-G0511 G1000-G1511 G2000-G2511		
	SB7	G0000-G0767 G1000-G1767 G2000-G2767		
Series 210i, 0i-B(SA1)	SA1/SA5	G0000-G0255 G1000-G1255		
Series 0i-D	PMC	G0000-G0767 G1000-G1767 G2000-G2767 G3000-G3767 G4000-G4767 G5000-G5767 G6000-G6767 G7000-G7767 G8000-G8767 G9000-G9767		
	PMC/L	G0000-G0767 G1000-G1767		
Series Mate 0i-D	PMC/L	G0000-G0767 G1000-G1767		
Power Mate	All	G0000-G0255 G1000-G1255		
Power Mate i	SB5	G0000-G0255 G1000-G1255		
	SB6	G0000-G0511 G1000-G1511 G2000-G2511		
CNC	1st PMC	*2nd PMC	*3rd PMC	
Series 30i/31i/32i	G0000-G0767 G1000-G1767 G2000-G2767 G3000-G3767 G4000-G4767 G5000-G5767 G6000-G6767 G7000-G7767 G8000-G8767 G9000-G9767	G0000-G0767 G1000-G1767 G2000-G2767 G3000-G3767 G4000-G4767 G5000-G5767 G6000-G6767 G7000-G7767 G8000-G8767 G9000-G9767	G0000-G0767 G1000-G1767 G2000-G2767 G3000-G3767 G4000-G4767 G5000-G5767 G6000-G6767 G7000-G7767 G8000-G8767 G9000-G9767	

* Optional.

F Data

- F Data definition.
- Digital points to reference individual bits configuration.
- Analog points to reference individual bytes, words, or longwords configuration.
- Supported addresses.

F Data definition

F Data	Is information sent:	
	From	CNC
	To	PMC

F data points	Are read-only
---------------	---------------

Digital points to reference individual bits

Point Class	DIGITAL
Type	BOOL
Access	Read-only
Valid Addresses	Fxxxx, where xxxx is a valid address for your PMC type
Address Offset	0-7, for the particular bit you want to reference

Analog points to reference individual bytes, words, or longwords configuration

Point Class	ANALOG
Type	SINT, INT, or DINT (1, 2, or 4 bytes)
Access	Read-only
Valid Addresses	Fxxxx, where xxxx is a valid address for your PMC type
Address Offset	none

Supported addresses

CNC	PMC Type	Valid Address Range
Series 150	NA	F0000-F0319
	NB/NB2	F0000-F0511
Series 150i	NB6	F0000-F0511 F1000-F1511
Series 160/180-B/C	SA1/SB3/SB5/SC3	F0000-F0255 F1000-F1255
	SSB4/SB6/SC4	F0000-F0511 F1000-F1511 F2000-F2511
Series 210-B, 0i-A	SA1/SA3	F0000-F0255 F1000-F1255
Series 160i/180i, 0i-B(SB7)	SB5	F0000-F0255 F1000-F1255
	SB6	F0000-F0511 F1000-F1511 F2000-F2511
	SB7	F0000-F0767 F1000-F1767 F2000-F2767

CNC	PMC Type	Valid Address Range	
Series 210i, 0i-B(SA1)	SA1/SA5	F0000-F0255 F1000-F1255	
Series 0i-D	PMC	F0000-F0767 F1000-F1767 F2000-F2767 F3000-F3767 F4000-F4767 F5000-F5767 F6000-F6767 F7000-F7767 F8000-F8767 F9000-F9767	
	PMC/L	F0000-F0767 F1000-F1767	
Series Mate 0i-D	PMC/L	F0000-F0767 F1000-F1767	
Power Mate	All	F0000-F0255 F1000-F1255	
Power Mate i	SB5	F0000-F0255 F1000-F1255	
	SB6	F0000-F0511 F1000-F1511 F2000-F2511	
CNC	1st PMC	*2nd PMC	*3rd PMC
Series 30i/31i/32i	F0000-F0767 F1000-F1767 F2000-F2767 F3000-F3767 F4000-F4767 F5000-F5767 F6000-F6767 F7000-F7767 F8000-F8767 F9000-F9767	F0000-F0767 F1000-F1767 F2000-F2767 F3000-F3767 F4000-F4767 F5000-F5767 F6000-F6767 F7000-F7767 F8000-F8767 F9000-F9767	F0000-F0767 F1000-F1767 F2000-F2767 F3000-F3767 F4000-F4767 F5000-F5767 F6000-F6767 F7000-F7767 F8000-F8767 F9000-F9767

* Optional

Y Data

- Y Data definition.
- Digital points to reference individual bits configuration.
- Analog points to reference individual bytes, words, or longwords configuration.
- Supported addresses.

Y Data definition

Y Data	Is output data:	
	From	PMC
	To	Machine tool
Y data points	Are read and write.	

Digital points to reference individual bits

Point Class	DIGITAL
Type	BOOL

Access	READ or READ/WRITE
Valid Addresses	Yxxxx, where xxxx is a valid address for your PMC type
Address Offset	0-7, for the particular bit you want to reference

Analog points to reference individual bytes, words, or longwords

Point Class	ANALOG
Type	SINT, INT, or DINT (1, 2, or 4 bytes)
Access:	READ or READ/WRITE
Valid Addresses	Yxxxx, where xxxx is a valid address for your PMC type
Address Offset	none

Supported addresses

CNC	PMC Type	Valid Address Range
Series 150	NA/NB/NB2	Y0000-Y0127
Series 150i	NB6	Y0000-Y0127 Y0200-Y0327
Series 160/180-B/C	SA1/SB3/SB4/SB5/SB6/SC3/SC4	Y0000-Y0127 Y1000-Y1014 Y1020-Y1034
Series 210-B, 0i-A	SA1/SA3	Y0000-Y0127 Y1000-Y1008
Series 160i/180i, 0i-B(SB7)	SB5/SB6/SB7	Y0000-Y0127
	SB6/SB7	Y0200-Y0327
Series 210i, 0i-B(SA1)	SA1/SA5	Y0000-Y0127
Series 0i-D	PMC	Y0000-Y0127 Y0200-Y0327
	PMC/L	Y0000-Y0127
Series Mate 0i-D	PMC/L	Y0000-Y0127
Power Mate	All	Y0000-Y0127 Y1000-Y1063
Power Mate i	SB5/SB6	Y0000-Y0127 Y1000-Y1002 Y1020-Y1051
CNC	1st PMC	*2nd PMC *3rd PMC

CNC	PMC Type		Valid Address Range
Series 30i/31i/32i	Y0000-Y0127 Y0200-Y0327 Y0400-Y0527 Y0600-Y0727 Y1000-Y1127**	Y0000-Y0127 Y0200-Y0327 Y0400-Y0527 Y0600-Y0727 Y1000-Y1127**	Y0000-Y0127 Y0200-Y0327 Y0400-Y0527 Y0600-Y0727 Y1000-Y1127**

* Optional

** Y1000-Y1127 is reserved for PMC management software. No I/O can be allocated in this area. Do not use it in user programs.

X Data

- X Data definition.
- Digital points to reference individual bits configuration.
- Analog points to reference individual bytes, words, or longwords configuration.
- Supported addresses.

X Data definition

X Data	Is input data:	
	From	Machine tool
	To	PMC
X data points	Are read only	

Digital points to reference individual bits

Point Class	DIGITAL
Type	BOOL
Access	Read only
Valid Addresses	Xxxxx, where xxxx is a valid address for your PMC type
Address Offset	0-7, for the particular bit you want to reference

Analog points to reference individual bytes, words, or longwords

Point Class	ANALOG
Type	SINT, INT, or DINT (1, 2, or 4 bytes)
Access	Read only
Valid Addresses	Xxxxx, where xxxx is a valid address for your PMC type
Address Offset	none

Supported addresses

CNC	PMC Type		Valid Address Range
Series 150	NA/NB/NB2		X0000-X0127
Series 150i	NB6		X0000-X0127 X0200-X0327
Series 160/180-B/C	SA1/SB3/SB4/SB5/SB6/SC3/SC4		X0000-X0127 X1000-X1019 X1020-X1039
Series 210-B, 0i-A	SA1/SA3		X0000-X0127 X1000-X1011
Series 160i/180i, 0i-B(SB7)	SB5/SB6/SB7		X0000-X0127
	SB6/SB7		X0200-X0327
Series 210i, 0i-B(SA1)	SA1/SA5		X0000-X0127
Series 0i-D	PMC		X0000-X0127 X0200-X0327
	PMC/L		X0000-X0127
Series Mate 0i-D	PMC/L		X0000-X0127
Power Mate	All		X0000-X0127 X1000-X1063
Power Mate i	SB5/SB6		X0000-X0127 X1000-X1003 X1020-X1051
CNC	1st PMC	*2nd PMC	*3rd PMC
Series 30i/31i/32i	X0000-X0127 X0200-X0327 X0400-X0527 X0600-X0727 X1000-X1127**	X0000-X0127 X0200-X0327 X0400-X0527 X0600-X0727 X1000-X1127**	X0000-X0127 X0200-X0327 X0400-X0527 X0600-X0727 X1000-X1127**

* Optional

** X1000-X1127 is reserved for PMC management software. No I/O can be allocated in this area. Do not use it in user programs.

A Data

- A Data definition.
- Digital points to reference individual bits configuration.
- Analog points to reference individual bytes, words, or longwords configuration.

- Supported addresses.

A Data definition

A Data	Is for message demand.
A data points	Are read and write.

Digital points to reference individual bits

Point Class	DIGITAL
Type	BOOL
Access	Read or Read/Write
Valid Addresses	Axxxx, where xxxx is a valid address for your PMC type
Address Offset	0-7, for the particular bit you want to reference

Analog points to reference individual bytes, words, or longwords

Point Class	ANALOG
Type	SINT, INT, or DINT (1, 2, or 4 bytes)
Access	Read or Read/Write
Valid Addresses	Axxxx, where xxxx is a valid address for your PMC type
Address Offset	none

Supported addresses

CNC	PMC Type	Valid Address Range
Series 150	NA/NB	A0000-A0024
	NB2	A0000-A0124
Series 150i	NB6	A0000-A0124
Series 160/180-B/C	SA1/SB3/SB5/SC3	A0000-A0024
	SB4/SB6/SC4	A0000-A0124
Series 210-B, 0i-A	SA1/SA3	A0000-A0024
Series 160i/180i, 0i-B(SB7)	SB5	A0000-A0024
	SB6	A0000-A0124
	SB7	A0000-A0249, A9000-A9249
Series 210i, 0i-B(SA1)	SA1/SA5	A0000-A0024
Series 0i-D	All	A0000-A0249 A9000-A9249

CNC	PMC Type		Valid Address Range
Series Mate 0i-D	PMC/L		A0000-A0249 A9000-A9249
Power Mate	All		A0000-A0024
Power Mate i	SB5		A0000-A0024
	SB6		A0000-A0124
CNC	1st PMC	*2nd PMC	*3rd PMC
Series 30i/31i/32i			
Message Display	A0000-A0249	A0000-A0249	A0000-A0249
Status Display	A9000-A9249	A9000-A9249	A9000-A9249

* Optional

**

R Data

- R Data definition.
- Digital points to reference individual bits configuration.
- Analog points to reference individual bytes, words, or longwords configuration.
- Supported addresses.

R Data definition

R Data	Is for internal relays.
R data points	Are read and write.

Digital points to reference individual bits

Point Class	DIGITAL
Type	BOOL
Access	Read or Read/Write
Valid Addresses	Rxxxx, where xxxx is a valid address for your PMC type
Address Offset	0-7, for the particular bit you want to reference

Analog points to reference individual bytes, words, or longwords

Point Class	ANALOG
Type	SINT, INT, or DINT (1, 2, or 4 bytes)
Access	Read or Read/Write

Valid Addresses	Rxxxx, where xxxx is a valid address for your PMC type
Address Offset	none

Supported addresses

CNC	PMC Type		Valid Address Range
Series 150	NA		R0000-R0999 R2000-R2999
	NB		R0000-R1499 R9000-R9117
	NB2		R0000-R2999 R9000-R9199
Series 150i	NB6		R0000-R2999 R9000-R9199
Series 160/180-B/C	SA1		R0000-R0999 R9000-R9099
	SB3/SB5/SC3		R0000-R1499 R9000-R9117
	SB4/SB6/SC4		R0000-R2999 R9000-R9199
Series 210-B, 0i-A	SA1		R0000-R0999 R9000-R9099
	SA3		R0000-R0999 R9000-R9117
Series 160i/180i, 0i-B(SB7)	SB5		R0000-R1499 R9000-R9117
	SB6	R0000-R2999 R9000-R9199	
	SB7		R0000-R7999 R9000-R9499
Series 210i, 0i-B(SA1)	SA1		R0000-R0999 R9000-R9099
	SA5		R0000-R0999 R9000-R9117
Series 0i-D	PMC		R0000-R7999 R9000-R9499
	PMC/L		R0000-R1499 R9000-R9499
Series Mate 0i-D	PMC/L		R0000-R1499 R9000-R9499
Power Mate	All		R0000-R0999 R9000-R9117
Power Mate i	SB5		R0000-R1499 R9000-R9117
	SB6		R0000-R2999 R9000-R9199
CNC	1st PMC	*2nd PMC	*3rd PMC
Series 30i/31i/32i			
User Range	R0000-R7999	R0000-R1499	R0000-R1499
System Range	R9000-R9499	R9000-R9499	R9000-R9499

* Optional.

T Data

- T Data definition.
- Digital points to reference individual bits configuration.
- Analog points to reference individual bytes, words, or longwords configuration.
- Supported addresses.

T Data definition

T Data	Is for changeable timers.
T data points	Are read and write.

Digital points to reference individual bits

Point Class	DIGITAL
Type	BOOL
Access	Read or Read/Write
Valid Addresses	Txxxx, where xxxx is a valid address for your PMC type
Address Offset	0-7, for the particular bit you want to reference

Analog points to reference individual bytes, words, or longwords

Point Class	ANALOG
Type	SINT, INT, or DINT (1, 2, or 4 bytes)
Access	Read or Read/Write
Valid Addresses	Txxxx, where xxxx is a valid address for your PMC type
Address Offset	none

Supported addresses

CNC	PMC Type	Valid Address Range
Series 150	NA/NB	T0000-T0079
	NB2	T0000-T0299
Series 150i	NB6	T0000-T0299
Series 160/180-B/C	SA1/SB3/SB5/SC3	T0000-T0079
	SB4/SB6/SC4	T0000-T0299
Series 210-B, 0i-A	SA1/SA3	T0000-T0079

CNC	PMC Type		Valid Address Range
Series 160i/180i, 0i-B(SB7)	SB5		T0000-T0079
	SB6	T0000-T0299	
	SB7		T0000-T0499, T9000-T9499
Series 210i, 0i-B(SA1)	SA1/SA5		T0000-T0079
Series 0i-D	PMC		T0000-T0499 T9000-T9499
	PMC/L		T0000-T0079 T9000-T9079
Series Mate 0i-D	PMC/L		T0000-T0079 T9000-T9079
Power Mate	All		T0000-T0079
Power Mate i	SB5		T0000-T0079
	SB6		T0000-T0299
CNC	1st PMC	*2nd PMC	*3rd PMC
Series 30i/31i/32i			
Changeable time	T0000-T0499	T0000-T0079	T0000-T0079
Variable-timer precision	T9000-T9499	T9000-T9079	T9000-T9079

* Optional

**

 **Note:** The CRT/MDI panel and the CNC Screens provide the ability to display Timer data as both individual bits, and as word data using the Timer screen. When displayed as word data, the Timer screen manipulates the data and displays the actual data as multiples of 48 or 8. software does not manipulate the data when you configure points as word data.

K Data

- K Data definition.
- Digital points to reference individual bits configuration.
- Analog points to reference individual bytes, words, or longwords configuration.
- Supported addresses.

K Data definition

K Data	Is for keep relays.
K data points	Are read and write.

Digital points to reference individual bits

Point Class	DIGITAL
Type	BOOL
Access	Read or Read/Write
Valid Addresses	Kxxxx, where xxxx is a valid address for your PMC type
Address Offset	0-7, for the particular bit you want to reference

Analog points to reference individual bytes, words, or longwords

Point Class	ANALOG
Type	SINT, INT, or DINT (1, 2, or 4 bytes)
Access	Read or Read/Write
Valid Addresses	Kxxxx, where xxxx is a valid address for your PMC type
Address Offset	none

Supported addresses

CNC	PMC Type	Valid Address Range
Series 150	NA	K0000-K0018
	NB	K0000-K0019
	NB2	K0000-K0039 K0900-K0909
Series 150i	NB6	K0000-K0039 K0900-K0909
Series 160/180-B/C	SA1/SB3/SB5/SC3	K0000-K0019
	SB4/SB6/SC4	K0000-K0039 K0900-K0909
Series 210-B, 0i-A	SA1/SA3	K0000-K0019
Series 160i/180i, 0i-B(SB7)	SB5	K0000-K0019
	SB6	K0000-K0039 K0900-K0909
	SB7	K0000-K0099 K0900-K0919
Series 210i, 0i-B(SA1)	SA1/SA5	K0000-K0019
Series 0i-D	PMC	K0000-K0099 K0900-K0999
	PMC/L	K0000-K0019
Series Mate 0i-D	PMC/L	K0000-K0019
Power Mate	All	K0000-K0019
Power Mate i	SB5	K0000-K0019
	SB6	K0000-K0039 K0900-K0909

CNC		PMC Type		Valid Address Range
CNC		1st PMC	*2nd PMC	*3rd PMC
Series 30i/31i/32i				
User Range	K0000-K0099	K0000-K0019		K0000-K0019
System Range	K0900-K0999	K0900-K0999		K0900-K0999

* Optional.

 **Note:** The CRT/MDI panel and the CNC Screens provide the ability to display K data as individual bits. To configure points to display data in the same format, configure DIGITAL points of type BOOL.

 **CAUTION:** If you have an NA, NB, RA1, RA3, RB3, or and RC3 PMC, you must not write to Keep Relay locations K0017-K0019. If you have an RB4 or an RC4 PMC, you must not write Keep Relay locations K0900-K0909. CIMPLICITY software will not prevent you from writing to these memory locations.

C Data

- C Data definition.
- Digital points to reference individual bits configuration.
- Analog points to reference individual bytes, words, or longwords configuration.
- Supported addresses.

C Data definition

C Data	Is for counters.
C data points	Are read and write.

Digital points to reference individual bits

Point Class	DIGITAL
Type	BOOL
Access	Read or Read/Write
Valid Addresses	Cxxxx, where xxxx is a valid address for your PMC type
Address Offset	0-7, for the particular bit you want to reference

Analog points to reference individual bytes, words, or longwords

Point Class	ANALOG
-------------	--------

Type	SINT, INT, or DINT (1, 2, or 4 bytes)
Access	Read or Read/Write
Valid Addresses	Cxxxx, where xxxx is a valid address for your PMC type
Address Offset	none

Supported addresses

CNC	PMC Type		Valid Address Range
Series 150	NA/NB		C0000-C0079
	NB2		C0000-C0199
Series 150i	NB6		C0000-C0199
Series 160/180-B/C	SA1/SB3/SB5/SC3		C0000-C0079
	SB4/SB6/SC4		C0000-C0199
Series 210-B, 0i-A	SA1/SA3		C0000-C0079
Series 160i/180i, 0i-B(SB7)	SB5		C0000-C0079
	SB5	C0000-C0199	
	SB7		C0000-C0399 C5000-C5199
Series 210i, 0i-B(SA1)	SA1/SA5		C0000-C0079
Series 0i-D	PMC		C0000-C0399 C5000-C5199
	PMC/L		C0000-C0079 C5000-C5039
Series Mate 0i-D	PMC/L		C0000-C0079 C5000-C5039
Power Mate	All		C0000-C0079
Power Mate i	SB5		C0000-C0079
	SB6		C0000-C0199
CNC	1st PMC	*2nd PMC	*3rd PMC
Series 30i/31i/32i			
Changeable counter	C0000-C0399	C0000-C0079	C0000-C0079
Fixed counter	C5000-C5199	C5000-C5039	C5000-C5039

*Optional

**

 **Note:** The CRT/MDI panel and the CNC Screens provide the ability to display C data as individual bits, or as word data from the Counter screen. On the Counter screen, the first 2 bytes will be displayed in a column labeled **Preset value**. The next 2 bytes are displayed in a column

labeled **Current data**. You should configure points as type INT to obtain data in a similar format to the Counter screen. For example, a point of type INT with address C0000 would contain the Preset value. A point of type INT with address C0002 would contain the Current value.

D Data

- D Data definition.
- Digital points to reference individual bits configuration.
- Analog points to reference individual bytes, words, or long words configuration.
- Supported addresses.

D Data definition

D Data	Is to access the data table.
D data points	Are read and write.

Digital points to reference individual bits

Point Class	DIGITAL
Type	BOOL
Access	Read or Read/Write
Valid Addresses	Dxxxx, where xxxx is a valid address for your PMC type
Address Offset	0-7, for the particular bit you want to reference

Analog points to reference individual bytes, words, or longwords

Point Class	ANALOG
Type	SINT, INT, or DINT (1, 2, or 4 bytes)
Access:	Read or Read/Write
Valid Addresses	Dxxxx, where xxxx is a valid address for your PMC type
Address Offset	none

Supported addresses

CNC	PMC Type	Valid Address Range
Series 150	NA/NB	D0000-D0299
	NB2	D0000-D7999
Series 150i	NB6	D0000-D7999
Series 160/180-B/C	SA1	D0000-D1859

CNC	PMC Type		Valid Address Range
	SB3/SB5/SC3		D0000-D2999
	SB4/SB6/SC4		D0000-D7999
Series 210-B, 0i-A	SA3		D0000-D1859
Series 160i/180i, 0i-B(SB7)	SB5		D0000-D2999
	SB6	D0000-D7999	
	SB7		D0000-D9999
Series 210i, 0i-B(SA1)	SA1/SA5		D0000-D1859
Series 0i-D	PMC		D0000-D9999
	PMC/L		D0000-D2999
Series Mate 0i-D	PMC/L		D0000-D2999
Power Mate	All		D0000-D1859
Power Mate i	SB5		D0000-D2999
	SB6	D0000-D7999	
CNC	1st PMC	*2nd PMC	*3rd PMC
Series 30i/31i/32i	D0000-D9999	D0000-D2999	D0000-D2999

* Optional

 **Note:** The CRT/MDI panel and the CNC Screens provide the ability to display D data individual bits, and as longwords from the Data screen. To have software display the data in the same format, configure points as type DINT.

E Data

 **Note:** E Data is supported only on Series 160i, 180i, and 0i with a PMC SB7, and Series 30i/31i/32i.

- E Data definition.
- Digital points to reference individual bits configuration.
- Analog points to reference individual bytes, words, or longwords configuration.
- Supported addresses.

E Data definition

E Data	Is for extended relay.
E data points	Are read and write.

Digital points to reference individual bits

Point Class	DIGITAL
Type	BOOL
Access	Read or Read/Write
Valid Addresses	Exxxx, where xxxx is a valid address for your PMC type
Address Offset	0-7, for the particular bit you want to reference

Analog points to reference individual bytes, words, or longwords

Point Class	ANALOG
Type	SINT, INT, or DINT (1, 2, or 4 bytes)
Access:	Read or Read/Write
Valid Addresses	Exxxx, where xxxx is a valid address for your PMC type
Address Offset	none

Supported addresses

CNC	PMC Type		Valid Address Range
Series 160i/180i, 0i-B(SB7)	SB7		E0000-E7999
Series 0i-D	All		E0000-E9999
CNC	1st PMC	*2nd PMC	*3rd PMC
Series 30i/31i/32i	E0000-E9999	E0000-E9999**	E0000-E9999**

* Optional

** This area is common memory for the multi-PMC function. It is possible for each program to read the same value from, and write to, the area.

Note: The 30i/31i/32i CNC's can have up to 3 PMC ladders. This is different than older controls. The E range listed is for sharing data between the 3 ladders.

Skip Data

Skip Data points	Are read-only.
------------------	----------------

When configuring Skip Data points, specify the following attributes.

Point Class	ANALOG
Type	REAL

Access	READ
CNC	Valid Addresses
Series 150/150i	SD1-SD24
Series 160/180/210, 160i/180i/210i, 0i	SD1-SD8
Series 30i/31i/32i	SD1-SD32
Power Mate i-D	SD1, SD2
Power Mate H	SD1-SD6
Address Offset	None

 **Note:** If the current number of controlled axes on your CNC is less than 8, then you will be able to obtain data only for the number of axes you have configured. For example, if your CNC is currently configured for 3 controlled axes, then you may define Skip Data points SD1 - SD8. However, only points SD1, SD2, and SD3 will have values.

Tool Offset Data

Tool Offset Data

Note:

- The types of data that you can access in the tool offset table depends on the type of:
- CNC (M, T or Power Mate) and
- Tool offset memory (A, B, or C)

that you purchased for your CNC.

- The Series 160i/180i W CNC, when using FOCA/HSSB, does not support tool offset data.
- Data type details.
- Number of allowed tool offsets for series.
- Significant digits before and after a decimal point.

Data type details

- Machining Series &endash; Memory Type A (including Power Mate and Series 30i/31i/32i).
- Machining Series &endash; Memory Type B
- Machining Series &endash; Memory Type C
- Lathe Series / Tool Offset &endash; Memory Type A
- Lathe Series &endash; Memory Type B

Number of allowed tool offsets for series

The total number of tool offsets that you can access for each memory type depends upon the number of tool offsets that you have purchased for your CNC.

The number of allowed tool offsets for series are:

CNC	Total number of allowed Tool offsets
Series 150/150i M	32, 99, 200, 499, or 999
Series 150 T	32, 64, or 160
Series 150TT	16, 32 or 80 (each path)
Series 160/180-210, 160i/180i/210i, Oi M	32, 64, 99, 200, 400, 499 or 999
Series 160/180/210, 160i/180i/210i, Oi T	16, 32, 64, or 99
Series 30i/31i,32i	16, 32, 64, 99, 200, 400, 499, 999 or 2000
Power Mate H	99
Power Mate i	32, 64, 99, 200, 400, 499 or 999

Significant digits before and after a decimal point

For example, the number of significant digits you can enter before and after the decimal point can include the following. Be aware that the actual number of digits will vary based on the CNC model you are using.

For	Number of Digits	
Inches	Before the decimal point	Up to 3 digits
	After the decimal point	4 digits
	Example 999.9999 is valid. 9999.9999 is not valid.	
Millimeters	Before the decimal point	Up to 4 digits
	After the decimal point	3 digits

 **Note:** The Power Mate control only supports Machining Series memory type A.

Machining Series - Memory Type A (Including Power Mate and Series Series 30i/31i,32i)

Point types that can be configured for Machining series - Memory Type A or Power Mate include:

- Single Tool offsets.
- Direction of imaginary tool nose (Series 30i/31i/32i).

Single Tool Offsets

Point Class	ANALOG
Type	REAL
Access	Read-only or Read/Write
Valid Addresses	TOSx, where x is a valid tool offset number for your CNC.
Address Offset	N/A

Direction of imaginary tool nose (Series 30i/31i,32i only)

Point Class	ANALOG
Type	REAL
Access	Read-only or Read/Write
Valid Addresses	DITNx, where x is a valid tool offset number for your CNC.
Address Offset	N/A

Machining Series - Memory Type B

Point types that can be configured for Machining series - Memory Type B include:

- Tool geometry offsets.
- Tool wear offsets.
- Direction of imaginary tool nose (Series 30i/31i/32i only).

Tool Geometry Offsets

Point Class	ANALOG
Type	REAL
Access	Read-only or Read/Write
Valid Addresses	TGOx, where x is a valid tool offset number for your CNC
Address Offset	N/A

Tool Wear Offsets

Point Class	ANALOG
Type	REAL
Access	Read-only or Read/Write
Valid Addresses	TWOx, where x is a valid tool offset number for your CNC

Address Offset	N/A
----------------	-----

Direction of Imaginary Tool Nose (Series 30i/31i/32i only)

Point Class	ANALOG
Type	REAL
Access	Read-only or Read/Write
Valid Addresses	DITNx, where x is a valid tool offset number for your CNC
Address Offset	N/A

Machining Series - Memory Type C

Point types that can be configured for Machining series - Memory Type C include:

- Tool length / Geometry offsets.
- Tool length / Wear offsets.
- Cutter radius / Geometry offsets.
- Cutter radius / Wear offsets.
- Direction of imaginary tool nose (Series 30i/31i/32i only).

Tool Length / Geometry Offsets

Point Class	ANALOG
Type	REAL
Access	Read-only or Read/Write
Valid Addresses	TLGx, where x is a valid tool offset number for your CNC
Address Offset	N/A

Tool Length / Wear Offsets

Point Class	ANALOG
Type	REAL
Access:	Read-only or Read/Write
Valid Addresses	TLWx, where x is a valid tool offset number for your CNC
Address Offset	N/A

Cutter Radius / Geometry Offsets

Point Class	ANALOG
Type	REAL

Access	Read-only or Read/Write
Valid Addresses	CRGx, where x is a valid tool offset number for your CNC
Address Offset	N/A

Cutter Radius / Wear Offsets

Point Class	ANALOG
Type	REAL
Access	Read-only or Read/Write
Valid Addresses	CRWx, where x is a valid tool offset number for your CNC
Address Offset	N/A

Direction of Imaginary Tool Nose (Series 30i/31i/32i only)

Point Class	ANALOG
Type	REAL
Access	Read-only or Read/Write
Valid Addresses	DITNx, where x is a valid tool offset number for your CNC
Address Offset	N/A

Lathe Series/Tool Offset - Memory Type A

Point types that can be configured for Lathe series - Memory Type A include:

- X-axis geometry offsets.
- Y-axis geometry offsets.
- Z-axis geometry offsets.
- Nose radius offsets
- Direction of imaginary tool nose.

X-axis Geometry Offsets

Point Class	ANALOG
Type	REAL
Access:	Read-only or Read/Write
Valid Addresses	XAOx, where x is a valid tool offset number for your CNC.
Address Offset	N/A

Y-axis Geometry Offsets

Point Class	ANALOG
Type	REAL
Access	Read-only or Read/Write
Valid Addresses	YAOx, where x is a valid tool offset number for your CNC.
Address Offset	N/A

Z-axis Geometry Offsets

Point Class	ANALOG
Type	REAL
Access	Read-only or Read/Write
Valid Addresses	ZAOx, where x is a valid tool offset number for your CNC.
Address Offset	N/A

Nose Radius Offsets

Point Class	ANALOG
Type	REAL
Access	Read-only or Read/Write
Valid Addresses	NROx, where x is a valid tool offset number for your CNC.
Address Offset	N/A

Direction of Imaginary Tool Nose

Point Class	ANALOG
Type	INT
Access	Read-only or Read/Write
Valid Addresses	DITNx, where x is a valid tool offset number for your CNC.
Address Offset	N/A

Lathe Series - Memory Type B

Point types that can be configured for Lather series - Memory Type B include:

- X-axis geometry offsets.
- Y-axis geometry offsets.
- Z-axis geometry offsets.
- Nose radius geometry offsets.
- X-axis wear offsets.

- Y-axis wear offsets.
- Z-axis wear offsets.
- Nose radius wear offsets.
- Direction of imaginary tool nose.

X-axis Geometry Offsets

Point Class	ANALOG
Type	REAL
Access	Read-only or Read/Write
Valid Addresses	XGOx, where x is a valid tool offset number for your CNC.
Address Offset	N/A

Y-axis Geometry Offsets

Point Class	ANALOG
Type	REAL
Access	Read-only or Read/Write
Valid Addresses	YGOx, where x is a valid tool offset number for your CNC.
Address Offset	N/A

Z-axis Geometry Offsets

Point Class	ANALOG
Type	REAL
Access	Read-only or Read/Write
Valid Addresses	ZGOx, where x is a valid tool offset number for your CNC.
Address Offset	N/A

Nose Radius Geometry Offsets

Point Class	ANALOG
Type	REAL
Access	Read-only or Read/Write
Valid Addresses	NRGx, where x is a valid tool offset number for your CNC.
Address Offset	N/A

X-axis Wear Offsets

Point Class	ANALOG
Type	REAL
Access	Read-only or Read/Write
Valid Addresses	XWOx, where x is a valid tool offset number for your CNC.
Address Offset	N/A

Y-axis Wear Offsets

Point Class	ANALOG
Type	REAL
Access	Read-only or Read/Write
Valid Addresses	YWOx, where x is a valid tool offset number for your CNC.
Address Offset	N/A

Z-axis Wear Offsets

Point Class	ANALOG
Type	REAL
Access	Read-only or Read/Write
Valid Addresses	ZWOx, where x is a valid tool offset number for your CNC.
Address Offset	N/A

Nose Radius Wear Offsets

Point Class	ANALOG
Type	REAL
Access	Read-only or Read/Write
Valid Addresses	NRWx, where x is a valid tool offset number for your CNC.
Address Offset	N/A

Direction of Imaginary Tool Nose

Point Class	ANALOG
Type	REAL
Access	Read-only or Read/Write
Valid Addresses	DITNx, where x is a valid tool offset number for your CNC.

Address Offset	N/A
----------------	-----

Work Zero Offset Data

Significant digits before and after a decimal point.
Number of allowed work zero offsets for series.
Work Zero Offset notes.
Work Zero Offset attributes.

Number of allowed work zero offsets for series

The total number of work zero offsets you may access depends upon the number you have purchased for your CNC.

The number of zero offsets for series are:

CNC	Total number of allowed Work Zero offsets
Series 150/150i, 0i-D	0-6, 7-54
Series 160/180/210, 160i/180i-210i, 0i-A/B/C M	0 -6, 7-54, 55-306
Series 160/180/210, 160i/180i-210i, 0i-A/B/C T	0-6
Series 30i/31i/32i	0-6, 7-54, 55-306
Value	Definition
0	External work zero offset value of Common.
1,...,6	Work zero offset value of G54 through G59.
7,...,54	Work zero offset value of G54.1P1 through G54.1P48.
55,...,306	Work zero offset value of G54.1P49 through G54.1P300.

Significant digits before and after a decimal point

For example, the number of significant digits you can enter before and after the decimal point can include the following. Be aware that the actual number of digits will vary based on the CNC model you are using.

For	Number of Digits	
Inches	Before the decimal point	Up to 4 digits

For	Number of Digits	
	After the decimal point	4 digits
	Example 9999.9999 is valid 99999.9999 is not.	
Millimeters	Before the decimal point	Up to 5 digits
	After the decimal point	3 digits

Work Zero Offset Notes

When configuring an array point to access work zero offset data, keep in mind that data is addressed one axis at a time.

Example

Configuraton	Description
Array point	10 elements
Address for the point	WZO1A1
Array	Description
First element	Offset 1, Axis 1
Second element	Offset 2, Axis 1 (not Offset 1, Axis 2).

! **Important:** The Power Mate, Power Mate i and Series 210 T CNC's do not support the Work Zero Offset table.

Work Zero Offset attributes

To configure a point to access work zero offset data, you must specify the following information.

Point Class	ANALOG
Type	REAL
Access	Read or Read/Write
Valid Addresses	WZOxAy, where x is a valid tool offset number for your CNC, and y is a valid axis number.
Address Offset	N/A

Tool Life Management Data

Tool Life Management Data

Be aware that:

- Bits for Tool Life Management and Tool Life Management B are options you can purchase .

- Tool Life Management B is supported only on Series 160i, 180i, and 30i/31i/32i .
- Tools and tool groups cannot be created or deleted using points; they can only be read, modified or cleared.

Point Configuration Criteria

- Clear tool life groups.
- Current number of registered tool groups.
- Current tool group number.
- Current tool number.
- Individual tool data.
- Maximum number of registered tool groups.
- Maximum number of registered tools.
- Optional group number for tool groups. (Tool Life management B only.)
- Tool group data.
- Tool group rest counter. (Tool Life Management B only.)
- Tool life counter.

Clear Tool Life Groups

Points can be configured to clear the following for each tool group or any number of tool groups.

- Tool life counter and
- Tool information.

Specify the following for clear the tool life group points.

Point Class	ANALOG
Type	INT
Access	Read/Write
Valid Addresses	CLTG<x>, where x is the tool group number and the data value is the end tool group number.
Number of Elements	1

Example 1

IF	Address =	CLTG1
	Data Value =	0 or 1
Then	Tool Group 1 is cleared from the CNC system data.	

Example 2

IF	Address =	CLTG1
----	-----------	-------

	Data Value =	20
Then	Tool Groups 1 through 20 are cleared from the CNC system data.	

Current Number of Registered Tool Groups

Specify the following for current number of registered tool groups points.

Point Class	ANALOG
Type	DINT
Access	Read-only
Valid Addresses	CNTG
Number of Elements	1

Current Tool Group Number

Specify the following for current tool group number points.

Point Class	ANALOG
Type	DINT
Access	Read-only
Valid Addresses	CTG
Number of Elements	1

Current Tool Number

Specify the following for current tool number data points in a currently selected group.

Point Class	ANALOG
Type	DINT
Access	Read-only
Valid Addresses	CTN
Number of Elements	1

Individual Tool Data

- Point data access.
- Point configuration.
- Point array elements.

Point data access

You can configure a point to access individual tool data, including the:

Tool number	T-code
Tool length compensation number	H-code
Cutter radius compensation number	D-code
Status of the individual tool	<ul style="list-style-type: none"> • Registered • Expired • Skipped

Note:

Access for:

Machining CNC	Type M	Are read/write.
Lathe CNC	Type T	Are read-only. The tool length compensation number and the cutter radius compensation number will always have a value of 0, since this data does not apply to a Lathe CNC.

Point configuration

Specify the following for individual tool data access points.

Point Class	ANALOG
Type	DINT
Elements	4-element array
Access	Read/Write
Valid Addresses	INTD< X >, where X is the tool number
Number of Elements	4

Point array elements

The elements of the Individual Tool Data point array are as follows:

Element 0	The tool number (T-code)	
Element 1	The tool length compensation number (H-code)	
Element 2	The cutter radius compensation number (D-code)	
Element 3	The status of the individual tool are as follows:	
	Value	The tool is:

	1	Registered
	2	Expired
	3	Skipped

 **Note:** If the first element of the array point, element 0, has a value of 0, this indicates that this tool does not exist. If this is the case, then you should not try to set the other elements of this array point.

Also, note that there is a special numbering mechanism that is used when configuring the address of individual tool points. The number of tool groups and the number of tools in each group is enabled in the controller. Therefore, the address of the first tool in tool group 1 is `INTD1` and the address of the first tool in tool group 2 could be `INTD 3, 5, 9, 17` or `33`. The first tool number in tool group 2 depends on the configuration of the controller.

Examples

- If each group has 2 tools.

Addresses are:

Tool Group	Addresses
Group 1	INTD1, INTD2
Group 2	INTD3, INTD4

- If each group has 4 tools.

Addresses are:

Tool Group	Addresses
Group 1	INTD1, INTD2, INTD3, INTD4
Group 2	INTD5, INTD6, INTD7, INTD8

Maximum Number of Registered Tool Groups

Specify the following for the maximum number of registered tool groups points.

Point Class	ANALOG
Type	DINT
Access	Read-only
Valid Addresses	MNTG
Number of Elements	1

Maximum Number of Registered Tools

You can configure a point to read the maximum number of tools that can be registered in any given tool group. This point may not be written.

Specify the following for the maximum number of registered tools points.

Point Class	ANALOG
Type	DINT
Access	Read-only
Valid Addresses	MNRT
Number of Elements	1

Optional Group Number for Tool Groups

You can configure a point to read and write the optional 8-digit group number for each tool group.

 **Note:** Optional Tool Group Number points can only be configured if you have purchased the **Tool Life Management B** option bit.

Specify the following for optional tool group number points.

Point Class	ANALOG
Type	DINT
Access	Read/Write
Valid Addresses	OTGN<X>, where X is the tool group number
Number of Elements	1

 **Note:** If a given tool group does not have any registered tools, the value of the optional tool group number will be 0. Attempts to set the optional tool group number will fail.

Tool Group Data

- Point data access.
- Point configuration.
- Point array elements.

Point data access

You can configure a point to access tool group data, including the:

- Number of tools in the tool group.

- Tool life value.
- Tool group count (number of cuts).
- Units to be used to increment the count (either Cycles or Minutes).

 **Note:**

Access for:

Machining CNC	Type M	Are read/write except for the number of tools in the tool group.
Lathe CNC	Type T	Are read-only.

Point Configuration

Specify the following for tool group data points.

Point Class	ANALOG
Type	DINT
Access	Read/Write
Valid Addresses	TDGN< X >, where X is the tool group number
Number of Elements	4

Point array elements

The elements of the Individual Tool Data point array are as follows.

Element 0	The number of tools in the tool group	
Element 1	The tool life value	
Element 2	The tool group count (number of cuts)	
Element 3	The units to be used to increment the counter. The value identifies the unit as follows.	
	Value	Unit
	0	Cycles
	1	Minutes

 **Note:** If the first element of the array point, element 0, has a value of 0, this indicates that no tools have been registered in this tool group. If this is the case, then you should not try to set the other elements of this array point.

Tool Group Rest Counter

You can configure a point to read and write the rest counter for each tool group.

 **Note:** Rest Counter points can only be configured if you have purchased the **Tool Life Management B** option bit.

Specify the following for tool group rest counter points.

Point Class	ANALOG
Type	DINT
Access	Read/Write
Valid Addresses	REST<X>, where X is the tool group number
Number of Elements	1

 **Note:** If a given tool group does not have any registered tools, the value of the rest counter will be 0. Attempts to set the rest counter will fail.

Tool Life Counter

You can configure a point to read and write the tool life counter for each tool group.

Specify the following for tool life counter points for each tool group.

Point Class	ANALOG
Type	DINT
Access	Read/Write
Valid Addresses	TLC<x>, where x is the tool group number
Number of Elements	1

 **Note:** If a given tool group does not have any registered tools, the value of the tool life counter will be 0. Attempts to set the tool life counter will fail.

Tool Management Data

 **Note:** Bits for Tool Management are options you can purchase .

 **Important:** Tool Management Data is supported only on Series 160i, 180i, 210i, and 30i/31i/32i .

- Point data access.
- Point configuration.
- Point array elements.

Point data access

You can configure a point to access the Tool Management Data table, including the:

• Tool number	T code
• Tool life counter	
• Maximum of tool life	
• Predictive tool life	
• State of tool life	<ul style="list-style-type: none"> • Tool is not managed • Unused tool • Enable to use • Life is over • Tool is broken
• Customizing Bits	
• Tool info	bit 0 : RGS bit 1 : TIM bit 2 : BDT bit 3 : LOC bit 4,...,15 : Reserved
• Tool length compensation number	H code
• Cutter compensation number	D code
• Spindle speed	S code
• Feed rate	F code
• Magazine number	Read-only

• Pot number	Read-only
• Tool geometric compensation number	G code Turning system only
• Tool wear compensation number	W code Turning system only

Point configuration

Specify the following for the Tool Management Data table access points.

Point Class	ANALOG
Type	DINT
Elements	15-element array
Access	Read/Write
Valid Addresses	TOOL<X>, where X is the tool number
Number of Elements	15

Point array elements

The elements of the Tool Management Data table point array are as follows.

Element 0	Tool number (T)			
	Setting range	0 to 99999999		
Element 1	Tool life counter			
	Setting range	0 to 99999999	Unit	count
	Setting range	0 to 3599999	Unit	sec
Element 2	Maximum of tool life			
	Setting range	0 to 99999999	Unit	count
	Setting range	0 to 3599999	Unit	sec
Element 3	Predictive tool life			
	Setting range	0 to 99999999	Unit	count

	Setting range	0 to 3599999	Unit	sec
Element 4	State of tool life			
	0	Tool is not managed		
	1	Unused tool		
	2	Enable to use		
	3	Life is over		
	4	Tool is broken		
Element 5	Customizing Bits			
Element 6	Tool info			
	bit 0	: RGS		
		0	Tool management data is void.	
		1	Tool management data is valid.	
	bit 1	: TIM		
		0	Tool life is specified by count.	
		1	Tool life is specified by time.	
	bit 2	: BDT		
		0	Normal tool.	
		1	Big tool.	
	bit 3	: LOC		
		0	Data accessible.	
		1	Data locked.	
	bit 4,...,15	Reserved		
Element 7	Tool length compensation number (H)			
	Setting range	0 to 999		
Element 8	Cutter compensation number (D)			
	Setting range	0 to 999		
Element 9	Spindle speed (S)			
	Setting range	0 to 99999	Unit	/min
Element 10	Feed rate (F)			
	Setting range	0 to 99999999	Unit	mm/min inch/min deg/min mm/rev inch/rev
Element 11	Magazine number	This data is read-only; it cannot be used for writing data.		

Element 12	Pot number	This data is read-only; it cannot be used for writing data.
Element 13	Tool geometric compensation number (G)	This data is Turning system only.
Element 14	Tool wear compensation number (W)	This data is Turning system only.

 **Note:** If the first element of the array point, element 0, has a value of 0, this indicates that this tool does not exist. If this is the case, then you should not try to set the other elements of this array point.

Step 6. Configure Screens

Step 6. Configure Screens

Step 6.1 (page 250)	Use CNC QuikStart Demo project screens.
-------------------------------------	---

 **Tip:** All of the CIMPLICITY CimEdit capability is available, in addition to the FANUC Controls, for creating HMI for CNC screens.

Step 6.1. Use the CNC QuikStart Demo Project screens

Step 6.1. Use the CNC QuikStart Demo Project screens

HMI for CNC includes a demo project named CNC Quikstart, which provides you with a configuration that can "quickstart" a customized project.

The demo project has several screens that enable you to monitor and modify the CNC.

Step 6.1.1 (page 250)	Start the CNC QuikStart Demo project.
Step 6.1.2 (page 253)	Review the CNC QuikStart Demo project screens.
Step 6.1.3 (page 261)	Stop the CNC QuikStart Demo project.

- Step 6. Configure screens.

Step 6.1.1. Start the CNC QuikStart Demo Project

1. Click Start on the Windows task bar.

2. Select (All) Programs> HMI SCADA - CIMPLICITY 10 >Start CNC QuikStart Demo project.

If the CNC_QUIKSTART project is not running

A Select CIMPLICITY® Project dialog box opens.

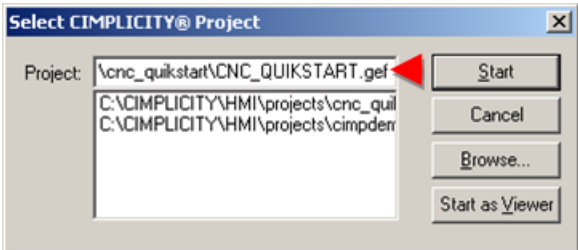

- a. Select CNC_QUIKSTART.gef.
- b. Click Start.

A message box asks if you want to start the project.

- a. Click Yes.

A Starting CNC_QUIKSTART window opens displaying the CIMPLICITY process startups.

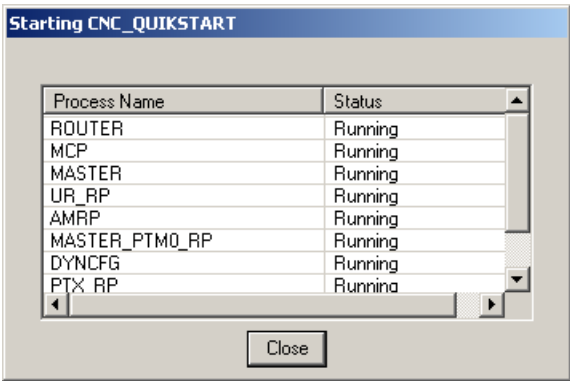

Result: A CIMPLICITY® Login dialog box opens.

When the CNC_QUIKSTART project is running

Result: A CIMPLICITY® Login dialog box opens.

3. Enter a **User ID** and **Password** for a user who has access to CNC runtime screens.



4. Click OK.

An HMI for CNC QuikStart Main Menu screen opens.

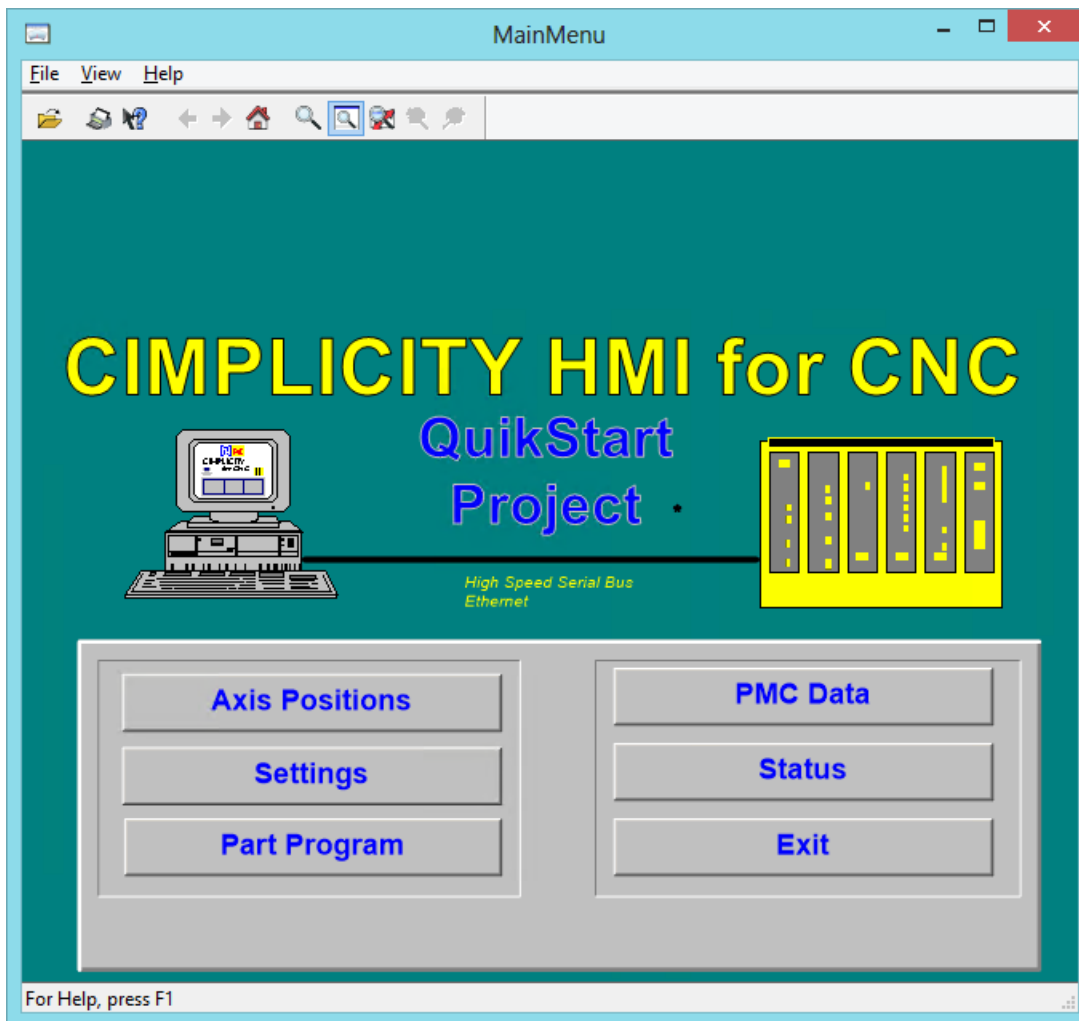

 **Note:** Your computer must be connected to a CNC and the CNC must be powered up for the CNC Demo project to function properly.

*Step 6.1.2. Review the CNC QuikStart Demo Project Screens**Step 6.1.2. Review the CNC QuikStart Demo Project Screens*

Several screens for the HMI for CNC QuikStart Project main menu are described in this section, along with a brief description of each screen's functionality.

 **Note:** Features on the screens are defaults. If necessary, you can modify any of the screens to customize them for your project.

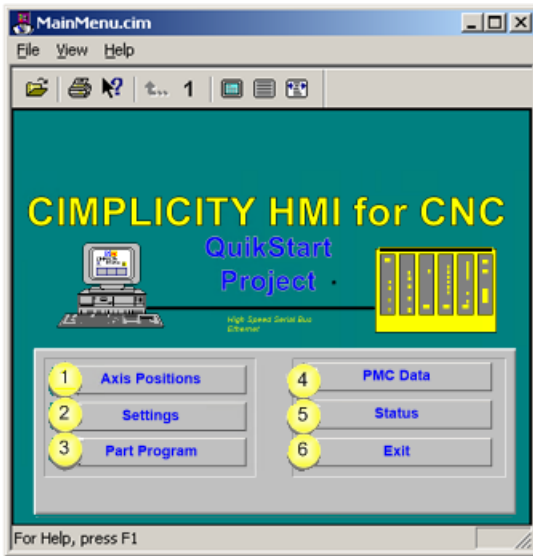

rect 19, 224, 112, 247 [Option 6.1.2.1. Axis Positions Screens \(page 254\)](#)

rect 19, 267, 112, 290 [Option 6.1.2.3. Part Program \(page 257\)](#)

rect 19, 245, 112, 268 [Option 6.1.2.2. Settings Screens \(page 255\)](#)

rect 114, 265, 207, 288 [Option 6.1.2.4. PMC Data Menu \(page 258\)](#)

rect 215, 245, 308, 268 [Option 6.1.2.5. Status Screen \(page 260\)](#)

rect 215, 267, 308, 290 [Option 6.1.2.6. Exit the QuikStart Project Main Menu \(page 261\)](#)

For Option 6.1.2.	
1 <i>(page 254)</i>	Axis Positions
2 <i>(page 255)</i>	Settings
3 <i>(page 257)</i>	Part Program
4 <i>(page 258)</i>	PMC Data

5 (page 260)	Status
6 (page 261)	Exit

Option 6.1.2.1. Axis Positions Screens

The **Axis Positions** button on the HMI for CNC QuikStart Project screen opens the Axis Positions Menu screen.

Axis Positions Menu

Buttons include:

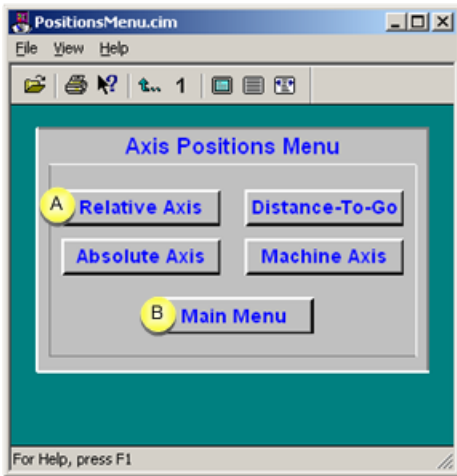

rect 19, 104, 146, 146 [\(page 255\)](#)

rect 84, 176, 217, 213 [Step 6.1.2. Review the CNC QuikStart Demo Project Screens \(page 253\)](#)

A (page 255)	Buttons on the Axis Positions Menu screen display the:	
	<ul style="list-style-type: none"> • Relative Axis. • Absolute Axis. • Distance-to-Go. • Machine Axis. 	
B (page 253)	Main Menu	Returns to the CNC QuikStart Project screen.

Relative Axis Screen

Note: The default screens that display for each of the selections are formatted the same, but are configured to report about the associated axis.

Default features include:

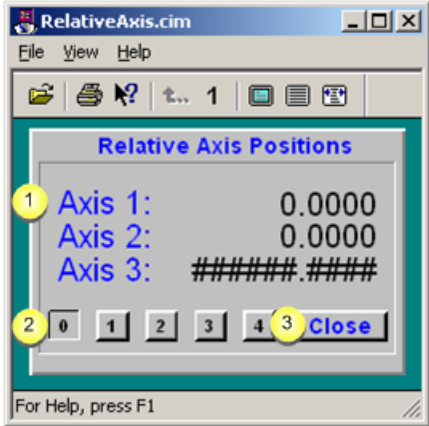

1	Axis positions 1 -3.	
2	Devices 0 - 4.	
3	Close	Returns to the Relative Axis Main Menu screen.

Option 6.1.2.2. Settings Screens

The **Settings** button on the HMI for CNC QuikStart Project screen opens the Settings Menu screen.

Buttons include:

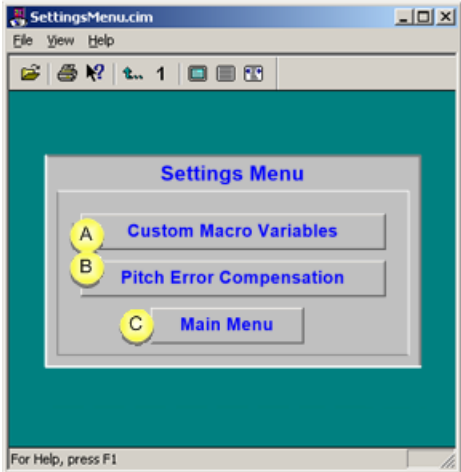

A (page 256)	Custom Macro Variables	
B (page 256)	Pitch Error Compensation	
C (page 253)	Main Menu	Returns to the CNC QuikStart Project screen.

1. Custom Macro Variables screen

Default features include:

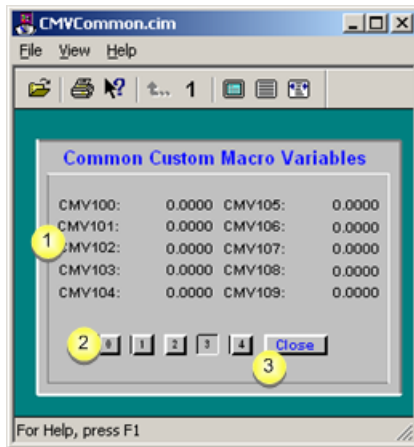

1	CMV macro variables	100 - 109	Read and write values.
2	Devices	0 - 4	
3	Close	Returns to the Settings Main Menu screen.	

Note: Set the value of a Custom Macro Variable by clicking selected value on screen.

[Up \(page 255\)](#)

1. Pitch Error Compensation screen

Default features include:

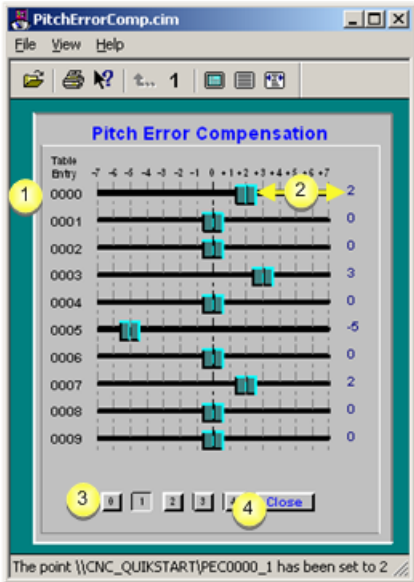

1	Pitch Error Compensation	0 - 9	Read and write values.
2	Slider - Value	Move slider to the:	
		Left	Decreases the value.
		Right	Increases the value.
3	Devices	0 - 4	
4	Close	Returns to the Settings Main Menu screen.	

[Up \(page 255\)](#)

Option 6.1.2.3. Part Program

The **Part Programs** button on the HMI for CNC QuikStart Project screen opens the Part Program window.

1. Part Program window

The CNC Part Program Application enables you to upload and download part programs between your PC and CNC.

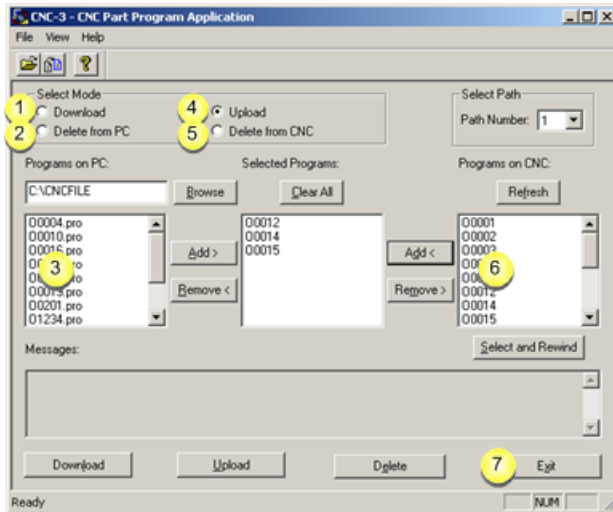

1	Download (page 332) part programs to the CNC.	
2	Delete (page 333) part program files from the PC>	
3	Part program files on the PC.	
4	Upload (page 334) part programs to the PC.	
5	Delete (page 336) part programs from the CNC.	
6	Part programs on the CNC.	
7 (page 250)	Exit	Returns to the CNC QuikStart Project screen.

Option 6.1.2.4. PMC Data Menu

The **PMC Data** button on the HMI for CNC QuikStart Project screen opens the PMC Data Menu screen.

PMC Data Menu

Buttons include:

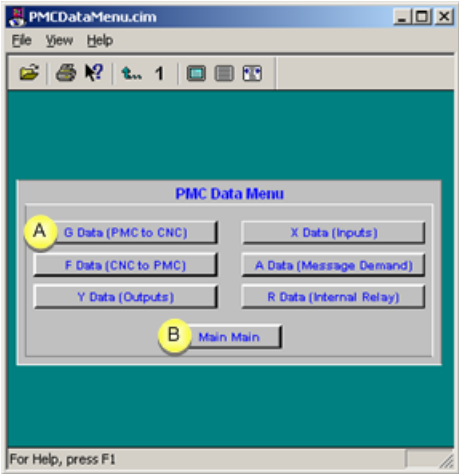

rect 94, 197, 182, 220 [Step 6.1.2. Review the CNC QuikStart Demo Project Screens \(page 253\)](#)
rect 18, 123, 258, 181 [\(page 259\)](#)

A	Buttons on the PMC Data Menu screen display the:	
	G Data	(PMC to CNC)
	F Data	CNC to PMC
	Y Data	Outputs
	X Data	Inputs
	A Data	Message Demand
	R Data	Internal Relay
B (page 253)	Main Menu	Returns to the CNC QuikStart Project screen.

G Data (PMC to CNC)

 **Note:** The default screens that display for each of the selections are formatted the same, but are configured to report about the associated PMC data.

Default features include:

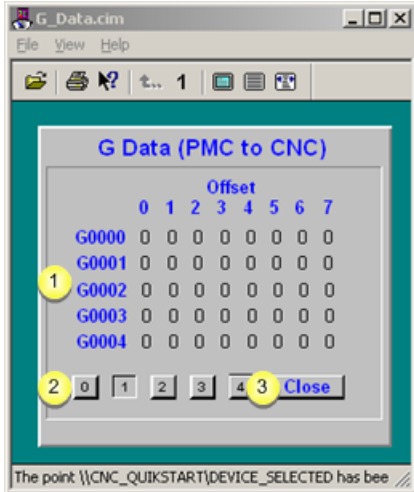

1	Offset	Read and write.
2	Devices	0 - 4
3	Close	Returns to the static Axis Main Menu screen.

 **Note:** Set the Offset value by clicking the selected value on screen.

Option 6.1.2.5. Status Screen

The **Status** button on the HMI for CNC QuikStart Project screen opens the Program Status screen.

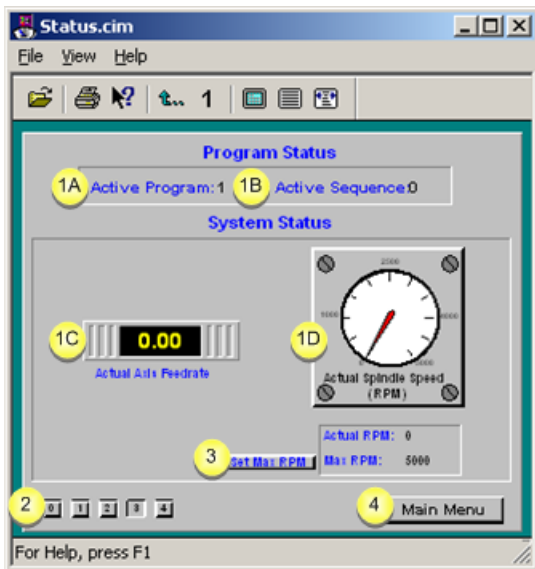

rect 223, 300, 311, 323 [Step 6.1.2. Review the CNC QuikStart Demo Project Screens \(page 253\)](#)

1	Displays the status for the CNC of the:
---	---

	<ol style="list-style-type: none">1. Active program number.2. Active sequence number.3. Actual axis feed rate.4. Actual spindle speed.
2	Devices 0-4
3	Set Max RPM. Set the maximum RPM scale on the Actual Spindle Speed gauge.
4 (page 253)	Main Menu. Returns to the CNC QuikStart Project screen.

Option 6.1.2.6. Exit the QuikStart Project Main Menu

Click **Exit** to close the HMI for CNC QuikStart Project screen.

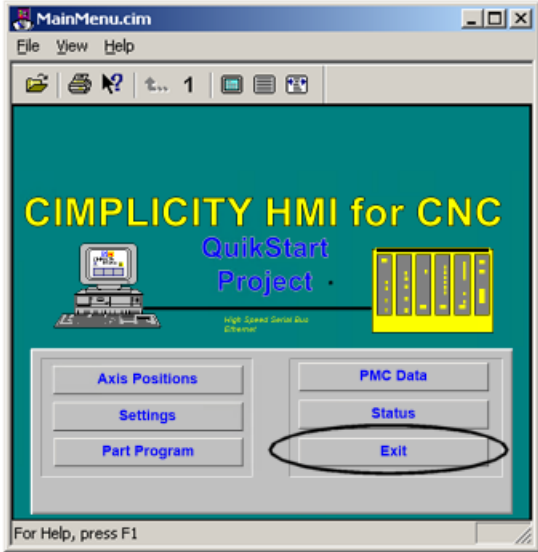

Step 6.1.3. Stop the CNC QuikStart Project

1. Click Start on the Windows task bar.
2. Select (All) Programs> HMI SCADA - CIMPLICITY version>CNC QuikStart Project.

The CIMPLICITY Workbench opens, displaying the CNC QuikStart project.

3. Click the Stop button.

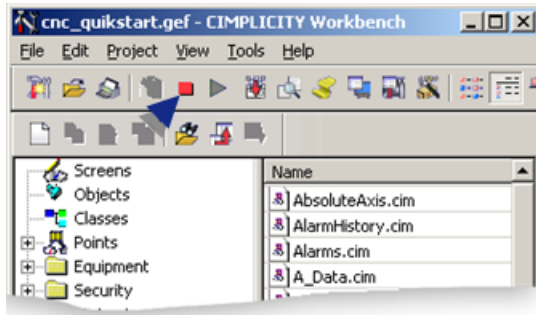

The CNC QuikStart Project stops.

Step 7. Configure and View Alarms

Step 7. Configure and View Alarms

Step 7.1 (page 262)	Configure CNC alarms.
Step 7.2 (page 264)	View CNC alarms in the Alarm Viewer.

Step 7.1. Configure CNC Alarms

Alarms can be configured to display with messages and other information about the state of CNC's in your production facility.

- CNC pre-configured alarm types.
- CNC pre-configured alarm class.
- Alarm settings.

CNC pre-configured alarm types

When you initially install the HMI for CNC software on your PC, three alarm types are automatically configured and added to the Alarms list.

The three pre-configured CNC alarm types are:

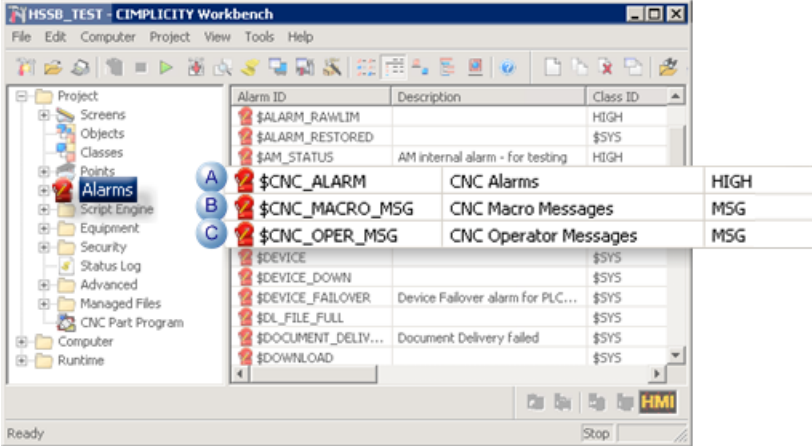

	Item	Description
1	CNC Alarms	Displays if the CNC is in an alarm state.
2	CNC Macro Messages	A CNC Macro Message alerts an operator to a situation that is worth noting. The message can simply be to let the operator know that something is happening, or to remind the operator that an action must be taken. Macro Messages are developed by the Machine Tool Builder and are programmed in Macro B or Macro Executor.
3	CNC Operator Messages	Alerts an operator to a situation that is worth noting. The message can simply be to let the operator know that something is happening, or to remind the operator that an action must be taken. Operator Messages are developed by the Machine Tool Builder and are programmed in CNC Ladder and are generated by setting PMC A Bits. The Alarm Class ID is always MSG, but will still show a state of ALARM in the Alarm Viewer. Once the operator acknowledges the message, the state will display as NORMAL.

CNC pre-configured alarm class

By default CNC alarms use the following alarm classes.

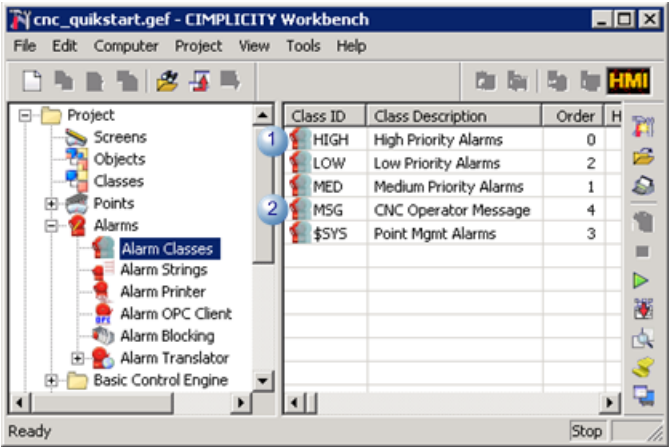

1	Commonly used default classes.	
	Class	Indicates a:

	HIGH	Serious condition that requires immediate attention.
	MED	Moderate condition that requires attention.
	LOW	Lesser condition that may require attention.
2	MSG	Pre-configured CNC alarm class for a CNC operator message.

Alarm settings

CNC alarms can be created and configured the same as other CIMPLICITY alarms.

The following topics provide detailed descriptions of CIMPLICITY alarms.

- Create new alarms.
- Modify alarm routing.
- Modify alarm options.
- Configure alarm classes.

Step 7.2. View CNC Alarms in the Alarm Viewer

When an alarm condition has occurred on your CNC for a local or remote project, alarm details, including the message display in the Alarm Viewer or Alarm Viewer Control.

In addition to alarms that are created specifically for the project, pre-configured generated alarms display.

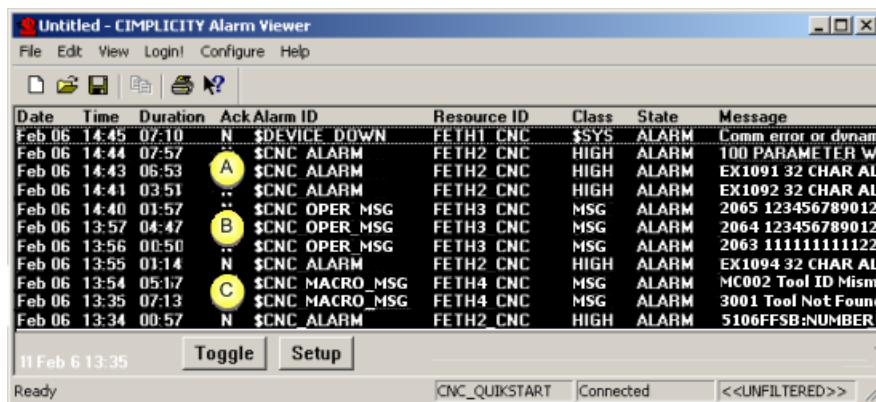

A	\$CNC_ALARM
B	\$CNC_OPER_MSG
C	\$CNC_MACRO_MSG

When a value from 0 to 200 is assigned to variable #3000, the CNC stops with a macro message alarm.

After an expression, a macro message can be described by adding #3000 to the alarm message.

Example

#3000=1 (TOOL NOT FOUND)

The alarm screen displays 3001 Tool not found.

 **Note:** You can view alarms and messages from a remote project in either the:

Stand-alone Alarm Viewer.
Alarm Viewer Control.

CNC Dynamic Link Library

CNC Dynamic Link Library

The CNC Dynamic Link Library enables you to transfer part programs and file data between your PC and CNC.

You have complete and total access to all the external entry points of the CNC DLL.

- CNC DLL entry point interfaces for FOCAS/HSSB.
- CNC DLL entry point interfaces for FOCAS/Ethernet.
- CNC DLL sample application script and screens.

The CNC Part Program Application (C++ program), the CNC Command Line Utilities (C Programs) and CIMPLICITY CimView screens (CimEdit scripts) use the CNC Dynamic Link Library's external entry points to access part programs and file data on a CNC.

Following is a graphic Dynamic Link Library overview.

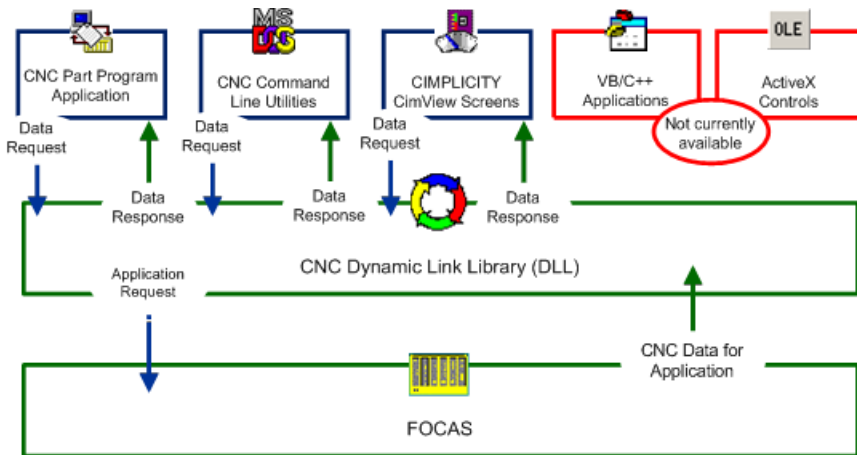

rect 15, 5, 128, 73 [CNC Part Program \(page 321\)](#)

rect 129, 1, 230, 75 [CNC Command Line Utilities \(page 346\)](#)

rect 245, -1, 339, 72 [Step 6.1. Use the CNC QuickStart Demo Project screens \(page 250\)](#)

! **Important:** In order to use the CNC DLL, make sure you:

- Understand the entry point interfaces provided by the CNC DLL.
- Understand the necessary configuration requirements of the CNC.
- Code appropriate application programs.

CNC DLL Entry Point Interfaces for FOCAS/HSSB

CNC DLL Entry Point Interfaces for FOCAS/HSSB

CNC DLL entry point interfaces for FOCAS/HSSB are used to communicate with an Open Factory CNC that uses the FOCAS/HSSB protocol.

The routines used for communicating through the CNC DLL are divided into two main categories as follows.

- Part Program routines for FOCAS/HSSB.
- File Data routines for FOCAS/HSSB.

Part Program Routines for FOCAS/HSSB

Part Program Routines for FOCAS/HSSB

The following CNC DLL entry point interfaces are used to communicate with an Open Factory CNC that uses the FOCAS/HSSB protocol.

- delete_pp

- dir_pp
- directory_pp
- download_pp
- select_pp
- upload_pp

delete_pp

Purpose

Delete a part program on your CNC.

Syntax

```
int delete_pp (long int node_no, short path_no, long int prognum)
```

Arguments

Input	
node_no	Node number 0-7
path_no	Value
	0
	1-2
	1-10
prognum	Part program number
Output	
None	

Return Value

ERR_BADPROGNUM	82	Bad program number/invalid range
----------------	----	----------------------------------

CNC [data window error \(page 372\)](#) handling return statuses.

dir_pp

Purpose

Retrieve a short directory (just the part program numbers) of registered part programs on your CNC.

Syntax

```
int dir_pp (long int node_no, short path_no, long int *prog, int max_files)
```

Arguments

Input	
<code>node_no</code>	Node number 0-7
<code>path_no</code>	Value: 0, 1-2, 1-10
<code>max_files</code>	Number of elements in prog array (Max 1024)
Output	
<code>prog</code>	Pointer to array of program numbers currently registered in the CNC.

Return Value

ERR_BADDIR	120	Bad directory info from CNC
------------	-----	-----------------------------

CNC [data window error \(page 372\)](#) handling return statuses.

directory_pp

Purpose

Retrieve long directory (including sizes and comments) of registered part programs on your CNC.

Syntax

```
int directory_pp (long int node_no, short path_no, long int *prog, char
 *comment, int *size, int comment_size, int max_files)
```

Arguments

Input	
<code>node_no</code>	Node number 0-7
<code>path_no</code>	Value: 0, 1-2, 1-10.
<code>comment_size</code>	Number of characters for each element of a comment array (Max 24)
<code>max_files</code>	Number of elements in a prog array (Max 1024)
Output	
<code>prog</code>	Pointer to integer array of program numbers currently registered in the CNC (Max 1024 elements).

<code>comment</code>	Pointer to string array of program comments currently registered in the CNC (Max 1024 elements of Max 24 characters).
<code>size</code>	Pointer to integer array of program sizes currently registered in the CNC (Max 1024 elements).

Return Value

<code>ERR_BADDIR</code>	120	Bad directory info from CNC
-------------------------	-----	-----------------------------

CNC [data window error \(page 372\)](#) handling return statuses.

download_pp

Purpose

Download a text file containing a single part program or multiple part programs to your CNC.

Syntax

`int download_pp (long int node_no, short path_no, char *progfile, long int *badprog)`

Arguments

Input	
<code>node_no</code>	Node number 0-7
<code>path_no</code>	Value: 0, 1-2, 1-10.
<code>progfile</code>	Pointer to file specification containing part program(s)
Output	
<code>badprog</code>	Pointer to bad program number, if a program error occurred, otherwise zero.

Return Value

ERR_BADPROGFILE	80	File open failed
ERR_BADPROG	81	Bad program
ERR_BADPROGNUM	82	Bad program number/invalid range
ERR_PROGSEL	84	Program already selected

CNC [data window error \(page 372\)](#) handling return statuses.

select_pp

Purpose

Select a part program on your CNC.

Syntax

int select_pp (long int node_no, short path_no, long int prognum)

Arguments

Input	
<code>node_no</code>	Node number 0-7
<code>path_no</code>	Value: 0, 1-2, 1-10.
<code>prognum</code>	Part program number
Output	
None	

Return Value

ERR_BADPROGNUM	82	Bad program number/invalid range
ERR_PROGNOTSEL	95	Program was not selected

CNC [data window error \(page 372\)](#) handling return statuses.

upload_pp

Purpose

Upload a single part program or multiple part programs to a file from your CNC.

Syntax

```
int upload_pp (long int node_no, short path_no, char *progfile, unsigned long int startprg, unsigned long int endprg)
```

Arguments

Input	
<code>node_no</code>	Node number 0-7
<code>path_no</code>	Value: 0, 1-2, 1-10.

progfile	Pointer to file specification to contain part program(s)
startprg	Starting part program number
endprg	Ending part program number
Output	
None	

Return Value

ERR_BADPROGFILE	80	File open failed
ERR_BADPROGNUM	82	Bad program number/invalid range
ERR_DISKERROR	87	Disk error
ERR_NOPROGS	110	No programs found
ERR_BADDIR	120	Bad directory info from CNC

CNC [data window error \(page 372\)](#) handling return statuses.

File Data Routines for FOCAS/HSSB

File Data Routines for FOCAS/HSSB

The following CNC DLL entry point interfaces are used to communicate with an Open Factory CNC using the FOCAS/HSSB protocol:

- download_cmv
- download_kbit
- download_parm
- download_pec
- download_tofs
- download_zofs
- upload_cmv
- upload_diag
- upload_kbit

- upload_parm
- upload_pec
- upload_tofs
- upload_zofs

download_cmv

Purpose

Download a file containing custom macro variable data, in comma-separated variable (.csv) format, to your CNC.

Syntax

```
int download_cmv (long int node_no, short path_no, char *filespec)
```

Arguments

Input	
node_no	Node number 0-7
path_no	Value: 0, 1-2, 1-10.
filespec	Pointer to file specification containing custom macro variable data values
Output	
download_tool_log.csv	

Return Value

ERR_BADCSVFILE	130	Unable to open CSV file
ERR_BADCSVFORMAT	131	Bad CSV format
ERR_BADLOGFILE	132	Unable to open LOG file
ERR_BADRANGE	133	Bad input number or invalid range

ERR_BADCNC	134	CNC type different than CNC
ERR_BADMODEL	135	Model type different than CNC

CNC [data window error \(page 372\)](#) handling return statuses.

download_kbit

Purpose

Download a file containing pmc k-bit data, in comma separated variable format, to your CNC.

Syntax

```
int download_kbit (long int node_no, short path_no, char *filespec)
```

Arguments

Input	
<code>node_no</code>	Node number 0-7
<code>path_no</code>	Value: 0, 1-2, 1-10.
<code>filespec</code>	Pointer to file specification containing pmc k-bit data values
Output	
<code>download_tool_log.csv</code>	

Return Value

ERR_BADCSVFILE	130	Unable to open CSV file
ERR_BADCSVFORMAT	131	Bad CSV format
ERR_BADLOGFILE	132	Unable to open LOG file
ERR_BADRANGE	133	Bad input number or invalid range

CNC [data window error \(page 372\)](#) handling return statuses.

download_parm

Purpose

Download a file containing parameter data, in comma separated variable format, to your CNC.

Syntax

```
int download_parm (long int node_no, short path_no, char *filespec)
```

Arguments

Input	
node_no	Node number 0-7
path_no	Value: 0, 1-2, 1-10.
filespec	Pointer to file specification containing parameter data values
Output	
download_tool_log.csv	

Return Value

ERR_BADCSVFILE	130	Unable to open CSV file
ERR_BADCSVFORMAT	131	Bad CSV format
Bad CSV format	132	Unable to open LOG file

CNC [data window error \(page 372\)](#) handling return statuses.

download_pec

Purpose

Download a file containing pitch error compensation data, in comma separated variable format, to your CNC.

Syntax

```
int download_pec (long int node_no, short path_no, char *filespec)
```

Arguments

Input	
<code>node_no</code>	Node number 0-7
<code>path_no</code>	Value: 0, 1-2, 1-10.
<code>filespec</code>	Pointer to file specification containing pitch error compensation data values
Output	
<code>download_tool_log.csv</code>	

Return Value

ERR_BADCSVFILE	130	Unable to open CSV file
ERR_BADCSVFORMAT	131	Bad CSV format
ERR_BADLOGFILE	132	Unable to open LOG file
ERR_BADRANGE	133	Bad input number or invalid range

CNC [data window error \(page 372\)](#) handling return statuses.

download_tofs

Purpose

Download a file containing tool offset data, in comma separated variable format, to your CNC.

Syntax

```
int download_tofs (long int node_no, short path_no, char *filespec)
```

Arguments

Input	
<code>node_no</code>	Node number 0-7
<code>path_no</code>	Value: 0, 1-2, 1-10.
<code>filespec</code>	Pointer to file specification containing tool offset data values
Output	
<code>download_tool_log.csv</code>	

Return Value

ERR_BADCSVFILE	130	Unable to open CSV file
ERR_BADCSVFORMAT	131	Bad CSV format
ERR_BADLOGFILE	132	Unable to open LOG file
ERR_BADMODEL	135	Model type different than CNC
ERR_BADMEMORY	136	Memory type different than CNC
ERR_UNKNOWNMEM	137	Unknown Memory type (A B C)

CNC [data window error \(page 372\)](#) handling return statuses.

download_zofs

Purpose

Download a file containing work zero offset data, in comma separated variable format, to your CNC.

Syntax

```
int download_zofs (long int node_no, short path_no, char *filespec)
```

Arguments

Input	
<code>node_no</code>	Node number 0-7
<code>path_no</code>	Value: 0, 1-2, 1-10.
<code>filespec</code>	Pointer to file specification containing work zero offset data values
Output	
<code>download_tool_log.csv</code>	

Return Value

ERR_BADCSVFILE	130	Unable to open CSV file
ERR_BADCSVFORMAT	131	Bad CSV format
ERR_BADLOGFILE	132	Unable to open LOG file

CNC [data window error \(page 372\)](#) handling return statuses.

upload_cmv

Purpose

Upload a range of custom macro variable data to a file, in comma separated variable format, from your CNC.

Syntax

```
int upload_cmvc (long int node_no, short path_no, char *filespec, unsigned short startrange, unsigned short endrange)
```

Arguments

Input	
<code>node_no</code>	Node number 0-7
<code>path_no</code>	Value: 0, 1-2, 1-10.
<code>filespec</code>	Pointer to file specification to contain custom macro variable data values
<code>startrange</code>	Low end of range to upload
<code>endrange</code>	High end of range to upload
Output	
<code>upload_tool_log.csv</code>	

Return Value

ERR_BADCSVFILE	130	Unable to open CSV file
ERR_BADLOGFILE	132	Unable to open LOG file
ERR_BADRANGE	133	Bad input number or invalid range

CNC [data window error \(page 372\)](#) handling return statuses.

upload diag

Purpose

Upload a range of diagnostic data to a file, in comma separated variable format, from your CNC.

Syntax

```
int upload_diag (long int node_no, short path_no, char *filespec, unsigned short startrange, unsigned short endrange)
```

Arguments

Input	
node_no	Node number 0-7
path_no	Value: 0, 1-2, 1-10.
filespec	Pointer to file specification to contain diagnostic data values
startrange	Low end of range to upload
endrange	High end of range to upload
Output	
upload_tool_log.csv	

Return Value

ERR_BADCSVFILE	130	Unable to open CSV file
ERR_BADLOGFILE	132	Unable to open LOG file
ERR_BADRANGE	133	Bad input number or invalid range

CNC [data window error \(page 372\)](#) handling return statuses.

upload_kbit

Purpose

Upload a range of pmv k-bit data to a file, in comma separated variable format, from your CNC.

Syntax

```
int upload_kbit (long int node_no, short path_no, char *filespec, unsigned
short startrange, unsigned short endrange)
```

Arguments

Input	
<code>node_no</code>	Node number 0-7
<code>path_no</code>	Value: 0, 1-2, 1-10.
<code>filespec</code>	Pointer to file specification to contain pmc k-bit data values
<code>startrange</code>	Low end of range to upload

endrange	High end of range to upload
Output	
upload_tool_log.csv	

Return Value

ERR_BADCSVFILE	130	Unable to open CSV file
ERR_BADLOGFILE	132	Unable to open LOG file
ERR_BADRANGE	133	Bad input number or invalid range

CNC [data window error \(page 372\)](#) handling return statuses.

upload_parm

Purpose

Upload a range of parameter data to a file, in comma separated variable format, from your CNC.

Syntax

```
int upload_parm (long int node_no, short path_no, char *filespec, unsigned short startrange, unsigned short endrange)
```

Arguments

Input	
node_no	Node number 0-7
path_no	Value: 0, 1-2, 1-10.
filespec	Pointer to file specification to contain parameter data values

<code>startrange</code>	Low end of range to upload
<code>endrange</code>	High end of range to upload
Output	
<code>upload_tool_log.csv</code>	

Return Value

<code>ERR_BADCSVFILE</code>	130	Unable to open CSV file
<code>ERR_BADLOGFILE</code>	132	Unable to open LOG file
<code>ERR_BADRANGE</code>	133	Bad input number or invalid range

CNC [data window error \(page 372\)](#) handling return statuses.

upload_pec

Purpose

Upload a range of pitch error compensation data to a file, in comma separated variable format, from your CNC.

Syntax

```
int upload_pec (long int node_no, short path_no, char *filespec, unsigned short startrange, unsigned short endrange)
```

Arguments

Input	
<code>node_no</code>	Node number 0-7
<code>path_no</code>	Value: 0, 1-2, 1-10.

<code>filespec</code>	Pointer to file specification to contain pitch error compensation data values
<code>startrange</code>	Low end of range to upload
<code>endrange</code>	High end of range to upload
Output	
<code>upload_tool_log.csv</code>	

Return Value

<code>ERR_BADCSVFILE</code>	130	Unable to open CSV file
<code>ERR_BADLOGFILE</code>	132	Unable to open LOG file
<code>ERR_BADRANGE</code>	133	Bad input number or invalid range

CNC [data window error \(page 372\)](#) handling return statuses.

upload_tofs

Purpose

Upload a range of tool offset data to a file, in comma separated variable format, from your CNC.

Syntax

```
int upload_tofs (long int node_no, short path_no, char *filespec, unsigned short startrange, unsigned short endrange)
```

Arguments

Input	
-------	--

<code>node_no</code>	Node number 0-7
<code>path_no</code>	Value: 0, 1-2, 1-10.
<code>filespec</code>	Pointer to file specification to contain tool offset data values
<code>startrange</code>	Low end of range to upload
<code>endrange</code>	High end of range to upload
Output	
<code>upload_tool_log.csv</code>	

Return Value

ERR_BADCSVFILE	130	Unable to open CSV file
ERR_BADLOGFILE	132	Unable to open LOG file
ERR_BADRANGE	133	Bad input number or invalid range

CNC [data window error \(page 372\)](#) handling return statuses.

upload zofs

Purpose

Upload a range of work zero offset data to a file, in comma separated variable format, from your CNC.

Syntax

```
int upload_zofs (long int node_no, short path_no, char *filespec, unsigned short startrange, unsigned short endrange)
```

Arguments

Input	
node_no	Node number (0-7)
path_no	Value: 0, 1-2, 1-10.
filespec	Pointer to file specification to contain work zero offset data values
startrange	Low end of range to upload
endrange	High end of range to upload
Output	
upload_tool_log.csv	

Return Value

ERR_BADCSVFILE	130	Unable to open CSV file
ERR_BADLOGFILE	132	Unable to open LOG file
ERR_BADRANGE	133	Bad input number or invalid range

CNC [data window error \(page 372\)](#) handling return statuses.

CNC DLL Entry Point Interfaces for FOCAS/Ethernet

CNC DLL Entry Point Interfaces for FOCAS/Ethernet

NC DLL entry point interfaces for FOCAS/Ethernet are used to communicate with an Open Factory CNC using FOCAS/Ethernet protocol.

The routines used for communicating through the CNC DLL are divided into two main categories as follows:

- Part Program Routines for FOCAS/Ethernet.
- File Data Routines for FOCAS/Ethernet.

Part Program Routines for FOCAS/Ethernet

Part Program Routines for FOCAS/Ethernet

The following CNC DLL entry point interfaces are used to communicate with an Open Factory CNC using FOCAS/Ethernet protocol:

- edelete_pp
- edir_pp
- edirectory_pp
- edownload_pp
- eselect_pp
- eupload_pp

edelete_pp

Purpose

Delete a part program on your CNC.

Syntax

```
int edelete_pp (char *ipaddr, unsigned short port, long int timeout, short path_no, long int prognum)
```

Arguments

Input	
-------	--

<code>ipaddr</code>	IP address of the CNC
<code>port</code>	Port number of the CNC
<code>timeout</code>	Seconds for timeout (0 to ignore and wait infinitely)
<code>path_no</code>	Value: 0, 1-2, 1-10.
<code>prognum</code>	Part program number
Output	
None	

Return Value

<code>ERR_BADPROGNUM</code>	82	Bad program number/invalid range
-----------------------------	----	----------------------------------

CNC [data window error \(page 372\)](#) handling return statuses.

edir_pp

Purpose

Retrieve a short directory (just the part program numbers) of registered part programs on your CNC.

Syntax

```
int edir_pp (char *ipaddr, unsigned short port, long int timeout, short path_no, long int *prog, int max_files)
```

Arguments

Input	
-------	--

<code>ipaddr</code>	IP address of the CNC
<code>port</code>	Port number of the CNC
<code>timeout</code>	Seconds for timeout (0 to ignore and wait infinitely)
<code>path_no</code>	Value: 0, 1-2, 1-10.
<code>max_files</code>	Number of elements in prog array (Max 1024)
Output	
<code>prog</code>	Pointer to array of program numbers currently registered in the CNC

Return Value

ERR_BADDIR	120	Bad directory info from CNC
------------	-----	-----------------------------

CNC [data window error \(page 372\)](#) handling return statuses.

edirectory_pp

Purpose

Retrieve long directory (including sizes and comments) of registered part programs on your CNC.

Syntax

```
int edirectory_pp (char *ipaddr, unsigned short port, long int timeout,  
short path_no, long int *prog, char *comment, int *size, int comment_size,  
int max_files)
```

Arguments

Input	
<code>ipaddr</code>	IP address of the CNC
<code>port</code>	Port number of the CNC
<code>timeout</code>	Seconds for timeout (0 to ignore and wait infinitely)
<code>path_no</code>	Value
<code>comment_size</code>	Number of characters for each element of comment array (Max 24)

max_files	Number of elements in prog array (Max 1024)
Output	
prog	Pointer to integer array of program numbers currently registered in the CNC (Max 1024 elements)
comment	Pointer to string array of program comments currently registered in the CNC (Max 1024 elements of Max 24 characters)

size	Pointer to integer array of program sizes currently registered in the CNC (Max 1024 elements)
------	---

Return Value

ERR_BADDIR	120	Bad directory info from CNC
------------	-----	-----------------------------

CNC [data window error \(page 372\)](#) handling return statuses.

edownload_pp

Purpose

Download a text file containing a single part program or multiple part programs to your CNC.

Syntax

```
int edownload_pp (char *ipaddr, unsigned short port, long int timeout,
short path_no, char *progfile, long int *badprog)
```

Arguments

Input	
ipaddr	IP address of the CNC
port	Port number of the CNC

<code>timeout</code>	Seconds for timeout (0 to ignore and wait infinitely)
<code>path_no</code>	Value: 0, 1-2, 1-10.
<code>progfile</code>	Pointer to file specification containing part program(s)
Output	
<code>badprog</code>	Pointer to bad program number, if a program error occurred, otherwise zero

Return Value

ERR_BADPROGFILE	80	File open failed
ERR_BADPROG	81	Bad program
ERR_BADPROGNUM	82	Bad program number/invalid range
ERR_PROGSEL	84	Program already selected

CNC [data window error \(page 372\)](#) handling return statuses.

eselect_pp

Purpose

Select a part program on your CNC.

Syntax

```
int eselect_pp (char *ipaddr, unsigned short port, long int timeout, short
path_no, long int prognum)
```

Arguments

Input	
ipaddr	IP address of the CNC
port	Port number of the CNC
timeout	Seconds for timeout (0 to ignore and wait infinitely)
path_no	Value: 0, 1-2, 1-10.
prognum	Part program number
Output	
None	

Return Value

ERR_BADPROGNUM	82	Bad program number/invalid range
ERR_PROGNOTSEL	95	Program was not selected

CNC [data window error \(page 372\)](#) handling return statuses.

eupload_pp

Purpose

Upload a single part program or multiple part programs to a file from your CNC.

Syntax

```
int eupload_pp (char *ipaddr, unsigned short port, long int timeout, short
path_no, char *progfile, unsigned long int startprg, unsigned long int
endprg)
```

Arguments

Input	
<code>ipaddr</code>	IP address of the CNC
<code>port</code>	Port number of the CNC
<code>timeout</code>	Seconds for timeout (0 to ignore and wait infinitely)
<code>path_no</code>	Value: 0, 1-2, 1-10.
<code>progfile</code>	Pointer to file specification to contain part program(s)
<code>startprg</code>	Starting part program number
<code>endprg</code>	Ending part program number

Output	
None	

Return Value

ERR_BADPROGFILE	80	File open failed
ERR_BADPROGNUM	82	Bad program number/invalid range
ERR_DISKERROR	87	Disk error
ERR_NOPROGS	110	No programs found
ERR_BADDIR	120	Bad directory info from CNC

CNC [data window error \(page 372\)](#) handling return statuses.

File Data Routines for FOCAS/Ethernet

File Data Routines for FOCAS/Ethernet

The following CNC DLL entry point interfaces are used to communicate with an Open Factory CNC using FOCAS/Ethernet protocol.

- edownload_cmv
- edownload_kbit
- edownload_parm
- edownload_pec
- edownload_tofs
- edownload_zofs
- eupload_cmv
- eupload_diag
- eupload_kbit
- eupload_parm
- eupload_pec
- eupload_tofs
- eupload_zofs

edownload_cmv

Purpose

Download a file containing custom macro variable data, in comma-separated variable (csv) format, to your CNC.

Syntax

```
int edownload_cmv (char *ipaddr, unsigned short port, long int timeout,
short path_no, char *filespec)
```

Arguments

Input	
<code>ipaddr</code>	IP address of the CNC
<code>port</code>	Port number of the CNC
<code>timeout</code>	Seconds for timeout (0 to ignore and wait infinitely)
<code>path_no</code>	Value: 0, 1-2, 1-10
<code>filespec</code>	Pointer to file specification containing custom macro variable data values
Output	
<code>upload_tool_log.csv</code>	

Return Value

ERR_BADCSVFILE	130	Unable to open CSV file
ERR_BADCSVFORMAT	131	Bad CSV format

ERR_BADLOGFILE	132	Unable to open LOG file
ERR_BADRANGE	133	Bad input number or invalid range
ERR_BADCNC	134	CNC type different than CNC
ERR_BADMODEL	135	Model type different than CNC

CNC [data window error \(page 372\)](#) handling return statuses.

edownload_kbit

Purpose

Download a file containing pmc k-bit data, in comma separated variable format, to your CNC.

Syntax

```
int edownload_kbit (char *ipaddr, unsigned short port, long int timeout,
short path_no, char *filespec)
```

Arguments

Input	
<code>ipaddr</code>	IP address of the CNC
<code>port</code>	Port number of the CNC
<code>timeout</code>	Seconds for timeout (0 to ignore and wait infinitely)
<code>path_no</code>	Value: 0, 1-2, 1-10
<code>filespec</code>	
Output	

upload_tool_log.csv

Return Value

ERR_BADCSVFILE	130	Unable to open CSV file
ERR_BADCSVFORMAT	131	Bad CSV format
ERR_BADLOGFILE	132	Unable to open LOG file
ERR_BADRANGE	133	Bad input number or invalid range

CNC [data window error \(page 372\)](#) handling return statuses.

edownload_parm

Purpose

Download a file containing parameter data, in comma separated variable format, to your CNC.

Syntax

```
int edownload_parm (char *ipaddr, unsigned short port, long int timeout,
short path_no, char *filespec)
```

Arguments

Input	
ipaddr	IP address of the CNC
port	Port number of the CNC
timeout	Seconds for timeout (0 to ignore and wait infinitely)
path_no	Value: 0, 1-2, 1-10

<code>filespec</code>	Pointer to file specification containing parameter data values
Output	
<code>upload_tool_log.csv</code>	

Return Value

<code>ERR_BADCSVFILE</code>	130	Unable to open CSV file
<code>ERR_BADCSVFORMAT</code>	131	Bad CSV format
Bad CSV format	132	Unable to open LOG file

CNC [data window error \(page 372\)](#) handling return statuses.

edownload_pec

Purpose

Download a file containing pitch error compensation data, in comma separated variable format, to your CNC.

Syntax

```
int edownload_pec (char *ipaddr, unsigned short port, long int timeout, short path_no, char *filespec)
```

Arguments

Input	
<code>ipaddr</code>	IP address of the CNC
<code>port</code>	Port number of the CNC

<code>timeout</code>	Seconds for timeout (0 to ignore and wait infinitely)
<code>path_no</code>	Value: 0, 1-2, 1-10.
<code>filespec</code>	Pointer to file specification containing pitch error compensation data values
Output	
<code>download_tool_log.csv</code>	

Return Value

ERR_BADCSVFILE	130	Unable to open CSV file
ERR_BADCSVFORMAT	131	Bad CSV format
ERR_BADLOGFILE	132	Unable to open LOG file
ERR_BADRANGE	133	Bad input number or invalid range

CNC [data window error \(page 372\)](#) handling return statuses.

edownload_tofs

Purpose

Download a file containing tool offset data, in comma separated variable format, to your CNC.

Syntax

```
int edownload_tofs (char *ipaddr, unsigned short port, long int timeout,
short path_no, char *filespec)
```

Arguments

Input	
<code>ipaddr</code>	IP address of the CNC
<code>port</code>	Port number of the CNC
<code>timeout</code>	Seconds for timeout (0 to ignore and wait infinitely)
<code>path_no</code>	Value: 0, 1-2, 1-10
<code>filespec</code>	Pointer to file specification containing tool offset data values
Output	
<code>upload_tool_log.csv</code>	

Return Value

ERR_BADCSVFILE	130	Unable to open CSV file
ERR_BADCSVFORMAT	131	Bad CSV format
ERR_BADLOGFILE	132	Unable to open LOG file
ERR_BADMODEL	135	Model type different than CNC
ERR_BADMEMORY	136	Memory type different than CNC
ERR_UNKNOWNMEM	137	Unknown Memory type (A B C)

CNC [data window error \(page 372\)](#) handling return statuses.

*edownload_zofs***Purpose**

Download a file containing work zero offset data, in comma separated variable format, to your CNC.

Syntax

```
int edownload_zofs (char *ipaddr, unsigned short port, long int timeout,
short path_no, char *filespec)
```

Arguments

Input	
<code>ipaddr</code>	IP address of the CNC
<code>port</code>	Port number of the CNC
<code>timeout</code>	Seconds for timeout (0 to ignore and wait infinitely)
<code>path_no</code>	Value: 0, 1-2, 1-10
<code>filespec</code>	Pointer to file specification containing work zero offset data values

<code>startrange</code>	Low end of range to upload
<code>endrange</code>	High end of range to upload
Output	
<code>upload_tool_log.csv</code>	

Return Value

<code>ERR_BADCSVFILE</code>	130	Unable to open CSV file
<code>ERR_BADCSVFORMAT</code>	131	Bad CSV format
<code>ERR_BADLOGFILE</code>	132	Unable to open LOG file

CNC [data window error \(page 372\)](#) handling return statuses.

eupload_diag

Purpose

Upload a range of diagnostic data to a file, in comma separated variable format, from your CNC.

Syntax

```
int eupload_diag (char *ipaddr, unsigned short port, long int timeout,
short path_no, char *filespec, unsigned short startrange, unsigned short
endrange)
```

Arguments

Input	
<code>ipaddr</code>	IP address of the CNC
<code>port</code>	Port number of the CNC

<code>timeout</code>	Seconds for timeout (0 to ignore and wait infinitely)
<code>path_no</code>	Value: 0, 1-2, 1-10
<code>filespec</code>	Pointer to file specification to contain diagnostic data values
<code>startrange</code>	Low end of range to upload
<code>endrange</code>	High end of range to upload
Output	
<code>upload_tool_log.csv</code>	

Return Value

<code>ERR_BADCSVFILE</code>	130	Unable to open CSV file
<code>ERR_BADLOGFILE</code>	132	Unable to open LOG file
<code>ERR_BADRANGE</code>	133	Bad input number or invalid range

CNC [data window error \(page 372\)](#) handling return statuses.

upload cmv

Purpose

Upload a range of custom macro variable data to a file, in comma separated variable format, from your CNC.

Syntax

```
int eupload_cmV (char *ipaddr, unsigned short port, long int timeout,  
short path_no, char *filespec, unsigned short startrange, unsigned short  
endrange)
```

Arguments

Input	
<code>ipaddr</code>	IP address of the CNC
<code>port</code>	Port number of the CNC
<code>timeout</code>	Seconds for timeout (0 to ignore and wait infinitely)
<code>path_no</code>	Value: 0, 1-2, 1-10
<code>filespec</code>	Pointer to file specification to contain custom macro variable data values

<code>startrange</code>	Low end of range to upload
<code>endrange</code>	High end of range to upload
Output	
<code>upload_tool_log.csv</code>	

Return Value

ERR_BADCSVFILE	130	Unable to open CSV file
ERR_BADLOGFILE	132	Unable to open LOG file
ERR_BADRANGE	133	Bad input number or invalid range

CNC [data window error \(page 372\)](#) handling return statuses.

eupload_kbit

Purpose

Upload a range of pmv k-bit data to a file, in comma separated variable format, from your CNC.

Syntax

```
int eupload_kbit (char *ipaddr, unsigned short port, long int timeout,
short path_no, char *filespec, unsigned short startrange, unsigned short
endrange)
```

Arguments

Input	
<code>ipaddr</code>	IP address of the CNC
<code>port</code>	Port number of the CNC

<code>timeout</code>	Seconds for timeout (0 to ignore and wait infinitely)
<code>path_no</code>	Value: 0, 1-2, 1-10
<code>filespec</code>	Pointer to file specification to contain pmc k-bit data values
<code>startrange</code>	Low end of range to upload
<code>endrange</code>	High end of range to upload
Output	
<code>upload_tool_log.csv</code>	

Return Value

ERR_BADCSVFILE	130	Unable to open CSV file
ERR_BADLOGFILE	132	Unable to open LOG file
ERR_BADRANGE	133	Bad input number or invalid range

CNC [data window error \(page 372\)](#) handling return statuses.

upload_parm

Purpose

Upload a range of parameter data to a file, in comma separated variable format, from your CNC.

Syntax

```
int eupload_parm (char *ipaddr, unsigned short port, long int timeout,
short path_no, char *filespec, unsigned short startrange, unsigned short
endrange)
```

Arguments

Input	
<code>ipaddr</code>	IP address of the CNC
<code>port</code>	Port number of the CNC
<code>timeout</code>	Seconds for timeout (0 to ignore and wait infinitely)
<code>path_no</code>	Value: 0, 1-2, 1-10
<code>filespec</code>	Pointer to file specification to contain parameter data values
<code>startrange</code>	Low end of range to upload

<code>endrange</code>	High end of range to upload
Output	
<code>upload_tool_log.csv</code>	

Return Value

ERR_BADCSVFILE	130	Unable to open CSV file
ERR_BADLOGFILE	132	Unable to open LOG file
ERR_BADRANGE	133	Bad input number or invalid range

CNC [data window error \(page 372\)](#) handling return statuses.

eupload_pec

Purpose

Upload a range of pitch error compensation data to a file, in comma separated variable format, from your CNC.

Syntax

```
int eupload_pec (char *ipaddr, unsigned short port, long int timeout,
short path_no, char *filespec, unsigned short startrange, unsigned short
endrange)
```

Arguments

Input	
<code>ipaddr</code>	IP address of the CNC
<code>port</code>	Port number of the CNC

<code>timeout</code>	Seconds for timeout (0 to ignore and wait infinitely)
<code>path_no</code>	Value: 0, 1-2, 1-10.
<code>filespec</code>	Pointer to file specification to contain pitch error compensation data values
<code>startrange</code>	Low end of range to upload
<code>endrange</code>	High end of range to upload
Output	
<code>upload_tool_log.csv</code>	

Return Value

ERR_BADCSVFILE	130	Unable to open CSV file
ERR_BADLOGFILE	132	Unable to open LOG file
ERR_BADRANGE	133	Bad input number or invalid range

CNC [data window error \(page 372\)](#) handling return statuses.

upload tofs

Purpose

Upload a range of tool offset data to a file, in comma separated variable format, from your CNC.

Syntax

```
int eupload_tofs (char *ipaddr, unsigned short port, long int timeout,  
short path_no, char *filespec, unsigned short startrange, unsigned short  
endrange)
```

Arguments

Input	
ipaddr	IP address of the CNC
port	Port number of the CNC
timeout	Seconds for timeout (0 to ignore and wait infinitely)
path_no	Value: 0, 1-2, 1-10.
filespec	Pointer to file specification to contain tool offset data values
startrange	Low end of range to upload

<code>endrange</code>	High end of range to upload
Output	
<code>upload_tool_log.csv</code>	

Return Value

ERR_BADCSVFILE	130	Unable to open CSV file
ERR_BADLOGFILE	132	Unable to open LOG file
ERR_BADRANGE	133	Bad input number or invalid range

CNC [data window error \(page 372\)](#) handling return statuses.

eupload_zofs

Purpose

Upload a range of work zero offset data to a file, in comma separated variable format, from your CNC.

Syntax

```
int eupload_zofs (char *ipaddr, unsigned short port, long int timeout,
short path_no, char *filespec, unsigned short startrange, unsigned short
endrange)
```

Arguments

Input	
<code>ipaddr</code>	IP address of the CNC
<code>port</code>	Port number of the CNC

<code>timeout</code>	Seconds for timeout (0 to ignore and wait infinitely)
<code>path_no</code>	Value: 0, 1-2, 1-10
<code>filespec</code>	Pointer to file specification to contain work zero offset data values
<code>startrange</code>	Low end of range to upload
<code>endrange</code>	High end of range to upload
Output	
<code>upload_tool_log.csv</code>	

Return Value

ERR_BADCSVFILE	130	Unable to open CSV file
ERR_BADLOGFILE	132	Unable to open LOG file
ERR_BADRANGE	133	Bad input number or invalid range

CNC [data window error \(page 372\)](#) handling return statuses.

CNC DLL Sample Application Script and Screens

CNC DLL Sample Application Script and Screens

The example in this section demonstrates how the CNC DLL works.

- A sample application script
- Declares an external entry point into the DLL.
- Shows how an application might be written to access CNC File Data using the FOCAS/HSSB protocol.
- Graphic examples in CimEdit and CimView illustrate how the CNC DLL accesses CNC data and returns runtime values that can be used to monitor the production facility.

CNC DLL Application Script

```

\CNC_DLL.DLL function declarations
Declare Function dir_pp CDecl Lib "cnc_dll" Alias "dir_pp" (ByVal node_no
As Long, ByVal path_no As Integer, ByRef prog() As Long, ByVal max_files
As Integer) As Integer
|
Sub OnScreenOpen()
|
Dim i As Integer
Dim node As Long
Dim path As Integer
Dim progs(1023) As Long
Dim maxfiles As Integer
Dim idx As Integer
Dim pp(1023) As CimObjectVariable
Dim cnc_error As CimObjectVariable
Dim cnc_node As CimObjectVariable
Dim cnc_path As CimObjectVariable
|
Set pp(0) = CimGetRootObject().GetVariable("pp0")
Set pp(1) = CimGetRootObject().GetVariable("pp1")
Set pp(2) = CimGetRootObject().GetVariable("pp2")
Set pp(3) = CimGetRootObject().GetVariable("pp3")
Set pp(4) = CimGetRootObject().GetVariable("pp4")
Set pp(5) = CimGetRootObject().GetVariable("pp5")
Set pp(6) = CimGetRootObject().GetVariable("pp6")
Set pp(7) = CimGetRootObject().GetVariable("pp7")
Set pp(8) = CimGetRootObject().GetVariable("pp8")
Set pp(9) = CimGetRootObject().GetVariable("pp9")
Set pp(10) = CimGetRootObject().GetVariable("pp10")
Set pp(11) = CimGetRootObject().GetVariable("pp11")
Set pp(12) = CimGetRootObject().GetVariable("pp12")
Set pp(13) = CimGetRootObject().GetVariable("pp13")
Set pp(14) = CimGetRootObject().GetVariable("pp14")

```

```

Set pp(15) = CimGetRootObject().GetVariable("pp15")
'
Set cnc_error = CimGetRootObject().GetVariable("cnc_error")
Set cnc_node = CimGetRootObject().GetVariable("cnc_node")
Set cnc_path = CimGetRootObject().GetVariable("cnc_path")
'
' Initial arguments
'
node = 0
cnc_node = node
path = 1
cnc_path = path
maxfiles = 1024
'
' Get short directory (no comments or sizes)
'
i = dir_pp ( node, path, progs, maxfiles )
'
If i <> 0 Then
    ' Log error to Status Log
    LogStatus CIM_FAILURE,"dir_pp","Unable to get directory information
    from CNC.",i,0
    ' Initialize all part program screen variable to make them invisible
    For idx = 0 To 15
        pp(idx) = 0
    Next idx
    ' Set screen variable to display error
    cnc_error = ""Unable to get directory info from CNC""
    Exit Sub
End If
' Loop thru all part programs returned and set screen variables
Do While (progs(idx) <> 0)
    pp(idx) = progs(idx)
    dx = idx + 1
Loop
End Sub
Sub OnTimer()
Dim i As Integer
Dim node As Long
Dim path As Integer
Dim progs(1023) As Long
Dim maxfiles As Integer
Dim idx As Integer
Dim pp(1023) As CimObjectVariable
Dim cnc_error As CimObjectVariable
Dim cnc_node As CimObjectVariable
Dim cnc_path As CimObjectVariable
Set pp(0) = CimGetRootObject().GetVariable("pp0")
Set pp(1) = CimGetRootObject().GetVariable("pp1")
Set pp(2) = CimGetRootObject().GetVariable("pp2")
Set pp(3) = CimGetRootObject().GetVariable("pp3")
Set pp(4) = CimGetRootObject().GetVariable("pp4")
Set pp(5) = CimGetRootObject().GetVariable("pp5")

```

```

Set pp(6) = CimGetRootObject().GetVariable("pp6")
Set pp(7) = CimGetRootObject().GetVariable("pp7")
Set pp(8) = CimGetRootObject().GetVariable("pp8")
Set pp(9) = CimGetRootObject().GetVariable("pp9")
Set pp(10) = CimGetRootObject().GetVariable("pp10")
Set pp(11) = CimGetRootObject().GetVariable("pp11")
Set pp(12) = CimGetRootObject().GetVariable("pp12")
Set pp(13) = CimGetRootObject().GetVariable("pp13")
Set pp(14) = CimGetRootObject().GetVariable("pp14")
Set pp(15) = CimGetRootObject().GetVariable("pp15")
Set cnc_error = CimGetRootObject().GetVariable("cnc_error")
Set cnc_node = CimGetRootObject().GetVariable("cnc_node")
Set cnc_path = CimGetRootObject().GetVariable("cnc_path")
' Initial arguments
node = cnc_node
path = cnc_path
maxfiles = 1024
' Get short directory (no comments or sizes)
i = dir_pp ( node, path, progs, maxfiles )
If i <> 0 Then
    ' Initialize all part program screen variable to make them invisible
    For idx = 0 To 15
        pp(idx) = 0
    Next idx
    ' Set screen variable to display error
    cnc_error = ""Unable to get directory info from CNC""
    Exit Sub
End If
' Loop thru all part programs returned and set screen variables
Do While (progs(idx) <> 0)
    pp(idx) = progs(idx)
    idx = idx + 1
Loop
End Sub
Sub OnF2KeyDown(key As Integer)
Dim cnc_node As CimObjectVariable
Set cnc_node = CimGetRootObject().GetVariable("cnc_node")
If ((cnc_node + 1) < 8) Then
    nc_node = cnc_node + 1
Else
    cnc_node = 0
End If
End Sub
Sub OnF3KeyDown(key As Integer)
Dim cnc_path As CimObjectVariable
Set cnc_path = CimGetRootObject().GetVariable("cnc_path")
If ((cnc_path + 1) < 3) Then
    cnc_path = cnc_path + 1
Else
    cnc_path = 1
End If
End Sub

```

CNC DLL CimEdit/CimView Example

Following is a sample of a script being applied to CimEdit/CimView to access CNC file data.

Note: You need to create a screen with

1 <i>(page 319)</i>	A sample application script is written to access CNC File Data.
2 <i>(page 319)</i>	The script is applied to CimEdit screen.
3 <i>(page 320)</i>	CimView displays available data.
4 <i>(page 320)</i>	CimView generates an error message.

A sample application script is written to access CNC File Data.

Note: The script used is the [CNC DLL application script \(page 316\)](#) provided in the previous topic.

The script is applied to CimEdit screen.

Text objects on the screen are populated with CNC data during runtime or an error is generated when there is a configuration problem or unavailable data.

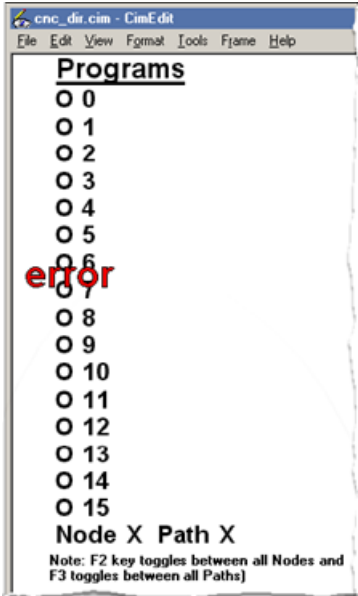

CimView displays available data.

Using the CNC DLL, a sample application screen in CimView displays a directory of part programs on a CNC.

The following graphic shows that the configuration data is correct and CNC information is available.

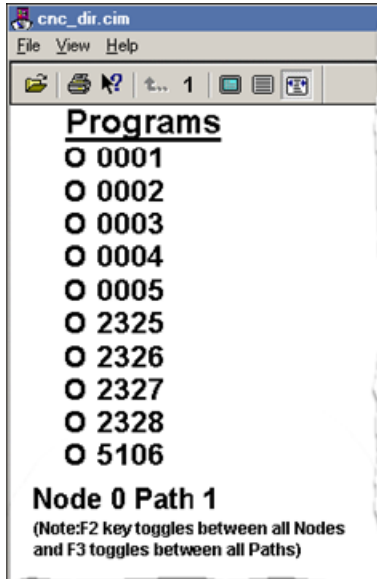

CimView generates an error message.

The CNC DLL sample application screen shows that Node 1 is either not configured or unavailable as demonstrated by the error message generated in CimView.

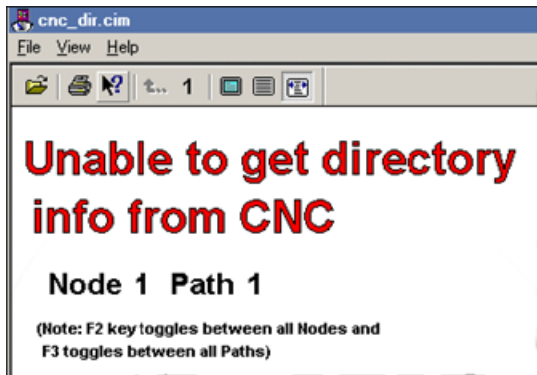

CNC Part Program

CNC Part Program

- Overview.
- Environment variables on the PC.
- Part Program file type associations.
- Part Program parameters.
- Use the CNC Part Program application.

Overview

- The CNC Part Program Application enables you to upload and download part programs between your PC and CNC.
- The CNC dynamic link library (**DLL**) provides a common interface for enabling communication between an application and a CNC device.

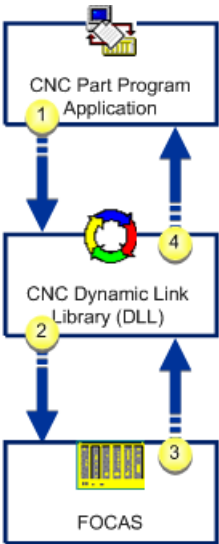

1	Application requests part program data.
2	DLL links request to CNC.
3	CNC sends part program data.
4	DLL links to the application.

 **Note:** All existing directories and part program files on your network can be used in this application.

Environment variables on the PC

Define a temporary directory name TEMP or TMP in your environment.

Part program file type associations

The recommended file extension for part program files is .pro.

 **Note:** Associate the file with your selected text editor through the Windows Explorer.

That way you can open quickly open the text editor whenever you select a part program file.

See Windows documentation for information about associating files.

Part Program Parameters

The CNC Part Program Application provides you with an easy to use interface for managing your part programs. Before you begin to use the application, there are some configuration guidelines to consider to ensure that your PC and CNCs are optimized for using the application.

- Part Program parameters on the CNC.
- Download program parameters.
- Upload Program parameters.

Part Program parameters on the CNC

Series	Parameter
HSSB	
<ul style="list-style-type: none"> • 160/180/210, 160i/180i/210i, 30i/31i/32i 	3202#0,#4,#6 influenced by setting 3210,3211 influenced by setting
<ul style="list-style-type: none"> • Power Mate i 	3202#0,#4,#6 influenced by setting
Ethernet	
<ul style="list-style-type: none"> • 160i/180i/210i, 30i/31i/32i 	3202#0,#4,#6 3204#3,#4 3210,3211

Series	Parameter	
• Power Mate i	3202#0,#4,#6 3204#3,#4	
CNC Mode	Mode	Search
HSSB		
• 150	• EDIT • Other	Foreground Background
• 150i, 160/180/210, 160i/180i/210i, 30i/31i/32i, Power Mate i	• EDIT, MEM • Other	Foreground Background
Ethernet		
The behavior of this function depends on the CNC mode.	EDIT, MEM Other	Foreground Background

Download program parameters

- Downstart
- Downstart3 (Ethernet only)

Downstart

Series	Parameter
Series 150,150i	0020=16(EDIT mode) must be set 0022=16(except EDIT mode) must be set 0000#0 influenced by setting 2200#1,#3,#4 influenced by setting 0011#0,2201#0 influenced by setting 2210,2211,2212,2213 influenced by setting
Series 160i/180i/210i, 30i/31i/32i	0000#0 influenced by setting 3201#2,#5,#6 influenced by setting 3202#0,#4 influenced by setting 3210,3211 influenced by setting 3290#7 influenced by setting
Series 160i/180i-W, Power Mate i	0000#0 influenced by setting 3201#2,#5,#6 influenced by setting 3202#0,#4 influenced by setting 3290#7 influenced by setting
CNC Mode	Mode
• 150/150i	It is possible to use in any CNC mode.(It is necessary to set the parameter according to the mode)
• 160/180/210, 160i/180i/210i, 30i/31i/32i, Power Mate I	(It is possible to use in other than MDI mode.)

<ul style="list-style-type: none"> • Power Mate i 	This function can be used in any CNC mode. (It is necessary to set mode according to the target data.)
--	--

[Up \(page 323\)](#)

Downstart3 (Ethernet only)

Series	Parameter	
Series 150i	0020=7(*) must be set 0022=7(*) must be set 0000#0 2200#1,#3,#4 0011#0,2201#0 2210,2211,2212,2213 8000#0	
	Program	Use
	<ul style="list-style-type: none"> • NC Program 	
	EDIT Mode	0020
	Not EDIT Mode	0022
	<ul style="list-style-type: none"> • All except NC 	
	Background Editing	0020
	Not Background Editing	Cannot be used.
Series 160i/180i/210i, 30i/31i/32i	0000#0 3201#2,#5,#6 3202#0,#4 3204#3,#4 3210,3211,8900#0	
Power Mate i	0000#0 3201#2,#5,#6 3202#0,#4 3204#3,#4 8900#0	
CNC Mode		
This function can be used in any CNC mode. (It is necessary to set mode according to the target data.)		

[Up \(page 323\)](#)

Upload program parameters

- Upstart
- Upstart3

Upstart

Series	Parameter
<ul style="list-style-type: none"> • 150i 	0021=16 (EDIT mode) must be set 0023=16 (except EDIT mode) must be set

[Up \(page 324\)](#)

Upstart3

Series	Parameter	
Series 150i	0021=7(*) must be set 0023=7(*) must be set 0000#0 2200#1,#3,#4 0011#0,2201#0 2210,2211,2212,2213	
	Program	Use
	• NC Program	
	EDIT Node	0021
	Not EDIT Mode	0023
	• All except NC	
	Background Editing	0023
	Not Background Editing	0021
Series 160i/180i/210i, 30i/31i/32i	0000#0 3201#2,#5,#6 3202#0,#4 3204#3,#4 3210,3211	
Power Mate i	0000#0 3201#2,#5,#6 3202#0,#4 3204#3,#4	

[Up \(page 324\)](#)

Use the CNC Part Program Application

Use the CNC Part Program Application

The CNC Part Program application provides the functionality you need to manage your part programs.

Step 1 (page 325)	Create or Edit CNC programs.
Step 2 (page 328)	Connect to an open factory CNC.
Step 3 (page 330)	Work in the CNC Part Program window.

Step 1. Create or Edit CNC Programs

1. Open the text editor of your choice.
2. Create a file with:
 - One program.
 - Two or more programs.

One program

The file with one part program must use the following format.

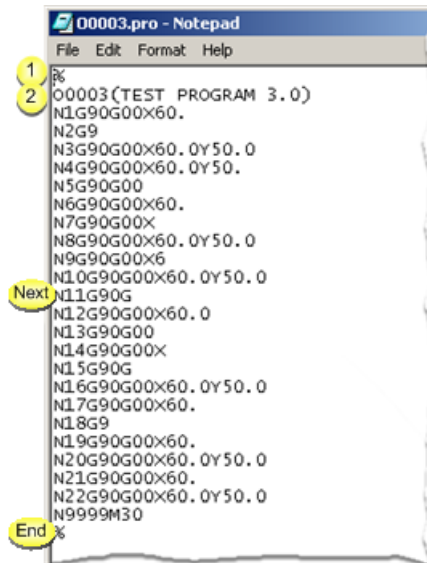

Line	Format
1	%
2	Oxxxxxxxx (XXXXXXX)
	Where o is a capital o. xxxxxxxx is the program number up to 8 digits. (xxxxxxx) (optional) is descriptive.
Next	Part program commands
End	%
	Where % is the end of file

Two or more programs

When downloading a file that contains multiple programs, the programs are downloaded one at a time.

The file with two or more part programs must use the following format.

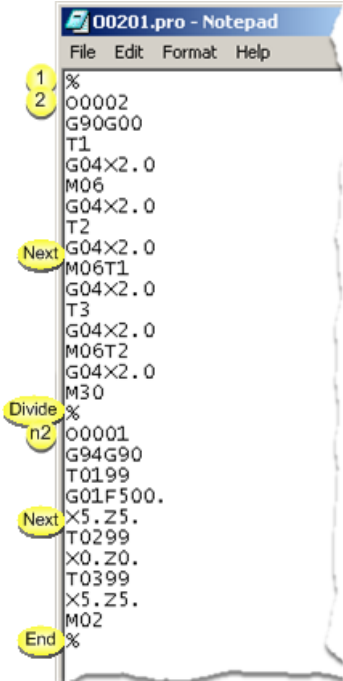

Line	Format
1	%
2	Oxxxxxxx (XXXXXX)
	Where o is a capital o. nnnnnnnn is the program number up to 8 digits. (xxxxxxx) (optional) is descriptive.
Next	Part program commands for the first program.
Divide	% (Optional)
	Where % is the file separator
n2	Oxxxxxxx (XXXXXX)
	Where Onnnnnnnn is the second line for the next program up to 8 digits. o is a capital o. nnnnnnnn is the program number up to 8 digits. (xxxxxxx) (optional) is descriptive.
Next	Part program commands for the next program.
End	%
	Where % is the end of file

3. Save the file in a selected directory.

Recommended: Use the extension .pro for part programs or when making the file type association.

.pro is the default extension used in the CNC Part Program Application.

Example

C:\CNCFile is the selected directory for the CNC .pro files.

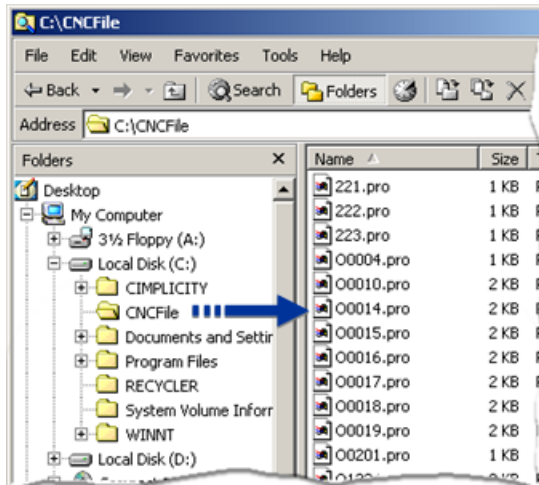

Step 2. Connect to an Open Factory CNC

Do any of the following.

Method 1

- a. Expand **Project** in the Workbench left pane.
- b. Double-click **CNC Part Program**.

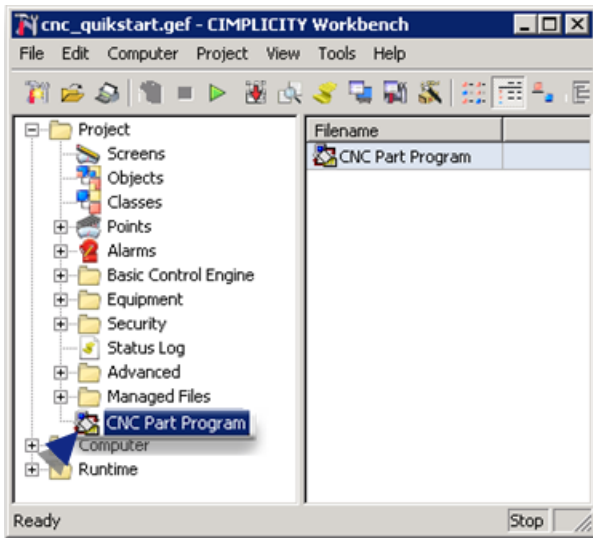

Method 2

- a. Click Start on the Windows task bar.
- b. Select (All) Programs> HMI SCADA - CIMPLICITY version>CNC Part Program

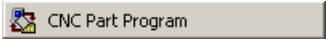

Method 6

- a. Click Start on the Windows task bar.
- b. Select Run.

The Run dialog box opens.

- a. Enter `cnc_program` in the **Open** field.
- b. Press Enter.

Method 4

Click a button that has been configured for a CimView screen.

 **Note:** A CimEdit screen designer can configure a button with an Execute Command action.

The entry in the **Command** field will be `cnc_program`

The CNC Part Program– Protocol Selection dialog box opens.

A CNC Part Program - Protocol Selection dialog box opens when you use any method.

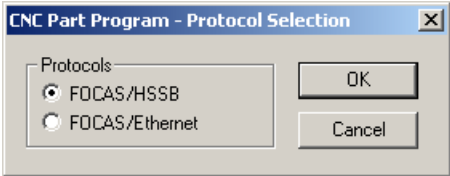

Method 5

- a. Click Programs on the CNC Quikstart Main Menu.
- b. Select the protocol you are using.
- c. Click **OK**.
- d. Continue based on your selection.

- FOCAS/HSSB
- FOCAS/Ethernet

FOCAS/HSSB

A CNC Part Program – Node Selection dialog box opens.

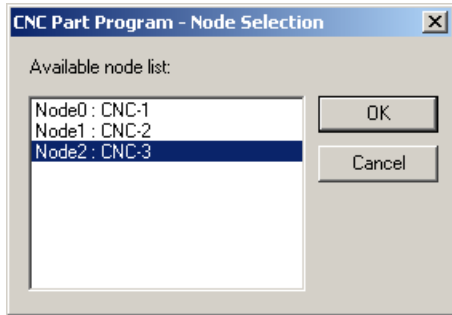

- a. Select a node from the Available node list.
- b. Click **OK**.

FOCAS/Ethernet

A CNC Part Program – Network Selection dialog box opens.

A. Enter the following.

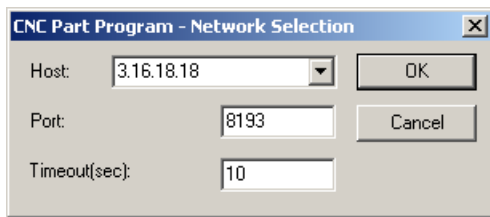

Field	Description
Host	Valid IP address for the host or select one from the available list.
Port	Port number the address is hooked to.
Timeout	

B. Click OK.

Step 3. Work in the CNC Part Program Window

Step 3. Work in the CNC Part Program Window

The Part Program Application window provides several features to work with part program files as follows.

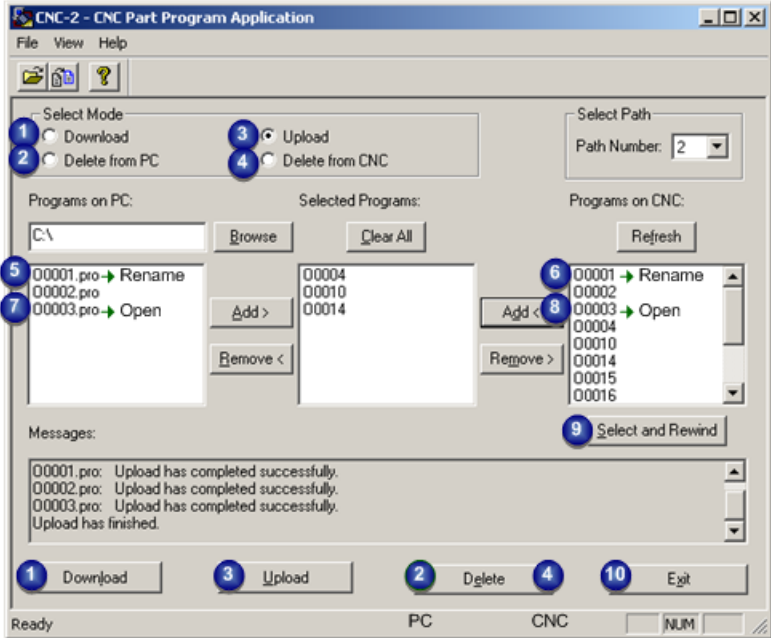

- rect 12, 351, 105, 369 [Option 3.1. Download a Part Program to the CNC \(page 332\)](#)
- rect 7, 74, 100, 92 [Option 3.1. Download a Part Program to the CNC \(page 332\)](#)
- rect 7, 89, 100, 107 [Option 3.2. Delete Part Programs on your PC \(page 333\)](#)
- rect 131, 350, 224, 368 [Option 3.3. Upload a Part Program to a PC \(page 334\)](#)
- rect 141, 92, 234, 110 [Option 3.4. Delete Part Programs on your CNC \(page 336\)](#)
- rect 2, 161, 126, 179 [Option 3.5. Rename PC Files through the Part Program Window \(page 337\)](#)
- rect 2, 185, 126, 203 [Option 3.7. Open a PC File through the CNC Part Program Window \(page 340\)](#)
- rect 337, 162, 461, 180 [Option 3.6. Rename CNC Files through the Part Program Window \(page 338\)](#)
- rect 337, 183, 461, 201 [Option 3.8. Open a CNC File through the CNC Part Program Window \(page 342\)](#)
- rect 350, 259, 460, 277 [Option 3.9. Select and Rewind Part Programs \(page 344\)](#)
- rect 142, 75, 235, 93 [Option 3.3. Upload a Part Program to a PC \(page 334\)](#)
- rect 239, 352, 302, 370 [Option 3.2. Delete Part Programs on your PC \(page 333\)](#)
- rect 301, 352, 357, 370 [Option 3.4. Delete Part Programs on your CNC \(page 336\)](#)
- rect 373, 351, 474, 369 [Option 3.10. Exit the Part Program Window \(page 345\)](#)

Option 3.1 (page 332)	Download a part program to the CNC.
Option 3.2 (page 333)	Delete part programs on your PC.
Option 3.3 (page 334)	Upload a part program to a PC.

Option 3.4 (page 336)	Delete part programs on your CNC.
Option 3.5 (page 337)	Rename PC files through the part program window.
Option 3.6 (page 338)	rename CNC files through the part program window.
Option 3.7 (page 340)	Open a PC file through the CNC Part Program window.
Option 3.8 (page 342)	Open a CNC file through the CNC Part program window.
Option 3.9 (page 344)	Select and rewind part programs
Option 3.10 (page 345)	Exit the Part Program window.

Option 3.1. Download a Part Program to the CNC

Download part programs to a CNC as follows.

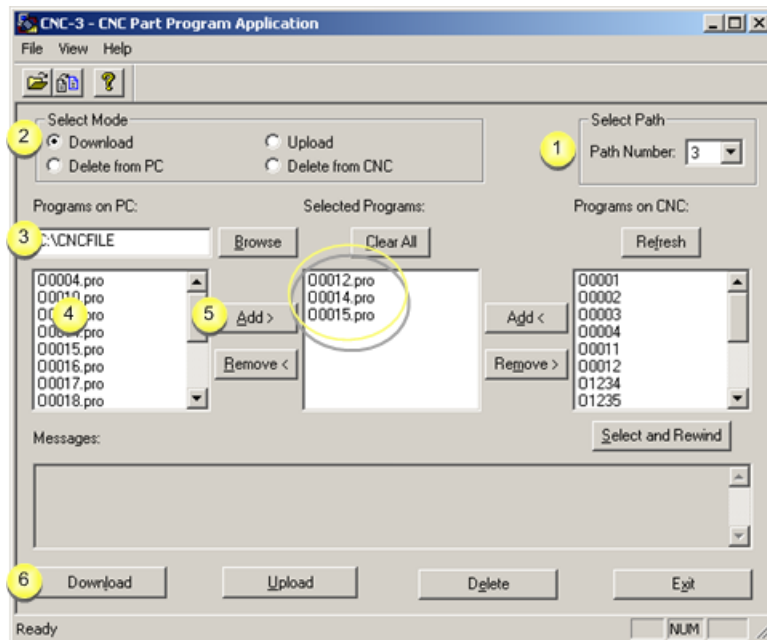

Step	Description
1	(Optional) Select the path. The path number is enabled if the device model supports multiple paths. The selected path from the drop down list is the path on the CNC to which files will be downloaded.
2	Check Download in the Select Mode box.
3	Select the directory in which the part program files are stored in the Programs on PC field. Browse opens the the Open browser to help find the directory. The files in the selected directory display in the Programs on PC box.
4	Select the files in the Programs on PC box that will be downloaded to the CNC. The selected filenames have a .pro extension, or another that may have been assigned to the file.
5	Click Add. The files are moved to the Selected Programs box.
6	Click Download.

Results

- Part programs are downloaded to the CNC, one at a time.
- The file name extensions (.pro) are removed.
- The download process is reported in the Messages box.
- Part programs that are not downloaded due to errors are shown in the Messages area.



Option 3.2. Delete Part Programs on your PC

Delete part programs from your PC as follows.

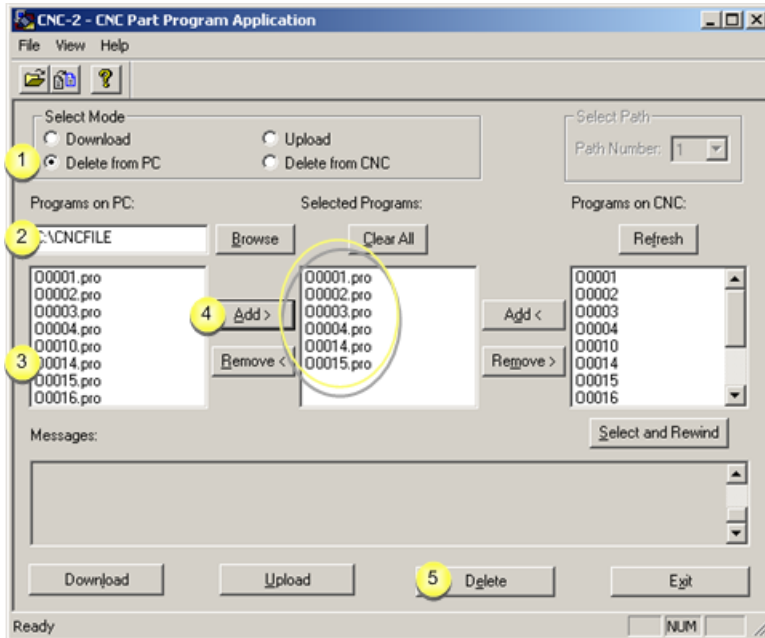

1	Check Delete from PC in the Select Mode box.
2	Select the directory in which the part program files are stored in the Programs on PC field.
	Browse Opens the Open browser to help find the directory.
	The files in the selected directory display in the Programs on PC box.
3	Select the files that will be deleted from the PC.
4	Click Add.
	The files are moved to the Selected Programs box.
5	Click Delete.

Result: Part programs are deleted from your PC one by one. The delete process is reported in the Messages box.



Option 3.3. Upload a Part Program to a PC

Upload part programs to a PC as follows.

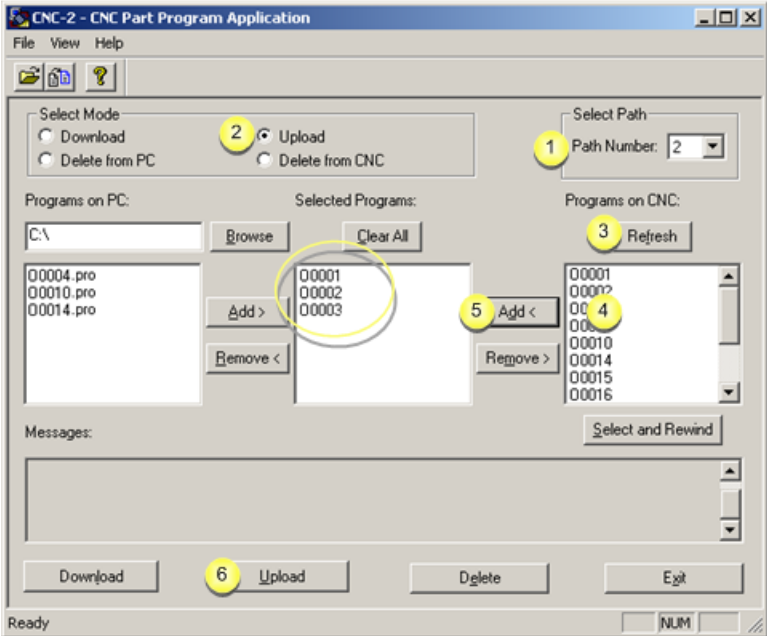

1	(Optional) Select the path.
	Note: The path number is enabled if the device model supports multiple paths. The selected path from the drop down list is the path on the CNC from which files will be uploaded.
2	Check Upload in the Select Mode box.
3	(Optional) Click Refresh.
	The file display in the Programs on CNC box is brought up-to-date.
4	Select the files in the Programs on CNC box that will be uploaded to the PC.
	Note: The filenames have no extensions.
5	Click Add.
	The files are moved to the Selected Programs box.
6	Click Upload.

Results

- Part programs are uploaded to the PC, one at a time.
- The file is created in the directory displayed in the **Programs on PC** box.
- The filename extension (e.g. .pro) is added to each of the files.
- The upload process is reported in the Messages box.



Option 3.4. Delete Part Programs on your CNC

Delete part programs from your CNC as follows.

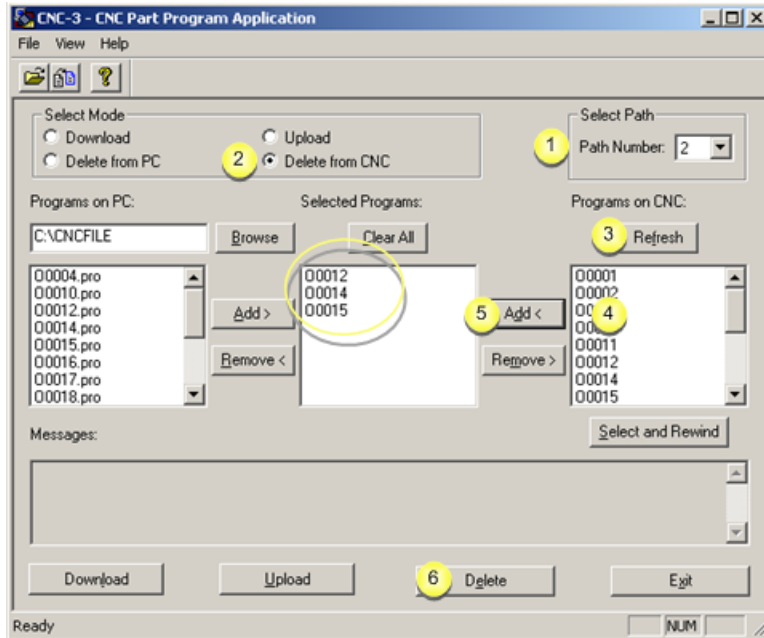

1	(Optional) Select the path.
	The path number is enabled if the device model supports multiple paths. The selected path from the drop down list is the path on the CNC from which files will be deleted.
2	Check Delete from CNC in the Select Mode box.
3	(Optional) Click Refresh.
	The file display in the Programs on CNC box is brought up-to-date.
4	Select the files in the Programs on CNC box that will be deleted from the CNC.
	Note: The filenames have no extensions.
5	Click Add.
	The files are moved to the Selected Programs box.
6	Click Delete.

Results

- The selected part programs are deleted from your CNC, one by one.
- The process is reported in the Messages area.



Option 3.5. Rename PC Files through the Part Program Window

Rename a part program file on the PC as follows.

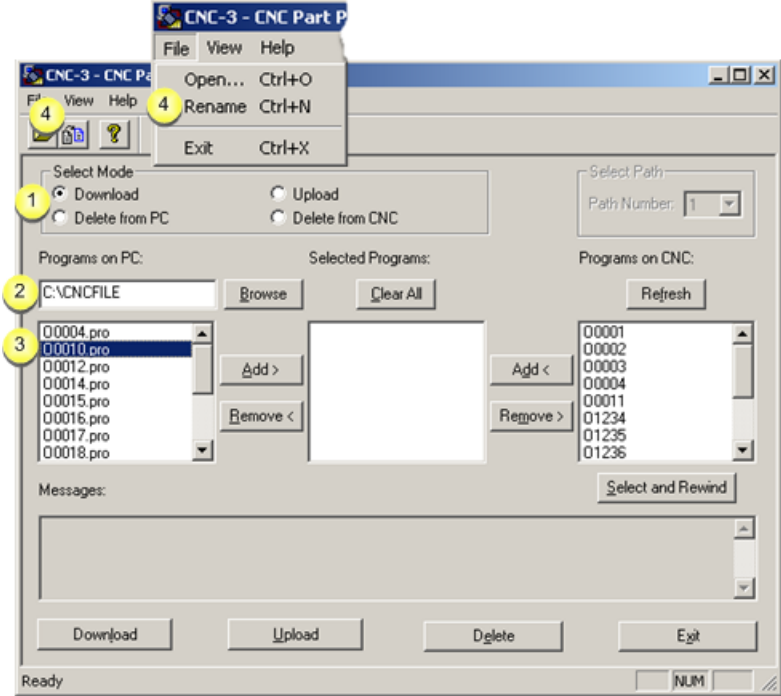

1	Check either Download or Delete from PC in the Select Mode box.		
2	Select the directory in which the part program files are stored in the Programs on PC field.		
	<table border="1"> <tr> <td>Browse</td> <td>Opens the Open browser to help find the directory.</td> </tr> </table>	Browse	Opens the Open browser to help find the directory.
Browse	Opens the Open browser to help find the directory.		
	The files in the selected directory display in the Programs on PC box.		
3	Select a file to rename in the Programs on PC box.		
	Note: The selected filenames have a three letter extension, e.g. .pro.		
4	Do one of the following.		
	<ul style="list-style-type: none"> • Click the Rename button on the CNC Part Program window toolbar. • Click File>Rename on the CNC Part Program window file menu. • Press Ctrl+N on the keyboard. <p>A Rename File dialog box opens.</p>		
5	Enter a new file name with the correct three letter extension, e.g. .pro, in the New Name field.		

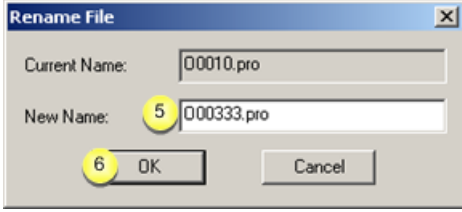
	 <p>The image shows a 'Rename File' dialog box. The 'Current Name' field contains '00010.pro'. The 'New Name' field contains '000333.pro', with a yellow circle containing the number '5' next to it. The 'OK' button has a yellow circle containing the number '6' next to it. There is also a 'Cancel' button.</p>
6	Click OK.

Result: The new filename displays in the Programs on PC box.

1. A message informs you that the name change is successful.

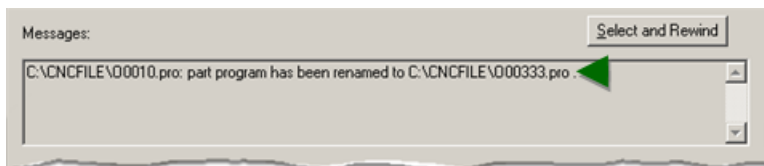

2. The renamed file displays in the:

Programs on PC box.

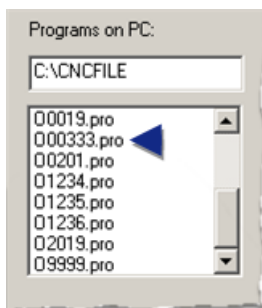

 **Note:** Files in the **Selected Programs** box can be renamed, regardless of what is checked in the **Select Mode** box.

Option 3.6. Rename CNC Files through the Part Program Window

Rename a part program file on the CNC as follows.

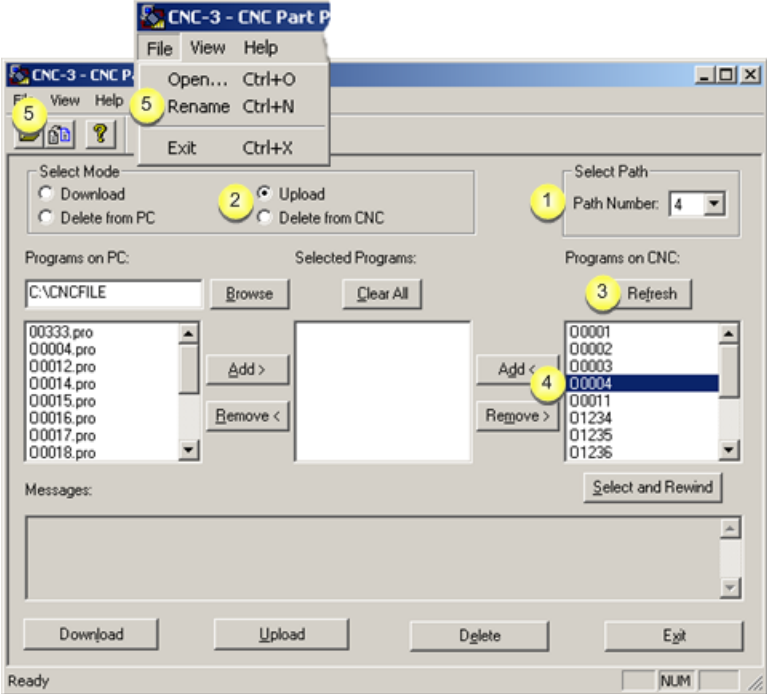

1	(Optional) Select the path.
	Note: The path number is enabled if the device model supports multiple paths. The selected path from the drop down list is the path on the CNC in which files can be selected to be renamed.
2	Check either Upload or Delete from CNC in the Select Mode box.
3	(Optional) Click Refresh.
	The file display in the Programs on CNC box is brought up-to-date.
4	Select a file to rename in the Programs on CNC box.
	Note: The selected filenames have no extension.
5	Do one of the following.
	<ul style="list-style-type: none"> • Click the Rename button on the CNC Part Program window toolbar. • Click File>Rename on the CNC Part Program window file menu. • Press Ctrl+N on the keyboard. <p>A Rename File dialog box opens.</p>
6	Enter a new file name with no extension New Name field.

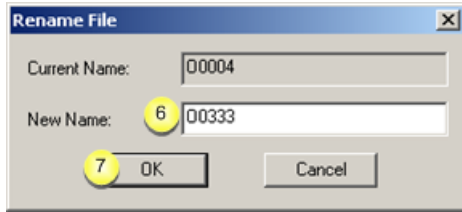

Messages inform you that the current file is uploaded to an ...Temp\CNCO00004 file. The temporary file will be deleted when the application exits.



7 Click OK.

Results

1. Messages inform you that:



A	The file has been successfully renamed to <code>0nnnnnnnn</code> , e.g. 00000333
B	The original file name, e.g. 00004, has been deleted.

2. The renamed file displays in the:

Programs on CNC box.

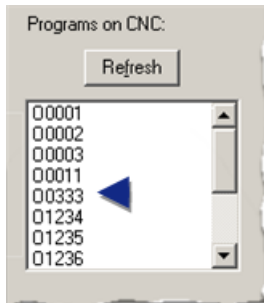

Note: Files in the **Selected Programs** box can be renamed, regardless of what is checked in the **Select Mode** box.

Option 3.7. Open a PC File through the CNC Part Program Window

Note: The program file extension, e.g. .pro, needs to be associated with a text editor for the file to open automatically. If it is not, a message will display asking you to find an application to open the file.

Consult Windows documentation for information about associating files with applications.

Open a part program file that is on the PC, as follows.

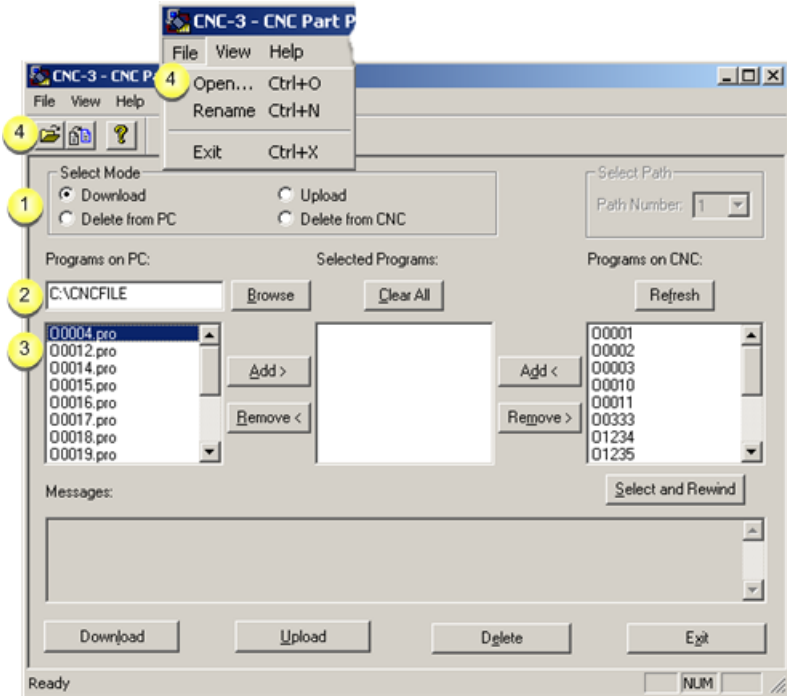

1	Check either Download or Delete from PC in the Select Mode box.
2	Select the directory in which the part program files are stored in the Programs on PC field.
	Browse Opens the Open browser to help find the directory.
	The files in the selected directory display in the Programs on PC box.
3	Select a file to open in the Programs on PC box.
	Note: The selected filenames have a three letter extension, e.g. .pro.
4	Do one of the following.
	<ul style="list-style-type: none"> • Click the Open button on the CNC Part Program window toolbar. • Click File>Open on the CNC Part Program window file menu. • Press Ctrl+O on the keyboard.

Result: The associated text editor, e.g. Notepad, opens the file.

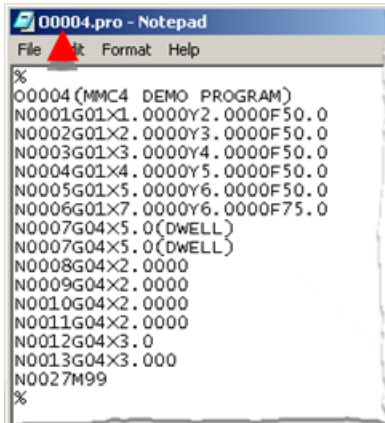

Option 3.8. Open a CNC File through the CNC Part Program Window

Note: The program file extension, e.g. .pro, needs to be associated with a text editor for the file to open automatically. If it is not, a message will display asking you to find an application to open the file.

Consult Windows documentation for information about associating files with applications.

Open a part program file that is on the PC, as follows.

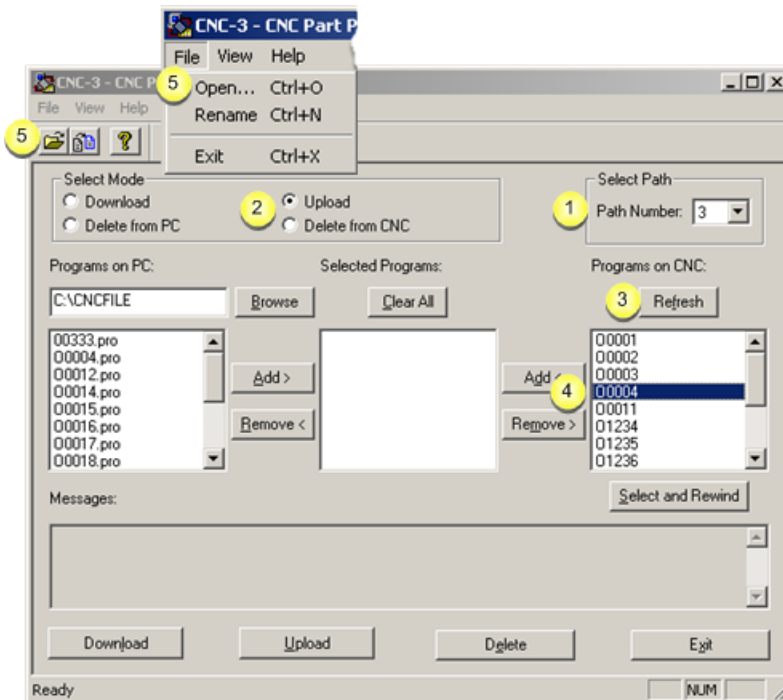

1	(Optional) Select the path.
	Note: The path number is enabled if the device model supports multiple paths. The selected path from the drop down list is the path on the CNC in which files can be selected to be opened.

2	Check either Upload or Delete from CNC in the Select Mode box.
3	(Optional) Click Refresh.
	The file display in the Programs on CNC box is brought up-to-date.
4	Select a file to open in the Programs on CNC box .
	Note: The selected filenames do not have an extension.
5	Do one of the following.
	<ul style="list-style-type: none"> • Click the Open button on the CNC Part Program window toolbar. • Click File>Open on the CNC Part Program window file menu. • Press Ctrl+O on the keyboard.

Results

1. Messages inform you that:

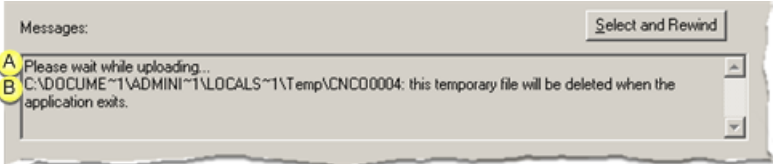

A	The file is uploading.
B	A ...Temp\CNCOnnnnnnnn temporary file will be deleted when the application exits.

2. The associated text editor, e.g. Notepad, opens the file.

The filename has a CNC prefix.

Example

Selected file O0004 displays as CNCO0004 on the text editor title bar.

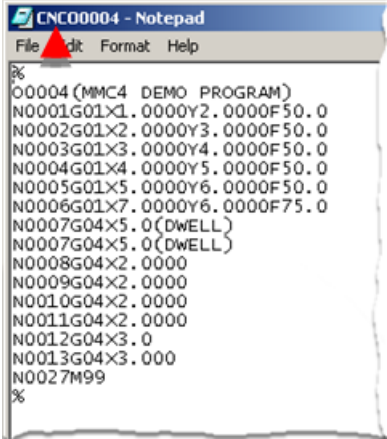

Option 3.9. Select and Rewind Part Programs

A program that you select and rewind is loaded into memory on the CNC and then rewound to the beginning.

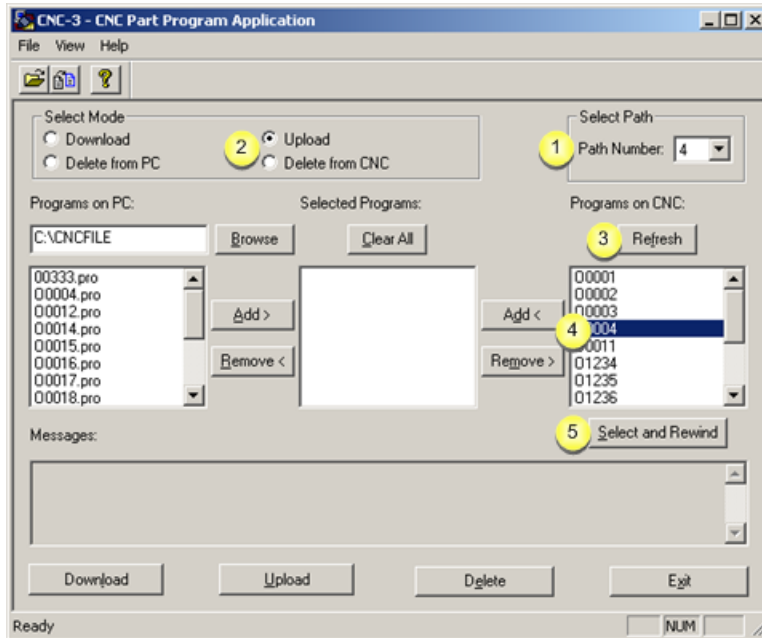

1	(Optional) Select the path.
	Note: The path number is enabled if the device model supports multiple paths. The selected path from the drop down list is the path on the CNC in which files can be selected for rewind.
2	Check either Upload or Delete from CNC in the Select Mode box.
3	(Optional) Click Refresh.
	The file display in the Programs on CNC box is brought up-to-date.
4	Select a file to rewind in the Programs on CNC box.
5	Click Select and Rewind.

Result: The program is loaded into memory on the CNC and then rewound to the beginning.

Select and Rewind Error

If either of the following messages is displayed:

- CNC is not in EDIT mode.
- CNC is not in EDIT or MEMORY mode.
- Ensure that the CNC is in the correct mode.

Option 3.10. Exit the Part Program Window

Exit the Part Program application, as follows.

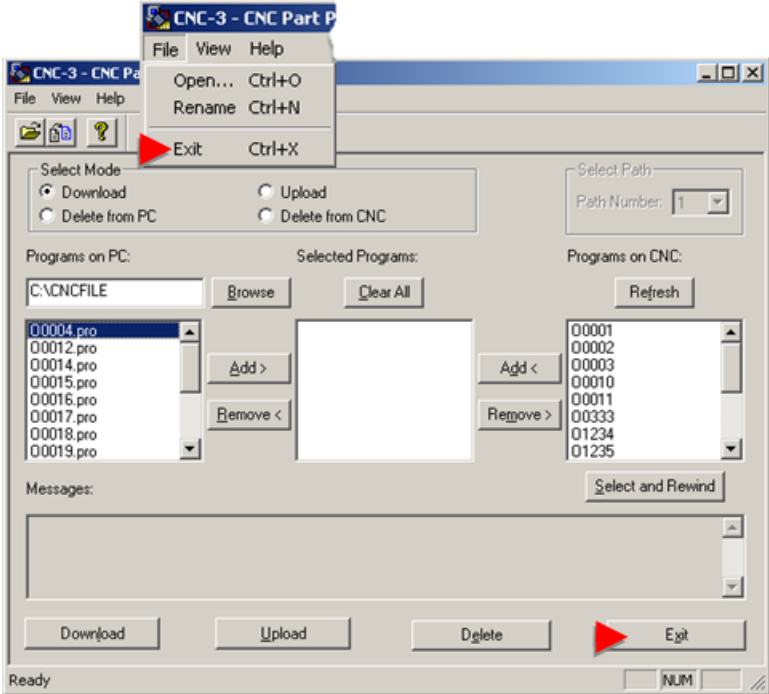

Do any of the following.

- Click Exit.
- Click File>Exit on the Part Program window menu bar.
- Press Ctrl+X on the keyboard.

Part Program Troubleshooting

- Unexpected files on PC.
- Select and rewind error.

Unexpected Files on PC

Problem

Unexpected files have names with the format of CNC0xxxx

Guideline

The files are temporary files created during the opening or renaming of part programs on your CNC.

Define the TMP or TEMP environment variable on your computer.

Select and Rewind Error

Problem

One of the following messages displays.

CNC is not in EDIT mode.

CNC is not in EDIT or MEMORY mode.

Guideline

Ensure that the CNC is in the correct mode.

Use the Programs on PC edit box

You can use the Programs on PC edit box to locate a part program on your PC.

To use Programs on PC edit box:

1. In the Programs on PC edit box, type the fully qualified path for the part program using the following format:

drive:[directory1\directory2\&ldots;][filename]

2. Click outside of the edit box.

The CNC Part Program application searches for the program and returns the result in the Programs on PC list box.

 **Tip:** You can use a ? (question mark) or an * (asterisk) as wild cards in the file name to expand search criteria.

CNC Command Line Utilities

CNC Command Line Utilities

The CNC Command Line Utilities enable you to:

- Manage and display CNC part program and file data by entering commands at the MS DOS prompt.

- Batch programming to create automated procedures.

This functionality extends to any existing directories and files on your PC network.

Associated utilities include:

CNC Part Program Command Line Utilities

- FOCAS/HSSB
- FOCAS/Ethernet

CNC File Data Command Line Utilities

- FOCAS/HSSB
- FOCAS/Ethernet

CNC Dynamic Link Library Graphic Overview

Using the CNC dynamic link library a request is made and responded to.

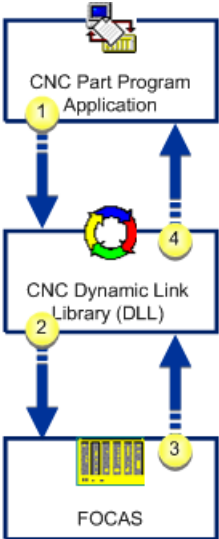

- circle 40, 69, 38 [\(page 347\)](#)
- circle 36, 201, 38 [\(page 347\)](#)
- circle 106, 280, 38 [\(page 347\)](#)
- circle 113, 153, 38 [\(page 347\)](#)

1	CNC data request.
2	Application request.
3	CNC data for application..

4 | CNC data response.

CNC Part Program Command Line Utilities for FOCAS/HSSB

CNC Part Program Command Line Utilities for FOCAS/HSSB

The CNC Part Program Command Line Utilities for FOCAS/HSSB enable you to:

- Manage and display part programs using an MS DOS window.
- Perform most of the same functions as the CNC Part Program application by entering the appropriate commands.
- Use any existing directories and part programs on your PC network.

CNC Part Program command line utilities for FOCAS/HSSB are:

- cnc_upload.exe
- cnc_download.exe
- cnc_delete.exe
- cnc_dir.exe
- cnc_select.exe

cnc_upload.exe

Purpose

Upload a single part program or a sequence of part programs from CNC memory to a single file on the PC.

Correct usage

```
C:\> cnc_upload <nodenum> <pathnum> <filespec> <startprogram> <endprogram>
```

Usage Defined

<nodenum>	Node number (configured HSSB card).	
<pathnum>	CNC path. Enter one of the following.	
	Value	Path
	0	None
	1	First
	2	Second

	3	Third	
	4	Fourth	Series 30i/31i/32i only
	5	Fifth	Series 30i/31i/32i only
	6	Sixth	Series 30i/31i/32i only
	7	Seventh	Series 30i/31i/32i only
	8	Eighth	Series 30i/31i/32i only
	9	Ninth	Series 30i/31i/32i only
	10	Tenth	Series 30i/31i/32i only
If the CNC does not support multiple paths, enter 0.			
<filespec>	File specification of file to receive the uploaded part program(s). This may be a fully qualified filename or a filename in the current directory.		
<startprogram>	Starting range of part programs to upload.		
<endprogram>	Ending range of part programs to upload.		

Example

The contents of CNC part programs between < startprogram > and < endprogram > are uploaded to the < filespec > for <nodenum> and < pathnum > :

```
C:\> cnc_upload 0 0 test.pp 1 10
Uploading part programs 00001 - 00010 to test.pp: Success
C:\>
```

The file test.pp is either created or overwritten with all the part programs in the range of **1** to **10** currently registered in CNC memory.

Following is a list of possible errors:

- Could not determine CNC type for node x.
- Failure to get directory info.
- Bad directory info returned.

cnc_download.exe

Purpose

Download one or more files from the PC to CNC memory. Each file may contain a single part program or a sequence of part programs.

Correct usage

```
C:\> cnc_download <nodenum> <pathnum> <filespec1> [<filespec2>]
[<filespec3>]&ldots;
```

Usage defined

<nodenum>	Node number (configured HSSB card).		
<pathnum>	CNC path. Enter one of the following.		
	Value	Path	
	0	None	
	1	First	
	2	Second	
	3	Third	
	4	Fourth	Series 30i/31i/32i only
	5	Fifth	Series 30i/31i/32i only
	6	Sixth	Series 30i/31i/32i only
	7	Seventh	Series 30i/31i/32i only
	8	Eighth	Series 30i/31i/32i only
	9	Ninth	Series 30i/31i/32i only
	10	Tenth	Series 30i/31i/32i only
	If the CNC does not support multiple paths, enter 0.		
<filespec>	File specification. Each file specification indicates a single file containing part program(s) to download. This may be a fully qualified filename or a filename in the current directory.		

Example

The contents of each file is downloaded to CNC memory and displays success or failure status when it is complete:

```
C:\> cnc_download 0 0 c:\00001.pp c:\00002.pp c:\00003.pp
Beginning download:
C:\00001.pp: Success
C:\00002.pp: File open failed
C:\00003.pp: Success
C:\>
```

The O0001.pp and O0003.pp part program files have been downloaded and registered in CNC memory. The part program O0002.pp could not be opened and was not processed.

The following is a list of possible errors:

- File not found.
- Failed to open file for reading.
- File contains bad program.
- CNC write protect.
- CNC out of memory.

cnc_delete.exe

Purpose

Delete one or more part programs from CNC memory.

Correct usage

```
C:\> cnc_delete <nodenum> <pathnum> <prognum1> [<prognum2>] [<prognum3>]
&ldots;
```

Usage defined

<nodenum>	Node number (configured HSSB card).		
<pathnum>	CNC path. Enter one of the following.		
	Value	Path	
	0	None	
	1	First	
	2	Second	
	3	Third	
	4	Fourth	Series 30i/31i/32i only
	5	Fifth	Series 30i/31i/32i only
	6	Sixth	Series 30i/31i/32i only
	7	Seventh	Series 30i/31i/32i only
	8	Eighth	Series 30i/31i/32i only
	9	Ninth	Series 30i/31i/32i only
	10	Tenth	Series 30i/31i/32i only

	If the CNC does not support multiple paths, enter 0.
<prognum>	Represents one or more part program numbers to delete.

Example

The contents of each part program are deleted from CNC memory. A success or failure status displays when each deletion completes:

```
C:\>cnc_delete 0 0 1 4 660 5000
Deleting part program 00001: Success
Deleting part program 00004: Success
Deleting part program 00660: Data error
Deleting part program 05000: Success
C:\>
```

The part programs O0001, O0004 and O5000 have been deleted from CNC memory. The part program O0660 did not exist on the CNC and was not processed.

The following is a list of possible errors:

- Program does not exist on CNC.
- CNC memory protected.

cnc_dir.exe

Purpose

Display a directory of registered part programs in CNC memory.

Correct usage

```
C:\> cnc_dir <nodenum> <pathnum> [/w]
```

Usage defined

<nodenum>	Node number (configured HSSB card).		
<pathnum>	CNC path. Enter one of the following.		
	Value	Path	
	0	None	
	1	First	
	2	Second	

	3	Third	
	4	Fourth	Series 30i/31i/32i only
	5	Fifth	Series 30i/31i/32i only
	6	Sixth	Series 30i/31i/32i only
	7	Seventh	Series 30i/31i/32i only
	8	Eighth	Series 30i/31i/32i only
	9	Ninth	Series 30i/31i/32i only
	10	Tenth	Series 30i/31i/32i only
	If the CNC does not support multiple paths, enter 0.		
	Optional request for a wide directory listing.		

Example

A directory of part programs registered in CNC memory is displayed, along with comments and sizes:

```
C:\> cnc_dir 0 0
Program Comment      Size
00020 TEST PROGRAM 20    216
00038 TEST PROGRAM 38    432
00039 TEST PROGRAM 39    288
00040 TEST PROGRAM 40    288
00041 TEST PROGRAM 41    216
00042 TEST PROGRAM 42    720
6 Total file(s).
C:\> cnc_dir 0 0 /w
00020  00038  00039  00040  00041  00042
6 Total file(s).
C:\>
```

Following is a list of possible errors:

- Bad directory info.
- CNC memory protected.

cnc_select.exe

Purpose

The command line utility **cnc_select.exe** selects one part program in CNC memory.

Correct usage

```
C:\> cnc_select <nodenum> <pathnum> <proignum>
```

Usage Defined

<nodenum>	Node number (configured HSSB card).		
<pathnum>	CNC path. Enter one of the following.		
	Value	Path	
	0	None	
	1	First	
	2	Second	
	3	Third	
	4	Fourth	Series 30i/31i/32i only
	5	Fifth	Series 30i/31i/32i only
	6	Sixth	Series 30i/31i/32i only
	7	Seventh	Series 30i/31i/32i only
	8	Eighth	Series 30i/31i/32i only
	9	Ninth	Series 30i/31i/32i only
	10	Tenth	Series 30i/31i/32i only
	If the CNC does not support multiple paths, enter 0.		
<program>	Represents the part program to select.		

Example

The part program was found and selected in CNC memory. A success or failure status displays when the selection completes:

```
C:\>cnc_select 0 0 5000
Selecting part program 05000: Successful
C:\>
```

The part program 05000 was found and selected in CNC memory.

Following is a list of possible errors:

- Program does not exist on CNC.

- CNC in wrong mode.

CNC Part Program Command Line Utilities for FOCAS/Ethernet

CNC Part Program Command Line Utilities for FOCAS/Ethernet

The CNC Part Program Command Line Utilities for FOCAS/Ethernet enable you to:

- Manage and display part programs using an MS DOS window.
- Perform most of the same functions as the CNC Part Program application by entering the appropriate commands.
- Use any existing directories and part programs on your PC network.

CNC Part Program command line utilities for FOCAS/Ethernet are:

- cnc_eupload.exe
- cnc_edownload.exe
- cnc_eddelete.exe
- cnc_edir.exe
- cnc_eselect.exe

cnc_eupload.exe

Purpose

Upload a single part program or a sequence of part programs from CNC memory to a single file on the PC.

Correct Usage

```
C:\> cnc_eupload <ipaddr> <portnum> <pathnum> <filespec> <startprogram>
<endprogram>
```

Usage Defined

<ipaddr>	IP address of the CNC.		
<portnum>	Port number of the CNC.		
<pathnum>	CNC path. Enter one of the following.		
	Value	Path	
	0	None	

	1	First	
	2	Second	
	3	Third	
	4	Fourth	Series 30i/31i/32i only
	5	Fifth	Series 30i/31i/32i only
	6	Sixth	Series 30i/31i/32ionly
	7	Seventh	Series 30i/31i/32i only
	8	Eighth	Series 30i/31i/32i only
	9	Ninth	Series 30i/31i/32i only
	10	Tenth	Series 30i/31i/32i only
	If the CNC does not support multiple paths, enter 0.		
<filespec>	File specification of file to receive the uploaded part program(s). This may be a fully qualified filename or a filename in the current directory.		
<startprogram>	Starting range of part programs to upload.		
<endprogram>	Ending range of part programs to upload.		

Example

The contents of CNC part programs between < startprogram > and < endprogram > are uploaded to the < filespec > for <ipaddr>, <portnum> and < pathnum > :

```
C:\> cnc_eupload 3.26.7.150 8172 0 test.pp 1 10
Uploading part programs 00001 - 00010 to test.pp: Success
C:\>
```

The file test.pp is either created or overwritten with all the part programs in the range of **1** to **10** currently registered in CNC memory.

Following is a list of possible errors.

- Could not determine CNC type for node x.
- Failure to get directory info.
- Bad directory info returned.

cnc_edownload.exe

Purpose

Download one or more files from the PC to CNC memory. Each file may contain a single part program or a sequence of part programs.

Correct usage

```
C:\> cnc_edownload <ipaddr> <portnum> <pathnum> <filespec1> [<filespec2>]
 [<filespec3>]&ldots;
```

Usage defined

<ipaddr>	IP address of the CNC.		
<portnum>	Port number of the CNC.		
<pathnum>	CNC path. Enter one of the following.		
	Value	Path	
	0	None	
	1	First	
	2	Second	
	3	Third	
	4	Fourth	Series 30i/31i/32i only
	5	Fifth	Series 30i/31i/32i only
	6	Sixth	Series 30i/31i/32i only
	7	Seventh	Series 30i/31i/32ionly
	8	Eighth	Series 30i/31i/32ionly
	9	Ninth	Series 30i/31i/32ionly
	10	Tenth	Series 30i/31i/32i only
	If the CNC does not support multiple paths, enter 0.		
<filespec>	File specification. Each file specification indicates a single file containing part program(s) to download. This may be a fully qualified filename or a filename in the current directory.		

Example

The contents of each file is downloaded to the CNC and displays success or failure status when it is complete:

```
C:\> cnc_edownload 3.26.7.150 8172 0 c:\00001.pp c:\00002.pp c:\00003.pp
Beginning download:
C:\00001.pp: Success
```

```
C:\O0002.pp: File open failed
C:\O0003.pp: Success
C:\>
```

The O0001.pp and O0003.pp part program files have been downloaded and registered in CNC memory. The part program O0002.pp could not be opened and was not processed.

Following is a list of possible errors.

- File not found.
- Failed to open file for reading.
- File contains bad program.
- CNC write protect.
- CNC out of memory.

cnc_delete.exe

Purpose

Delete one or more part programs from CNC memory.

Correct usage.

```
C:\> cnc_delete <ipaddr> <portnum> <pathnum> <prognum1> [<prognum2>]
[<prognum3>] &ldots;
```

Usage defined

<ipaddr>	IP address of the CNC.		
<portnum>	Port number of the CNC.		
<pathnum>	CNC path. Enter one of the following.		
	Value	Path	
	0	None	
	1	First	
	2	Second	
	3	Third	
	4	Fourth	Series 30i/31i/32i only
	5	Fifth	Series 30i/31i/32i only
	6	Sixth	Series 30i/31i/32ionly

	7	Seventh	Series 30i/31i/32i only
	8	Eighth	Series 30i/31i/32i only
	9	Ninth	Series 30i/31i/32ionly
	10	Tenth	Series 30i/31i/32i only
If the CNC does not support multiple paths, enter 0.			
<prognum>	One or more part program numbers to delete.		

Example

In the following example, the contents of each part program are deleted from CNC memory. A success or failure status displays when each deletion completes:

```
C:\>cnc_edelate 3.26.7.150 8172 0 1 4 660 5000
Deleting part program 00001: Success
Deleting part program 00004: Success
Deleting part program 00660: Data error
Deleting part program 05000: Success
C:\>
```

The part programs O0001, O0004 and O5000 have been deleted from CNC memory. The part program O0660 did not exist on the CNC and was not processed.

Following is a list of possible errors.

- Program does not exist on CNC.
- CNC memory protected.

cnc_dir.exe

Purpose

Display a directory of registered part programs in CNC memory.

Correct usage

```
C:\> cnc_dir <ipaddr> <portnum> <pathnum> [/w]
```

Usage defined

<ipaddr>	IP address of the CNC.
<portnum>	Port number of the CNC.

<input type="text" value="<pathnum>"/>	CNC path. Enter one of the following.		
	Value	Path	
	0	None	
	1	First	
	2	Second	
	3	Third	
	4	Fourth	Series 30i/31i/32i only
	5	Fifth	Series 30i/31i/32i only
	6	Sixth	Series 30i/31i/32i only
	7	Seventh	Series 30i/31i/32i only
	8	Eighth	Series 30i/31i/32i only
	9	Ninth	Series 30i/31i/32i only
	10	Tenth	Series 30i/31i/32i only
	If the CNC does not support multiple paths, enter 0.		
<input type="text" value=" /w"/>	Optional request for a wide directory listing.		

Example

A directory of part programs registered in CNC memory is displayed, along with comments and sizes:

```
C:\> cnc_edir 3.26.7.150 8172 0
Program Comment      Size
00020 TEST PROGRAM 20      216
00038 TEST PROGRAM 38      432
00039 TEST PROGRAM 39      288
00040 TEST PROGRAM 40      288
00041 TEST PROGRAM 41      216
00042 TEST PROGRAM 42      720
6 Total file(s).
C:\> cnc_edir 3.26.7.150 8172 0 /w
00020  00038  00039  00040  00041  00042
6 Total file(s).
C:\>
```

Following is a list of possible errors:

- Bad directory info.

- CNC memory protected.

cnc_eselect.exe

Purpose

Select one part program in CNC memory.

Correct usage

```
C:\> cnc_eselect <ipaddr> <portnum> <pathnum> <prognum>
```

Usage Defined

<ipaddr>	IP address of the CNC.		
<portnum>	Port number of the CNC.		
<pathnum>	CNC path. Enter one of the following.		
	Value	Path	
	0	None	
	1	First	
	2	Second	
	3	Third	
	4	Fourth	Series 30i/31i/32i only
	5	Fifth	Series 30i/31i/32i only
	6	Sixth	Series 30i/31i/32i only
	7	Seventh	Series 30i/31i/32i only
	8	Eighth	Series 30i/31i/32i only
	9	Ninth	Series 30i/31i/32i only
	10	Tenth	Series 30i/31i/32i only
	If the CNC does not support multiple paths, enter 0.		
<program>	Part program to select.		

Example

The part program was found and selected in CNC memory. A success or failure status displays when the selection completes:

```
C:\> cnc_eselect 3.26.7.150 8172 5000
Selecting part program 05000: Successful
C:\>
```

The part program 05000 was found and selected in CNC memory.

Following is a list of possible errors.

- Program does not exist on CNC.
- CNC in wrong mode.

CNC File Data Command Line Utilities for FOCAS/HSSB

CNC File Data Command Line Utilities for FOCAS/HSSB

The CNC File Data Command Line Utilities for FOCAS/HSSB enable you to manage and display CNC file data in an MS DOS window. You can upload or download CNC file data by entering the appropriate commands.

- The following CNC file data can be uploaded to your PC from the CNC.
 - Parameter
 - Tool offset
 - Work zero offset
 - Custom macro variable
 - Pitch error compensation
 - Keep relay
 - Diagnostic data
- All of the CNC file data and most of the keep relay data can be downloaded from your PC to the CNC.

The CNC Part Program command line utilities for FOCAS/HSSB to upload and download are:

- cnc_upload_tool.exe
- cnc_download_tool.exe

cnc_upload_tool.exe

Purpose

The command line utility **cnc_upload_tool.exe** uploads CNC file data from CNC memory to files on the PC.

Correct usage

```
C:\> cnc_upload_tool <data> <nodenum> <pathnum> <filespec.csv> <start>
<end>
```

Usage defined

<data>	CNC file data. Enter one of the following.		
	parm	Parameter Data	
	tofs	Tool Offset Data	
	zofs	Work Zero Offset Data	
	cmv	Custom Macro Variable Data	
	pec	Pitch Error Compensation	
	kbit	Keep Relay Data	
	diag	Diagnostic Data	
<nodenum>	Node number (configured HSSB card).		
<pathnum>	Path to the CNC. Enter one of the following.		
	Value	Path	
	0	None	
	1	First	
	2	Second	
	3	Third	
	4	Fourth	Series 30i/31i/32i only
	5	Fifth	Series 30i/31i/32i only
	6	Sixth	Series 30i/31i/32i only
	7	Seventh	Series 30i/31i/32i only
	8	Eighth	Series 30i/31i/32i only
	9	Ninth	Series 30i/31i/32i only
	10	Tenth	Series 30i/31i/32i only
	If the CNC does not support multiple paths, enter 0.		

<filespec>	File specification of file to receive the uploaded data. This may be a fully qualified filename or a filename in the current directory in comma separated variable (.csv) format.
<start>	Starting range of file data to upload.
<end>	Ending range of file data to upload.
	If both the start and end are left blank, all of the specified data for the CNC is uploaded.

Example

The contents of the CNC parameter data table between < start > and < end > are uploaded to the < filespec > for < nodenum > and < pathnum > :

```
C:\> cnc_upload_tool parm 0 0 parm1000.csv 1 1000
Uploading parm 0001 - 1000 to parm1000.csv: Success
C:\>
```

The file **parm1000.csv** is either created or overwritten with all the parameters in the range of **1** to **1000** currently registered in CNC memory. The file **upload_tool_log.csv** is either created or overwritten with any errors during the upload.

In the following example, the entire contents of the CNC parameter data table is uploaded to the < filespec > for < nodenum > and < pathnum > :

```
C:\> cnc_upload_tool parm 0 0 parmall.csv
Uploading all parm to parmall.csv: Success
C:\>
```

The file **parmall.csv** is either created or overwritten with all the parameters currently registered in CNC memory. The file **upload_tool_log.csv** is either created or overwritten with any errors during the upload.

The following is a list of possible errors:

- Could not determine CNC type for node x.
- Could not link to DLL.
- Failure to get directory info.
- Bad directory info returned.

cnc_download_tool.exe

Purpose

Download CNC file data from files on the PC to CNC memory.

Correct usage

```
C:\> cnc_download_tool <data> <nodenum> <pathnum> <filespec.csv>
```

Usage defined

<data>	CNC file data. Enter one of the following.		
	parm	Parameter Data	
	tofs	Tool Offset Data	
	zofs	Work Zero Offset Data	
	cmv	Custom Macro Variable Data	
	pec	Pitch Error Compensation	
	kbit	Keep Relay Data	
<nodenum>	Node number (configured HSSB card).		
<pathnum>	Path to the CNC. Enter one of the following.		
	Value	Path	
	0	None	
	1	First	
	2	Second	
	3	Third	
	4	Fourth	Series 30i/31i/32i only
	5	Fifth	Series 30i/31i/32i only
	6	Sixth	Series 30i/31i/32ionly
	7	Seventh	Series 30i/31i/32i only
	8	Eighth	Series 30i/31i/32i only
	9	Ninth	Series 30i/31i/32i only
	10	Tenth	Series 30i/31i/32i only
	If the CNC does not support multiple paths, enter 0.		
<filespec>	File specification of file to receive the uploaded data. This may be a fully qualified filename or a filename in the current directory in comma separate variable (.csv) format.		

Example

The contents of the file **parm1000.csv** is downloaded to the CNC parameter data table <nodenum > and <pathnum > :

```
C:\> cnc_download_tool parm 0 0 parm1000.csv
Downloading parm for parm1000.csv: Success
C:\>
```

The file **download_tool_log.csv** is either created or overwritten with any errors during the download.

Following is a list of possible errors.

- Could not determine CNC type.
- Could not link to DLL.
- Failure to get directory info.
- Bad directory info returned.

CNC File Data Command Line Utilities for FOCAS/Ethernet

CNC File Data Command Line Utilities for FOCAS/Ethernet

The CNC File Data Command Line Utilities for FOCAS/Ethernet enable you to manage and display CNC file data in an MS DOS window. You can upload or download CNC file data by entering the appropriate commands.

- The following CNC file data can be uploaded to your PC from the CNC.
 - Parameter
 - Tool offset
 - Work zero offset
 - Custom macro variable
 - Pitch error compensation
 - Keep relay
 - Diagnostic data
- All of the CNC file data and most of the keep relay data can be downloaded from your PC to the CNC.

The CNC Part Program command line utilities for FOCAS/Ethernet to upload and download are:

- cnc_eupload_tool.exe
- cnc_edownload_tool.exe

cnc_eupload_tool.exe

Purpose

Upload CNC file data from CNC memory to files on the PC.

Correct usage

```
C:\> cnc_eupload_tool <data> <ipaddr> <portnum> <pathnum> <filespec.csv>
<start> <end>
```

Usage defined

<data>	CNC file data. Enter one of the following.		
	parm	Parameter Data	
	tofs	Tool Offset Data	
	zofs	Work Zero Offset Data	
	cmv	Custom Macro Variable Data	
	pec	Pitch Error Compensation	
	kbit	Keep Relay Data	
	diag	Diagnostic Data	
<ipaddr>	IP address of the CNC.		
<portnum>	Port number of the CNC.		
<pathnum>	Path to the CNC. Enter one of the following.		
	Value	Path	
	0	None	
	1	First	
	2	Second	
	3	Third	
	4	Fourth	Series 30i/31i/32i only
	5	Fifth	Series 30i/31i/32i only
	6	Sixth	Series 30i/31i/32i only
	7	Seventh	Series 30i/31i/32i only

	8	Eighth	Series 30i/31i/32i only
	9	Ninth	Series 30i/31i/32i only
	10	Tenth	Series 30i/31i/32i only
	If the CNC does not support multiple paths, enter 0.		
<filespec>	File specification of file to receive the uploaded data. This may be a fully qualified filename or a filename in the current directory in comma separated variable (.csv) format.		
<start>	Starting range of file data to upload.		
<end>	Ending range of file data to upload.		
	If both the start and end are left blank, all of the specified data for the CNC is uploaded.		

Example

The contents of the CNC parameter data table between < start > and < end > are uploaded to the < filespec > for <ipaddr>, <portnum> and < pathnum > :

```
C:\> cnc_eupload_tool parm 3.26.7.150 8172 0 parm1000.csv 1 1000
Uploading parm 0001 - 1000 to parm1000.csv: Success
C:\>
```

The file **parm1000.csv** is either created or overwritten with all the parameters in the range of **1** to **1000** currently registered in CNC memory. The file **upload_tool_log.csv** is either created or overwritten with any errors during the upload.

In the following example, the entire contents of the CNC parameter data table is uploaded to the < filespec > for <ipaddr>, <portnum> and < pathnum > :

```
C:\> cnc_eupload_tool parm 3.26.7.150 8172 0 parmall.csv
Uploading all parm to parmall.csv: Success
C:\>
```

The file **parmall.csv** is either created or overwritten with all the parameters currently registered in CNC memory. The file **upload_tool_log.csv** is either created or overwritten with any errors during the upload.

Following is a list of possible errors:

- Could not determine CNC type for node x.
- Could not link to DLL.
- Failure to get directory info.
- Bad directory info returned.

cnc_edownload_tool.exe

Purpose

Download CNC File data.

The command line utility **cnc_edownload_tool.exe** downloads CNC file data from files on the PC to CNC memory.

Correct usage

The following is the correct usage.

```
C:\> cnc_edownload_tool <data> <ipaddr> <portnum> <pathnum> <filespec.csv>
```

User defined

<data>	CNC file data. Enter one of the following.		
	parm	Parameter Data	
	tofs	Tool Offset Data	
	zofs	Work Zero Offset Data	
	cmv	Custom Macro Variable Data	
	pec	Pitch Error Compensation	
	kbit	Keep Relay Data	
<ipaddr>	IP address of the CNC.		
<portnum>	Port number of the CNC.		
<pathnum>	CNC path. Enter one of the following.		
	Value	Path	
	0	None	
	1	First	
	2	Second	
	3	Third	
	4	Fourth Series 30i/31i/32i only	
	5	Fifth Series 30i/31i/32i only	

	6	Sixth	Series 30i/31i/32i only
	7	Seventh	Series 30i/31i/32i only
	8	Eighth	Series 30i/31i/32i only
	9	Ninth	Series 30i/31i/32i only
	10	Tenth	Series 30i/31i/32i only
If the CNC does not support multiple paths, enter 0.			
<filespec>	File specification of file to receive the uploaded data. This may be a fully qualified filename or a filename in the current directory in comma separate variable (.csv) format.		

Example

The contents of the file **parm1000.csv** is downloaded to the CNC parameter data table <ipaddr>, <portnum> and <pathnum>:

```
C:\> cnc_edownload_tool parm 3.26.7.150 8172 0 parm1000.csv
Downloading parm for parm1000.csv: Success
C:\>
```

The file **download_tool_log.csv** is either created or overwritten with any errors during the download.

Following is a list of possible errors.

- Could not determine CNC type.
- Could not link to DLL.
- Failure to get directory info.
- Bad directory info returned.

Error Handling

Error Handling

Descriptions about error codes and handling errors are as follows.

- Connection error handling.
- CNC Data window error handling.
- Ethernet version only error handling.
- PMC Data window error handling.

 **Note:** Consult FANUC CNC documentation for more details about handling error codes.

Connection Error Handling

The PC must be able to communicate successfully with the CNC.

If communication fails, run the [test_cnc \(page 169\)](#) utility in order to verify communication to the CNC.

Suggestions to resolve communication problems.

- HSSB.
- Ethernet.

HSSB

If you do not receive a response when you try to connect to the CNC.

1. Check to see if any other PC-vendor printed circuit board is using the HSSB assigned I/O address.
2. Check the rotary switch settings on the CNC-based HSSB printed circuit board.

The switch should be set to 1 to start up in normal mode. (If you change the setting, remember to cycle CNC power.)

3. Reboot the PC and look at Windows Boot Log or the CIMPLICITY supported operating system System Log for errors that HSSB Driver is installed.
4. Verify that the target CNC has the correct software and the option is enabled.
5. Verify that the green LED located on the HSSB PC printed circuit board is ON after the CNC/PC boot. This LED is visible from the rear of the PC next to the fiber optic connection.
6. Reboot the PC and CNC after changing any setup configuration data.

Ethernet

If you do not receive a response when you ping the IP address:

7. Check with your Network Administrator to ensure that the
 - IP address is not in use by another device,
 - Subnet mask is correct for the device.
8. Reboot the PC and CNC after changing any setup configuration data.

CNC Data Window Error Handling

Return	Meaning	Explanation	Error Handling
EW_PROTOCOL (-17)	Protocol error Ethernet version only	Data from Ethernet Board is incorrect	Contact with the service section or the section in charge.
EW_SOCKET (-16)	Socket error Ethernet version only		Investigate CNC power supply, Ethernet cable and I/F board.
EW_NODLL (-15)	DLL file error	There is no DLL file for each CNC series corresponding to specified node.	
EW_BUS (-11)	Bus error HSSB version only	A bus error of CNC system occurred.	Contact with the service section or the section in charge.
EW_SYSTEM2 (-10)	System error (2) HSSB version only	A system error of CNC system occurred.	Contact with the service section or the section in charge.
EW_HSSB (-9)	Communication error of HSSB HSSB version only		Investigate the serial line or I/F board of HSSB.
EW_HANDLE (-8)	Handle number error		Get the library handle number.
EW_VERSION (-7)	Version mismatch between the CNC/PMC and library	The CNC/PMC version does not match that of the library.	Replace the library or the CNC/PMC control software.
EW_UNEXP (-6)	Abnormal library state	An unanticipated error occurred.	Contact with the section in charge.
EW_SYSTEM (-5)	System error HSSB version only	A system error of CNC occurred.	Contact with the service section or the section in charge.
EW_PARITY (-4)	Shared RAM parity error HSSB version only	A hardware error occurred.	Contact with the service section.
EW_MMCSYS (-3)	FANUC drivers installation error HSSB version only		The drivers required for execution are not installed.

Return	Meaning	Explanation	Error Handling
EW_RESET (-2)	Reset or stop request	The RESET or STOP button was pressed.	Call the termination function.
EW_BUSY (-1)	Busy		Wait until the completion of CNC processing, or retry.
EW_OK (0)	Normal termination		
EW_FUNC (1)	Error (function is not executed, or not available)	Specific function which must be executed beforehand has not been executed. Otherwise that function is not available.	
EW_LENGTH (2)	Error (data block length error, error of number of data)		Check and correct the data block length or number of data.
EW_NUMBER (3)	Error (data number error)		Check and correct the data number.
EW_ATTRIB (4)	Error (data attribute error)		Check and correct the data attribute.
EW_DATA (5)	Error (data error)		Check and correct the data. For the following operations, this code indicates that the specified program cannot be found. <ul style="list-style-type: none"> • Delete specified program • Search specified program • Start uploading NC program
EW_NOOPT (6)	Error (no option)	There is no corresponding CNC option.	
EW_PROT (7)	Error (write protection)	Write operation is prohibited.	
EW_OVRFLOW (8)	Error (memory overflow)	CNC tape memory is overflowed.	
EW_PARAM (9)	Error (CNC parameter error)	CNC parameter is set incorrectly.	
EW_BUFFER (10)	Error (buffer empty/full)	The buffer is empty or full.	Wait until completion of CNC processing, or retry.
EW_PATH (11)	Error (path number error)	A path number is incorrect.	

Return	Meaning	Explanation	Error Handling
EW_MODE (12)	Error (CNC mode error)	The CNC mode is incorrect.	Correct the CNC mode.
EW_REJECT (13)	Error (CNC execution rejection)	The execution at the CNC is rejected.	Check the condition of execution.
EW_DTSSVR (14)	Error (Data server error)	Some errors occur at the data server.	
EW_ALARM (15)	Error (alarm)	The function cannot be executed due to an alarm in CNC.	Remove the cause of alarm.
EW_STOP (16)	Error (stop)	CNC status is stop or emergency.	
EW_PASSWD (17)	Error (State of data protection)	Data is protected by the CNC data protection function.	

Ethernet Version Only Error Handling

Return	Meaning
EW_SOCKET (-16)	Socket API related error.
err_no	Meaning
1	ErrorReturn value of Windows API WSAGetLastError function. of socket API function
2	Error of connect API function
3	Error of send API function
4	Error of recy API function

Return	Meaning	
5	Error of select API function	
6	Error of setsockopt API function	
7	Error of gethostbyname API function	
8	Time out error of send API function	Where the error is occurred.
	1	At sending request
	2	At sending data of download
9	Time out error of recv API function	Where the error is occurred.
	1	At receiving request header
	2	At receiving request data
	3	At canceling upload data
	4	At receiving data of upload
	5	At starting or finishing the communication
10	Error of Winsock API is occurred in other process	Always 0.

Return	Meaning	
11	EOF Where the error is occurred. (end of file) detected	
	1	At send API function
	2	At recv API function
Return	Meaning	
EW_PROTOCOL (=-17)	Violation of the protocol.	
err_no	Meaning	dtno
1	The Always 0. send data is larger than the maximum transfer unit.	
2	The sending data size is illegal.	
3	The number of the recieved packet is 0.	
4	The mark of the protocol is incorrect in the received packet header.	

Return	Meaning	
5	The packet type flag is incorrect in the received packet header.	
6	The flag of the direction is incorrect in the received packet header.	
7	Illegal received data size.	The detail information is shown.
	1	The received data size is larger than the maximum transfer unit.
	2	The received data size is incorrect at start of communication.
	3	The data size of the received packet is less than 2 bytes.
	4	The sum of data blocks of the received packet is larger than all packet size.
	5	The sum of data blocks of the received packet is smaller than all packet size.
8	Communication error in the Ethernet Board	Communication of the Ethernet Board When the error occurs, its detail message is displayed in the log screen of the Ethernet Board on CNC side. And refer it. The main error is as follows.
	2	The personal computer would establish over limited connection. See FANUC documentation for details.

PMC Data Window Error Handling

Return	Meaning	Explanation	Error Handling
EW_PROTOCOL (-17)	Protocol error Ethernet version only	Data from Ethernet Board is incorrect.	Contact with the service section or the section in charge.
EW_SOCKET (-16)	Socket error Ethernet version only		Investigate CNC power supply, Ethernet cable and I/F board.
EW_NODLL (-15)	DLL file error	There is no DLL file for each CNC series corresponding to specified node.	
EW_BUS (-11)	Bus error HSSB version only	A bus error of CNC system occurred.	Contact with the service section or the section in charge.
EW_SYSTEM2 (-10)	System error (2 HSSB version only	A system error of CNC system occurred.	Contact with the service section or the section in charge.
EW_HSSB (-9)	Communication error of HSSB HSSB version only		Investigate the serial line or I/F board of HSSB.
EW_HANDLE (-8)	Handle number error		Get the library handle number.
EW_VERSION (-7)	Version mismatch between the CNC/ PMC and library	The CNC/PMC version does not match that of the library.	Replace the library or the CNC/PMC control software.
EW_UNEXP (-6)	Abnormal library state	An unanticipated error occurred.	Contact with the section in charge.
EW_SYSTEM (-5)	System error HSSB version only	A system error of CNC occurred.	Contact with the service section or the section in charge.
EW_PARITY (-4)	Shared RAM parity error HSSB version only	A hardware error occurred.	Contact with the service section.
EW_MMCSYS (-3)	FANUC drivers installation error HSSB version only	The drivers required for execution are not installed.	
EW_OK (0)	Normal termination		
EW_NOPMC (1)	Error (No PMC)	The PMC does not exist.	
EW_LENGTH (2)	Error (data block length error)		Check and correct the data block length.

Return	Meaning	Explanation	Error Handling
EW_RANGE (3)	Error (address range error)		Check and correct the address range.
EW_TYPE (4)	Error (address type/ data type error)		Check and correct the address type/data type.
EW_DATA (5)	Error (data error)		Check and correct the data.
EW_NOOPT (6)	Error (no option)	There is no corresponding CNC option.	
EW_BUFFER (10)	Error (buffer empty/ full)	The buffer is empty or full.	Wait until completion of PMC processing, or retry. Alternatively, add the required processing for the PMC.
EW_PASSWD (17)	Error (State of data protection)	Data is protected by the CNC data protection function.	

CNC Dynamic Link Library Error Codes and Messages

Error codes:

Error Number	Description
[-17]	Protocol error, bad data from CNC.
[-16]	Socket error, investigate CNC.
[-15]	No FOCAS DLL.
[-11]	Bus error.
[-10]	System 2 error.
[-9]	HSSB communications error.
[-8]	FOCAS DLL allocation error.
[-7]	FOCAS DLL and CNC/PMC version error.
[-6]	Unexpected FOCAS DLL error.
[-5]	System error.
[-4]	Shared RAM parity error.
[-3]	No FOCAS HSSB drivers.
[-2]	Reset or stop button pressed.
[-1]	CNC is busy.

Error Number	Description
(1)	Function not executed or not available.
(1)	PMC does not exist.
(2)	Function data length or data amount error.
(3)	Function data number error.
(3)	Function address range error.
(4)	Function data attribute error.
(4)	Function address type or data type error.
(5)	Data error or specified program not found.
(6)	CNC option not enabled or found.
(7)	Write operation prohibited.
(8)	CNC tape memory overflow.
(9)	CNC parameter not set correctly.
(10)	Buffer is empty or full.
(11)	Incorrect path number.
(12)	Incorrect CNC mode.
(13)	CNC execution rejected.
(14)	Data server error.
(15)	Function not executed due to CNC alarm.
(16)	CNC status is stop or emergency.
(17)	CNC data password is enabled.

Error messages:

Description
File open failed.
Bad program.
Bad program number/invalid range.
Timeout.
CNC edit in progress.
Program already selected.
Disk error.
CNC is not in EDIT mode.

Description
CNC is not in EDIT or MEMORY mode.
Error getting directory.
No Programs found.
Bad directory info from CNC.
Failure.
Unable to open CSV file.
Bad CSV file format.
Unable to open LOG file.
Bad input number or invalid range.
CNC type in file does not match control.
Model type different than CNC.
Memory type different than CNC.
Unknown memory type (A B C).
Number of values greater than number of axes.
Initiation of Windows Sockets DLL failed.

Software Removal and Driver Deletion

Software Removal and Driver Deletion

- Software removal.
- HSSB driver deletion.

Software Removal

 **Important:** Before you remove HMI for CNC software from your computer, you should save any projects that you do not want to lose. You can save them on storage media, or in a directory other than CIMPLICITY.

1. Open the Add or Remove Program window in the Windows Control Panel.

One method is as follows.

- a. Click Start on the Windows task bar.

b. Select Settings>Control Panel>Add or Remove Programs  Add or Remove Programs .

2. Select CIMPLICITY HMI for CNC in the **Currently installed programs** list.

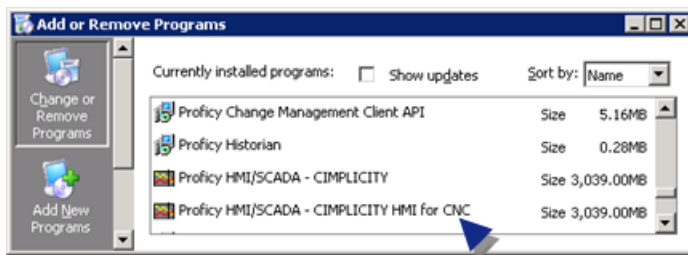

3. Click Remove.

4. Click OK in the message box.

5. Restart your computer.

HSSB Driver Deletion

Consult FANUC to uninstall the HSSB driver.

Chapter 4. Machine Edition Integration with CIMPLICITY

About Machine Edition Integration with CIMPLICITY

You can view the live point data for a running Machine Edition project through any of the following CIMPLICITY tools.

- Point Control Panel.
- CimView/CimEdit
- Basic scripting (to set points)
- Enterprise server (for points only)
- Point data logging.

For example, the CIMPLICITY Point Control Panel may display the following data.

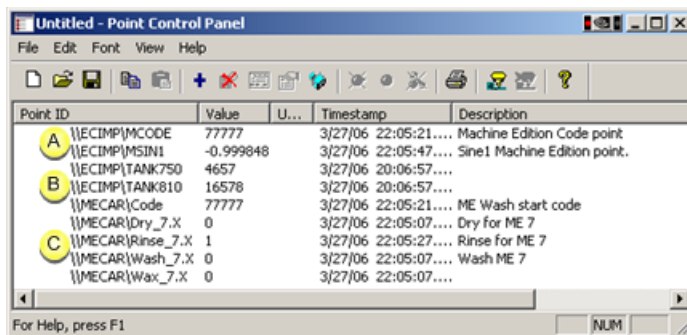

The screenshot shows a window titled "Untitled - Point Control Panel" with a menu bar (File, Edit, Font, View, Help) and a toolbar. Below the toolbar is a table with the following data:

Point ID	Value	U...	Timestamp	Description
A	\\ECIMP\MCODE	77777	3/27/06 22:05:21....	Machine Edition Code point
	\\ECIMP\MSINI	-0.999848	3/27/06 22:05:47....	Sine1 Machine Edition point.
	\\ECIMP\TANK750	4657	3/27/06 20:06:57....	
B	\\ECIMP\TANK810	16578	3/27/06 20:06:57....	
	\\MECAR\Code	77777	3/27/06 22:05:21....	ME Wash start code
	\\MECAR\Dry_7.X	0	3/27/06 22:05:07....	Dry for ME 7
C	\\MECAR\Rinse_7.X	1	3/27/06 22:05:27....	Rinse for ME 7
	\\MECAR\Wash_7.X	0	3/27/06 22:05:07....	Wash ME 7
	\\MECAR\Wax_7.X	0	3/27/06 22:05:07....	

A	CIMPLICITY points that access Machine Edition variables.
B	CIMPLICITY points for the CIMPLICITY project.
C	Machine Edition variables.

Machine Integration Architecture

CIMPLICITY integration of Machine Edition point data supports two types of architecture:

- Enterprise Server connectivity.
- Viewer connectivity.

Enterprise Server connectivity

CIMPLICITY can use Enterprise Server architecture to interact with Machine Edition View nodes as data providers.

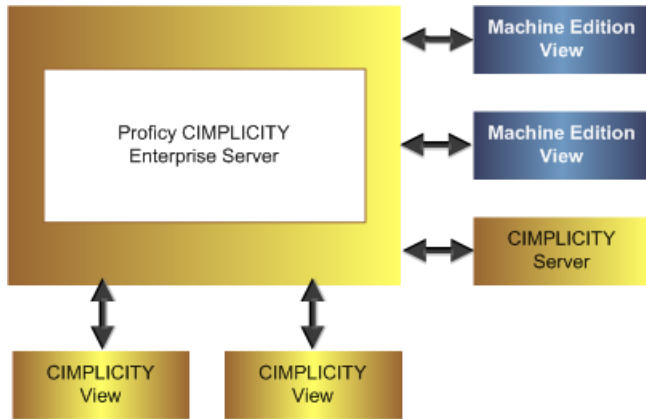

The CIMPLICITY Enterprise Server serves data from one or more Machine Edition projects.

Condition	Enterprise Server:
Enterprise Server starts.	<ul style="list-style-type: none"> Obtains a list of exported Machine Edition points Adds the Machine Edition points to the points it is serving.
Machine Edition node is restarted.	Re-synchronizes the list of points
Enterprise Server point goes into demand (e.g. a Viewer starts using the point).	Starts collecting the point data from the Machine Edition or CIMPLICITY node.

! **Important:** CIMPLICITY Enterprise server architecture provides scalability. Therefore, the server can handle data distribution to hundreds of viewers while limiting the impact on the CIMPLICITY View to one request per point.

Viewer connectivity

A CIMPLICITY Viewer application can connect directly to View systems on the network without the need for an intermediate Enterprise Server.

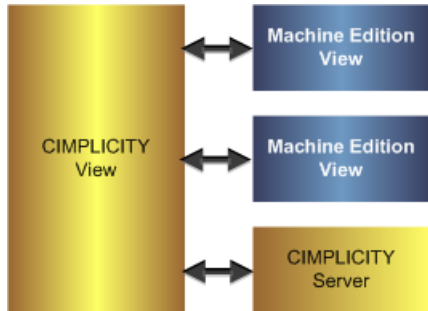

Machine Edition Variables in CIMPLICITY

Machine Edition Variables in CIMPLICITY

Note: Guidelines

- The data that Machine Edition refers to as variables or tags are referred to as points in CIMPLICITY.
- Machine Edition provides detailed documentation with sample projects to explain how to create a Machine Edition project and variables.

Step 1 (page 385)	Configure the Machine Edition project for CIMPLICITY.
Step 2 (page 388)	(Optional) Configure CIMPLICITY points to access machine Edition Variables.
Step 3 (page 401)	View/set/log Machine Edition variable data through CIMPLICITY.

Step 1. Configure the Machine Edition Project for CIMPLICITY

Step 1. Configure the Machine Edition Project for CIMPLICITY

Step 1.1 (page 386)	Set up Machine Edition project broadcast.
Step 1.2 (page 387)	Download the Machine Edition project to View.

Step 1.1. Set up Machine Edition Project Broadcast

Setting up the Machine Edition Project broadcast includes the following.

1 (page 386)	Enable the Machine Edition project broadcast'
2 (page 386)	Mark variables that will be viewed in CIMPLICITY as used.

1. Enable the Machine Edition project broadcast.

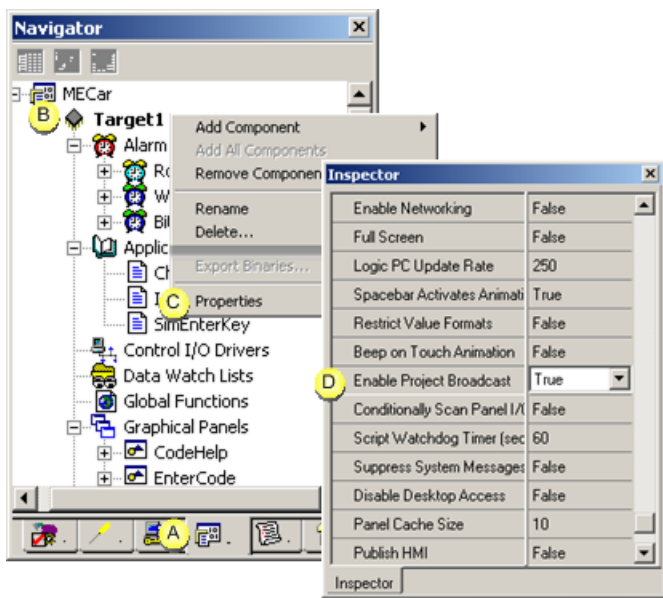

A	Select the Project tab in the Machine Edition Navigator.
B	Right-click the Target project.
C	Select Properties. The Inspector opens.
D	Select True in the Enable Project Broadcast field.

1. Mark variables that will be viewed in CIMPLICITY as used.

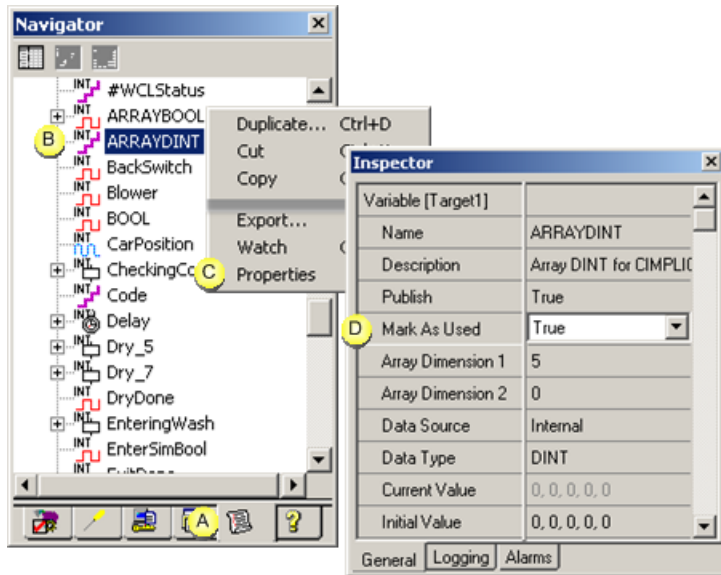

A	Select the Variables tab in the Machine Edition Navigator.
B	Right-click a variable that should be available to CIMPLICITY.
C	Select Properties on the Popup menu. The Inspector opens.
D	Select True in the Mark As Used field.

Save the Machine Edition project.

Step 1.2. Download the Machine Edition Project to View

Do the following download and start the Machine Edition project.

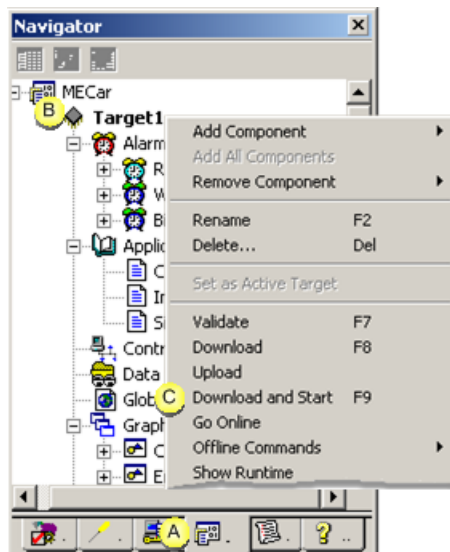

A	Select the Project tab in the Navigator.
---	--

B	Select the Target that will be downloaded.
C	Do one of the following. <ul style="list-style-type: none"> • Right-click the Target>Select Download and Start on the Popup menu. • Press F9 on the keyboard.

The View Runtime window opens if the download succeeded.

! **Important:** View must be open to display Machine Edition points in CIMPLICITY..

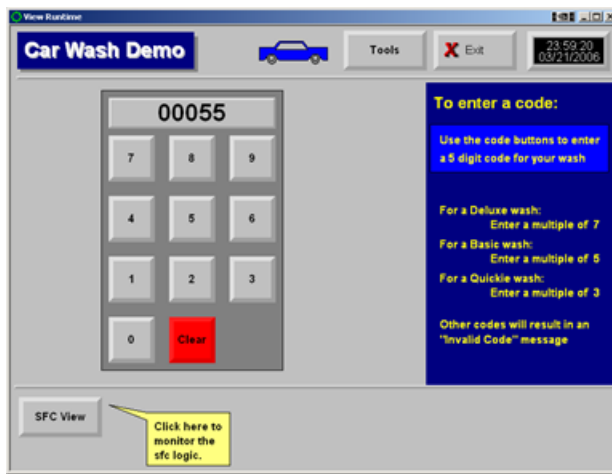

Step 2. (Optional) Configure CIMPLICITY Points to Access Machine Edition Points

Step 2. (Optional) Configure CIMPLICITY Points to Access Machine Edition Variables

A runtime user can view Machine Edition variable values directly from the Machine Edition project.

However, you can also set up the CIMPLICITY project and configure CIMPLICITY points to access Machine Edition variables. During runtime, the CIMPLICITY points will display the Machine Edition variable data.

! **Important:** The following steps are very straightforward. However, they include several details that are required for successful communication.

Steps to configure the CIMPLICITY project and points are as follows.

Step 2.1 (page 389)	Add a remote project to the CIMPLICITY project.
-------------------------------------	---

Step 2.2 (page 391)	Add a Machine Edition user to the CIMPLICITY project.
Step 2.3 (page 393)	Create a resource for the Machine Edition project.
Step 2.4 (page 394)	Enable the Machine Edition resource for the Machine Edition user.
Step 2.5 (page 395)	Create a port to communicate with the Machine Edition project.
Step 2.6 (page 396)	Create a device to communicate with the Machine Edition project.
Step 2.7 (page 397)	Create CIMPLICITY device points to access Machine Edition variables.

Step 2.1. Add a Remote Project to the CIMPLICITY Project

1. Select Project>Security>Advanced>Remote Projects in the Workbench left pane.
2. Do any of the following.

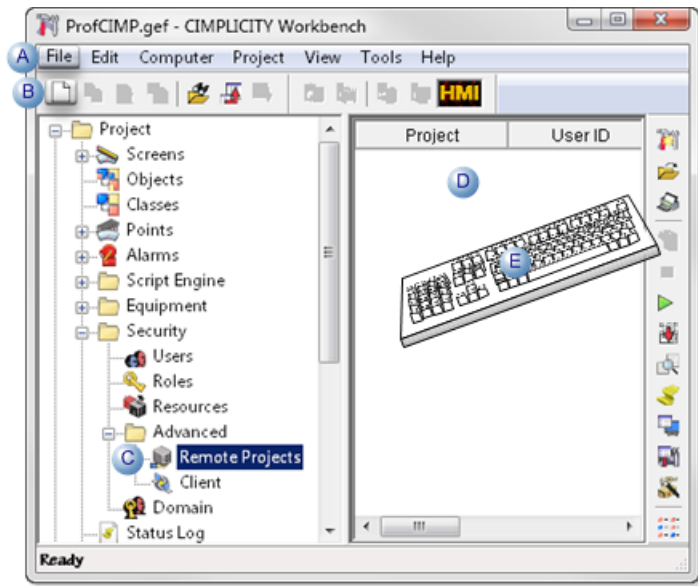

A	Click File>New>Object on the Workbench menu bar.
B	Click the New Object button on the Workbench toolbar.
C	In the Workbench left pane:

	Either	Or
	Double click Remote Projects .	a. Right-click Remote Projects . b. Select New on the Popup menu.
D	In the Workbench right pane. a. Right-click anywhere. b. Select New on the Popup menu.	
E	Press Ctrl+N on the keyboard.	

A New Project dialog box opens when you use any method.

3. Right-click **Remote Projects**.
4. Select New on the Popup menu.
5. Enter the Machine Edition project name in the **Project name** field.

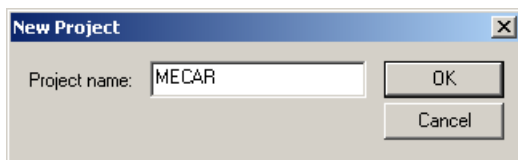

6. Click OK.

The Remote Project - <Machine Edition project name> dialog box opens.

7. Select the General tab.
8. Enter the following.

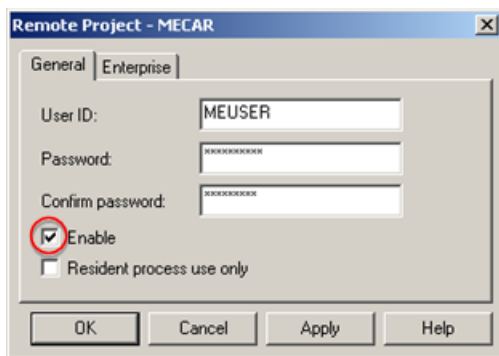

Feature	Description
User ID	The ID of a user who has rights to access and right to the Machine Edition project.
Password	Valid Machine Edition password for the User ID
Confirm password	Password repeated.

Feature	Description
Enable	Check to enable login.

9. Select the Enterprise tab.

10. Check Collect points.

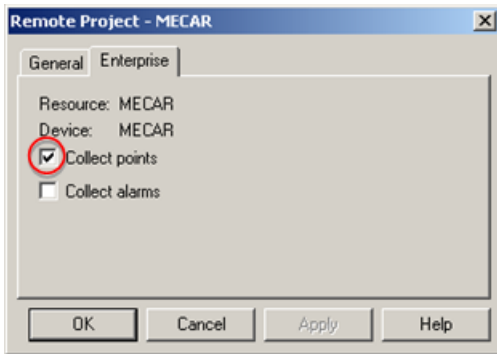

11. Click OK.

The remote project is now available to when configuring a resource and device to collect data from the selected project.

Step 2.2. Add a Machine Edition User to the CIMPLICITY Project

1. Expand Security in the Workbench left pane.

2. Double-click **Users**.

Note: You can use any of the available methods to create a new user.

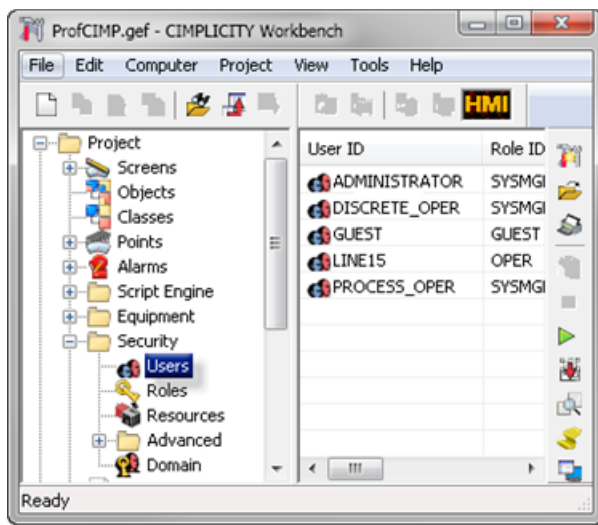

A New User dialog box opens.

3. Enter a valid Machine Edition administrator user ID in the **User ID** field.

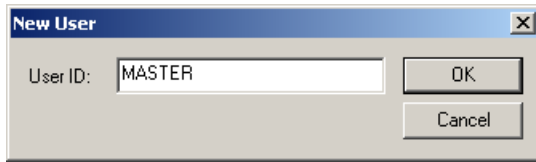

4. Click OK.

A User Properties - <user name> dialog box opens.

5. Select the General tab.

6. Enter the following.

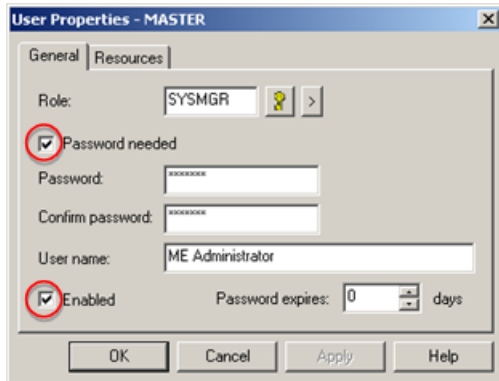

Feature	Description
Role	Role that has administrative privileges in the CIMPLICITY project.
Password needed	Check to require a password when user log in is required.
Password	Password user must enter when logging in.
Confirm password	Password repeated.
User name	User's name or descriptive text about the user, e.g. ME Administrator.

7. Select the Resources tab.

8. Make sure that the Machine Edition resource is in the **Configured** box.

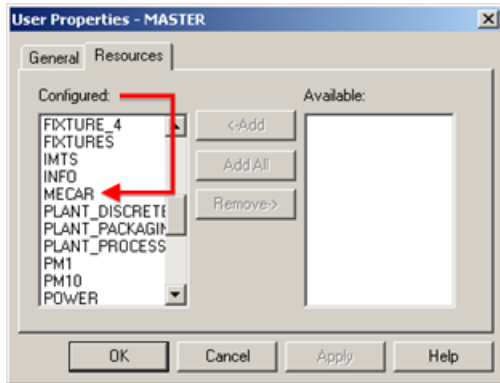

9. Click OK.

An authorized Machine Edition user is now also authorized FOR CIMPLICITY.

Step 2.3. Create a Resource for the Machine Edition Project

1. Expand Security in the Workbench left pane.
2. Double-click **Resources**.

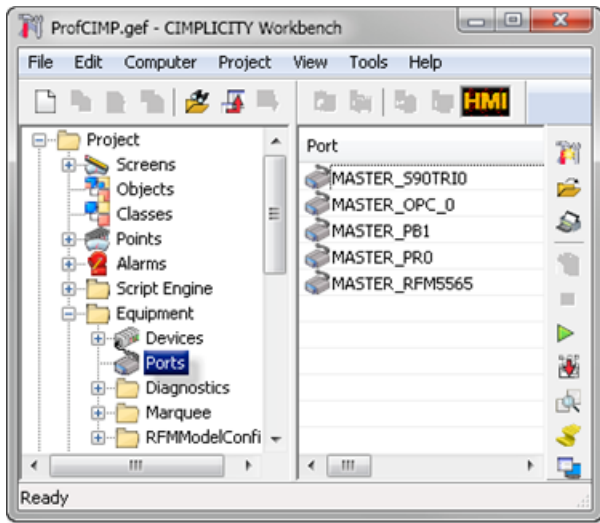

A New Resource dialog box opens.

3. Enter the remote project name in the **Resource ID** field.

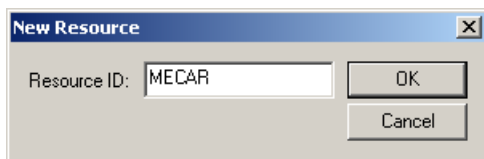

4. Click OK.

The Resource Definition - <Resource name> dialog box opens.

5. Make sure an authorized user in the Machine Edition project is in the **Users for this resource** box.

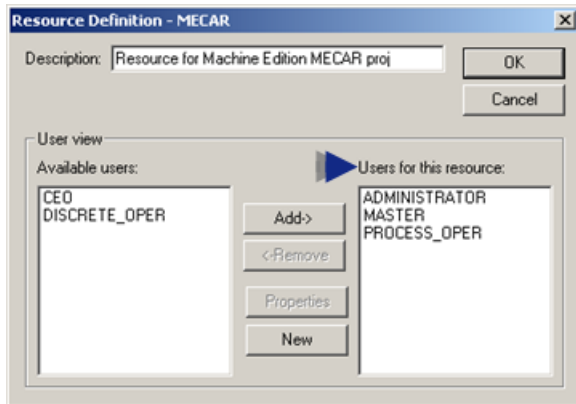

6. Click OK.

A CIMPLICITY resource with an assigned authorized user are now available for the Machine Edition variable data.

Step 2.4. Enable the Machine Edition Resource for the Machine Edition User

1. Re-open the Machine Edition user's User Properties dialog box.

2. Select the Resources tab.

3. Move the Machine Edition resource to the **Configured** box.

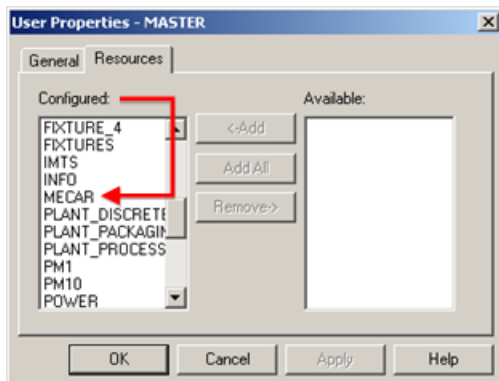

4. Click OK.

An authorized Machine Edition user now also authorized for the CIMPLICITY Machine Edition resource.

Step 2.5. Create a Port to Communicate with the Machine Edition Project

1. Expand the Equipment folder in the Workbench left pane.
2. Double-click **Ports**.

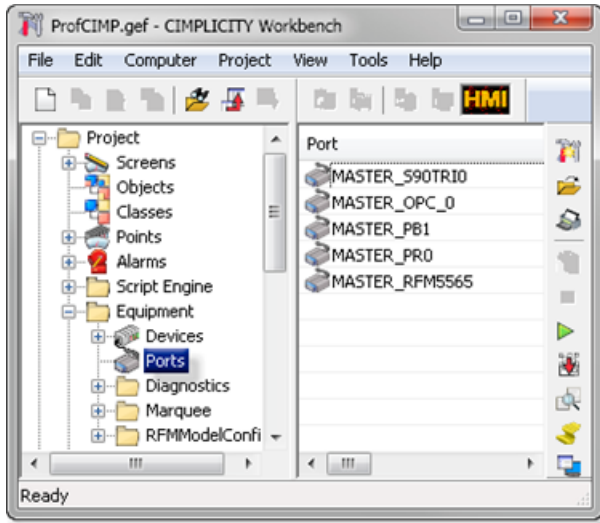

A New Port dialog box opens.

3. Select the following.

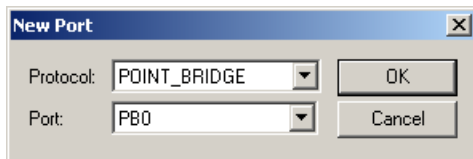

Field	Description
Protocol	POINT_BRIDGE
Port	Available POINT_BRIDGE port

4. Click OK.

The Port Properties - <Port> dialog box opens.

5. Check Enable.

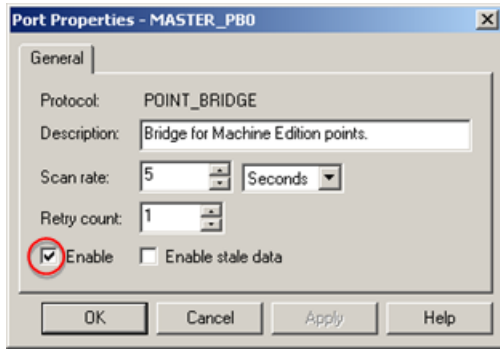

6. Click OK.

A port is now set up to access Machine Edition variable data.

Step 2.6. Create a Device to Communicate with the Machine Edition Project

1. Expand the Equipment folder in the Workbench left pane.
2. Double-click **Devices**.

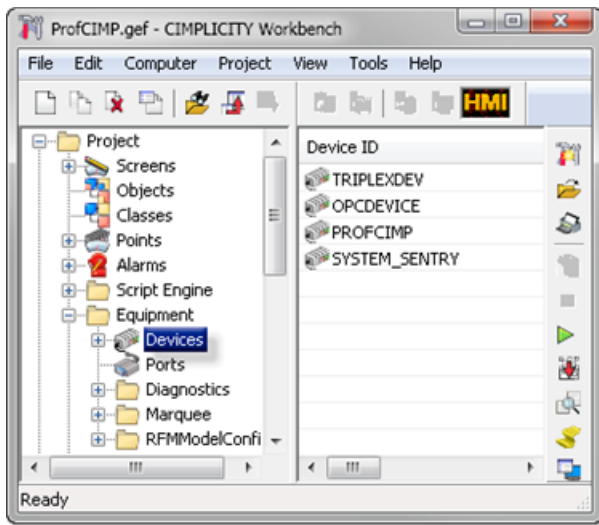

A New Device dialog box opens.

3. Enter the following.

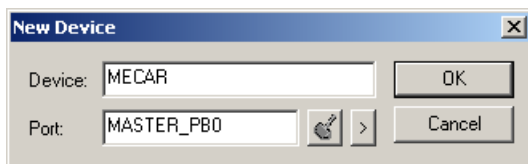

Field	Description
Device	Machine Edition (remote) project name.
Port	POINT_BRIDGE port.

4. Click OK.

The Device - <device name> dialog box opens.

5. Make sure the following is selected.

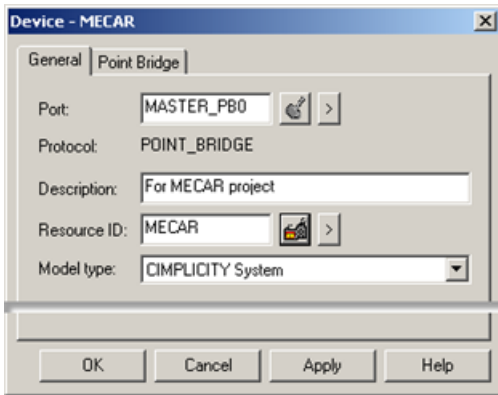

Field	Select
Port	POINT_BRIDGE port.
Description	(Recommended) Enter a brief statement to help identify the device.
Resource ID	Machine Edition resource (page 393)
Model type	CIMPLICITY System

6. Click OK.

A device is now set up to communicate with the Machine Edition project.

Step 2.7. Create CIMPLICITY Device Points to Access Machine Edition Variables

Note: The CIMPLICITY point definition must match the Machine Edition variable definition for the point to access variable data.

1 (page 398)	Create a point.
2 (page 399)	Configure the General tab.

3 (page 399)	Configure the Device tab.
4 (page 401)	Complete point configuration.

Create a point.

1. Double-click **Points** in the Workbench left pane.

Note: You can use any of the available methods to create a new device point.

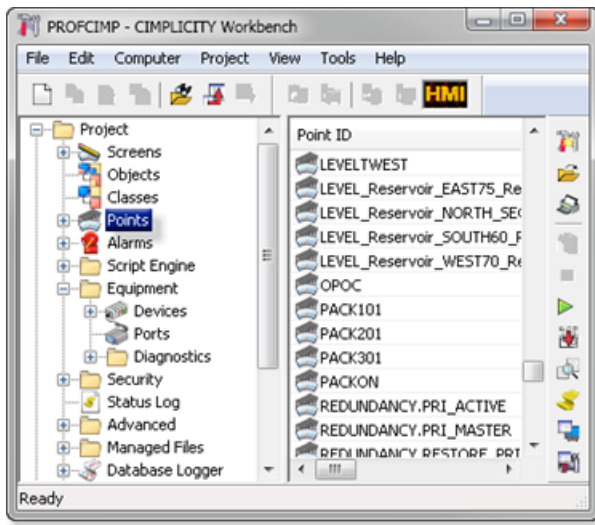

A New Point dialog box opens.

1. Enter and select the following.

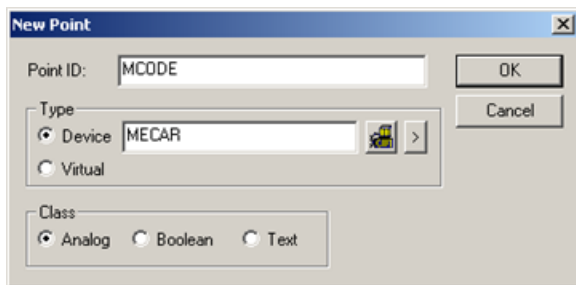

Field	Description	
Point ID	Name of the CIMPLICITY point that will access a selected Machine Edition variable's values. The name does not have to be the same as the Machine Edition variable name, but it can be.	
Type	Device	Device created to communicate with the Machine Edition project.

Field	Description
Class (page 414)	Must correspond to the selected Machine Edition variable.

1. Click OK.

Result: The Point Properties - <Point name> dialog box opens.

Configure the General tab

1. Select the General tab.
2. Make sure the following is entered/selected.

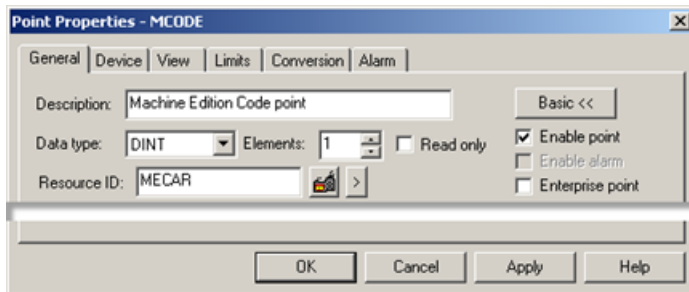

Field	Description	
Description	(Optional) Point identification.	
Data type (page 414)	Machine Edition variable data type defined as a CIMPLICITY data types.	
Elements	Same number of elements as the Machine Edition variable. If the point is an array	
Read only	Check	If the Machine Edition variable cannot be set.
	Clear	If the Machine Edition variable can be set.
Enable point	Check	Enable the point.
Resource ID	Resource configured for Machine Edition variables.	

Configure the Device tab

1. Select the Device tab.
2. Make sure the following is entered/selected.

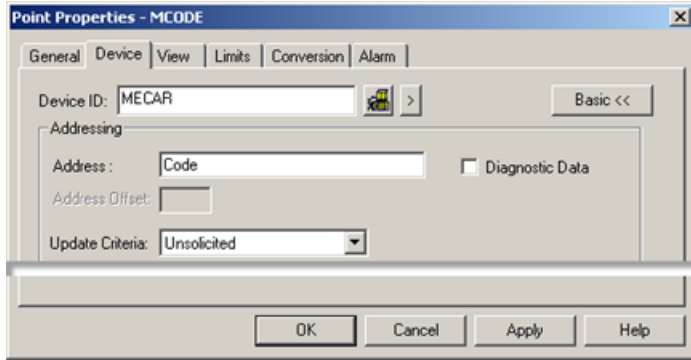

Field	Description
Device ID	Device created to communicate with the Machine Edition project.
Address	<p>Machine Edition variable name. Any Machine Edition variable that corresponds to the point definition can be entered, including an array element. Important</p> <ul style="list-style-type: none"> Two CIMPLICITY points cannot be configured to access the same Machine Edition variable. <p>POINT_BRIDGE checks for duplicate address names. If two points use the exact same names in the Address field, only the first point will be validated. A duplicate name log will be entered in the status log for the second point. Example</p> <ul style="list-style-type: none"> A CIMPLICITY point, CSin1, is configured to access a Machine Edition variable, Sine1. A second CIMPLICITY point, e.g. CSin1_2 cannot access data from the same variable, Sine1. Two or more CIMPLICITY points can be configured to access different elements in an array variable, including the array variable itself. <p>POINT_BRIDGE views points that access different elements in an array as non-duplicate points. Each of the array element points will be validated. Creating different CIMPLICITY points for elements is more efficient than creating a single point for the array variable Example</p> <ul style="list-style-type: none"> A CIMPLICITY point, MARRAYDINT[2], is configured to access element 2 in a Machine Edition variable, ARRAYDINT. Another CIMPLICITY point MARRAYDINT[3] can also access element 3 in the same Machine Edition variable, ARRAYDINT. <p> Note: When a CIMPLICITY point that accesses a Machine Edition array element is updated, values for every element in the array are transmitted back to Machine Edition. As a result, in some rare instances old array element values from CIMPLICITY may overwrite new array element values in Machine Edition.</p> <p>Example</p> <ul style="list-style-type: none"> A CIMPLICITY point, CARRAY2, is configured to access a Machine Edition array element, MARRAY[2]. The Machine Edition array element, MARRAY[5] has changed from 9 to 11. However, this change has not been transmitted to CIMPLICITY; CIMPLICITY still has the old Machine Edition array element values. A CIMPLICITY user sets the CIMPLICITY point CARRAY2 value from 6 to 10. Values for every element in MARRAY are transmitted from CIMPLICITY back to Machine Edition when the CIMPLICITY point is set; this includes the old MARRAY[5] value, 9. The old MARRAY[5], 9, from CIMPLICITY overwrites Machine Edition's new value, 11.

Complete point configuration

1. Click OK.
2. Repeat this step to create all required points.

Result: The configured points will now report Machine Edition variable data. Read/write points can be used to set values in the Machine Edition project.

Step 3. View/Set/Log Machine Edition Variable Data through CIMPLICITY

Step 3. View/Set/Log Machine Edition Variable Data through CIMPLICITY

Machine Edition variable configuration and runtime use is essentially the same as for any CIMPLICITY remote project.

Machine Edition variables can be viewed, set and logged using the following CIMPLICITY applications.

- Point Control Panel.
- CimView/CimEdit
- Point data logging.

CIMPLICITY points that access Machine Edition variables and Machine Edition variables can be selected in any CIMPLICITY Select a Point browser by a user who is authorized to use both projects.

- Machine Edition variables selected in a Select a Point browser.
- Machine Edition in CIMPLICITY example

Machine Edition Variables selected in a Select a Point Browser

 **Note:** A log in user name and password may or may not be required to access CIMPLICITY and/or Machine Edition variables based on security configuration.

1. Make sure the Machine Edition project is running.
2. Make sure the CIMPLICITY project is running.
3. Open the Select a Point browser through the Point Control Panel, CimEdit or the DATA_LOG.

The local CIMPLICITY project name displays in the disabled **Project** field.

(If a user ID and password are required for CIMPLICITY) a CIMPLICITY Login dialog box - <CIMPLICITY project name> opens.

4. Enter a valid CIMPLICITY **User ID** and **Password**.

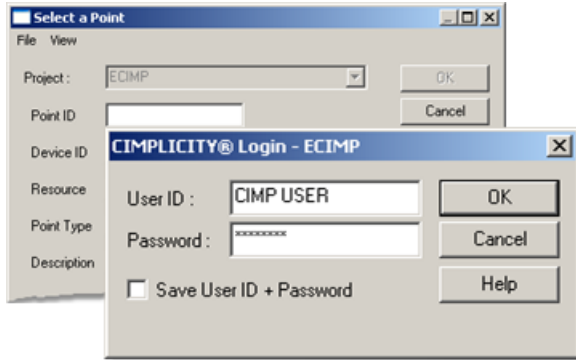

5. Click OK.

Points in the running CIMPLICITY project are now available to be selected.

6. Do one of the following.

Select one or more CIMPLICITY device points that have access to a Machine Edition variable.

Select the CIMPLICITY device point(s) the same way you select any point.

Select one or more Machine Edition variables.

The **Project** field is enabled when the CIMPLICITY user log in is validated.

- a. Select the Machine Edition project in the **Project** drop-down list.
- b. Click Browse.

(If a user ID and password are required for Machine Edition) a CIMPLICITY Login dialog box - <Machine Edition project name> opens.

a. Enter a valid Machine Edition **User ID** and **Password**.

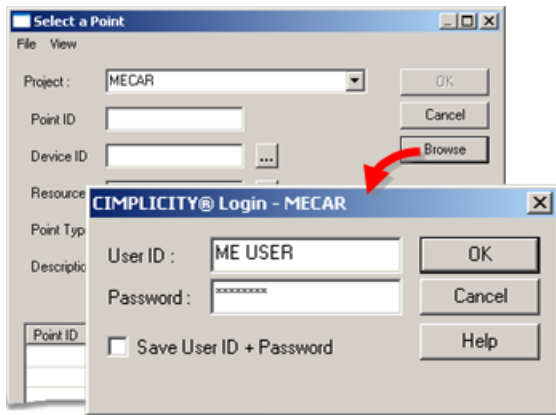

a. Click Ok.

The points that fill the Select a Point browser criteria and that were [made available \(page 386\)](#) for the Machine Edition project are listed.

a. Do the following.

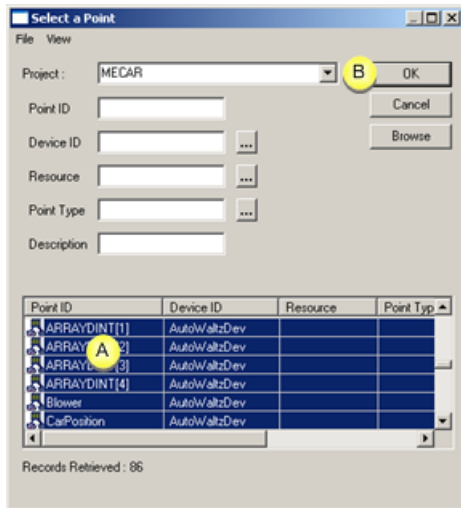

A	Select the Machine Edition variable(s) that you want to display, use or log.
B	Click OK.

Result: The selected points display in the application for which they were selected.

Machine Edition in CIMPLICITY Example

Authorized CIMPLICITY users need to monitor a Machine Edition Car Wash project through CIMPLICITY.

In order to do this, an authorized user.

7. Starts a Machine Edition project named MECar.
8. Starts a CIMPLICITY project named ECIMP.
9. Configures the CIMPLICITY project to support POINT_BRIDGE device points that can access Machine Edition variables.
10. Creates the following device points to access Machine Edition variables.

CIMPLICITY Point	Machine Edition variable
MCode	Code
MSIN1	SINE1

11. Configures and uses Machine Edition variables with the following.

Example 3.1 (page 404)	Point Control Panel.
Example 3.2 (page 407)	CimEdit/CimView.
Example 3.3 (page 410)	CIMPLICITY point logs.

Example 3.1. Machine Edition Variables in the Point Control Panel

Note: Both CIMPLICITY points that access Machine Edition variables and Machine Edition variables display and are updated in the CIMPLICITY Point Control Panel as long as Machine Edition View is running.

If a user has authorization, CIMPLICITY points and Machine Edition variables can be set.

An authorized CIMPLICITY and Machine Edition opens the Point Control Panel.

The user uses the Point Control Panel as follows.

1 (page 404)	Changes the Machine Edition Code variable to 77777. This variable selects the highest price car wash.
2 (page 406)	Reviews the values in the Machine Edition array variable named ARRAY_DINT.

Change the Machine Edition code variable to 77777

The authorized Point Control Panel user:

- [Adds \(page 401\)](#) either of the following.

CIMPLICITY device point MCode.

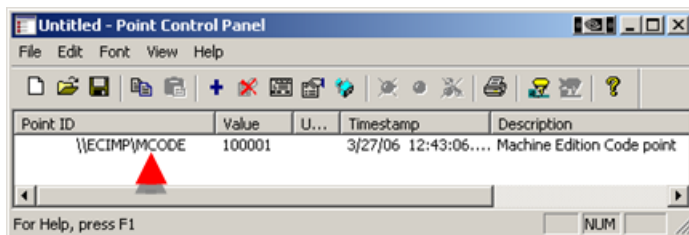

Machine Edition variable `\\MECAR\Code`.

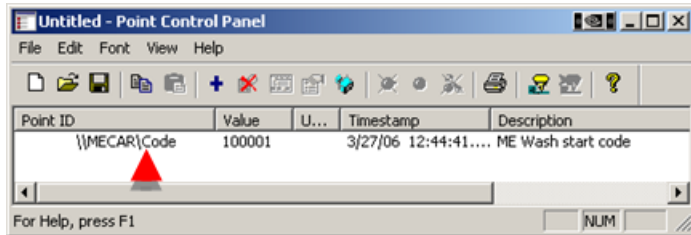

1. Open the PCP Point Properties dialog box for the selected point or variable.
2. Set the value to 77777.

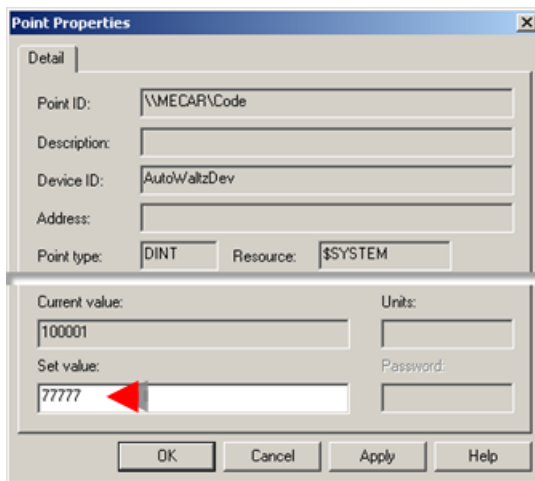

1. Closes the PCP Point Properties dialog box.

Result: The value displays as 77777 for the:

- CIMPLICITY point MCode and Machine Edition variable Code in the Point Control Panel.

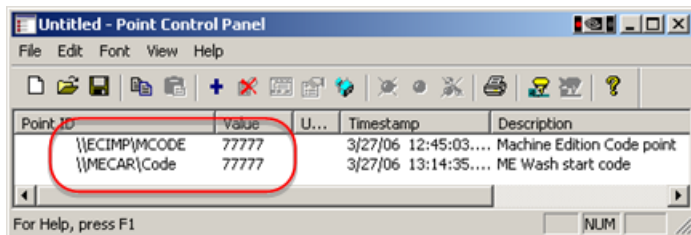

- Machine Edition variable Code in the Machine Edition Variable Inspector.

Consult Machine Edition documentation to review details about the Variable Inspector.

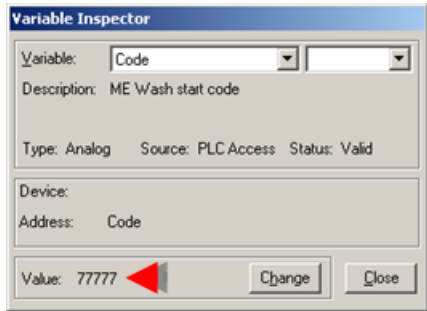

Review the values in a Machine Edition Array

The authorized Point Control Panel user:

1. Opens the Select a Point browser.
2. Selects the following.

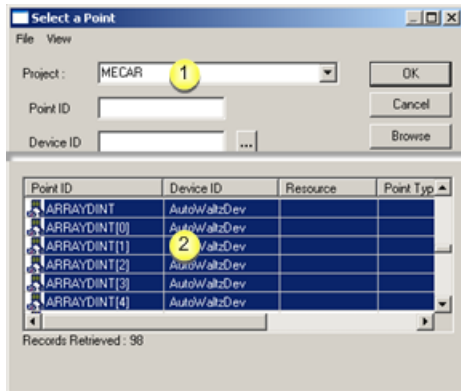

1	Machine Edition Project in the Project field.
2	Machine Edition integer array, ARRAY_DINT and all of its elements.

1. Reviews the array variable and array element values in the Point Control Panel.

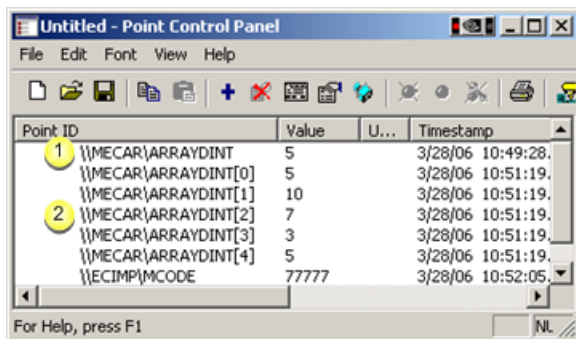

1	Array variable	Values in the array variable can be set the same way a CIMPLICITY array point is set.
---	----------------	---

2	Array variable elements	A value for each array element can be set the same way a value for a CIMPLICITY point is set.
---	-------------------------	---

Example 3.2. Machine Edition Variables in CimEdit/CimView

 **Note:** Machine Edition variables can be selected in CimEdit directly or through CIMPLICITY device points to be viewed and set in CimView.

A CIMPLICITY CimView screen is required for users to view and set the car wash Code and stages of the wash, e.g. Rinse, Wash, Dry and Wax.

An authorized screen designer creates a CimEdit screen to include Machine Edition data.

The screen designer configures and tests objects on the screen as follows.

1 <i>(page 407)</i>	Text object to display the CIMPLICITY MCode device point data.
2 <i>(page 408)</i>	Text objects to display Machine Edition variable data.
3 <i>(page 409)</i>	Other objects to complete the screen.
4 <i>(page 409)</i>	CimView/View runtime test.

Text object to display the CIMPLICITY MCode device point data.

The screen designer:

1. Places a text object on the screen.
2. Opens the text object's Properties dialog box.
3. Configures the Text tab as follows.

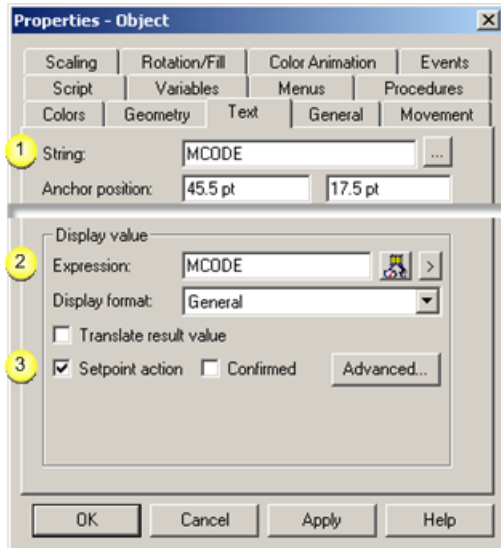

1	Enters MCODE as the default string .
2	Selects the point MCODE as the expression .
3	Enables Setpoint action.

Text objects to display Machine Edition variable data.

The screen designer:

1. Places several text objects on the screen that will display Machine Edition variable values.
2. Opens the Properties dialog box for one text object.
3. Configures the Text tab as follows.

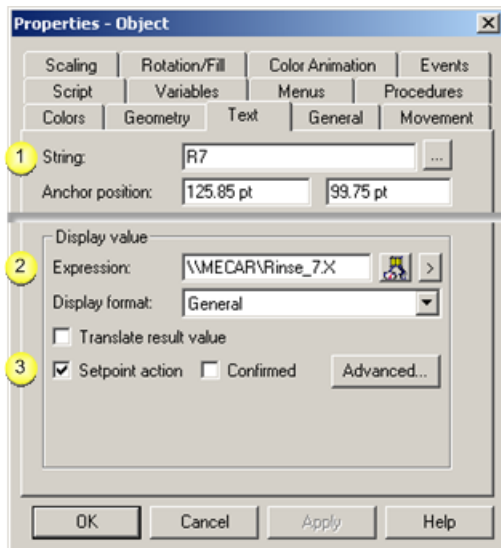

1	Enters R7 as the default string .
---	--

2	<p>Selects the fully qualified Machine Edition variable \\MECAR\Rinse_7X as the expression. Note: The designer selects the variable as follows.</p> <ol style="list-style-type: none"> 1. Selects Browse Point ID on the Expression field's Popup menu 2. Uses the Select a Point browser to select (page 401) the variable.
3	<p>Enables Setpoint action.</p>

Other objects that complete the screen.

The screen designer adds graphics and text to enhance the screen.

Note: The designer could use the Machine Edition variables:

- In Basic scripts.
- CimEdit actions, e.g. Toggle Setpoint
- Other CIMPLICITY features in which a CIMPLICITY point can be used.

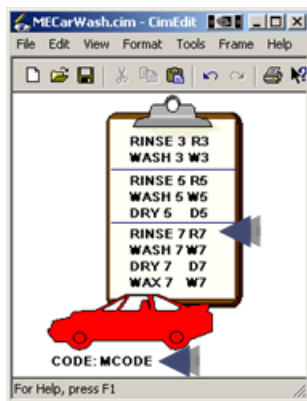

Result: The CimEdit screen is now ready use the CIMPLICITY points and Machine Edition variables during runtime.

CimView/View Runtime test

During runtime an authorized operator can:

- Set the wash code or any of the car wash phases.



The value is changed in the Machine Edition project.

Note: Consult Machine Edition documentation to review details about viewing variable values in Machine Edition.

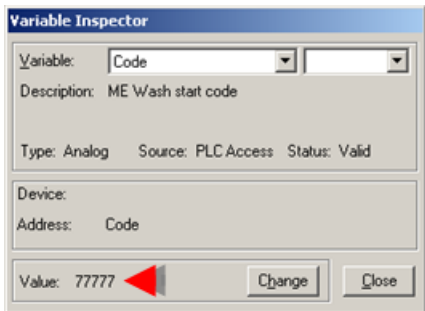

- Monitor a car's progress through the car wash based on values that were generated in the Machine Edition project.

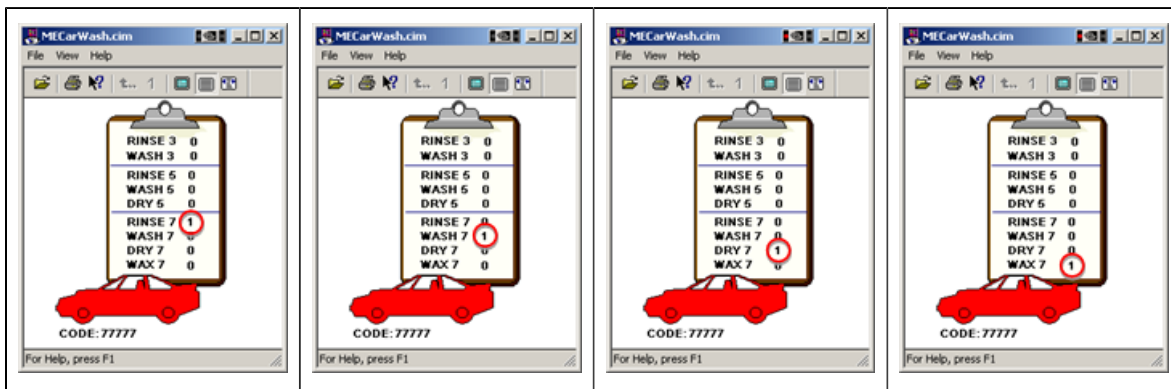

Example 3.3. Machine Edition Variables Logged through CIMPLICITY

- Log to Historian

- Log to SQL

Log to Historian

 **Note:** CIMPLICITY device points that access Machine Edition variable values can be logged to Historian.

The data for two Machine Edition variables, Code and SINE1, must be logged to Historian.

The authorized user:

1. Makes sure that the Historian Interface options are checked in the CIMPLICITY Project Properties dialog box.
2. Creates CIMPLICITY points, MCode and MSIN1, to access the corresponding Machine Edition variables.
3. Checks Log Data on the General tab in each point's Point Properties dialog box.

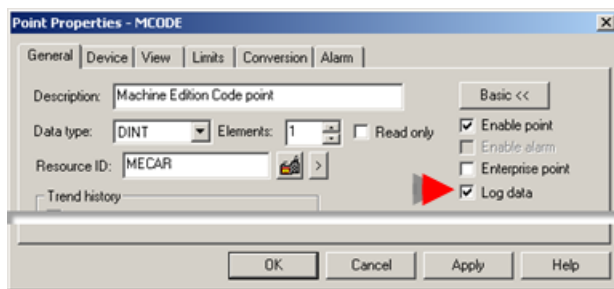

4. Makes sure the project configuration is updated (e.g. configuration update or configured in dynamic configuration).

Result: When the project is running the point data will be logged to Historian.

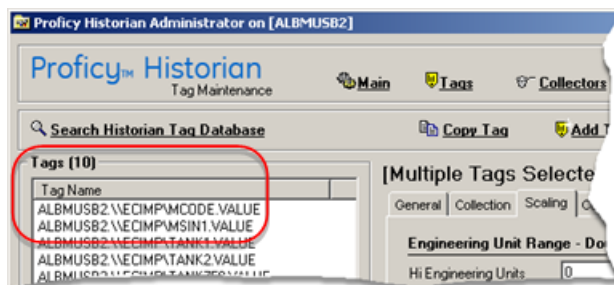

Log to SQL

 **Note:** Both CIMPLICITY device points and Machine Edition variables can be logged to CIMPLICITY DATA_LOG and GROUP_LOG tables in SQL.

Car wash data for the high price car wash needs to be logged to SQL.

- Both CIMPLICITY device points and Machine Edition variables are logged.
- CIMPLICITY log tables are both the DATA_LOG and GROUP_LOG.

An authorized user:

5. Opens the DATA_LOG in the Database Logger.
6. Opens the Select a Point browser.
7. Selects [Machine Edition variables \(page 401\)](#).
8. Adds the selected Machine Edition variables to the DATA_LOG.

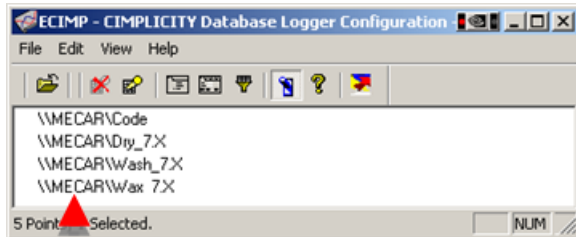

Note: Points that have Log Data checked in their Point Properties dialog box will be logged to the DATA_LOG.

9. Opens the GROUP_LOG.
10. Adds the following to the GROUP_LOG.

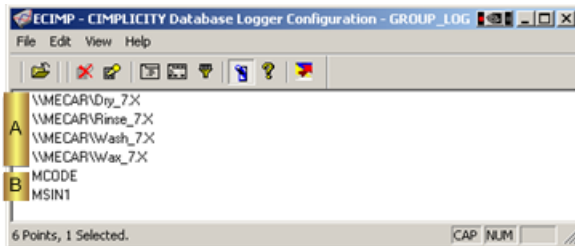

A	Machine Edition variables.
B	CIMPLICITY device points that access Machine Edition variables.

Data for both CIMPLICITY device points and Machine Edition variables is logged to the SQL DATA_LOG and GROUP_LOG.

- SQL DATA_LOG displays:

A	Machine Edition variables.
B	CIMPLICITY device points that access Machine Edition variables.

- SQL GROUP_LOG displays:

A	CIMPLICITY device points that access Machine Edition variables.
B	Machine Edition variables.

Machine Edition to CIMPLICITY Technical Reference

Machine Edition to CIMPLICITY Technical Reference

- Point data integration technical reference.
- Machine Edition variable data types defined as CIMPLICITY point data types.

Point Data Integration Technical Notes

Following is a list of how CIMPLICITY handles feature variations in the two products.

Feature	Description of how Handled through Integration
Point ID's	Machine Edition long point ID's are supported.
Point Readings	Any valid user can read point data. There are no restrictions on users accessing point data.
Setpoint Privilege	Machine Edition has a privilege that allows the user to perform setpoints. This privilege is mapped to the CIMPLICITY Setpoint Privilege.

Feature	Description of how Handled through Integration
Security	CIMPLICITY allows logging into View using the View User ID. Note: Connections will only be allowed using View User Ids of 32 characters or less with passwords of less than 16 characters.
EU Conversion	In CIMPLICITY the client performs Engineering Unit conversions. In the Machine Edition, View will indicate that the data type of the point is REAL and send the converted value to the application instead of the raw value. Likewise, on a setpoint PTMAP will send the EU value and View will convert it back to a raw value before sending it to the device.
Duplicate Project Broadcast	By default, Machine Edition will broadcast more than one project with the same name. For proper operating, the user must ensure that no two broadcasting projects have the same name. If two project broadcasts use the same name, it will not be predictable as to which project CIMPLICITY will get data from.
Project Acknowledgement Time	Machine Edition broadcasts projects every 75 seconds. Therefore, it can take up to 75 seconds for a project to appear on a list of projects available for point data monitoring.
Point Updates	Machine Edition uses a scan based reporting mechanism for reporting point values. As a result, CIMPLICITY will miss intermediate values of a point that changes faster than the scan rate. Note: If a point exists in CIMPLICITY and the description of the corresponding variable changes in Machine Edition, the point description does not get updated when the variable is exported from Machine Edition into CIMPLICITY.

More information

- Machine Edition to CIMPLICITY technical reference.

Machine Edition Variable Data Types Defined as CIMPLICITY Point Data Types

Machine Edition variable data types and default display format definitions are defined as CIMPLICITY point classes and data types as follows.

Use the CIMPLICITY class and data type that corresponds to the Machine Edition data type when you create a CIMPLICITY device point that accesses a Machine Edition variable.

Machine Edition		CIMPLICITY	
Data Type	Default Display Format	Class	Data Type
BOOL		Boolean	BOOL
COUNTER.CV		Analog	DINT
DATE (YR, MO, DAY)		Analog	DINT
DATE_AND_TIME (YR, MO, DAY, HR, MIN, SEC)		Analog	DINT
DINT	Binary	Analog	DINT
	Decimal	Analog	DINT

Machine Edition		CIMPLICITY	
	Hexadecimal	Analog	DINT
	Octal	Analog	DINT
	Text	Analog	DINT
LREAL	Floating point	Analog	REAL
	Scientific notation	Analog	REAL
STEP.X		Boolean	BOOL
STEP.T.DAY, STEP.T.HR		Analog	DINT
STRING	<Max Length>	Text	STRING
TIME(DAY, HR, MIN, MS, SEC)		Analog	DINT
TIMER.PT, TIMER.ET		Analog	DINT
TIME_OF_DAY(HR, MIN, MS, SEC)		Analog	DINT

Chapter 5. Recipes Configuration

About Recipes

The CIMPLICITY Recipes software option enables you to create and manage recipe data for your production processes. The Recipes interface consists of a spreadsheet format in which you enter the configuration data for each of your recipes. This format allows you to group similar products together.

- Recipes overview.
- Recipe configuration.

Recipes Overview

Using the Recipes Configuration you can:

- Create and manage recipe parameters, recipes, and maps in a spreadsheet format.
- Import and export recipe groups to and from CSV file formats.
- Archive recipe groups.
- Reconcile recipe groups automatically to accommodate changes in the group's structure and layout.
- Compare recipes.
- Upload recipes manually.
- Review and modify parameters and values.
- Download recipes manually.

Recipe objects can also be embedded in CimView screens (using OCX Controls). These objects enable you to:

- Upload and download recipes manually.
- Review and modify parameters manually.

Recipe Configuration

Recipe overview and configuration topics include the following.

- Open a RecipeConfig window.
- RecipeConfig window overview.
- Recipe group configuration.
- Recipe control configuration.

Open a RecipeConfig Window

Open a RecipeConfig Window

 **Note:** Make sure the Recipes is checked in the Optionsbox in the Project Properties dialog box.

Option 1 (page 417)	Open a new RecipConfig window.
Option 2 (page 418)	Open an existing recipe group window.

Option 1. Open a new RecipeConfig Window

 **Note:** Make sure the Recipes is checked in the Optionsbox in the Project Properties dialog box.

CIMPLICITY provides several methods to open a new RecipeConfig window.

1. Start the CIMPLICITY project.
2. Select **Project>Recipes** in the Workbench left pane.
3. Do one of the following.

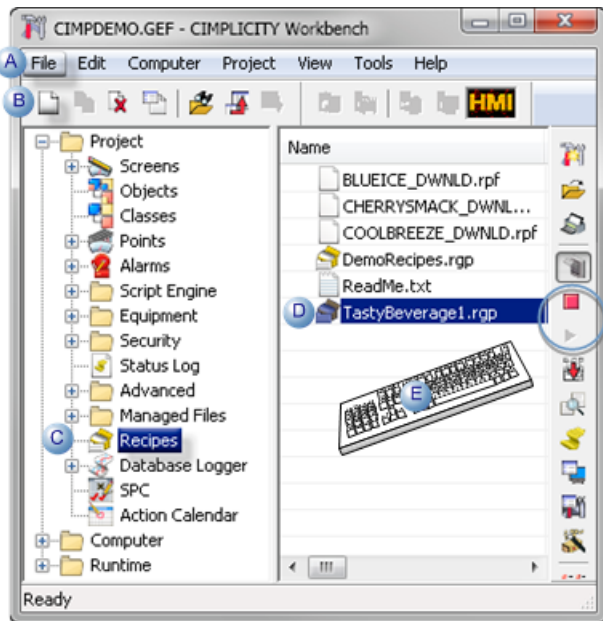

A	Click File>New on the Workbench menu bar.	
B	Click the New Object button on the Workbench toolbar.	
C	In the Workbench left pane:	
	Either	Or
	Double click Recipes .	a. Right-click Recipes . b. Select New on the Popup menu.
D	a. In the Workbench right pane. a. Right-click any recipe file. b. Select New on the Popup menu.	
E	Press Ctrl+N on the keyboard.	

4. Right-click **Recipes**.

5. Select New on the Popup menu.

6. Right-click any recipe file.

7. Select New on the Popup menu.

Option 2. Open an existing Recipe Group Window

1. Select **Project>Recipes** in the Workbench left pane.

2. Select a recipe in the Workbench right pane.

3. Do one of the following.

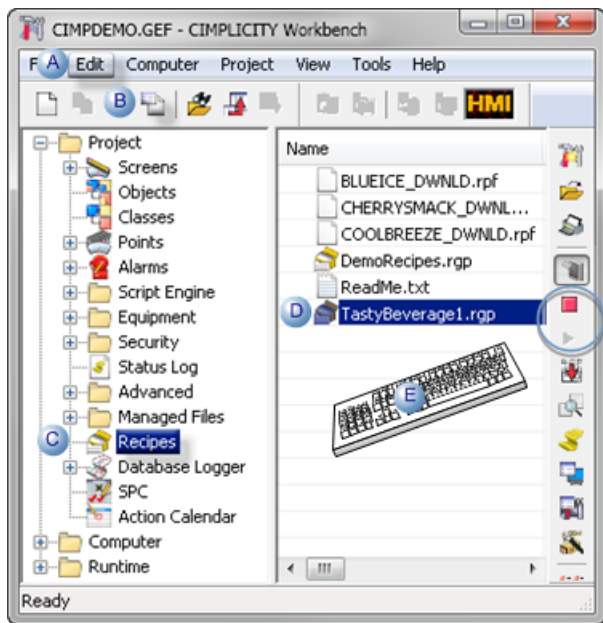

A	Click Edit>Properties on the Workbench menu bar.	
B	Click the Properties button on the Workbench toolbar.	
C	In the Workbench left pane: a. Right-click Recipes . b. Select Open on the Popup menu.	
D	In the Workbench right pane:	
	Either	Or
	Double click a recipe.	a. Right-click a recipe. b. Select OPen on the Popup menu.
E	Press Alt+Enter on the keyboard.	

4. Right-click **Recipes**.
5. Select Open on the Popup menu.
6. Right-click a recipe.
7. Select OPen on the Popup menu.

RecipeConfig Window Overview

RecipeConfig Window Overview

The RecipeConfig window is divided into two panes.

The left pane lists the recipe group's basic components.

The right pane provides a grid that displays the values applied to the recipe group's components.

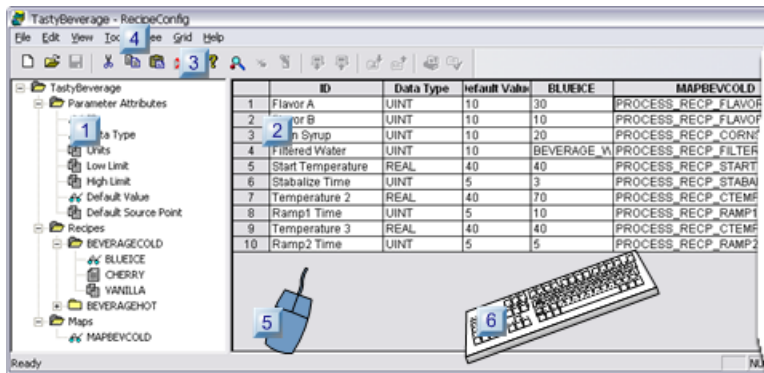

rect 29, 66, 70, 93 [1. RecipeConfig Window: Left Pane \(page 420\)](#)

rect 286, 180, 318, 214 [6. RecipeConfig Window: Keyboard Operations \(page 428\)](#)

rect 147, 184, 180, 213 [5. RecipeConfig Window: Mouse Operations \(page 426\)](#)

rect 66, 9, 94, 29 [4. RecipeConfig Window: Menu Items \(page 423\)](#)

rect 102, 23, 139, 44 [3. RecipeConfig Window: Toolbar Buttons \(page 422\)](#)

rect 153, 58, 186, 98 [2. RecipeConfig Window: Right Pane \(page 422\)](#)

1 (page 420)	Window left pane.
2 (page 422)	Window right pane.
3 (page 422)	Toolbar buttons
4 (page 423)	Menu items
5 (page 426)	Mouse operations
6 (page 428)	Keyboard operations.

1. RecipeConfig Window: Left Pane

The RecipeConfig window left pane is a tree that lists the recipe group components.

- Left pane components.
- Left pane icons.

Left Pane Components

Recipe group components are as follows.

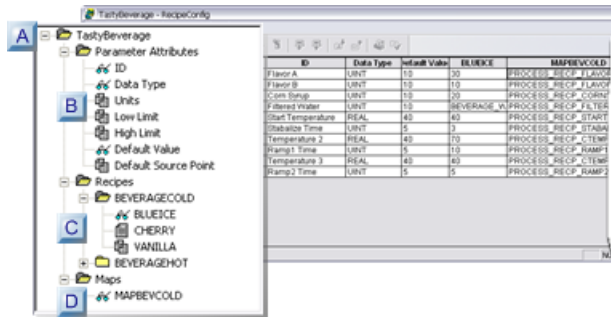

rect 28, 171, 54, 196 ([page 421](#))

rect 28, 127, 54, 152 ([page 421](#))

rect 27, 51, 53, 76 ([page 421](#))







rect -4, 8, 22, 33 ([page 421](#))

	Component	Description
A	Recipe group	Recipes and maps that share a common structure. The common structure is made up of the list of ingredients needed to produce a recipe, process variables, and point IDs that map the recipes to process equipment in the factory.
B	Parameter Attributes	(Pre-defined) Seven attributes that contain user specified values for user created parameters. The parameters are the list of ingredients and process variables (e.g. temperature) that can be included in any of the group's recipes. The pre-defined parameter attributes are: <ul style="list-style-type: none"> • ID. • Data Type. • Units. • Low Limit. • High Limit. • Default Value. • Default Source Point.
C	Recipes	(User created) A recipe provides the values needed for each parameter to manufacture a specific batch of product. Recipes that use the same parameters can be placed in a recipe group.
D	Maps	(User created) List of point IDs that recipe parameter values are either:
	Written to	on Download.
	Read from	on Upload.
		A map's points may represent noncontiguous device addresses and can span several devices. Each group can contain one or more maps.

Left Pane Icons

The RecipeConfig window uses standard icons to view and change the left pane display.

Icons are as follows.

Icon	Description
	Folder is not selected.
	Folder is selected and its items are displayed.
	Represents a recipe item that has not yet been loaded into memory.
	Represents a recipe item that has been loaded into memory.
	Item is displayed in the right pane (spreadsheet grid).
	Expand a folder.
	Collapse a folder.

2. RecipeConfig Window: Right Pane

The RecipeConfig Window provides a grid in which you can enter values for all of the components in the left pane.

Columns that can be displayed or hidden, re-sized and moved include values for the following.

 **Note:** Columns are added at the:

- Right side of the grid
- Default size of 5 characters.

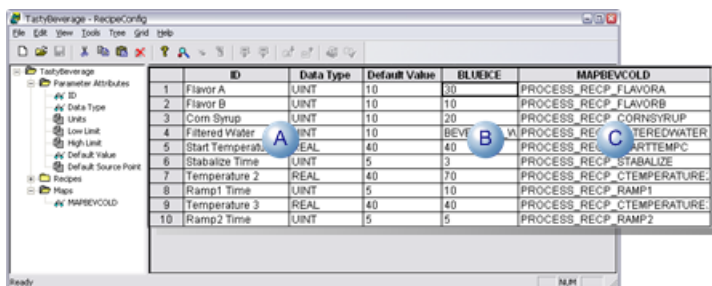

A	Parameter attributes.
B	Recipes.
C	Maps.

3. RecipeConfig Window: Toolbar Buttons

The toolbar buttons offer one-click access to the most commonly used functions.



	Button	Description
1	New	Creates a new group, recipe or map, based on which type of component is selected in the tree.
2	Open	Opens an existing group.
3	Save	Saves the selected group, attribute, recipe, map or folder.
4	Cut	Cuts the current grid cell contents to the clipboard.
5	Copy	Copies the current grid cell contents to the clipboard.
6	Paste	Inserts the contents of the clipboard into the current grid cell.
7	Delete	Deletes the current selection in the tree or grid.
8	About	Displays program information, version number and copyright.
9	Browse	Browses for points.
10	New Point	Creates a new point.
11	Dynamic	Enables/disables dynamic configuration updates.
12	Download	Initiates a download of the selected recipe or map.
13	Upload	Initiates an upload of the selected recipe or map.
14	Import	Imports a new group.
15	Export	Exports the group to a .csv file.
16	Archive	Converts the group to a read-only archive.
17	Validate	Validates the selected column(s) in the grid.

4. RecipeConfig Window: Menu Items

The menu bar offers several options for creating and maintaining data items in your Recipes directory, along with maintaining the spreadsheet structure in the right pane.

- File
- Edit
- View
- Tools
- Tree
- Grid

- Help

File menu

The File menu has the following options:

Option	Description
New	Based on the item selected in the directory, creates a new folder or data item.
Open	Opens the Open dialog box to open an existing Group.
Save	Saves the item selected in the directory.
Save As	Opens the Save As dialog box to name and save the Group.
Save All	Saves all folders and data items in the directory.
Rename	Enables a selected tree item to be edited.
Archive	Converts the Group
Export	Exports data in the Group to a CSV file.
Import	Imports a new Group.
Recent Files	Shows the files most recently opened and allows you to select them directly.
Exit	Quits the Recipe Configuration interface.

Edit menu

The Edit menu has the following options:

Option	Description
Cut	Removes the contents of the selected cell and place them on the Clipboard.
Copy	Copies the contents of the selected cell and places them on the Clipboard.
Paste	Place the contents on the Clipboard into the selected cell.
Delete	Deletes the selected data item in the directory, or the selected cell contents.
Properties	Launches the Properties dialog box for the selected item.

View menu

The View menu has the following options:

Option	Description
Toolbar	Displays the toolbar. A check mark indicates active option.
Status Bar	Displays the status bar. A check mark indicates active option.

Option	Description
Split	Resizes the left and right panes of the interface.

Tools menu

The Tools menu has the following options:

Option	Description
Upload	Uploads the selected Recipe or Map.
Download	Downloads the selected Recipe or Map.
Create Auto Action	Generates a Recipe Parameter file, which supplies the information required to automatically upload or download a Recipe.
Validate	Validates the entries in the selected column and report errors.
Compare	Compares the selected Recipe to other recipes and displays the results in the grid.
Dynamic Config	Toggles dynamic configuration update function.
New Point	Launches the New Point dialog box to create a new point.
Point Browse	Launches the Select a Point dialog box to enable browsing for points.

Tree menu

The Tree menu has the following options:

Option	Description
Expand One Level	Opens the selected folder.
Expand One Branch	Opens the selected folder and any subfolders.
Expand All	Opens all the folder and subfolders in the directory.
Collapse Branch	Closes the selected folder.
Indicate Expandable Branches	Displays the symbols for expanding folders. A check mark indicates active option.
View	Displays the selected data item in the grid.
View All	Displays all data items from the selected folder in the grid.
Copy	Copies the selected Recipe or Map.
Create Subfolder	Creates a Recipe or Map subfolder.

Grid menu

The Grid menu has the following options:

Option	Description
Select Column	Highlights the selected column.
Select Row	Highlights the selected row.
Freeze Selection	Disables scrolling for the selected column(s) or row(s).
Unfreeze Rows	Re-enables scrolling of the frozen row(s).
Unfreeze Columns	Re-enables scrolling of the frozen column(s).
Hide Column	Removes the selected column from the grid. Column is only hidden, not deleted.
Hide All Columns	Removes all columns from the grid. Columns are only hidden, not deleted.
Hide All Attribute Columns	Removes all Attribute columns only from the grid. Columns are only hidden, not deleted.
Hide All Recipe Columns	Removes all Recipe columns only from the grid. Columns are only hidden, not deleted.
Hide All Map Columns	Removes all Map columns only from the grid. Columns are only hidden, not deleted.
Insert Parameters	Adds a row(s) to the grid.
Delete Parameters	Removes a row(s) from the grid.

Help menu

The Help menu has the following options:

Option	Description
Contents	Launches the Help contents file.
About Recipe Config.	Displays the current version number for Recipes.

5. RecipeConfig Window: Mouse Operations

- Directory operations
- Grid operations

Directory Operations

Use your mouse to quickly navigate within the directory:

Action	Mouse Operation
Select an item	Left click.
Edit item text	Left click; left click.
Display popup menu	Right-click.

Action	Mouse Operation
Download	Left click on Recipe and drag onto a Map.
Upload	Left click on Map and drag onto a Recipe.
Move Recipe into folder	Left click on Recipe and drag into a Recipe folder.
Copy Receipt into folder	Left click + Ctrl Key on Recipe and drag into a Recipe folder.
Move Map into folder	Left click on Map and drag into a Map folder.
Copy Map into folder	Left click + Ctrl Key on Map and drag into a Map folder.
Display popup menu	Right-click on folder or data item in the directory.

Grid Operations

Use your mouse to quickly navigate within the grid:

Action	Mouse Operation
Select column	Left click on unfrozen column header.
Select two or more columns out of sequence	Left click on first column; hold down Ctrl key and left click on subsequent columns. Columns cannot be frozen.
Select two or more columns in sequence	Left click on first column; hold down Shift key and left click on the last column in the sequence. Columns cannot be frozen. For example if you want to select four columns, select column 1 and then hold down the Shift key and select column 4 to select all four columns.
Select row	Left click on a cell in a frozen column.
Select two or more rows out of sequence	Left click on a cell in a frozen column; hold down the Ctrl key and left click on subsequence rows in the frozen column
Select two or more rows in sequence	Left click on first row in frozen column; hold down Shift key and left click on the last row in the sequence. For example if you want to select four rows, select row 1 and then hold down the Shift key and select row 4 to select all four rows.
Edit cell	Double-click cell. Column cannot be frozen.
Move a column	Left click on a column header and drag into position (either to the left or the right). Column cannot be frozen.

Action	Mouse Operation
Move a row	Left click on a row and drag into position (either up or down).
Display popup menu	Right-click on a column header or any cell.

6. RecipeConfig Window: Keyboard Operations

- Quick keys
- Keystrokes in Recipes
- Grid navigation

Quick keys

Here are some commonly used shortcuts using keystrokes:

Keystrokes	Function
Alt+Enter	Displays the Properties dialog box for the selected recipe or map data item in the directory or grid.
+	Expands all branches in the directory.
-	Collapses all branches in the directory.
Ctrl+A	Converts the Groups to a read-only archive.
Ctrl+C	Copies cell contents to the Clipboard.
Ctrl+D	Initiates download of the selected Recipe or Map.
Ctrl+E	Exports Group data to a .csv file when the top level folder is selected.
Alt+F+M	Enables renaming a selected recipe.
Ctrl+I	Imports a new Group when the top level folder is selected.
Ctrl+L	Validates the selected column(s).
Ctrl+N	Based on the item selected in the directory, creates a new Group, Recipe or Map.
Ctrl+O	Opens the Open dialog box for opening an existing Group.
Ctrl+S	Based on the item selected in the directory, saves a Group, Parameter Attribute, Recipe, Map or Folder; if the group structure changes the entire group has to be saved, when save is selected.
Ctrl+U	Initiates an upload of the selected Recipe or Map.
Ctrl+V	Pastes the contents from the Clipboard into the selected cell.
Ctrl+X	Removes the cell contents and places them on the Clipboard.
Delete	Deletes the selected data item in the directory, or the highlighted contents in the cell.

Keystrokes in Recipes

The following symbols on the keyboard can be used to perform functions as follows:

Symbol	Function
+	Opens the selected folder in the directory.
*	Opens the selected folder and its subfolders.
-	Collapses the selected folder in the directory.

Grid navigation

Keystrokes	Function
Left arrow	Moves to the left in the grid.
Right arrow	Moves to the right in the grid.
Up arrow	Moves up in the grid.
Down arrow	Moves down in the grid.
F2	Edit cell contents.
F6	Moves between directory and grid panes.
End	Moves to the end of the selected row.
Ctrl+End	Moves to the last cell in the last row of the grid.
Home	Moves to the beginning of the selected row.
PageUp	Scrolls up in the pane.
PageDown	Scrolls down in the pane.
Enter	Moves down one cell.
Esc	Aborts edit and reverts to original text.
Tab	Moves between directory and grid panes.

Recipe Group Configuration

Recipe Group Configuration

A recipe group includes recipes, maps and parameters that share a common structure.

Steps to configure a recipe group are as follows.

Step 1 (page 430)	Select a recipe group.
Step 2 (page 435)	Define parameter attributes for the recipe group.
Step 3 (page 441)	Configure recipes.
Step 4 (page 454)	Configure recipe maps.
Step 5 (page 460)	Upload/download recipes and maps.
Step 6 (page 471)	Administer recipe groups.

Step 1. Select a Recipe Group

Step 1. Select a Recipe Group

Option 1.1 (page 430)	Create a new recipe group.
Option 1.2 (page 433)	Use an existing recipe group.

Option 1.1. Create a New Recipe Group

A recipe group includes your entire configuration in a single RecipeConfig window.

The configuration includes:

- Parameter attributes.
- Recipes.
- Maps.

You may define one or more Recipe Groups, depending on your application. Each Recipe Group that you create and save is stored in a file with an **. rgp** extension.

Do the following to create your new recipe group.

1 (page 431)	Open a new recipe group.
2 (page 431)	Define the recipe group.
3 (page 432)	Name the recipe group.

Open a new recipe group.

Open a new RecipeConfig window to open a new recipe group.

You can open a new window from the [Workbench. \(page 417\)](#)

If a RecipeConfig window is already open:

1. Select the Group folder.
2. Do one of the following.

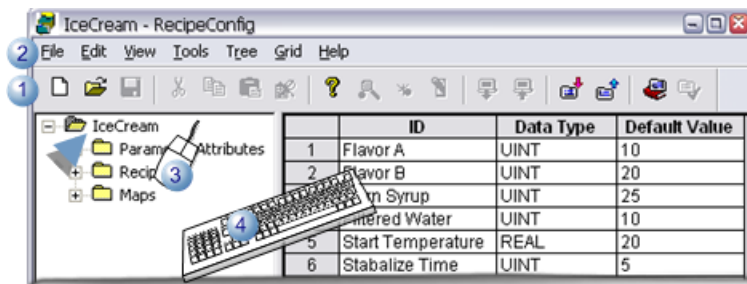

1	Click the New button on the RecipeConfig toolbar.
2	Click File>New on the RecipeConfig menu bar.
3	Right-click the group; select New on the Popup menu
4	Press Ctrl+N on the keyboard.

A message may open if you have unsaved data in the current, asking if you want to save the data.

1. Select whether or not to save the data.

Result: The current window closes; a new untitled RecipeConfig window opens.

Define the Recipe group

1. Select the Untitled group.

2. Do one of the following.

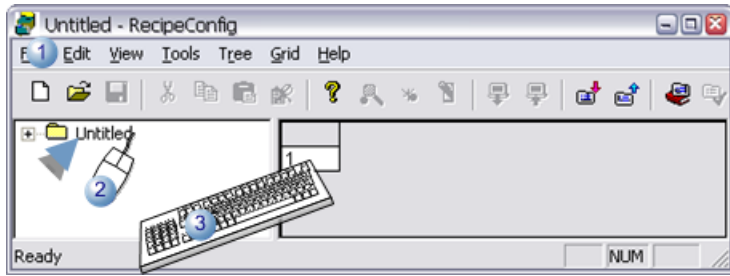

1	Click Edit>Properties on the Recipes menu bar.
2	Click the right mouse button; select Properties on the Popup menu.
3	Press Alt+Enter.

The Recipe Group Data dialog opens.

1. Enter the following.

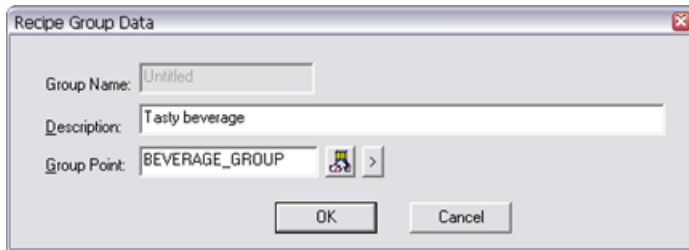

Group Name	(Read-only) Untitled displays before the RecipeConfig window is saved.
Description	Description of the Group.
Group Point	Name of a CIMPLICITY Point ID to write the Group Name to when a Recipe is Downloaded or Uploaded. <ul style="list-style-type: none"> • The Point ID may be unqualified or fully qualified. • The Point ID must be a Text point of sufficient length to hold the group name.

1. Click OK.

Result: The Recipe Group Data dialog box closes.

Name the Recipe group

The name you use when you save the RecipeConfig window is the name that is assigned to the group.

1. Do one of the following.

- Click the Save button on the RecipeConfig toolbar.

Note: The Save button is enabled after you open the Recipe Group Data dialog box.

- Click File>Save on the RecipeConfig menu bar.
- Press Ctrl+S on the keyboard.

A Save As dialog box opens.

1. Enter a name for the group.
2. Click Save.

Results

- The Group is saved as an .rgp file.
- The name given to the group replaces Untitled at the top of the tree.

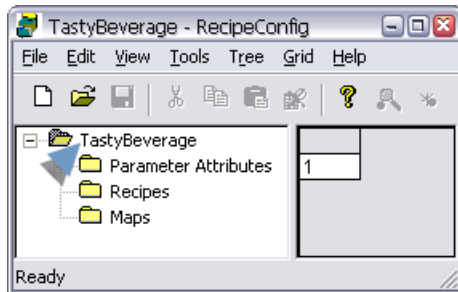

- The new group name displays in the Group Name field in the Recipe Group Data dialog box.

Option 1.2. Use an Existing Recipe Group

- Open an existing recipe group window.
- Import a recipe group.

Open an Existing Recipe Group window

You open an existing Recipe group when you open an [existing Recipe Group window \(page 418\)](#).

Import a Recipe Group

1. Select the top folder in a RecipeConfig window.

2. Do one of the following.

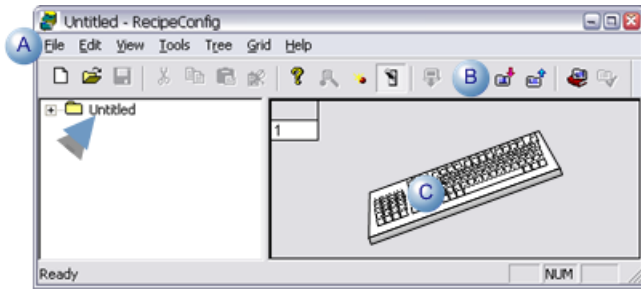

A	Click File>Import on the RecipeConfig window menu bar.
B	Click the Import Recipes button on the RecipeConfig window toolbar.
C	Press Ctrl+I on the keyboard.

An Open dialog box opens when you use any method.

3. Select the file (.csv) that you want to import.

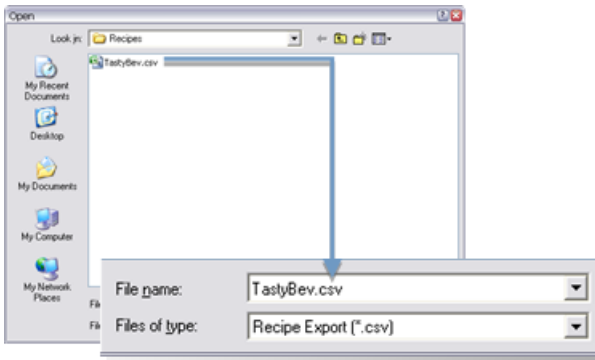

4. Click Open.

The selected recipe group opens in the RecipeConfig window.

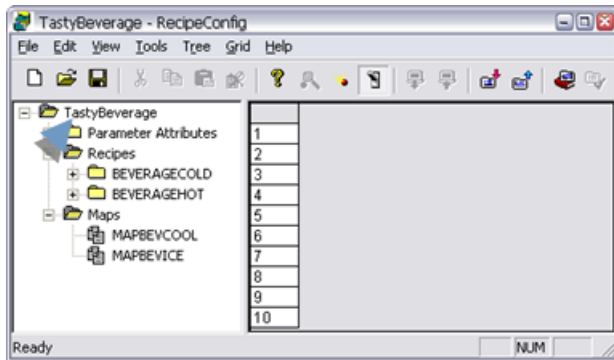

Step 2. Define Parameter Attributes for a Recipe Group

Step 2. Define Parameter Attributes for a Recipe Group

- Parameters overview
- Parameter configuration

Parameters Overview

A recipe group may have one or more Parameters associated with it.

Parameters attributes identify the components (e.g. ingredients, temperature, ramp time) used to produce a product.

Each Parameter that you define for the Group has seven attributes.

You can use these attributes to

- Define the data type for the Parameter.
- Describe the Parameter.
- Set limits for the Parameter in Recipes.
- Define default values for Recipes.

The parameters and parameter attributes display in the RecipeConfig window as follows.

ID	Data Type	Units	Low Limit	High Limit	Default Value	Default Source Point
1						
2	Flavor B	U/INT	Gal.	1	100	10
3	Corn Syrup	U/INT	Gal.	1	100	10
4	Filtered Water	U/INT	Gal.	1	100	10
5	Start Temperature	REAL	Degrs. C	0	100	40
6	Stabilize Time	U/INT	Sec	1	10	5
7	Temperature 2	REAL	Degrs. C	0	100	40
8	Ramp1 Time	U/INT	Sec.	1	30	5
9	Temperature 3	REAL	Degrs. C	0	100	40
10	Ramp2 Time	U/INT	Sec.	1	30	5

1	Parameters are listed in rows in the grid.
2	Values for parameter attributes (available in the RecipeConfig window's left pane) display in columns in the grid. Notes The column can display or be hidden for one or more attributes.

! **Important:** Any time you add, delete or rearrange Parameters in the group, all recipes and maps will automatically be reconciled to reflect your changes.

Parameter Configuration

Step 2.1 (page 436)	Insert rows for parameter attributes.
-------------------------------------	---------------------------------------

Step 2.2 (page 438)	Define parameter attributes.
--	------------------------------

Step 2.1. Insert Rows for Parameter Attributes

Each parameter for your group is placed on its own row in the table.

You can insert parameters in a new group or existing group.

- New group.
- Existing group.

New Group

A new Group has, by default, one cell in the RecipeConfig window right pane.

1. Select the one cell in the in the RecipeConfig window right pane.
2. Do any of the following.

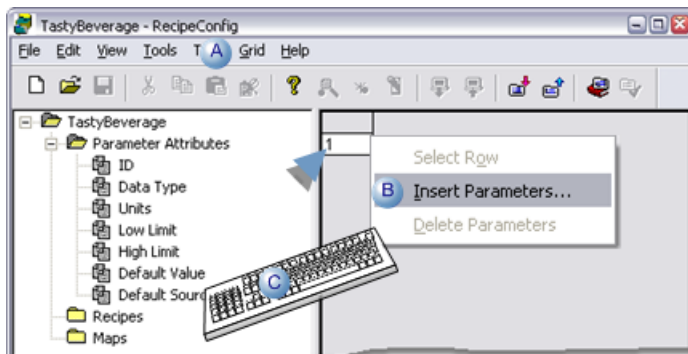

A	Click Grid>Insert parameters on the RecipeConfig window menu bar.
B	Right click the cell; select Insert Parameters on the Popup menu.
C	Click Alt+G+I on the keyboard.

An Insert Parameters dialog box opens.

3. Enter a number that represents the additional number of parameters you want to define.

Note: You can add up to 250 parameters each time you open the Insert Parameters dialog box and enter a value.

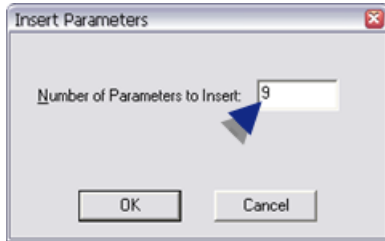

4. Click OK.

Result: The number of rows entered in the Insert Parameters dialog box are added before the existing cell. Columns to enter the attribute values are hidden.

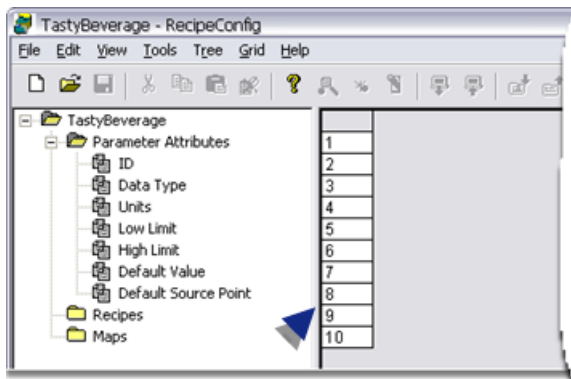

Existing Group

You can add additional parameter to your recipe group at anytime.

5. Click a row number in the RecipeConfig window grid.

The a row is selected.

6. Do any of the following.

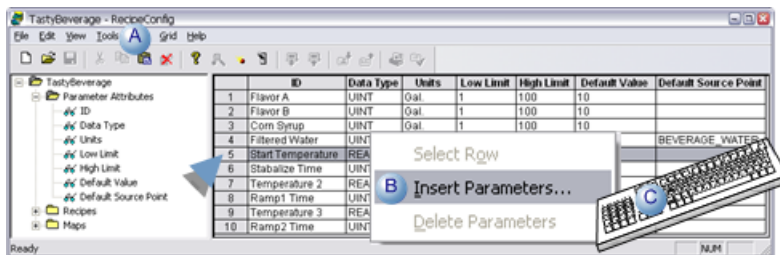

A	Click Grid>Insert parameters on the RecipeConfig window menu bar.
B	Right click the cell; select Insert Parameters on the Popup menu.
C	Click Alt+G+I on the keyboard.

An Insert Parameters dialog box opens.

7. Enter a number that represents the additional number of parameters you want to define.

Note: You can add up to 250 parameters each time you open the Insert Parameters dialog box and enter a value.

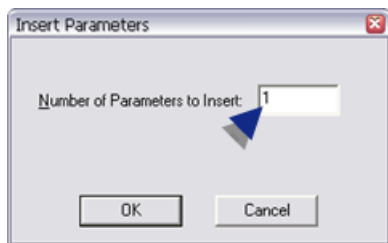

8. Click OK.

The specified number of blank rows are inserted above the selected row; the new Parameter rows will automatically be inserted in all existing Recipes and Maps.

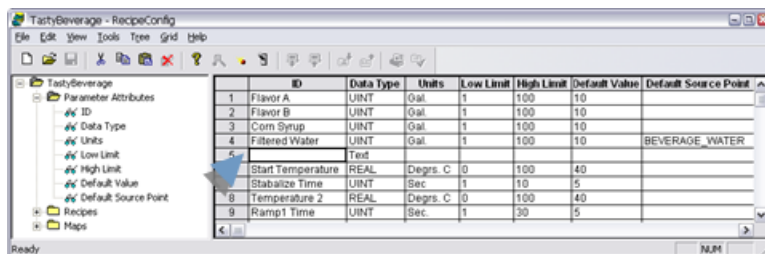

Step 2.2. Define Parameter Attributes

<p>1 (page 438)</p>	<p>Display parameter attribute columns.</p>
<p>2 (page 439)</p>	<p>Enter attribute values.</p>
<p>3 (page 440)</p>	<p>(Optional) Remove parameter attributes.</p>

Display parameter attribute columns.

1. (Optional) Expand the Parameters tree.

The list of seven available attribute categories displays in the Recipeconfig window left pane.



1. Do one of the following.

- Right-click one of the attributes in the list; select View on the Popup menu.
- Right-click the Parameters Attributes folder; select View All on the Popup menu.
- Double-click a selected attribute.

Result: The selected attribute columns display in the table.

 **Note:**

- Attribute cells are blank the first time you display the columns, except the Data Type column, which displays Text as the default value.
- The icon that displays to the left of an attribute in the Recipeconfig window left pane identifies whether the attribute's column is hidden or visible, as follows.

Icon	Attribute's Column is:
	Hidden.
	Visible

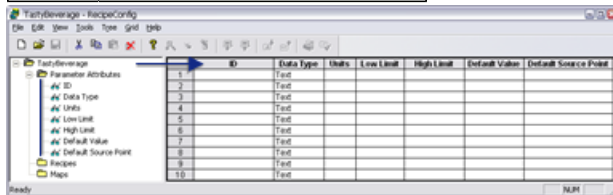

Enter attribute values.

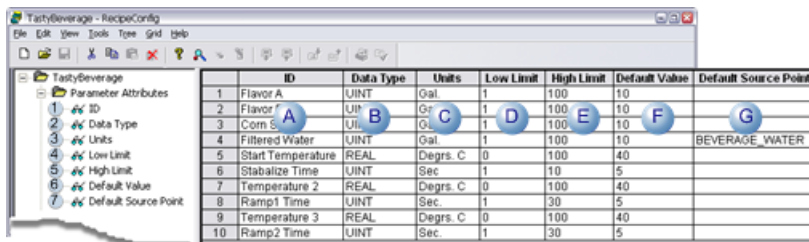

A	ID	(Optional) Identifies the Parameter.
---	----	--------------------------------------

B	Data Type	<p>(Required) Parameter's data type of the Parameter. The following options are in the field's drop down list.</p> <ul style="list-style-type: none"> • SINT • INT • DINT • Digital • REAL • Text • USINT • UINT • UDINT <p>Important: When a Recipe is downloaded, the parameter's data type must match the point's data type in the map (page 454) to which the Recipe parameter is being downloaded. The default data type is Text. You may choose one of the following types:</p>
C	Units	(Optional) Engineering units that this Parameter's value refers to.
D	Low Limit	(Optional) The lowest value allowed for the selected parameter.
E	High Limit	(Optional) The highest value allowed for the selected parameter.
F	Default Value	(Optional) Default value for the selected parameter. Once you specify a default value, new Recipes will automatically use this value as a starting point. If you change the default value, existing Recipes are not updated with the new default value.
G	Default Source Point	<p>(Optional) Default source point for the selected parameter.</p> <ul style="list-style-type: none"> • Once you specify a default source point, new Recipes will automatically use this value as a starting point. If you change the default source point, existing Recipes are not updated with the new default value. • If both the Default Value and Default Source Point are specified for a Parameter, the Default Source Point takes precedence when you create a new Recipe.

(Optional) Remove Parameter Attributes

You can remove parameters from your recipe group.

1. Click the number of the row you want to remove.

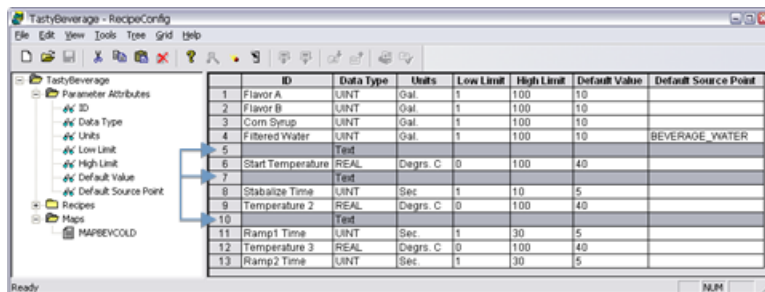

 **Note:** Hold down the following keys for multiple rows.

Shift key	Adjacent rows.
Ctrl key	Non-adjacent rows

1. Do one of the following:

- Click the right mouse button; select Delete Parameters on the Popup menu.
- Click Grid>Delete Parameters on the RecipeConfig window menu bar.

1. Confirm your selection.

Result: The selected parameter row or rows are deleted. The parameters are also deleted from all recipes and maps in the group.

Step 3. Configure Recipes

Step 3. Configure Recipes

A Recipe specifies the amount (value) of each Parameter that will be used to manufacture a specific batch of product. All the Recipes for a Recipe Group are found in the Recipes folder.

- Recipe organization.
- Recipe configuration.

Recipe Organization

You can create subfolders at anytime in the Recipes folder to further classify your Recipes.

1. Select Recipes in the RecipeConfig window left pane.

2. Do one of the following.

- Select Tree>Create SubFolder on the RecipeConfig window menu bar.
- Right-click Recipes; select New>SubFolder on the Popup menu.

A new subfolder is created in the Recipe tree.

3. Enter the name of the new subfolder.

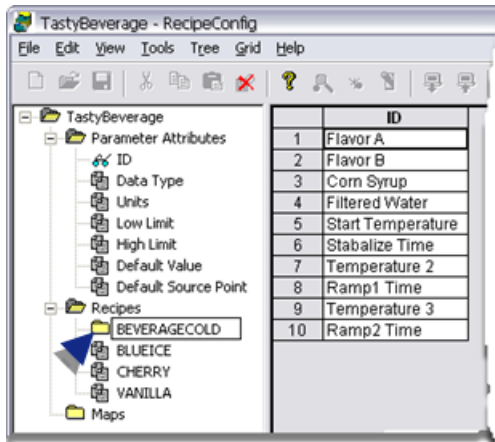

4. (Optional) Drag existing recipes into any subfolder to re-organize your group.

There is no restriction on the number of levels of subfolders you can create. You can create a Recipe in the Recipes folder or in any Recipes subfolder.

Recipe Configuration

Initially, the Recipes folder contains no Recipes or Recipe subfolders.

Steps to create, configure and administer recipes are as follows.

Step 3.1 (page 443)	Create a recipe
Step 3.2 (page 443)	Rename a recipe.
Step 3.3 (page 444)	Display/hide recipe parameter values.
Step 3.4 (page 445)	Enter recipe parameter values.
Step 3.5 (page 449)	Enter recipe properties.
Step 3.6 (page 450)	Compare recipes
Step 3.7 (page 452)	Copy/move/delete recipes.

Step 3.8 (page 453)	Print recipe data.
--	--------------------

Step 3.1. Create a Recipe

1. Select one of the following.

- Recipes folder
- Recipes subfolder.
- Existing recipe.

2. Do one of the following.

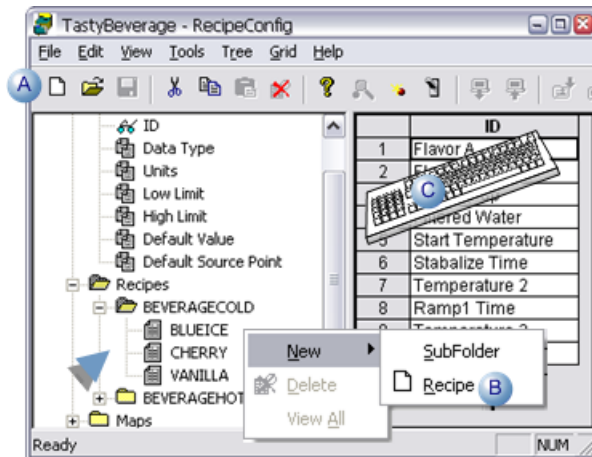

A	Click the New button on the RecipeConfig toolbar.
B	Right-click your selection: select New>Recipe on the Popup menu.
C	Press Ctrl+N on the keyboard.

The new Recipe is added to the end of the Recipe list in the selected folder and is given the default name New Recipe.

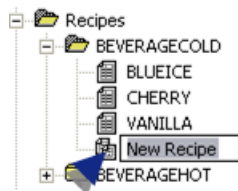

Note: The next time the recipe group is saved, the [recipe \(page 473\)](#) list will be resorted so the new recipe will be listed in the correct alphanumeric order.

Step 3.2. Rename a Recipe

When a recipe is first created, the default name is available for editing.

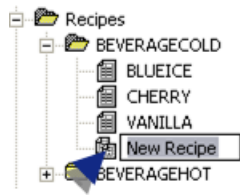

You can edit any recipe names as follows.

1. Select a recipe.
2. Do one of the following.
 - Click File>Rename on the RecipeConfig window menu bar.
 - Right-click the name; select Rename on the Popup menu.
 - Press Alt+F+M on the keyboard.

The name becomes available for editing.

3. Enter the new recipe name.

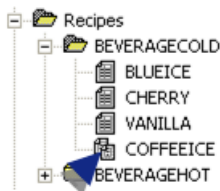

Note: The maximum length for a recipe name is 255 characters.

 **Note:** The name must be unique across the entire Group. The maximum length is 255 characters.

Step 3.3. Display/Hide Recipe Parameter Values

You can display or hide values for a single or all recipes in order to review them and modify them.

- Display a single recipe's values.
- Display values for recipes in a selected subfolder
- Display all recipes' values.
- Hide recipes' values

Display a single recipe's values

1. Select a recipe.
2. Do one of the following.
 - Double-click the recipe in the RecipeConfig window left pane.
 - Click Tree>View on the RecipeConfig window menu bar.
 - Right-click the recipe; select View on the Popup menu.

Result: Parameter values for the selected recipe display in a column in the RecipeConfig right pane (grid).

Display values for recipes in a selected subfolder

3. Select a recipe subfolder.
4. Do one of the following:
 - Click Tree>View All on the RecipeConfig window menu bar.
 - Right-click the subfolder; select View All on the Popup menu.

Result: Parameter values for all recipes in the selected subfolder and its subfolders display in the RecipeConfig right pane.

Display all recipes' values

5. Select the Recipes folder.
6. Do one of the following to display
 - Click Tree>View All on the RecipeConfig window menu bar.
 - Right-click the Recipes folder; select View All on the Popup menu.

Result: Parameter values for all recipes in the Recipes folder and all subfolders display in the RecipeConfig right pane.

Hide Recipes' Values

7. Select one or more columns in the RecipeConfig window right pane.
8. Do one of the following to hide your selection.
 - Click Grid>Hide column
 - Click Grid>Hide all columns
 - Click Grid>Hide all Recipe columns.
 - Right-click your selection>select Hide Column on the Popup menu.

The columns are hidden based on your selection.

Step 3.4. Enter Recipe Parameter Values

1 (page 446)	(New recipe) Review default recipe values.
2 (page 446)	Modify recipe parameter values.
3 (page 447)	Confirm recipe properties.
4 (page 448)	Validate parameters.

(New recipe) Review default recipe values

[Display \(page 444\)](#) the values for a new recipe.

The column that displays in the grid default values for the new recipe in the following priority.

ID	Default Value	Default Source Point	COFFEEICE
1	Flavor A	10	
2	Flavor B		10
3	Corn Syrup	10	
4	Filtered Water	10	BEVERAGE_WATER
5	Start Temperature	40	40
6	Stabilize Time	5	5
7	Temperature 2	40	40
8	Ramp1 Time	5	5
9	Temperature 3	40	40
10	Ramp2 Time	5	5



1	Default source points that are defined for the Parameter have top priority.
2	A default value, when there is no default source point, is used as the recipe parameter's default value.
3	When a parameter has no default value or source point, the recipe parameter default value is blank.,

Modify recipe parameter values

1. [Display \(page 444\)](#) parameter values for any Recipe in the RecipeConfig window's grid.
2. Select the Parameter value you want to modify.
3. Change the value for the Parameter.

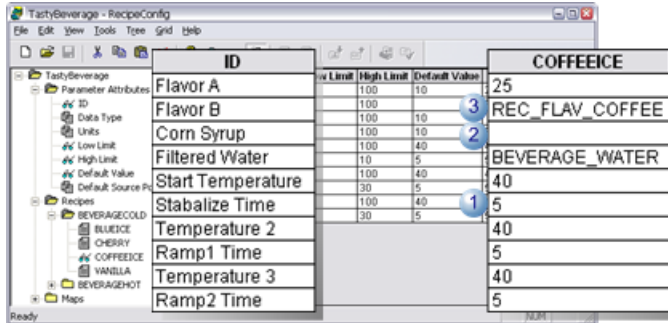
Possible values are:



1	Absolute value.
2	Blank (no value). Important: The cell can only be blank if a default source point is specified for the parameter.
3	Point ID
<p>Tip: There are several tools to help you select and enter point ID's. Select the field in the Recipe column that is on the same row as the ID. Do any of the following.</p> <ul style="list-style-type: none"> • Create a point • Click the New Point button  on the RecipeConfig toolbar. • Click Tools>New Point on the RecipeConfig menu bar. <p>Note:</p> <ul style="list-style-type: none"> • If the project is running, make sure Dynamic Configuration is turned on in the RecipConfig window. • If you create a new point, you may have to browse for the point or type its ID in the field to enter it. • Browse for a point • Click the Browse point button  on the RecipeConfig toolbar. • Click Tools>Point Browse on the RecipeConfig menu bar. • Right-click the field; select Point Browse on the Popup menu. • Type the point ID in the field. 	

Confirm recipe properties

A Recipe Cell Properties dialog box is available to do a quick check for each Recipe entry.

Do one of the following.

- Click Edit>Properties on the RecipeConfig menu bar.
- Right-click the field; select Properties on the Popup menu.

A Recipe Cell Properties dialog box opens.

Options are as follows.

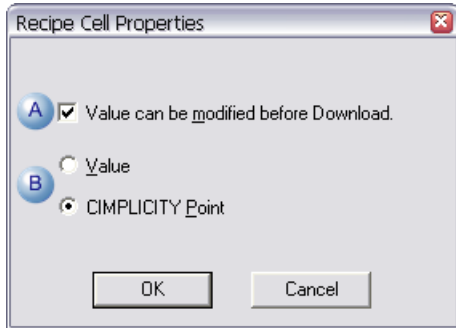

A	Options for Value can be modified before Download are:	
	Checked	(Default) Allows the value to be read/write before download.
	Clear	Makes the value read-only before download.
B	Options are:	
	Value	
	Checked	The value in the cell is downloaded to the corresponding Map point.
		Checked by default if one of the following happens. <ul style="list-style-type: none"> • An absolute value is entered • The field is blank • A point ID that is entered is not available in the project.
	CIMPPLICITY Point	(Checked) Contents of the CIMPPLICITY Point ID are downloaded to the corresponding Map point. Checked by default if a point ID is entered that is available in the project.

Validate parameters

The following validations are performed in Parameter columns:

- High/Low Limits
- Default Value
- Default Source Point

- High/Low Limits

The following validations are performed for the High Limit and Low Limit columns:

- If the cell is blank, no validation is performed.
- If the cell is not blank, the Data Type of the row must be numeric.
- When validating the Low Limit column, each Low Limit must be less than its corresponding High Limit.
- When validating the High Limit column, each High Limit must be greater than its corresponding Low Limit.

- Default Value

The following validations are performed for the Default Value column:

- Cell can only be blank if a Default Source Point is filled in for the row.
- If the Data Type for the row is numeric, the cell can contain only a numeric value.
- If the Data Type for the row is digital, the cell can contain only 0 or 1.
- If the Data Type for the row is text, the cell can contain anything.
- If the Data Type for the row is numeric, and Default High/Low limits are defined, the Default Value is verified to be within those limits.
- Default Source Point

The following validations are performed for the Default Source Point column:

- If the cell is blank, no validation is performed.
- The Point Type for the Default Source Point must match the Data Type of the row.
- If the Default Source Point is an array element, it must be within the array bounds.
- The point must be Enabled.

Step 3.5. Enter Recipe Properties

1. Select a recipe using either of the following methods.
 - Click a recipe in the RecipeConfig window left pane.
 - Click the recipe's name that identifies its column in the RecipeConfig window right pane.
2. Do one of the following.
 - Click Edit>Properties on the RecipeConfig window menu bar.
 - Click the right-mouse button; select Properties on the Popup menu.
 - Press Alt+Enter.

The Recipe Data dialog opens.

3. Enter and review the following.

Field	Description
Recipe Name	(Read-only) Name of the Recipe.
Create Time	(Read-only) Date and time the Recipe was initially created.
Last Modified	(Read-only) Date and time the Recipe was last modified.
Version	Recipe version.
Product Code	Product code associated with the Recipe.
Author	Author of the Recipe.
Recipe Point	CIMPLICITY Point ID to write the Recipe Name to when the Recipe is downloaded or uploaded. The point ID: <ul style="list-style-type: none"> • May be unqualified or fully qualified. • Must be a Text point of sufficient length to hold the Recipe name.
Batch Point	CIMPLICITY Point ID to write the user defined Batch ID to when the Recipe is Downloaded. The point ID: <ul style="list-style-type: none"> • May be unqualified or fully qualified. • Must be a Text point of sufficient length to hold the Batch ID.
Comments	Text box for any comments about the recipe that should be recorded.

Step 3.6. Compare Recipes

1. Select a recipe.
2. Do one of the following:
 - Click Tools>Compare on the RecipeConfig menu bar.

- Right-click the recipe; select Compare from the Popup menu.

A Recipe Compare Select browser opens displaying the additional recipes in the Recipes folder.

3. Select the recipes you want to compare.

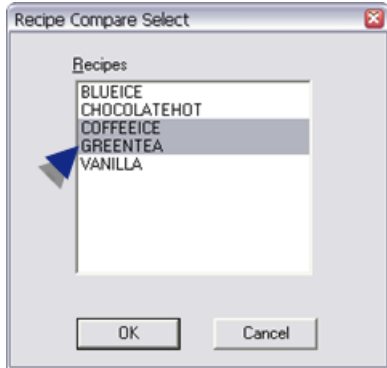

4. Click OK (or Cancel).

A message opens asking if you want to clear the grid before displaying the recipe comparisons.

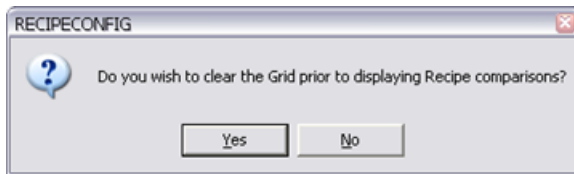

5. Click one of the buttons.

Yes	Clears the grid.
No	Leaves current data displaying in the grid.

The message closes; the grid displays your selections..

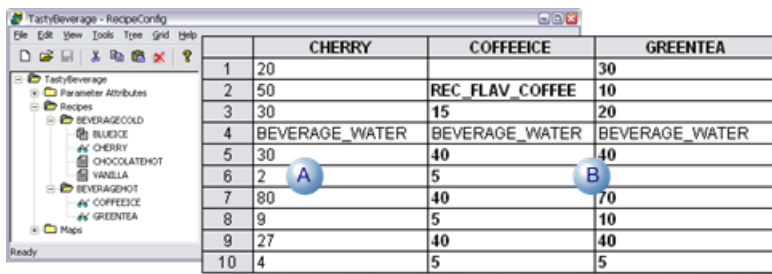

A	Values for the selected recipe display.
B	Values for the recipes selected for comparison display. Note: Values that are different from the first recipe display in bold.

Step 3.7. Copy/Move/Delete Recipes

As you manage your recipes, you can copy or move recipes between recipe folders, add more or delete ones that are no longer needed. You can also cut, copy and paste values from one recipe to another.

- Copy recipes.
- Move recipes.
- Delete recipes.
- Cut/copy a recipe value.
- Paste a recipe value.

Copy recipes

1. Select a recipe name.
2. Do one of the following.
 - Right-click the recipe; select Copy on the Popup menu.
 - Click Tree>Copy on the RecipeConfig menu bar.
 - Hold down the Ctrl key and the left mouse button; drag the recipe to the Recipes folder or a subfolder ; release the left mouse button.

Result: A Copy of the selected recipe is created in the selected folder; the default name is ready to be edited.

Move recipes

3. Select a recipe name.
4. Hold down the left mouse button; drag the recipe to a selected Recipes folder or subfolder; release the left mouse button.

Result: The recipe is moved to the selected location.

Delete recipes

5. Select the recipe you want to delete.
6. Do one of the following.
 - Click Edit>Delete on the RecipeConfig menu bar.
 - Click the Delete button on the RecipConfig toolbar.
 - Right-click the recipe; select Delete on the Popup menu.
 - Press the Delete key.

Cut/Copy/ a recipe value

7. Select a recipe value in the RecipeConfig window right pane.
8. Do one of the following.
 - Click the Cut or Copy buttons on the RecipeConfig toolbar.
 - Click Edit>Cut or Edit>Copy on the RecipeConfig menu bar.
 - Right-click the value; select Cut or Copy on the Popup menu.
 - Press Ctrl+X (Cut) or Ctrl+C (Copy) on the keyboard.

Result: The selected value is cut or copied.

Paste a recipe value

9. Select a recipe cell in the RecipeConfig window right pane where the value should be pasted.
10. Do one of the following.
 - Click the Paste button on the RecipeConfig toolbar.
 - Click Edit>Paste on the RecipeConfig menu bar.
 - Right-click the value; select Paste on the Popup menu.
 - Press Ctrl+V (Paste) on the keyboard.

The value is pasted into the selected cell.

Step 3.8. Print Recipe Data

1. Right-click a recipe.
2. Select Print on the Popup menu.

A Printer dialog box for the system's default printer appears.

3. Select the printer you want to use.
4. Select Landscape printing.
5. Print the document.

Recipes prints the following.

- The Recipe name is in the report heading.

Note: If the recipe name contains spaces, the text will wrap within the space boundaries.

- Columns include:

- ID
- Data Type
- Units
- Low Limit
- High Limit
- Default Value
- Default Source Point
- StoreValue

Step 4. Configure Recipe Maps

Step 4. Configure Recipe Maps

A Map is a list of CIMPLICITY Point IDs to which Recipe parameter values will be written during a Download request, or from which Recipe parameter values will be read during an Upload request. Map points may represent non-contiguous device addresses, and can span several devices.

You can create subfolders in the Maps folder to further classify your Maps. There is no restriction on the number of levels of subfolders you can create. You can create a Map in the Maps folder or in any Map subfolder.

Initially, the Maps folder contains no Maps or Map subfolders.

Component names must be unique.

Steps to create, configure and administer recipe maps are as follows.

Step 4.1 <i>(page 455)</i>	Create a recipe map.
Step 4.2 <i>(page 455)</i>	Rename a recipe map.
Step 4.3 <i>(page 456)</i>	Display recipe map values.
Step 4.4 <i>(page 457)</i>	Enter recipe map parameter values.
Step 4.5 <i>(page 458)</i>	Enter recipe map properties.
Step 4.6 <i>(page 459)</i>	Create, rename, copy and delete a recipe map.

Step 4.1. Create a Recipe Map

1. Select one of the following.

- Maps folder
- Maps subfolder.
- Existing map.

2. Do one of the following.

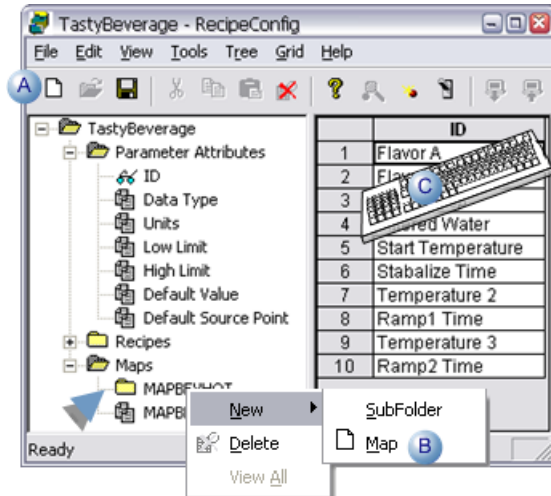

A	Click the New button on the RecipeConfig toolbar.
B	Right-click your selection: select New>Map on the Popup menu.
C	Press Ctrl+N on the keyboard.

The new map is added to the end of the map list in the selected folder and is given the default name New Map.



Note: The next time the recipe group is saved, the [map \(page 473\)](#) list will be resorted so the new recipe will be listed in the correct alphanumeric order.

Step 4.2. Rename a Recipe Map

When a map is first created, the default name is available for editing.



You can edit any map names as follows.

1. Select a map.
2. Do one of the following.
 - Click File>Rename on the Recipes menu bar.
 - Right-click the name; select Rename on the Popup menu.
 - Press Alt+F+M on the keyboard.

The name becomes available for editing.



3. Enter the new map name.



Note: The name must be unique across the entire Group. The maximum length is 255 characters.

Step 4.3. Display Recipe Map Values

You can display the contents of a single Map, all Maps, or all Maps in a subfolder.

Note: The icon in the Tree changes from  or  to  for Maps that you are displaying in the Grid.

- Display a single map.
- Display all maps

Display a single recipe's map values

1. Select a map.
2. Do one of the following.
 - Double-click the map in the RecipeConfig window left pane.
 - Click Tree>View on the RecipeConfig window menu bar.
 - Right-click the recipe; select View on the Popup menu.

Result: Parameter values for the selected map display in a column in the RecipeConfig right pane (grid).

Display recipe map values in a selected subfolder

3. Select a map subfolder.
4. Do one of the following:
 - Click Tree>View All on the RecipeConfig window menu bar.
 - Right-click the subfolder; select View All on the Popup menu

Result: Parameter values for all maps in the selected subfolder and its subfolders display in the RecipeConfig right pane.

Display all recipe map values

5. Select the Maps folder.
6. Do one of the following.
 - Click Tree>View All on the RecipeConfig window menu bar.
 - Right-click the Maps folder; select View All on the Popup menu.

All Maps in the Maps folder and all Map subfolders will be displayed in the Grid.

Parameter values for all maps in the Maps folder and all subfolders display in the RecipeConfig right pane.

Step 4.4. Enter Recipe Map Parameter Values

Map parameter values are device points where CIMPLICITY software can Download or Upload Recipe parameters. You can enter Point IDs manually or use the Point Browser to select them. Point IDs may be unqualified or fully qualified.

- Define map parameter values
- Modify map parameter values

Define map parameter values

The device points you define for the Map do not need to be contiguous or on the same device. However, the more non-contiguous points you have in the Map, the more time will be needed to perform Uploads and Downloads.

For best performance on Uploads or Downloads, use contiguous array points in a Map. For example, consider the following Maps:

MAP1	MAP2
PT[0]	PT [0]
PT[1]	PT [1]
PT[2]	PT [2]
PT[3]	NPT[0]
PT[4]	NPT[1]
PT[5]	NPT[2]
PT[6]	NPT[3]
PT[7]	PT [3]
PT[8]	PT [4]

When MAP1 is used for a Download or Upload, a single write/read request is issued.

When MAP2 is used for a Download or Upload, three write/read requests are issued.

Modify map parameter values

1. Display the Map in the Grid.
2. In the Map, select the Parameter value you want to modify.
3. Change the CIMPLICITY Point ID for the Parameter. You may enter the new Point ID manually, or use the Point Browser to select a Point ID. The Point ID may be unqualified or fully qualified.

Step 4.5. Enter Recipe Map Properties

1. Select a recipe map using either of the following methods.
 - Click a map in the RecipeConfig window left pane.
 - Click the map's name that identifies its column in the RecipeConfig window right pane.
2. Do one of the following:
 - Click Edit>Properties on the RecipeConfig window menu bar.
 - Click the right-mouse button; select Properties on the Popup menu.
 - Press Alt+Enter.

The Map Data dialog box opens.

3. Enter and review the following.

Map Data

Map Name: MAPBEVICE

Description: Map to points for Cold beverages

Map Point: BEVICEMAP

Status Point: BEVICESTATUS

OK Cancel

Map Name	(Read-only) Name of the selected map.
Description	Descriptive phrase to help identify the map.
Map Point	CIMPLICITY point ID that the map name will be written to when a Recipe is downloaded or uploaded. Note: The point ID may be: <ul style="list-style-type: none"> • May be unqualified or fully qualified. • Must be a text point of sufficient length to hold the map name.
Status Point	CIMPLICITY Point ID that the status will be written to while a Recipe is downloaded or uploaded. <p>Notes</p> <ul style="list-style-type: none"> • The point ID can be unqualified or fully qualified. • The way the status is reported depends on the point type, as follows. • An analog or float type point provides a numeric percentage (0-100%) that will be written to the point while the recipe is downloaded or uploaded. <p>This point can then be used to animate an object on a CimView screen.</p> <ul style="list-style-type: none"> • A text point provides a status message that will be written to the point. <p>Be sure to use a TEXT_80 type point so that the status message can be displayed in full.</p>

Step 4.6. Create, Rename, Copy and Delete a Recipe Map

- Copy recipe maps.
- Move recipe maps.
- Delete recipe maps.
- Cut/copy a map value.
- Paste a map value.

Copy recipe maps

1. Select a map name.
2. Do one of the following.
 - Right-click the map; select Copy on the Popup menu.
 - Hold down the Ctrl key and the left mouse button; drag the map to the Recipes folder or a subfolder ; release the left mouse button.

Result: A Copy of the selected map is created in the selected folder; the default name is ready to be edited.

Move recipe maps

3. Select a map name.
4. Hold down the left mouse button; drag the map to a selected Maps folder or subfolder; release the left mouse button.

Result: The map is moved to the selected location.

Delete a recipe map

5. Select the map you want to delete.
6. Do one of the following.
 - Click Edit>Delete on the RecipeConfig menu bar.
 - Click the Delete button on the RecipConfig toolbar.
 - Right-click the map; select Delete on the Popup menu.
 - Press the Delete key.

Cut/Copy/ a recipe map value

7. Select a map value in the RecipeConfig window right pane.
8. Do one of the following.
 - Click the Cut or Copy buttons on the RecipeConfig toolbar.
 - Click Edit>Cut or Edit>Copy on the RecipeConfig menu bar.
 - Right-click the value; select Cut or Copy on the Popup menu.
 - Press Ctrl+X (Cut) or Ctrl+C (Copy) on the keyboard.

Result: The selected value is cut or copied.

Paste a recipe value

9. Select a map cell in the RecipeConfig window right pane where the value should be pasted.
10. Do one of the following.
 - Click the Paste button on the RecipeConfig toolbar.
 - Click Edit>Paste on the RecipeConfig menu bar.
 - Right-click the value; select Paste on the Popup menu.
 - Press Ctrl+V (Paste) on the keyboard.

The value is pasted into the selected cell.

Step 5. Upload/Download Recipes and Maps

Step 5. Upload/Download Recipes and Maps

Map values can be uploaded or downloaded to or from any selected recipe.

The process can be triggered manually or automatically.

Option 5.1 (page 461)	Upload/download recipes and maps manually.
---------------------------------------	--

Option 5.2 (page 468)	Configure recipe automatic upload/download actions.
---------------------------------------	---

Option 5.1. Upload/Download Recipes and Maps Manually

Option 5.1. Upload/Download Recipes and Maps Manually

Recipes can be manually uploaded or downloaded through the RecipeConfig window.

Option 5.1.2 (page 461)	Upload recipes and maps manually.
Option 5.1.2 (page 464)	Download recipes and maps manually.

Option 5.1.1. Upload Recipes and Maps Manually

Option 5.1.1. Upload Recipes and Maps Manually

Step 5.1.1.1 (page 461)	Open an Upload a Recipe dialog box.
Step 5.1.1.2 (page 462)	Enter recipe upload properties.

Step 5.1.1.1. Open an Upload a Recipe Dialog Box

1. Select a recipe or map in the RecipeConfig window left pane.
2. Do one of the following:

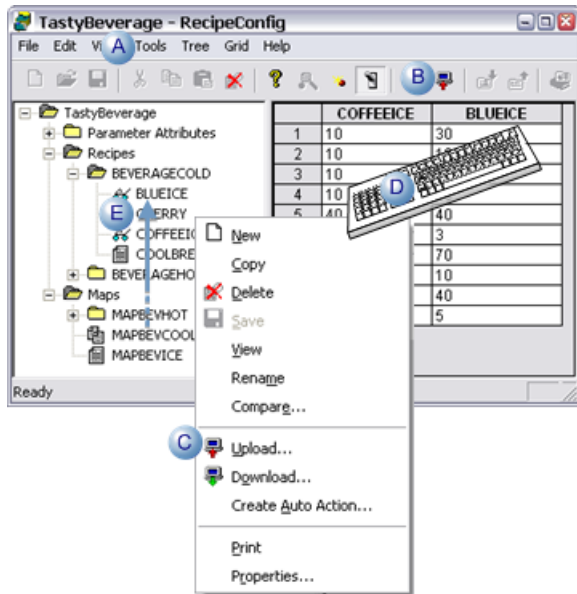

A	Click Tools>Upload on the RecipeConfig window menu bar.
B	Click the Upload Recipes button on the RecipeConfig window toolbar.
C	Right-click the selected recipe or map; select Upload on the Popup menu.
D	Press Ctrl+U on the keyboard.
E	Drag a map onto the recipe that you want to use for the upload.

An Upload a Recipe dialog box opens when you use any method.

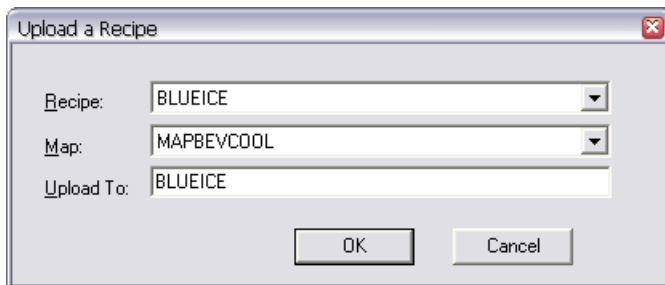

Step 5.1.1.2. Enter Recipe Upload Properties

1. Enter the following.

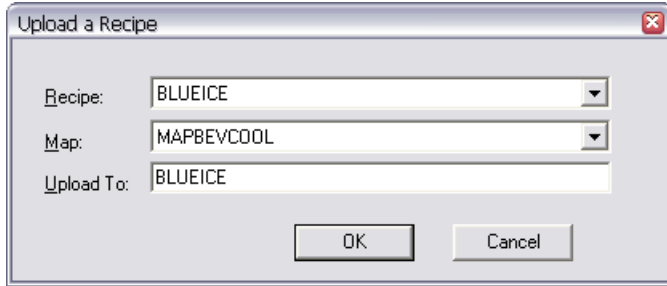

Recipe	Recipe to be uploaded. Recipes that are included in the recipe group are available in the drop down list.		
	If the:	Recipe was selected	Recipe was not selected
	Default is:	Selected recipe.	First recipe in the list.
Map	Map to be uploaded. Maps that are included in the recipe group are available in the drop down list.		
	If the:	Map was selected	Map was not selected
	Default is:	Selected map	First map in the list
Upload To	Recipe to which map values will be uploaded. Recipes that are included in the recipe group are available in the drop down list.		
	If the:	Recipe was selected	Recipe was not selected
	Default is:	Selected recipe.	First recipe in the list.

2. Click one of the following.

- OK

One of the following occurs.

- If the target already exists a message will open.

Click on of the following.

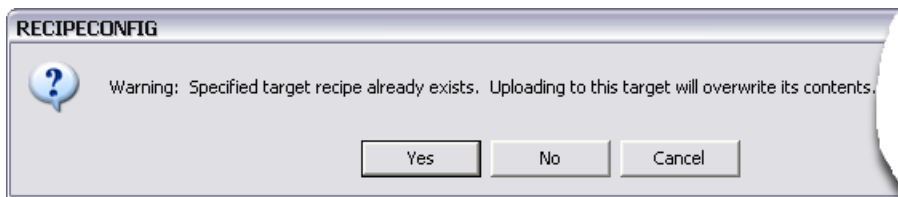

Yes	Uploads the recipe and overwrites the existing recipe's contents.
No	Closes the message so another target can be selected.
Cancel	Closes the message and the Upload a Recipe dialog box.

- If the target recipe does not already exist.

The selected recipe and map values are uploaded.

- Cancel

The Upload a Recipe dialog box closes: the upload is cancelled.

Option 5.1.2. Download Recipes and Maps Manually

Option 5.1.2. Download Recipes and Maps Manually

Step 5.1.2.1 (page 464)	Open a Download a Recipe dialog box.
Step 5.1.2.2 (page 465)	Enter recipe download general properties.
Step 5.1.2.3 (page 466)	Modify recipe parameters for download.
Step 5.1.2.4 (page 467)	Manually start the recipe download.

Step 5.1.2.1. Open a Download a Recipe Dialog Box

1. Select a recipe or map in the RecipeConfig window left pane.
2. Do one of the following:

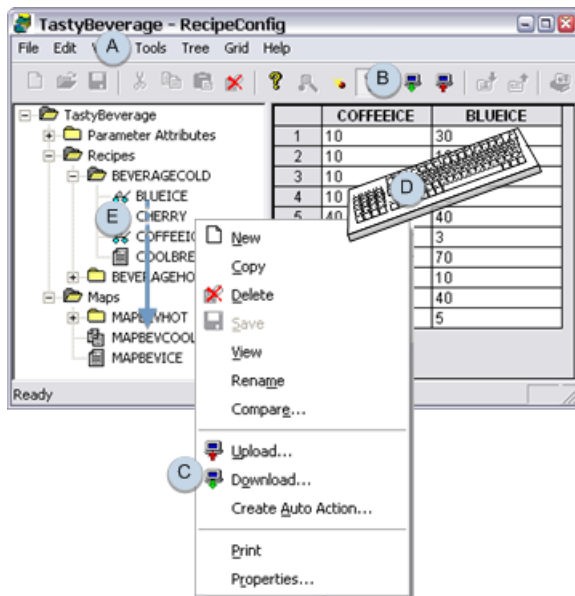

A	Click Tools>Download on the RecipeConfig window menu bar.
B	Click the Download Recipes button on the RecipeConfig window toolbar.
C	Right-click the selected recipe or map; select Upload on the Popup menu.
D	Press Ctrl+D on the keyboard.
E	Drag a recipe onto the map that you want to use for the upload.

A Download a Recipe dialog opens when you use any method.

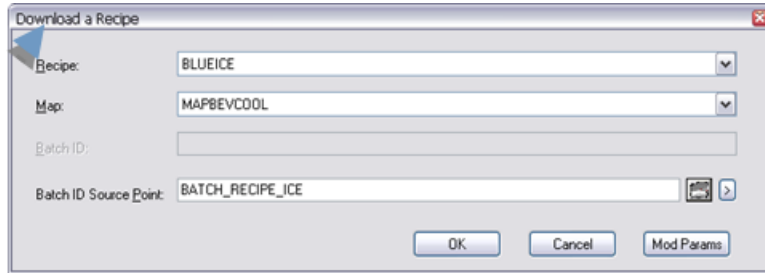

Step 5.1.2.2. Enter Recipe Download General Properties

The default values that display on the General tab depend on whether a recipe, map or both were selected to open the Download a Recipe dialog box.

Review and enter the following.

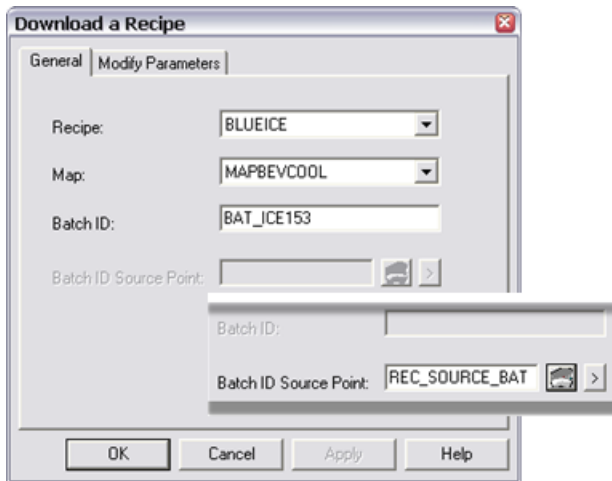

Recipe	Recipe to be downloaded. Recipes that are included in the recipe group are available in the drop down list.		
	If the:	Recipe was selected	Recipe was not selected
	Default	Selected recipe.	First recipe in the list.
Map	Map to be downloaded. Maps that are included in the recipe group are available in the drop down list.		
	If the:	Map was selected	Map was not selected

	Default	Selected map	First map in the list
Batch ID	(Option) Batch Identifier for the product to be manufactured. When the Download is executed, this text will be placed in the Batch Point defined for the Recipe. Note: When a value is entered in the Batch ID field, the Batch ID Source Point field is disabled.		
Batch ID Source Point	(Option) CIMPLICITY Point ID. When the Download is executed, the text contained in this Point ID will be placed in the Batch Point defined for the Recipe. The point ID: <ul style="list-style-type: none"> • May be unqualified or fully qualified. • Must be a Text point of sufficient length to hold the batch ID. Note: When a value is entered in the Batch ID Source Point field, the Batch ID field is disabled.		

Step 5.1.2.3. Modify Recipe Parameters for Download

1. Select the Modify Parameters tab.

The parameters and values that display represent the selected recipe and map.

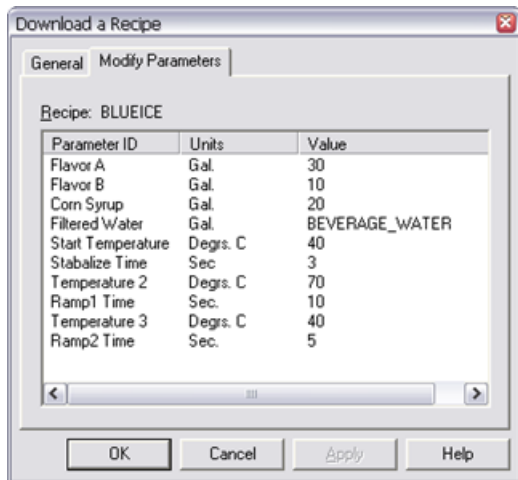

2. (Optional) Modify any parameter that has the [Value can be modified before Download \(page 447\)](#) checkbox checked, as follows.
 - a. Double-click the parameter in the Recipe list.

A Modify Recipe Value dialog box opens.

- a. Review and enter the following.

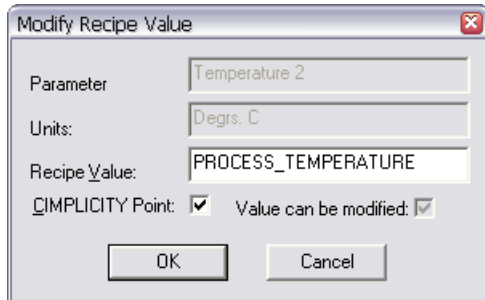

Parameter	(Read-only) Parameter selected to be modified.
Units	(Read-only) Units assigned to the parameter.
Recipe Value	New value that should be downloaded.
CIMPLICITY Point	Check if the new value is a CIMPLICITY point ID.

3. Click **OK**.

Step 5.1.2.4. Manually Start the Recipe Download

1. Click OK when the recipe download specifications are accurate.

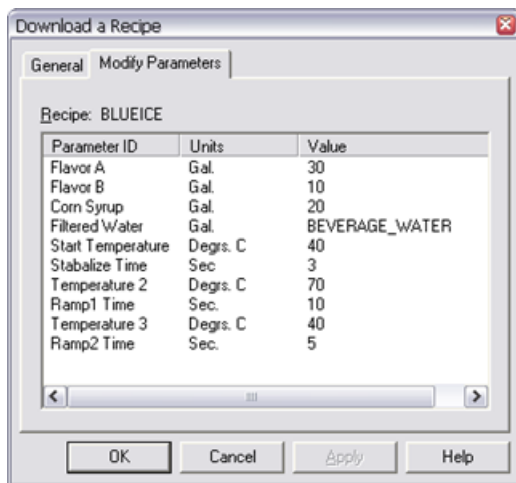

A message opens asking if you want to validate the recipe and map before you download.

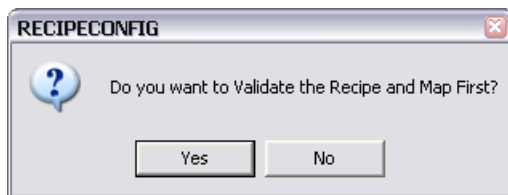

2. Click one of the following.

- Yes

During the download, Recipes validates the parameters.

If a parameter is invalid a message displays reporting the issue.

You can choose to continue or stop the validation when the recipe resumes and continues downloading.

- No

The recipe is downloaded with no validation.

Option 5.2. Configure Recipe Automatic Upload/Download Actions

Option 5.2. Configure Recipe Automatic Upload/Download Actions

For Recipes, Automatic Actions are Downloads and Uploads that are done automatically through the Event Manager. Once you configure an Automatic Action, you can use the Event Editor to create Events that will cause the Action to be executed.

Step 5.2.1 (page 468)	Open a Create auto Action Parameter File dialog box.
Step 5.2.2 (page 469)	Create an automatic upload or download parameter file.

Step 5.2.1. Open a Create Auto Action Parameter File Dialog Box

1. Select a recipe or map in the RecipeConfig window left pane.
2. Do one of the following:

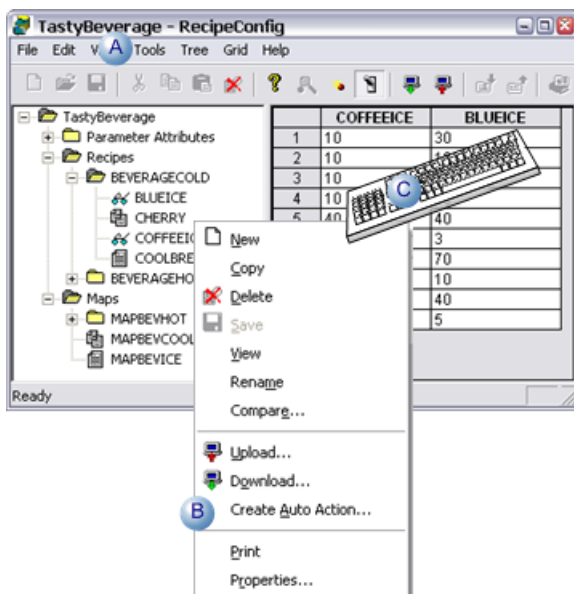

A	Click Tools>Create Auto Action on the RecipeConfig window menu bar.
B	Right-click the selected recipe or map; select Create Auto Action on the Popup menu.

D | Press Alt+T+A on the keyboard.

A Create Auto Action Parameter File dialog box opens when you use any method.

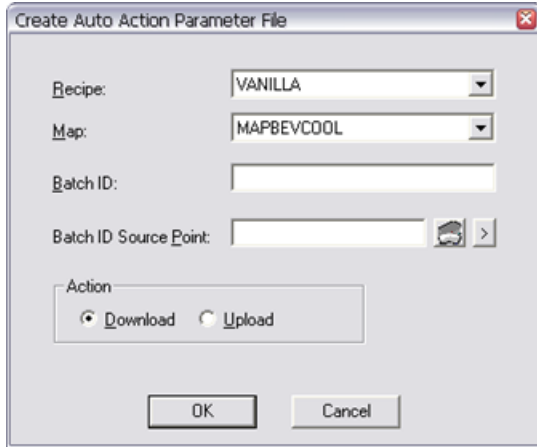

Step 5.2.2. Create an Automatic Upload or Download Parameter File

<p>A <i>(page 469)</i></p>	<p>Select the recipe and map that will be automatically uploaded or downloaded.</p>
<p>B <i>(page 470)</i></p>	<p>Enter upload or download specifications.</p>
<p>C <i>(page 471)</i></p>	<p>Save the parameter file.</p>

1. Select the Recipe and Map that will be automatically uploaded or downloaded.

Enter the following.

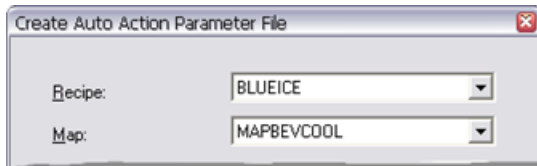

<p>Recipe</p>	<p>Recipe to be uploaded. Recipes that are included in the recipe group are available in the drop down list.</p>		
	<p>If the:</p>	<p>Recipe was selected</p>	<p>Recipe was not selected</p>
	<p>Default is:</p>	<p>Selected recipe.</p>	<p>First recipe in the list.</p>
<p>Map</p>	<p>Map to be uploaded. Maps that are included in the recipe group are available in the drop down list.</p>		
	<p>If the:</p>	<p>Map was selected</p>	<p>Map was not selected</p>

	Default is:	Selected map	First map in the list
--	-------------	--------------	-----------------------

1. Enter upload or download specifications.

Upload Specifications

Do the following.

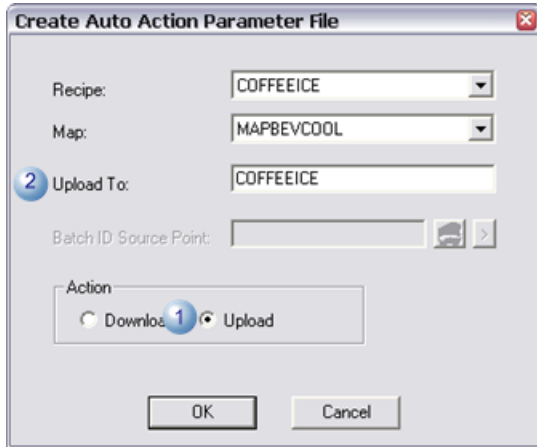

1	Check Upload.
2	Enter the name of the recipe to which map values will be uploaded.

Download Specifications

Do the following.

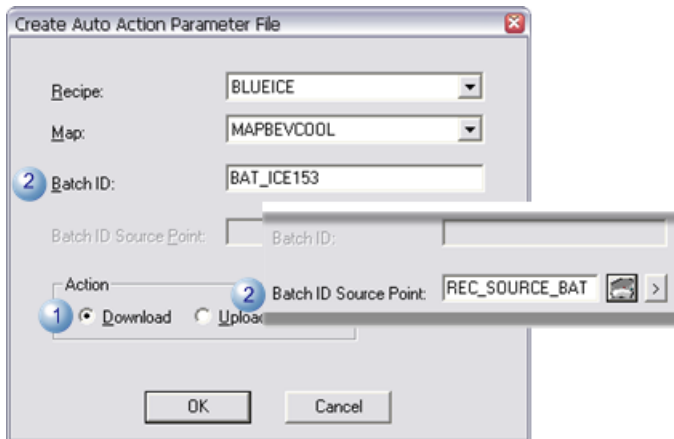

1	Check Download.
2	Enter one of the following.
Batch ID	(Option) Batch Identifier for the product to be manufactured. When the Download is executed, this text will be placed in the Batch Point defined for the Recipe. Note: When a value is entered in the Batch ID field, the Batch ID Source Point field is disabled.

Batch ID Source Point	<p>(Option) CIMPLICITY Point ID. When the Download is executed, the text contained in this Point ID will be placed in the Batch Point defined for the Recipe. The point ID:</p> <ul style="list-style-type: none"> • May be unqualified or fully qualified. • Must be a Text point of sufficient length to hold the batch ID. <p>Note: When a value is entered in the Batch ID field, the Batch ID Source Point field is disabled.</p>
-----------------------	---

1. Save the parameter file.

1. Click OK in the Create Auto Action Parameter File dialog box.

A Save as dialog box opens.

2. Enter the name of the upload or download file in the **File name** field.

Note: If the file already exists a message will display asking you if you want to overwrite it.

3. Click Save.

The file will now be available to be used with a CIMPLICITY event.

Step 6. Administer Recipe Groups

Step 6. Administer Recipe Groups

Option 6.1 (page 471)	Validate recipe group columns.
Option 6.2 (page 473)	Save and refresh a modified recipe group.
Option 6.3 (page 474)	Export a recipe group.
Option 6.4 (page 475)	Archive a recipe group.

Option 6.1. Validate Recipe Group Columns

You can validate the following information in your Recipe Group:

- Parameters
- Recipes

- Maps

The type of validation done, and the messages displayed, depends on the type of column you are validating.

! Important: To validate Default Source Points, Recipe Points, or Maps, your CIMPLICITY project must be running.

1. Make sure the information you want to validate displays in a column in the RecipeConfig window right pane.

2. Select the column you want to validate.

Note: You can validate one column at a time.

3. Do one of the following:

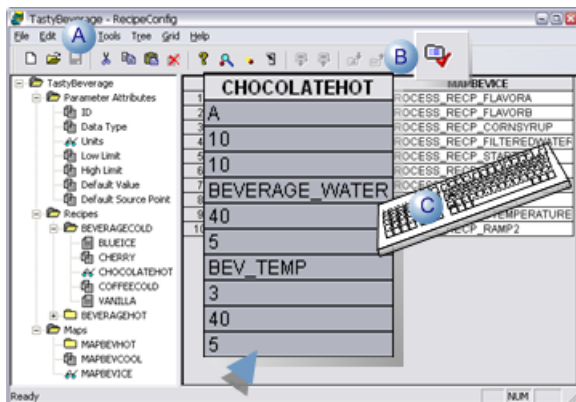

A	Click Tools>Validate on the RecipeConfig window menu bar.
B	Click the Validate button on the RecipeConfig window toolbar.
C	Press Ctrl+L on the keyboard.

Result: When the Validation procedure finds a problem, it does the following.

- Displays a dialog box with detailed information about the location and type of problem

Example

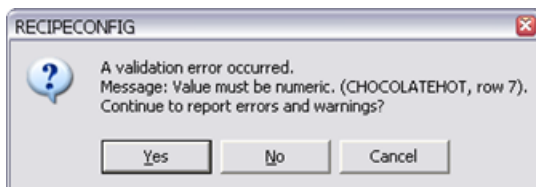

- Is recorded in the project's Status Log.

4. Click one of the following buttons.

Button	Result
Yes	The validation continues and displays additional warnings and errors.
No	The validation continues without displaying messages. Messages will still be logged to the project's Status Log.
Cancel	Cancel the validation.

Option 6.2. Save and Refresh a Modified Recipe Group

Note:

First time save, make sure you are saving in the correct project folder.

Do one of the following.

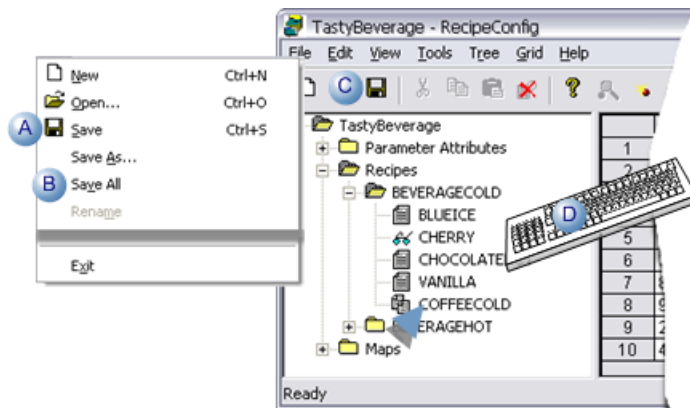

A	Click File>Save on the RecipeConfig window menu bar.	
B	Click File>Save All on the RecipeConfig window menu bar.	
C	Click the Save button on the RecipeConfig window toolbar. Note: The Save button is enabled if the Recipe group has been modified since the last time it was saved.	
D	Press one of the following on the keyboard.	
	For	Press
	Save	Ctrl+S
	Save All	Alt+F+V

Result: One of the following happens depending on whether Save or Save All was used.

- Save

A message box opens reporting the entire group must be saved.

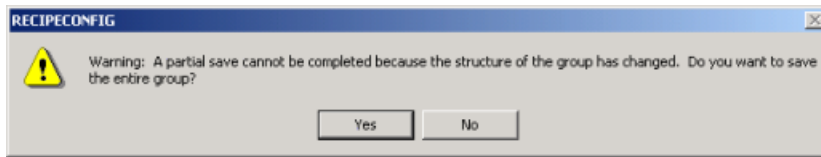

Click Yes to save the recipe group.

- Save All

The recipe group is saved.

The recipe group is saved; the view in the RecipeConfig window is refreshed, e.g. the recipe and maps lists are resorted so all items including additions are listed in alphanumeric order.

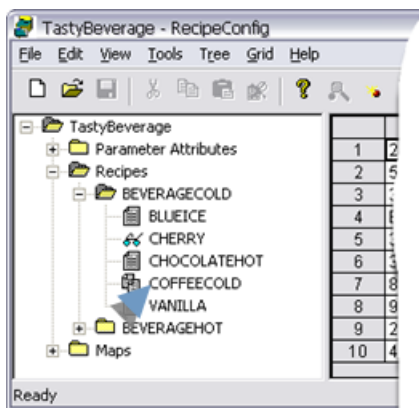

 **Note:** When you attempt to close the Recipe Group, if there are unsaved modifications, you will be notified and asked if you want to save them.

Option 6.3. Export a Recipe Group

A recipe group can be exported as a .csv file.

1. Select the Group folder in RecipeConfig window left pane.

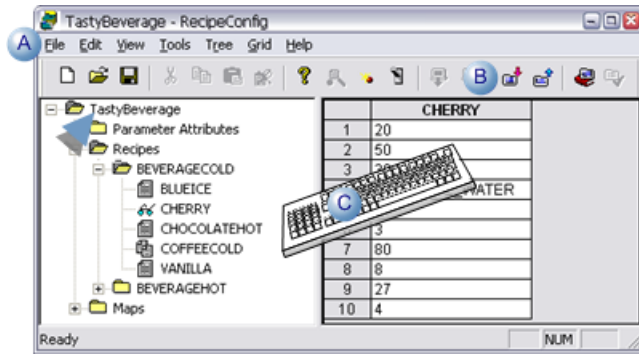

A	Click File>Export on the RecipeConfig window menu bar.
B	Click the Export Recipes button on the RecipeConfig window toolbar.
C	Press Ctrl+E on the keyboard.

A Save As dialog box opens.

2. In the Save As dialog, enter a file name and select a directory for the export file.

Note: The file type for an exported Recipe Group is .csv.

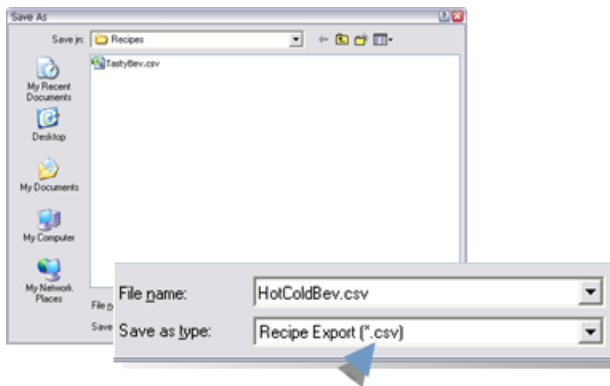

3. Click **OK** to export the recipe group, or **Cancel** to cancel the Export request.

The recipe group is exported.

 **Note:** You can use Notepad or Microsoft Excel to display and make changes in the .csv file.

Option 6.4. Archive a Recipe Group

1. Select the Group folder in the RecipeConfig window left pane.

2. Do one of the following:

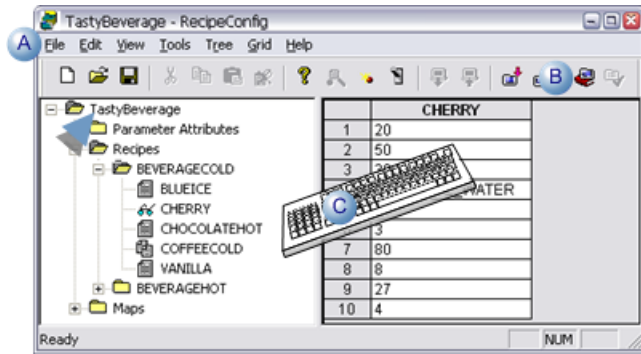

A	Click File>Archive on the RecipeConfig window menu bar.
B	Click the Archive button on the RecipeConfig window toolbar.
C	Press Ctrl+A on the keyboard.

A Save As dialog box opens.

3. Enter a file name (the default name is the Group name) and select a directory for the archive file.

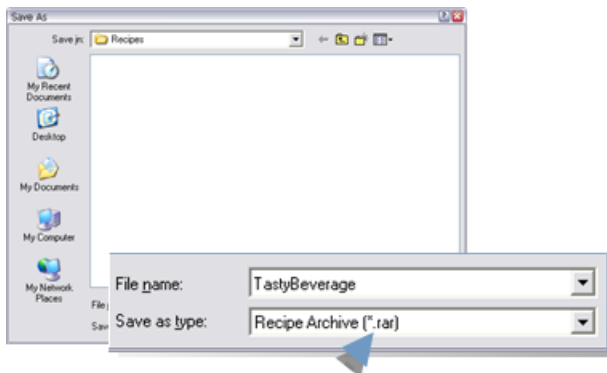

Notes

- The default name is the recipe group name.
- The file type for an archived Recipe Group is .rar.

4. Click **OK** to archive the file, or **Cancel** to cancel the Archive request.

The recipe group is archived.

 **Note:** If there are differences between the displayed Recipe Group and the saved Recipe Group, you will be asked if you want to save the Group before archiving it.

Recipe Control Configuration

Recipe Control Configuration

You can configure a Recipes ActiveX control in CimEdit that enables operators to Upload and Download Recipes during runtime.

Steps to configure and use a recipe control are as follows.

Step 1 (page 477)	Place a recipe control on a CimEdit screen.
Step 2 (page 478)	Open a CIMPLICITY Recipe Control Properties dialog box.
Step 3 (page 479)	Define general recipe control properties.
Step 4 (page 481)	Specify recipe control batch ID properties.
Step 5 (page 482)	Upload or download recipes during runtime.

Step 1. Place a Recipe Control on a CimEdit Screen

1. Do the following.

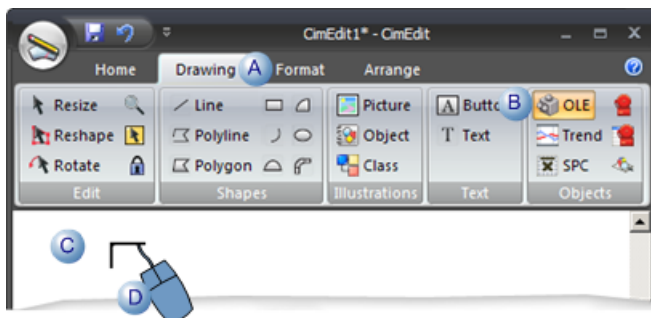

A	Select the Drawing tab on the CimEdit Ribbon bar.
B	Click the OLE OLE button in the Objects group.
C	Place the cursor in the location where the control should be placed.

D	Click the left-mouse button.
---	------------------------------

An Insert Object browser opens.

2. Do the following.

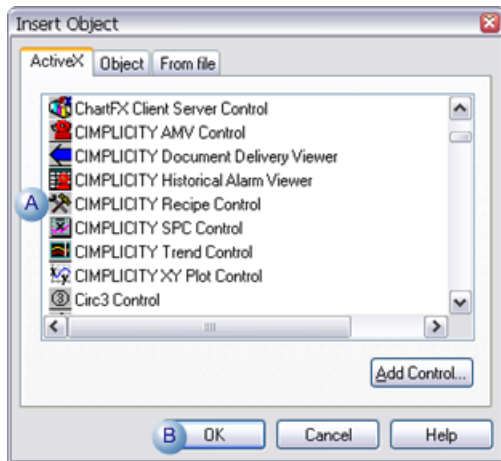

A	Select CIMPLICITY Recipe Control.
B	Click OK.

A Recipe control button is placed on the CimEdit screen.

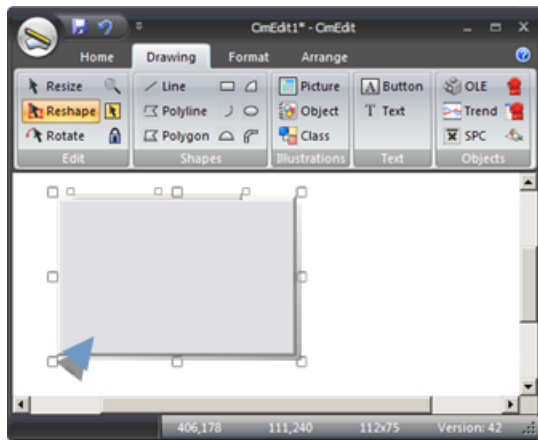

Note: You can resize or move the Recipe control object the using the same methods used for other objects on a CimEdit screen.

Step 2. Open a CIMPLICITY Recipe Control Properties Dialog Box

Do one of the following.

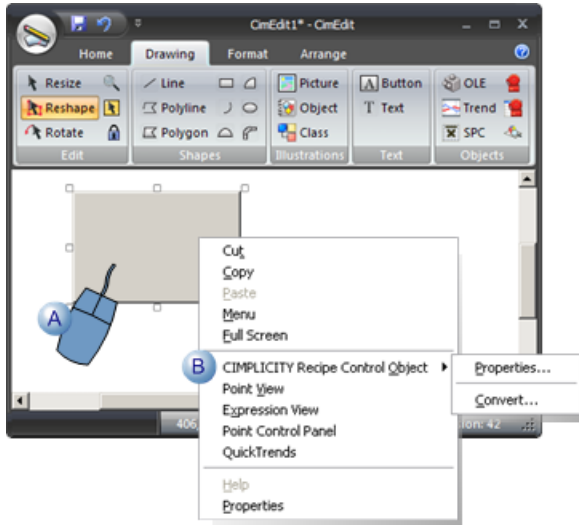

A	Double-click the Recipe control object.
B	Right-click the Recipe control object; select CIMPLICITY Recipe Control Object>Properties on the Popup menu.

Result: The Recipe Control Properties dialog box opens when you use either method.

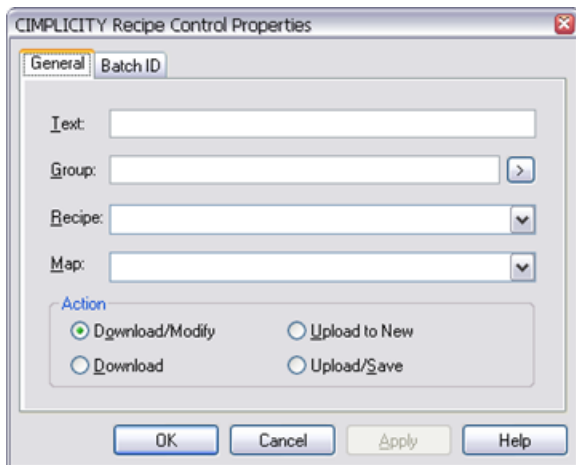

Step 3. Define General Recipe Control Properties

1. Enter general Recipe control specifications, as follows.

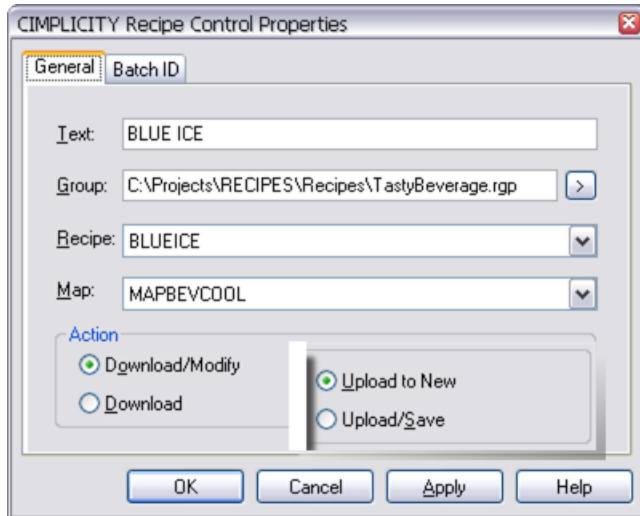

Text	Text that will display on the button.	
Group	Recipe group that contains the selected recipe and map. Note: The Popup Menu button to the right of the input field enables you to search for and select a Group. Important: The recipe group cannot be open in the RecipeConfig window when you select it in the CIMPLICITY Recipe Control Properties dialog box.	
Recipe	Name of the Recipe that will be uploaded or downloaded. Note: The drop-down list includes a list of the Recipes that are in the recipe group.	
Map	Map whose values will be downloaded or uploaded. Note: The drop-down list includes a list of the maps that are in the recipe group.	
Action	Select one of the following actions for the control:	
	Action	Description
	Download/Modify	a. Modify Recipe parameters. b. Download the modified Recipe.
	Download	Download a Recipe without modifying it.
	Upload to New	a. Upload a Recipe. b. Save the values in a new Recipe.
	Upload/Save	Upload a Recipe and overwrite its existing values with the new ones.

2. Modify Recipe parameters.
3. Download the modified Recipe.
4. Upload a Recipe.
5. Save the values in a new Recipe.
6. Do one of the following when you have entered the general specifications.

Button	Result
OK	Applies the changes; closes the CIMPLICITY Control Properties dialog box.
Cancel	Cancels the changes.
Apply	Applies the changes; does not close the dialog box. Note: If you have selected to download the recipe/map, you can enter Batch specifications on the Batch ID tab.

Step 4. Specify Recipe Control Batch ID Properties

When you create a Recipe, you can define a Batch Point.

Recipes will place a Batch ID in the Batch Point when the Recipe is downloaded.

1. Select the Batch ID tab in the CIMPLICITY Recipe Control Properties dialog box.
2. Enter one of the following.

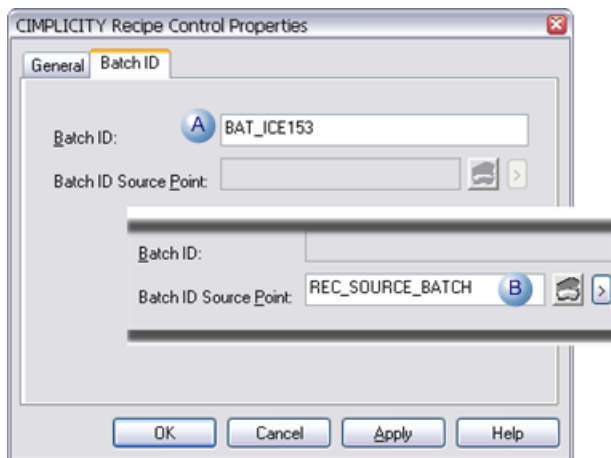

- a. Batch ID

Enter text in the **Batch ID** field.

When the Recipe is downloaded the text will be written to the Batch point when the Recipe is downloaded.

Note: When a value is entered in the Batch ID field, the Batch ID Source Point field is disabled.

- a. Batch ID Source Point

Enter a Point ID in the **Batch ID Source Point** field.

When the Recipe is downloaded, the contents of this Point ID are written to the Batch Point.

 **Note:**

- The Point ID:
- May be unqualified or fully qualified.
- Must be a Text point.
- Use the Browser and Popup Menu buttons to the right of the input field to browse for an existing point ID or create a new one.
- When a value is entered in the **Batch ID Source Point** field, the **Batch ID** field is disabled.

3. Click one of the following.

Button	Result
OK	Applies the changes; closes the CIMPLICITY Control Properties dialog box.
Cancel	Cancels the changes.
Apply	Applies the changes; does not close the dialog box.

Step 5. Upload or Download Recipes during Runtime

When a Recipe Control dialog box opens during runtime, entries made during configuration display as default values in the dialog box fields.

- Download a recipe.
- Upload a recipe.

Download a recipe

1. Click a Recipe control on a CimView screen that was configured to download a recipe/map.



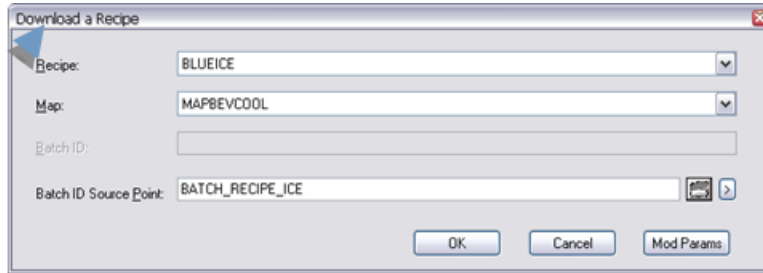

A Download a Recipe dialog box opens.

The specifications entered in the CIMPLICITY Recipe Control Properties dialog box display in the Download a Recipe dialog box.

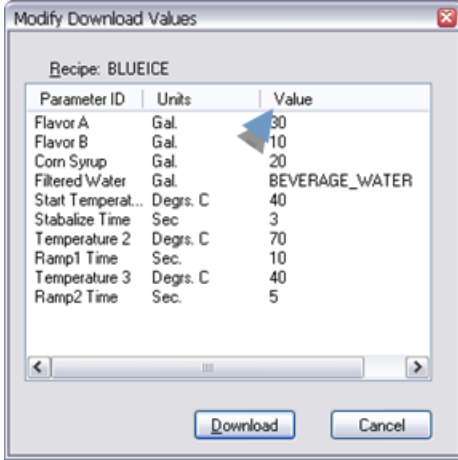

2. (Optional) Change any of the [recipe/map and batch \(page 465\)](#) specifications to accommodate runtime download requirements.
3. Click one of the following.

Button	Result
OK	Starts the download.
Cancel	Cancels the download.
Mod Params	<p>Opens a Modify Download Values dialog box. You can modify parameter values, as follows.</p> <ol style="list-style-type: none"> a. Click each value that should be modified. <p>The fields in the Value column are read/write.</p> <ol style="list-style-type: none"> a. Enter the modified value. b. Click Download when the values comply with the download specifications.  <p>Result: The download proceeds using the modified values.</p>

 **Note:** You can lengthen or shorten the width of the Download a Recipe dialog box.

Upload a Recipe

4. Click each value that should be modified.
The fields in the **Value** column are read/write.
5. Enter the modified value.
6. Click Download when the values comply with the download specifications.

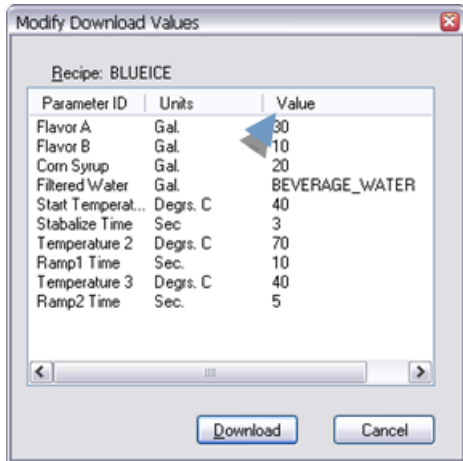

7. Click a Recipe control on a CimView screen that was configured to upload a recipe/map.



An Upload a Recipe dialog box opens; the dialog box width is the same width as the width of the last dialog box that was open during the runtime session.

The specifications entered in the CIMPLICITY Recipe Control Properties dialog box display in the Upload a Recipe dialog box.

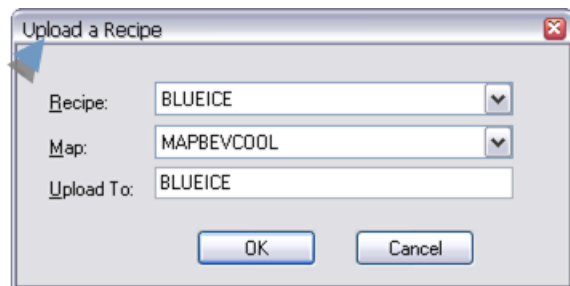

8. (Optional) Change any of the specifications to accommodate runtime upload requirements.

9. Click one of the following.

Button	Result
OK	Starts the upload.
Cancel	Cancels the upload.

 **Note:** You can lengthen or shorten the width of the Upload a Recipe dialog box.

Technical Reference

Technical Reference

1 <i>(page 485)</i>	CSV file format for import/export.
2 <i>(page 487)</i>	Basic Control Engine extensions for recipes.

1. CSV File Format for Import/Export

1. CSV File Format for Import/Export

The data included in the .csv file for Recipes is divided into four areas:

A <i>(page 485)</i>	Group information
B <i>(page 486)</i>	Recipes information
C <i>(page 486)</i>	Maps information
D <i>(page 486)</i>	Parameters information

Each area consists of one line that lists the fields included in the area, followed by as many lines needed to contain the data for the area.

1. Group information

The first and second lines consist of the following.

Line	Consists of
1	Text for <code>Group Name, Description, GroupPoint</code>
2	Data for the Line 1 fields.

1. Recipe information

The first line and several following lines consist of the text:

Line	Consists of
1	Text for <code>Recipe Name, Version, ProductCode, Author, RecipePoint, BatchPoint, Comments</code>
2 - N	(One line for each recipe in the recipe group) Data for the Line 1 fields.

1. Map information

The first line and several following lines consist of the text:

Line	Consists of
1	Text for <code>Map Name, Description, MapPoint, StatusPoint</code>
2 - N	(One line for each map in the recipe group) Data for the Line 1 fields.

1. Parameters information

The first line and several following lines consist of the text:

Line	Consists of
1	Text for <code>ID,Data Type,Units,Low Limit,High Limit,Default Value,Default Source Point,r1,Can Mod,IsPoint,r2,Can Mod,IsPoint,...,rn,Can Mod,IsPoint</code>
2 - N	(One line for each parameter in the recipe group) Data for the Line 1 fields. This parameter information also includes information about whether the corresponding Recipes parameters can be modified or are CIMPLICITY points.

Sample .csv File

The following is an example of the CSV file that is exported by Recipes:

```
Group Name, Description, GroupPoint
Breads,,
Recipe Name, Version, ProductCode, Author, RecipePoint, BatchPoint,
Comments
```

```

\\Breads\Recipes\White,,,,,
\\Breads\Recipes\Raisin,,,,,
\\Breads\Recipes\Rye,,,,,
Map Name, Description, MapPoint, StatusPoint
\\Breads\Maps\Old Line,,,
\\Breads\Maps\New Line,,,
ID,Data Type,Units,Low Limit,High Limit,Default Value,Default Source
Point,White,Can Mod,IsPoint,Raisin,Can Mod,IsPoint,Rye,Can Mod,IsPoint,Old
Line,New Line
Yeast,USINT,oz.,,,,,,2,Y,N,2,Y,N,2,Y,N,PT_700_PLC1,PT_1
Water,INT,gal.,,,,,,20,Y,N,30,Y,N,23,Y,N,PT_701_PLC1,PT_2
Milk,INT,gal.,,,,,,40,Y,N,35,Y,N,40,Y,N,PT_703_PLC1,PT_3
Sugar,INT,lbs.,,,,,,15,Y,N,15,Y,N,13,Y,N,PT_704_PLC1,PT_4
Shortning,INT,cups,,,,,10,Y,N,10,Y,N,12,Y,N,PT_705_PLC1,PT_5
Salt,INT,tsp.,,,,,,1,Y,N,1,Y,N,1,Y,N,PT_706_PLC1,PT_6
Flour,INT,lbs.,,,,,,50,Y,N,50,Y,N,0,Y,N,PT_707_PLC1,PT_7
Raisins,INT,cups,,,,,0,Y,N,10,Y,N,0,Y,N,PT_112_PLC1,PT_8
Molasses,INT,cups,,,,,0,Y,N,0,Y,N,10,Y,N,PT_113_PLC1,PT_9
Rye Flour,INT,lbs.,,,,,,0,Y,N,0,Y,N,50,Y,N,PT_114_PLC1,PT_10
Caraway Seeds,INT,tbsp.,,,,,,0,Y,N,0,Y,N,13,Y,N,PT_712_PLC1,PT_11
Temperature,INT,deg. F,,,,,425,Y,N,425,Y,N,420,Y,N,PT_1310_PLC2,PT_12
Mix Time,REAL,min.,,,,,,15,Y,N,15,Y,N,17.5,Y,N,PT_1908_PLC2,PT_13
Bake Time,REAL,min.,,,,,,25,Y,N,25,Y,N,29,Y,N,PT_2506_PLC2,PT_14

```

2. Basic Control Engine Extensions for Recipes

The Recipes option has a Scripting interface (using extensions to the Basic Control Engine) that enables you to:

- Upload and download recipes automatically based on system events, such as point changes from a shop floor device.
- Import and export recipe groups from/to CSV file formats.
- RCPDownload (statement)
- RCPUpload (statement)
- RCPGroupExport (statement)
- RCPGroupImport (statement)

Chapter 6. Statistical Process Control

About Statistical Process Control

SPC uses statistical methods to determine whether processes are within required limits. While CIMPLICITY's normal alarm functions detect when individual points actually exceed limits, SPC analysis can provide early warning by detecting undesirable systematic variations in your process. This can help you pinpoint process, machine, operator, or material problems so that actions can be taken to diagnose and resolve the problem.

CIMPLICITY performs a series of functions in order to provide you with information through the SPC option.

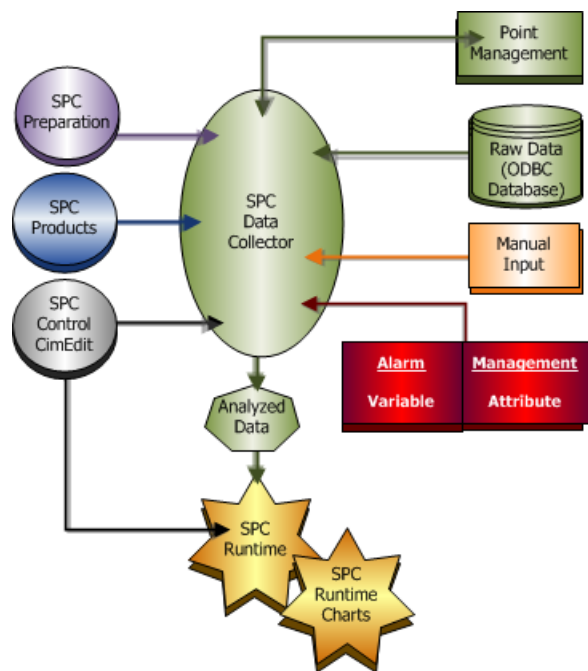

circle 36, 66, 33 [SPC Preparation \(page 491\)](#)

circle 32, 133, 33 [SPC Products: Configuration \(page 500\)](#)

circle 32, 198, 33 [SPC Control: Configuration \(page 574\)](#)

rect 277, 0, 357, 45 [3. SPC Preparation: Points \(page 493\)](#)

rect 282, 59, 358, 124 [4. SPC Preparation: Database Logger \(page 495\)](#)







rect 283, 131, 359, 175 [SPC Runtime \(page 590\)](#)





rect 115, 288, 171, 378 [SPC Runtime \(page 590\)](#)

rect 207, 205, 283, 261 [5.5. SPC Variable: Alarms/Control Tests \(page 536\)](#)

rect 283, 205, 363, 261 [6.5. SPC Attribute: Alarms/Control Tests \(page 558\)](#)

rect 176, 323, 252, 413 [SPC Charts \(page 609\)](#)

Item	Descriptions	
 (page 491)	SPC Preparation CIMPLICITY features, such as security, points and database logging require some configuration to work with and/or be available for SPC.	
	 (page 493)	Point Management includes points used in SPC document configuration.
	 (page 495)	ODBC database
 (page 500)	SPC Products Configuration includes creating and defining quality characteristics for:	
	 (page 520)	Variables
		 (page 536) Variable alarms/control tests.
	 (page 542)	Attributes
		 (page 558) Attribute alarms/control tests.
	 (page 564)	Defects
 (page 574)	SPC Control Configuration provides options for chart properties and display.	
 (page 590)	SPC runtime During runtime users can interact with SPC charts. Options include:	
	 (page 592)	Manual data entry.
	 (page 598)	Annotation.

Item	Descriptions	
 (page 595)		Exclusion.
 (page 609)	SPC Runtime Charts SPC provides many charts for quality characteristics.	
 (page 609)		Variables
 (page 615)		Attributes
 (page 619)		Defects

SPC Administration Alarms

During runtime the SPC application detects the following kinds of inconsistencies:

- Points are unavailable.
- Limits are out of sequence.
- Sampling parameters are invalid.

Therefore, SPC comes with a built-in \$SPC_ADMIN_ALARM to alert operators to those conditions. This alarm is generated because of configuration inconsistencies, in contrast to SPC alarms that are generated because of process problems.

Each instance of this alarm, which will display in your Alarm Viewer, provides you with:

\\Group Name\Product Name\QC Name\Alarm number

Alarm Numbers are as follows:

1	Required Points(s) are unavailable.
2	XBar control limits are out of sequence.
3	R/S control limits are out of sequence.
4	Sample size is invalid.

5	Gap size is invalid.
---	----------------------

SPC Preparation

SPC Preparation

Some CIMPLICITY setup is necessary before you begin to configure the SPC features.

1 <i>(page 491)</i>	SPC Preparation: Enable SPC.
2 <i>(page 492)</i>	SPC Preparation: Security..
3 <i>(page 493)</i>	SPC Preparation: Points..
4 <i>(page 495)</i>	SPC Preparation: Database Logger.
5 <i>(page 497)</i>	SPC Preparation: PKCS #7 Certificate.

1. SPC Preparation: Enable SPC

1. Click Project>Properties on the Workbench menu bar.

The Project Properties dialog box opens.

2. Select the General tab.

3. Check SPC Charts in the **Options** box.

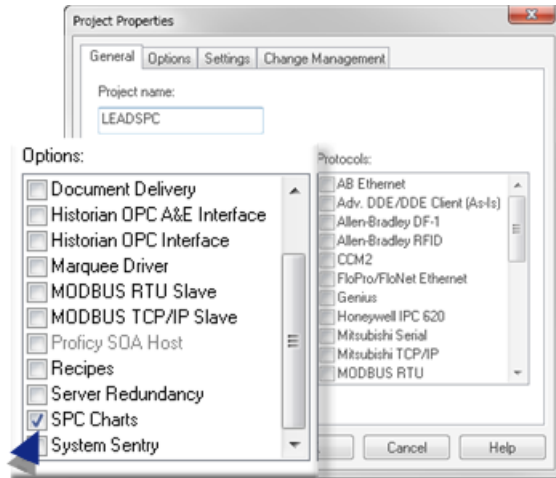

SPC is enabled for the CIMPLICITY project.

2. SPC Preparation: Security

- SPC: Roles
- SPC: Resources

SPC: Roles

SPC charts include an annotation feature, for which user access can be permitted or denied in the Roles Properties dialog box.

1. Select **Project>Security>Roles** in the Workbench left-pane.
2. Select a role in the Workbench right-pane.

The Roles Properties dialog box opens.

3. Select the SPC Annotation tab.
4. Check or clear the [Multi-Annotation \(page 598\)](#) checkbox to do the following.

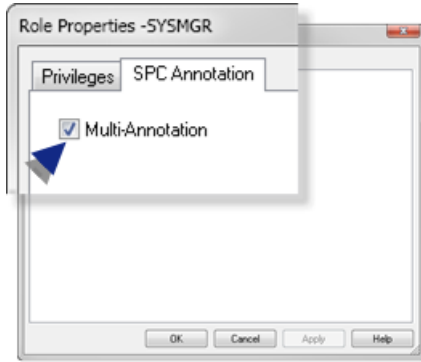

Check/Clear	Role:
Check	Can do multi-annotation
Clear	Cannot do multi-annotation

During runtime the user will/will not be able to do annotations based on the assigned role.

SPC: Resources

SPC may have one or more unique resources. Make sure to assign the appropriate users to the resources being used for SPC.

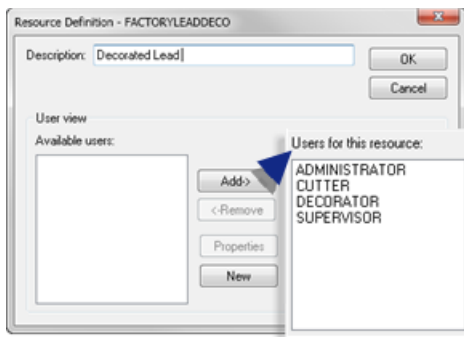

3. SPC Preparation: Points

Although there are areas in SPC where values can be entered manually, CIMPLICITY points are at the core of data collection and evaluation.

Points can be created at any time and used in the SPC configuration.

However, the following list of fields where runtime points might be used may help you create a logical naming convention as processes are evaluated and monitored.

- Points: For Variables
- Points: For Attributes

- Points: For Defects

 **Note:** These fields are based on runtime points being selected as the data source. The points can also be logged and logged values used as the data source. If you use logged values, make sure to check Logged Data on the Point Properties dialog box>General tab for the points that will be logged.

Points: For Variables

A **Variable Quality Characteristics Properties dialog box** provides the tools to measure a product's selected variable quality characteristics.

Dialog Box Tab	Field
General	Data setpoint ID
Collection	Point ID
Collection	Match Point ID
Collection	Batch Point ID
Limits	XBar UCL
Limits	XBar CL
Limits	XBar LCL
Limits	R/S UCL
Limits	R/S CL
Limits	R/S LCL
Limits	Setpoint ID
Limits	Force Auto Recalc
Alarm	Setpoint ID (XBar Alarms)

Points: For Attributes

A **Attribute Quality Characteristics Properties dialog box** provides the tools to measure a product's selected attribute quality characteristics.

Dialog Box Tab	Field
General	Data setpoint ID
Collection	Point ID
Collection	Match Point ID
Collection	Batch Point ID
Limits	UCL

Dialog Box Tab	Field
Limits	CL
Limits	LCL
Limits	Setpoint ID
Limits	Force Auto Recalc
Alarm	Setpoint ID

Points: For Defects

Defects are both grouped into categories and measured individually.

Defect Folders

The **Defect Folder Properties dialog box** provides tools to help measure a defect group's characteristics.

Dialog Box Tab	Field
General	Match Point ID
General	Batch Point ID

Defect Properties

The **Defect Properties dialog box** provides tools to measure a specific defect's occurrence.

Dialog Box Tab	Field
Collection	Point ID

4. SPC Preparation: Database Logger

- ODBC data source
- Database Logger: Enabled
- Database Logger: SPC Tables

ODBC Data Source

SPC automatically creates a default SQL Server data source, CIMPPLICITY Logging - SPC.

New SPC documents will use this data source by default.

! Important: All the SPC documents in a CIMPLICITY project must log their data to the same SPC data source. You can share an SPC data source between projects or create a data source for each project.

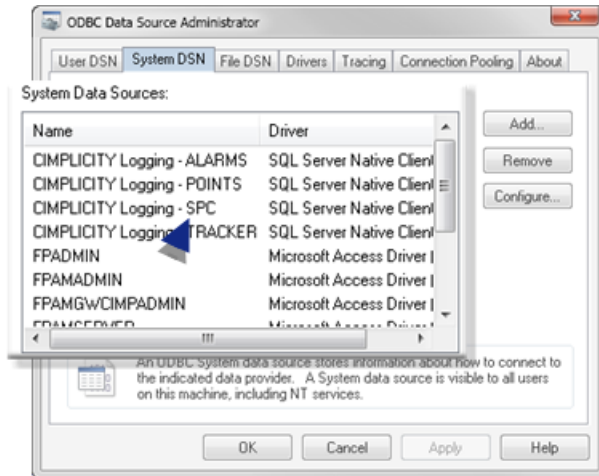

Database Logger: Enabled

Make sure the Database Logger is enabled; it will be listed in the Workbench left-panewhen it is.

Database Logger: SPC Tables

SPC includes the following tables to log and store data specifically for SPC. These are system tables and cannot be opened in the Database Logger window.

The tables are:

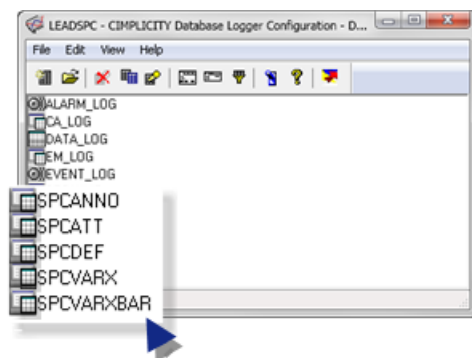

rect 0, 109, 23, 126 [5. SPC Runtime: Annotation \(page 598\)](#)

rect 1, 125, 24, 140 [6. SPC Products: Attribute Quality Characteristics \(page 542\)](#)

rect 2, 140, 22, 157 [7. SPC Products: Defect Properties \(page 564\)](#)

rect 3, 157, 24, 172 [5. SPC Products: Variable Quality Characteristics \(page 520\)](#)

rect 0, 174, 21, 189 [5. SPC Products: Variable Quality Characteristics \(page 520\)](#)

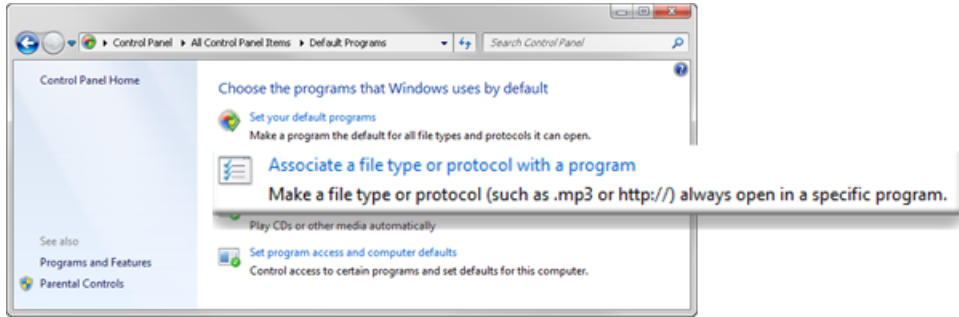

The Associate a file type or protocol with a specific program window opens.

2. Do the following.

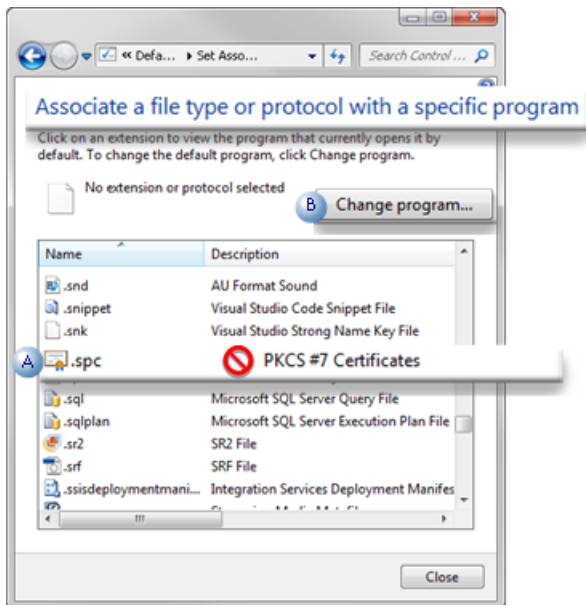

A	Select .spc - PKCS #7 Certificate
B	Click Change program.

An Open with window opens.

3. Click the Browse button.

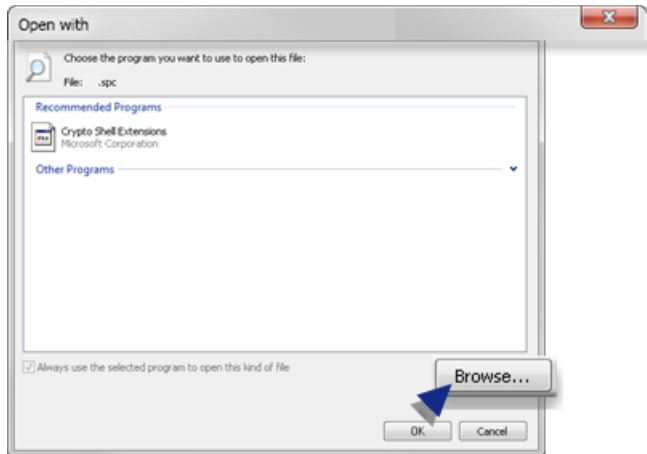

Windows Explorer displays in the Open with window.

4. Select ..<CIMPLICITY Installation>\exe\SpcCfg.exe

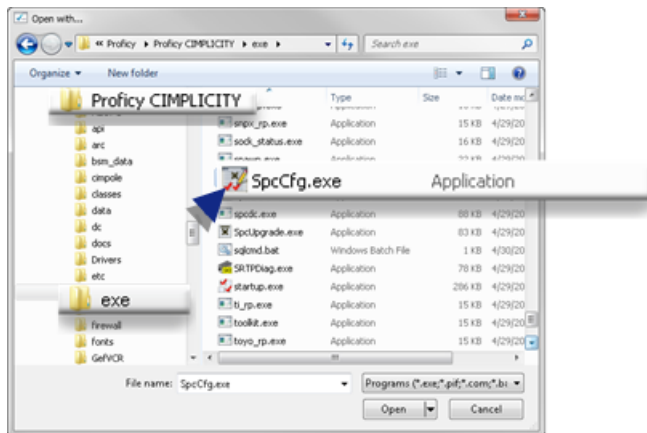

The Open with window now lists many options; SPCCFG is selected.

5. Click OK.

The Associate a file type or protocol with a specific program window reopens.

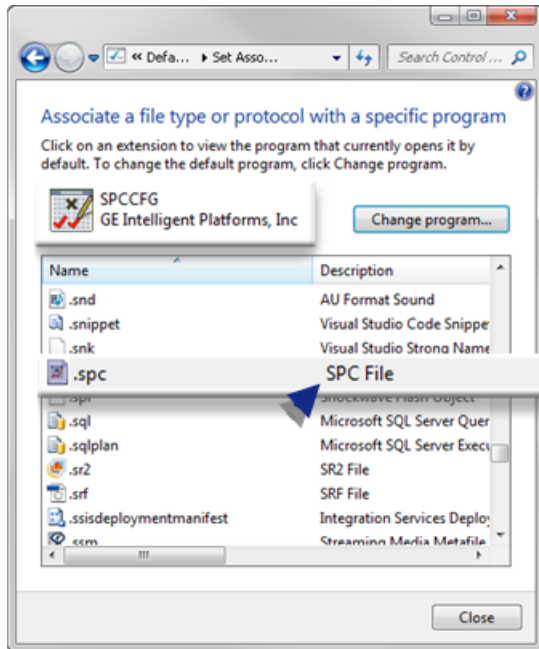

6. Click Close.

The SPC documents can now be opened and configured.

SPC Products: Configuration

SPC Products: Configuration

An SPC document is the container for:

- All of the products that should be grouped together.
- A product group's quality control information

A selected product can include: variables, defects and attributes that are stored in a directory structure similar to Windows Explorer. When the product is selected, its

- Quality characteristics display in the SPC Configuration window right-pane.
- Defect folders in the SPC Configuration window left-pane.

Items in the hierarchy can be added, configured and modified.

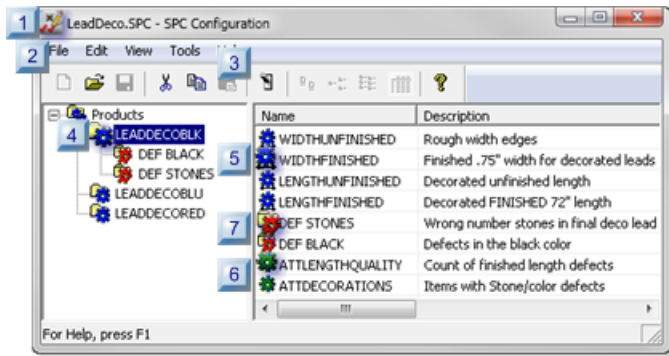

- rect 131, 127, 153, 148 [7. SPC Products: Defect Properties \(page 564\)](#)
- rect 130, 157, 152, 178 [6. SPC Products: Attribute Quality Characteristics \(page 542\)](#)
- rect 134, 87, 153, 106 [5. SPC Products: Variable Quality Characteristics \(page 520\)](#)
- rect 30, 71, 52, 91 [4. SPC Products: Product Properties \(page 518\)](#)
- rect 132, 27, 155, 44 [3. SPC Products: File Menu/Toolbar/Quick Keys \(page 511\)](#)
- rect 4, 19, 28, 43 [2. SPC Products: Document Properties \(page 509\)](#)
- rect -2, -3, 19, 21 [1. SPC Products: Open the SPC Configuration Window \(page 502\)](#)

	Icon	Section
1 (page 502)		SPC Document: Open.
2 (page 509)		SPC Products: Document properties.
3 (page 511)		SPC Products: File menu/Toolbar/Quick keys.
4 (page 518)		SPC Products: Product properties.
5 (page 520)		SPC Products: Variable Quality characteristics.
6 (page 542)		SPC Products: Attribute Quality characteristics.
7 (page 564)		SPC Products: Defect properties.

! **Important:** The SPC Data Collector logs its raw and calculated data to an ODBC data source. Before you start configuring SPC for a project, make sure that the CIMPLICITY Database Logger is installed and configured for the project.

1. SPC Products: Open the SPC Configuration Window

1. SPC Products: Open the SPC Configuration Window

Software configuration for SPC begins with opening and configuring an SPC document. The SPC document is the container for one or more products that you will add and configure. When the document is active, every included product will be tracked, unless you deactivate tracking for one or more of the products at the product level .

1.1 (page 502)	SPC Document: Create.
1.2 (page 507)	SPC Document: Open existing.

1.1. SPC Products: Create a Document

A (page 502)	Open a new SPC Configuration window.
B (page 504)	Define document properties.
C (page 505)	Save a new SPC document.

1. Open a new SPC Configuration Window

You can open a new SPC Configuration window:

- Through the Workbench.
- Through an open SPC Configuration window.

Through the Workbench

1. Make sure the SPC Charts option is enabled.
2. Select **Project>SPC** in the Workbench left pane.
3. Do one of the following.

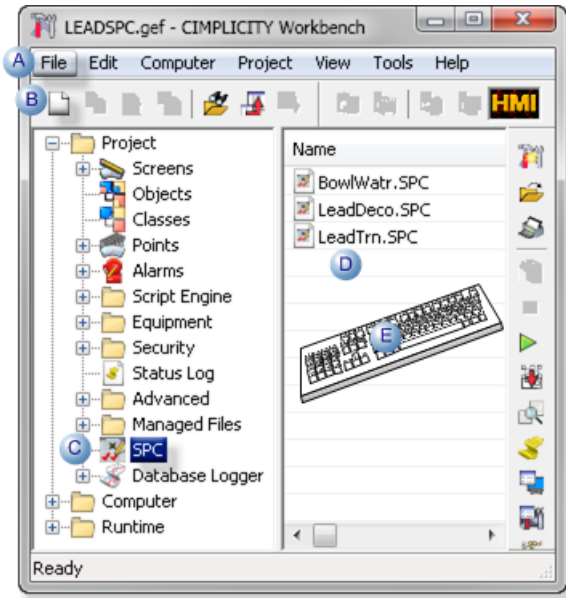

A	Click File>New on the Workbench menu bar.	
B	Click the New Object button on the Workbench toolbar.	
C	In the Workbench left pane:	
	Either	Or
	Double click SPC .	a. Right-click SPC . b. Select New on the Popup menu.
D	a. In the Workbench right pane. a. Right-click any SPC file. b. Select New on the Popup menu.	
E	Press Ctrl+N on the keyboard.	

Result: A blank SPC Configuration window opens when you use any method; the Save features are disabled.

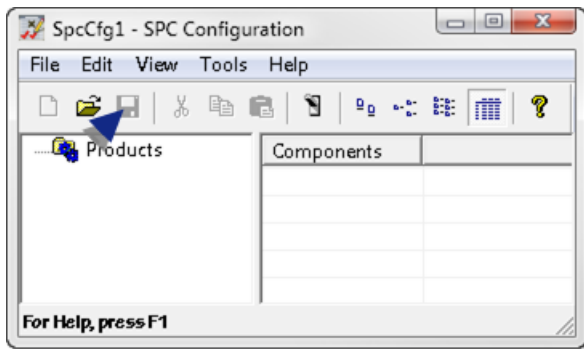

Through an open SPC Configuration Window

You can open an empty SPC Configuration window through an open SPC Configuration window.

Click File>New>SPC Configuration Document on the SPC Configuration window menu bar.

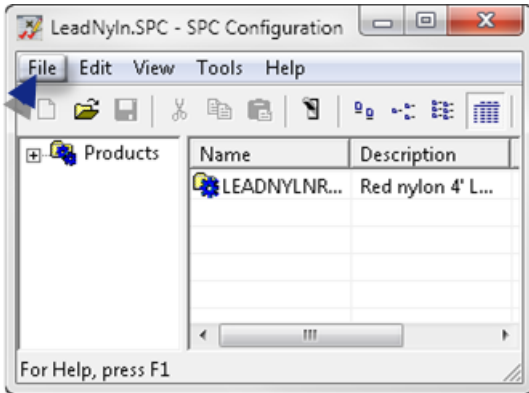

Result: A blank SPC Configuration window overlays the previous open window.

Note: The Save features may be enabled. However you cannot save the new document until the document properties are defined.

- a. Define Document Properties
- a. Click File>Properties on the SPC Configuration window menu bar.

The Document Properties dialog box opens.

- a. Select the following.

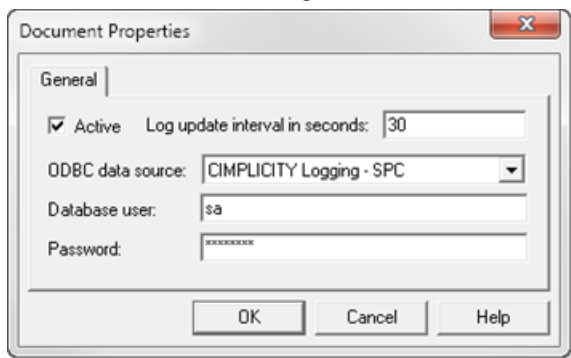

Option	Description	
Active	Activate data collection for the document. Important: The Database Logger must be configured for the project to enable the SPC Data Collector.	
	Default	Checked.
Log update interval in seconds	Number (of seconds) that raw data will be retrieved from the database when using logged data as input.	

Option	Description
ODBC data source	ODBC data source to use for the open CIMPLICITY project.
Database user	Authorized database user.
Password	Valid user password.

Result: The SPC Configuration window can now be saved.

 **Important:**

- All the SPC documents in a CIMPLICITY project must log their data to the same SPC data source.
- System Data Sources may not be listed on the System DSN tab when you open The ODBC Data Source Administrator on a 64-bit system.

Do the following.

CIMPLICITY Start menu

- Expand All Programs>Proficy HMI SCADA - CIMPLICITY 8.2 on the Windows start menu.
- Click **ODBCAD32 - View 32bit DSNs**.

The ODBC Data Source Administrator opens.

- Select the DSN tab.

Result: The System Data Sources will be listed.

Command Line field.

- Click the Start button on the Windows task bar.
- Enter the following in the **Command Line** field.

c:\windows\syswow64\odbcad32.exe

- Press Enter.

The ODBC Data Source Administrator opens.

- Select the DSN tab.

Result: The System Data Sources will be listed.

- Save a new SPC Document

4. Right-click **SPC**.

5. Select New on the Popup menu.

6. Right-click any SPC file.
7. Select New on the Popup menu.
8. Do one of the following.

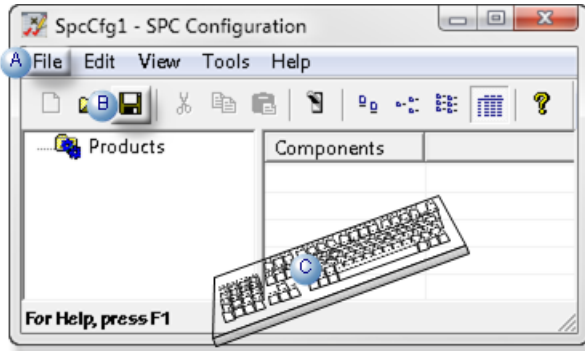

A	Click File>Save on the SPC Configuration window menu bar.
B	Click the Save button on the SPC Configuration window tool bar.
C	Press Ctrl+S on the keyboard.

A Save As dialog box opens.

9. Save the SPC document as an .spc file.

! **Important:** The maximum name length is 8 characters.

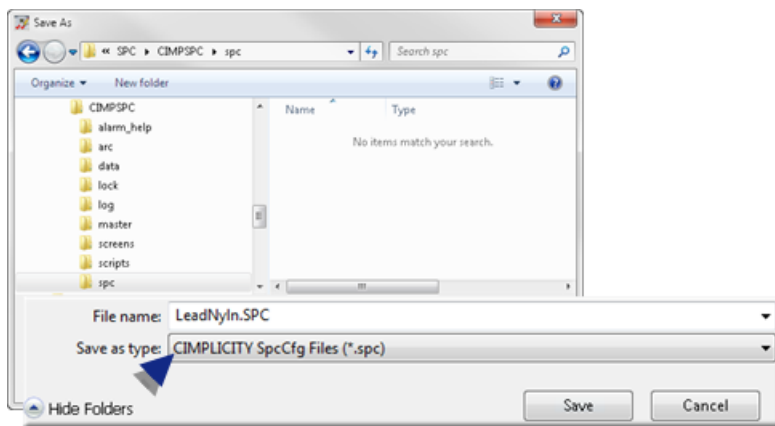

10. Click Save.

The Save As dialog box closes; The <Document Name>.SPC - SPC Configuration window is ready for the SPC products and specifications.

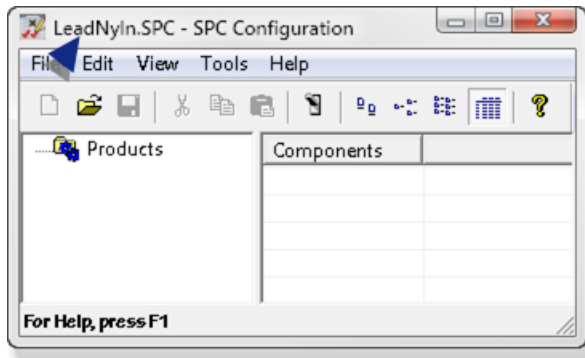

i Tip: Refresh (F5) the Workbench if the new document is not listed in the right-pane when you close the SPC Configuration window.

1.2. SPC Products: Open an Existing Document

An existing SPC document can be opened:

- Through the Workbench.
- Through an open SPC Configuration window.

Open an Existing SPC Document: Through the Workbench

1. Make sure the SPC Chartsoption is enabled.
2. Select **Project>SPC** in the Workbench left pane.
3. Select the SPC document to open.
4. Do one of the following.

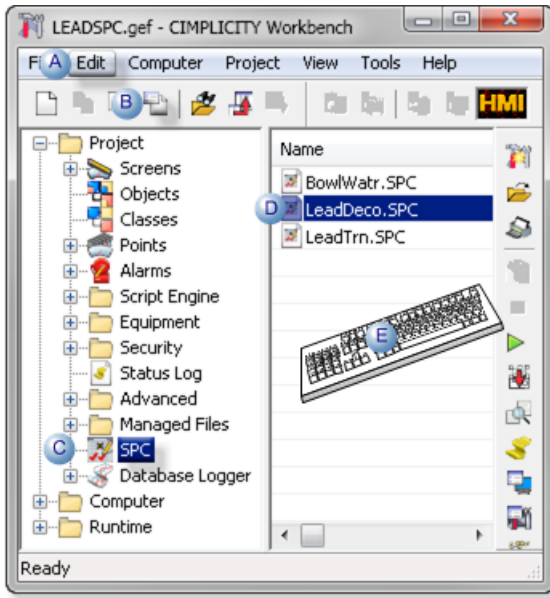

A	Click Edit>Properties on the Workbench menu bar.	
B	Click the Properties button on the Workbench toolbar.	
C	In the Workbench left pane: a. Right-click SPC. b. Select Open on the Popup menu.	
D	In the Workbench right pane	
	Either	Or
	Double click the selected file..	a. Right-click the selected file. b. Select Open on the Popup menu.
E	Press Alt+Enter on the keyboard.	

Result: The selected file opens in the CIMPLICITY SPC Configuration window.

Open an Existing SPC Document: Through the SPC Configuration Window

You can open an existing SPC document through an open SPC Configuration window.

5. Right-click SPC.
6. Select Open on the Popup menu.
7. Right-click the selected file.
8. Select Open on the Popup menu.
9. Do one of the following.

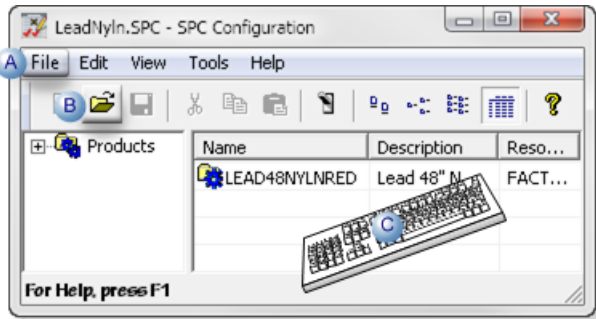

A	Click File>Open on the SPC Configuration window menu bar.
B	Click the Open button on the Workbench toolbar.
C	Press Ctrl+O on the keyboard.

An Open dialog box opens.

10. Select the .SPC document that you want to open.

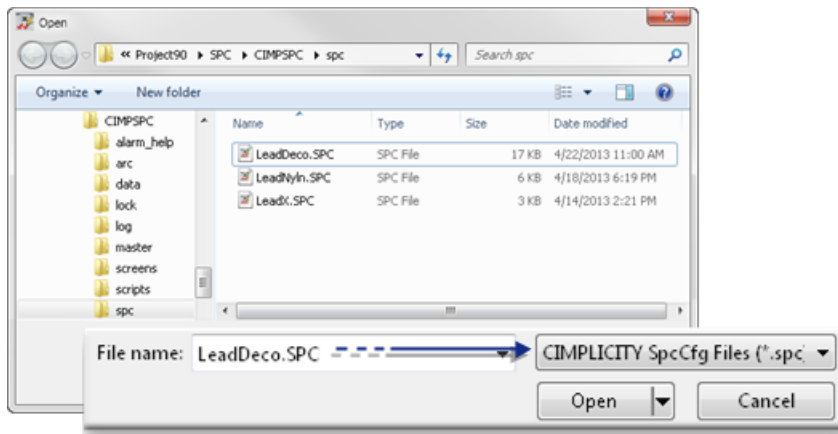

11. Click Open.

The selected file opens in the CIMPLICITY SPC Configuration window.

2. SPC Products: Document Properties

The SPC document is the primary container for your quality control information. You can set its properties to:

- Activate or deactivate data collection for every included product.
- Specify basic parameters including the:
 - Logged update interval in seconds.
 - ODBC data source.

CIMPLICITY Start menu

1. Expand All Programs>Proficy HMI SCADA - CIMPLICITY 8.2 on the Windows start menu.
2. Click **ODBCAD32 - View 32bit DSNs**.

The ODBC Data Source Administrator opens.

1. Select the DSN tab.

The System Data Sources will be listed.

Command Line field.

1. Click the Start button on the Windows task bar.
2. Enter the following in the **Command Line** field.

```
c:\windows\syswow64\odbcad32.exe
```

1. Press Enter.

The ODBC Data Source Administrator opens.

1. Select the DSN tab.

The System Data Sources will be listed.

3. SPC Products: File Menu/Toolbar/Quick Keys

The SPC Configuration window includes many menu items and toolbar buttons to facilitate creating and finding products and quality characteristics.

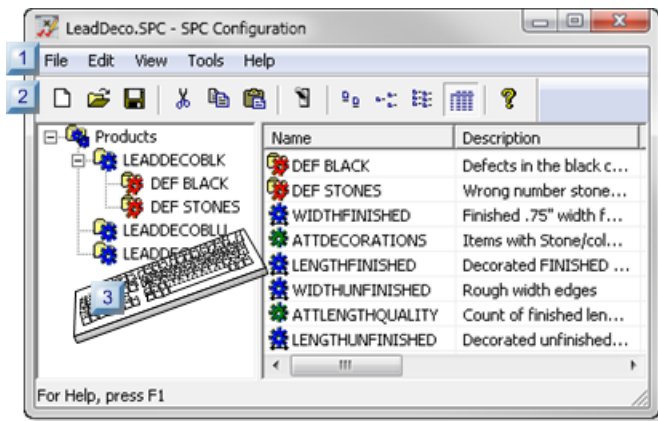

rect 0, 45, 20, 65 [\(page 516\)](#)

rect 0, 21, 20, 41 [\(page 512\)](#)

rect 52, 170, 72, 190 [\(page 516\)](#)

1 (page 512)	SPC Configuration: Menu bar.
2 (page 516)	SPC Configuration: Toolbar
3 (page 516)	SPC Configuration: Quick keys.

SPC Configuration: Menu Bar

The SPC Configuration window menu bar includes the following menus/items.

- File menu.
- Edit menu.
- View menu.
- Tools menu.
- Help menu.

File Menu

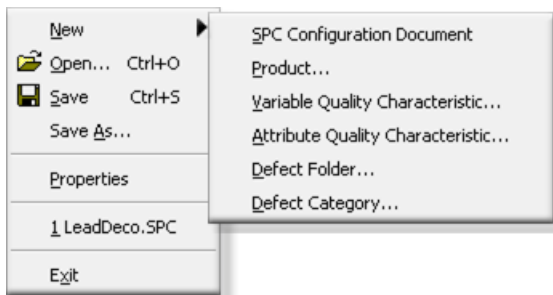

New	Create a new item. Note: Items on the extended menu are enabled/disabled based on what current item is selected in the SPC Configuration window.
Open	Open the Open browser to replace the open SPC document with another SPC document.
Save	Save the selected SPC document.
Save As	Open the Save as browser to save the open SPC document in a different location and/or with a different name.
Properties	Open the Document Properties dialog box.
Documents	Open a listed recently opened document.
Exit	Close the SPC Configuration window.

Edit Menu

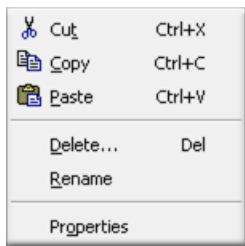



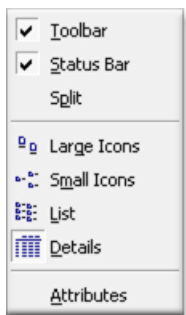

Cut	Cut the selected item.
Copy	Copy the selected item.
Paste	Paste the selected item in the same or a different SPC document.
Delete	Delete the selected item.
Rename	Rename the selected item.
Properties	Open the Properties dialog box for the selected item.

View Menu

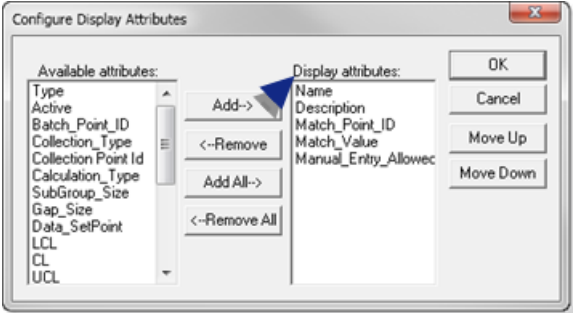

Toolbar	Display/hide the toolbar.	
	Check	Displays the toolbar.
	Clear	Hides the toolbar.

Status Bar	Display/hide the status bar.																																				
	Check	Displays the status bar.																																			
	Clear	Hides the status bar.																																			
Split	Displays a temporary slider that instantly changes the left/right pane widths when you click the mouse.																																				
Icons	Display your selection in the right-pane.  Note: Click anywhere in the right-pane to enable the display options on the menu and toolbar. Options are:																																				
Large Icons																																					
Small Icons																																					
List																																					
Details		<table border="1" data-bbox="878 1245 1409 1413"> <thead> <tr> <th>Name</th> <th>Description</th> <th>Match_Point_ID</th> <th>Matc...</th> <th>Ma</th> </tr> </thead> <tbody> <tr> <td> ATTLENGTHQUA...</td> <td>Count of finishe...</td> <td>ATTLeadDeco...</td> <td>1</td> <td>Yes</td> </tr> <tr> <td> DEF BLACK</td> <td>Defects in the b...</td> <td>LeadDecorat...</td> <td>5</td> <td>Yes</td> </tr> <tr> <td> DEF STONES</td> <td>Wrong number ...</td> <td>LeadDecorat...</td> <td>4</td> <td>Yes</td> </tr> <tr> <td> LENGTHFINISHED</td> <td>Decorated FINI...</td> <td>LeadDecorat...</td> <td>1</td> <td>Yes</td> </tr> <tr> <td> LENGTHUNFINIS...</td> <td>Decorated unfi...</td> <td>LeadDecorat...</td> <td>2</td> <td>Yes</td> </tr> <tr> <td> WIDTHFINISHED</td> <td>Finished .75" wi...</td> <td>LeadDecorat...</td> <td>3</td> <td>Yes</td> </tr> </tbody> </table>	Name	Description	Match_Point_ID	Matc...	Ma	ATTLENGTHQUA...	Count of finishe...	ATTLeadDeco...	1	Yes	DEF BLACK	Defects in the b...	LeadDecorat...	5	Yes	DEF STONES	Wrong number ...	LeadDecorat...	4	Yes	LENGTHFINISHED	Decorated FINI...	LeadDecorat...	1	Yes	LENGTHUNFINIS...	Decorated unfi...	LeadDecorat...	2	Yes	WIDTHFINISHED	Finished .75" wi...	LeadDecorat...	3	Yes
Name	Description	Match_Point_ID	Matc...	Ma																																	
ATTLENGTHQUA...	Count of finishe...	ATTLeadDeco...	1	Yes																																	
DEF BLACK	Defects in the b...	LeadDecorat...	5	Yes																																	
DEF STONES	Wrong number ...	LeadDecorat...	4	Yes																																	
LENGTHFINISHED	Decorated FINI...	LeadDecorat...	1	Yes																																	
LENGTHUNFINIS...	Decorated unfi...	LeadDecorat...	2	Yes																																	
WIDTHFINISHED	Finished .75" wi...	LeadDecorat...	3	Yes																																	
Attributes	Open the Configure Display Attributes dialog box. The attributes, which can be added or removed, display in the Details view.																																				
																																					

	<p>Note: Attributes listed in the Display attributes box display in the right-pane Details view, left to right, in the order they are listed.</p>
--	--

Tools Menu

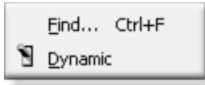

Find	Opens a Find a Product/Quality Characteristics browser. Wild cards can replace the following.																															
	*	One or more characters in the string.																														
	?	One character in the string.																														
	Filters are:																															
	<table border="1" style="margin-top: 10px;"> <thead> <tr> <th>Product Name</th> <th>Qc Name</th> <th>Qc Type</th> </tr> </thead> <tbody> <tr><td>LEADDECOBLU</td><td>COLORBLUE</td><td>Defect</td></tr> <tr><td>LEADDECOBLK</td><td>DEF BLACK</td><td>Defect</td></tr> <tr><td>LEADDECOBLK</td><td>DEF STONES</td><td>Defect</td></tr> <tr><td>LEADDECOBLK</td><td>WIDTHFINISHED</td><td>Var/Att QC</td></tr> <tr><td>LEADDECOBLK</td><td>ATTDECORATI...</td><td>Var/Att QC</td></tr> <tr><td>LEADDECOBLK</td><td>LENGTHFINISH...</td><td>Var/Att QC</td></tr> <tr><td>LEADDECOBLK</td><td>WIDTHHUNFINI...</td><td>Var/Att QC</td></tr> <tr><td>LEADDECOBLK</td><td>ATTLNGTHQ...</td><td>Var/Att QC</td></tr> <tr><td>LEADDECOBLK</td><td>LENGTHUNFIN...</td><td>Var/Att QC</td></tr> </tbody> </table>		Product Name	Qc Name	Qc Type	LEADDECOBLU	COLORBLUE	Defect	LEADDECOBLK	DEF BLACK	Defect	LEADDECOBLK	DEF STONES	Defect	LEADDECOBLK	WIDTHFINISHED	Var/Att QC	LEADDECOBLK	ATTDECORATI...	Var/Att QC	LEADDECOBLK	LENGTHFINISH...	Var/Att QC	LEADDECOBLK	WIDTHHUNFINI...	Var/Att QC	LEADDECOBLK	ATTLNGTHQ...	Var/Att QC	LEADDECOBLK	LENGTHUNFIN...	Var/Att QC
Product Name	Qc Name	Qc Type																														
LEADDECOBLU	COLORBLUE	Defect																														
LEADDECOBLK	DEF BLACK	Defect																														
LEADDECOBLK	DEF STONES	Defect																														
LEADDECOBLK	WIDTHFINISHED	Var/Att QC																														
LEADDECOBLK	ATTDECORATI...	Var/Att QC																														
LEADDECOBLK	LENGTHFINISH...	Var/Att QC																														
LEADDECOBLK	WIDTHHUNFINI...	Var/Att QC																														
LEADDECOBLK	ATTLNGTHQ...	Var/Att QC																														
LEADDECOBLK	LENGTHUNFIN...	Var/Att QC																														
	Product Name	All or part of the product name																														
	QC Name	(Quality Characteristic name) All or part of the name assigned to the variable, attribute or defect.																														
	QC Type	Variable, Attribute, defect																														
Dynamic	(When the project is running) Turns on/off Dynamic mode for SPC. Important: : The CIMPLICITY project needs to be running when you work with SPC charts in CimEdit/ CimView. Dynamic mode must be turned on in order for a chart to be alerted to product and quality characteristic changes made in the SPC Configuration dialog box.																															

Help Menu

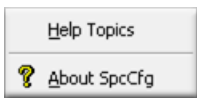

Help Topics	Open CIMPLICITY documentation beginning with SPC.
About SpcCfg	View build, copyright and other details about SPC and CIMPLICITY.

SPC Configuration: Toolbar

Toolbar buttons correspond to basic menu items.



A (page 513)	New item.
B (page 513)	Open.
C (page 513)	Save.
D (page 513)	Cut.
E (page 513)	Copy.
F (page 513)	Paste.
G (page 515)	Dynamic.
H (page 514)	View: Large icons.
I (page 514)	View: Small icons.
J (page 514)	View: List.
K (page 514)	View: Details.
L (page 515)	About SpcCfg.

SPC Configuration: Quick Keys

Some quick keys in the SPC Configuration window are as follows.

Important: The key strokes work when the correct item is selected.

Example

When a product is selected the quality characteristics and Defect folder can be created. Quick keys to create other items will not do anything.

o (page 502)	Alt+f+n+s	New SPC Configuration Document.
o (page 518)	Alt+f+n+p	New product.
o (page 521)	Alt+f+n+v	New Variable Quality characteristic.
o (page 543)	Alt+f+n+a	New Attribute Quality characteristic.
o (page 565)	Alt+f+n+d	New Defect folder.
o (page 569)	Alt+f+n+d	New Defect category.
	Ctrl+o	Open
	Ctrl+s	Save
	Alt+f+a	Save as
	Alt+f+p	Open Document Properties dialog box.
	Alt+f+x	Exit the SPC Configuration window.
	Ctrl+x	Cut the selected item.
	Ctrl+c	Copy the selected item.
	Ctrl+v	Paste the selected item in the same or a different SPC document.
	Del	Delete selected item.
	Alt+e+r	Rename selected item.
	Alt+e+o	Open the Properties dialog box for the selected item.
	Alt+v+t	Display/hide the toolbar.
	Alt+v+s	Display/hide the status bar.

o (page 514)	Alt+v+g	View: Large icons.
o (page 514)	Alt+v+m	View: Small icons.
o (page 514)	Alt+v+l	View: List
o (page 514)	Alt+v+d	View: Details
	Alt+v+a	Open the Configure Display Attributes dialog box.
	Ctrl+f	Open a Find a Product/Quality Characteristics browser.
	Alt+t+d	(When the project is running) Turns on/off Dynamic mode for SPC.
	F1	Open CIMPLICITY documentation beginning with SPC.

4. SPC Products: Product Properties

1 (page 518)	Open a Product Properties dialog box.
2 (page 519)	Define product properties.

Open a Product Properties Dialog Boxes

1. Select **Products** in the SPC Configuration window left-pane.
2. Do one of the following.

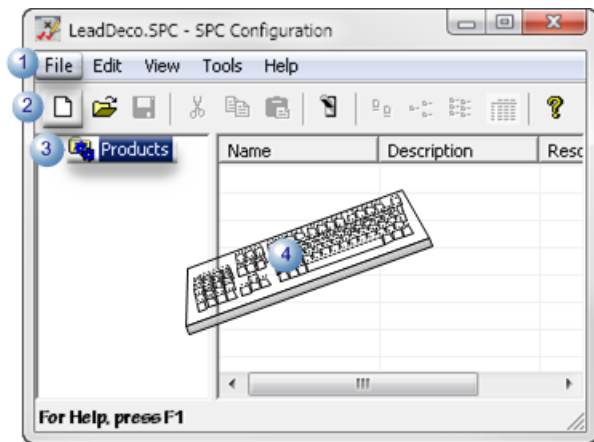

1	Click File>New>Product on the SPC Configuration window menu bar.
2	Click the New button on the SPC Configuration window toolbar.
3	Right-click Products ; select New Product on the Popup menu.
4	Press Ctrl+N on the keyboard.

Result: The Product Properties dialog box opens.

Define Product Properties

1. Enter the following to clearly identify the product.

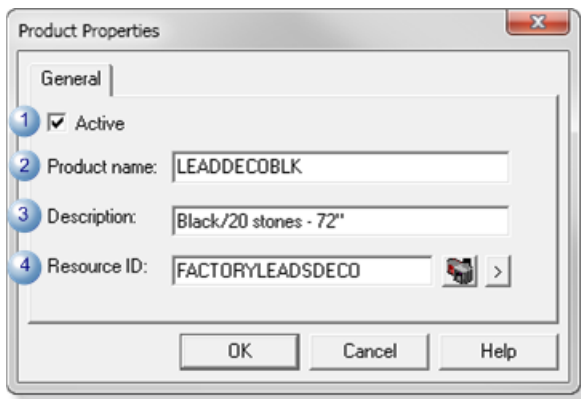

	Item	Description
1	Active	Check or clear the Active checkbox to do the following.
		Checked Activate data collection for the product.
		Clear Disable the product.
		Default Checked
2	Product name	Name that identifies the product folder. Note: The maximum length is 16 characters.
3	Description	(Optional) Provide details to more clearly identify the product.
4	Resource ID	Resource to be used by alarms generated for the product.
		Opens the Select a Resource browser.
		Displays a Resource Popup menu

1. Click OK.

Result: The Product Properties dialog box closes; the new product is listed in the SPC Configuration window.

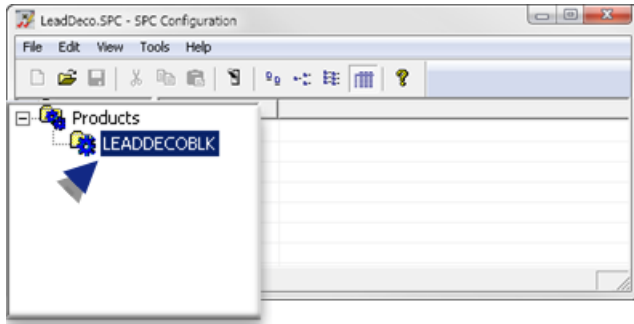

5. SPC Products: Variable Quality Characteristics

5. SPC Products: Variable Quality Characteristics

Information that you enter in the Variable Quality Control Characteristics dialog box is used to configure the selected chart set in the CimEdit/CimView ActiveX control.

Options include the following.

5.1 (page 521)	SPC Variable: Add a variable.
5.2 (page 522)	SPC Variable: General characteristics.
5.3 (page 524)	SPC Variable: Collection characteristics.
5.4 (page 530)	SPC Variable: Limits.
5.5 (page 536)	SPC Variable: Set alarms/Control tests.

CAUTION:

- If numeric values are entered (e.g. on the [Limits \(page 532\)](#) tab) during configuration and an inconsistency is detected, SPC will display an error message. You cannot save the configured data until the error is corrected.

Example

You select **Values** to enter a variable's control limits and enter 25 for an Upper Control Limit and 50 for a Lower Control Limit. SPC will display the following error message,

The upper control limit must be greater than the center line and the center line must be greater than the lower control limit.

- If Point IDs are entered (e.g. on the [Limits \(page 533\)](#) tab), SPC will alert the user when the values become specific at runtime. If SPC detects configuration inconsistencies, it will display an \$SPC_ADMIN _ALARM in the Alarm Viewer.

5.1. SPC Variable: Add a Variable

1. Select a product in the SPC Configuration window left-pane.
2. Do one of the following.

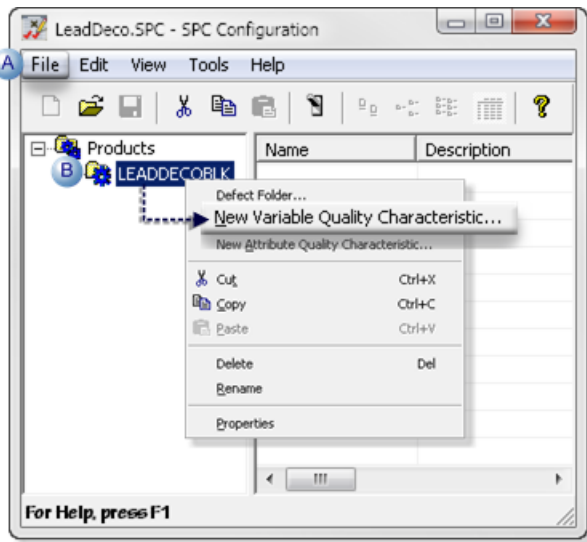

A	Click File>New>Variable Quality Characteristic on the SPC Configuration window menu bar.
B	Right-click the selected product; select New Variable Quality Characteristic on the Popup menu.

A Variable Quality Characteristic Properties - VAR dialog box opens.

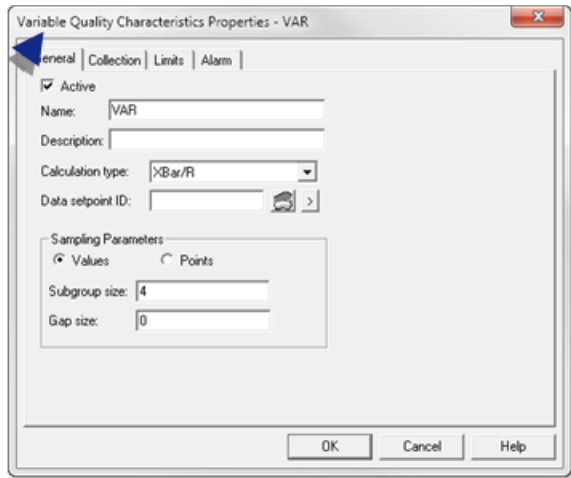

Note: When you create a new characteristic, SPC refers to it as VAR by default in the document tree. If there is more than one variable that you have not named, SPC numbers them in the order they were created and lists the description you enter on the Variable Quality Characteristics Properties dialog box>General tab. You can rename the variable at any time.

5.2. SPC Variable: General Characteristics

Select the General tab in the Variable Quality Characteristics Properties dialog box.

General features are as follows.

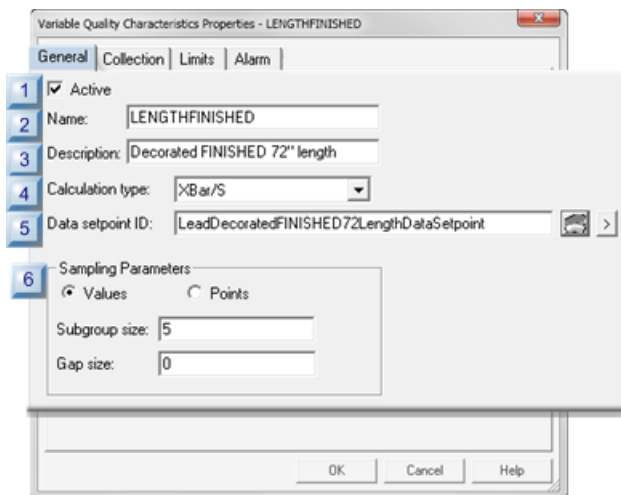

rect 2, 156, 26, 179 ([page 524](#))

rect -2, 126, 22, 153 ([page 524](#))

rect -1, 103, 23, 126 ([page 523](#))

rect -3, 80, 21, 103 ([page 523](#))

rect -4, 58, 20, 81 ([page 523](#))

rect -3, 38, 21, 61 ([page 523](#))

1 (page 523)	Active.
2 (page 523)	Name.
3 (page 523)	Description.
4 (page 523)	Calculation type.
5 (page 524)	Data setpoint ID.
6 (page 524)	Sampling Parameters

1	Active
---	--------

Does the following.

Checked	Activates data collection for the product variable.
Clear	De-activates data collection for the product variable.
Default	Checked

2	Name
---	------

Identifies the product's variable characteristic that will be measured.

Default	VAR
Maximum Length	16 characters.

3	Description
---	-------------

Provides details to clearly identify the characteristic.

Maximum Length	40 characters
----------------	---------------

 **Note:** The description displays in the SPC Configuration window list.

4	Calculation type
---	------------------

Selects the variable characteristics calculation type that will be available for charting.

Types are:

Chart	Values for:
X-Bar/R	X-Bar and range.
X-Bar/S	X-Bar and standard deviation.

 **Note:** The X-Bar chart type you select will be available on the CimEdit SPC Control Properties dialog box Chart menu; the other will not be. You can change your selection at any time; however, you will have to stop and restart a running project to have the SPC Control recognize the change.

5	Data setpoint ID
---	------------------

Enables usage of the current XBar-R or XBar- S values elsewhere in the selected project, or downloaded to a device.

Point type	Floating-point array point of 2 elements	
The array contains values for the following.		
	Chart	Values for:
	XBar/R	XBar and range
	XBar/S	XBar and standard deviation

6	Sampling Parameters
---	---------------------

Identifies the Subgroup size and gap size based on the Values or Points selection

Values	Requires integers for values.	
	Subgroup size	(Integer) identifies sample size. Important: The subgroup size must be between 2 and 100.
	Gap size	(Integer) identifies how many units will be skipped before the next sample is taken.
Points	Requires analog points for values.	
	Subgroup size	(Point) identifies sample size.
	Gap size	(Point) identifies how many units will be skipped before the next sample is taken.

5.3. SPC Variable: Collection Characteristics

The Collection tab in the Variable Quality Characteristics Properties dialog box:

- Enables/Disables collection.
- identifies the data collection source.

The three collection methods are:

- Point (Live data)
- Logged
- None

Point (Live Data)

Variable values can be retrieved from runtime point values.

Specifications for point value collection are as follows.

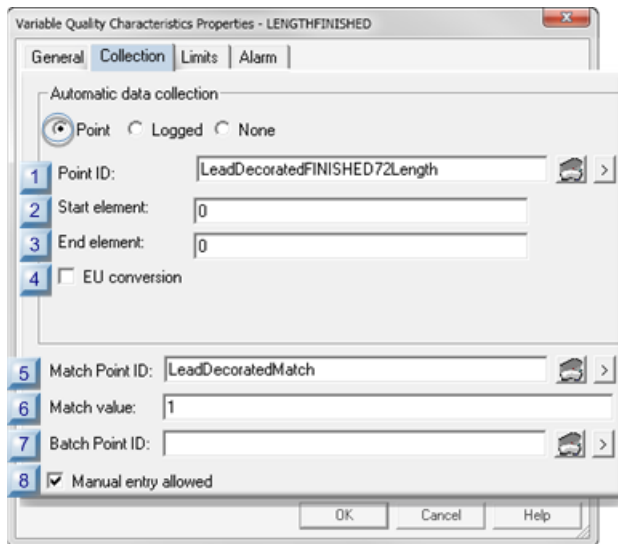

rect -1, 283, 19, 305 ([page 527](#))

rect -1, 261, 19, 283 ([page 527](#))

rect -1, 238, 19, 260 ([page 527](#))

rect -1, 217, 19, 239 ([page 526](#))

rect 6, 158, 26, 180 ([page 526](#))

rect 6, 137, 26, 159 ([page 526](#))

rect 6, 115, 26, 137 ([page 526](#))

rect 6, 95, 26, 117 ([page 526](#))

1 (page 526)	Point ID
2 (page 526)	Start element
3 (page 526)	End element
4 (page 526)	EU conversion

5 <i>(page 526)</i>	Match Point ID
6 <i>(page 527)</i>	Match value
7 <i>(page 527)</i>	Batch Point ID
8 <i>(page 527)</i>	Manual entry allowed

1	Point ID
---	----------

Identifies the point data source from which the SPC Data Collector retrieves variable values.

Point type	Analog
------------	--------

 **Note:** A batch point ID can be entered for a batch process.

2	Start element
---	---------------

(If the Point ID is an array point) Identifies the element number in the point array to start collection.

Default	0
---------	---

3	End element
---	-------------

(If the Point ID is an array point) Identifies the element number in the point array to end collection.

Default	0
---------	---

4	EU conversion
---	---------------

Selects between EU and raw values for the point measurement unit..

Check or clear, as follows.

Check/Clear	The SPC Data Collector will use:
Check	EU value(s) for the point.
Clear	Raw value(s) for the point.

5	Match Point ID
---	----------------

Provides one data source to Identify for which of multiple variables data should be collected.

Point type	Integer
------------	---------

Note: The same or different match point can be used for attributes, variables and defects.

6	Match value
---	-------------

Match point value that directs the selected SPC chart to collect data for the selected variable characteristic.

! **Important:** During runtime, the Match point value must be the value entered in the **Match value** field for collection to occur. If the Match point value is different from the value entered for the selected variable, the selected SPC chart will report that there is not enough data available for it to be created.

Example

A match value to collect data for the finished decorated lead length variable is 1.

Data for the finished length is or is not collected if the selected Match point value is as follows.

Collection	Match Value equals:
Is collected	1
Is not collected	Anything other than 1

7	Batch Point ID
---	----------------

(For a batch process) Distinguish between different batches for the same product quality characteristic.

📄 Note: The value of the Batch Point is associated with the calculated data and can be used as search criteria for charts and reports.

8	Manual entry allowed
---	----------------------

Enables or disables manual data entry.

Do one of the following.

Check/Clear	Manual data entry for SPC chart sets at runtime is:
Check	Enabled
Clear	Disabled

Logged

Retrieves data from an ODBC database table. Define the ODBC data source, table and column names.

Specifications for logged value collection are as follows.

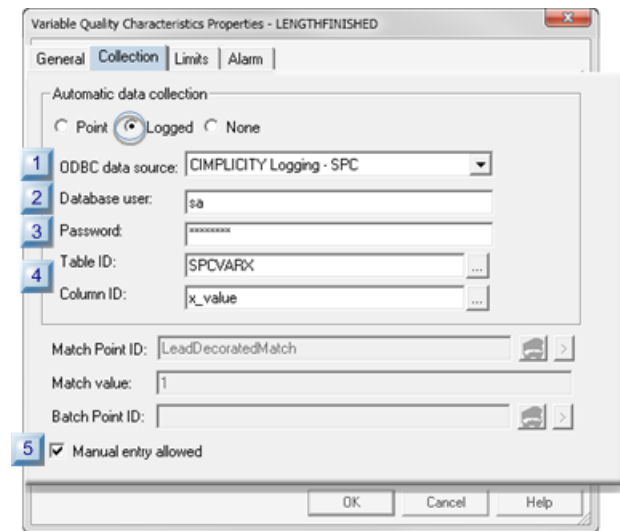

rect -1, 265, 23, 286 [\(page 529\)](#)

rect 7, 159, 26, 180 [\(page 529\)](#)

rect 6, 129, 25, 150 [\(page 529\)](#)

rect 6, 86, 25, 107 [\(page 528\)](#)

rect 6, 106, 25, 127 [\(page 529\)](#)

1 (page 528)	ODBC data source
2 (page 529)	Database user
3 (page 529)	Password
4 (page 529)	Table ID/Column ID
5 (page 529)	Manual entry allowed

1	ODBC data source
---	------------------

Selects the database from which SPC will retrieve data.

2 Database user

Identifies the valid user name when logging into the ODBC data source.

3 Password

Identifies the required user password for logging into the ODBC data source.

4 Table ID/Column ID

Selects the database table and column from which logged data will be retrieved.

Click the Browse button to the right of the **Table ID** or **Column ID** fields.

The table and column that are selected in the Select a Table/Column browser will be entered in the **Table ID/Column ID** fields.

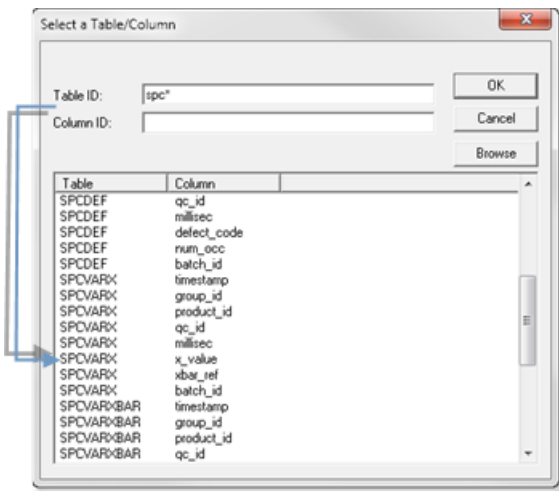

5 Manual entry allowed

Enables or disables manual data entry.

Do one of the following.

Check/Clear	Manual data entry for SPC chart sets at runtime is:
Check	Enabled
Clear	Disabled

None

If you choose to enter your own data, do not designate a data collection source.

Check None to prevent automatic data collection.

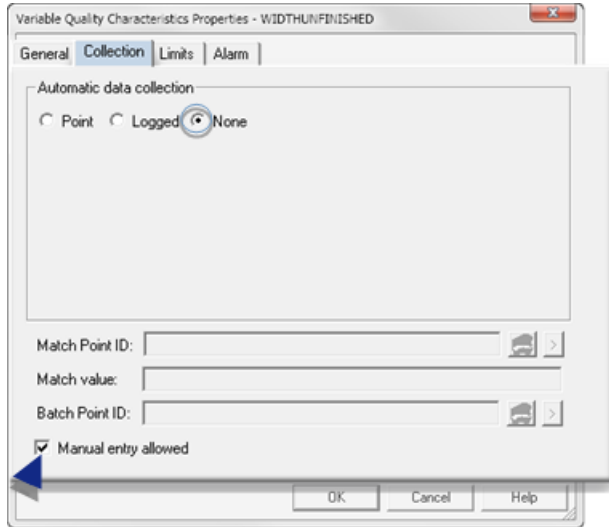

Manual data entry can be enabled or disabled.

Do one of the following.

Check/Clear	Manual data entry for SPC chart sets at runtime is:
Check	Enabled
Clear	Disabled

 **Note:** SPC automatically includes manual entry when you select None.

5.4. SPC Variable: Limits

In order to set control limits for your chart sets, SPC provides you with several different options. If you know the limits that you want to set, you can use Points or Values. If the process is new and you would like to have limits calculated automatically for you, you can use the auto recalculation features. Whatever your preference, SPC provides you with an option.

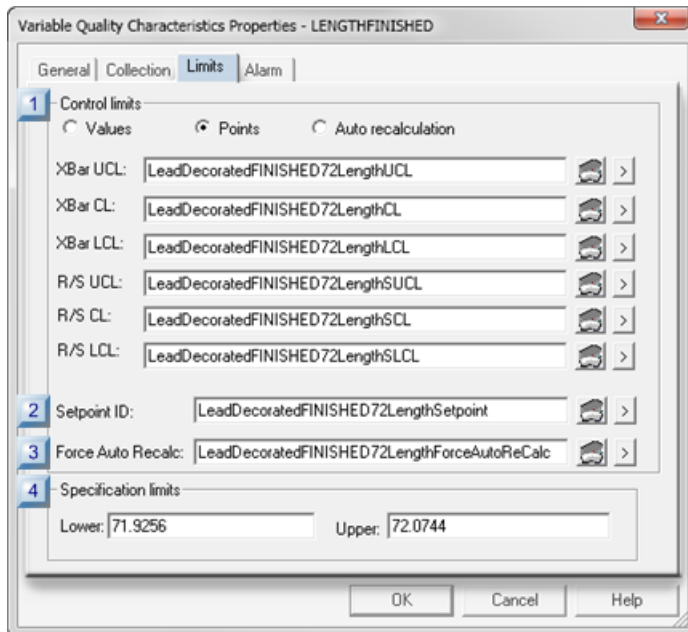

rect 3, 290, 28, 314 ([page 535](#))

rect 3, 267, 28, 291 ([page 535](#))

rect 3, 240, 28, 264 ([page 535](#))

rect 3, 50, 28, 74 ([page 531](#))

1 (page 531)	Control Limits
2 (page 535)	Setpoint ID
3 (page 535)	Force Auto Recalc
4 (page 535)	Specification limits
5 (page 536)	Control Limits: Guidelines

1	Control Limits
---	----------------

The control limits source types are as follows.

- Values
- Points
- Auto recalculation

Values

You can use your own absolute criteria to set control limits. Generally, when absolute values are used, the process is assessed to be in control.

Check Values.

Entries include the following.

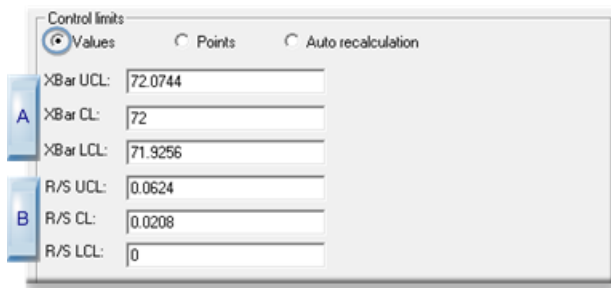

rect -2, 103, 22, 157 [\(page 532\)](#)

rect -2, 40, 22, 94 [\(page 532\)](#)

A (page 532)	XBar UCL; XBar CL; XBar LCL
B (page 532)	R/S UCL; R/S CL; R/S LCL

A	XBar UCL; XBar CL; XBar LCL
---	-----------------------------

Provides absolute values for the samples' limits.

XBar UCL	XBar Upper Control Limit
XBar CL	XBar Center Line
XBar LCL	XBar Lower Control Limit

B	R/S UCL; R/S CL; R/S LCL
---	--------------------------

Provides absolute values for either the samples' range or sigma limits.

R/S UCL	Range or Sigma Upper Control Limit
R/S CL	Range or Sigma Center Line
R/S LCL	Range or Sigma Lower Control Limit

The limits type depend on whether [XBar-R](#) or [XBar-S](#) [\(page 523\)](#) was selected as the calculation type on the General tab in the Variable Quality Characteristics dialog box.

Note: If you enter specific values during configuration and SPC detects an inconsistency, it will display an error message and will not allow you to save the configuration until you correct the error.

Points

Points can provide the control limit values that can be easily changed, when necessary simply by changing their value (e.g. in the Point Control Panel). The new value will display on the chart when the chart updates.

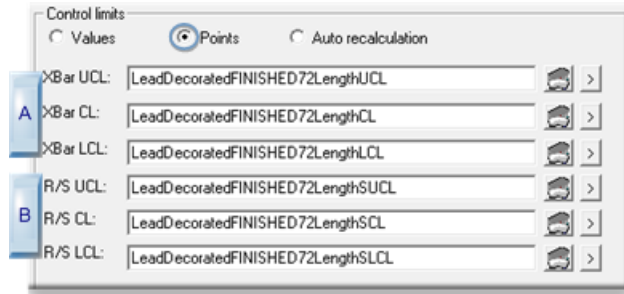

rect 1, 105, 22, 159 [\(page 533\)](#)

rect 1, 42, 22, 96 [\(page 533\)](#)

rect 1, 105, 22, 159 [\(page 533\)](#)

A (page 533)	XBar UCL; Bar CL; XBar LCL
B (page 533)	R/S UCL; R/S CL; R/S LCL

A	XBar UCL; XBar CL; XBar LCL
---	-----------------------------

Provides point ID's whose value identifies the samples' limits.

XBar UCL	XBar Upper Control Limit
XBar CL	XBar Center Line
XBar LCL	XBar Lower Control Limit
Point Type	Analog

B	R/S UCL; R/S CL; R/S LCL
---	--------------------------

Provides point ID whose values either the samples' range or sigma limits.

R/S UCL	Range or Sigma Upper Control Limit
R/S CL	Range or Sigma Center Line
R/S LCL	Range or Sigma Lower Control Limit

Point Type	Analog
------------	--------

The limits type depend on whether [XBar-R](#) or [XBar-S \(page 523\)](#) was selected as the calculation type on the General tab in the Variable Quality Characteristics dialog box.

Note:

- If you use **Points** for general characteristics on limits rather than specific values, SPC will alert the user when the values become specific at runtime. If SPC detects configuration inconsistencies, it will display an [\\$SPC ADMIN ALARM \(page 490\)](#) in the Alarm Viewer.
- Points need to be logged to be validated.

Auto recalculation

One of the many advantages SPC offers is its ability to automatically calculate the control limits for a process. This is particularly useful if your process is new and you want SPC to generate control limits.

Check Auto recalculation.

SPC recalculates the relevant control limits when the selected chart updates.



Control limits

Values Points Auto recalculation

XBar UCL:

XBar CL:

XBar LCL:

R/S UCL:

R/S CL:

R/S LCL:

 **Note:** Once the control limits are automatically calculated, select either Values or Points for the life of the process.

 **Important:** The Quality Control rules you have always followed for control limits still apply to both SPC automatic recalculation options, as follows:

- When your process is new or in optimum condition, calculate the limits using the Auto Recalculation or Force Auto Recalculation option.
- Once you determine that SPC has automatically collected enough data to calculate the correct control limits, disable the automatic calculation option.
- The calculated control limits are then used for the life of the process.
- Control limits produced by auto recalculation are valid only when your process is "in control." If you calculate them while your process is going "out of control," then the limits will be incorrect.

- A global variable `SPC_RESIZE_OUT_OF_BOUNDS` causes graph re-scaling and re-centering.

`SPC_RESIZE_OUT_OF_BOUNDS` is enabled by default.

When the `SPC_RESIZE_OUT_OF_BOUNDS` is disabled charts are not re-scaled and re-centered.

2	Setpoint ID
---	-------------

A setpoint entered in the **Setpoint ID** field enables usage of the current XBar, Range or Sigma control limits values elsewhere in the selected project or downloaded to a device.

The array contains values for the following.

- XBar LCL
- XBar CL
- XBar UCL
- R/S LCL
- R/S CL
- R/S UCL

Point type	Floating (Real) array point of 6 elements
------------	---

3	Force Auto Recalc
---	-------------------

A point can be used to Force Auto Recalc in addition to specifying control limit values or points. This option provides the flexibility to reset control limits during runtime.

As a result, when you send an application to production, you can have SPC recalculate the control limits so that they are accurate for the process.

Point On/Off	Set to:	Auto-calculation is:
Point On	TRUE	Activated and the XBar-R/S control limits are recalculated. Pre-set values are ignored.
Point Off	FALSE	Deactivated and the last calculated values are used. Pre-set values are ignored until the data collector is restarted or dynamically refreshed.
Point type	BOOLEAN	

 **Note:**

- Whenever the Force Auto Recalc point is set to either TRUE or FALSE, the data collector will drop the current sample and start over .
- When the control limits have been automatically recalculated and the process is assessed to be under control, disable the Force Auto Recalc option.

4	Specification limits
---	----------------------

Entered values for specification limits are the maximum and minimum tolerances set to determine acceptable limits for the variable.

The values may or may not be the same as the upper and lower control limits.

Lower	Lower specification limit.
Upper	Upper specification limit.
Point Type	Analog

 **Note:** The entered values display in the Histogram Information box as USL and LSL.

5	Control Limits: Guidelines
---	----------------------------

 **Important:** The Quality Control rules you have always followed for control limits still apply to both SPC automatic recalculation options (Auto recalculation and **Force Auto Recalc**) as follows:

- When your process is new or in optimum condition, calculate the limits using the Auto Recalculation or Force Auto Recalculation option.
- Once you determine that SPC has automatically collected enough data to calculate the correct control limits, disable the automatic calculation option.
- The calculated control limits are then used for the life of the process.
- Control limits produced by auto recalculation are valid only when your process is "in control." If you calculate them while your process is going "out of control," then the limits will be incorrect.
- A global variable `SPC_RESIZE_OUT_OF_BOUNDS` causes graph re-scaling and re-centering.

`SPC_RESIZE_OUT_OF_BOUNDS` is enabled by default.

When the `SPC_RESIZE_OUT_OF_BOUNDS` is disabled charts are not re-scaled and re-centered.

5.5. SPC Variable: Alarms/Control Tests

SPC can track several different types of occurrences to warn you if a process is slightly off, even if production has not exceeded its control limits on a regular basis. As a result, you can anticipate and handle potential problems before they occur.

Use the Alarm tab in the Variable Quality Characteristics Properties box to specify the:

- Type of alarm that will be triggered.
- Setpoint ID.
- Control test criteria that will initiate alarms or change setpoints.

Note: The SPC variable charts display values between -4 sigma (-4) σ and +4 sigma (+4) σ . Data outside of this range is not displayed, but it is still used in the chart calculations unless they are [excluded \(page 595\)](#).

When one of the control tests meets your criteria for issuing a warning, it will generate the type of warning you configure.

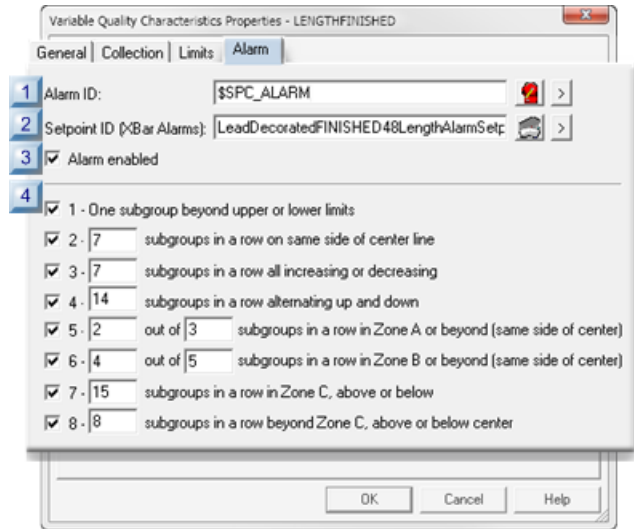

rect 1, 107, 22, 129 [\(page 538\)](#)

rect 1, 83, 22, 105 [\(page 538\)](#)

rect 1, 61, 22, 83 [\(page 538\)](#)

rect 1, 41, 22, 63 [\(page 537\)](#)

1 (page 537)	Alarm ID
2 (page 538)	Setpoint ID (XBar Alarms)
3 (page 538)	Alarm enabled
4 (page 538)	Control Tests

1	Alarm ID
---	----------

Do one of the following:

- Select the \$SPC_ALARM system Alarm ID.
- Create your own alarm in the **Alarm ID** field.

Tip: Use the `SPC_ALARM` type when creating your own alarm.

The alarm message for SPC alarms consists of the following strings:

- Document Name.
- Product Name.
- Quality/Defect Characteristic Name.
- A description of the control check that triggered the alarm.
- The value of the sample that triggered the alarm.
- An alarm to alert operators.

If alarms are generated for more than one control test, they will stack up and be deleted according to specifications you enter in the CIMPLICITY Alarm Configuration (e.g. the assigned alarm severity for the assigned alarm).

2	Setpoint ID (XBar Alarms)
---	---------------------------

Changes the setpoint value to the number of the XBar test that is in an alarm state (1 - 8).

Setpoints provide you with a way to automate corrective action. You can write scripts that trigger the appropriate action whenever the criteria have been met for one of the control tests.

The value of the Setpoint reflects the last test for which an alarm was triggered.

3	Alarm enabled
---	---------------

Enables/disables the alarm.

Check/Clear	The alarm is:
Check	Enabled
Clear	Disabled

4	Control Tests
---	---------------

- SPC performs all checked control tests during runtime.
- If any control test that is checked fails:
 - An alarm will be generated (if enabled).
 - The Nth subgroup and all following subgroups that fail the test criteria display in red.
 - A tool tip displays the date, time, value and tests that failed when a failed value is right-clicked.
 - The failure displays on the XBar, Range and/or Sigma chart.
 - Some tests report when a specified number of values occur in one or more of the following zones.

Zone	Is the area:
A	Up to one standard deviation from the center line.
B	Between one and two standard deviations from the center line.
C	Between two and three standard deviations from the center line.

- When you create a control chart, you can select samples for [exclusion \(page 595\)](#) .

Control tests (with sample charts) are:

1 (page 539)	One Subgroup beyond upper or lower limits
2 (page 540)	N subgroups in a row on same side of center line
3 (page 540)	N Subgroups in a row all increasing or decreasing
4 (page 540)	N Subgroups in a row alternating up and down
5 (page 541)	N Subgroups out of N Subgroups in a row in Zone A or beyond (same side of center)
6 (page 541)	N Subgroups out of N Subgroups in a row in Zone B or beyond (same side of center)
7 (page 541)	N Subgroups in a row in Zone C, above or below
8 (page 542)	N Subgroups in a row beyond Zone C, above or below center

1 - One Subgroup beyond upper or lower limits

Test 1 Failure	Any time a subgroup goes beyond the UCL or LCL.
----------------	---

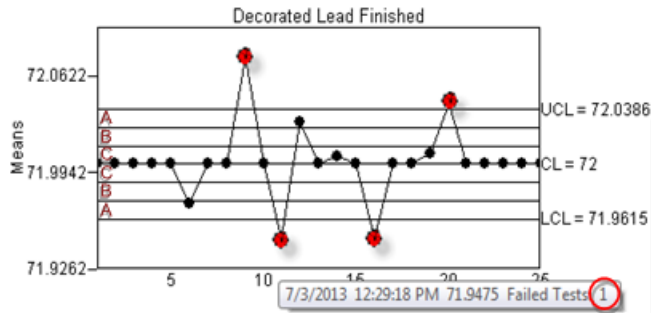

2 - N subgroups in a row on same side of center line

Test 2 Failure	When the specified number of subgroups fall on the same side of the center line, one after the other.
Default	7

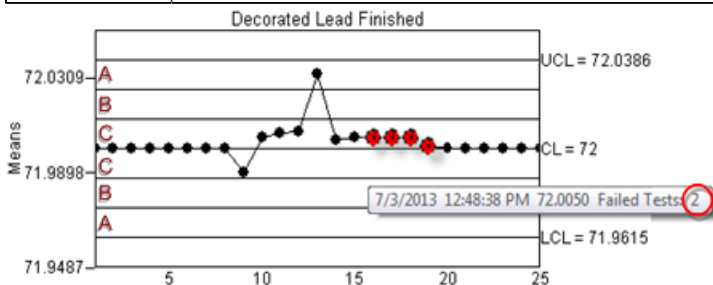

3 - N Subgroups in a row all increasing or decreasing

Test 3 Failure	When the specified number of subgroups increase or decrease in a row on either side of the center line.
Default	7

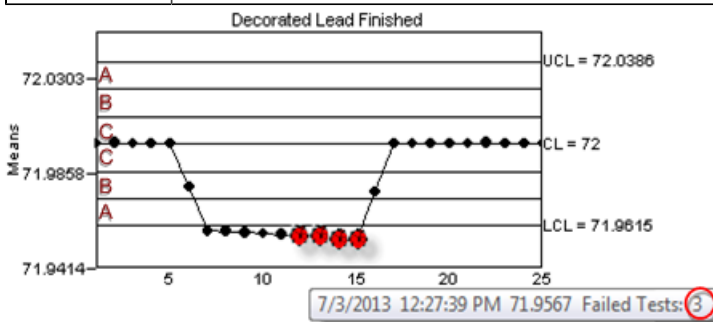

4 - N Subgroups in a row alternating up and down

Test 4 Failure	When the specified number of subgroups increase and then decrease on either side of the center line.
Default	14

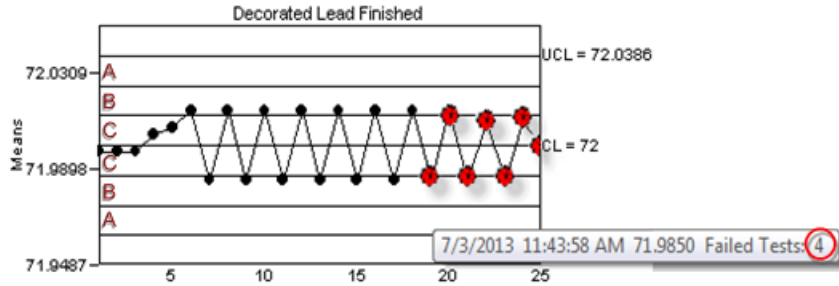

5 - N Subgroups our of N Subgroups in a row in Zone A or beyond (same side of center)

Test 5 Failure	When N subgroups in N1 subgroups are in Zone A or beyond on the same side of the center line.
Default	2 out of 3

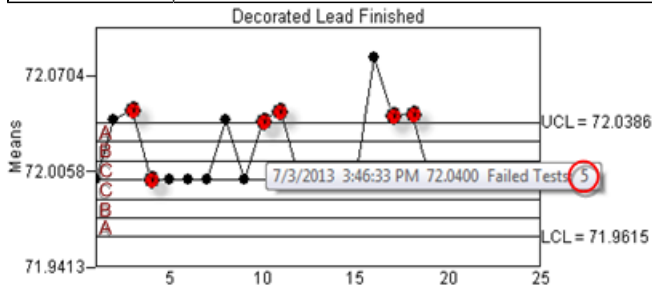

6 - N Subgroups our of N Subgroups in a row in Zone B or beyond (same side of center)

Test 6 Failure	When N subgroups in N1 subgroups are in Zone B or beyond on the same side of the center line.
Default	4 out of 5

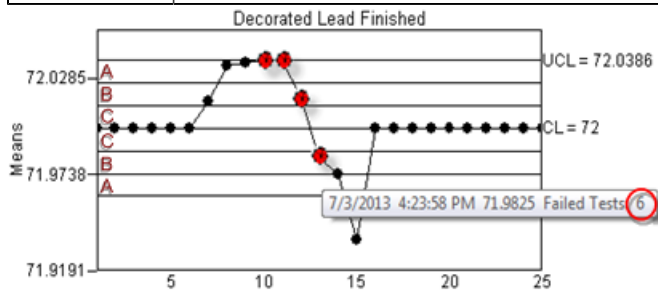

7 - N Subgroups in a row in Zone C, above or below

Test 7 Failure	When the specified number of subgroups in a specified number of subgroups are in a row are in Zone C (either or both sides of the center line).
Default	15

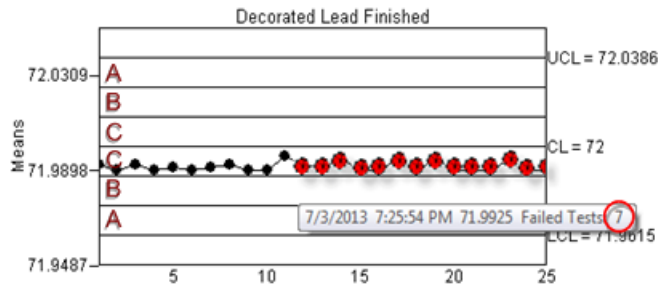

8 - N Subgroups in a row beyond Zone C, above or below center

Test 8 Failure	When the specified number of subgroups in a specified number of subgroups are in a row are in Zones B, A or beyond (above or below the center line).
Default	8

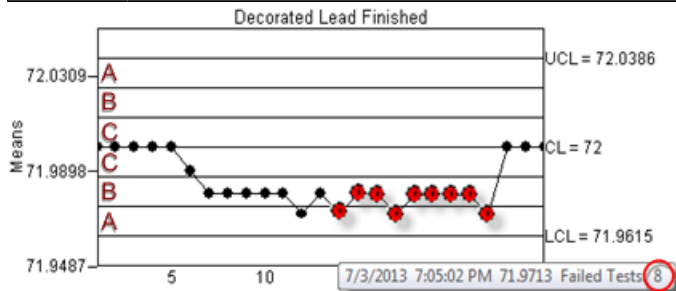

6. SPC Products: Attribute Quality Characteristics

6. SPC Products: Attribute Quality Characteristics

Information that you enter in the Attribute Quality Characteristics dialog box is used to configure the selected chart set in the CimEdit/CimView ActiveX control.

Options include the following.

6.1 (page 543)	SPC Attribute: Add an Attribute
6.2 (page 544)	SPC Attribute: General characteristics.
6.3 (page 546)	SPC Attribute: Collection characteristics.
6.4 (page 553)	SPC Attribute: Limits.

6.5 (page 558)	SPC Attribute: Alarms/Control tests.
-----------------------------------	--------------------------------------

⚠ CAUTION: If you enter specific values during configuration and an inconsistency is detected, SPC will display an error message. You cannot save the configured data until the error is corrected.

📌 Note: If you use Points for general characteristics on limits rather than specific values, SPC will alert the user when the values become specific at runtime. If SPC detects configuration inconsistencies, it will display an [\\$SPC_ADMIN_ALARM \(page 490\)](#) in the Alarm Viewer.

6.1. SPC Attribute: Add an Attribute

1. Select a product in the SPC Configuration window left-pane.
2. Do one of the following.

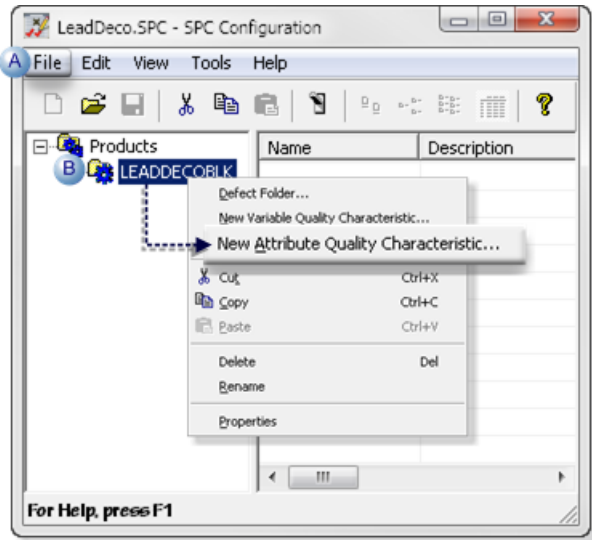

A	Click File>New>Attribute Quality Characteristic on the SPC Configuration window menu bar.
B	Right-click the selected product; select New Attribute Quality Characteristic on the Popup menu.

An Attribute Quality Characteristic Properties - ATT dialog box opens.

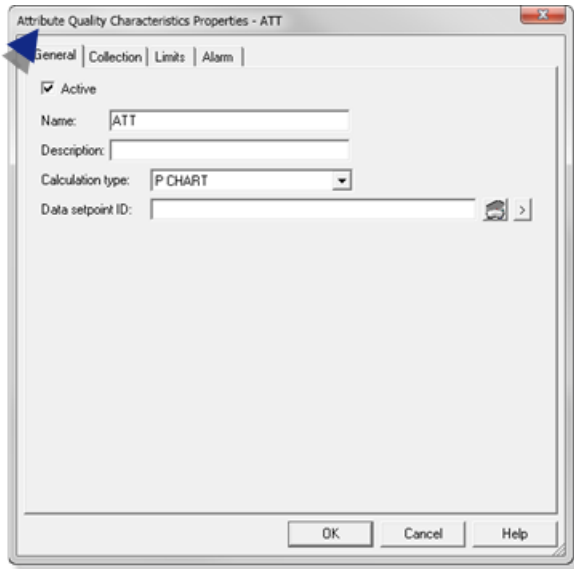

6.2. SPC Attribute: General Characteristics

Select the General tab in the Attribute Quality Characteristics properties dialog box.

General features are as follows.

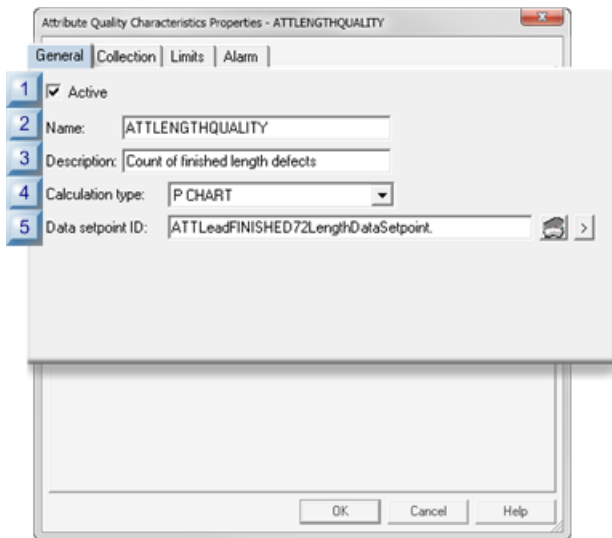

rect 0, 127, 23, 150 [\(page 546\)](#)

rect 0, 103, 23, 126 [\(page 545\)](#)

rect 0, 81, 23, 104 [\(page 545\)](#)

rect 0, 60, 23, 83 [\(page 545\)](#)

rect 0, 39, 23, 62 [\(page 545\)](#)

1 (page 545)	Active
---	--------

2 (page 545)	Name
3 (page 545)	Description
4 (page 545)	Calculation type
5 (page 546)	Data setpoint ID

1	Active
---	--------

Does the following.

Checked	Activates data collection for the product attribute.
Clear	De-activates data collection for the product attribute.
Default	Checked

2	Name
---	------

Identifies the product's attribute characteristic that will be measured

Maximum Length	16 characters.
Default	ATT

3	Description
---	-------------

Provides details to clearly identify the characteristic.

 **Note:** The description displays in the SPC Configuration window list.

Maximum Length	40 characters
----------------	---------------

4	Calculation type
---	------------------

Selects the attribute characteristics calculation type that will be available for charting.

Types are:

Chart	Values for:
nP Chart	Number of defective units in each sample.
P CHART	Proportion of defective units in each sample.

Chart	Values for:
C CHART	Total number of defects in a unit.
U CHART	Mean (average) defects per unit during the sampling period.

 **Important:**

- Only 1 of the 4 available attribute chart types can be configured for a single product at a time.
- A maximum of 4 attribute charts can be configured per product.

5	Data setpoint ID
---	------------------

Enables usage of the selected chart values elsewhere in the selected project, or downloaded to a device.

Point type	Floating-point array point of 2 elements
------------	--

6.3. SPC Attribute: Collection Characteristics

The Collection tab in the Variable Quality Characteristics Properties dialog box:

- Enables/Disables collection.
- identifies the data collection source.

The three collection methods are:

- Point (Live data)
- Logged
- None

Point (Live Data)

Attribute values can be retrieved from runtime point values.

Point data collection includes one or more CIMPLICITY points, are specified, along with start and end indices for array Points, and any engineering unit conversion (default).

Specifications for point value collection are as follows.

Attribute Quality Characteristics Properties - ATTLNGTHQUALITY

General Collection Limits Alarm

Automatic data collection

Point Logged None

1 Point ID: ATTLeadDecoratedFINISHED72Ler

2 Start element: 0 3 End element: 0

4 Match Point ID: ATTLeadDecoratedMatch

5 Match value: 1

6 Batch Point ID:

7 Sampling

Value Point

Subgroup Size: 400

8 Manual entry allowed 9 EU conversion

OK Cancel Help

rect 162, 312, 184, 338 ([page 549](#))

rect 14, 312, 36, 338 ([page 549](#))

rect -1, 243, 21, 269 ([page 549](#))

rect 0, 159, 22, 185 ([page 549](#))

rect 0, 139, 22, 161 ([page 548](#))

rect 0, 118, 22, 139 ([page 548](#))

rect 139, 100, 161, 121 ([page 548](#))

rect 1, 100, 23, 121 ([page 548](#))

rect 1, 79, 23, 100 ([page 548](#))

1 (page 548)	Point ID
2 (page 548)	Start element
3 (page 548)	End element
4 (page 548)	Match Point ID
5 (page 548)	Match value
6 (page 549)	Batch Point ID

7 (page 549)	Sampling
8 (page 549)	Manual entry allowed
9 (page 549)	EU conversion

1	Point ID
---	----------

Identifies the point data source from which the SPC Data Collector retrieves attribute values.

Note: The point must be a numeric point type.

2	Start element
---	---------------

(If the Point ID is an array point) Identifies the element number in the point array to start collection.

Default	0
---------	---

3	End element
---	-------------

(If the Point ID is an array point) Identifies the element number in the point array to end collection.

Default	0
---------	---

4	Match Point ID
---	----------------

Provides one data source to Identify for which of multiple attribute data should be collected.

Point type	Integer
------------	---------

Note: The same or different match point can be used for attributes, variables and defects.

5	Match value
---	-------------

Match point value that directs the selected SPC chart to collect data for the selected attribute characteristic.

! **Important:** During runtime, the Match point value must be the value entered in the **Match value** field for collection to occur. If the Match point value is different from the value entered for the selected attribute, the selected SPC chart will report that there is not enough data available for it to be created.

Example

A match value to collect data for the finished decorated lead length attribute is 5.

Data for the finished length is or is not collected if the selected Match point value is as follows.

Collection	Match Value equals:
Is collected	5
Is not collected	Anything other than 5

6	Batch Point ID
---	----------------

(For a batch process) Distinguish between different batches for the same product quality characteristic.

 **Note:** The value of the Batch Point is associated with the calculated data and can be used as search criteria for charts and reports.

7	Sampling
---	----------

Identifies the Subgroup size and gap size based on the Values or Points selection

Values	Requires integers for values.	
	Subgroup size	(Integer) identifies sample size. Important: The subgroup size must be between 2 and 100.
	Gap size	(Integer) identifies how many units will be skipped before the next sample is taken.
Points	Requires analog points for values.	
	Subgroup size	(Point) identifies sample size.
	Gap size	(Point) identifies how many units will be skipped before the next sample is taken.

Default	400
---------	-----

8	Manual entry allowed
---	----------------------

Enables or disables manual data entry.

Do one of the following.

Check/Clear	Manual data entry for SPC chart sets at runtime is:
Check	Enabled
Clear	Disabled

9	EU conversion
---	---------------

Selects between EU and raw values for the point measurement unit..

Check or clear, as follows.

Check/Clear	The SPC Data Collector will use:
Check	EU value(s) for the point.
Clear	Raw value(s) for the point.

Logged

Retrieves data from an ODBC database table. Define the ODBC data source, table and column names.

Specifications for logged value collection are as follows.

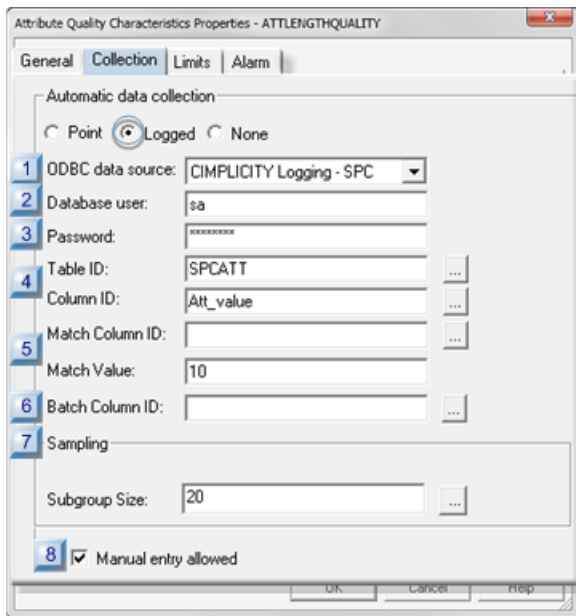

rect 17, 330, 37, 354 [\(page 552\)](#)

rect 1, 260, 21, 284 [\(page 552\)](#)

rect 2, 236, 22, 260 [\(page 552\)](#)

rect 1, 201, 21, 225 [\(page 552\)](#)

rect 1, 158, 21, 182 [\(page 551\)](#)

rect 0, 128, 23, 152 [\(page 551\)](#)

rect 1, 108, 21, 130 [\(page 551\)](#)

rect 1, 90, 21, 110 [\(page 551\)](#)

1 (page 551)	ODBC data source
2 (page 551)	Database user
3 (page 551)	Password

4 <i>(page 551)</i>	Table ID\Column ID
5 <i>(page 552)</i>	Match Column ID\Match Value
6 <i>(page 552)</i>	Batch Column ID
7 <i>(page 552)</i>	Sampling (subgroup size)
8 <i>(page 552)</i>	Manual entry allowed

1	ODBC data source
---	------------------

Selects the database from which SPC will retrieve data.

Default	CIMPLICITY Logging - SPC
---------	--------------------------

2	Database user
---	---------------

Identifies the valid user name when logging into the ODBC data source.

3	Password
---	----------

Identifies the required user password for logging into the ODBC data source.

Note: The password is hidden by stars (****).

4	Table ID/Column ID
---	--------------------

Selects the database table and column from which logged data will be retrieved.

Click the Browse button to the right of the **Table ID** or **Column ID** fields.

The table and column that are selected in the Select a Table/Column browser will be entered in the **Table ID/Column ID** fields.

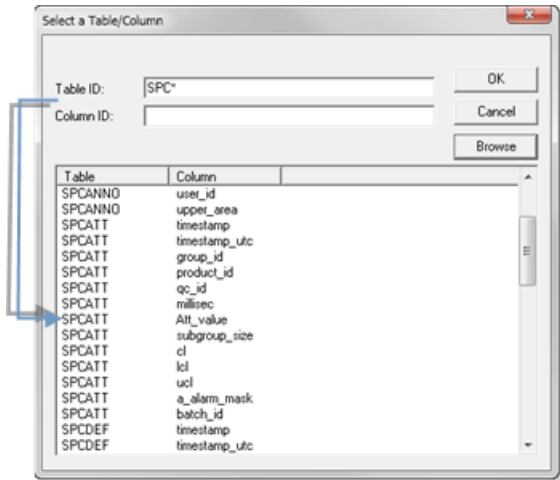

5 Match Column ID/Match Value

6 Batch Column ID

(For a batch process) Distinguish between different batches for the same product quality characteristic.

7 Sampling (Subgroup Size)

(Integer) identifies sample size that will be used during runtime.

8 Manual entry allowed

Enables or disables manual data entry.

Do one of the following.

Check/Clear	Manual data entry for SPC chart sets at runtime is:
Check	Enabled
Clear	Disabled

None

If you choose to enter your own data, do not designate a data collection source.

Check None to prevent automatic data collection.

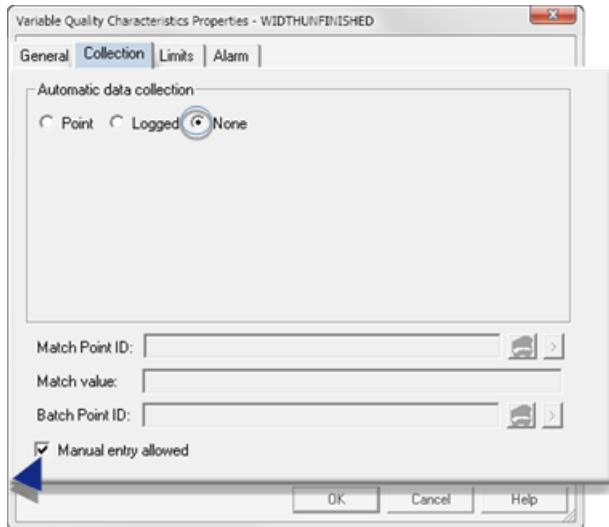

Manual data entry can be enabled or disabled.

Do one of the following.

Check/Clear	Manual data entry for SPC chart sets at runtime is:
Check	Enabled
Clear	Disabled

 **Note:** SPC automatically includes manual entry when you select None.

6.4. SPC Attribute: Limits

In order to set control limits for your chart sets, SPC provides you with several different options. If you know the limits that you want to set, you can use Points or Values. If the process is new and you would like to have limits calculated automatically for you, you can use the auto recalculation features. Whatever your preference, SPC provides you with an option.

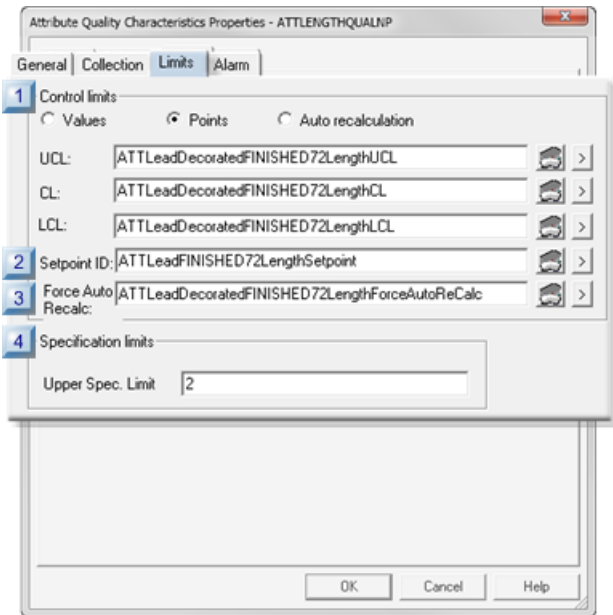

- rect 0, 198, 23, 220 [\(page 557\)](#)
- rect -1, 172, 22, 194 [\(page 557\)](#)
- rect -1, 149, 22, 171 [\(page 556\)](#)
- rect -1, 45, 22, 67 [\(page 554\)](#)

1 (page 554)	Control limits.
2 (page 556)	Setpoint ID.
3 (page 557)	Force Auto Recalc.
4 (page 557)	Specification limits.
5 (page 557)	Control limits: Guidelines.

1	Control Limits
---	----------------

The control limits source types are as follows.

- Values
- Points
- Auto recalculation

Values

You can use your own absolute criteria to set control limits. Generally, when absolute values are used, the process is assessed to be in control.

Check Values.

Entries include the following.

The screenshot shows a 'Control limits' dialog box with three radio buttons: 'Values' (selected), 'Points', and 'Auto recalculation'. Below the buttons are three input fields: 'UCL:' with the value '9', 'CL:' with the value '5', and 'LCL:' with the value '0'.

Provides absolute values for the subgroup limits.

UCL	Upper Control Limit
CL	Center Line
LCL	Lower Control Limit
Value type	Numeric Note: The data type depends on the selected attribute chart.

Points

Points can provide the control limit values that can be easily changed, when necessary simply by changing their value (e.g. in the Point Control Panel). The new value will display on the chart when the chart updates.

The screenshot shows a 'Control limits' dialog box with three radio buttons: 'Values', 'Points' (selected), and 'Auto recalculation'. Below the buttons are three input fields, each containing the text 'ATTLeadDecoratedFINISHED72Length' followed by the respective limit name (UCL, CL, LCL). Each field has a small icon and a right-pointing arrow next to it.

UCL	Upper Control Limit
CL	Center Line
LCL	Lower Control Limit
Point type	Analog Note: The data type depends on the selected attribute chart.

Note:

- If you use **Points** for general characteristics on limits rather than specific values, SPC will alert the user when the values become specific at runtime. If SPC detects configuration inconsistencies, it will display an [\\$SPC ADMIN ALARM \(page 490\)](#) in the Alarm Viewer.

- Points need to be logged to be validated.

Auto recalculation

One of the many advantages SPC offers is its ability to automatically calculate the control limits for a process. This is particularly useful if your process is new and you want SPC to generate control limits.

Check Auto recalculation.

SPC recalculates the relevant control limits when the selected chart updates.

The screenshot shows a dialog box titled "Control limits". It has three radio buttons: "Values", "Points", and "Auto recalculation". The "Auto recalculation" button is selected. Below the radio buttons are three input fields: "UCL:" with the value "9", "CL:" with the value "5", and "LCL:" with the value "0".

Note: Once the control limits are automatically calculated, select either Values or Points for the life of the process.

Important: The Quality Control rules you have always followed for control limits still apply to both SPC automatic recalculation options, as follows:

- When your process is new or in optimum condition, calculate the limits using the Auto Recalculation or Force Auto Recalculation option.
- Once you determine that SPC has automatically collected enough data to calculate the correct control limits, disable the automatic calculation option.
- The calculated control limits are then used for the life of the process.
- Control limits produced by auto recalculation are valid only when your process is "in control." If you calculate them while your process is going "out of control," then the limits will be incorrect.
- A global variable `SPC_RESIZE_OUT_OF_BOUNDS` causes graph re-scaling and re-centering.

`SPC_RESIZE_OUT_OF_BOUNDS` is enabled by default.

When the `SPC_RESIZE_OUT_OF_BOUNDS` is disabled charts are not re-scaled and re-centered.

2	Setpoint ID
---	-------------

A setpoint entered in the **Setpoint ID** field enables usage of the current P, nP, C or U control limits values elsewhere in the selected project or downloaded to a device.

The array contains values for the following.

- LCL
- CL

- UCL

Point type	Floating (Real) array point of 3 elements
------------	---

3	Force Auto Recalc
---	-------------------

A point can be used to Force Auto Recalc in addition to specifying control limit values or points. This option provides the flexibility to reset control limits during runtime.

As a result, when you send an application to production, you can have SPC recalculate the control limits so that they are accurate for the process.

Point On/Off	Set to:	Auto-calculation is:
Point On	TRUE	Activated and the XBar-R/S control limits are recalculated. Pre-set values are ignored.
Point Off	FALSE	Deactivated and the last calculated values are used. Pre-set values are ignored until the data collector is restarted or dynamically refreshed.
Point type	BOOLEAN	

 **Note:**

- Whenever the Force Auto Recalc point is set to either TRUE or FALSE, the data collector will drop the current sample and start over .
- When the control limits have been automatically recalculated and the process is assessed to be under control, disable the Force Auto Recalc option.

4	Specification limits
---	----------------------

Entered values for specification limits are the maximum tolerances set to determine acceptable limits for the attribute.

The values may or may not be the same as the upper control limits.

Upper	Upper specification limit.
Point Type	Analog

 **Note:** The entered values display in the Histogram Information box as USL and LSL.

5	Control Limits: Guidelines
---	----------------------------

 **Important:** The Quality Control rules for control limits also apply to both SPC automatic recalculation options (Auto recalculation and **Force Auto Recalc**) as follows:

- When your process is new or in optimum condition, calculate the limits using the Auto Recalculation or Force Auto Recalculation option.
- Once you determine that SPC has automatically collected enough data to calculate the correct control limits, disable the automatic calculation option.
- The calculated control limits are then used for the life of the process.
- Control limits produced by auto recalculation are valid only when your process is "in control." If you calculate them while your process is going "out of control," then the limits will be incorrect.
- A global variable `SPC_RESIZE_OUT_OF_BOUNDS` causes graph re-scaling and re-centering.

`SPC_RESIZE_OUT_OF_BOUNDS` is enabled by default.

When the `SPC_RESIZE_OUT_OF_BOUNDS` is disabled charts are not re-scaled and re-centered.

Example

An

- Upper Control Limit is set to 25.
- Lower Control Limit is set to 50.

SPC will display the following error message:

The upper control limit must be greater than the center line and the center line must be greater than the lower control limit.

 **Note:** If you use **Points** for general characteristics on limits rather than specific values, SPC will alert the user when the values become specific at runtime. If SPC detects configuration inconsistencies, it will display an `$SPC_ADMIN (page 490) _ALARM` in the Alarm Viewer. See "SPC Administration Alarms" in this chapter.

6.5. SPC Attribute: Alarms/Control Tests

SPC can track several different types of occurrences to warn you if a process is slightly off, even if production has not exceeded its control limits on a regular basis. As a result, you can anticipate and handle potential problems before they occur.

Use the Alarm tab in the Variable Quality Characteristics Properties box to specify the:

- Type of alarm that will be triggered.
- Setpoint ID.
- Control test criteria that will initiate alarms or change setpoints.

When one of the control tests meets your criteria for issuing a warning, it will generate the type of warning you configure.

Overview

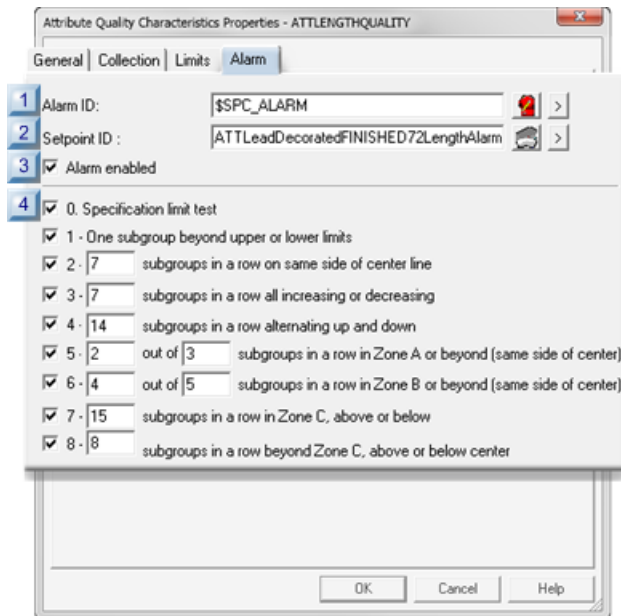

rect -1, 111, 23, 134 ([page 560](#))

rect -1, 87, 23, 110 ([page 560](#))

rect -1, 66, 23, 89 ([page 560](#))

rect -1, 45, 23, 68 ([page 559](#))

1 (page 559)	Alarm ID
2 (page 560)	Setpoint ID (XBar Alarms)
3 (page 560)	Alarm enabled
4 (page 560)	Control Tests

1	Alarm ID
---	----------

Do one of the following:

- Select the \$SPC_ALARM system Alarm ID.
- Create your own alarm in the **Alarm ID** field.

Tip: Use the SPC_ALARM type when creating your own alarm.

The alarm message for SPC alarms consists of the following strings:

- Document Name.
- Product Name.
- Quality/Defect Characteristic Name.
- A description of the control check that triggered the alarm.
- The value of the sample that triggered the alarm.
- An alarm to alert operators.

If alarms are generated for more than one control test, they will stack up and be deleted according to specifications you enter in the CIMPLICITY Alarm Configuration (e.g. the assigned alarm severity for the assigned alarm).

2	Setpoint ID
---	-------------

Changes the setpoint value to the number of the Attribute test that is in an alarm state.

Upper Specification Limit	0
Alarm state	1-8

Setpoints provide you with a way to automate corrective action. You can write scripts that trigger the appropriate action whenever the criteria have been met for one of the control tests.

The value of the Setpoint reflects that last test for which an alarm was triggered.

3	Alarm enabled
---	---------------

Enables/disables the alarm.

Check/Clear	The alarm is:
Check	Enabled
Clear	Disabled

4	Control Tests
---	---------------

- SPC performs all checked control tests during runtime.
- If any control test that is checked fails:
 - An alarm will be generated (if enabled).
 - The Nth subgroup and all following subgroups that fail the test criteria display in red.
 - A tool tip displays the date, time, value and tests that failed when a failed value is right-clicked.
 - The failure displays on the P, nP, C and/or U chart.
- Some tests report when a specified number of values occur in one or more of the following zones.

Zone	Is the area:
A	Up to one standard deviation from the center line.
B	Between one and two standard deviations from the center line.
C	Between two and three standard deviations from the center line.

- When you create a control chart, you can select samples for [exclusion \(page 595\)](#) .

Control tests (with sample charts) are:

0 (page 561)	Specification limit test
1 (page 561)	One Subgroup beyond upper or lower limits
2 (page 562)	N subgroups in a row on same side of center line
3 (page 562)	N Subgroups in a row all increasing or decreasing
4 (page 562)	N Subgroups in a row alternating up and down
5 (page 563)	N Subgroups out of N Subgroups in a row in Zone A or beyond (same side of center)
6 (page 563)	N Subgroups out of N Subgroups in a row in Zone B or beyond (same side of center)
7 (page 563)	N Subgroups in a row in Zone C, above or below
8 (page 564)	N Subgroups in a row beyond Zone C, above or below center

0 - Specification limit test

Test 0 Failure	Calculated acceptable percentage of nonconforming units or defects in the total sample size.
----------------	--

1 - One Subgroup beyond upper or lower limits

Test 1 Failure	Any time a subgroup goes beyond the UCL or LCL.
----------------	---

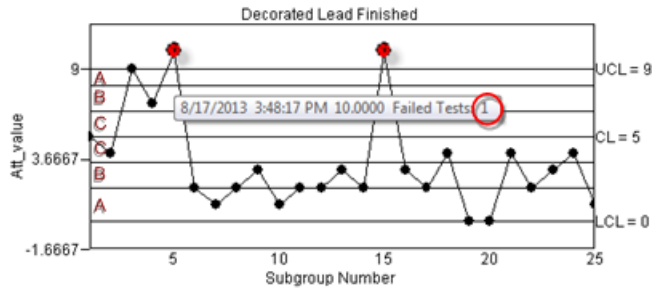

2 - N subgroups in a row on same side of center line

Test 2 Failure	When the specified number of subgroups fall on the same side of the center line, one after the other.
Default	7

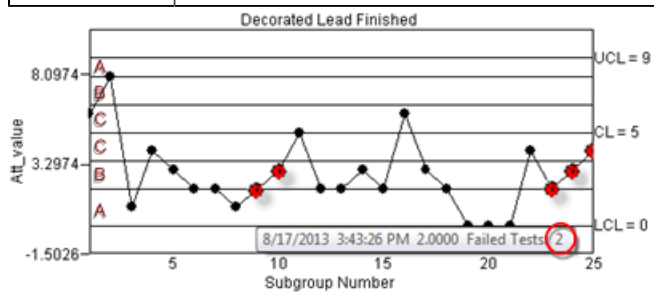

3 - N Subgroups in a row all increasing or decreasing

Test 3 Failure	When the specified number of subgroups increase or decrease in a row on either side of the center line.
Default	7

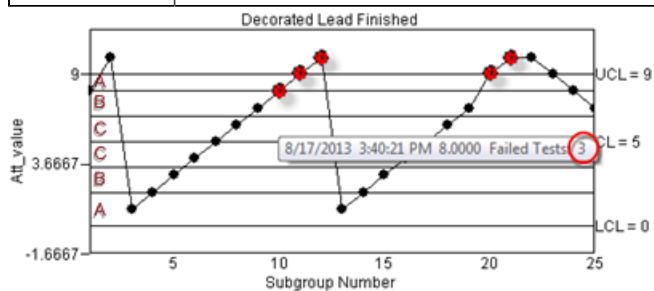

4 - N Subgroups in a row alternating up and down

Test 4 Failure	When the specified number of subgroups increase and then decrease on either side of the center line.
Default	14

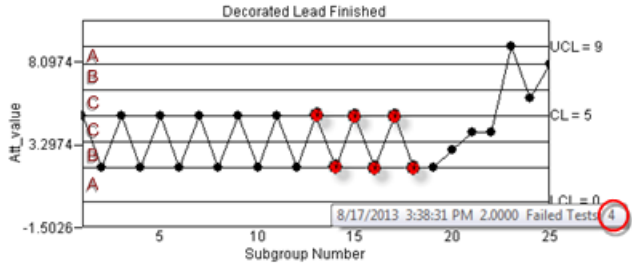

5 - N Subgroups our of N Subgroups in a row in Zone A or beyond (same side of center)

Test 5 Failure	When N subgroups in N1 subgroups are in Zone A or beyond on the same side of the center line.
Default	2 out of 3

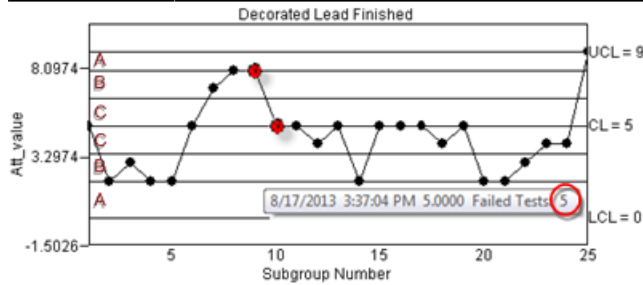

6 - N Subgroups our of N Subgroups in a row in Zone B or beyond (same side of center)

Test 6 Failure	When N subgroups in N1 subgroups are in Zone B or beyond on the same side of the center line.
Default	4 out of 5

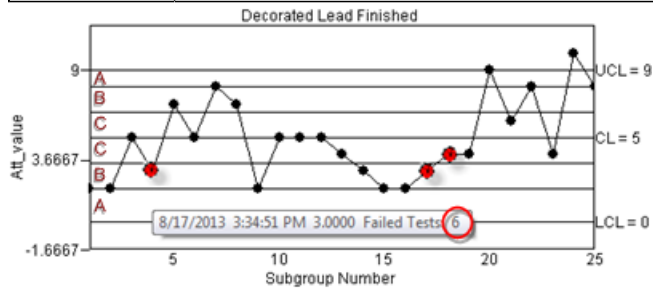

7 - N Subgroups in a row in Zone C, above or below

Test 7 Failure	When the specified number of subgroups in a specified number of subgroups are in a row are in Zone C (either or both sides of the center line).
Default	15

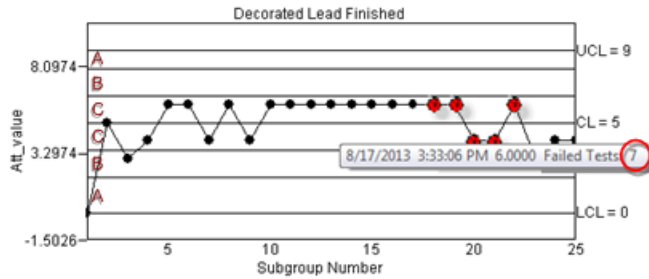

8 - N Subgroups in a row beyond Zone C, above or below center

Test 8 Failure	When the specified number of subgroups in a specified number of subgroups are in a row are in Zones B, A or beyond (above or below the center line).
Default	8

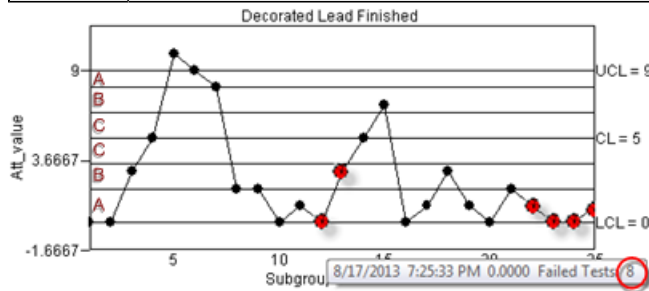

7. SPC Products: Defect Properties

7. SPC Products: Defect Properties

Information can be entered to track a product's defects. SPC displays each group of defects on a Pareto chart.

7.1 (page 565)	SPC Defect Group: Add a defect group.
7.2 (page 565)	SPC Defect Group: Properties.
7.3 (page 569)	SPC Defect Category: Add a category.
7.4 (page 570)	SPC Defect Category: General properties.
7.5 (page 570)	SPC Defect Category: Collection properties.

7.1. SPC Defect Group: Add a Defect Group

1. Select a product in the SPC Configuration window left-pane.
2. Do one of the following.

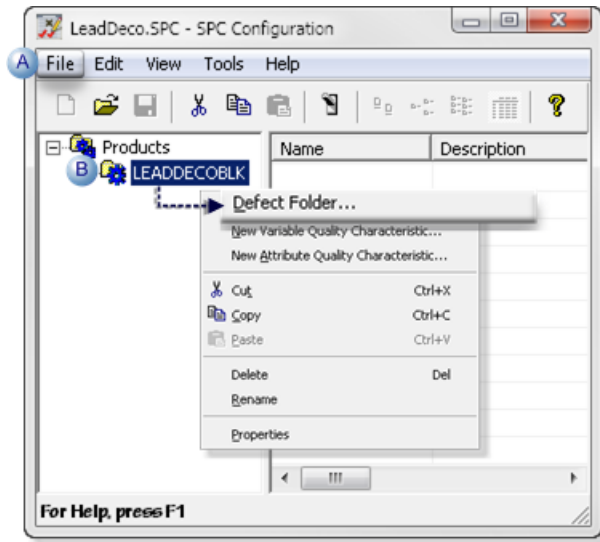

A	Click File>New>Defect Folder on the SPC Configuration window menu bar.
B	Right-click the selected product; select Defect Folder on the Popup menu.

A Defect Folder Properties dialog box opens.

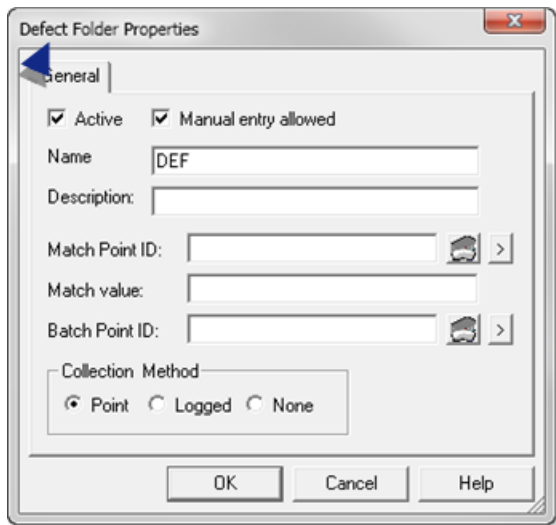

7.2. SPC Defect Group: Properties

The Defect Folder Properties dialog box identifies the group of defect categories that will be included on one Pareto chart.

Information you enter here applies to every defect category in the group.

Defect folder properties are as follows.

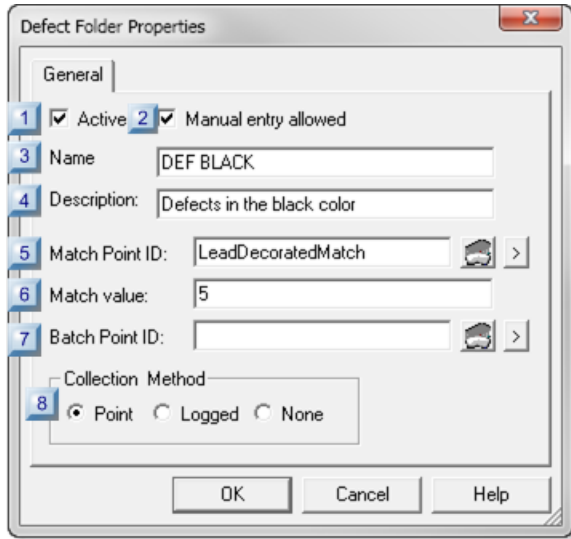

rect 11, 238, 33, 258 ([page 568](#))

rect 1, 200, 23, 220 ([page 568](#))

rect 0, 170, 22, 190 ([page 568](#))

rect 1, 146, 23, 166 ([page 567](#))

rect 0, 113, 22, 133 ([page 567](#))

rect 1, 83, 23, 103 ([page 567](#))

rect 74, 60, 96, 80 ([page 567](#))

rect 0, 60, 22, 80 ([page 567](#))

1 (page 567)	Active
2 (page 567)	Manual entry allowed
3 (page 567)	Name
4 (page 567)	Description
5 (page 567)	Match Point ID

6 (page 568)	Match value
7 (page 568)	Batch Point ID
8 (page 568)	Collection Method

1	Active
---	--------

Does the following.

Checked	Activates data collection for the defect group.
Clear	De-activates data collection for the defect group.
Default	Checked

2	Manual entry allowed
---	----------------------

Enables or disables manual data entry.

Do one of the following.

Check/Clear	Manual data entry for SPC chart sets at runtime is:
Check	Enabled
Clear	Disabled

3	Name
---	------

Identifies the product's defect group that will be measured

Default	DEF
---------	-----

Note: The maximum length is 10 characters.

4	Description
---	-------------

Provides details to clearly identify the defect group.

 **Note:**

- The description displays in the SPC Configuration window list.
- The maximum length is 40 characters.

5	Match Point ID
---	----------------

Provides one data source to Identify for which of product characteristics data should be collected.

Point type	Integer
------------	---------

Note: The same or different match point can be used for attributes, variables and defects.

6	Match value
---	-------------

Match point value that directs the selected SPC chart to collect data for the selected defect group.

! **Important:** During runtime, the Match point value must be the value entered in the **Match value** field for collection to occur. If the Match point value is different from the value entered for the selected variable, the selected SPC chart will report that there is not enough data available for it to be created.

Example

A match value to collect data for the finished decorated a black color defect group is 5.

Data for the black color defect is or is not collected if the selected Match point value is as follows.

Collection	Match Value equals:
Is collected	5
Is not collected	Anything other than 5

7	Batch Point ID
---	----------------

(For a batch process) Distinguish between different batches for the same color defect.

📄 Note: The value of the Batch Point is associated with the calculated data and can be used as search criteria for charts and reports

8	Collection Method
---	-------------------

Specifies the:

- Data source for the defect group.
- Corresponding input fields in the Collection tab of the Defect Properties dialog box for each category in the defect group.

All Defect Categories in this Defect folder will use the collection method selected for the folder.

Available collection methods are:

Point	Retrieves data from CIMPLICITY point values.
-------	--

Logged	Retrieves data from one or more ODBC database tables.
None	No data will be collected by the SPC Data Collector. Note: The Manual entry allowed box is checked by default.

7.3. SPC Defect Category: Add a Category

Within a defect folder, you can create one or more defect categories that define the defect characteristics.

Note: A bar on the Pareto chart represents each defect category.

1. Select a defect folder in the SPC Configuration window left-pane.
2. Do one of the following.

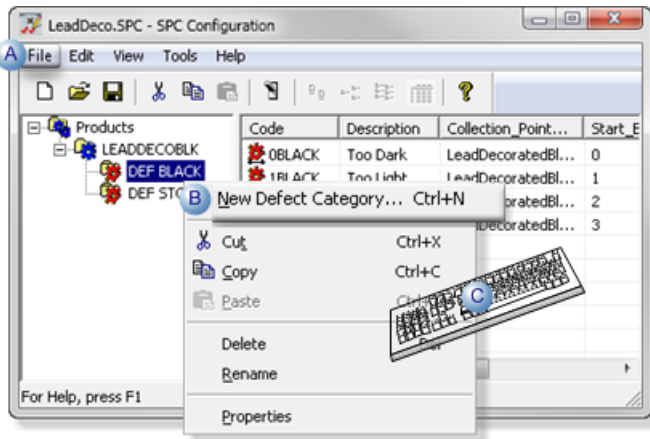

A	Click File>New>Defect Category on the SPC Configuration window menu bar.
B	Right-click the selected product; select New Defect Category on the Popup menu.
C	Press Ctrl+N on the keyboard.

A Defect Properties dialog box opens.



7.4. SPC Defect Category: General Properties

The General tab in the Defect Properties dialog box identifies the defect.

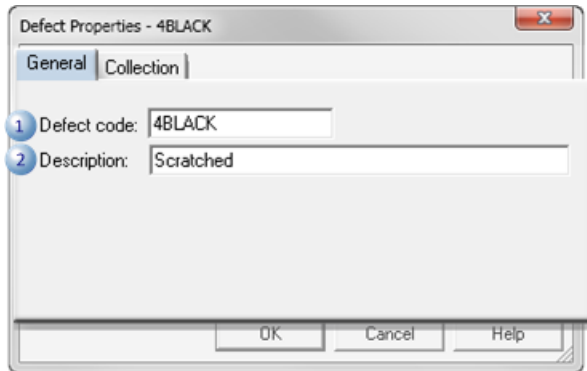

1	Defect code	Selected defect identification.	
		Maximum length	6 characters
2	Description	Describes exactly what the defect is. Example A defect's: <ul style="list-style-type: none"> • Category is the lead's BLACK color. • Type is Scratched. • Code 4BLACK will be applied to all leads that are scratched. 	
		Maximum length	40 characters

7.5. SPC Defect Category: Collection Properties

The Collection tab in the Defect Properties dialog box provides details about the collection source that was [selected \(page 568\)](#) in the Defect Folder Properties dialog box.

The three collection methods are:

- Point (Live data)
- Logged
- None

Point

Specifications for point value collection are as follows.

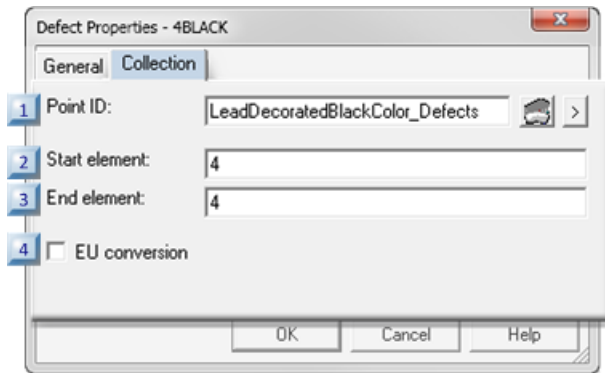

rect 0, 140, 21, 164 ([page 572](#))

rect 0, 110, 21, 131 ([page 571](#))

rect 0, 86, 21, 107 ([page 571](#))

rect 0, 53, 21, 74 ([page 571](#))

1 (page 571)	Point ID
2 (page 571)	Start element
3 (page 571)	End element
4 (page 572)	EU conversion

1	Point ID
---	----------

Identifies the point data source from which the SPC Data Collector retrieves defect property values.

Point type	Analog (with enough array elements to include the defect properties in the group).
------------	--

guide: Guideline: Defect groups generally include more than one property. Each property is an element in the array point.

2	Start element
---	---------------

(If the Point ID is an array point) Identifies the element number in point array to start collection.

Default	0
---------	---

3	End element
---	-------------

(If the Point ID is an array point) Identifies the element number in point array to end collection.

Default	0
---------	---

4	EU conversion
---	---------------

Selects between EU and raw values for the point measurement unit..

Check or clear, as follows.

Check/Clear	The SPC Data Collector will use:
Check	EU value(s) for the point.
Clear	Raw value(s) for the point

Logged

Retrieves data from an ODBC database table. Define the ODBC data source, table and column names.

Specifications for logged value collection are as follows.

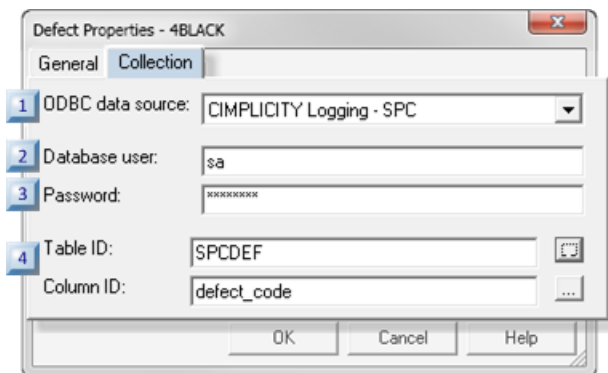

rect 1, 146, 21, 168 [\(page 573\)](#)

rect 0, 107, 20, 123 [\(page 573\)](#)

rect -1, 82, 19, 101 [\(page 573\)](#)

rect -1, 47, 19, 70 [\(page 573\)](#)

1 (page 573)	ODBC data source
2 (page 573)	Database user
3 (page 573)	Password
4 (page 573)	Table ID/Column ID

1	ODBC data source
---	------------------

Selects the database from which SPC will retrieve data.

2	Database user
---	---------------

Identifies the valid user name when logging into the ODBC data source.

3	Password
---	----------

Identifies the required user password for logging into the ODBC data source.

4	Table ID/Column ID
---	--------------------

Selects the database table and column from which logged data will be retrieved.

Click the Browse button to the right of the **Table ID** or **Column ID** fields.

The table and column that are selected in the Select a Table/Column browser will be entered in the **Table ID/Column ID** fields.

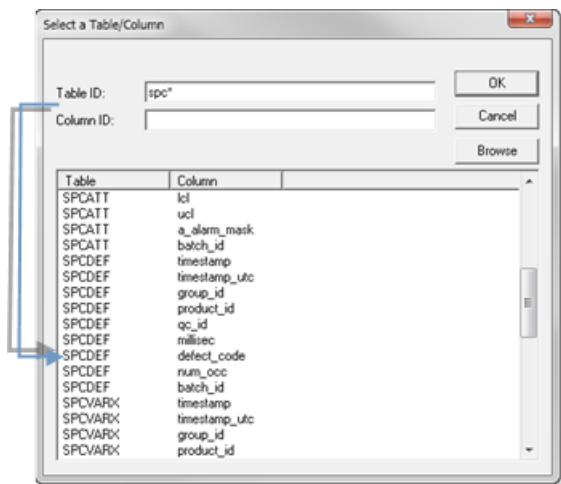

None

If None is checked for the collection method in the Defect Folder Properties dialog box, the Collection tab in the Defect Properties dialog box is blank.

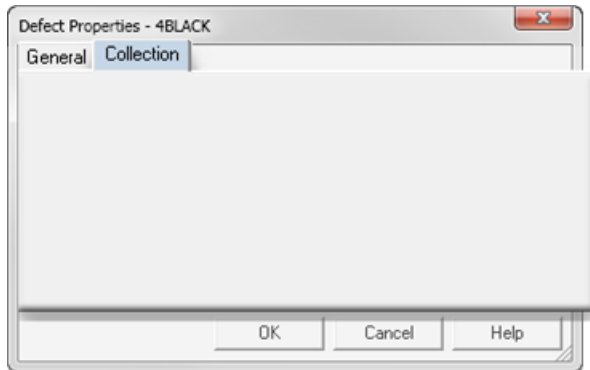

SPC Control: Configuration

SPC Control: Configuration

! **Important:** The CIMPLICITY project must be running in order to connect the chart with SPC data.

1 (page 575)	SPC Control: Insert in CimEdit.
2 (page 576)	SPC Control: Open an SPC Control Properties dialog box.
3 (page 577)	SPC Control: General properties.
4 (page 580)	SPC Control: Chart properties.
5 (page 580)	SPC Control: Line display.
6 (page 581)	SPC Control: Axis display.
7 (page 582)	SPC Control: Bar chart.
8 (page 585)	SPC Control: Report.

[9](#)
(page
588)

SPC Control: Annotation.

1. SPC Control: Insert in CimEdit

After you create your ODBC data source and configure your SPC data collection, you can configure SPC ActiveX controls in CimEdit/CimView screens or other ActiveX containers, such as Internet Explorer, to display your SPC data.

- SPC button.
- OLE button.

SPC Button

Click SPC on the in the Drawing>Objects group on the CimEdit Ribbon bar.



Result: An SPC control is placed on the CimEdit screen. The top left corner is located at the top left corner of the screen.

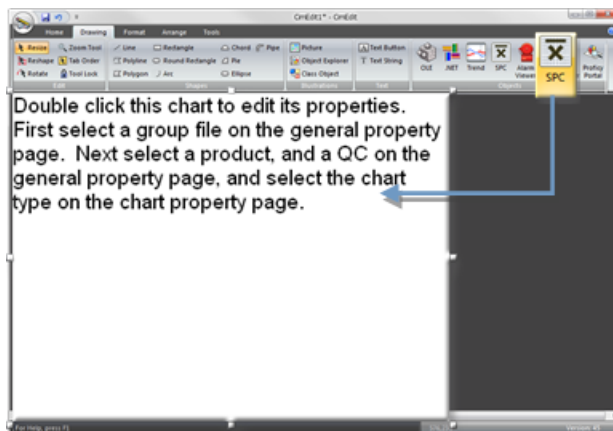

OLE Button

1. Click OLE on the in the Drawing>Objects group on the CimEdit Ribbon bar.

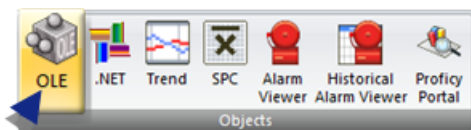

An ActiveX Placement cursor  displays on the CimEdit screen.

2. Place the ActiveX Placement cursor where you want the top left corner of the control to be located.

The Insert Object dialog box opens.

3. Select the CIMPLICITY SPC Control in the ActiveX list.

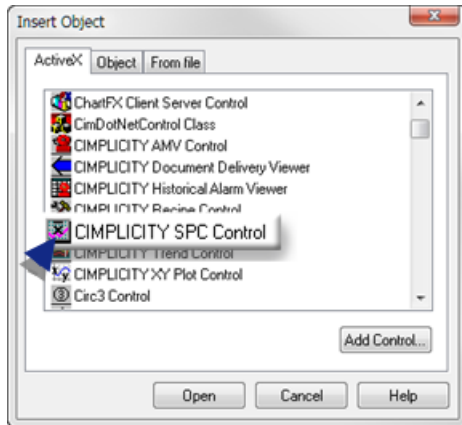

4. Click **OK**.

A new SPC Control is placed at the position you selected in your CimEdit screen. The SPC control initially is empty and displays a message for editing the control.

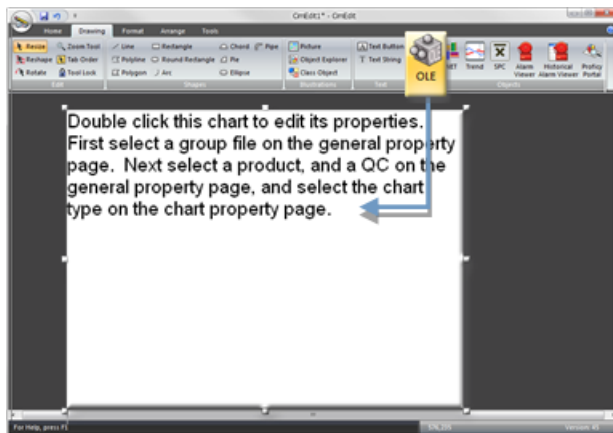

2. SPC Control: Open an SPC Control Properties Dialog Box

1. Make sure the CIMPLICITY project is running.

2. Right-click the SPC Control object.
3. Select SPC Control Object>Properties on the Popup menu.

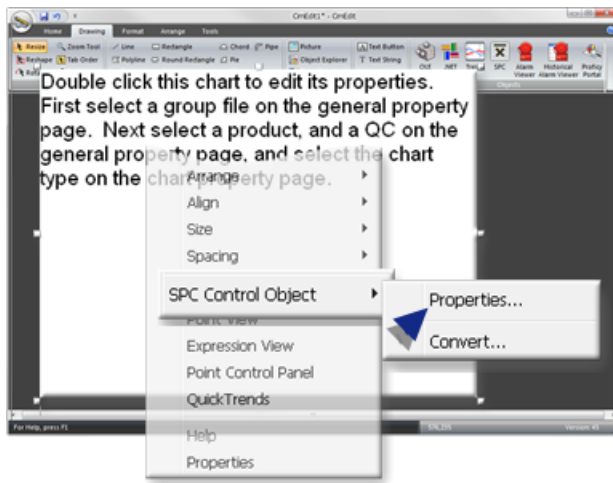

An SPC Control Properties dialog box opens.

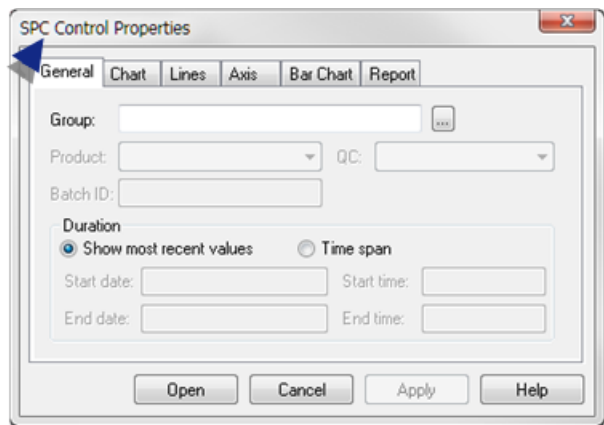

3. SPC Control: General Properties

The General tab in the SPC Control Properties dialog box identifies the quality characteristic that will be charted and the time the tests will be run.

Options are as follows.

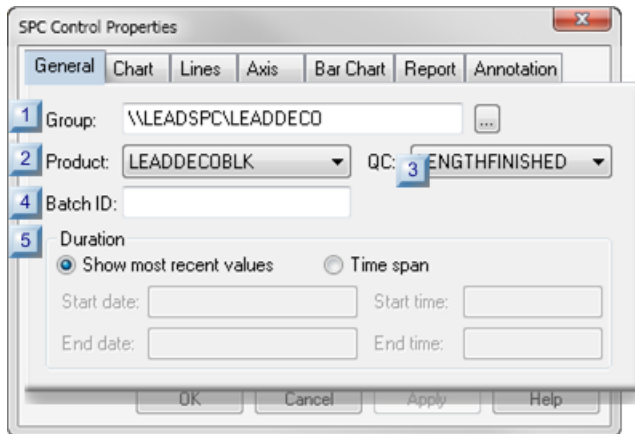

rect 0, 137, 22, 156 [\(page 579\)](#)

rect 0, 113, 22, 132 [\(page 579\)](#)

rect 242, 91, 264, 110 [\(page 579\)](#)

rect 1, 86, 23, 105 [\(page 579\)](#)

rect 1, 58, 23, 77 [\(page 578\)](#)

1 (page 578)	Group
2 (page 579)	Product
3 (page 579)	QC
4 (page 579)	Batch ID
5 (page 579)	Duration
6 (page 580)	Chart date/time format

1	Group
---	-------

Identifies the project and SPC document that will be applied to the chart.

Group	Qualified path to project\SPC Document (page 502)
-------	--

Click the Browse button to the right of the **Group** field.

A Select an SPC Group browser opens; search options include the following.

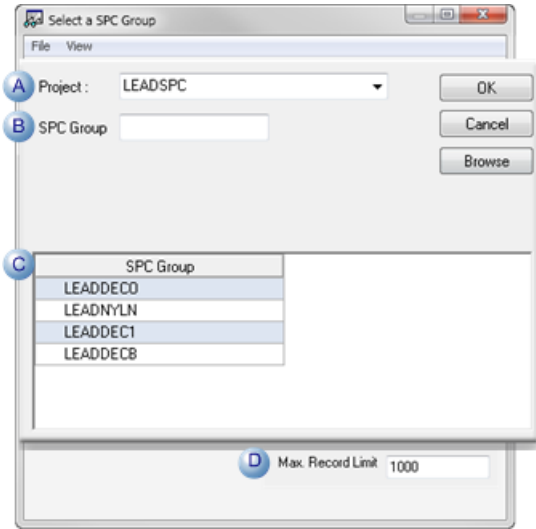

A	Project	Available SPC projects
B	SPC Group	Group name or search criteria for a group.
C	SPC Group	Groups found by browsing.
D	Max. Record Limit	Maximum number of found groups that will be listed.

2	Product
---	---------

Provides a drop down list of the products created for the selected SPC document (group).

3	QC
---	----

Provides a drop down list of all quality characteristics (variables, attributes and defects) that were configured for the selected product.

Note: Your selection determines what charts will be available.

4	Batch ID
---	----------

Text that identifies the batch process to be examined. The chart will display only those points where the content of the Batch Point ID matches this identifier.

5	Duration
---	----------

Options are:

Show most recent values	Displays the most recent values collected in the chart. Note: The number of values that display is specified on the Chart tab	
Time span	Start time and date and the ending time and date to collect data to be displayed on the chart. The format is:	
	Start date/End date	MM/DD/YYYY

	Start time/End time	HH:MM:SS AM/PM
--	---------------------	----------------

6	Chart Date/Time Format
---	------------------------

SPC uses the short date style.

To change the date/time format of that style on a chart, use the Regional Settings option on your Windows Control Panel.

! Important: If data has been logged to a SQL database in a selected time zone and that time zone is changed, SPC continues to display the timestamp from the original time zone.

4. SPC Control: Chart Properties

1. Click the Font button.
A Font dialog box opens.
2. Select the **font/style/size** to be used for the title.

5. SPC Control: Line Display

The SPC Control Properties dialog box>Lines tab enables you to select whether to display/hide each of the control lines and zones.

Check each line type or zone that should display on the chart.

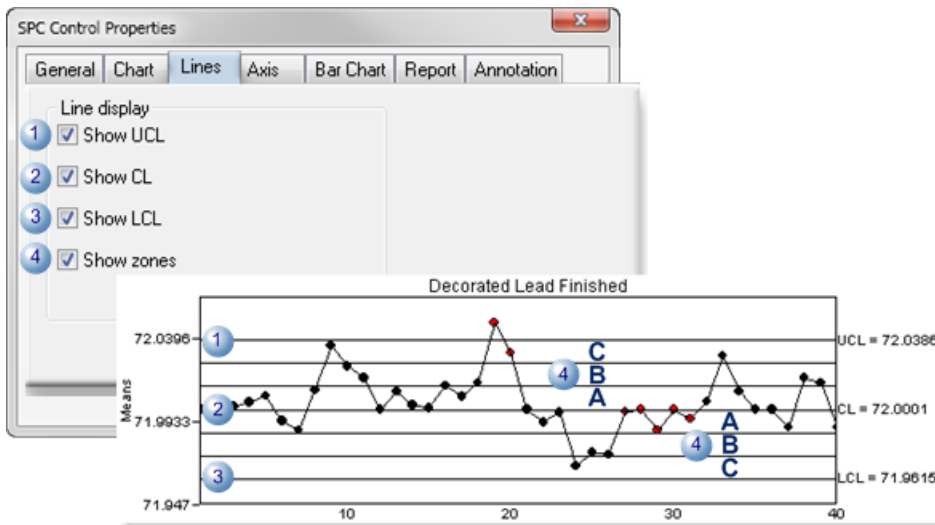

1	UCL	Upper Control Limit
2	CL	Center Line

3	LCL	Lower Control Limit
4	Zones	A, B, C

Notes

Zones are as follows.

Zone	Area
C	Up to one standard deviation from the center line.
B	Between one and two standard deviations from the center line.
A	Between two and three standard deviations from the center line.

In general, a control chart consists of the center line corresponding to the average value at which the quality characteristic should perform, and lines corresponding to the upper and lower control limits for the characteristic. The upper and lower control limits are also referred to as the upper and lower three-sigma control limits.

6. SPC Control: Axis Display

The Axis tab in the SPC Control Properties dialog box enables you to select whether to display/hide each axis title and/or labels and configure the title and label fonts.

Options are:

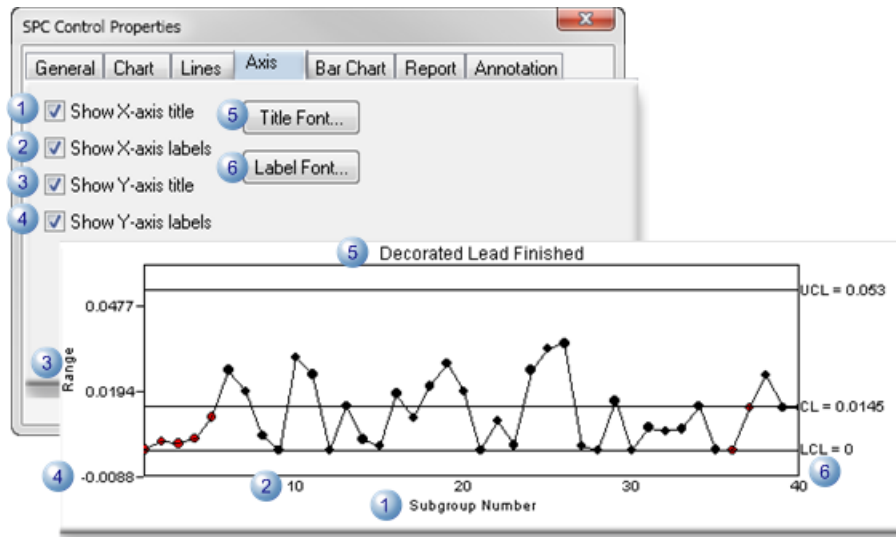

1	Show X-axis title	Displays the title under the X-axis labels. Note: If the chart is an XBar-R or XBar-S chart, the title displays under the axis labels for the Range or Sigma Chart.
2	Show X-axis labels	Displays the X-axis labels under each chart.

3	Show Y-axis title	Displays the title to the left of each chart
4	Show Y-axis labels	Displays
5	Title Font button	Opens the Font dialog box to configure the font for the chart's title.
6	Label Font button	Opens the Font dialog box to configure the font for the X-axis and Y-axis labels.

7. SPC Control: Bar Chart

Display options are available for **Histograms** and **Pareto** charts on the Bar Chart tab in the SPC Control Properties dialog box.

The chart that is selected on the Chart tab will be enabled.

- Histograms
- Pareto Charts

Histogram Charts

The **Histogram** chart is available for **Variable** properties. It is particularly valuable when setting up/adjusting your system and determining appropriate specification limits for the process.

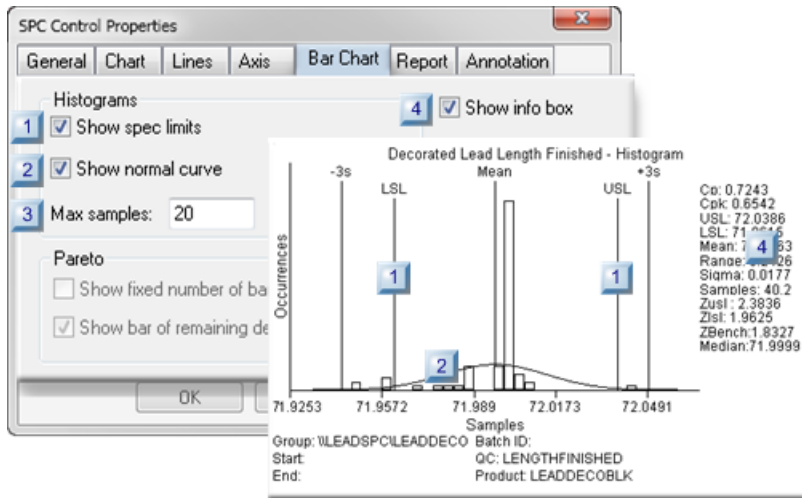

- rect 460, 139, 482, 161 [\(page 584\)](#)
- rect 244, 52, 266, 74 [\(page 584\)](#)
- rect 2, 117, 24, 139 [\(page 584\)](#)
- rect 1, 92, 23, 114 [\(page 583\)](#)
- rect 259, 213, 281, 235 [\(page 583\)](#)
- rect 370, 159, 392, 181 [\(page 583\)](#)
- rect 230, 157, 252, 179 [\(page 583\)](#)
- rect 1, 63, 23, 85 [\(page 583\)](#)

1 (page 583)	Show spec limits.
2 (page 583)	Show normal curve
3 (page 584)	Max samples
4 (page 584)	Show info box

[1](#) Show spec limits

Displays/hides the specification limits (USL/LSL).

Check	Displays the specification limits.
Clear	Hides the specification limits.

[2](#) Show normal curve

Displays/hides a normal distribution curve.

Check	Displays a normal distribution curve
Clear	Hides the normal distribution curve.

3	Max samples
---	-------------

Maximum number of samples that will be used to create the curve.

 **Note:**

- The samples that are selected are based on the:

o (page 579)	Duration selection on the General tab in the SPC Control Properties
o (page 524)	Sampling parameters selected in the General tab in the Variable Quality Characteristics Properties dialog box.

- The actual number of samples may be slightly larger than the entered number. For example, if 40 is entered, the actual number of samples may be 40.2.

4	Show info box
---	---------------

Displays/hides a list of values calculated for the Histogram.

Check	Displays the info list.
Clear	Hides the info list.
<p> Note:</p> <p>The information/values that display are:</p> <ul style="list-style-type: none"> • Cp metrics • Cpk metrics • USL (Upper Specification Limit) • LSL (Lower Specification Limit) • Mean • Range • Sigma • Samples (Number included in calculations) • Zusi score • Zlsl score • ZBench score • Median 	

Pareto Charts

The **Pareto** chart provides a visual gage of the number of selected **Defects** that occur in the process. Visual aids can be selected, as follows.

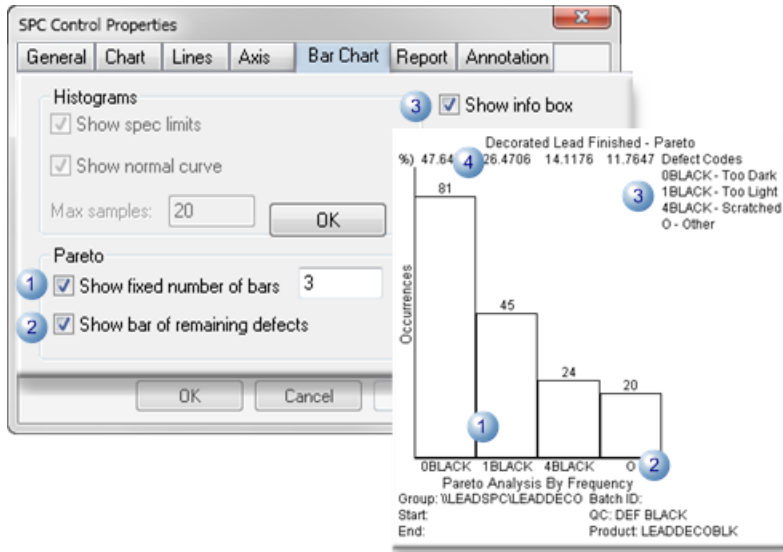

1	Show fixed number of bars	Check or clear to do the following.	
		Check	Displays the number of bars entered in the field.
		Clear	Displays the number of bars for all defects that have values greater than 0.
2	Show bar of remaining defects	Displays a bar that: <ul style="list-style-type: none"> • Reports the total of all defects that are not included in the defect categories for the bars that display in the chart. • Is labelled O (for English systems). 	
3	Show info box	Displays/hides a list of defect names/descriptions that are included in the Pareto chart.	
		Check	Displays the info list.
		Clear	Hides the info list.

8. SPC Control: Report

Checked fields on the SPC Control Properties dialog box>Report tab display as columns in the selected report.

Fields in each of the three columns on the SPC Control Properties>Report tab are enabled/disabled based on whether the quality characteristic is a variable or attribute.

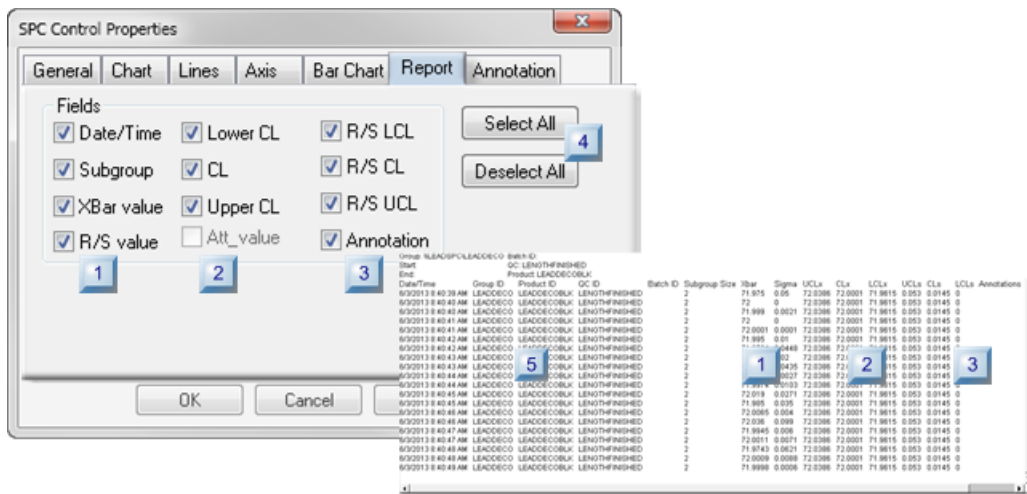

- rect 315, 210, 339, 236 ([page 587](#))
- rect 348, 69, 372, 95 ([page 587](#))
- rect 589, 209, 613, 235 ([page 587](#))
- rect 210, 153, 234, 179 ([page 587](#))
- rect 525, 210, 549, 236 ([page 587](#))
- rect 120, 154, 144, 180 ([page 587](#))
- rect 46, 153, 70, 179 ([page 586](#))
- rect 461, 209, 485, 235 ([page 586](#))

1 (page 586)	Fields: Column 1.
2 (page 587)	Fields: Column 2.
3 (page 587)	Fields: Column 3.
4 (page 587)	Buttons.
5 (page 587)	Report: Quality Characteristic Description Columns

1	Fields: Column 1
---	------------------

The first column includes the following fields.

Field	Description	Variable	Attribute
		Enabled for:	
Date/Time	Value date/time: MM/DD/YYYY HH:MM:SS AM/PM	Yes	Yes

Field	Description	Variable	Attribute
Subgroup	Size entered on the SPC Document General tab	Yes	Yes
XBar value	XBar/R or XBar/S variable value	Yes	No
R/S value	Range (XBar/R) or Sigma (XBar/S) variable value	Yes	No

2	Fields: Column 2
---	------------------

The second column includes the following fields.

Field	Description	Variable	Attribute
		Enabled for:	
Lower CL	Lower Control Limit value	Yes	Yes
CL	Center line value	Yes	Yes
Upper CL	Upper Control Limit value	Yes	Yes
Att_value	Attribute value	No	Yes

3	Fields: Column 3
---	------------------

The third column includes the following fields.

Field	Description	Variable	Attribute
		Enabled for:	
R/S LCL	Range or Sigma Lower Control Limit	Yes	No
R/S CL	Range or Sigma Center line	Yes	No
R/S UCL	Range or Sigma Upper Control Limit	Yes	No
Annotation	Annotations entered for selected values	Yes	Yes

4	Buttons
---	---------

Buttons are available to do the following.

Select All	Checks all of the check boxes available for the selected chart type.
Deselect All	Clears all of the check boxes.

5	Report: Quality Characteristic Description Columns
---	--

The following columns are not optional. They display even if all the check boxes have been deselected.

Field	Description
Group ID	Group the QC is included in
Product ID	Product being tested
QC ID	Quality Characteristic ID
Batch ID	If a batch is used the batch ID; the column displays with no values if a batch is not being used.

9. SPC Control: Annotation

SPC enables users whose [role \(page 492\)](#) has been assigned access to enter comments (annotations) about one or more values that display on the charts.

The SPC Control Properties dialog box>Annotation tab enables you to specify colors that can help users quickly see what subgroups have annotations

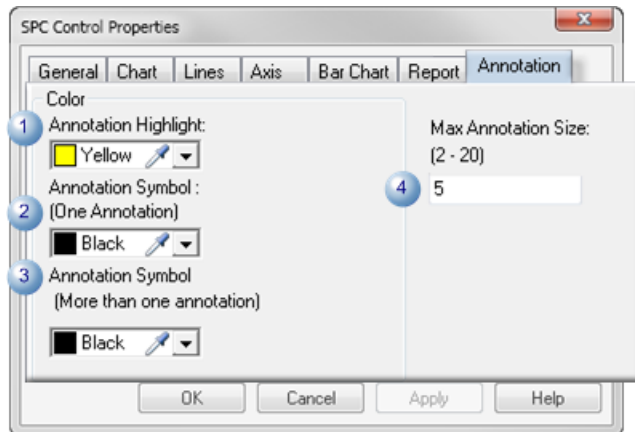

1 (page 599)	Annotation Highlight	The subgroup that represents the value on the SPC chart displays the Annotation highlight color when that subgroup is selected to display its existing annotations or to be assigned a new annotation.
2 (page 599)	Annotation Symbol: One annotation	A light weight circle will display around subgroups that have one annotation; the circle will display in the selected color.
3 (page 599)	Annotation Symbol: More than one annotation	A heavy weight circle will display around subgroups that have two or more annotations; the circle will display in the selected color.

4 (page 602)	Max Annotation Size	Each subgroup value on a chart (page 602) can have the maximum number of annotations specified in the Max Annotation Size field. The maximum number can be 2 through 20 annotations.	
		Default	5
		Note: If a user attempts to enter more than the specified number of annotations, a message will open to explain that the limit was exceeded.	

SPC Runtime

SPC Runtime

CIMPLICITY SPC provides many runtime features that enable users to evaluate chart results.

Features include the following.

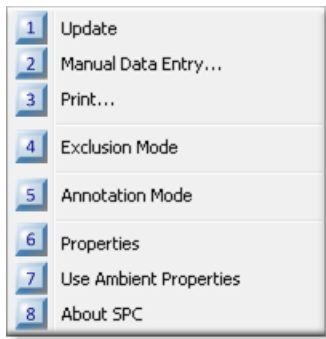

- rect 4, 182, 25, 202 [8. SPC Runtime: About SPC \(page 608\)](#)
 rect 4, 160, 25, 180 [7. SPC Runtime: Ambient Properties \(page 607\)](#)
 rect 4, 135, 25, 155 [6. SPC Runtime: Properties \(page 607\)](#)
 rect 4, 107, 25, 127 [5. SPC Runtime: Annotation \(page 598\)](#)
 rect 4, 78, 25, 98 [4. SPC Runtime: Exclusion Mode \(page 595\)](#)
 rect 4, 48, 25, 68 [3. SPC Runtime: Print \(page 594\)](#)
 rect 4, 25, 25, 45 [2. SPC Runtime: Manual Data Entry \(page 592\)](#)
 rect 4, 3, 25, 23 [1. SPC Runtime: Update \(page 591\)](#)

1 <i>(page 591)</i>	SPC Runtime: Update
2 <i>(page 592)</i>	SPC Runtime: Manual Data entry
3 <i>(page 594)</i>	SPC Runtime: Print
4 <i>(page 595)</i>	SPC Runtime: Exclusion Mode
5 <i>(page 598)</i>	SPC Runtime: Annotation Mode
6 <i>(page 607)</i>	SPC Runtime: Properties
7 <i>(page 607)</i>	Use Ambient Properties
8 <i>(page 608)</i>	SPC Runtime: About SPC

1. SPC Runtime: Update

1. Right-click the chart to be updated.
2. Select Update on the Popup menu.

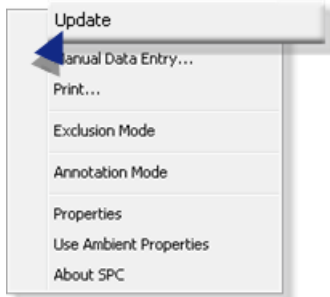

The chart is updated with the most recent data.

2. SPC Runtime: Manual Data Entry

If Manual entry allowed was checked in a selected feature's SPC Configuration window>Properties dialog box, it is available during runtime.

<p>1 (page 592)</p>	<p>Open a Manual Data Entry dialog box.</p>
<p>2 (page 593)</p>	<p>Enter data manually.</p>

Manual Data Entry: Open a Manual Data Entry Dialog Box

1. Right-click an SPC chart.
2. Select Manual Data Entry on the Popup menu.

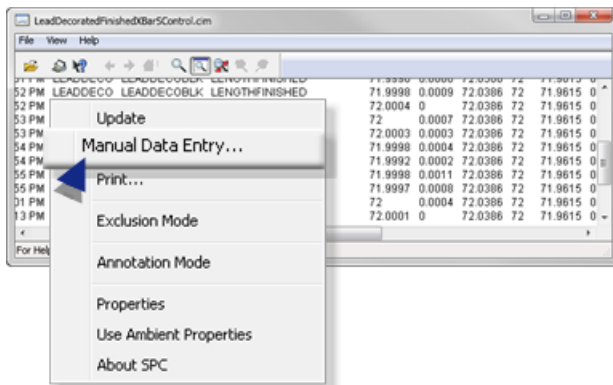

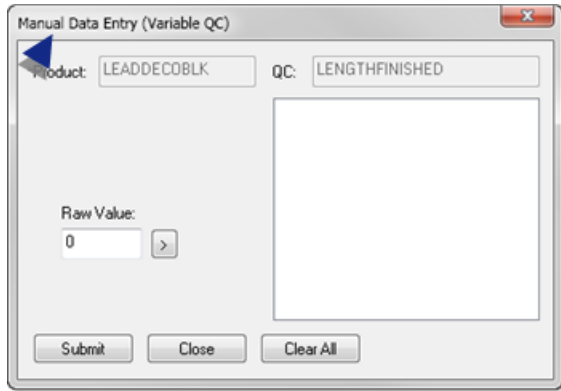

A Manual Data Entry dialog box opens.

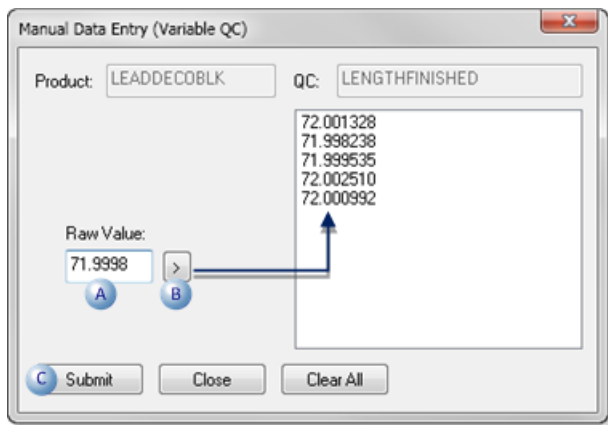

1. Enter Data Manually

Do the following.



A	Raw Value field	Enter a value.
B		Click the Entry button. The entered value is added to the manual entry list.
C		Click the Submit button.

Result: SPC:

1. Groups the values into samples.

The sample (subgroup) size was entered on the

- Variable Quality Characteristics dialog box>General tab.
- Attribute Quality Characteristics dialog box>Collection tab.

2. Calculates the sample value.

Note: If individual values remain in the list, after SPC creates the subgroups, those individual values will not be applied to the chart.

Example

Five manual entries are listed in the Manual Data Entry dialog box when the Submit button is clicked.

- The subgroup size is 2.
- SPC:
- Creates two subgroups the first four values.
- Ignores the fifth value.

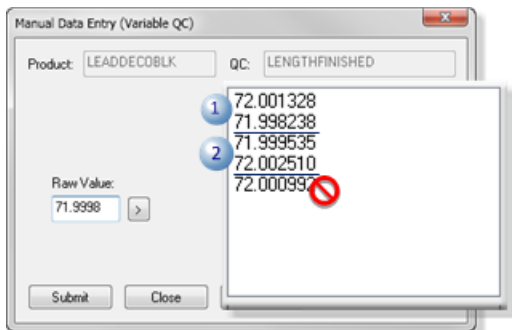

- Adds the two subgroup values to the chart.

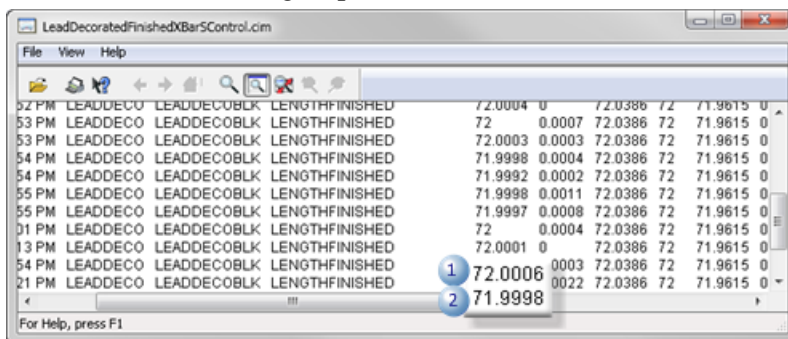

3. SPC Runtime: Print

1. Right-click the chart to be printed.
2. Select Print on the Popup menu.

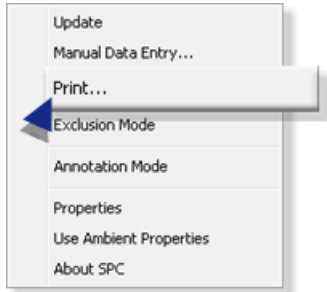

A Print dialog box that lists the available printers opens.

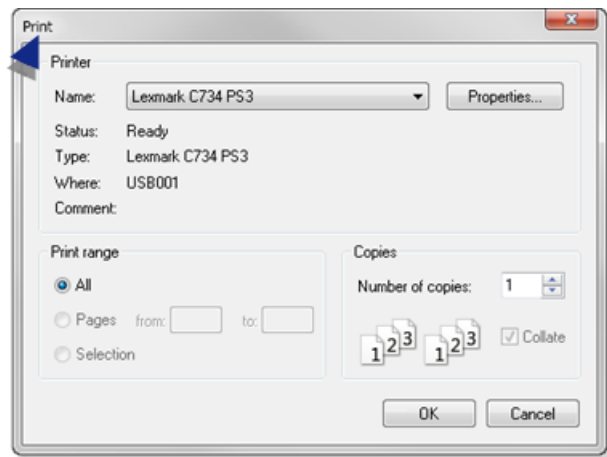

3. Make any necessary adjustments to the selected printer.

4. Print the chart.

4. SPC Runtime: Exclusion Mode

A process must be in control when you determine its control limits. Some values (e.g. values collected when a machine is warming up or when a cutter is being recalibrated) contaminate the results. CIMPLICITY SPC includes the Exclusion mode so those values can be excluded from the calculations.

! Important: When calculating control limits, variation must be due to common causes only. Variation cannot be attributable to special causes or control limits are not valid.

SPC Exclusion Mode is enabled on the following chart types:

Variable	Attribute
XBar-R	P
XBar-S	nP

Variable	Attribute
	C
	U

1 (page 596)	Detect explained erratic values.
2 (page 596)	Enable exclusion mode.
3 (page 597)	Exclude values.

Detect Explained Erratic Values

A chart with normally consistent values can show deviations for known reasons (e.g. a cutter was being re-calibrated while product was being cut and finished).

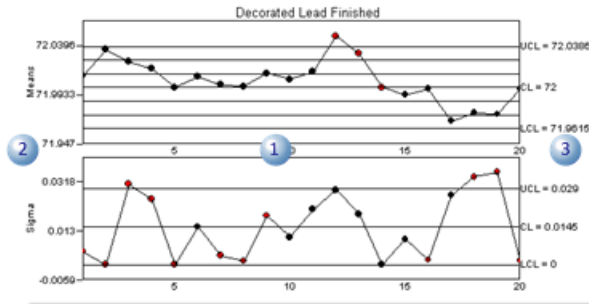

1	Charts report values that deviate from the targeted product length of 72 inches.
2	Auto-calculated means and upper/lower sample values.
3	UCL/CL/LCL values are were entered in the variable's Variable Quality Characteristics Properties dialog box>Limits tab.

Enable Exclusion Mode

1. Right-click the mouse a chart
2. Select Exclusion Mode on the Popup menu.

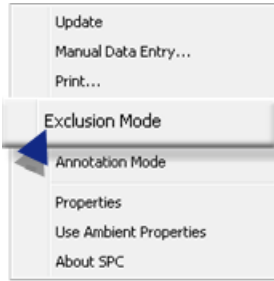

Result: The chart goes into Exclusion mode; the ability to exclude values is enabled.

Exclude Values

When values that are normally consistent deviate from the norm for known reasons, they can be excluded from SPC calculations.

Example

Values on a chart that are normally flat increase in value; the change is known to be a temporary machine adjustment.

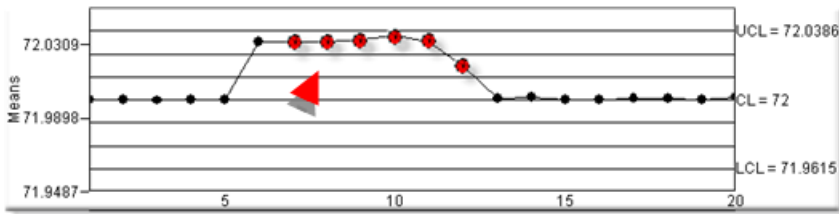

The chart is put into Exclusion mode.

Note: An **X** in the upper-left corner indicates that the chart is in Exclusion mode.

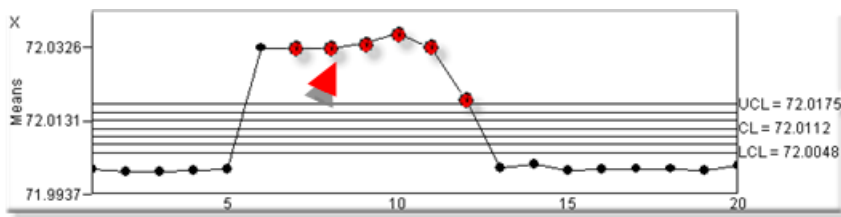

An **X** replaces the value. The X will be red if the value has failed one or more tests.

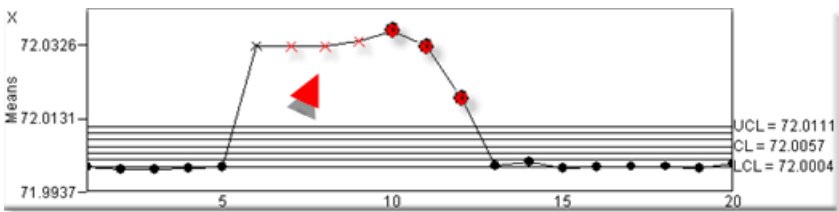

The X'd values are not included in the calculation; they may go beyond the new chart limits.

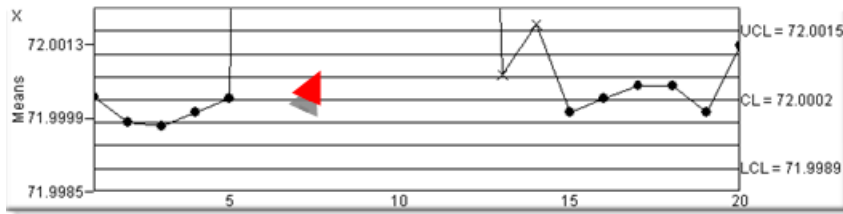

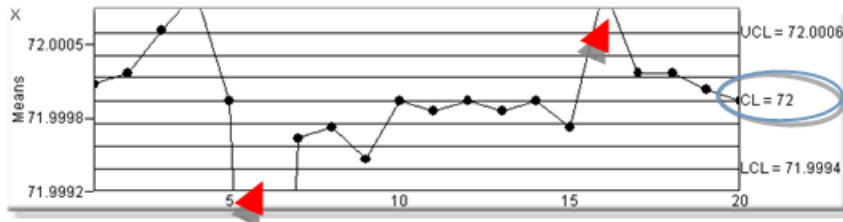

As the chart runs in Exclusion mode additional values may be X'd out.

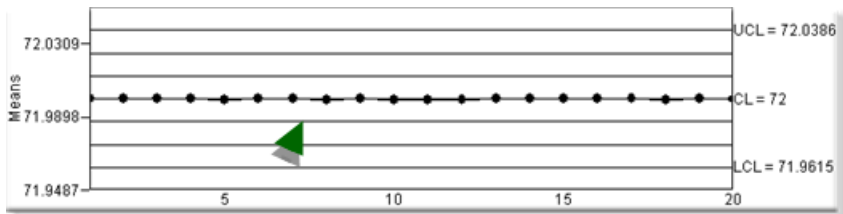

Once you leave Exclusion mode and return the previously excluded values are again included in the sampling/calculations.

If the out of control values were a temporary, known reason, the process will again be in control.



 **Note:** The GetControlLimits() ActiveX method provides access to the control limits displayed on the chart.

5. SPC Runtime: Annotation

5. SPC Runtime: Annotation

SPC enables users whose [role \(page 492\)](#) has been assigned access to enter comments (annotations) about one or more values that display on the charts.

- Annotation Mode: Enabled.
- Annotation: Procedures.

Annotation Mode: Enabled

Right-click the SPC chart; select Annotation Mode on the Popup menu.

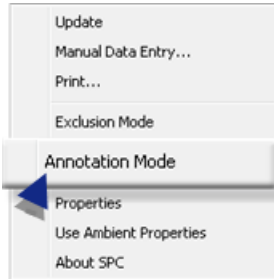

Result: SPC goes into annotation mode; one or more values can be selected to enter or review comments.

A slider follows the mouse cursor as it moves over subgroups. The subgroup value displays at the top of the slider.

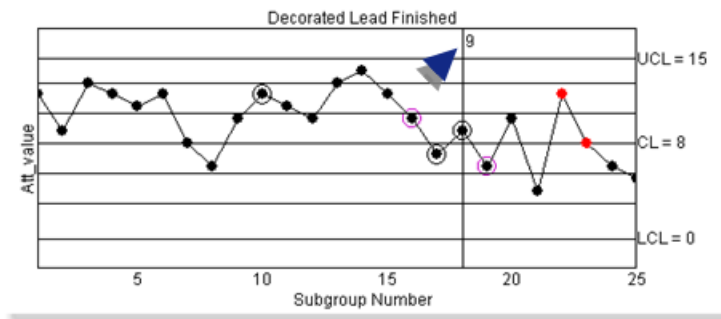

Annotation: Procedures

5.1 (page 599)	SPC Annotation: Values selected.
5.2 (page 602)	SPC Annotation: Entries.

5.1. SPC Annotation: Values Selected

Note: The chart pauses while it is in annotation mode. Values that can be selected include.

- Individual values.
- Group of values.

Individual Values





Individual values can be selected for a list of annotation ready and annotation items.

1. Double-click one or more values on the SPC chart.

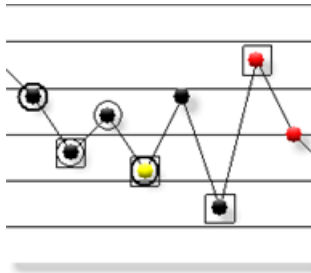
A box displays around selected values indicating that they will be listed in the Annotation Viewer.

Subgroups that display the following symbols are or have been included in an annotation session as follows.



Symbol	Description	Subgroup
	Annotation highlight.	Is selected for immediate annotation in the Annotation Viewer. Note: The subgroup displays a unique color.
	Annotation symbol: One annotation.	Has one annotation.
	Annotation symbol: More than one annotation.	Has more than one annotation
	Box surrounding subgroup.	Is selected to be listed currently in the Annotation Viewer.

 **Note: Guidelines**

- Single-click any box to remove the subgroup from being listed in the Annotation Viewer.
- Colors can be selected on the SPC Control Properties dialog box>Annotation tab, as follows.
- Annotation highlight.
- Annotation symbol: One annotation
- Annotation symbol: More than one annotation

2. Right click a selected value; select Add Annotation(s) on the Popup menu.

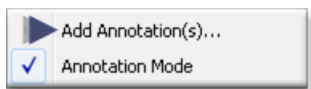

Note: Click the checked Annotation mode at any time to return to standard runtime mode.

Result: The Annotation Viewer opens listing the selected values.

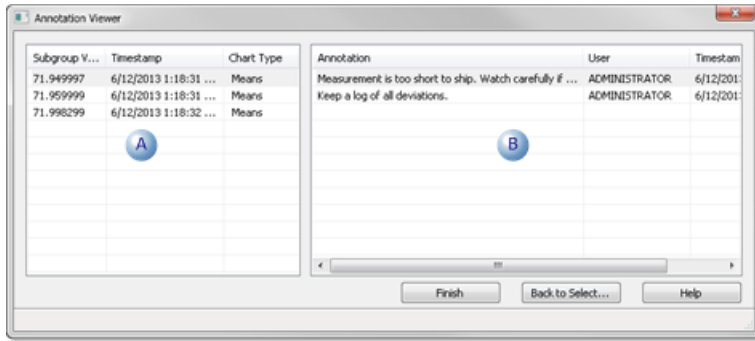

A	Values selected for annotation are listed in the left-pane. Source Information includes the following.	
	Subgroup value	Sample value
	Timestamp	Time the sample value was calculated
	Chart Type	(e.g. Means)
B	Annotation information includes the following.	
	Annotation	All or part of the annotation. Note: An Annotation dialog box can be opened to display a longer annotation.
	User	User who entered the annotation.
	Timestamp	Time the annotation was entered.

Note: Additional annotations for the same value are listed on separate lines.

Group of Values

Many values can be selected at one time for annotation.

3. Hold down the left-mouse button as you drag the mouse over the chart area with the values that should be selected.

A box displays around the selections.

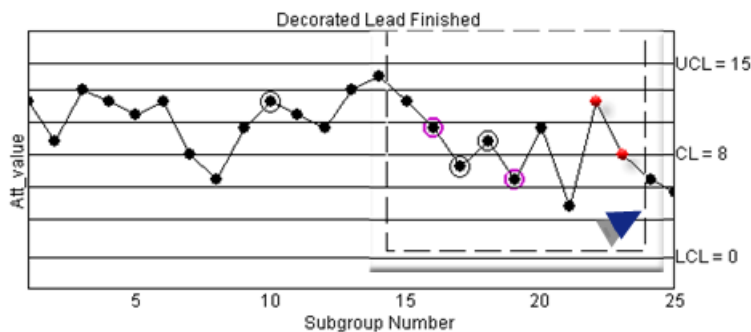

4. Release the mouse button.

Each value in the group is surrounded by a box.

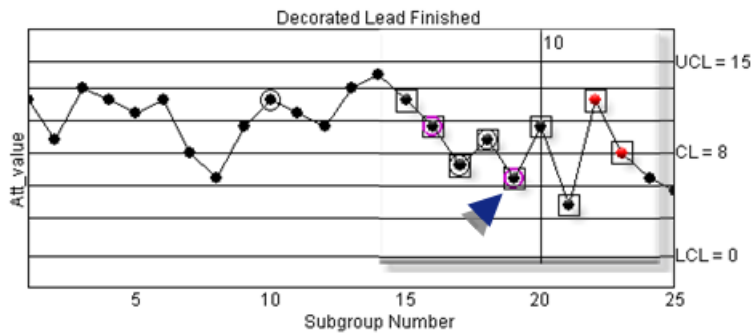

5. Right-click in the selected area; select Add Annotation(s) on the Popup menu.

The Annotation Viewer opens listing the selected values.

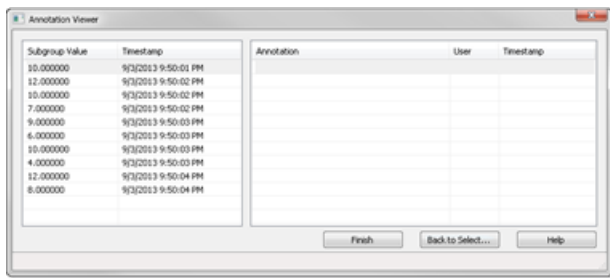

5.2. SPC Annotation: Entries

The Annotation Viewer may list one to many values, depending on what was selected.

1 (page 602)	Enter annotations.
2 (page 605)	Read annotations.

1. Enter Annotations

- Quick entry.
- Detailed entry.

! **Important:** The maximum number of annotations that can be entered for a single subgroup value is entered on the Control Properties dialog box > [Annotation tab \(page 588\)](#). If a user attempts to enter more than the specified number of annotations, a message will open to explain that the limit was exceeded.

Quick Entry

You can enter a quick annotation for a selected value directly in the Annotation Viewer.

Do the following.

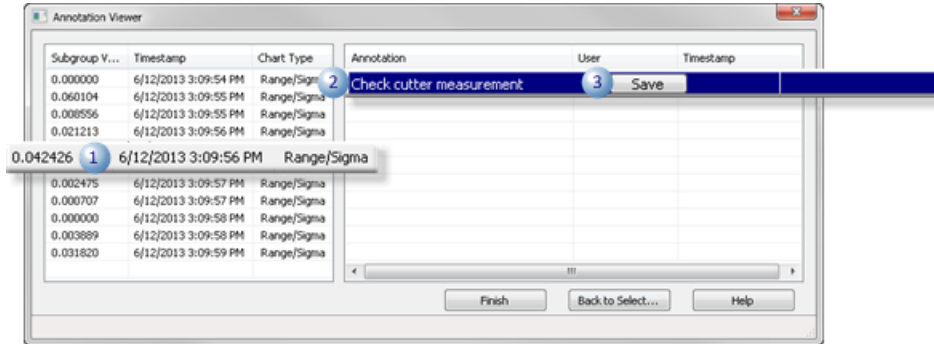

1	Select a value in the Annotation Viewer left pane.
2	Do the following.
A	Double-click the next blank line in the Annotation Viewer right-pane.
	The line becomes a read-write line. 
B	Enter the annotation. ! Important: <ul style="list-style-type: none"> The maximum number of characters for a quick entry is 255 Use the Annotation Detail dialog box to increase the annotation to a maximum of 1024 characters.
3	Do the following.
A	Press Enter on the keyboard.
	The Save button displays.
B	Click Save.

Result: The annotation is entered for the selected value.

Detailed Entry

You can enter a detailed annotation for a selected value in an Annotation dialog box.

1. Do the following.

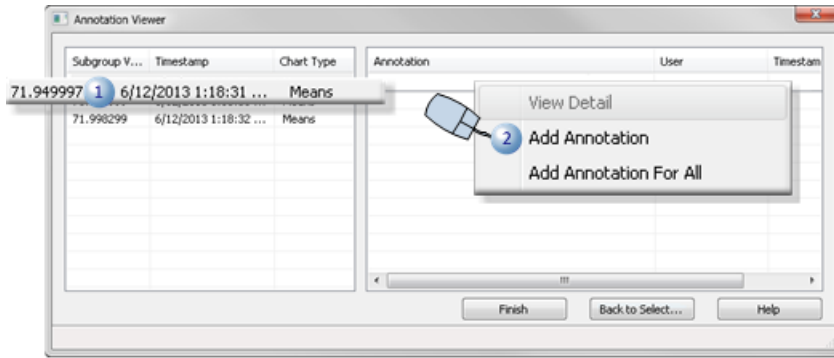

1	Select a value in the Annotation Viewer left pane.
2	Do the following.
A	Right-click the first blank row in the Annotation Viewer right-pane.
B	Select Add Annotation on the Popup menu.

An Annotation Detail dialog box opens.

2. Enter the annotation.

The fields are as follows.

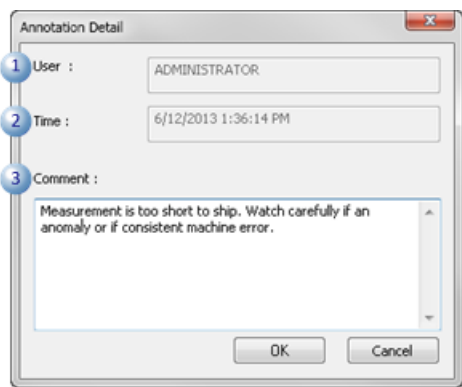

1	User	(Read only) Logged in user who is entering the annotation.
2	Time	(Read only) Time the Annotation Detail dialog box was opened.
3	Comment	(Read-write) Text box to enter a detailed annotation, if necessary. Important: Important: The maximum number of characters you can enter in the Comment box is 1024.

3. Click OK.

The Annotation Detail dialog box closes; the annotation wholly or partly (depending on the length) displays in the Annotation Viewer right-pane.

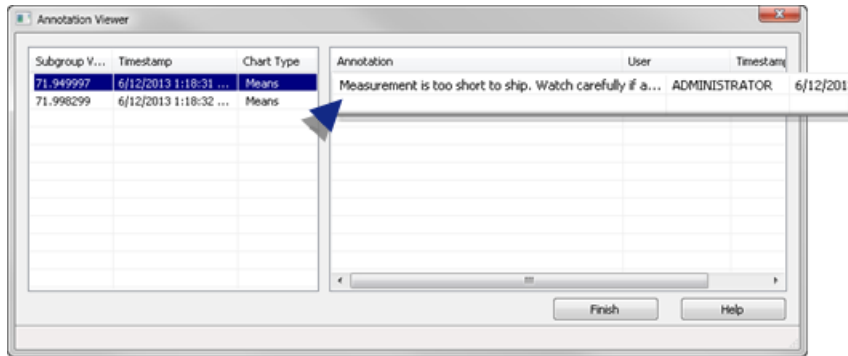

a. Read Annotations

Annotations can be read in and through the Annotation Viewer and when a value on that chart that has one or more annotations is selected.

- Annotation Viewer.
- Chart Popup message.

Annotation Viewer

You can view annotations in the Annotation Viewer as follows.

wc

1 (page 605)	Detailed annotation
2 (page 606)	Quick entry annotation

1	Detailed annotation
---	---------------------

If a detailed annotation is too long to be read on the Annotation Viewer line, do the following.

- Right-click the line with the annotation you want to read.
- Select View Detail on the Popup menu.

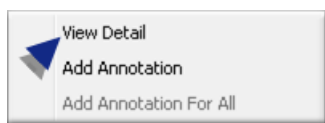

Result: A read-only Annotation Detail dialog box opens displaying the entire annotation.

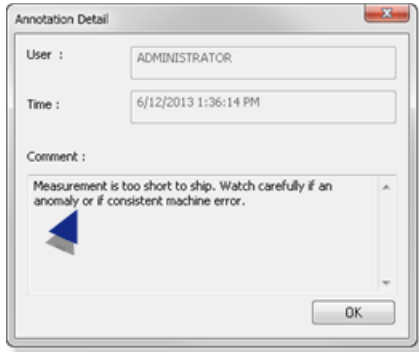

2	Quick entry annotation
---	------------------------

Annotations that were entered on a line in the Annotation Viewer are generally short enough to read on that line. However, if necessary a read-only Annotation Detail dialog box can be opened for these annotations.

Chart Popup Message

4. Hover the mouse over a value on the chart.

A Popup opens with details about the value. If there are one or more annotations, one, at least, will display on the Popup. If More annotations... is included in the Popup message,

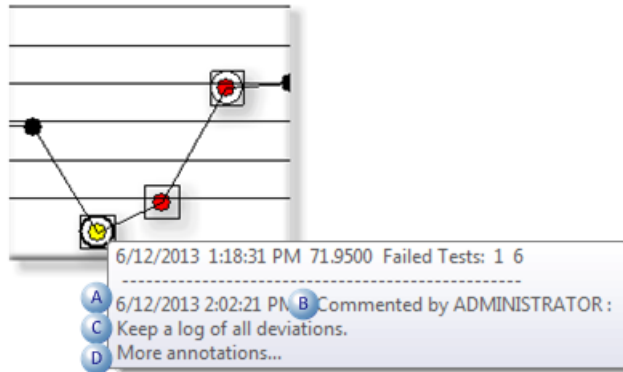

A	Date/time the annotation was entered.	
B	User who entered the annotation.	
C	The annotation related to the date/time and user.	
D	More annotations...	(If on the Popup) indicates that there are additional annotations assigned to the selected value.

5. (More annotations... is on the Popup) Right-click the selected value.

6. Select View All Annotation(s)... on the Popup menu.



The Annotation Viewer opens. All of the annotations can be read in the Annotation Viewer and/or the Annotation Detail dialog box.

6. SPC Runtime: Properties

1. Right-click the SPC chart.
2. Select Properties on the Popup menu.

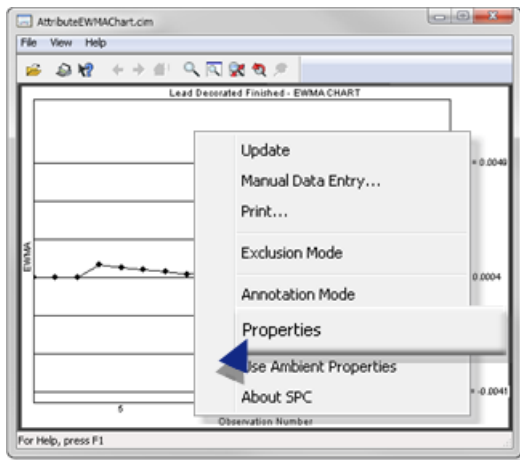

The SPC chart's Properties dialog box opens. Options that apply to the selected chart are enabled.

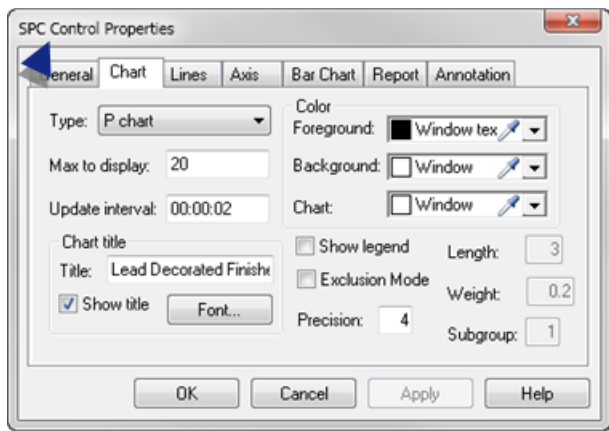

7. SPC Runtime: Ambient Properties

An SPC runtime chart can use ambient properties as the display properties at any time.

Right click the chart; select Use Ambient Properties on the Popup menu.

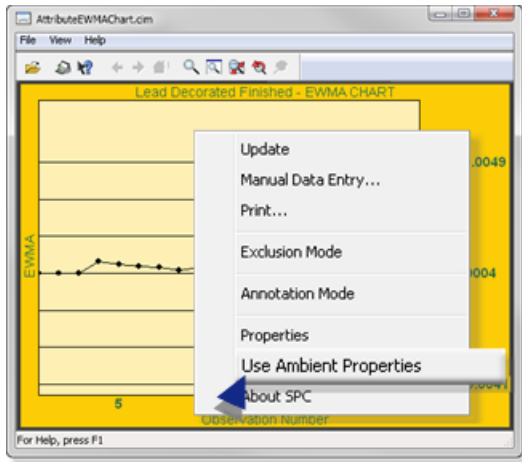

Result: The chart format now display in ambient properties.

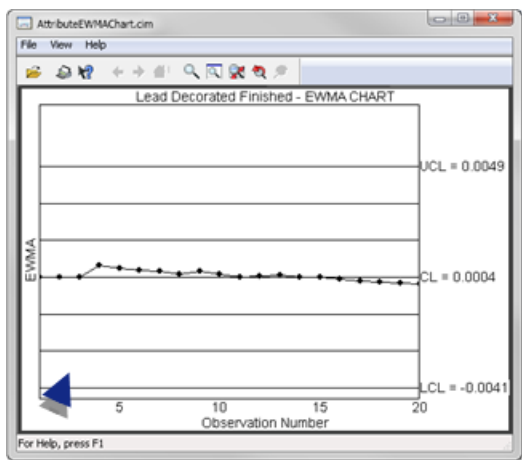

8. SPC Runtime: About SPC

1. Right-click an SPC runtime chart.
2. Select About SPC on the Popup menu.

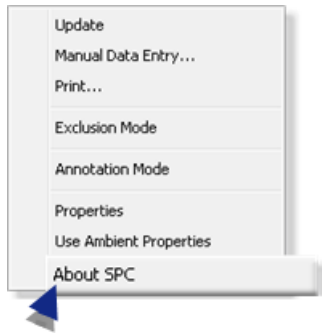

An About SPC message box opens providing you with administrative details about the installed SPC version.

SPC Technical Reference

SPC Technical Reference

- SPC charts.
- ActiveX methods.
- ActiveX properties.

SPC Charts

SPC Charts

CIMPLICITY SPC provides a number of SPC charts to determine if a system process is in control or stable.

Note: The SPC charts can also indicate a process that may be in control, but is producing unacceptable product. In this case, the entire process will require revamping.

- SPC Charts: Variables.
- SPC Charts: Attributes.
- SPC Charts: Defects.

SPC Charts: Variables

Variable charts track and report the fluctuations of a particular process to help determine if the process is stable (in control).

- Chart: Individual
- Chart: Histogram
- Chart: XBar-S
- Chart: XBar-R
- Chart: (Simple) Moving Average
- Chart: Moving Range
- Chart: Exponentially Weighted Moving Average (EWMA)
- Chart: Report

Chart: Individual

X-Individual charts:

Track	Individual values
Report	Individual values over time.

Note: The control limits are calculated by determine the standard deviation of the sample population.

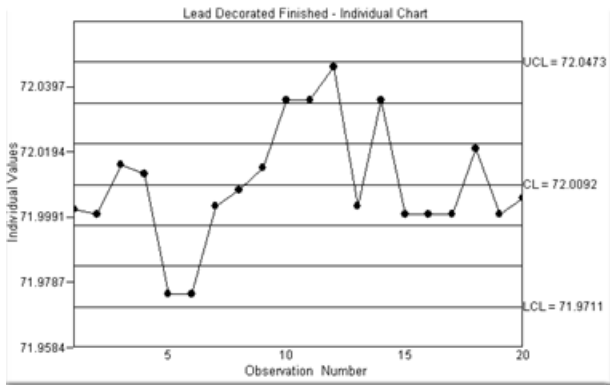

The Individual chart is selected on the SPC Control Properties dialog box>Chart tab.

Chart: Histogram

Histogram charts:

Track	Individual values over a selected time period.
Report	Distribution and other statistics based on the individual values.

A Histogram chart displays the following.:

- Sample data.
- Distribution
- Central tendency
- Scatter or variability

- Data
- Calculated process capability.

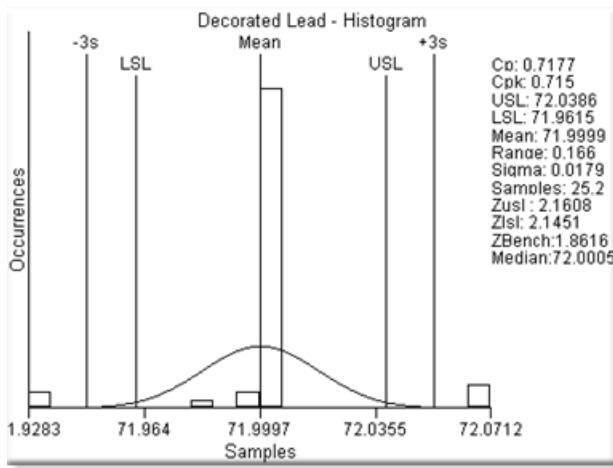

- Depending on whether the source of the data is an XBar-R or XBar-S chart, the estimate of the process standard deviation differs.
- When arranged from lowest to highest; if the number of values is even, by convention the average of the middle two values is use.
- The histogram is selected on the SPC Control Properties dialog box>Chart tab.

Chart: XBar-S

XBar-S charts:

Track	Selected characteristic value of each unit in a subgroup.	
Report	XBar	Subgroup means over time. Control limits are calculated using the average standard deviation.
	Sigma	Subgroup standard deviation over time.

XBar-S subgroup is:

- Variable in size.
- Relatively large.
- Collected at regular intervals.
- Common with other subgroups in one or more features.

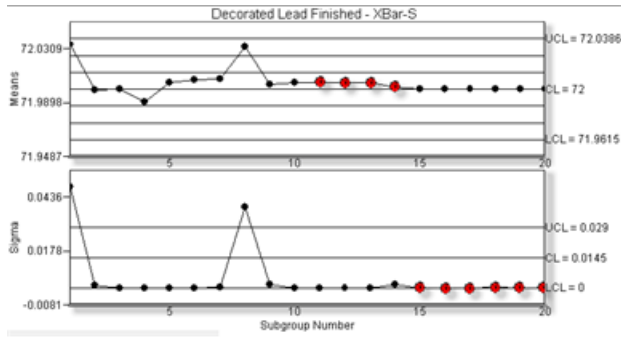

Notes

- The XBar-S chart is selected on the:
 1. Variable Quality Characteristics Properties dialog box > [General \(page 523\)](#) tab.
 2. SPC Control Properties dialog box > Chart tab.
- [Control tests \(page 560\)](#) are available for the XBar-S chart.

Chart: XBar-R

XBar-R charts

Track	Selected characteristic value of each unit in a subgroup.	
Report	XBar	Subgroup means over time. Control limits are calculated using the average standard deviation.
	Range	Ranges within the subgroups.

XBar-R subgroup is:

- The same size.
- At regular collection intervals
- Common with other subgroups in one or more features.

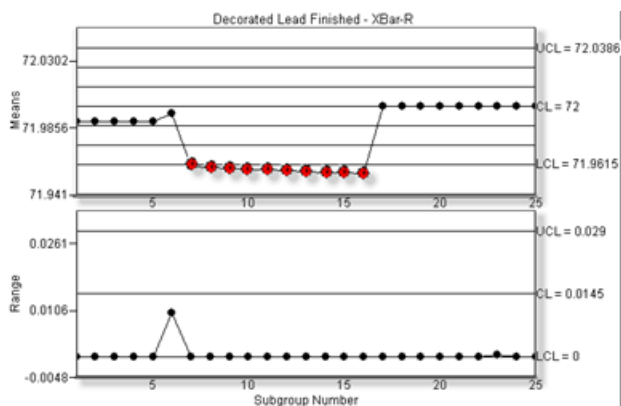

Notes

- The XBar-R chart is selected on the:
 1. Variable Quality Characteristics Properties dialog box>[General \(page 523\)](#) tab.
 2. SPC Control Properties dialog box>Chart tab.
- [Control tests \(page 560\)](#) are available for the XBar-R chart.

Chart: (Simple) Moving Average

Moving Average charts:

Track	Selected characteristic value of each unit in a fixed subset.
Report	Average for the first fixed subset and then the average of the rolling subset. Note: SPC drops the first value in the existing subset; picks up the next value after the existing subset.

Moving Average observation is a rolling, fixed size subset.

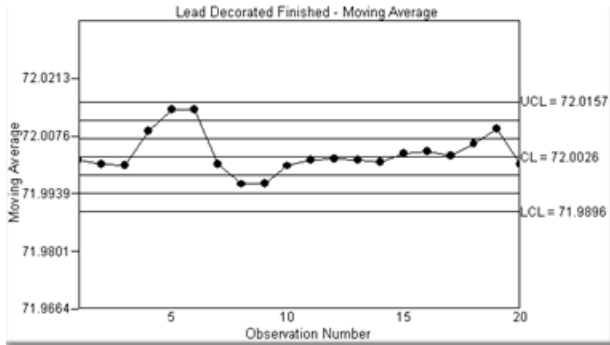

The Moving Average chart is selected on the SPC Control Properties dialog box>Chart tab.

Chart: Moving Range

Moving Range charts:

Track	Selected characteristic value of each unit in a fixed subset.
Report	Difference between one point and its predecessor.

Moving Range observation is:

- An individual unit
- Normally paired with the Individual chart to display the individual measured values.

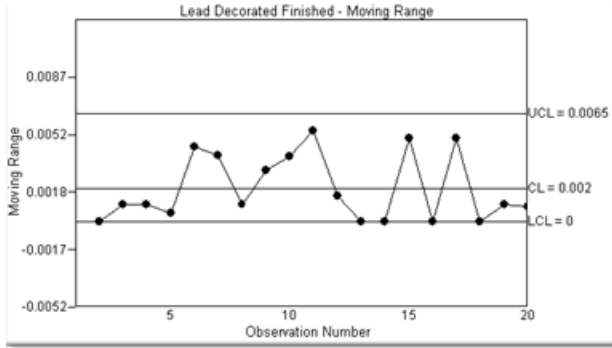

The Moving Range chart is selected on the SPC Control Properties dialog box>Chart tab.

Chart: Exponentially Weighted Moving Average (EWMA)

EWMA charts:

Track	Selected characteristic value of each unit in a fixed subset.
Report	Weighted subgroup mean, the more recent the sample, the higher the weight. This detects much smaller process shifts than a normal control chart would.

EWMA observation is a rolling, fixed size weighted subset.

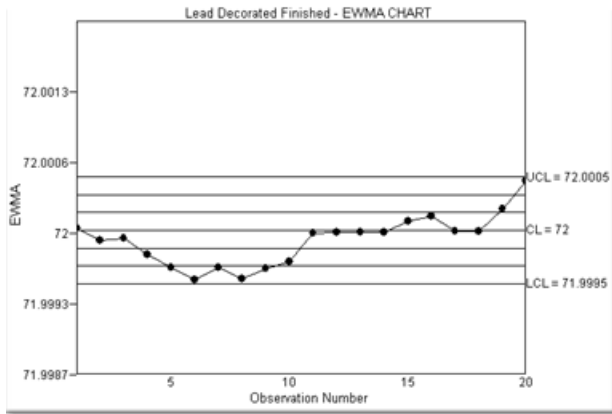

The EWMA chart is selected on the SPC Control Properties dialog box>Chart tab.

Chart: Report

Report charts display variable values in table format.

```

Group: \LEADSPC\LEADDECO Batch ID:
Start: QC: LENGTHFINISHED
End: Product LEADDECOBLK
: ID Batch ID Subgroup Size Xbar Sigma UCLx CLx LCLx UCLs CLs LCLs /
NOTFINISHED 2 71.975 0.05 72.0386 72.0001 71.9615 0.053 0.0145 0
NOTFINISHED 2 72 0 72.0386 72.0001 71.9615 0.053 0.0145 0
NOTFINISHED 2 71.999 0.0021 72.0386 72.0001 71.9615 0.053 0.0145 0
NOTFINISHED 2 72 0 72.0386 72.0001 71.9615 0.053 0.0145 0
NOTFINISHED 2 72.0001 0.0001 72.0386 72.0001 71.9615 0.053 0.0145 0
NOTFINISHED 2 71.995 0.01 72.0386 72.0001 71.9615 0.053 0.0145 0
NOTFINISHED 2 71.9784 0.0448 72.0386 72.0001 71.9615 0.053 0.0145 0
NOTFINISHED 2 71.9755 0.02 72.0386 72.0001 71.9615 0.053 0.0145 0
NOTFINISHED 2 71.9782 0.0435 72.0386 72.0001 71.9615 0.053 0.0145 0
NOTFINISHED 2 71.9966 0.0027 72.0386 72.0001 71.9615 0.053 0.0145 0
NOTFINISHED 2 71.9974 0.0103 72.0386 72.0001 71.9615 0.053 0.0145 0
NOTFINISHED 2 72.019 0.0271 72.0386 72.0001 71.9615 0.053 0.0145 0
NOTFINISHED 2 71.985 0.035 72.0386 72.0001 71.9615 0.053 0.0145 0
NOTFINISHED 2 72.0065 0.004 72.0386 72.0001 71.9615 0.053 0.0145 0
NOTFINISHED 2 72.026 0.099 72.0386 72.0001 71.9615 0.053 0.0145 0
NOTFINISHED 2 71.9945 0.006 72.0386 72.0001 71.9615 0.053 0.0145 0
NOTFINISHED 2 72.0011 0.0071 72.0386 72.0001 71.9615 0.053 0.0145 0
NOTFINISHED 2 71.9743 0.0621 72.0386 72.0001 71.9615 0.053 0.0145 0
NOTFINISHED 2 72.0009 0.0089 72.0386 72.0001 71.9615 0.053 0.0145 0
NOTFINISHED 2 71.9998 0.0006 72.0386 72.0001 71.9615 0.053 0.0145 0
    
```

Note: Optional fields that display on the Report chart are selected on the SPC Control Properties dialog box > [Report \(page 585\)](#) tab.

SPC Charts: Attributes

SPC attribute charts provide different perspectives for reviewing defective units. What constitutes a defective unit depends on your definition (e.g. a unit might have to have three defects or certain type of defects to be classified as defective).

- Chart: nP
- Chart: P
- Chart: C
- Chart: U
- Chart: Exponentially Weighted Moving Average (EWMA)
- Chart: Report

Chart: nP

nP charts:

Track	Number of defective units in each sample.
Report	Number of defective units in each sample.

Note: Each unit is treated as pass or fail regardless of the number of defects it might have.

nP chart sample is:

- A constant: size.
- Normally collected in a frequency that emulates the process being evaluated.

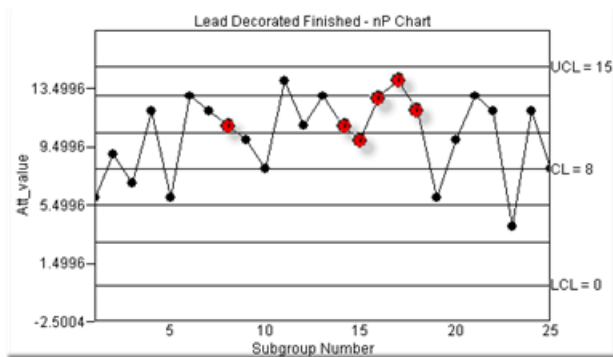

- The nP chart is selected on the:

1. Attribute Quality Characteristics Properties dialog box>General tab.
2. SPC Control Properties dialog box>Chart tab.

- [Control tests \(page 560\)](#) are available for the nP chart.

Chart: P

P charts:

Track	Number of defective units in each sample.
Report	Proportion (percent) of defective units in each sample

Note: Each unit is treated as pass or fail regardless of the number of defects it might have.

P chart subgroup is

- Possibly different from other subgroups in size.
- Normally collected in a frequency that emulates the process being evaluated.

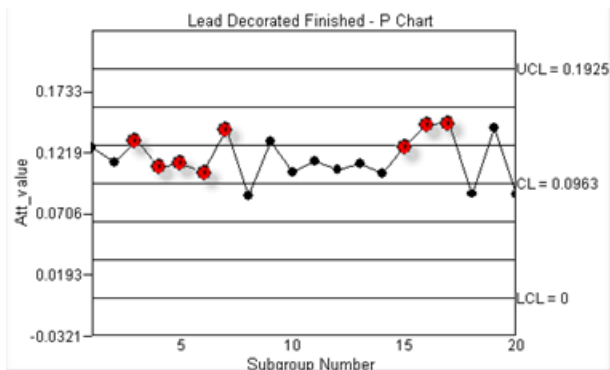

- The nP chart is selected on the:

1. Attribute Quality Characteristics Properties dialog box>General tab.
2. SPC Control Properties dialog box>Chart tab.

- Control tests are available for the P chart.

Chart: C

C charts:

Track	Total number of defects in a unit.
Report	Total number of defects in a unit.

C chart subgroup is:

- Either:
- One item.
- A fixed number of items that are treated as one item.
- Assigned one or more defects to track.

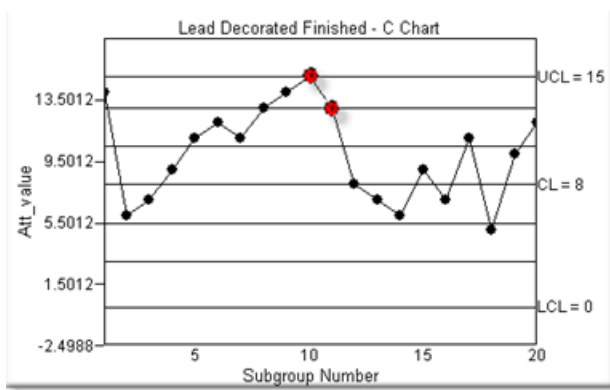

- The C chart is selected on the:

1. Attribute Quality Characteristics Properties dialog box>General tab.
2. SPC Control Properties dialog box>Chart tab.

- [Control tests \(page 560\)](#) are available for the C chart.

Chart: U

U charts:

Track	Total number of defects per unit that occur during the sampling period.
Report	Mean (average) defects per unit during the sampling period. Note: Currently in CIMPLICITY SPC, the UCL is 1 or lower.

U chart subgroup is:

- Able to have a different number of sampling units in each sampling period
- Assigned one or more defects to track.

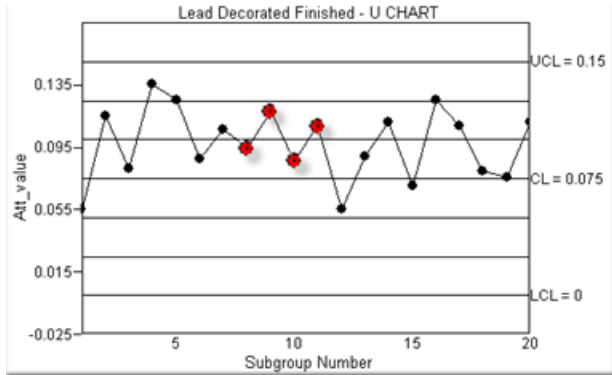

- The U chart is selected on the:
 1. Attribute Quality Characteristics Properties dialog box>General tab.
 2. SPC Control Properties dialog box>Chart tab.
- [Control tests \(page 560\)](#) are available for the U chart.

Chart: Exponentially Weighted Moving Average (EWMA)

EWMA charts

Track	Number of defective units in an observation.
Report	Weighted subgroup mean, the more recent the sample, the higher the weight. Note: This detects much smaller process shifts than a normal control chart would

EWMA observation is a rolling, fixed size weighted subset.

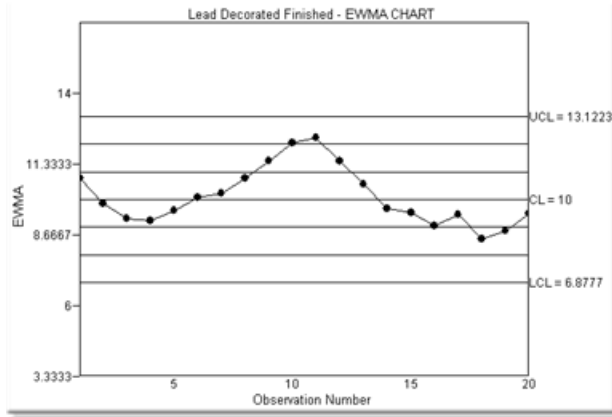

The EWMA chart is selected on the SPC Control Properties dialog box>Chart tab.

Chart: Report

Report charts display variable values in table format.

Date/Time	Group ID	Product ID	QC ID	Batch ID	Subgroup Size	Att_Value	UCL	CL	LCL
9/3/2013 1:40:41 PM	LEADDECO	LEADDECOBLK	ATTLENGTHQUAL03		15	12	15	8	0
9/3/2013 1:40:41 PM	LEADDECO	LEADDECOBLK	ATTLENGTHQUAL03		15	11	15	8	0
9/3/2013 1:40:41 PM	LEADDECO	LEADDECOBLK	ATTLENGTHQUAL03		15	10	15	8	0
9/3/2013 1:40:41 PM	LEADDECO	LEADDECOBLK	ATTLENGTHQUAL03		15	8	15	8	0
9/3/2013 1:40:42 PM	LEADDECO	LEADDECOBLK	ATTLENGTHQUAL03		15	14	15	8	0
9/3/2013 1:40:42 PM	LEADDECO	LEADDECOBLK	ATTLENGTHQUAL03		15	11	15	8	0
9/3/2013 1:40:42 PM	LEADDECO	LEADDECOBLK	ATTLENGTHQUAL03		15	13	15	8	0
9/3/2013 1:40:42 PM	LEADDECO	LEADDECOBLK	ATTLENGTHQUAL03		15	11	15	8	0
9/3/2013 1:40:43 PM	LEADDECO	LEADDECOBLK	ATTLENGTHQUAL03		15	10	15	8	0
9/3/2013 1:40:43 PM	LEADDECO	LEADDECOBLK	ATTLENGTHQUAL03		15	13	15	8	0
9/3/2013 1:40:43 PM	LEADDECO	LEADDECOBLK	ATTLENGTHQUAL03		15	14	15	8	0
9/3/2013 1:40:43 PM	LEADDECO	LEADDECOBLK	ATTLENGTHQUAL03		15	12	15	8	0
9/3/2013 1:40:44 PM	LEADDECO	LEADDECOBLK	ATTLENGTHQUAL03		15	6	15	8	0
9/3/2013 1:40:44 PM	LEADDECO	LEADDECOBLK	ATTLENGTHQUAL03		15	10	15	8	0
9/3/2013 1:40:44 PM	LEADDECO	LEADDECOBLK	ATTLENGTHQUAL03		15	13	15	8	0
9/3/2013 1:40:44 PM	LEADDECO	LEADDECOBLK	ATTLENGTHQUAL03		15	12	15	8	0
9/3/2013 1:40:45 PM	LEADDECO	LEADDECOBLK	ATTLENGTHQUAL03		15	4	15	8	0
9/3/2013 1:40:45 PM	LEADDECO	LEADDECOBLK	ATTLENGTHQUAL03		15	12	15	8	0
9/3/2013 1:40:45 PM	LEADDECO	LEADDECOBLK	ATTLENGTHQUAL03		15	8	15	8	0

Optional fields that display on the Report chart are selected on the SPC Control Properties dialog box>Report (page 585) tab.

SPC Charts: Defects

CIMPLICITY SPC provides the Pareto chart to review instances of defined defects.

Chart: Pareto

The Pareto bar chart displays the cumulative instances for each defined defect in a [defect \(page 565\)](#) group.

The maximum bar height is based on the Max to display value in the SPC Control Properties dialog box>Chart tab.

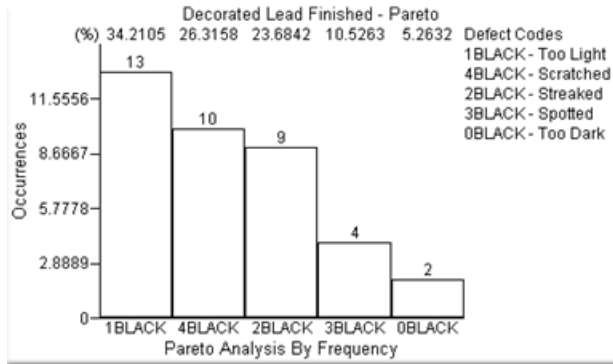

ActiveX Methods

SPC charting provides you with a wide range of built-in functionality. However, if you are familiar with ActiveX and want to add to that functionality as you design your screens, the following methods are available.

void AboutBox();	Calls the About dialog box.
Boolean GetControlLimits (ucl, cl, lcl, rucl, rcl, rlcl)	Gets the current control limits displayed on the chart
void Print();	Calls the Print dialog box.
void UseAmbientProperties();	Automatically changes an ActiveX control to use the ambient properties of the container

ActiveX Properties

The following Active-X properties are available.

```

BSTR ChartTitle;
BSTR UpdateInterval;
short ChartType;
boolean ByTime;
BSTR StartTime;
BSTR EndDate;
BSTR EndTime;
short MaxDisplay;
boolean Exclusion mode;
OLE_COLOR BackgroundColor;
OLE_COLOR ChartColor;
OLE_COLOR ForegroundColor;
BSTR StartDate;
IFontDisp* TitleFont;
boolean UseAmbientBgColor;
boolean UseAmbientFgColor;
boolean UseAmbientChartTitleFont;

```

```
boolean UseAmbientChartColor;
BSTR BatchID;
BSTR ProjectGroup;
BSTR Product;
BSTR QC;
boolean ShowLegend;
boolean ShowChartTitle;
boolean ShowXAxisLabels;
boolean ShowXAxisTitle;
boolean ShowYAxisLabels;
boolean ShowYAxisTitle;
boolean UseAmbientAxisLabelFont;
boolean UseAmbientAxisTitleFont;
IFontDisp* AxisLabelFont;
IFontDisp* AxisTitleFont;
short ReportFields;
ISpcSPCLineProperties* UCLSPCLineProperties;
ISpcSPCLineProperties* CLSPCLineProperties;
ISpcSPCLineProperties* LCLSPCLineProperties;
ISpcSPCLineProperties* ZoneSPCLineProperties;
ISpcSPCLineProperties* SpecLimitSPCLineProperties;
ISpcSPCLineProperties* NormalCurveSPCLineProperties;
boolean ShowUpperControlLimit;
boolean ShowCenterLine;
boolean ShowLowerControlLimit;
boolean ShowZones;
boolean ShowSpecLimits;
boolean ShowNormalCurve;
boolean ShowInfoBox;
boolean ShowFixedNumberOfBars;
boolean ShowRemainingDefects;
boolean ShowValues;
MaxHistogramSamples;
NumberOfZones;
float UpperSpecLimit;
float LowerSpecLimit;
```

Chapter 7. System Sentry

About System Sentry

Bottlenecks occur even in the best-designed systems. They occur when a resource, for example hard disk space, memory or cache, is asked to do more than it can handle. The result can slow down or even stop an entire system.

A system administrator may know that one or more of the many diverse resources in a system are potential trouble spots. The challenge he or she faces is to catch a bottleneck before it occurs. Other problems can be more difficult to track, simply because they occur "under the hood". Without suitable tools, finding them can turn into a guessing game that, at best, is frustrating, at worst wastes time and money.

Welcome to the System Sentry. You no longer have to cross your fingers and hope that your computer system will avoid the bottlenecks and overloads that occur even in the best of system designs.

The System Sentry can provide you with performance data for every resource in your system, ranging from available hard drive space, CPU usage and free memory at any given moment to the accumulated number of alarms that have been generated since you started a CIMPLICITY project.

The System Sentry can warn you before the bottlenecks occur. You can:

- Use your own customized System Sentry screens to display the performance of any process in your system (that comes with counters).
- Be warned audibly by an alarm if a bottleneck in a selected process is about to occur.
- Be paged if a bottleneck in a selected process is about to occur.
- Be warned of irregularities by visual or audio alarms while you work with a system.
- View the performance of all the processes on easy-to-read, pre-configured System Sentry screens.

You can use the System Sentry to diagnose:

- One or more CIMPLICITY projects.
- A local computer.
- Primary and secondary SQL server computers.
- Simple networks.
- Other systems, for example, Web systems.

System Sentry at a Glance

The System Sentry provides a variety of tools to address your requirements and level of system expertise.

The tools that, when configured, enable you to knowledgeably maintain and diagnose your system include:

- System Sentry pre-configured screens that enable you to diagnose a CIMPLICITY project's performance, either for maintenance purposes or to find the source of a bottleneck.
- Customized CimView screens that display data for any process in your system. Integrated CIMPLICITY power tools including:
 - Data logging
 - Alarming
 - Paging

When you activate the System Sentry, you give yourself this flexible access to data that is collected by several counters in your system.

Your Windows system will have at least two types of counters:

- CIMPLICITY counters that are installed when you install the System Sentry.
- Windows Performance counters

Other types of counters include counters that come with:

- Remote Access Server (RAS)
- SQL Server
- Internet Information Server (IIS)

The System Sentry enables you to take full advantage of any of these counters, as well as any other that might be on your system. In addition to simply opening the pre-configured screens, you can create any or all of the working tools listed above.

The CIMPLICITY tools that you use for configuration are the tools with which you are already familiar. They are:

- Device points
- Points by address

You configure one or the other to report data from a specific instance of a specific process, for example, the percent of free space on your logical disk's D drive. The System Sentry provides you with an easy to use Address Builder dialog box that you open when you configure either a device point or point by address. It is through this dialog box that you choose the instance of the process you want to monitor.

Activate the System Sentry

1. Click Project>Properties on the Workbench menu bar.
2. Select the General tab.
3. Check System Sentry in the Options box.

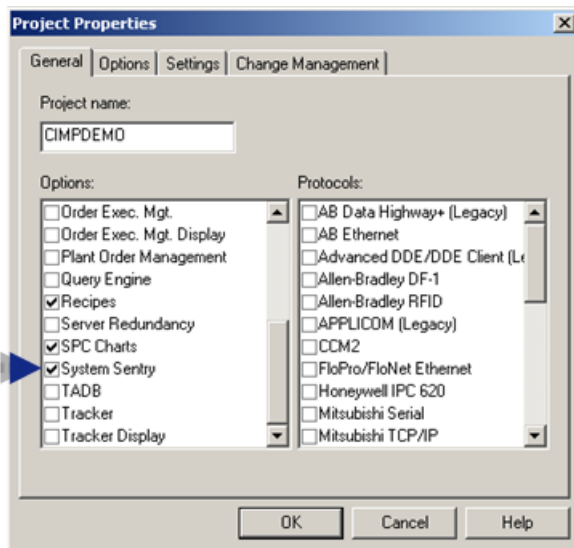

System Sentry Screens

System Sentry Screens

The System Sentry screens enable you to view the actual statistics of your system's CPU memory and disk space usage in addition to the details of the current CIMPLICITY project's processes.

The System Sentry screens help take the guesswork out of keeping your CIMPLICITY projects running at peak performance, in addition diagnosing bottlenecks that might occur.

The System Sentry screens enable you to view the performance of CIMPLICITY objects by:

- Glancing at visual indicators, including thermometers, gauges and trend lines
- Reviewing the data in numbers and percents

This capability makes it easy for you to:

- Monitor each component of CIMPPLICITY to maintain highly efficient performance
- Spot bottlenecks before a problem occurs
- Provide data that helps you find the source of a bottleneck if one occurs

The System Sentry divides the data into the following screens:

Overview screen.
Processes screen.
CimView screen.
Point Manager screen.
Alarm Manager screen.
Logging screen.
Point Logging screen.
Data Logging screen.
Event Manager screen.
Derived Points screen.
User Registration screen.
Router screen.
Devices screen
Ports (Devcom) screen

Open System Sentry Screens

Open System Sentry Screens

Option 1 (page 626)	Open the System Sentry Overview screen.
Option 2 (page 627)	Open a selected System Sentry screen..

Option 1. Open the System Sentry Overview Screen

1. Select Computer>System Sentry in the Workbench left-pane.
2. Do either of the following.
 - Select any screen in the Workbench right-pane.
 - Select _Main.cim in the Workbench right-pane.

Select any screen in the Workbench right-pane.

Do one of the following.

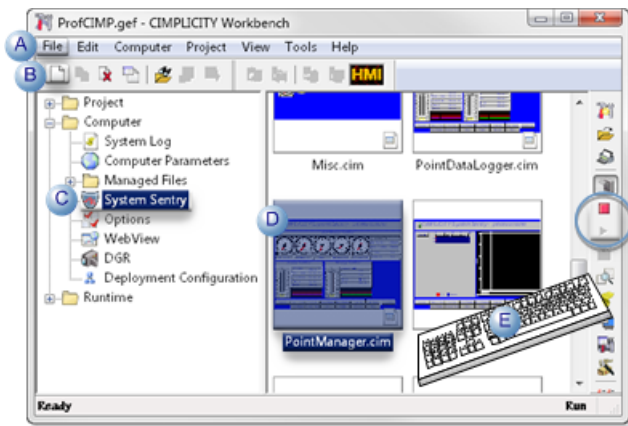

A	Click File>New>Object on the Workbench menu bar.	
B	Click the New Object button on the Workbench toolbar.	
C	In the Workbench left pane:	
	Either	Or
	Double click System Sentry .	a. Right-click System Sentry . b. Select New on the Popup menu.
D	a. In the Workbench right pane. a. Right-click any screen. b. Select New on the Popup menu.	
E	Press Ctrl+N on the keyboard.	

Select _Main.cim in the Workbench right-pane.

Do one of the following.

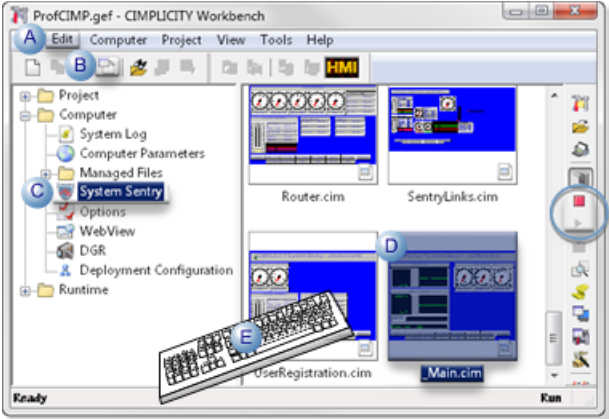

A	Click Edit>Properties on the Workbench menu bar.	
B	Click the Properties button on the Workbench toolbar.	
C	In the Workbench left pane:	
	Either	Or
	Double click System Sentry .	a. Right-click System Sentry . b. Select Open on the Popup menu.
D	a. In the Workbench right pane. a. Right-click any screen. b. Select Open on the Popup menu.	
E	Press Alt+Enter on the keyboard.	

3. Right-click **System Sentry**.
4. Select New on the Popup menu.
5. Right-click any screen.
6. Select New on the Popup menu.
7. Right-click **System Sentry**.
8. Select Open on the Popup menu.
9. Right-click any screen.
10. Select Open on the Popup menu.

Option 2. Open a selected System Sentry Screen

1. Select Computer>System Sentry in the Workbench left pane.

2. Select any System Sentry screen in the Workbench right pane.
3. Do one of the following.

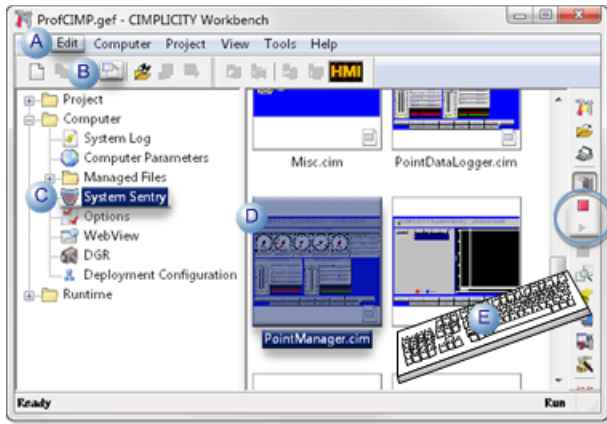

A	Click Edit>Properties on the Workbench menu bar.	
B	Click the Properties button on the Workbench toolbar.	
C	In the Workbench left pane: a. Right-click System Sentry . b. Select Open on the Popup menu.	
D	In the Workbench right pane:	
	Either	Or
	Double-click a System Sentry screen.	a. Right-click a System Sentry screen. b. Select Open on the Popup menu.
E	Press Alt+Enter on the keyboard.	

4. Right-click **System Sentry**.
5. Select Open on the Popup menu.
6. Right-click a System Sentry screen.
7. Select Open on the Popup menu.

System Sentry Overview Screen

The **Overview** screen provides a general view of the computer and CIMPLICITY's performance.

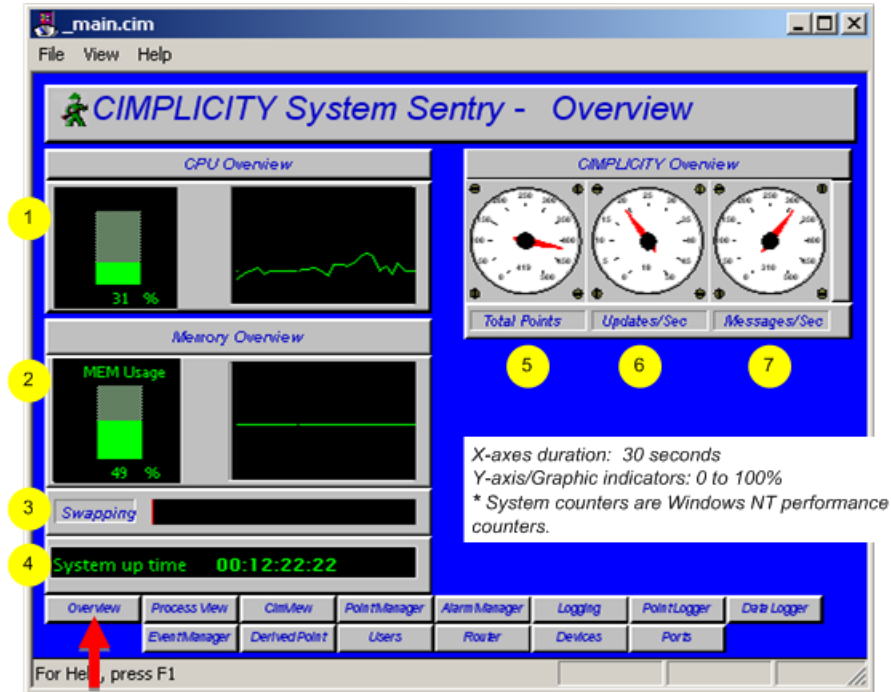

1	System's current % CPU use.
2	System's current memory usage.
3	System memory swapping*.
4	Time is days:hours:minutes:seconds since the system booted up.
5	Total points in the current CIMPLICITY project.
6	Total point updates/sec.
7	Messages in and out of CIMPLICITY.

 **guide: Guidelines for reading the Overview screen include:**

- Review the **CPU Overview** for:
 - Current CPU Utilization
 - Trend of CPU usage.

The steady state CPU Usage should be below 60% for a non-redundant project and below 45% for a redundant project.

Do not let your system become fully utilized. A lower utilization enables CIMPLICITY to respond in a timely manner to events in your process. This is particularly critical when using redundancy.

When your computer is over-utilized, you have two choices:

1. Replace it with faster hardware.

2. Reduce the software load on the system. To do this you need to identify what Process is using the majority of the CPU time. The System Sentry Process Screen can provide you with this information. Some typical ways to reduce CPU utilization are:
 - a. Reduce Device Communications Scan Rate (Port Configuration).
 - b. Reduce Database Logging frequency.
 - c. Reduce the number of points.
 - Review the **Memory Overview** for:
 - Current memory utilization
 - Trend of memory utilization

As with excessive CPU utilization, excessive memory utilization will degrade system performance.

As a rule-of-thumb, the

Steady-state memory utilization should not exceed 75%.

To increase virtual memory

- a. Open the Microsoft Windows Control Panel
- b. Select System.
- c. Select the Performance tab.

Use Microsoft Help for details on how to adjust the virtual memory size, which should be twice as high as physical memory.

Note: increasing virtual memory size will not reduce swapping if it is occurring. It simply gives the computer more memory "headroom."

- Swapping indicator should indicate no swapping while running in a steady state (EX. not opening new applications).

Swapping occurs because there is not enough physical memory in the computer and memory is swapped to disk. This rule-of-thumb is most important because a system that is constantly swapping will exhibit poor performance.

Two ways to reduce swapping are:

- a. Add more physical memory to the computer.
- b. Decrease the memory being used by applications on computer.
 - Check **System Disk Usage** for the amount disk space being used. Running out of disk space will cause application problems. Therefore, you must maintain free disk space on the computer.

System Sentry Processes Screen

The **Process** screen displays information about each CIMPLICITY process in the project being monitored.

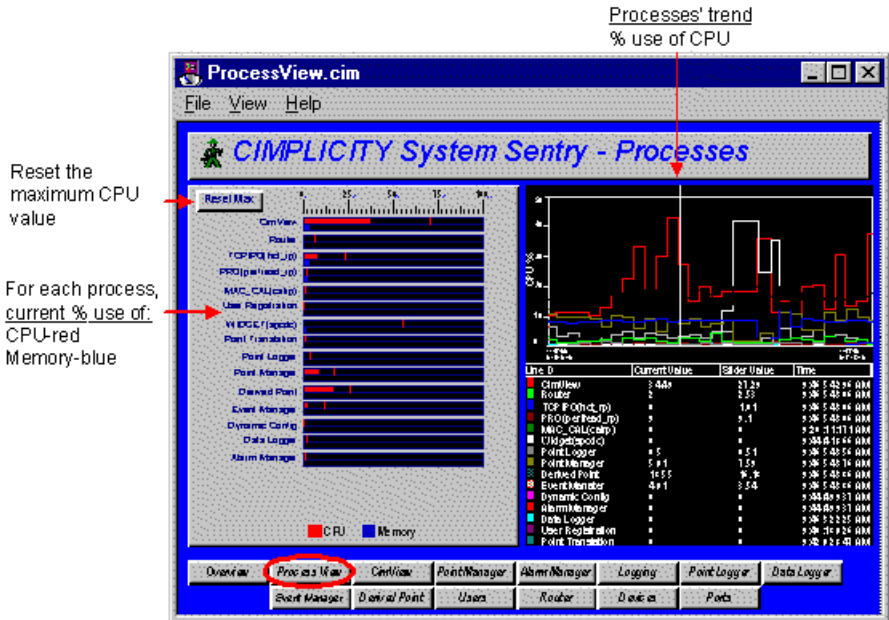

X-axis duration: 1 minute
Graphic indicators: 0 to 100%
Y-axis: auto scales

guide: Guidelines for reading the Processes screen include:

- Use the **CPU utilization** views for each process, particularly when you suspect excessive CPU utilization and need to determine which process, or processes, is causing it.

Views include:

- A **Max Capture** for CPU Utilization on the bar chart. The Max Capture indicator shows the highest reading since the screen has been open.

To track when a process is using excessive memory:

1. Leave the screen open for a period of days to capture the spikes.
2. Click the **Max line** at regular intervals to display the date and time at which maximum utilization occurred.

Example

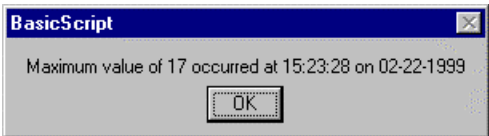

- A one minute trend chart that provides a graphic comparison of the percent CPU utilization by each process.
- The actual **percent CPU utilization** currently and at the trend chart slider, for each process.
- Check each process' **Memory Utilization** as a percent of available system memory on the bar chart if the system is running low on memory. This can help you determine which process, or processes, is using the memory.

If any you require more information for any process, click its button at the bottom of the screen. A screen dedicated to that process will open.

System Sentry CimView Screen

CimView is the graphics process that displays your screens at runtime.

The **CimView** screen displays CimView performance information.

Note: Since the System Sentry uses CimView, the numbers you see include the System Sentry's use in monitoring the process.

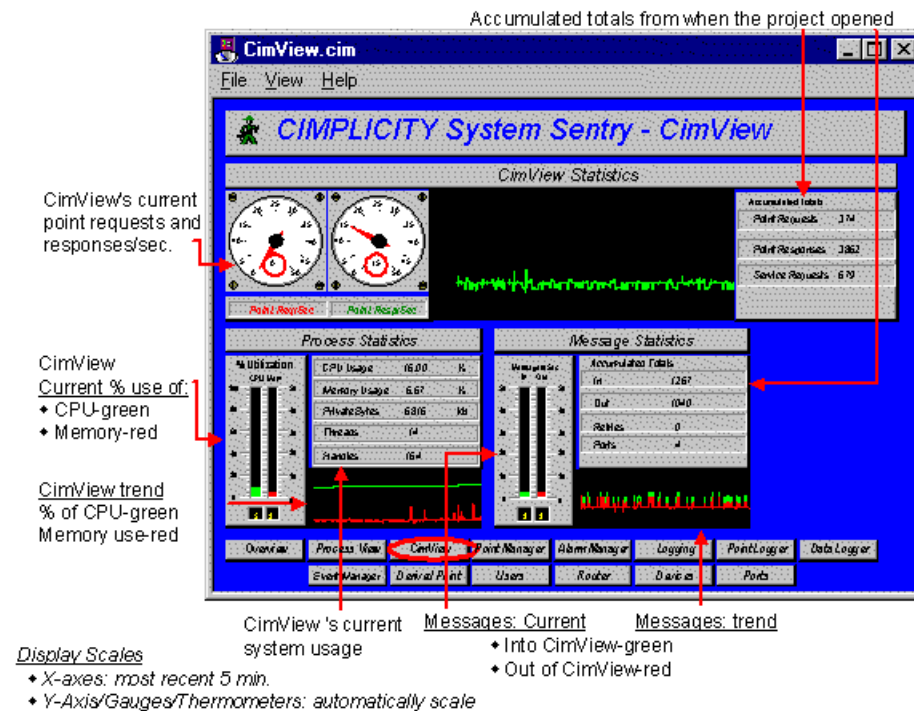

guide: Guidelines for reading the CimView screen include:

- Check **CPU Usage** to make sure CimView's use is in an acceptable range.

- Look at **Point Resp/Sec** if CimView's CPU usage is excessive. This counter indicates the number of point updates per second that are coming into CimView. If this number is large (over 100) and CPU Utilization is high, it may indicate that too much data is being sent to CimView.

Solutions to too much data being sent to CimView include:

- Reduce the number of screens in the cache.
- Reduce the number of points on the screens.
- Reduce the scan rate of the points in Device Communications.
- Verify that device points are configured as **On Change**, not On Scan.

System Sentry Point Manager Screen

The Point Manager process manages point activity in a CIMPLICITY project.

The **Point Manager** screen displays the Point Manager's performance and activity.

Accumulated totals from when the project started running

The screenshot shows the 'PointManager.cim' window with a menu bar (File, View, Help) and a title bar. The main area is titled 'CIMPLICITY System Sentry - Point Manager' and contains several sections:

- Point Manager Statistics:** Five circular gauges for Total Points, Updates/Sec, Clients, Message Queue, and Points by Addr. To the right is a table of 'Accumulated totals' including App Overflows, Device Overflows, SS Points, and Queue Size.
- Process Statistics:** A bar chart for '% Utilization' and a table with CPU Usage, Memory Usage, Private Bytes, Processes, and Handles.
- Message Statistics:** A bar chart for 'Messages by Sec' and a table for 'Accumulated totals' including In, Out, Packets, and Points.
- Bottom Panel:** A row of buttons for Overview, Process View, CimView, PointManager (circled in red), Alarm Manager, Logging, PointLogger, and Data Logger. Below this is another row of buttons: Event Manager, Derived Point, Users, Router, Devices, and Ports.

Annotations on the left side of the screenshot:

- 'Gauges display current totals and updates/sec.' with arrows pointing to the gauges in the Point Manager Statistics section.
- 'Point Mgr.'s Current % use of: CPU-green, Memory-red' with arrows pointing to the Utilization bar chart.
- 'Point Mgr. trend % of CPU-green, Memory use-red' with arrows pointing to the trend line below the Utilization bar chart.
- 'Point Mgr.'s current system usage' with an arrow pointing to the CPU Usage value in the Process Statistics table.
- 'Messages: Current' with an arrow pointing to the Messages by Sec bar chart.
- 'Messages: trend' with an arrow pointing to the trend line below the Messages by Sec bar chart.

Display Scales

- X-axis: most recent 5 min.
- Y-Axis/Gauges/Thermometers: automatically scale

guide: Guidelines for reading the Point Manager screen include:

- Check **Updates/Sec** to see how many point values are being updated per second. This indicates how much data is changing in the project.
- Check **Clients** to see how many clients are connected to the Point Manager. Clients include CimView, Database Logging, Point Control Panel, Event Manager, etc.

- Check **App Overflows** and **Device Overflows**. These numbers should be zero. A non-zero number indicates that data is being lost in the system.

App Overflows indicate that data is being lost when being sent to a client. Typically indicating that too much data is being sent too fast to an application (typically Database Logging or CimView) – and that the application cannot keep up with the rate. A check of the system status log will indicate the process that is having the problem.

Device Overflows indicate that too much data is being sent too fast to the Point Manager by a Device Communications Process. Both of these problems will affect system stability and need to be remedied immediately.

To remedy these problems you must decrease the data rate to the application as follows:

- Reduce the number of points used by application.
- Reduce the scan rate of the device points.
- Improve the computer's performance by adding memory or buying a faster processor. (Check the System Sentry Overview screen to review the computer's performance.)
- Verify that device points are configured as **On Change**, NOT **On Scan**.

If overflows persist after you have implemented the above suggestions, contact GE Intelligent Platforms technical support immediately.

System Sentry Alarm Manager Screen

The Alarm Manager process manages alarm activity in a CIMPLICITY project.

The **Alarm Manager** screen displays the Alarm Manager's performance and activity.

Accumulated totals from when the project started running

The screenshot shows the AlarmManager.cim interface with several sections:

- Alarm Statistics:** Five gauges at the top left showing current totals and updates per second. A table on the right shows accumulated totals for Generated (174), Reset (406), Deleted (0), and Acked (174).
- Process Statistics:** A table showing CPU Usage (0.00%), Memory Usage (0.640%), Private Bytes (916 kb), Threads (6), and Handles (136). A bar chart below shows utilization over time.
- Message Statistics:** A table showing accumulated totals for In (2369), Out (2063), Replies (0), and Ports (4). A bar chart below shows message activity.
- Navigation:** A bottom menu with buttons for Overview, Process View, Config, Point Manager, Alarm Manager (highlighted), Logging, Point Logger, Data Logger, Event Manager, Display Point, Users, Router, Devices, and Ports.

Annotations on the left side of the screenshot:

- Gauges display current totals and updates/sec.
- Alarm Mgr.'s Current % use of:
 - CPU-green
 - Memory-red
- Alarm Mgr. trend % of CPU-green Memory use-red

Annotations at the bottom of the screenshot:

- Alarm Mgr.'s current system usage
- Messages: Current
 - Into the Alarm Mgr.-green
 - Out of the Alarm Mgr.-red
- Messages: trend

Display Scales

- X-axis: most recent 5 min.
- Y-Axis/Gauges/Thermometers: automatically scale

guide: Guidelines for using the Alarm Manager screen include:

- The top row contains statistics on the number of active alarms in the system. **Alarms/Sec** represents the number of Alarms per Second that are being generated in the system.

System Sentry Logging Screen

CIMPLICITY maintains several Logging tables that document data, alarm and event statistics, in addition to other processes such as SPC.

The System Sentry **Logging** screen enables you to see the total number of entries to the different log files.

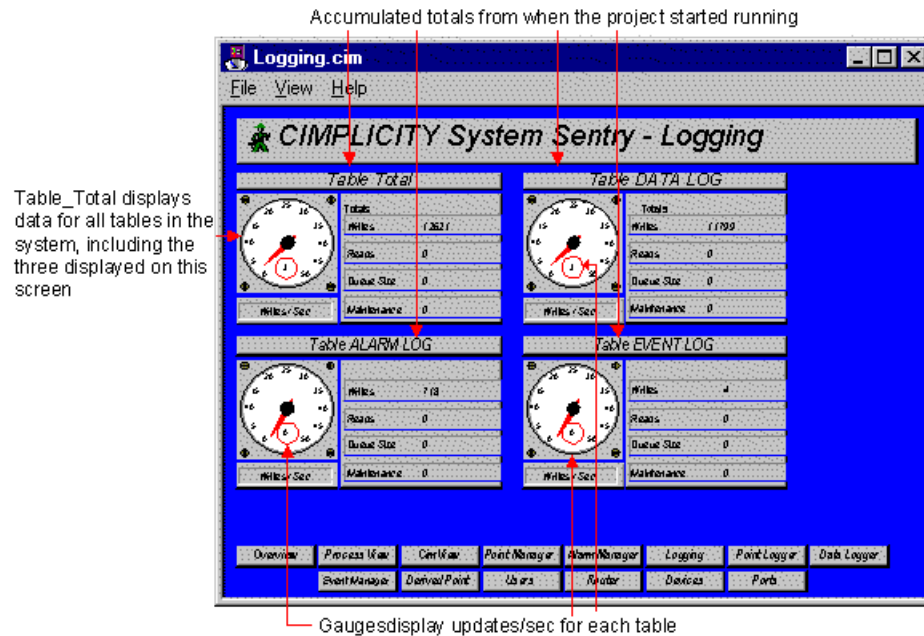

guide: Guidelines for using the Logging screen include:

- The **Table Total** is the total for all the tables that exist within the computer that are being registered by any Data Log Manager on that computer including Point Data Log, Event Log and Alarm Log.
- The Table Totals, including number of **Writes, Reads, Queue and Maintenance Actions** are the totals that have occurred since the project has been running on the computer that is being monitored.
- The gauge shows how many **Writes/Sec** are actually occurring.

Example

For Data Log, **Writes/Sec** keeps an average, how fast logging is occurring onto the Data Log table.

 **Note:** When a queue overflow is reported, it includes the number of overflows seen on this table since the logger was started. This value may be used to assess the correct setting for the **DB_QUEUE_SIZE** parameter.

System Sentry Point Logging Screen

The CIMPLICITY Point Logger logs point values to the Data Log table.

The System Sentry **Point Logging** screen reports point logging performance and activity.

Trend of:

- Point request/sec-red
- Point response/sec-green

Accumulated totals from when the project started running

Current point requests and responses/sec.

Point Logging Current % use of:

- CPU-green
- Memory-red

Point Logging trend % of CPU-green
Memory use-red

Point Logging current system usage

Messages: Current

- Into the Point Mgr.-green
- Out of the Point Mgr.-red

Messages: trend

Display Scales

- X-axis: most recent 5 min.
- Y-Axis/Gauges/Thermometers: automatically scale

guide: Guidelines for using the Point Logging screen include:

Entries under **Process Statistics** should remain constant. The actual number depends on what applications are running.

System Sentry Data Logger Screen

The **Data Logger** lets you log alarms, events, and point values to a database, then retrieve the information for reports via a variety of ODBC-compliant applications.

The System Sentry **Data Logger** screen reports the Database Logger's performance and activity.

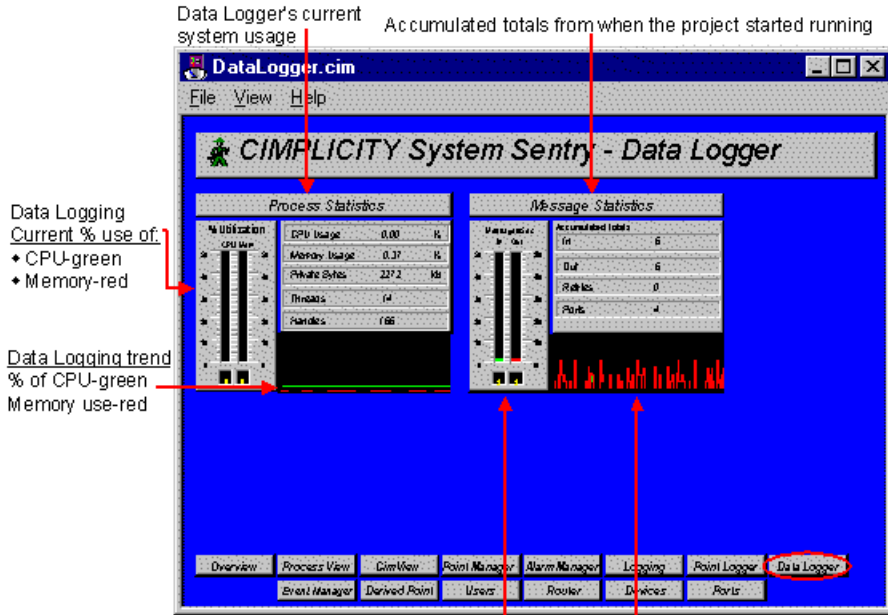

Display Scales

- X-axis: most recent 5 min.
- Y-Axis/Gauges/Thermometers: automatically scale
- Into the Data Logger-green
- Out of the Data Logger-red

guide: Guidelines for using the Data Logger screen include:

Entries under **Process Statistics** should remain constant. The actual number depends on what applications are running.

System Sentry Event Manager Screen

The Event Manager process, configured through the Event Editor, runs actions in response to system events. These actions can be simple set points or user written Basic Control Engine Scripts. The Basic Control Engine User Interface (BCE User Interface) can be used to obtain a detailed view of event processing within the Event Manager.

This **Event Manger** Screen provides a measurement of how the Event Manager process is performing.

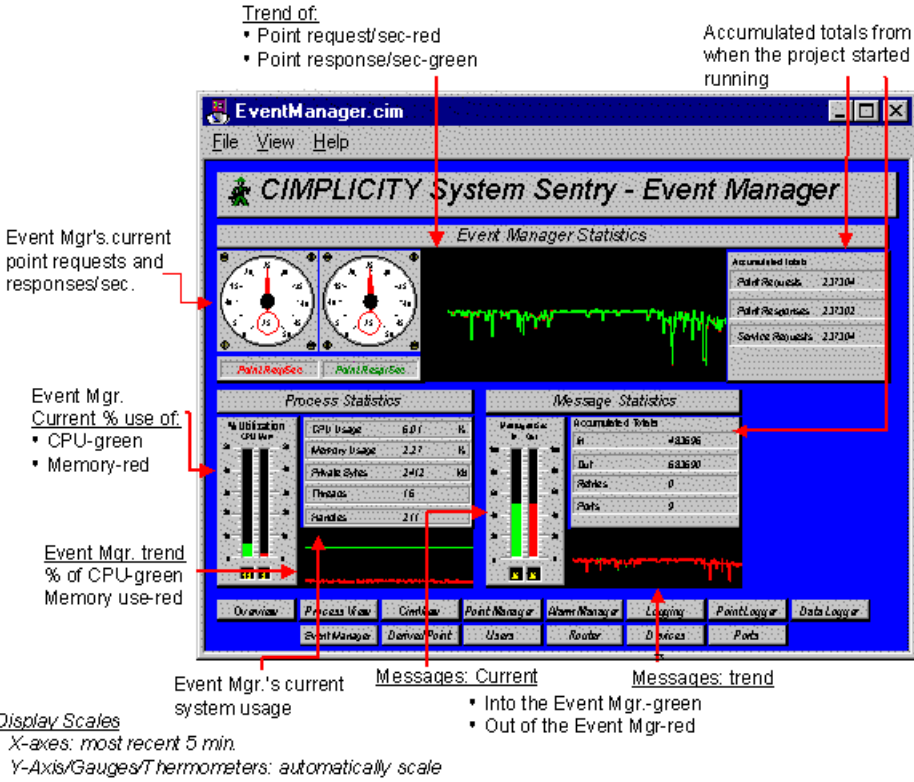

guide: Guidelines for using the Event Manager screen include:

- Review **Point Requests/Sec** for the number of requests being sent to the Point Manager per Second. The Event Manager point requests are one of the following:
- Set points that are issued by the Event Manager or your script
- Requests to read a point value (through the BCE PointGet command.)

This counter is directly dependent on your Event Manager application.

- Check the **CPU Usage** to see how much processing time the Event Manager is using. Typically, this value will not be steady. Instead, it should reflect the processing performed by the Event Manager when it has work to do.

In a typical application, the CPU Usage should drop to zero periodically. This indicates that there is enough CPU bandwidth for the Event Manager to complete its work in response to factory events. An Event Manager that never idles, is an Event Manager that is constantly busy and prone to fall behind in event processing.

- If you see a large spike in **CPU Utilization** along with a large spike in **Point Requests/Sec** check to see if a script is polling a point value in a loop with little or no delay.

To correct the spikes:

1. Identify the script through the BCE UI.
2. Correct the logic in the script to use the **On Change** notification as opposed to busy polling.

Polling is a drain on system resources and will prevent you from getting the best performance from your project.

Note: The performance data for the Basic Control Engine includes all scripts that are run under the control of the Basic Control Engine.

System Sentry Derived Points Screen

The Derived Point process maintains and updates all calculation points in the project. Calculation points typically take input from a device point and perform arithmetic, max capture, min capture, etc., and output this information to a point.

Data in the System Sentry **Derived Points** screen reports the derived point system use and performance.

Trend of:

- ◆ Derived point request/sec-red
- ◆ Derived point response/sec-green

Accumulated totals from when the project started running

The screenshot shows the 'DerivedPoint.cim' application window. The main title is 'CIMPLICITY System Sentry - Derived Points'. The interface is divided into several sections:

- Derived Point Statistics:** Contains two gauges for 'Point Req/Sec' and 'Point Res/Sec', and a table of 'Accumulated Totals' with columns for Point Requests, Point Responses, and Service Requests.
- Process Statistics:** A table showing CPU Usage (0.00%), Memory Usage (0.76%), Private Bytes (1,304 Kb), Handles (0), and Handles (0.00).
- Message Statistics:** A table showing Message In (26660) and Message Out (26660), with sub-totals for Alerts (0) and Ports (3).
- Point Logging:** Includes a section for 'Current % use of' with gauges for CPU (green) and Memory (red), and a 'Trend' section for '% of CPU' and 'Memory use-red'.
- Derived point messages:** A section with 'Current' and 'Trend' views, showing messages into the Point Manager (green) and out of the Point Manager (red).

Current point requests and responses/sec.

Point Logging Current % use of:

- ◆ CPU-green
- ◆ Memory-red

Point Logging trend

- % of CPU-green
- Memory use-red

Derived points' current system usage

Derived point messages:

- ◆ Into the Point Mgr.-green
- ◆ Out of the Point Mgr-red

Display Scales

- ◆ X-axis: most recent 5 min
- ◆ Y-Axis/Gauges/Thermometers: automatically scale

 **guide: Guidelines for reading the Derived Points screen include:**

- Check point requests per second (**Point Req/Sec**) and point responses per second (**Point Resp/Sec**)
- **Point Requests/Sec** represents the number of calculation points the derived point manager updates.
- **Point Responses/Sec** represents the number of point value updates the derived point manager receives. The derived point manager uses these point values to produce the calculations.
- Check the derived point manager's **CPU Usage**. Excessive CPU usage and a large number of **Point Req/Sec** may indicate that too many calculation points are being updated too rapidly.

To reduce the load on the Derived Point Process:

1. Verify that device points are being reported **OnChange** rather than **OnScan**.
2. Reduce the number of calculation being performed.
3. Reduce the scan rate of the device points.

System Sentry User Registration Screen

The User Registration process provides security management for the CIMPPLICITY project. When users log into CIMPPLICITY, they are validated by User Registration. In addition, User Registration manages the security policies configured for the CIMPPLICITY Users.

The **User Registration** screen provides a count of the number of users that are logged into the project.

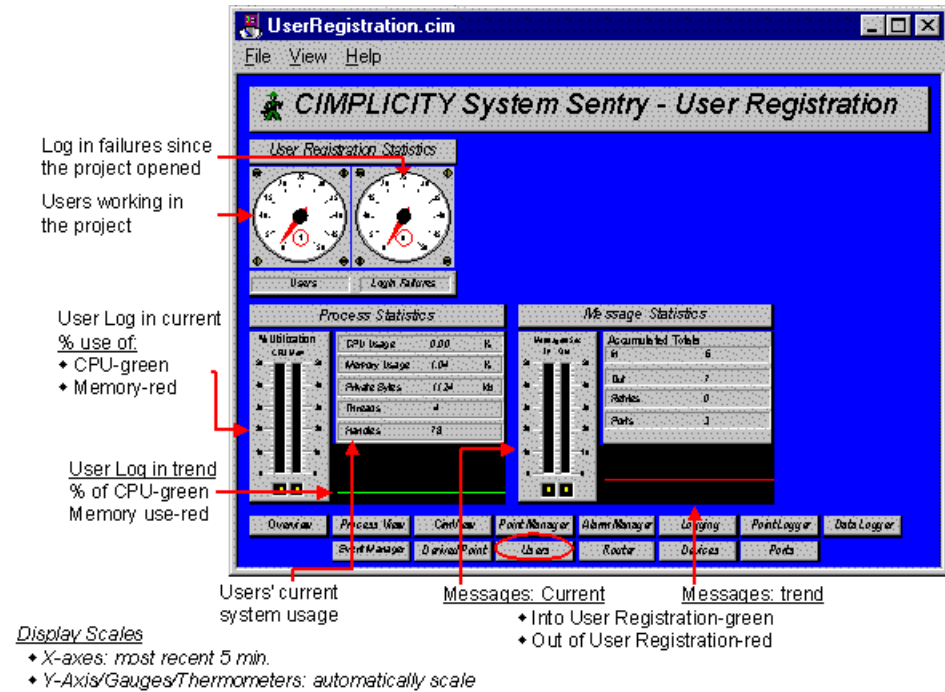

guide: Guidelines for reading the User Registration screen include:

Check the number of **Login Failures**. A high number of login failures indicate that users are trying to guess passwords. If there is a high number, review your CIMPLICITY Event Log to determine what computers are being utilized to try to gain access.

System Sentry Router Screen

The Router provides communications channels between the various CIMPLICITY processes and performs communication across the network to other routers.

The **Router** screen provides vital information about the efficiency of these channels.

Accumulated totals from when the project started running

Gauges display current totals and updates/sec.

Router's Current % use of:
 ♦ CPU-green
 ♦ Memory-red

Router trend
 % of CPU-green
 Memory use-red

Router's current system usage

Current and accumulated network statistics

Accumulated:
 ♦ Dropped final responses
 ♦ Dropped intermediate responses
 Current: responses required out

Display Scales
 ♦ X-axis: most recent 5 min.
 ♦ Y-Axis/Gauges/Thermometers: automatically scale

guide: Guidelines for reading the Router screen include:

- Make sure the **Overflows** counter is zero. Overflows mean that inter-process messages are being dropped and indicate that data loss is occurring in your project. Typically this means that too much data is being sent too fast to an application. It cannot keep up with the data rate. Important data, such as alarm information may be lost.

To reduce the messaging load on the project, first identify the offending application by examining the overflow counters for the various ports. This is best accomplished through the Windows operating system Performance Monitor.

- Make sure **Retries/Sec** and **Accumulated Totals–Retries** are zero, or very close. Non-zero values indicate bottlenecks in inter-process communication.
- Review **Sent/Sec** and **Receive/Sec** for a general idea of the amount of inter-process communication that is occurring. Typically, the Sent and Received numbers should be close.
- Monitor the **RR Out** counter in the Messages box. This number represents the number of Response Require Messages that are outstanding. The number will change as your system runs, but should not grow without bounds.
- Contact GE Intelligent Platforms technical support immediately if:
 - You cannot resolve a reported **Overflow**
 - **Retries/Sec** or **Retries Accumulated Totals** are not zero, or very close to zero
 - **RR Out** grows without bounds

System Sentry Devices Screen

The **Devices** screen provides statistics concerning the communication to a factory device.

 **todo:** To choose a device for evaluation:

1. Click the button to the right of the Device ID bar.

The Select a Device dialog box opens.

2. Select the device to be evaluated.

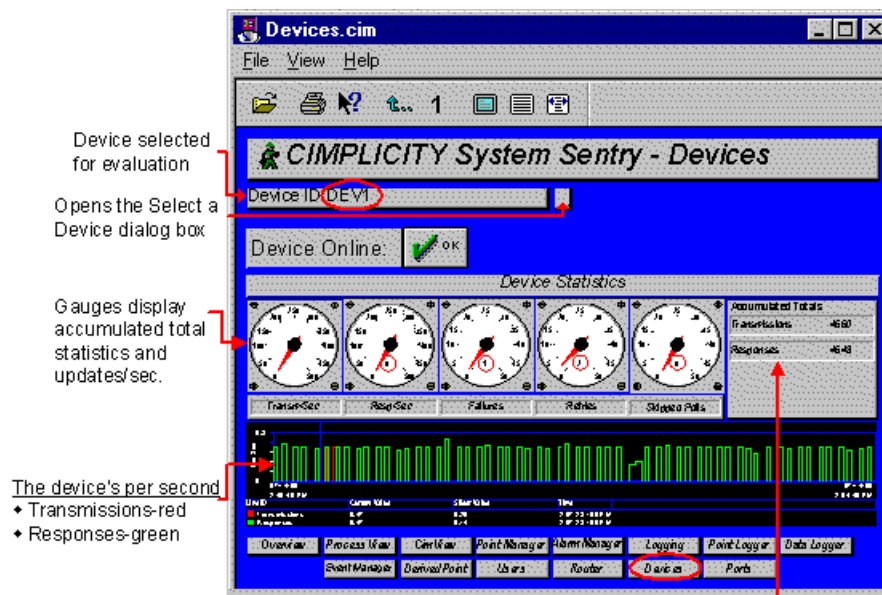

Device selected for evaluation

Opens the Select a Device dialog box

Gauges display accumulated total statistics and updates/sec.

The device's per second
 ♦ Transmissions-red
 ♦ Responses-green

Accumulated totals from when the project started running

Display Scales
 ♦ X-axis: most recent 5 min.
 ♦ Y-Axis/Gauges/Thermometers: automatically scale

 **guide:** Guidelines for reading the Devices screen include:

- Review the number of [transmissions \(page 673\)](#) per second (Transm/Sec) and responses per second (Resp/Sec) to and from the device are meeting your polling requirements.
- Make sure **Failures** and **Retries** are zero. Non-zero values indicate a problem. They could indicate that the device is being turned off or the communication link to the device is periodically failing.
- Check the **Skipped Polls** to determine if too many points are being polled too fast. If they are, you will need to reduce the polling rate to a rate that can be sustained by the communication media and PLC.

System Sentry Ports (Devcom) Screen

The **Ports (Devcoms)** screen provides statistics for a selected port.

📌 todo: To choose a port for evaluation:

1. Click the button to the right of the Port ID bar.

The Select a Port dialog box opens.

2. Select the port to be evaluated.

Accumulated totals from when the project started running

Devcom selected for evaluation

Opens the Select a Port dialog box

Devcom current % use of:
 ♦ CPU-green
 ♦ Memory-red

Devcom trend:
 % of CPU-green
 Memory use-red

Devcom current system usage

Messages: Current
 ♦ Into the Point Logger-green
 ♦ Out of the Point Logger-red

Messages: trend

Display Scales
 ♦ X-axes: most recent 5 min.
 ♦ Y-Axis/Gauges/Thermometers: automatically scale

% Utilization	CPU usage	Memory usage	Private Bytes	Threads	Handles
	4.62 K	2.99 K	1068 K	7	123

Messages	Accumulated Totals
In	1440
Out	1440
Retries	0
Ports	3

Accumulated Totals	
Point Requests	17
Point Responses	1686
Service Requests	34

📌 guide: Guidelines for reading the Ports screen include:

If the port's CPU usage is excessive, verify that device points are configured as **On Change**, NOT **On Scan**.

Frequently Used Features on System Sentry Screens

Frequently Used Features on System Sentry Screens

Some indicators appear on several System Sentry screens. This is because the data they report is important to know for several individual applications.

Frequently used features include:

- Process statistics.
- Message statistics.

Process Statistics on a System Sentry Screen

System Sentry Screen Section:
The Featured CIMPLICITY HMI Application's System Usage

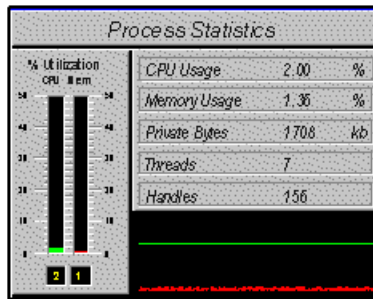

Display Scales
 ♦ X-axis default: most recent 5 min.
 ♦ Y-axis/Thermometer: automatically scale

Process Statistics	Description
CPU Usage	Displays in three locations, the bar chart, text display and the trend chart. The CPU Usage is directly related to activity within the physical process. For example, when a conveyor system starts, we should expect an increase in CPU Usage as device points start changing and pass through the system
Memory Usage	Displays as a percent of system memory. Because it is a ratio, this number will change as other applications open and close on the system. However, when the system is in a steady state this counter easily identifies where the memory is being used. A more accurate measure of memory usage is Private Bytes . This counter shows the amount of memory in Kilobytes being used by the process. In general, private bytes should remain constant for a process that is in a constant state.
Threads	Indicates the number of operating system threads active in the process. This number should be static for most processes except Event Manager and CimView.
Handles	Indicates the number of operating system handles in use by the process. This number may increase or decrease. However, the number should not constantly increase without bounds. If it does, it may indicate a software problem.

Message Statistics on a System Sentry Screen

System Sentry Screen Section
The Featured CIMPLICITY HMI's Message Statistics

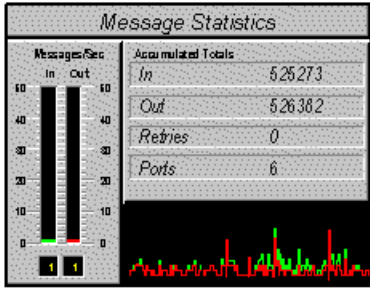

- Display Scales
- ◆ X-axis default: most recent 5 min.
 - ◆ Y-Axis/Gauges/Thermometers: automatically scale

The message statistics object provides information on the processes usage of CIMPLICITY Inter-process Communication (IPC.) IPC provides the mechanism by which CIMPLICITY processes send information (such as Point Updates) to each other. As such, these counters indicate the utilization and performance of this critical internal message delivery.

Message Statistics	Description
Messages In	Displays as an accumulated total as well as per second counters in the bar chart and trend chart. Message In is a count of the number of messages received by this process from other CIMPLICITY processes. Typically messaging is directly related to the flow of point data from device communications to other processes. The Messages Out counter displays the number of message sent out of the process.
Retries	Indicates the number of times message delivery had to be retried. Message retries occur when the applications mailbox is full and cannot accept more data. Retries should be close to zero in a properly configured application. Excessive retries degrade system performance and can be indicative of messaging bottlenecks. Additionally, retries may be the precursor to the more serious condition of message loss due to overflow.
Ports	Indicates the number of mailboxes the process is using. This number will be different for different processes.

System Sentry Screen Viewing and Navigation Tools

System Sentry Screen Viewing and Navigation Tools

- Navigate from one screen to screen.
- System Sentry screen viewing tools.
- Print System Sentry screens.

Navigate from Screen to Screen

Method 1. Go from screen to screen

Click the appropriate button in the rows of buttons that appear at the bottom of every screen.

Method 2. Go to the previous screen

Do one of the following.

Option 1

Click View on the System Sentry menu bar.

Select Previous Screen.

Option 2

Click **Previous Screen** on a System Sentry screen toolbar.

Method 3. Go to the Overview screen

1. Click View on the System Sentry menu bar.
2. Select Home.

System Sentry Viewer Navigation Tools

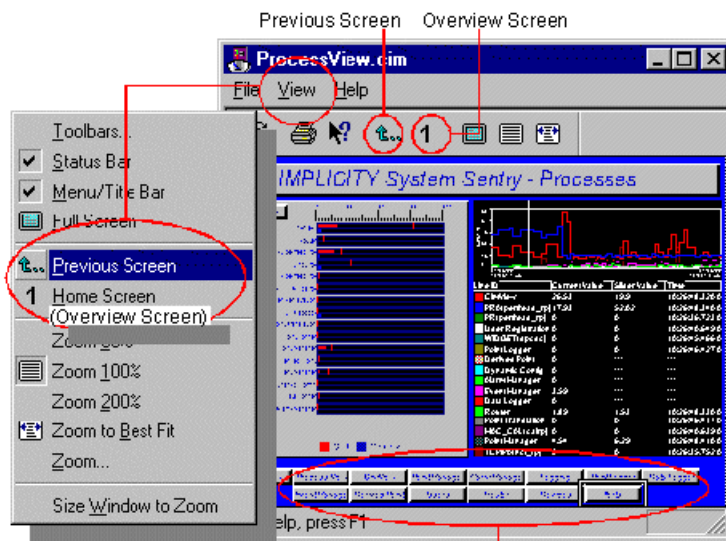

Navigation buttons to every screen appear on every screen.

Using the System Sentry Screen Viewing Tools

System Sentry Screen Viewing Tools

- System Sentry screen size.

- System Sentry screen display tools.

System Sentry Screen Size

System Sentry Screen Size



1. Choose any of the following to zoom the screen.

1 (page 649)	System Sentry Viewer toolbar buttons.
2 (page 649)	Zoom Percents on a System Sentry Screen's Edit Menu
3 (page 650)	Precise Zoom Percent

2. Fit the window to the new workspace display size.

1. System Sentry Screen's Toolbar Buttons

Click either the:

- **Zoom 100-toolbar** button  to zoom the screen to the size it will display in CimView.
- **Full Screen** toolbar button  to use the entire monitor screen for display.

Press **ESC** on the keyboard to return to the System Sentry window environment.

2. Zoom Percents on a System Sentry Screen's Edit Menu

1. Click View on a System Sentry screen's menu bar.
2. Select the percent you want the display to zoom from one of the three- percent choices.

Edit Menu: Zoom Percent Selected

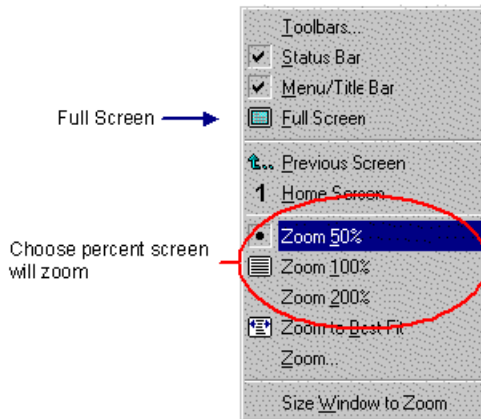

Note: You can also display a full screen by selecting Full Screen on the drop down menu.

3. *Precise Zoom Percent*

1. Click Edit on the System Sentry menu bar.
2. Select Zoom.

Edit Menu: Open Zoom Dialog Box

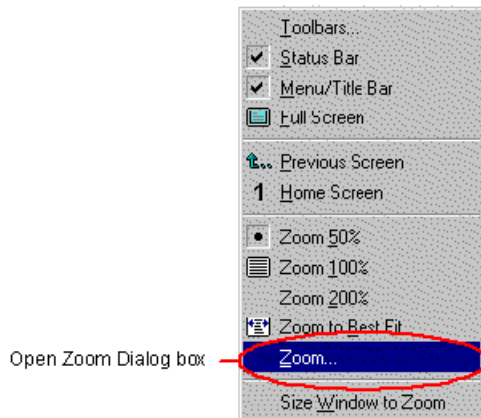

The Zoom dialog box opens.

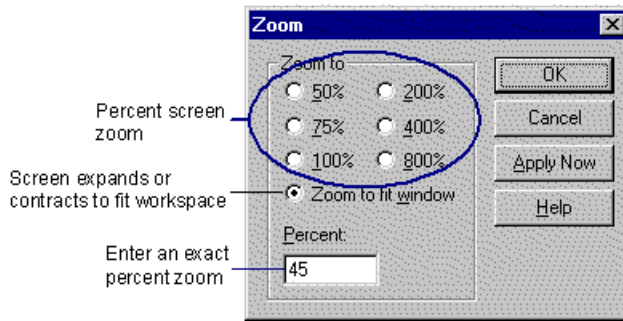
Zoom (Screen) Dialog Box

3. Either:
 - a. Select one of the zoom choices.
 - b. Enter a precise zoom percent in the **Percent** field.
4. Click **OK**.

System Sentry Screen Display Tools

You can choose to display or hide the System Sentry toolbar, status bar and/or menu and title bar.

 **todo: To display or hide a System Sentry screen's display tools:**

1. Click Edit on the System Sentry menu bar.
2. Select any one or all of the following.

Toolbars

- a. Select Toolbars...

The Options dialog box opens.

- a. Check one or all of the check boxes to display the options.

Status Bar

Check the check box to display the status bar.

Menu/Title Bar

Check the check box to display the menu and title bars.

Edit Menu: Display Tools

Display/hide toolbar, status bar or menu/title bar

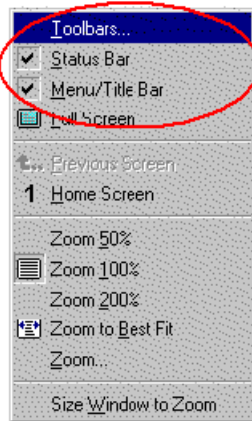

Print System Sentry Screens

A very powerful feature of System Sentry screens is that you can easily print any screen at any time. Whenever you see a System Sentry Screen that you want to print out to review on paper, you can.

Do one of the following.

Method 1

Click the **Print** button .

Method 2

1. Click File on the System Sentry menu bar.
2. Select Print.

The Print dialog box for your printer will open.

 **Note:** The System Sentry file menu also provides you with Print Setup so you can configure your printer the same way you do in other Windows applications.

Every system is unique. Therefore, you need to evaluate many of the numbers that display on your System Sentry screens in context with baseline and other system data.

System Sentry Power Tools

System Sentry Power Tools

The System Sentry takes monitoring capability to a new level by enabling you to create valuable customized tools that:

- Alert you if a selected instance in your system is exceeding its normal limits.
- Monitor objects other than CIMPLICITY objects that reside on your system, either on a local or remote computer.

By integrating the System Sentry with CIMPLICITY power tools, you can create:

- Logs to record performance data, including baseline performance.
- Alarms to audibly and/or visibly alert users that an instance has gone into alarm state.
- Pagers to page you if you are away from the system and an instance goes into alarm state.
- CimView screens—to display instances that are on your system in addition to the CIMPLICITY counters. You can dedicate entire or partial screens to your custom configuration.

You can create these power tools by doing configurations with which you are already familiar. You simply:

1. Use the familiar CIMPLICITY dialog boxes along with a new easy-to-use System Sentry Address builder to create a System Sentry
 - Device point.
 - Point by address.

Whether you choose a device point or point by address depends on the use to which it will be put. The same advantages and limitations apply to System Sentry device points and points by address that apply to any others in a CIMPLICITY project.

Note: In order to improve the performance, invalid points return a value of zero; they are not marked as invalid.

2. Continue configuring the CIMPLICITY power tools the same way you would for any other device point or point by address.

 **Tip:** Use these tools to monitor:

- Local computers
- Remote computers
- SQL server primary and secondary computers

Power Tools Using System Sentry Device Points

Power Tools Using System Sentry Device Points

You can integrate System Sentry device points with several CIMPLICITY power tools to create System Sentry power tools. You can:

- Create log files to develop baseline data and review a performance history.
- Configure alarms to warn you before a bottleneck occurs.
- Configure pagers to warn you, even when you are not near the system, before a bottleneck occurs.

 **Note:** You can also configure objects on a CimEdit/CimView screen using a System Sentry device point. However, you can also use points by address. In order to improve the performance, invalid points return a value of zero; they are not marked as invalid.

System Sentry Device Points

System Sentry device points perform like any other configured device points. What makes them special is they report data, which is collected by internal performance counters, from your internal network systems and projects.

System Sentry obtains its data through an automatically installed System Sentry device that is connected to an automatically installed System Sentry software port. The System Sentry software port can access every counter in the system.

The counters include:

- CIMPLICITY counters.
- Windows Performance Monitor counters.
- SQL Server counters.
- Any other counters that reside in the system.

You go through the same steps to create a System Sentry device as you would any other device point for which a port and a device are already installed.

Creating a System Sentry device point is straightforward.

- When the System Sentry is installed, CIMPLICITY automatically installs a System Sentry protocol called PERFREARD.
- When you activate the System Sentry in the Project Properties dialog box, CIMPLICITY automatically installs a:
 - Port called MASTER_PRO.

- Device called SYSTEM_SENTRY.
- When you create a new System Sentry device point, you simply choose the:
- System Sentry device.
- Address you want the device to reference.

System Sentry Port Configuration

When the System Sentry is activated, CIMPLICITY automatically installs a System Sentry:

- Protocol called PERFREARD.
- Port icon called MASTER_PR0 in the Workbench Ports area.

1. Open the CIMPLICITY Workbench.
2. Click the **Ports** icon in the Workbench left pane.
3. Double-click MASTER_PR0 in the Workbench right pane.

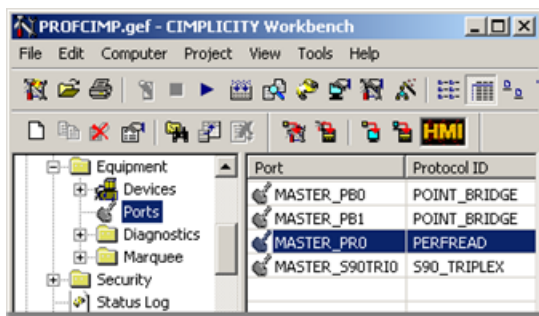

The Port Properties dialog box opens.

4. Select the General tab.
5. Enter the following:



Option	Description
Description	Descriptive identifier for the System Sentry device communication.

Option	Description	
Scan rate	Interval length between scans. The time type options are: <ul style="list-style-type: none"> • Seconds • Minutes • Hours 	
	Default	2 seconds
Retry count	Use the default.	
	Default	1
Enable	Check to activate the port. Note: The port is automatically created for System Sentry.	
	Default	Checked.

- a.  **Note:** There is no configuration on the Default tab of the Port Properties dialog box.

System Sentry Device Configuration

When the System Sentry is activated, CIMPLICITY automatically installs a System Sentry device called System_Sentry.

CIMPLICITY also automatically configures the System_Sentry device. The default configuration should not be changed.

 **todo:** To view the System Sentry device configuration:

1. Open the Workbench.
2. Click the **Devices** icon in the Workbench's left pane.
3. Double-click System_Sentry in the Device ID column in the right pane.

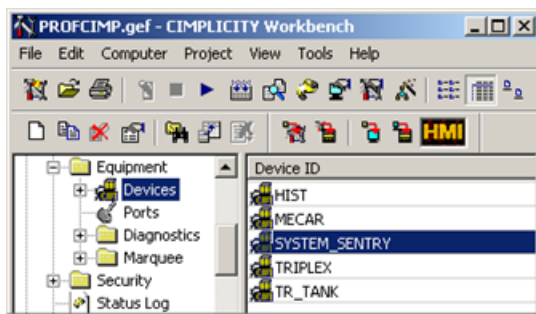

The General tab of the Device Properties dialog box opens. The configuration that displays is the correct configuration.

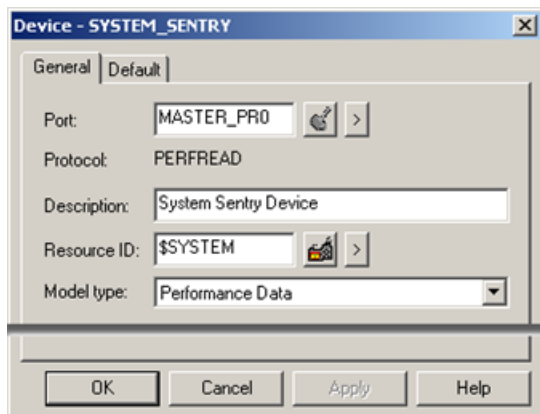

System Sentry Device Point Configuration

System Sentry Device Point Configuration

You configure a System Sentry device point the same way that you do any device point.

You categorize the point as a System Sentry point by selecting the System Sentry device. :

The steps are

Step 1 (page 657)	Create a new System Sentry device point.
Step 2 (page 659)	Configure a System Sentry device point general properties.
Step 3 (page 658)	Configure a System Sentry device point device properties.
Step 4 (page 659)	Specify the address for the System Sentry device.
Step 5 (page 660)	Specify when the device point should be updated.

 **Note:** In order to improve the performance, invalid points return a value of zero; they are not marked as invalid.

Step 1. Create a New System Sentry Device Point

1. Open a New Point dialog box, using any of the following methods.

Method 1

- a. Select Points in the left pane of the Workbench.
- b. Double-click the left mouse button.

Method 2

- a. Select Points in the left pane of the Workbench.
- b. Click File on the Workbench menu bar.
- c. Select New.
- d. Select Object.

Method 3

- a. Select Points in the left pane of the Workbench.
- b. Press **Ctrl+N** on the keyboard.

Method 4

- a. Select a point in the right pane.
- b. Click the right mouse button.
- c. Select New from the popup menu.

The New Point dialog box opens.

2. Define the point.
 - a. Name the System Sentry point.
 - b. Select Device as the Type.
 - c. Name System_Sentry as the device.
 - d. Choose Analog as the Class.
 - e. Click **OK**.

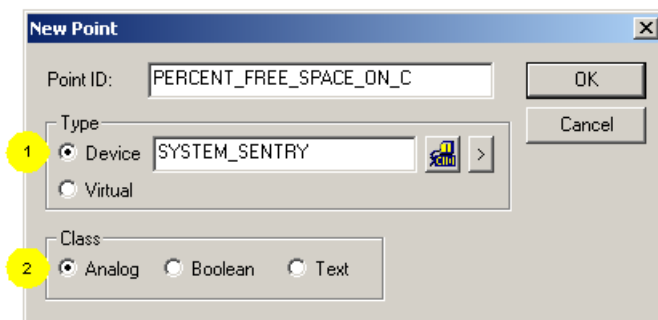

- 1 Device for System Sentry device point
- 2 System Sentry point class

The point's Properties dialog box opens.

Step 3. Configure a System Sentry Device Point Device Properties

1. Select the Device tab on the Point Properties dialog box.
2. Make sure the System_Sentry device displays in the **Device ID** field.

3. Click **Address Builder**.

Step 2. Configure a System Sentry Device Point General Properties

1. Select the General tab of the Point Properties dialog box.
2. (Optional) Enter a description of the point in the **Description** field.
3. Choose one of the two following data types.

UDINT	Unsigned integers ranging from 0 to 4,294,967,295. The UDINT format is the format in which the counter results are stored. Note: Decimals are truncated when UDINT is selected.
REAL	Floating-point numbers. The REAL format is useful when the counter tracks current data, for example, per second counts.

4. Select one (1) in the **Elements** field. The counter counts one (1) element.
5. Check the **Read Only** check box. If the **Read Only** check box is clear and someone tries to enter a setpoint value, CIMPLICITY will display an error message.

General Tab-Basic View-System Sentry Device Point

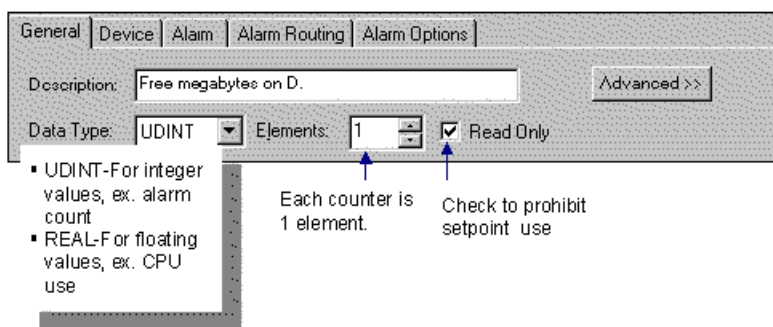

Step 4. Specify the Address for the System Sentry Device

1. Select the object, in the **Object** field, that you want to monitor.

You will see that every object in the system that has counters is available for you to choose.

2. Select the counter, from the Counter drop down list, that the device point will represent.
3. Select the instance, in the **Instance** field, that the counter will count.

The available selections reflect the counter you selected and your system configuration.

 **Note:** The Total option appears whenever a total count can be made. This option enables you to include every system instance that can be counted by the selected counter.

4. Check the **Include Computer Name** check box to specify which computer will provide the counter definitions. (The computer on which the System Sentry resides is used when you leave the check box blank.)

Note: Checking this simple check box enables you to specify a SQL Server or remote computer reference.

The **Computer Name** field displays.

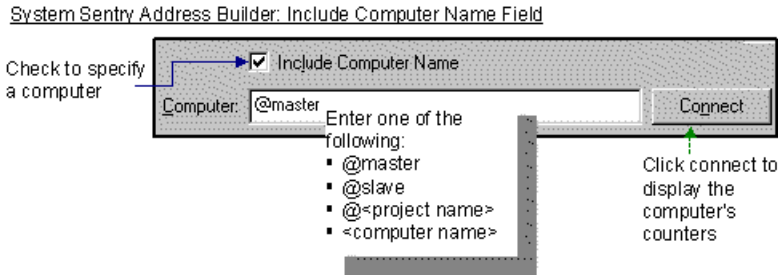

Note: To retrieve counters from remote computers make sure that the CIMPPLICITY service can access the remote computer.

This means the service must run as a specific user and the user has to have access to the remote computer.

5. Enter one of the following:

Entry	References
@master	Whatever server is currently the active server. The primary may have been switched, moved, or renamed, or the secondary may have taken over the active function. If it is the current active, it will be referenced.
@slave	Whatever server is currently the standby. The secondary server may have been switched, moved, or renamed. If it is the current standby, it will be referenced.
@<project name>	A project in the system. If the project is not running, the point will be unavailable.
<computer name>	A computer that has the specified name. If the computer is renamed, it will no longer provide the counter definitions.

6. Click **Connect** to connect to the specified computer.

7. Click **OK**.

The Device tab on the Point Properties dialog box appears displaying your selection in the **Address** field.

Step 5. Specify when the Device Point should be Updated

Select the update criteria in the **Update Criteria** field. The choices are:

On Change (Default)	
Data Collected	At a regular interval. The interval equals the base scan rate for the port on which the device is located multiplied by the scan rate for the point.
Value Updated	Only when the value changes. This is an efficient criterion.
On Scan	
Data Collected	At a regular interval. The interval equals the base scan rate for the port on which the device is located multiplied by the scan rate for the point.
Value Updated	The point's value is updated at the point's scan interval, whether or not the value changes. Because this can increase system load, it is recommended that you use On Scan sparingly or not at all.

Specifying a System Sentry Device Point Address Overview

1. Select the System_Sentry device.

2. Click the Address Builder.

3. Select the object

4. Select the counter

5. Check to specify the computer

6. Select the instance

7. Press OK.

8. Specify the Update Criteria

System Sentry Log File Creation

You can most accurately diagnose a system's performance when you have some baseline and historical data to use as a reference. You can easily collect this information for any System Sentry point data or alarm.

- Add points to a data log table.
- Add point alarms and alarms to the ALARM_LOG table.

System Sentry Alarms Creation

You unleash the power of a System Sentry device point when you configure alarms for the point.

You use the same process to configure alarms for a System Sentry point as you use for any other device point. You also receive the same benefits from the configuration.

When a point goes into your pre-defined alarm state, you can:

- Trigger a visual or audio alarm
- Transmit the alarm through a pager when you are not near the system
- Alert any roles (individuals doing specified tasks) who should be alerted

 **Tip:** When in doubt, log the point's data when the system is in a quiet state. The resulting baseline data can help you define when the point is in an alarm state.

System Sentry Pager Configuration

1. Configure an alarm for the device point you want to attach to a pager.
2. Click the Pager folder in the CIMPLICITY Workbench.
3. Click the Alarms icon.

The CIMPLICITY Pager – Configuration window opens.

4. Click File on the Pager – Configuration window's menu bar.
5. Select New Entry.

The Add Alarm Pagers window opens.

6. Click **Browse**.
7. Select the Alarm ID (Point ID) name from the Alarm ID list.
8. Continue configuration as you would for any pager selection.

CimView Screens Using System Sentry Points by Address

CimView Screens Using System Sentry Points by Address

A point by address provides an alternative to a device point when you want to periodically view one or more system instances on a CimView screen.

System Sentry Points by Address

System Sentry points by address provide you with the same advantages and limitations as any CIMPLICITY point by address.

Points by address enable you to view raw device information without the overhead of configuring a CIMPLICITY point.

When a user opens a screen in CimView, the point is dynamically created in memory.

When the user closes the screen, the point is dynamically removed from memory.

The benefit of choosing a point by address is that point by address descriptions do not take up memory while they are not in use. This is because they are created and destroyed dynamically. However, there is a small delay during startup for these points to be created.

There are restrictions for point by address descriptions because they only exist while they are being viewed. A point by address:

- May only be used in applications like CimView, which directly display point data.
- Cannot be alarmed.
- Cannot be logged.
- Cannot be used in the configuration of another point.
- Cannot have engineering units conversion.

In general, a System Sentry point that is frequently used or is referenced by multiple CimView screens should be configured as a CIMPLICITY point. For diagnostic information, which is seldom used and is included in only one screen, a Point by Address is appropriate.

If you choose to use a point by address, you will discover that the System Sentry makes it easy to configure.

System Sentry Point by Address on a CimEdit Screen

System Sentry Point by Address on a CimEdit Screen

You can create an object that is governed by a system point by address on any CimEdit screen. These objects can provide you with system monitoring capabilities that augment the pre-configured System Sentry screens.

 **Note:** If you want to use alarms with your object, you have to create an object that uses a System Sentry device point.

The steps to configure a System Sentry point by address are:

Step 1 (page 664)	Insert or create an object (on an open CimEdit screen) that will be governed by the point by address at runtime
Step 2 (page 665)	Open the Point by Address dialog box.
Step 3 (page 666)	Fill in the Point by Address dialog box.
Step 4 (page 667)	Select the object-counter-instance whose value will display.
Step 5 (page 668)	(Optional) Change the scan rate.
Step 6 (page 669)	Test the configuration.

 **Note:** These steps configure a simple shape and text object as an example. However, CimEdit offers you an extensive selection of objects that can be inserted or created in a screen.

Step 1. Insert or Create an Object

Select or create an object from CimEdit's enormous selection.

- Text example
- Rectangle example

Text Example

1. Click the **Text** button  in the Text group on the CimEdit Ribbon bar.
2. Click the spot on the CimEdit screen where the text will display
3. Double-click the default Text object.

The Properties dialog box opens.

Rectangle Example

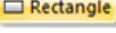
- 4. Click the **Rectangle** button  in the Shapes group on the CimEdit toolbar.
- 5. Create the rectangle shape on the CimEdit screen.
- 6. Double-click the rectangle.

The Properties dialog box opens.

Step 2. Open the Point by Address Dialog Box

Click the Point menu button to the right of an expression field that applies to your configuration.

- Text example
- Rectangle example

Text Example

- 1. Select a list item that enables you to enter a point or expression, e.g. Text.
- 2. Do the following.

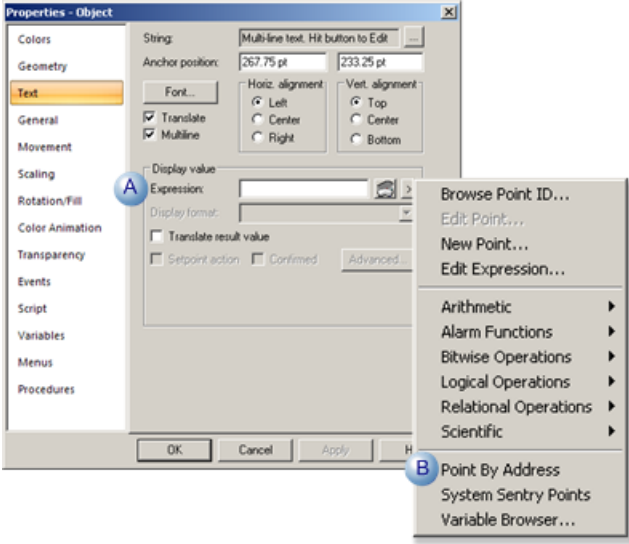

A	Click the button to the right of the Expression field.
B	Select Point by Address on the Popup menu.

Result: The Point by Address dialog box opens.

Rectangle Example

3. Select a list item that enables you to enter a point or expression, e.g. Fill/Rotation.
4. Do the following.

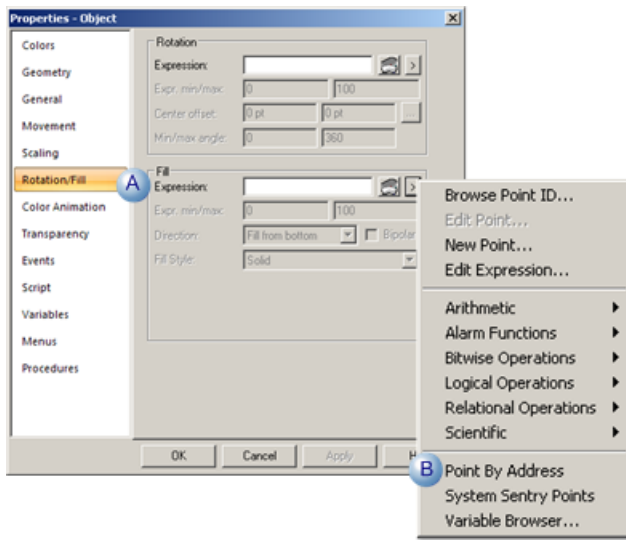

A	Click the button to the right of the Expression field.
B	Select Point by Address on the Popup menu.

The Point by Address dialog box opens.

Note: Instead of selecting Point by Address you can select Browse Point ID or New Point from the Point ID popup menu. Choosing the former you will complete the System Sentry part of your object configuration; choosing the latter will open the New Point dialog box.

Step 3. Fill in the Point by Address Dialog Box

1. Select the following in the Point By Address dialog box.

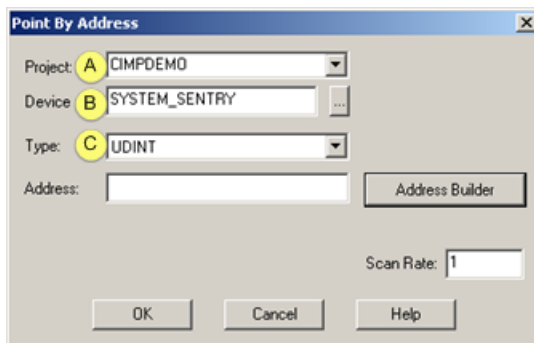

	Field	Select:
A	Project	The project that will be running when the System Sentry collects the point by address values.
B	Device	SYSTEM_SENTRY.
C	Type	A numeric format. <ul style="list-style-type: none"> • UDINT is recommended. • REAL can also be meaningful for per second values.

2. Click Address Builder.

The Address Builder dialog box opens.

Step 4. Select the Object-Counter Instance Whose Value will Display

 **Note:** The Address Builder dialog box is the same dialog box you use when configuring a System Sentry device point.

1. Select the following in the System Sentry Address Builder dialog box.

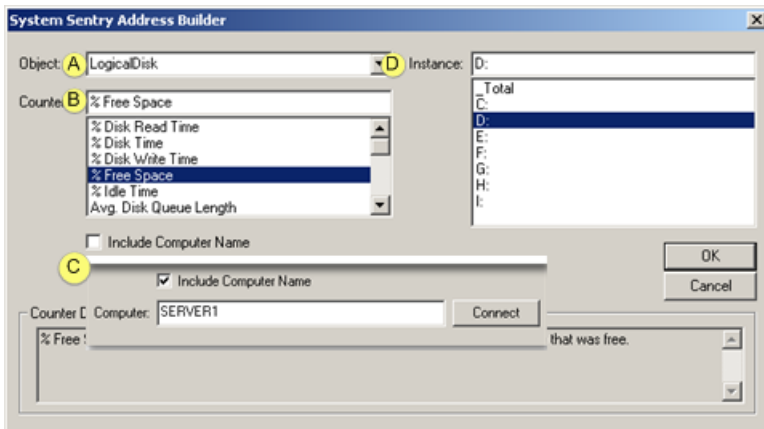

	Field	Select:
A	Object	An objects that can be monitored from the available objects in the drop-down list. The exact list of objects is determined by your system configuration.
B	Counter	A counter for the object. The selected object determines the counters that are listed.
C	Include Computer Name	(Optional) Check to monitor a remote computer. <ol style="list-style-type: none"> Enter the remote computer name in the Computer field. Click Connect. Result: The instances that are listed reside on the connected computer. Note: The counter must be available to the network, not a local counter for the connection to succeed.
D	Instance	An instance for the counter. The selected object determines that instances that are listed.

2. Enter the remote computer name in the **Computer** field.

3. Click Connect.

4. Click OK.

The Point By Address dialog box opens; an expression that applies to your selection displays in the Expression field.

Example

The following are selected for the rectangle and text object.

Object	Logical Disk
Counter	% Free Space
Remote computer	SERVER1
Drive	D

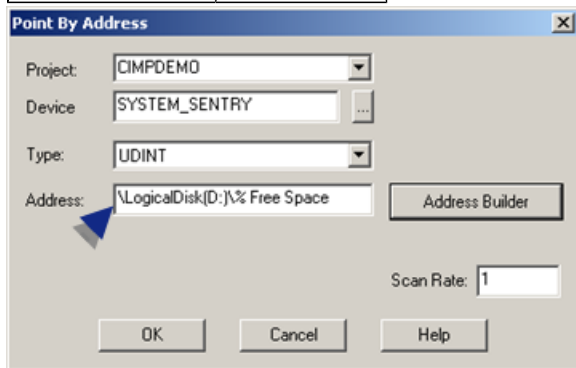

Step 5. (Optional) Change the Scan Rate

1. (Optional) Change the scan rate from the default of one second in the **Scan Rate** field in the Point By Address dialog box.

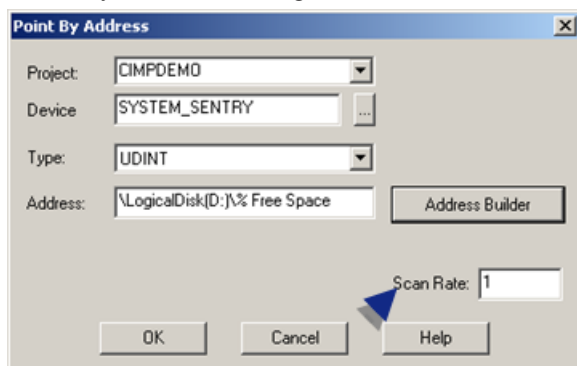

2. Click OK

The Point By Address box closes; the instance you selected displays in the Expression field in the Properties - Object dialog box.

3. Do any other configuration that the object requires.
4. Close the Properties - Object dialog box.

Step 6. Test the Configuration

Click the CimEdit Runtime button .

Examples

The text and fill objects display that the D drive is 52% free.

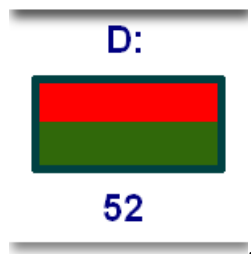

CIMPLICITY Counters

CIMPLICITY Counters

The System Sentry comes with several CIMPLICITY counters. These counters provide the hard data that enables you to numerically diagnose the different components in your CIMPLICITY projects.

These numbers provide you with the tools to:

- Knowledgeably track a project's performance.
- Make a project run more efficiently.
- Avert potential bottlenecks.

The counters include accumulated totals, per second performance indicators and other statistics for the following CIMPLICITY objects:

- HMI Alarm Manager.
- HMI CimView.

- HMI Device Communication (Devcom).
- HMI Device.
- HMI IPC.
- HMI Logging Table.
- HMI Point App.
- HMI Point Manager.
- HMI PRT DS Counters
- HMI Router.
- HMI Router Port.
- HMI User Registration.
- Levels in a system in which counters operate.

Levels in a System in which Counters Operate

 **Note:** Following are the levels in a system in which counters operate.

Level	Description
Level 1– Object	A system can be divided in several objects. Example There is a CIMPLICITY object called Alarm Class. There is a Windows object called LogicalDisk
Level 2– Counter	There are one or more resources in an object that can be numerically counted. Example HMI Alarm Class includes Acknowledged alarms (Aked) and any Alarms (Alarms). Both can be counted LogicalDisk includes several resources that can be numerically tracked. Resources include % Free Space, % Disk Read time, Avg. Disk Bytes per read
Level 3– Instance	Each counter includes one or more specific instance that can be singled out for diagnosis. Example: HMI Alarm Class Acknowledged alarms can focus on a specific CIMPLICITY project, or all the projects on a system (_Total) LogicalDisk % Free space can focus on a specific drive, such as the C: drive or all the drives in the system (_Total)

CIMPLICITY Objects with Counters

CIMPLICITY Objects with Counters

The System Sentry provides several counters for CIMPLICITY objects.

CIMPLICITY counters can be grouped into three different categories that reflect the type of information they provide.

Code	Counter Level	Counter Provides:
N	Novice	Straightforward system indicators that alert a user if there is a potential problem. These counters, which are at the core of the System Sentry's usefulness, are the counters to use for most situations.

Code	Counter Level	Counter Provides:
A	Advanced	Diagnostic data for a user, who is frequently responsible for increasing the project's efficiency or correcting a problem.
E	Expert	Diagnostic data for some of the most complex diagnostic requirements in CIMPLICITY project development.

A category code appears before each counter.

HMI Alarm Manager Counters

HMI Alarm Manager counters provide you with the capability to review a detailed performance of the alarms in one or all projects running on your system. Any one counter may raise a red flag that the system is generating more alarms than anticipated. When all of the counters are reviewed, the possibility that there is a problem in the system can be evaluated.

Accumulated totals since a CimView session started

For	Counter	Counts the Number of:
A	Alarms Generated	Alarms that have been generated and reset. In the case of reset, the message must be re-sent to clients to change state Example The same alarm may have been generated 100 times since the project started. The last instance of the alarm being generated has not been deleted from the Alarm Manager. The Alarm Count is one (1). The Alarms Generated count is 100.
A	Alarms Acknowledged	Alarms that have been acknowledged.
A	Alarms Reset	Alarms that have been reset.
A	Alarms Deleted	Alarms that have been manually deleted.

Indicators of current performance

For	Counter	Displays the
N	Alarm Count	Current alarms that display in the Alarm Manager. The generated alarms are either acknowledged or not acknowledged. They have not been deleted.
N	Update Queue Length	Requests to generate alarms. The alarms are put in a queue. Then the queue is processed. This can cause the alarm manager to back up. The Update Queue Length should always be around 0.
N	Application Queue Length	Applications can make requests to the Alarm Manager, for example, for the current list of alarms. The queue that forms before requests are processed should be a small number.
N	PTMRP Queue Length	Data comes from the point manager. The queue that forms before the data is processed should be a small number.

For	Counter	Displays the
N	Clients	The number of clients that are currently requesting alarm data and have not yet received it. Clients include both allocated processes and alarm interested processes.
N	Alarms Generated/sec	The number of alarms that are being generated per second. This counter tells you if more alarms are being generated than you anticipated which, in context of other counters, could indicate a problem with the system.

Expertise Code

N	Novice
A	Advanced
E	Expert

HMI CimView Counters

HMI CimView counters provide you with the capability to review the performance of CimView during any single session. A CimView session begins when the first CimView screen is opened and ends when the last open CimView screen is closed. A session can include CimView, and Terminal Services access.

Accumulated totals since a CimView session started

For	Counter	Counts the Number of:
E	BitBlts	Cumulative number of BitBlockTransfers for a CimView session.
N	Object Redraws	Cumulative number of times objects are redrawn from the start of a CimView session. For example, each object on a screen is included in the total when the screen opens; animated objects are counted each time they are redrawn.
A	Events	Cumulative number of events that have been fired from the start of a CimView session.

Indicators of current CimView performance

For	Counter	Displays the
E	BitBlts/sec	Current rate (per second) at which the BitBlockTransfers occur during a CimView session.
N	Object Redraws/sec	Current rate (per second) that objects are being redrawn in a CimView session.
N	Open Screens	The number of open CimView screens.
A	Event Queue Length	Current number of events waiting to be fired.
A	Events per sec	Current rate (per second) that events are fired in a CimView session.

Other CimView session indicators

For	Counter	Displays the
N	Maximum Cache Size	The maximum cache size available during a CimView session. CimView, Terminal Services and WebView have individual sizes. A system administrator can change any of the cache sizes for future CimView sessions using CIMPLICITY global parameters. The global parameters are: <ul style="list-style-type: none"> • GSM_CACHE_SIZE (CimView) • GSM_TERMSERV_CAHE_SIZE(Terminal Services) • PROWLER_CACHE_SIZE(WebView)
N	Process ID	The process number that Windows assigns CimView when a session starts. This number remains constant during a single CimView session. When the session ends and a new session begins, a new number is assigned.

Expertise Code

N	Novice
A	Advanced
E	Expert

HMI Device Communication (Devcom) Counters

HMI Device Communication (Devcom) Counters provide you with the capability to review the performance of any one communication device in a project or all of the communication devices in the system.

Accumulated totals since the project started

For	Counter	Counts the Number of:
A	Point Updates	Point updates that have occurred on one or all communication devices.

Indicators of current performance

HMI Device Counters

System Sentry provides performance data totals that indicate device performance since one or all projects in the system started. System Sentry also provides indicators that enable you to monitor current device performance.

Accumulated totals since the project started

For	Counter	Collection	Counts the Number of:
A	Transmissions	Polled	Transmissions to one or all devices, indicates how much activity is going into a communication device. A rapid increase may provide a warning for a communication device overflow.

For	Counter	Collection	Counts the Number of:
		Unsolicited	Transmissions will not occur.
A	Responses	Polled	Responses from the device.
		Unsolicited	Responses will increase every time a response for unsolicited communication is received even though transmission will not increase.
	Retries	Polled	Times a device has been retried.
A		Unsolicited	Retries will not occur; unsolicited communication requires two transmission failures before a retry can occur.
A	Failures	All	Failures communicating to one or all devices.
E	Skipped Polls	All	Number of polls skipped when communicating to an Async device.

 **Note:** Transmissions, Responses, Retries Failures and Skipped Polls can also be found in diagnostic data for a device.

Indicators of current performance

For	Counter	Collection	Displays the
N	Transmissions/ sec	Polled	Transmissions to one or all devices per second.
		Unsolicited	Transmissions will not occur.
	Responses/ sec	Polled	Responses from the device per second.
N		Unsolicited	Responses will increase every time a response for unsolicited communication is received even though transmission will not increase.
For	Other Counter	Indicates if the Device is Currently:	
N	Device Up	1 means the device is up.	
N	Device Down	1 means the device is down.	

 **Note:** and **Device Down** can also be found in diagnostic data for a device.

Expertise Code

N	Novice
A	Advanced
E	Expert

HMI IPC Counters

The System Sentry provides CIMPLICITY counters for the Inter-process Communications sub-system.

Accumulated totals since the project started

For	Other Counter	Indicates if the Device is Currently:
A	Messages Sent	Messages sent by one or all processes. A number higher or lower than expectation may indicate a problem
A	Messages Received	Messages received by one or all processes. A number lower than messages sent indicates that one or more processes is not processing the messages as quickly as it is receiving them. The acceptable difference depends on the system and which process is being monitored.
A	Logical Link Writes	Writes performed over the logical links. A logical link is a direct connection between processes, as opposed to sending the data through a router.
A	Logical Link Reads	Reads performed over the logical links.
N	Write Retries	Times a write operation was retried. If a process tries to write to a port and fails, it tries again. Write Retries can indicate that a process is backing up. Important: Retries will not occur on unsolicited communication; unsolicited communication requires two transmission failures before a retry occurs.

Indicators of current performance

For	Counter	Displays the
E	Ports	Software ports created by one or all projects' processes. A process might create entry ports at startup or continuously while it is running.
A	Messages Sent/sec	Messages being sent by one or all processes per second.
	Messages Received/sec	
A	Messages Received/sec	Messages being received by one or all processes per second.
A	Write Retries/sec	Times a write operation is retried per second.

Expertise Code

N	Novice
A	Advanced
E	Expert

HMI Logging Table Counters

Listing of performance data for Database Logger Tables.

Accumulated totals since the project started

For	Counter	Counts the Number of:
A	Writes	Rows inserted into one or all logging tables. Accumulated Writes indicate that there is activity in the system.
A	Reads	Rows read from one or all logging tables. Reads will accumulate only if an application in the project performs reads, for example SPC. If not Reads will display as 0.
A	Maintenance Events	Maintenance events submitted for one or all logging tables.
A	Maintenance Actions	Maintenance actions successfully completed for one or all logging tables. Each Export, Purge or other action configured for the table is counted separately.

Indicators of current performance

For	Counter	Displays the
N	Writes/sec	Rows inserted into the specified table per second indicate how quickly a process is trying to send messages through the system.
N	Reads/sec	Rows read from the specified table per second, are only read if an application in the project performs reads, for example SPC. If not, Reads/sec will display as 0.
N	Queue Size	Database operations (including Reads, Writes and Maintenance Events) which have been submitted but not yet processed. If there is no application in the project that processes writes, the queue size will be 0.

Expertise Code

N	Novice
A	Advanced
E	Expert

HMI Point App Counters

The System Sentry provides CIMPLICITY counters for any one or all applications using the PTMAP API.

Accumulated totals since the project started

For	Counter	Counts the Number of:
A	Point Requests	Requests to the Point Manager for point values.
A	Service Requests	Requests to the Point Manager for anything other than a point value. For example, a setpoint would be a service request.

Indicators of current performance

For	Counter	Displays the
N	Point Requests/sec	Requests per second to the Point Manager for point values, clearly showing how much demand is being placed on the Point Manager
N	Service Requests/sec	Requests per second to the Point Manager for anything other than a point value, clearly showing how much demand is being placed on the Point Manager

Expertise Code

N	Novice
A	Advanced
E	Expert

HMI Point Manager Counters

The System Sentry provides performance data for each instance of the Point Manager.

Accumulated totals since the project started

For	Counter	Counts the Number of:
A	Messages Sent	Total of all messages sent by the Point Manager.
N	Devcom Queue Overflows	Messages dropped from the communication device queues. The Point Manager has direct connections to the communication devices. If a communication device is not processing its messages quickly enough, the queue can back up and start dropping the Point Manager's messages. This counter shows the number of overflow messages since the project started.
N	App Queue Overflows	Messages dropped from point application queues. For example, if the Point Control panel is not processing its messages quickly enough, the queue can back up and start dropping the Point Manager's messages. This counter shows the number of overflow messages since the project started.

Indicators of current performance

For	Counter	Displays the
N	Clients	Clients requesting point data from the Point Manager.
N	Points	Points known to the Point Manager.
N	Messages Queued	Messages that the Point Manager has added to an application's queue. These messages are waiting to be sent.
A	App Queue Size	Largest size of any Application message queue.

For	Counter	Displays the
A	Adhoc Requests	Requests for a Point by Address value.
A	ES Points	All the Enterprise Points on an Enterprise server. The points may have requests or may be idle. One computer stores point values from several computers. This allows viewers to collect data from one computer, an Enterprise server, instead of having to be connected to several. The enterprise points are on one computer that is collecting data from all the other computers.
A	ES Points Idle	Enterprise Points on an Enterprise server that are waiting to be released (currently not being collected).
For	Other Counter	Indicates if the Device is Currently:
N	Configured Master	Server is the configured primary in a Server Redundant project. One (1) means yes.
N	Current Master	Server is the current active in a Server Redundant project. This may be the configured primary or a secondary server that has assumed the role. One (1) means yes.

Expertise Code

N	Novice
A	Advanced
E	Expert

HMI PRT DS Counters

The System Sentry provides counters to monitor the Production Tracker Data Server sub-system.

Accumulated totals since the project started

For	Counter	Counts the Number of:
E	DG Requests Added	Datagram requests that have been added (accumulated) since the project started.
E	DL Requests Added	Data logger requests that have been added (accumulated) since the project started.
E	LL Requests Added	Logical link requests that have been added (accumulated) since the project started.

Indicators of current performance

For	Counter	Displays the Number of:
E	DG Request Queue Size	Datagram requests that are currently in the queue.
E	DG Requests Added/sec	Datagram requests that were added in the last second.
E	DG Requests Removed/sec	Datagram requests were removed in the last second.
E	DL Request Queue Size	Data logger requests that are currently in the queue.

For	Counter	Displays the Number of:
E	DL Requests Added/sec	Data logger requests that were added in the last second.
E	DL Requests Removed/sec	Data logger requests that were removed in the last second.
E	LL Request Queue Size	Logical Link requests that are currently in the queue.
E	LL Requests Added/sec	Logical link requests that were added in the last second.
E	LL Requests Removed/sec	Logical link requests that were removed in the last second.

Expertise Code

N	Novice
A	Advanced
E	Expert

HMI Router Counters

The System Sentry provides counters to monitor CIMPLICITY router performance.

Accumulated totals since the project started

For	Counter	Counts the Number of:
A	Messages Sent	Messages sent by the router.
A	Messages Rec	Messages received by the router.
A	RCM Requests	Connection management requests. When a viewer needs to attach to a project, it makes an RCM request.
N	Socket Errors	TCP/IP sockets are used to communicate. For example, if a cable is accidentally pulled off a socket, an error will be counted. Typically, there should not be many socket errors.

Indicators of current performance

For	Counter	Displays the
N	Messages Sent/sec	Messages sent by the router per second.
N	Messages Rec/sec	Messages received by the router per second.
N	Sockets	Sockets that are currently in use by the router. The router opens a socket for each connection to each computer. The router also uses sockets for other reasons. Example The router creates a separate connection between redundant nodes beyond the router message queue connection to show if the element has gone away. That can add extra sockets.

For	Counter	Displays the
N	Socket Errors/sec	Socket errors per second show if there currently is a problem. For example, a cable needs to be tightened.
N	Connected Nodes	Nodes that are connected to the selected node.
E	Ports	Application ports in use by the router. This may be a well-known or anonymous port that is being sent out to a process. This indicates the current level of use.
E	RR Outstanding	Response required messages from a process that are on the router's queue waiting to be received by another process. If the router knows that the receiving process is unavailable, it informs the originating process.

Expertise Code

N	Novice
A	Advanced
E	Expert

HMI Router Port Counters

The CIMPLICITY counters for the IPC Ports inside the Router. The CIMPLICITY router is w32rtr.exe.

CIMPLICITY has three types of messages:

Message	Description
Intermediate Response	Messages will follow this message
Final Response	The last message in a chain sent by a process
Response Required	Messages that require a response. This type of message eliminates waiting by quickly showing if a process is unavailable.

The difference between the number of these messages written and read can be a helpful diagnostic tool for solving a problem.

Accumulated totals since the project started

For	Counter	Counts the Number of:
E	RR Writes	Response Required messages that an application has sent via a software port to the router. The CIMPLICITY counter can count one or all ports.
E	IR Writes	Intermediate Response messages that an application has sent via a software port to the router. The CIMPLICITY counter can count one or all ports.

For	Counter	Counts the Number of:
E	FR Writes	Final Response messages that an application has sent via a software port to the router. The CIMPLICITY counter can count one or all ports.
E	RR Reads	Response Required messages sent from the router to an application via a software port. The CIMPLICITY counter can count one or all ports.
E	IR Reads	Intermediate Response messages sent from the router to an application via a software port. The CIMPLICITY counter can count one or all ports.
E	FR Reads	Final Response messages sent from the router to an application via a software port. The CIMPLICITY counter can count one or all ports.
E	RR Cancels	Response Required messages that have been canceled on one or all ports.
N	IR Drops	Intermediate Response messages that have been dropped by the router. The router has a buffer in which it stores the queue. Messages are dropped when the router's buffer is full. The CIMPLICITY counter can count one or all ports. This, along with FR Drops, is a clear indicator that the system is not processing messages quickly enough.
N	FR Drops	Final Response message has been dropped by the router on one or all software ports. The router has a buffer in which it stores the queue. Messages are dropped when the router's buffer is full. The CIMPLICITY counter can count one or all ports. This, along with IR Drops, is a clear indicator that the system is not processing messages quickly enough.
A	Messages Written	All of the messages sent from an application to the router via one or all software ports. The CIMPLICITY counter can count one or all ports.
A	Messages Read	All of the messages sent from the router to an application. The CIMPLICITY counter can count one or all ports.

Indicators of current performance

For	Counter	Displays the
A	Messages Out	Messages that the router has queued waiting for a process.
For	Other Counter	Indicates that:
N	Overflows	Inter-process messages are being dropped and data loss is occurring in your project.

Expertise Code

N	Novice
A	Advanced
E	Expert

HMI User Registration Counters

The System Sentry provides counters to monitor the User Registration sub-system.

Accumulated totals since the project started

For	Counter	Counts the Number of:
N	Login Failures	Login failures for this project.

Indicators of current performance

For	Counter	Displays the
N	Users	Users currently connected to the project.
N	Send Queue Length	Number of users attempting to log on to a project. This indicator should be zero.

Expertise Code

N	Novice
A	Advanced
E	Expert

CIMPLICITY Counters' Log Files

CIMPLICITY Counters' Log Files

The collection of the CIMPLICITY counters occurs whenever the router process (w32rtr.exe) is running.

Data is stored in log files. When the log file has reached a configured size it is closed and all the log files are rolled over.

The counter collection, including the number of files kept, is controlled by a configuration file.

The log files generated by the CIMPLICITY counter collection process are in the CIMPLICITY Log directory.

Example

\CIMPLICITY\hmi\log

There are two variations on the log file names

PERFDATA_#_DATA

PERFDATA_#_HEADER

Where:

PERFDATA_ indicates that the file is a CIMPLICITY counter log file

indicates when the file was created static to the other **PERFDATA_** files. The newest file is **PERFDATA_1**.

_DATA file contains the actual values recorded.

_HEADERS file is used to match a column from the DATA file to a specific counter.

These files are in a comma-separated format (CSV) and can be loaded into Excel.

Configuration File for the Counter Log Files

Configuration File for the Counter Log Files

The configuration file that controls the counter collection is called **DefaultCounters.txt**.

- DefaultCounters.txt location
- DefaultCounters.txt format and directives

DefaultCounters.txt Location

DefaultCounters.txt is in the CIMPLICITY perfserv directory.

Example

...\Proficy\Proficy CIMPLICITY\perfserv\DefaultCounters.txt

DefaultCounters.txt Format and Directives

The following text displays when you open the DefaultCounters.txt file:

#VERSION 1

#UPDATERATE 300000

#MAXFILESIZE 1000000

#MAXFILES 7

Process|Private Bytes|_Total

Objects|Threads|

The format of the DefaultCounters.txt file is

- Directives preceded by a #
- Record indicating the counter to collect

The following directives are supported:

- **VERSION** indicates the version of this file, should not be changed.
- **UPDATERATE** how often data should be collected in milliseconds
- **MAXFILESIZE** how large can a log file be in bytes
- **MAXFILES** how many versions of the log file to save

Each record in the file can have up to three fields separated by the '|' character:

- Object Name – name of the object to collect.
- Counter Name – name of counter to collect, can contain * as a wildcard character.
- Instance Name – name of the instance to collect, can be blank, can contain * as a wildcard character.

Specify the Number of Counter Log Files

DefaultCounters.txt specifies how many log files will accumulate before the oldest is deleted. The default number is seven. This number can be changed, for example, made smaller to free up disk space.

To change the number of accumulated CIMPLICITY counter log files:

1. Select the CIMPLICITY directory.
2. Select the **perserv** folder.
3. Open the **DefaultCounters.txt** file in a text editor application such as Notepad.
4. Change the number 7 for the entry **#MAXFILES 7** to whatever number you want.

Specify What Objects, Counters and Instances will be Logged

A CIMPLICITY technical support person may request that you log system information to provide information that is pertinent to solving a problem.

You will have to add the instances to be logged the System Sentry DefaultCounters.txt file.

Each line of the list will include:

Object|Counter|Instance

Where

Name	Description
Object Name	Name of object to collect.
Counter Name	Name of counter to collect, can contain * as a wildcard character.
Instance Name	Name of the instance to collect, can be blank, can contain * as a wildcard character.

i Tip: Open a System Sentry Address Builder dialog box to see a list of all the objects available on your system. You can open the dialog box through a Point or Point by Address Properties dialog box.

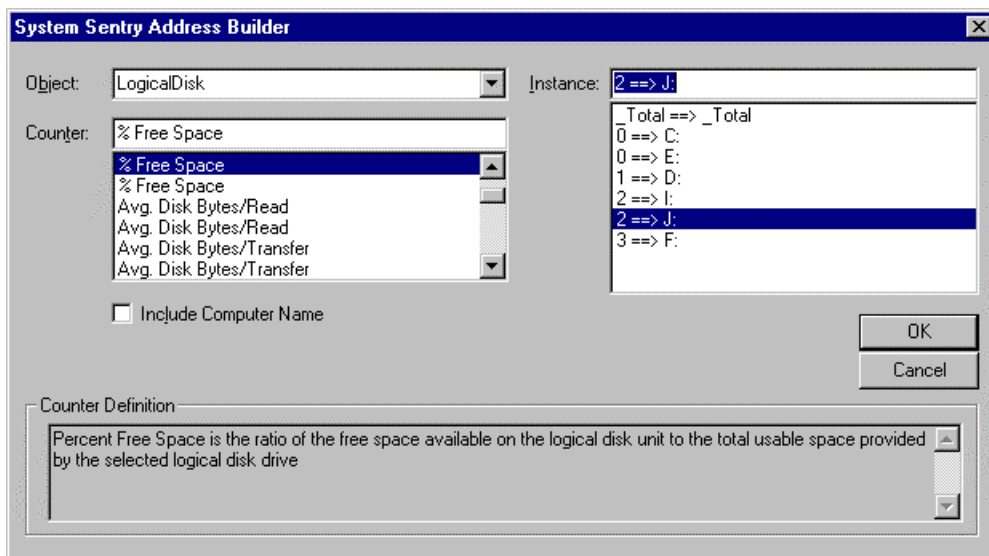

System Sentry Privileges from Other Nodes

System Sentry Privileges from Other Nodes

System Sentry can monitor performance data from nodes other than the server on which it is installed. With some configuration, a system administrator can make use of this powerful feature for any or all of the nodes in your system.

Note: You may not have to do any of the configuration changes described in this section. You can typically connect to a Windows Workstation without the extra configuration.

Step 1 (page 686)	Make CIMPLICITY a domain user.
-----------------------------------	--------------------------------

Step 2 (page 688)	Change local machine key privileges in the Windows Registry.
-----------------------------------	--

Step 1. Make CIMPLICITY a Domain User

Step 1. Make CIMPLICITY a Domain User

In addition to [changing permission for local machine keys \(page 688\)](#) in the Windows Registry, you need to make CIMPLICITY a domain user, when configuring node access privileges for the System Sentry.

Steps to make a CIMPLICITY service a domain user are:

Step 1.1 (page 686)	Create a domain user on a local machine.
Step 1.2 (page 686)	Log CIMPLICITY on as the domain user with administrative privileges.

Step 1.1. Create a Domain User on a Local Machine

1. Create a User in the Windows User Manager dialog box.
2. Make sure the User is listed in the domain.

Example

Your company's domain is rloshkosh.

You create a user called sysnode5.

Make sure that sysnode5 is included in the domain so the name become s:

rloshkosh\sysnode5

3. Grant the domain user administrative privileges for the local node.

Consult your Windows operating system documentation for more information about setting up user accounts.

Step 1.2. Log CIMPLICITY on as the Domain User with Administrative Privileges

1. Open the Windows Control Panel.

2. Double-click the **Services** icon .



The Services dialog box opens.

3. Double-click CIMPLICITY service.

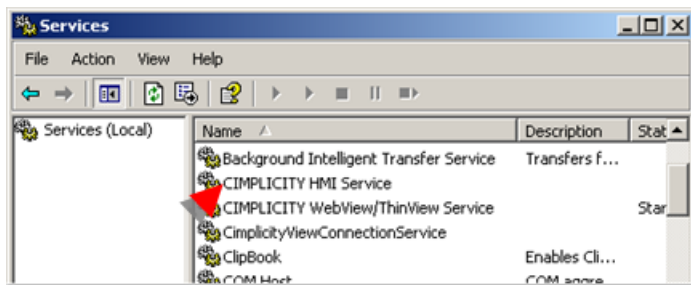

The Service dialog box opens.

4. Click the **This Account** radio button.

5. Enter a domain name that has administrative privileges on the local node in the **This Account** field. (Click the Add User button to open the Add User browser.)

6. Enter a password in the **Password** fields that will have to be entered when logging on to the domain.

7. Click **OK**.

If the User name you entered is on the domain or work group list, the CIMPLICITY service can log on as that user.

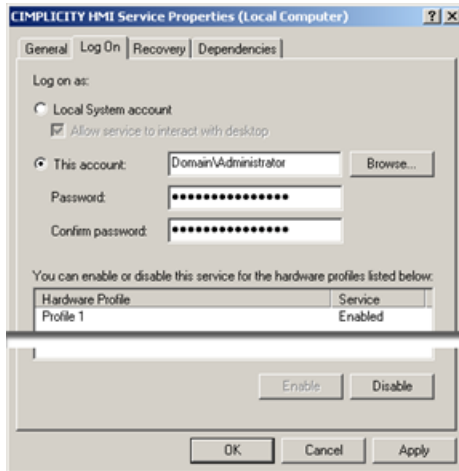

 **Note:** In a work group, the user name and password must be the same on both nodes.

Step 2. Change Local Machine Key Privileges in the Windows Registry

Step 2. Change Local Machine Key Privileges in the Windows Registry

In addition to [making CIMPLICITY a domain user \(page 686\)](#), you need to change permission for local machine keys in the Windows Registry, when configuring node access privileges for the System Sentry.

In order for the System Sentry to read performance data on remote computers there are two keys that need to give **Everyone** Read access.

Step 2.1 (page 688)	Set the <code>\Winreg</code> key to Read access.
Step 2.2 (page 689)	Set the <code>\Perflib</code> key to Read access.

 **CAUTION:** Before you edit the registry, make sure you understand how to restore it if a problem occurs. For information on how to do this, view Microsoft documentation.

Step 2.1. Set the \Winreg key to Read Access

1. Do one of the following.

Vista

Click the Start button on the Vista task bar.

Windows XP

- a. Click Start on the Windows task bar.
- b. Select Run.

The Run dialog box opens.

2. Type Regedt32.exe in the **Start Search/Open** field.
3. Click OK.

The Registry Editor window opens.

4. Select HKEY_LOCAL_MACHINE.
5. Select SYSTEM>CurrentControlSet>Control>SecurePipeServers>Winreg.
6. Click Edit>Permissions on the Registry Editor menu bar.

The Permissions for winreg dialog box opens.

Note: The permissions that are available in the dialog box depend on the Windows operating system.

7. Select Everyone.
8. Check Read in the **Allow** column.

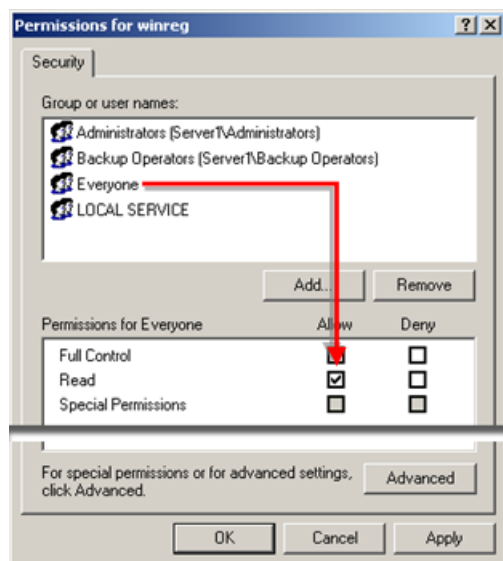

Step 2.2. Set the \Perflib Key to Read Access

1. Do one of the following.

Vista

Click the Start button on the Vista task bar.

Windows XP

- a. Click Start on the Windows task bar.
 - b. Select Run.
2. Type **Regedt32.exe** in the **Open** field.
 3. Click **OK**.

The Registry Editor window opens.

4. Select HKEY_LOCAL_MACHINE.
5. Select SOFTWARE>Microsoft>Windows NT>CurrentVersion>Perflib.
6. Click Edit>Permissions on the Registry Editor menu bar.

The Permissions for Perflib dialog box opens.

Note: The permissions that are available in the dialog box depend on the Windows operating system.

7. Select Everyone.
8. Check Read in the **Allow** column.

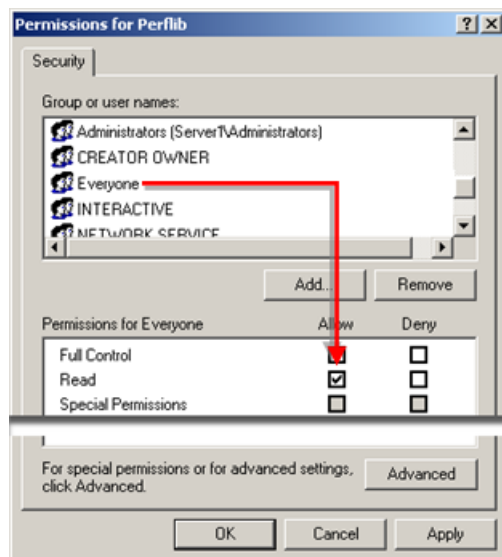

Chapter 8. Pager

CIMPLICITY Marquee Manager Administrator

About CIMPLICITY Marquee Manager Administrator

The following topics provide an overview of the CIMPLICITY Marquee Manager Administrator product including detailed configuration descriptions:

- [Marquee Manager Administrator: Key Features \(page 691\)](#)
- [Marquee Manager Administrator: How it Works \(page 692\)](#)
- [Marquee Manager Administrator: Available Object Types \(page 693\)](#)
- [Marquee Manager Administrator Pre-configuration \(page 695\)](#)
- [Marquee Manager Administrator Configuration \(page 699\)](#)
- [Marquee Manager Administrator Tools: Users \(page 743\)](#)
- [Marquee Manager Administrator Other Tools \(page 745\)](#)
- [Marquee Manager Administrator Technical Reference \(page 750\)](#)
- [Marquee Manager Administrator Glossary \(page 757\)](#)

Marquee Manager Administrator: Key Features

The Marquee Manager product family monitors manufacturing environments and sends real time, automated messages to visual or audible devices including LED display/Andon boards, stack lights and sounder alarms the moment a tolerance is breached. As an integral part of any lean initiative, Andon boards provide visibility into the activity on the plant floor but need to be driven by a robust, easy-to-use software solution. Marquee Manager is the only multi-vendor marquee solution, supporting the majority of boards, including legacy displays.

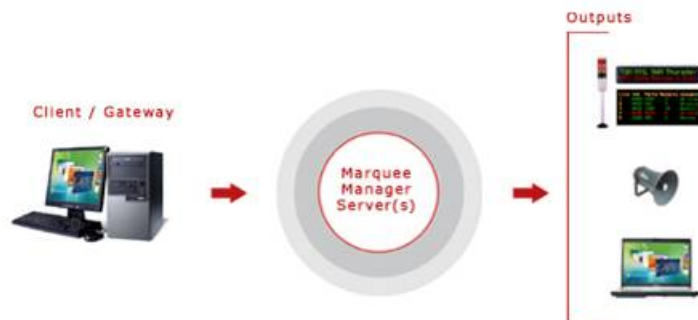

Key Features

- Delivers real-time information to most active matrix boards, including legacy displays.
- Industry standard NETCON Unit Protocol is a control language that speaks to numerous manufacturers' boards.
- Easy-to-use message management system includes prioritization and queuing.
- Includes a full suite of flexible administration tools, all accessible remotely.
- Multiple applications can publish to the same board.
- Using Test/Disabled/Enabled modes allows for firmware changes to be made.
- Supports all industrial marquee manufacturers.
- Marquee details and attributes may be cloned for easy configuration.
- Provides full unattended recovery from network outages or display power loss/recovery.
- Once configured in server, users are isolated from requiring any knowledge of marquee protocols.
- Provides preview of any device's current content from a windows workstation.
- For security, regulate system usage to authorized users only.
- Allows changes to any aspect of your configuration at runtime.
- Easy integration for custom implementations.

Marquee Manager Administrator: How it Works

Marquee Manager is a marquee management system that allows you to easily communicate to a variety of different marquees, using a simple generic language. Marquee Manager establishes connectivity to visual displays through serial ports, TCP/IP sockets, or RF connections through the Alarm Cast Server. The core engine controls marquee connectivity and implements marquee drivers. The gateways or clients then feed requests to Marquee Manager for processing. The engine sorts and prioritizes messages to be displayed to ensure high priority messages are displayed first. Because Marquee Manager allows you to manage templates, board resources can be shared by production, maintenance, health and safety. Marquee Manager centrally controls messages to visual displays from multiple sources simultaneously. It displays data from OPC, HMI / SCADA, MES, Building Management and maintenance systems.

Data Sources:

- GE CIMPLICITY

Visual / Audible Display Devices:

- Adaptive Micro Systems
- Allen-Bradley InView
- Electro-Matic Products Inc.
- Full matrix LED Andon boards
- Line matrix LED Andon boards

- MacDonald Humphries
- NETCON Unit
- Nu-Media Display Systems
- Stack Lights
- Static Controls Corporation
- Sounders and PA Systems
- Uticor Technology







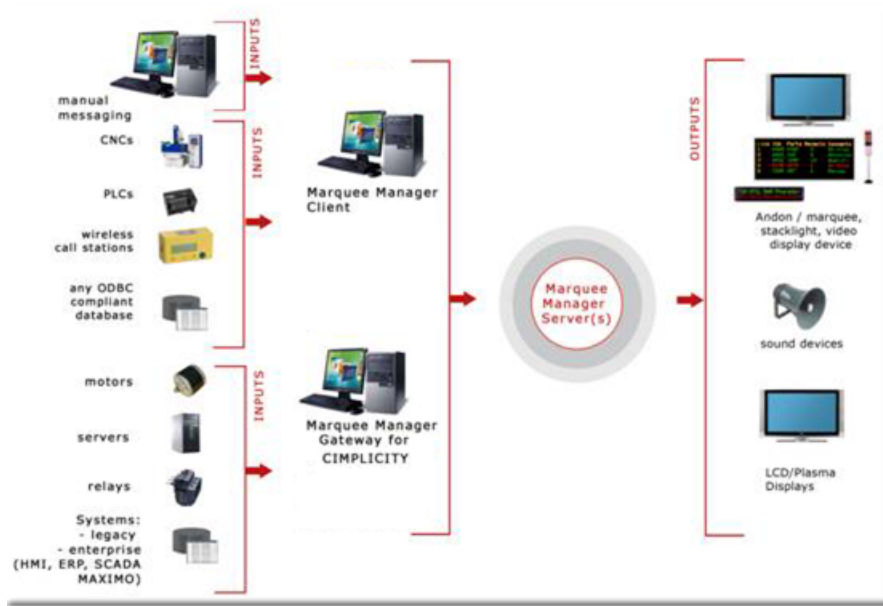

Andon Systems

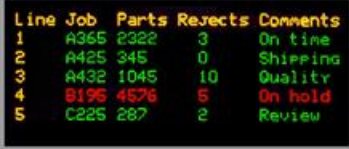
Andon systems are production quality control and monitoring systems that support plant management. Functioning as communication systems, Andon systems aid plant line workers, team leaders, and supervisors in completing assembly operations in-station.

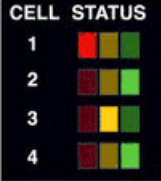
If there is a problem at a station, an operator can pull the Andon cord or activate a push button, causing the conveyor to stop and the marquee board to display the problem. The Andon marquee boards inform every team member of the status of the assembly process. When a problem is reported, using the Andon system, the marquee board will illuminate the appropriate station number and play the associated music or vocal announcement. Other information displayed on the board could include production information, material calls, quality checks, system faults, OEE, and health and safety messages.



Marquee Manager Administrator: Available Object Types

Object	Description	Sample
Andon Bin Cell	Cell type displays are typically used to display data best represented in a grid format. Example A manufacturing facility is divided into numerous assembly stations, each cell represents a station's state.	
Andon Char Cell	Cell type displays are typically used to display data best represented in a grid format. Example Displays what station or plant location is experiencing a problem and display information such as the area and nature of the problem.	
Clock	A display element specifically designed to display the time of day.	
Color Block	Used to display a block of color for the state of a plant station.	
Controller	Used to display various templates in a cycle defined by the administrator or by gateway events.	
Counter	A display element specifically designed to display numeric counts.	
Marquee	One or more lines to display time, date and message text such as production counts.	
Sounder	Typically used for speaker support to play tunes.	
Stack Light	Used to display colors in a vertical grid pattern.	

Marquee Manager Administrator Pre-configuration

Marquee Manager Administrator Pre-configuration

- Marquee Manager Administrator: DSN Specifications
- Marquee Manager Administrator: Application Folder Availability

Marquee Manager Administrator: DSN Specifications

Marquee Manager installation creates a Marquee Manager Server ODBC data source entry; the entry is a default.

Open the ODBC Data Source Administrator.

- 32-Bit System
1. Open the Control Panel
 2. Select Administrative Tools > Data Sources (ODBC).

The ODBC Data Source Administrator opens.

1. Choose the System DSN tab.

- 64-Bit System

Important: System data sources are created in the `ODBCAD32` location; they may not be listed on the System DSN tab when you open the ODBC Data Source Administrator on a 64-bit system.

1. Click the Start button on the Windows task bar.
2. Enter the following in the **Command Line** field.

```
c:\windows\syswow64\odbcad32.exe
```

1. Press Enter.

The ODBC Data Source Administrator opens.

1. Select the DSN tab.

Result: The System Data Sources will be listed.

guide: Guidelines

- The DSN name and location can be changed
- There are no restrictions to name or location of the DSN or databases as long as the structure and table names don't change.

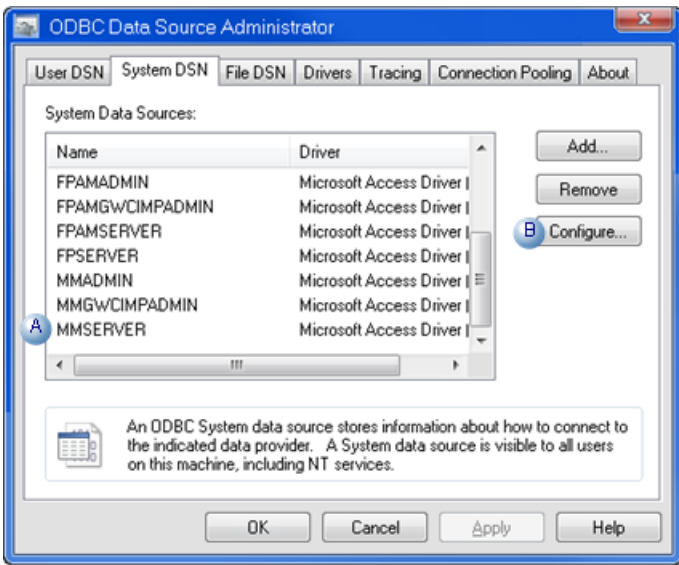

A	Select MMSERVER.
B	Click Configure.

An ODBC Microsoft Access Setup dialog box opens.

guide: Guidelines

- The database (.mdb) location can be changed.

For a UNC address, enter `\\<Server name>\<Shared folder name>\<data>\<database filename>`

- There are no restrictions to name or location of the DSN or databases as long as the structure and table names don't change.
- Administration tools that are provided by Marquee Manager must be used to modify data in the databases.
- The default path is `..\Proficy CIMPLICITY\MARQUEEMANAGER\DATA\MMServer.MDB`.

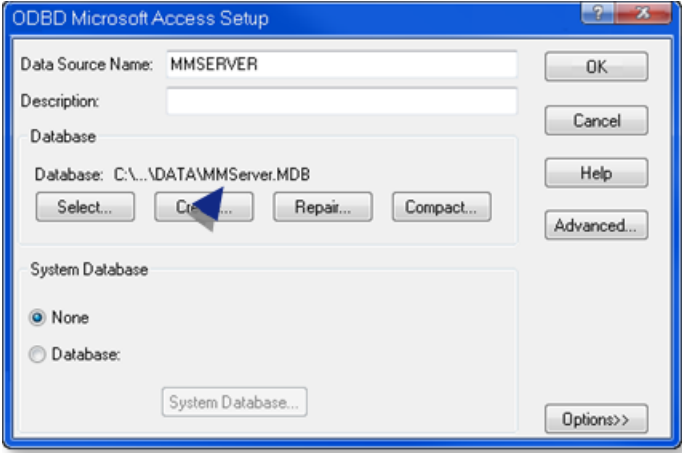

Marquee Manager Administrator: Application Folder Availability

1. Choose the **MARQUEEMANAGER** application folder, which contains the Marquee Manager data and log files.

Following are the default paths for 32-bit and 64-bit systems.

32-bit system	..\Program Files\Proficy\Proficy CIMPLICITY\MARQUEEMANAGER
64-bit system	..\Program Files (x86)\Proficy\Proficy CIMPLICITY\MARQUEEMANAGER

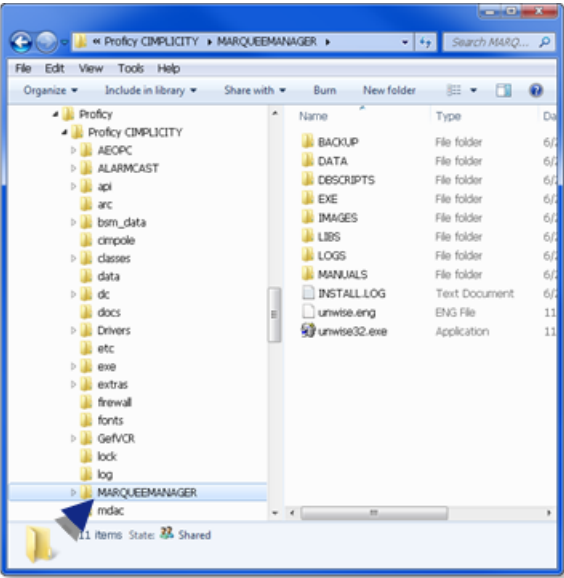

2. Right-click the **MARQUEEMANAGER** folder.
3. Assign Full Control to the **Everyone** user.

Example: Assign Sharing Permissions to the Everyone User

Do the following on a Windows 7 system; other Windows operating systems may differ slightly.

- a. Select Advanced Sharing on the MARQUEEMANAGER Popup menu.

The MARQUEEMANAGER dialog box opens.

- a. Select the Sharing tab.
- b. Click Advanced Sharing.

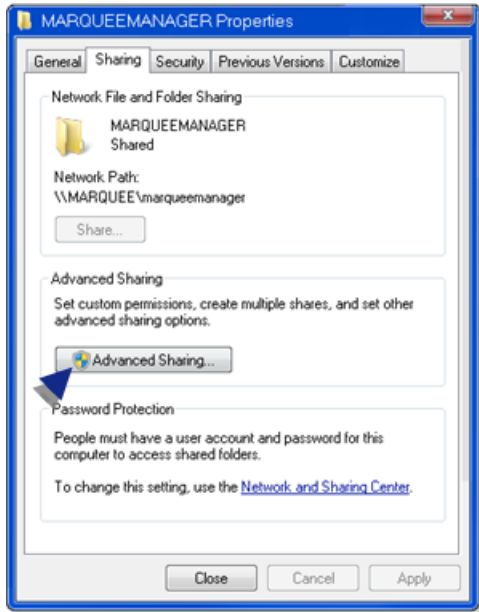

The Advanced Sharing dialog box opens.

- a. Do the following.

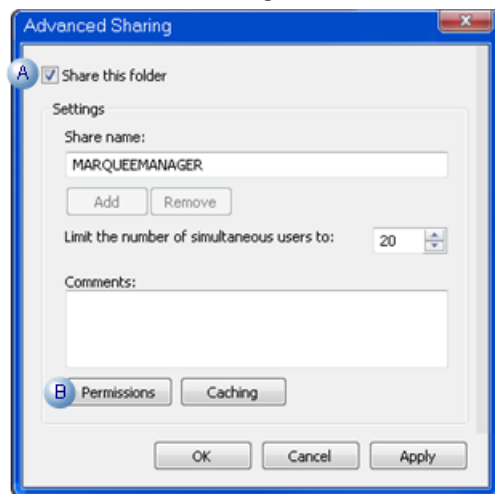

A	Check Share this folder.
B	Click Permissions.

A Permissions for MARQUEEMANAGER dialog box opens.

- a. Assign Full Control to the **Everyone** user.

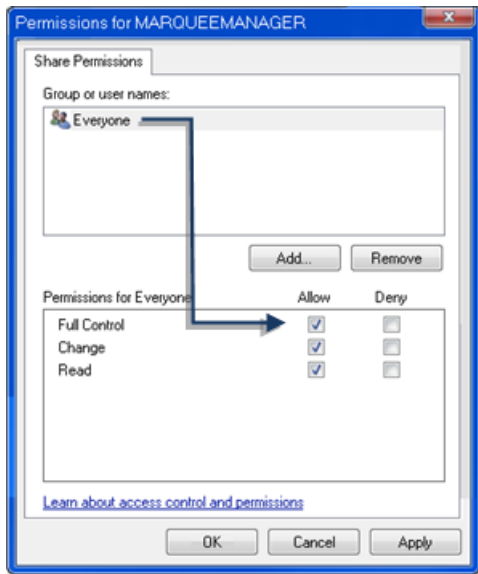

- a. Click OK to close the dialog boxes.

MARQUEEMANAGER is now available

Marquee Manager Administrator Configuration

Marquee Manager Administrator Configuration

- Marquee Manager Administrator Server
- Marquee Manager Administrator Devices
- Marquee Manager Administrator Marquee Types
- Marquee Manager Administrator Distribution Lists
- Marquee Manager Administrator Clients

Marquee Manager Administrator Server

1. Do the following.
 - a. Expand Computer in the Workbench left-pane.
 - b. Double-click Marquee Manager Administrator (in the left or right-pane).

The Marquee Manager Administrator opens.

2. Click New Marquee Server on the Marquee Manager Administrator toolbar.

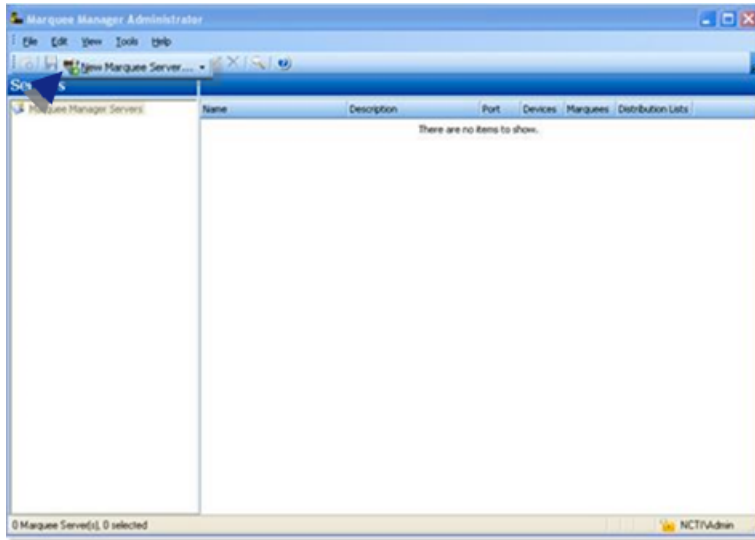

A Select Data Source dialog box opens.

3. Select the Marquee Manager Server data source.

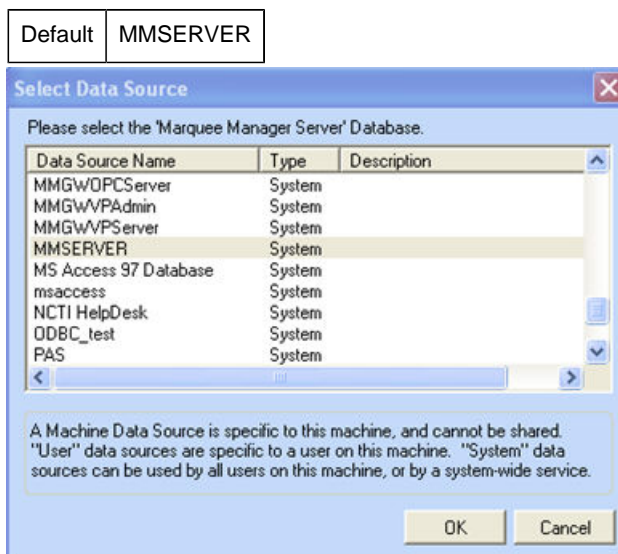

4. Click OK.

Server configuration includes the following tabs.

- Details Tab
- Settings Tab
- Security Tab

Details Tab

Select the Details tab; options are as follows.

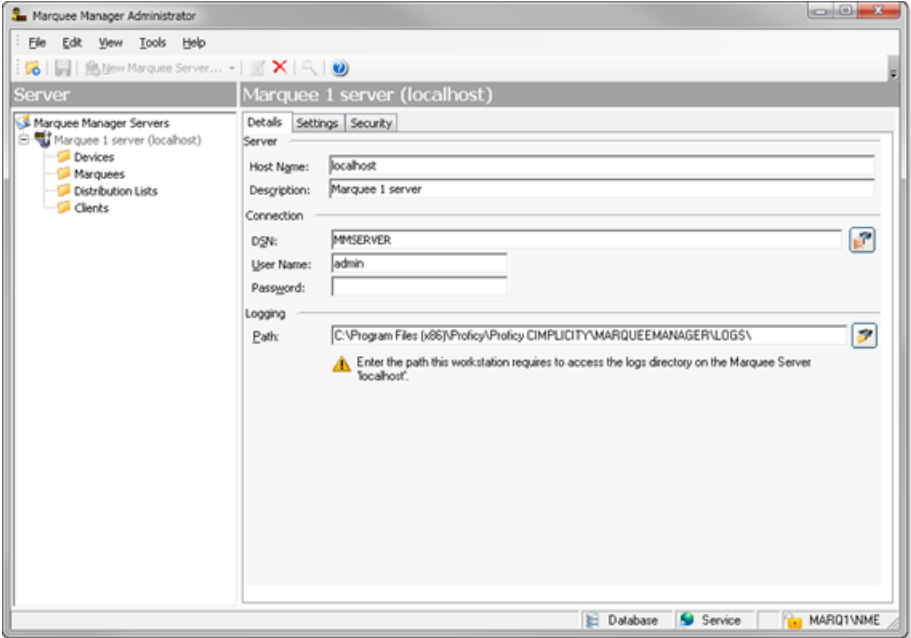

Field	Description
Server	
Host Name	TCP/IP resolvable name for the machine running Marquee Manager Server. This will be in your DNS server or local host file and can be reached from the Administrator workstation.
Description	(Optional) Additional details about the Server.
Connection	
DSN	Automatically entered.
User Name	Optional.
Password	Optional.
Logging	
Path	Log Path required to access the logs directory on the current Marquee Manager Server. In most cases, if the server is locally installed this path will be a drive letter based directory specification Example C:\Program Files(x86)\Proficy\Proficy CIMPLICITY\MARQUEEMANAGER\Logs\ If the server being managed is not the local server then this path will most likely be a UNC path (\server\share\directory\), which provides access to the remote servers log directory. Example \LAB1\MMServer\logs\).

Settings Tab

Select the Settings tab.

If the Server:	The Settings contain:
Has never been configured	Defaults

If the Server:	The Settings contain:
Is already configured and operational	Configured specifications

Options are as follows.

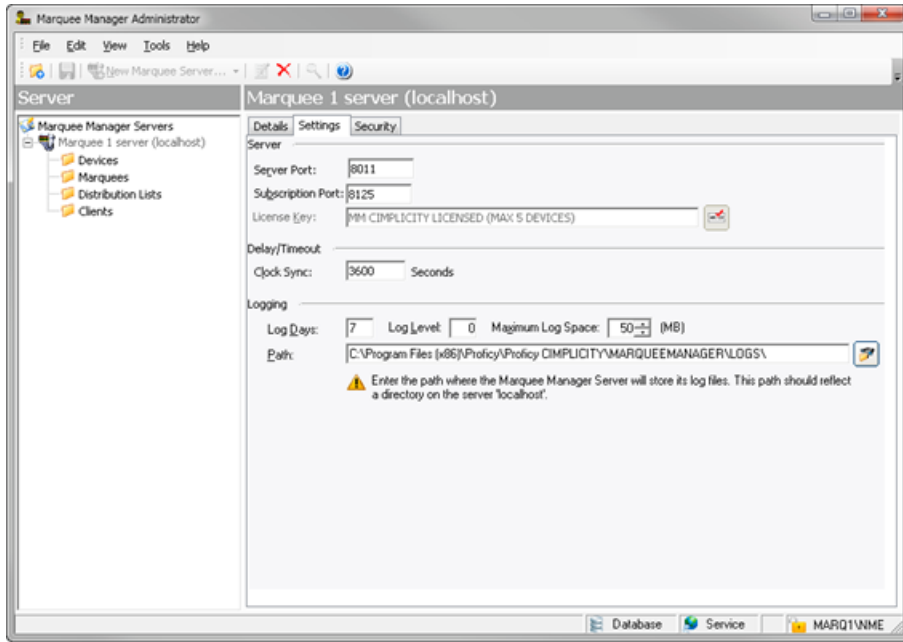

Field	Description
Server	
Server Port	Port that connects to the Marquee Manager Server. Defaults to 8011.
License Key	Valid Marquee Manager license key.
Delay/Timeout	
Clock Sync	Automatically syncs the internal marquee times to that of the Marquee server. Important: It is recommended that you run NTP (Network Time Protocol) on the Marquee Server machine to set the clock. This will ensure the accuracy of all marquee internal times. Default is 3600 seconds (1 hour).
Logging	
Log Days	Number of days the log file will be kept before being purged. Default is 7 days.
Log Level	For use at the request of the Marquee Manager. In the event of any problems, CIMPLICITY may request additional levels of logging to assist in problem solving. Default is 0.
Maximum Space	Amount of space to allot to the log file. Note: This prevents the log files from consuming too much drive space. Default is 50 MB.
Path	Path specification, local to the actual Marquee Manager Server. Note: The path contains the directory where the Marquee Manager Server will store its log files.

Click Save.

! **Important:** If you are setting up Remote Administrator, the Settings Tab will already be populated.

Security Tab

If security is enabled a Login dialog box will open when a user tries to open the Marquee Manager Administrator window. Only users who have been configured in the Marquee Manager Administrator Tools: Users tree will have access.

Select the Security tab: security options for the selected server are as follows.

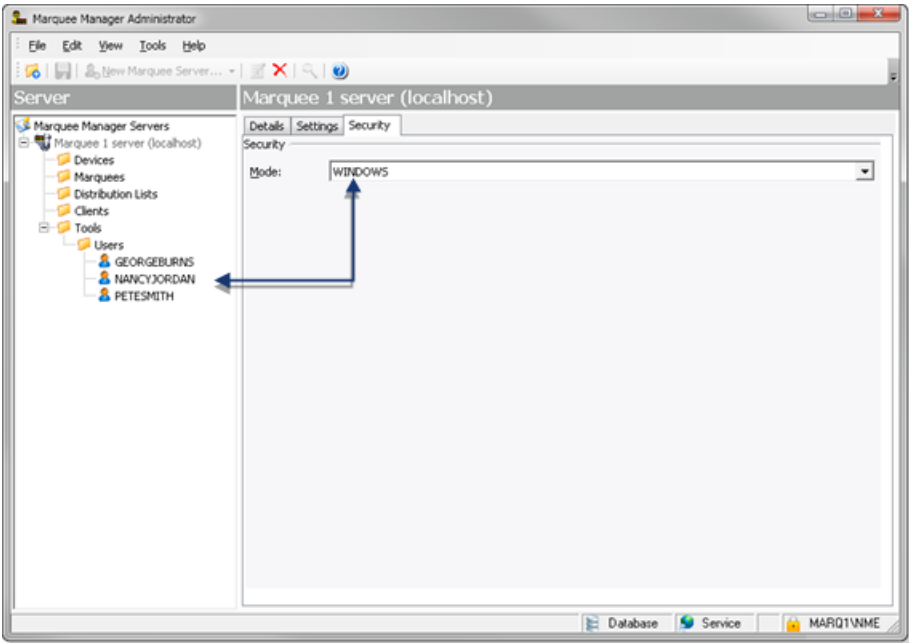

Field	Description	
Security		
Mode	Security options for the Marquee Manager server are as follows.	
	NONE	Marquee Manager security is not enabled for the server.

Field	Description	
	Windows	<p>A valid user name/password are required. Security is as follows.</p> <ol style="list-style-type: none"> A Users folder is added to the Tools tree. Users who should have access to the Marquee Manager server need to be added. A Login dialog box opens when a user attempts to open the Alarm Administrator window.  <p>Result: Listed users with valid user names/passwords will have access to the server.</p>
	Windows Trusted	<p>Uses a trusted domain account; does not require a password.</p> <ol style="list-style-type: none"> A Users folder is added to the Tools tree. Users who should have access to the Marquee Manager server need to be added. <p>Result: After a listed user logs into Windows, the user can open the Marquee Manager Administrator window; a Login dialog box for the Marquee Manager Administrator is not required.</p>
	Default	NONE

! **Important:** If you change the Security mode for Windows/Windows Trusted after you have registered users, the users will be deleted. You will have to add users who can be registered for the newly selected mode.

- A **Users** folder is added to the Tools tree.
- Users who should have access to the Marquee Manager server need to be added.
- A Login dialog box opens when a user attempts to open the Alarm Administrator window.



- A **Users** folder is added to the Tools tree.
- Users who should have access to the Marquee Manager server need to be added.

After a listed user logs into Windows, the user can open the Marquee Manager Administrator window; a Login dialog box for the Marquee Manager Administrator is not required.

Marquee Manager Administrator Devices

Marquee Manager Administrator Devices

- Marquee Manager: Device overview.
- Marquee Manager: Devices

Marquee Manager: Device Overview

Marquee Manager Server formats and delivers the message to the marquee. To accomplish this task, Marquee Manager first utilizes a concept of a Device. A Device in Marquee Manager is the physical path that the engine will utilize to connect to the marquee.

Using this device connection, Marquee Manager Server communicates to the marquee using the manufacturers protocol defined for the marquee. Once the device is named and defined, you can begin to add marquees.

TCP/IP:

Sample 1



Sample 2



Serial:

Sample Serial Connection



FirstPAGE:

Sample Alarm Cast Connection



Marquee Manager: Device Types

1. Click the Devices folder in the Marquee Manager Administrator left-pane.
2. Click New Device on the toolbar.

A Details tab displays.

1. Select a Communications>Type.

Marquee Manager communications types are as follows:

- Marquee MMarquee Manager Administrator
- Device: Serial.anager Administrator Device: FirstPAGE.
- Marquee Manager Administrator Device: Subscription
- Marquee Manager Administrator Device: TCP/IP.

Marquee Manager Administrator Device: TCP/IP

A Device in Marquee Manager is the physical path that the engine will utilize to connect to the marquee.

TCP/IP is the set of communications protocols used for the Internet and other similar networks. It stands for Transmission Control Protocol (TCP) and the Internet Protocol (IP).

IP handles lower-level transmissions from computer to computer as a message makes its way across the Internet.

TCP:

- Operates at a higher level, concerned only with the two end systems (i.e. a Web browser and a Web server).
- Provides a reliable, ordered delivery of a stream of bytes from one program on one computer to another program on another computer.
- Serves as a common application for features such as:

- The Web
- Email
- File transfer
- Performs management tasks that include controlling the following:
- Message size
- Rate at which messages are exchanged
- Network traffic congestion

1. Click the **Devices** folder in the Marquee Manager Administrator left-pane.
2. Click New Device on the toolbar.

A Details tab displays.

3. Select TCP/IP in the Communications>**Type** field.

The TCP/IP options are as follows.

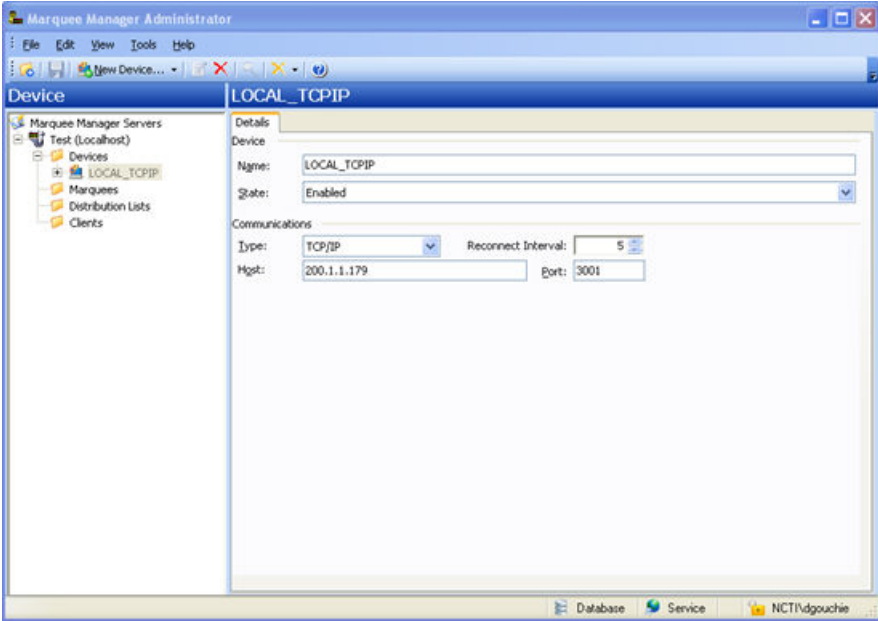

Field	Description
Device	
Name	Logical name utilized by the administrator to refer to this physical device. Example A Serial Device may be named IPSERVER10.

Field	Description
State	Either Enabled or Disabled. Note: Multiple individual devices can be enabled/disabled by doing the following. <ol style="list-style-type: none"> a. Select the Devices folder. A list view displays in the right pane <ol style="list-style-type: none"> a. Press Ctrl. b. Select the devices that should be enabled/disabled. c. Right-click the selection. d. Select Enable, Enable All or Disable on the Popup menu. Default is Enabled.
Communication	
Type	Device type to be associated with the selected Marquee. Note: A drop-down list contains all available Device types.
Reconnect Interval	Rate in seconds that a device will try to reconnect when it loses connection with the boards. Default is 5 second intervals. Note: If no value is set the device will try to reconnect every second, which can cause excessive network traffic.
Host	Host or IP address of the marquee's connection point.
Port	Port used to connect to the terminal server or LAN.

4. Select the Devices folder.
A list view displays in the right pane
5. Press Ctrl.
6. Select the devices that should be enabled/disabled.
7. Right-click the selection.
8. Select Enable, Enable All or Disable on the Popup menu.
Default is Enabled.
9. Click Save.

The Device will now be visible under the Devices folder in the tree view.

Marquee Manager Administrator Device: Serial

1. Click the **Devices** folder in the Marquee Manager Administrator left-pane.
2. Click New Device on the toolbar.
A Details tab displays.
3. Select Serial in the Communications>**Type** field.

The Serial options are as follows.

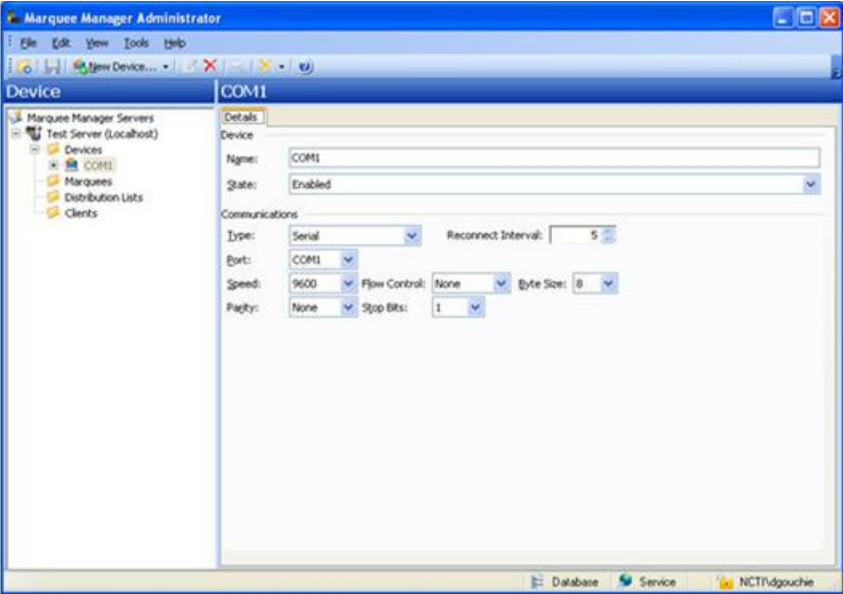

Field	Description				
Device					
Name	Logical name utilized by the administrator to refer to this physical device. Example Serial Device may be named SERIALCOM1.				
State	Either Enabled or Disabled. Note: Multiple individual devices can be enabled/disabled by doing the following. <ol style="list-style-type: none"> a. Select the Devices folder. A list view displays in the right pane <ol style="list-style-type: none"> a. Press Ctrl. b. Select the devices that should be enabled/disabled. c. Right-click the selection. d. Select Enable, Enable All or Disable on the Popup menu. Default is Enabled.				
Communication					
Type	Dropdown list contains all available Device types				
Reconnect Interval	Rate in seconds that a device will try to reconnect when it loses connection with the boards. Default is 5 second intervals. Note: If no value is set the device will try to reconnect every second, which can cause excessive network traffic.				
Port	COM port to which the device is connected. Notes <ul style="list-style-type: none"> • Available ports are in the dropdown list. • More than one sign may connect through the same COM port providing a single connection point to these devices; this enables multiple applications to share them. 				
Speed	Serial port speed. Important: The selected speed must match the speed that the marquee is using. Range is 300-115200. Default is 9600.				
Flow Control	Method with which the devices throttle the flow of send and receive data. Select one of the following in the dropdown list.				
	<table border="1" style="width: 100%; border-collapse: collapse;"> <tr> <td style="width: 20%; padding: 2px;">Hardware</td> <td style="padding: 2px;">Uses the device's Hardware control method</td> </tr> <tr> <td style="padding: 2px;">Software</td> <td style="padding: 2px;">Uses the device's software flow control method.</td> </tr> </table>	Hardware	Uses the device's Hardware control method	Software	Uses the device's software flow control method.
Hardware	Uses the device's Hardware control method				
Software	Uses the device's software flow control method.				

Field	Description
	Important: The selection must match the flow control that the Marquee is using. Default is set to None.
Byte Size	Serial port byte size settings Important: Settings must match the settings the Marquee is using. Options are 7 or 8. Default is 8.
Parity	Serial port parity settings Important: Settings must match the settings the Marquee is using. Options are: <ul style="list-style-type: none"> • Even • Odd • Mark • Space Default is None.
Stop Bits	Serial port stop bit settings. Important: Settings must match the settings the Marquee is using. Options are: <ul style="list-style-type: none"> • 0 • 1 • 1.5 • 2 Default is 1.

4. Click Save.

The Device will now be visible under the Devices folder in the tree view.

Marquee Manager Administrator Device: FirstPAGE

1. Click the **Devices** folder in the Marquee Manager Administrator left-pane.
2. Click New Device on the toolbar.

A Details tab displays.
3. Select FirstPAGE in the Communications>**Type** field.

The FirstPAGE options are as follows.

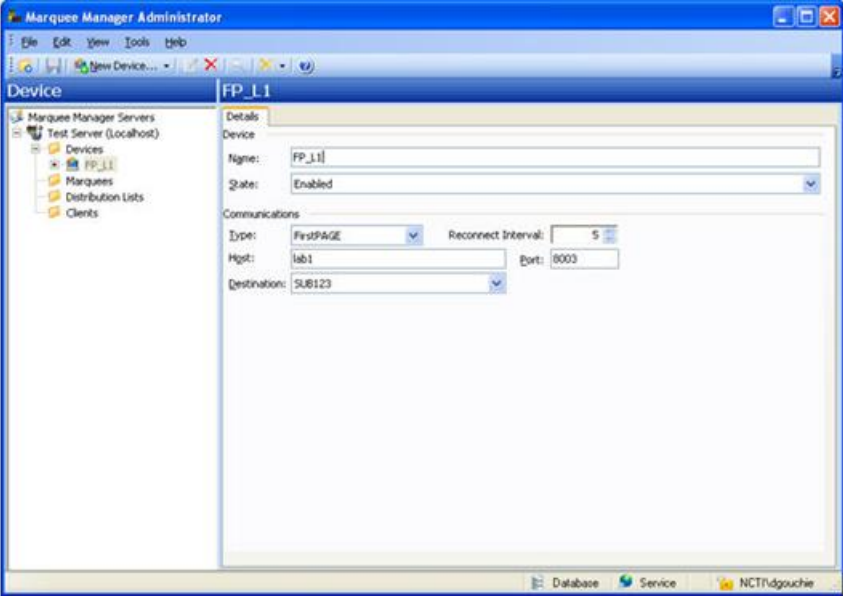

Field	Description
Device	
Name	Logical name utilized by the administrator to refer to this physical device. Example A serial device may be named RF_CONNECT.
State	Either Enabled or Disabled. Note: Multiple individual devices can be enabled/disabled by doing the following. a. Select the Devices folder. A list view displays in the right pane. a. Press Ctrl. b. Select the devices that should be enabled/disabled. c. Right-click the selection. d. Select Enable, Enable All or Disable on the Popup menu. Default is Enabled.
Communication	
Type	Dropdown list contains all available Device types.
Reconnect Interval	Rate in seconds that a device will try to reconnect when it loses connection with the boards. Default is 5 second intervals. Note: If no value is set the device will try to reconnect every second, which can cause excessive network traffic.
Host	Host name where the Alarm Cast Server is running.
Port	Defaults to 8003.
Destination	Destination from those available in the dropdown list. Note: These are generated from the Alarm Cast Destination list.

4. Click Save.

The Device will now be visible under the Devices folder in the tree view.

Marquee Manager Administrator Device: Subscription

Reserved for future use.

Marquee Manager Administrator Marquee Types

Marquee Manager Administrator Marquee Types

A Marquee is a sign display that serves as a visualization communication tool, providing the means to display time, date and message text, (e.g. production counts, and what areas of a plant are experiencing problems).

The Marquees folder contains information pertaining to marquees and their configuration settings.

 **Important:** Before using Marquee Manager, you must add one or more marquees to a device. This includes the name, manufacturer, model, address and other specifications.

- Marquee Manager Marquee Type: Details Tab.
- Marquee Manager Marquee Type: Types Overview
- Marquee Manager Marquee Type: Andon Bin Cell
- Marquee Manager Marquee Type: Andon Char Cell
- Marquee Manager Marquee Type: Clock
- Marquee Manager Marquee Type: Color Block
- Marquee Manager Marquee Type: Controller
- Marquee Manager Marquee Type: Counter
- Marquee Manager Marquee Type: Marquee
- Marquee Manager Marquee Type: Speaker
- Marquee Manager Marquee Type: Stack Light
- Marquee Manager Marquee Type: Web

Marquee Manager Marquee Type: Details Tab

Do either of the following to begin Marquee Manager configuration.

- Select the **Marquees** folder in the Marquee Manager Administrator left-pane; click New Marquee on the toolbar.
- Expand a **Marquee** device folder in the Marquee Manager Administrator left-pane; select the **Marquees** folder; click New Marquee on the toolbar.

Result: The selected:

- Device type is automatically selected in the **Device** field.
- Marquee type determines the additions tabs that will be available for configuration.

Details Tab

Select the Details tab; options are as follows.

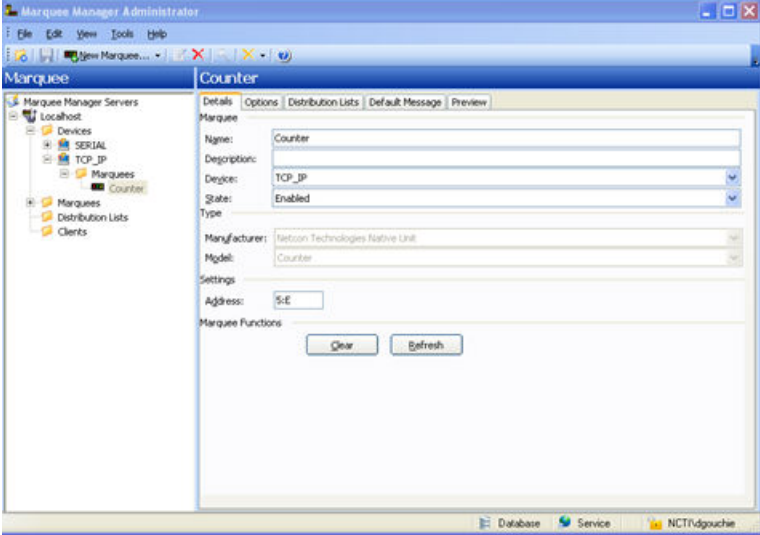

Field	Description	
Marquee		
Name	Marquee name. The name will display in the Marquee Manager Client and gateways exactly as it is entered in this field.	
Description	(Optional) Details to help identify the Marquee.	
Device	How the device is selected depends on where the marquee is added. Options are:	
	Device folder	Device name is automatically entered
	Marquee folder	A Device must be selected from the dropdown list.
State	<p>Either Enabled or Disabled. Note: Multiple marquees can be enabled/disabled/tested (e.g. to make firmware changes or for testing).</p> <ol style="list-style-type: none"> 1. Select the Marquees folder. <p>A list view displays in the right pane.</p> <ol style="list-style-type: none"> 1. Press Ctrl. 2. Select the marquees that should be enabled/disabled/tested. 3. Right-click the selection. 4. Select Enable, Disable or Test on the Popup menu <p>Marquee's Manufacturer's default is Test; this mode can determine if the marquee is fully functional. State default is Enabled.</p>	
Type		
Manufacturer	Dropdown list contains supported manufacturers.	
Model	Dropdown list contains the Models specific to the manufacturer selection.	

Settings	
Address	Each manufacturer will have a different address format (page 750) .
Buttons	
Note: The following buttons display when the Marquee has been saved.	
Clear	Clears the Marquee of all messages, including those sent through Marquee Manager Client.
Refresh	Refreshes the Marquee to be refreshed, maintaining all current messages that are currently displayed or in the queue to be displayed.

i Tip: Click the **Marquee** folder in the Marquee Manager Administrator left-pane to display the list of marquees in the right pane.

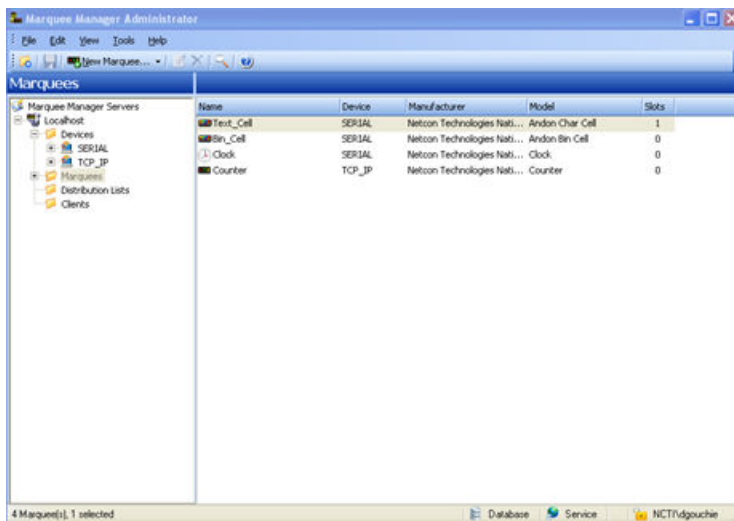

































































































































































































Marquee Manager Marquee Type: Types Overview

The range of Options you are offered for each marquee is dependent on which manufacturer and model you chose. Each marquee type has list of configurable options.

Andon Bin Cell	Andon Char Cel	Clock	Color Block	Controller	Counter	Marquee	Sounder	Stack Light

Option	Definition	Marquee Type
Cell Height	The height, in model specific units (perhaps pixels), of each cell within an Andon type display.	
Cell Width	The width, in model specific units (perhaps pixels) of each cell within an Andon type display.	
Channel Info	Number of speaker channels.	

Channel Volume	Speaker volume of specific speaker channel.	
Cyclic Settings	Tune type commands that are available. Options are: <ul style="list-style-type: none"> • On duration only. • Continuous only. • Full cyclic tunes with on, off, and iteration control. 	
Default Delay	Length of time to wait with an empty message queue before sending the default message.	                          
Delivery Confirmation	Enable or disable confirmation that the message was delivered to the appropriate display. If delivery was unsuccessful, the logs will indicate that the delivery failed.	                        
Insertion Order	Location for inserting new messages in the queue. Options are: <ul style="list-style-type: none"> • LIFO: Last In First Out <p>The last message received is displayed first in the queue.</p> <ul style="list-style-type: none"> • FIFO: First in First Out <p>Messages are displayed in the order they are received.</p>	                            
Justification/ Alignment Support	Layout of the message on the marquee. Options on the Marquee are: <ul style="list-style-type: none"> • Right-aligned • Left-aligned • Centered 	                      
Keep Alive Interval	Interval at which something (keep-alive) is sent to the board to avoid dropping the connection.	                    
Maximum Duration	Maximum number of seconds to display the message. Default is calculated as 400 milliseconds per character for the length of the roll-up message. Note: Once the value is calculated, it will be increased to the min viewing duration if smaller, or limited to the max if larger.	                 
Maximum Roll-ups	Maximum number of roll-up pages will be sent. Note: This is calculated after a message has been broken down into pages.	              
Minimum Duration	Minimum number of seconds to display the message. The Default is calculated as 400 milliseconds per character for the length of the roll-up message. Note: Once this value is calculated, it will be increased to the min viewing duration if smaller, or limited to the max if larger.	            
Number of Bins per Cell	Number of cell variables, or bins, available per cell.	         
Number of Columns	Number of columns on a particular cell board.	       

Number of Lines	Number of vertical lines on the marquee.	
Number of Rows	Number of rows on a particular cell board.	
Number of Slots	Number of messages in the queue that will be displayed.	
Number of Tunes	Number of tunes available for a particular sounder.	
Priority Threshold	Lowest or highest priority message that will be queued and sent to the marquee.	
Roll-up Wrapping Length	Length a particular word must be in order to be split and hyphenated, rather than carried to the next line.	
Scroll Mode	List of the available scroll modes for the target. The options include, enabled, disable, or roll-up.	
Sign Height	Height, in model specific units (e.g. pixels), of the target.	
Sign Width	Width, in model specific units (e.g. pixels), of the target.	
Slot Throttling Rate	Minimum time between messages sends (not yet implemented).	
Time Format	Marquee will display in 12 or 24 hours from the Time Display drop-down.	
Tune Auto Clear	Amount of time to allow a tune to play before clearing automatically. This will clear the tune from the sounders queue even if the clear for it has not yet been processed.	

Marquee Manager Marquee Type: Andon Bin Cell

Cell type displays are typically used to display data best represented in a grid format.

Example

In a manufacturing facility divided into numerous assembly stations, each cell may represent a station’s state. They can be used to show what station or plant location is experiencing a problem and display information such as the area and nature of the problem.

Cell-based displays, such as Andon and AndonQueue Boards, require specific setup to define the various cells and bins available to display data.

1. Select Netcon Technologies Native Unit in the **Manufacturer** field.
2. Select Andon Bin Cell in the **Model** field.

Andon Bin Cell configuration includes the following tabs.

- Details tab.
- Options tab.
- Distribution Lists tab.
- Default Config tab.
- Bin Config tab.

Details Tab

Complete [Details \(page 712\)](#) tab configuration.

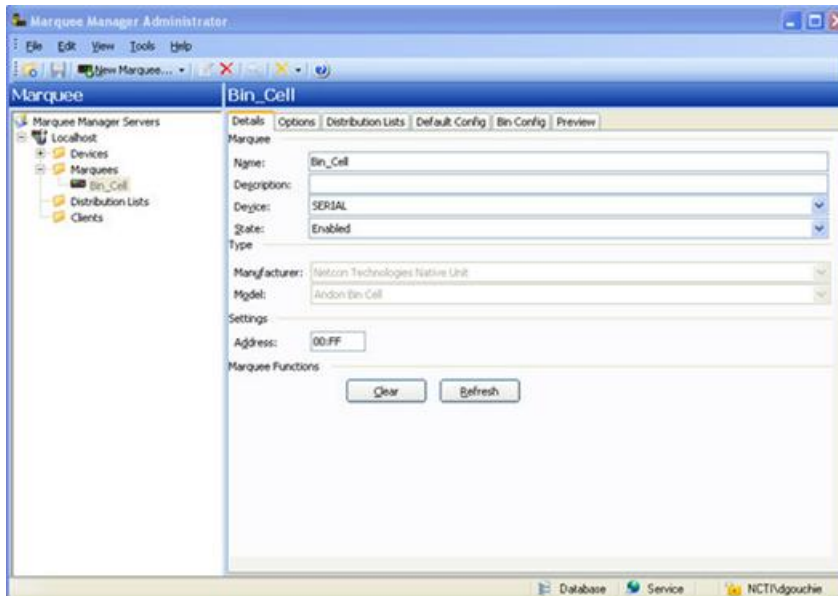

Options Tab

Select the Options tab; configure the [options \(page 714\)](#) settings according to your system requirements.

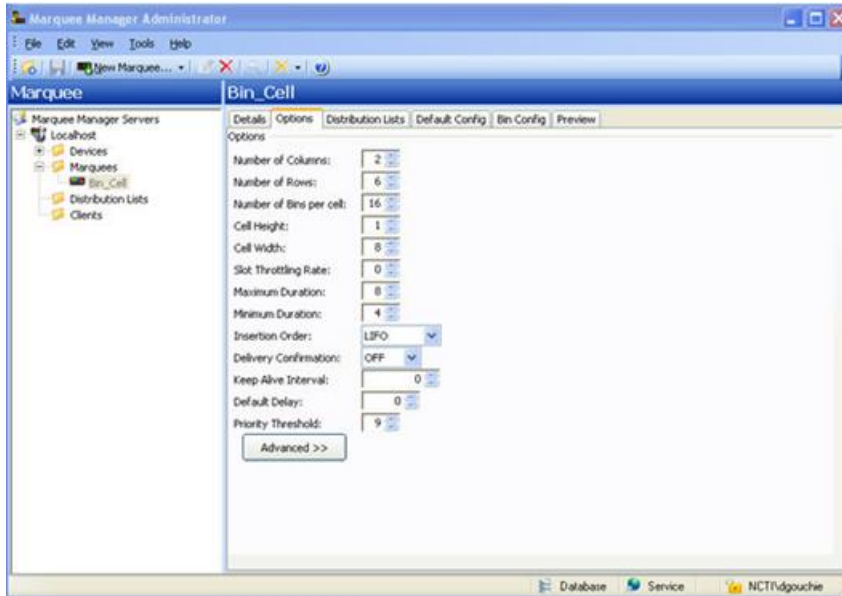

Distribution Lists

Select the Distribution Lists tab; configure the [distribution lists \(page 741\)](#) according to your system requirements.

3. Click Save.
4. Highlight the cells to be configured.
5. Enter a Value in the Bin Value field.
Bin Values entered here must match the bin values that have been entered into the Andon Board's on-board memory by the display installer.

Marquee Manager Marquee Type: Andon Char Cell

1. Select Netcon Technologies Native Unit in the **Manufacturer** field.
2. Select Andon Char Cell in the **Model** field.

Andon Char Cell configuration includes the following tabs.

- Details tab.
- Options tab.
- Distribution Lists tab.
- Default Config tab.

Details Tab

Complete [Details \(page 712\)](#) tab configuration.

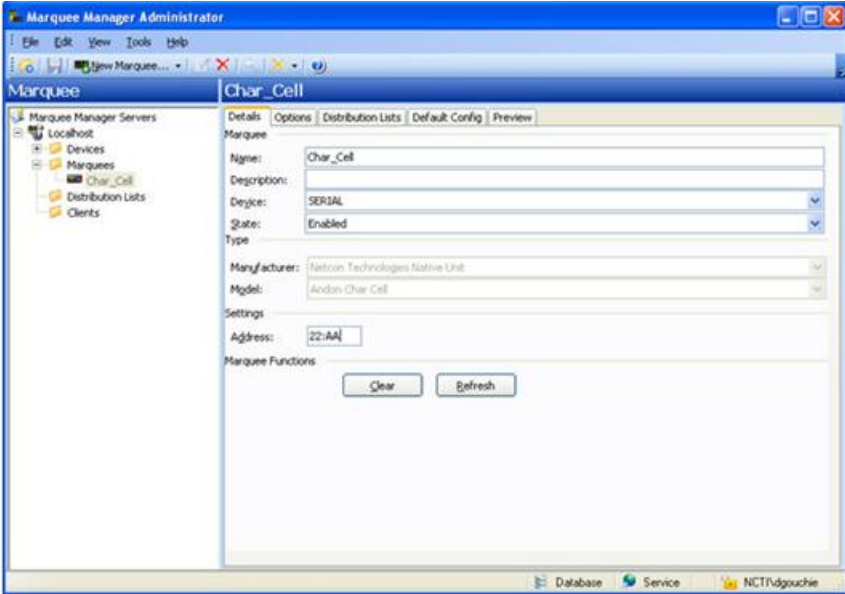

Options Tab

Select the Options tab; configure the [options \(page 714\)](#) settings according to your system requirements.

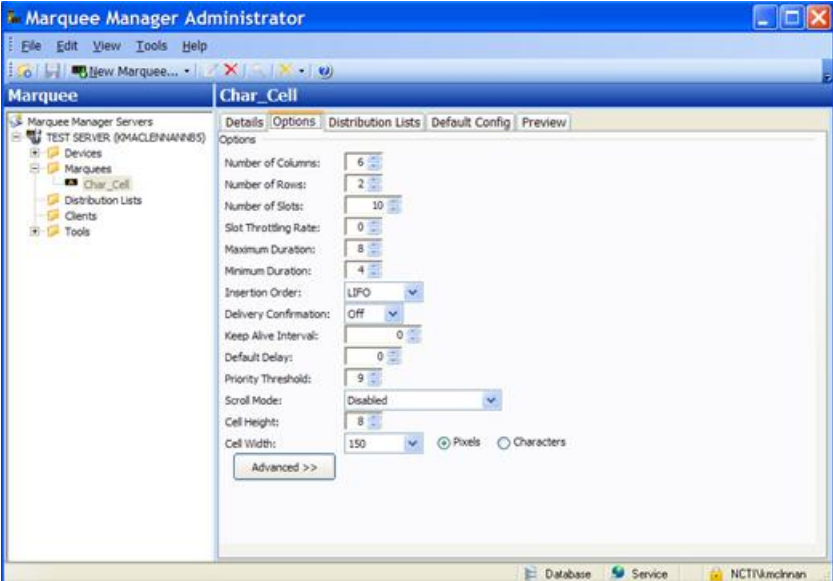

Distribution Lists

- 3. Select the Distribution Lists tab; configure the [distribution lists \(page 741\)](#) according to your system requirements.
- 4. Click Save.

The Default Config tab is enabled.

Default Config Tab

The Default Config tab is where you enter a message that will display when no active messages are being sent.

Select the Default Config tab; options are as follows.

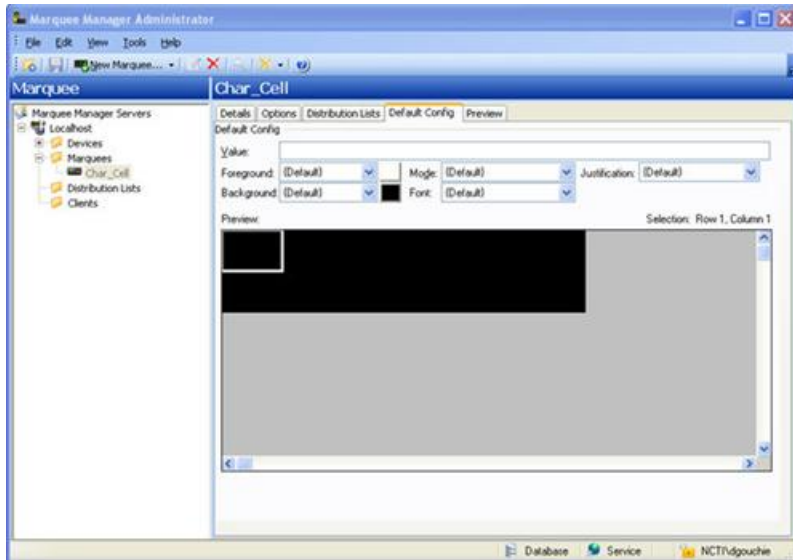

Field	Description
Configuration	
Value	Text that will display on the marquee when no active messages are being sent.
Foreground	Foreground color options are: <ul style="list-style-type: none"> • Choose a color from the dropdown list of predetermined colors. • Click the color swatch to the right of the dropdown list; create a custom color.
Background	Background color options are. <ul style="list-style-type: none"> • Choose a color from the dropdown list of predetermined colors. • Click the color swatch to the right of the dropdown list; create a custom color.
Mode	Options to establish how the information will display on the marquee are: <ul style="list-style-type: none"> • Static • Flashing • Fast Flashing • Strobe • Reverse • Reverse Flash • Reverse Fast Flash

Font	Font options are: <ul style="list-style-type: none">• Default• Small
Justification	Message layout on the marquee. The message can be: <ul style="list-style-type: none">• Right-aligned• Left-aligned• Centered

Click Save.

The Marquee setup can now be viewed on the Preview tab.

Marquee Manager Marquee Type: Clock

A Clock Display is a display element specifically designed to display the time of day. The time may be displayed in either 12 or 24 hour format.

1. Select Clock in the **Model** field.

Clock configuration includes the following tabs.

- Details tab.
- Options tab.

Details Tab

Complete [Details \(page 712\)](#) tab configuration.

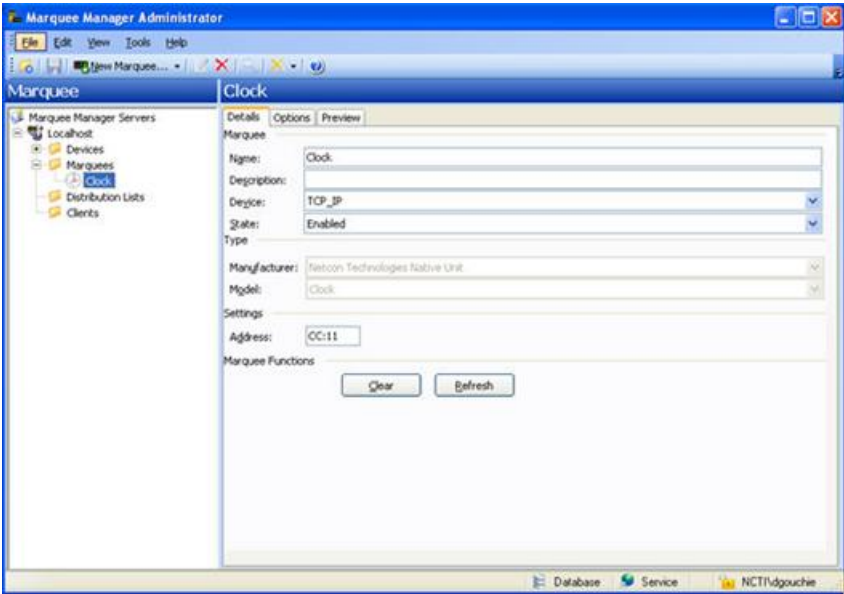

Options Tab

Select the Options tab; configure the [options \(page 714\)](#) settings according to your system requirements.

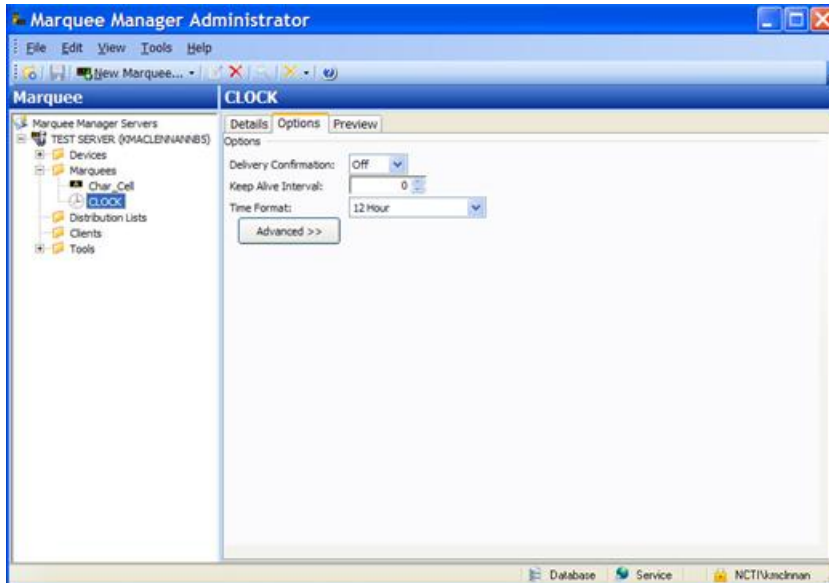

2. Click Save.

The Marquee setup can now be viewed on the Preview tab.

Marquee Manager Marquee Type: Color Block

Color Block models such as the NETCON Technologies Native Unit Color Block, are typically used to display a block of color for the state of a plant station.

Example

In a manufacturing facility divided into numerous assembly stations, each block may represent a station's state. If a station is experiencing a problem, they display a color to alert personnel.

1. Select Netcon Technologies Native Unit in the **Manufacturer** field.
2. Select Clock Block in the **Model** field.

Clock Block configuration includes the following tabs.

- Details tab.
- Options tab.
- Distribution Lists tab.
- Default Config tab.

Details Tab

Complete [Details \(page 712\)](#) tab configuration.

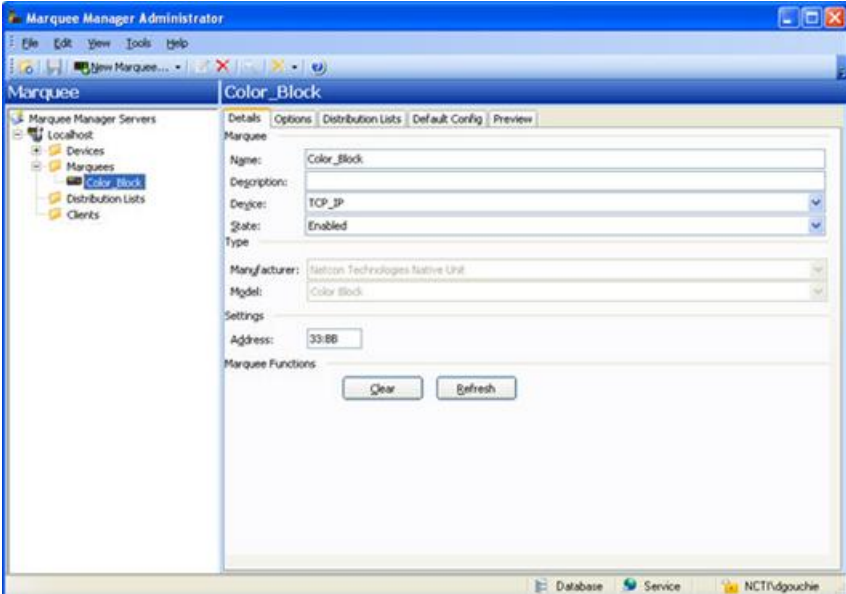

Options Tab

Select the Options tab; configure the [options \(page 714\)](#) settings according to your system requirements.

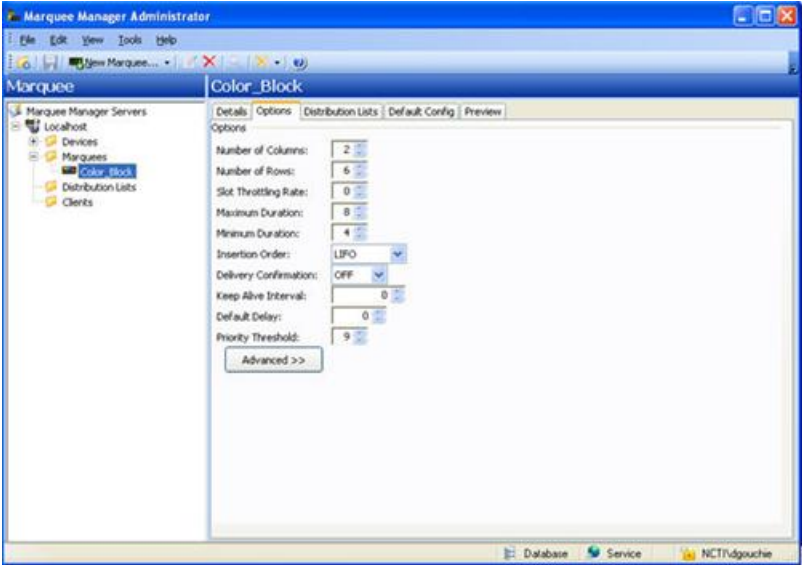

Distribution Lists

3. Select the Distribution Lists tab; configure the [distribution lists \(page 741\)](#) according to your system requirements.
4. Click Save.

The Default Config and Bin Config tabs are enabled.

Default Config Tab

The Default Config tab is where you enter a message that will display when no active messages are being sent.

Select the Default Config tab; options are as follows.

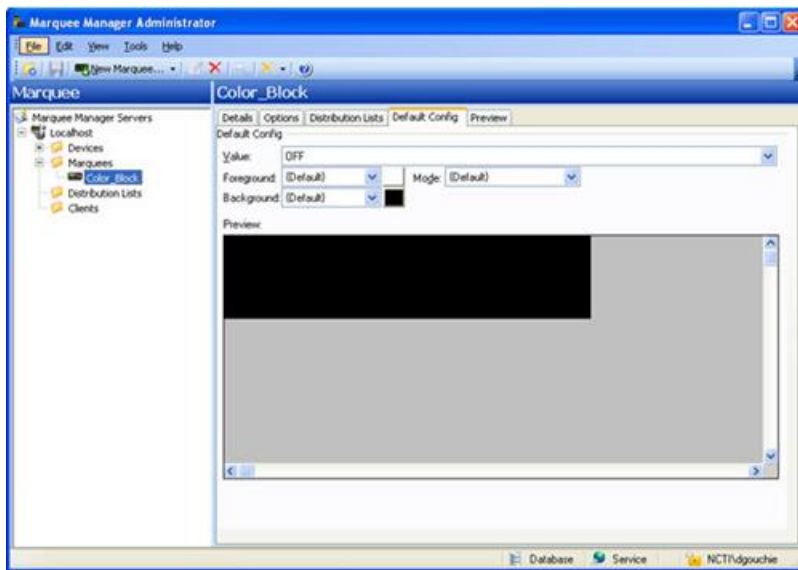

Field	Description
Configuration	
Value	Options are: <ul style="list-style-type: none"> • ON • OFF
Foreground	Foreground color options are: <ul style="list-style-type: none"> • Choose a color from the dropdown list of predetermined colors. • Click the color swatch to the right of the dropdown list; create a custom color.
Background	Background color options are. <ul style="list-style-type: none"> • Choose a color from the dropdown list of predetermined colors. • Click the color swatch to the right of the dropdown list; create a custom color.

Mode	Options to establish how the information will display on the marquee are: <ul style="list-style-type: none"> • Static • Flashing • Fast Flashing • Strobe • Reverse • Reverse Flash • Reverse Fast Flash
------	---

Click Save.

The Marquee setup can now be viewed on the Preview tab.

Marquee Manager Marquee Type: Controller

1. Select Controller in the **Model** field.

Controller configuration includes the following tabs and folders/subfolders.

Note

Folder/subfolder	Tab
Controller marquee	Details tab.
Controller marquee	Options tab.
Controller template	Template Details tab.
Controller cycle	Cycle Details tab.
Controller marquee	Default Template tab.

Controller Tabs

Details Tab

Complete [Details \(page 712\)](#) tab configuration.

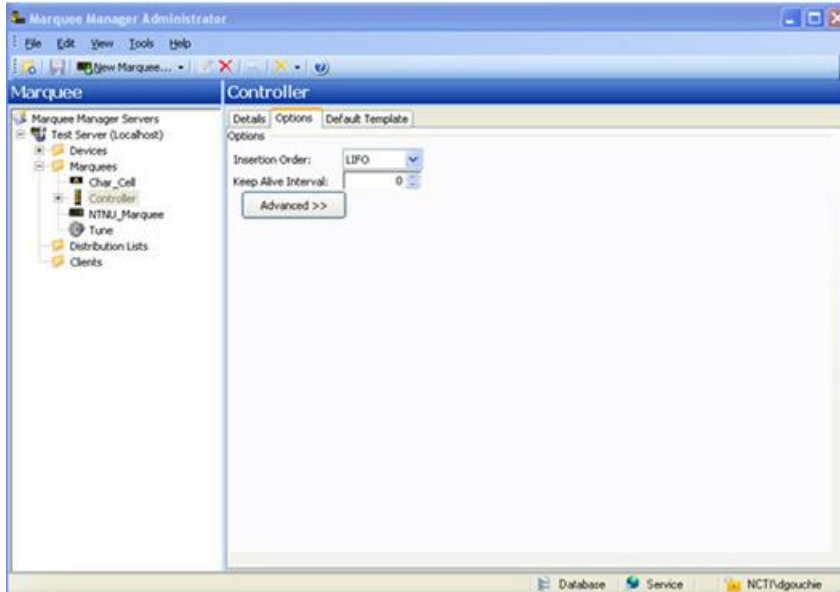

Options Tab

Select the Options tab; configure the [options \(page 714\)](#) settings according to your system requirements.

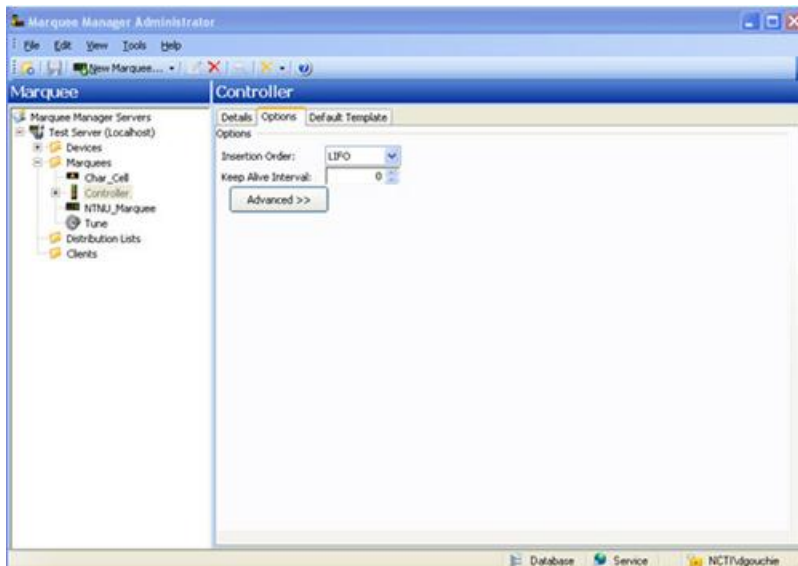

Click Save.

Result: When the Controller marquee options have been saved, two subfolders, Templates and Cycles, display under the Controller marquee folder.

In order to configure the Controller marquee's Template Default tab, you must set up a New Template to select the template that will be used, as well as the time period or cycle for that template.

Template Tabs

- 2. Expand a **Controller** folder in the Marquee Manager Administrator left-pane.
- 3. Click the **Templates** folder in the Marquee Manager Administrator left-pane.
- 4. Click New Template on the toolbar.

A Template Details tab displays; options are as follows.

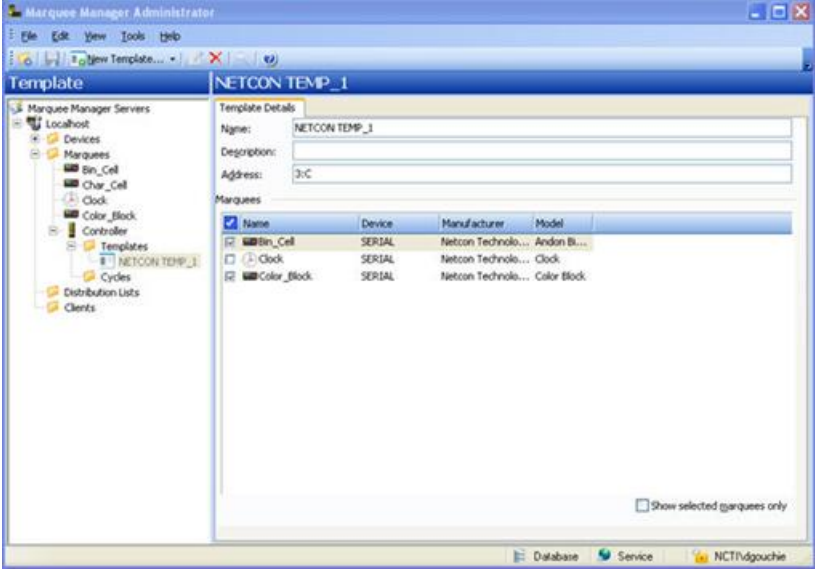

Field	Description
Template Details	
Name	Logical name to describe the marquees that will be on this template.
Description	(Optional) Details to help identify the Template.
Address	ID for the template. Important: The ID must match the Model Number that was created when the various models were added.
Marquees	
List	List of available marquees. Check the marquees that should be added to the distribution list.

Tip: Check Show selected only to display only the marquees that will be included in the distribution list.

Cycle Tabs

Defining a Cycle is only required if you to display templates in a sequence for a set duration of time.

5. Expand a **Controller** folder in the Marquee Manager Administrator left-pane.
6. Click the **Cycles** folder.
7. Click New Cycle on the toolbar.

A Cycle Details tab displays; options are as follows.

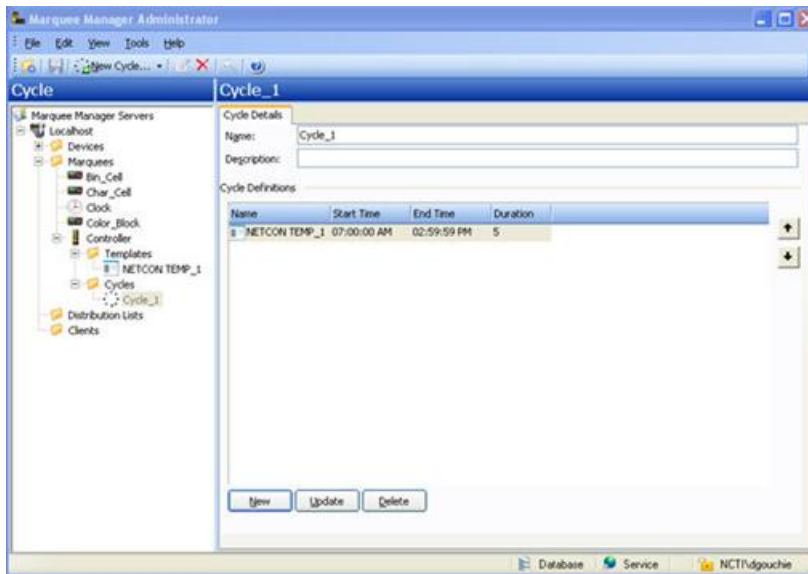

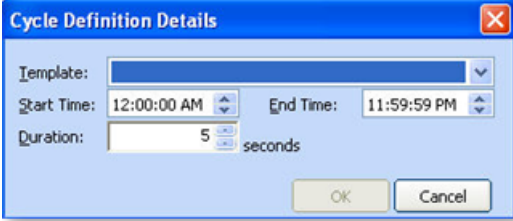
Field	Description
Cycle Definitions	
Name	Logical name to describe the Cycle.
Description	(Optional) Details to help identify the Cycle.
Address	ID for the template. Important: The ID must match the Mode Number that was created when the various models were added to the 980 via SCC Draw and uploaded to the sign
Buttons	
New	<p>Opens a Cycle Definition Details dialog box. Options are as follows.</p> 
Template	Template that will be used. Choose the template from the dropdown list.
Start and End Time	Start and End Time that the cycle will run from and to. The times can be defined for each template within a cycle.

	Duration	Time in seconds the template will run before running the next template in the cycle.
Update	Updates the list.	
Delete	Deletes a selected marquee.	

8. Click Save.

Controller Tab

When templates and cycles are available for the Controller marquee, a default template or cycle can be selected.

Default Template

Select the Controller's Default Template tab; options are as follows.

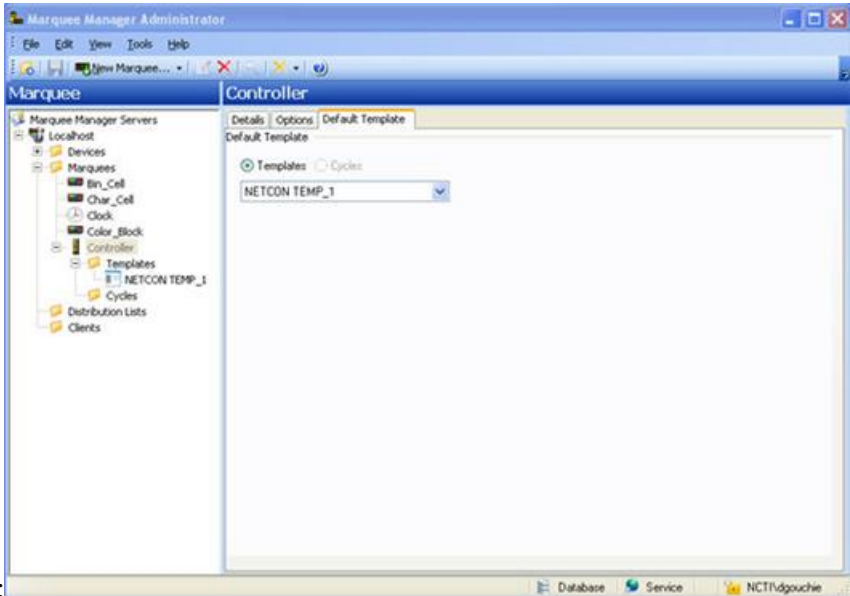

Field	Description
Default Template	
Templates	a. Check Template to display a default template. b. Select the default template in the drop down list.
Cycles	a. Check Cycle to display cycles b. Select a cycle yin the drop down list

Note: The contents of the drop down menu will change based on which option is checked: Template or Cycle. It is recommended that Template 1 (Mode Number 1) be configured as an information template to indicate that Marquee Manager is unavailable. This can be blank or show a hardware default message such as Marquee Manager Unavailable.

Default is Template 1.

When it is the default, Template 1 is labeled Default on the Default Template tab.

Click Save.

The Controller template items are listed in the Marquee Manager Administrator left-pane.

Marquee Manager Marquee Type: Counter

1. Select Netcon Technologies Native Unit in the **Manufacturer** field.
2. Select Counter in the **Model** field.

Counter configuration includes the following tabs.

- Details tab.
- Options tab.
- Distribution Lists tab.
- Default Config tab.

Details Tab

Complete [Details \(page 712\)](#) tab configuration.

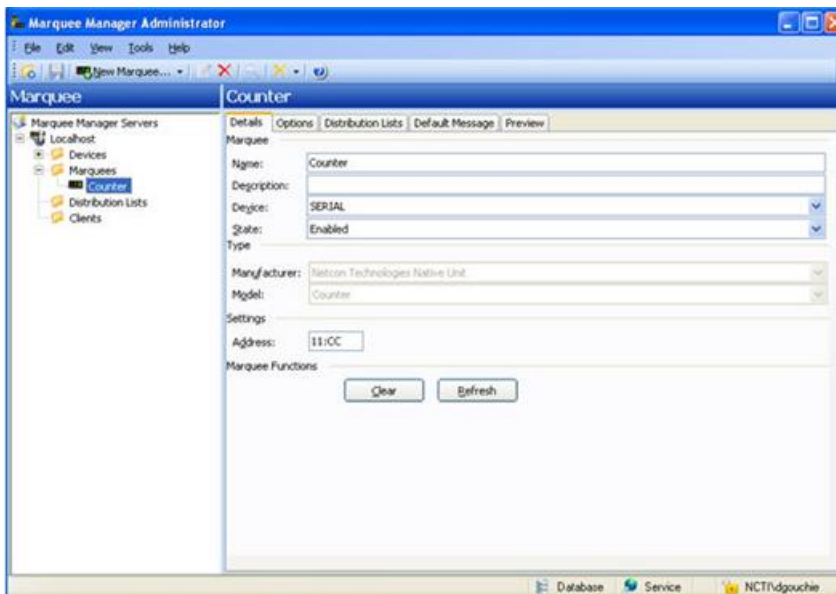

Options Tab

Select the Options tab; configure the [options \(page 714\)](#) settings according to your system requirements.

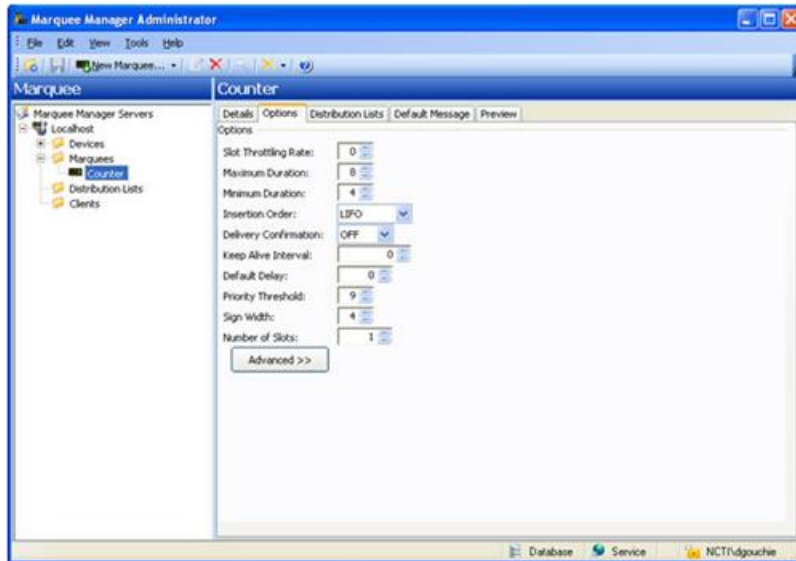

Distribution Lists

3. Select the Distribution Lists tab; configure the [distribution lists \(page 741\)](#) according to your system requirements.
4. Click Save.

The Default Config tab is enabled.

Default Config Tab

The Default Config tab is where you enter a message that will display when no active messages are being sent.

Select the Default Config tab; options are as follows.

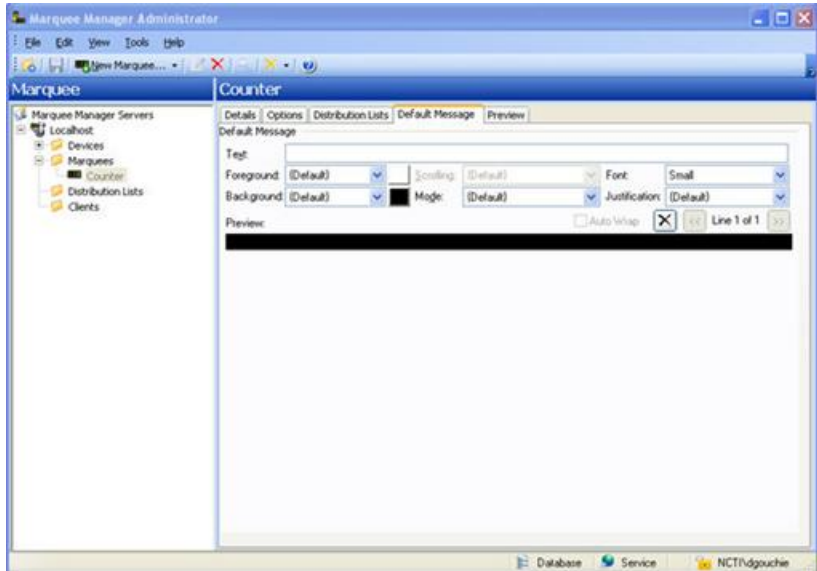

Field	Description
Configuration	
Text	Enter the text you want to appear on the marquee.
Foreground	<p>Foreground color options are:</p> <ul style="list-style-type: none"> • Choose a color from the dropdown list of predetermined colors. • Click the color swatch to the right of the dropdown list; create a custom color.
Background	<p>Background color options are.</p> <ul style="list-style-type: none"> • Choose a color from the dropdown list of predetermined colors. • Click the color swatch to the right of the dropdown list; create a custom color.
Scrolling	Read-only
Mode	<p>Options to establish how the information will display on the marquee are:</p> <ul style="list-style-type: none"> • Static • Flashing • Fast Flashing • Strobe • Reverse • Reverse Flash • Reverse Fast Flash
Font	<p>Font options are:</p> <ul style="list-style-type: none"> • Default • Small.

Justification	Message layout on the marquee. The message can be: <ul style="list-style-type: none">• Right-aligned• Left-aligned• Centered
---------------	--

Click Save.

The Marquee setup can now be viewed on the Preview tab.

Marquee Manager Marquee Type: Marquee

1. Select Netcon Technologies Native Unit in the **Manufacturer** field.
2. Select Marquee in the **Model** field.

Marquee configuration includes the following tabs.

- Details tab.
- Options tab.
- Distribution Lists tab.
- Default Message tab.

Details Tab

Complete [Details \(page 712\)](#) tab configuration.

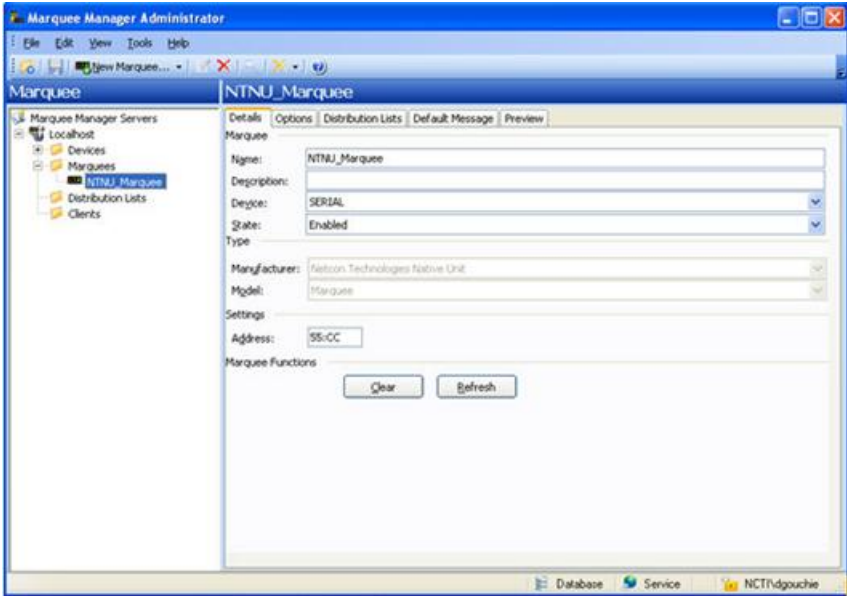

Options Tab

Select the Options tab; configure the [options \(page 714\)](#) settings according to your system requirements.

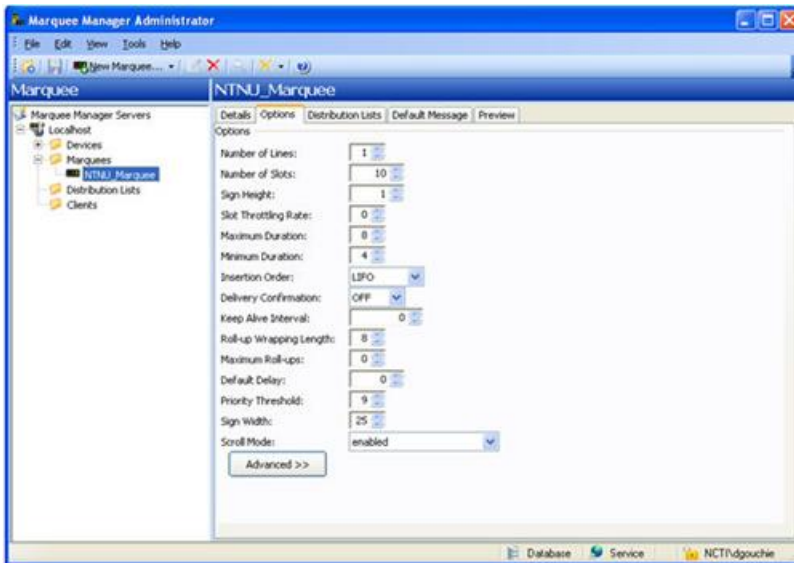

Distribution Lists

Select the Distribution Lists tab; configure the [distribution lists \(page 741\)](#) according to your system requirements.

Default Message Tab

Select the Default Message tab; options are as follows.

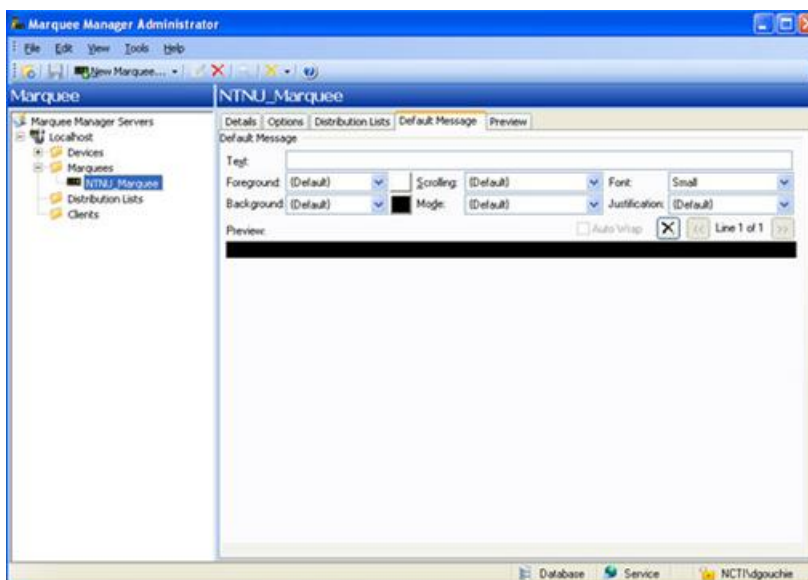

Field	Description
-------	-------------

Configuration	
Text	Text that will display on the marquee when no active messages are being sent.
Foreground	Foreground color options are: <ul style="list-style-type: none"> • Choose a color from the dropdown list of predetermined colors. • Click the color swatch to the right of the dropdown list; create a custom color.
Background	Background color options are. <ul style="list-style-type: none"> • Choose a color from the dropdown list of predetermined colors. • Click the color swatch to the right of the dropdown list; create a custom color.
Scrolling	Read-only
Mode	Options to establish how the information will display on the marquee are: <ul style="list-style-type: none"> • Static • Flashing • Fast Flashing • Strobe • Reverse • Reverse Flash • Reverse Fast Flash
Font	Font options are: <ul style="list-style-type: none"> • Default • Small
Justification	Message layout on the marquee. The message can be: <ul style="list-style-type: none"> • Right-aligned • Left-aligned • Centered

Click Save.

The Marquee setup can now be viewed on the Preview tab.

Marquee Manager Marquee Type: Speaker

The speaker models available are Static Controls' MusicMaker, Electro-Matic's Stack Light Sounder and Netcon Technologies Native Unit's Sounder. They are typically used for speaker support. It gives the user up to 999 tunes to select from, depending on the model selected.

Select Sounder in the **Model** field.

Sounder configuration includes the following tabs.

- Details tab.
- Options tab.
- Distribution Lists tab.
- Default Tune tab.

Details Tab

Complete [Details \(page 712\)](#) tab configuration.

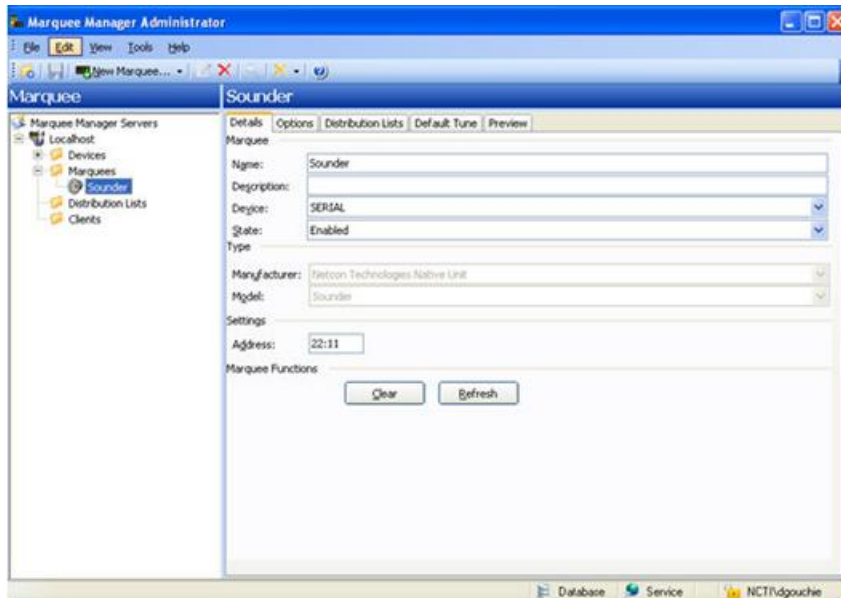

Options Tab

Select the Options tab; configure the [options \(page 714\)](#) settings according to your system requirements.

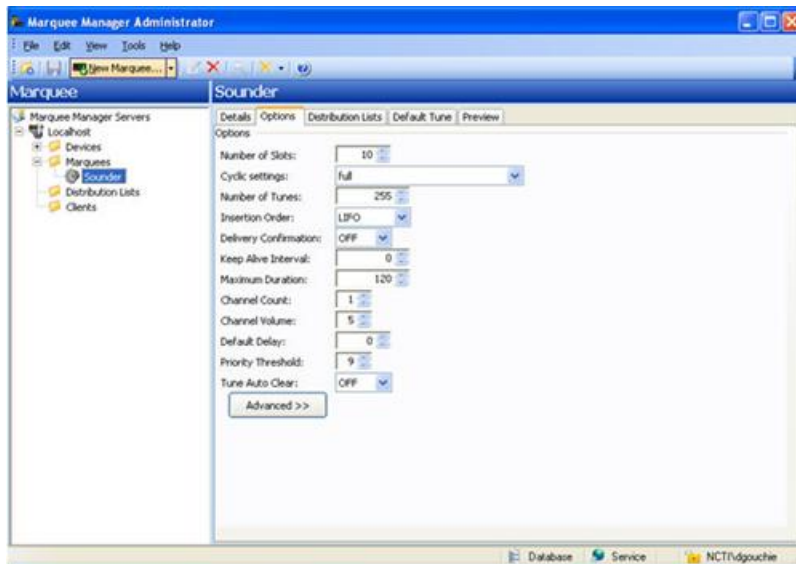

Distribution Lists

1. Select the Distribution Lists tab; configure the distribution lists, according to your system requirements.

2. Click Save.
3. On Duration
4. Off Duration
5. Repeat Count
ExampleIf the:
6. **On Duration** setting is 5 sec
7. **Off Duration** setting is 5 sec
8. **Repeat Count** is 3.

Then the:Default tune will play for 5 sec and be off for 5 sec, 3 times in a row.

Marquee Manager Marquee Type: Stack Light

Stack Light models such as Electro-Matic's Stack Light – 5 High are typically used to display colors in a vertical grid pattern. As with Color Block models, it may be used to show if a station is experiencing a problem then display a color to alert personnel.

Select Stack Light in the **Model** field.

Stack Light configuration includes the following tabs.

- Details tab.
- Options tab.
- Distribution Lists tab.
- Default Config tab.
- Light Config tab.

Details Tab

Complete [Details \(page 712\)](#) tab configuration.

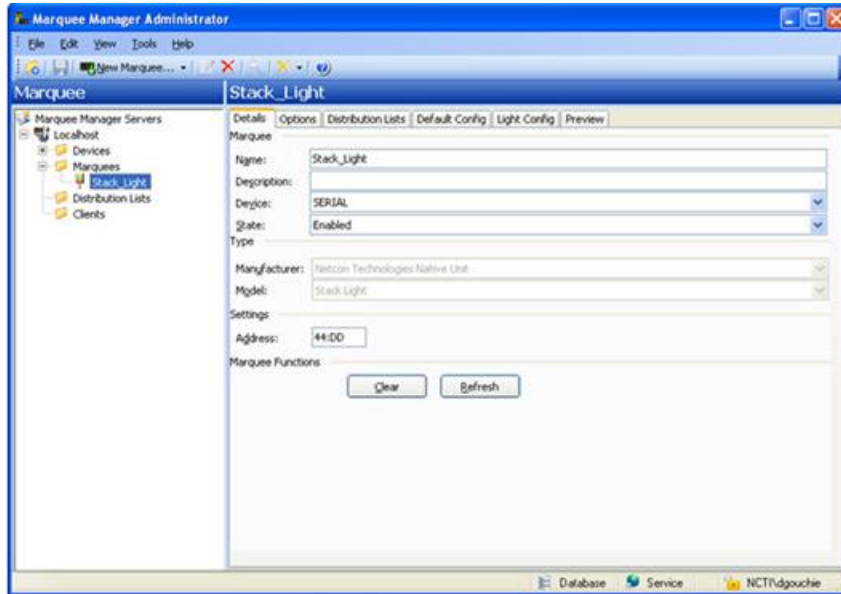

Options Tab

Select the Options tab; configure the [options \(page 714\)](#) settings according to your system requirements.

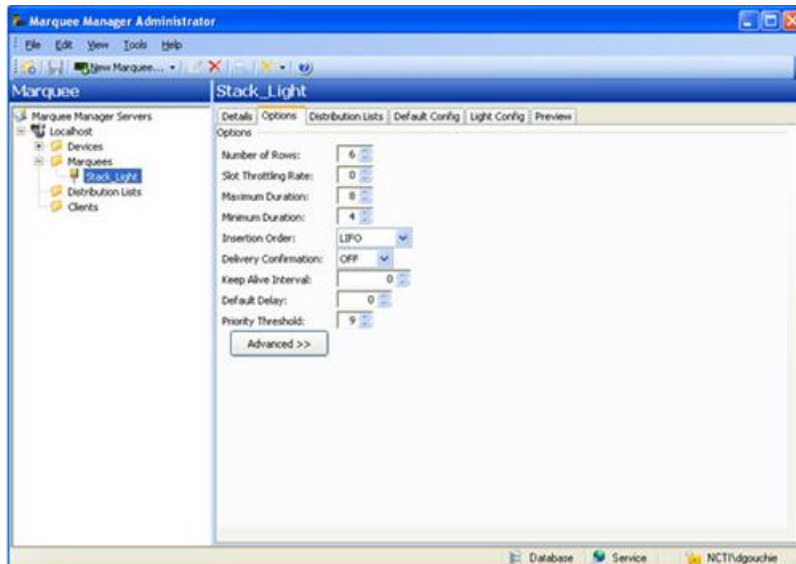

Distribution Lists

1. Select the Distribution Lists tab; configure the [distribution lists \(page 741\)](#) according to your system requirements.
2. Click Save.

3. On Duration

4. Off Duration

5. Repeat Count

ExampleIf the:

6. **On Duration** setting is 5 sec

7. **Off Duration** setting is 5 sec

8. **Repeat Count** is 3.

Then the:Default tune will play for 5 sec and be off for 5 sec, 3 times in a row.

Marquee Manager Marquee Type: Web

Web models such as that supplied by the Netcon Technologies Native Unit are typically used to display web objects on a Video Server display. It may be used to show multiple URLs on a Video Server and can be mixed with regular Andon/Marquee objects. Marquee Manager Server sends the URL to the Video Server and the Video Server then connects to the web server to display it.

Select Web in the **Model** field.

Web configuration includes the following tabs.

- Details tab.
- Options tab.
- Distribution Lists tab.
- Default Config tab.

Details Tab

Complete [Details \(page 712\)](#) tab configuration.

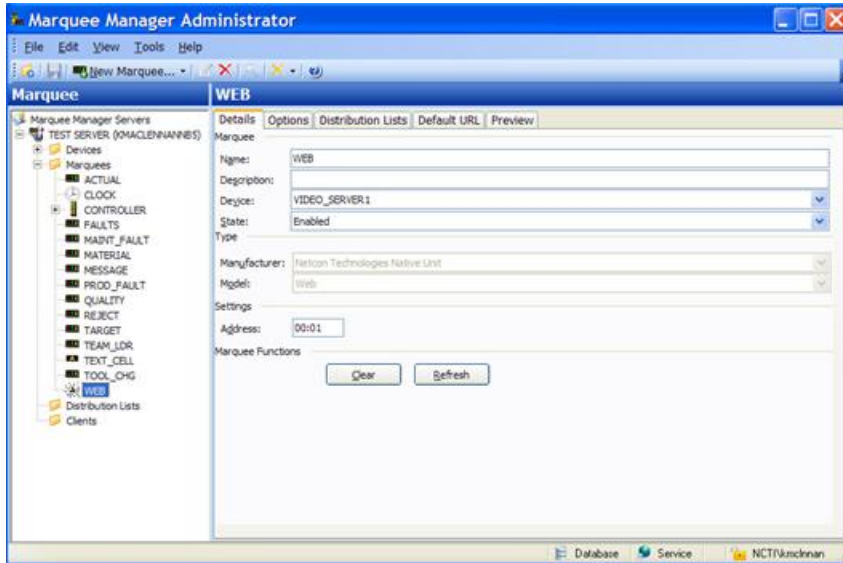

Options Tab

Select the Options tab; configure the [options \(page 714\)](#) settings according to your system requirements.

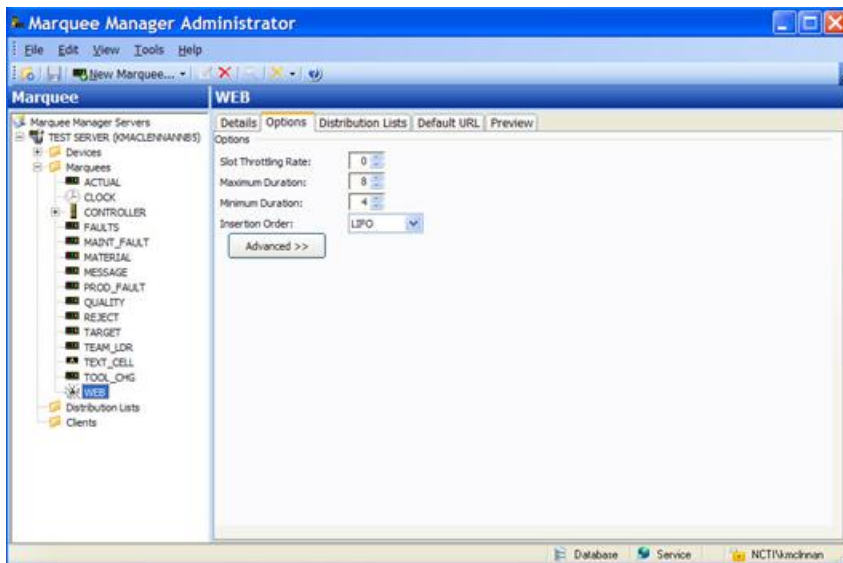

Distribution Lists

1. Select the Distribution Lists tab; configure the [distribution lists \(page 741\)](#) according to your system requirements.
2. Click Save.

Result: The Default URL tab is enabled.

Default URL Tab

The Default URL tab defines what URL will be displayed as the default when no active messages are being sent.

Select the Default URL tab; options are as follows.

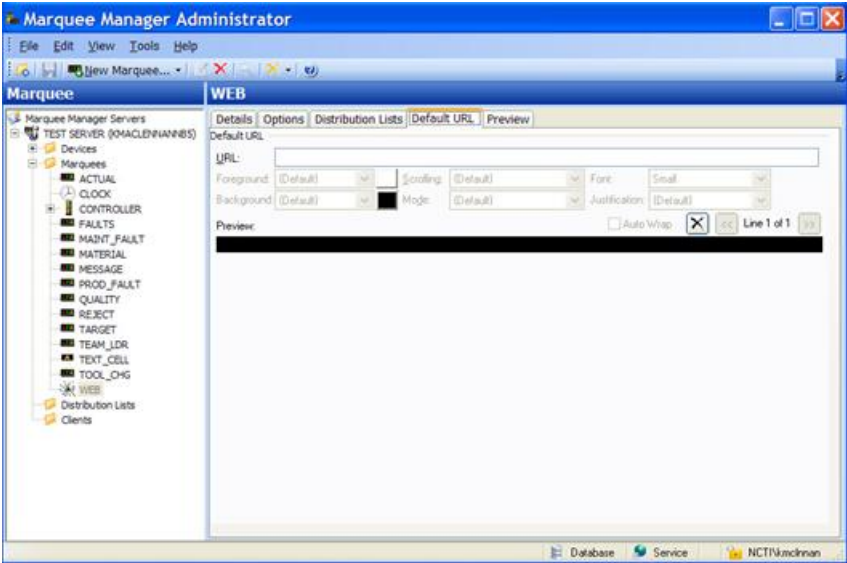

Field	Description
Default URL	
URL	URL to appear on the Video Server display when no active messages are being sent.

3. Click Save.

The Marquee setup can now be viewed on the Preview tab.

Marquee Manager Administrator Distribution Lists

Configured marquees can be added to distribution lists enabling the same message to be sent to multiple marquees with a single request.

Note: Marquee Manager Client applications provide the ability to compose messages and send them to a marquee distribution list, as to gateways.

1. Click the **Distribution Lists** folder in the Marquee Manager Administrator left-pane.
2. Click New Distribution List on the toolbar.

A Details tab displays; options are as follows.

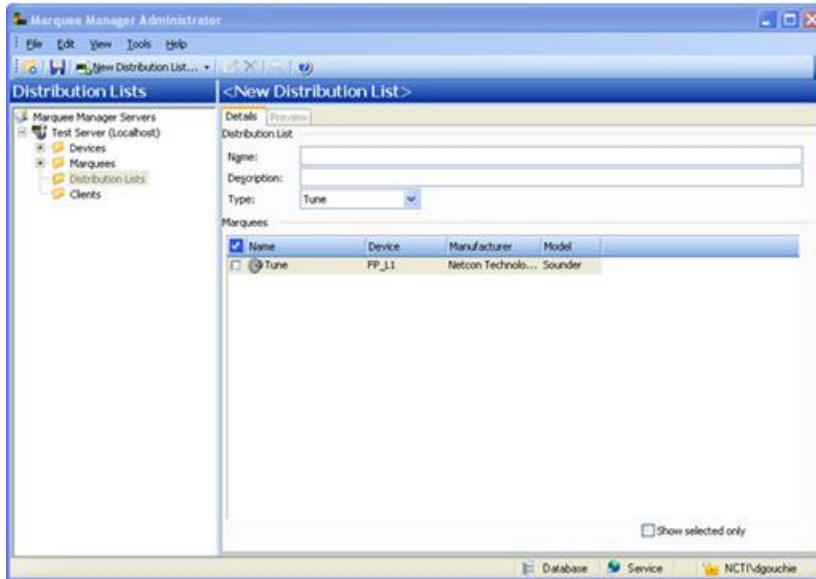

Field	Description
Name	Distribution List name.
Description	(Optional) Details to help identify the distribution list.
Background	Use either method to select the background color. <ul style="list-style-type: none"> • Choose a color from the dropdown list of predetermined colors, • Click the color swatch to the right of the dropdown list; create a custom color.
Type	Select which Type of Distribution List to create. Marquees that are listed in the Marquees box are determined by the Type . Available options include: <ul style="list-style-type: none"> • Bin Cell • Solid Cell • Stack Light • Text Cell • Text/Counter • Tune
Marquees	When a Type is selected, a list of configured marquees that are the selected type displays. Check the marquees that should be added to the distribution list.

 **Tip:** Check Show selected only to display only the marquees that will be included in the distribution list.

3. Click Save.

Distribution list details are saved.

Marquee Manager Administrator Clients

The Clients folder contains a list of applications or gateways that are using the configured marquees to display information. Clicking on a Client folder allows users to see what registered applications

are using the Marquee Manager. By choosing a specific application, you can clear any transactions if the client or gateways lose connection to the Marquee Manager Server.

1. Click the **Clients** folder.

A list of current transactions for each client displays in the right pane:

1. Select a Client from the left tree view to see the details of each transaction.

The Transaction Count displays the total number of transactions currently active on each client.

 **Note:** To clear all transactions for a specific client:

1. Click the host.
2. Click the Clear button.

Result: The default message for that marquee will now display

Marquee Manager Administrator Tools: Users

If Windows or Windows Trusted is selected for the server security, a Users folder is added to the Tools tree, if it was not already there.

 **Important:**

- Security is configured separately in the Marquee Manager components:
 - Marquee Manager Administrator
 - Marquee Gateway
 - Marquee Manager Client authenticates against configured Marquee Manager Administrator users when Security is enabled.
- New User
- Details Tab

New User

Do the following.

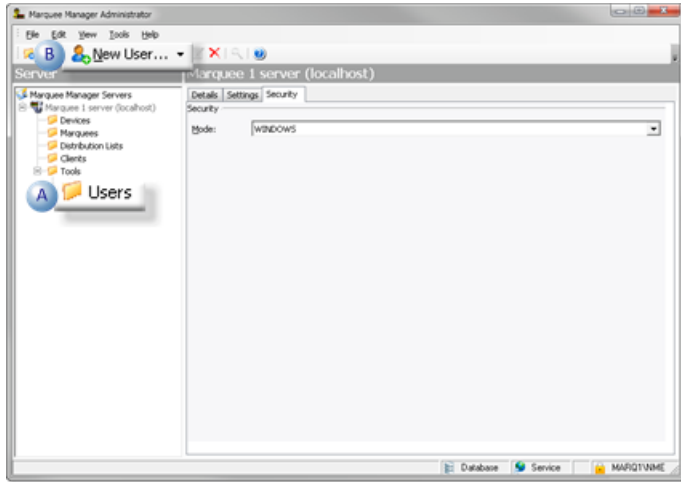

A	Select Users in the Marquee Manager Administrator window left-pane.
B	Click New User on the Marquee Manager Administrator window toolbar.

Result: Tabs for the User profile display in the Alarm Cast Administrator right-pane.

Details Tab

Details options to register Marquee Manager users are as follows.

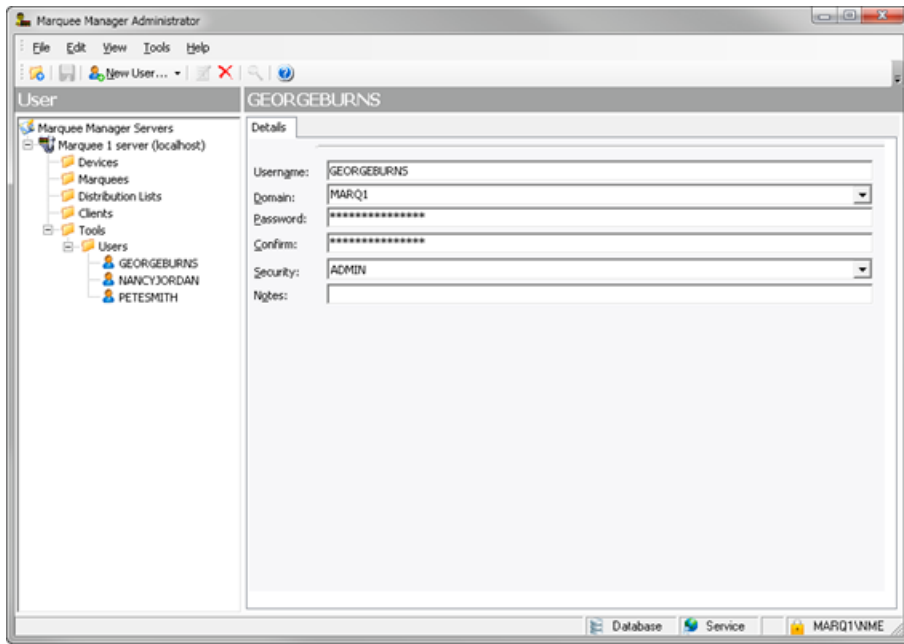

Field	Description
User	
Username	Valid Windows user.

Field	Description	
Domain	Domain the user logs into.	
Password	(Required with Windows Security) Password assigned to the logged in Windows user.	
Confirm	(Required with Windows Security) Re-entered password.	
Security	Security levels are as follows.	
	ADMIN	Full rights to all features.  Important: The ADMIN security level is required to access (open) applications. For almost all instances, it is recommended that ADMIN be assigned to registered Marquee Manager users.
	USER	Can access only the Marquee Manager Client.
	DEFAULT	USER
Notes		
Notes	(Optional) Additional details about or for the user.	

Marquee Manager Administrator Other Tools

Marquee Manager Administrator Other Tools

There are many features that make using Marquee Manager easier and more effective that include:

- Marquee Manager Administrator: Toolbar and Tree.
- Marquee Manager Administrator: Cloning.
- Marquee Manager Administrator: Options.
- Marquee Manager Administrator: Reports.
- Marquee Manager Administrator: Log Files.

Marquee Manager Administrator Other Tools: Toolbar and Tree

Anything created on the tree view side of the screen (the left hand side) can be modified or deleted at any time. You can also change the state to disable.

Tree View Items: Modify

Select the item you want to alter. The information regarding it will show up on the right hand side of the screen. At this point, you can change the name along with any other variables attached to it (e.g. configuration settings etc.)When you save your changes, they will appear in the Tree View.

! **Important:** Information regarding manufacturer or models, cannot be altered. Once the modified information has been saved, you cannot revert to the old information. The only way to retrieve it is to change it back to its original state.

Tree View Items: Delete

There are two ways to delete items on the Tree View side of your screen. By selecting the item you want to delete, you can choose Edit >Delete on the Menu bar or simply click the red **Delete** symbol (X).

! **Important:** You cannot recover any deleted item or any information attached to it. You must recreate it.

In certain applications, if a particular item is being used in another part of the application, you will not be able to delete it at that level. You must go further down in the Tree View to discern where it is being used, and delete it there first.

Marquee Manager Administrator Other Tools: Cloning

1. Right-click the marquee that will be cloned; select Clone Marquee on the Popup menu.

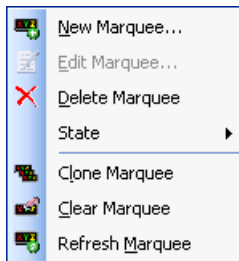

A new configuration screen will display. T

Details that are not cloned are the:

- **Name**

This insures that no duplicates will be created.

- **Device**

This enables the user to select the device to which the new marquee will be connected.

- **Address**

All other details, including the default message and attributes, are cloned.

2. Click Save.

The cloned marquee is saved.

Marquee Manager Administrator Other Tools: Options

The Options menu enables users to set Marquee Manager Server details.

Click the Tools>Options on the Marquee Manager Administrator menu bar.

An Options dialog box opens; options tabs are as follows.

- General tab.
- Preference tab.

General Tab

Select the Details tab.

Options are as follows.

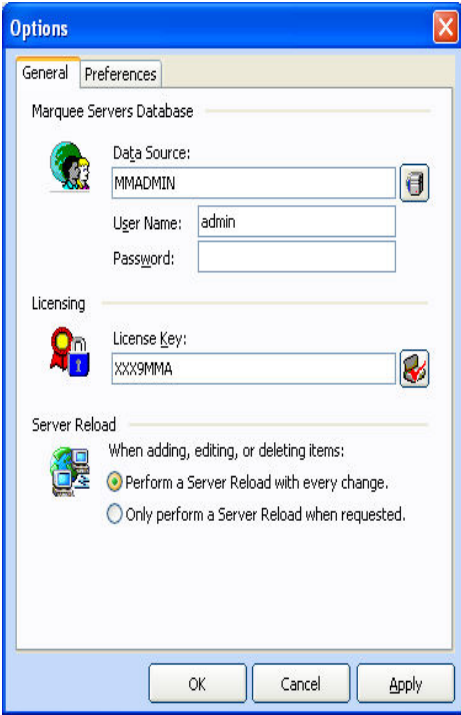

Option	Description
Data Source	Provides the Marquee Manager Server database and user/password requirement.
License key.	Determines the number of servers that can be configured.

Option	Description	
Server Reload	Provides the option to reload the server with any additions, edits or deletions automatically or when requested by the user.	
	Reload with every change	Reload will occur when the Save button is clicked.
	Reload only when requested	You will be informed that there are data changes the server needs to be notified about and have the option to either send the reload before closing or close the system without reloading the changes.

Preferences Tab

Select the Preferences tab in the Options dialog box.

Options control the Marquee Manager Administrator data entry preferences.

You can control prompting in the event no default was supplied and specify the default attribute handling for marquee attributes.

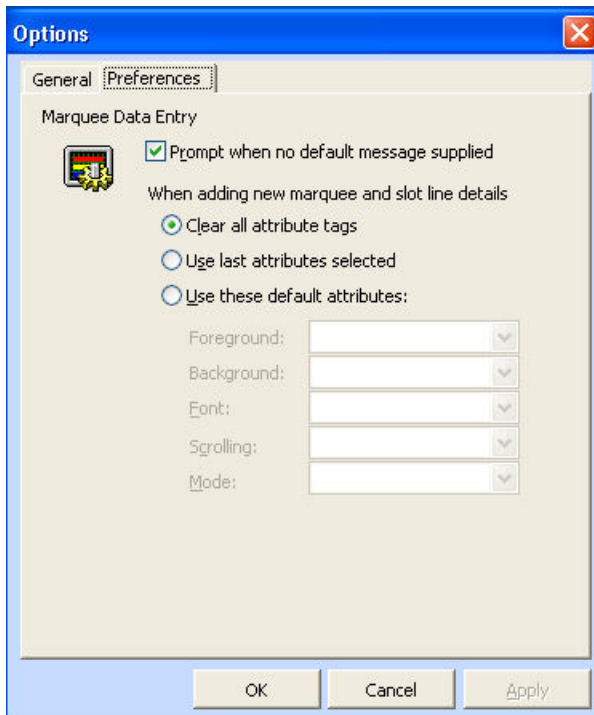

Marquee Manager Administrator Other Tools: Reports

Select Tools>Reports><Report type> on the Marquee Manager Administrator menu bar.

You can preview and print out a detailed list any of the following current features.

- Devices
- Marquees
- Distribution lists.

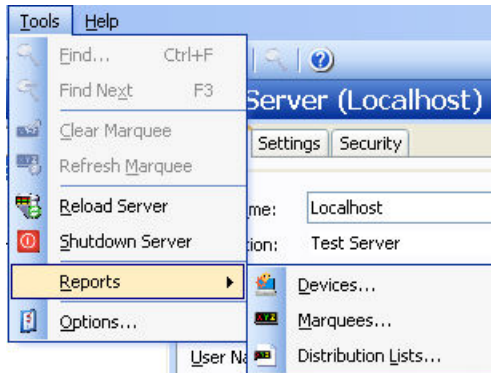

Marquee Manager Administrator Other Tools: Log Files

In each application, you are able to view the log files associated with the various components of the software. The log files contain an accurate history of every transaction and modification made to the database. Log files are important because they ensure the integrity of the data and provide a means of data recovery.

Select View to get View Server and View Admin Log options.

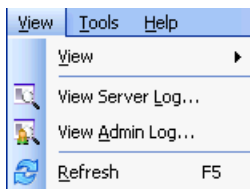

The selected log opens.

Marquee Manager Administrator Filter Guidelines

Click the Filters button on the selected log window toolbar.

A Marquee Manager Filter dialog box opens.

The **Events On:** field defaults to the current day.

The **Status Message** field can be used to search for a portion of the message in the log.

Important: When matching special characters, enclose them in brackets.

Example

To find all log items that start with [enter in [[]* in the **Status Message** field.

The common allowed search characters are as follows:

Field	Description
Events On	Default is the current day.
Status Message	Note: A portion of the status message can be searched in the log. Important: Only certain characters may be used in this field. When matching the following special characters, enclose them in brackets: Left Bracket ([), Question Mark (?), Number Sign (#), Asterisk (*).
	Example To find all log items that start with [enter in [[]* in the Status Message field.

Example: Search Characters

Character	Match Made	Example
?	Any single character	Text in the log is: ABC, DBC, and XYZ. Entering ?BC returns only: ABC, DBC
*	Zero or more characters	Entering *Initiated* returns: All log items with the word Initiated
#	Any single digit (0-9)	Text in the log is: Device1, Device5, Device8, Device10. Entering Device# returns: Device1, Device5, Device8.

Check Automatic Refresh to automatically refresh the log file based on the seconds specified.

Marquee Manager Administrator Technical Reference

Marquee Manager Administrator Technical Reference

- Marquee Manager Administrator: Manufacturers Address Formats
- Marquee Manager Administrator: Sign Properties
- Marquee Manager Administrator: Insertion Tags

Marquee Manager Administrator: Manufacturers Address Formats

Manufacturer	Address Format
Adaptive Alpha Version 2	2-digit hex from the display Range = 00-FF e.g. 01
Adaptive Micro Systems	2-digit hex from the display Range = 00-FF e.g. 0A
Allen-Bradley Inview	2-digit hex from the display Range = 00-FF e.g. 0C

Manufacturer	Address Format
Electro-Matic Products Inc.	Stack Light & Sounder: group:unit hex Range = 00-FF for group and unit 4-digit display: 2-digit hex from the display Range = 00-FF e.g. 03
NETCON Technologies Native Unit	Fixed length 4-character address field. First two bytes represent group, second two bytes represent unit. Valid values 00-FF. All characters in uppercase. e.g. 01:EF
Nu-Media Display Systems	8-bit addressing where group = 0 2-digit hex value e.g. 01
Static Controls Corporation	group:unit hex Range = 00-FF for group and unit e.g. 01:FF
Uticor Technology	group:unit with 00:0000 format e.g. 00:0003

You can use the number zero as a wildcard character when searching for an unknown address. e.g. 01 will return all addresses with two digits where the last digit is 1.

Marquee Manager Administrator: Sign Properties

Sign properties include the following.

- Adaptive ALPHA VERSION 2
- Adaptive Micro Systems
- ALLEN-BRADLEY INVIEW
- Electro-Matic Products Inc.
- NETCON Technologies Native Unit
- NU-MEDIA DISPLAY SYSTEMS*
- STATIC CONTROLS CORPORATION
- Uticor Technology

Adaptive ALPHA VERSION 2

Model	Color	Font	Scrolling	Flashing	Notes
BIGDOT 13Char	Tri-color	Double Height	#	#	Supports Rollup
BIGDOT 26Char	Tri-color	Small, Fixed Width, Bold	#	#	Supports Rollup

Adaptive Micro Systems

Model	Color	Font	Scrolling	Flashing	Notes
ALL	Tri-color	Small, Bold, Fixed Width	ü	ü	
Beta-Brite	Tri-color	Small, Bold, Fixed Width	ü	ü	
BIGDOT	Tri-color	Small, Bold, Fixed Width	ü	ü	

Model	Color	Font	Scrolling	Flashing	Notes
BIGDOT_26Char	Tri-color	Small, Bold, Fixed Width	ü	ü	
PPD		Small, Bold, Fixed Width	ü	#	Red and green models
215	Tri-color	Small, Bold, Fixed Width	#	#	
215C	Tri-color	Small, Bold, Fixed Width	#	#	
320C	Tri-color	Small, Bold, Fixed Width	#	#	
330C	Tri-color	Small, Bold, Fixed Width	#	#	
4080C	Tri-color	Small, Bold, Fixed Width	#	#	
4120C	Tri-color	Small, Bold, Fixed Width	#	#	
4120R	Red	Small, Bold, Fixed Width	#	#	
4160C	Tri-color	Small, Bold, Fixed Width	#	#	
4160R	Red	Small, Bold, Fixed Width	#	#	
4200C	Tri-color	Small, Bold, Fixed Width	#	#	
4200R	Red	Small, Bold, Fixed Width	#	#	
4240C	Tri-color	Small, Bold, Fixed Width	#	#	
4240R	Red	Small, Bold, Fixed Width	#	#	
7120	Tri-color	Small, Bold, Fixed Width	#	#	
7160	Tri-color	Small, Bold, Fixed Width	#	#	
7200	Tri-color	Small, Bold, Fixed Width	#	#	
7200_4Line	Tri-color	Small Caps	#	#	
9120	Tri-color	Small, Bold, Fixed Width	#	#	
9160	Tri-color	Small, Bold, Fixed Width	#	#	
9200	Tri-color	Small, Bold, Fixed Width	#	#	
9240	Tri-color	Small, Bold, Fixed Width	#	#	

ALLEN-BRADLEY INVIEW

Model	Color	Font	Scrolling	Flashing	Notes
P42C	Tri-color	Small, Fixed Width, Bold	#	#	
P42R	Red	Small, Fixed Width, Bold	#	#	
P43C	Tri-color	Small, Fixed Width, Bold	#	#	
P43R	Red	Small, Fixed Width, Bold	#	#	
P44C	Tri-color	Small, Fixed Width, Bold	#	#	

Model	Color	Font	Scrolling	Flashing	Notes
P44R	Red	Small, Fixed Width, Bold	#	#	
P72CN2/1	Tri-color	Small, Fixed Width, Bold	#	#	3 line/20characters
P72CN2/1- 4 line	Tri-color	Small Caps	#	#	4 line/20 characters
P74CN2/1	Tri-color	Small, Fixed Width, Bold	#	#	3 line/33 characters
P74CN2/1 – 4 line	Tri-color	Small Caps	#	#	4 line/33 characters

Electro-Matic Products Inc.

Model	Color	Font	Scrolling	Flashing	Notes
4 Digit Display	Red	Fixed Width	ü	ü	4 characters- Alpha or numeric
Stack Light – 1 High	Blue, Brown, Green, Light Green, Light Red, Orange, Red, White, Yellow	N/A	N/A	#	
Stack Light – 2 High	Blue, Brown, Green, Light Green, Light Red, Orange, Red, White, Yellow	N/A	N/A	#	
Stack Light – 3 High	Blue, Brown, Green, Light Green, Light Red, Orange, Red, White, Yellow	N/A	N/A	#	
Stack Light – 4 High	Blue, Brown, Green, Light Green, Light Red, Orange, Red, White, Yellow	N/A	N/A	#	
Stack Light – 5 High	Blue, Brown, Green, Light Green, Light Red, Orange, Red, White, Yellow	N/A	N/A	#	
Stack Light - Sounder	Blue, Brown, Green, Light Green, Light Red, Orange, Red, White, Yellow	N/A	N/A	N/A	1 tune played

NETCON Technologies Native Unit *

Model	Color	Font	Scrolling	Flashing	Notes
Clock	N/A	N/A	ü	ü	Displays time only
Counter	Red	Fixed Width	ü	ü	Numeric only Max. 8 digits # of Characters can be set on the Options tab in Marquee Administrator
Marquee	Multi-Color	Fixed Width	#	#	Supports Rollup # of Lines and Characters can be set on the Options tab in Marquee Administrator
Sounder	N/A	N/A	N/A	N/A	255 Tunes

NU-MEDIA DISPLAY SYSTEMS*

Model	Color	Font	Scrolling	Flashing	Notes
v4.67 Single Line	Red	Double Height	#	#	

Model	Color	Font	Scrolling	Flashing	Notes
v4.67 Dual Line	Red	Small, Fixed Width, Bold	#	#	

STATIC CONTROLS CORPORATION

Model	Color	Font	Scrolling	Flashing	Notes
Alpha 952_20	Red	Fixed Width	ü	#	one line 20 characters
Alpha 952_25	Red	Fixed Width	ü	#	one line 25 characters
Alpha 952_40	Red	Fixed Width	ü	#	one line 40 characters
Alpha 954_10	Red	Fixed Width	#	#	
Andon 974_0206	Multi-color	N/A	ü	#	Cell board size: 2 rows, 6 columns
Andon 974_0307	Multi-color	N/A	ü	#	Cell board size: 3 rows, 7 columns
Andon 974_0308	Multi-color	N/A	ü	#	Cell board size: 3 rows, 8 columns
Andon 974_0408	Multi-color	N/A	ü	#	Cell board size: 4 rows, 8 columns
Andon 974_0420	Multi-color	N/A	ü	#	Cell board size 4 rows, 20 columns
AndonQueue 974_0206	Multi-color	Fixed Width	ü	#	Cell board size: 2 rows, 6 columns
AndonQueue 974_0307	Multi-color	Fixed Width	ü	#	Cell board size: 3 rows, 7 columns
AndonQueue 974_0308	Multi-color	Fixed Width	ü	#	Cell board size: 3 rows, 8 columns
AndonQueue 974_0408	Multi-color	Fixed Width	ü	#	Cell board size: 4 rows, 8 columns
AndonQueue 974_0420	Multi-color	Fixed Width	ü	#	Cell board size: 4 rows, 20 columns
AndonQueue 974_0614	Multi-color	Fixed Width	ü	#	Cell board size: 6 rows, 14 columns
ColorBlock 974_0104	Multi-color	N/A	ü	#	ColorBlock board size: 1 row, 4 columns
ColorBlock 974_0404	Multi-color	N/A	ü	#	ColorBlock board size: 4 rows, 4 columns

Model	Color	Font	Scrolling	Flashing	Notes
Marquee 955GM_0120	Multi-color	Fixed Width	ü	#	GM specific SCC protocol: 1 line, 20 characters
Marquee 955GM_0125	Multi-color	Fixed Width	ü	#	GM specific SCC protocol: 1 line, 25 characters
Marquee 955GM_0133	Multi-color	Fixed Width	ü	#	GM specific SCC protocol: 1 line, 33 characters
Marquee 955GM_0135	Multi-color	Fixed Width	ü	#	GM specific SCC protocol: 1 line, 35 characters
Marquee 955GM_0140	Multi-color	Fixed Width	ü	#	GM specific SCC protocol: 1 line, 40 characters
Marquee 955GM_0225	Multi-color	Fixed Width	ü	#	GM specific SCC protocol: 2 line, 25 characters/line
Marquee 955GM_0235	Multi-color	Fixed Width	ü	#	GM specific SCC protocol: 2 line, 35 characters/line
Marquee 955GM_0240	Multi-color	Fixed Width	ü	#	GM specific SCC protocol: 2 line, 40 characters/line
MusicMaker_AC1	N/A	N/A	N/A	N/A	255 tunes
Num 801_N	Red	Fixed Width	ü	ü	Numeric only
SCC980_Controller	N/A	N/A	N/A	N/A	Template switching controller
Tim 801_T			ü	ü	Displays time only

Uticor Technology

Model	Color	Font	Scrolling	Flashing	Notes
Uticor Client 3000 – 1 line	Red	Small, Double Height, Full Height	#	#	
Uticor Client 3000 – 2 line	Red	Small, Double Height, Full Height	#	#	
Uticor Client 3000 – 4 line	Red	Small, Double Height, Full Height	#	#	
Uticor Client 3000 Double Wide – 1 line	Red	Small, Double Height, Full Height	#	#	
Uticor Client 3000 Double Wide – 2 line	Red	Small, Double Height, Full Height	#	#	
Uticor Client 3000 Double Wide – 4 line	Red	Small, Double Height, Full Height	#	#	

- For all supported signs, only the bottom line of the sign supports the scrolling feature.

- If the default message is changed, the Allen-Bradley Inview sign will reboot itself. With Allen-Bradley signs, there is no address field passed to specify on which display you want to set the default message.

Marquee Manager Administrator: Insertion Tags

Tag	Description	Attributes Available	
COL	Color	#rrggbb	RGB in uppercase hex
		AMB	Amber
		BLK	Black
		BLU	Blue
		BRN	Brown
		CLR	Clear
		DEF	Default
		GRN	Green
		LGR	Light green
		ORG	Orange
		RED	Red
		WHI	White
		YLW	Yellow
BCL	Background color		Same as COL
FNT	Font	BLD	Bold
		CAP	All Capitols
		DEF	Default
		Fix	Fixed Width
		SML	Small
JST	Justification	CEN	Center
		DEF	Default
		LEFT	
		RIGHT	
MOD	Mode	DEF	Default
		FFL	Fast flash
		FL	Flash

Tag	Description	Attributes Available	
		REV	Reverse
		RFF	Reverse fast flash
		RFL	Reverse flash
		ST	Static
		STR	Strobe
SCR	Scrolling	DEF	Default
		FAST	(or SCR-2)
		MED	(or SCR-1)
		S	Static
		SLOW	(or SCR-0)
DATE	Date	DATE DD/MM/YY DD/MM/YYYY DD-MM-YY DD-MM-YYYY MM/DD/YY MM/DD/YYYY MM- DD-YY MM-DD-YYYY YY/MM/DD YY-MM-DD YYYY/MM/DD YYYY-MM-DD <DATE-DDD> <DATE-DDDD>	
TIME	Time	12 24 TIME	
WRAP	Wrap long line around on multi-line text marquee.	Only applies to multi-line Text Displays. All <LIN-##> tokens will be removed and the most text that can be displayed across all lines on the display will be shown. Any resulting text that exceeds the displays capabilities will be truncated.	

Marquee Manager Administrator Glossary

Administrator

Typically a GUI application, this component facilitates configuration and monitoring of a server engine. If changes are made to the server configuration the administrator notifies the engine to reload its running configuration either automatically or on user demand. An example of an administrator component is Marquee Manager Administrator.

This administrator allows you to maintain the Marquee Manager server's engine configuration.

Administrator Kit

An administrator kit contains the product's administration component only. After installing this kit on a workstation you may utilize any of the features of the Administrator component.

Andon

Andon boards are used to show where (station or location) there is a problem (fault) or a potential problem (blocked or starved station or low on stock). They are used to alert the proper personnel that

something needs their attention - either immediate or in the near future. A marquee may be used to give mention to upcoming meetings, or events and can display the time, date, number of parts that are expected and actually produced. Basically, they are a visual communication tool used to help production meet their goals and minimize shut down time.

Bin

An area within each cell that contains data relevant to various locations in an environment. (e.g. plant stations such as paint) and various statuses typically used in these areas. Data such as current station state or a station that may be experiencing a problem may be displayed on the Andon Board.

Cell

For Andon type marquee signs, a cell refers to one block of data on the sign.

Client

A client component utilizes the facilities of a standard Marquee Manager server. Typically a GUI application, this component provides a user-friendly interface of the available services offered by the server engine.

Cycle

The time period defined for the display of Controller 980 templates, allowing the display of multiple screen templates in sequence.

Device

A Marquee Manager Server device is a name assigned to a physical connection point on the server, which will be used to establish a connection with a marquee.

Distribution List

A Marquee Manager Server distribution list is a collection of marquees, which can be sent a message with a single transaction. Similar to an email distribution list, a client which initiates a transaction with a distribution list will automatically send the same message to all associated marquees.

DSN

A DSN, Data Source Name, is the name assigned to an ODBC driver and configuration information that allows an ODBC enabled application to connect to a data source.

Engine

An engine component implements a unified interface to a set of common, related protocols. The engine provides services to clients and gateways such that a common interface may be used to

manipulate many different types of devices. Engines are administered via Administrator components and are utilized by clients, gateways or user written components.

Gateway

A gateway component creates a bridge between a third party product and a standard CIMPLICITY server. Typically an engine, this component provides a conduit for forwarding events from the third party product into a CIMPLICITY standard server.

An example of a gateway would be an interface to an HMI or SCADA system forwarding events from that system to Marquee Manager Alarm Manager for processing. An example of a gateway is Marquee Manager Gateway for ActivPlant. This gateway forwards ActivPlant incidents to Marquee Manager.

Marquee

A sign display that serves as a visualization communication tool, providing the means to display time, date and message text such as production counts, and what areas of a plant are experiencing problems.

ODBC

The ODBC protocol is an implementation of the Microsoft 'Open Database Connectivity'. The ODBC API is utilized to access the Marquee Manager configuration database.

Priority Threshold

The importance or priority that is given to each marquee. This number is taken into consideration when assigning messages to that marquee, with regards to which messages hold greater importance and when that message will display.

Example

If your marquee has a priority threshold set to three, all messages with a priority of three or higher (and only those messages) will be displayed. When they have been acknowledged and are no longer being displayed, any other messages with a lower priority will then start displaying on the marquee.

Server Kit

A server kit typically contains the server engine and administrator components. In some cases a client component is also included with this kit. The server kit is usually installed on a centralized host and is utilized by one or more clients or gateways. An example of a server kit is Marquee Manager Server. This kit contains the Marquee Manager engine, administrator and client.

Stack Light

Stacked lights typically used to display colors in a vertical grid pattern from one to five lights high. They may be used to show if a station is experiencing a problem then turn a light on to alert personnel.

Template

A user formatted guide or page of configured marquees, allowing you to display a page at any given time without the need to customize each marquee.

Marquee Manager Gateway

About Marquee Manager Gateway

The following topics contain an overview of the CIMPager product, detailed installation instructions, and administration user instructions.

- [Marquee Manager Gateway: Key Features](#)
- [Marquee Manager Gateway: How it Works](#)
- [Marquee Manager Gateway Components](#)
- [Marquee Manager Gateway Tools: Users](#)
- [Marquee Manager Gateway for CIMPLICITY Other Tools](#)
- [Marquee Manager Gateway Insertion Tag List](#)
- [Marquee Manager Gateway Glossary](#)

Marquee Manager Gateway: Key Features

Marquee Manager Gateway for CIMPLICITY is a marquee administration system that allows users to easily configure various rules that once triggered will display a message to a variety of different marquees, using a simple generic language.

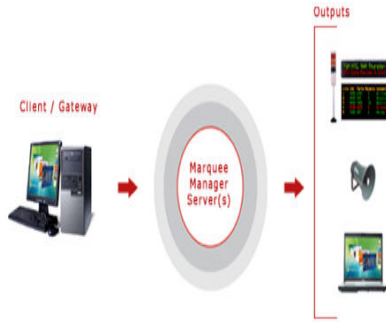

Key Features:

- Local project configuration management
- Support for both scrolling marquees and Andon type marquees
- Support for speaker and marquee on any alarm
- Hot reload of configuration information
- Default messages can be configured for display when no alarms are currently active on a marquee
- Support for embedded point values in alarm messages
- Support for alarm values to be inserted into the alarm message
- Multiple CIMPLICITY projects can populate a shared Marquee Server.
- Wrapping of alarm text messages and defaults for message lengths - may be specified per individual marquee including word wrap rules
- If a Marquee Server connection is lost, the Gateway for CIMPLICITY will queue marquee requests until the server is back on-line.
- Support for multiple projects per machine (Version 6.1 or higher)

Marquee Manager Gateway: How it Works

Marquee Manager Gateway for CIMPLICITY is another product in the Marquee Manager Suite of products and may reside on your Marquee Manager Server or access a Marquee Manager Server over a LAN or WAN connection.

The Marquee Manager Gateway for CIMPLICITY provides a bridge between CIMPLICITY project alarms and your Marquee Manager Server. Various routing rules can be defined by selecting available Resources, Alarms, Classes and alarm message text that have been configured in your CIMPLICITY project. When one of these rules is met, message text can be dispatched to your Marquee Manager Server, including embedding alarm and point values within the message text.

There are four valid alarm states that may be configured for each Routing Rule:

Generate	The alarm becomes active by meeting the rules defined in the CIMPLICITY Point Properties dialog box> Alarm tab.
Acknowledged	The alarm is Acknowledged by an operator with Alarm Viewer or the point is set up to Auto Ack in the Alarm Options of that point.

Reset	The alarm is back within normal parameters or the point is set up to Auto Reset under the Alarm Options of that point.
Delete	The alarm has met the rules under the Deletion Requirements in the Alarm Options.

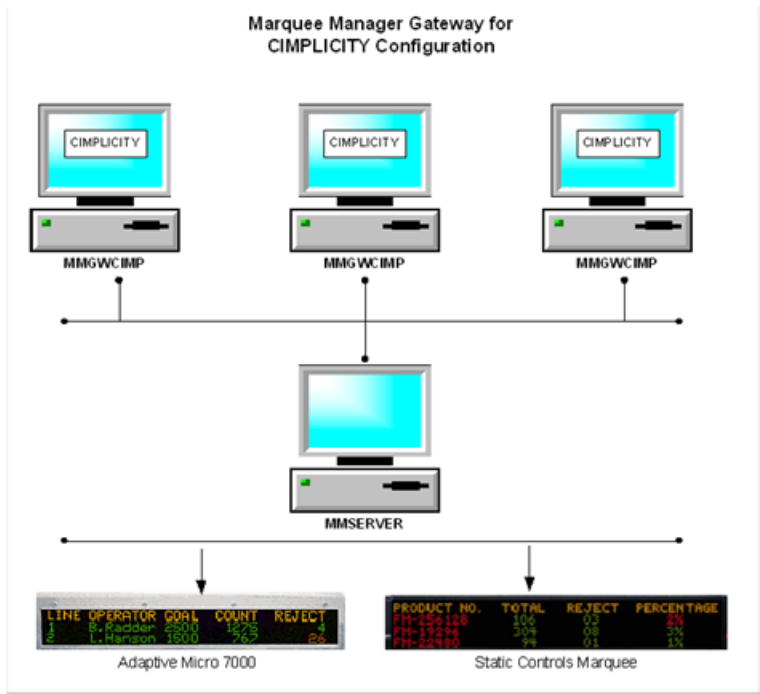

Marquee Manager Gateway Components

Marquee Manager Gateway Components

- Marquee Manager Gateway Server
- Marquee Manager Gateway Routing Rules
- Marquee Manager Gateway Defaults
- Marquee Manager Gateway Insertion Tags

Marquee Manager Gateway Server

- Marquee Gateway Pre-configuration
- Marquee Gateway Administrator

Marquee Gateway Pre-configuration

Marquee Gateway Enabled

1. Open the appropriate CIMPPLICITY project in the Workbench.

2. Click Project>Properties on the Workbench menu bar.

The Project Properties dialog box opens.

3. Select the General tab.

4. Check Marquee Gateway.

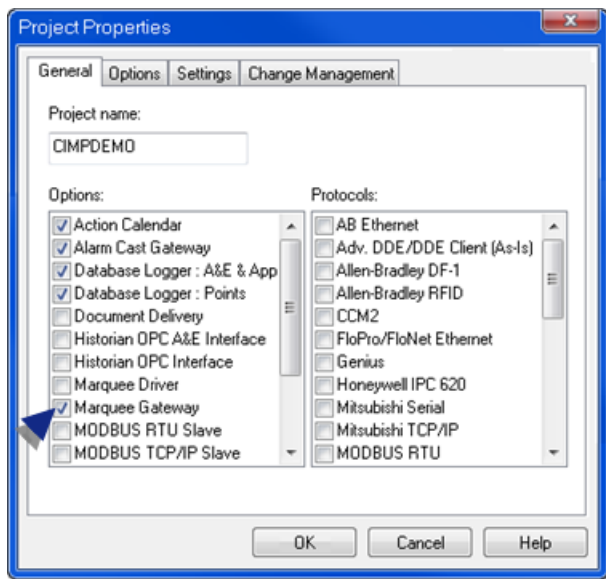

Remote Client

5. Expand Project >Security>Advanced in the Workbench left-pane.

6. Double-click **Client**.

A New Client dialog box opens.

7. Enter the **Computer** name in the Computer field.

8. Click OK.

The client Properties dialog box opens.

9. Enter the following.

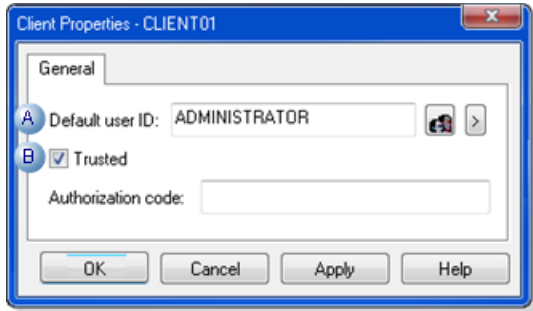

A	Enter ADMINISTRATOR.
B	Check Trusted.

Marquee Gateway Administrator

10. Start the CIMPPLICITY project.
11. Stop the MMGATEWAY process, as follows.
 - a. Expand Runtime in the Workbench left-pane; double-click **Process Control**.

The CIMPPLICITY Process control dialog box opens.

- a. Do the following.
 - a. Select MMGAMGATEWAY.
 - b. Click Stop Process.

The MMGAMGATEWAY process is halted.

12. Open the Marquee Gateway, as follows.
 - a. Expand Project>Equipment>Marquee Gateway in the Workbench left-pane.
 - b. Select **Administrator**.
 - c. Double-click **Administrator** in the Workbench right-pane.

Result: The Marquee Manager Gateway opens.

Note: Click the Save button on the Marquee Manager Gateway toolbar if the window is empty when it first opens.

The Marquee Manager Gateway for CIMPPLICITY user interface conveniently displays all information in a tree view which, when expanded, shows the current sign default message or the current active message of the sign. It includes a Routing Rules folder, and a Marquees folder that displays Marquees that have already been configured in the Marquee Manager Administrator.

Marquee Gateway Server configuration includes the following tabs.

- Details tab
- Settings tab

- Security tab
- CIMPLICITY tab

Details Tab

Select the Details tab; options are as follows.

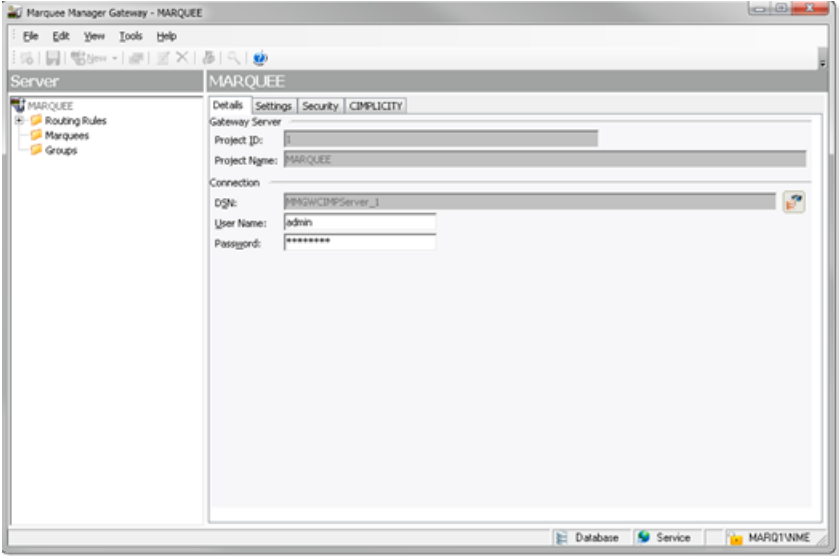

Field	Description
Gateway Server	
Project ID	Automatically assigned when the new server has been saved.
Project Name	Automatically entered. Note: This is the same name as the name of the project that was opened in the Workbench.
Connection	
DSN	Automatically entered when the server is saved.
User Name	Optional.
Password	Optional.

Settings Tab

Select the Settings tab; options are as follows.

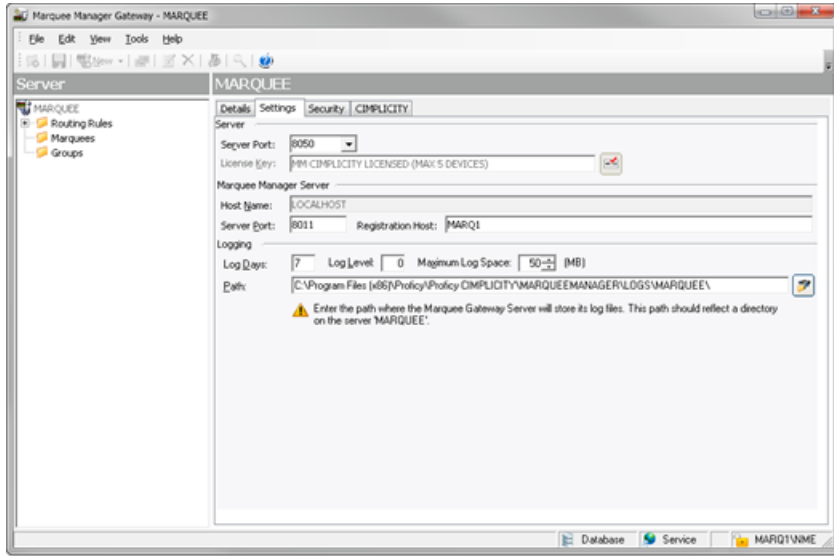

Field	Description
Server	
Server Port	(Automatically entered) default value in the range from 8050 to 8069. Important <ul style="list-style-type: none"> Each project must have a unique port assigned to it. Keep the value the system assigns unless instructed by CIMPLICITY to do otherwise.
License Key	Valid Marquee Gateway for CIMPLICITY license key
Alarm Cast Alarm Manager Server	
Host Name	TCP/IP resolvable name for the machine running the Marquee Manager Server.
Server Port	Port that connects to the Marquee Manager Server. Default is 8011.
Logging	
Log Days	Number of days the log file will be kept before being purged. Default is 7 days.
Log Level	For use at the request of the Marquee Manager. In the event of any problems, CIMPLICITY may request additional levels of logging to assist in problem solving. Default is 0.
Maximum Log Space	Amount of space to allot to the log file. Note: This prevents the log files from consuming too much drive space. Default is 50 MB.
Path	Path to the directory where the Marquee Manager Server will store its log files. Important: The path should reflect a directory on the CIMPLICITY project server..

Security Tab

Select the Security tab; options are as follows.

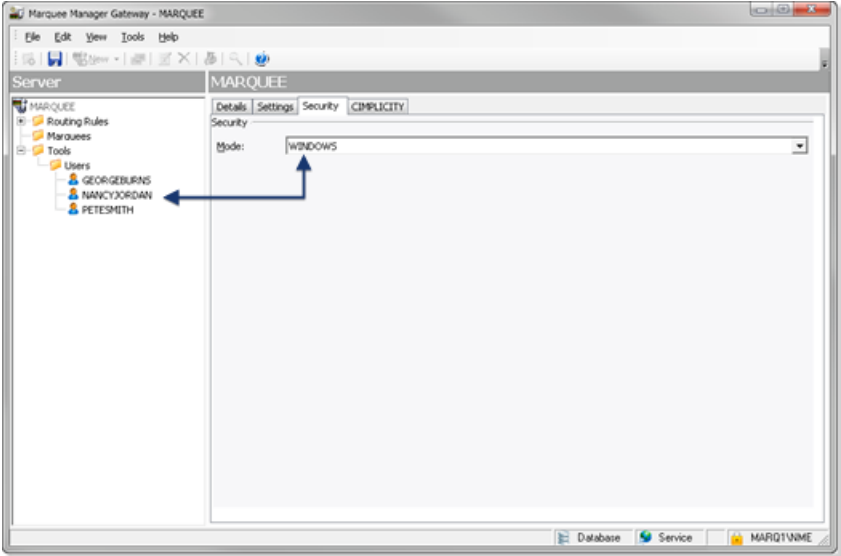

Field	Description	
Security		
Mode	Security options for the Alarm Cast Gateway server are as follows.	
	NONE	Alarm Cast Gateway security is not enabled for the server.
	Windows	<p>A valid user name and password are required. Security is as follows.</p> <ul style="list-style-type: none"> a. A Users folder is added to the Tools tree. b. Users who should have access to the Alarm Gateway server need to be added. <p>A Login dialog box opens when a user attempts to open the Alarm Cast Gateway window.</p>  <p>Result: Listed users with valid user names/passwords will have access to the server.</p>
	Windows Trusted	<p>Uses a trusted domain account; does not require a password.</p> <ul style="list-style-type: none"> a. A Users folder is added to the Tools tree. b. Users who should have access to the Alarm Gateway server need to be added. <p>Result: After a listed user logs into Windows, the user can open the Alarm Cast Gateway window; a Login dialog box for the Alarm Cast Gateway is not required.</p>
	Default	NONE

CIMPLICITY Tab

13. A Users folder is added to the Tools tree.

14. Users who should have access to the Alarm Gateway server need to be added.

A Login dialog box opens when a user attempts to open the Alarm Cast Gateway window.



15. A Users folder is added to the Tools tree.

16. Users who should have access to the Alarm Gateway server need to be added.

17. Select the CIMPLICITY tab; options are as follows.

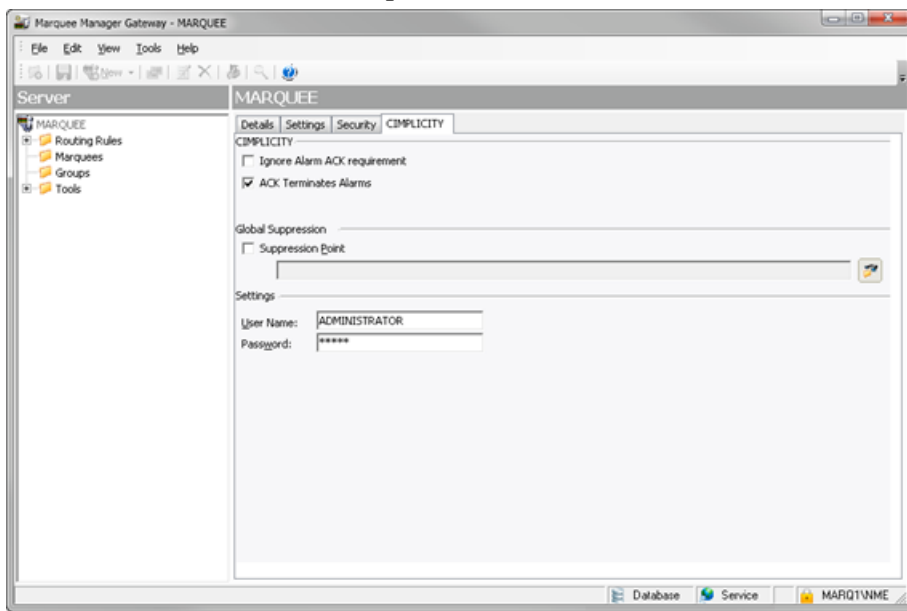

Field	Description
CIMPLICITY	
Ignore Alarm ACK	Alarm does not need to be acknowledged by an operator to suppress messaging Note: The message will be suppressed even if ACK is required in the alarm's CIMPLICITY configuration.
Terminate between state changes	Stop messaging from escalating further when the alarm state changes. Messaging will commence at level one for the alarm on each state change.
ACK Terminate Alarms	Terminate an alarm when the engine receives an ACK.

18. Click Save on the Marquee Manager Gateway toolbar.

19. Restart the MMGGATEWAY process in the CIMPLICITY Process Control dialog box.

A Project ID now displays on the Gateway Server Details tab.

Marquee Manager Gateway Routing Rules

1. Click the **Distribution Lists** folder in the Marquee Manager Gateway left-pane.
2. Click New Rule on the toolbar.

Routing rules configuration includes the following tabs.



- Routing Rule Details tab.
- Routing Rule Generated Tab
- Routing Rules Acknowledged Tab
- Routing Rules Reset Tab
- Routing Rules Deleted Tab

Routing Rule Details Tab

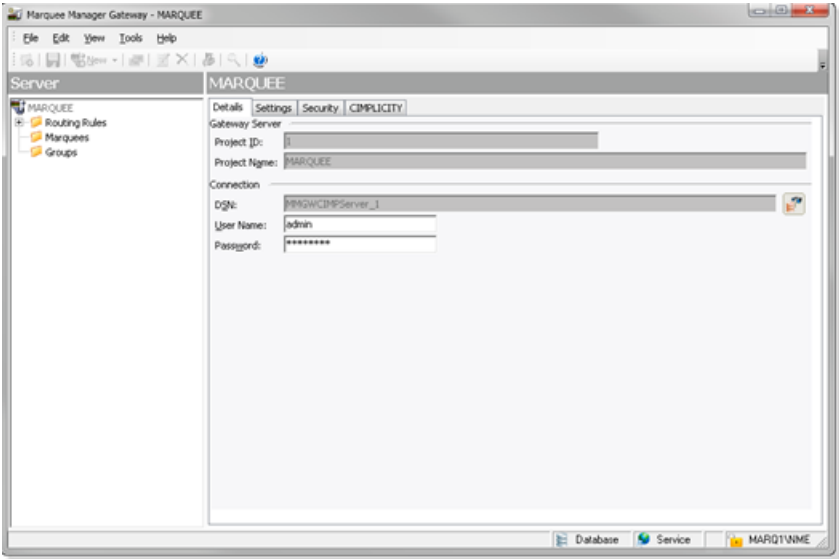
Select the Rule Details tab; options are as follows.



Field	Description	
Description	Description for the rule. This should be a logical name to describe the data that will be met with this rule.	
Alarm Load button		Click the Alarm Load button to load the alarms from the CIMPLICITY server and populate the drop downs with the available Resources, Alarms, and Classes.
Resource/ Alarm/Class	Drop down lists contain resources, alarms and classes that have been configured in the CIMPLICITY project.	

Field	Description
Message	Part of the message text configured in the CIMPLICITY Point Properties dialog box>Alarm tab to filter the alarms returned that match the rule.
Suppression Point	(Check to enable the field) Points are used for suppression in the Marquee Manager Gateway for CIMPLICITY.
	 Click the Suppression Point button to open a Browse Server browser that lists available points.
	When suppression is configured and a point evaluates to match one of the following values, the associated effect will be applied:
1	Marquee (displayed items, e.g. Andon cells)
2	Tune (sounds)
3	Sum of the values for multiple items to be suppressed (Marquee and Tune suppression)
4	Controller (template switch)
	<p>Example A tune is playing because a fault has occurred. Plant floor persons are aware of the fault. A plant floor person can push a button on an HMI that sets the Suppression point to the value 2 and temporarily turn off the tunes.</p> <p> Important: Point ID lengths can have a maximum of 255 characters.</p>

guide: Guidelines: Details tab

- The Gateway for CIMPLICITY supports CIMPLICITY wildcards for these fields where * matches multiple characters and ? matches single characters.

Examples

TANK* matches all tanks.

TANK?0 matches only tanks ending with 0 (e.g. TANK10, TANK20).

- The **Message:** field enables a user to specify a portion of the message text configured in the alarm details of point's properties to narrow the alarms returned that will match the rule.

By default the **Message** field value is the wildcard *, effectively matching all messages.

Example

To display only alarms with text including the word HIGH, you could customize the **Message** field to show *HIGH*.

- Alarm states can send to a marquee, including Andon type boards, a speaker or both. This may be edited in each alarm state as one of the following.
- Generated
- Acknowledge

- Reset
- Deleted

Routing Rules Generated Tab

The Generated tab provides the options to specify where the message will be displayed and details for that marquee/speaker.

Select the Generated tab; options are as follows.

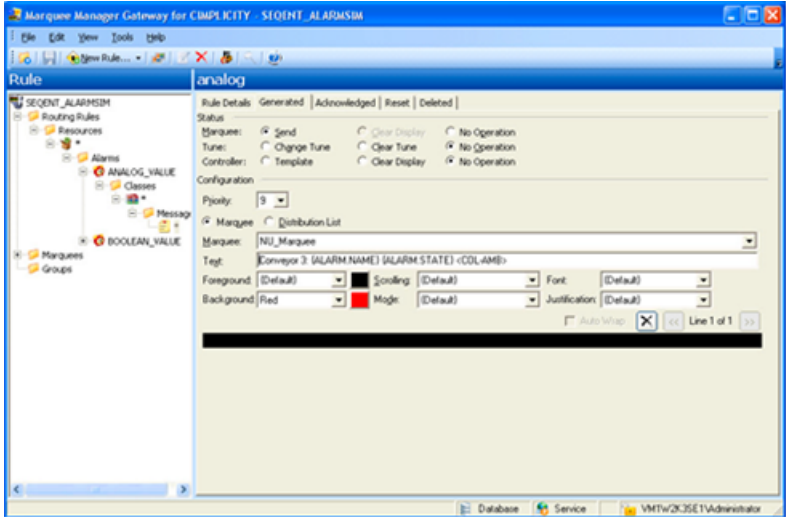

Field	Description						
Status							
	Check one of the following.						
	<table border="1"> <tr> <td><input type="radio"/></td> <td>Marquee</td> </tr> <tr> <td><input type="radio"/></td> <td>Tune</td> </tr> <tr> <td><input type="radio"/></td> <td>Controller</td> </tr> </table>	<input type="radio"/>	Marquee	<input type="radio"/>	Tune	<input type="radio"/>	Controller
<input type="radio"/>	Marquee						
<input type="radio"/>	Tune						
<input type="radio"/>	Controller						
Default	Marquee/No Operation						
Configuration							
Priority	Order in which messages sent to the marquee will be displayed. Highest priority messages are 1. Lowest priority messages are 9. Default is 9.						
Marquee	<p>Marquee to which the message will be sent.</p> <p> Note: The message can be displayed to either a Group or Distribution List that has been configured for the Marquee Manager Administrator.</p> <p>Check Distribution List to display a list of available groups.</p>						

Text	<p>Text to display on the marquee. Valid entries are:</p> <ul style="list-style-type: none"> • Point values <p>Point values can be inserted in the alarm text with the following syntax: <code>{POINT.pointname}</code>.</p> <ul style="list-style-type: none"> • Alarm values • Regular text <p>Text can either be:</p> <ul style="list-style-type: none"> • Entered manually, using the values shown in the table below <p>or</p> <ul style="list-style-type: none"> • Chosen from the drop down menu that displays when you type {. <p> Important: Point lengths can have a maximum of 255 characters.</p>
Foreground	<p>Use either method to select the foreground color.</p> <ul style="list-style-type: none"> • Choose a color from the dropdown list of predetermined colors, • Click the color swatch to the right of the dropdown list; create a custom color.
Background	<p>Use either method to select the background color.</p> <ul style="list-style-type: none"> • Choose a color from the dropdown list of predetermined colors, • Click the color swatch to the right of the dropdown list; create a custom color.
Scrolling	<p>Options are:</p> <ul style="list-style-type: none"> • Default • No Scrolling • Slow Speed • Medium Speed • Fast Speed.
Font	<p>Font options are:</p> <ul style="list-style-type: none"> • Default • Small
Mode	<p>The dropdown list contains the following choices to establish how the information will display on the marquee. Static</p> <ul style="list-style-type: none"> • Flashing • Fast Flashing • Strobe • Reverse • Reverse Flash • Reverse Fast Flash
Justification	<p>Message layout on the marquee. The message can be:</p> <ul style="list-style-type: none"> • Right-aligned • Left-aligned • Centered

 **Note:** Guidelines: Generated tab

- Marquee Manager Gateway for CIMPPLICITY allows the configuration of additional insertion tags to the default message.

Value	Result
{ALARM.NAME}	Alarm name
{POINT.XXX}	Point name where XXX is the point name that must be entered by the user.
{ALARM.RESOURCE}	Associated resource name for alarms
{ALARM.CLASS}	Associated alarm class

{ALARM.MESSAGE}	Alarm message text from the Alarm tab in the alarm's configuration
{ALARM.STATE}	One of GEN, RST, ACK or DEL
{ALARM.SYSTEM}	Project name

- (Optional) A maximum length parameter in the format of {CLASS.XXX[:max-length]} allows you to specify the number of characters that will be displayed for that Point value.
- The format is:

```
CLASS.XXX[:max-length]}
```

- The valid range is 0 to 1024.

Example

ALARM.RESOURCE:6} will display only 6 characters of the alarm resource point value.

- Additional configuration includes the following.
 - a. When sending a message to a group, only the common colors, fonts, scrolling attributes and modes will be displayed in the drop down menus. If only one color, font, scrolling attribute or mode exists among all signs in a group, the dropdown list will default to that.

{Default} will also be available to default these attributes to that of the manufacturer.

Depending on the marquee selected, the Preview section will display the available Lines that may be configured.

- a. If a Group is added with marquees that contain one and two-line signs, the Preview will only have one line available for configuration.

Example

A Group contains a two-line Numedia and a Static Controls 952 one-line.

The preview will only display one line available for configuration.

- a. Click the Change Tune button and/or the Template button if a tune or a template should play when an alarm is generated. This can be selected in addition to displaying the message on the selected marquee.

Marquee, speaker and template buttons will then be available to toggle between configurations.



Marquee Manager Gateway Generated: Template

Click the **Template** icon to configure the template that will play.

Template options are as follows.

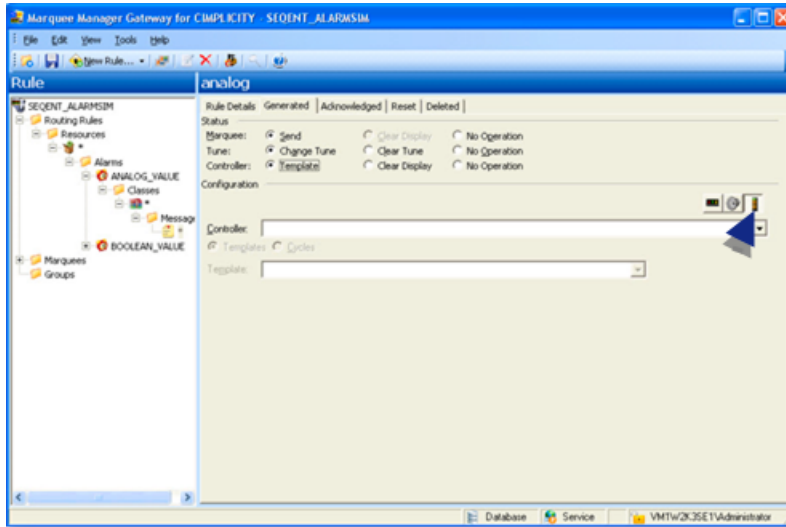

Field	Description
Controller	Select from the dropdown list. Note: The controllers were configured for the Marquee Manager Administrator.
Template	Select from the dropdown list. Note: The templates were configured for the Marquee Manager Administrator.

Routing Rules Generated: Speaker

Click the **Speaker** icon to configure a tune that will play.

Speaker options are as follows.

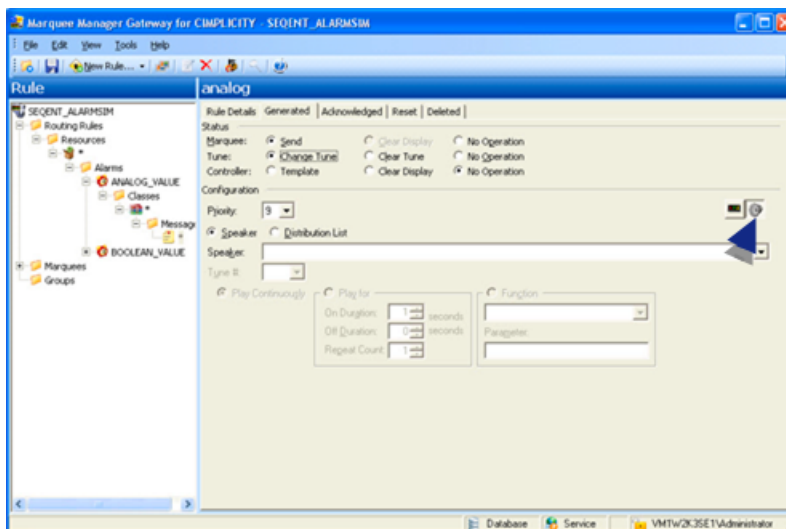

Field	Description
Priority	Order in which messages sent to the marquee will be displayed. Highest priority messages are 1. Lowest priority messages are 9. Default is 9.

Speaker	Select the from the dropdown list. Note: The list includes all sounder models that have been configured in Marquee Manager Administrator.
Play Duration	Select one of the following to specify the amount of time the tune will play. <ul style="list-style-type: none"> Continuously. For a specific duration of time; enter in the seconds the amount of time the tune will play.

Routing Rules Acknowledged Tab

The Acknowledged tab enables users to configure details for alarms that have been acknowledged.

Select the Acknowledged tab; options are as follows.

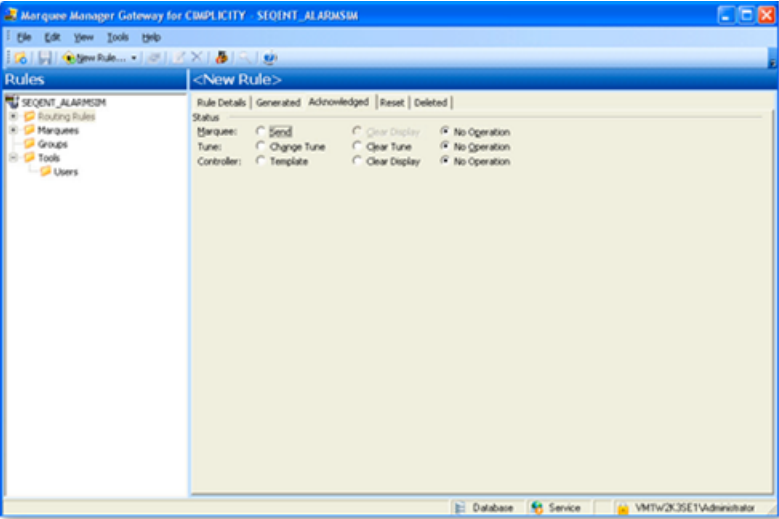

guide: Guidelines: Marquee Manager Gateway Acknowledged

- Follow the steps for configuring the Marquee Manager Gateway Routing: Generated Tab to set the display attributes for alarms that have been acknowledged.

Example

The Change Display feature for acknowledged alarms could be used to change the message from Red to Yellow to indicate it was acknowledged.

Important: Point ID lengths can have a maximum of 255 characters. Point IDs can be entered into Text fields that display when Marquee and/or Tune are checked.

- Default is No Operation for both Marquees and Tunes.

Routing Rules Reset Tab

The Reset tab enables users to configure details for alarms that have been reset.

Select the Reset tab.

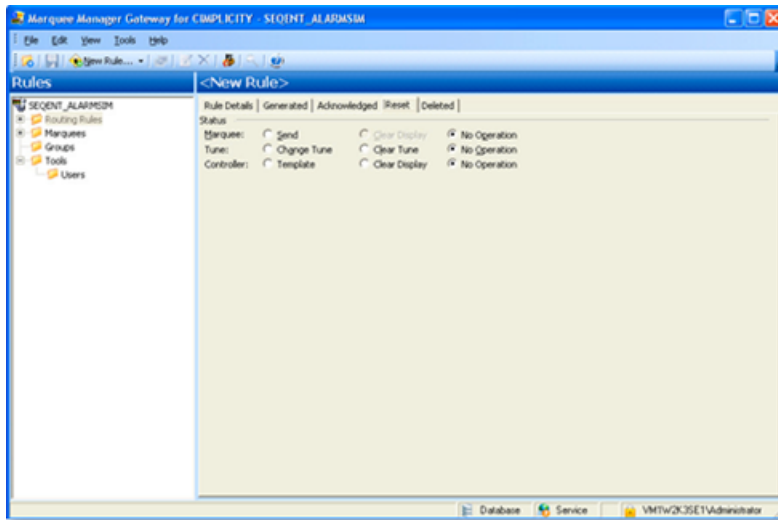

 **guide:** Guidelines: Marquee Manager Gateway Reset

- Follow the steps for configuring the Marquee Manager Gateway Routing: Generated Tab to set the display attributes for alarms that have been reset.

 **Note:** Point ID lengths can have a maximum of 255 characters. Point IDs can be entered into Text fields that display when Marquee and/or Tune are checked.

- Default is No Operation for both Marquees and Tunes.

Routing Rules Deleted Tab

The Deleted tab enables users to configure details for alarms that have been deleted.

Select the Deleted tab.

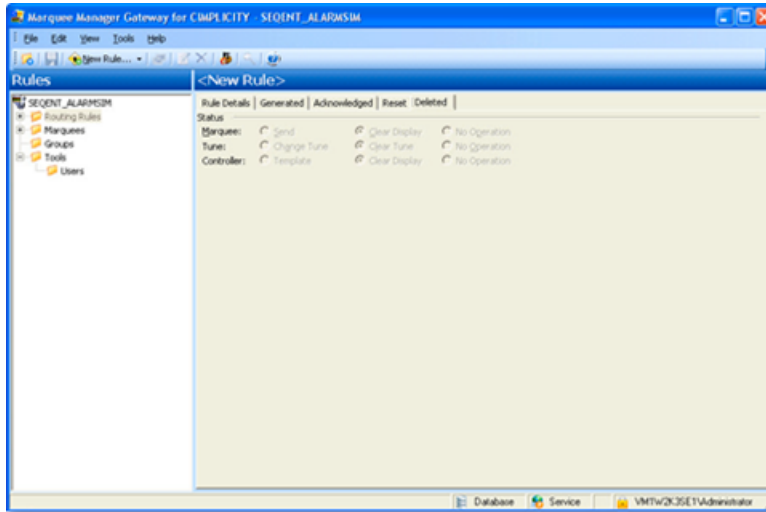

guide: Guidelines: Marquee Manager Gateway Deleted

- The status for alarms that have been deleted cannot be changed.

Note: This is the last opportunity the gateway will have to take the message down or stop the speaker from playing a tune.

- Default is Clear Display and Clear Tune for both Marquees and Tunes.

Click the **Save** icon on the Marquee Manager Gateway for CIMPPLICITY window toolbar to save the routing rule.

Marquee Manager Gateway Defaults

The Marquees folder allows users to add and maintain default messages on each marquee that has been configured in Marquee Manager Administrator.

The default configuration allows you to set word wrapping details for multiple line marquees, taking long messages values such as {ALARM.MESSAGE} and wrapping them across multiple lines.

Marquee Manager Gateway: Add a Marquee Default

1. Expand the Marquees folder.
2. Select a configured marquee to which a default message should be sent.

Options are as follows.

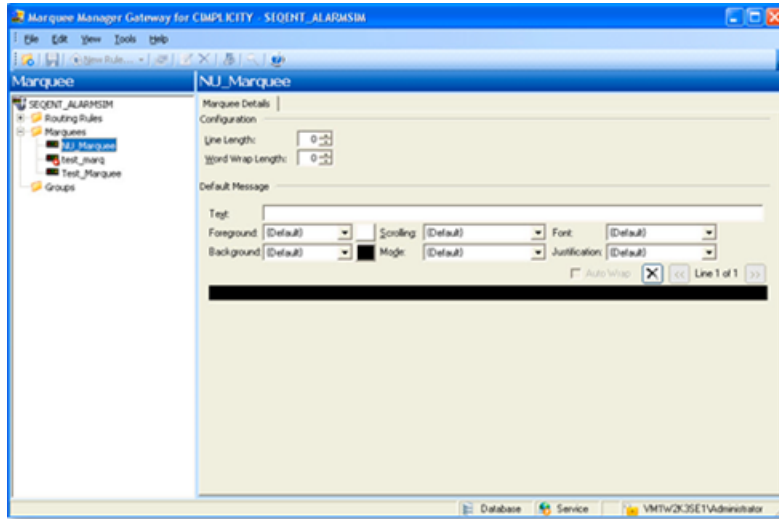

Field	Description
Configuration	
Line Length	Display line number of characters determines when to wrap the message to the next line. Note: The number can be entered or selected by scrolling the field.
Word Wrap Length	<p>Where to divide a word to wrap it to the next line.</p> <ol style="list-style-type: none"> Words longer than this value will be broken with a – at a point that is equal to or less than the value. The remaining portion will be wrapped to the next line. (See Note below for additional details) <p>If the last word on line 1 is broken with a - and it exceeds the word wrap length, the whole word will be wrapped to the next line based on what is configured in the Word Wrap Length field.</p> <p>Example</p> <ul style="list-style-type: none"> A message to be displayed is: "My MMSGWCIMP Test Message" Line Length set to 20. Word Wrap set to 6. <p>Normally Message would be broken with a - since it is longer than 6 characters; however, as the break would leave less than 4 characters on line 1, the whole word Message will get bumped to the next line.</p>
Default Message	
Text	<p>Text for the marquee's default message. Notes</p> <ul style="list-style-type: none"> The default message for a marquee will display if no alarms are coming from the Gateway for CIMPLICITY for that marquee. Point values can be inserted in the alarm text with the following syntax: <code>{POINT.pointID}</code>. <p>! Important: Point ID lengths can have a maximum of 255 characters.</p>
Foreground	<p>Use either method to select the foreground color.</p> <ul style="list-style-type: none"> Choose a color from the dropdown list of predetermined colors, Click the color swatch to the right of the dropdown list; create a custom color.
Background	<p>Use either method to select the background color.</p> <ul style="list-style-type: none"> Choose a color from the dropdown list of predetermined colors, Click the color swatch to the right of the dropdown list; create a custom color.

Field	Description
Scrolling	Options are: <ul style="list-style-type: none">• Default• No Scrolling• Slow Speed• Medium Speed• Fast Speed.
Font	Font options are: <ul style="list-style-type: none">• Default• Small
Mode	The dropdown list contains the following choices to establish how the information will display on the marquee. Static <ul style="list-style-type: none">• Flashing• Fast Flashing• Strobe• Reverse• Reverse Flash• Reverse Fast Flash
Justification	Message layout on the marquee. The message can be: <ul style="list-style-type: none">• Right-aligned• Left-aligned• Centered

 **Note:**

- If a marquee is configured in the Gateway with a default message, then it is removed from Marquee Manager Server, it will show up in the tree view under the Marquees folder with an X. The Gateway will then allow this marquee to be deleted.
- A **Groups** folder will display in the tree view under the Marquee folder, if
 - a. If you are using Marquee Manager Gateway for CIMPLICITY version 9.0 or higher,
 - b. Distribution Lists are configured in Marquee Manager.
- When an item is selected in Groups, there is an option to configure the **Line Length** and **Word Wrap Length**.

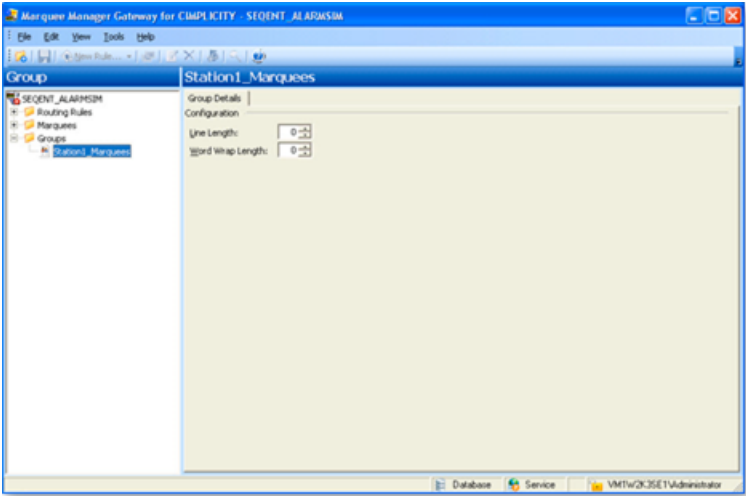

3. Words longer than this value will be broken with a – at a point that is equal to or less than the value.
4. The remaining portion will be wrapped to the next line. (See Note below for additional details)
If the last word on line 1 is broken with a - and it exceeds the word wrap length, the whole word will be wrapped to the next line based on what is configured in the **Word Wrap Length** field. Example
 - A message to be displayed is: “My MMSGWCIMP Test Message”
 - Line Length set to 20.
 - Word Wrap set to 6.
 Normally Message would be broken with a - since it is longer than 6 characters; however, as the break would leave less than 4 characters on line 1, the whole word Message will get bumped to the next line.

Marquee Manager Gateway Insertion Tags

Marquee Manager Gateway for CIMPPLICITY allows for additional tags to be added to the Slot Details tab>Text field Insertion tags can be used to specify different attributes per marquee line.

Example

```
ALARM.NAME } - <COL-YLW><MOD-ST> {ALARM.RESOURCES }
```

Add an insertion tag

Select the line of the slot to which an insertion tag will be added.

Tip: the symbol < opens a drop down of available tags.

The tags currently available are:

- <COL>
- <BCL>
- <FNT>
- <JST>
- <MOD>
- <SCR>
- <DATE>
- <TIME>

 **Note:** The insertion tags must be included in brackets and must be all upper case.

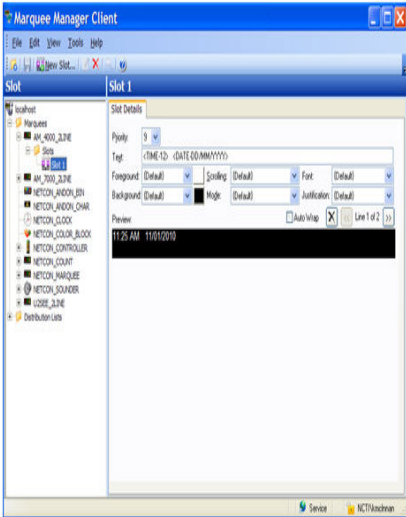

Marquee Manager Gateway Tools: Users

If Windows or Windows Trusted is selected for the server security, a Tools tree with a Users folder is added to the Marquee Manager Gateway window left-pane.

Do the following.

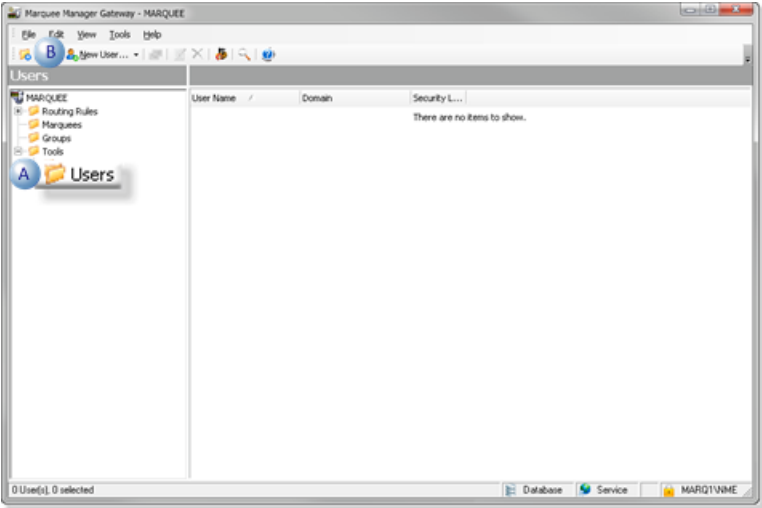

- A Select **Users** in the Marquee Manager Gateway window left-pane.
- B Click New User on the Marquee Manager Gateway window toolbar.

A Details Tab displays; options to register users are as follows.

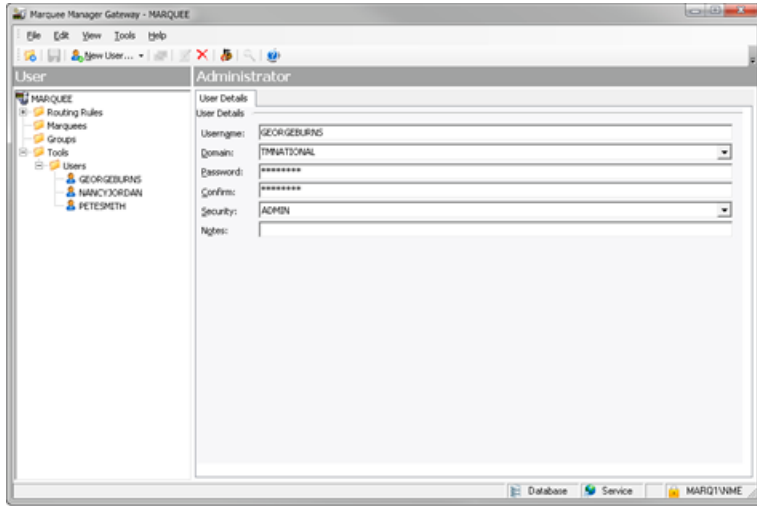

Field	Description	
User		
Username	Valid Windows user.	
Domain	Domain the user logs into.	
Password	(Required with Windows Security) Password assigned to the logged in Windows user.	
Confirm	(Required with Windows Security) Re-entered password	
Security	Security levels are as follows.	
	ADMIN	Full rights to all features. ! Important: The ADMIN security level is required to access (open) applications. For almost all instances, it is recommended that ADMIN be assigned to registered Alarm Cast users.
	DEFAULT	(Optional) Additional details about or for the user.
Notes		
Notes	(Optional) Additional details about or for the user.	

Marquee Manager Gateway for CIMPLICITY Other Tools

Marquee Manager Gateway for CIMPLICITY Other Tools

Marquee Manager Gateway for CIMPLICITY usage tools include the following.

The Marquee Manager Gateway for CIMPLICITY user interface is conveniently displayed in a tree view. The Server, when expanded, displays a **Resources** folder that enables the user to select from resources that have been configured in the CIMPLICITY project.

It includes an Alarms folder and a Classes folder that enable the user to add various alarms and classes of alarms that once triggered, will route alarms to a marquee or a speaker that have been configured in Marquee Manager Administrator.

There are many features that make using Marquee Manager Gateway for CIMPLICITY easier and more effective that include:

- Marquee Manager Gateway Other Tools: Toolbar and Tree
- Marquee Manager Gateway Other Tools: Options
- Marquee Manager Gateway Other Tools: Log Files

Marquee Manager Gateway Other Tools: Toolbar and Tree

Anything created on the tree view side of the screen (the left hand side) can be modified or deleted at any time.

Tree View Items: Modify

Select the item you want to alter. The information regarding it will show up on the right hand side of the screen. At this point, you can change the name along with any other variables attached to it (e.g. configuration settings etc.)When you save your changes, they will appear in the Tree View.

 **Important:** Information regarding manufacturer or models, cannot be altered. Once the modified information has been saved, you cannot revert to the old information. The only way to retrieve it is to change it back to its original state.

Tree View Items: Delete

There are two ways to delete items on the Tree View side of your screen. By selecting the item you want to delete, you can choose Edit >Delete on the Menu bar or simply click the red **Delete** symbol (X).

 **Important:** You cannot recover any deleted item or any information attached to it. You must recreate it.

In certain applications, if a particular item is being used in another part of the application, you will not be able to delete it at that level. You must go further down in the Tree View to discern where it is being used, and delete it there first.

Marquee Manager Gateway Other Tools: Options

Before using Marquee Manager Gateway for CIMPLICITY, configure the various settings that control the interface to the gateway. The Options menu allows users to set Marquee Manager Gateway for CIMPLICITY details.

Click the Tools>Options on the Marquee Manager Gateway menu bar.

General Tab

Select the General tab; options are as follows.

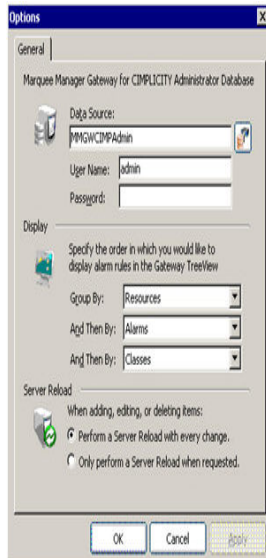

Option	Description	
Data Source	Installation will default the Data Source to <code>MMGWCMFADMIN</code> , pointing to the Marquee Manager Gateway for CIMPLICITY administrator database.	
Display	Display options, specifying how the alarm rules will be displayed in the tree view. An example of a typical tree view is to group by Resources, then Alarms, then Classes. In this sample, a typical Resource may be TANK, a typical Alarm may be LEVEL-OVERFLOW and Class may be HIGH. This information would be displayed in the tree view as: TANK (Resource) LEVEL-OVERFLOW (Alarm) HIGH (Class) Display options may be changed at any time without affecting your current configuration.	
Server Reload	Enables the user to select when they want a reload to server: with every change, or only when requested.	
	Reload with every change	Reload will occur when the Save button is clicked.
	Reload only when requested	You will be informed that there are data changes the server needs to be notified about and have the option to either send the reload before closing or close the system without reloading the changes.

Marquee Manager Gateway Other Tools: Log Files

In each application, you are able to view the log files associated with the various components of the software. The log files contain an accurate history of every transaction and modification made to the database. Log files are important because they ensure the integrity of the data and provide a means of data recovery.

To View:

Select View to get View Server and View Admin Log options.

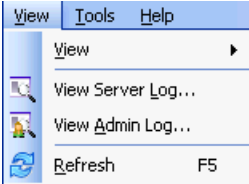

The selected log opens.

Marquee Manager Gateway Filter Guidelines

- Click the Filters button on the selected log window toolbar.

An Alarm Cast Gateway Filter dialog box opens.

The **Events On:** field defaults to the current day.

The **Status Message** field can be used to search for a portion of the message in the log.

Important: When matching special characters, enclose them in brackets.

Example

To find all log items that start with [enter in [[]* in the **Status Message** field.

The common allowed search characters are as follows:

Character	Match Made	Example
?	Any single character	Text in the log is: <ul style="list-style-type: none"> • ABC • DBC • XYZ. Entering ?BC returns only: <ul style="list-style-type: none"> • ABC • DBC
*	Zero or more characters	Entering *Initiated* returns: All log items with the word Initiated

Character	Match Made	Example
#	Any single digit (0-9)	<p>Text in the log is</p> <ul style="list-style-type: none"> • Device1 • Device5 • Device8 • Device10. <p>Entering Device# returns:</p> <ul style="list-style-type: none"> • Device1 • Device5 • Device8.

Check Automatic Refresh to automatically refresh the log file based on the seconds specified.

Marquee Manager Gateway Insertion Tag List

Tag	Description	Attributes Available	
COL	Color	#rrggbb	RGB in uppercase hex
		AMB	Amber
		BLK	Black
		BLU	Blue
		BRN	Brown
		CLR	Clear
		DEF	Default
		GRN	Green
		LGR	Light green
		ORG	Orange
		RED	Red
		WHI	White
		YLW	Yellow
BCL	Background color		Same as COL
FNT	Font	BLD	Bold
		CAP	All Capitols
		DEF	Default
		Fix	Fixed Width

Tag	Description	Attributes Available	
		SML	Small
JST	Justification	CEN	Center
		DEF	Default
		LEFT	
		RIGHT	
MOD	Mode	DEF	Default
		FFL	Fast flash
		FL	Flash
		REV	Reverse
		RFF	Reverse fast flash
		RFL	Reverse flash
		ST	Static
		STR	Strobe
SCR	Scrolling	DEF	Default
		FAST	(or SCR-2)
		MED	(or SCR-1)
		S	Static
		SLOW	(or SCR-0)
DATE	Date	DATE DD/MM/YY DD/MM/YYYY DD-MM-YY DD-MM-YYYY MM/DD/YY MM/DD/YYYY MM-DD-YY MM-DD-YYYY YY/MM/DD YY-MM-DD YYYY/MM/DD YYYY-MM-DD <DATE-DDD> <DATE-DDDD>	
TIME	Time	12 24 TIME	
WRAP	Wrap long line around on multi-line text marquee.	Only applies to multi-line Text Displays. All <LIN-##> tokens will be removed and the most text that can be displayed across all lines on the display will be shown. Any resulting text that exceeds the displays capabilities will be truncated.	

Marquee Manager Gateway Glossary

Administrator

Typically a GUI application, this component facilitates configuration and monitoring of a server engine. If changes are made to the server configuration the administrator notifies the engine to reload its running configuration either automatically or on user demand. An example of an administrator component is Marquee Manager Administrator.

This administrator allows you to maintain the Marquee Manager server's engine configuration.

Administrator Kit

An administrator kit contains the product's administration component only. After installing this kit on a workstation you may utilize any of the features of the Administrator component.

Alarm

Generates alarms for points that are in an alarm state. It can generate alarm messages about system events, such as device failures, and device statuses.

Class

Alarm class is the order in which an alarm appears relative to other alarms. Alarms with similar characteristics are usually grouped by class.

Default Message

The message that has been configured in Marquee Manager Gateway for CIMPPLICITY as the default, should the sign be cleared of all slots.

Distribution List

A Marquee Manager Server distribution list is a collection of marquees, which can be sent a message with a single transaction. Similar to an e-mail distribution list a client who initiates a transaction with a distribution list will automatically send the same message to all associated marquees.

Marquee

A sign display that serves as a visualization communication tool, providing the means to display time, date and message text such as production counts, and what areas of a plant are experiencing problems.

Point

Data that can be collected from various devices such as programmable controllers. Point configuration defines where a point originates, how the data is collected, and what constitutes an alarm state.

Priority

The importance or priority that can be placed on each message sent to the marquee sign, with one being the highest priority and nine being the lowest priority.

Resource

The physical or conceptual units that comprise your facility and can be anything from devices and machines to stations where work is performed.

Server Kit

A server kit typically contains the server engine and administrator components. In some cases a client component is also included with this kit. The server kit is usually installed on a centralized host and is utilized by one or more clients or gateways. An example of a server kit is Marquee Manager Server. This kit contains the Marquee Manager engine, administrator and client.

Speaker

A device connected to the marquee display that allows a tune to be played for alarm states of Generate, Acknowledge, or Reset.

Marquee Manager Client

About CIMPPLICITY Marquee Manager Client

The following topics contain an overview of the CIMPPLICITY Marquee Manager Client product, detailed installation instructions, and administration user instructions.

- Marquee Manager Client: Key Features
- Marquee Manager Client: How it Works
- Marquee Manager Client Components
- Marquee Manager Client Tools
- Marquee Manager Client Sign Properties
- Marquee Manager Client Glossary

Marquee Manager Client: Key Features

Marquee Manager Client is the end user interface of the Marquee Manager Suite of applications. It allows you to maintain the contents of a network of marquee signs.

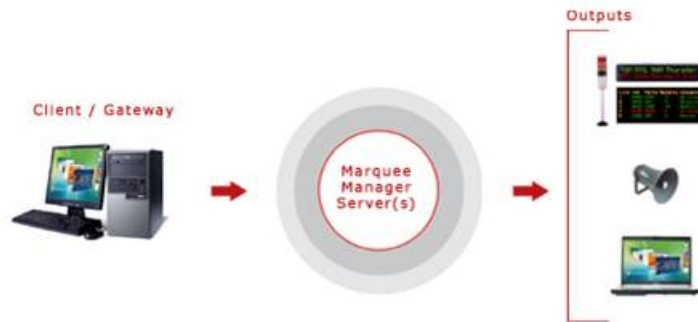

Key Features:

User-friendly maintenance of Marquee and Distribution List Slot information.

- Supports up to 10 slot messages per marquee/distribution list.
- Ability to view all message details on all configured marquees
- Supported Manufacturers/Models:

Manufacturer	Model
AdaptiveMicro	All models
AllenBradley	InView
Electro-Matic	Stack lights
Nu-Media	FIS models
Static Controls	All models
Uticor	PMD3000 models

Marquee Manager Client: How it Works

The Marquee Manager Client provides a single unified interface for adding and editing messages to numerous different marquee manufacturers and models that have been configured in the Marquee Manager Administrator.

The Marquee Manager Client, when refreshed, displays a list of all configured Marquees and Distribution Lists that have been added via Marquee Manager Administrator. The user can view, edit or delete sign details for all marquees and distribution lists. The full page of the sign where messages can be configured is referred to as a Slot, which contains one or more lines depending on the sign type. Each configured slot is automatically scrolled once it has been loaded into the sign.

A copy of Marquee Manager Client is included with the Marquee Manager Server software; it will be installed automatically when you install the server. The Marquee Manager Client program can be accessed from the server, or any workstation by purchasing the Marquee Manager Client kit.

The Marquee Manager Client user interface conveniently displays all information in a tree view that when expanded shows the current sign default message or the current active message of the sign.

It includes a Marquees folder and a Distribution List folder that display Marquees and Distribution Lists that have already been configured using the Marquee Manager Administrator.

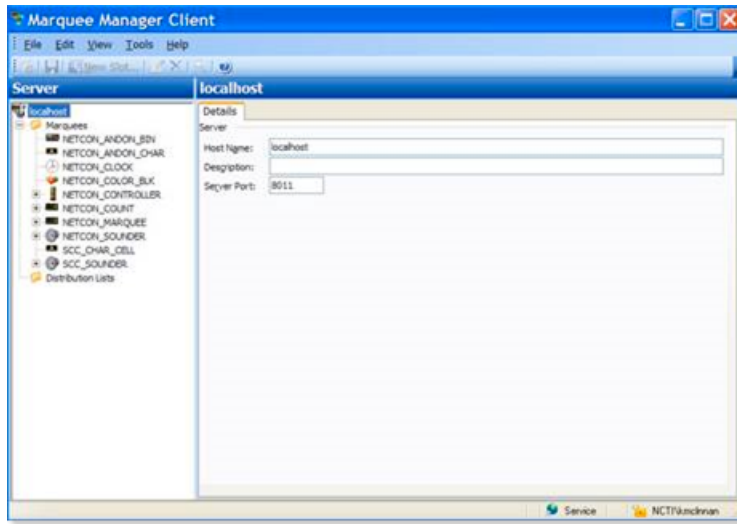

If your administrator has enabled security in Marquee Manager Client, you will be prompted for the following before you can access Marquee Manager Client.

- User ID/password.
- Valid Domain name.

Marquee Manager Client Components

Marquee Manager Client Components

Marquee Manager Client key component configuration includes the following.

- Marquee Manager Client Slots
- Marquee Manager Client Insertion Tags
- Marquee Manager Client Marquee Types

! **Important:** If Windows security has been implemented in the Marquee Manager Administrator, a Login dialog box will open before a user can access the Marquee Manager Client. Valid user names and passwords are pulled from the names configured in the Marquee Manager Administrator.



Marquee Manager Client Slots

1. Expand the Marquees folder.
2. Select the marquee to which a message will be added.
3. Right-click Slots in the tree view and select New Slot. Or, select the Slots folder and click New Slot on the toolbar. The Slots Details options are as follows.

Field	Description
Priority	Order in which messages that are sent to the sign will be displayed. Priorities are 1 – 9, where 1 is the highest priority Default is 9.
Text	Message that will display for each line of the selected sign.
<p>Note: Sign properties (page 809) in the drop down menus are automatically limited to the selected sign's capabilities. Features, whose options can be selected from the drop down lists, include:</p> <ul style="list-style-type: none"> • Foreground • Scrolling • Font • Background • Mode • Justification 	
Preview	Reflects what is currently on the marquee. It will display any slots, if available, or display the default message that was configured in the Marquee Manager Administrator. Note: The Preview is only an approximation of the exact marquee contents. All textual data will be correct but slot order, font, pixel height etc. may not match exactly.

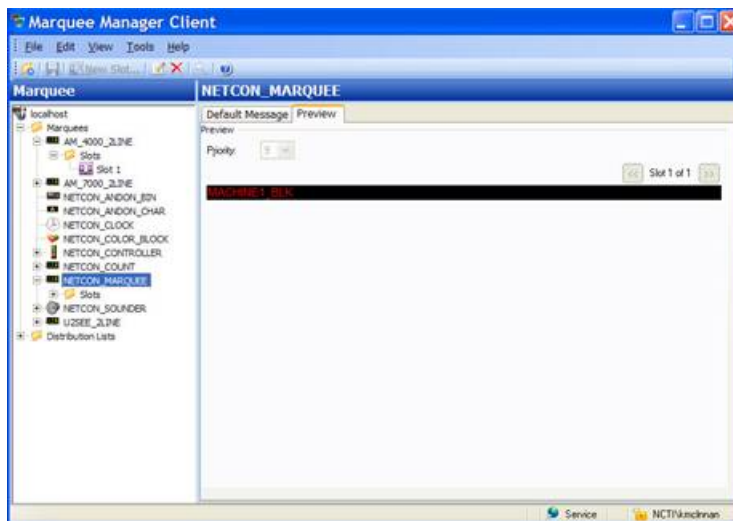

Click the **Save** icon to save your new Slot details

guide: Guidelines

- If the number of slots exceeds the queue size configured on the marquee in the Marquee Manager Administrator, the message will be submitted and will wait until an available slot is available or a match is found on the priority threshold set for that marquee. If the Queue size is set to 5 and more than five slots have been added in the Marquee Manager Client, only those matching the priority threshold set on that marquee will be displayed. Priority threshold is set to 3 on that marquee, only those slots with a priority of 3 or higher will be displayed. The two remaining slots will display when the higher priority slots have been cleared.
- Any marquees that have an unknown display type will display in the tree view with a red X through the **Marquee** icon

Marquee Manager Client Insertion Tags

Marquee Manager Client allows additional tags to be added to the **Text** field of the Slot configuration.

1. Select the line of the slot to which the insertion tag will be added.

Note: The symbol < opens a drop down of available tags.

The tags that are currently available are:

- <COL>
- <BCL>
- <FNT>
- <JST>
- <MOD>

- <SCR>
- <DATE>
- <TIME>

2. 2. Make sure the insertion tags are in brackets and are all UPPER case.

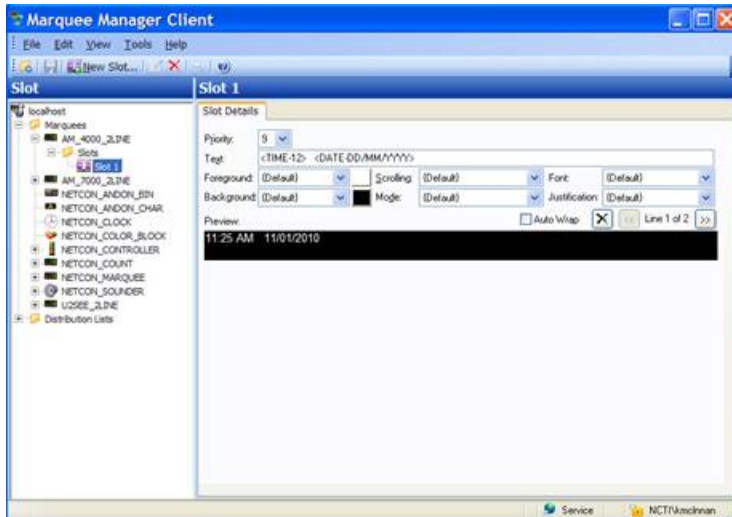

Marquee Manager Client Marquee Types

Marquee Manager Client Marquee Types

Following are the Marquee Manager Client Marquee types.

- Marquee Manager Client Marquee Type: Andon Bin Cell.
- Marquee Manager Client Marquee Type: Andon Char Cell.
- Marquee Manager Client Marquee Type: Clock.
- Marquee Manager Client Marquee Type: Color block.
- Marquee Manager Client Marquee Type: Controller.
- Marquee Manager Client Marquee Type: Counter.
- Marquee Manager Client Marquee Type: Marquee.
- Marquee Manager Client Marquee Type: Sounder.
- Marquee Manager Client Marquee Type: Stack light.
- Marquee Manager Client Marquee Type: Distribution lists.

Marquee Manager Client Marquee Type: Andon Bin Cell

1. Select the Andon Bin Cell in the Marquee Manager Client window left-pane.
2. Select the Cell Config tab.

Note: Cell configuration must be completed in the Marquee Manager Administrator window and cannot be edited in the Client application.

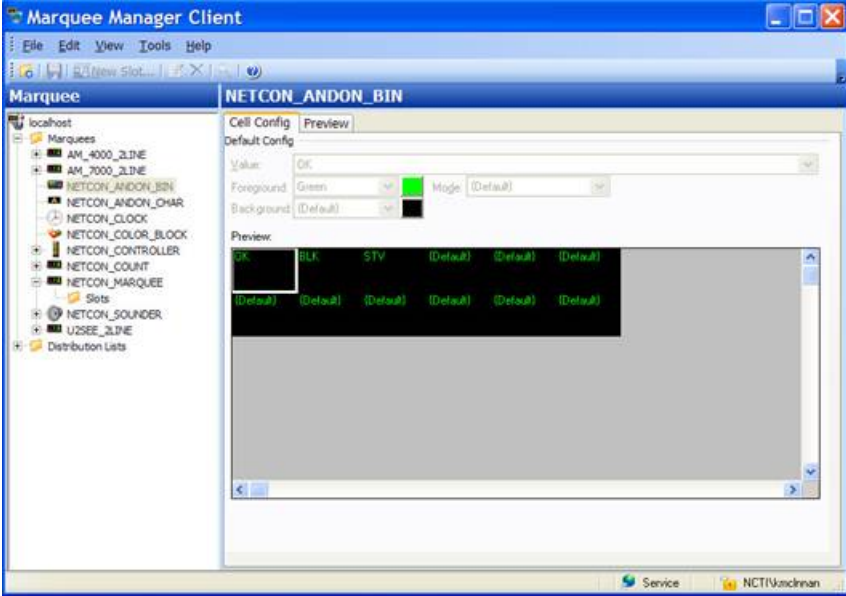

3. Select the Preview tab.

A preview of what is currently on the Andon Bin Cell displays.

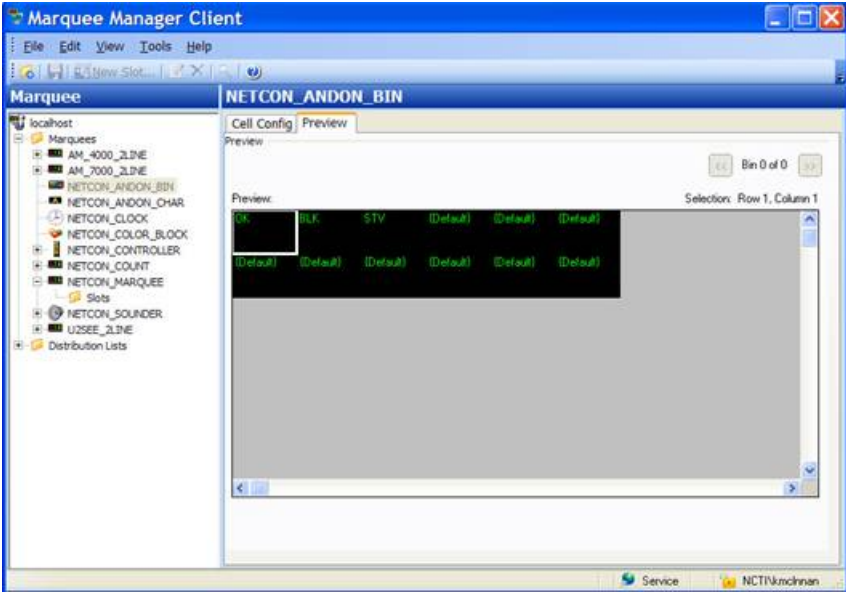

Marquee Manager Client Marquee Type: Andon Char Cell

- Cell type displays:
- Are typically used to display data best represented in a grid format.

Example

In a manufacturing facility divided into numerous assembly stations, each cell may represent a station's state.

The cells can be used to show what station or plant location is experiencing a problem and display information such as the area and nature of the problem.

- Require specific setup to define the various cells and bins available to display data.
- Char cell boards contain text cells that may be configured with up to three characters for display.
- Each cell can have one or more values displayed at one time.
- Each value is displayed on the marquee for eight seconds before proceeding to the next value in that cell.

1. Select the Andon Char Cell board in the Marquee Manager Client window left-pane.
2. Select the Cell Config tab.

Note: Configuration must be completed in the Marquee Manager Administrator window and cannot be edited in the Client application.

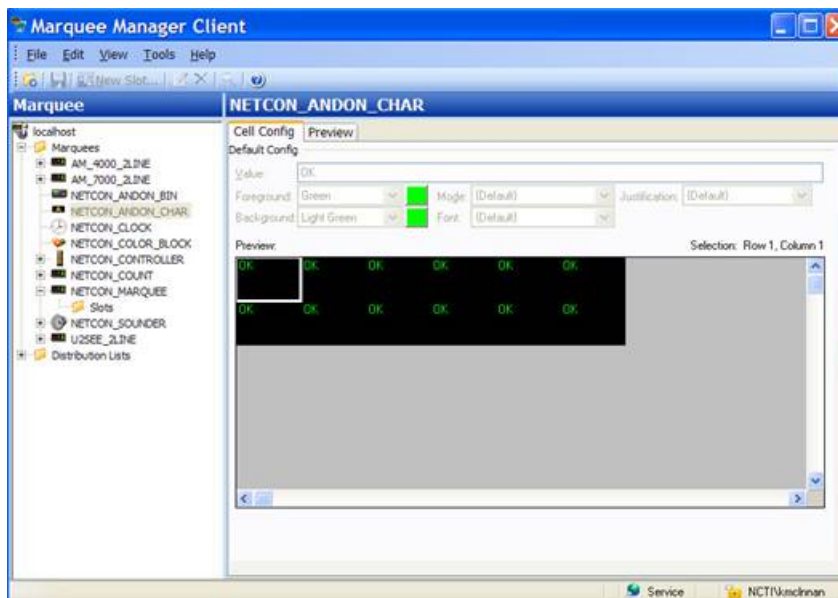

3. Select the Preview tab.

A preview of what is currently on the Andon Char Cell displays.

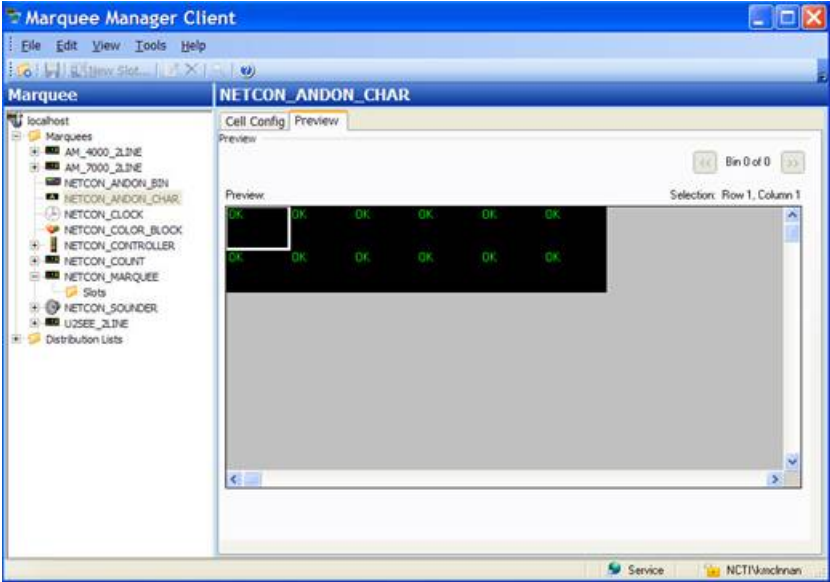

Marquee Manager Client Marquee Type: Clock

- 1. Select the Clock board in the Marquee Manager Client window left-pane.

Note: Configuration must be completed in the Marquee Manager Administrator window and cannot be edited in the Client application.

- 2. Select the Preview tab.

A preview of what is currently on the clock displays

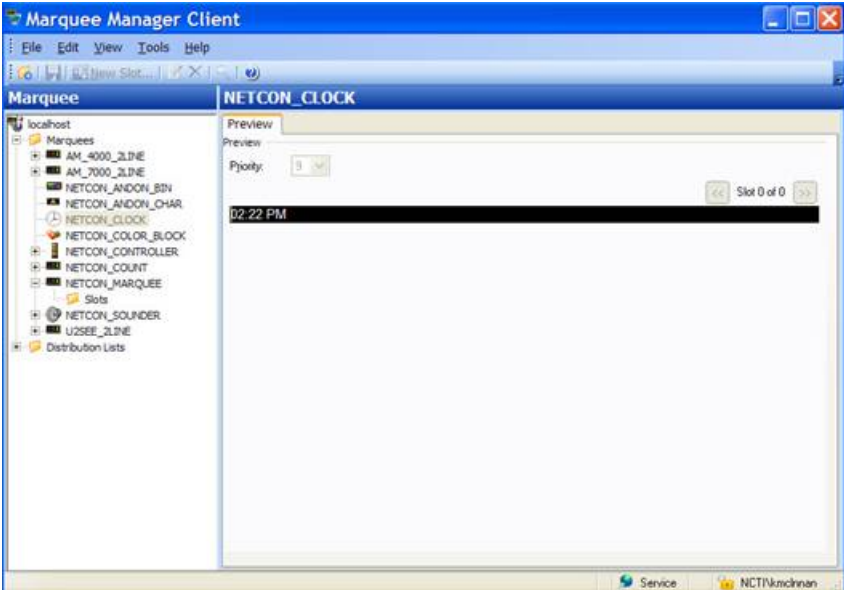

Marquee Manager Client Marquee Type: Color Block

Color Block models such as the NETCON Technologies Native Unit Color Block, are typically used to display a block of color for the state of a plant station.

Example

In a manufacturing facility divided into numerous assembly stations, each block may represent a station's state.

If a station is experiencing a problem, they display a color to alert personnel.

1. Select the Color Block in the Marquee Manager Client window left-pane.
2. Select the Cell Config tab.

Note: Configuration must be completed in the Marquee Manager Administrator window and cannot be edited in the Client application.

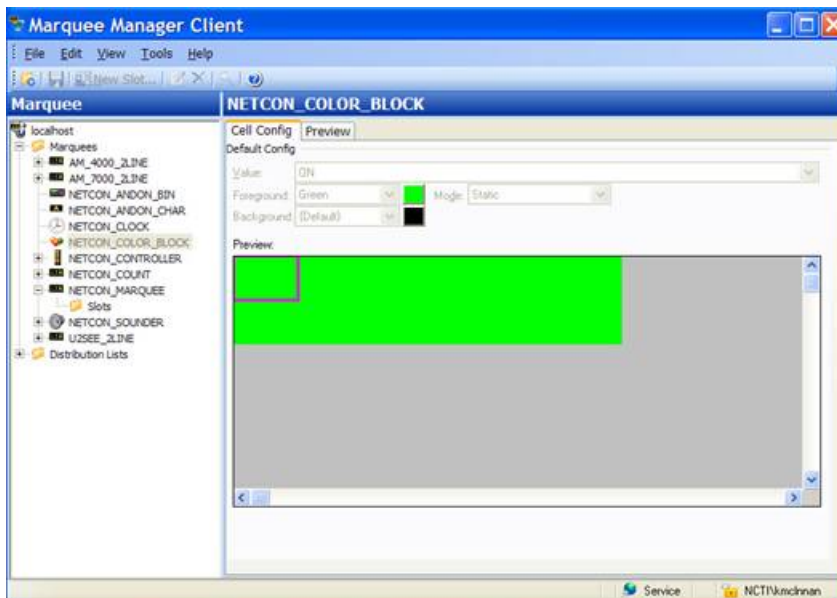

3. Select the Preview tab. to view what is currently displayed on the Color Block.

A preview of what is currently on the Color Block marquee displays.

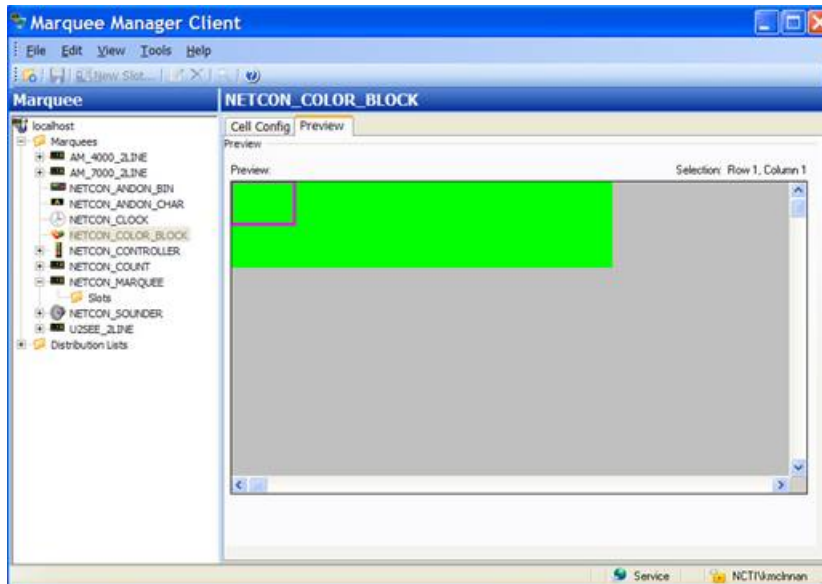

Marquee Manager Client Marquee Type: Controller

1. Select the **Controller** type marquee in the Marquee Manager Client window left-pane.
2. Do one of the following.
 - Right click **Slots** in the tree view; Select New Template on the Popup menu.
 - Select the **Slots** folder; click the New Template button on the Marquee Manager Client toolbar.
3. Check which to add to the slot on the Template Details tab.
 - Template
 - Cycle

A drop-down menu, based on your selection, displays a list of available templates or cycles that have been configured in the Marquee Manager Administrator.

4. Select the template or cycle to display.
5. Click the Save button to save the slot details.

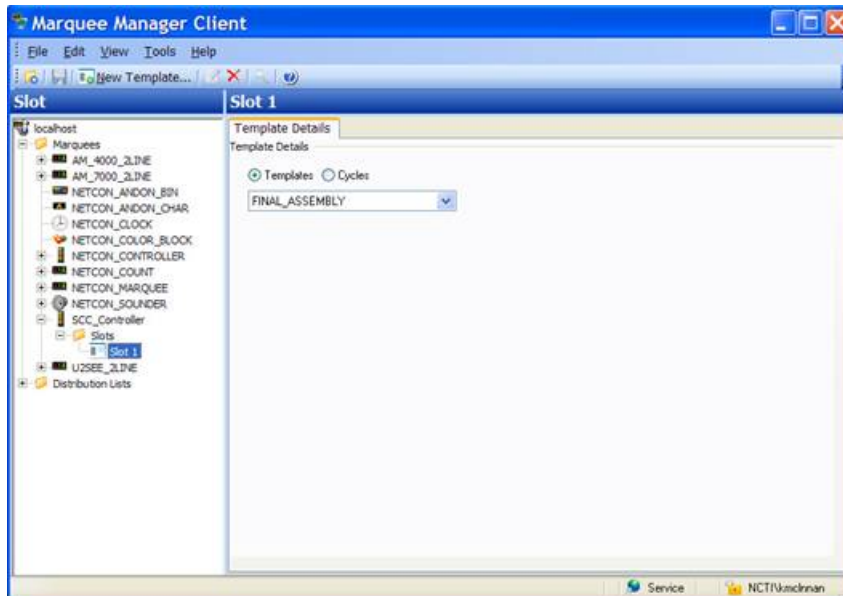

Marquee Manager Client Marquee Type: Counter

A Counter Display is a display element specifically designed to display numeric counts.

The counts may be positive or negative.

1. Select the **Counter** type marquee in the Marquee Manager Client window left-pane.
2. Do one of the following.
 - Right click **Slots** in the tree view; Select New Template on the Popup menu.
 - Select the **Slots** folder; click the New Template button on the Marquee Manager Client toolbar.

3. Select the message **Priority**.

This determines the order in which messages sent to the sign will be displayed.

High priority messages have a priority of 1.

Low priority message have a priority of 9.

Default is 9.

4. Enter Text that will display for each message line on the selected sign.

Note: [Sign properties \(page 809\)](#) in the drop down menus will automatically be limited to the sign capabilities.

5. Select the following options from the dropdown lists.

- Foreground
- Background
- Scrolling
- Mode
- Font
- Justification

The Preview reflects what is currently on the marquee.

It will display either of the following.

- Any slots, if available.
- The default message that was configured in Marquee Manager Administrator.

The Preview is only an approximation of the exact marquee contents. All textual data will be correct but slot order, font, pixel height etc. may not match exactly.

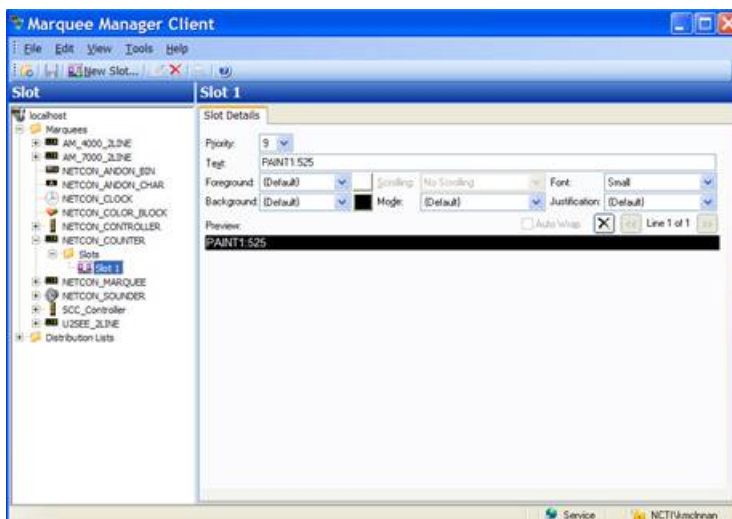

6. Click the Save button to save your new Slot details.

Marquee Manager Client Marquee Type: Marquee

1. Select the Marquee type marquee in the Marquee Manager Client window left-pane.
2. Do one of the following.
 - Right click **Slots** in the tree view; Select New Template on the Popup menu.
 - Select the **Slots** folder; click the New Template button on the Marquee Manager Client toolbar.
3. Select the message **Priority**.

This determines the order in which messages sent to the sign will be displayed.

High priority messages have a priority of 1.

Low priority message have a priority of 9.

Default is 9.

4. Enter Text that will display for each message line on the selected sign.

Note: [Sign properties \(page 809\)](#) in the drop down menus will automatically be limited to the sign capabilities.

5. Select the following options from the dropdown lists.

- Foreground
- Background
- Scrolling
- Mode
- Font
- Justification

The Preview reflects what is currently on the marquee.

It will display either of the following.

- Any slots, if available.
- The default message that was configured in Marquee Manager Administrator.

The Preview is only an approximation of the exact marquee contents. All textual data will be correct but slot order, font, pixel height etc. may not match exactly.

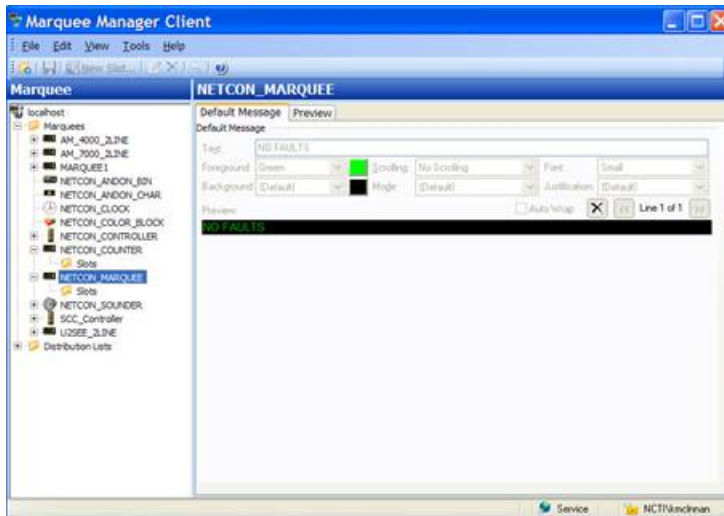

If the Marquee has more than one line, click the Forward/Back button to configure the details on that line(s) if required.

6. Click the Save button to save your new Slot details.

Marquee Manager Client Marquee Type: Sounder

1. Select the Sounder type marquee in the Marquee Manager Client window left-pane.
2. Do one of the following.
 - Right click **Tunes** in the tree view; Select New Tune on the Popup menu.
 - Select the **Tunes** folder; click the New Tune button on the Marquee Manager Client toolbar.

The Tune Details tab displays

3. Select the tune **Priority**.

This determines the order in which tunes sent to the sign will be played.

High priority tunes have a priority of 1.

Low priority tunes have a priority of 9.

Default is 9.

4. Select the tune to be played from the **Tune #** field.

Note: Static Controls' MusicMaker model has up to 255 tunes available.

5. Check one of the following.

- Play Continuously

The tune will play continuously

- Play for

Duration entries in seconds are:

On Duration	(seconds) the tune plays in an on/off segment.
Off Duration	(seconds) the tune pauses in an on/off segment
Repeat	Number of times the on/off segment is repeated.

6. Click the Save button to save the Tune details.

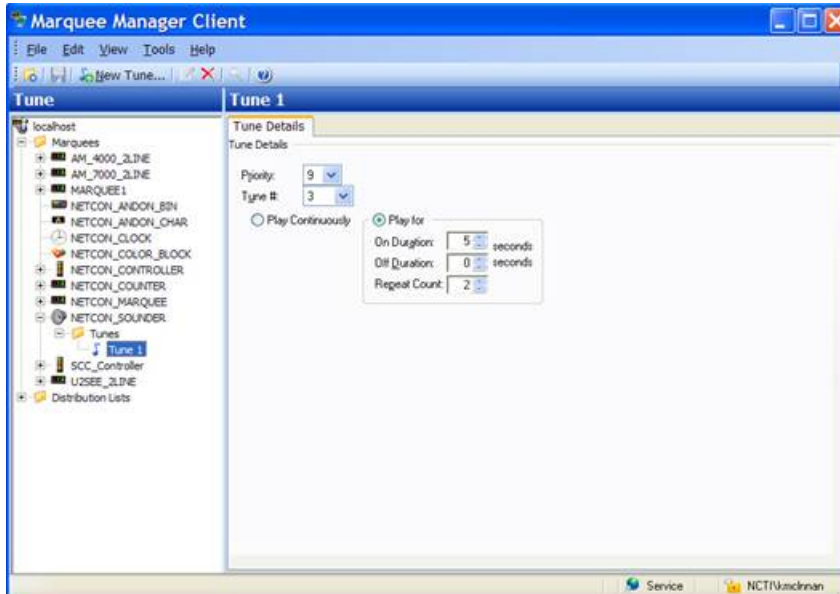

Marquee Manager Client Marquee Type: Stack Light

1. Select the Stack Light marquee type in the Marquee Manager Client window left-pane.
2. Select the Stack Light Config tab.

Note: Configuration must be completed in the Marquee Manager Administrator window and cannot be edited in the Client application.

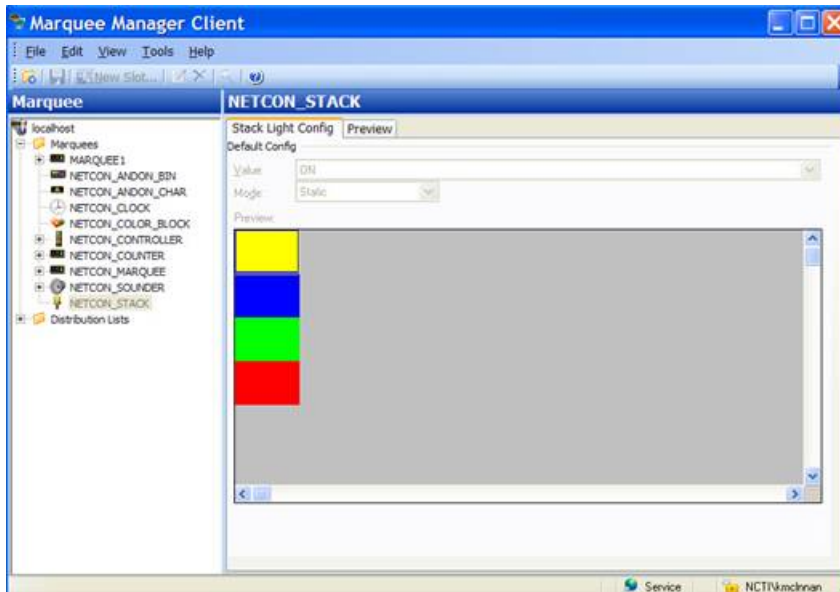

3. Select the Preview tab.

A preview of what is currently on the Stack Light displays.

Marquee Manager Client Distribution Lists

The Distribution Lists folder in the Marquee Manager Client window left-pane:

- Displays a list of all distribution lists that have been configured in Marquee Administrator.

This allows the same message to be sent to multiple marquees at the same time.

- Allows users to add slots to configured marquees in distribution lists, enabling the same message to be sent to multiple marquees with a single request.

Marquee Manager Client applications provide the ability to compose messages and send them to a marquee distribution list, as to gateways.

1. Expand the Distribution Lists folder in the Marquee Manager Client window left-pane.
2. Select the Slots folder; click the New Slot button on the Marquee Manager Client toolbar.

A Slot Details tab displays.

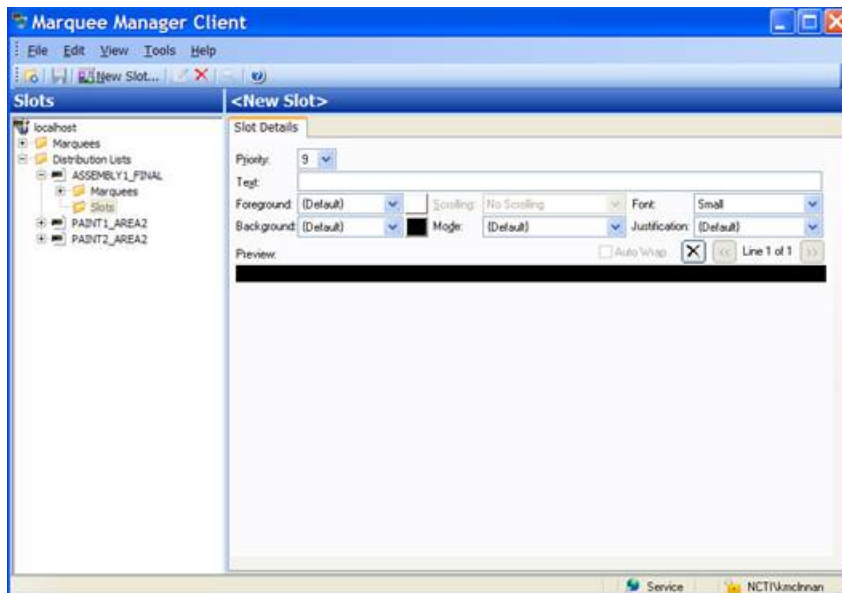

Enter Text that will display for each message line on the selected [sign \(page 809\)](#).

- a. Select the following options from the dropdown lists.

- Foreground
- Background

- Scrolling
- Mode
- Font
- Justification

The Preview reflects what is currently on the marquee.

It will display either of the following.

- Any slots, if available.
- The default message that was configured in Marquee Manager Administrator.

The Preview is only an approximation of the exact marquee contents. All textual data will be correct but slot order, font, pixel height etc. may not match exactly.

- a. Click the Save button to save the new Distribution List Slot details.

Marquee Manager Client Tools

Marquee Manager Client Tools

Marquee Manager Client tools include the following.

- Modifying and deleting Tree View items.
- Using Marquee tools - Options.
- Viewing the Log files.

Marquee Manager Client Tools: Tree View

Anything created on the tree view side of the screen (the left hand side) can be modified or deleted at any time.

Tree View Items: Modify

Select the item you want to alter. The information regarding it will show up on the right hand side of the screen. At this point, you can change the name along with any other variables attached to it (e.g. configuration settings etc.) When you save your changes, they will appear in the Tree View.

 **Important:** Information regarding manufacturer or models, cannot be altered. Once the modified information has been saved, you cannot revert to the old information. The only way to retrieve it is to change it back to its original state.

Tree View Items: Delete

There are two ways to delete items on the Tree View side of your screen. By selecting the item you want to delete, you can choose Edit >Delete on the Menu bar or simply click the red **Delete** symbol (X).

! Important: You cannot recover any deleted item or any information attached to it. You must recreate it.

In certain applications, if a particular item is being used in another part of the application, you will not be able to delete it at that level. You must go further down in the Tree View to discern where it is being used, and delete it there first.

Marquee Manager Client Tools: Options

The Options menu allows users to set Marquee Manager Server details.

1. Click Tools>Options on the Marquee Manager Client window menu.

An Options dialog box opens displaying a Preferences tab.

The Preferences tab controls the Marquee Manager Administrator data entry preferences.

1. Select how attributes will be handled in the event that no default was supplied.

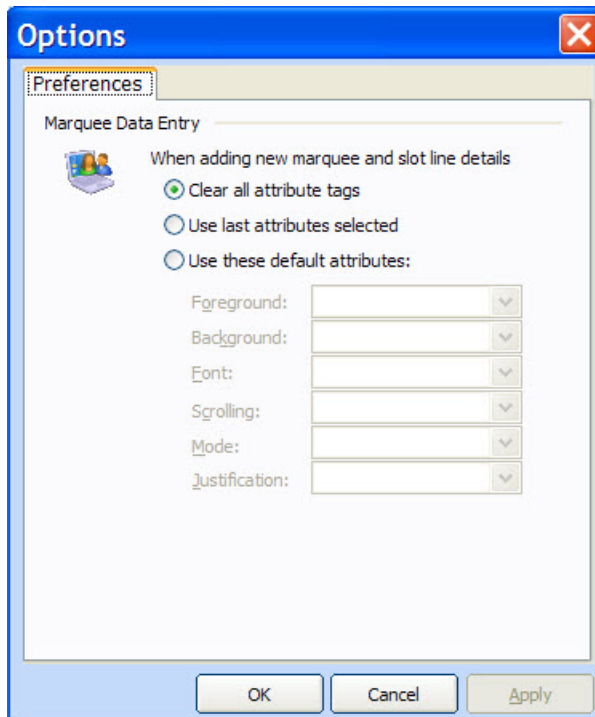

Marquee Manager Client Tools: Log Files

Select View to get the View Admin Log options.



The selected log opens.

 **guide:** Marquee Manager Client Filter Guidelines

- Click the Filters button on the selected log window toolbar.

An Alarm Cast Gateway Filter dialog box opens.

The **Events On:** field defaults to the current day.

The **Status Message** field can be used to search for a portion of the message in the log.

Important: When matching special characters, enclose them in brackets.

Example

To find all log items that start with [enter in [[]]* in the **Status Message** field.

The common allowed search characters are as follows:

Character	Match Made	Example
?	Any single character	Text in the log is: <ul style="list-style-type: none"> • ABC • DBC • XYZ. Entering ?BC returns only: <ul style="list-style-type: none"> • ABC • DBC
*	Zero or more characters	Entering *Initiated* returns: All log items with the word Initiated

Character	Match Made	Example
#	Any single digit (0-9)	Text in the log is <ul style="list-style-type: none"> • Device1 • Device5 • Device8 • Device10. Entering Device# returns: <ul style="list-style-type: none"> • Device1 • Device5 • Device8.

- Check Automatic Refresh to automatically refresh the log file based on the seconds specified.

Marquee Manager Client Sign Properties

Adaptive ALPHA VERSION 2 *

Model	Color	Font	Scrolling	Flashing	Notes
BIGDOT 13Char	Tri-color	Double Height	0	0	Supports Rollup
BIGDOT 26Char	Tri-color	Small, Fixed Width, Bold	0	0	Supports Rollup

Adaptive Micro Systems*

Model	Color	Font	Scrolling	Flashing	Notes
ALL	Tri-color	Small, Bold, Fixed Width	ü	ü	
Beta-Brite	Tri-color	Small, Bold, Fixed Width	ü	ü	
BIGDOT	Tri-color	Small, Bold, Fixed Width	ü	ü	
BIGDOT_26Char	Tri-color	Small, Bold, Fixed Width	ü	ü	
PPD		Small, Bold, Fixed Width	ü	ü	Red and green models
215	Tri-color	Small, Bold, Fixed Width	ü	ü	
215C	Tri-color	Small, Bold, Fixed Width	ü	ü	
320C	Tri-color	Small, Bold, Fixed Width	ü	ü	
330C	Tri-color	Small, Bold, Fixed Width	ü	ü	
4080C	Tri-color	Small, Bold, Fixed Width	ü	ü	
4120C	Tri-color	Small, Bold, Fixed Width	ü	ü	

Model	Color	Font	Scrolling	Flashing	Notes
4120R	Red	Small, Bold, Fixed Width	ü	ü	
4160C	Tri-color	Small, Bold, Fixed Width	ü	ü	
4160R	Red	Small, Bold, Fixed Width	ü	ü	
4200C	Tri-color	Small, Bold, Fixed Width	ü	ü	
4200R	Red	Small, Bold, Fixed Width	ü	ü	
4240C	Tri-color	Small, Bold, Fixed Width	ü	ü	
4240R	Red	Small, Bold, Fixed Width	ü	ü	
7120	Tri-color	Small, Bold, Fixed Width	ü	ü	
7160	Tri-color	Small, Bold, Fixed Width	ü	ü	
7200	Tri-color	Small, Bold, Fixed Width	ü	ü	
7200_4Line	Tri-color	Small Caps	ü	ü	
9120	Tri-color	Small, Bold, Fixed Width	ü	ü	
9160	Tri-color	Small, Bold, Fixed Width	ü	ü	
9200	Tri-color	Small, Bold, Fixed Width	ü	ü	
9240	Tri-color	Small, Bold, Fixed Width	ü	ü	

ALLEN-BRADLEY INVIEW**

Model	Color	Font	Scrolling	Flashing	Notes
P42C	Tri-color	Small, Fixed Width, Bold	ü	ü	
P42R	Red	Small, Fixed Width, Bold	ü	ü	
P43C	Tri-color	Small, Fixed Width, Bold	ü	ü	
P43R	Red	Small, Fixed Width, Bold	ü	ü	
P44C	Tri-color	Small, Fixed Width, Bold	ü	ü	
P44R	Red	Small, Fixed Width, Bold	ü	ü	
P72CN2	Tri-color	Small, Fixed Width, Bold	ü	ü	3 line/20characters
P72CN2/1- 4 line	Tri-color	Small Caps	ü	ü	4 line/20 characters
P74CN2/1	Tri-color	Small, Fixed Width, Bold	ü	ü	3 line/33 characters
P74CN2/1 – 4 line	Tri-color	Small Caps	ü	ü	4 line/33 characters

Electro-Matic Products Inc.

Model	Color	Font	Scrolling	Flashing	Notes
4 Digit Display	Red	Fixed Width	x	x	4 characters alpha or numeric
Stack Light – 1 High	Blue, Brown, Green, Light Green, Light Red, Orange, Red, White, Yellow	N/A	N/A	ü	
Stack Light – 2 High	Blue, Brown, Green, Light Green, Light Red, Orange, Red, White, Yellow	N/A	N/A	ü	
Stack Light – 3 High	Blue, Brown, Green, Light Green, Light Red, Orange, Red, White, Yellow	N/A	N/A	ü	
Stack Light – 4 High	Blue, Brown, Green, Light Green, Light Red, Orange, Red, White, Yellow	N/A	N/A	ü	
Stack Light – 5 High	Blue, Brown, Green, Light Green, Light Red, Orange, Red, White, Yellow	N/A	N/A	ü	
Stack Light - Sounder	Blue, Brown, Green, Light Green, Light Red, Orange, Red, White, Yellow	N/A	N/A	N/A	1 tune played

NETCON Technologies Native Unit *

Model	Color	Font	Scrolling	Flashing	Notes
Clock	N/A	N/A	x	x	Displays time only
Counter	Red	Fixed Width	x	x	<ul style="list-style-type: none"> • Numeric only • Max. 8 digits • # of Characters can be set on the Options tab in Marquee Administrator
Marquee	Multi-Color	Fixed Width	ü	ü	<ul style="list-style-type: none"> • Supports Rollup • # of Lines and Characters can be set on the Options tab in Marquee Administrator
Sounder	N/A	N/A	N/A	N/A	255 Tunes

NU-MEDIA DISPLAY SYSTEMS*

Model	Color	Font	Scrolling	Flashing	Notes
v4.67 Single Lin	Red	Double Height	ü	ü	
v4.67 Dual Line	Red	Small, Fixed Width, Bold	ü	ü	

STATIC CONTROLS CORPORATION

Model	Color	Font	Scrolling	Flashing	Notes
Alpha 952_20	Red	Fixed Width	x	ü	<ul style="list-style-type: none"> • one line • 20 characters
Alpha 952_25	Red	Fixed Width	x	ü	<ul style="list-style-type: none"> • one line • 20 characters
Alpha 952_40	Red	Fixed Width	x	ü	<ul style="list-style-type: none"> • one line • 20 characters
Alpha 954_10	Red	Fixed Width	ü	ü	
Andon 974_0206	Multi-color	N/A	x	ü	Cell board size: 2 rows, 6 columns
Andon 974_0307	Multi-color	N/A	x	ü	Cell board size: 3 rows, 7 columns
Andon 974_0308	Multi-color	N/A	x	ü	Cell board size: 3 rows, 8 columns
Andon 974_0408	Multi-color	N/A	x	ü	Cell board size: 4 rows, 8 columns
Andon 974_0420	Multi-color	N/A	x	ü	Cell board size: 4 rows, 20 columns
AndonQueue 974_0206	Multi-color	Fixed Width	x	ü	Cell board size: 2 rows, 6 columns
AndonQueue 974_0307	Multi-color	Fixed Width	x	ü	Cell board size: 3 rows, 7 columns
AndonQueue 974_0308	Multi-color	Fixed Width	x	ü	Cell board size: 3 rows, 8 columns
AndonQueue 974_0408	Multi-color	Fixed Width	x	ü	Cell board size: 4 rows, 8 columns
AndonQueue 974_0420	Multi-color	Fixed Width	x	ü	Cell board size: 4 rows, 20 columns
AndonQueue 974_0614	Multi-color	Fixed Width	x	ü	Cell board size: 6 rows, 14 columns
ColorBlock 974_0104	Multi-color	N/A	x	ü	ColorBlock board size: 1 row, 4 columns
ColorBlock 974_0404	Multi-color	N/A	x	ü	ColorBlock board size: 4 rows, 4 columns
Marquee 955GM_0120	Multi-color	Fixed Width	x	ü	GM specific SCC protocol: 1 line, 20 characters

Model	Color	Font	Scrolling	Flashing	Notes
Marquee 955GM_0125	Multi-color	Fixed Width	x	ü	GM specific SCC protocol: 1 line, 25 characters
Marquee 955GM_0133	Multi-color	Fixed Width	x	ü	GM specific SCC protocol: 1 line, 33 characters
Marquee 955GM_0135	Multi-color	Fixed Width	x	ü	GM specific SCC protocol: 1 line, 35 characters
Marquee 955GM_0140	Multi-color	Fixed Width	x	ü	GM specific SCC protocol: 1 line, 40 characters
Marquee 955GM_0225	Multi-color	Fixed Width	x	ü	GM specific SCC protocol: 2 line, 25 characters/line
Marquee 955GM_0235	Multi-color	Fixed Width	x	ü	GM specific SCC protocol: 2 line, 35 characters/line
Marquee 955GM_0240	Multi-color	Fixed Width	x	ü	GM specific SCC protocol: 2 line, 40 characters/line
MusicMaker_AC1	N/A	N/A	N/A	N/A	255 tunes
Num 801_N	Red	Fixed Width	x	x	Numeric only
SCC980_Controller	N/A	N/A	N/A	N/A	Template switching controller
Tim 801_T					Displays time only

Uticor Technology

Model	Color	Font	Scrolling	Flashing	Notes
Uticor Slave 3000 – 1 line	Red	Small, Double Height, Full Height	ü	ü	
Uticor Slave 3000 – 2 line	Red	Small, Double Height, Full Height	ü	ü	
Uticor Slave 3000 – 4 line	Red	Small, Double Height, Full Height	ü	ü	
Uticor Slave 3000 Double Wide – 1 line	Red	Small, Double Height, Full Height	ü	ü	
Uticor Slave 3000 Double Wide – 2 line	Red	Small, Double Height, Full Height	ü	ü	
Uticor Slave 3000 Double Wide – 4 line	Red	Small, Double Height, Full Height	ü	ü	

* For all supported signs, only the bottom line of the sign supports the scrolling feature.

** If the default message is changed, the Allen-Bradley Inview sign will reboot itself. With Allen-Bradley signs, there is no address field passed to specify on which display you want to set the default message.

Marquee Manager Client Glossary

Administrator

Typically a GUI application, this component facilitates configuration and monitoring of a server engine. If changes are made to the server configuration the administrator notifies the engine to reload its running configuration either automatically or on user demand. An example of an administrator component is Marquee Manager Administrator.

This administrator allows you to maintain the Marquee Manager server's engine configuration.

Administrator Kit

An administrator kit contains the product's administration component only. After installing this kit on a workstation you may utilize any of the features of the Administrator component.

Andon

Andon boards are used to show where (what station or location) there is a problem (blocked or starved station) or a potential problem (blocked or starved station) or a potential problem (low on stock). They are used to alert the proper personnel that something needs their attention - either immediate or in-the near future. A marquee may be used to give mention to upcoming meetings, or events and can display the time, date, number of parts that are expected and actually produced. They are a visual communication tool used to help production meet their goals and minimize shut down time.

Bin

An area within each cell that contains data relevant to various locations in an environment. (i.e. plant stations such as paint) Data such as station state or a station that may be experiencing a problem, may be displayed on the Andon Board.

Cell

For cell-based Andon Board marquee signs, a cell refers to one block of data on the sign.

Client

A client component utilizes the facilities of a standard NETCON server. Typically a GUI application, this component provides a user-friendly interface of the available services offered by the

server engine. An example of a client tool would be FirstPAGE Client, which presents the user with a list of known messaging destinations and allows them to send messages to one or more destinations.

Default Message

The message that has been configured in Marquee Manager Administrator as the default, should the sign be cleared of all slots.

Distribution List

A Marquee Manager Server distribution list is a collection of marquees, which can be sent a message with a single transaction. Similar to an e-mail distribution list a client who initiates a transaction with a distribution list will automatically send the same message to all associated marquees.

Marquee

A sign display that serves as a visualization communication tool, providing the means to display time, date and message text such as production counts, and what areas of a plant are experiencing problems.

Server Kit

A server kit typically contains the server engine and administrator components. In some cases a client component is also included with this kit. The server kit is usually installed on a centralized host and is utilized by one or more clients or gateways. An example of a server kit is FirstPAGE Server. This kit contains the FirstPAGE engine, administrator and client.

Slot

The full page or area of the sign where messages can be configured. Each slot contains one or more lines depending on the sign type. Marquees may contain up to ten slots. Each will be displayed in a rotating queue.

Stack Light

Stacked lights typically used to display colors in a vertical grid pattern from one to five lights high. They may be used to show if a station is experiencing a problem then turn a light on to alert personnel.

Alarm Cast Administrator

About Alarm Cast Administrator

The following topics provide an overview of the CIMPLICITY Alarm Cast Administrator product including detailed configuration descriptions.

- [Alarm Cast Administrator - Key Features \(page 816\)](#)
- [Alarm Cast Administrator: How it Works \(page 817\)](#)
- [Alarm Cast Administrator Pre-configuration \(page 818\)](#)
- [Alarm Cast Administrator Components \(page 826\)](#)
- [Alarm Cast Administrator Other Tools \(page 887\)](#)
- [Alarm Cast Redundancy \(page 892\)](#)
- [Alarm Cast Administrator Glossary \(page 904\)](#)

Alarm Cast Administrator - Key Features

CIMPLICITY Alarm Cast is a high volume message processing engine that can be coupled with any combination of Alarm Cast auxiliary products to have messages dispatched from any application. It is easy to use in an operational setting and includes a full suite of flexible administration tools, all accessible remotely.

The Alarm Cast messaging engine is a standardized interface between personal communication devices and applications sending messages through either an internal paging service and/or external service providers. Alarm Cast Server maintains a database of all destinations, the addressing information of the device and the associated service provider connection information. This database can be shared with any application allowing messages to be dispatched from any part of the organization.

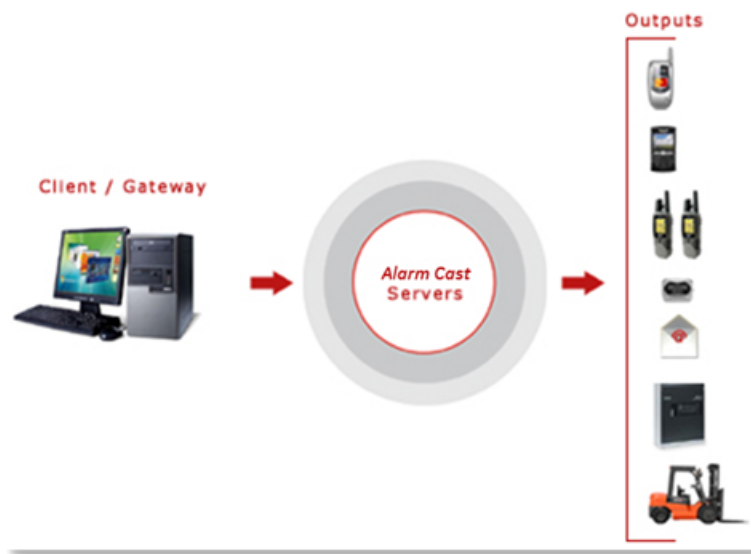

Key Alarm Cast Features:

- Simple, efficient installation wizards make for easy installation.
- Supports personal messaging groups (i.e. distribution lists).
- User-friendly maintenance of Devices, Providers, Destinations, Distribution Lists, Groups, Modems, etc.
- Unlimited messaging groups and destinations.
- Detailed transaction logging and viewing of these logs.
- Allows the administrator to import modem manufacturer modem definition files.
- Compatible with in-house paging systems.
- Supports serial modems, direct connections, TCP/IP sockets and terminal servers.
- Dispatches 60+ pages/minutes per modem.
- Dispatches 10000+ pages/minute via direct connections
- Online re-configuration of any engine setting or device/provider configuration.
- Concurrent device/modem support allows for extreme message throughput (i.e. 1,000,000 + pages per 8 hour day).

Alarm Cast Administrator: How it Works

Alarm Cast Server provides its clients with a single unified interface for dispatching text messages to numerous different destination types. The destination may be an actual text pager, a mobile phone handset, or an email address. The format and connection method is irrelevant; Alarm Cast Server formats and delivers the message to the destination for you.

To accomplish this task Alarm Cast utilizes a concept of a Device. A Device in Alarm Cast is the physical path the engine will utilize to connect to the destination service providers. Examples of devices include serial ports, internal or external modems, modems hosted via TCP/IP connected

modem sharing devices, or Internet connections etc. Once the device is named and defined, it may be used to define service providers.

Using this device connection Alarm Cast Server communicates to the service provider using the protocol defined for the provider. In the case of most North American one-way paging service providers, the TAP protocol is used. In this case, serial packets are sent to the provider using the associated device. Once protocol initiation is established, message transactions are dispatched to the provider using the selected protocol method for transaction initiation and completion.

For each destination a unique network id is sent along with the message to identify the end destination on the provider's network. The creation of a destination in Alarm Cast Server allows you to use a familiar name in place of the unique provider's network id, which is often numeric and not easily remembered. Once the message request is sent, a response from the provider is returned to Alarm Cast where it is evaluated for transaction success or failure. The result of this message is logged within the Alarm Cast Server logs for later review. Should the transaction require a retry, it is scheduled for the next connection to the provider.

Supported Alarm Cast Protocols:

MS-SPEECH	Speech API that converts text to speech
ODBC	Open Database Connectivity (Support for any ODBC compliant database)
OUCHPUSH	Orange Ouch Protocol
SMTP	Simple Mail Transport Protocol (For e-mail input to messaging service providers)
SMTP-FORDAU	Simple Mail Transport Protocol for Ford Australia (Proprietary protocol)
SNPP	Simple Network Paging Protocol (For Internet input into messaging service providers)
TAP	Telocator Alphanumeric Protocol, including IXO and PET (For most North American messaging service providers)
TR500	TR500 PBX Protocol
UCP	Universal Computer Protocol (Primarily for European GSM/SMS handsets)

Alarm Cast Administrator Pre-configuration

Alarm Cast Administrator Pre-configuration

The Alarm Cast Administrator utility program is used to configure and control the Alarm Cast Server engine.

System managers responsible for Alarm Cast are the intended users of Alarm Cast Administrator.

The features and operations that can be performed with Alarm Cast Administrator include adding, modifying, deleting, listing, printing database information, viewing logs and changing server configurations, etc.

Do the following before configuring the Alarm Cast Administrator.

- Alarm Cast Administrator Database Conversion
- Alarm Cast Administrator DSN Specifications
- Alarm Cast Administrator Application Folder
- Availability

Alarm Cast Administrator Database Conversion

The database for the Alarm Cast server is FPServer.mdb.

Important:

If the previous CIMPLICITY Pager was installed, the corresponding FPAdmin.mdb database will be incompatible with Alarm Cast Administrator; however it can be converted

If you have not converted the database, when you start the Alarm Cast Administrator for the first time after you install Alarm Cast, a message will report that the database is incompatible; the Database Converter must be run.

Example: Windows 7

1. 1. Open the Windows Start menu.
2. 2. Select CIMPLICITY>Alarm Cast>Database Conversion.

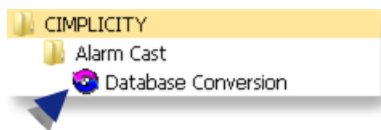

An Unavailable Servers dialog box opens.

3. 3. Click OK.

A Database Conversion dialog box opens.

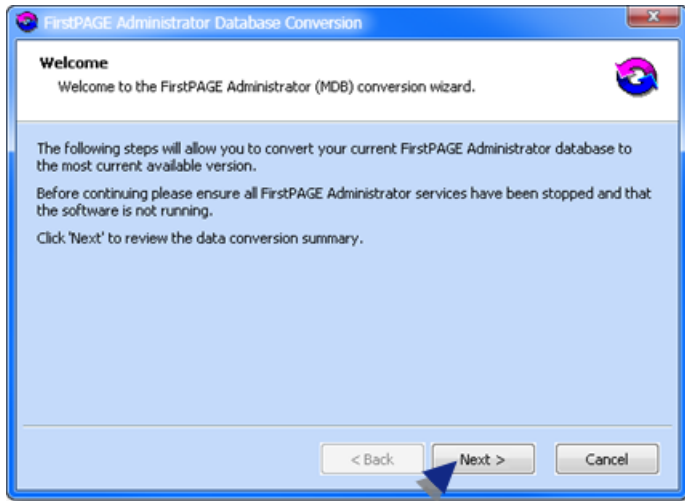

4. Click Next.

The Wizard will:

- Report if the database is up to date or needs conversion; if the database requires conversion the Wizard will guide you through the steps for the Alarm Cast Administrator and Alarm Cast Alarm Administrator.
- Display a summary of changes that will be made to your database, including the current version that is running and the target database.

Click Start to run the converter. Conversion results will then be displayed.

! **Important:** Restart the Alarm Cast Server service after completing the database conversion.

Alarm Cast Administrator: DSN Specifications

1. Open the ODBC Data Source Administrator.
 - 32-Bit System
 - a. Open the Control Panel
 - b. Select Administrative Tools > Data Sources (ODBC).

The ODBC Data Source Administrator opens.

- a. Choose the System DSN tab.
 - 64-Bit System

Important: System data sources are created in the ODBCAD32 location; they may not be listed on the System DSN tab when you open the ODBC Data Source Administrator on a 64-bit system.

- a. Expand the HMI/SCADA CIMPLICITY v<n> on the Windows Start menu.
- b. Enter the following in the Command Line field.

c:\windows\syswow64\odbcad32.exe

- a. Press Enter.

The ODBC Data Source Administrator opens.

- a. Select the System DSN tab.

Note: You can also click ODBCAD32 – View 32bit DSNs.

- On many operating systems, it is located in the HMI/SCADA CIMPLICITY v<n>list on the Start menu.
- On operating systems, such as Windows 8, it will have its own icon on the Start screen.

Result: The System Data Sources will be listed.

2. Click Add.

A Create New Data Source screen opens.

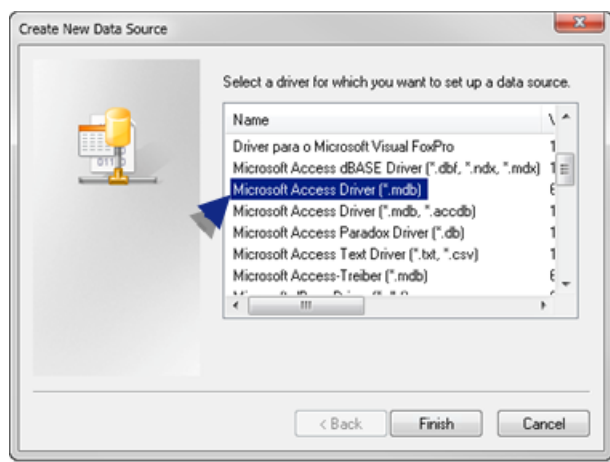

3. Double click Microsoft Access Driver (*.mdb).

4. Click Finish.

An ODBC Microsoft Access Setup dialog box opens.

5. Do the following.

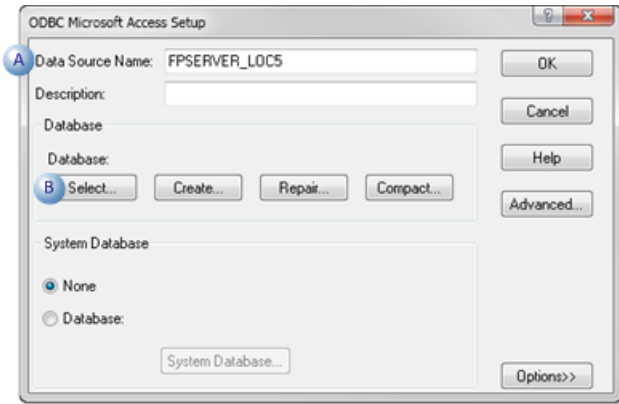

A	Enter the Data Source name.
B	Click Select.

A Select Database dialog box opens.

6. Do the following.

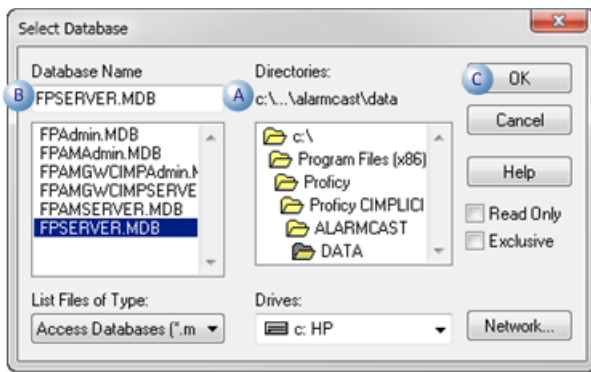

A	Select the database file's directory. Note: The path is ..\<CIMPLICITY installation>\ALARMCAST\DATA
B	Select FPSEVER.MDB.
C	Click OK.

The ODBC Microsoft Access Setup dialog box re-opens; the database path is entered.

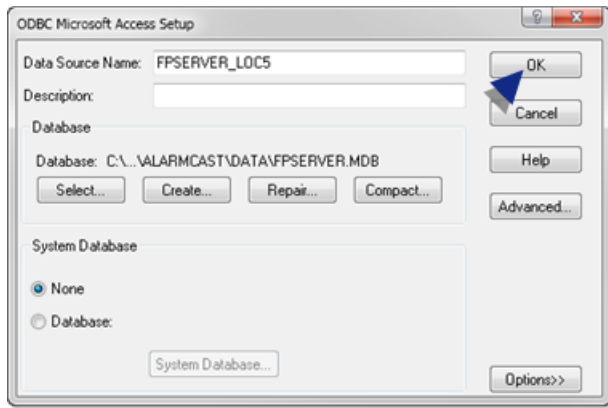

7. Click OK.

The new data source is listed on the ODBC Data Source Administrator>System DSN tab.

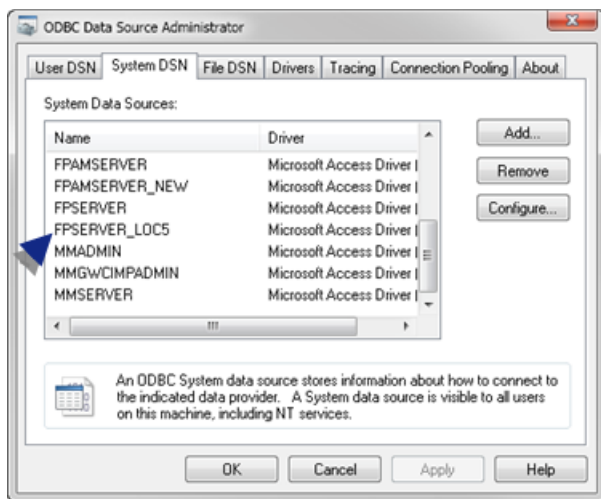

Alarm Cast Administrator: Application Folder Availability

The Alarm Cast Administrator utility program is used to configure and control the Alarm Cast Server engine. System managers responsible for Alarm Cast are the intended users of Alarm Cast Administrator.

The features and operations that can be performed with Alarm Cast Administrator include adding, modifying, deleting, listing, printing database information, viewing logs and changing server configurations, etc.

A copy of Alarm Cast Administrator is included with the Alarm Cast Server software; it will be installed automatically when you install the server. The Alarm Cast Administrator program can be accessed from any administrator workstation by purchasing the Alarm Cast Administrator Kit.

Before installing and configuring Alarm Cast Administrator do the following.

Note: This procedure is for a Windows 7 system. The exact steps may differ slightly on your system.

Choose the **ALARMCAST** application folder, which contains the Alarm Cast data and log files.

Following are the default paths for 32-bit and 64-bit systems.

32-bit system	..Program Files\Proficy\Proficy CIMPLICITY\ALARMCAST
64-bit system	...Program Files (x86)\Proficy\Proficy CIMPLICITY\ALARMCAST

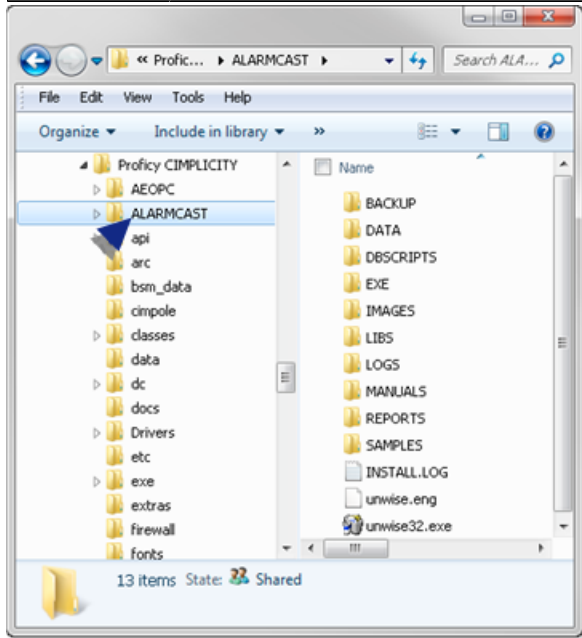

Right-click the **ALARMCAST** folder to open the ALARMCAST Properties dialog box.

Assign Full Control to the **Everyone** user.

Example: Assign Sharing Permissions to the Everyone User

Do the following on a Windows 7 system; other Windows operating systems may differ slightly.

Select Properties on the ALARMCAST Popup menu.

The Server Properties dialog box opens.

Do the following.

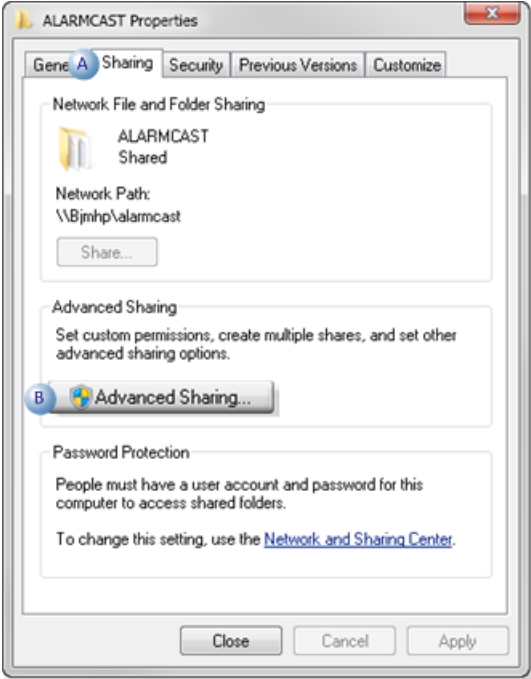

A	Select the Sharing tab.
B	Click Advanced Sharing.

An Advanced Sharing dialog box opens.

Do the following.

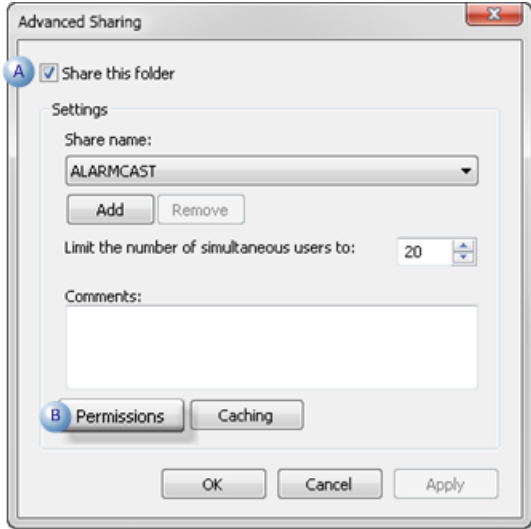

A	Check Share this folder.
B	Click Permissions.

A Permissions for ALARMCAST dialog box opens.

Do the following.



A	Select Everyone.
B	Make sure Allow is checked for all options.
C	Click Apply.

Click OK to close the dialog boxes.

Result: ALARMCAST is now available

Alarm Cast Administrator Components

Alarm Cast Administrator Components

- Alarm Cast Administrator Server.
- Alarm Cast Administrator Devices.
- Alarm Cast Administrator Providers.
- Alarm Cast Administrator Destinations.

- Alarm Cast Administrator Distribution Lists.

Alarm Cast Administrator Server

- Alarm Cast Administrator: New Server
- Alarm Cast Administrator: Server Configuration
- Alarm Cast Administrator Server: Save

Alarm Cast Administrator: New Server

1. Enable Alarm Cast Gateway in the CIMPLICITY Workbench, as follows.
 - a. Click Project>Properties on the Workbench menu bar.

The Project Properties dialog box opens.

- a. Check Alarm Cast Gateway in the General tab>Options box.
- b. Close the Project Properties dialog box.

2. Do the following.

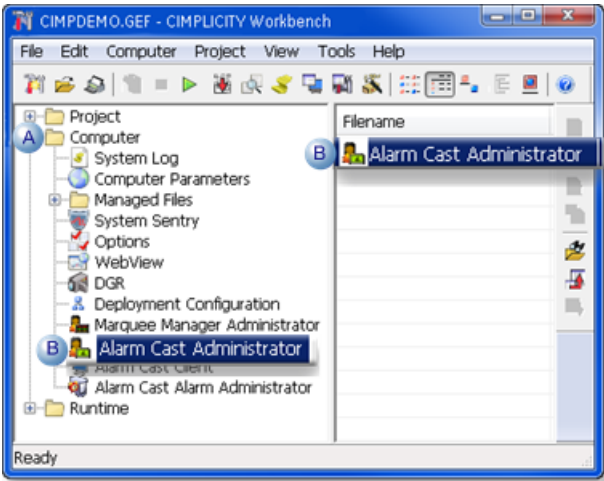

A	Expand Computer in the Workbench left-pane.
B	Double-click Alarm Cast Administrator (in the left or right-pane).

The Alarm Cast Administrator window opens.

3. Do the following.

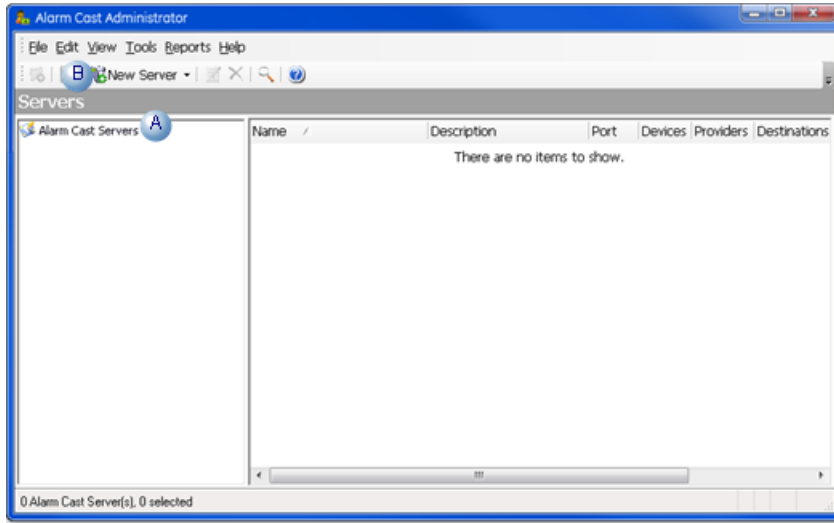

A	Select Alarm Cast Servers in the Alarm Cast Administrator left-pane.
B	Click the New Server button on the Alarm Cast Administrator toolbar. A New Server menu displays.

4. Select Alarm Cast Server on the New Server menu.

A Select Data Source dialog box opens.

5. Select the Alarm Cast Server data source.

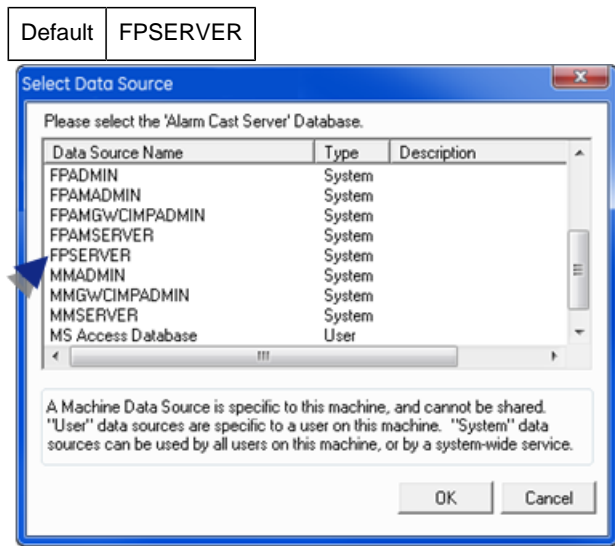

6. Click OK.

7. Must be in your DNS server or local host file.

8. Can be reached from the Administrator workstation

9. Three alternate names.

10. One locator name.

Note

- Aliases can be customized by editing the text preceding and following the **&** symbol.
- The **&** symbol serves as a shortcut key and can be placed anywhere in the Alias descriptions.

11. A **Users** folder is added to the Tools tree.

12. Users who should have access to the Alarm Cast server need to be added.

13. A Login dialog box opens when a user attempts to open the Alarm Administrator window.



14. A **Users** folder is added to the Tools tree.

15. Users who should have access to the Alarm Cast server need to be added.

After a listed user logs into Windows, the user can open the Alarm Cast Administrator window; a Login dialog box for the Alarm Cast Administrator is not required.

Alarm Cast Administrator Devices

Alarm Cast Administrator Devices

- Alarm Cast Administrator: Device overview.
- Alarm Cast Administrator: Devices

Alarm Cast Administrator: Device Overview

The Devices folder allows you to add and maintain all devices and device-related information such as device type and communication settings. Devices are the physical connections that the server will utilize to connect to the various service providers required. Devices must be configured before any service providers may be defined.

 **guide: Guideline:** To facilitate high throughput via serial communications numerous similar devices may be pooled together. To accomplish this more than one device can have the same name. The resulting device pool can then operate in tandem.

Example

If two modems are entered under the name DIALOUT; this device is assigned to a provider, then the server can utilize both of the modems simultaneously to connect to the service provider and allow it to send pages concurrently to the provider.

When choosing a Device type, the type you choose will determine what Communications options display on this tab.

The following outlines the device options

Database using ODBC protocol

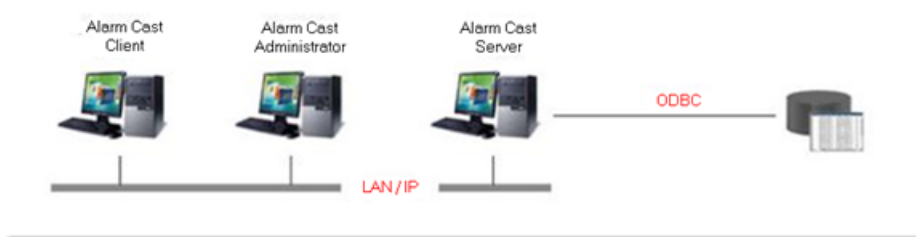

Direct connection (by serial cable)

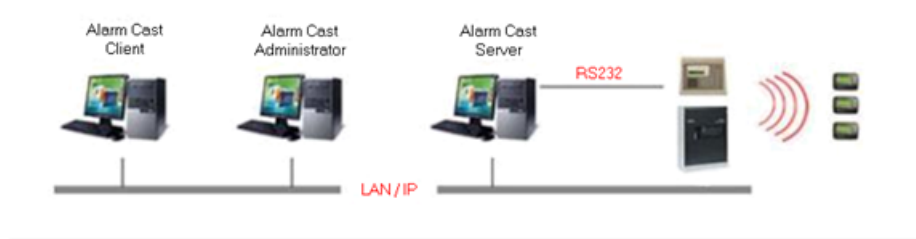

Modem, ModemIP (a modem hosted on a TCP/IP sharing device)



TCP/IP for an Internet connection



Audio for text to speech output

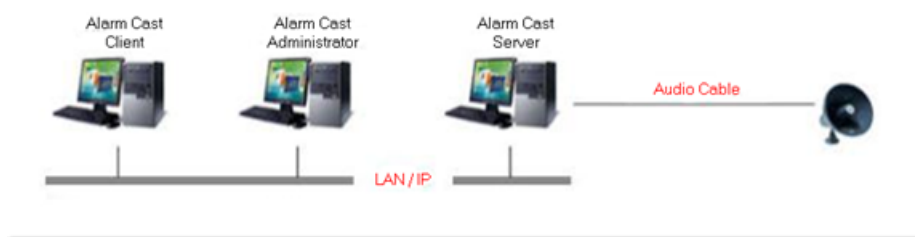

Alarm Cast Administrator: Devices

- Alarm Cast Administrator Device: Audio.
- Alarm Cast Administrator Device: Database.
- Alarm Cast Administrator Device: Direct.
- Alarm Cast Administrator Device: Modem.
- Alarm Cast Administrator Device: TCP/IP.
- Alarm Cast Administrator Device: UDP.
- Alarm Cast Administrator Device: Wizard.

Alarm Cast Administrator Device: Audio

1. Click the **Devices** folder in the Alarm Cast Administrator left-pane.
2. Click New Device on the toolbar.

A Details tab displays.

3. Select Audio in the Communications>**Type** field.

The Audio options are as follows.

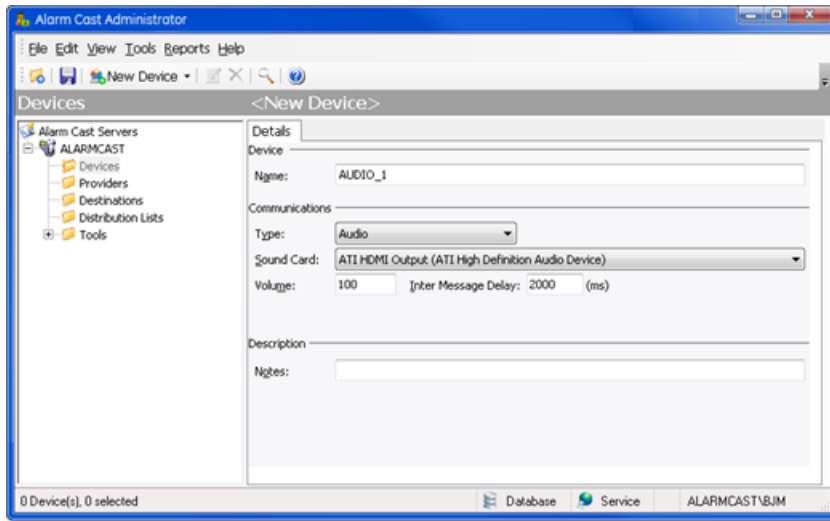

Field	Description
Device	
Name	(Logical name) utilized by the administrator to refer to this physical device. Example An Audio Device may be named AUDIO_1.
Communications	
Type	All Audio from the list of device types.
Sound Card	All available output cards.
Volume	Measured in percent.
Inter Message Delay	The delay between messages specified in milliseconds. Values are 1000 – 5000 ms. Default is 2000.
Description	
Notes	Optional

4. Click Save.

The Device will now be visible under the Devices folder in the tree view.

Alarm Cast Administrator Device: Database

1. Click the **Devices** folder in the Alarm Cast Administrator left-pane.
2. Click New Device on the toolbar.

A Details tab displays.

3. Select Database in the Communications>**Type** field.

The Database options are as follows.

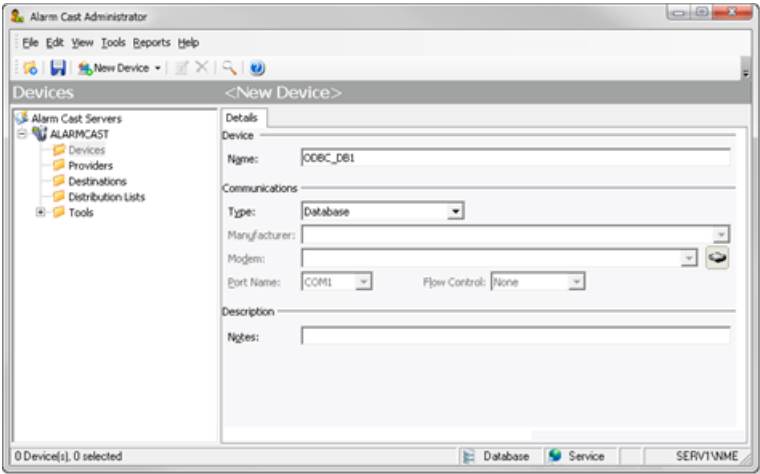

Field	Description
Device	
Name	Logical name utilized by the administrator to refer to this physical device. Example An ODBC Database Device may be named ODBC_DB1.
Communications	
Type	Select Database from the list of device types.
Description	
Notes	Optional

4. Click Save.

The Device will now be visible under the Devices folder in the tree view. By selecting the Devices folder, all of the devices will be visible in the working pane.

Alarm Cast Administrator Device: Direct

1. Click the **Devices** folder in the Alarm Cast Administrator left-pane.
2. Click New Device on the toolbar.
A Details tab displays.
3. Select Direct in the Communications>**Type** field.

The Direct options are as follows.

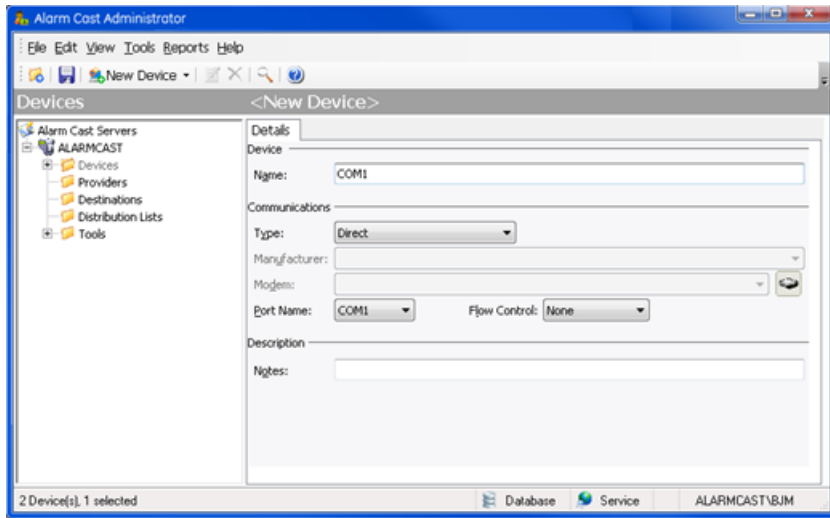

Field	Description
Device	
Name	(Logical name) utilized by the administrator to refer to this physical device. For example, a Direct Device may be named COM1.
Communications	
Type	Select Direct from the list of Device types. .
Port Name	All available ports.
Flow Control	The way the devices throttle the flow of send and receive data. Select one of the following. <ul style="list-style-type: none"> • Hardware to use the devices hardware flow control method • Software to use the devices software flow control method. Default value is None.
Description	
Notes	Optional

4. Click Save.

The Device will now be visible under the Devices folder in the tree view. By selecting the Devices folder, all of the devices will be visible in the working pane.

Alarm Cast Administrator Device: Modem

- Modem/ModemIP.
- Modem Pool.

! **Important:** A modem is hosted on a TCP/IP sharing device. Several steps are required to set up a Modem device. To make changes to the default Modem configuration, you must add a modem to the Tools folder.

Modem/ModemIP

Do the following to configure the Modem/ModemIP option.

- 1. Click the **Devices** folder in the Alarm Cast Administrator left-pane.
- 2. Click New Device on the toolbar.

A Details tab displays.

- 3. Select Modem or ModemIP in the Communications>**Type** field.

Note: If you select ModemIP, your screen will differ slightly, with **Host Name** and **Host Port** replacing Port Name and Flow Control.

The Modem/ModemIP options are as follows.

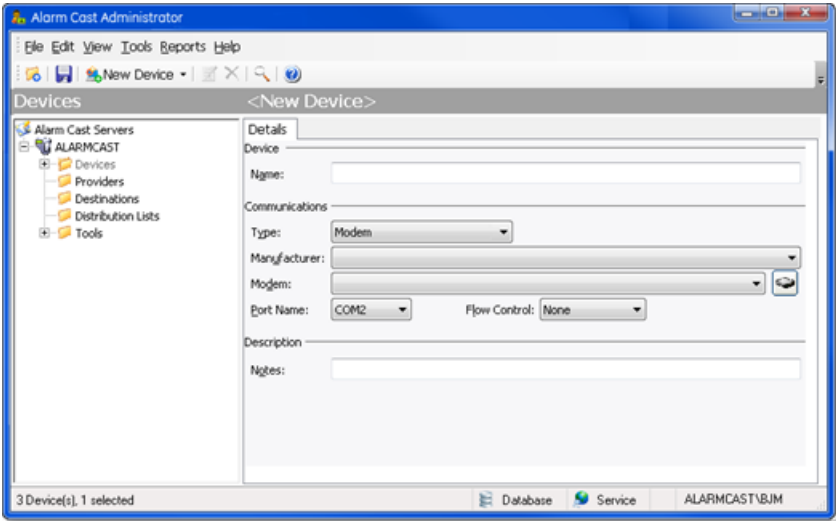

Field	Description
Device	
Name	(Logical name) utilized by the administrator to refer to this physical device. For example, a Modem Device may include the name of the modem.
Communications	
Type	Select Modem or ModemIP from the list of device types.
Manufacturer	All available output cards. Important: A modem must be added before choosing a manufacturer.

Field	Description
Modem	Click the Modem button to add a modem.
Port Name (Modem)	List of available ports. Default is the next available port.
Flow Control (Modem)	The way that devices throttle the flow of send and receive data. Select one of the following. <ul style="list-style-type: none"> • Hardware to use the devices hardware flow control method • Software to use the devices software flow control method. Default value is None.
Host Name (ModemIP)	Name of the machine being connected.
Host Port (ModemIP)	Port of the machine being connected.
Description	
Notes	Optional

Modem/ModemIP: Add a Modem

The Modems folder enables users to add a modem that does not display in the list of available modem manufacturers and models.

Adding a modem involves the import of modem definitions from Windows INF files supplied by Microsoft or the modem manufacturer.

There are two ways to add a modem:

- Modem Included with Windows
- Import the INF files
- Modem from a Manufacturer Supplied INF File
- Utilize a manufacturer supplied INF file

Modem Included with Windows

Import the INF files that are included with Microsoft Windows

- a. Click the Modem button to the right of the **Modem** field.

The Add Modem Wizard opens.

- a. Select a modem in the **Standard Modem Types** list.

 **Tip:** If your modem is not available in the browse list, use the Show Excluded option to display modem configurations that have been suppressed by the manufacturer.

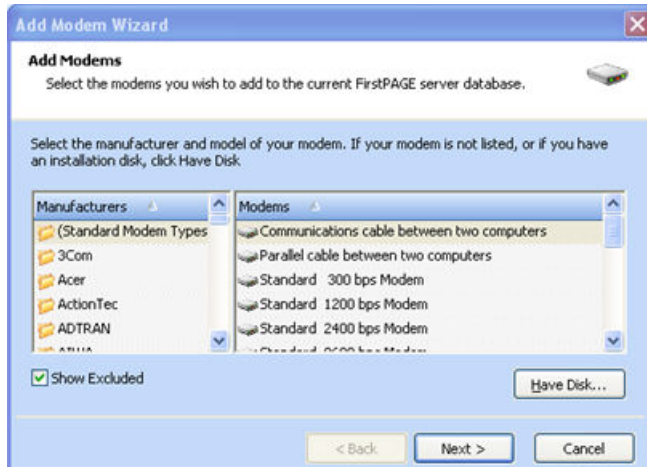

a. Click Next.

A Target Server screen opens.

- a. Select the Alarm Cast Server to connect to.
- a. Click Next.

A Notes screen opens.

- a. (Optional) Enter a note in the **Notes** field.
- b. Click Next.

A Ready to Add screen will indicate that your modem is being added.

- a. Click Finish.

Result: Adding the modem is completed.

Modem from a Manufacturer Supplied INF File

Utilize a manufacturer supplied INF file from a modem CD or diskette distribution.

- a. Click the Modem button to the right of the **Modem** field.

The Add Modem Wizard opens.

- a. Select a manufacturer in the Add Modem Wizard left-pane.
- b. Select a modem in the **Manufacturer's** list.

i Tip: If your modem is not available in the browse list, use the Show Excluded option to reveal modem configurations that have been suppressed by the manufacturer.

- a. Click Have Disk to add your manufacturer/model of modem.
- b. Select the location of your modem INF file then select OK. This will begin the file transfer.

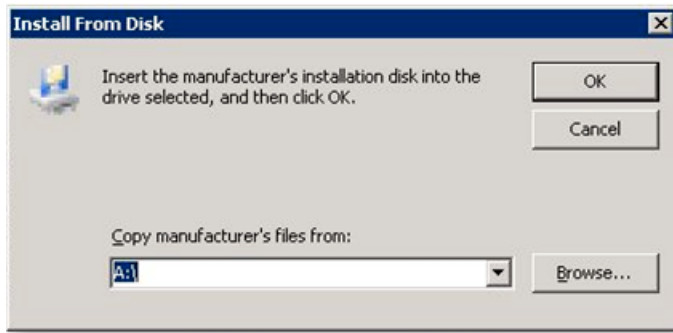

a. Click Finish to complete the addition of the Modem.

Result: When you have added the required modem(s), you can choose the Manufacturer and Modem from the drop-down menu in the Alarm Cast Administrator.

4. Click Save.

Result: The Modem device(s) display:

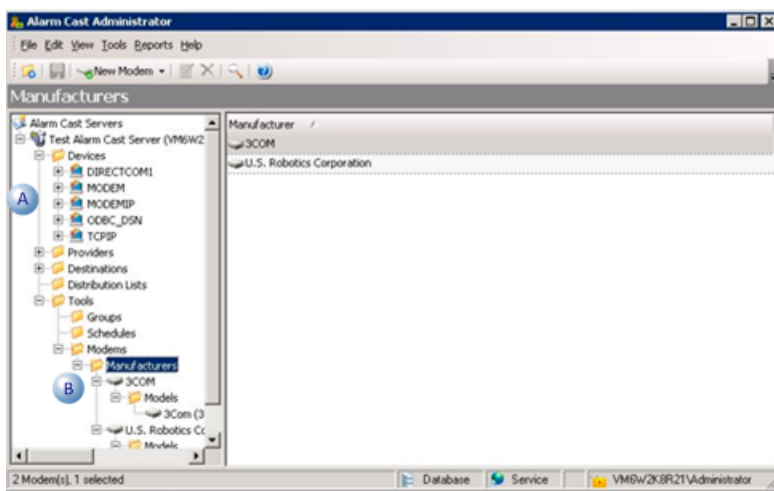

A	In the Devices folder.
B	On the Tools menu in the tree view. By selecting a modem, the details specific to that modem show up in the Window pane. Note: These fields are read-only.

Modem Pool

A modem pool adds multiple modems to a single device to share the load of sending messages, using more than one modem at one time.

Do the following to configure the Modem Pool option.

5. Click the **Devices** folder in the Alarm Cast Administrator left-pane.

6. Click New Device on the toolbar.

A Details tab displays.

7. Select Modem Pool in the Communications>**Type** field.

The Pool options are as follows.

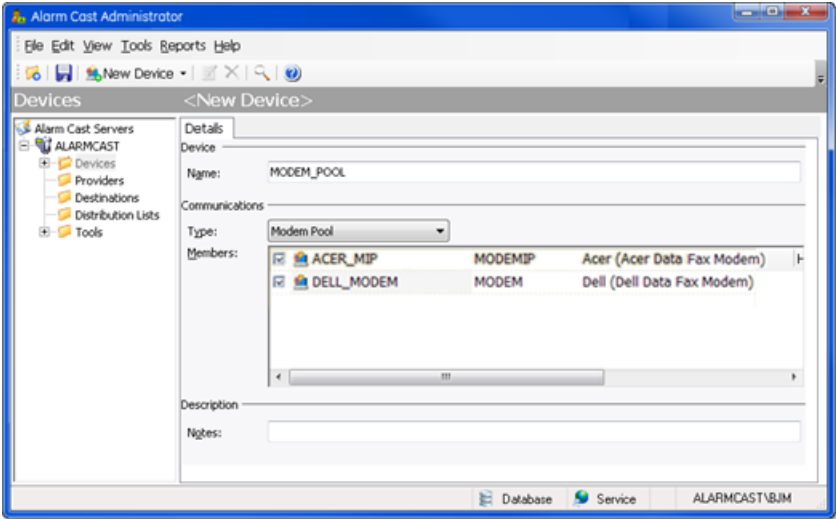

Field	Description
Device	
Name	(Logical name) utilized by the administrator to refer to this physical device. Example A Modem Pool Device may be named DELL_POOL to show that the members are all Dell modems in this modem pool.
Communications	
Type	Select Modem Pool from the list of device types.
Members	A list of all available modems to add to the modem pool. Check the modems that will be members of this modem pool.
Description	
Notes	Optional

8. Click Save.

The Device will now be visible under the Devices folder in the tree view. By selecting the Devices folder, all of the devices will be visible in the working pane.

Alarm Cast Administrator Device: TCP/IP

1. Click the **Devices** folder in the Alarm Cast Administrator left-pane.

2. Click New Device on the toolbar.

A Details tab displays.

3. Select TCP/IP in the Communications>**Type** field.

4. Enter the device name in the **Name** field.

There are no other TCP/IP options.

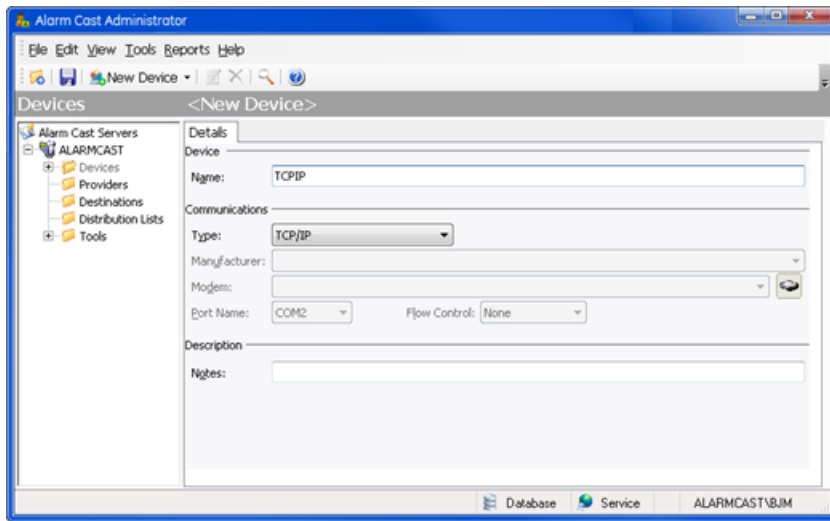

5. Click Save.

The Device will now be visible under the Devices folder in the tree view. By selecting the Devices folder, all of the devices will be visible in the working pane.

Alarm Cast Administrator Device: UDP

1. Click the **Devices** folder in the Alarm Cast Administrator left-pane.

2. Click New Device on the toolbar.

A Details tab displays.

3. Select UDP in the Communications>**Type** field.

4. Enter the device name in the **Name** field.

There are no other UDP options.

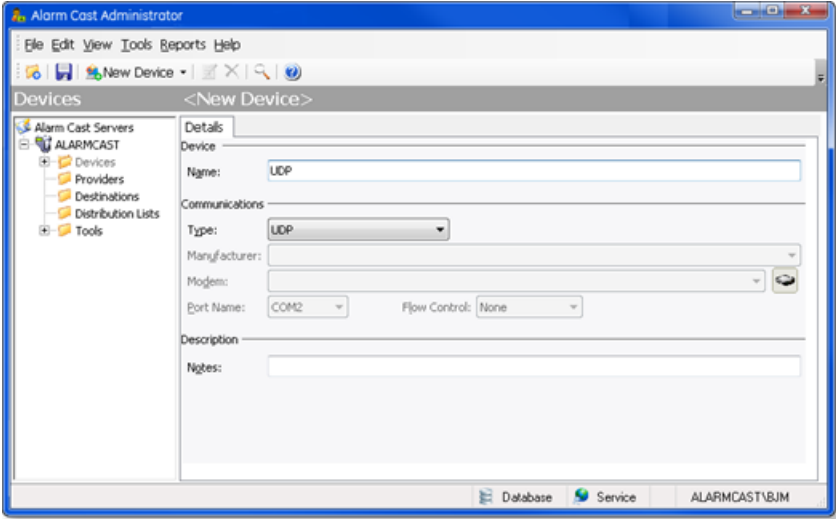

5. Click Save.

The Device will now be visible under the Devices folder in the tree view. By selecting the Devices folder, all of the devices will be visible in the working pane.

Alarm Cast Administrator Device: Wizard

1. A new Device can also be added using the Wizard, which guides the user through the required fields for each device type.

1. Click File>New on the Alarm Cast Administrator menu bar.

A New Item screen opens.

2. Do the following.

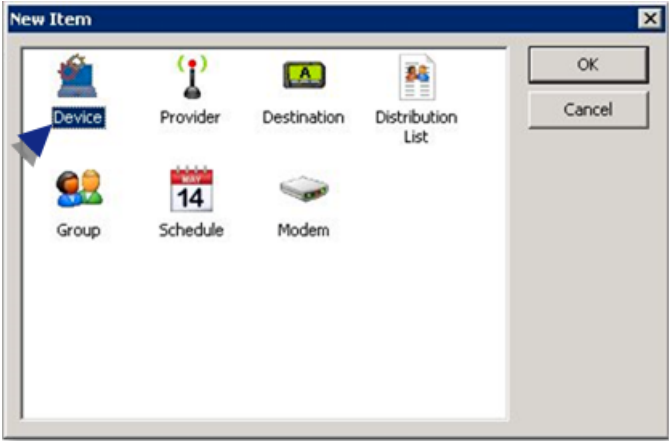

A	Select Device .
---	------------------------

B	Click OK.
---	-----------

A Select Server screen opens.

3. Do the following.

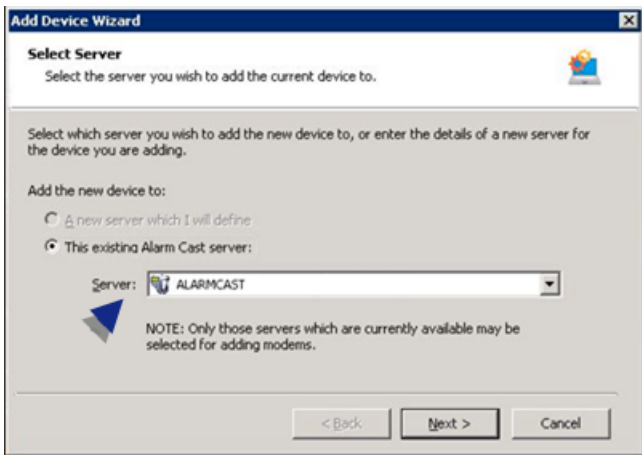

A	Select the server to which the device will be added.
B	Click Next.

4. Do the following.

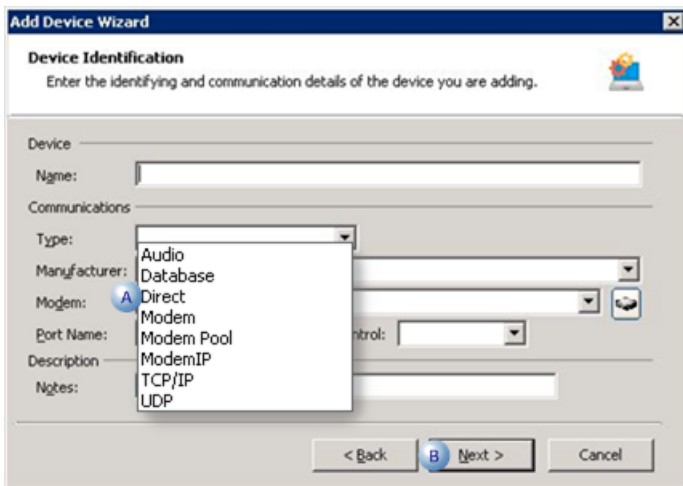

A	Select the device type in the dropdown Type list.
B	Click Next.

A summary of the device details will display..If the information is not correct, click the Back button to edit details.

5. Click Finish to add the new device to the Alarm Cast Administrator.

The Device will now be listed in the Devices folder in the Alarm Cast Administrator left-pane.

Alarm Cast Administrator Providers

Alarm Cast Administrator Providers

- 1. When the limit is reached, all messages for this provider will be bounced and logged as being dropped due to excessive activity.
Messages will continue to be dropped while the level of activity is higher than the limit.
- 2. When messages per period drop below the specified trigger limit, the flow of messages will be restored automatically and logged in the sender log.

Alarm Cast Administrator Provider: Audio

- 1. Do one of the following.
 - Select the Providers folder in the Alarm Cast Administrator left-pane.
 - a. Click New Provider on the toolbar.
 - b. Select Audio in the **Devices** field.
 - Expand an **Audio** device folder in the Alarm Cast Administrator left-pane.
 - a. Select the **Providers** folder.
 - b. Click New Provider on the toolbar.

Audio is automatically selected in the **Devices** field.

Audio provider tabs are as follows.

- Details Tab
- Connection Tab
- Common Tabs for Providers

Details Tab

Select the Details tab; options are as follows.

Field	Description
Server	
Name	Name associated with the provider.
Coverage	Geographical area in which the provider can deliver messages.
Device	Device to associate with the Provider.
Protocol	

Field	Description
Max. Connection	Not required.
Max. Transactions	Not required.
Alpha Length (page 862)	Maximum length of alphanumeric pages allowed by the provider.
Numeric Length (page 862)	Maximum length of numeric pages allowed by the provider. Messages longer than this will be split into segments and sent automatically.
Protocol	Language used for communicating with the messaging service provider. In this case, MS-SPEECH.
Communications	
	These fields are not required for a Provider created on an Audio type Device.

Connection Tab

Select the Connection tab; options are as follows.

Field	Description
Address 1	
Voice	Drop-down list of MS voices installed on the computer.
Description	
Notes	Optional.

2. Click Save.

The provider will be listed under the Provider folder as well as the Device - Provider sub-folder of the modem device it is associated with.

Alarm Cast Administrator Provider: Database

1. Do one of the following.

- Select the Providers folder in the Alarm Cast Administrator left-pane.
 - a. Click New Provider on the toolbar.
 - b. Select Database in the **Devices** field.
- Expand a **Database** device folder in the Alarm Cast Administrator left-pane.
 - a. Select the **Providers** folder.
 - b. Click New Provider on the toolbar.

Database is automatically selected in the **Devices** field.

Database provider tabs are as follows.

- Details Tab
- Connection Tab
- Common Tabs for Providers

Details Tab

Select the Details tab; options are as follows.

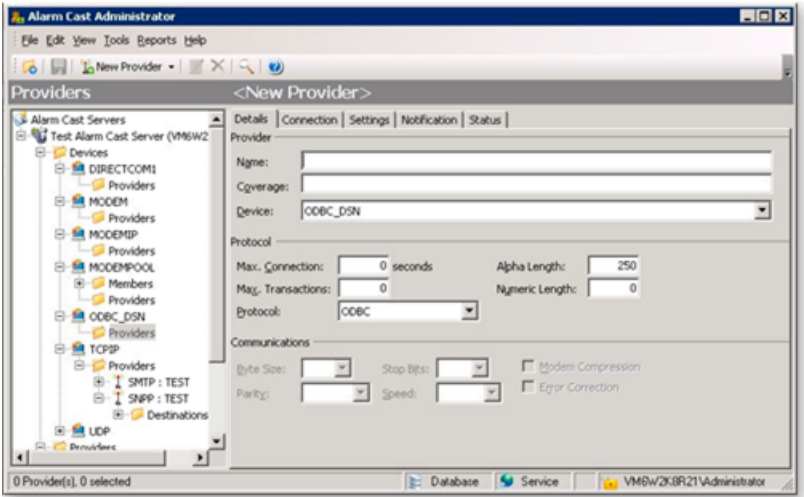

Field	Description
Server	
Name	Name associated with the provider.
Coverage	Geographical area in which the provider can deliver messages.
Device	Device to associate with this Provider. Note: Select the device from the dropdown list.
Protocol	
Max. Connection	Maximum connection time, in seconds, that Alarm Cast Server will remain connected to the provider. This controls how long the server will attempt to transmit to the provider in a single session. The entry should be slightly less than the actual time to avoid being disconnected during transmission of a message. Important If there is no maximum number, enter 0; 0 = infinite.
Max. Transactions	Maximum number of transactions that the Alarm Cast Server will perform during one connection. Important: If there is no maximum number, enter 0; 0 = infinite.
Alpha Length (page 862)	Maximum length of alphanumeric pages allowed by the provider.
Numeric Length (page 862)	Maximum length of numeric pages allowed by the provider. Messages longer than this will be split into segments and sent automatically
Protocol	Language used for communicating with the messaging service provider. In this case, ODBC.

Field	Description
Communications	
	Not required.

Connection Tab

Select the Connection tab; options are as follows.

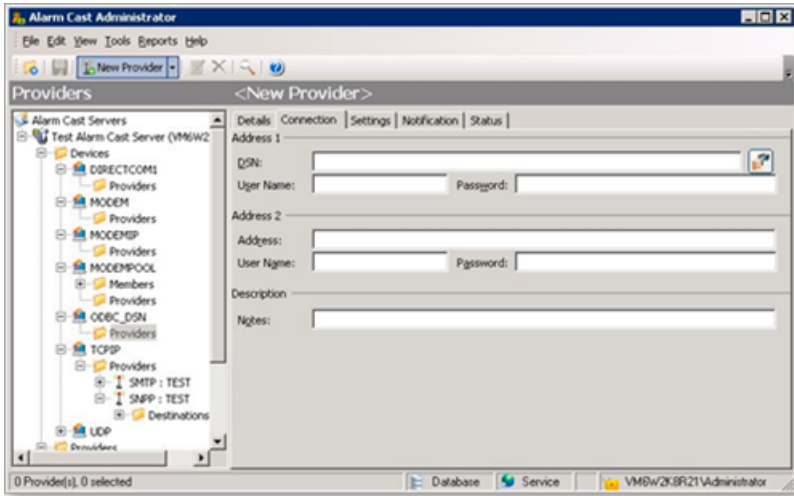

Field	Description
Address 1	
DSN	Data source that has been configured to access the ODBC database for this device.
User Name	Optional.
User Password	Optional.
Address 2	
Address	Phone number or Internet address the messaging service provider uses to accept pages based on the coverage area.
User Name	Optional.
User Password	Optional.
Description	
Notes	Optional.

2. Click Save.

The provider will be listed under the Provider folder as well as the Device - Provider sub-folder of the modem device it is associated with.

Alarm Cast Administrator Provider: Direct

Do one of the following to configure the Direct provider option.

- Select the Providers folder in the Alarm Cast Administrator left-pane. Click New Provider on the toolbar. Select Direct in the **Devices** field.
- Expand a **Direct** device folder in the Alarm Cast Administrator left-pane. Select the **Providers** folder. Click New Provider on the toolbar.

Direct is automatically selected in the **Devices** field.

Direct provider tabs are as follows.

- Details Tab
- Connection Tab
- Common Tabs for Providers

Details Tab

Select the Details tab; options are as follows.

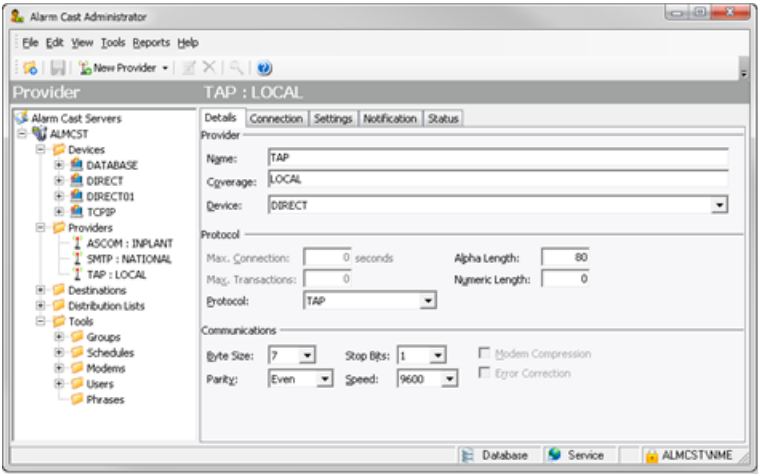

Field	Description
Server	
Name	Name associated with the provider. Note: The name helps users identify the provider; it does not affect Pager functionality.
Coverage	Geographical area in which the provider can deliver messages.

Field	Description
Device	Device to associate with this Provider. Note: Select the device from the dropdown list
Protocol	
Max. Connection	Not required.
Max. Transactions	Not required.
Alpha Length (page 862)	Maximum length of alphanumeric pages allowed by the provider.
Numeric Length (page 862)	Maximum length of numeric pages allowed by the provider. Messages longer than this will be split into segments and sent automatically.
Protocol	Language used for communicating with the messaging service provider. In this case, TAP.
Communications	
Byte Size	Number of data bits encoding a character. The value can be 7 or 8.
Parity	<p>Method of detecting some errors in transmission. The parity bit in each character can be set to any of the following.</p> <ul style="list-style-type: none"> • None • Odd • Even • Mark • Space. <p>Note: None means that no parity bit is sent at all.</p>
Stop Bits	Stop bits sent at the end of every character allow the receiving signal hardware to detect the end of a character and to resynchronize with the character stream. Options are 0, 1, 1.5, and 2. Electronic devices usually use one stop bit.
Speed	Rate of the transmission.
Modem Compression	Read-only.
Error Correction	Read-only.

Connection Tab

Select the Connection tab; options are as follows.

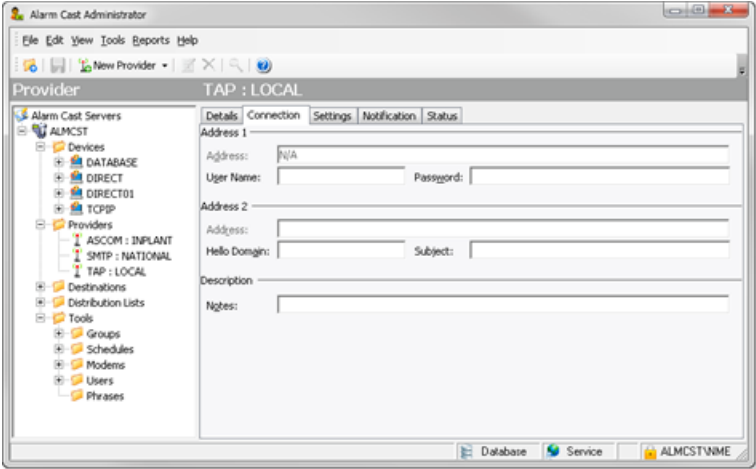

Field	Description
Address 1	
Address	Not applicable.
User Name	Optional.
User Password	Optional.
Address 2	
Address	
User Name	Optional.
User Password	Optional.
Description	
Notes	Optional.

Click Save.

Result: The provider will be listed under the Provider folder as well as the Device - Provider subfolder of the modem device it is associated with.

Alarm Cast Administrator Provider: Modems

- Modem/ModemIP Provider
- Modem Pool Provider

Modem/ModemIP Provider

Do the following to configure the Modem/ModemIP Provider option.

1. Do one of the following.

- Select the Providers folder in the Alarm Cast Administrator left-pane.
 - a. Click New Provider on the toolbar.
 - b. Select Modem/ModemIP in the **Devices** field.
 - Expand a **Modem/ModemIP** device folder in the Alarm Cast Administrator left-pane.
 - a. Select the **Providers** folder.
 - b. Click New Provider on the toolbar.

Modem/ModemIP is automatically selected in the **Devices** field.

Modem/ModemIP provider tabs are as follows.

- Modem/ModemIP: Details Tab
- Modem/ModemIP: Connection Tab
- Common Tabs for Providers

Details Tab

Select the Details tab; options are as follows.

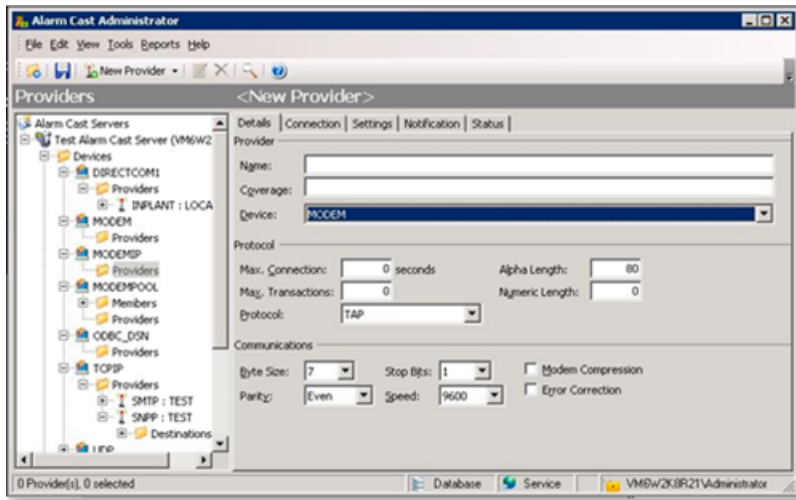

Field	Description
Server	
Name	Name associated with the provider
Coverage	Geographical area in which the provider can deliver messages.
Device	Device to associate with this Provider. Note: Select the device from the dropdown list
Protocol	

Field	Description
Max. Connection	<p>Maximum connection time, in seconds, Alarm Cast Server will remain connected to the provider. Typically this:</p> <ul style="list-style-type: none"> • Specifies the maximum connection time, in seconds, allowed by the messaging service provider for the modem connection. • Controls how long the server will attempt to transmit to the provider in a single session. <p>The entry should be slightly less than the actual time to avoid being disconnected during transmission of a message. Important If there is no maximum number, enter 0; 0 = infinite.</p>
Max. Transactions	<p>Maximum number of transactions that the Alarm Cast Server will perform during one connection. Some commercial service providers place a maximum on the number of messages that may be transmitted during one communication. If this is the case, enter the maximum number here so Alarm Cast Server does not exceed the threshold and get disconnected unexpectedly. Important If there is no maximum number, enter 0; 0 = infinite.</p>
Alpha Length	<p>Maximum length of alphanumeric pages allowed by the provider.</p>
Numeric Length	<p>Maximum length of numeric pages allowed by the provider. Messages longer than this will be split into segments and sent automatically.</p>
Protocol	<p>Language used for communicating with the messaging service provider. The drop-down list gives you various protocols depending on the Device type selected. Any other protocols should only be used as requested from CIMPLICITY. Available protocols include the following.</p> <ul style="list-style-type: none"> • ASCOM • HARK3IDS • HARBANNER • IXO • PET • SMS • TAP • UCP
Communications	
Byte Size	<p>Number of data bits encoding a character. This value can be 7 or 8.</p>
Parity	<p>Method of detecting some errors in transmission. The parity bit in each character can be set to any of the following.</p> <ul style="list-style-type: none"> • None • Odd • Even • Mark • Space. <p>Note: None means that no parity bit is sent at all.</p>
Stop Bits	<p>Stop bits sent at the end of every character allow the receiving signal hardware to detect the end of a character and to re-synchronize with the character stream. Options are:</p> <ul style="list-style-type: none"> • 0 • 1 • 1.5 • 2 <p>Electronic devices usually use 1 stop bit.</p>
Speed	<p>Rate of the transmission.</p>
Modem Compression	<p>Use the default values unless otherwise instructed by your service provider.</p>

Field	Description
Error Correction	(Checked) error correction will be used when connecting to this service provider.

Connection Tab

Select the Connection tab; options are as follows.

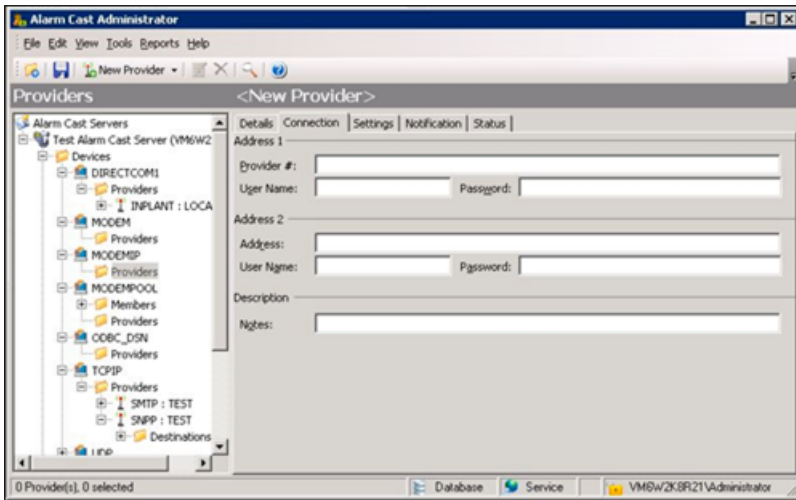

Field	Description
Address 1	
Provider #	Phone number or Internet address the messaging service provider uses to accept pages based on the coverage area.
User Name	Optional.
User Password	Optional.
Address 2	
Address	Phone number or Internet address the messaging service provider uses to accept pages based on the coverage area.
User Name	Optional.
User Password	Optional.
Description	
Notes	Optional.

2. Click Save.

Result: The provider will be listed under the Provider folder as well as the Device - Provider sub-folder of the modem device it is associated with.

Modem Pool Provider

- 3. Do the following to configure the Modem Pool Provider option.
 - Select the Providers folder in the Alarm Cast Administrator left-pane.
 - a. Click New Provider on the toolbar.
 - b. Select Modem Pool in the **Devices** field.
 - Expand an **Modem Pool** device folder in the Alarm Cast Administrator left-pane.
 - a. Select the **Providers** folder.
 - b. Click New Provider on the toolbar.

Modem Pool is automatically selected in the **Devices** field.

Modem Pool provider tabs are as follows.

- Modem Pool: Details tab.
- Modem Pool: Connection tab.

Details Tab

Select the Details tab; options are as follows.

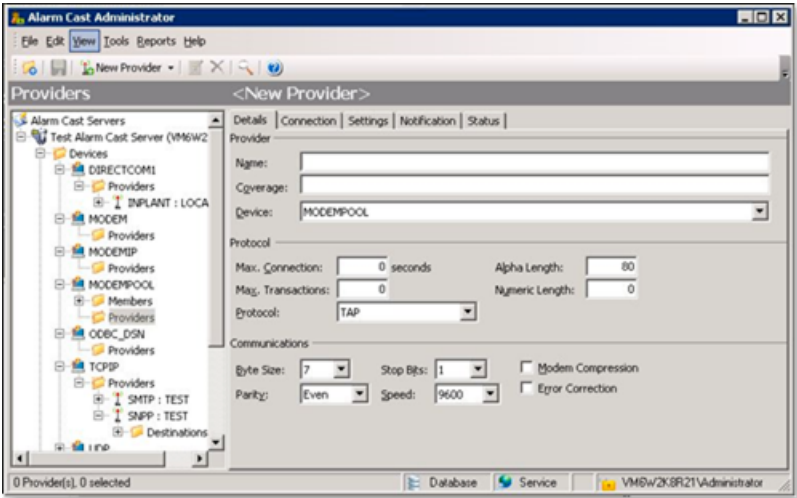

Field	Description
Server	
Name	Name associated with the provider.
Coverage	Geographical area in which the provider can deliver messages.
Device	Device to associate with this Provider. Note: Select the device from the dropdown list
Protocol	

Field	Description
Max. Connection	<p>Maximum connection time, in seconds, Alarm Cast Server will remain connected to the provider. Typically this:</p> <ul style="list-style-type: none"> • Specifies the maximum connection time, in seconds, allowed by the messaging service provider for the modem connection. • Controls how long the server will attempt to transmit to the provider in a single session. <p>The entry should be slightly less than the actual time to avoid being disconnected during transmission of a message. Important If there is no maximum number, enter 0; 0 = infinite.</p>
Max. Transactions	<p>Maximum number of transactions that the Alarm Cast Server will perform during one connection. Some commercial service providers place a maximum on the number of messages that may be transmitted during one communication. If this is the case, enter the maximum number here so Alarm Cast Server does not exceed the threshold and get disconnected unexpectedly. Important If there is no maximum number, enter 0; 0 = infinite.</p>
Alpha Length	<p>Maximum length of alphanumeric pages allowed by the provider.</p>
Numeric Length	<p>Maximum length of numeric pages allowed by the provider. Messages longer than this will be split into segments and sent automatically.</p>
Protocol	<p>Language used for communicating with the messaging service provider. In this case, TAP.</p>
Communications	
Byte Size	<p>Number of data bits encoding a character. This value can be 7 or 8.</p>
Parity	<p>Method of detecting some errors in transmission. The parity bit in each character can be set to any of the following.</p> <ul style="list-style-type: none"> • None • Odd • Even • Mark • Space. <p>Note: None means that no parity bit is sent at all.</p>
Stop Bits	<p>Stop bits sent at the end of every character allow the receiving signal hardware to detect the end of a character and to re-synchronize with the character stream. Options are:</p> <ul style="list-style-type: none"> • 0 • 1 • 1.5 • 2 <p>Electronic devices usually use 1 stop bit.</p>
Speed	<p>Rate of the transmission.</p>
Modem Compression	<p>Use the default values unless otherwise instructed by your service provider.</p>
Error Correction	<p>(Checked) error correction will be used when connecting to this service provider.</p>

Connection Tab

Select the Connection tab; options are as follows.

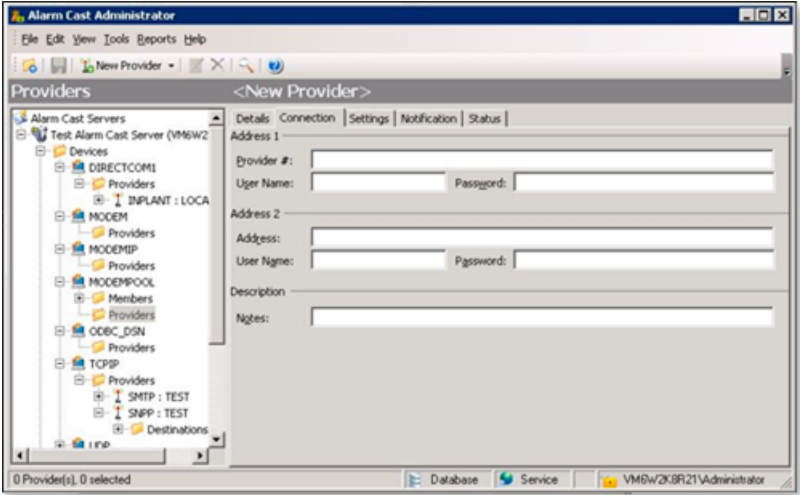

Field	Description
Address 1	
Provider #	Phone number or Internet address the messaging service provider uses to accept pages based on the coverage area.
User Name	Optional.
User Password	Optional.
Address 2	
Address	Phone number or Internet address the messaging service provider uses to accept pages based on the coverage area.
User Name	Optional.
User Password	Optional.
Description	
Notes	Optional.

4. Click Save.

The provider will be listed under the Provider folder as well as the Device - Provider sub-folder of the modem device it is associated with.

Alarm Cast Administrator Provider: TCP/IP

- Configuration: TCP/IP Procedure
- Configuration: Connection Tests

Configuration: TCP/IP Procedure

Do one of the following.

- Select the Providers folder in the Alarm Cast Administrator left-pane. Click New Provider on the toolbar. Select TCP/IP in the **Devices** field.
- Expand a **TCP/IP** device folder in the Alarm Cast Administrator left-pane. Select the **Providers** folder. Click New Provider on the toolbar.

TCP/IP is automatically selected in the **Devices** field.

TCP/IP provider tabs are as follows.

- Details Tab
- Connection Tab
- Common Tabs for Providers

Details Tab

Select the Details tab; options are as follows.

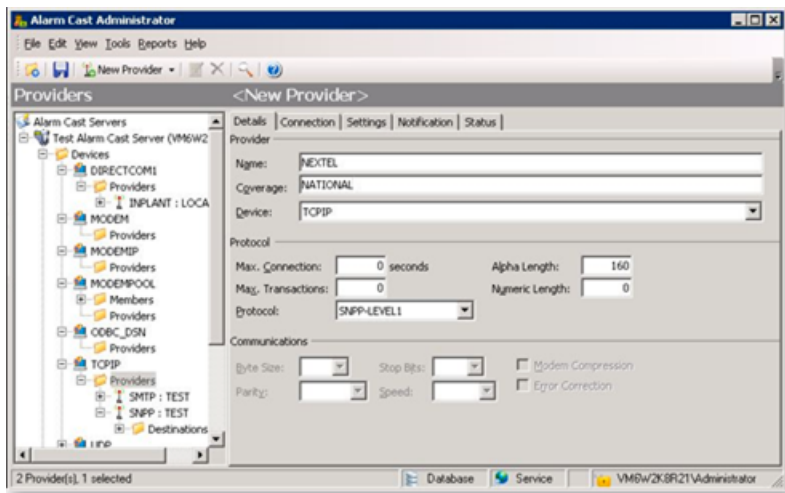

Field	Description
Server	
Name	Name associated with the provider.
Coverage	Geographical area in which the provider can deliver messages.
Device	Device to associate with this Provider. Note: Select the device from the dropdown list
Protocol	

Field	Description
Max. Connection	Maximum connection time, in seconds, Alarm Cast Server will remain connected to the provider. Typically this: <ul style="list-style-type: none"> • Specifies the maximum connection time, in seconds, allowed by the messaging service provider for the modem connection. • Controls how long the server will attempt to transmit to the provider in a single session. The entry should be slightly less than the actual time to avoid being disconnected during transmission of a message. Important If there is no maximum number, enter 0; 0 = infinite.
Max. Transactions	Maximum number of transactions that the Alarm Cast Server will perform during one connection. Some commercial service providers place a maximum on the number of messages that may be transmitted during one communication. If this is the case, enter the maximum number here so Alarm Cast Server does not exceed the threshold and get disconnected unexpectedly. Important If there is no maximum number, enter 0; 0 = infinite.
Alpha Length (page 862)	Maximum length of alphanumeric pages allowed by the provider.
Numeric Length (page 862)	Maximum length of numeric pages allowed by the provider. Messages longer than this will be split into segments and sent automatically.
Protocol	Language used for communicating with the messaging service provider. In this case, SNPP-LEVEL1.
Communications	
	Not required

Connection Tab

Select the Connection tab; options are as follows.

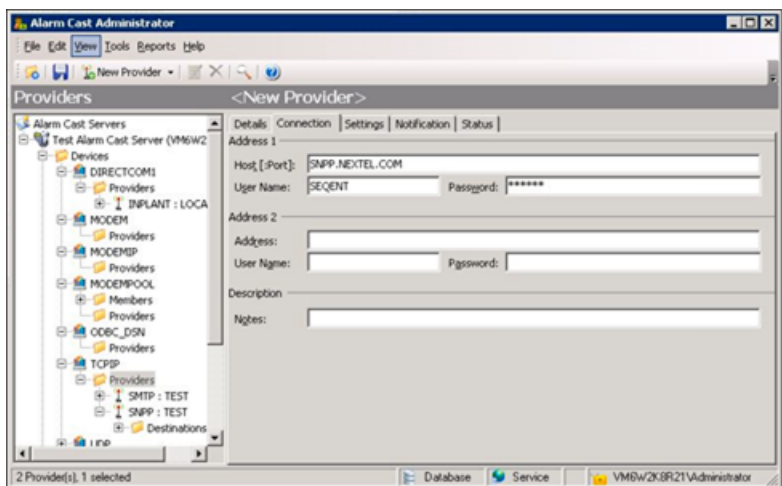

Field	Description
Address 1	

Field	Description
Host[Port]	(SNPP or OUCHPUSH type Protocol) DSN name of the provider.
	(SMTP type Protocol) Email server to send the message to the provider.
User Name	Optional.
Password	Optional.
Address 2 (for SNPP type Protocol)	
Address	Phone number or Internet address the messaging service provider uses to accept pages based on the coverage area.
User Name	Optional.
Password	Optional.
Address 2 (for SMTP type Protocol)	
From Address	Email where the message was sent. The service provider uses this address, if required, to send back a message about problems sending to the destination you specified.
Hello Domain	Domain name used to log on to the SMTP mail server specified for this provider.
Subject	Message that will be sent to the destination. Max length is 40 characters.
Description	
Notes	Optional.
Address 2 (for OUCHPUSH type Protocol)	
Service Code	Service code supplied by provider.
Originator	Specifies the phone number or name of the sender.

Click Save.

Result: The provider will be listed under the Provider folder as well as the Device - Provider sub-folder of the modem device it is associated with.

Configuration: Connection Tests

Test: SNPP

To test connection to your SNPP mail server from a DOS prompt type:

```
TELNET snppserverhostname 444 (SNPP is usually port 444)
```

It should return a string in the `ncformat` similar to the following:

```
220 SNPP Gateway Ready
```

Example

NEXTEL returns:

```
220 SNPP Gateway Ready
```

after initiating the following command:

```
C:> TELNET SNPP.NEXTEL.COM 444
```

Tag	Description
AUTH.HOST	Host or IP-address of message sender
AUTH.DOMAIN	Domain used to log in by message sender
AUTH.USER	User ID used to log in by message sender
MSG.DEST	FPS destination name
MSG.NETID	Email address of destination
SRV.HOST	FPS hostname
SRV.DATE_S	Locale specific short date format
SRV.DATE_L	Locale specific long date format
SRV.TIME	Locale specific time
SRV.TIME_12	Forced 12 hour time
SRV.TIME_24	Forced 24 hour time

Test: SMTP

If Protocol type is SMTP, a similar test can be done test connection.

To test connection to your SMTP mail server from a DOS prompt type:

```
TELNET smtpmailserverhostname 25 (mail is usually port 25)
```

It should return a string in the format:

```
220 mailservername SMTP mailserversoft version date/timestamp
```

Example

Netcon's site returns:

220 ncti103.ncti.com ESMTP Sendmail 8.11.3nb1/8.11.1;Mon, 22 Sep 2003 22:08:22-0400 (EDT)

after initiating the following command:

C:> TELNET SMTP.NCTI.COM 25

Alarm Cast Administrator Provider: UDP

1. Do one of the following.
 - Select the Providers folder in the Alarm Cast Administrator left-pane.
 - a. Click New Provider on the toolbar.
 - b. Select UDP in the **Devices** field.
 - Expand an **UDP** device folder in the Alarm Cast Administrator left-pane.
 - a. Select the **Providers** folder.
 - b. Click New Provider on the toolbar.

UDP is automatically selected in the **Devices** field.

UDP provider tabs are as follows.

- Details Tab
- Connection Tab
- Common Tabs for Providers

Details Tab

Select the Details tab; options are as follows.

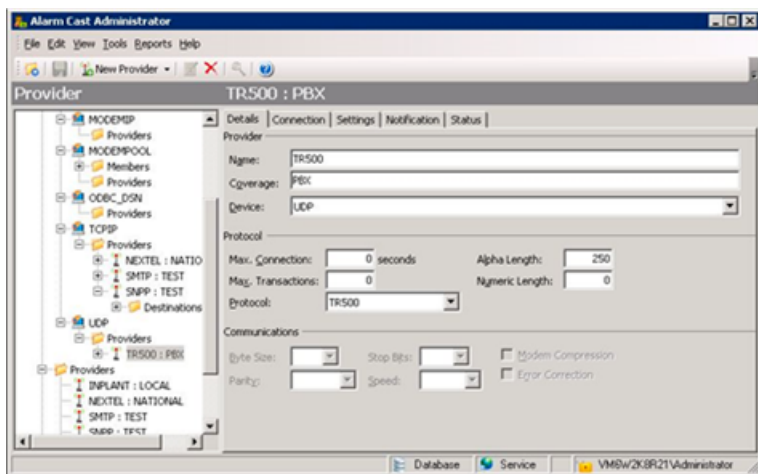

Field	Description
Server	

Field	Description
Name	Name associated with the provider.
Coverage	Geographical area in which the provider can deliver messages.
Device	Device to associate with this Provider. Note: Select the device from the dropdown list
Protocol	
Max. Connection	Maximum connection time, in seconds, Alarm Cast Server will remain connected to the provider. Typically this: <ul style="list-style-type: none"> • Specifies the maximum connection time, in seconds, allowed by the messaging service provider for the modem connection. • Controls how long the server will attempt to transmit to the provider in a single session. The entry should be slightly less than the actual time to avoid being disconnected during transmission of a message. Important If there is no maximum number, enter 0; 0 = infinite.
Max. Transactions	Maximum number of transactions that the Alarm Cast Server will perform during one connection. Some commercial service providers place a maximum on the number of messages that may be transmitted during one communication. If this is the case, enter the maximum number here so Alarm Cast Server does not exceed the threshold and get disconnected unexpectedly. Important If there is no maximum number, enter 0; 0 = infinite.
Alpha Length (page 862)	Maximum length of alphanumeric pages allowed by the provider.
Numeric Length (page 862)	Maximum length of numeric pages allowed by the provider. Messages longer than this will be split into segments and sent automatically.
Protocol	Language used for communicating with the messaging service provider. In this case, SNPP-LEVEL1.
Communications	
	Not required.

Connection Tab

Select the Connection tab; options are as follows.

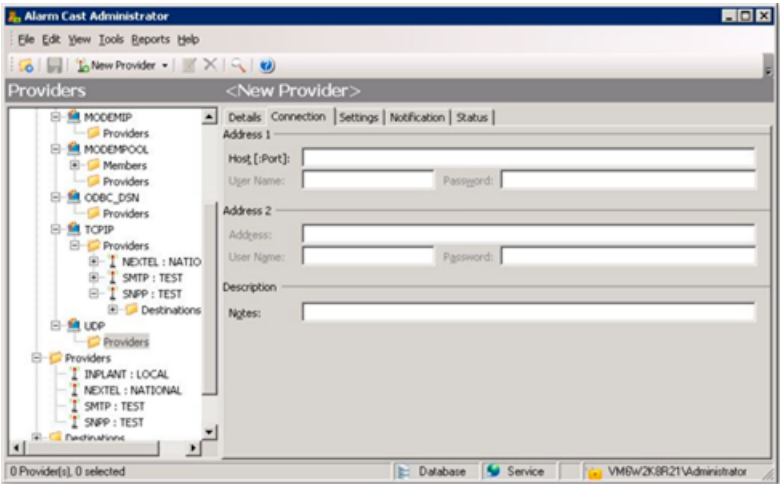

Field	Description
Address 1	
Host[Port]	DSN name of the provider.
User Name	Optional.
User Password	Optional.
Address 2	
Address	Not applicable.
User Name	Optional.
User Password	Optional.
Description	
Notes	Optional.

2. Click Save.

The provider will be listed under the Provider folder as well as the Device - Provider sub-folder of the modem device it is associated with.

Alarm Cast Administrator Provider: Alpha and Numeric Lengths

The following tables lists the minimum and maximum alpha and numeric lengths for selected protocols.

Protocol	Minimum	Maximum
ANS	5	250
ASCOM	5	160
HARK3IDS	5	250
HARKBANNER	5	250
IXO	5	250
PET	5	250
MS-SPEECH	5	250
OUCHPUSH	5	150
SMS	5	160
SMTP	5	250
SMTP-FORDAU	5	250
SNPP	5	160

Protocol	Minimum	Maximum
TAP	5	250
TP500	5	128
UCP	5	160

Alarm Cast Administrator Provider: Wizard

1. A new Provider can also be added using the Wizard which guides the user through the required fields for each device type.

1. Click File>New on the Alarm Cast Administrator menu bar.

A New Item screen opens.

2. Do the following.

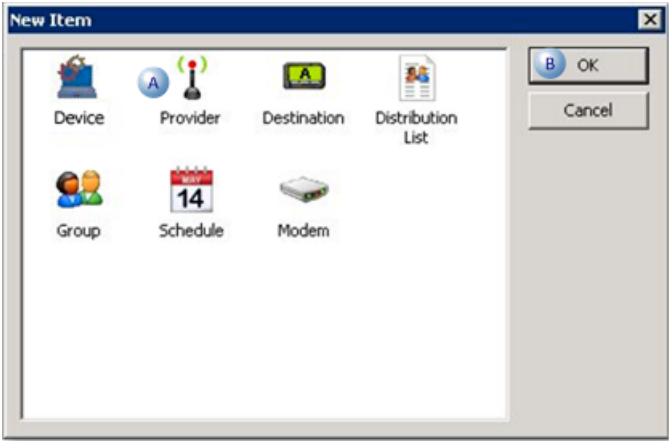

A	Select Provider .
B	Click OK.

A Select Server screen opens.

3. Do the following.

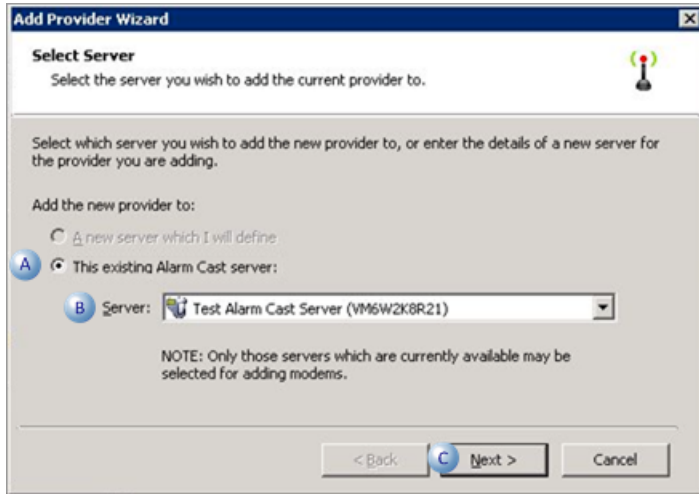

A	Check This existing Alarm Cast server:
B	Select the server to which the provider will be added.
C	Click Next.

A Select Device screen opens.

4. Do the following.

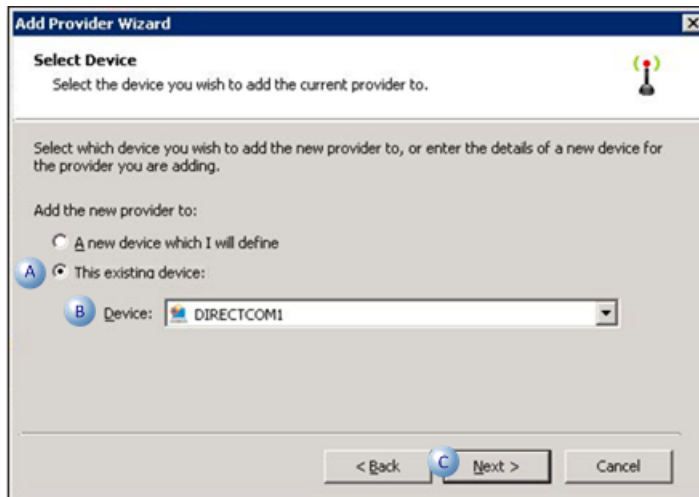

A	Check This existing device:
B	Select the device to which the provider will be added.
C	Click Next.

The Provider Identification screen opens.

a. Do the following.

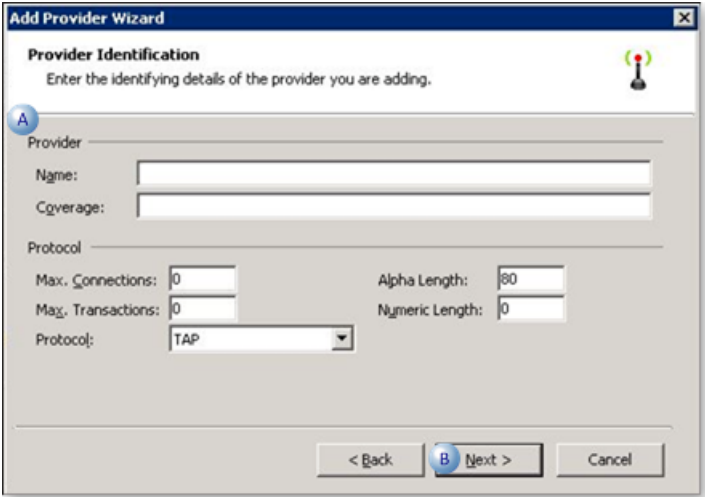

A	Enter the specifications that are also on the provider's Details tab in the Alarm Cast Administrator.
B	Click Next.

The Provider Addresses opens.

- a. Do the following.

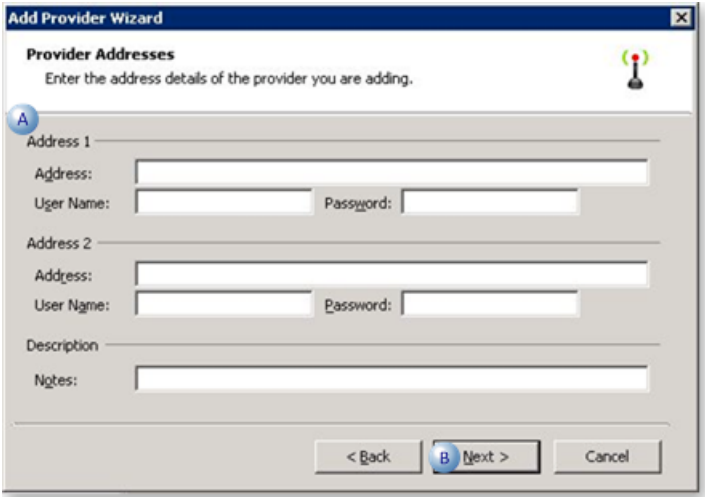

A	Enter the specifications that are also on the provider's Connection tab in the Alarm Cast Administrator.
B	Click Next.

A summary of the provider details will display. If the information is not correct, click the Back button to edit details.

- 5. Click Finish to add the new provider to the Alarm Cast Administrator.

The provider will now be listed under the Devices folder and the Provider's folder in the Alarm Cast Administrator left-pane.

Alarm Cast Administrator Destinations

Alarm Cast Administrator Destinations

A Destination:

- Contains information pertaining to destinations and their configuration settings.
- Is a messaging service such as a pager, mobile phone or a database or e-mail account.
- Will be available in the Alarm Cast Alarm Administrator window.

By selecting the destinations folder you can add destinations to the system and modify their settings.

1. Click the **Destinations** folder in the Alarm Cast Administrator left-pane.
2. Click New Destination on the toolbar.

Destination configuration includes the following tabs.

- Details tab.
- Aliases tab.

Details Tab

Select the Details tab; options are as follows.

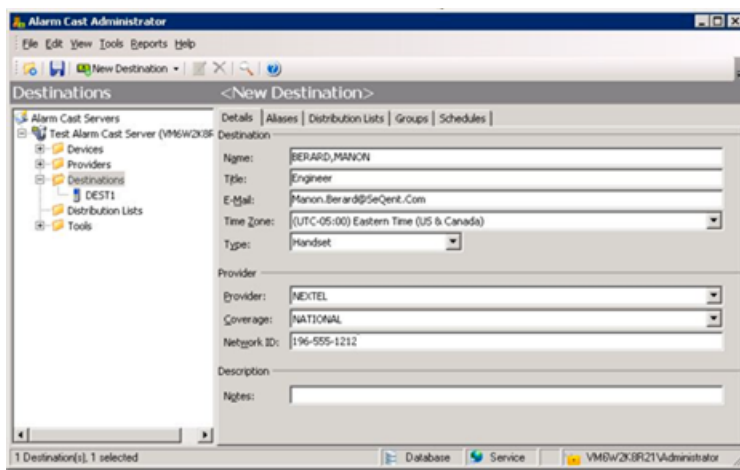

Description

Destination **Note:** Administrative section; entries are not functional.

Name	Description
	Logical name utilized by the administrator to refer to this destination.

Description		
Title	Optional.	
E-Mail	Optional Note: For administrative use only; the destination that is used is entered in the Network ID field.	
Time Zone	Time Zone name that the destination resides in. Default is the Alarm Cast Administrator workstation time zone.  Note: <ul style="list-style-type: none"> • The Time Zone can be changed in the Time Zone field. • Time Zone is used when determining when schedules apply to destinations. 	
Type	Medium for receiving messages for this destination.	
	Alpha Pager	Alphabetic text.
	Numeric Pager	Only numerals (i.e. 0-9).
	Handset	Alphabetic text and numbers Example: Handset A handheld mobile multifunction device such as a Nextel handset.
	Email	Alphabetic text and number to a destination's email address.
	Unknown	Destination device type is unknown, and assumed to be alpha numeric.
Provider		
Provider	Known Providers that have been added to each Device type.	
Coverage	Geographical area in which the provider can deliver messages.	
Network ID	Provider's user ID number. See table below.	
Description		
Notes	Optional	

The following table outlines the Network ID for each Protocol type:

Protocol	Network ID
ANS	Numeric ID
ASCOM	Telephone Handset Number
HARBANNER	Numeric ID
HARK3IDS	Numeric ID
IXO	Numeric ID
PET	Numeric ID
MS-SPEECH	Numeric ID
SMS	Numeric ID

SMTP	Email address
SMTP-FORDAU	Numeric ID
SNPP	Numeric ID
TAP	Numeric ID
UCP	Numeric ID
TR500	Subscriber Number (a group number should be preceded with an "@" symbol

Aliases Tab

Select the Aliases tab; options are as follows.

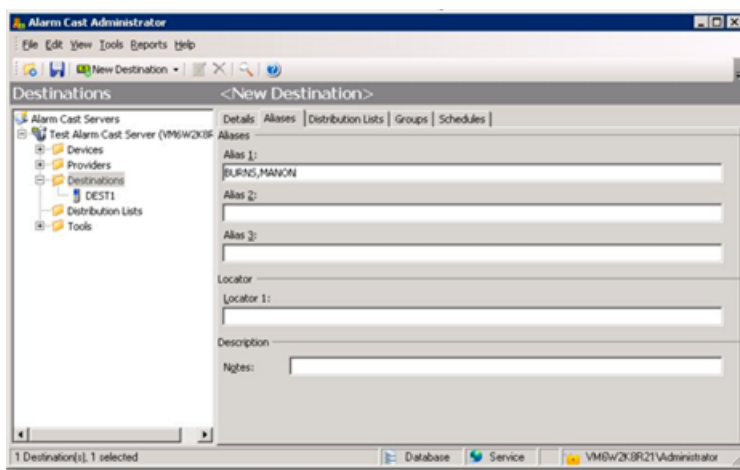

Field	Description
Aliases	
Alias 1	Alternate name that can be used for each destination. Aliases may be typed in place of the full destinations name in the Alarm Cast Client.
Alias 2	Alternate name that can be used for each destination. Aliases may be typed in place of the full destinations name in the Alarm Cast Client.
Alias 3	Alternate name that can be used for each destination. Aliases may be typed in place of the full destinations name in the Alarm Cast Client.
Locator	
Locator 1	Reference field only which usually signifies the location of the pager. Example PLANTFLOOR
Description	
Notes	Optional

3. Click Save.

The Destination will now be listed in the Destinations folder. By selecting the Destinations folder, all of the destinations will be visible in the working pane.

 **Note: Guidelines**

- It is advisable to test the new destination connection to the provider.

Click the Test button on the Alarm Cast Administrator toolbar.

Alarm Cast will send a test message to the destination and notify of success or failure.

- Details of the message can be viewed from the Message Log.
- The Distribution Lists, Groups, and Schedules tabs on a new Destination will not be populated until they are first added to the Administrator.

Alarm Cast Administrator Destinations: Wizard

1. A new destination can also be added using the Wizard, which guides the user through the required fields for each device type.

1. Click File>New on the Alarm Cast Administrator menu bar.

A New Item screen opens.

2. Do the following.

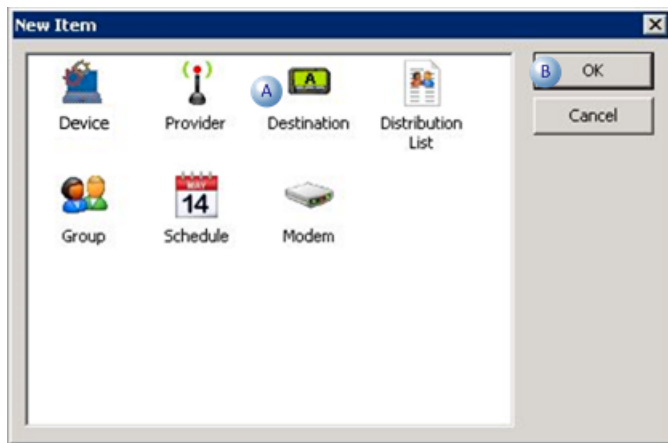

A	Select Destination .
B	Click OK.

A Select Server screen opens.

3. Do the following.

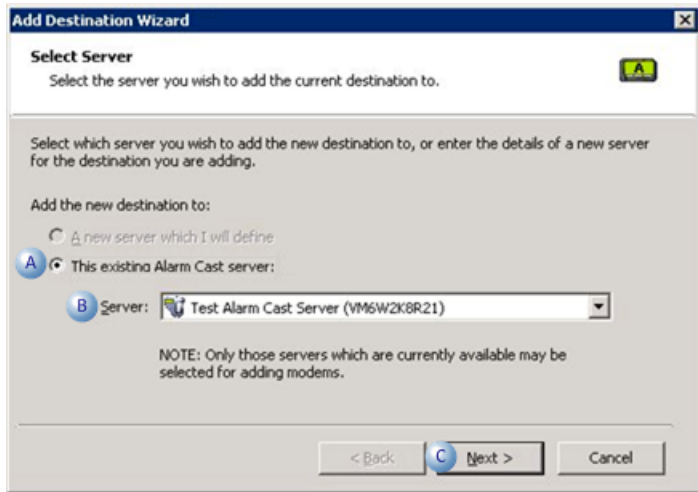

A	Check This existing Alarm Cast server:
B	Select the server to which the destination will be added.
C	Click Next.

A Select Device screen opens.

4. Do the following.

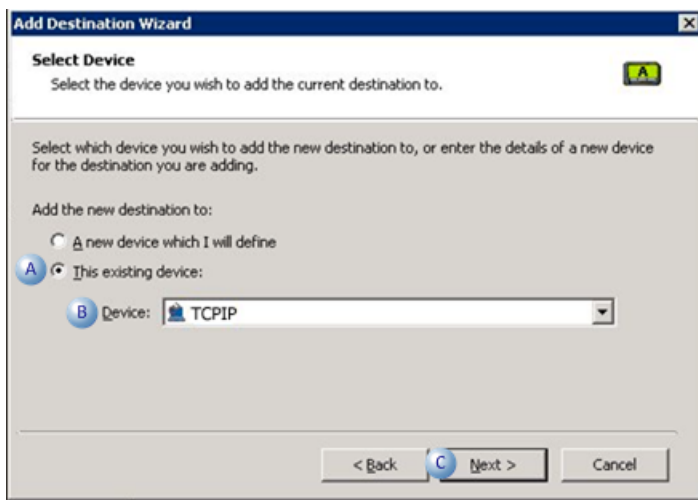

A	Check This existing device:
B	Select the device to which the destination will be added.
C	Click Next.

A Select Provider screen opens.

5. Do the following.

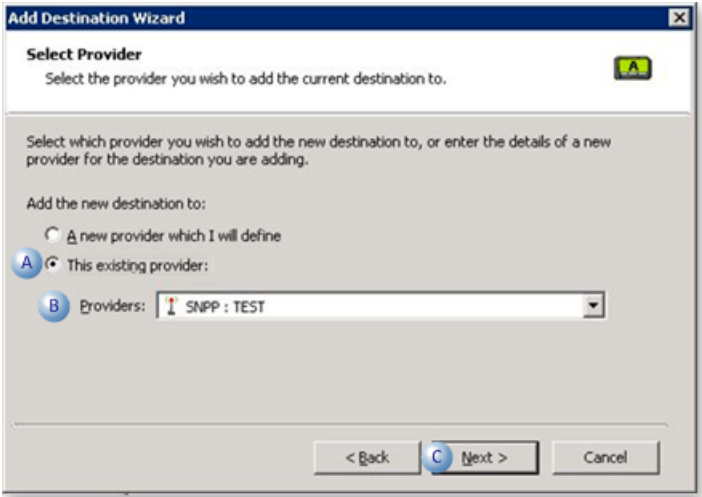

A	Check This existing provider:
B	Select the provider to which the Destination will be added
C	Click Next.

The next screen contains all the information that appears on the Destination’s Details tab.

Note: If the information is not correct, click the Back button to edit details.

- 6. Click Finish to add the new destination to the Alarm Cast Administrator.

The destination will now be listed under the Destinations folder in the Alarm Cast Administrator left-pane.

.More information

- Alarm Cast Administrator destinations.

Alarm Cast Administrator Distribution Lists

Alarm Cast Administrator Distribution Lists

1. Click the **Distribution Lists** folder in the Alarm Cast Administrator left-pane.
2. Click New Distribution List on the toolbar.

Distribution configuration includes the following tabs.

- Details tab.
- Schedules tab.

Details Tab

Select the Details tab; options are as follows.

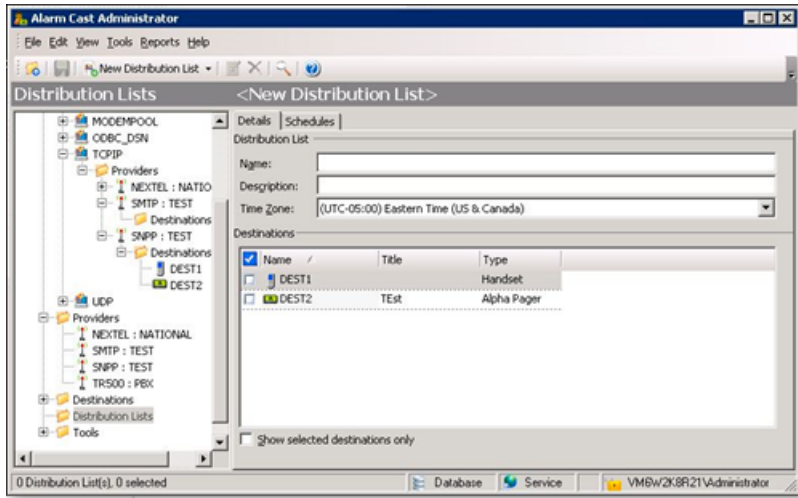

Field	Description
Distribution List	
Name	(Logical name) utilized by the administrator to refer to this distribution list.
Description	Optional.
Time Zone	Time Zone name that the destination resides in. Default is the Alarm Cast Administrator workstation time zone.  Note: <ul style="list-style-type: none"> The Time Zone can be changed in the Time Zone field. Time Zone is used when determining when schedules apply to destinations.
Destinations	
Name	Checked destination names will be members of this distribution list.

 **Tip:** Check Show selected destinations only to filter the destinations list.

Schedules Tab

Select the Schedules tab.

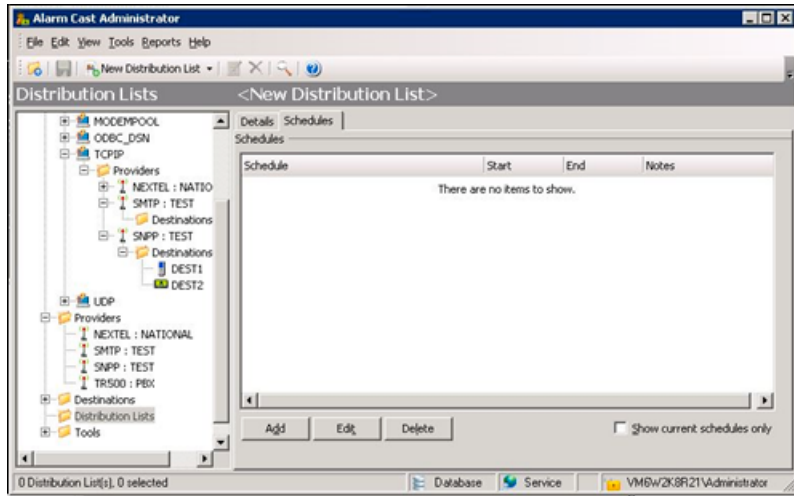

Schedule details must first be added via the Tools folder before assigning distribution lists.

3. Click Save.

The distribution list will now be listed under the Distribution Lists folder in the tree view. By selecting the Distribution Lists folder, all of the devices will be visible in the working pane.

i Tip: You can also add a Destination to a Distribution List by selecting the destination through the Devices folder then selecting the Distribution Lists tab for a list of already configured distribution lists.

Alarm Cast Administrator Distribution Lists: Wizard

A new distribution list can also be added using the Wizard which guides the user through the required fields for each provider type.

1. Click File>New on the Alarm Cast Administrator menu bar.

A New Item screen opens.

1. Do the following.

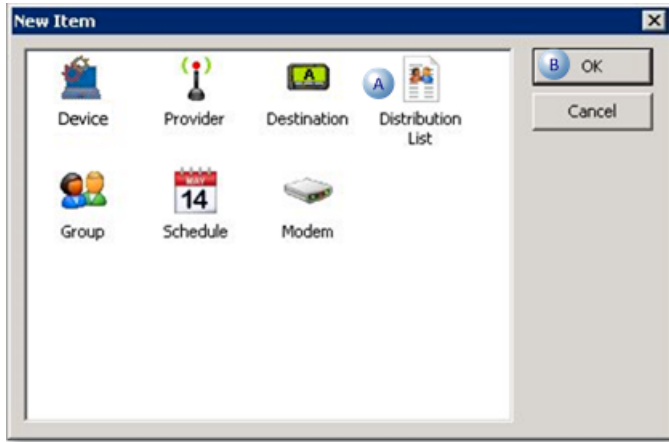

A	Select Distribution List .
B	Click OK.

A Select Server screen opens.

2. Do the following.

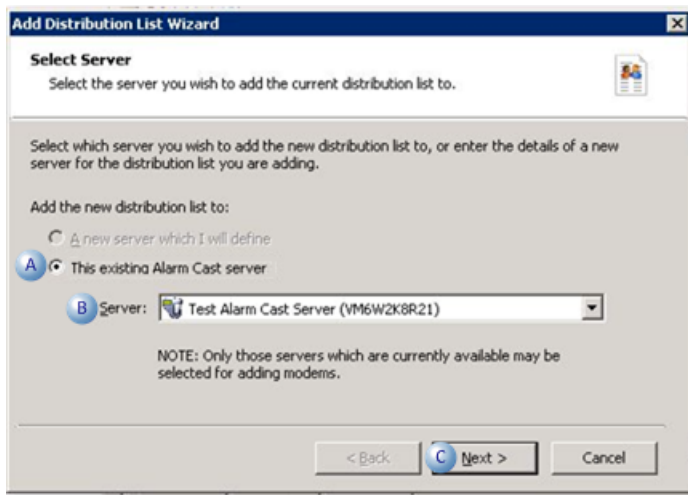

A	Check This existing Alarm Cast server:
B	Select the server to which the distribution list will be added.
C	Click Next.

A Distribution List Identification screen opens.

3. Do the following.

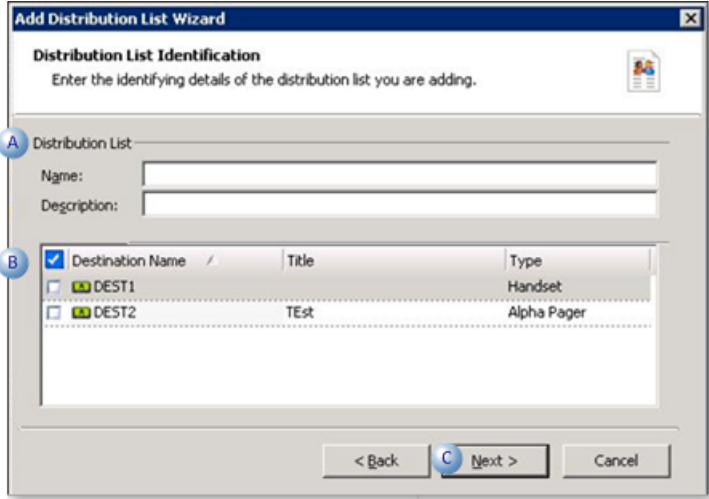

A	Enter a name for the distribution list:
B	Check destinations that will be added to this distribution list.
C	Click Next.

A summary of the distribution list details will display.

If the information is not correct, click the Back button to edit details.

4. Click Finish to add the new distribution list to the Alarm Cast Administrator.

The distribution list will now be visible under the Distribution Lists folder in the tree view. By selecting the Distribution Lists folder, all of the devices will be visible in the working pane.

i Tip: You can also add a Destination to a Distribution List by selecting the destination through the Devices folder then selecting the Distribution Lists tab for a list of already configured distribution lists.

Alarm Cast Administrator Tools

Alarm Cast Administrator Tools

Alarm Cast Administrator comes equipped with additional tools that allow a user to configure Groups, Schedules and Phrases. The tools are conveniently displayed in the tree view in the Tools folder.

- Alarm Cast Administrator Tools: Groups.
- Alarm Cast Administrator Tools: Schedules.

- Alarm Cast Administrator Tools: Users

Alarm Cast Administrator Tools: Groups

A Group enables you to control more than one configured destination in a single package.

Adding destinations to groups provides a limitation on the available list of destinations to control, to which destinations a client can send messages.

1. Expand the **Tools** folder.
2. Select the Groups folder in the Alarm Cast Administrator left-pane.
3. Click New Group on the Alarm Cast Administrator toolbar.

A Details tab displays; group options are as follows.

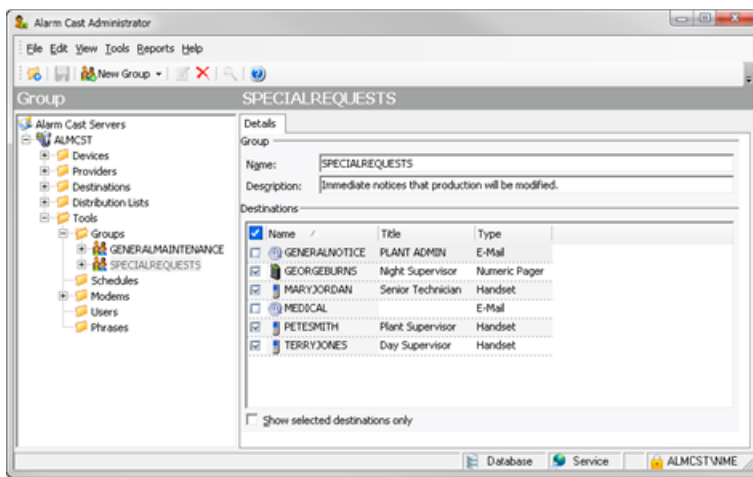

Field	Description
Group	
Name	Name of the Group.
Description	Optional
Destination	
Name	Checked destination names will be members of this distribution list.

 **Tip:** Check Show selected destinations only to filter the destinations list.

Click Save.

The Group will now be visible under the Groups folder in the tree view. By selecting the Groups folder, all of the groups will be visible in the working pane.

Registry Setting

A registry setting has been created during the Alarm Cast server installation to enable you to exclude or include various groups in Alarm Cast Client. This enables you to filter out the list of available destinations that are available for paging in Alarm Cast Client.

Open the Registry Editor (regedit.exe) on the Alarm Cast server.

Select the following:

```
HKEY_LOCAL_MACHINE\SOFTWARE\NETCON\Alarm Cast\  
Client\Config
```

Double click the Group List key to enter which groups to exclude or include in Alarm Cast Client.

Groups are excluded/included, as follows.

Exclude/Include	Enter as:
Exclude	<code>-GROUPNAME</code>
Include	<code>GROUPNAME</code>

Example

Two groups have been created in Alarm Cast Administrator:

- SUPPORT (containing DEST1, DEST2 and DEST3)
- TEST (containing DEST1, DEST4 and DEST5)

Exclude/Include	Enter :
Exclude the groups	<code>-TEST</code> This removes DEST1, DEST2, DEST4 and DEST5 from the list.
Include the groups	<code>SUPPORT</code> DEST1, DEST2 and DEST3 will be included in the list.

Alarm Cast Administrator Tools: Schedules

1. Expand the **Tools** folder.
2. Select the **Schedules** folder in the Alarm Cast Administrator left-pane.
3. Click New Schedule on the Alarm Cast Administrator toolbar.

A Details tab displays; schedule detail options are:

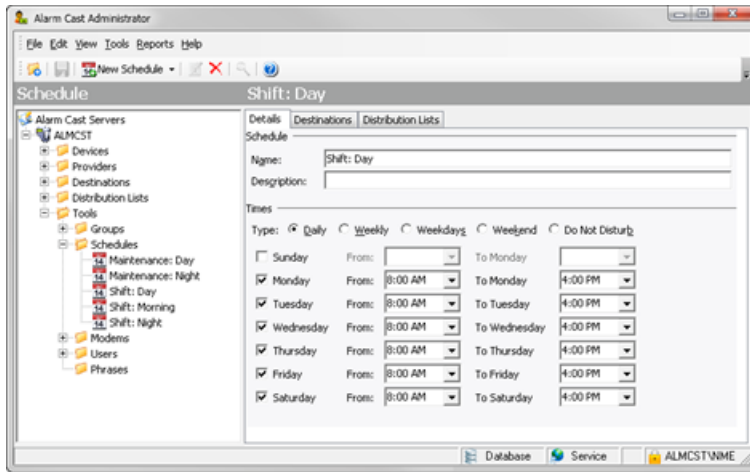

Field	Description
Schedule	
Name	Name associated with the Schedule.
Description	Optional
Times	
Type	<p>Schedule type options are:</p> <ul style="list-style-type: none"> • Daily • Weekly • Weekdays • Weekend • Do Not Disturb. <p>Do either of the following.</p> <ul style="list-style-type: none"> • Use the dropdown menu options. <p>Time is in 30 Min. increments.</p> <ul style="list-style-type: none"> • Type in your own time. <p>Important: The schedule details must be saved before adding Destinations</p>

4. Select the Destinations tab.

5. Click the Add button to add destinations to the schedule.

An Assign Schedule Wizard opens; a Source screen displays.

Selection tools are as follows.

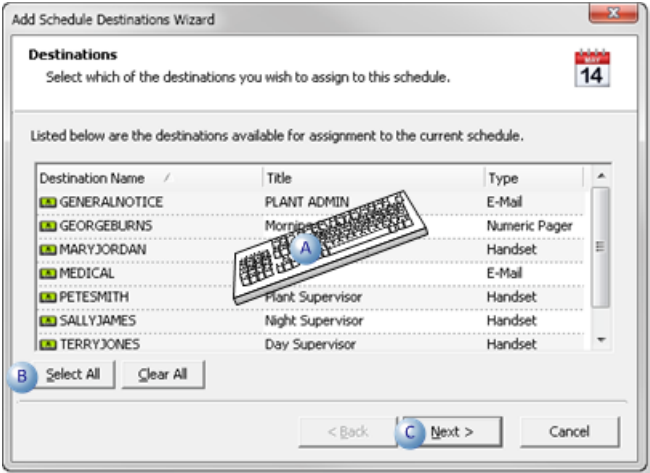

A	Press Ctrl or Shift to multi-select the desired destinations.
B	Click the Select All button to add all destinations.
C	Click Next.

A Schedule Dates screen opens.

6. Do the following.

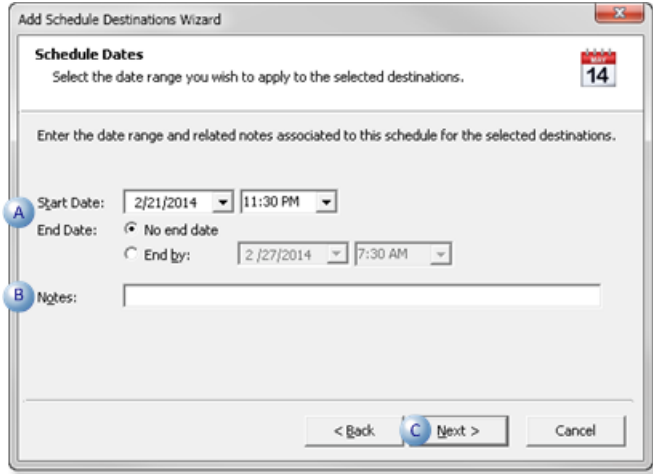

A	Select the Start and End Date for the Schedule
B	(Optional) Enter a note about the selected schedule dates.
C	Click Next.

A summary of the schedule details will display.

If the information is not correct, click the Back button to edit details.

7. Click Finish to add the new schedule to the Alarm Cast Administrator.

Result: The schedule will now be listed under the Tools Schedules folder in the Alarm Cast Administrator left-pane.

New Schedule Wizard (Alternative Launch)

The New Schedule Wizard can also be opened through the New Item screen.

8. Click File>New on the Alarm Cast Administrator menu bar.

A New Item screen opens.

9. Do the following.

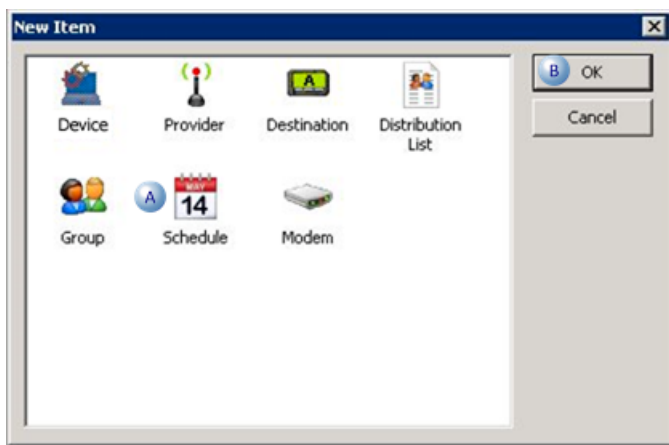

A	Select Schedule .
B	Click OK.

A Select Server screen opens.

10. Do the following.

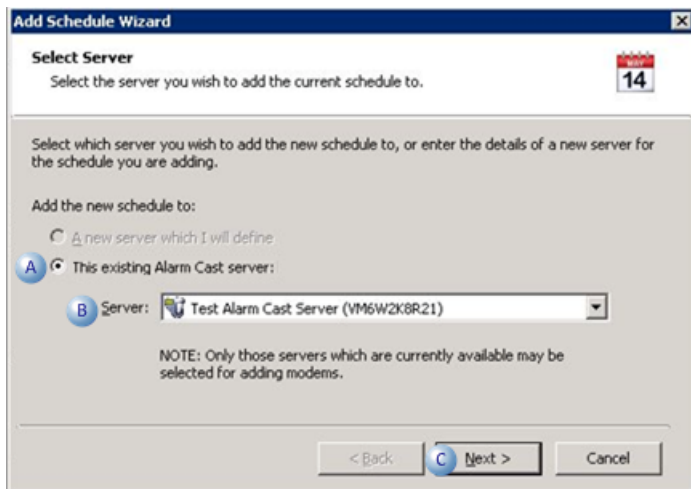

A	Check This existing Alarm Cast server:
B	Select the server to which the schedule will be added.
C	Click Next.

A Schedule Identification screen opens.

11. Do the following.

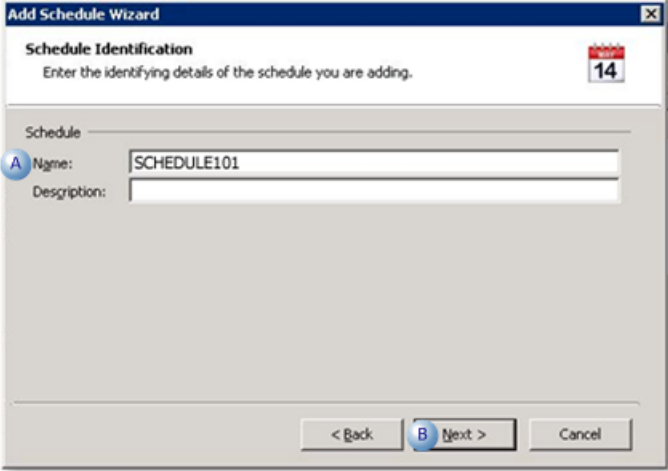

A	Enter a name for the schedule.
B	Click Next.

A Schedule Times screen opens.

12. Do the following.

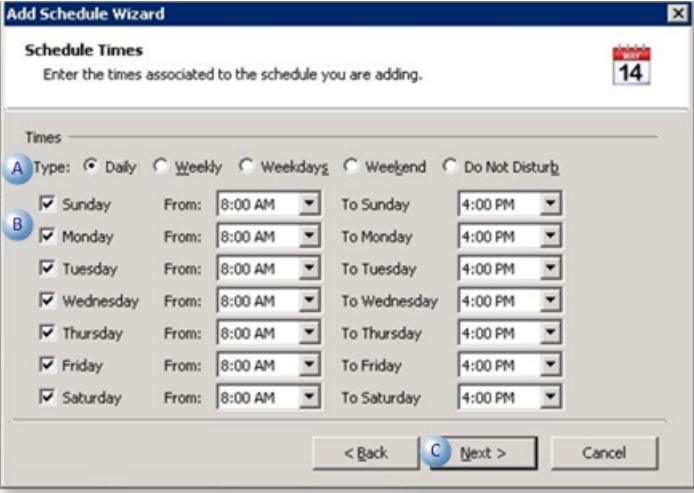

A	Check the schedule type; options are: <ul style="list-style-type: none"> • Daily • Weekly • Weekdays • Weekend • Do Not Disturb <p>Note: The Do Not Disturb type is a schedule that can be set up to suppress a currently active schedule. Example An employee works Jan 1 – Mar 15 and wants to take a vacation Mar 16 – Mar 23. The employee will continue to get paged during holiday unless a Do Not Disturb schedule is created, like or similar to the following.</p>	
	MORNING	Jan 1 – Mar15
	Do Not Disturb	Mar 16 – Mar 23
	AFTERNOON	Mar 24 – June 31
	Do Not Disturb	July 1 – July 20
	In these sample schedules, the employee would not receive any pages during the Do Not Disturb periods, but paging would resume during the regular schedules of MORNING and AFTERNOON.	
B	Enter schedules for the selected type times.	
C	Click Next.	

A summary of the schedule details will display.

If the information is not correct, click the Back button to edit details.

13. Click Finish to add the new schedule to the Alarm Cast Administrator.

Result: The Schedule will now be listed in the tree view under the Tools, Schedules folder.

Add a Group, Schedule or Phrase

Alarm Cast Administrator comes equipped with additional tools that allow a user to configure Groups, Schedules and Phrases. It is conveniently displayed in the tree view under the Tools folder.

The schedules option only displays if the required license key is entered on the Server’s Settings tab. The **Tools** folder contains the following options:

- Groups
- Schedules
- Modems
- Users
- Phrases

There are two ways to add Tools Options.

Method 1

Add Tools Options directly under the Destination through either of the following.

- Device>Provider>Destination.
- Destinations folder.

- 14. Select the Destinations folder.
- 15. Select the destination to be configured.
- 16. Click the Groups or Schedules tabs to configure these options.

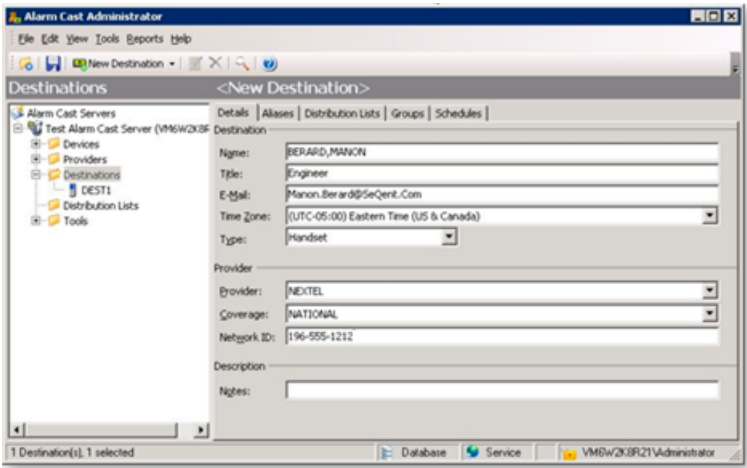

Method 2

- 17. Select the Tools folder
- 18. Select the options to configure from the available folders.
- 19. Click the Groups folder to add a new Group.

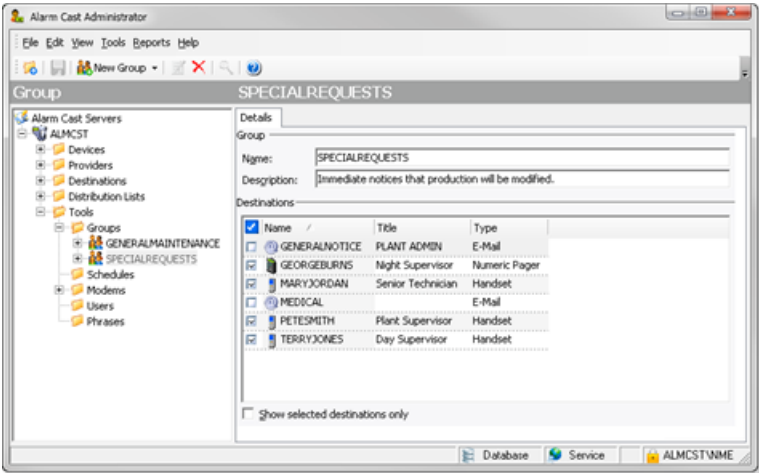

Note: Modems and Users may already be populated if they have already been added.

Alarm Cast Administrator Tools: Users

If Windows or Windows Trusted is selected for the server security, a Users folder is added to the Tools tree, if it was not already there.

! Important:

- Security is configured separately in the Alarm Cast components:
- Alarm Cast Administrator
- Alarm Cast Alarm Administrator
- Alarm Cast Gateway
- Alarm Cast Client authenticates against configured Alarm Cast Administrator users when Security is enabled.

Alarm Cast Administrator: New User

Do the following.

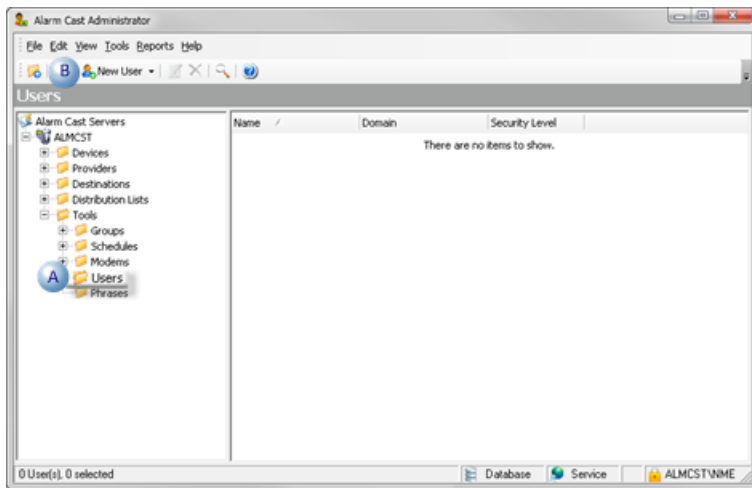

A	Select Users in the Alarm Cast Administrator window left-pane.
B	Click New User on the Alarm Cast Administrator window toolbar.

Result: Tabs for the User profile display in the Alarm Cast Administrator right-pane.

Alarm Cast Administrator: User Configuration

User configuration includes the following tabs.

- Details Tab
- Destinations Tab
- Distribution Lists Tab

- Preferences Tab

Details Tab

Select the Details tab; details options to register users are as follows.

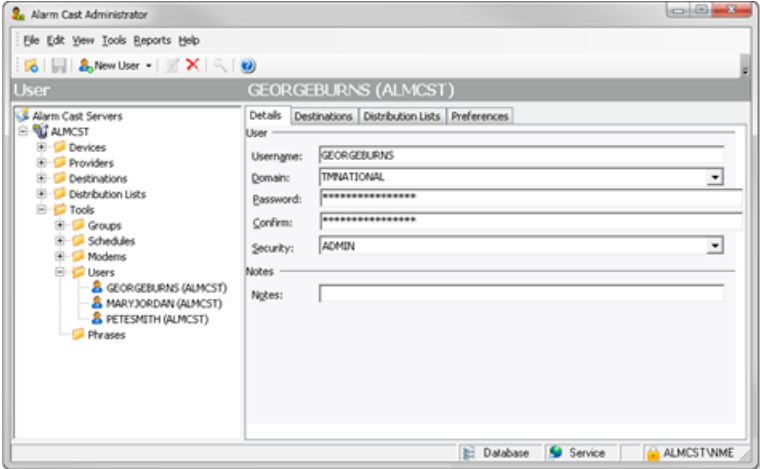

Field	Description	
User		
Username	Valid Windows user.	
Domain	Domain the user logs into.	
Password	(Required with Windows Security) Password assigned to the logged in Windows user.	
Confirm	(Required with Windows Security) Re-entered password	
Security	Security levels are as follows.	
	ADMIN	Full rights to all features. ! Important: : The ADMIN security level is required to access (open) applications. For almost all instances, it is recommended that ADMIN be assigned to registered Alarm Cast users.
	DEFAULT	Can access only the Alarm Cast Client to send a manual message.
Notes		
Notes	(Optional) Additional details about or for the user.	

Destinations Tab

Select the Destinations tab; do the following.

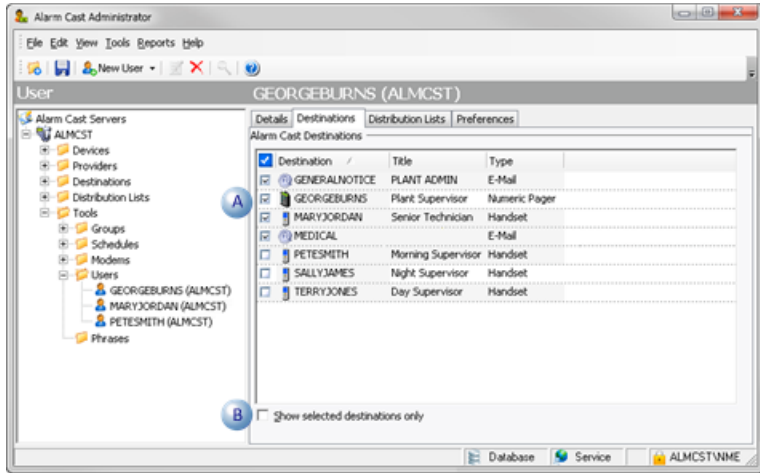

- | | |
|---|--|
| A | Check the destinations for the selected user's notices. |
| B | (Optional) Check to display only the checked destinations. |

Distribution Lists Tab

Select the Distribution Lists tab; do the following.

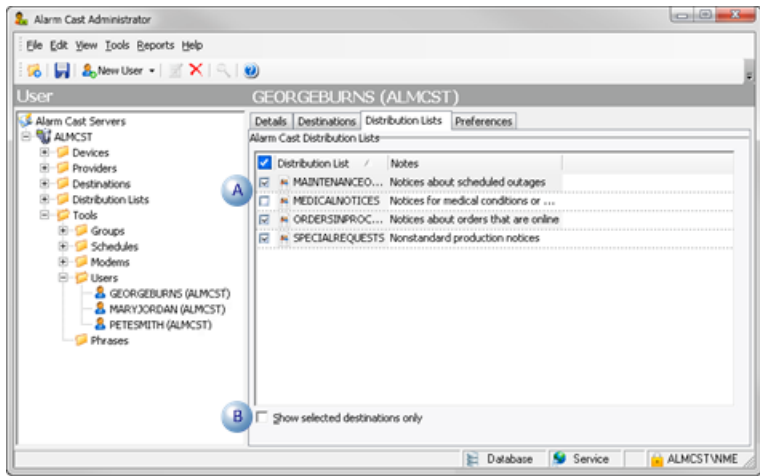

- | | |
|---|--|
| A | Check the distribution lists for the selected user's notices. |
| B | (Optional) Check to display only the checked distribution lists. |

Preferences Tab

Select the Preferences tab; options for the registered user are as follows.

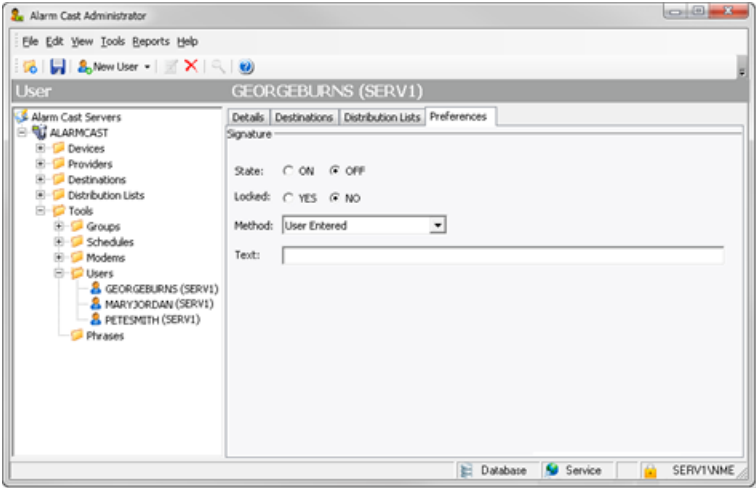

Field	Description	
Signature		
State	VOptions for manual messages being dispatched from the Alarm Cast Client are as follows.	
	ON	Includes the signature.
	OFF	Does not include the signature.
Locked	Options to control editing the signature are as follows.	
	YES	The signature cannot be edited; it is locked.
	NO	The signature can be edited; it is unlocked.
Method	Signature sources can be any of the following.	
	Authenticated User	Login user name.
	Environment Variable	Defined windows variable used as a signature
	User Entered	Typed literal text from the Text field (below).
Text	User entered text. Note: The text is used as the signature when the: <ul style="list-style-type: none"> • State is On. • Method is User Entered. 	

Alarm Cast Administrator Other Tools

Alarm Cast Administrator Other Tools

The Alarm Cast Administrator provides other tools that can be accessed through the Alarm Cast Administrator menu bar.

- Alarm Cast Administrator Other Tools: Toolbar and Tree.
- Alarm Cast Administrator Other Tools: Options.
- Alarm Cast Administrator Other Tools: Reports.
- Alarm Cast Administrator Other Tools: Log Files

Alarm Cast Administrator Other Tools: Toolbar and Tree

The Alarm Cast Administrator user interface is conveniently displayed in a tree view. The Server, when expanded, shows folders for Devices, Providers, Destinations, and Distribution Lists. They enable the user to add information about the devices the server will use to communicate with the destinations and will serve as shortcuts to already configured Destinations and Distribution Lists, allowing the user to quickly locate this information without knowing the device that supports them.

Under the Devices folder, there will be a Provider folder which contains the providers set up under that particular device. The same providers are also listed under the main Provider folder.

Under the Providers folder, there will be Destinations folder which contains the destinations set up under that particular provider. The same destinations are also listed under the main Destinations folder.

The Distribution Lists folder also contains a Destinations folder which contains the destinations included under each particular list.

Anything created on the tree view side of the screen (left-pane) can be modified or deleted at any time. You can also change the state to disable.

Tree View Items: Modify

Select the item you want to alter. The information regarding it will show up on the right hand side of the screen. At this point, you can change the name along with any other variables attached to it (e.g. configuration settings etc.)When you save your changes, they will appear in the Tree View.

 **Important:** Information regarding manufacturer or models, cannot be altered. Once the modified information has been saved, you cannot revert to the old information. The only way to retrieve it is to change it back to its original state.

Tree View Items: Delete

There are two ways to delete items on the Tree View side of your screen. By selecting the item you want to delete, you can choose Edit >Delete on the Menu bar or simply click the red **Delete** symbol (X).

! **Important:** You cannot recover any deleted item or any information attached to it. You must recreate it.

In certain applications, if a particular item is being used in another part of the application, you will not be able to delete it at that level. You must go further down in the Tree View to discern where it is being used, and delete it there first.

Alarm Cast Administrator Other Tools: Options

The Tools menu enables users to set Alarm Cast Server options and details.

Click the Tools>Options on the Alarm Cast Administrator menu bar.

An Options dialog box opens; options tabs are as follows.

- Details tab.
- Preference tab.

Details Tab

Select the Details tab.

Options are as follows.

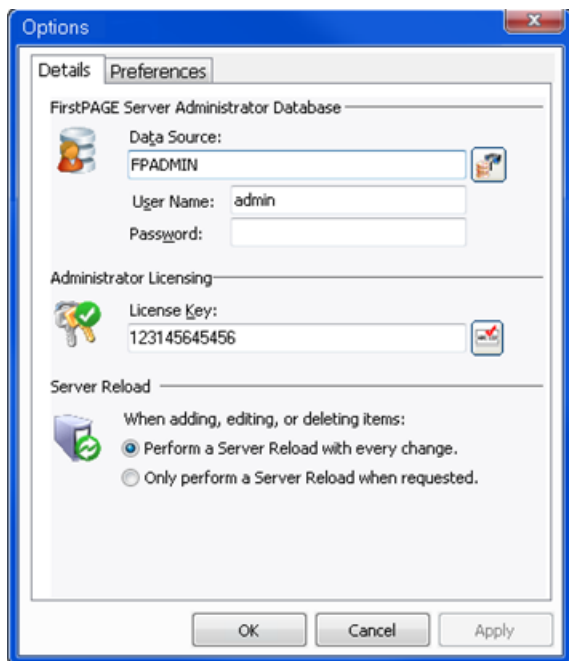

Option	Description	
Data Source	Provides the Alarm Cast Server database and user/password requirement.	
License key.	Enter the license key. Note: The key determines the number of servers that can be configured.	
Server Reload	Provides the option to reload the server with any additions, edits or deletions automatically or when requested by the user.	
	Reload with every change	Reload will occur when the Save button is clicked.
	Reload only when requested	Alarm Cast will report that there are data changes with the option to either: <ul style="list-style-type: none"> • Send the reload before closing • Close the system without reloading the changes.

Preferences Tab

Select the Preferences tab in the Options dialog box.

Options are as follows.

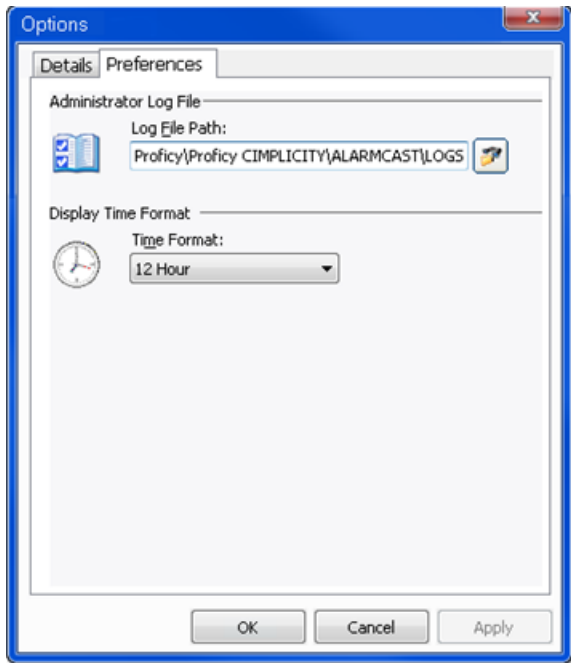

Option	Description
Log File Path	Identifies the Log File path. Example C:\Proficy\Proficy CIMPLICITY\ALARMCAST\LOGS

Option	Description
Time Format	Identifies the default format for time. Note: Change the Display Time Format and Inactivity Timeout according to your system needs.

Alarm Cast Administrator Other Tools: Reports

The Reports menu enables users to view and print various reports on configured devices, providers, destinations or aliases.

1. Click Reports on the Alarm Cast Administrator menu bar.
2. Select a report to view or print.

Reports display the following.

- Devices report displays devices that have been configured, including:
 - Audio, Database
 - Direct
 - Modem
 - Modem Pool
 - Modem IP
 - TCP/IP
 - UDP.
- Providers report displays the providers that have been configured such SJNPP or SMTP type providers.
- Destinations report displays each destination and the provider they are configured to.
- Aliases report displays all configured aliases that have been assigned to each destination.

Alarm Cast Administrator Other Tools: Log Files

1. Select View>View Logs on the Alarm Cast Administrator menu bar.
2. Click the log to be viewed.

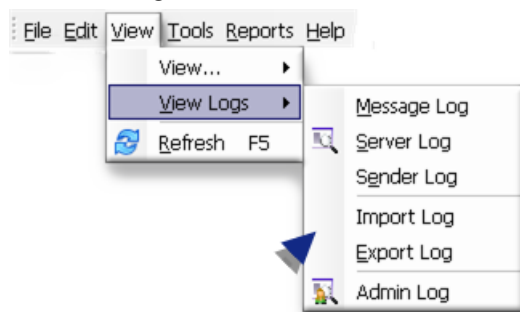

The selected log opens.

guide: Alarm Cast Administrator Filter Guidelines

- Click the Filters button on the selected log window toolbar.

An Alarm Cast Gateway Filter dialog box opens.

- The **Events On:** field defaults to the current day.
- The **Status Message** field can be used to search for a portion of the message in the log.

Important: When matching special characters, enclose them in brackets.

Example

To find all log items that start with [enter in [[]* in the **Status Message** field.

The common allowed search characters are as follows:

Character	Match Made	Example
?	Any single character	Text in the log is ABC, DBC and XYZ. If ?BC is used in the Status Message field, only ABC and DBC will be returned.
*	Zero or more characters	*Initiated* in the Status Message field would return all log items with the word 'Initiated'
#	Any single digit (0-9)	Text in the log is Device1, Device5, Device8, Device10. Keying in Device# in the Status Message field, will return Device1, Device5, and Device8.

- Check Automatic Refresh to automatically refresh the log file based on the seconds specified.

Alarm Cast Redundancy

Alarm Cast Redundancy

Beginning with CIMPLICITY v9.0, Alarm Cast redundancy can be implemented with some redundancy functionality, while preserving Alarm Cast for paging.

This documentation provides a configuration guide based on using an **email server** as the endpoint for paging.

1 (page 893)	Alarm Cast Redundancy: Primary Server
2 (page 898)	Alarm Cast Redundancy: Secondary Server

3 <i>(page 903)</i>	Alarm Cast Redundancy: Final Setup Steps
9 <i>(page 904)</i>	Alarm Cast Redundancy: Known Issues

! **Important:** Before you configure redundancy for Alarm Cast, make sure that the following is true.

- Server Redundancy without Alarm Cast is:
- Configured
- Working properly
- The host files have been configured.
- An Email server is accessible from both the Primary and Secondary systems
- You have a working knowledge of Alarm Cast standalone configuration.

1. Alarm Cast Redundancy: Primary Server

Configure the following on the Primary server.

A <i>(page 893)</i>	Primary Server: Alarm Cast Administrator
B <i>(page 894)</i>	Primary Server: Start CIMPLICITY Project
C <i>(page 894)</i>	Primary Server: Alarm Cast Gateway
D <i>(page 897)</i>	Primary Server: Stop CIMPLICITY Project
E <i>(page 897)</i>	Primary Server: Alarm Cast Alarm Administrator
F <i>(page 898)</i>	Primary Server: Alarm Cast Registry Settings

1. Primary Server: Alarm Cast Administrator

Configure the Alarm Cast Administrator first on the Primary computer.

1. Open the Alarm Cast Administrator window on the primary server.

2. Select the Details tab.
3. Make sure the required values are entered correctly.

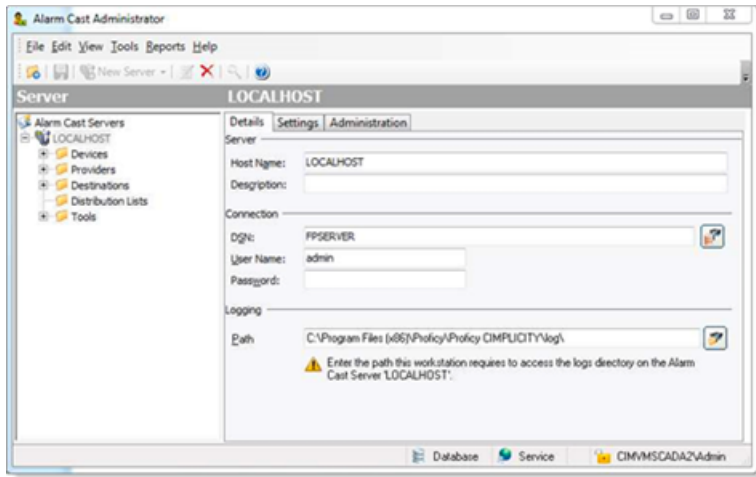

Field	Description
Alarm Cast Alarm Manager Server	
Host Name	LOCALHOST must be entered for the host name. Important: Using a computer name will prevent a smooth copy of the configuration to the secondary server.
Connection	
DSN	(Source host) Primary computer name.
Logging	
Path	The same log paths (as defined in this configuration) must exist on the secondary system. This physical path must exist on both systems.

4. Define your:
 - a. Email/ISP providers.
 - b. Destinations.
 - c. Distribution lists.
5. Test your configuration to be sure you can send and receive the test emails.
 - a. Primary Server: Start CIMPLICITY Project

Start the CIMPLICITY project on the primary server only.

 - a. Primary Server: Alarm Cast Gateway

Open the Alarm Cast Gateway window on the primary server.
6. Expand Equipment>Alarm Cast in the Workbench left-pane.
7. Double-click Administrator.

Alarm Cast Gateway configuration for redundancy includes the following.

- Primary Alarm Cast Gateway: Details Tab
- Primary Alarm Cast Gateway: Security

Primary Alarm Cast Gateway: Details Tab

8. Select the Details tab in the Alarm Cast Gateway window.

9. Make sure the required values are entered correctly

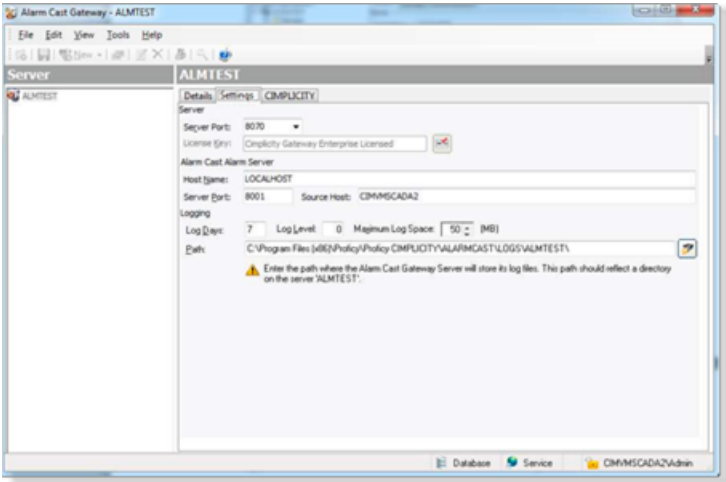

Field	Description
Alarm Cast Alarm Server	
Host Name	LOCALHOST must be entered for the host name.
Source Host	Primary computer name.
Logging	
Path	The same log paths (as defined in this configuration) must exist on the secondary system.

Primary Alarm Cast Gateway: Security

In order for Alarm Cast to communicate with the CIMPPLICITY project security must be configured so the processes can exchange information.

Configuration options for the Security component are as follows.

- Primary Alarm Cast Gateway Security: Workbench Option
- Primary Alarm Cast Gateway Security: Alarm Cast Option

Primary Alarm Cast Gateway Security: Workbench Option

(Not Recommended) The nodes can be configured to be trusted clients in CIMPLICITY security.

! **Important:** Using the trusted method will create a trust that forces CIMPLICITY to always use the specified user for login to these nodes.

10. Open the Pager project in the CIMPLICITY Workbench.
11. Select **Security>Advanced>Client** in the Workbench left-pane.
12. Create a new client for each node.
13. Check Trusted in the Client Properties dialog box for each node.

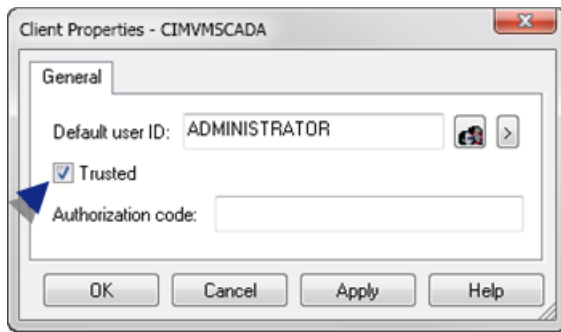

Result: Both nodes will be listed as trusted nodes in the Workbench right-pane.

Node ID	User ID	Trusted
CIMVMSCADA2	ADMINISTRATOR	Y
CIMVMSCADA	ADMINISTRATOR	Y

Primary Alarm Cast Gateway Security: Alarm Cast Option

(Recommended)

14. Make sure at least Alarm Cast v9.4.01 is installed.

Note: Additional options are available in the Alarm Cast CIMPLICITY Gateway beginning with version 9.4.01.

15. Open the Alarm Cast Gateway window, if it is not already opened.

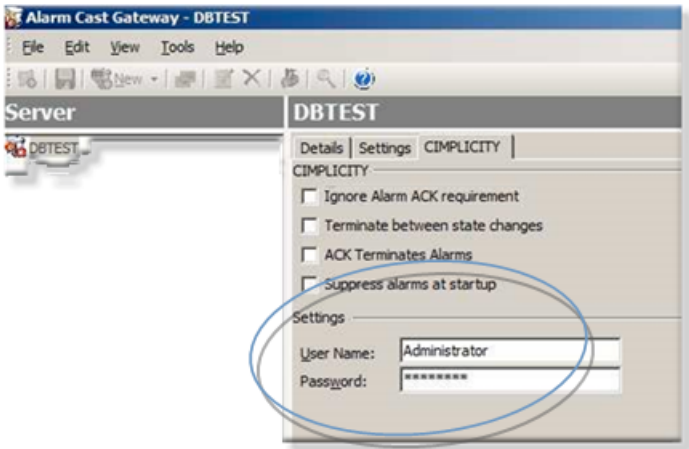

16. Enter the following.

Field	Description
Settings	
User Name	Name of user who has access to Pager alarms.
Password	Valid password for the specified user.

a. Primary Server: Stop CIMPPLICITY Project

Stop the project on the primary server.

a. Primary Server: Alarm Cast Alarm Administrator

The Alarm Cast Alarm Administrator on the primary server has one configuration requirement for a successful redundancy setup.

17. Open the Alarm Cast Alarm Administrator window.

- a. Expand Computer in the Workbench left-pane.
- b. Double-click Alarm Cast Alarm Administrator in the Workbench left or right-pane.

18. Select the Connections tab.

19. Enter LOCALHOST in the **Host Name** field.

Note: The Alarm Manager should look locally for the alarms.

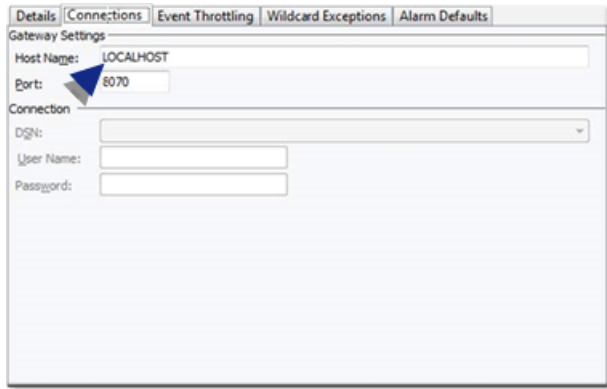

a. Primary Server: Alarm Cast Registry Settings

Alarm Cast redundancy requires edits in the Microsoft Windows Registry.

20. Stop both of the following services.
 - First Page Alarm Manager service.
 - First Page Server service.

21. Open Regedit.exe.

22. Add/modify the following string registry key:
 - a. Select the key.

Locations on 32-bit and 64-bit machines are as follows.

32-bit:	HKEY_LOCALMACHINE\Software\SEQENT\FirstPAGE Alarm Manager\Server\Config\CIMPRedundancy
64-bit:	HKEY_LOCALMACHINE\Software\Wow6432Node\SEQENT\FirstPAGE Alarm Manager\Server\Config\CIMPRedundancy

- a. Enter Enabled for the **Value**.

23. Close the Microsoft Windows Registry.

24. Perform a configuration update for the CIMPLICITY project on the primary server.

25. Restart the following services:
 - First Page Alarm Manager service.
 - First Page Server service.

The primary server has been set up for Alarm Cast redundancy.

2. Alarm Cast Redundancy: Secondary Server

Configure the following on the secondary server.

A (page 899)	Secondary Server: Database
B (page 900)	Secondary Server: Alarm Cast Administrator
C (page 900)	Secondary Server: Start CIMPLICITY Project
D (page 900)	Secondary Server: Alarm Cast Gateway
E (page 902)	Secondary Server: Stop CIMPLICITY Project
F (page 902)	Secondary Server: Alarm Cast Alarm Administrator
G (page 902)	Secondary Server: Alarm Cast Registry Settings

1. Secondary Server: Database

1. Select the secondary server.
2. Stop the following services.
 - First Page Alarm Manager service.
 - First Page Server service.
3. Copy the database files from the Alarm Cast configuration of the Primary system to the secondary.

The database files are located in a default installation path:

32-bit:	C:\Program Files\Proficy\Proficy Cimplicity\AlarmCast\DATA\
64-bit:	C:\Program Files (X86)\Proficy\Proficy Cimplicity\AlarmCast\DATA\

 **Important:**

- a. Backup the currently existing .mdb files on the secondary server.
- b. Copy only the .mdb files from the primary to the secondary server.
4. Configure the Data source Name (DSN) for the Alarm Cast Gateway.
5. Create an exact copy of the ALARMCASSTGWCIMPServer_1 DSN that was created on the Primary System.

Note the path where you copied the .mdb files.

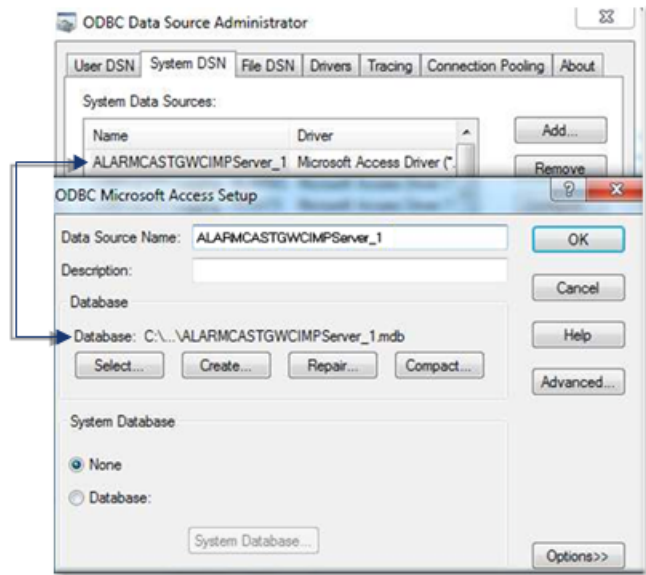

6. Restart the following services:
 - First Page Alarm Manager service.
 - First Page Server service.
 - a. Secondary Server: Alarm Cast Administrator

7. Expand the Proficy HMI SCADA – CIMPLICITY v<n>Alarm Cast folder on the Windows Start menu.

Note: The Alarm Cast folder may be at the bottom of the list, below Workbench.

8. Click Administrator.

The Alarm Cast Administrator window opens.

9. Verify that the:
 - a. Configuration was brought over from the primary server.
 - b. COMPUTER name information matches the Secondary server name.
 - c. Secondary Server: Start CIMPLICITY Project

10. Make sure the CIMPLICITY project is stopped on the primary server.

11. Create a new project with the same name as the CIMPLICITY project on the primary server.

12. Make sure Alarm Cast Gateway is enabled in the project.

13. Start the project on the secondary server.
 - a. Secondary Server: Alarm Cast Gateway

Open the Alarm Cast Gateway window on the secondary server.

Configuration is as follows.

- Secondary Alarm Cast Gateway: Settings Tab
- Secondary Alarm Cast Gateway: CIMPLICITY Tab

Secondary Alarm Cast Gateway: Settings Tab

14. Select the Settings tab in the Alarm Cast Gateway window.

15. Change the **Source Host** name to the **name of the secondary server**.

Note: The name that is automatically entered is the name of the primary server; this is incorrect.

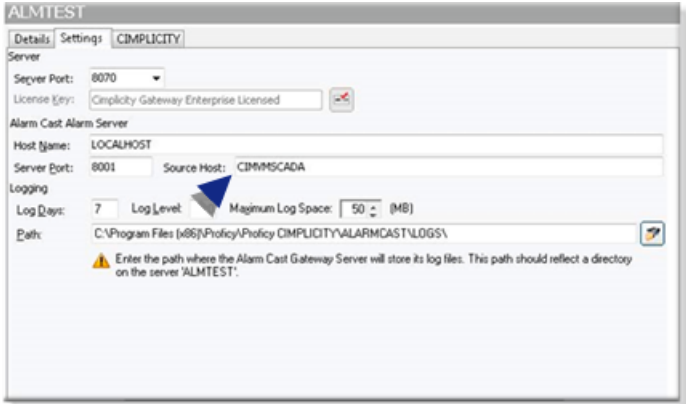

Secondary Alarm Cast Gateway: CIMPLICITY Tab

16. Select the CIMPLICITY tab in the Alarm Cast Gateway window.

17. Verify that the configuration has been set with the correct project **User name/Password** connection credentials.

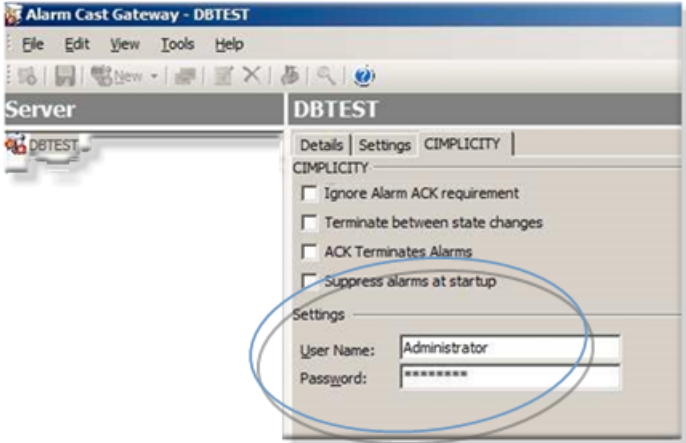

18. Save the changes.
 - a. Secondary Server: Stop CIMPLICITY Project
19. Stop the CIMPLICITY project on the secondary server.
20. Close the project's Workbench.
21. Delete the project.

Note: This project is no longer needed.

- a. Secondary Server: Alarm Cast Alarm Administrator
22. Expand the Proficiency HMI SCADA – CIMPLICITY v<n>Alarm Cast folder on the Windows Start menu.

Note: The Alarm Cast folder may be at the bottom of the list, below the Workbench.

23. Click Alarm Administrator.

The Alarm Cast Alarm Administrator window opens.

24. Select the Connections tab.
25. Change the Host Name to reflect the proper Gateway.

Note:The Computer name should reflect the name of the secondary computer.

If the **Host Name** is set to LOCALHOST, leave this setting.

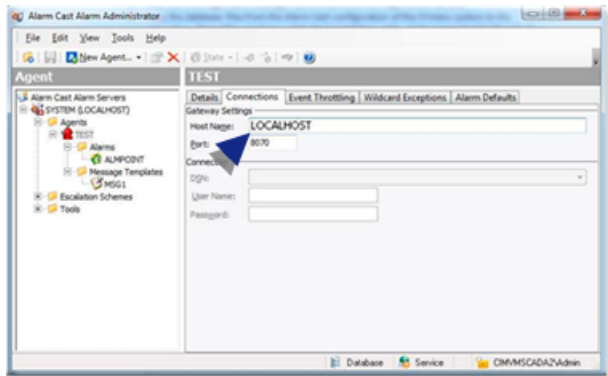

- a. Secondary Server: Alarm Cast Registry Settings

Alarm Cast redundancy requires edits in the Microsoft Windows Registry.

26. Stop both of the following services.
 - First Page Alarm Manager service.

- First Page Server service.

27. Open Regedit.exe.

28. Add/modify the following string registry key:

- Select the key.

Locations on 32-bit and 64-bit machines are as follows.

32-bit:	HKEY_LOCALMACHINE\Software\SeQuent\FirstPAGE Alarm Manager\Server\Config\CIMPRedundancy
64-bit:	HKEY_LOCALMACHINE\Software\Wow6432Node\SeQuent\FirstPAGE Alarm Manager\Server\Config\CIMPRedundancy

- Enter Enabled for the **Value**.

29. Close the Microsoft Windows Registry.

30. Perform a configuration update for the CIMPLICITY project on the secondary server.

31. Restart the following services:

- First Page Alarm Manager service.
- First Page Server service.

The secondary server has been set up for Alarm Cast redundancy.

3. Alarm Cast Redundancy: Final Setup Steps

1. Make sure that:

- A configuration update was performed on the redundant project.
- The following services have been started on both the primary and secondary servers.
- First Page Alarm Manager Service
- First Page Server Services

2. Start the project.

3. Open the Alarm Cast Alarm Administrator on both the Primary and Secondary servers.

4. Navigate to one of your alarms.

5. Click the Initiate alarm button.

6. Click Terminate alarm.

Any errors regarding the Gateway will indicate the host name resolution to LOCALHOST.

You should verify that you can resolve to 127.0.0.1 or you are having port issues with the firewall.

i Tip: You can use the {SERVER.HOST.CURR} message shortcut to state which system is sending the message.

Alarm Cast Redundancy: Known Issues

1. Stop the CIMPPLICITY project.
2. Confirm that Alarm Cast is stopped.
3. Add all new Alarm Cast modifications on the primary server.
4. Copy the modifications over to the secondary server.

i Tip: You can manually enter the alarm into the Alarm Administrator or the Administrator tool; as long as you keep the modifications entered the same.

Ping LOCALHOST resolution to ::1 (IPV6 TCP IP Protocol) breaks alarm cast:

If the ping response of LOCALHOST is ::1, you are using IPV6.

Alarm Cast does not support the IP6 standard.

Do the following.

5. Disable the protocol on all network cards
6. Remove the `\# ::1 LOCALHOST\` entry from the host file in windows.
7. Add the line `127.0.0.1 LOCALHOST` to the host file
8. Reboot the server.

Alarm Cast Administrator Glossary

Administrator

Typically a GUI application, this component facilitates configuration and monitoring of a server engine. If changes are made to the server configuration the administrator notifies the engine to reload its running configuration either automatically or on user demand. An example of an administrator component is Alarm Cast Administrator. This administrator allows you to maintain the Alarm Cast server's engine configuration.

Administrator Kit

An administrator kit contains the product's administration component only. After installing this kit on a workstation you may utilize any of the features of the Administrator component.

Alias

An Alarm Cast Server alias is an alternate name, which may be assigned to a destination. Alarm Cast Server client applications may choose to allow users to utilize aliases to lookup actual destination names.

Alpha Length

The Alpha Length property of a provider indicates the maximum length a single message may be for this service provider. Messages of longer than this length will either be rejected by the provider or truncated. By setting this value to a number either the same or smaller than the provider's maximum, Alarm Cast Server will automatically break any transactions exceeding this limit into multiple messages.

ANS

The ANS protocol is a proprietary messaging protocol of Ford Motor Company.

ASCOM

The ASCOM protocol is a proprietary messaging protocol used to interface with the ASCOM PBX.

Client

A client component utilizes the facilities of a standard server. Typically a GUI application, this component provides a user-friendly interface of the available services offered by the server engine. An example of a client tool would be Alarm Cast Client, which presents the user with a list of known messaging destinations and allows them to send messages to one or more destinations.

Coverage

The coverage property of a provider is a name assigned to reflect the geographical area that this connection to the service provider allows you to send message too. Usually for example in the case of dial-up modem connection to service providers a different phone number is provider for each city. The coverage field provides the administrator an easy method of tracking all of the different coverage areas a single provider is supporting.

Destination

An Alarm Cast Server destination is a name assigned to a messaging location to which text messages may be delivered. Ex. SCOTTS_PAGER, KENS_PHONE, JIMS_EMAIL.

Device

An Alarm Cast Server device is a name assigned to a physical connection point on the server that will be used to establish a connection with a service provider.

Device Pool

A device pool is a collection of multiple devices that work together to provide a higher throughput connection to one or more providers. Commonly used with modems a device pool of 3 modems can provide a high level of throughput to a provider with only dialup modems for input, or two or more providers can share the modem pool and use as many modems as they require at the time. Should more throughputs be required one or more additional devices may be added to the pool at any time.

Distribution List

An Alarm Cast Server distribution list is a collection of destinations that can be sent a message with a single transaction. Similar to an e-mail distribution list a client that initiates a transaction with a distribution list will automatically send the same message to all associated destinations.

DSN

A DSN, Data Source Name, is the name assigned to an ODBC driver and configuration information that allows an ODBC enabled application to connect to a data source.

Engine

An engine component implements a unified interface to a set of common, related protocols. The engine provides services to clients and gateways such that a common interface may be used to manipulate many different types of devices. Engines are administered via Administrator components and are utilized by clients, gateways or use written components.

Error Correction

The Error Correction property of a provider indicates that for the modem connection to this provider the providers modem use or do not use modem error correction features. If this item is unchecked then error correction will not be used when connecting to this service provider.

Gateway

A gateway component creates a bridge between a third party product and a standard server. Typically an engine this component provides a conduit for forwarding events from the third party product into a standard server.

Group

An Alarm Cast Server group is a name assigned to a collection of destinations that are logically connected. Groups are used by Alarm Cast Server clients to limit the destinations which are available for use.

IXO

The IXO protocol is the predecessor to the TAP protocol. See TAP.

Max Transactions

The max transactions property for an Alarm Cast Server provider reflects the maximum number of message transactions the provider will allow in a single session, before disconnecting the device. Entering a value of slightly lower than the provider, allows Alarm Cast Server to cleanly interface with the service provider.

Max Connection

The max connection property for a Alarm Cast Server provider reflects the maximum number of seconds the Alarm Cast Server may remain connected to the provider before the provider initiates a disconnect. By entering a value of slightly lower than the time the provider allows before forcing a disconnect, Alarm Cast Server will be able to more cleanly interface with the service provider.

Modem Compression

The Modem Compression property of a provider indicates that for the modem connection to this provider the providers modem use or do not use modem compression features. If this item is unchecked then modem compression will not be used when connecting to this service provider.

Modem Pool

A modem pool is a device pool consisting of only devices of type: Modem, ModemIP, or a combination of the two.

Network ID

A destination network id is the identifier the messaging network requires to remit a message to an end destination. Similar to a phone number a network id can be any number of numbers, alphabetic

characters, or a combination of the two. For TAP connected providers the network id is usually a numeric value. For SMTP connected providers the network id is the devices assigned e-mail address.

Numeric Length

The Numeric Length property of a provider provides the same functionality as the Alpha Length property.

ODBC

The ODBC protocol is an implementation of the Microsoft 'Open Database Connectivity' API allows Alarm Cast Server to forward messages to any ODBC compliant data source.

PET

The PET protocol is the predecessor to the IXO protocol. See TAP.

Phrase

An Alarm Cast Server phrase is a word or group of words, which the system administrator can restrict from being transmitted to a destination. Primarily designed to limit the use of foul language, any transaction containing one of the defined phrases will be rejected by the engine.

Provider

An Alarm Cast Server provider is a name assigned to the configuration information required to connect to a messaging service provider.

MS-Speech

The MS-Speech protocol is a speech API protocol that converts text to speech using available voice options.

Schedule

An Alarm Cast Server schedule is a name assigned to a set of weekday configuration rules, which define the times during which a destination may receive messages. A schedule, once defined may then be assigned to a destination over a time period.

Server Kit

A server kit typically contains the server engine and administrator components. In some cases a client component is also included with this kit. The server kit is usually installed on a centralized host, and one or more clients or gateways utilize this server. An example of a server kit is Alarm Cast Server. This kit contains the Alarm Cast engine, administrator and client.

SMS

The SMS acronym stands for ‘Short Message Service’. This term is usually used to define the paging component of today’s multi-functional wireless phone handsets.

SMTP

The SMTP protocol is the ‘Simple Mail Transfer Protocol’. Forming the backbone of the Internet mail transport, this protocol is used to move almost 100% of all e-mail sent via the Internet. Some wireless service providers assign a unique e-mail address to each wireless device to allow anyone with an Internet e-mail account to send messages to the device.

SNPP

The SNPP protocol is the ‘Simple Network Paging Protocol’. Loosely based on the SMTP protocol, SNPP has been tailored to support both one and two way messaging services. It is used to connect to providers who offer connections to their networks via the Internet.

TAP

The TAP provider protocol is the ‘Telocator Access Protocol’. This protocol, standardized by the PCIA (Personal Communications Industry Association) it provides Alarm Cast Server with the primary connection method for most of North America’s one-way paging providers.

UCP

The UCP protocol is the ‘Universal Computer Protocol’. Primary utilized to connect to European GSM/SMS telephone handset PBX’s, this protocol contains many more features than the more common TAP protocol.

Wizard

A wizard is a prompted process that guides an application user through a complicated data entry process, providing hints as to the appropriate answers required for each field or screen.

Alarm Cast Alarm Administrator

About Alarm Cast Alarm Administrator

The following topics contain an overview of the CIMPLICITY Alarm Cast Alarm Administrator and Alarm Cast Alarm server.

! Important:

- The Alarm Cast Administrator and Alarm Cast Alarm Administrator must be on the same machine.
- Warning messages might open during configuration that Alarm Cast cannot connect to the project if the Alarm Cast Gateway is not running.

Note: The Alarm Cast Gateway runs when the project is running.

Alarm Cast Alarm Administrator: Key Features
Alarm Cast Alarm Administrator: How it Works.
Alarm Cast Alarm Administrator Pre-configuration.
Alarm Cast Alarm Administrator Components.
Alarm Cast Alarm Administrator Tools
Alarm Cast Alarm Administrator Glossary

Alarm Cast Alarm Administrator: Key Features

Alarm Cast Alarm Administrator is another product in the Alarm Cast Suite of products and may reside on your Alarm Cast Server or access an Alarm Cast Server over a LAN or WAN connection. It is designed to centralize all wireless alarm management into one single application. This means that alarms/events from all automated monitoring systems in your enterprise can be centrally maintained and dispatched from one system.

Alarm Cast Alarm Administrator adds full alarm management capabilities to Alarm Cast. Utilizing the alarm management features of Alarm Cast Alarm Administrator, proper attention can be directed towards events based on severity including repeat messages and event escalation. Active alarms are then reported to the engine for initiation; the engine then records and tracks each alarm over its lifetime.

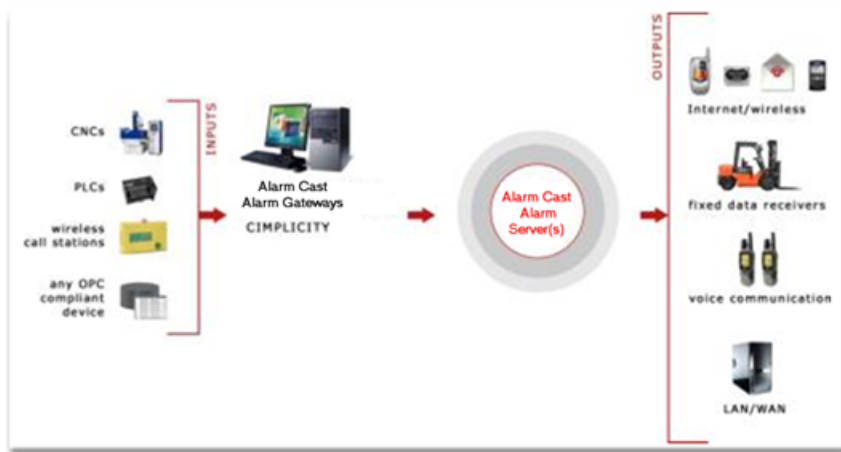

Key Features:

- Escalation hierarchy: includes built-in logic including attributes, delay before send, repeat and more
- Optionally sends terminate message to prevent unnecessary responses once problem resolved
- Server configuration is hot reloadable, allowing real-time changes to the live system with no impact on alarms in process
- Time-based escalation

Alarm Cast Alarm Administrator: How it Works

Alarm Cast Alarm server alarms or events are triggered by automated monitoring systems and communicated to Alarm Cast Alarm Administrator through a Gateway for CIMPPLICITY for a specific product, or a user developed application.

The most popular and reliable interface is TCP/IP sockets. Upon receipt of an alarm, the Alarm Cast Alarm engine repeatedly notifies and escalates messages until they are cleared by the automated monitoring system. Utilizing the Alarm Cast Alarm Administrator, alarm names are selected from a dynamic list of alarms or events and configured. Destinations and text messages are defined for each level of escalation. Escalation templates are utilized to provide rapid for setup.

Alarm Cast Alarm Administration requires that the source application only report when an event has started and (optionally) when an event has stopped. The Alarm Cast Alarm Server is informed as to which alarms to process and what messaging attributes to apply to each event. This enables the applicable level of attention to be paid to each event, depending on its severity.

These attributes can include:

- People who should be alerted.
- A delay (time active) before the event is sent.
- How often and at what interval a message can be resent.
- Notifications that an event has cleared.
- Optional text if the text sent by the source application is not applicable.

An alarm message database can be quite dynamic and require a lot of management. Alarm Cast Alarm Manager Server has the following tools to make the job easier:

- Mass Add, Position Swap and Mass Delete configuration tools.
- Report generator - by alarm or individual.
- Workstation administrator to allow decentralized alarm configuration.
- Visual icons that display what has /has not been configured.

Alarm Cast Alarm Administrator: Supported Gateways

HMI/SCADA CIMPLICITY

Alarm Cast Alarm Administrator Pre-configuration

Alarm Cast Alarm Administrator Pre-configuration

The Alarm Cast Alarm Manager Administrator utility program is used to configure and control the Alarm Cast Alarm Manager Server engine.

System managers responsible for Alarm Cast are the intended users of Alarm Cast Alarm Manager Administrator.

The features and operations that can be performed with Alarm Cast Alarm Manager Administrator include adding, modifying, deleting, listing, printing database information, viewing logs and changing server configurations, etc.

Do the following before configuring the Alarm Cast Alarm Administrator.

Alarm Cast Alarm Administrator: Database conversion.
Alarm Cast Alarm Administrator: DSN Specifications.
Alarm Cast Alarm Administrator: Application folder availability.

Alarm Cast Alarm Administrator: Database Conversion

The database for the Alarm Cast server is FPAMServer.mdb.

Note:

If the previous CIMPLICITY Pager was installed, the corresponding FPAMAdmin.mdb database will be incompatible with Alarm Cast Administrator; however it can be converted

Note: If you have not converted then database, when you start the Alarm Cast Administrator for the first time after you install Alarm Cast, a message will report that the database is incompatible; the Database Converter must be run.

Example: Windows 7

1. Open the Windows Start menu.
2. Select CIMPLICITY>Alarm Cast>Database Conversion.

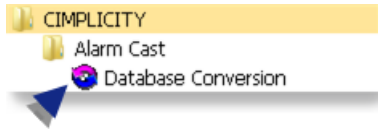

A Database Conversion dialog box opens.

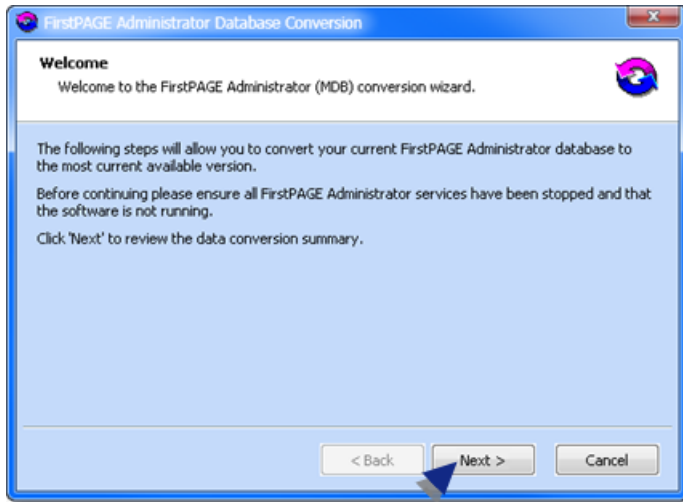

3. Click Next.

The Wizard will report if the database is up to date or needs conversion; if the database requires conversion the Wizard will guide you through the steps

Alarm Cast Alarm Administrator: DSN Specifications

Open the ODBC Data Source Administrator.

- 32-Bit System
 - a. Open the Control Panel
 - b. Select Administrative Tools > Data Sources (ODBC).

The ODBC Data Source Administrator opens.

- a. Choose the System DSN tab.

- 64-Bit System

Important: System data sources are created in the `ODBCAD32` location; they may not be listed on the System DSN tab when you open the ODBC Data Source Administrator on a 64-bit system.

- a. Click the Start button on the Windows task bar.

b. Enter the following in the **Command Line** field.

c:\windows\syswow64\odbcad32.exe

a. Press Enter.

The ODBC Data Source Administrator opens.

a. Select the DSN tab.

The System Data Sources will be listed.

 **Note: Guidelines**

- The DSN name and location can be changed
- There are no restrictions to name or location of the DSN or databases as long as the structure and table names don't change.

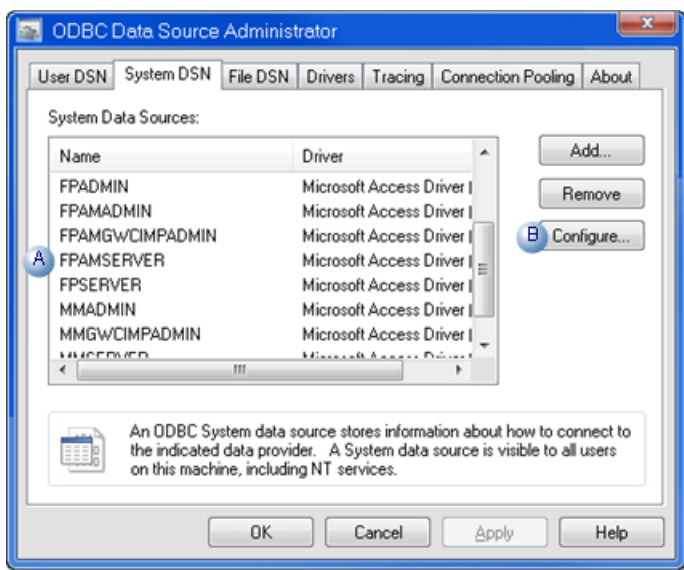

A	Select FPAMSERVER.
B	Click Configure.

An ODBC Microsoft Access Setup dialog box opens.

 **Note: Guidelines**

- The database (.mdb) location can be changed.

For a UNC address, enter \\<Server name>\<Shared folder name>\<data>\<database filename>

- There are no restrictions to name or location of the DSN or databases as long as the structure and table names don't change.
- Administration tools that are provided by Alarm Cast must be used to modify data in the databases.
- The default path is ..\Proficy CIMPLICITY\ALARMCAST\DATA\FPAMServer.MDB.

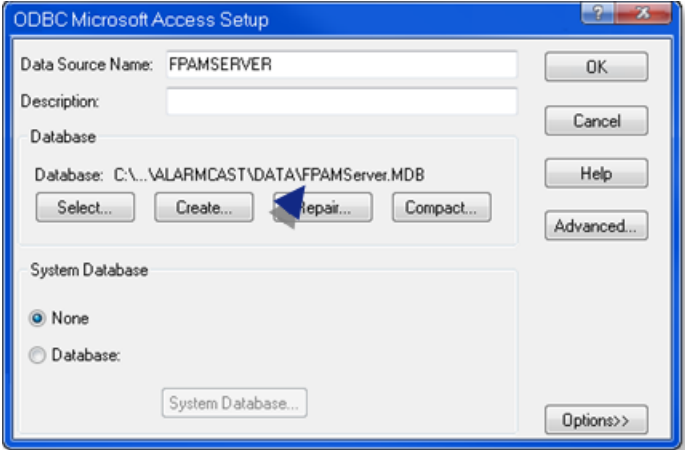

Alarm Cast Alarm Administrator: Application Folder Availability

An Alarm Cast application folder that contains data and log files needs to be shared in order to be accessible for Alarm Cast requirements.

Note: This procedure is for Windows 7 64-bit; it might be slightly different for other operating systems.

1. Choose the **ALARMCAST** application folder, which contains the Alarm Cast data and log files.

Following are the default paths for 32-bit and 64-bit systems.

32-bit system	...Program Files\Proficy\Proficy CIMPLICITY\ALARMCAST
64-bit system	...Program Files (x86)\Proficy\Proficy CIMPLICITY\ALARMCAST

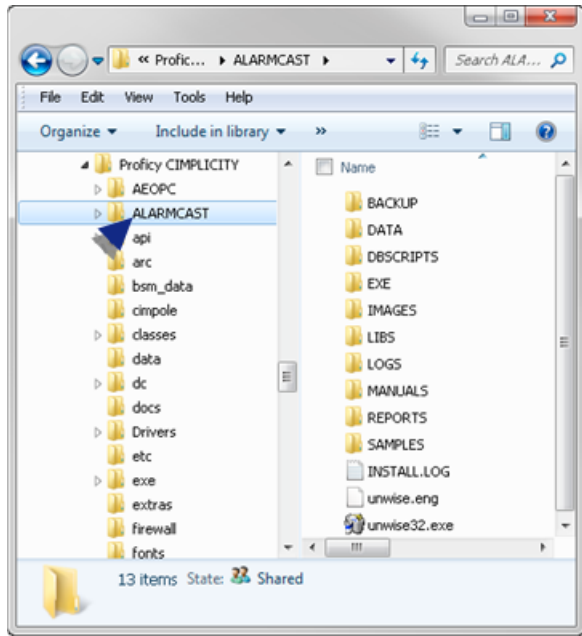

2. Right-click the **ALARMCAST** folder to open the ALARMCAST Properties dialog box.

3. Assign Full Control to the **Everyone** user.

Example: Assign Sharing Permissions to the Everyone User

Do the following on a Windows 7 system; other Windows operating systems may differ slightly.

a. Select Properties on the ALARMCAST Popup menu.

The Server Properties dialog box opens.

4. Do the following.

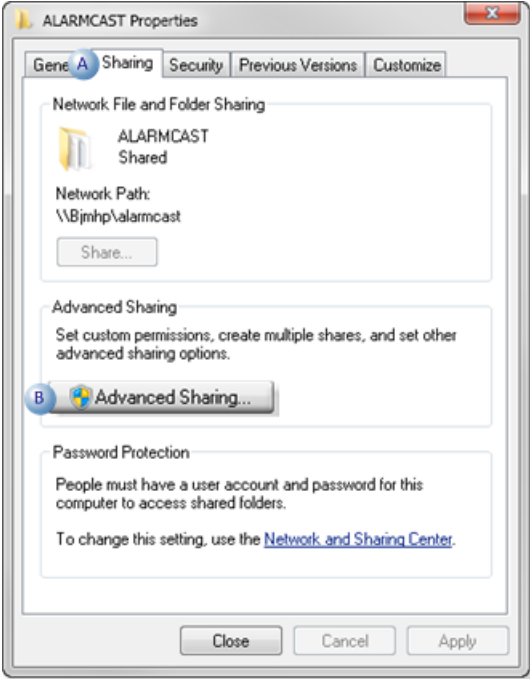

- | | |
|---|-------------------------|
| A | Select the Sharing tab. |
| B | Click Advanced Sharing. |

An Advanced Sharing dialog box opens.

a. Do the following.

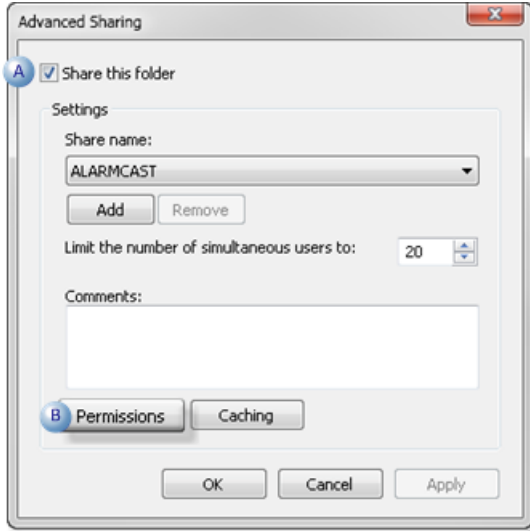

- | | |
|---|--------------------------|
| A | Check Share this folder. |
| B | Click Permissions. |

A Permissions for ALARMCAST dialog box opens.

5. Do the following.

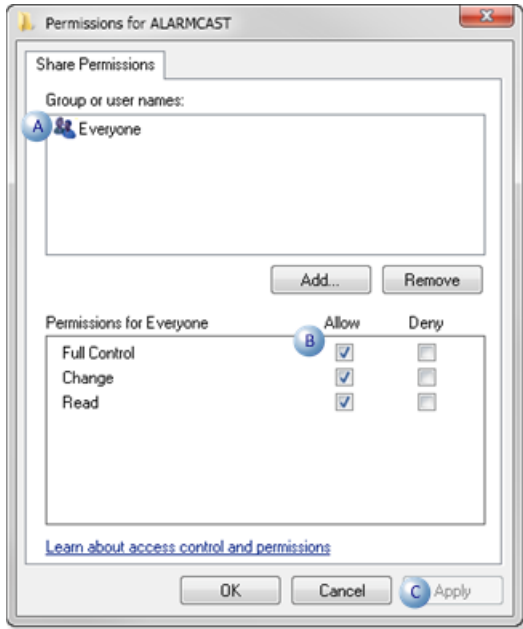

A	Select Everyone.
B	Make sure Allow is checked for all options.
C	Click Apply.

6. Click OK to close the dialog boxes.

ALARMCAST is now available

Alarm Cast Alarm Administrator Components

Alarm Cast Alarm Administrator Components

Note: Configure the Alarm Cast Alarm Administrator key components in the following order.

Alarm Cast Alarm Administrator Server.
Alarm Cast Alarm Administrator Escalation Schemes.
Alarm Cast Alarm Administrator Gateway for CIMPLICITY Agents

Alarm Cast Alarm Administrator Server

- Alarm Cast Alarm Administrator: New Server
- Alarm Cast Alarm Administrator: Server Configuration

Alarm Cast Alarm Administrator: New Server

1. Do the following.

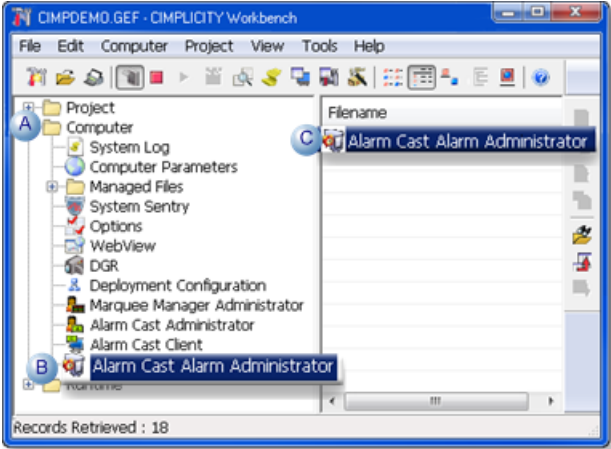

A	Expand Computer in the Workbench left-pane.
B	Select Alarm Cast Alarm Administrator .
C	Double-click Alarm Cast Alarm Administrator in the Workbench right-pane.

2. Do the following.

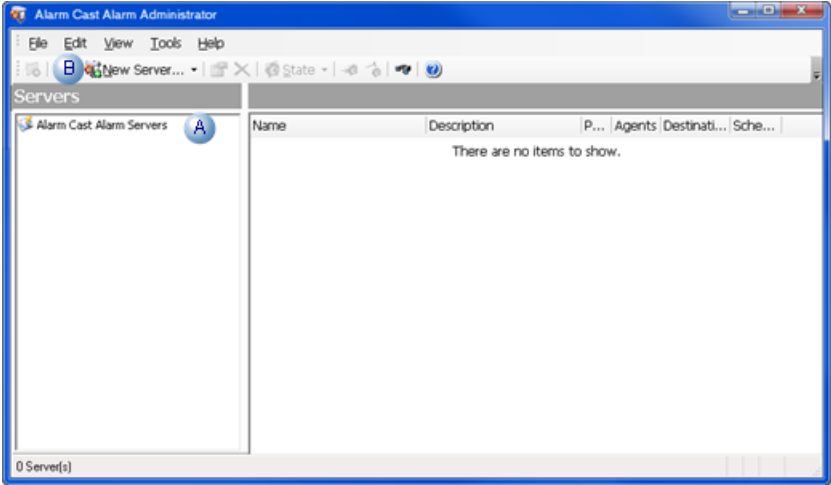

A	Select Alarm Cast Alarm Servers in the Alarm Cast Alarm Administrator left-pane.
B	Click the New Server button on the Alarm Cast Alarm Administrator toolbar.

A Select Data Source browser opens.

3. Select the Alarm Cast Alarm Server data source.

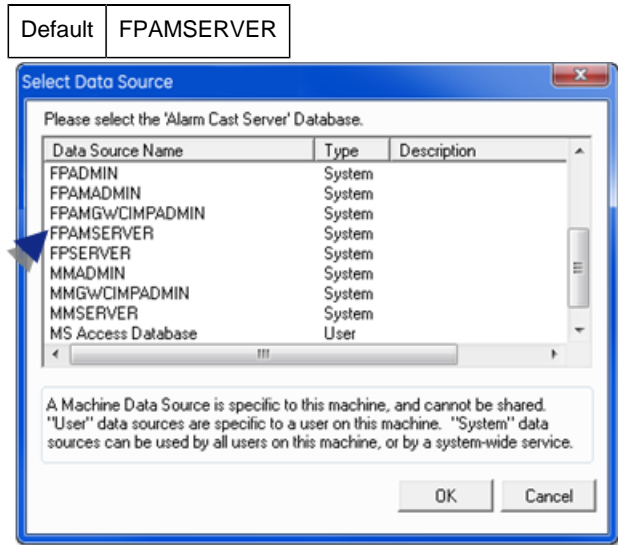

4. Click OK.

Alarm Cast Alarm Administrator: Server Configuration

Server configuration includes the following tabs.

- Details tab.
- Settings tab.
- Alarm Cast Servers tab.
- Agent Licenses tab.
- Security Tab

Details Tab

The Details tab defines the connection from the Alarm Cast Alarm Administrator to the Alarm Cast Alarm Server allowing it to maintain a server.

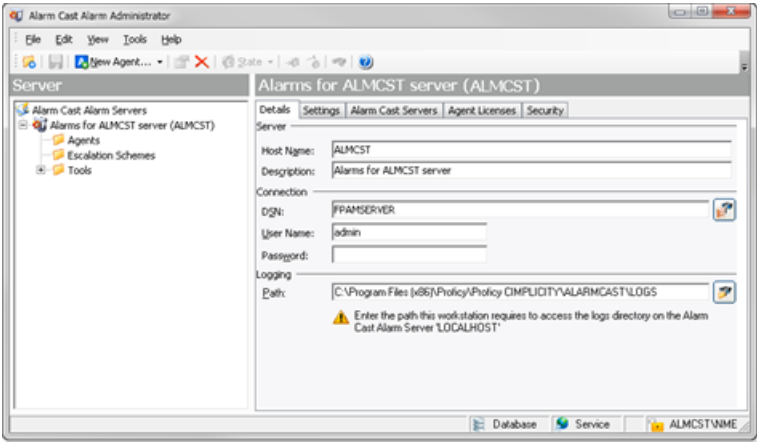

Field	Description
Server	
Host Name	TCP/IP resolvable name that: a. Must be in your DNS server or local host file. b. Can be reached from the Administrator workstation.
Description	Additional details to help identify the server.
Connection	
DSN	Automatically entered when the server is saved.
User Name	Optional
Password	Optional
Logging	
Path	Log Path required to access the logs directory on the current Alarm Cast server. In most cases, if the server is locally installed this path will be a drive letter based directory specification. Example C:\Program Files(x86)\Proficy\Proficy CIMPLICITY\ALARMCAST \Logs\ If the server being managed is not the local server then this path will most likely be a UNC path (\server\share\directory\), which provides access to the remote servers log directory. Example \\LAB1\FPServer\logs\.

Settings Tab

Select the Settings tab to configure the server options.

- If the server has never been configured, the contents of the Settings tab contain defaults.
- If the server is already configured and operational, these fields will be filled with the current server's settings

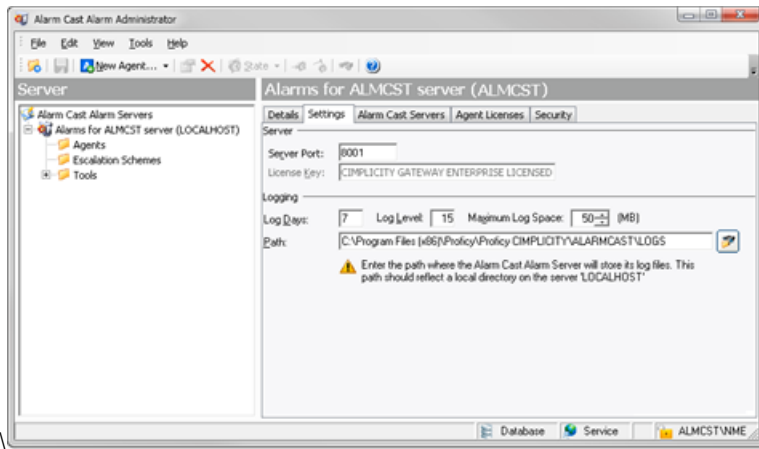

Field	Description
Server	
TCP/IP Port	Default is 8001.
License Key	Valid license key
Logging	
Log Days	Number of days the log file will be kept before being purged. Defaults is 7 days.
Log Level	<p>Notes</p> <ul style="list-style-type: none"> • In the event of any problems, CIMPLICITY may request additional levels of logging to assist in problem solving. • A log level of 15 is recommended for initial setup. <p>If something is going to go wrong it will be on initial setup; a 15 log level will capture that. When everything is set up you can decrease the level or leave it at 15; it does not affect functionality. However, the higher number will cause the logs to collect more, which will make them roll over more on a busy system. This may make it more difficult to go through them and understand.</p>
Maximum Space	Amount of space to allot to the log file. Note: This prevents the log files from consuming too much drive space. Default is 50 MB.
Path	Path specification, local to the actual Alarm Cast Alarm Manager Server. It contains the directory where the Alarm Cast Server will store its log files. Tip: You can copy the path selected on the Details tab into this field.

Alarm Cast Servers Tab

Select the Alarm Cast Servers tab to configure the Alarm Cast Server details.

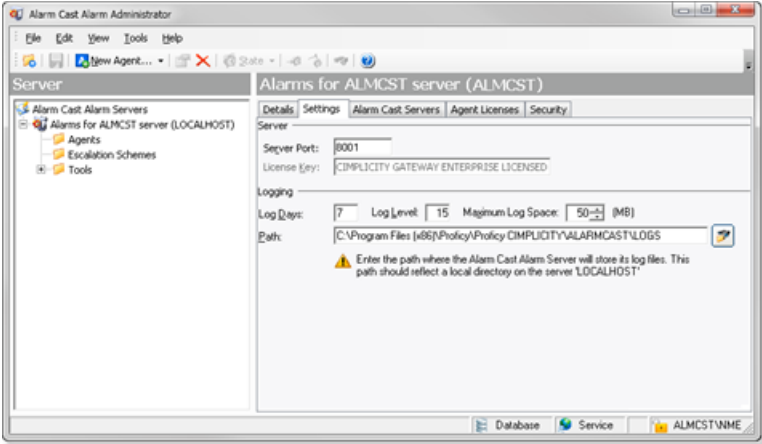

Field	Description
Alarm Cast Server	
Server Name	Name of the Alarm Cast Server. Note: It is preferable to enter the actual machine name rather than use LOCALHOST.
Port	Port the Alarm Cast Server uses. Default is 8003.
Retries	Number of attempts that are made to connect to the Alarm Cast Server. Default is 3 attempts.
Honor Schedules	Check this option if Alarm Cast alarms should honor schedules that have been configured in the Alarm Cast Alarm server.

Agent Licenses Tab

Select the Agent Licenses tab to enter valid license keys for all agents that will be utilized.

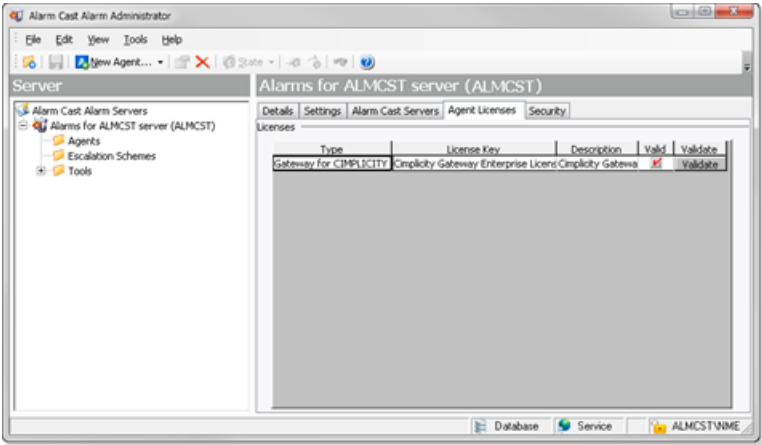

Alarm Cast Alarm Administrator has been designed to centralize alarm/event management and notification. To handle the many different types of alarm/event monitoring systems and other plant floor devices, different agents have been developed to interface with the various types of systems.

Alarm Cast Alarm Administrator enables users to register only the agents desired by entering a license key specific to that agent.

Security Tab

If security is enabled a Login dialog box will open when a user tries to open the Alarm Cast Alarm Administrator window. Only users who have been configured in the Tools>Users tree will have access.

Select the Security tab: security options for the selected server are as follows.

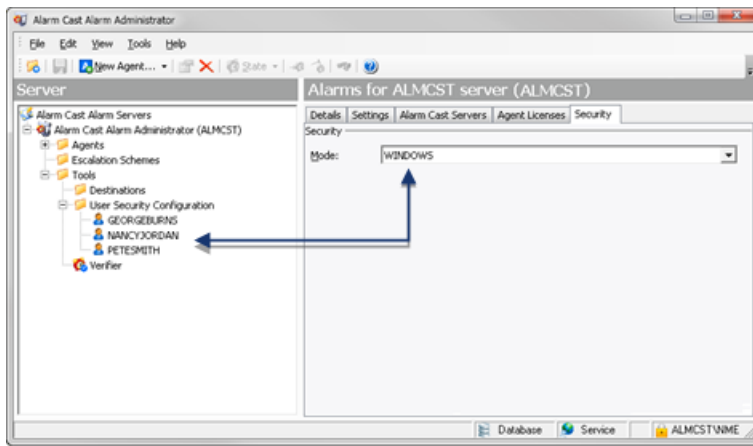

Field	Description	
Security		
Mode	Security options for the Alarm Cast Alarm Administrator server are as follows.	
	NONE	Alarm Cast security is not enabled for the server.
	Windows	<p>A valid user name/password are required. Security is as follows.</p> <ol style="list-style-type: none"> A Users folder is added to the Tools tree. Users who should have access to the Alarm Cast server need to be added. A Login dialog box opens when a user attempts to open the Alarm Cast Alarm Administrator window.  <p>Result: Listed users with valid user names/passwords will have access to the server.</p>
	Windows Trusted	<p>Uses a trusted domain account; does not require a password.</p> <ol style="list-style-type: none"> A Users folder is added to the Tools tree. Users who should have access to the Alarm Cast server need to be added. <p>Result: After a listed user logs into Windows, the user can open the Alarm Cast Alarm Administrator window; a Login dialog box is not required.</p>
	Default	NONE

5. Must be in your DNS server or local host file.
6. Can be reached from the Administrator workstation.
7. A **Users** folder is added to the Tools tree.
8. Users who should have access to the Alarm Cast server need to be added.
9. A Login dialog box opens when a user attempts to open the Alarm Cast Alarm Administrator window.



10. A **Users** folder is added to the Tools tree.
11. Users who should have access to the Alarm Cast server need to be added.
12. Click Save on the Alarm Cast Alarm Administrator toolbar.

the server configuration is saved.

Alarm Cast Alarm Administrator: Escalation Schemes

The Escalation Schemes folder enables you to add and maintain all escalation schemes that determine the hierarchy of incoming alarms. Multiple escalation schemes can be created to handle and organize alarms by priority or by level of importance. For example, low level escalation schemes might be required to deal with low level priorities and high-level escalation schemes to deal with higher priority alarms.

Due to the hierarchical nature of escalation levels, the function of each alarm scheme is directly related to the escalation levels directly above and below it.

Escalation schemes include the following configuration.

- Escalation Scheme: Defined
- Escalation Scheme: Item

Escalation Scheme: Defined

Escalation scheme configuration options depend on what type is selected.

1. Select Escalation Schemes in the Alarm Cast Alarm Administrator left-pane.

2. Click the New Escalation Scheme button on the Alarm Cast Alarm Administrator toolbar.

A Details tab displays; options are as follows.

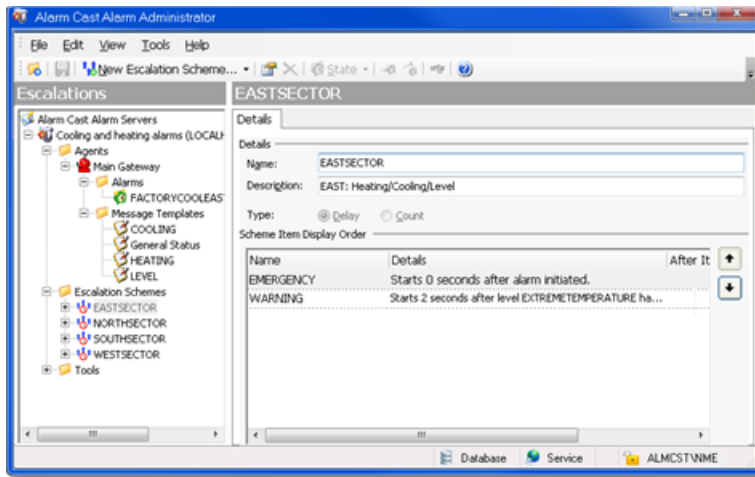

Field	Description	
Details		
Name	Logical name utilized by the administrator to refer to this escalation scheme.	
Description	Additional details to help identify the escalation.	
Type	Types are as follows.	
	Delay	Advances through its levels as the alarm ages.
	Count	Begins notification only after the specified number of times an incident occurs in a time frame.
Scheme Items		
	Lists the escalation scheme items in order of priority; the first scheme is the highest priority. Tip: Click the Up or Down arrow to change a selected scheme's position in the list.	

3. Click Save on the Alarm Cast Alarm Administrator toolbar.

Result: The escalation scheme will now be visible in the Escalation Schemes folder in the tree view.

Escalation Scheme: Item

4. Expand an Escalation Scheme in the Alarm Cast Alarm Administrator left-pane.

An Items folder displays.

5. Select the Items folder;

6. Click New Escalation Item on the Alarm Cast Alarm Administrator toolbar.

Escalation scheme item configuration includes the following tabs.

- Details tab
- Destinations tab

Details Tab

Select the Details tab options depend on the escalation scheme type.

- Delay
- Count

Escalation Scheme: Delay

Select the Details tab; escalation scheme Delay type, options are as follows.

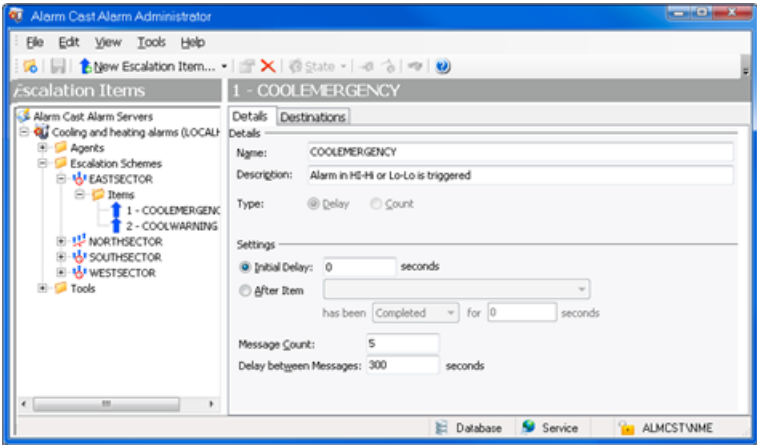

Field	Description
Details	
Name	Logical name utilized by the administrator to refer to this escalation item/level. Example An area at this level will send a message first to: SUPERVISOR_ASSMBLY_LINE1
Description	Details that help identify the escalation level.
Type	Automatically set when the Escalation Scheme was created.
Settings	
Initial Delay	Delay in seconds after an alarm has been initiated; before a message is sent.

After Item	<p>Check to send the message after another level has been completed.</p> <p> guide: Guidelines</p> <ul style="list-style-type: none"> • Select the level from the dropdown list. • One level must be completed before using the After Item option. • Select either of the following options to specify when the message will be sent: <ul style="list-style-type: none"> • After the specified item is completed for X seconds • The item has been active for X seconds.
Message Count	Number of messages to be sent. Default is 5 messages.
Delay between Messages	Delay in seconds between each message that will be sent.

Escalation Scheme: Count

Select the Details tab; escalation scheme Count type, options are as follows.

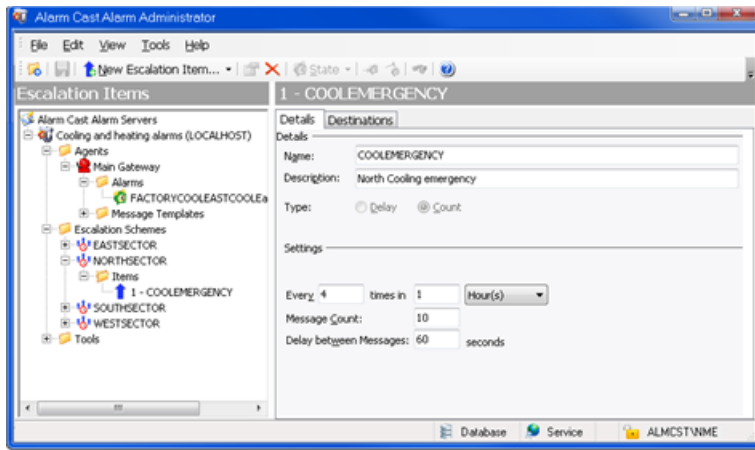

Field	Description
Details	
Name	Logical name utilized by the administrator to refer to this escalation item/level. Example An area at this level will send a message first to: <code>SUPERVISOR_ASSMBLY_LINE1</code>
Description	Details that help identify the escalation item/level.
Type	Automatically set when the Escalation Scheme was created.
Settings	
Every x times in x	<p>Number of occurrences to monitor the fault occurrence as well as the specified time frame in one of the following.</p> <ul style="list-style-type: none"> • Seconds • Minutes • Hours • Days <p>When the criteria are met, the notification process will begin.</p>

Message Count	Number of messages to be sent. Default is 5 messages.
Delay between Messages	Delay in seconds between each message that will be sent.

Destinations Tab

7. Select the Destinations tab.
8. Check the names of persons and/or groups who should receive notifications about the selected item.

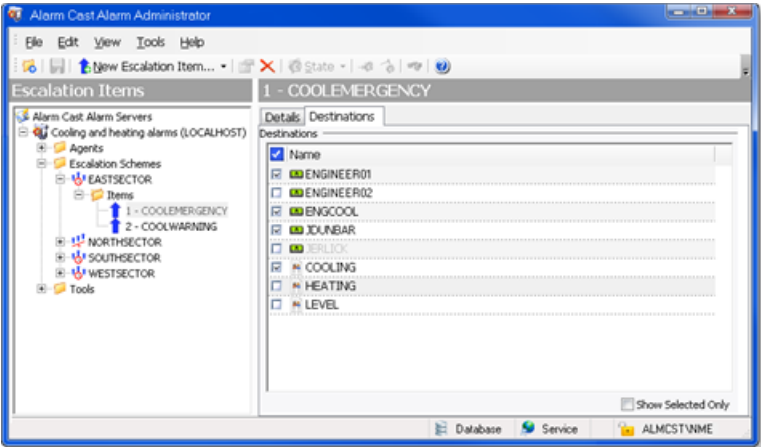

9. Click Save.

The escalation scheme item will now be visible in the associated escalation scheme's folder in the tree view.

Alarm Cast Alarm Administrator Agents

Alarm Cast Alarm Administrator Agents

- Gateway: For CIMPPLICITY Agents
- Gateway: For Message Templates
- Gateway: For CIMPPLICITY Alarms
- Gateway: Message Value Fields

Gateway for CIMPPLICITY: Agents

1. Click the **Agents** folder in the Alarm Cast Administrator left-pane.
2. Click New Agents on the toolbar.

Gateway for CIMPLICITY automatically displays in the **Agent Type** field.

Gateway for CIMPLICITY agent configuration provides the following tabs.

- Details tab
- Connections tab
- Settings tab
- Event Throttling tab
- Wildcard Exceptions tab
- Alarm Defaults tab

Details Tab

Select the Details tab; details options are as follows.

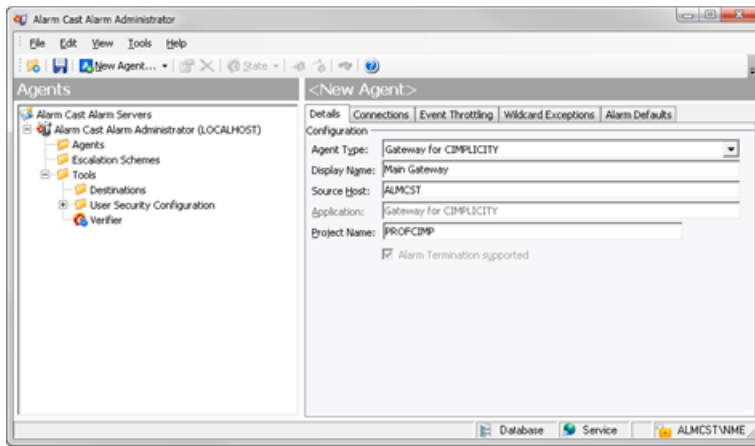

Field	Description
Configuration	
Agent Type	Gateway for CIMPLICITY.
Display Name	Logical name utilized by the administrator to refer to the agent. Note: The name will be listed in the tree view when the configuration is saved.
Source Host	Name of the machine where the agent selected is running. Important: The name must match the Source Host name that is configured on the Gateway. This becomes particularly important if you are working with more than one project and there is one Alarm Cast Administrator and Alarm Cast Alarm Administrator running.
Application	Gateway for CIMPLICITY.
Project Name	CIMPLICITY project that is opened and running; this connects the agent to that project.
Alarm Terminate supported	Automatically checked if the agent type supports alarm termination.

Connections Tab

Select the Connections tab; connections options, which are automatically created based on the source host, are as follows.

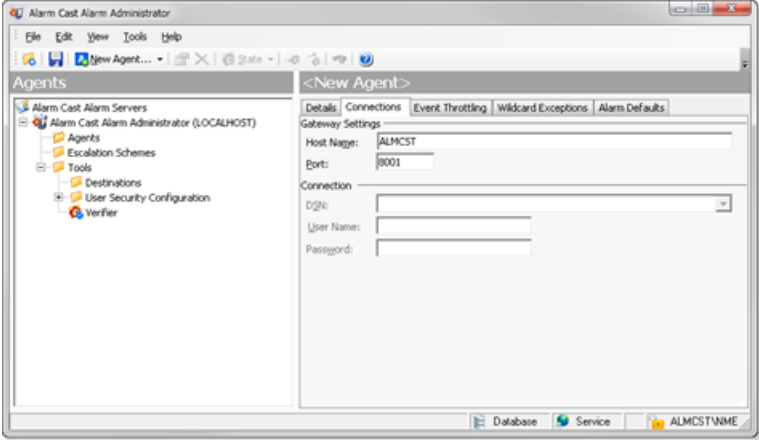

Field	Description
Gateway Settings	
Host Name	Only required when connecting to the Gateways.
Port	Only required when connecting to the Gateways. Default is the port of the Host Name entered on the Details tab.
Connection	
DSN	Not required.
User Name	Not required.
Password	Not required.

Event Throttling Tab

Select the Event Throttling tab; event throttling options are as follows.

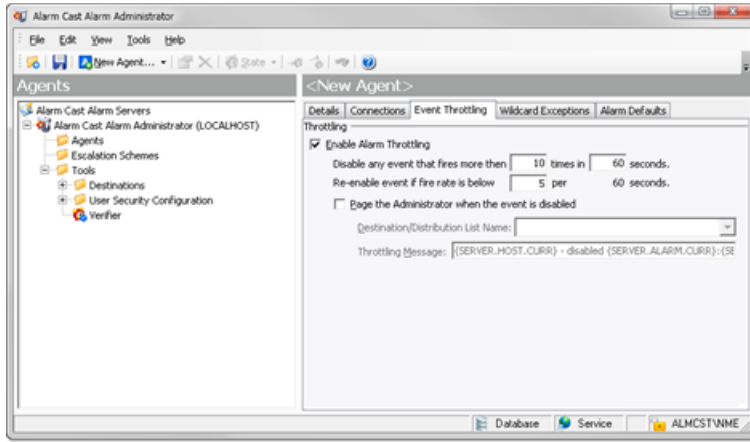

Field	Description
Throttling	
Enable Alarm Throttling	Check to enable the throttling feature.
Disable any Event that fires more than n times in n seconds.	Number of times and seconds that must occur before the event is disabled.
Page the Administrator when the event is disabled	Check if an administrator is to be paged when event throttling is enabled, to report that a particular event stops sending alarms.
Destination Distribution List Name	Message destination.
Throttling Message	Message that will be sent to the Administrator

Wildcard Exceptions Tab

3. Select the Wildcard Exceptions tab if there are exceptions to be made on an Agent level for events being paged.

Example

A system has more than 100 tanks and one, TANK7, is down for maintenance.

TANK7 is entered in the Exception Details tab.

Tank* can still be used in the alarm configuration.

However, the alarm for TANK7 will be excluded/ignored when an alarm is fired.

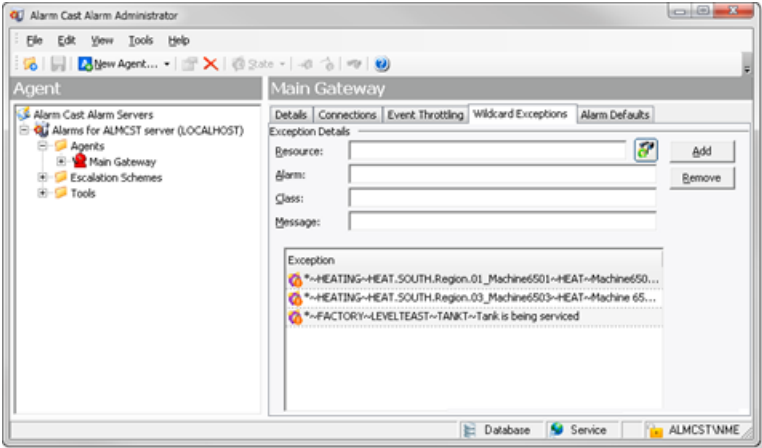

Field	Description
Exception Details	
Resource	CIMPLICITY resource associated with the alarm
Alarm	Alarm that will be included in the exception.
Class	Alarm class associated with the alarm.
Message	Message that describes the alarm or alarm exception.

4. Click Add.

Result: The alarm is added to the Exception list.

Note: Tips

- A dialog box is available in which you can select a value for each field from drop down lists; the values are taken from the associated project.
 - a. Select the alarm and specifications in the drop down lists.

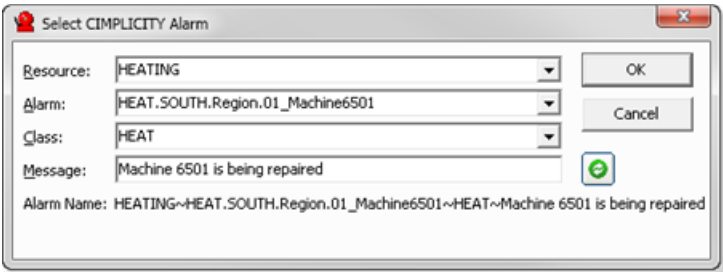

a. Click OK.

The Select CIMPLICITY Alarm dialog box closes; field selections display in the fields on the Wildcard Exceptions tab.

Important: Alarm ID lengths can have a maximum of 255 characters. If an alarm ID has 256 characters it will not be included in the dropdown list.

- a. Click Add to add the exception to the list.
 - Any exception can be deleted from the list.

Select an exception in the list; click Remove.

Alarm Defaults Tab

5. Select the Alarm Defaults tab to set defaults that will be used during new alarm configuration; options are as follows.

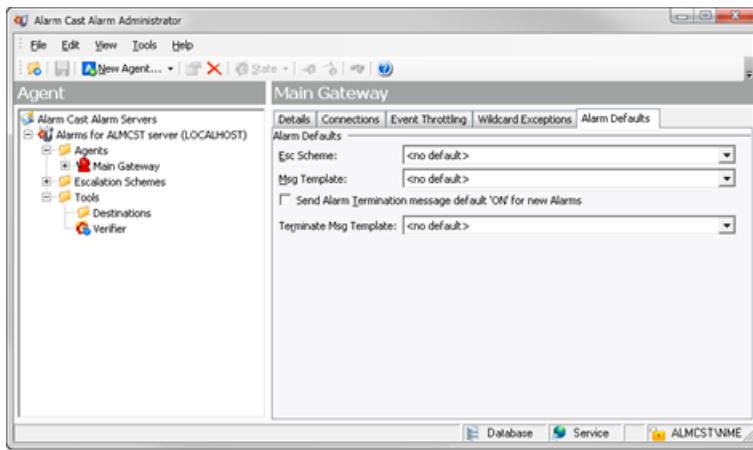

Field	Description
Alarm Defaults	
Esc Scheme	Escalation scheme that will be the default for all new alarms. Note: The dropdown list includes all configured escalation schemes.
Msg Template (page 934)	<p>Message for the agent that can be saved as a template for further alarm configuration.</p> <p> guide: Guidelines</p> <ul style="list-style-type: none"> • To configure the message, use the { symbol to launch a drop down list of message options. • The agent must be configured and saved first before a message template may be configured.
Send Alarm Termination message default "ON" for new Alarms	<p>Do the following.</p> <ul style="list-style-type: none"> • Check if an alarm termination message will be sent for new Alarms • Select the Terminate template from the dropdown list. <p>Important: The agent must be configured and saved first before a terminate message template may be configured.</p>

6. Click Save.

The CIMPLICITY GATE will now be visible in the Agents folder; the CIMPLICITY GATE folder includes an Alarms and Message Templates folder.

Gateway for CIMPLICITY: Message Templates

1. Expand Agents < CIMPLICITY GATE in the Alarm Cast Alarm Administrator left-pane.
2. Select the **Message Templates** folder.
3. Click New Message Template on the Alarm Cast Alarm Administrator toolbar.

A Details tab is available; options are as follows.

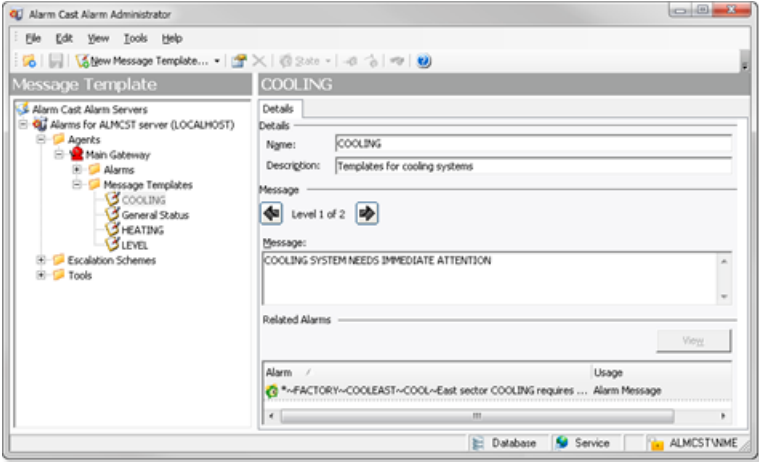

Field	Description
Details	
Name	Logical name utilized by the administrator to refer to the message. Note: The name will be listed in the tree view when the configuration is saved.
Description	Additional text to describe the message.
Message	
Level x of x	Allows up to infinite levels to be configured.
Message	Text that will display when the message template is added to an alarm.  guide: Guidelines: The following may be used: <ul style="list-style-type: none"> • Regular text. • The { symbol, to obtain other values. • ESCALATIONTEXT LEVEL1-LEVEL10, which was added when the escalation schemes were created.
Related Alarms	
View	Click View to display alarms that use the selected message template. The resulting list displays the alarm and its usage.

4. Click Save.

The message template will be listed in the selected agent's Message Templates folder.

Gateway for CIMPLICITY: Alarms

1. Expand Agents < CIMPLICITY GATE in the Alarm Cast Alarm Administrator left-pane.
2. Select the **Alarms** folder.
3. Click the New Alarms button on the Alarm Cast Alarm Administrator toolbar.

Alarms configuration includes the following tabs.

- Details tab
- Message tab
- Wildcard Exceptions tab
- Destination Exceptions tab

Details Tab

Select the Details tab; options are as follows.

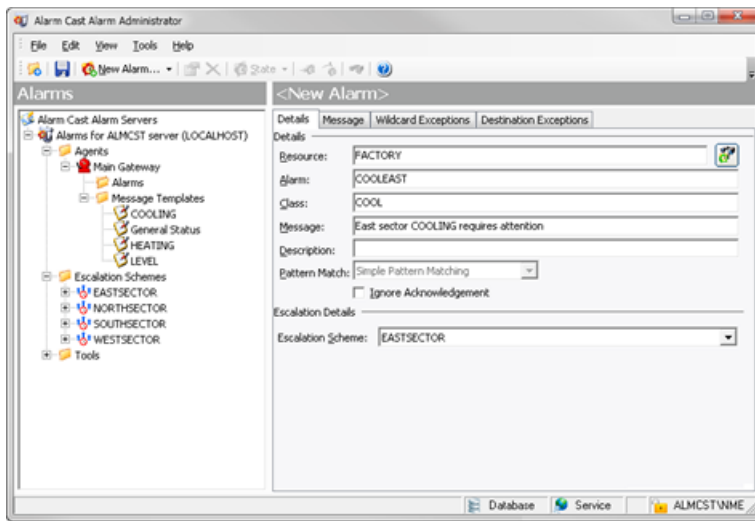

Field	Description
Details	
Resource	Machine name (e.g. TANK1)
Alarm	Alarm that is associated with the resource (e.g. HIGH, LOW).
Class	Further category to organize alarms
Message	Configured by the user to match message text configured on CIMPLICITY alarm. Wild cards can be used. Example *CRITICAL* will find all alarms with the text 'CRITICAL'.
Description	Additional text to further describe the alarm.

Pattern Match	Options are: <ul style="list-style-type: none"> • None • Simple Pattern Matching • Full Regular Expressions. Note: Information at this URL http://en.wikipedia.org/wiki/Regular_expression provides further details about creating regular expressions.
Ignore Acknowledgement	Used for the Alarm Cast Alarm Administrator console, which will send pages regardless if acknowledgement of the alarm is given.
Escalation Details	
Escalation Scheme	Escalation scheme that will be the default for all new alarms. Note: The dropdown list includes all configured escalation schemes

Message Tab

Select the Message tab; options are as follows.

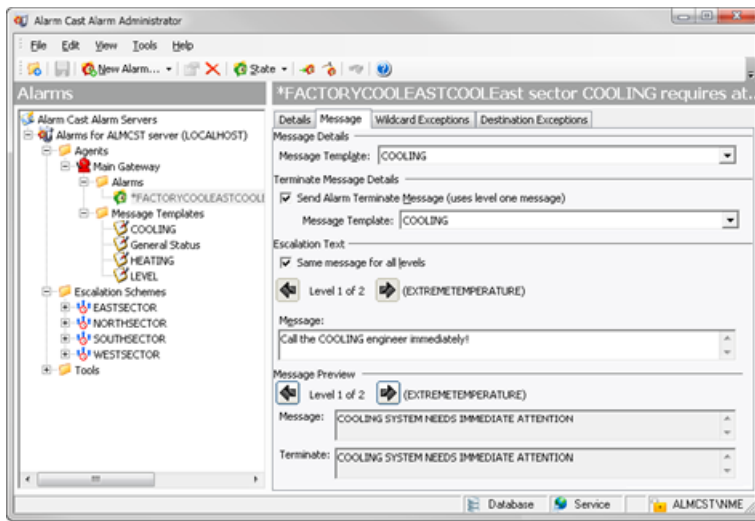

Field	Description
Message Details	
Message Template	Message template to be associated with the alarm. Note: The dropdown list contains configured templates for the agent being configured.
Terminate Message Details	
Send Alarm Message Terminate	Check if the alarm is to receive a message when the alarm is terminated.
Message Template	Message that will be sent when the alarm is terminated. Note: The dropdown list contains configured templates for the agent being configured.
Escalation Text	
Same message for all levels	Check if all alarm levels are to send the same message.

Message	Alarm specific message, created at the alarm level.  guide: Guideline: Either of the following can be used. <ul style="list-style-type: none"> • Regular text • The { symbol to obtain other values.
Message Preview	
Message	Displays the selected escalation text message
Terminate	Displays the Level one message.

Wildcard Exceptions Tab

Select the [Wildcard Exceptions \(page 932\)](#) tab if there are exceptions to be made on an Agent level for events being paged.

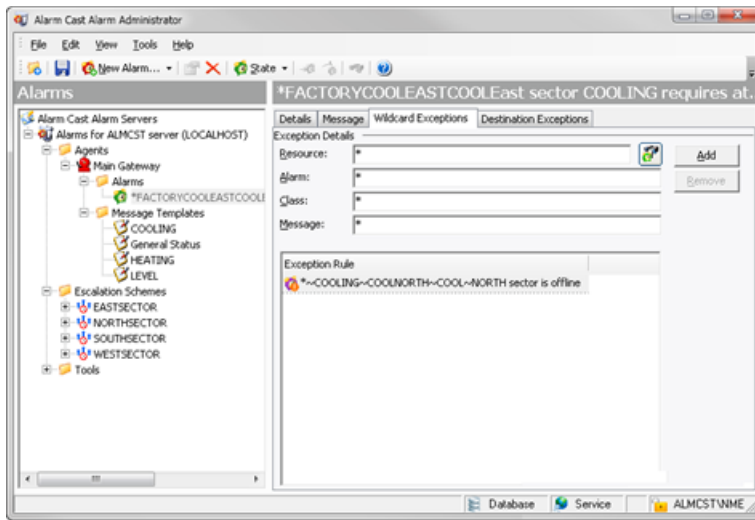

Note: Click the Add button to add multiple exceptions.

Click the Browse button  to the right of the **Resource** field to open the Select a [CIMPLICITY Alarm dialog box \(page 933\)](#) and select a resource, alarm and (alarm) class from dropdown menus.

Destination Exceptions Tab

Select the Destination Exceptions tab to set which destination will be excluded or added for the current alarm

Destination exception options are as follows.

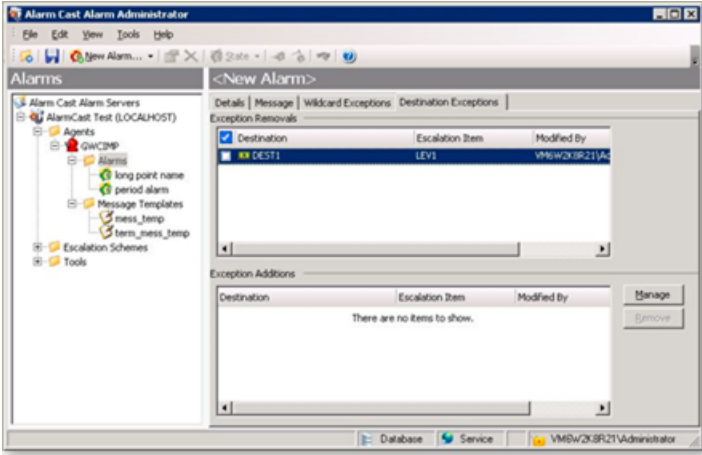

Field	Description
	Exception Removals
	Destinations that will be excluded from receiving messages regarding this alarm. Note: The destinations were configured in the Alarm Cast Server Administrator.
	Exception Additions
	Destinations that will be added to/receive messages regarding this alarm. Note: These are additional destinations that are not currently part of the alarm's escalation scheme and have been configured in the Alarm Cast Server Administrator.

Note: Click Add to add multiple exceptions.

4. Click Save.

The alarm will be listed in the selected agent's Alarms folder.

Gateway for CIMPLICITY: Message Value Fields

Following are Gateway for CIMPLICITY Agents message value fields.

Message Value	Available Fields	Description
SERVER	ACTIVE ALARM	Full string representation of the active alarm, including: <ul style="list-style-type: none"> • SERVER • System • Resource • Alarm Name • Alarm Class.
	ALARM	Name of the active CIMPLICITY alarm.
	APPLICATION	Which source (i.e. Gateway) the alarm originated from.
	DATE	Date the alarm was initiated.

	DATETIME	Date and time the alarm was initiated.
	DESCRIPTION	Alarm Cast description (display name) of the active alarm.
	DESTNAME	Destination or distribution list to which this alarm is being routed.
	ESCITEM	Numeric value of the current level of escalation for this alarm.
	HOST	Host name of the machine where the page originated.
	TIME	Timestamp of when the alarm was initiated.
USERTEXT	ALARM	Name of the active CIMPLICITY alarm.
	CLASS	Class of the active CIMPLICITY alarm.
	RESOURCE	Resource of the active CIMPLICITY alarm.
	SYSTEM	Project containing the active CIMPLICITY alarm.
	STATE	State of the active CIMPLICITY alarm.
	RULE	String representation of the rule that captured this alarm for action.
	MESSAGE	Message value of the active CIMPLICITY alarm.
ESCALATIONTEXT	LEVEL1... LEVEL10	Level specific escalation text templates as defined on the Messages tab of the alarm.

Alarm Cast Alarm Administrator Tools

Alarm Cast Alarm Administrator Tools

Alarm Cast Alarm Administrator comes equipped with additional tools that allow a user to view destinations and alarms with which they are associated, register users and verify destinations. The tools are conveniently displayed in the tree view in the Tools folder.

Alarm Cast Alarm Administrator Tools: Destinations
Alarm Cast Alarm Administrator Tools: Users
Alarm Cast Alarm Administrator Tools: Verifier

Alarm Cast Alarm Administrator Tools: Destinations

1. Expand the Tools folder.
2. Select the Destinations folder in the Alarm Cast Administrator left-pane.

The destinations, which are pulled in from the Alarm Cast server, are listed and can be associated with alarms and escalation schemes.

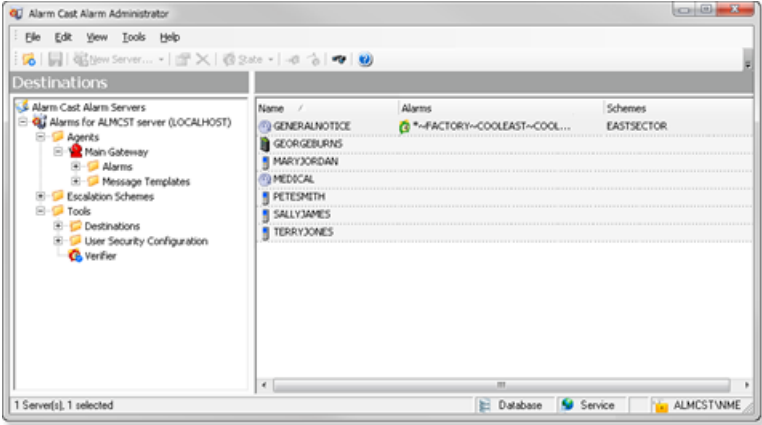

Alarm Cast Alarm Administrator Tools: Users

If Windows or Windows Trusted is selected for the Alarm Cast Alarm server security, a User Security Configuration folder is added to the Tools tree, if it was not already there.

Do the following.

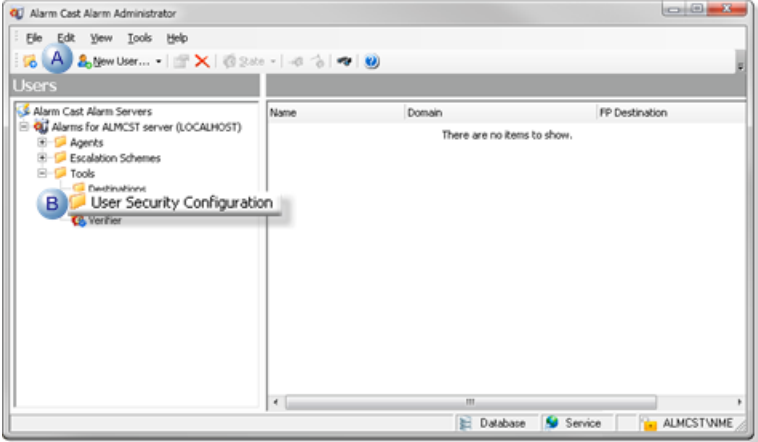



- | | |
|---|---|
| A | Select User Security Configuration in the Alarm Cast Alarm Administrator window left-pane. |
| B | Click New User on the Alarm Cast Alarm Administrator window toolbar. |

Result: Tabs for the User profile display in the Alarm Cast Administrator right-pane.

Alarm Cast Administrator Users: Details Tab

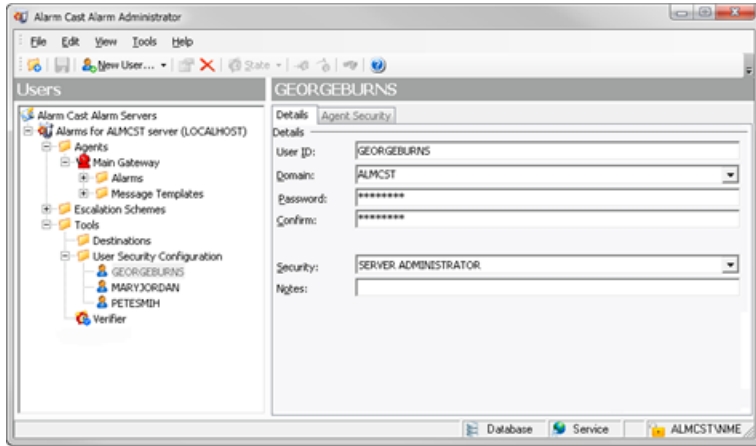
Select the Details tab; details options to register users are as follows.



Field	Description	
User		
User ID	Valid Windows user.	
Domain	Domain the user logs into.	
Password	(Required with Windows Security (page 924)) Password assigned to the logged in Windows user.	
Confirm	(Required with Windows Security (page 924)) Re-entered password	
Security	Security levels are as follows.	
	SERVER ADMINISTRATION	Full rights to all features.  Important: : The SERVER ADMINISTRATION security level is required to access (open) applications. For almost all instances, it is recommended that SERVER ADMINISTRATION be assigned to registered Alarm Cast users.
	USER	Can access only the Alarm Cast Client to send a manual message.
Notes		
Notes	(Optional) Additional details about or for the user.	

Alarm Cast Alarm Administrator Tools: Verifier

The Verifier tool alerts you to discrepancies in destination configuration and eliminates invalid destinations.

(If a destination name was changed in the Alarm Cast Administrator, the Verifier provides you with the tool to verify if the original name should be removed or replace the new name.)

1. Expand the **Tools** folder.
2. Select Verifier in the Alarm Cast Alarm Administrator left-pane.
3. The Alarm Cast Alarm Administrator right-pane provides the following.

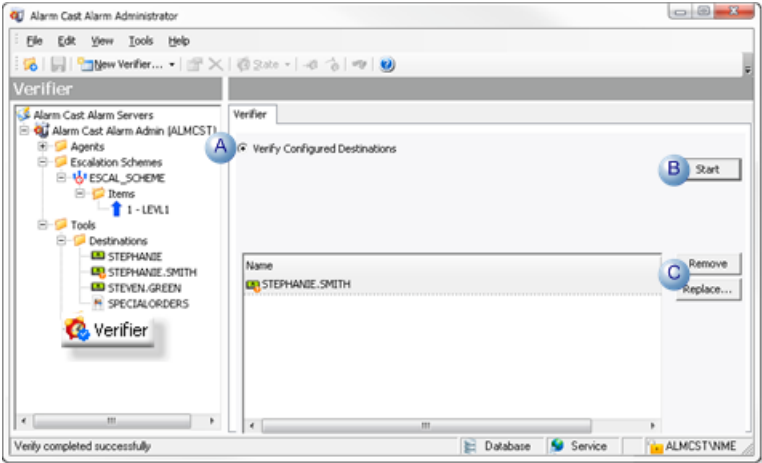

A	Make sure Verify Configured Destinations is checked. Default is checked.
B	Click Start.
	The Verifier lists the discrepancies.
C	Select the items in the list; click Remove or Replace to tell the Verifier what to do with each discrepancy.

The Alarm Cast Alarm Administrator verifies and fixes, when necessary, the configured destinations.

Alarm Cast Alarm Administrator Other Tools

Alarm Cast Alarm Administrator Other Tools

Alarm Cast Alarm Administrator: Toolbar and tree.
Alarm Cast Alarm Administrator: Options.
Alarm Cast Alarm Administrator: Reports.
Alarm Cast Alarm Administrator: Alarm search.
Alarm Cast Alarm Manager: Log files.

Alarm Cast Alarm Administrator Other Tools: Toolbar and Tree

The Alarm Cast Alarm Manager Administrator user interface is displayed in a tree view. The Server, when expanded, shows folders for Agents, Escalation Schemes and Tools. They enable the user to register various agents to work closely with a specific alarming/event notification system. An agent is then set up to manage alarms from each notification system.

It includes a Destination folder that serves as a shortcut to already configured destinations, allowing the user to quickly locate the alarms that the destinations are configured to without knowing the agent/alarm that supports them.

Anything created on the tree view side of the screen (the left hand side) can be modified or deleted at any time. You can also change the state to disable.

Tree View Items: Modify

Select the item you want to modify. The information regarding it will display on the right hand side of the window. At this point, you can change the name along with any other variables attached to it (e.g. configuration settings etc.) When you save your changes, they will appear in the Tree View.

 **Important:** Information regarding manufacturer or models, cannot be altered. Once the modified information has been saved, you cannot revert to the old information. The only way to retrieve it is to change it back to its original state.

Tree View Items: Delete

There are two ways to delete items on the tree view side of the window. By selecting the item you want to delete, you can choose Edit >Delete on the Menu bar or simply click the red **Delete** symbol (X).

 **Important:** You cannot recover any deleted item or any information attached to it. You must recreate it.

In certain applications, if a particular item is being used in another part of the application, you will not be able to delete it at that level. You must go further down in the Tree View to discern where it is being used and delete it there first.

Alarm Cast Alarm Administrator Other Tools: Options

The Tools menu enables users to set Alarm Cast Alarm Server options and details.

Click the Tools>Options on the Alarm Cast Administrator menu bar.

An Options dialog box opens.

The General tab determines the number of servers that can be configured; options are as follows.

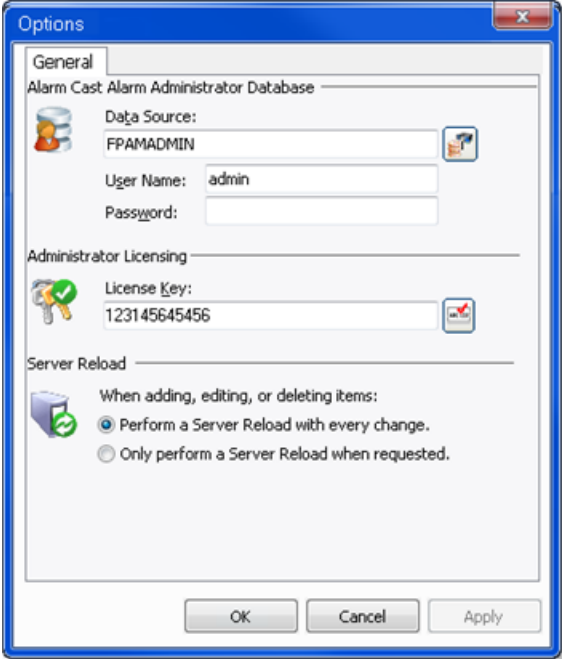

Option	Description	
Data Source	Provides the Alarm Cast Alarm Server database and user/password requirement.	
License key.	Determines the number of servers that can be configured.	
Server Reload	Provides the option to reload the server with any additions, edits or deletions automatically or when requested by the user.	
	Reload with every change	Reload will occur when the Save button is clicked.
	Reload only when requested	Reports that there are data changes about which the server needs to be notified. Options are: <ul style="list-style-type: none"> • Send the reload before closing. • Close the system without reloading the changes.

Alarm Cast Alarm Administrator Other Tools: Reports

The Reports menu enables users to view and print various reports on configured devices, providers, destinations or aliases.

1. Click Tools>Reports on the Alarm Cast Alarm Administrator menu bar.
2. Select a report to view or print.

Reports display the following.

- Alarm List report displays the alarms that have been configured and the agent they are configured to.
- Destination Alarm List report displays the destinations that have been configured and the agent they are configured to.
- Destination List report displays the destinations that have been configured and the agent they are configured to.
- Escalation Scheme List report displays each escalation scheme and associated levels or items.

More information

- Alarm Cast Alarm Administrator Other Tools

Alarm Cast Alarm Administrator Other Tools: Alarm Search

1. Click Tools>Search Configured Alarms on the Alarm Cast Alarm Administrator toolbar.

A Find Configured Alarms dialog box opens.

2. Do one of the following.

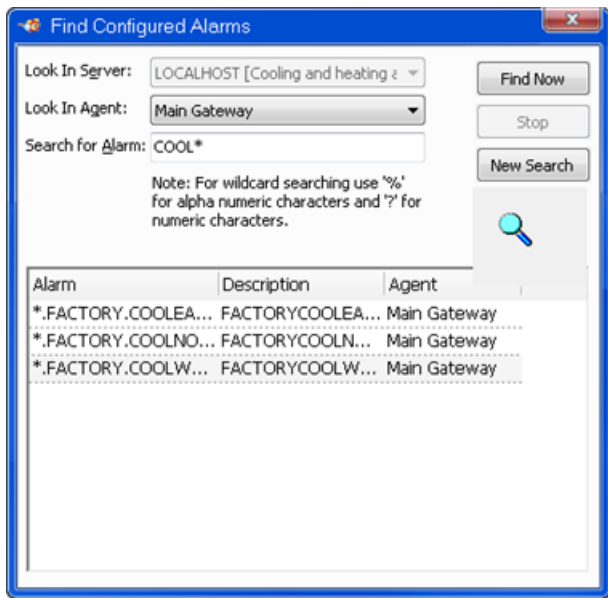

Field	Description
Look In Agent	Agent that might contain the alarm being searched
Search for Alarms	Alarm name. Note: Wild cards can be used.

3. Click Find Now.

Alarms that match the selected criteria are listed in the Results box.

Alarm Cast Alarm Administrator Other Tools: Log Files

1. Select View on the Alarm Cast Gateway menu bar.
2. Click the log to be viewed. Options are:
 - View Server Log
 - View Admin Log
3. Double-click the log entry for further information.

 **guide:** Alarm Cast Gateway Filter Guidelines

- Click the Filters button on the selected log window toolbar.

An Alarm Cast Gateway Filter dialog box opens.

The **Events On:** field defaults to the current day.

The **Status Message** field can be used to search for a portion of the message in the log.

Important: When matching special characters, enclose them in brackets.

Example

To find all log items that start with [enter in [[]* in the **Status Message** field.

The common allowed search characters are as follows:

Character	Match Made	Example
?	Any single character	Text in the log is ABC, DBC and XYZ. If ?BC is used in the Status Message field, only ABC and DBC will be returned.
*	Zero or more characters	*Initiated* in the Status Message field would return all log items with the word 'Initiated'
#	Any single digit (0-9)	Text in the log is Device1, Device5, Device8, Device10. Keying in Device# in the Status Message field, will return Device1, Device5, and Device8.

- Check Automatic Refresh to automatically refresh the log file based on the seconds specified.

Alarm Cast Alarm Administrator Glossary

Administrator

Typically a GUI application, this component facilitates configuration and monitoring of a server engine. If changes are made to the server configuration the administrator notifies the engine to reload its running configuration either automatically or on user demand. An example of an administrator component is Alarm Cast Administrator. This administrator allows you to maintain the Alarm Cast server's engine configuration.

Administrator Kit

An administrator kit contains the product's administration component only. After installing this kit on a workstation you may utilize any of the features of the Administrator component.

Agent

A module that is developed to work closely with a specific alarming/event notification system.

Client

A client component utilizes the facilities of a standard server. Typically a GUI application, this component provides a user-friendly interface of the available services offered by the server engine. An example of a client tool would be Alarm Cast Client, which presents the user with a list of known messaging destinations and allows them to send messages to one or more destinations.

Destination

An Alarm Cast Server destination is a name assigned to a messaging location to which text messages may be delivered. Ex. SCOTT'S_PAGER, KENS_PHONE, JIMS_EMAIL.

DSN

A DSN, Data Source Name, is the name assigned to an ODBC driver and configuration information that allows an ODBC enabled application to connect to a data source.

Engine

An engine component implements a unified interface to a set of common, related protocols. The engine provides services to clients and gateways such that a common interface may be used to manipulate many different types of devices. Engines are administered via Administrator components and are utilized by clients, gateways or use written components.

Gateway

A gateway component creates a bridge between a third party product and a standard server. Typically an engine this component provides a conduit for forwarding events from the third party product into a CIMPLICITY standard server.

An example of a gateway would be an interface to an HMI or SCADA system forwarding events from that system to Alarm Cast Alarm Manager for processing.

Host

The host is the location or machine name where alarms are initiated from.

ODBC

The ODBC protocol is an implementation of the Microsoft 'Open Database Connectivity' API allows Alarm Cast Server to forward messages to any ODBC compliant data source.

Schedule

An Alarm Cast Server schedule is a name assigned to a set of weekday configuration rules, which define the times during which a destination may receive messages. A schedule, once defined may then be assigned to a destination over a time period.

Server Kit

A server kit typically contains the server engine and administrator components. In some cases a client component is also included with this kit. The server kit is usually installed on a centralized host, and one or more clients or gateways utilize this server. An example of a server kit is Alarm Cast Server. This kit contains the Alarm Cast engine, administrator and client.

User Text

Custom text fields that may be added to alarm messages. Alarm Manager allows up to 20 user text messages to be configured.

Wizard

A wizard is a prompted process that guides an application user through a complicated data entry process, providing hints as to the appropriate answers required for each field or screen.

Alarm Cast Gateway for CIMPLICITY

About Alarm Cast Gateway for CIMPLICITY

The following topics provide an overview of the Alarm Cast Gateway for CIMPLICITY including detailed configuration descriptions.

Alarm Cast Gateway for CIMPLICITY: Key Features
Alarm Cast Gateway for CIMPLICITY: How it Works
Alarm Cast Gateway for CIMPLICITY Components
Alarm Cast Gateway for CIMPLICITY Tools: Users
Alarm Cast Gateway for CIMPLICITY Other Tools
Alarm Cast Gateway for CIMPLICITY Glossary

Alarm Cast Gateway for CIMPLICITY: Key Features

Alarm Cast Alarm Manager Gateway for CIMPLICITY is an Alarm Cast administration system that enables users to easily configure various rules that, once triggered, will send a message to a variety of Alarm Cast destinations, using a simple generic language.

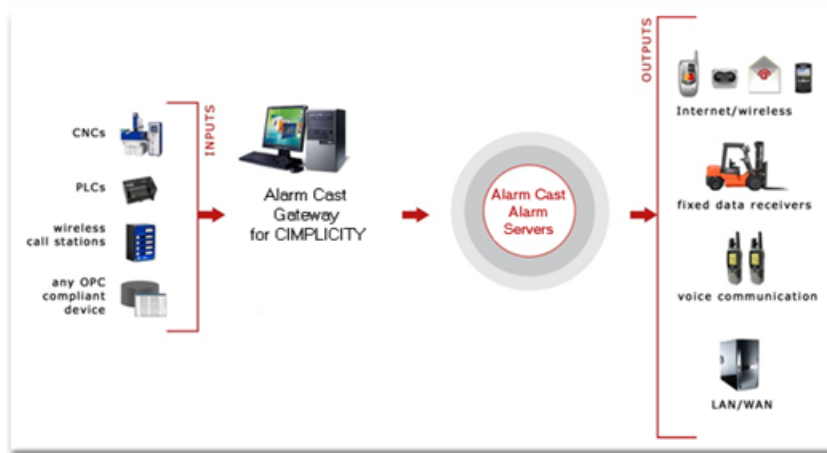

Key Features:

- Hot reload for any configuration changes/additions.
- Data items embedded in alarm messages are updated during the life of the alarm.

Alarm Cast Gateway for CIMPPLICITY: How it Works

Alarm Cast Gateway for CIMPPLICITY is another product in the Alarm Cast suite of products. Alarm Cast Alarm Manager Gateway can reside on your Alarm Cast Alarm Manager Server or access an Alarm Cast Alarm Manager Server over a LAN or WAN connection.

The Alarm Cast Gateway for CIMPPLICITY provides a bridge between CIMPPLICITY project alarms and the Alarm Cast Alarm Manager Server. Various routing rules can be defined by selecting available Resources, Alarms, Classes and alarm message text that have been configured in a CIMPPLICITY project. When one of these rules is met, message text can be dispatched to Alarm Cast Server, including embedding alarm and point values within the message text.

There are four valid alarm states that may be configured for each Routing Rule:

State	The alarm:
Generate	Has gone into an active state.
Acknowledged	Is acknowledged either: <ul style="list-style-type: none"> • Manually by an operator in the Alarm Viewer. • Automatically (The point alarm is set up to Auto Ack).
Reset	<ul style="list-style-type: none"> • Is back either: • Manually by an operator in the Alarm Viewer. • Automatically reset.
Delete	Has been terminated after meeting the Deletion Requirements.

Alarm Cast Gateway for CIMPPLICITY Components

- Alarm Cast Gateway: Enabled
- Alarm Cast Gateway: Remote Client
- Alarm Cast Gateway: Server

Alarm Cast Gateway: Enabled

1. Open the appropriate CIMPPLICITY project in the Workbench.
2. Click Project>Properties on the Workbench menu bar.

The Project Properties dialog box opens.

3. Select the General tab.
4. Check Alarm Cast Gateway.

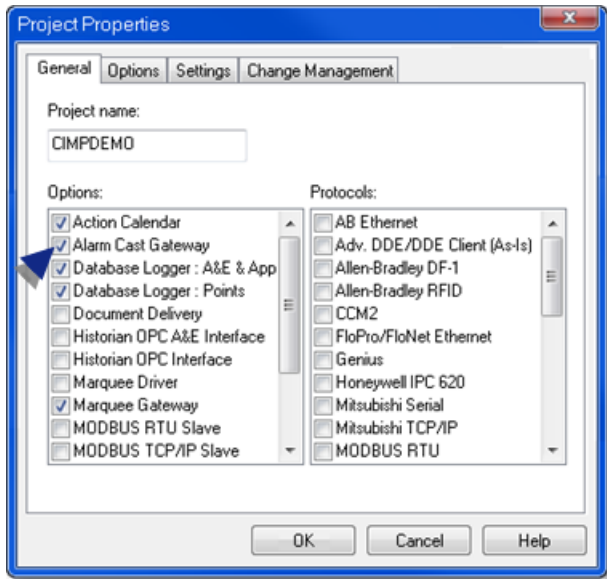

Alarm Cast Gateway: Remote Client

5. Expand Project >Security>Advanced in the Workbench left-pane.
6. Double-click **Client**.

A New Client dialog box opens.

7. Enter the **Computer** name in the Computer field.
8. Click OK.

The client Properties dialog box opens.

9. Enter the following.

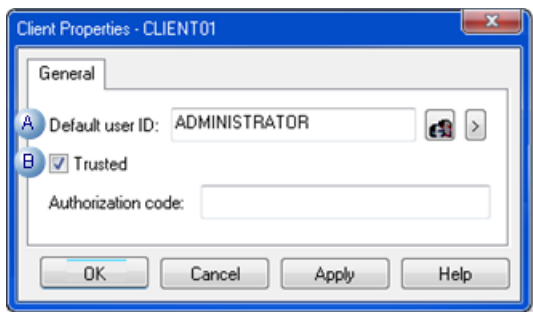

A	Enter ADMINISTRATOR.
---	----------------------

B	Check Trusted.
---	----------------

Alarm Cast Gateway: Server

- 10. Start the CIMPLICITY project.
- 11. Stop the `FPAMGATEWAY` process, as follows.
 - a. Expand Runtime in the Workbench left-pane; double-click **Process Control**.

The CIMPLICITY Process control dialog box opens.

- a. Do the following.

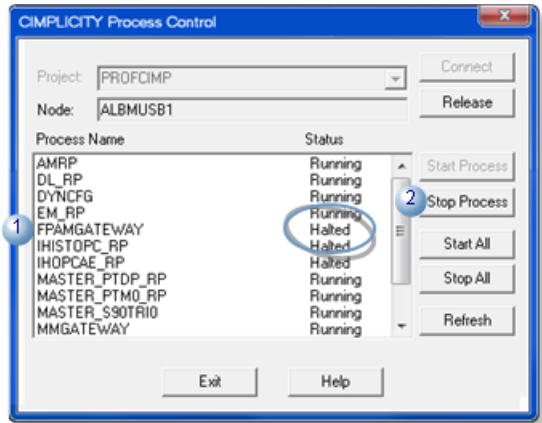

1	Select <code>FPAMGATEWAY</code> .
2	Click Stop Process.

The `FPAMGATEWAY` process is halted.

- 12. Open the Alarm Cast Gateway, as follows.

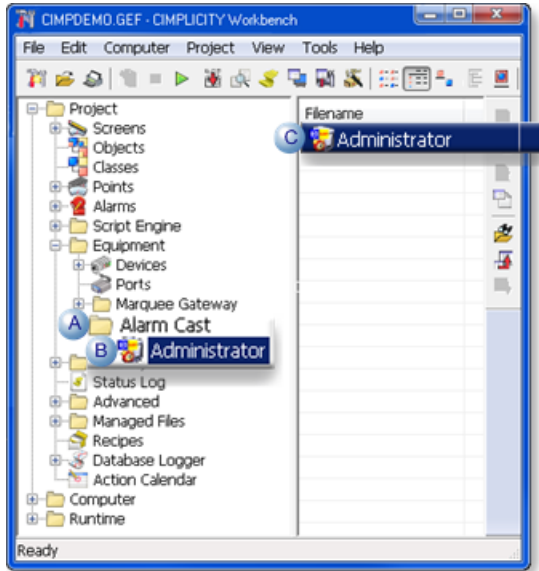

A	Expand Project>Equipment>Alarm Cast in the Workbench left-pane.
B	Select Administrator .
C	Double-click Administrator in the Workbench right-pane.

Result: The Alarm Cast Gateway window opens.

Alarm Cast Gateway configuration includes the following tabs.

- Details Tab
- Settings Tab
- Security Tab
- CIMPLICITY Tab

Details Tab

Select the Details tab; options are as follows.

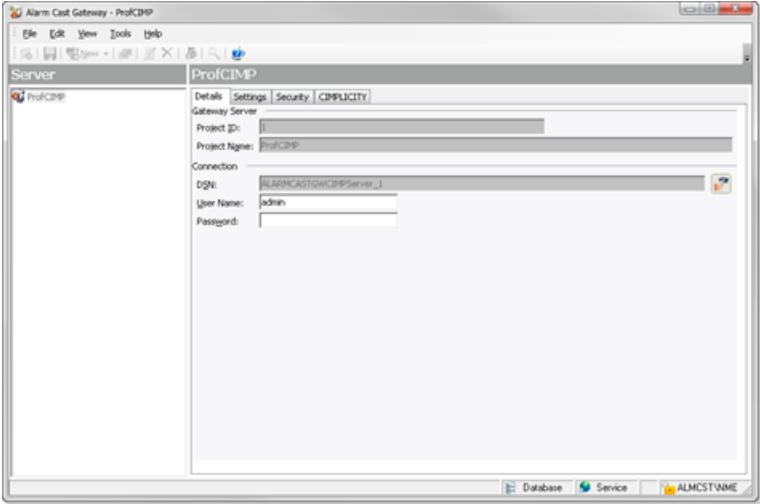

Field	Description
Gateway Server	
Project ID	Automatically assigned when the new server has been saved.
Project Name	Automatically entered. Note: This is the same name as the project that was opened in Workbench.
Connection	
DSN	Automatically entered when the server is saved.
User Name	Optional.
Password	Optional.

Settings Tab

Select the Settings tab; options are as follows.

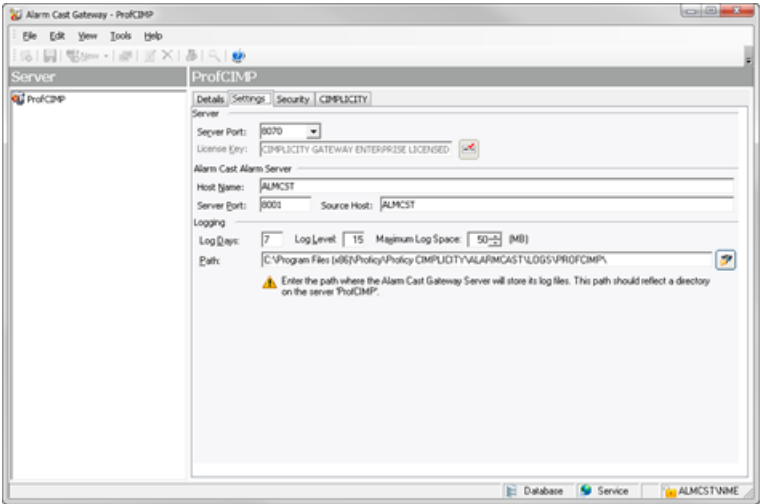



Field	Description
Server	
Server Port	(Automatically entered) default value in the range from 8070 to 8089.  Important: <ul style="list-style-type: none"> • Each project must have a unique port assigned to it. • Keep the value the system assigns unless instructed by CIMPLICITY to do otherwise.
License Key	Valid Alarm Cast Gateway for CIMPLICITY license key
Alarm Cast Alarm Manager Server	
Host Name	TCP/IP resolvable name for the machine running Alarm Cast Alarm Manager Server.
Server Port	Port that connects to the Alarm Cast Alarm Manager Server. Default is 8001.
Source Host	(Automatically entered) TCP/IP resolvable name for the machine running the Alarm Cast Alarm Manager Gateway for CIMPLICITY and where the CIMPLICITY project is running.
Logging	
Log Days	Number of days the log file will be kept before being purged. Default is 7 days.
Log Level	For use at the request of CIMPLICITY. In the event of any problems, CIMPLICITY may request additional levels of logging to assist in problem solving. Default is 0.
Maximum Log Space	Amount of space to allot to the log file. Note: This prevents the log files from consuming too much drive space. Default is 50 MB.
Path	Path to directory where the Marquee Manager Server will store its log files. Important: The path should reflect a directory on the CIMPLICITY project server.

Security Tab

If security is enabled a Login dialog box will open when a user tries to open the Alarm Cast Gateway window. Only users who have been configured in the Tools>Users tree will have access.

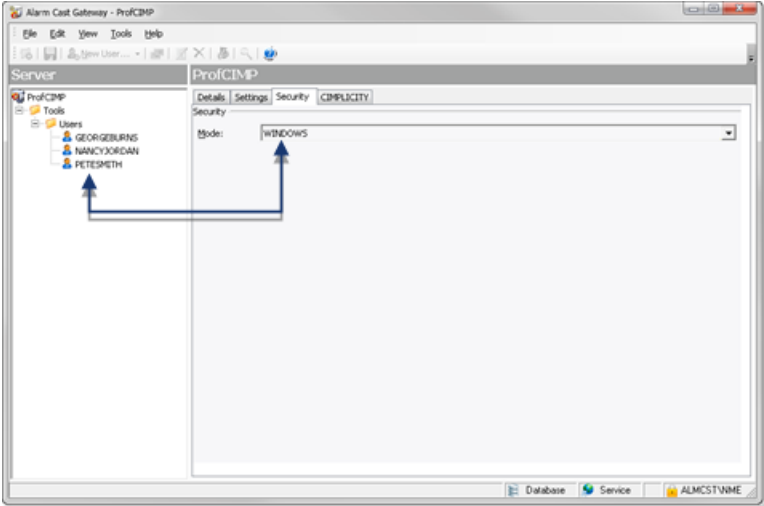
Select the Security tab: security options for the selected server are as follows.



Field	Description	
Security		
Mode	Security options for the Alarm Cast Gateway server are as follows.	
	NONE	Alarm Cast Gateway security is not enabled for the server.
	Windows	<p>A valid user name/password are required. Security is as follows.</p> <ul style="list-style-type: none"> a. A Users folder is added to the Tools tree. b. Users who should have access to the Alarm Gateway server need to be added. c. A Login dialog box opens when a user attempts to open the Alarm Cast Gateway window.  <p>Result: Listed users with valid user names/passwords will have access to the server.</p>
	Windows Trusted	<p>Uses a trusted domain account; does not require a password.</p> <ul style="list-style-type: none"> a. A Users folder is added to the Tools tree. b. Users who should have access to the Alarm Gateway server need to be added. <p>Result: After a listed user logs into Windows, the user can open the Alarm Cast Gateway window; a Login dialog box for the Alarm Cast Gateway is not required.</p>
	Default	NONE

CIMPLICITY Tab

Select the CIMPLICITY tab.

Selections are global to all alarms within the project; options are as follows.

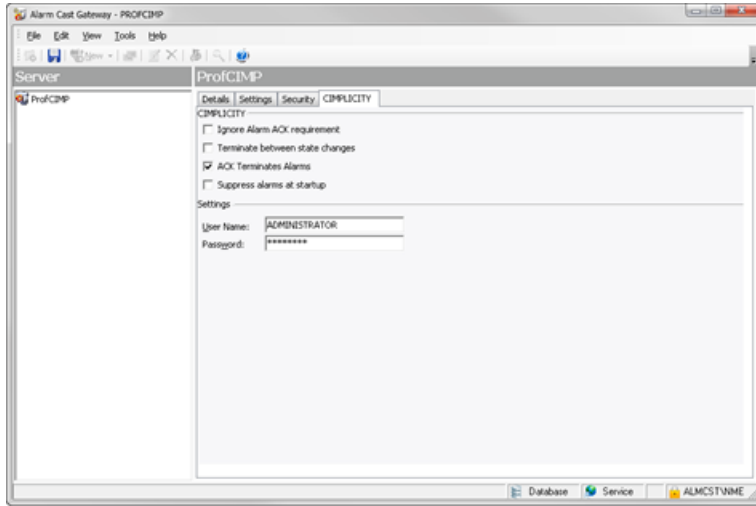

Field	Description
CIMPLICITY	
Ignore Alarm ACK	Alarm does not need to be acknowledged by an operator to suppress messaging Note: The message will be suppressed even if ACK is required in the alarm's CIMPLICITY configuration.
Terminate between state changes	Stop messaging from escalating further when the alarm state changes. Messaging will commence at level one for the alarm on each state change.
ACK Terminate Alarms	Terminate an alarm when the engine receives an ACK.
Suppress alarms at startup	Will not initiate enabled alarms that are found at the startup.
Settings	
User Name	Name that matches a user name in the CIMPLICITY project Note: The users are accessed by selecting Security>Users in the Workbench left-pane; the users are listed in the right-pane.
Password	Valid password for the selected user.

13. A **Users** folder is added to the Tools tree.

14. Users who should have access to the Alarm Gateway server need to be added.

15. A Login dialog box opens when a user attempts to open the Alarm Cast Gateway window.



- 16. A **Users** folder is added to the Tools tree.
- 17. Users who should have access to the Alarm Gateway server need to be added.
- 18. Click Save on the Alarm Cast Gateway toolbar.
- 19. Restart the `FPAMGATEWAY` process in the CIMPPLICITY Process Control dialog box.

A Project ID now displays on the Gateway Server Details tab.

Alarm Cast Gateway for CIMPPLICITY Tools: Users

If Windows or Windows Trusted is selected for the server security, a Tools tree with a Users folder is added to the Alarm Cast Gateway window left-pane.

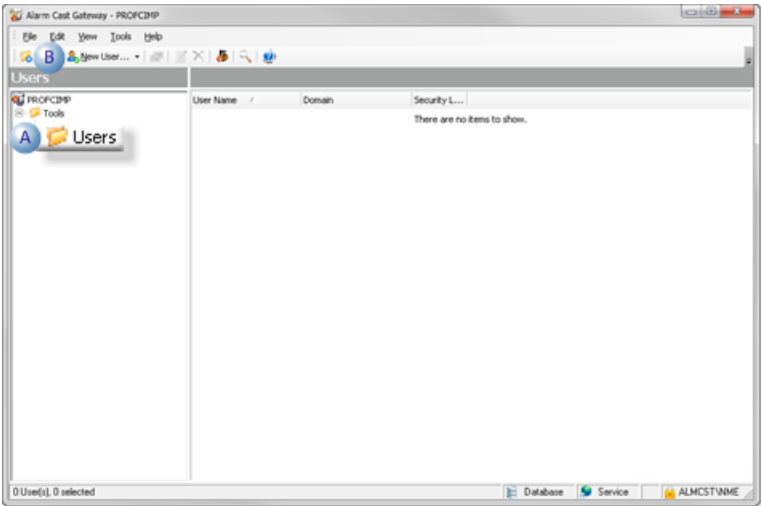

Do the following.

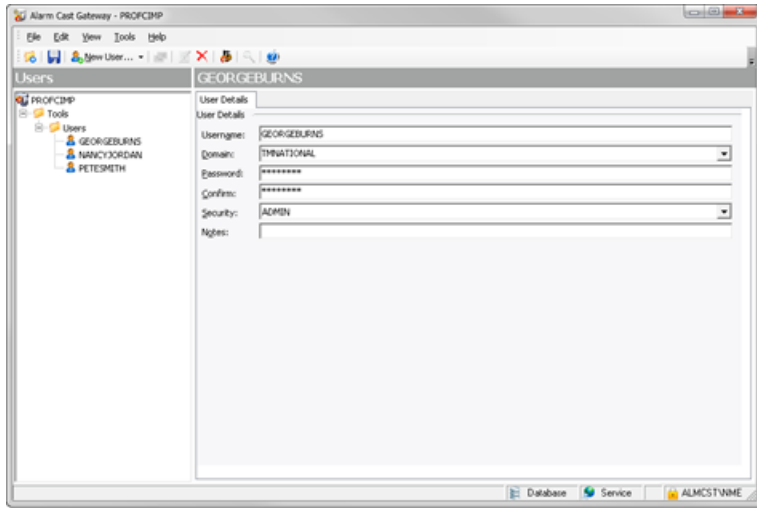

- | | |
|---|---|
| A | Select Users in the Alarm Cast Gateway window left-pane. |
| B | Click New User on the Alarm Cast Gateway window toolbar. |

A Details Tab displays; options to register users are as follows.



Field	Description				
User Details					
Username	Valid Windows user.				
Domain	Domain the user logs into.				
Password	(Required with Windows Security (page 956)) Password assigned to the logged in Windows user.				
Confirm	(Required with Windows Security (page 956)) Re-entered password				
Security	Security levels are as follows.				
	<table border="1"> <tr> <td>ADMIN</td> <td>Full rights to all features.  Important: : The ADMIN security level is required to access (open) applications. For almost all instances, it is recommended that ADMIN be assigned to registered Alarm Cast users.</td> </tr> <tr> <td>DEFAULT</td> <td>Can access only the Alarm Cast Client to send a manual message.</td> </tr> </table>	ADMIN	Full rights to all features.  Important: : The ADMIN security level is required to access (open) applications. For almost all instances, it is recommended that ADMIN be assigned to registered Alarm Cast users.	DEFAULT	Can access only the Alarm Cast Client to send a manual message.
ADMIN	Full rights to all features.  Important: : The ADMIN security level is required to access (open) applications. For almost all instances, it is recommended that ADMIN be assigned to registered Alarm Cast users.				
DEFAULT	Can access only the Alarm Cast Client to send a manual message.				
Notes					
Notes	(Optional) Additional details about or for the user.				

Alarm Cast Gateway for CIMPLICITY Other Tools

Alarm Cast Gateway for CIMPLICITY Other Tools

Once configured, there is very little interaction between the user and Alarm Cast Gateway for CIMPLICITY. The management of this application takes place within its associated Alarm Cast Administrator agent.

Alarm Cast Gateway for CIMPLICITY: Options.
Alarm Cast Gateway for CIMPLICITY: Log Files

Alarm Cast Gateway for CIMPLICITY: Options

Before using Alarm Cast Gateway for CIMPLICITY, configure the various settings that control the interface to the gateway.

Click the Tools>Options on the Alarm Cast Gateway menu bar.

An Options dialog box opens; options are as follows.



Option	Description	
Data Source	Installation will default the Data Source to FPAMGWCIMPADMIN , pointing to the Gateway for CIMPLICITY administrator database.	
Server Reload	Enables the user to select when they want a reload to server: with every change, or only when requested.	
	Reload with every change	Reload will occur when the Save button is clicked.
	Reload only when requested	You will be informed that there are data changes the server needs to be notified about and have the option to either send the reload before closing or close the system without reloading the changes.

Alarm Cast Gateway: Log Files

1. Select View on the Alarm Cast Gateway menu bar.

2. Click the log to be viewed. Options are:

- View Server Log
- View Admin Log

3. Double-click the log entry for further information.

 **guide:** Alarm Cast Gateway Filter Guidelines

- Click the Filters button on the selected log window toolbar.

An Alarm Cast Gateway Filter dialog box opens.

- The **Events On:** field defaults to the current day.
- The **Status Message** field can be used to search for a portion of the message in the log.

Important: When matching special characters, enclose them in brackets.

Example

To find all log items that start with [enter in [[]* in the **Status Message** field.

The common allowed search characters are as follows:

Character	Match Made	Example
?	Any single character	Text in the log is: <ul style="list-style-type: none"> • ABC • DBC • XYZ. Entering ?BC returns only: <ul style="list-style-type: none"> • ABC • DBC
*	Zero or more characters	Entering *Initiated* returns: All log items with the word Initiated
#	Any single digit (0-9)	Text in the log is <ul style="list-style-type: none"> • Device1 • Device5 • Device8 • Device10. Entering Device# returns: <ul style="list-style-type: none"> • Device1 • Device5 • Device8.

- Check Automatic Refresh to automatically refresh the log file based on the seconds specified.

Alarm Cast Gateway for CIMPLICITY Glossary

Administrator

Typically a GUI application, this component facilitates configuration and monitoring of a server engine. If changes are made to the server configuration the administrator notifies the engine to reload its running configuration either automatically or on user demand. An example of an administrator component is Alarm Cast Administrator.

This administrator allows you to maintain the Alarm Cast server's engine configuration.

Administrator Kit

An administrator kit contains the product's administration component only. After installing this kit on a workstation you may utilize any of the features of the Administrator component.

Alarm

Generates alarms for points that are in an alarm state. It can generate alarm messages about system events, such as device failures, and device statuses.

Class

Alarm class is the order in which an alarm appears relative to other alarms. Alarms with similar characteristics are usually grouped by class.

Distribution List

An Alarm Cast Server distribution list is a collection of marquees, which can be sent a message with a single transaction. Similar to an e-mail distribution list a client who initiates a transaction with a distribution list will automatically send the same message to all associated marquees.

Point

Data that can be collected from various devices such as programmable controllers. Point configuration defines where a point originates, how the data is collected, and what constitutes an alarm state.

Resource

The physical or conceptual units that comprise your facility and can be anything from devices and machines to stations where work is performed.

Server Kit

A server kit typically contains the server engine and administrator components. In some cases a client component is also included with this kit. The server kit is usually installed on a centralized host

and is utilized by one or more clients or gateways. An example of a server kit is Alarm Cast Server. This kit contains the Alarm Cast engine, administrator and client.

Alarm Cast Client

About Alarm Cast Client

Alarm Cast Client provides a simple, easy to use interface for creating and manually sending messages to remote users. It provides full access to a detailed address book of all users accessible by name, alias or locator.

Alarm Cast Client: Key Features
Alarm Cast Client: How it Works
Alarm Cast Client Components
Alarm Cast Client Tools
Alarm Cast Client Glossary

Alarm Cast Client: Key Features

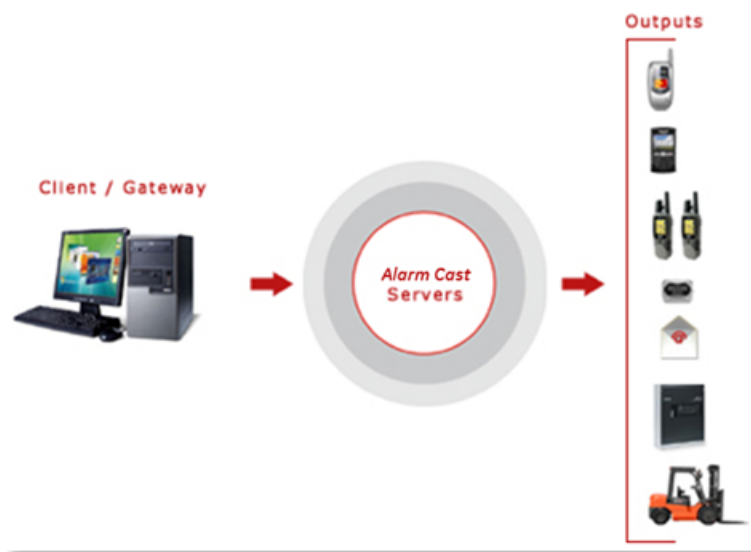

Key Features:

- Full access to a detailed address book of all users accessible by name, alias or locator.
- User-friendly maintenance of Destinations, Distribution Lists, Recurrences and Common Messages conveniently displayed in a tree view.

- Supports the addition of personal destinations and personal distribution lists.
- Detailed transaction logging and viewing of these logs.
- Logon security that can be configured for each Client machine.
- The ability to view Client in Classic Mode, for quick efficient processing of messages.

Alarm Cast Client: How it Works

Alarm Cast Client is the end user interface of the Alarm Cast Suite of applications. It enables you to create and send pages to remote users.

The primary function of Alarm Cast is to send pages to remote destinations. This is facilitated through the use of Alarm Cast Server and a central service provider.

Alarm Cast Client allows the use of these two elements to create and deliver electronic pages simply and efficiently.

Alarm Cast Client Components

Alarm Cast Client Components

Before using Alarm Cast Client, more personal destinations may be added and other features can be configured that will facilitate the efficient sending of messages.

Alarm Cast Client key component configuration includes the following.

- Alarm Cast Client Personal Destinations
- Alarm Class Client Recurrence Items
- Alarm Cast Client Common Message
- Alarm Cast Client Transaction Viewing

! **Important:** If Windows security has been implemented in the Alarm Cast Administrator, a Login dialog box will open before a user can access the Alarm Cast Client. Valid user names and passwords are pulled from the names configured in the Alarm Cast Administrator.



Alarm Cast Client Personal Destinations

There are two types of destinations.

Destination Type	Defined in	Description
Public	Alarm Cast Server Administrator	Display on all clients that are connected to the Alarm Cast server.
Personal	Alarm Cast Client	Only available on the selected Alarm Cast client.

! **Important:** Personal Destination to providers must already be configured as Destinations in the Alarm Cast Server.

Do the following to configure the Personal Destination option.

1. Click the **Destination** folder in the Alarm Cast Client left-pane.
2. Click New Personal Destination on the toolbar.

A Details tab displays; details options are as follows.

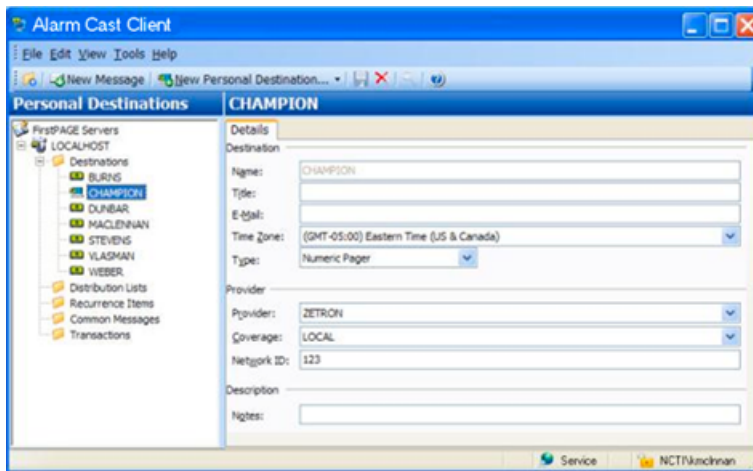

Field	Description
Destination	
Name	Logical name utilized by the administrator to refer to this destination.
Title	Optional.
E-Mail	Optional.
Time Zone	Time Zone name that the destination resides in. Defaults to the Alarm Cast Administrator workstation time zone, but may be changed here. Is used when determining when schedules apply to destinations.
Type	This is the medium for receiving messages for this destination.

	Alpha Pager	Alphabetic text
	Numeric Pager	Only numerals (i.e. 0-9).
	Handset	Allows alphabetic text and numbers such as a handheld mobile multifunction device such as Nextel handset.
	Email	Alphabetic text and number to a destination's email address.
	Unknown	Destination device type is unknown and assumed to be alpha numeric.
Provider		
Provider	Provider selected from the dropdown list of the known Providers that have been added to each Device type.	
Coverage	Geographic area in which the provider can deliver messages.	
Network ID	Provider's user ID number.	
Description		
Notes	Optional.	

3. Click Save.

The Personal Destination is listed in the Destination folder.

Alarm Cast Client Personal Distribution Lists

The **Distribution Lists** folder provides the tools to add configured destinations to distribution lists, allowing the same message to be sent to multiple destinations at the same time. Alarm Cast Client applications provide the ability to compose messages and send them to a destination, distribution list, or multiple combinations of both types.

Alarm Cast Client allows the user to create Distribution Lists: Standard Client or Classic Client.

- Standard Mode utilizes a tree view, convenient for locating the desired destination or distribution list to send a message.
- Classic Mode utilizes a simplified interface with a single list of all destinations and distribution lists.

New Distribution List: Standard Client

1. Click the Distribution Lists folder in the Alarm Cast Client left-pane.
2. Click New Client on the Alarm Cast Client toolbar.

A Details tab displays; options are as follows.

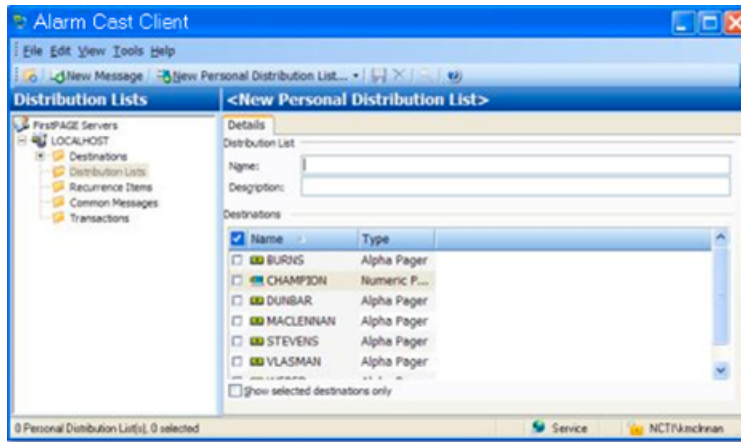

Field	Description
Distribution List	
Name	Logical name utilized by the administrator to refer to this distribution list.
Description	Optional
Destinations	
Name	Checked names will are members of the selected distribution list.

3. Click Save.

Result: The Distribution List will now be listed in the Distribution Lists folder in the Alarm Cast Client window left-pane.

 **Note:** Destinations can be:

- Filtered out of the destinations list by selecting the Show selected destinations only option.

You will not be able to edit any public distribution lists that have been created in Alarm Cast Administrator.

- Added to the Distribution list by selecting the destination in the Devices folder, then selecting the Distribution Lists tab for a list of already configured distribution lists.

New Distribution List: Classic Client

4. Click View>View Classic Mode on the Alarm Cast Client window menu bar.

The following window opens; options are as follows.

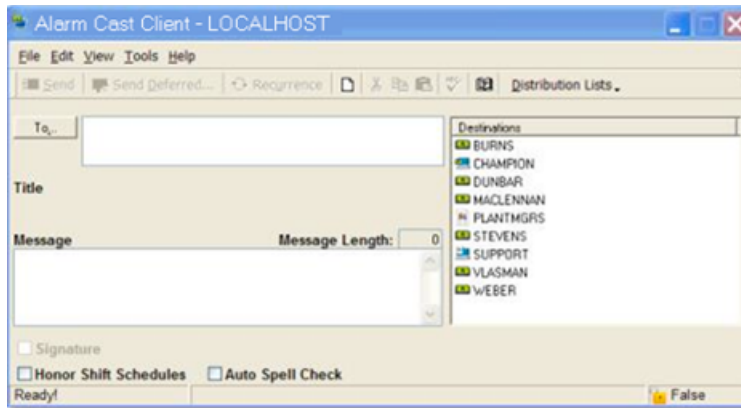

5. Click Tools>Distribution List on the alarm Cast Client - <LOCALHOST> window menu bar.

An Alarm Cast User Distribution List dialog box opens.

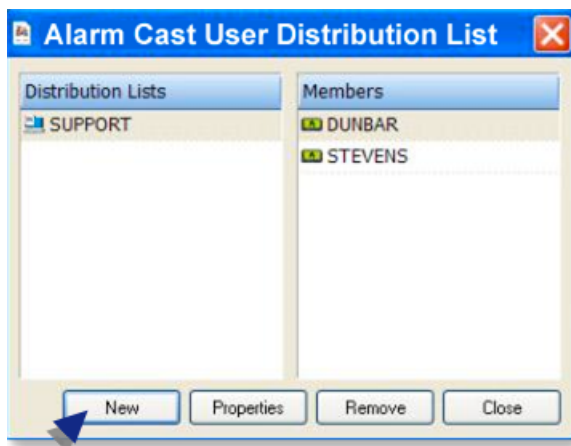

Note:

- Public distribution lists can be viewed but not edited. A Personal distribution list has to be added; the list will be available only to this Client.
- Click Properties to edit existing personal distribution lists.

6. Click New.

A Distribution List Properties dialog box opens.

7. Entries are as follows.

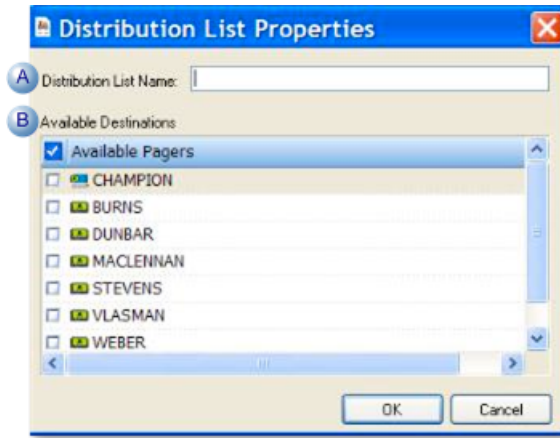

A	Distribution List Name	Name for the new personal distribution list.
B	Available Destinations	Checked destinations that will be members of the distribution list.

8. Click OK.

The distribution list is saved for the local client.

Alarm Cast Client Recurrence Items

A recurrence enables the user to set a recurrence pattern (schedule) to send a page daily, weekly, monthly or yearly. A one-time page can also be sent to a destination at a given time.

Alarm Cast Client enables the user to create Recurrence Items via Standard Client or Classic Client.

- Standard Mode utilizes a tree view, convenient for locating the desired destination or distribution list to send a message.
- Classic Mode utilizes a simplified interface with a single list of all destinations and distribution lists.
- Standard mode.
- Classic mode.

Standard Mode

1. Click the **Recurrence Items** folder in the Alarm Cast Client left-pane.
2. Click New Recurrence on the toolbar.

Recurrence configuration includes the following tabs.

- Message tab.
- Details tab.

Message Tab

Select the Message tab; options are as follows.

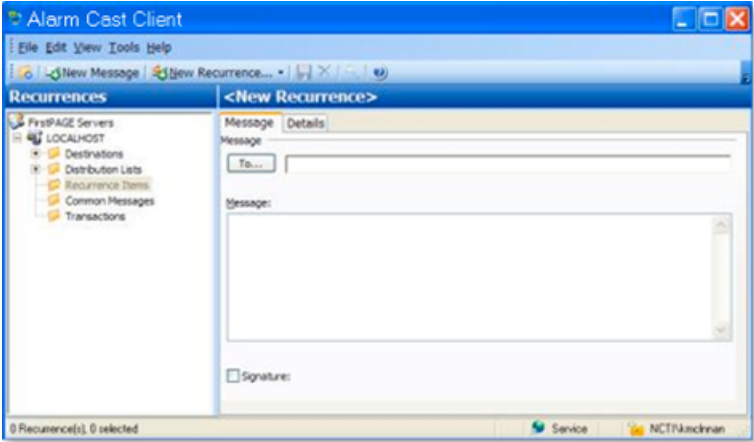

Field	Description
Message	
To	Click to select a name associated with the Recurrence. Currently recipients may only be selected from Public Destinations or Public Distribution Lists.
Message	Message that will be sent with this recurrence.
Signature	(If signature is set in Tools/Options>Preferences) When checked Signature will include the signature with the recurrence message.

Details Tab

Select the Details tab; options are as follows.

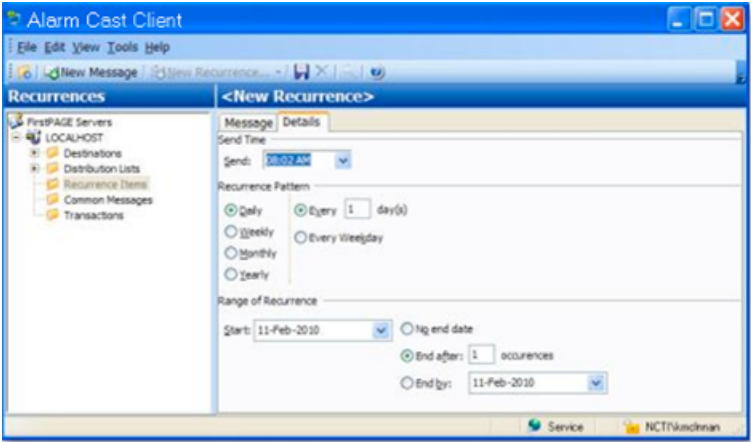

Field	Description
Send Time	

Send	Time the recurrence will be sent. Default is current time + 5 minutes.
Recurrence Pattern	
Pattern	When the recurrence will be sent: Options are: <ul style="list-style-type: none"> • Daily • Weekly • Monthly • Yearly • Every x days • Every Weekday
Range of Recurrence	
Start	Date the recurrence will start, specifying when the recurrence will end. Options are: <ul style="list-style-type: none"> • No end date • End after x occurrences • End by a specified date.

3. Click Save.

The recurrence item is listed in the Recurrence Items folder in the Alarm Cast Client left-pane.

Classic Mode

As per Standard Client Mode, recurrences can only be sent to Public Destinations and Public Distribution Lists.

Click View> View Classic Mode on the Alarm Cast Client window menu bar.

An Alarm Cast Client <LOCALHOST> dialog box opens; entries are as follows.

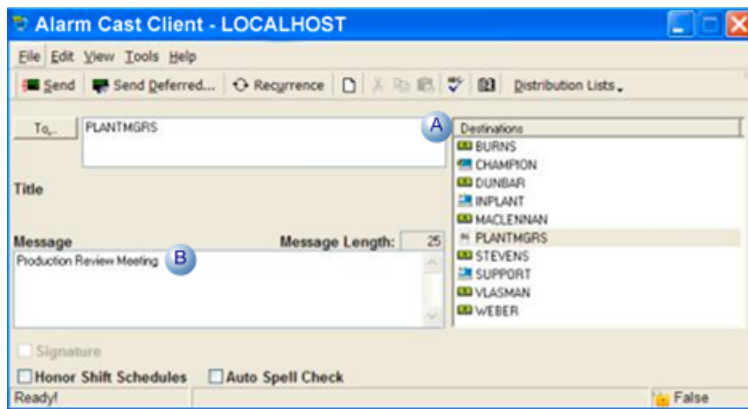

A	Destinations	Selected lists are the destination lists for the selected recurrence.
B	Message	Message for the selected recurrence.

Details for the recurrence are the same as they are for the Standard Client mode.

Alarm Cast Client Common Message

The Common Message folder enables users to

- Add text that is used frequently when sending messages. This feature is optional but can make sending of messages more efficient.
- Create Common Messages using the Standard Client or Classic Client.
- Standard mode.
- Classic mode.

Standard Mode

The Standard Mode utilizes a tree view, convenient for locating the desired destination or distribution list to send a message.

1. Click the **Common Messages** folder in the Alarm Cast Client left-pane.
2. Click New Common Message on the toolbar.

A Details tab displays.

3. Enter a common message in the **Common Message** box.

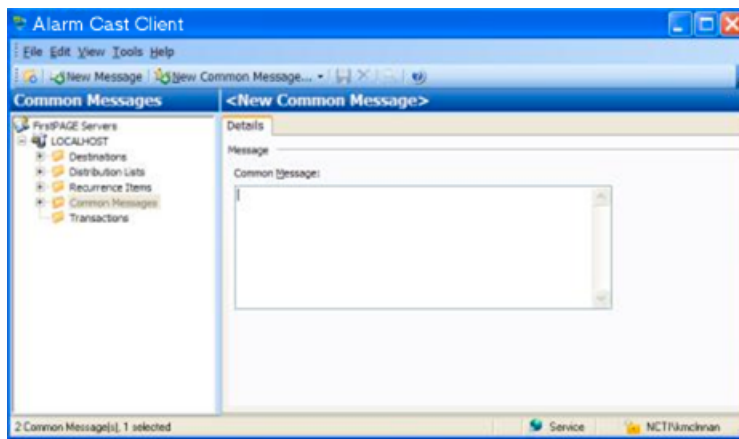

4. Click Save.

Result: The common message is assigned an ID number and listed in the Common Messages folder.

Classic Mode

The Classic Mode utilizes a simplified interface with a single list of all destinations and distribution lists.

5. Click Tools>Common Messages on the Alarm Cast Client toolbar.

An Alarm Cast Client dialog box opens.

6. Enter a common message in the Message box.
7. Click Common Messages>Add on the Alarm Cast Client toolbar.
8. Select View>View Classic Mode on the Alarm Cast Client menu bar.

The Alarm Cast Client dialog box closes; the message is listed in the Common Messages folder in the Alarm Cast Client (window) left-pane.

Alarm Cast Client Transactions

Alarm Cast Client provides the capability to view all page transactions to determine the status of each message that has been sent.

Click the **Transactions** folder in the Alarm Cast Client left-pane.

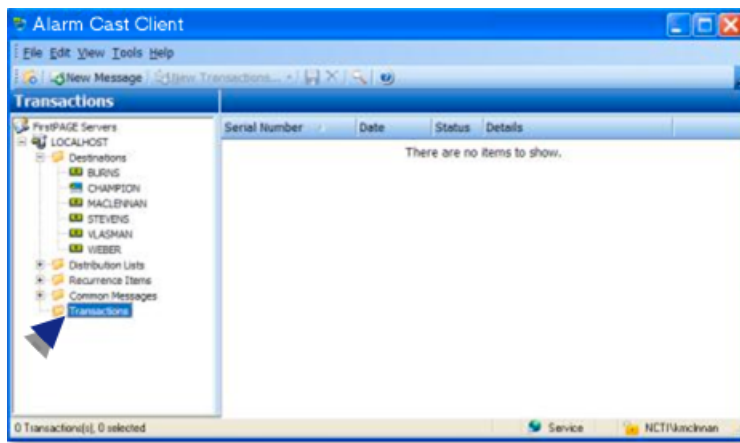

Result: The Alarm Cast Client right pane provides a listing of transactions with details as to the status of the transaction.

Alarm Cast Client Tools

Alarm Cast Client Tools

The Alarm Cast Client user interface is conveniently displayed in a tree view with folders for Destinations, Distribution Lists, Recurrence Items, Common Messages and Transactions. They serve as shortcuts to already configured Destinations and Distribution Lists, allowing the user to quickly locate this information for sending messages.

Alarm Cast Client Tools: Send a Message

Alarm Cast Client Tools: Address Book
Alarm Cast Client Tools: Tree View
Alarm Cast Client Tools: Options
Alarm Cast Client Tools: Log Files

Alarm Cast Client Tools: Send a Message

Alarm Cast Client enables a user to send messages via a Standard Mode as well as a Classic Mode.

- Standard Mode utilizes a tree view, convenient for locating the desired destination or distribution list to send a message.
 - Classic Mode utilizes a simplified interface with a single list of all destinations and distribution lists.
-
- Standard mode.
 - Classic mode.

Standard Mode

Do the following to configure the Database Provider option.

1. Do one of the following.
 - Select the **Destinations** folder in the Alarm Cast Client left-pane; select a destination in the Alarm Cast Client right-pane.
 - Expand the **Destinations** folder in the Alarm Cast Administrator left-pane; select a destination in the expanded tree.

A read-only Details tab for the selected destination displays.

2. Click New Message on the Alarm Cast Client toolbar.

A Message dialog box opens; options are as follows.

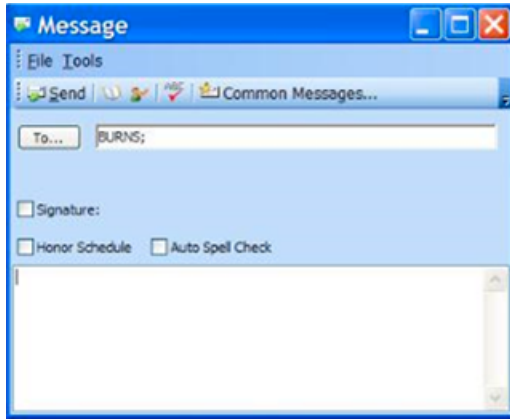

Option	Description
To	Name of the destination to page. <ul style="list-style-type: none"> The To button opens a Select Names browser that includes a list of destinations available for messaging. A destination's Alias that has been configured in Alarm Cast Administrator can also be entered. Example Enter alias Bob to page Robert Plant.
Honor Schedule	When checked, sends the message to the users who are currently available, as a result, limits pages only to those users who are currently working.
Signature	When checked, includes a signature with the message.
File>Check Names	(On the Message dialog box menu bar) verifies the destination names. If keying the destination name, be sure to use the full name or enter in the Alias for the destination, if one has been created in the Pager Administrator.
Auto Spell Check	When checked, verifies the text used in the message text field.
Common Messages	When clicked, displays a list of previously entered messages, which are available for selection..
Send	When clicked, sends the message.

guide: Guidelines

- Some service providers have upper limits on the amount of data per page. If the message is longer than is supported by the service provider. Alarm Cast will automatically break the message up into multiple pages.
- If the user you have chosen has a numeric pager, you will be limited to typing numeric characters (i.e. 0, 1, 2...9).

The following cannot be sent to a distribution list that contains users with numeric destinations.

- An empty message cannot.
- Textual messages.

Alarm Cast will prompt that users with numeric destinations exist in the distribution list and that the message cannot be sent.

Classic Mode

- Message configuration.
- Page postponement.

Message Configuration

Click View> View Classic Mode on the Alarm Cast Client menu bar.

An Alarm Cast Client dialog box opens; options are as follows.

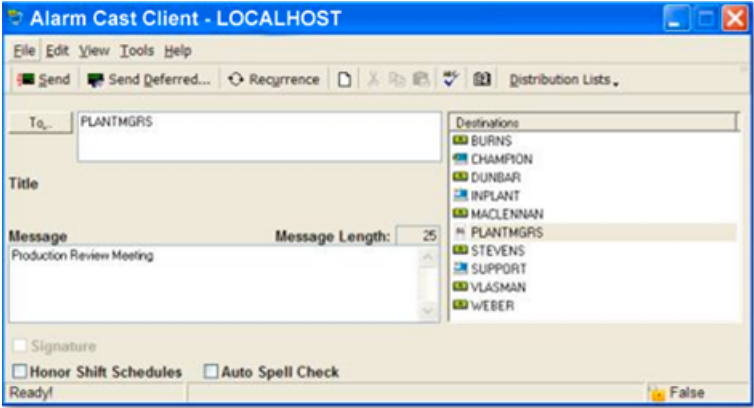

Option	Description
To	Name of the destination to page. <ul style="list-style-type: none"> • The To button opens a Select Names browser that includes a list of destinations available for messaging. • A destination's Alias that has been configured in Alarm Cast Administrator may be also be entered. Example Enter alias Bob to page Robert Plant.
Message	Text of the message. Note: The Message Length field provides an automatic count of characters in the message.
Signature	When checked, includes a signature with the message.
Honor Shift Schedules	When checked, sends the message to the users who are currently available, as a result, limits pages only to those users who are currently working.
Send	When clicked, sends the message. Note: Pressing Enter also sends the page.

Page Postponement

Classic Mode enables a user to send a single deferred page to a destination.

The page for a message that has been configured to be sent can be postponed to a later time or date. This feature is particularly useful when used to set up a reminder for meetings, appointments, etc.

Do the following.

3. Click the Send Deferred button on the toolbar after entering text in the **Message** field and selecting at least one recipient.

A Deferred Date Time calendar opens.

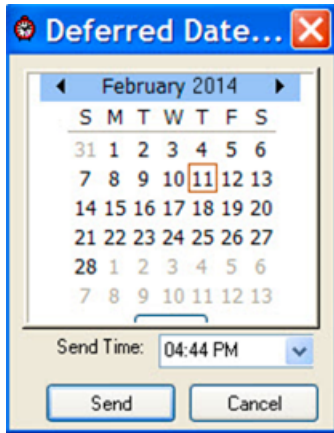

4. Select the date and time that the deferred page will be sent.
5. Click the Send button.

The page will be sent at the specified date and time.

! Important: Make sure a destination is selected to send the message to, as well as a message then click the Send button. The message will be stored and sent on the date and time specified.

Alarm Cast Client Tools: Address Book

The address book is a built in directory of all available destinations in the database. It enables you to search through the entire database to select a destination.

- Standard mode.
- Classic mode.

Standard Mode

1. Select the destination to send a message to then
2. Click New Message on the toolbar. A Message dialog box opens.
3. Click the To button, or click Tools>Address Book on the Message menu bar. A Select Names browser opens.

4. Select names in any of the following: Destinations, Distribution lists, Personal destinations, or Personal distribution lists, and click OK. Selecting the check box by the Name category, e.g. Destinations, selects all names/distribution lists under that category.

Result: The Alarm Cast Client re-opens. All of the selected destinations will be listed in the To: field.

Classic Mode

5. Click Tools>Address Book on the Alarm Cast client (classic) dialog box menu bar. A Users Search browser opens.
6. Enter the first letter of the last name of the user or use the scroll bar to locate the user within the list.
7. Double click the user name to select it from the list.
8. Click OK.

The Alarm Cast Client re-opens. All of the selected destinations will be listed in the To: field.

Note: Multiple users can be selected at the same time by holding down the Shift key or the Ctrl key, then selecting destinations from the list.

Alarm Cast Client Tools: Tree View

Anything created on the tree view side of the screen (the left hand side) can be modified or deleted at any time with the exception of Public Destinations and Public Distribution Lists. The delete option is greyed out and can only be performed via Alarm Cast Administrator.

Tree View Items: Modify

Select the item you want to alter. The information regarding it will show up on the right hand side of the screen. At this point, you can change the name along with any other variables attached to it (e.g. configuration settings etc.) When you save your changes, they will appear in the Tree View.

 **Important:** : Once the modified information has been saved, you cannot revert to the old information. The only way to retrieve it is to change it back to its original state.

Tree View Items: Delete

There are two ways to delete items on the Tree View side of your screen. By selecting the item you want to delete, you can choose Edit >Delete on the Menu bar or simply click the Delete symbol (X).

! **Important:** : You cannot recover any deleted item or any information attached to it. You must recreate it.

In certain applications, if a particular item is being used in another part of the application, you will not be able to delete it at that level. You must go further down in the Tree View to discern where it is being used and delete it there first.

Alarm Cast Client Tools: Options

The Tools menu enables users to set Alarm Cast Client options.

Click Tools>Options on the Alarm Cast Client window menu bar.

The Options dialog box opens.

Client Tools Options: General Tab

Select the General tab in the Options dialog box.

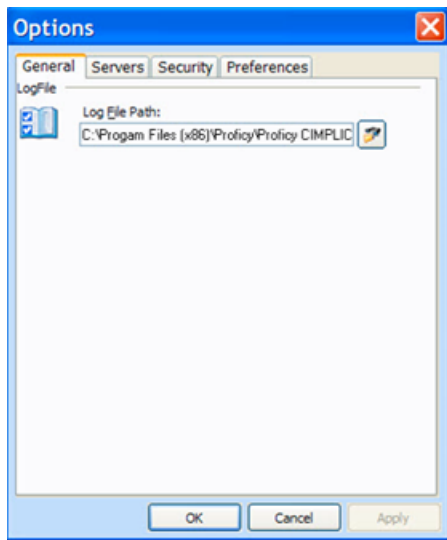

The General tab displays the Log File Path to the ALARMCASST Server where messages successes and failures are logged as well as details about the server connection.

Client Tools Options: Servers Tab

Select the Servers tab in the Options dialog box.

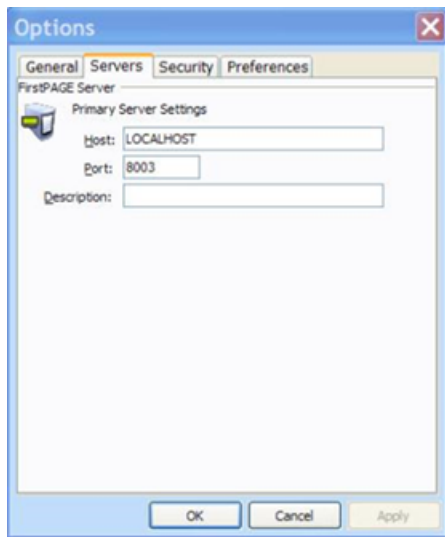

The Servers tab displays the ALARMCASST server Host name and port details.

Client Tools Options: Security Tab

Select the Security tab in the Options dialog box.



(Optional) Select the Wait time.

When set, the machine will lock after the given time has expired, requiring a valid login user name and password.

Client Tools Options: Preferences Tab

Select the Preferences tab in the Options dialog box.

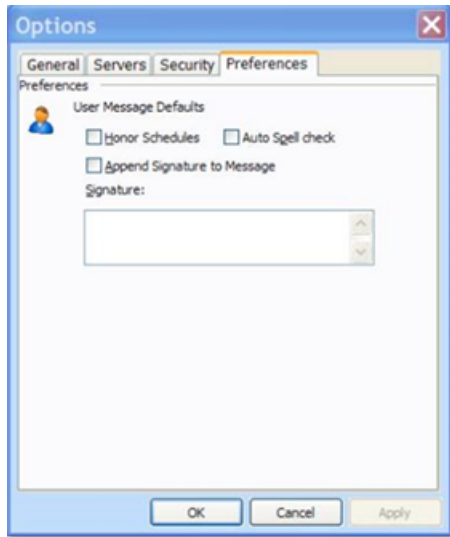

Alarm Cast Client **User Message Defaults** is where:

- Schedules that have been configured in the Alarm Cast Administrator will be honored
- Auto spell check messages can be enabled.
- A signature can be set and appended to messages,

Alarm Cast Client Tools: Log Files

In each application, you are able to view the log files associated with the various components of the software. The log files contain an accurate history of every transaction and modification made to the database. Log files are important because they ensure the integrity of the data and provide a means of data recovery.

Click View>View Log on the Alarm Cast Client menu bar.

An Alarm Cast Client log opens.

Alarm Cast Client Filter Guidelines

- Click the Filters button on the selected log window toolbar.

An Alarm Cast Gateway Filter dialog box opens.

- The **Events On:** field defaults to the current day.
- The **Status Message** field can be used to search for a portion of the message in the log.

Important: When matching special characters, enclose them in brackets.

Example

To find all log items that start with [enter in [[]* in the **Status Message** field.

The common allowed search characters are as follows:

Character	Match Made	Example
?	Any single character	Text in the log is: <ul style="list-style-type: none"> • ABC • DBC • XYZ. Entering ?BC returns only: <ul style="list-style-type: none"> • ABC • DBC
*	Zero or more characters	Entering *Initiated* returns: All log items with the word Initiated
#	Any single digit (0-9)	Text in the log is <ul style="list-style-type: none"> • Device1 • Device5 • Device8 • Device10. Entering Device# returns: <ul style="list-style-type: none"> • Device1 • Device5 • Device8.

- Check Automatic Refresh to automatically refresh the log file based on the seconds specified.

Alarm Cast Client Glossary

Administrator

Typically a GUI application, this component facilitates configuration and monitoring of a server engine. If changes are made to the server configuration the administrator notifies the engine to reload its running configuration either automatically or on user demand. An example of an administrator component is Alarm Cast Administrator. This administrator allows you to maintain the Alarm Cast server's engine configuration.

Administrator Kit

An administrator kit contains the product's administration component only. After installing this kit on a workstation you may utilize any of the features of the Administrator component.

Client

A client component utilizes the facilities of a standard server. Typically a GUI application, this component provides a user-friendly interface of the available services offered by the server engine. An example of a client tool would be Alarm Cast Client, which presents the user with a list of known messaging destinations and allows them to send messages to one or more destinations.

Common Message

Frequently used text messages that may be used to send out common or broadcast messages.

Destination

An Alarm Cast Server destination is a name assigned to a messaging location to which text messages may be delivered. e.g. SCOTTS_PAGER, KENS_PHONE, JIMS_EMAIL.

Distribution List

An Alarm Cast Server distribution list is a collection of destinations that can be sent a message with a single transaction. Similar to an e-mail distribution list a client that initiates a transaction with a distribution list will automatically send the same message to all associated destinations.

Recurrence

Similar to a deferred page, allowing the user to set a schedule to send pages daily, weekly, monthly or yearly as well as the range of the recurrence.

Server Kit

A server kit typically contains the server engine and administrator components. In some cases a client component is also included with this kit. The server kit is usually installed on a centralized host, and one or more clients or gateways utilize this server. An example of a server kit is Alarm Cast Server. This kit contains the Alarm Cast engine, administrator and client.

Transaction

The life cycle of every Alarm Cast message sent, allowing the user to see the current status of a message: Sent, Pending or Failure.