



Risk Based Inspection (RBI) 581



Contents

Chapter 1: Overview	1
Overview of the Risk Based Inspection (RBI) Module	2
Overview of the RBI 581 Methodology	2
About RBI Methodologies	2
Access the Risk Based Inspection Overview Page	3
Access the Unit Summary Workspace	4
Access the Asset Summary Workspace	5
Access the Asset Summary Workspace for a New Asset	7
Chapter 2: Workflows	9
Define Component	10
Perform an RBI Analysis	12
RBI Recommendation Management	15
RBI Recommendation Implementation	18
Chapter 3: Corrosion Loops	21
About Corrosion Loops	22
Access an RBI Corrosion Loop	23
Create an RBI Corrosion Loop	24
Link RBI Corrosion Loops to a Process Unit	25
Unlink an RBI Corrosion Loop from a Unit	26
Link Potential Degradation Mechanisms (PDMs) to an RBI Corrosion Loop	26
Unlink a Potential Degradation Mechanism (PDM)	28
Delete an RBI Corrosion Loop	29
Chapter 4: RBI Components	30
About RBI Components	31
About Integration with Thickness Monitoring (TM)	33
About Using TM Analysis Values at the Thickness Monitoring Location (TML) Group Level	33
About Using TM Analysis Values at the Asset Level	33

Access an RBI Component	33
Create an RBI Component	35
Access the Inventory Group of a Component	36
Link RBI Components to an RBI Corrosion Loop	38
Unlink an RBI Component from an RBI Corrosion Loop	39
Link Potential Degradation Mechanisms (PDMs) to an RBI Component	40
Unlink a Potential Degradation Mechanism (PDM) from an RBI Component	41
Link an RBI Component to a TML Group	42
Apply an RBI Component	43
Delete an RBI Component	44
Chapter 5: RBI Analyses	46
About RBI Analysis	47
About Active Analysis	47
About What-If Analysis	48
About Inspection Planning	48
About the RBI 581 Asset Risk Report	50
Access an RBI 581 Risk Analysis	55
Create an RBI Analysis	56
Add a What-If Analysis	57
Override Flow Stress	58
Calculate an RBI 581 Risk Analysis	59
Calculate all RBI 581 Risk Analyses Associated with a Process Unit	61
Calculate all RBI 581 Risk Analyses Associated with a Single Asset or Corrosion Loop	62
Calculate all RBI 581 Risk Analyses Associated with Multiple Assets	65
Generate a Report for an Asset	67
Duplicate an RBI 581 Risk Analysis	68
Apply an RBI 581 Risk Analysis	70
Finalize Risk of an RBI 581 Risk Analysis	72
Finalize Risk of Multiple RBI 581 Risk Analyses	73
Delete an RBI 581 Risk Analysis	74
Chapter 6: RBI Bulk Evergreening 581	76
About RBI Bulk Evergreening	77
Access Analyses that are Pending Evergreening	77

Duplicate Analysis for Evergreening	80
Delete Analyses Created for Evergreening	81
Export Evergreened Analyses	82
Calculate Evergreened Analyses	82
Finalize Risk for Evergreened Analyses	84
Access Active Analyses	86
Generate Recommendations for Active Evergreened Analyses	86
Chapter 7: RBI Analysis Export	89
About RBI Analysis Export	90
Access the RBI Analysis Export Workspace	93
Export Analyses	94
Chapter 8: RBI 581 ISO Risk Plot	96
About the RBI 581 ISO Risk Plot	97
Access the Inventory Groups in a Process Unit	98
Access the RBI 581 ISO Risk Plot Page of a Functional Location	99
Access the RBI 581 ISO Risk Plot Page of an Asset	103
Access the RBI 581 ISO Risk Plot Page of a Corrosion Loop	104
Access the RBI 581 ISO Risk Plot Page of a Component	105
Access the RBI 581 ISO Risk Plot Page of an Analysis	106
Chapter 9: Degradation Mechanisms	107
About Degradation Mechanisms (DMs)	108
About Degradation Mechanism Evaluations (DMEs)	109
About Inspection Integration	110
About Related DMEs	111
About Assigning Inspections to a Degradation Mechanism Evaluation (DME)	112
About Associating Potential Degradation Mechanisms (PDMs)	113
About Inspection History	114
Add Degradation Mechanisms (DMs)	114
Evaluate a Degradation Mechanism (DM)	116
Assess the Unmitigated Risk of a Degradation Mechanism (DM)	117
Access the Inspection History of a Degradation Mechanism (DM)	119

Assign Inspections to a Degradation Mechanism Evaluation (DME)	121
Link an Inspection Consequence Evaluation to an RBI Degradation Mechanism Evaluation (DME)	122
Delete Degradation Mechanisms (DMs)	123
Chapter 10: RBI Recommendations	125
About RBI Recommendations	126
Access the Recommended Actions Pane	130
View RBI Recommendations Linked to an Inspection Plan	130
About Auto-Consolidating RBI Recommendations	131
Create an RBI Recommendation Manually	133
Generate Recommendations for a Single RBI Criticality Analysis	134
Generate RBI Recommendations for Multiple RBI 581 Risk Analyses	135
Generate Recommendations for all Analyses in an Asset Hierarchy Level	135
Chapter 11: Inspection Plans	139
RBI Inspection Plans	140
Inspection Plan Management	144
Managing Recommended Actions in Inspection Plan	152
Implement Recommended Actions to Inspection Tasks	154
Inspection Plan Revision History	156
Chapter 12: ASM Integration	158
About Asset Strategy Management (ASM) Integration	159
Asset Strategy Management (ASM) Integration Workflow	162
About Unmitigated Risk	162
About Mitigated Risk	163
Access Asset Strategy Manager (ASM) from an Inspection Plan	163
Approving the Inspection Plan of an Asset	163
Chapter 13: Admin	165
Access the Global Preferences Workspace	166
About Global Preferences	167
About Evaluation of All Risk Targets in RBI 581	169

About RBI 581 Admin Options	169
About RBI 581 ISO-Risk Plot Preferences	173
About Inspection Auto-Selection	174
RBI 581 Inspection Auto-Selection Workflow	176
RBI 581 Inventory Grouping Workflow	177
Access the RBI 581 Admin Options Workspace	178
Access the RBI 581 ISO-Risk Plot Preferences Workspace	179
Access the Inspection Auto-Selection Workspace	181
Access the RBI 581 Inventory Groups Workspace	183
Create an Inventory Group Configuration Record	185
Delete an Inventory Group Configuration Record	187
Link Components to an Inventory Group	188
Unlink Components from an Inventory Group	190
Use the Upgrade APM Version 3 Active Analyses Utility	192
Chapter 14: Deployment	194
Deployment and Upgrade	195
Chapter 15: Data Loaders	196
RBI 581	197
Corrosion Loop	328
RBI Components to TML Groups Relationship Data Loader	335
Chapter 16: Reference	340
General Reference	341
Data Models	375
Family Field Descriptions	375
Calculations	538
Family Search Configuration	542
ASM Integration	542
Inspection Strategies	547
RBI Policies	547
Catalog Items	550

Copyright GE Digital

© 2023 General Electric Company.

GE, the GE Monogram, and Predix are either registered trademarks or trademarks of General Electric Company. All other trademarks are the property of their respective owners.

This document may contain Confidential/Proprietary information of General Electric Company and/or its suppliers or vendors. Distribution or reproduction is prohibited without permission.

THIS DOCUMENT AND ITS CONTENTS ARE PROVIDED "AS IS," WITH NO REPRESENTATION OR WARRANTIES OF ANY KIND, WHETHER EXPRESS OR IMPLIED, INCLUDING BUT NOT LIMITED TO WARRANTIES OF DESIGN, MERCHANTABILITY, OR FITNESS FOR A PARTICULAR PURPOSE. ALL OTHER LIABILITY ARISING FROM RELIANCE UPON ANY INFORMATION CONTAINED HEREIN IS EXPRESSLY DISCLAIMED.

Access to and use of the software described in this document is conditioned on acceptance of the End User License Agreement and compliance with its terms.

Chapter 1

Overview

Topics:

- [Overview of the Risk Based Inspection \(RBI\) Module](#)
- [Overview of the RBI 581 Methodology](#)
- [About RBI Methodologies](#)
- [Access the Risk Based Inspection Overview Page](#)
- [Access the Unit Summary Workspace](#)
- [Access the Asset Summary Workspace](#)
- [Access the Asset Summary Workspace for a New Asset](#)

Overview of the Risk Based Inspection (RBI) Module

Risk Based Inspection (RBI) allows you to analyze the risk of the components of a piece of asset failing due to specific degradation mechanisms through defining both the consequence and probability of failure and then to define an Inspection Strategy for each mechanism.

Using RBI, you can set up corrosion loops to organize the components that you want to analyze. For each component in a corrosion loop, you can create one of the following types of analyses:

- **RBI Criticality Analysis:** To create an RBI Criticality Analysis, you must use the RBI 580 methodology. You can also create an RBI PRD Criticality Analysis or an RBI Pipeline Analysis.
- **RBI 581 Risk Analysis:** To create an RBI 581 Risk Analysis, you must use the RBI 581 methodology.

Overview of the RBI 581 Methodology

You can create an RBI 581 Risk Analysis using the RBI 581 methodology. If it is possible to mitigate risk at the component, RBI 581 recommends inspection tasks that will, for a specified period, keep the projected risk below the thresholds. If risk cannot be mitigated (i.e., inspections would not bring risk below the Risk Target values), the Risk Summary of the analysis provides a synopsis which will help determine the next course of action.

Based on the analysis results, if risk is mitigated, you can generate recommendations to capture recommended actions. You can also create non-recurring inspection tasks that must be completed to mitigate risk over the plan period.

About RBI Methodologies

Risk Based Inspection supports the following methodologies.

- **RBI 580:** This methodology is included in the Risk Based Inspection module.
- **RBI 581:** This methodology is implemented with the RBI 581 module.

The RBI 581 Methodology

After you conduct a RBI 581 Risk Analysis, if it is possible to mitigate risk at the component, RBI 581 will recommend inspection tasks that will, for a specified period, keep the projected risk below the thresholds. These thresholds are called Risk Targets. They are determined by your organization. If risk cannot be mitigated (i.e., inspections would not bring risk below the Risk Target values), the Risk Summary of the analysis provides a synopsis which will help determine the next course of action.

Based on the analysis results, if risk is mitigated, you can generate recommendations. This is to capture recommended actions and create non-recurring inspection tasks that must be completed in order to mitigate risk over the plan period.

The RBI 580 Methodology

After you conduct an RBI Criticality Analysis, if the risk values are unacceptable, you can analyze hypothetical scenarios using What If Analyses and Future Risk Analyses to see how additional actions or factors might affect the risk. For example, you might create a What If Analysis to see what the risk level would be if you changed the operating pressure. Or, you might create a Future Risk Analysis to see what the risk level might be in five years.

Based on the analysis results, you can create RBI Recommendations to capture recommended actions that might mitigate the risk associated with a component. You can then create Tasks or SAP Notifications from the RBI Recommendations to track the progress and ensure that the recommended actions are implemented.

After the recommended actions are implemented, you can conduct another RBI Criticality Analysis to determine if the new operating procedures or environment have actually reduced the risk.

Access the Risk Based Inspection Overview Page

Procedure

In the module navigation menu, select **Integrity > Risk Based Inspection**.

Note: You can also access the **Risk Based Inspection Overview** page for a process unit (i.e., functional location marked as a unit). To do so:

- a. In the main navigation bar, select .
The Asset Hierarchy appears.
- b. In the pane, navigate to and select the functional location for which you want to access the **Risk Based Inspection Overview** page, and then, in the workspace, select **Integrity**.
The **Integrity** section appears, displaying a list of analyses performed on the selected functional location.
- c. In the row containing **Risk Based Inspection**, select the link.

The **Risk Based Inspection Overview** page appears, displaying the following information:

- The **Assets** section: Contains a list of assets in the selected process unit.
- The **Process Units** section: Contains a list of process units under the selected functional location, a description for each process unit, the number of assets in each process unit, and the number of Corrosion Loops in each process unit.
- The **Pending Reassessment** section: Contains a list of assets that are ready to be duplicated for evergreening.
- The **No Recommendations** section: Contains a list of assets in the process unit that have at least one component with a Risk Completed analysis with no recommendations.
- The **Inspection/TM Updates** section: Contains two sections, the **Inspection Updates** and **TM Updates** sections. The **Inspection Updates** section contains a list of recent Inspections performed on assets which have an active analysis in the process unit. This list contains Inspections that have a Completion Date after the analysis Calculation Date. The **TM Updates** section contains a list of Corrosion Analyses performed on assets which have an active analysis in the process unit if the Corrosion Analyses have been calculated after the RBI Analysis.
- The **Current Risk Overview** graph: Plots the number of assets in the process unit by their current risk values in a pie chart.
- The **Current Risk** section: Contains a list of assets plotted in the Current Risk Overview pie chart.
- The **The RBI Risk Matrix** graph: Plots the total number of RBI Components based on their consequence of failure and probability of failure values. Only if a component is linked to an active RBI Criticality Analysis, RBI PRD Criticality Analysis, or RBI Pipeline Analysis, it is considered while plotting the graph. This graph appears only if the Risk Based Inspection license is active.
- The **Past Risk Overview** graph: Plots the number of assets in the process unit by their past risk values in a pie chart.
- The **Past Risk** section: Contains a list of assets plotted in the Past Risk Overview pie chart.

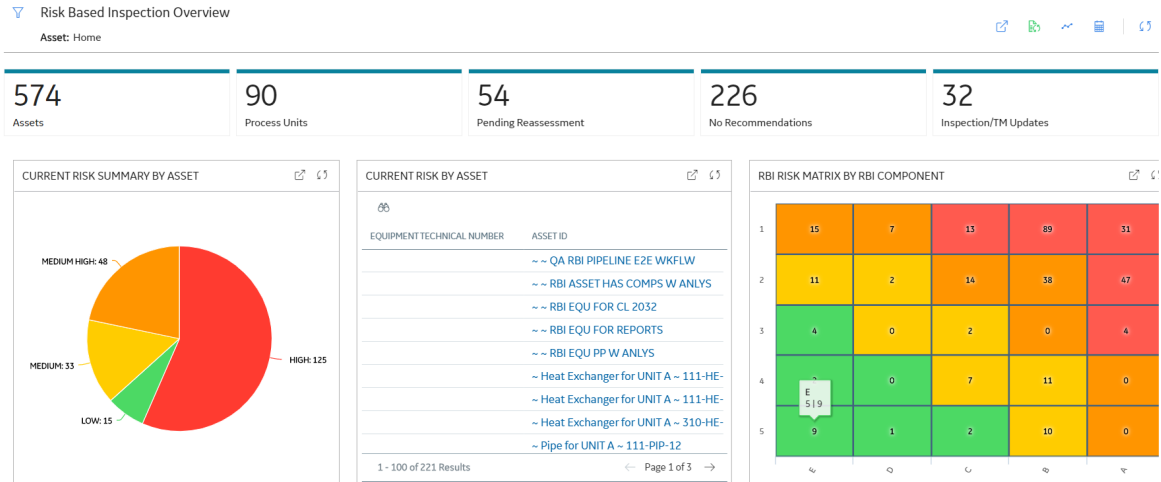

Tip: To return to the **Risk Based Inspection Overview** page after selecting a tab, select the tab again.

Note: The **Risk Based Inspection Overview** page is not updated automatically when you return to the previously opened tab. You can select Refresh (🔄) button to update the page.

Access the Unit Summary Workspace

Before You Begin

To mark a Functional Location as a Process Unit, access the Functional Location via Record Manager, and then select the **Is a Unit?** check box.

Procedure

1. Access the **Risk Based Inspection Overview** page.
2. In the workspace, select the **Process Units** tab.
The **Process Units** section appears, displaying a list process units.
3. In the row containing the process unit that you want to access, select the link.

The **Unit Summary** workspace appears, displaying the following information:

- The left pane: Contains a list of Corrosion Loops in the process unit.
- The **Unit Overview** section: Contains the following graphs and a list of Corrosion Loops in the process unit:
 - The first graph plots the risk category of each Corrosion Loop associated with an RBI Criticality Analysis, RBI PRD Analysis, or an RBI Pipeline Analysis. If you pause over a bar on the graph, the Corrosion Loop ID and the respective lowest Inspection Priority value appear. This graph appears only if the value in the **RBI Overview Graph Preference** box in the **Global Preferences** workspace on the **RBI Admin Preferences** page is either RBI 580 or 580 and 581.
 - The second graph plots the SHE risk value of each Corrosion Loop that is associated with an RBI 581 Risk Analysis. If you pause over a bar on the graph, the Corrosion Loop ID and the respective maximum SHE risk value appear. This graph appears only if the value in the **RBI Overview Graph Preference** box in the **Global Preferences** workspace on the **RBI Admin Preferences** page is either RBI 581 or 580 and 581.

If you select a bar on either of the graphs, the **Corrosion Loop Overview** section for the Corrosion Loop appears.

- The **Unit Details** section: Contains the datasheet of the Functional Location that represents the process unit.

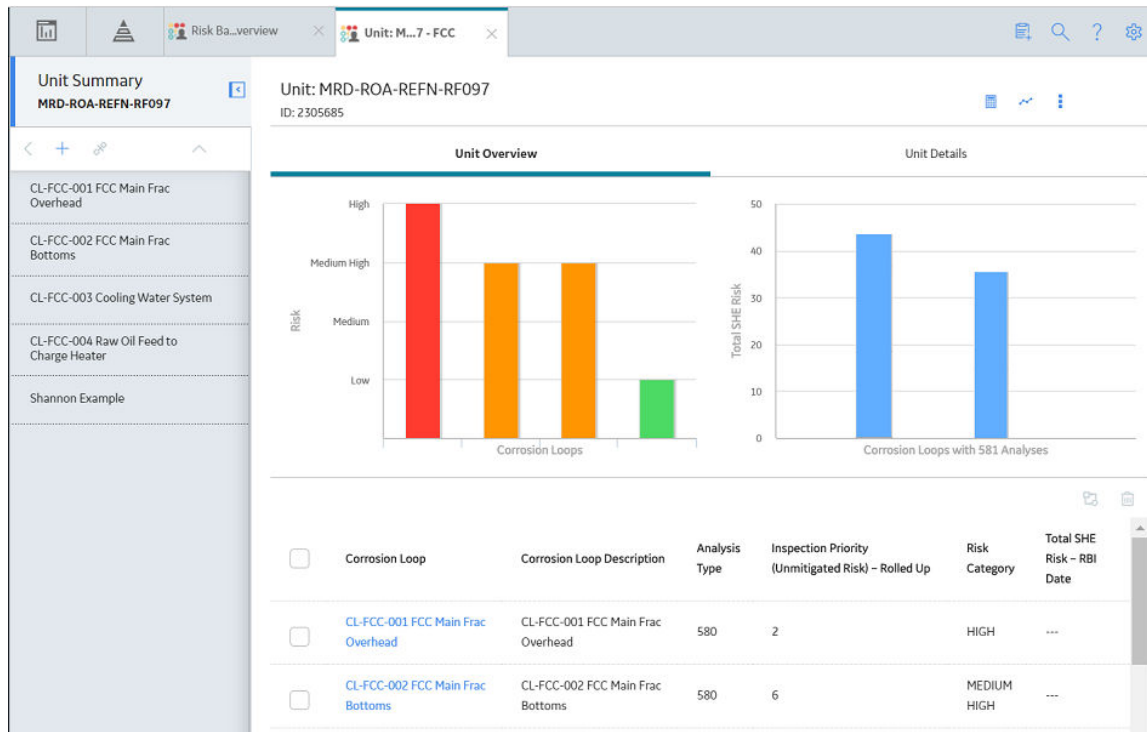

Access the Asset Summary Workspace

Procedure

1. Access the [Risk Based Inspection Overview](#) page.
2. In the workspace, select the **Assets** tab.
The **Assets** section appears, displaying a list of assets.

356 Assets	90 Process Units	40 Pending Reassessment	115 No Recommendations	32 Inspection/TM Updates
----------------------	----------------------------	-----------------------------------	----------------------------------	------------------------------------

<input type="checkbox"/>	EQUIPMENT TECHNICAL NUMBER	ASSET ID
<input type="checkbox"/>		~ ~ RBI EQU COMP ALL DATA
<input type="checkbox"/>		~ ~ EQU W PRD COMP TO BE LINKED TO UNIT
<input type="checkbox"/>		~ ~ QA RBI 581 AST BTM DF CALC METRIC
<input type="checkbox"/>		~ ~ QA RBI 581 CAUSTIC CRCK DF CALC
<input type="checkbox"/>		~ ~ QA RBI 581 CONS CALC
<input type="checkbox"/>		~ ~ QA RBI 581 CONS NFNT CALC
<input type="checkbox"/>		~ ~ QA RBI 581 EXT THNG CUI DF CALC
<input type="checkbox"/>		~ ~ QA RBI PIPELINE EQU W METRIC TNG
<input type="checkbox"/>		~ ~ RBI 580 EQUP FOR FLEXI DM & ANALYS ROLL UP
<input type="checkbox"/>		~ ~ 581 ALKLINE CRCK DF CALC
<input type="checkbox"/>		~ ~ 581 AMINE CRCK DF CALC
<input type="checkbox"/>		~ ~ 581 AMINE CRCK SUSCEPTLTY
<input type="checkbox"/>		~ ~ 581 CAUSTIC CRCK DF CALC

Rows per page 50 200 500 1 - 100 of 356 Results ← 2 3 4 →

Note: The Assets section displays the Equipment or Functional Locations that have at least one component.

- In the row containing the asset that you want to access, in the **Asset ID** column, select the link. The **Asset Summary** workspace appears, displaying the following information:
 - The left pane: Contains a list of RBI Components in the asset. If you select a component, the **Component Overview** section appears in the workspace.
 - The **Asset Overview** section: Contains the following graphs and a list of RBI Components in the asset:
 - The first graph plots the risk category of each RBI Component that is linked to an RBI Criticality Analysis, RBI PRD Analysis, or an RBI Pipeline Analysis. If you pause over a bar on the graph, the Component ID and the respective Inspection Priority value appear. This graph appears only if the value in the **RBI Overview Graph Preference** box in the **Global Preferences** workspace on the **RBI Admin Preferences** page is either RBI 580 or 580 and 581.
 - The second graph plots the SHE risk value of each RBI Component that is linked to an RBI 581 Risk Analysis. If you pause over a bar on the graph, the Component ID and the respective SHE risk value appear. This graph appears only if the value in the **RBI Overview Graph Preference** box in the **Global Preferences** workspace on the **RBI Admin Preferences** page is either RBI 581 or 580 and 581.
- If you select a bar on either of the graphs, the **Component Overview** section for the component appears.
- The **Asset Details** section: Contains the datasheet of the Equipment or the Functional Location that represents the asset.

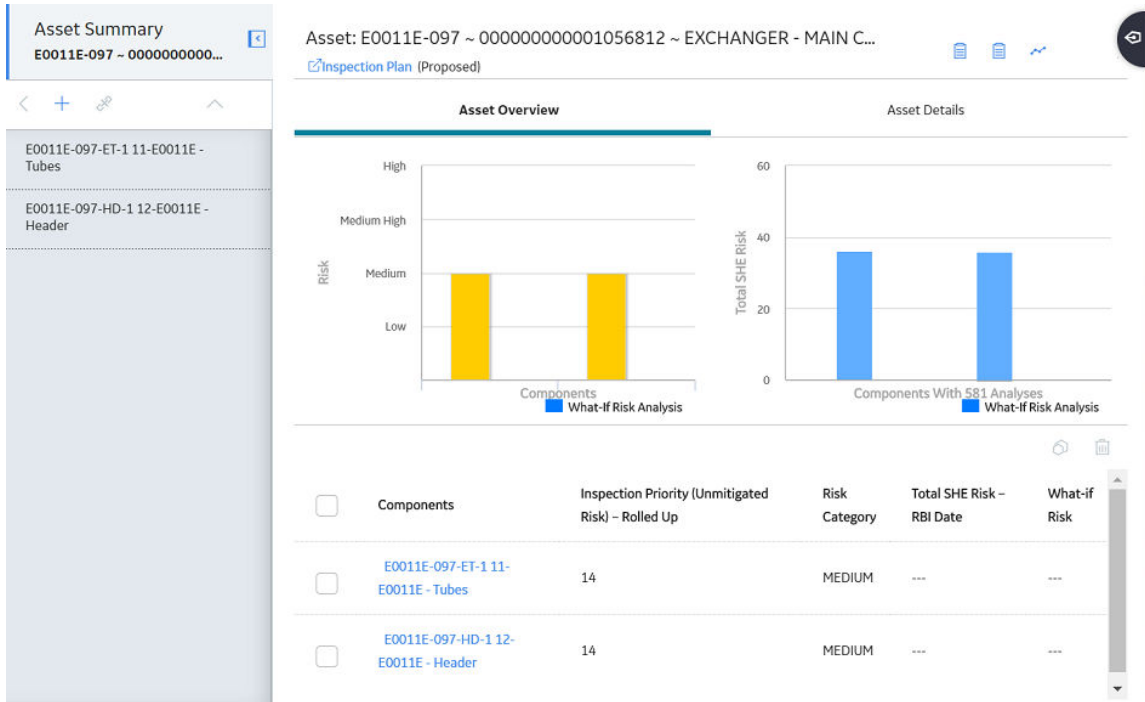

Access the Asset Summary Workspace for a New Asset

Procedure

1. In the Asset Summary workspace, select the **Assets** using the **Asset Hierarchy**.
2. In the module navigation menu, select **Integrity > Risk Based Inspection**.

For Equipment Records, the **Asset Summary** workspace appears.

or

For Functional Location Records, the **Risk Based Inspection Overview** page appears.

3. For Functional Location Records, select [🔗](#).
The **Asset Summary** workspace appears.

Note: The Asset Summary workspace displays the following information:

- The left pane: Contains a list of RBI Components in the asset. If you select a component, the **Component Overview** section appears in the workspace.
- The **Asset Overview** section: Contains the following graphs and a list of RBI Components in the asset:
 - The first graph plots the risk category of each RBI Component that is linked to an RBI Criticality Analysis, RBI PRD Analysis, or an RBI Pipeline Analysis. If you pause over a bar on the graph, the Component ID and the respective Inspection Priority value appear. This graph appears only if the value in the **RBI Overview Graph Preference** box in the **Global Preferences** workspace on the **RBI Admin Preferences** page is either RBI 580 or 580 and 581.
 - The second graph plots the SHE risk value of each RBI Component that is linked to an RBI 581 Risk Analysis. If you pause over a bar on the graph, the Component ID and the respective SHE risk value appear. This graph appears only if the value in the **RBI Overview Graph Preference**

box in the **Global Preferences** workspace on the **RBI Admin Preferences** page is either RBI 581 or 580 and 581.

If you select a bar on either of the graphs, the **Component Overview** section for the component appears.

- The **Asset Details** section: Contains the datasheet of the Equipment or the Functional Location that represents the asset.

Chapter 2

Workflows

Topics:

- [Define Component](#)
- [Perform an RBI Analysis](#)
- [RBI Recommendation Management](#)
- [RBI Recommendation Implementation](#)

Define Component

RBI: Define Components

This workflow describes the process of identifying and creating records for the following elements of a process unit:

- Corrosion loops
- Components
- Potential degradation mechanisms for each component

In the following workflow diagram, the blue text in a shape indicates that a corresponding description has been provided in the sections that follow the diagram. For more information, refer to the topic [Interpreting the Workflow Diagrams](#).

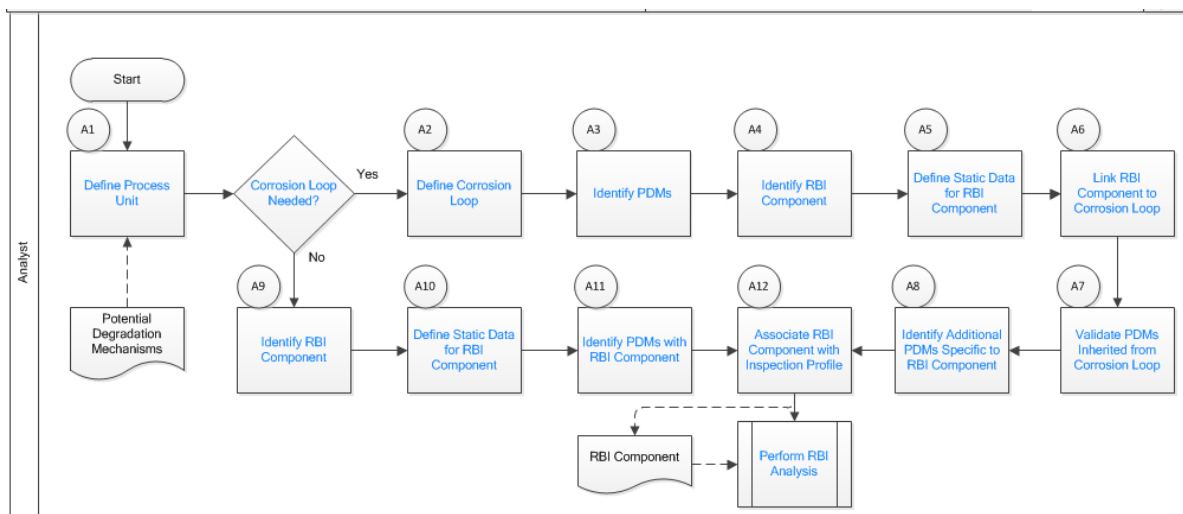

1. [Define Process Unit](#) on page 10
2. [Corrosion Loop Needed?](#) on page 11
3. [Define Corrosion Loop](#) on page 11
4. [Identify Potential Degradation Mechanisms \(PDMs\)](#) on page 11
5. [Identify RBI Component](#) on page 11
6. [Define Static Data for RBI Component](#) on page 11
7. [Link RBI Component to Corrosion Loop](#) on page 11
8. [Validate PDMs Inherited from Corrosion Loop](#) on page 12
9. [Identify Additional PDMs Specific to RBI Component](#) on page 12
10. [Perform RBI Analysis](#) on page 18
11. [Associate RBI Component with Inspection Profile](#) on page 12
12. [Identify PDMs with RBI Component](#) on page 12
13. [Define Static Data for RBI Component](#) on page 11
14. [Identify RBI Component](#) on page 11

Define Process Unit

Persona: Analyst

Define the Process Unit record that corresponds to the unit on which you want to perform an RBI analysis. A Functional Location record for which the **Is Unit** check box is selected is the Process Unit record.

Corrosion Loop Needed?

Persona: Analyst

Identify whether the process unit can be divided into corrosion loops in the process unit. Although this is not always required, defining corrosion loops allows components in the loop to inherit Potential Degradation Mechanisms (PDMs) from the loop. Defining a corrosion loop is not applicable in the case of a storage tank.

Define Corrosion Loop

Persona: Analyst

Create a Corrosion Loop record for each corrosion loop that you have identified in the process unit. Groups of assets or components that are subject to similar degradation mechanisms can be part of a single corrosion loop.

Identify Potential Degradation Mechanisms (PDMs)

Persona: Analyst

PDMs are processes that induce deleterious micro and macro material changes over time that are harmful to material condition or mechanical properties. Damage mechanisms are usually incremental, cumulative, and, in some instances, unrecoverable. Common damage mechanisms include corrosion, chemical attack, creep, erosion, fatigue, fracture, and thermal aging.

GE Digital APM provides a library of PDMs that you can link to a corrosion loop. The available PDMs differ between RBI 580 and RBI 581. They store the details of the damage mechanisms to which the assets or components in the corrosion loop are vulnerable. PDMs also provide details on how the damage mechanisms will be evaluated while performing an RBI analysis.

Identify RBI Component

Persona: Analyst

Identify RBI Components, each of which is a part of an asset that is modeled for the purpose of performing an RBI Risk Assessment. Create a Criticality Calculator RBI Component record for each component that you have identified.

These RBI Components may be comprised of one or more subcomponents. For example, a Column top RBI Component might consist of the head, nozzle, and shell asset subcomponents.

Define Static Data for RBI Component

Persona: Analyst

Provide process and design data of the component such as operating pressure, operating temperature, and so on in the Criticality Calculator RBI Component record that you have created. This information is used to calculate an RBI analysis. If you want to perform an RBI 581 Risk Analysis, then you should also provide details in the **RBI 581** section of the RBI Component datasheet.

Link RBI Component to Corrosion Loop

Persona: Analyst

Link the RBI Components that have been created to the corresponding Corrosion Loop. PDMs created in a corrosion loop are inherited by the RBI Components in that loop. These PDMs serve as a starting point when you perform an RBI analysis on the component.

Validate PDMs Inherited from Corrosion Loop

Persona: Analyst

For each RBI Component, validate the PDMs that have been inherited from the corrosion loop. This will help you decide whether additional PDMs need to be linked to the RBI Component, or if existing PDMs can be removed.

Identify Additional PDMs Specific to RBI Component

Persona: Analyst

Identify additional PDMs that may need to be added to the RBI Component based on its specific conditions, design, or process. Link the RBI Component to the appropriate PDM by selecting from the library of PDMs available. The available PDMs differ between RBI 580 and RBI 581.

Associate RBI Component with Inspection Profile

Persona: Analyst

To utilize data from the Inspection History and Corrosion History records of an RBI Component, associate the related RBI Component with the Inspection Profile. This information can be used to perform an RBI analysis on the component.

Perform RBI Analysis

Persona: Analyst

Go to the [Perform RBI Analysis workflow](#).

Identify PDMs with RBI Component

Persona: Analyst

If you have not defined a corrosion loop in the process unit, PDMs will not be inherited by the RBI Components. Therefore, you have to link the RBI Component to applicable PDMs. The PDMs used in RBI 580 differ from those used in RBI 581.

Perform an RBI Analysis

RBI: Perform RBI Analysis

This workflow describes the process of performing an RBI Criticality Analysis or an RBI 581 Risk Analysis on the components that you have created. Specifically, this workflow describes how to evaluate consequences and probability of failure and assess the unmitigated risk rank for each damage mechanism in an analysis.

In the following workflow diagram, the blue text in a shape indicates that a corresponding description has been provided in the sections that follow the diagram. For more information, refer to the topic [Interpreting the Workflow Diagrams](#).

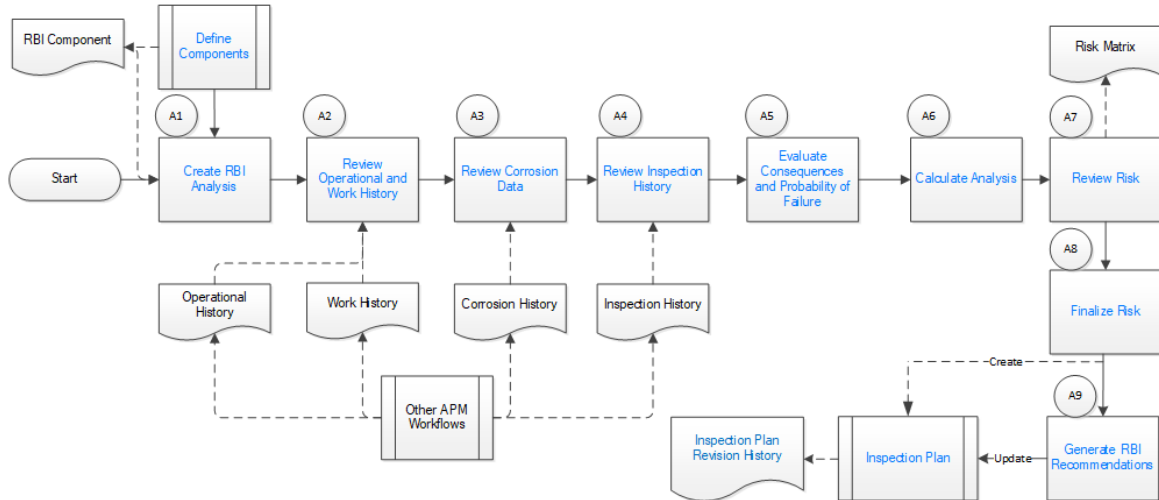

Define Components

Persona: Analyst

Go to the [Define Components workflow](#).

Create RBI Analysis

Persona: Analyst

For each RBI Component that you have defined:

- If you want to perform an RBI 580 analysis, create an RBI Criticality Analysis record.
- If you want to perform an RBI 581 analysis, create an RBI 581 Risk Analysis record.

Note: For an RBI Component, you can create multiple RBI analyses. However, only one analysis is active per component.

When you create an RBI Analysis, information related to the operating conditions and design data of the component is inherited by the analysis. You can, however, modify these values. The RBI Analysis also stores details of the risk assessments, probability of failure, and other details.

Review Operational and Work History

Persona: Analyst

Review and understand the relevant history of the RBI Component from the following records:

- **Operational History:** This will provide details on the extent of degradation that may have already taken place with regard to each PDM. This information is available in the Asset Health Manager module.
- **Work History:** This will provide details of the repair, replacement, or refurbishment activities that may have been performed on the component. This information is available in the APM Foundation module.

Review Corrosion Data

Persona: Analyst

Review and understand the corrosion data of the component. This information is available in the TM Corrosion Analysis performed on the asset in the Thickness Monitoring module.

After you integrate the RBI and Thickness Monitoring modules, the controlling corrosion data defined in the TM Corrosion Analysis is used to populate the corresponding field in the component.

Review Inspection History

Persona: Analyst

Review the most recent evaluation of the condition of the component.

You can access a list of Inspections performed on a specific Degradation Mechanism by accessing the Inspection History of the Degradation Mechanism. After an Inspection is assigned to a Degradation Mechanism, the inspection is accounted for mitigating risk during inspection planning.

Evaluate Consequences and Probability of Failure

Persona: Analyst

If you are performing an RBI 581 Risk Analysis, then assess the outcome of a failure event or situation for the component by evaluating the Safety, Health, and Environmental (SHE) Consequences, and Financial Consequences.

If you are performing an RBI Criticality Analysis, then assess the outcome of a failure event or situation for that particular component by evaluating Flammable, Toxic, Product loss, Environmental, and Production loss consequence categories in addition to evaluating the damage mechanism.

Evaluate the probability of failure for each DM.

Calculate Analysis

Persona: Analyst

Calculate the analysis to view the final damage factor, driving risk, and risk summary. The risk summary indicates whether risk is mitigated by plan date with help of inspection planning.

Review Risk

Persona: Analyst

If you have performed an RBI 580 analysis, assess the unmitigated risk for each damage mechanism (that is, the Probability of Failure determined for the individual DMs combined with the Consequence). This unmitigated risk is represented on a RBI 5x5 risk matrix and forms the basis for prioritizing Inspection Activities.

If you have performed an RBI 581 analysis, assess the mitigated and unmitigated risk for each damage mechanism (i.e., the Probability of Failure determined for the individual DMs combined with the Consequence). The unmitigated and mitigated risks are represented on a RBI 581 ISO risk graph.

Finalize Risk

Persona: Analyst

After the RBI analysis is calculated, the analyst needs to review the risk and approve the calculations. When the risk is finalized, an inspection plan is created or updated for that asset.

If you have performed an RBI 580 analysis, finalize the unmitigated risk assessment by:

- Reviewing the cumulative risk rank for RBI 580 analysis.
- Changing the state of the analysis to Risk Completed.

If you have performed an RBI 581 analysis, finalize the mitigated and unmitigated risk assessments by:

- Reviewing the Safety, Health, and Environmental (SHE) Risk and the Probability of Failure (POF) values for an RBI 581 analysis.
- Changing the state of the analysis to Risk Completed.

Generate Recommendations

Persona: Analyst

After you finalize the unmitigated risk assessment, you [can have GE Digital APM generate Recommendations for the analysis.](#)

Recommendations are generated based on the unmitigated risk that you have assessed and the acceptable risk threshold values. These recommendations, when implemented, can mitigate the risk associated with the individual damage mechanisms. Inspection Strategies outline the recommended inspection scope, method, and interval or target completion date to be applied based on the result of the RBI Analysis. After the recommendations are generated, they can be reviewed and approved within the Inspection Plan.

If you have performed an RBI 580 analysis:

- Each damage mechanism in the analysis is designated an Inspection priority value based on the unmitigated risk. This value is used to generate recommendations. Implementing these recommendations will mitigate the risk. As a general rule, an increased scope, a more effective inspection method, and more frequent inspections will be recommended for higher risk assets.
- Inspection Strategies provide recommendations for inspection activities to mitigate risks assessed for the individual damage mechanisms. After you complete the analysis, each damage mechanism is assigned an Inspection Priority value based on the unmitigated risk. This value, along with a few others, is used to generate Recommendations.
- Recommendations are generated only for quantitative damage mechanisms.
- The recommendations are recurring.

If you have performed an RBI 581 analysis:

- Recommendations are generated for all the damage mechanisms that contain a value in the Recommended Inspection Effectiveness field.
- The recommendations are non-recurring.

Recommendation Management

Persona: Analyst

Go to the [Recommendation Management workflow.](#)

RBI Recommendation Management

RBI: Recommendation Management

This workflow describes the process of reviewing the recommendations that are generated by GE Digital APM. You can also create recommendations manually, supersede recommendations, or consolidate recommendations. After the Inspection Plan is approved, you can implement the RBI Recommendation as an Inspection Task in the **Inspection Plan** page or implement the resulting Action as a task in Asset Strategy Management (ASM).

In the following workflow diagram, the blue text in a shape indicates that a corresponding description has been provided in the sections that follow the diagram. For more information, refer to the topic [Interpreting the Workflow Diagrams.](#)

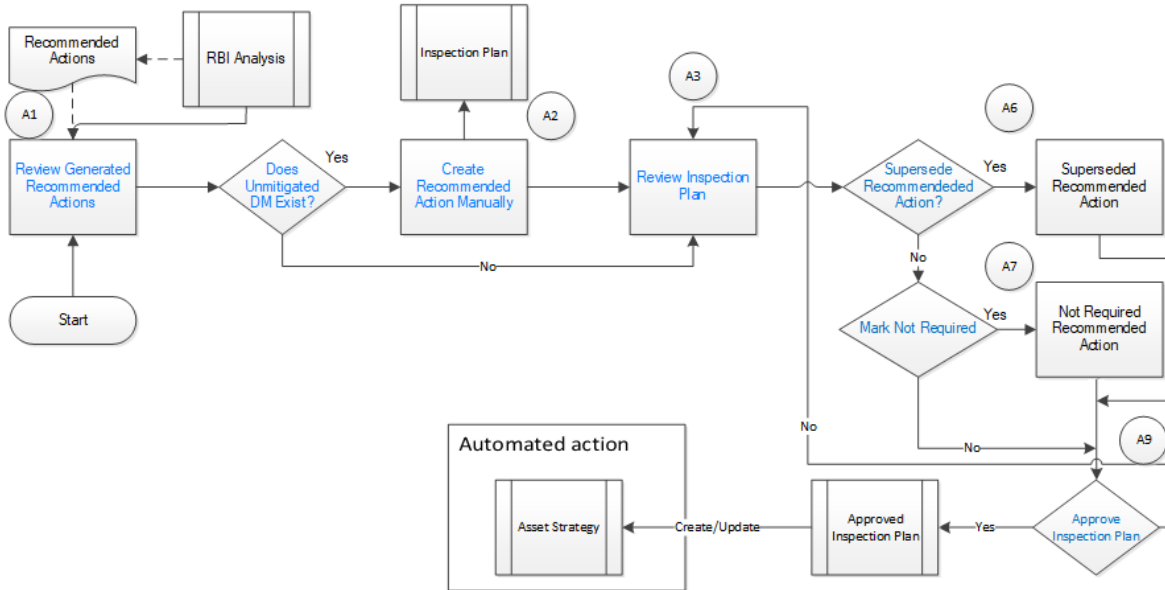

Review Generated Recommended Actions

Persona: Analyst

Review the generated Recommended Actions for applicability, effectiveness, and practicality. If you disagree with the Recommended Actions, you must update them in the associated damage mechanism to mitigate the risk.

Update Recommendation to Mitigate Risk

Persona: Analyst

If you think that implementing the generated recommendation will not mitigate the risk, update the recommendation with details on how to improve it so that the risk is mitigated to below the risk threshold values.

Does Unmitigated DM Exist?

Persona: Analyst

Verify if there is a damage mechanism for which the risk is not mitigated to below the risk threshold values. This can happen when the damage mechanism does not have an agreed-upon inspection strategy defined. In such cases, the damage mechanism is identified as unmitigated.

Assess Mitigated Risk

Persona: Analyst

Assess the mitigated risk of the damage mechanisms for which the risk is not mitigated to below the risk threshold values.

Create Recommended Actions Manually

Persona: Analyst

For DMs whose recommendations are not created by the Inspection Strategies, if further risk mitigation is needed, then manually create appropriate Recommended Actions. The risk mitigation can be based on several factors that include (but are not limited to):

- Collective experience of the team
- Statutory compliance
- Industry standards

Review Inspection Plan

Persona: Analyst

The Recommendations created from an RBI analysis will be available for review within the Inspection Plan for the asset. You can review all the Recommendations for each damage mechanism.

Supersede Recommended Action?

Persona: Analyst

If a recommendation becomes invalid or redundant because of implementing another recommendation, you must supersede it. For example, if a recommendation suggests that you perform an annual external inspection of a piece of asset, and if another recommendation suggests that you perform a quarterly external inspection of the same piece of asset, then you can choose to supersede the former.

Mark Not Required

Persona: Analyst

If a recommendation becomes invalid or redundant due to the implementation of another recommendation, you can mark it as Not Required. For example, if there is a time based and risk based recommendation for the same damage mechanism with the same task type, you can choose to mark either of the recommendation as Not Required.

Approve Inspection Plan

Persona: Analyst

As a result of the reconciliation process, recommendations that are superseded, consolidated, and not required remain in the system for auditing purposes. After the Inspection Plan is approved, the recommendations that are in the Approved state can be implemented as Inspection Tasks in the **Asset Strategy Management** page or in the **Inspection Plan** page.

Asset Strategy Management

Persona: Analyst

Go to the Asset Strategy Management Workflow.

Risks and Actions

Persona: Analyst

After you approve an Inspection Plan, the recommendations linked to the asset are converted into actions. The damage mechanisms are converted into risks.

Recommendation Implementation

Persona: Analyst

Go to the [Recommendation Implementation workflow](#).

Perform RBI Analysis

Persona: Analyst

Go to the [Perform RBI Analysis workflow](#).

RBI Recommendation Implementation

RBI: Recommendation Implementation

This workflow describes the process of:

- Reviewing the recommendations linked to an asset.
- Deciding if you want to implement the approved RBI Recommended Actions through Inspection Plan or Asset Strategy Management.
- Reviewing the inspection tasks linked to an asset.
- Modifying or creating tasks.

In the following workflow diagram, the blue text in a shape indicates that a corresponding description has been provided in the sections that follow the diagram. For more information, refer to the topic [Interpreting the Workflow Diagrams](#).

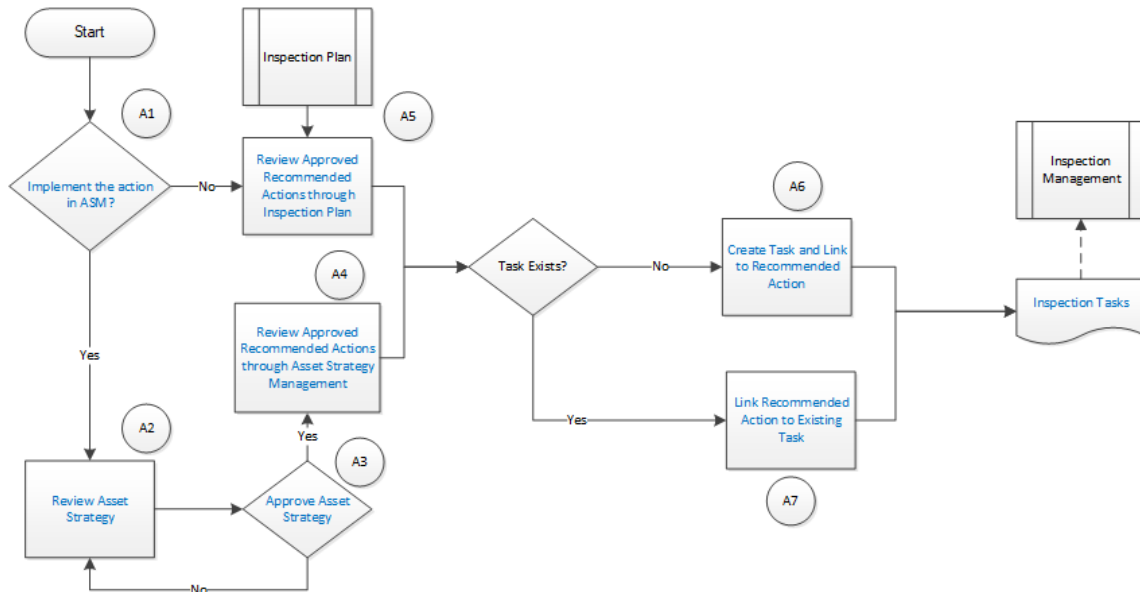

Recommendation Management

Persona: Analyst

Go to the [Recommendation Management workflow](#).

Implement the action in ASM?

Persona: Analyst

After you approve an Inspection Plan, you can choose to implement the RBI Recommended Actions through Inspection Plan or Asset Strategy Management. This decision needs to be made by the owner operator depending on the corporate philosophy of implementing RBI Recommendations.

Review Asset Strategy

Persona: Analyst

After you approve an Inspection Plan, an Asset Strategy is created or updated for the asset. The RBI recommendations linked to the asset are converted into actions and the damage mechanisms are converted into risks.

You can review the risks and Actions created in Asset Strategy Management to verify that implementing the suggested actions will mitigate the risk (to values below the risk threshold). You cannot modify the unmitigated risk assessment for the risk and the mitigated risk assessment for the Action inherited from an RBI Analysis. You can, however, add an ad hoc Action to mitigate the risk.

If the suggested Actions does not mitigate the risk (to values below the risk threshold), create an ad hoc Action in the Asset Strategy that was created after approving the Inspection Plan for the asset.

Approve Asset Strategy

Persona: Analyst

After you review the risk and its associated Actions, when the Actions are ready for implementation, you must approve the Asset Strategy so that its state changes to Active.

Review Approved Recommended Actions through Inspection Plan

Persona: Analyst

Review the approved RBI Recommended Actions through Inspection Plan, if you want to implement the Actions through Inspection Plan and not Asset Strategy Management.

Review Approved Recommended Actions through Asset Strategy Management

Persona: Analyst

Review the approved RBI Recommended Actions through Asset Strategy Management to evaluate the implementation options, if you want to implement the Actions through Asset Strategy Management.

Link Recommended Action to Existing Task

Persona: Analyst

If an existing Inspection Task provides the same instructions as a Recommended Action, link the Recommended Action to the task. You can modify the task if needed. You can link only one Inspection Task to a Recommended Action. If you have performed an RBI 580 analysis, these tasks must be recurring. If you have performed an RBI 581 analysis, these tasks must not be recurring. Similarly, you can link an RBI sourced Action to an existing task if you choose to implement from Asset Strategy Management.

Create Task and Link to Recommended Action

Persona: Analyst

If an appropriate Task does not exist, create a task to implement a Recommended Action. Link the Task to the Recommended Action. The new Task is populated with appropriate information from the

Recommended Action. If you have performed an RBI 580 analysis, then these tasks must be recurring. If you have performed an RBI 581 analysis, then these tasks must not be recurring. Similarly, you can create a new Task from Asset Strategy Management to implement the RBI sourced action, and the new Task will be populated with appropriate information from the RBI sourced action.

Inspection Tasks

Persona: Analyst

The asset strategy may be implemented as Tasks that have been defined directly from Recommended Actions through Inspection Plan or Asset Strategy Management. These Tasks can be managed from the Inspection Management or Thickness Monitoring module.

Inspection Planning

Persona: Analyst

Go to the Inspection Planning Workflow.

Chapter 3

Corrosion Loops

Topics:

- [About Corrosion Loops](#)
- [Access an RBI Corrosion Loop](#)
- [Create an RBI Corrosion Loop](#)
- [Link RBI Corrosion Loops to a Process Unit](#)
- [Unlink an RBI Corrosion Loop from a Unit](#)
- [Link Potential Degradation Mechanisms \(PDMs\) to an RBI Corrosion Loop](#)
- [Unlink a Potential Degradation Mechanism \(PDM\)](#)
- [Delete an RBI Corrosion Loop](#)

About Corrosion Loops

A Corrosion Loop is a collection of components grouped together for the purpose of conducting an RBI 581 Risk Analysis.

In GE Digital APM, Corrosion Loops are used to store relevant identifying and grouping information of the loop. Each Corrosion Loop is linked to other records to further define the Corrosion Loop. For example, Corrosion Loops are linked to Potential Degradation Mechanisms (PDMs), which define the ways in which the components in the Corrosion Loop can fail.

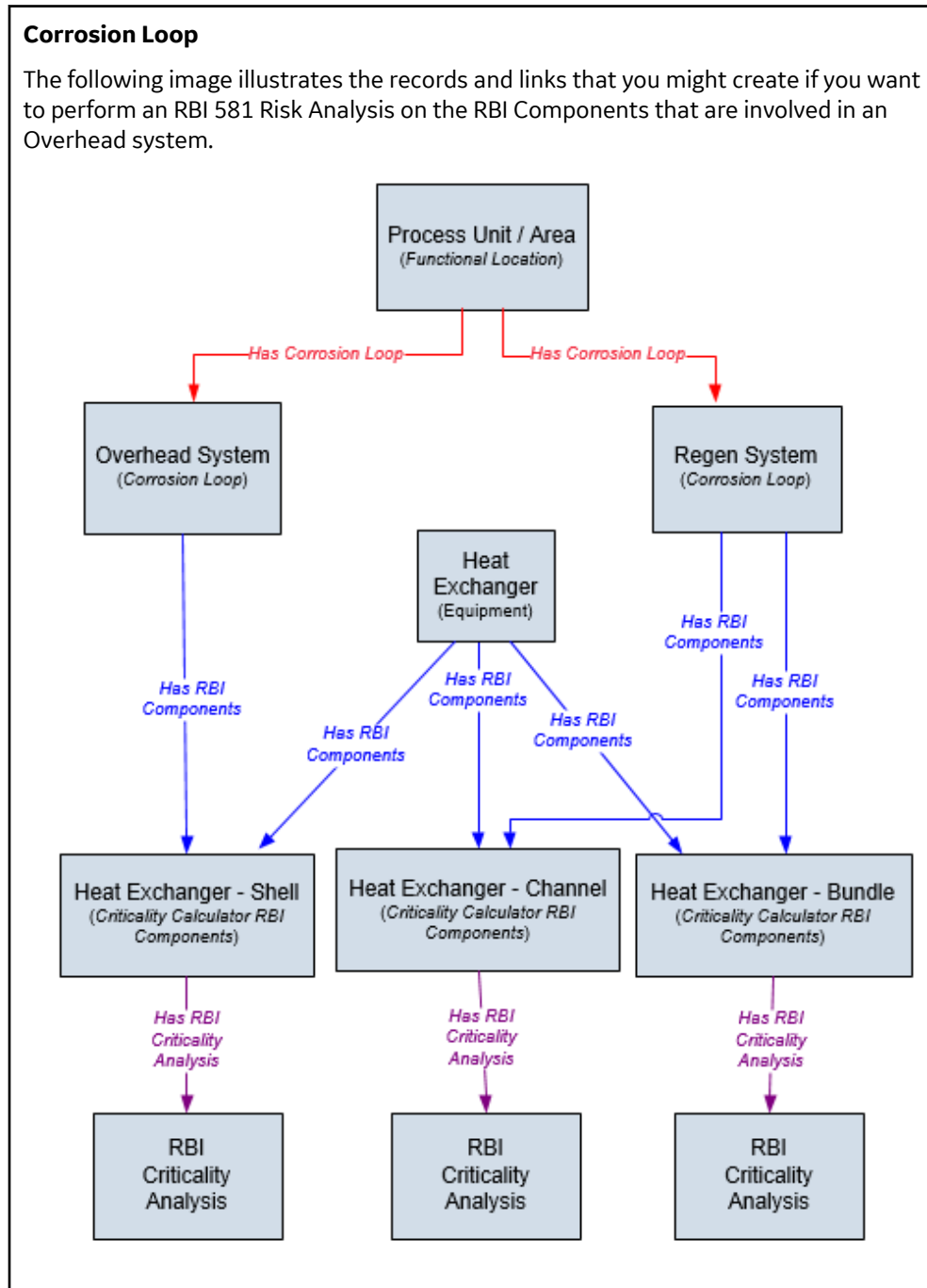

Access an RBI Corrosion Loop

Procedure

1. Access the **Unit Summary workspace** of the process unit that is linked to the Corrosion Loop you want to access.
2. In the left pane, select the Corrosion Loop that you want to access.

-or-

In the list of Corrosion Loops below the graphs, in the row containing the Corrosion Loop that you want to access, select the link.

The **Corrosion Loop: <name>** workspace appears, displaying the following information:

- The left pane: Contains a list of RBI Components in the corrosion loop.
- The **Corrosion Loop Overview** section: Contains the following graphs and a list of RBI Components in the corrosion loop:
 - The first graph plots the risk category of each RBI Component that is linked to an RBI Criticality Analysis, RBI PRD Analysis, or an RBI Pipeline Analysis. If you pause over a bar on the graph, the Component ID and the respective lowest Inspection Priority value appear. This graph appears only if the value in the **RBI Overview Graph Preference** box in the **Global Preferences** workspace on the **RBI Admin Preferences** page is either RBI 580 or 580 and 581.
 - The second graph plots the maximum SHE risk value of each RBI Component that is linked to an RBI 581 Risk Analysis. If you pause over a bar on the graph, the Component ID and the respective SHE risk value appear. This graph appears only if the value in the **RBI Overview Graph Preference** box in the **Global Preferences** workspace on the **RBI Admin Preferences** page is either RBI 581 or 580 and 581.

If you select a bar on either of the graphs, the **Component Overview** section for the component appears.

- The **Potential Degradation Mechanisms** section: Contains a list of Potential Degradation Mechanisms (PDMs) that are linked to the Corrosion Loop.
- The **Corrosion Loop Details** section: Contains the Corrosion Loop datasheet.

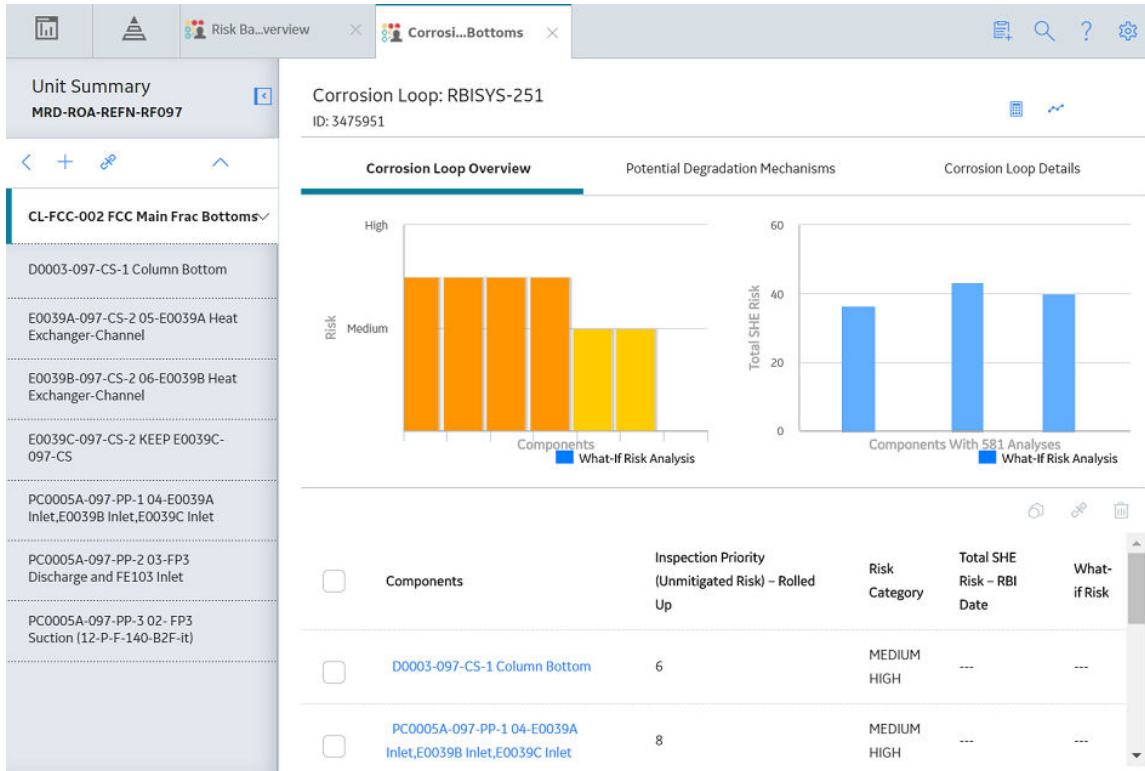

Create an RBI Corrosion Loop

About This Task

This topic describes how to create a Corrosion Loop and link it to a Process Unit. You can also [link an existing Corrosion Loop to a Process Unit](#).

Procedure

1. [Access the Process Unit](#) for which you want to create a Corrosion Loop.
2. In the left pane, select , and then select **Create New Corrosion Loop**.

The **Corrosion Loops Details** section appears, displaying a blank datasheet for the Corrosion Loop. The value in the RBI Corrosion Loop ID field is populated automatically.

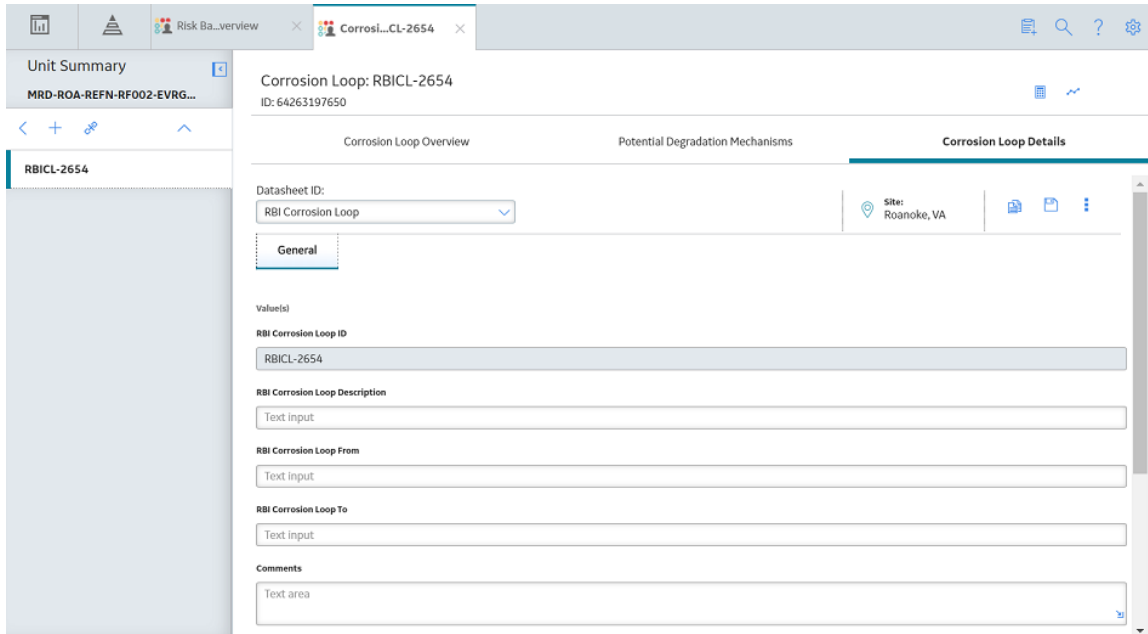

3. As needed, enter values in the [available fields](#).
4. In the upper-right corner of the section, select .
The RBI Corrosion Loop is created, and linked to the selected Process Unit.

Next Steps

- [Link Potential Degradation Mechanisms \(PDMs\) to an RBI Corrosion Loop](#)

Link RBI Corrosion Loops to a Process Unit

About This Task

This topic describes how to link an existing Corrosion Loop to a Process Unit. You can also [create a new Corrosion Loop and link it to a Process Unit](#).

Procedure

1. [Access the Process Unit](#) to which you want to link Corrosion Loops.
2. In the left pane, select , and then select **Link Existing Corrosion Loop**.

The **Select Corrosion Loops** window appears, displaying a list of Corrosion Loops that are not yet linked to a process unit.

Select Corrosion Loops



	RBI CORROSION LOOP ID	RBI CORROSION LOOP DESCRIPTION	RBI CORROSION L
<input type="checkbox"/>	RBICL-2060	HAS COMP W 580 ANLYS AND COMP W 581 ANLYS	
<input type="checkbox"/>	RBICL-2211		

Rows per page 100 v ← 1 of 1 →

Cancel
Done

3. In the row containing each Corrosion Loop that you want to link to the unit, select the check box, and then select **Done**.
The selected Corrosion Loops are linked to the unit.

Next Steps

- [Link Potential Degradation Mechanisms \(PDMs\) to an RBI Corrosion Loop.](#)

Unlink an RBI Corrosion Loop from a Unit

Procedure

1. [Access the Process Unit](#) from which you want to unlink a Corrosion Loop.
2. In the left pane, select the Corrosion Loop that you want to unlink, and then select .
A message appears, asking you to confirm if you want to unlink the selected Corrosion Loop.
3. Select **Yes**.
The selected RBI Corrosion Loop is unlinked from the unit.

Link Potential Degradation Mechanisms (PDMs) to an RBI Corrosion Loop

About This Task

When you link PDMs to an RBI Corrosion Loop, the PDMs are applied to all the RBI Components contained in that RBI Corrosion Loop.

This topic describes how to link one or more PDMs to a Corrosion Loop. You cannot create PDMs; you can only link them. Therefore, a PDM must already exist to be linked to a Corrosion Loop.

Procedure

1. [Access the Corrosion Loop](#) to which you want to link PDMs.
2. In the workspace, select the **Potential Degradation Mechanisms** tab.

The **Potential Degradation Mechanisms** section appears.

The screenshot shows a software interface with a sidebar on the left and a main content area. The sidebar contains 'Unit Summary' and 'RBISYS-1328'. The main content area has a header for 'Corrosion Loop: RBISYS-1328' with ID '64252739304'. Below the header are three tabs: 'Corrosion Loop Overview', 'Potential Degradation Mechanisms' (which is selected), and 'Corrosion Loop Details'. An 'Add PDM' button is located in the top right of the main content area. Below the button is a table with two columns: 'Degradation Mechanism' and 'Methodology Type'. The table lists three mechanisms, all with a 'Quantitative' methodology type and a small icon to the right.

Degradation Mechanism	Methodology Type
Carbonate Cracking	Quantitative
Criticality Calculator External Corrosion	Quantitative
Criticality Calculator Internal Corrosion	Quantitative

3. In the **Potential Degradation Mechanisms** section, select **Add PDM**.
A list of PDMs appears, displaying the methodology type of each PDM.

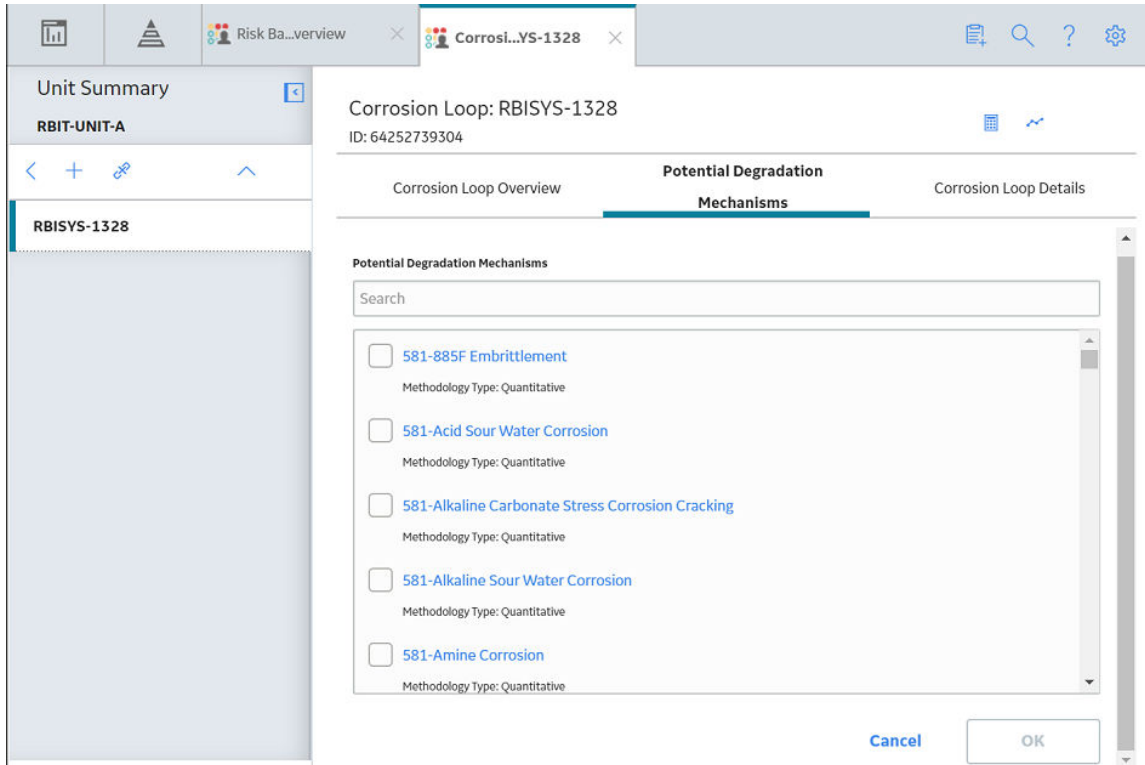

Tip: If you select the link that corresponds to a PDM, the PDM record appears in Record Explorer on a new page.

4. In the row containing each PDM that you want to link to the Corrosion Loop, select the check box, and then select **OK**.
The selected PDMs are linked to the Corrosion Loop.

Next Steps

- [Create an RBI Component.](#)
- [Link RBI Components to an RBI Corrosion Loop.](#)

Unlink a Potential Degradation Mechanism (PDM)

Procedure

1. [Access the Corrosion Loop](#) from which you want to unlink a PDM.
2. In the workspace, select the **Potential Degradation Mechanisms** tab.

The **Potential Degradation Mechanisms** section appears, displaying a list of associated PDMs.

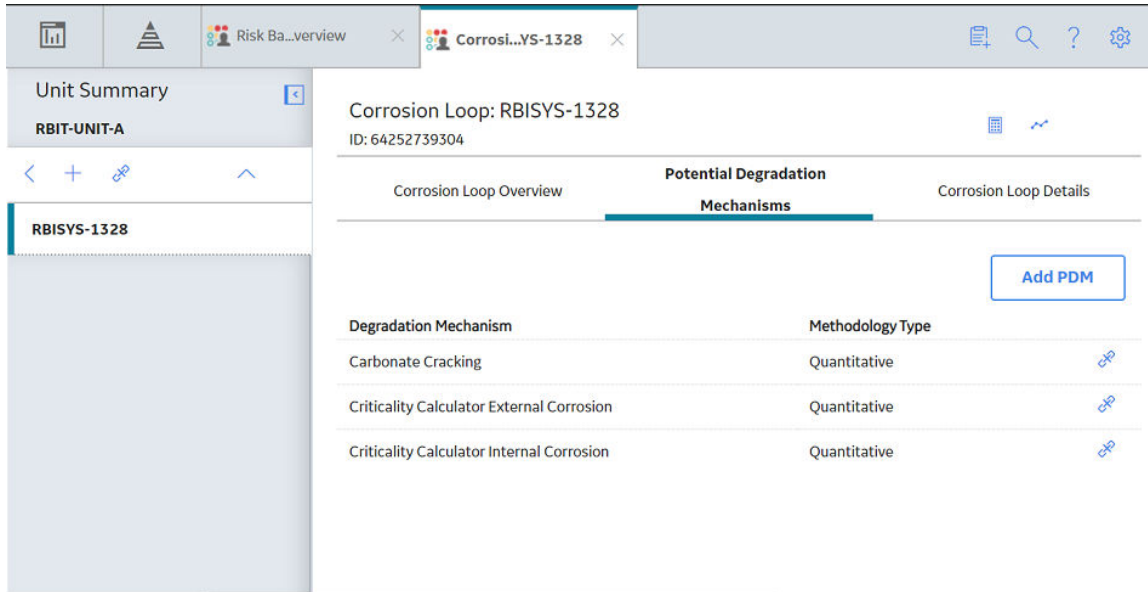

- In the **Potential Degradation Mechanisms** section, in the row that contains the PDM that you want to unlink from the RBI Corrosion Loop, select

A message appears, asking you to confirm that you want to unlink the selected PDM.

- Select **Yes**.

The PDM is unlinked from the selected RBI Corrosion Loop.

Delete an RBI Corrosion Loop

Before You Begin

If the Corrosion Loop that you want to delete is linked to a Potential Degradation Mechanisms record (PDM), [unlink the PDM](#) before deleting the Corrosion Loop.

Procedure

- [Access the Process Unit](#) that is linked to the Corrosion Loop that you want to delete.
- In the **Unit Overview** section, below the graph, select the check box next to the Corrosion Loop that you want to delete, and then select .

A message appears, asking you to confirm that you want to delete the selected Corrosion Loop.

- Select **Yes**.

The Corrosion Loop is deleted.

Chapter

4

RBI Components

Topics:

- [About RBI Components](#)
- [About Integration with Thickness Monitoring \(TM\)](#)
- [About Using TM Analysis Values at the Thickness Monitoring Location \(TML\) Group Level](#)
- [About Using TM Analysis Values at the Asset Level](#)
- [Access an RBI Component](#)
- [Create an RBI Component](#)
- [Access the Inventory Group of a Component](#)
- [Link RBI Components to an RBI Corrosion Loop](#)
- [Unlink an RBI Component from an RBI Corrosion Loop](#)
- [Link Potential Degradation Mechanisms \(PDMs\) to an RBI Component](#)
- [Unlink a Potential Degradation Mechanism \(PDM\) from an RBI Component](#)
- [Link an RBI Component to a TML Group](#)
- [Apply an RBI Component](#)
- [Delete an RBI Component](#)

About RBI Components

In Risk Based Inspection, you can divide asset into components whose risk you want to analyze using an RBI 581 Risk Analysis. You can divide a piece of asset into components based on shared degradation mechanisms. Each sub-part of the asset that shares the same degradation mechanisms will belong to the same RBI Component.

In GE Digital APM, the information related to an RBI component is stored in the following Criticality Calculator RBI Component records:

- Criticality RBI Component - Cylindrical Shell
- Criticality RBI Component - Exchanger Bundle
- Criticality RBI Component - Exchanger Header
- Criticality RBI Component - Exchanger Tube
- Criticality RBI Component - Piping
- Criticality RBI Component - Pump Compressor Casing
- Criticality RBI Component - Tank Bottom
- Criticality RBI Pipeline Segment (only if the Pipeline Management license is active)

Heat Exchanger

Consider a Heat Exchanger, which is a piece of asset that contains the following components:

- A Cylindrical Shell that makes up the Heat Exchanger Shell section.
- A Cylindrical Shell that makes up the Heat Exchanger Channel section.
- Any number of small tubes that make up the Heat Exchanger Bundle section.

Each of the components can contain items such as Nozzles, Flanges, or Piping.

In RBI, to analyze the ways in which the exchanger can fail, you must divide the components into logical groups that represent common failure characteristics. Each group of components is a separate component and is represented by a single RBI Component record. Keep in mind that some of these groups are involved in the overhead system, and others are involved in the cooling water system.

For example, you might group the asset's components as follows:

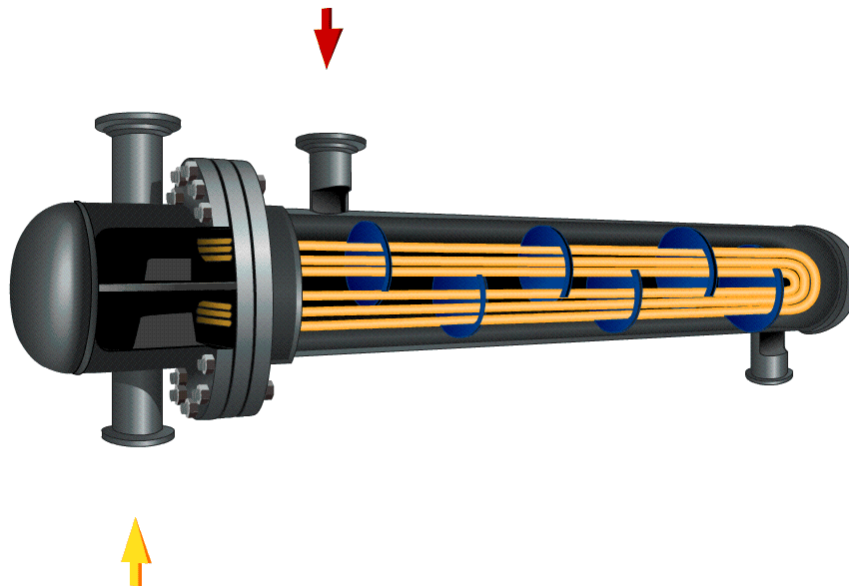

- Heat Exchanger Shell: Includes a cylindrical shell, an inlet nozzle, an outlet nozzle, and a head, often referred to as a shell cover. The Shell is part of the Cooling Water System (blue) because the purpose of the shell is to allow water to flow over the tubes and cool the process fluid running through the channel and bundle section of the exchanger.
- Heat Exchanger Channel: Includes a cylindrical shell, an inlet nozzle an outlet nozzle and a flat head, often referred to as a dollar plate. The Channel is part of the OVHD System (yellow) because the purpose of the Channel is to funnel the process fluid in to the tubes and allow cooling of the process fluid running through the channel and bundle section of the exchanger.
- Heat Exchanger Bundle: Includes tubes, baffles, and a tubesheet. The Bundle is part of the OVHD System (yellow) because the purpose of the bundle is to provide as much surface area as possible for the process fluid in to the tubes and allow cooling of the process fluid running through the bundle section of the exchanger.

If you create an [RBI 581 Risk Analysis](#) using this example, your database contains the following records:

- Unit / Area (Functional Location record)
- Overhead System (Corrosion Loop record)
- Cooling Water System (Corrosion Loop record)
- Heat Exchanger (Asset record)
- Heat Exchanger Shell (Criticality Calculator RBI Components record)
- Heat Exchanger Channel (Criticality Calculator RBI Components record)
- Heat Exchanger Bundle (Criticality Calculator RBI Components record)

Note: If you have already created Functional Location records to represent the OVHD System and Cooling Water System using the recommended asset hierarchy, you must create additional Corrosion Loop records to represent these same systems. The existing Functional Location records need not be linked to the Corrosion Loop records.

About Integration with Thickness Monitoring (TM)

This topic has been intentionally excluded from the GE Digital APM product documentation website. This topic is available to you via the product documentation that is provided within the GE Digital APM system.

About Using TM Analysis Values at the Thickness Monitoring Location (TML) Group Level

This topic has been intentionally excluded from the GE Digital APM product documentation website. This topic is available to you via the product documentation that is provided within the GE Digital APM system.

About Using TM Analysis Values at the Asset Level

This topic has been intentionally excluded from the GE Digital APM product documentation website. This topic is available to you via the product documentation that is provided within the GE Digital APM system.

Access an RBI Component

Procedure

1. [Access the Asset Summary workspace](#) for the asset that contains the RBI Component that you want to access.

-or-

[Access the Corrosion Loop](#) that contains the RBI Component that you want to access.

2. Below the graph, select the link corresponding to the component that you want to access.

-or-

In the left pane, select the component that you want to access.

The workspace for the selected component appears, displaying the **Component Overview** section.

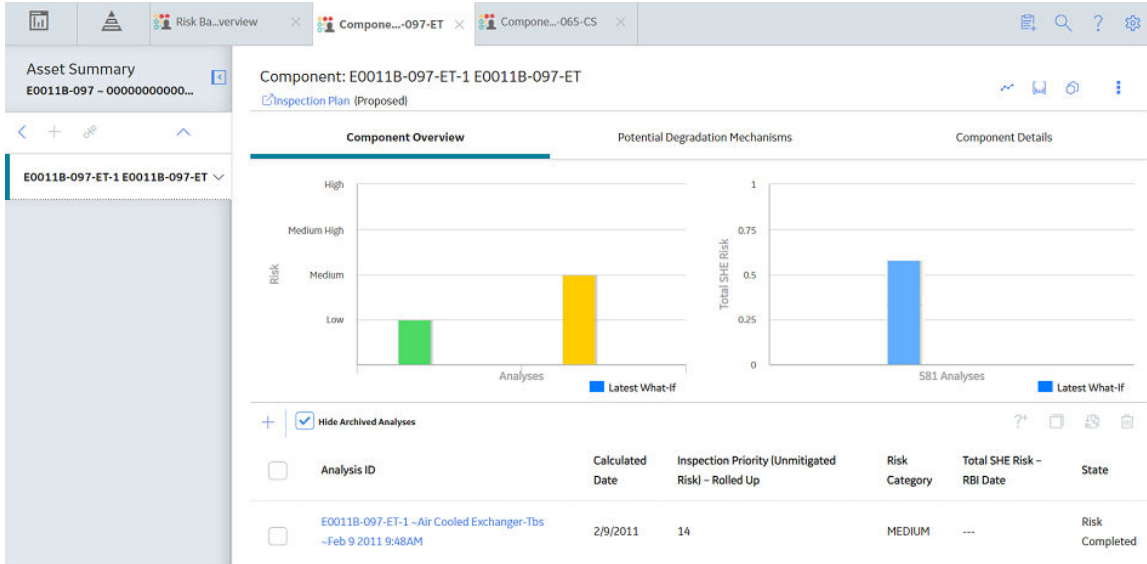

3. Select the **Component Details** tab.

The **Component Details** section appears, displaying the datasheet of the Component.

Datasheet ID: RBI Comp - Exchanger Ti

Site: Roanoke, VA

Technical Data: RBI-581

Asset Details

Functional Location: MRD-ROA-REFN

Equipment: E0011B-097 ~ 00000000001056809 ~ EXC

Equipment Taxonomy: Air Cooled Heat

Component: E0011B-097-ET-1

Component Type: Air Cooled I

Component Date in Se...: 10/22/2019 11:32:41

Component Status: [Dropdown]

Component Comments: Text area

Component Description: E0011B-097-ET

Note: If needed, modify values in the [available fields](#), and then select  to save your changes.

Create an RBI Component

About This Task

This topic describes how to create a new RBI Component and link it to an Asset or a Corrosion Loop. You can also [link an existing RBI Component to an Asset or a Corrosion Loop](#).

Procedure

1. Access the **Asset Summary workspace** of the asset in which you want to create an RBI Component.

-or-

[Access the Corrosion Loop](#) in which you want to create an RBI Component.

2. In the left pane, select , and then select **Create New Component**.

The **Create New RBI Component** window appears.

Create New RBI Component

Asset
~ ~ RBI EQU COMP ALL DATA

Component Family
Select a Component Family ▼

Component Type
Select Component Type ▼

[Cancel](#) [Create](#)

3. Enter values in the following fields:

- Asset: This field is automatically populated with the asset for which you are creating an RBI Component.
- Component Family: Select the component family for the Component that you want to create.

- Component Type: Select the component type for the RBI Component that you want to create.

Note: You can use only the following component types with the component family Criticality RBI Component – Tank Bottom:

- Storage Tank Bottom

4. Select **Create**.

A new RBI Component is created, and is automatically linked to the selected Asset and the Corrosion Loop. The **Component Details** section appears, displaying the component datasheet.

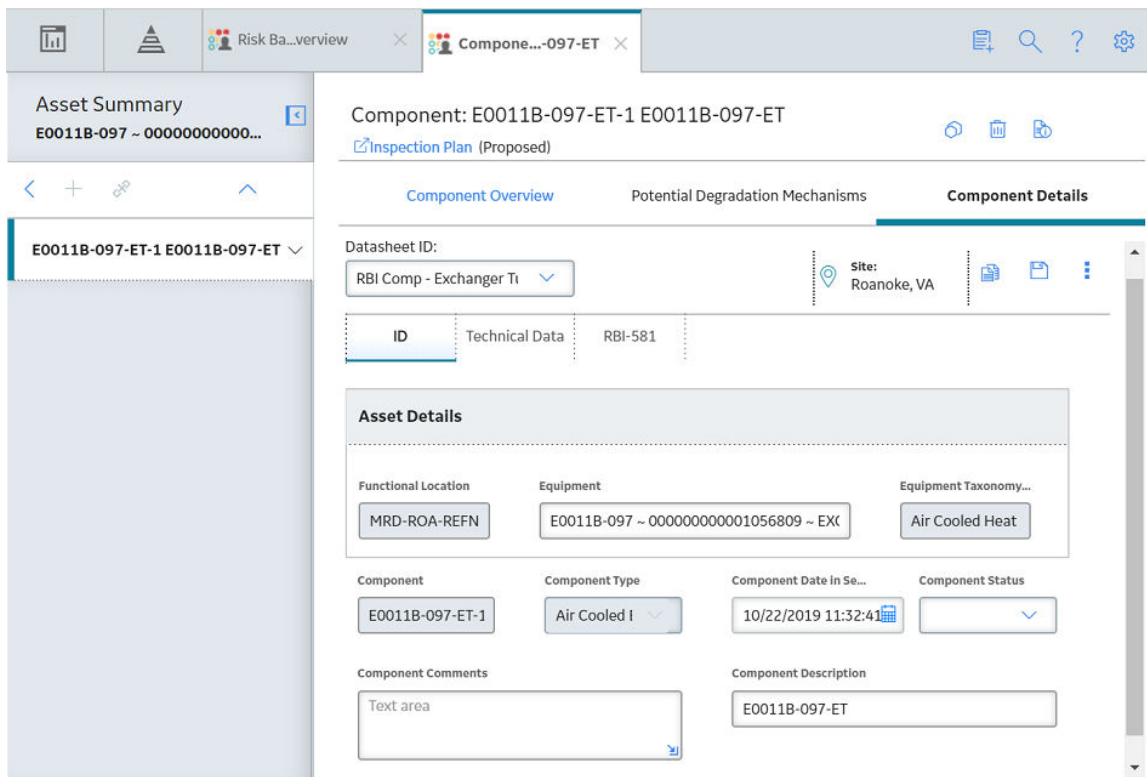

5. Enter values in the [available fields](#).
6. In the **RBI-581** section of the datasheet, enter values in the available fields.
7. In the upper-right corner of the datasheet, select . The changes made to the RBI Component are saved.

Results

- The RBI Component inherits linked [Potential Degradation Mechanisms](#) from the RBI Corrosion Loop.

Next Steps

- [Link Potential Degradation Mechanisms \(PDMs\) to an RBI Component](#).

Access the Inventory Group of a Component

About This Task

You can also [access all the inventory groups in a process unit](#).

Procedure

1. [Access the Component](#) that is linked to the inventory group.
2. In the upper-right corner of the page, select , and then select **Inventory Group**.

The **RBI 581 Inventory Groups** workspace appears on a new page, displaying the following information:

- If the component is linked to an inventory group, then the Inventory Group Configuration datasheet for the inventory group associated with the component appears.

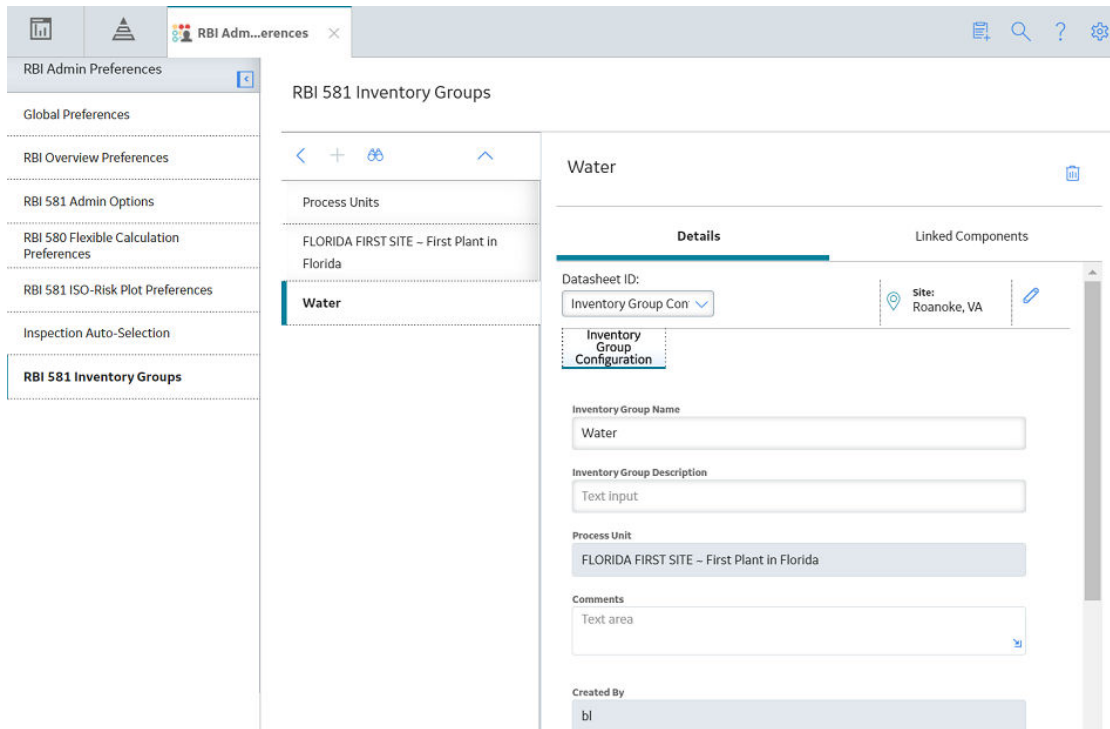

The screenshot displays the 'RBI 581 Inventory Groups' workspace. On the left is a navigation menu with options: 'RBI Admin Preferences', 'Global Preferences', 'RBI Overview Preferences', 'RBI 581 Admin Options', 'RBI 580 Flexible Calculation Preferences', 'RBI 581 ISO-Risk Plot Preferences', 'Inspection Auto-Selection', and 'RBI 581 Inventory Groups' (which is selected). The main workspace is titled 'RBI 581 Inventory Groups' and contains a 'Process Units' section with 'FLORIDA FIRST SITE - First Plant in Florida' and a 'Water' section. The 'Water' section is expanded to show the 'Inventory Group Configuration' datasheet. The 'Details' tab is active, showing fields for 'Inventory Group Name' (Water), 'Inventory Group Description' (Text input), 'Process Unit' (FLORIDA FIRST SITE - First Plant in Florida), 'Comments' (Text area), and 'Created By' (bl). A 'Linked Components' tab is also visible, showing 'Inventory Group Con' and 'Site: Roanoke, VA'.

Tip: If you want to access a list of components linked to the inventory group, select the **Linked Components** tab.

- If the component is not linked to an inventory group, then the Process Units with Inventory Groups graphs appears. A list of process units appear in the left section in the workspace.

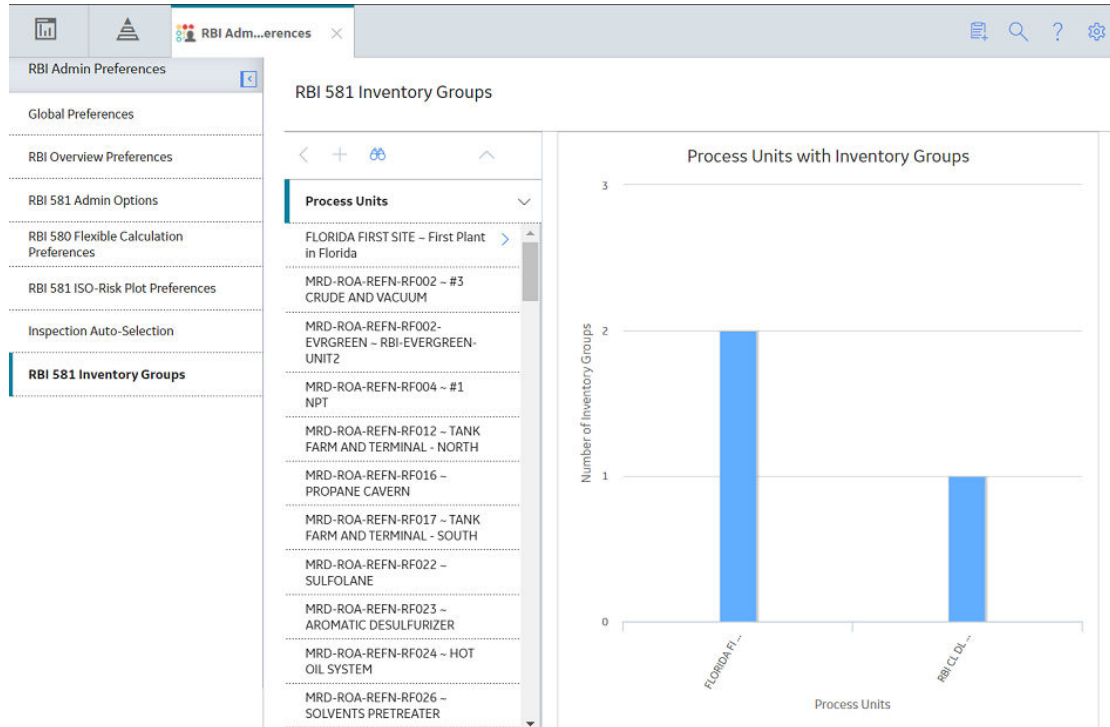

Tip: If you are a member of the RBI Admin Security Group, you can [create an Inventory Group Configuration record](#) in the **RBI 581 Inventory Groups** workspace.

Link RBI Components to an RBI Corrosion Loop

About This Task

This topic describes how to link existing RBI Components to an Asset or Corrosion Loop. You can also [create a new RBI Component](#).

Procedure

1. [Access the Corrosion Loop](#) that you want to link to an RBI Component.
2. In the left pane, select **+**, and then select **Link Existing Component**.

The **Select RBI Components** window appears, displaying a list of components in the same site that are not linked to a Corrosion Loop.

Select RBI Components



<input type="checkbox"/>	ASSET ID	COMPONENT ↓	COMPONENT DESCRIPTION
<input type="checkbox"/>	T0001-097 ~ 000000000001058364 ~ TANK -...	T0001-097-T...	T0001-097-TB
<input type="checkbox"/>	T0001-097 ~ 000000000001058364 ~ TANK -...	T0001-097-C...	T0001-097-CS
<input type="checkbox"/>	PC0004A-097 ~ 000000000001104785 ~ RE...	PC0004A-09...	Reactor O/H to Main Colum
<input type="checkbox"/>	MDM001A ~ 000000000001073804 ~ INLET ...	MDM001A-C...	02- Inlet Separator Base M
<input type="checkbox"/>	MCM001 ~ 000000000001073796 ~ GLYCOL ...	MCM001-CS-3	Glyc Cont Btm-Base Mtl
<input type="checkbox"/>	F0038-065 ~ 000000000001034648 ~ VESSE...	F0038-065-C...	F0038-065-CS
<input type="checkbox"/>	F0036-065 ~ 000000000001034646 ~ VESSE...	F0036-065-C...	F0036-065-CS
<input type="checkbox"/>	F0035-065 ~ 000000000001034645 ~ VESSE...	F0035-065-C...	F0035-065-CS
<input type="checkbox"/>	F0035-065 ~ 000000000001034645 ~ VESSE...	F0035-065-C...	F0035-065-CS
<input type="checkbox"/>	F0030-065 ~ 000000000001034644 ~ VESSE...	F0030-065-C...	F0030-065-CS
<input type="checkbox"/>	F0030-065 ~ 000000000001034644 ~ VESSE...	F0030-065-C...	F0030-065-CS

1 - 74 of 74 Results ← Page 1 of 1 →

Cancel

Done

3. Select the check boxes that correspond to the components that you want to link, and then select **Done**.

The selected RBI Components are linked to the Corrosion Loop.

Results

- The PDMs that are linked to the Corrosion Loop are linked to the RBI Components, in addition to the ones that are directly linked to the component.

Next Steps

- [Link Potential Degradation Mechanisms \(PDMs\) to an RBI Component](#).

Unlink an RBI Component from an RBI Corrosion Loop

Procedure

1. [Access the Corrosion Loop](#) from which you want to unlink the RBI Component.

2. In the left pane, select the RBI Component that you want to unlink from the Corrosion Loop, and then select .

-or-

Below the graph, next to the RBI Component that you want to unlink from the Corrosion Loop, select the check box, and then select .

A message appears, asking you to confirm that you want to unlink the selected RBI Component.

3. Select **Yes**.

The RBI Component is unlinked from the selected Corrosion Loop.

Link Potential Degradation Mechanisms (PDMs) to an RBI Component

About This Task

If the RBI Component is linked to a Corrosion Loop, then all the PDMs linked to the Corrosion Loop are also linked to the Component. You can, however, link additional PDMs to the Component.

This topic describes how to link one or more PDMs to an RBI Component. You cannot create PDMs; you can only link them. Therefore, a PDM must already exist to be linked to an RBI Component.





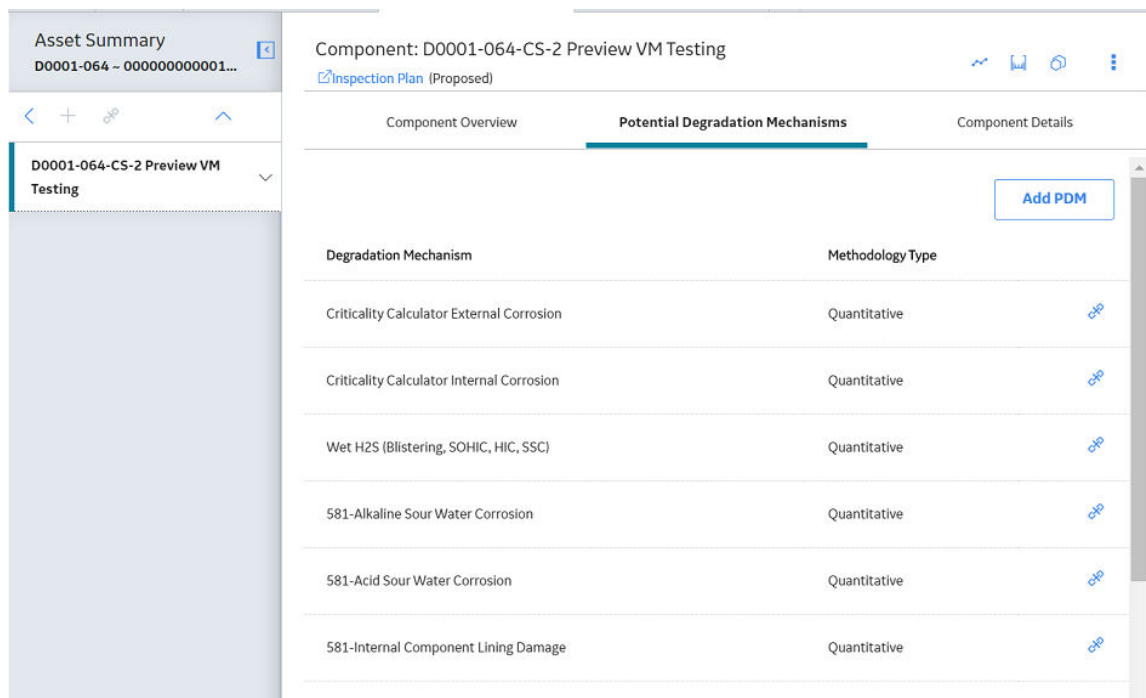

Procedure

1. [Access the RBI Component](#) to which you want to link PDMs.
2. Select the **Potential Degradation Mechanisms** tab.

The **Potential Degradation Mechanisms** section appears, displaying a list of PDMs linked to the RBI Component.



The screenshot shows a software interface with a left sidebar and a main content area. The sidebar has a search bar and a list of components, with 'D0001-064-CS-2 Preview VM Testing' selected. The main content area has a header for the component and a tabbed interface. The 'Potential Degradation Mechanisms' tab is active, showing a table of PDMs. An 'Add PDM' button is visible in the top right of the table area.

Degradation Mechanism	Methodology Type	
Criticality Calculator External Corrosion	Quantitative	
Criticality Calculator Internal Corrosion	Quantitative	
Wet H2S (Blistering, SOHIC, HIC, SSC)	Quantitative	
581-Alkaline Sour Water Corrosion	Quantitative	
581-Acid Sour Water Corrosion	Quantitative	
581-Internal Component Lining Damage	Quantitative	

3. Select **Add PDM**.

A list of PDMs appears, displaying the methodology type of each PDM.

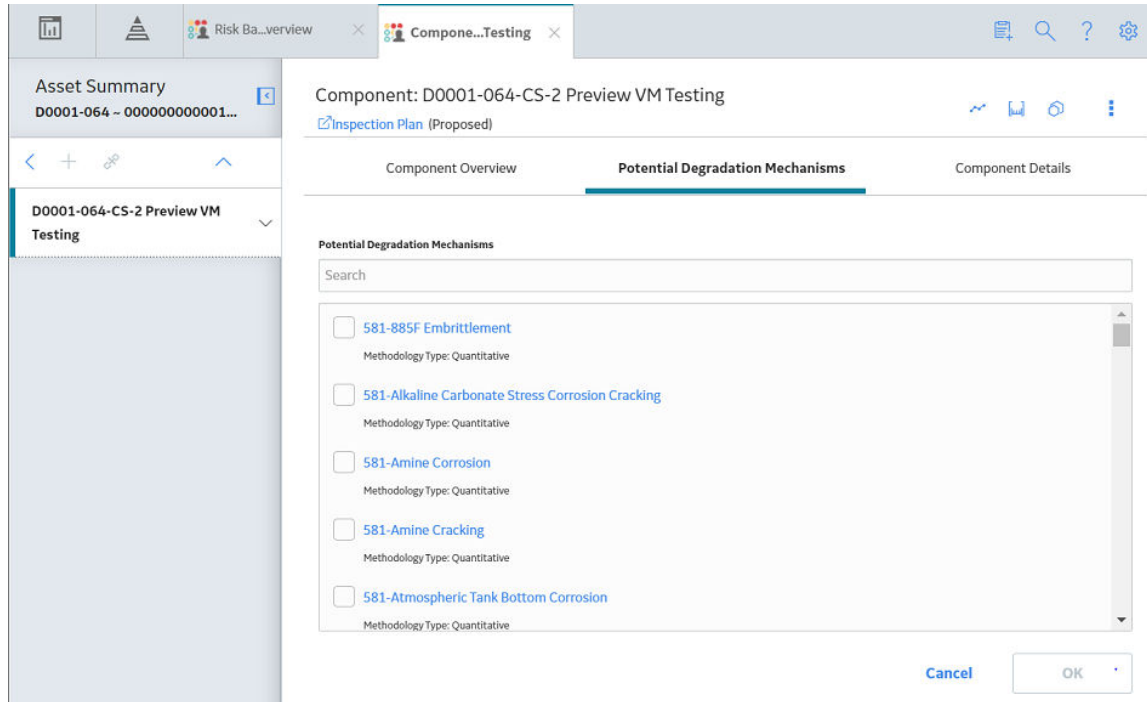

Tip: If you select the link that corresponds to a PDM, the PDM record appears in Record Explorer on a new page.

4. Next to each PDM that you want to link to the RBI Component, select the check box, and then select **OK**.

Note: PDMs that can be used with an RBI 581 Risk Analysis contain a 581 prefix (e.g., 581-Amine Cracking).

The selected PDMs are linked to the RBI Component.

Next Steps

- [Create an RBI 581 Risk Analysis](#).

Unlink a Potential Degradation Mechanism (PDM) from an RBI Component

Procedure

1. [Access the RBI Component](#) from which you want to unlink a PDM.
2. Select the **Potential Degradation Mechanisms** tab.

The **Potential Degradation Mechanisms** section appears, displaying a list of PDMs linked to the RBI Component.

3. In the row that contains the PDM you want to unlink from the RBI Component, select .

A message appears, asking you to confirm that you want to unlink the selected PDM.

4. Select **Yes**.

The PDM is unlinked from the RBI Component.

Link an RBI Component to a TML Group

Before You Begin

- The value in the Source of Calculated Corrosion Rates field in the RBI Component must be Component.
- The parent Asset of the RBI Component must not be a Thickness Monitoring Piping Asset.
- You must have an active license for the Thickness Monitoring module.

Procedure

1. [Access the RBI Component](#) to which you want to link a TML group.
2. In the upper-right corner of the workspace, select .

The **Manage TML Groups** window appears.

Manage TML Groups - EQU W TML GRPS (RT AND UT...

TML Group	
<input type="checkbox"/>	TMLGRP-64253064401 - RT TMLS
<input type="checkbox"/>	TMLGRP-64253064416 - UT AND RT TMLS

Cancel

OK

3. Next to the TML Groups that you want to link to the RBI Component, select the check boxes, and then select **OK**.

The selected TML Groups are linked to the RBI Component.

Note: If the Source of Calculated Corrosion rate is set to Asset or Component on the related component and the related TML asset has more than 1000 TMLs where the related TML Corrosion

Analysis has not been calculated, you need to calculate the asset in the Thickness Monitoring module before continuing.

Results

- An RBI Component linked to a TML Group inherits the TM corrosion rate values from the TML Group. If the component contains an RBI 581 Thinning and Lining Damage Mechanism Evaluation, the resulting damage factor value will be based on the corrosion rate determined by the value in the [Selected Corrosion Rate field](#).

Apply an RBI Component

About This Task

When you apply an RBI Component, you make a copy of the original record. The applied RBI Component is not automatically linked to the original RBI Component's Corrosion Loop. Instead, the applied RBI Component can be linked to the same or a different asset and then to a Corrosion Loop.

Procedure

1. [Access the RBI Component](#) that you want to apply.
2. In the upper-right corner of the page, select .
The **Hierarchy Finder** window appears.

Hierarchy Finder

Search

Filter

- ▼ Home
 - ▼ MRD ~ Meridium, Inc. +
 - ▼ MRD-DUB ~ Meridium Dubai +
 - ▶ MRD-DUB-CHEM ~ Meridium Dubai Chemicals +
 - ▶ MRD-DUB-DRE ~ DRE Unit +
 - ▶ MRD-DUB-MANU ~ Meridium Dubai Manufacturing +
 - ▶ MRD-DUB-MING ~ Meridium Dubai Mining +
 - ▶ MRD-DUB-PLPR ~ Meridium Dubai Pulp and Paper +
 - ▶ MRD-DUB-REFN ~ Meridium Dubai Refining +
 - ▶ MRD-HOU ~ Meridium Houston +
 - ▶ MRD-PER ~ Meridium Perth +

Cancel OK

3. Navigate through the **Hierarchy Finder** to select the asset to which you want to apply the RBI Component.
4. Select **OK**.

The RBI Component is applied to the selected asset.

Next Steps

- [Link RBI Components to an RBI Corrosion Loop](#)

Delete an RBI Component

Before You Begin

- [Unlink all the Potential Degradation Mechanisms \(PDMs\) linked to the RBI Component.](#)
- [Delete all the RBI Analyses linked to the RBI Component.](#)

Procedure

1. Access the [Asset Summary workspace](#) of the asset that is linked to the RBI Component that you want to delete.

-or-

[Access the Corrosion Loop](#) that is linked to the RBI Component that you want to delete.

2. Next to the Component what you want to delete, select the check box next, and then select .
3. Select **Yes**.

The RBI Component is deleted, and all links to existing related entities are removed.

Chapter 5

RBI Analyses

Topics:

- [About RBI Analysis](#)
- [About Active Analysis](#)
- [About What-If Analysis](#)
- [About Inspection Planning](#)
- [About the RBI 581 Asset Risk Report](#)
- [Access an RBI 581 Risk Analysis](#)
- [Create an RBI Analysis](#)
- [Add a What-If Analysis](#)
- [Override Flow Stress](#)
- [Calculate an RBI 581 Risk Analysis](#)
- [Calculate all RBI 581 Risk Analyses Associated with a Process Unit](#)
- [Calculate all RBI 581 Risk Analyses Associated with a Single Asset or Corrosion Loop](#)
- [Calculate all RBI 581 Risk Analyses Associated with Multiple Assets](#)
- [Generate a Report for an Asset](#)
- [Duplicate an RBI 581 Risk Analysis](#)
- [Apply an RBI 581 Risk Analysis](#)
- [Finalize Risk of an RBI 581 Risk Analysis](#)
- [Finalize Risk of Multiple RBI 581 Risk Analyses](#)
- [Delete an RBI 581 Risk Analysis](#)

About RBI Analysis

An RBI Analysis is a combination of linked RBI Analysis records and their successor records. These records contain risk information about the RBI Component for which the analysis was created. There are two kinds of RBI Analyses: RBI 581 and RBI 580.

- The details of an RBI 580 analysis are stored in an RBI Criticality Analysis record. It is based on the API 580 specification for Risk Based Inspection requirements and methodologies, and is the type of analysis provided in baseline RBI.
- The details of an RBI 581 analysis are stored in an RBI 581 Risk Analysis. It is based on the API 581 specification, and is provided by the RBI 581 module.

Depending on the requirements of the organization, generally you will use one of the two types of analyses, but not both.

Note: Unless otherwise specified, RBI Analysis procedures are the same for both RBI 581 and RBI 580 analyses. Generally, RBI 581 Risk Analysis and RBI Criticality Analysis records will be referred to collectively as RBI Analyses.

Details

There are two types of RBI Analyses:

- **Main RBI Analysis:** An RBI Analysis that represents current information about the RBI Component and the operating environment. You can use the information in a main RBI Analysis as the starting point for a child What If Analysis.
- **What-If Analysis:** A child analysis of a main RBI Analysis. What If Analyses allow you to calculate the risk associated with an RBI Component under hypothetical circumstances or at some future date. For example, you might want to see what the risk would be if you changed the operating pressure or what the risk could be in a few years.

Note: While the RBI Analysis is linked to child What-If Analyses (through the Has RBI Analysis family), those child RBI Analysis records are not considered part of the main RBI Analysis. Instead, they are considered part of their own RBI Analysis.

About Active Analysis

An RBI 581 Risk Analysis can be active or inactive. An active analysis is the one on which recommendations and tasks for a particular RBI Analysis will be based. For an RBI Component, you can have only one active analysis. There is no limit, however, to the number of inactive analyses that can exist for an RBI Component.

When you create an analysis, it is in the Created state. If the analysis is active, you can then set the analysis to one of the following states in that order:

- Risk Completed
- Accepted by ASM

If the analysis is inactive, however, the state of the analysis will automatically be set to Archived. If you change the state of an analysis to Risk Completed, all the other analyses are marked inactive (i.e., their state is set to Archived).

About What-If Analysis

A What-If Analysis is a child analysis of a main RBI Analysis (or another What-If Analysis) in an active state that allows you to calculate the risk associated with an RBI Component under hypothetical circumstances. What-If Analyses allow you to analyze hypothetical situations to determine how operational and procedural changes would impact the risk associated with a component's failure on a certain date.

When you create a What-If Analysis:

- A record of the RBI 581 Risk Analysis is created. For the What-If Analysis, however, the value in the Event Type field is populated with the value W.
Note: For a normal RBI Analysis, the value in the Event Type field is blank.
- The What-If Analysis is linked to the main analysis through the Has Child RBI Criticality Analysis relationship.
- The Consequence Evaluation, Degradation Mechanisms (DMs), and Degradation Mechanism Evaluations (DMEs) linked to the main analysis are copied and linked to the What-If Analysis.
- The Analysis ID of the What-If Analysis is in the following format: W <Analysis ID of the main analysis> <Number> <Scenario ID>, where <Number> is the sequential number of the What-If Analysis.
- You can duplicate the What-If Analysis. You cannot, however, apply the What-If Analysis.
- You can [change the state of the What-If Analysis](#). The [state assignments and operations that are applicable to an RBI Analysis](#) are also applicable to a What-If Analysis.
- GE Digital APM copies the values from the fields in the main analysis to the What-If Analysis. However, values in the output fields (i.e., fields that appear in the **Risk Results** and **Risk Analysis** sections of the datasheet) are not copied.

About Inspection Planning

Inspection Planning is a methodology used by the RBI 581 module as outlined by API RP 581. The purpose of this methodology is to mitigate the risk of a failure within a given period of time. This period is called the plan period.

To mitigate risk based on inspection planning:

1. Calculate the analysis.
2. If the analysis results are acceptable, change the state of the analysis to Risk Completed.
3. Generate Recommendations.
GE Digital APM creates non-recurring recommendations based on the recommended inspections for each Degradation Mechanisms record (DM).
4. Promote the asset to Asset Strategy Management (ASM).
Actions are created in ASM for each RBI Recommendation.
5. Create Inspection Tasks based on the proposed actions.
6. Implement the Inspection Tasks.

Risk is calculated for all applicable Degradation Mechanism Evaluations (DMEs) at RBI Date and plan Date. Risk calculated on plan date without mitigation appears on the **Without Plan** section of the analysis datasheet. Risk calculated on the plan date with mitigation appears on the **With Plan** section of the datasheet.

Inspection Planning, however, is applied only to the following DMEs:

- RBI 581 Cracking Damage Evaluation

- RBI 581 External Damage Evaluation
- RBI 581 Thinning and Lining Evaluation

Inspection Planning determines if mitigation will help, and if it does, GE Digital APM recommends an Inspection for the DM with an A, B, or C level of Inspection Effectiveness.

Risk Targets

The following risk targets are defined in RBI 581:

- Target Damage Factor Max: This value represents maximum acceptable damage factor for calculating probability of failure.
Target Damage Factor Max will still be considered even if your organization specifies that the SHE Risk or Financial Risk should be the driving risk for RBI 581 Risk Analyses. This is because, even if the SHE Risk or Financial Risk is less than the target, it can still lead to a failure if the damage factor is high. For example, suppose there is a condensate piping with insulation. In this case, the consequence of a condensate leakage is low. Therefore, the SHE Risk and Financial Risk are considerably low, which results in a risk value lower than the target. Even if the condensate leaks frequently, the low risk value does not help the analyst identify the high probability of failure due to ferritic corrosion under insulation. Therefore, it is necessary to ensure that the damage factor is less than the target damage factor as well.
- Target SHE Risk : This value represents maximum acceptable safety, health, and environmental risk.
- Target Financial Risk : This value represents maximum acceptable financial risk.

These targets appear in the **Planning Targets** section of the RBI 581 Risk Analysis datasheet.

Risk Summary

Each risk target represents a threshold value. Based on whether the total risk value is already below the target risk, or will be mitigated after inspection planning, the appropriate Risk Summary is specified for the analysis.

The following Risk Summaries are defined in the Inspection Planning Risk Summary family as an outcome from Inspection Planning:

- Risk exceeded, Mitigation does not help : Indicates that the risk exceeds the target, and the highest level of inspection cannot mitigate the risk to a value less than the target. In this case, the Risk Summary Description field is populated with the value Residual Risk after applying highest level of Inspection.
- Total DF Max Exceeded, Mitigation does not help : Indicates that the highest level of inspection cannot mitigate the risk, which is greater than the driving target (Total DF Max). In this case, the Risk Summary Description field is populated with the value Residual Damage Factor after applying highest level of Inspection.
- Risk within Target, Mitigation not required : Indicates that the risk is below the target, no mitigation is required. In this case, the Risk Summary Description field is populated with the value Risk is less than target hence Inspection not required.
- Risk exceeded target, but mitigated by inspection : Indicates that the risk exceeds the target, but inspection can mitigate the risk. In this case, the Risk Summary Description field is populated with the value Risk Mitigated after applying required level of Inspection.

RBI Date, Plan Date, and Target Inspection Date

The values in the RBI Date, Plan Date, and Target Inspection Date fields are used to determine the Risk Summary of an analysis.

- RBI Date : It is the date on which you have started conducting the RBI analysis. By default, it is set to the date on which you create an RBI Analysis.

- Plan Date : It is the end date of the plan period. By default, this is set to ten years from the RBI date.
- Target Inspection Date : It is the date on which the risk will first exceed the Risk Targets.
 - If risk exceeds the target on the RBI date, then the Target Inspection Date is set to the RBI Date.
 - If risk does not exceed the target at Plan Date, then the Target Inspection Date is set to the Plan Date.

Note: Target Inspection Date is used to calculate age during Inspection Planning for RBI 581 External Cracking Damage Evaluations and RBI 581 Cracking Damage Evaluations.

When calculating the damage factor, age is calculated based on Inspection Date. The Inspection Date is determined using the following table:

RBI Date			With Plan		Without Plan	
Damage Mechanism	Last Known Inspection Date Set	Last Known Inspection Date Not Set	Last Known Inspection Date Set	Last Known Inspection Date Not Set	Last Known Inspection Date Set	Last Known Inspection Date Not Set
External Cracking	Last Known Inspection Date	Date In Service	Last Known Inspection Date	Date In Service	Target Inspection Date	
Environment Cracking	Last Known Inspection Date	Date In Service	Last Known Inspection Date	Date In Service	Target Inspection Date	
Thinning	Last Known Inspection Date if there is a thickness. Else, Date In Service	Date In Service	Last Known Inspection Date	Date In Service	Last Known Inspection Date	Date In Service
Lining	Last Known Inspection Date if there is a thickness. Else, Date In Service	Liner Installation Date	Last Known Inspection Date	Liner Installation Date	Last Known Inspection Date	Liner Installation Date
External	Last Known Inspection Date if there is a thickness. Else, Date In Service	Date In Service	Last Known Inspection Date	Date In Service	Last Known Inspection Date	Date In Service

About the RBI 581 Asset Risk Report

The RBI 581 Asset Risk report provides information about the risk assessments on all the components in the asset, along with a risk matrix and supporting data.

The RBI 581 Asset Risk report contains the following sections:

- Equipment Data
- Component Summary
- Planning Targets
- Risk / Damage Mechanism Analysis
- RBI Component Risk Results

- RBI Recommendations
- Inspection History
- Corrosion Analysis
- Reference Documents

Equipment Data

This section provides the equipment details. The following table provides a list of items that are included in the **Equipment Data** section of the report and their corresponding fields in RBI.

Report Item	Corresponding Field in RBI (Family Name)
Equipment ID	Equipment ID (Equipment)
Equipment Technical No	Equipment Technical Number (Equipment)
Description	Equipment Short Description (Equipment)
Functional Location	Functional Location (Functional Location)

Component Summary

This section provides the design and operating details of all the components linked to the asset, including the components that have an active analysis (that is, analysis in Risk Completed or Accepted by ASM state). The following table provides a list of items that are included in the **Component Summary** section of the report and their corresponding fields in RBI.

Report Item	Corresponding Field in RBI (Family Name)
Component	RBI Component (Criticality Calculator RBI Components)
Component Type	Component Type (Criticality Calculator RBI Components)
Date in Service	Component Date in Service (Criticality Calculator RBI Components)
Design Code	Construction Code (Criticality Calculator RBI Components)
Material Spec	Material Spec (Criticality Calculator RBI Components)
Material Grade	Material Grade (Criticality Calculator RBI Components)
PWHT	PWHT (Criticality Calculator RBI Components)
Insulation	Insulated? (Criticality Calculator RBI Components)
Insulation Type	Insulation Type (Criticality Calculator RBI Components)
Process Fluid	Process Fluid (Criticality Calculator RBI Components)
Design Pressure	Design Pressure (Criticality Calculator RBI Components)
Design Temperature	Design Temperature (Criticality Calculator RBI Components)
Operating Pressure	Operating Pressure (Criticality Calculator RBI Components)
Operating Temperature	Operating Temperature (Criticality Calculator RBI Components)
Design Pressure - Shell	Design Pressure - Shell Side (Criticality RBI Component - Exchanger Bundle)

Report Item	Corresponding Field in RBI (Family Name)
Design Temperature - Shell	Design Temperature - Shell Side (Criticality RBI Component - Exchanger Bundle)
Operating Pressure - Shell	Operating Pressure - Shell (Criticality RBI Component - Exchanger Bundle)
Operating Temperature - Shell	Operating Temperature - Shell (Criticality RBI Component - Exchanger Bundle)

Planning Targets

This section provides the details of components that have an active analysis. The RBI Components with no active analysis are not included in this section. The following table provides a list of items that are included in the **Planning Targets** section of the report and their corresponding fields in RBI.

Report Item	Corresponding Field in RBI (Family Name)
Component	RBI Component (Criticality Calculator RBI Components)
Driving Risk Target	Driving Risk Target (RBI 581 Risk Analysis)
Damage Factor Max	Target Damage Factor Max (RBI 581 Risk Analysis)
SHE Risk	Target SHE Risk (RBI 581 Risk Analysis)
Financial Risk	Target Financial Risk (RBI 581 Risk Analysis)
Cracking Minimum Damage Factor	Target Cracking Minimum Damage Factor (RBI 581 Risk Analysis)
External Minimum Damage Factor	Target Cracking Minimum Damage Factor (RBI 581 Risk Analysis)
Thinning and Lining Minimum Damage Factor	Target Thinning And Lining Minimum Damage Factor (RBI 581 Risk Analysis)

Risk / Damage Mechanism Analysis

This section provides details of degradation mechanisms linked to active RBI 581 Risk Analyses of RBI Components in the Asset. Risk details of RBI Components with no active analysis is not included in this section. The following table provides a list of items that are included in the **Risk / Damage Mechanism Analysis** section of the report and their corresponding fields in RBI.

Report Item	Corresponding Field in RBI (Family Name)
Degradation Mechanism	Degradation Mechanism (RBI Degradation Mechanisms)
Damage Factor (RBI Date)	Total Damage Factor - RBI Date (RBI Degradation Mechanisms)
SHE Risk (RBI Date)	Total SHE Risk - RBI Date (RBI Degradation Mechanisms)
Financial Risk (RBI Date)	Total Financial Risk - RBI Date (RBI Degradation Mechanisms)
Damage Factor (Without Plan)	Total Damage Factor Without Plan (RBI Degradation Mechanisms)
SHE Risk (Without Plan)	Total SHE Risk Without Plan (RBI Degradation Mechanisms)

Report Item	Corresponding Field in RBI (Family Name)
Financial Risk (Without Plan)	Total Financial Risk Without Plan (RBI Degradation Mechanisms)
Damage Factor (With Plan)	Total Damage Factor With Plan (RBI Degradation Mechanisms)
SHE Risk (With Plan)	Total SHE Risk With Plan (RBI Degradation Mechanisms)
Financial Risk (With Plan)	Total Financial Risk With Plan (RBI Degradation Mechanisms)
Recommended Inspection Effectiveness	Recommended Inspection Effectiveness (RBI Degradation Mechanisms)

RBI Component Risk Results

This section provides the cumulative risk details of the Active RBI 581 Analyses of the components. These details are captured from **Risk Results** and **Risk Analysis** sections of RBI 581 Risk Analysis datasheet. The following table provides a list of items that are included in the **RBI Component Risk Results** section of the report and their corresponding fields in RBI.

Report Item	Corresponding Field in RBI (Family Name)
Total Damage Factor (RBI Date)	Total Damage Factor - RBI Date (RBI 581 Risk Analysis)
SHE Risk (RBI Date)	Total SHE Risk - RBI Date (RBI 581 Risk Analysis)
Financial Risk (RBI Date)	Total Financial Risk - RBI Date (RBI 581 Risk Analysis)
SHE Risk Category (RBI Date)	SHE Risk Category - RBI Date (RBI 581 Risk Analysis)
Financial Risk Category (RBI Date)	Financial Risk Category - RBI Date (RBI 581 Risk Analysis)
Total Damage Factor (Without Plan)	Total Damage Factor Without Plan (RBI 581 Risk Analysis)
SHE Risk (Without Plan)	Total SHE Risk Without Plan (RBI 581 Risk Analysis)
Financial Risk (Without Plan)	Total Financial Risk Without Plan (RBI 581 Risk Analysis)
SHE Risk Category (Without Plan)	SHE Risk Category - Without Plan (RBI 581 Risk Analysis)
Financial Risk Category (Without Plan)	Financial Risk Category - Without Plan (RBI 581 Risk Analysis)
Total Damage Factor (With Plan)	Total Damage Factor With Plan (RBI 581 Risk Analysis)
SHE Risk (With Plan)	Total SHE Risk With Plan (RBI 581 Risk Analysis)
Financial Risk (With Plan)	Total Financial Risk With Plan (RBI 581 Risk Analysis)
SHE Risk Category (With Plan)	SHE Risk Category - With Plan (RBI 581 Risk Analysis)
Financial Risk Category (With Plan)	Financial Risk Category - With Plan (RBI 581 Risk Analysis)
Target Inspection Date	Target Inspection Date (RBI 581 Risk Analysis)
Risk Summary ID	Risk Summary ID (RBI 581 Risk Analysis)
Risk Summary Description	Risk Summary Description (RBI 581 Risk Analysis)
Inspection will Mitigate	Inspection Will Mitigate (RBI 581 Risk Analysis)

RBI Recommendations

This section provides the details of the RBI Recommendation that is linked to the asset and are in Proposed or Accepted by ASM state. The following table provides a list of items that are included in the **RBI Recommendations** section of the report and their corresponding fields in RBI.

Report Item	Corresponding Field in RBI (Family Name)
Component	RBI Component (RBI Recommendation)
Task Type	Task Type (RBI Recommendation)
Damage Mechanism	Damage Mechanism (RBI Recommendation)
Recommended Inspection Scope	Recommended Inspection Scope (RBI Recommendation)
Target Inspection Date	Target Completion Date (RBI Recommendation)
State	State (RBI Recommendation)

Inspection History

This section provides the details of the Inspection Confidence Evaluations linked to the damage mechanisms of the Active Analysis of the components. If the component has an active analysis, but the degradation mechanisms do not have Inspection Confidence Evaluations, such components are not included in this section. The following table provides a list of items that are included in the **Inspection History** section of the report and their corresponding fields in RBI.

Report Item	Corresponding Field in RBI (Family Name)
Component	RBI Component (Criticality Calculator RBI Components)
Damage Mechanism	Damage Mechanism (RBI 581 Damage Mechanism Evaluation)
Inspection Report	Inspection Report (Inspection)
Completion Date	Completion Date (Inspection Confidence Evaluation)
Inspection Effectiveness	Inspection Confidence (Inspection Confidence Evaluation)
Inspection Family	Inspection Family (Inspection)
Status	Inspection Document Status (Inspection)

Corrosion Analysis

This section provides the corrosion rate details of an RBI Component if the component has an active analysis and at least one RBI 581 Thinning and Lining Evaluation degradation mechanism linked. In the component, if the Source of Calculated Corrosion Rate field value is Component, and has any TML Groups linked, then the TML Groups are also included in the report. The following table provides a list of items that are included in the **Corrosion Analysis** section of the report and their corresponding fields in RBI.

Report Item	Corresponding Field in RBI (Family Name)
Component	RBI Component (Criticality Calculator RBI Components)
Damage Mechanism	Damage Mechanism (RBI 581 Thinning and Lining Evaluation)

Report Item	Corresponding Field in RBI (Family Name)
Selected Corrosion Rate	Selected BM Corrosion Rate (RBI 581 Thinning and Lining Evaluation)
Corrosion Rate	Base Material Estimated Corrosion Rate, Base Material Calculated Corrosion Rate, Long Term Avg Corr Rate, Short Term Avg Corr Rate, Controlling Corrosion Rate (RBI 581 Thinning and Lining Evaluation)
Source of Calculated Corrosion Rate	Source of Calculated Corrosion Rates (Criticality Calculator RBI Components)
TML Group	Corrosion Group (TML Group)

Reference Documents

This section provides information on any reference documents attached to the RBI Component of the asset. The following table provides a list of items that are included in the **Reference Documents** section of the report and their corresponding fields in RBI.

Report Item	Corresponding Field in RBI (Family Name)
Component	RBI Component (Criticality Calculator RBI Components)
Document ID	ID (Reference Document)
Document Description	Description (Reference Document)

Access an RBI 581 Risk Analysis

About This Task

Procedure

1. [Access the component](#) that contains the RBI Analysis that you want to access.
2. Below the graph, select the RBI Analysis that you want to access.

The **Analysis Details** section appears, displaying the analysis datasheet.

Note: If needed, you can modify values in the [available fields](#), review the [required fields](#) and [valid Representative Fluids](#), and then select  to save your changes.

Create an RBI Analysis

About This Task

You can create an RBI 581 Risk Analysis for an RBI Component.

Procedure

1. [Access the RBI Component](#) for which you want to create an RBI 581 Risk Analysis.
2. Below the graph, select , and then select **Quantitative (581)**.
A new analysis is created, and the **Analysis Details** section appears.

Note: When an analysis is created, the Consequence Evaluations and [Degradation Mechanisms](#) corresponding to the [Potential Degradation Mechanisms](#) linked to the selected component are also created.

3. Enter values in the [available fields](#).
4. [Review the required fields](#), and the [valid Representative Fluids](#).
5. In the upper-right corner of the section, select .
The RBI analysis is created.

Results

- For each Potential Degradation Mechanism (PDM) linked to the Component, a Degradation Mechanism (DM) is added to the Analysis.

Next Steps



- [Add Degradation Mechanisms \(DMs\)](#).

Add a What-If Analysis

About This Task

When you create a What-If Analysis, a copy of the main RBI Analysis is created. In the What-If Analysis, however, the value in the Event Type field is populated with the value W.

Procedure

1. Perform one of the following sets of steps:
 - a. [Access the analysis](#) to which you want to add a What-If Analysis.
 - b. In the upper-right corner of the workspace, select , and then select **Create What If Analysis**.-or-
 - a. [Access the component](#) that is linked to the analysis to which you want to add a What-If Analysis. Below the graph, a list of analyses linked to the component appears in a grid.
 - b. Select the check box that corresponds to the analysis to which you want to add a What-If Analysis.
 - c. In the upper-right corner of the grid, select .

The **Create What If Analysis** window appears.

Create What If Analysis

Scenario ID

Plan Date

Cancel

Done

2. In the **Create What If Analysis** window:
 - In the **Scenario ID** box, enter an ID to identify the scenario.

- In the **Plan Date** box, select a date that is the same as or later than the RBI date (as specified in the RBI Date field in the main analysis).
3. Select **Done**.

The What-If Analysis is created and linked to the main analysis. The **Analysis** workspace appears, displaying the **Analysis Details** section.

Note:

- If needed, modify values in the [available fields](#), and then select  to save your changes.
- If the Source of Calculated Corrosion rate is set to Asset or Component on the related component and the related TML asset has more than 1000 TMLs where the related TML Corrosion Analysis has not been calculated, you need to calculate the asset in the Thickness Monitoring module before continuing.

Results

- The Analysis ID of the What-If Analysis is in the following format: W <Analysis ID of the main analysis> <Number> <Scenario ID>, where <Number> is the sequential number of the What-If Analysis.
- All the fields (with a few [exceptions](#)) in the What-If Analysis are populated with values in the main analysis fields.
- The Consequence Evaluation, Degradation Mechanisms (DMs), and Degradation Mechanism Evaluations (DMEs) linked to the main analysis are copied and linked to the What-If Analysis.

Override Flow Stress

Procedure

1. [Access the RBI 581 Risk Analysis](#) for which you want to override Flow Stress.
2. Select the **Design** tab.

The **Design** section appears.

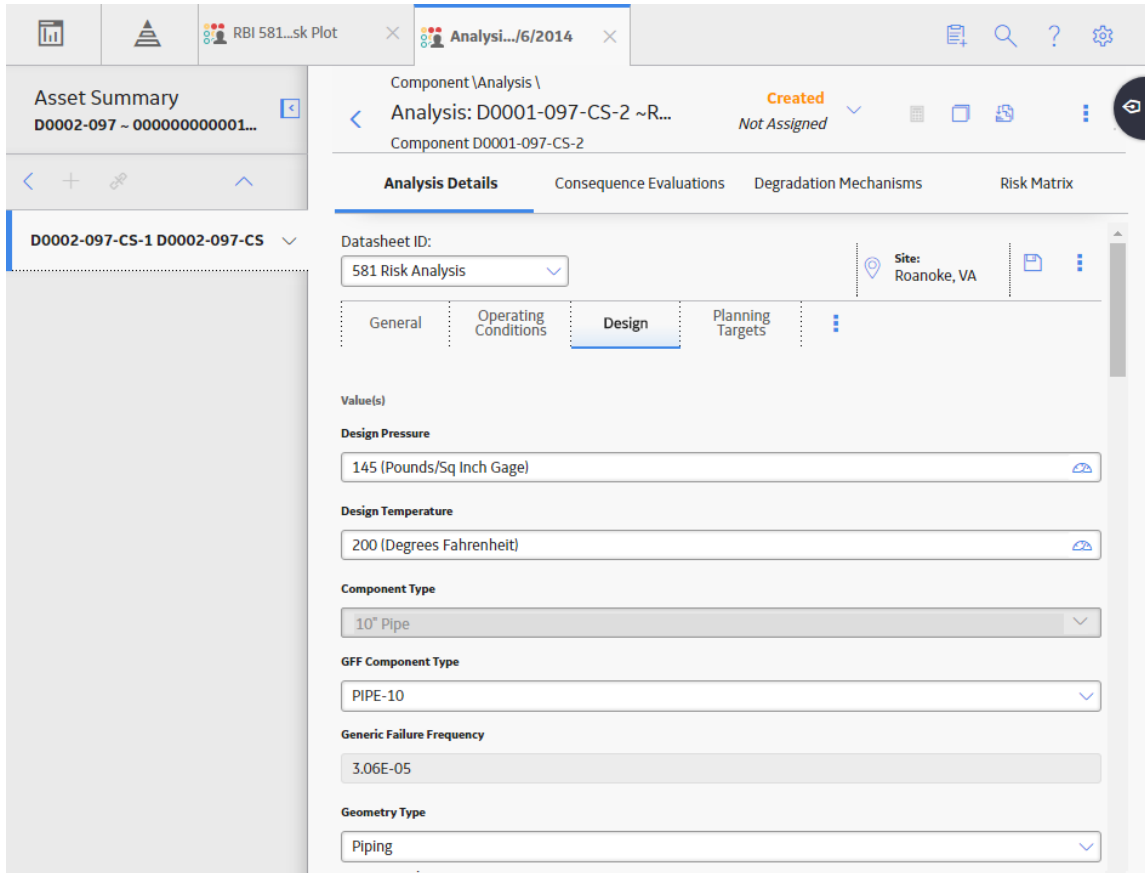

3. Select the **Stress Override** check box.
The Allowable Stress and Flow Stress fields are enabled.
4. Enter a new value in the Flow Stress field, and then, in the section heading, select .
The new Flow Stress value is saved.

Calculate an RBI 581 Risk Analysis

Before You Begin

- Make sure that you have entered values in all the [required fields](#). Otherwise, the calculation fails.
- Make sure that you have selected [valid representative and toxic fluids](#).
- Make sure that a DM is linked to the RBI 581 Risk Analysis. Otherwise, the calculation fails.

About This Task

This topic describes how to calculate a single analysis. In addition to an individual analysis, you can also calculate:

- [All analyses associated with a Process Unit](#).
- [All analyses associated with a single asset or Corrosion Loop](#).
- [All analyses associated with multiple assets](#).

Tip: This procedure also applies to calculating a What-If Analysis.

Procedure

1. [Access the RBI 581 Risk Analysis](#) that you want to calculate.
2. In the upper-right corner of the workspace, select .

Note: The  button is enabled only for [RBI Analyses in the Created state](#).

The **Analysis Calculation** window appears, displaying the calculation progress and a log detailing any errors. If the calculation fails, a list of the required fields appear in an error report at the bottom of the **Analysis Calculation** window.

Analysis Calculation

1 of 1 Analyses Calculated

100%

Asset	Components	Analysis	Calculation Status
	08-GD-M-15-25-505-Z03-PP-1	08-GD-M-15-25-505-Z03-PP-1 ~8" Pipe ~2/24/2012	 Successful

Log for: 08-GD-M-15-25-505-Z03-PP-1 ~8" Pipe ~2/24/2012

```
ANALYSIS_VALIDATION_FAILED_MSG
Analysis : 08-GD-M-15-25-505-Z03-PP-1 ~8" Pipe ~2/24/2012
Component : RBICOMP- ~ ~ QA RBI E2E WKFLW-TB-1851
Asset : ~ ~ QA RBI E2E WKFLW
Calculation Completed Successfully.
```

Close

View Complete Log

3. After the calculation is complete:
 - To view log details, select **View Complete Log**.
 - To close the window, select **Close**.

The RBI 581 Risk Analysis is calculated.

Calculate all RBI 581 Risk Analyses Associated with a Process Unit

Before You Begin

- Ensure that you have entered values in all the [required fields](#). Otherwise, the calculation fails.
- Ensure that you have selected [valid representative and toxic fluids](#).

About This Task

This topic describes how to calculate all RBI Analyses associated with a single Process Unit. You can also calculate:

- [A single analysis](#).
- [All analyses associated with a single asset or Corrosion Loop](#).
- [All analyses associated with multiple assets](#).

Procedure

1. Access the [Unit Summary](#) workspace.
2. On the upper-right corner of the page, select .

This begins the calculation of any RBI 580, RBI 581, PRD, or Pipeline analyses associated with the process unit.

The **Analysis Calculation** window appears, displaying the calculation progress and a log detailing any errors. If a calculation fails, a list of the required fields appear in an error report at the bottom of the **Analysis Calculation** window.

Analysis Calculation

17 of 29 Analyses Calculated

100%

Asset	Components	Analysis	Calculation Status
F0014-035 ~ 000000000001020494 ~ VESSEL - KNOCKOUT POT ~ Accumulator/Cylinder ~ SUB FIX ACC	F0014-035- CS-1	F0014-035-CS-1 ~Pressure Vessel ~9/17/2015	✓ Successful
	E0012A- 097-EB-1	E0012A-097-EB-1 ~Heat Exchanger- Bundle ~9/25/2015	⚠ Calculation Failed

Log for: E0012D-097-EB-1 ~Heat Exchanger-Bundle ~9/8/2015

Currently Calculating -

Analysis : E0012D-097-EB-1 ~Heat Exchanger-Bundle ~9/8/2015

Component : E0012D-097-EB-1

Asset : E0012A-097 ~ EXCHANGER - MAIN COLUMN OVERHEAD TRIM CONDENSERS ~ 000000000001056820 ~ Shell and Tube Heat Exchanger ~ FIX HEA SHE

Family: RBI Criticality Analysis

- Field Nominal Thickness is required.

Family: Criticality Int. Corr. Deg. Mech. Eval.

- Field Inspection Confidence is required.
- Field Number of Inspections is required.

[Close](#) [View Complete Log](#)

3. After the calculation is complete:

- To view the log details for all calculated analyses, select **View Complete Log**.
- To view the log details for a single analysis, in the list, select that analysis.
- To close the window, select **Close**.

The RBI 581 Risk Analyses for the selected Process Unit are calculated.

4. Optionally, if you want to view the status of all bulk analyze operations, on the upper-right corner of the **Risk Based Inspection Overview** page, select .

The **Schedule Logs** page appears, displaying a list of all the operations in GE Digital APM that are in progress, along with the percentage of completion. You can also access a list of operations that have been successful or have failed.

Calculate all RBI 581 Risk Analyses Associated with a Single Asset or Corrosion Loop

Before You Begin

- Ensure that you have entered values in all the [required fields](#). Otherwise, the calculation fails.
- Ensure that you have selected [valid representative and toxic fluids](#).

About This Task

This topic describes how to calculate all analyses associated with a single Asset or Corrosion Loop. You can also calculate:

- [A single analysis.](#)
- [All analyses associated with a single Process Unit.](#)
- [All analyses associated with multiple assets.](#)

Procedure

1. [Access the Asset Summary workspace](#) of the Asset that is associated with the analyses you want to calculate.

-or-

[Access the Corrosion Loop](#) that is associated with the analyses that you want to calculate.

2. In the upper-right corner of the section, select .

This begins the calculation of any RBI 580, RBI 581, PRD, or Pipeline analyses associated with the process unit.

The **Analysis Calculation** window appears, displaying the calculation progress and a log detailing any errors. If the calculation fails, a list of the required fields appear in an error report at the bottom of the **Analysis Calculation** window.

Analysis Calculation

17 of 29 Analyses Calculated

100%

Asset	Components	Analysis	Calculation Status
F0014-035 ~ 000000000001020494 ~ VESSEL - KNOCKOUT POT ~ Accumulator/Cylinder ~ SUB FIX ACC	F0014-035-CS-1	F0014-035-CS-1 ~Pressure Vessel ~9/17/2015	✓ Successful
	E0012A-097-EB-1	E0012A-097-EB-1 ~Heat Exchanger-Bundle ~9/25/2015	⚠ Calculation Failed

Log for: E0012D-097-EB-1 ~Heat Exchanger-Bundle ~9/8/2015

Currently Calculating -

Analysis : E0012D-097-EB-1 ~Heat Exchanger-Bundle ~9/8/2015

Component : E0012D-097-EB-1

Asset : E0012A-097 ~ EXCHANGER - MAIN COLUMN OVERHEAD TRIM CONDENSERS ~ 000000000001056820 ~ Shell and Tube Heat Exchanger ~ FIX HEA SHE

Family: RBI Criticality Analysis

- Field Nominal Thickness is required.

Family: Criticality Int. Corr. Deg. Mech. Eval.

- Field Inspection Confidence is required.
- Field Number of Inspections is required.

[Close](#) [View Complete Log](#)

3. After the calculation is complete:

- To view the log details for all calculated analyses, select **View Complete Log**.
- To view the log details for a single analysis, in the list, select that analysis.
- To close the window, select **Close**.

The RBI 581 Risk Analysis is calculated.

4. Optionally, if you want to view the status of all bulk analyze operations, on the upper-right corner of the **Risk Based Inspection Overview** page, select .

The **Schedule Logs** page appears, displaying a list of all the operations in GE Digital APM that are in progress, along with the percentage of completion. You can also access a list of operations that have been successful or have failed.

Tip: For more information on Schedule Logs, refer to the Schedule Logs section of the documentation.

Calculate all RBI 581 Risk Analyses Associated with Multiple Assets

Before You Begin

- Ensure that you have entered values in all the [required fields](#). Otherwise, the calculation fails.
- Ensure that you have selected [valid representative and toxic fluids](#).

About This Task

This topic describes how to calculate all the RBI Analyses associated with multiple assets. You can also calculate:

- [A single analysis](#).
- [All analyses associated with a Process Unit](#).
- [All analyses associated with a single asset or Corrosion Loop](#).

Procedure

1. [Access the Risk Based Inspection Overview page](#) for the Functional Location that contains the assets for which you want to calculate all analyses.
2. If you want to calculate analyses associated with all the assets in the functional location, then proceed to step 5. You cannot, however, calculate all analyses if you have selected Home on the **Asset Hierarchy** page.

-or-

If you want to calculate analyses associated with selected assets, then in the workspace heading, select the **Assets** tab.

The **Assets** section appears.

356 Assets	90 Process Units	40 Pending Reassessment	115 No Recommendations	32 Inspection/TM Updates
----------------------	----------------------------	-----------------------------------	----------------------------------	------------------------------------

<input type="checkbox"/>	EQUIPMENT TECHNICAL NUMBER	ASSET ID
<input type="checkbox"/>		~~ RBI EQU COMP ALL DATA
<input type="checkbox"/>		~~ EQU W PRD COMP TO BE LINKED TO UNIT
<input type="checkbox"/>		~~ QA RBI 581 AST BTM DF CALC METRIC
<input type="checkbox"/>		~~ QA RBI 581 CAUSTIC CRCK DF CALC
<input type="checkbox"/>		~~ QA RBI 581 CONS CALC
<input type="checkbox"/>		~~ QA RBI 581 CONS NFNT CALC
<input type="checkbox"/>		~~ QA RBI 581 EXT THNG CUI DF CALC
<input type="checkbox"/>		~~ QA RBI PIPELINE EQU W METRIC TNG
<input type="checkbox"/>		~~ RBI 580 EQUIP FOR FLEXI DM & ANALYS ROLL UP
<input type="checkbox"/>		~~ 581 ALKLINE CRCK DF CALC
<input type="checkbox"/>		~~ 581 AMINE CRCK DF CALC
<input type="checkbox"/>		~~ 581 AMINE CRCK SUSCEPTBLTY
<input type="checkbox"/>		~~ 581 CAUSTIC CRCK DF CALC

Rows per page: 50 200 500 1 - 100 of 356 Results < 1 2 3 4 >

3. Select the check boxes that correspond to the assets for which you want to calculate all analyses.
4. In the upper-right corner of the section, select

Note: If you have selected Home on the **Asset Hierarchy** page, and have not selected any assets, then the button is disabled.

A message appears, specifying the number of assets that you have selected, and asking you if you want to continue.

5. Select **Yes**.

This begins the calculation of any RBI 580, RBI 581, PRD, or Pipeline analyses associated with the process unit.

The **Analysis Calculation** window appears, displaying a list of analyses that are sent for calculation, the asset and the component that each analysis is associated with, and the status of each calculation. If the calculation fails, a list of the required fields appear in an error report at the bottom of the **Calculate Analysis** window.

Analysis Calculation

17 of 29 Analyses Calculated

100%

Asset	Components	Analysis	Calculation Status
F0014-035 ~ 000000000001020494 ~ VESSEL - KNOCKOUT POT ~ Accumulator/Cylinder ~ SUB FIX ACC	F0014-035-CS-1	F0014-035-CS-1 ~Pressure Vessel ~9/17/2015	✓ Successful
	E0012A-097-EB-1	E0012A-097-EB-1 ~Heat Exchanger-Bundle ~9/25/2015	⚠ Calculation Failed

Log for: E0012D-097-EB-1 ~Heat Exchanger-Bundle ~9/8/2015

Currently Calculating -

Analysis : E0012D-097-EB-1 ~Heat Exchanger-Bundle ~9/8/2015

Component : E0012D-097-EB-1

Asset : E0012A-097 ~ EXCHANGER - MAIN COLUMN OVERHEAD TRIM CONDENSERS ~ 000000000001056820 ~ Shell and Tube Heat Exchanger ~ FIX HEA SHE

Family: RBI Criticality Analysis

- Field Nominal Thickness is required.

Family: Criticality Int. Corr. Deg. Mech. Eval.

- Field Inspection Confidence is required.
- Field Number of Inspections is required.

[Close](#) [View Complete Log](#)

6. After the calculation is complete:

- To view the log details for all calculated analyses, select **View Complete Log**.
- To view the log details for a single analysis, in the list, select that analysis.
- To close the window, select **Close**.

The RBI 581 Risk Analysis is calculated.

7. Optionally, if you want to view the status of all bulk analyze operations, on the upper-right corner of the **Risk Based Inspection Overview** page, select .

The **Schedule Logs** page appears, displaying a list of all the operations in Meridium Enterprise APM that are in progress, along with the percentage of completion. You can also access a list of operations that have been successful or have failed.

Tip: For more information on Schedule Logs, refer to the Schedule Logs section of the documentation.

Generate a Report for an Asset

This topic describes how to generate the RBI 581 Asset Risk Report.

Before You Begin

Configure GE Digital APM to use Reporting Server.

Procedure

1. Access the **Asset Summary** workspace for the asset for which you want to generate the report.
2. Select , and then select RBI 581 Asset Risk Report.
The RBI 581 Asset Risk Report appears.



RBI 581 Asset Risk Report

EQUIPMENT DATA

Equipment ID	QA RBI 581 INSP PLAN SHE	Equipment Technical No	
Description		Functional Location	RBI Equipment

COMPONENT SUMMARY

COMPONENT: RBICOMP- ~ ~ QA RBI 581 INSP PLAN SHE-PP-2007

Component Type	10" Pipe	Date in Service	1/1/2000
Design Code	ASME VIII DIV 1	Material Spec	SA-106
Material Grade	B	PWHT	False
Insulation	No	Process Fluid	C6
Design Pressure	145 Pounds/Sq Inch Gage	Design Temperature	200 Degrees Fahrenheit
Operating Pressure	101 Pounds/Sq Inch Gage	Operating Temperature	121 Degrees Fahrenheit

COMPONENT: RBICOMP- ~ ~ QA RBI 581 INSP PLAN SHE-PP-2337

Component Type	10" Pipe	Date in Service	
Design Code	ASME VIII DIV 1	Material Spec	SA-106
Material Grade	B	PWHT	False
Insulation	No	Process Fluid	C6
Design Pressure	145 Pounds/Sq Inch Gage	Design Temperature	200 Degrees Fahrenheit
Operating Pressure	101 Pounds/Sq Inch Gage	Operating Temperature	121 Degrees Fahrenheit

Duplicate an RBI 581 Risk Analysis

About This Task

When you duplicate an RBI 581 Risk Analysis, you make an exact copy of the original RBI Analysis. The duplicated RBI 581 Risk Analysis is linked to the same RBI Component as the original RBI 581 Risk Analysis. To copy an RBI 581 Risk Analysis, and link it to a different RBI Component, you can [apply an RBI Analysis](#).

Procedure

1. [Access the component](#) that contains the RBI 581 Risk Analysis that you want to duplicate.
2. Below the graph, select the check box next to the RBI 581 Risk Analysis that you want to duplicate, and then select .

The **Select Degradation Mechanisms** window appears.

Select Degradation Mechanisms

581-Acid Sour Water Corrosion

581-Alkaline Carbonate Stress Corrosion Cracking

581-Alkaline Sour Water Corrosion

Copy Recommendations for Degradation Mechanisms

Cancel Done

Only [Degradation Mechanisms \(DMs\)](#) that can be applied to the duplicated analysis appear in the window. By default, the check boxes next to all the Degradation Mechanisms are selected.

3. If you do not want a particular DM to be applied, clear the check box that corresponds to the DM.
4. If you want the Recommendations to be copied, select the **Copy Recommendations for Degradation Mechanisms** check box. You can select this check box only if the **Enable Recommendation To be Generated at Created State** check box in the **Global Preferences** workspace is selected.
5. Select **Done**.

The RBI 581 Risk Analysis is duplicated.

Note:

- Similarly, you can duplicate a What-If Analysis regardless of its state. The duplicated What-If Analysis is a copy of the main RBI Analysis.
- If the Source of Calculated Corrosion rate is set to Asset or Component on the related component and the related TML asset has more than 1000 TMLs where the related TML Corrosion Analysis has not been calculated, you need to calculate the asset in the Thickness Monitoring module before continuing.

Results

- All the DMs that you have selected are copied and linked to the duplicated analysis.
- If you have selected the **Copy Recommendations for Degradation Mechanisms** check box, then Recommendations are also copied.

Apply an RBI 581 Risk Analysis

About This Task

When you apply an RBI 581 Risk Analysis, you make a copy of the original RBI 581 Risk Analysis. The applied RBI 581 Risk Analysis is not automatically linked to the original RBI Component. Instead, the applied RBI 581 Risk Analysis can be linked to any RBI Component of the same type as the source component. To copy an RBI 581 Risk Analysis and link it to the same RBI Component, you can [duplicate an RBI 581 Risk Analysis](#).

Procedure

1. [Access the component](#) that contains the RBI 581 Risk Analysis that you want to apply.
2. Below the graph, select the check box next to the RBI 581 Risk Analysis that you want to apply, and then select .

The **Select RBI Components to Apply Analysis** window appears.

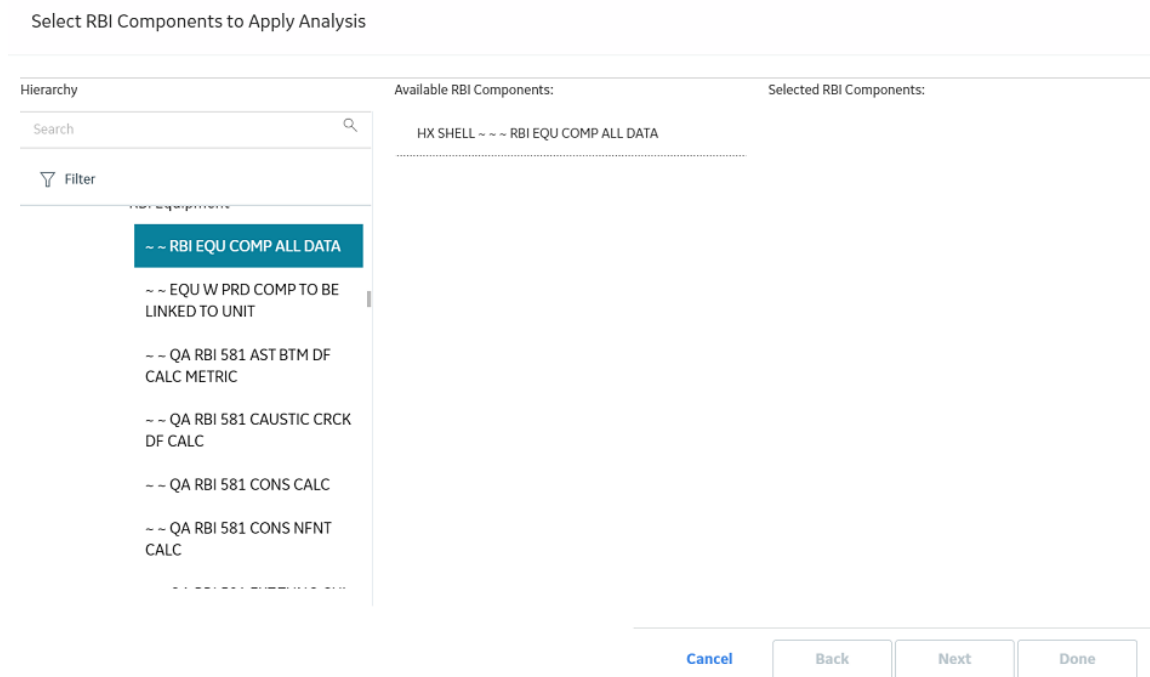

3. In the **Hierarchy** section, navigate to and select the asset that contains the RBI Component to which you want to apply the analysis.

A list of available RBI Components in the selected asset appears in the **Available RBI Components** section.

Select RBI Components to Apply Analysis

Hierarchy

Search

Filter

RBI Equipment

- ~ ~ RBI EQU COMP ALL DATA
- ~ ~ EQU W PRD COMP TO BE LINKED TO UNIT
- ~ ~ QA RBI 581 AST BTM DF CALC METRIC
- ~ ~ QA RBI 581 CAUSTIC CRCK DF CALC
- ~ ~ QA RBI 581 CONS CALC
- ~ ~ QA RBI 581 CONS NFNT CALC

Available RBI Components:

HX SHELL ~ ~ ~ RBI EQU COMP ALL DATA

Selected RBI Components:

Cancel Back Next Done

4. Select the RBI Components to which you want to apply the analysis.

The selected RBI Components appear in the **Selected RBI Components** column.

Select RBI Components to Apply Analysis

Hierarchy

Search

Filter

RBI Equipment

- ~ ~ RBI EQU COMP ALL DATA
- ~ ~ EQU W PRD COMP TO BE LINKED TO UNIT
- ~ ~ QA RBI 581 AST BTM DF CALC METRIC
- ~ ~ QA RBI 581 CAUSTIC CRCK DF CALC
- ~ ~ QA RBI 581 CONS CALC
- ~ ~ QA RBI 581 CONS NFNT CALC

Available RBI Components:

HX SHELL ~ ~ ~ RBI EQU COMP ALL DATA

Selected RBI Components:

X HX SHELL ~ ~ ~ RBI EQU COMP ALL DATA

Cancel Back Next Done

5. Select **Next**.

A list of Degradation Mechanisms (DMs) linked to the analysis appears.

6. In each row containing the DMs that you want to link to the new analysis, ensure that the check box is selected.
7. Select **Done**.

The RBI 581 Risk Analysis is applied.

Note: The values in the Inventory Group and Inventory Group Mass fields are not copied after you apply an analysis.

Finalize Risk of an RBI 581 Risk Analysis

Procedure

1. [Access the analysis](#) whose state you want to modify.
2. Select the button that indicates the current state of the analysis (that is, Created).

A menu appears, displaying a list of operations that you can perform on the analysis to modify its state.

The screenshot shows the 'Analysis Details' tab for 'Analysis: 581-6...'. The state is 'Created' and 'Not Assigned'. A menu is open over the 'Finalize Risk' button, showing options: 'Finalize Risk', 'Manage State', and 'Assignments'. A 'Done' button is also visible. Below the menu, the 'Header Data' section is visible, containing fields for Equipment ID, Analysis ID, Analysis Type, Scenario ID, Component, Data Confidence, RBI Date, Plan Date, Cracking Inspection D..., Date Criticality Calcul..., Component Description, and Component Comments.

Equipment ID	Analysis ID	Analysis Type	Scenario ID
~ ~ QA RBI 581	581-6426281070	RBI 581	Text input
Component	Data Confidence	RBI Date	Plan Date
QA RBI 581 AST I	Low Confidence	07/01/2015 13:13:54	07/01/2025 13:13:54
Cracking Inspection D...	Date Criticality Calcul...	Component Description	
		QA RBI 581 AST BTM DF CALC-TB	
Component Comments			
Verify Thinning AST Bottom Damage Factor calculated based on Age & Furnished Thickness when Time Since Last Inspection			

3. Select **Finalize Risk**, and then select **Done**.

Note: You can modify the state of an analysis to Risk Completed only if you have calculated the analysis.

The state of the RBI 581 Risk Analysis is modified, and an Inspection Plan is created and linked to the parent asset of the analysis.

Note:

- If you want to access the Inspection Plan, select the **Inspection Plan** link.
- When an RBI 581 Risk Analysis is not in the Created state, you cannot modify the analysis and the related Consequence Evaluations, Degradation Mechanisms, and Degradation Mechanism Evaluations through the Risk Based Inspection (RBI) module. You can, however, modify the fields that are not disabled when the record is accessed through Record Manager.

Component \Analysis \
 Analysis: 581-6... Risk Completed Not Assigned

[Inspection Plan](#) (Pr...

Analysis Details | Consequence Evaluations | Degradation Mechanisms | Risk Matrix

Datasheet ID: 581 Risk Analysis Site: Roanoke, VA

Analysis Details | Risk Results | Technical Data

Header Data

Equipment ID ~ ~ QA RBI 581	Analysis ID 581-6426281070	Analysis Type RBI 581	Scenario ID Text input
Component QA RBI 581 AST I	Data Confidence Low Confidence	RBI Date 07/01/2015 13:13:54	Plan Date 07/01/2025 13:13:54
Cracking Inspection D...	Date Criticality Calcul... 08/05/2019 11:00:37	Component Description QA RBI 581 AST BTM DF CALC-TB	

Component Comments
 Verify Thinning AST Bottom Damage Factor calculated based on Age & Furnished Thickness when Time Since Last Inspection

Next Steps

- [Create an RBI Recommendation Manually](#) on page 133.

Finalize Risk of Multiple RBI 581 Risk Analyses

Before You Begin

- Ensure that all the analyses to which you want to assign a new state are assigned to the same state.

About This Task

This topic describes how to finalize risk of the analyses that are linked to multiple assets or Corrosion Loops. You can finalize risk of only the analyses that are calculated and are in the Created state. You cannot finalize risk of multiple analyses that belong to the same component. In such cases, the status of the analyses that belong to the same component are not modified, however, the status of the remaining analyses are updated to Risk Completed.

Procedure

1. Access the [Risk Based Inspection Overview page](#), and then select the **Assets** tab.

or

Access the [Unit Summary workspace](#) of the Process Unit that is linked to the Corrosion Loops.

2. In the **Assets** section, select the check boxes that correspond to the assets that contain the analyses for which you want to finalize risk.

or

Select the check box for each Corrosion Loop containing analyses for which you want to finalize risk.

The  button is enabled.

3. Select .

The **Finalize Risk** window appears, displaying any RBI 580, RBI 581, PRD, or Pipeline analyses that are calculated and are in the Created state.

Finalize Risk

<input type="checkbox"/>	STATE	ANALYSIS ID	EQUIPMENT ID	RBI COMPONENT
<input type="checkbox"/>	Created	RBI-64260432175	~ ~ QA RBI PIPELINE EQU W MET...	RBICOMP- ~ ~ QA RBI PIPELINE EQU
<input type="checkbox"/>	Created	RBI-64253025972	~ ~ Arch Anlys, Rsk Cmpl Anlys, ...	RBICOMP- ~ ~ Arch Anlys, Rsk Cmp
<input type="checkbox"/>	Created	RBI-64253026990	~ ~ Comp Anlyzd Every 5 Yrs	RBICOMP- ~ ~ Comp Anlyzd Every 5
<input type="checkbox"/>	Created	RBI-64253027292	~ ~ Comp Has 10 Anlys	RBICOMP- ~ ~ Comp Has 10 Anlys-
<input type="checkbox"/>	Created	RBI-64253027757	~ ~ COMP W ARCH, RC, and CR ...	RBICOMP- ~ ~ COMP W ARCH, RC, ;
<input type="checkbox"/>	Created	RBI-64253027682	~ ~ COMP W CR ANLYS W RECO...	RBICOMP- ~ ~ COMP W W-IF ANLY:
<input type="checkbox"/>	Created	RBI-64253027682	~ ~ COMP W CR ANLYS W RECO...	RBICOMP- ~ ~ COMP W W-IF ANLY:
<input type="checkbox"/>	Created	RBI-64253027772	~ ~ COMP W CR ANLYS W RECO...	RBICOMP- ~ ~ COMP W W-IF ANLY:
<input type="checkbox"/>	Created	RBI-64253027697	~ ~ COMP W W-IF ANLYS	RBICOMP- ~ ~ COMP W CR ANLYS \
<input type="checkbox"/>	Created	RBI-64253025708	~ ~ Crtd Anlys, Crtd W-ifs	RBICOMP- ~ ~ Crtd Anlys, Crtd W-If
<input type="checkbox"/>	Created	RBI-64253025708	~ ~ Crtd Anlys, Crtd W-ifs	RBICOMP- ~ ~ Crtd Anlys, Crtd W-If
<input type="checkbox"/>	Created	RBI-64253025708	~ ~ Crtd Anlys, Crtd W-ifs	RBICOMP- ~ ~ Crtd Anlys, Crtd W-If
<input type="checkbox"/>	Created	RBI-64253025723	~ ~ Crtd Anlys.No W-If	RBICOMP- ~ ~ Crtd Anlys.No W-If-c

Rows per page 50 200 500 1 - 23 of 23 Results < 1 >

[Close](#) [Finalize Risk](#)

4. Select the check box for each analysis for which you want to finalize risk.

The **Finalize Risk** button is enabled.

5. Select **Finalize Risk**.

The selected analyses are moved to the Risk Completed state.

Note: If an Inspection Plan does not exist for the parent asset of the analyses, an Inspection Plan is created and linked to the asset.

6. Select **Close**.

Next Steps

- [Generate RBI Recommendations for Multiple RBI 581 Risk Analyses](#) on page 135.

Delete an RBI 581 Risk Analysis

Before You Begin

You cannot delete an RBI 581 Risk Analysis if it is Active, has a child analysis, or has Recommendations.

- If an RBI 581 Risk Analysis has a child analysis, delete the child analysis.
- If an RBI 581 Risk Analysis has Recommendations, delete the recommendations.

Procedure

1. [Access the component](#) containing the RBI 581 Risk Analysis that you want to delete.

2. Below the graph, in the row containing the Analysis ID that you want to delete, select the check box, and then select .

A message appears, asking you to confirm that you want to delete the RBI 581 Risk Analysis.

3. Select **Yes**.

The RBI 581 Risk Analysis is deleted.

Chapter 6

RBI Bulk Evergreening 581

Topics:

- [About RBI Bulk Evergreening](#)
- [Access Analyses that are Pending Evergreening](#)
- [Duplicate Analysis for Evergreening](#)
- [Delete Analyses Created for Evergreening](#)
- [Export Evergreened Analyses](#)
- [Calculate Evergreened Analyses](#)
- [Finalize Risk for Evergreened Analyses](#)
- [Access Active Analyses](#)
- [Generate Recommendations for Active Evergreened Analyses](#)

About RBI Bulk Evergreening

RBI Bulk Evergreening is the process of duplicating active analyses in bulk based on the associated process unit or functional location. The evergreened analyses use the latest Risk Completed data available to create more up-to-date analyses for the process unit or functional location.

When to Evergreen

When an analysis is initially created, its record contains details that are observed at the time of the assessment. Evergreening is useful when a functional location or process unit has undergone changes. These changes can include the implementation of risk mitigation strategies or maintenance. Additionally, evergreening is useful after a set amount of time has passed since the previous analysis.

Batches

During the duplication process, you select or create an Evergreening Batch ID to group your evergreened analyses. You can filter analyses based on the batch in the RBI Bulk Evergreening workspace. The Evergreen Batch ID that you select will be copied to the Scenario ID field in the duplicated analysis.

Access Analyses that are Pending Evergreening

About This Task

Analyses that are ready for evergreening or pending reassessment are analyses which are active on components that are linked to assets related to the given functional location or process unit.

Note: The analyses that are ready for evergreening are either 580 or 581 analyses. You can choose which analyses you want to evergreen in the Global Preferences page in Application Settings. Also, RBI PRD Criticality analyses and RBI Pipeline analyses are not supported for evergreening.

Procedure

- Access Analyses that are Pending Evergreening from the **RBI Bulk Evergreening** workspace:
 1. Select the **Actions** button.
 2. Select the **RBI Bulk Evergreening** option.

The **RBI Bulk Evergreening** workspace appears, displaying a list of analyses that are ready for evergreening under the **Pending Evergreening** tab.

Pending Evergreening (All Active Analyses)		Created	Active
<input type="checkbox"/>	ASSET ID	COMPONENT	ANALYSIS ID
<input type="checkbox"/>	RF097-016 ~ ~ QA RBI EVRGREEN EQUIP16	F0065-097-ST-1	RBI-64262536017
<input type="checkbox"/>	RF097-017 ~ ~ QA RBI EVRGREEN EQUIP17	F0065-097-CS-2	RBI-64262533412
<input type="checkbox"/>	RF097-019 ~ ~ QA RBI EVRGREEN EQUIP19	RBICOMP-RF097-019 ~ ~ QA RBI EVRGREEN E...	RBI-64262540158
<input type="checkbox"/>	RF002-028 ~ ~ QA RBI EVRGREEN EQUIP28	F0065-097-EB-1	RBI-64262534427
<input type="checkbox"/>	~ ~ Comp Anlyzd Every 5 Yrs	RBICOMP- ~ ~ Comp Anlyzd Every 5 Yrs-CS-14...	RBI-64253026990
<input type="checkbox"/>	RF097-020 ~ ~ QA RBI EVRGREEN EQUIP20	RBICOMP-RF097-020 ~ ~ QA RBI EVRGREEN E...	RBI-64262536267
<input type="checkbox"/>	~ ~ Comp Has 10 Anlys	RBICOMP- ~ ~ Comp Has 10 Anlys-CS-1449	RBI-64253027292
<input type="checkbox"/>	RF002-026 ~ ~ QA RBI EVRGREEN EQUIP26	F0065-097-ST-2	RBI-64262534327
<input type="checkbox"/>	RF002-027 ~ ~ QA RBI EVRGREEN EQUIP27	F0065-097-CS-3	RBI-64262534381
<input type="checkbox"/>	RF002-029 ~ ~ QA RBI EVRGREEN EQUIP29	F0065-097-ET-2	RBI-64262533201
<input type="checkbox"/>	~ ~ MI EQU W TASKS	RBICOMP- ~ ~ MI EQU W TASKS-CS-1186	RBI-64252712357
<input type="checkbox"/>	~ ~ RBI EQU SOME ANLYS	RBICOMP- ~ ~ RBI EQU SOME ANLYS-CS-1192	RBI-64252728910
<input type="checkbox"/>	~ C-488 LUBE/SEAL OIL COOLER ~ HXST 105	RBIComp-HXST 105-CS-475	RBI-64252337342
	DATE CRITICALITY CALCULATED	RISK CATEGORY	
	5/15/2000 8:00:00 AM	MEDIUM	
	5/15/2004 8:00:00 AM	MEDIUM HIGH	
	5/15/2008 10:20:31 AM	HIGH	
	5/15/2009 8:00:00 AM	MEDIUM	
	5/13/2010 12:00:00 PM	MEDIUM HIGH	
	5/15/2010 11:20:31 AM	HIGH	
	9/25/2010 12:00:00 PM	HIGH	
	5/15/2011 8:00:00 AM	MEDIUM HIGH	
	5/15/2012 8:00:00 AM	HIGH	
	4/15/2013 12:30:00 PM	HIGH	
	9/24/2013 4:32:31 PM	MEDIUM HIGH	
	10/10/2013 3:06:42 PM	MEDIUM HIGH	
	10/11/2013 1:56:02 PM	MEDIUM	

- Access Analyses that are Pending Evergreening from the Risk Based Inspection Overview page:

1. Select the **Pending Reassessment** tab.

The **Pending Reassessment** section appears, displaying a list of analyses that are ready for evergreening. The analyses listed have a Date Criticality Calculated that is five or more years prior to the current date.

Pending Evergreening (All Active Analyses)		Created	Active
<input type="checkbox"/>	ASSET ID	COMPONENT	ANALYSIS ID
<input type="checkbox"/>	D0040-002 - 00000000001000071 ~ VESSEL - CYLINDER STOCK...	D0040-002-CS-1	581-0005026755
<input type="checkbox"/>	D0040-065 - 00000000001034605 ~ VESSEL - MDEA SCRUBBER...	D0040-065-CS-1	581-0005027661
<input type="checkbox"/>	F0003-065 - 00000000001034630 ~ VESSEL - ACID TANK ACCU...	F0003-065-CS-1	581-0005029136
<input type="checkbox"/>	F0005-065 - 00000000001034632 ~ VESSEL - COPPER TEAT, WA...	F0005-065-CS-1	581-0005029188
<input type="checkbox"/>	F0013-065 - 00000000001034641 ~ VESSEL - (OUT OF SERVICE)...	F0013-065-CS-1	581-0005029425
<input type="checkbox"/>	F0025-065 - 00000000001034641 ~ VESSEL - Pressure Vessel ~...	F0025-065-CS-1	581-0005029483
<input type="checkbox"/>	F0004-065 - 00000000001034631 ~ VESSEL - 2-2-F-17 BOTTO...	F0004-065-CS-1	581-0005029551
<input type="checkbox"/>	F0008-065 - 00000000001034633 ~ VESSEL - CAUSTIC KNOCK...	F0008-065-CS-1	581-0005029611
<input type="checkbox"/>	F0021-065 - 00000000001034638 ~ VESSEL - DOCTOR SETTLIN...	F0021-065-CS-1	581-0005029697
<input type="checkbox"/>	F0030-065 - 00000000001034644 ~ VESSEL - Pressure Vessel ~...	F0030-065-CS-1	581-0005029852
<input type="checkbox"/>	F0035-065 - 00000000001034645 ~ VESSEL - NEYTRALIZED CA...	F0035-065-CS-1	581-0005029912
<input type="checkbox"/>	F0030-065 - 00000000001034644 ~ VESSEL - Pressure Vessel ~...	F0030-065-CS-2	581-0005030035
	DATE CRITICALITY ...	SHE RISK CATEGORY - RBI DATE	TOTAL SHE RISK - RBI DATE
	4/17/2016 8:4...		4.88
	4/18/2016 10...		3.43
	6/6/2016 4:31...		1.47
	6/7/2016 5:47...		46.74
	6/7/2016 5:57...		13.67
	6/7/2016 6:11...		3.18
	6/17/2016 3:1...		11.82
	6/17/2016 3:4...		28.62
	6/17/2016 4:0...		153.32
	6/21/2016 5:0...		6.26
	6/21/2016 5:2...		3.02
	6/21/2016 11...		0.11

Rows per page 50 200 500

1 - 16 of 16 Results

- Access Analyses that are Pending Evergreening from a Process Unit:

1. Access the **Risk Based Inspection Overview** page.
2. Select the **Process Units** tab.

The **Process Units** section appears.

Asset: Home

356 Assets	90 Process Units	40 Pending Reassessment	115 No Recommendations	32 Inspection/TM Updates
----------------------	----------------------------	-----------------------------------	----------------------------------	------------------------------------

PROCESS UNIT	DESCRIPTION	CORROSION LOOPS	ASSETS
FLORIDA FIRST SITE	First Plant in Florida	0	0
MRD-ROA-REFN-RF002	#3 CRUDE AND VACUUM	0	0
MRD-ROA-REFN-RF002-EVRGREEN	RBI-EVERGREEN-UNIT2	1	20
MRD-ROA-REFN-RF004	#1 NPT	0	0
MRD-ROA-REFN-RF012	TANK FARM AND TERMINAL - NORTH	0	0
MRD-ROA-REFN-RF016	PROPANE CAVERN	0	0
MRD-ROA-REFN-RF017	TANK FARM AND TERMINAL - SOUTH	0	0
MRD-ROA-REFN-RF022	SULFOLANE	0	0
MRD-ROA-REFN-RF023	AROMATIC DESULFURIZER	0	0
MRD-ROA-REFN-RF024	HOT OIL SYSTEM	0	0
MRD-ROA-REFN-RF026	SOLVENTS PRETREATER	0	0
MRD-ROA-REFN-RF029	CUMENE	0	0
MRD-ROA-REFN-RF031	#2 VACUUM	0	0

Rows per page: 50 200 500 1 - 90 of 90 Results →

3. Select the process unit that you want to evergreen.

4. Select

The RBI Bulk Evergreening workspace appears, displaying a list of analyses that are ready for evergreening. The analyses listed belong to the selected process unit.

RBI Bulk Evergreening
ID: Home

Pending Evergreening (All Active Analyses)		Created	Active
ASSET ID	COMPONENT	ANALYSIS ID	DATE CRITICALITY CALCULATED RISK CATEGORY
<input type="checkbox"/> RF097-016 ~ ~ QA RBI EVRGREEN EQUIP16	F0065-097-ST-1	RBI-64262536017	5/15/2000 8:00:00 AM MEDIUM
<input type="checkbox"/> RF097-017 ~ ~ QA RBI EVRGREEN EQUIP17	F0065-097-CS-2	RBI-64262533412	5/15/2004 8:00:00 AM MEDIUM HIGH
<input type="checkbox"/> RF097-019 ~ ~ QA RBI EVRGREEN EQUIP19	RBICOMP-RF097-019 ~ ~ QA RBI EVRGREEN E...	RBI-64262540158	5/15/2008 10:20:31 AM HIGH
<input type="checkbox"/> RF002-028 ~ ~ QA RBI EVRGREEN EQUIP28	F0065-097-EB-1	RBI-64262534427	5/15/2009 8:00:00 AM MEDIUM
<input type="checkbox"/> ~ ~ Comp Anlyzd Every 5 Yrs	RBICOMP- ~ ~ Comp Anlyzd Every 5 Yrs-CS-14...	RBI-64253026990	5/13/2010 12:00:00 PM MEDIUM HIGH
<input type="checkbox"/> RF097-020 ~ ~ QA RBI EVRGREEN EQUIP20	RBICOMP-RF097-020 ~ ~ QA RBI EVRGREEN E...	RBI-64262536267	5/15/2010 11:20:31 AM HIGH
<input type="checkbox"/> ~ ~ Comp Has 10 Anlys	RBICOMP- ~ ~ Comp Has 10 Anlys-CS-1449	RBI-64253027292	9/25/2010 12:00:00 PM HIGH
<input type="checkbox"/> RF002-026 ~ ~ QA RBI EVRGREEN EQUIP26	F0065-097-ST-2	RBI-64262534327	5/15/2011 8:00:00 AM MEDIUM HIGH
<input type="checkbox"/> RF002-027 ~ ~ QA RBI EVRGREEN EQUIP27	F0065-097-CS-3	RBI-64262534381	5/15/2012 8:00:00 AM HIGH
<input type="checkbox"/> RF002-029 ~ ~ QA RBI EVRGREEN EQUIP29	F0065-097-ET-2	RBI-64262533201	4/15/2013 12:30:00 PM HIGH
<input type="checkbox"/> ~ ~ MI EQU W TASKS	RBICOMP- ~ ~ MI EQU W TASKS-CS-1186	RBI-64252712357	9/24/2013 4:32:31 PM MEDIUM HIGH
<input type="checkbox"/> ~ ~ RBI EQU SOME ANLYS	RBICOMP- ~ ~ RBI EQU SOME ANLYS-CS-1192	RBI-64252728910	10/10/2013 3:06:42 PM MEDIUM HIGH
<input type="checkbox"/> ~ ~ C-488 LUBE/SEAL OIL COOLER ~ HXST 105	RBIComp-HXST 105-CS-475	RBI-64252337342	10/11/2013 1:56:02 PM MEDIUM
<input type="checkbox"/> ~ ~ Rsk Cmpl Anlys, Crted W-lfs	RBICOMP- ~ ~ Rsk Cmpl Anlys, Crted W-lfs-CS-1...	RBI-64253025614	1/15/2014 12:00:00 PM MEDIUM
<input type="checkbox"/> ~ ~ RBI V351 EQU	RBICOMP- ~ ~ RBI V351 EQU-CS-1318	RBI-64252739055	3/12/2014 12:49:30 PM MEDIUM HIGH
<input type="checkbox"/> ~ ~ RBI V351 EQU	RBICOMP- ~ ~ RBI V351 EQU-ET-1324	RBI-64252739195	3/12/2014 2:17:51 PM
<input type="checkbox"/> ~ ~ RBI CORR LOOP3 VIEW ANLYS	RBICOMP- ~ ~ RBI CORR LOOP3 VIEW ANLYS-E...	RBI-64253024922	4/28/2014 10:08:46 AM MEDIUM
<input type="checkbox"/> ~ ~ RBI CORR LOOP3 MNG ANLYS.DM	RBICOMP- ~ ~ RBI CORR LOOP3 MNG ANLYS.D...	RBI-64253025058	4/28/2014 4:09:22 PM MEDIUM

Rows per page: 50 200 500 1 - 100 of 115 Results 2 →

Duplicate Analysis for Evergreening

Procedure

1. Access the **RBI Bulk Evergreening** workspace from a process unit or any workspace
2. In the **Ready for Evergreening** section, select the analyses that you want to duplicate.
3. Select .

The **Duplicate Active Analyses** window appears.

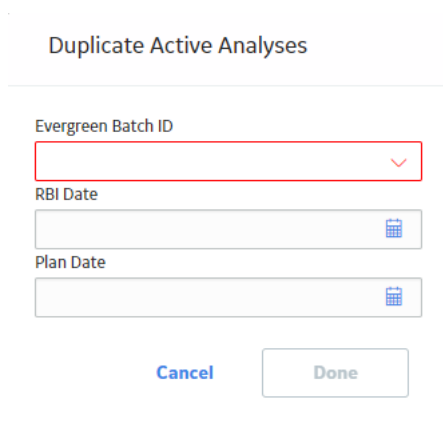

4. In the **Evergreen Batch ID** box:
 - Select an existing Evergreen Batch ID.
 - or-
 - Select **add caption** and enter a new scenario.

Note: The Evergreen Batch ID you select is copied to the Scenario ID field. Also, the batch you select is saved as a user preference in your browser.

5. In the **RBI Date** box, enter a date.
6. In the **Plan Date** box, enter a date.
7. Select **Done**.

Note: If you select an existing Evergreen Batch ID and then select **Done**, a window appears, stating the batch already exists and asking if you want to continue.

The **Created** section appears, displaying a list of analyses that have been created. A progress indicator for the duplication process appears in the **Created** section. If the analyses duplicated successfully, a green check mark appears. If there were errors in the duplication process, a red warning icon appears.

RBI Bulk Evergreening
ID: Home

Evergreen Batch ID: TR

Pending Evergreening (All Active Analyses) **Created (100%)** Active

ASSET ID	COMPONENT	ANALYSIS ID	TOTAL DAMAGE FACTOR - RBI DATE	SHE COF - RBI DATE	TOTAL SHE RISK - RBI DATE
D0040-002 - 000000000001000071 - VESSEL - CYLINDER STO...	D0040-002-CS-1	581-0005362388			
D0040-065 - 000000000001034605 - VESSEL - MDEA SCRUB...	D0040-065-CS-1	581-0005362438			

Rows per page 50 **100** 200 500

1 - 2 of 2 Results

8. Optionally, if you want to view the status of all bulk analyze operations, in the **Risk Based Inspection Overview** page, select . The **Schedule Logs** page appears, displaying a list of all the operations in GE Digital APM that are in progress, along with the percentages of completion. You can also access a list of operations that have been successful or have failed.

Delete Analyses Created for Evergreening

Procedure

1. Access the **RBI Bulk Evergreening** workspace from a process unit or any workspace
2. Select the **Created** tab.

The **Created** section appears.

RBI Bulk Evergreening
ID: Home

Evergreen Batch ID: TR

Pending Evergreening (All Active Analyses) **Created (100%)** Active

ASSET ID	COMPONENT	ANALYSIS ID	TOTAL DAMAGE FACTOR - RBI DATE	SHE COF - RBI DATE	TOTAL SHE RISK - RBI DATE
D0040-002 - 000000000001000071 - VESSEL - CYLINDER STO...	D0040-002-CS-1	581-0005362388			
D0040-065 - 000000000001034605 - VESSEL - MDEA SCRUB...	D0040-065-CS-1	581-0005362438			

Rows per page 50 **100** 200 500

1 - 2 of 2 Results

3. Next to each analysis that you want to delete, select the check box.

Tip: For optimal performance, GE Digital APM recommends deleting 10 or fewer analyses at a time.

4. Select .

A message appears, asking you to confirm that you want to delete one or more selected analyses.

5. Select **Yes**.

The selected analyses are deleted.

Export Evergreened Analyses

About This Task

The RBI Export functionality gives users the ability to export one or more Analyses and its related data from the Evergreening page. The export allows the user to bulk review analyses and its related data and subsequently allows to import it back to GE Digital APM. To facilitate this functionality, the data is exported to a file which is in the RBI 581 Data Loader format to allow for importing and updating the data.

Note: The RBI 581 Data Loader file that is exported will contain relevant Asset, Component, Consequence Evaluation, and Degradation Mechanism Evaluation data related to the Analyses selected for export.

Procedure

1. Access the [RBI Bulk Evergreening workspace from a process unit or any workspace](#).
2. Select the **Created** tab.
The **Created** section appears.

Tip: The analyses that appear in this section are filtered by Evergreen Batch ID. The Evergreen Batch ID that appears by default is the one you selected while creating analyses; the batch that appears is also a default user preference in your browser. You can select a batch using the **Evergreen Batch** box in the **RBI Bulk Evergreening** workspace. To access all analyses, select the blank value in the box.

3. Next to each analysis that you want to export, select the check box.
4. Select .
5. Select **Yes**.

The selected analyses are exported to an excel file which is downloaded to the browser.

Note:

- The RBI 581 Data loader excel worksheets which is exported from the Evergreening page will include all fields present on the respective family's Default datasheet. All fields that are considered calculated, system populated, or informational fields will not be exported.
- Exported excel worksheet field values will take into account the logged in users culture settings and unit of measure conversion set.

Calculate Evergreened Analyses

Procedure

1. Access the [RBI Bulk Evergreening workspace from a process unit or any workspace](#).
2. Select the **Created** tab.

The **Created** section appears.

RBI Bulk Evergreening
ID: Home

Evergreen Batch ID: TR

Pending Evergreening (All Active Analyses) **Created (100%)** Active

ASSETID	COMPONENT	ANALYSIS ID	TOTAL DAMAGE FACTOR - RBI DATE	SHE COF - RBI DATE	TOTAL SHE RISK - RBI DATE
<input type="checkbox"/> D0040-002 - 000000000001000071 - VESSEL - CYLINDER STO...	D0040-002-CS-1	581-0005362388			
<input type="checkbox"/> D0040-065 - 000000000001034605 - VESSEL - MDEA SCRUB...	D0040-065-CS-1	581-0005362438			

Rows per page: 50 **100** 200 500 1 - 2 of 2 Results 1

Tip: The analyses that appear in this section are filtered by Evergreen Batch ID. The Evergreen Batch ID that appears by default is the one you selected while creating analyses; the batch that appears is also a default user preference in your browser. You can select a batch using the **Evergreen Batch** box in the **RBI Bulk Evergreening** workspace. To access all analyses, select the blank value in the box.

- Next to each analysis that you want to calculate, select the check box.
- Select .

The **Analysis Calculation** window appears, displaying the calculation progress and a log detailing any errors.

Analysis Calculation

2 of 2 Analyses Calculated

100%

Asset	Components	Analysis	Calculation Status
RF097-016 ~ ~ QA RBI EVRGREEN EQUIP16	F0065-097-ST-1	RBI-64262572465	✓ Successful
RF097-017 ~ ~ QA RBI EVRGREEN EQUIP17	F0065-097-CS-2	RBI-64262572500	✓ Successful

Log for: RBI-64262572500

Currently Calculating -
Analysis : RBI-64262572500
Component : F0065-097-CS-2
Asset : RF097-017 ~ ~ QA RBI EVRGREEN EQUIP17
Calculation Completed Successfully.

Close

View Complete Log

5. After the calculation is complete:

- To view the log details for all calculated analyses, select **View Complete Log**.
- To view the log details for a single analysis, in the list, select that analysis.
- To close the window, select **Close**.

The evergreened analysis is calculated.

6. Optionally, if you want to view the status of all bulk analyze operations, in the **Risk Based Inspection**

Overview page, select .

The **Schedule Logs** page appears, displaying a list of all the operations in GE Digital APM that are in progress, along with the percentages of completion. You can also access a list of operations that have been successful or have failed.

Finalize Risk for Evergreened Analyses

Before You Begin

You must [calculate risk on an evergreened analysis](#) before finalizing risk.

Procedure

1. Access the **RBI Bulk Evergreening** workspace from a process unit or any workspace

2. Select the **Created** tab.

The **Created** section appears.

RBI Bulk Evergreening
ID: Home

Evergreen Batch ID: TR

Pending Evergreening (All Active Analyses) **Created (100%)** Active

<input type="checkbox"/>	ASSET ID	COMPONENT	ANALYSIS ID	TOTAL DAMAGE FACTOR - RBI DATE	SHE COF - RBI DATE	TOTAL SHE RISK - RBI DATE
<input type="checkbox"/>	D0040-002 - 000000000001000071 - VESSEL - CYLINDER STO...	D0040-002-CS-1	581-0005362388			
<input type="checkbox"/>	D0040-065 - 000000000001034605 - VESSEL - MDEA SCRUB...	D0040-065-CS-1	581-0005362438			

Rows per page: 50 **100** 200 500 1 - 2 of 2 Results 1

Tip: The analyses that appear in this section are filtered by Evergreen Batch ID. The Evergreen Batch ID that appears by default is the one you selected while creating analyses; the batch that appears is also a default user preference in your browser. You can select a batch using the **Evergreen Batch** box in the **RBI Bulk Evergreening** workspace. To access all analyses, select the blank value in the box.

3. Next to each analysis for which you want to finalize risk, select the check box.
4. Select .

A window appears, confirming that you want to finalize risk for the selected analyses.

5. Select **Yes**.
The selected analyses are moved to the Risk Completed state.

Note: If an Inspection Plan does not exist on the parent asset of the analyses, a new Inspection Plan will be created and linked to the asset after the analysis has been successfully moved to the Risk Completed state.

The **Active** section appears, displaying a list of active evergreened analyses for the selected batch.

RBI Bulk Evergreening
ID: Home

Evergreen Batch ID:

Pending Evergreening (All Active Analyses) Created **Active**

<input type="checkbox"/>	ASSET ID	COMPONENT	ANALYSIS ID	RECOMMENDATIONS	SHE RISK CATEGORY - RBI DATE	TARGET INSPECTION DATE	STAT
<input type="checkbox"/>	D0040-002 - 000000000001000071 - VESSEL - CYLINDER ...	D0040-002-CS-1	581-0015636709	0	MEDIUM	8/6/2028 8:00:00 PM	Accr

Rows per page: 50 **100** 200 500 1 - 1 of 1 Results 1

Access Active Analyses

About This Task



Active evergreened analyses are RBI Criticality Analyses for RBI Components linked to RBI Assets. These analyses were created during the bulk evergreening process, and they are not in the Created or Archived state.

Procedure

1. Access the **RBI Bulk Evergreening** workspace from a process unit or any workspace.
2. In the **RBI Bulk Evergreening** workspace, select the **Active** tab.



The **Active** section appears, displaying a list of active evergreen analyses and a count of their associated RBI Recommendations records.

RBI Bulk Evergreening
ID: Home

Evergreen Batch ID:  

Pending Evergreening (All Active Analyses)		Created			Active		
<input type="checkbox"/>	ASSET ID	COMPONENT	ANALYSIS ID	RECOMMENDATIONS	SHE RISK CATEGORY - RBI DATE	TARGET INSPECTION DATE	STAT
<input type="checkbox"/>	D0040-002 - 000000000001000071 - VESSEL - CYLINDER ...	D0040-002-CS-1	581-0015636709	0	MEDIUM	8/6/2028 8:00:00 PM	Acc

Rows per page 50 200 500

1 - 1 of 1 Results  

Tip: The analyses that appear in this section are filtered by Evergreen Batch ID. The Evergreen Batch ID that appears by default is the one you selected while creating analyses; the batch that appears is also a default user preference in your browser. You can select a batch using the **Evergreen Batch** box in the **RBI Bulk Evergreening** workspace. To access all analyses, select the blank value in the box.



Generate Recommendations for Active Evergreened Analyses

Procedure

1. Access the **RBI Bulk Evergreening** workspace from a process unit or any workspace.
2. Select the **Active** tab.



The **Active** section appears.

RBI Bulk Evergreening
ID: Home

Evergreen Batch ID:  

Pending Evergreening (All Active Analyses)		Created		Active			
	ASSET ID	COMPONENT	ANALYSIS ID	RECOMMENDATIONS	SHE RISK CATEGORY - RBI DATE	TARGET INSPECTION DATE	STAT
<input type="checkbox"/>	D0040-002 - 000000000001000071 - VESSEL - CYLINDER ...	D0040-002-CS-1	581-0015636709	0	MEDIUM	8/6/2028 8:00:00 PM	Accr

Rows per page 50 200 500

1 - 1 of 1 Results  

Tip: The analyses that appear in this section are filtered by Evergreen Batch ID. The Evergreen Batch ID that appears by default is the one you selected while creating analyses; the batch that appears is also a default user preference in your browser. You can select a batch using the **Evergreen Batch** box in the **RBI Bulk Evergreening** workspace. To access all analyses, select the blank value in the box.

- Next to each analysis for which you want to generate recommendations, select the check box.

Tip:

- You can generate recommendations for all listed analyses in the selected batch in the **Active** section by selecting  when all check boxes in the first column of the table are cleared. If you select the check box in the first row of the table, recommendations are generated for the analyses that appear in the current page in the **Active** section (up to 100 analyses can be displayed in a page).
- The **Recommendations** column contains a count of recommendations that are directly linked to the analysis. Consolidated recommendations (CREC) are excluded from this count.

- Select .

The **Confirm Bulk Generate Recommendations** window appears, asking if you want to generate recommendations and generate duplicate recommendations if recommendations have already been generated.

- Select **Yes**.

The **Generate Recommendations** window appears, asking if you want to consolidate recommendations for each Degradation Mechanism and Task Type.

Tip: If you choose to consolidate recommendations, the recommendations generated during this process will be consolidated with existing recommendations. For more information on consolidating recommendations, consult recommendation consolidation in RBI 580 and RBI 581.

- Select **Yes**.

The Recommendations are generated. The **Recommendation Generation** window appears, displaying the progress and number of Recommendations generated and consolidated for each asset.

Recommendation Generation

Asset: ~ ~ EQU W 581 ANALYS FOR GRAPH /TABLE
2 new recommendations have been created for Analysis 581-64262922511 .
No recommendations have been consolidated based on Task Type and Damage Mechanism .
Generated Recommendations have been linked to the Inspection Plan.

Asset: ~ ~ QA RBI PIPELINE E2E WKFLW
3 new recommendations have been created for Analysis RBI-64258466767 .
No recommendations have been consolidated based on Task Type and Damage Mechanism .
Generated Recommendations have been linked to the Inspection Plan.

Close

Note: You can close the **Recommendation Generation** window before it is complete. You can view progress using the Schedule Logs.

7. Select **Close**.
8. Optionally, if you want to view the status of all bulk operations, select .
The **Schedule Logs** page appears, displaying a list of all the operations in GE Digital APM that are in progress, along with the percentage of completion. You can also access a list of operations that have been successful or have failed.

Results

Generated recommendations are linked to the Inspection Plan of the related RBI asset.

Note:

- You can use the **Inspection Plan Summary** page to approve the Inspection Plan and implement recommendations.
- If, in the RBI Global Preference settings, the **Enable Recommendation To be Generated at Created State** check box is selected, recommendations will not be linked to the Inspection Plan until the related analysis is moved to the Risk Complete state and the Inspection Plan is generated.

Chapter 7

RBI Analysis Export

Topics:

- [About RBI Analysis Export](#)
- [Access the RBI Analysis Export Workspace](#)
- [Export Analyses](#)

About RBI Analysis Export

RBI Analysis Export workspace allows you to view analyses that can be exported with the related asset and component data. You can export the data in the RBI data loader template format for easy data modification and re-importing.

Note: When exporting the existing analyses and component data in the **RBI Analysis Export** section, the (Picklist) sheet in the RBI data loader template is excluded. To reference the valid values for picklist fields, you can download the RBI data loader template in the **Data Loaders** workspace.

When to Export

- Export is useful when you want to evergreen or re-assess existing analyses based on triggers such as time, process variations, inspection, or thickness updates. These changes can include the implementation of risk mitigation strategies or maintenance based on your inspection plan.
- Export is also useful for providing a quick solution to bulk edit current analyses in the Created state and their related components. After exporting the records which need to be modified, you can update the records in the resulting excel file. After updating, you can re-import using the [RBI Data loader](#) process.

What to Export

The data displayed in the RBI Analysis Export workspace is based on the catalog query `\\Public\Meridium\Modules\Risk Based Inspection\Queries\Data Export Analyses - 581`. By default, this query returns the analyses in the Created state that are linked to RBI Components on Assets, which fall within the selected level of the asset hierarchy. This query has the following parameters:

- **Asset:** The query returns the analyses of the assets that are available after the selected value in the asset hierarchy. By default, this parameter displays the current asset hierarchy context of the RBI Overview page when navigating to the RBI Analysis Export workspace.
- **Analysis State:** The query returns analyses for only those assets which are in the selected state, Created or Active. The default value of this parameter is Created.

The export tool takes the Component Entity Key, Asset Entity Key, and Analysis Entity Key from the selected query results to determine what data to export. The following families are considered on each exported worksheet:

- **Asset:** Equipment and Functional location
- **RBI Component:**
 - Criticality RBI Component – Cylindrical Shell
 - Criticality RBI Component – Exchanger Bundle
 - Criticality RBI Component – Exchanger Header
 - Criticality RBI Component – Exchanger Tube
 - Criticality RBI Component – Piping
 - Criticality RBI Component – Tank Bottom
- **RBI_581_Analysis:** RBI 581 Risk Analysis
- **RBI_581_Consequence:** RBI 581 Consequence Evaluation
- **DME_Lining:** 581-Internal Component Lining Damage Degradation Mechanisms in the RBI 581 Thinning and Lining Evaluation
- **DME_AST:** 581-Atmospheric Tank Bottom Corrosion Degradation Mechanisms in the RBI 581 Thinning and Lining Evaluation family:
 - 581-High Temperature Oxidation

- 581-Cooling Water Corrosion
- 581-High Temperature H₂/H₂S Corrosion
- 581-Amine Corrosion
- 581-Hydrofluoric Acid Corrosion
- 581-Sulfuric Acid Corrosion
- 581-Hydrochloric Acid Corrosion
- 581-Acid Sour Water Corrosion
- 581-High Temperature Sulfidic and Naphthenic Acid
- 581-Alkaline Sour Water Corrosion
- 581-Soil Side Corrosion
- 581-Thinning Damage
- **DME_Thinning:** The following Degradation Mechanisms are available in the RBI 581 Thinning and Lining Evaluation family:
- **DME_ExternalDamage:** RBI 581 External Damage Evaluation
- **DME_ExternalCracking:** RBI 581 External Cracking Damage Evaluation
- **DME_Cracking:** RBI 581 Cracking Damage Evaluation
- **DME_HTHA:** RBI 581 HTHA Fracture Damage Evaluation
- **DME_BrittleFracture:** RBI 581 Brittle Fracture Damage Evaluation

RBI Analysis Export Data

The RBI Analysis Export allows you to bulk review the analyses and related data, and subsequently import it to GE Digital APM. You can export the data in the RBI 581 Data Loader format to enable importing and updating data.

To match the RBI 581 Data Loader format, the following lookup fields are included in each sheet:

- **Asset:** Equipment ID, CMMS System, Equipment Technical Number
- **RBI_Component:** Asset Lookup Fields, Component, Component Type, Component Family
- **RBI_Criticality_Analysis:** Component Lookup Fields, Analysis Unique ID
- **Consequence_Evaluation:** Analysis Lookup Fields, Consequence
- **All DME Sheets:** Analysis Lookup Fields, Damage Mechanism
- **Degradation_Mechanism:** Analysis Lookup Fields, Damage Mechanism

Following the lookup fields, datasheet fields for each family associated with the template sheet are exported with the following exceptions:

- **System Fields:** You cannot edit these fields. These fields are maintained by GE Digital APM
- **Output Fields:** These fields are calculative. You cannot set these fields. Output fields are fields, which are not copied when an analysis is duplicated.

The default datasheet in the Family Management determines the fields to be exported for each family. If there is no datasheet marked as Default in Family Management for a family, then the fields from the first available datasheet is used.

System Fields Excluded from Export

These fields are usually disabled in the datasheet.

Table 1: Component System Fields

Field ID	Field Caption
MI_CCRBICEB_FLD_VLD_581_SH_S_F	Fluid Valid for 581 Analysis - Shell Side
MI_CCRBICOM_EQUIP_FAMIL_C	Asset Family
MI_CCRBICOM_CALC_INV_N	Calculated Inventory
MI_CCRBICOM_FLD_VLD_581_F	Fluid Valid for 581 Analysis
MI_CCRBICOM_TOX_FLU_VLD_581_F	Toxic Fluid Valid for 581 Analysis
MI_RBICOMPO_COMPO_STATUS_C	Component Status
MI_RBICOMPO_EQUIP_C	Asset
MI_RBICOMPO_EQUIP_TYPE_C	Asset Type
MI_RBICOMPO_FUNCT_LOCAT_C	Functional Location

Table 2: Analysis System Fields

Field ID	Field Caption
MI_581RANAL_DATA_CONFIDENCE_C	Data Confidence
MI_581RANAL_FLD_VLD_581_F	Fluid Valid for 581 Analysis
MI_581RANAL_MTRL_YLD_STRNGTH_N	Material Yield Strength
MI_581RANAL_RELEASE_FLD_PHSE_C	Release Fluid Phase
MI_581RANAL_TOX_FLD_VLD_581_F	Toxic Fluid Valid for 581 Analysis
MI_AN_ANALY_ID_CHR	Analysis ID
MI_AN_ANALY_TYPE_CHR	Analysis Type
MI_CRITANAL_COMP_C	Component
MI_CRITANAL_COMP_TP_C	Component Type
MI_CRITANAL_EQ_ID_C	Asset ID
MI_CRITANAL_EQ_ITEM_TYPE_C	Criticality Item Type
MI_CRITANAL_MAN_FAC_N	Management Factor
MI_CRITANAL_MAN_SCOR_N	Management Score

Table 3: Consequence System Fields

Field ID	Field Caption
MI_RBI_EVNO_OUTAGE_MULTI_N	Equipment Outage Multiplier
MI_RCONEVAL_POP_DENS_N	Population Density

Table 4: Degradation Mechanism Evaluation System Fields

Field ID	Field Caption
MI_581DMCHE_CRN_RTE_FCR_DM_1_N	Corrosion Rate Factor Damage State 1
MI_581DMCHE_CRN_RTE_FCR_DM_2_N	Corrosion Rate Factor Damage State 2
MI_581DMCHE_CRN_RTE_FCR_DM_3_N	Corrosion Rate Factor Damage State 3
MI_581DMCHE_FLOW_STRSS_VRNCE_N	Flow Stress Variance
MI_581DMCHE_PRESSURE_VARINCE_N	Pressure Variance
MI_581DMCHE_THINNING_VARINCE_N	Thinning Variance
MI_581THNL_API_653_MNTE_ADT_N	API 653 Maintenance Adjustment
MI_RBDEMEEV_DEG_MEC_DESC_C	Degradation Mechanism Description
MI_RBDEMEEV_DF_N	DF

RBI Analysis Export Best Practices

- The RBI Analysis Export workspace displays the analyses in the Created state by default. Using the RBI 581 Data Loader template, you can review the data for the analyses and re-import them into GE Digital APM. When you re-import the data, any modifications that are made to the RBI Analyses and RBI Component data in GE Digital APM, are updated. The RBI Analysis, CE, and DME updated are looked up based on the defined lookup fields and the Analysis Unique ID (MI_ANALYSIS_ID).
- To export an active analysis with a state other than Created and re-import it as a new analysis in a Created state, consider the following steps:
 1. Select Active for the Analysis State query parameter to return the active analysis and export.
 2. Update the **MI_ANALYSIS_ID** column on the analysis, consequence evaluation and degradation mechanism evaluation sheets to a unique value before importing the file into GE Digital APM.

This creates a new Analysis with ID matching the value provided in the data loader template.

Note:

- Data will be exported using your login and culture settings.

Important: Only users with the same unit of measure and culture settings can re-import through the Risk Based Inspection (RBI) 581 Data loader.
- You cannot export Custom Damage Mechanism Evaluations (DME). Only baseline DME families can be exported.
- RBI 581 Mechanical Fatigue Damage Evaluation records cannot be exported and are not supported through the Risk Based Inspection (RBI) 581 Dataloader.

Access the RBI Analysis Export Workspace

About This Task

Analyses displayed for export are linked to assets related to the given functional location or process unit.

Note:

- The analyses that are displayed for export are either 580 or 581 analyses. You can choose which analyses should be displayed by default by setting the value of the **RBI Analysis Type Preference** dropdown in the **RBI Global Preferences** page.
- RBI PRD Criticality analyses and RBI Pipeline analyses are not supported for export.

Procedure

1. Access the **Risk Based Inspection Overview** page.
2. Select the **Actions** button.
3. Select **Export Analyses**.

Results

The **RBI Analysis Export** workspace appears, displaying analyses to export. By default, the analyses will be filtered based on the asset hierarchy using the key passed from the Risk Based Inspection Overview and in Created state.

Note:

- You can use the filter to change the default analyses displayed. When you select the filter button, a query prompt will be displayed where you can change the Asset Hierarchy Asset or the Analysis State.
- When both RBI 580 and RBI 581 are licensed, you can override the default preference for the type of analyses displayed for export by setting the value of the **Analysis Type** dropdown in the **RBI Analysis Export** workspace.

Export Analyses

About This Task

The RBI Export functionality allows you to export one or more analyses and its related data from the **RBI Analysis Export** page. The export allows you to bulk review analyses and its related data and subsequently import it back to GE Digital APM. To facilitate this functionality, the data is exported to a file which is in the RBI 581 Data Loader format to allow for importing and updating the data.

Note: The RBI 581 Data Loader file that is exported will contain relevant Asset, Component, Consequence Evaluation, and Degradation Mechanism Evaluation data related to the Analyses selected for export.

Procedure

1. Access the **RBI Analysis Export Workspace** page.
2. Select the check box next to each of the analysis that you want to export.
3. Select .

A message appears, asking you to confirm that you want to export one or more selected analyses.

4. Select **Yes**.

The selected analyses are exported to an excel file which is downloaded to the browser.

Note:

- The RBI 581 Data loader excel worksheets which is exported from the Evergreening page will include all fields present on the respective family's default datasheet. All fields that are considered calculated, system populated, or informational fields will not be exported.
- Exported excel worksheet field values will be updated with the logged in users culture settings and unit of measure conversion set.

- You can click the **Open Data Loaders** button to launch the **APM Data Loaders** workspace and re-import the exported data.

Chapter 8

RBI 581 ISO Risk Plot

Topics:

- [About the RBI 581 ISO Risk Plot](#)
- [Access the Inventory Groups in a Process Unit](#)
- [Access the RBI 581 ISO Risk Plot Page of a Functional Location](#)
- [Access the RBI 581 ISO Risk Plot Page of an Asset](#)
- [Access the RBI 581 ISO Risk Plot Page of a Corrosion Loop](#)
- [Access the RBI 581 ISO Risk Plot Page of a Component](#)
- [Access the RBI 581 ISO Risk Plot Page of an Analysis](#)

About the RBI 581 ISO Risk Plot

The RBI 581 ISO Risk Plot is a graph that plots the SHE risk and financial risk of:

- [A single RBI 581 Risk Analysis.](#)
- All RBI 581 Risk Analyses in a [process unit](#), [asset](#), [corrosion loop](#), or [component](#). In this scenario, the risk data of all the analyses in Risk Completed, Accepted by ASM, Pending Approval, or Approved state are plotted on the graph.

Note: The maximum number of Assets that can be plotted on the RBI 581 ISO Risk plot is 10,000.

By default, the graph for the SHE risk appears. If you want to view the graph for the financial risk, you must select the **Financial Risk** tab.

For SHE risk:

- Consequence of Failure (in square feet) is plotted on the horizontal axis, using a logarithmic scale.
- Probability of Failure (in events per year) is plotted on the vertical axis, using a logarithmic scale.

For financial risk:

- Consequence of Failure (in USD) is plotted on the horizontal axis, using a logarithmic scale.
- Probability of Failure (in events per year) is plotted on the vertical axis, using a logarithmic scale.

Note: The units of measure can vary depending on the UOM Conversion Set that you use. For example, if you use the Metric conversion set, the Consequence of Failure will be measured in square meters instead of square feet.



By default, the risk on the RBI date is plotted. If you want the without plan risk or the with plan risk to be plotted, then on the upper-right corner of the page, in the **Risk Data** box, select the appropriate option.

The background color for various sections in the graph indicate the risk levels as defined by the International Organization for Standardization (ISO).

Background color	Risk Level
Red	High
Orange	Medium High
Yellow	Medium
Green	Low

If you hover over a data point, then the ID of the analysis, the ID of the associated asset, the consequence of failure, probability of failure, and risk data of the analysis appear. If you select the data point, the **Asset Summary** page appears, displaying the analysis datasheet in the **Analysis Details** section.

Note: If you want to specify a different set of values to be plotted on this graph, or modify the ranges for each axis and risk level, then access the **RBI 581 ISO-Risk Plot Preferences** workspace.

Fields Used in Plotting Risk Data

The following fields provides a list of fields that are used to plot risk data on the RBI 581 ISO-Risk Plot.

Family	Fields
RBI 581 Risk Analysis	Total Financial Risk Without Plan
	Total POF Without Plan
	Total SHE Risk Without Plan
	Total Financial Risk With Plan
	Total POF With Plan
	Total SHE Risk With Plan
	Total Financial Risk - RBI Date
	Total POF - RBI Date
	Total SHE Risk - RBI Date
RBI 581 Consequence Evaluation	Final Consequence Area
	Total Financial Consequence

Access the Inventory Groups in a Process Unit

About This Task

You can also [access the inventory group of a component](#).

Procedure

1. Access the **Unit Summary** workspace for the process unit for which you want to access inventory groups.
2. In the upper-right corner of the workspace, select  , and then select **Inventory Group**.

The **RBI 581 Inventory Groups** workspace appears on a new page, displaying a list of inventory groups in the process unit in the left section and the datasheet for the corresponding Functional Location in the details section.

The screenshot shows the 'RBI 581 Inventory Groups' workspace. On the left, a sidebar lists various preferences, with 'RBI 581 Inventory Groups' highlighted. The main content area is divided into two sections. The top section, 'Process Units', shows a list of units, with 'MRD-ROA-REFN-RF002 - RF002 - CRUDE' selected. The bottom section, 'Functional Location Identification', displays a datasheet for the selected unit. The datasheet includes the following fields:

Field	Value(s)	Description
Functional Location	MRD-ROA-REFN-RF002	RF002 - CRUDE
Functional Location Long Desc...	RF002 - CRUDE	
System Status	Text input	
SAP Class	Text input	Text input
Superior Function Location	MRD-ROA-REFN	
Business Area	1026	Meridium Roanoke Refi
Catalog Profile	0004	Unit
Category	0	Organizational
CO Area	9100	Meridium Roanoke Proc

Tip: If you are a member of the RBI Admin Security Group, you can [create an Inventory Group Configuration record](#) in the **RBI 581 Inventory Groups** workspace.

Access the RBI 581 ISO Risk Plot Page of a Functional Location

About This Task

You can also access the **RBI 581 ISO Risk Plot** page for an [asset](#), [corrosion loop](#), [component](#), or [analysis](#).

Note:

The risk data of an analysis is plotted on the ISO risk plot only if the analysis is in one of the following states:

- Risk Completed
- Accepted by ASM

Procedure

1. [Access the Risk Based Inspection Overview](#) page for the functional location for which you want to access the ISO risk plot.
2. In the upper-right corner of the page, select the **Actions** button.

3. Select the **RBI 581 ISO-Risk Plot** option.

The **RBI 581 ISO-Risk Plot** page appears, displaying the SHE Risk.

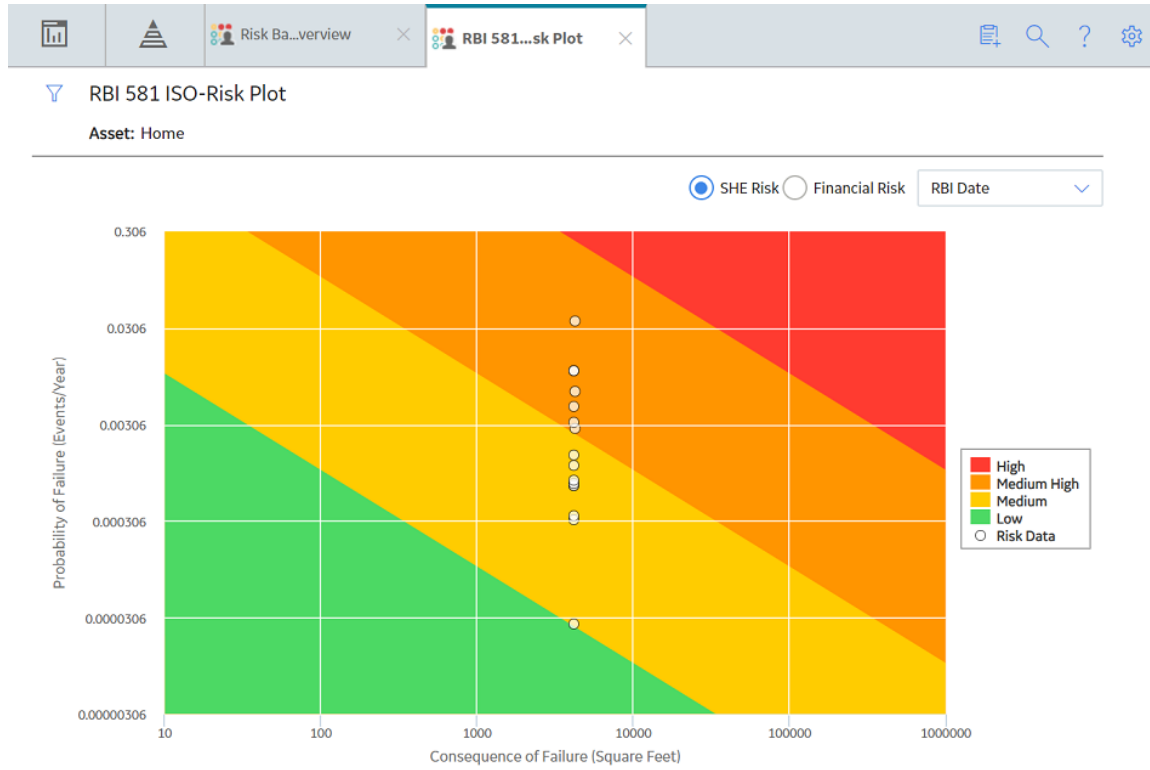

Note: By default, the risk on the RBI date is plotted. If you want the without plan risk or the with plan risk to be plotted, then on the upper-right corner of the page, in the drop-down list box, select the appropriate option.

4. If you want to view the Financial Risk, then select the **Financial Risk** radio button.
5. If you want to access the datasheet of the analysis that corresponds to a data point, then select the data point.
6. If you want to select a different functional location, then:
 - a. On the upper-left corner of the page, select . The **Enter Parameter Values** window appears.

Enter Parameter Values

ENTY_KEY



Cancel

Done

- b. Select the process unit that is already set as the context.
The **Hierarchy** window appears.

Hierarchy

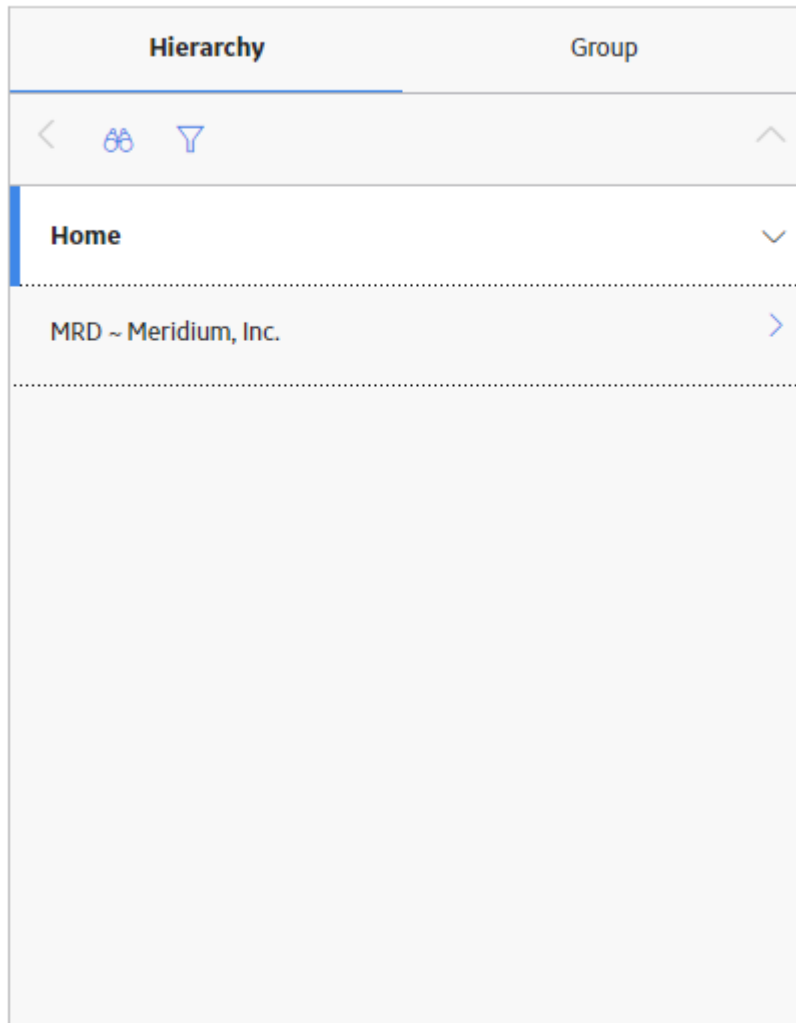

Done

- c. Navigate to the process unit whose ISO risk plot you want to access, and then select **Done**.
The **Hierarchy** window closes.
- d. On the **Enter Parameter Values** window, select **Done**.
The ISO risk plot for the selected functional location appears.

Access the RBI 581 ISO Risk Plot Page of an Asset

About This Task

You can also access the **RBI 581 ISO Risk Plot** page for a [functional location](#), [corrosion loop](#), [component](#), or [analysis](#).

Note:

The risk data of an analysis is plotted on the ISO risk plot only if the analysis is in one of the following states:

- Risk Completed
- Accepted by ASM

Procedure

1. Access the **Asset Summary workspace** of the asset for which you want to access the ISO Risk plot.
2. On the upper-right corner of the page, select , and then select **RBI 581 ISO-Risk Plot**.

The **RBI 581 ISO-Risk Plot** page appears, displaying the SHE Risk.



Note: By default, the risk on the RBI date is plotted. If you want the without plan risk or the with plan risk to be plotted, then on the upper-right corner of the page, in the drop-down list box, select the appropriate option.

3. If you want to view the Financial Risk, then select the **Financial Risk** radio button.
4. If you want to access the datasheet of the analysis that corresponds to a data point, select the data point.

Access the RBI 581 ISO Risk Plot Page of a Corrosion Loop

About This Task

You can also access the **RBI 581 ISO Risk Plot** page for a [functional location](#), [asset](#), [component](#), or [analysis](#).

Note:

The risk data of an analysis is plotted on the ISO risk plot only if the analysis is in one of the following states:

- Risk Completed
- Accepted by ASM

Procedure

1. [Access the Corrosion Loop](#) containing the ISO risk plot that you want to access.
2. On the upper-right corner of the page, select .

The **RBI 581 ISO-Risk Plot** page appears, displaying the SHE Risk.



Note: By default, the risk on the RBI date is plotted. If you want the without plan risk or the with plan risk to be plotted, in the upper-right corner of the page, select the appropriate option in the drop-down list box.

3. To view the Financial Risk, select the **Financial Risk** radio button.
4. To access the datasheet of the analysis that corresponds to a data point, select the data point.

Access the RBI 581 ISO Risk Plot Page of a Component

About This Task

You can also access the **RBI 581 ISO Risk Plot** page for a [functional location](#), [asset](#), [corrosion loop](#), or [analysis](#).

Note:

The risk data of an analysis is plotted on the ISO risk plot only if the analysis is in one of the following states:

- Risk Completed
- Accepted by ASM

Procedure

1. [Access the Component](#) whose ISO risk plot you want to access.
2. On the upper-right corner of the page, select .

The **RBI 581 ISO-Risk Plot** page appears, displaying the SHE Risk.



Note: By default, the risk on the RBI date is plotted. If you want the without plan risk or the with plan risk to be plotted, then on the upper-right corner of the page, in the drop-down list box, select the appropriate option.

3. If you want to view the Financial Risk, then select the **Financial Risk** radio button.
4. If you want to access the datasheet of the analysis that corresponds to a data point, then select the data point.

Access the RBI 581 ISO Risk Plot Page of an Analysis

About This Task

You can also access the **RBI 581 ISO Risk Plot** page for a [functional location](#), [asset](#), [corrosion loop](#), or [component](#).

Procedure

1. [Access the RBI 581 Risk Analysis](#) whose ISO risk plot you want to access.
2. In the workspace heading, select the **Risk Matrix** tab.

The **Risk Matrix** section appears, displaying the ISO risk plot.

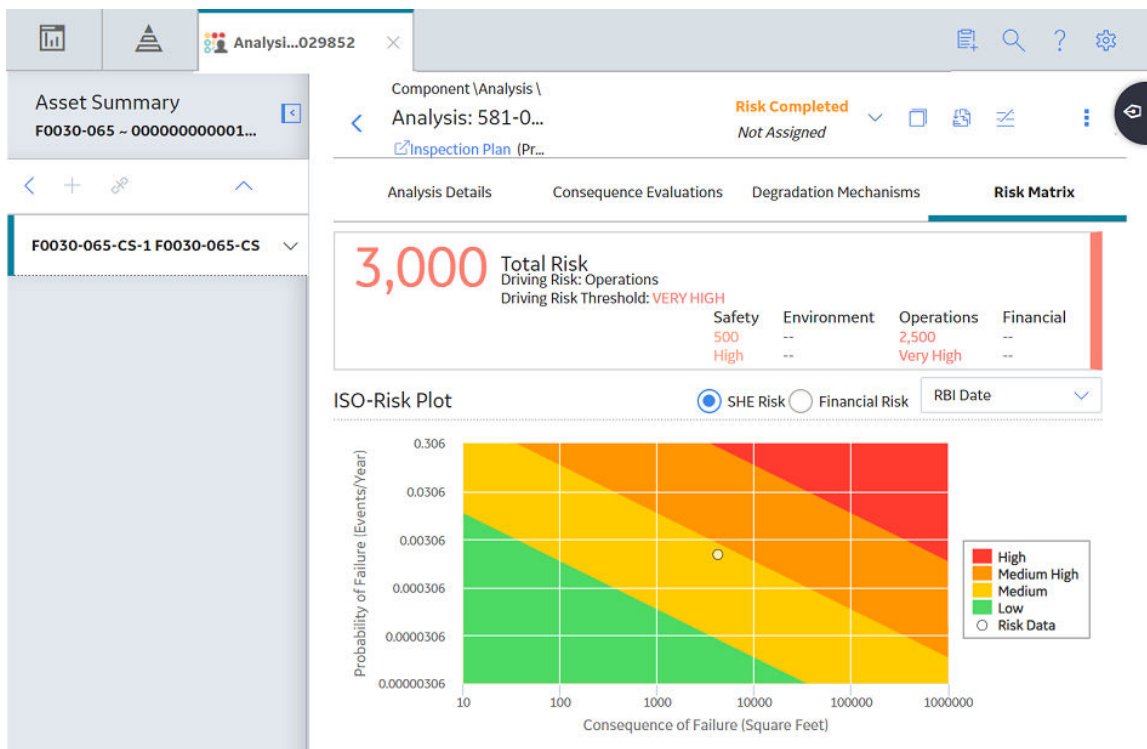

Note: By default, the risk on the RBI date is plotted. If you want the without plan risk or the with plan risk to be plotted, then on the upper-right corner of the page, in the drop-down list box, select the appropriate option.

3. If you want to view the Financial Risk, then select the **Financial Risk** radio button.
4. If you want to view the default risk matrix, then select the Risk Matrix tab that appears above the ISO risk plot.

Note: By default, RBI 581 Risk Analyses are only mapped to the default Risk Matrix. The Standard Practice Risk Matrix is not supported by RBI 581 Risk Analyses.

Chapter 9

Degradation Mechanisms

Topics:

- [About Degradation Mechanisms \(DMs\)](#)
- [About Degradation Mechanism Evaluations \(DMEs\)](#)
- [About Inspection Integration](#)
- [About Related DMEs](#)
- [About Assigning Inspections to a Degradation Mechanism Evaluation \(DME\)](#)
- [About Associating Potential Degradation Mechanisms \(PDMs\)](#)
- [About Inspection History](#)
- [Add Degradation Mechanisms \(DMs\)](#)
- [Evaluate a Degradation Mechanism \(DM\)](#)
- [Assess the Unmitigated Risk of a Degradation Mechanism \(DM\)](#)
- [Access the Inspection History of a Degradation Mechanism \(DM\)](#)
- [Assign Inspections to a Degradation Mechanism Evaluation \(DME\)](#)
- [Link an Inspection Consequence Evaluation to an RBI Degradation Mechanism Evaluation \(DME\)](#)
- [Delete Degradation Mechanisms \(DMs\)](#)

About Degradation Mechanisms (DMs)

A Degradation Mechanism is a defined method that affects failure as explained in an RBI Analysis. When an RBI Analysis is performed, DMs are assigned to capture the failure that should apply to an RBI Analysis to calculate its risk.

Degradation Mechanisms	
The following table provides a list of DMs that can be linked to each component type. This list is not comprehensive.	
Component	Degradation Mechanism
Pump	581-Amine Cracking
	581-Piping Mechanical Fatigue
	581-Brittle Fracture
Vessel	581-High Temperature Oxidation
	581-Caustic Cracking
	581-Chloride Stress Corrosion Cracking
Heat Exchanger	581-Amine Cracking
	581-Caustic Cracking
	581-Austenitic Component Atmospheric Cracking
When you associate degradation mechanisms with a Corrosion Loop, you have two options:	
<ul style="list-style-type: none"> You can link only the DMs that are common across all underlying RBI Components. If you choose this option, you will need to link additional degradation mechanisms with each RBI Component as needed. -or- You can associate all possible DMs for all underlying RBI Components, even if those DMs apply only to one or a few of the components. If you choose this option, you will need to unlink DMs from each component as needed. 	

Unmitigated Risk for RBI Degradation Mechanisms

When you [calculate an RBI 581 Risk Analysis](#), the unmitigated risk and unmitigated financial risk for each DM is calculated automatically and stored in the related RBI Degradation Mechanisms record. If you have created a custom calculator, unmitigated risk will be calculated by your custom calculator and displayed on the following datasheets:

- Risk Matrix
- Degradation Mechanism with Risk Mitigation
- Degradation Mechanism without Risk Mitigation

After the unmitigated risk and unmitigated financial risk are calculated for the DMs, depending on how the administrative settings are configured, you can:

- Accept the calculated unmitigated values.
- or-
- Override the calculated unmitigated values.

About Degradation Mechanism Evaluations (DMEs)

For each Degradation Mechanism (DM) that belongs to an RBI 581 Risk Analysis, a corresponding RBI 581 Damage Mechanism Evaluation record also belongs to that RBI 581 Risk Analysis. In each RBI 581 Damage Mechanism Evaluation that is associated with a qualitative degradation mechanism (i.e., the corresponding RBI Degradation Mechanisms record was created from a Potential Degradation Mechanism with the value Qualitative in the Methodology Type field), you can specify the probability that the corresponding component will fail due to that degradation mechanism.

For example, if an RBI 581 Risk Analysis contains a 581-Amine Cracking DM, it will also contain a corresponding RBI 581 Cracking Damage Evaluation. In this DME, you can specify a value in the Probability Category field to indicate the probability that the RBI Component will fail due to amine cracking.

After you select a value in the Probability Category field and calculate the RBI 581 Risk Analysis, the Probability Category Description field will be populated automatically based on the values in an existing Degradation Mechanisms Evaluation Factors record.

Degradation Mechanisms

Suppose a Degradation Mechanisms Evaluation Factors record contains the following values in the following fields:

- Degradation Mechanism: 581-Amine Cracking
- Ranking: 1
- Ranking Description: 581-Amine Cracking - Impact Resistant Material. Good Inspection History with no evidence of Damage.

If an RBI Analysis is linked to a 581-Amine Cracking Degradation Mechanism, and you select 1 in the Probability Category field, the value in the Probability Category Description field will be populated with the value in the Ranking Description field in the Degradation Mechanisms Evaluation Factors record containing the values 581-Amine Cracking and 1. In this example, the Probability Category Description field would be populated with the value 581-Amine Cracking - Impact Resistant Material. Good Inspection History with no evidence of Damage.

DMs that Belong to each DME

The following table provides a list of DMs that belong to each DME.

Damage Mechanism Evaluation	Degradation Mechanism
RBI 581 Brittle Fracture Damage Evaluation	<ul style="list-style-type: none"> • 581-Brittle Fracture • 581-Low Alloy Steel Embrittlement • 581-Sigma Phase Embrittlement • 581-885F Embrittlement
RBI 581 Cracking Damage Evaluation	<ul style="list-style-type: none"> • 581-Amine Cracking • 581-Alkaline Carbonate Stress Corrosion Cracking • 581-HIC/SOHIC - HF • 581-HIC/SOHIC - H₂S • 581-Caustic Cracking • 581-Hydrogen Stress Cracking • 581-Other Cracking • 581-Sulfide Stress Cracking • 581-Chloride Stress Corrosion Cracking • 581-Polythionic Acid Cracking
RBI 581 External Cracking Damage Evaluation	<ul style="list-style-type: none"> • 581-Austenitic Component Atmospheric Cracking • 581-Austenitic Component Cracking Under Insulation
RBI 581 External Damage Evaluation	<ul style="list-style-type: none"> • 581-Ferritic Component Atmospheric Corrosion • 581-Ferritic Component Corrosion Under Insulation
RBI 581 HTHA Damage Evaluation	<ul style="list-style-type: none"> • 581-High Temperature Hydrogen Attack
RBI 581 Mechanical Fatigue Damage Evaluation	<ul style="list-style-type: none"> • 581-Piping Mechanical Fatigue
RBI 581 Thinning and Lining Evaluation	<ul style="list-style-type: none"> • 581-High Temperature Oxidation • 581-Cooling Water Corrosion • 581-High Temperature H₂/H₂S Corrosion • 581-Amine Corrosion • 581-Hydrofluoric Acid Corrosion • 581-Sulfuric Acid Corrosion • 581-Hydrochloric Acid Corrosion • 581-Acid Sour Water Corrosion • 581-High Temperature Sulfidic and Naphthenic Acid • 581-Alkaline Sour Water Corrosion • 581-Soil Side Corrosion • 581-Thinning Damage • 581-Atmospheric Tank Bottom Corrosion • 581-Internal Component Lining Damage

About Inspection Integration

Integration between the RBI and Inspection Management modules allows you to take credit for inspection history when you calculate the damage factor of a Damage Mechanism (DM). You can, however, take credit for inspection history only for DMs that belong to the following Damage Mechanism Evaluations (DMEs):

In RBI 581:

- RBI 581 Cracking Damage Evaluation
- RBI 581 External Damage Evaluation
- RBI 581 Thinning and Lining Evaluation

In RBI 580:

- Criticality Env. Crack. Deg. Mech. Eval.
- Criticality Ext. Corr. Deg. Mech. Eval.
- Criticality Int. Corr. Deg. Mech. Eval.

To take credit for inspection history, you must:

- Enable the Inspection Auto-Selection feature. If you enable this feature, GE Digital APM automatically assigns Inspections to a DM.
- or-
- Assign Inspections to a DME manually.

To assign Inspections to a DME manually:

1. Create an Inspection in Inspection Management.
2. Specify the DM that you have inspected.
3. [Create an RBI Analysis](#) on the component that you have inspected.
4. [Add the DM](#) that you have selected in step 2.
5. [Access the Inspection History](#) of the DM.

The Inspection that you have created in step 1 appears in the grid only if:

- The date entered in the Date in Service field in the DME is earlier than the date entered in the Inspection Completion Date field in the Inspection.
- The Inspection Confidence field in the Inspection is not blank.

Additionally, if you have created an Inspection for a DM that belongs to the same or a [related](#) DME, it appears in the list as well.

6. [Assign the Inspection to the DME](#). You can assign any inspection that appears in the list.

About Related DMEs

When you assign an Inspection to a DM, you can select Inspections performed on a DM that belong to the same DME or a related DME.

The following table provides a list of DMEs in RBI 580 that are related to DMEs in RBI 581. You cannot modify this mapping.

The following DME in RBI 580...	...is related to the following DME in RBI 581
Criticality Env. Crack. Deg. Mech. Eval.	RBI 581 Cracking Damage Evaluation
Criticality Ext. Corr. Deg. Mech. Eval.	RBI 581 External Damage Evaluation
Criticality Int. Corr. Deg. Mech. Eval.	RBI 581 Thinning and Lining Evaluation

When you select an Inspection on a related DME, the values in the Inspection Confidence and Inspection Effectiveness fields are mapped as follows:

Inspection Confidence	Inspection Effectiveness
Very High	Highly Effective (A)
High	Usually Effective (B)
Medium	Fairly Effective (C)
Low	Poorly Effective (D)

Assigning Inspections that Belong to Same or Related DME

Suppose that you have created four Inspections: Insp 1, Insp 2, Insp 3, and Insp 4. You have linked the Inspections to DMs as specified in the following table.

Inspection	DM
Insp 1	581-Amine Cracking
Insp 2	581-Sulfide Stress Cracking
Insp 3	Amine Cracking (ASCC)
Insp 4	Criticality Calculator Internal Corrosion

You have then created an RBI Analysis, and linked it to 581-Amine Cracking. If you access the inspection history for 581-Amine Cracking, the following Inspections appear:

- Insp 1 : This is because Insp 1 is linked to 581-Amine Cracking.
- Insp 2 : This is because Insp 2 is linked to 581-Sulfide Stress Cracking, which belongs to the same DME as 581-Amine Cracking (i.e., RBI 581 Cracking Damage Evaluation).
- Insp 3 : This is because Insp 3 is linked to Amine Cracking (ASCC), which belongs to a related DME (i.e., Criticality Env. Crack. Deg. Mech. Eval.).

Therefore, you can assign 581-Amine Cracking to Insp 1, Insp 2, and Insp 3. You cannot assign it to Insp 4 because it is linked to Criticality Calculator Internal Corrosion, which belongs to Criticality Int. Corr. Deg. Mech. Eval. And, this DME is not related to RBI 581 Cracking Damage Evaluation.

About Assigning Inspections to a Degradation Mechanism Evaluation (DME)

You can use Inspection Management to record inspection results for a piece of asset. In each Inspection, you can specify the DM for which you were looking during the inspection.

In RBI, you use [RBI Components](#) to divide a piece of asset into parts. You then define DMs for those components, and then conduct analyses for each RBI Component.

Assigning Inspections to DMEs in RBI

If an RBI Component represents parts of a piece of asset that you have inspected in the past, and have recorded results in Inspection records, you can assign those inspections to the appropriate DMEs for that component. By doing so, you identify the inspections that were used to detect DMs for that component.

You can either assign Inspections to a DME manually or enable the Inspection Auto-Selection feature to have GE Digital APM assign Inspections to the DME automatically.

The type of analysis used will determine what happens when you assign an inspection to a DM. For any RBI 580 DME, the listed inspections fall within a specified 20-year window. When you are working with an RBI Analysis, GE Digital APM uses the values in the Inspection Confidence field of the Inspection records to automatically populate the following fields in the RBI 581 Damage Mechanism Evaluation representing that degradation mechanism:

- Inspection Confidence: Indicates how effective the last inspection was at detecting the DM and identifying the rate of degradation.
- Equivalent Number of Inspections: Indicates the number of inspections that will be used when calculating the analysis.

About Associating Potential Degradation Mechanisms (PDMs)

Each RBI Corrosion Loop contains multiple RBI Components. Each of these components can fail in multiple ways. To indicate the ways in which components can fail, you can link Potential Degradation Mechanisms (PDMs) to the RBI Corrosion Loops.

Each PDM that is linked to the RBI Corrosion Loop represents a degradation mechanism (a way in which the components in that Corrosion Loop might fail). Once the RBI Corrosion Loop has been associated with a PDM, all components added to that RBI Corrosion Loop will inherit the PDM.

For each component, you can define the specific ways in which the RBI Component that it represents can fail.

Note: PDMs can be standardized and inherited from RBI Corrosion Loops. When a new RBI Component is generated from and linked to a specific RBI Corrosion Loop, the PDMs associated with that RBI Corrosion Loop will be inherited by the new RBI Component.

Overhead (OVHD) System

Suppose you have created an RBI Corrosion Loop to represent an OVHD system. You may have determined that components in this corrosion loop can fail in the following ways:

- Exchanger Failure: The tubes in the exchanger could foul and cause the exchanger to produce too much or too little cooling.
- Column Failure: The column may be susceptible.

In this case, the RBI Corrosion Loop would be linked to two PDMs to represent each type of degradation mechanism in the preceding list. After the PDMs are linked to the RBI Corrosion Loop as a whole, and you have determined the components in the corrosion loop, you will need to validate the degradation mechanisms for each component.

Assuming that the OVHD system contains the Exchanger and the Column, the RBI Corrosion Loop representing the OVHD system would be linked to the following RBI Component records:

- Column Top (belongs to the Column)
- Outlet Nozzle (belongs to the Column)
- Exchanger Shell (belongs to the Water Heater)

Each of these RBI Components would be linked automatically to all the PDMs that are linked to the Corrosion Loop. You would need to determine, however, which degradation mechanisms make sense for each component. To do so, you might decide

that the RBI Component should be linked to the PDMs as described in the following table.

RBI Component	PDM
Column Top	581-Amine Cracking
Outlet Nozzle	581-Cooling Water Corrosion
Exchanger Shell	581-Amine Cracking

So, while the RBI Corrosion Loop is linked to two PDMs, each RBI Component is linked to only one PDM in this case.

About Inspection History

When you [calculate an RBI 581 Risk Analysis](#), Degradation Mechanism Evaluations (DMEs) are used as an input to calculate the Probability of Failure. A key factor in calculating the Probability of Failure for the analysis is the assessment of previous inspections, which are contained in the Inspection History.

Details

As part of each analysis, you can choose the inspection for each DME. This selection assists in reducing uncertainty posed by the particular Degradation Mechanism (DM) and in determining its rate of deterioration. Each Inspection is quantitatively assessed to determine its effectiveness in achieving this goal.

You can select the Inspections used to populate the following fields on RBI 581 datasheets to drive calculations:

- In the 581 Cracking Damage Evaluation, the 581 AST Bottom, and the RBI 581 External Cracking Damage Evaluation Datasheets
 - Use Combined Confidence
 - Number of Highest Effective Inspections
 - Highest Effective Inspection Level
- In the RBI 581 Thinning and Lining Damage Evaluation Datasheet
 - Use Related Inspections
 - Number of A Level Inspections
 - Number of B Level Inspections
 - Number of C Level Inspections
 - Number of D Level Inspections

Add Degradation Mechanisms (DMs)

About This Task

For each Potential Degradation Mechanism (PDM) linked to the Component, a DM is added to the Analysis. You can, however, add additional DMs to the analysis.

Note: You cannot add a DM if the [state of the analysis](#) is Risk Completed.

Procedure

1. Access the analysis to which you want to add DMs.
2. In the workspace, select the **Degradation Mechanisms** tab.

The **Degradation Mechanisms** section appears, displaying a list of DMs associated with the analysis.

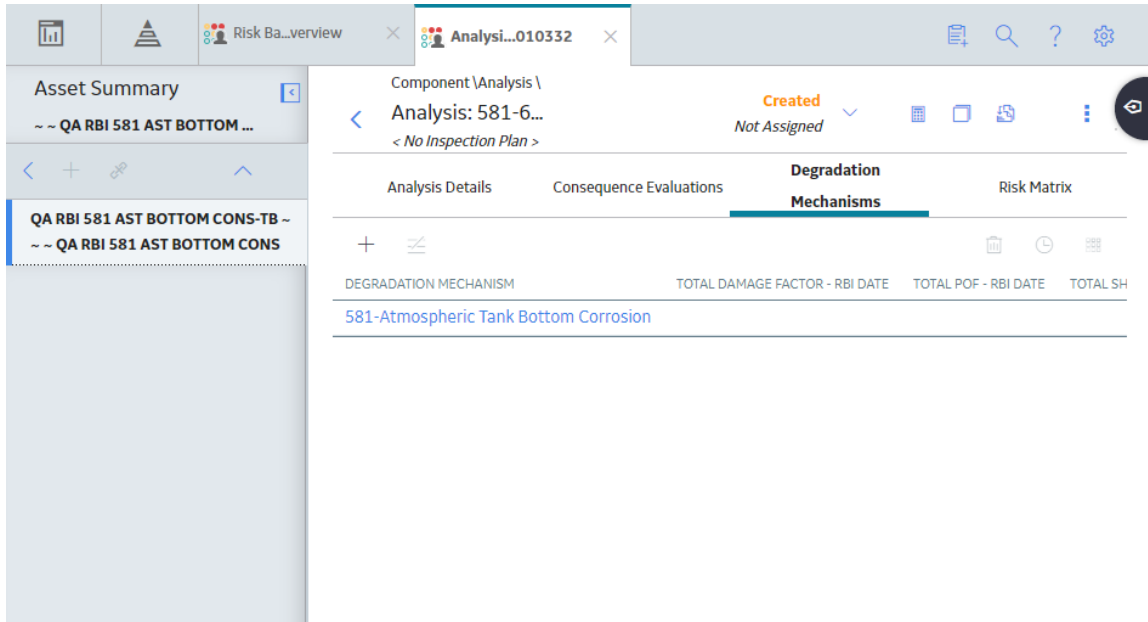

3. In the upper-left corner of the section, select **+**.

A list of the DMs that can be applied to the RBI 581 Risk Analysis appears, displaying the methodology type of each DM.

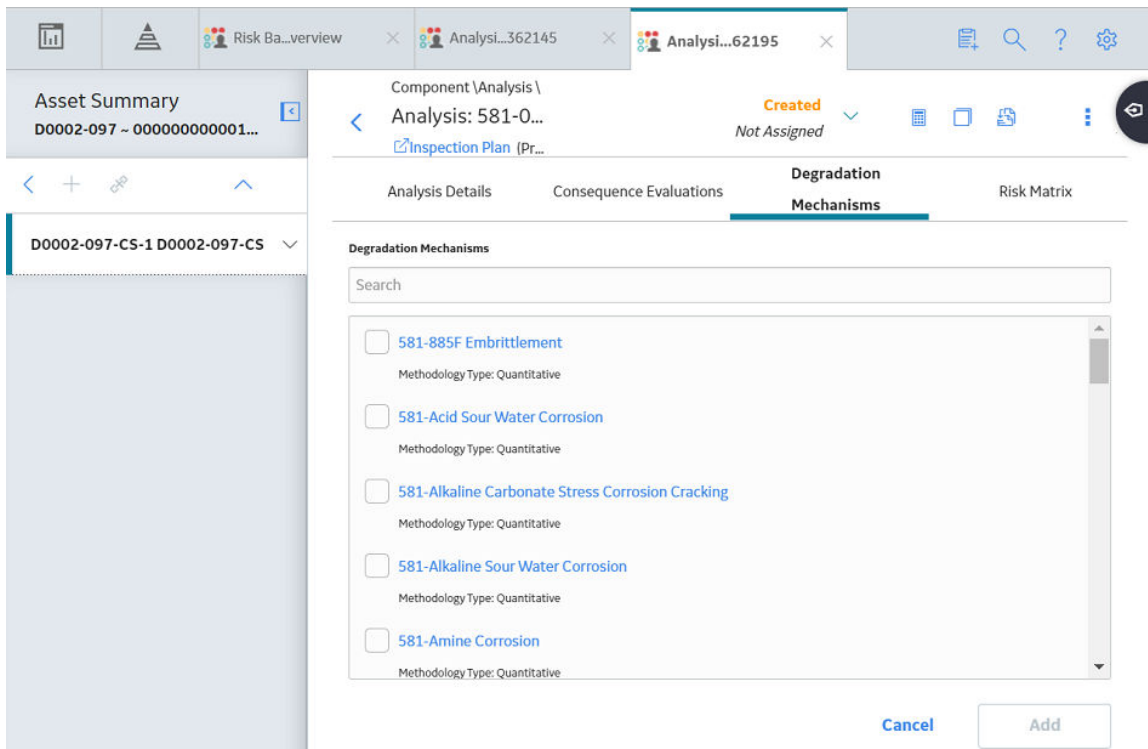

Tip: If you select the link that corresponds to a DM, the associated PDM record appears in Record Explorer on a new page.

Note: DMs that can be added to an RBI 581 Risk Analysis contain a 581 prefix (e.g., 581-Amine Cracking).

4. In the row containing each DM that you want to add, select the check box, and then select **Add**.
The selected DMs are added to the RBI 581 Risk Analysis.

Results

- A Consequence Evaluation is created and linked to the RBI 581 Risk Analysis.

Next Steps

- [Evaluate a Degradation Mechanisms Record \(DM\)](#).

Evaluate a Degradation Mechanism (DM)

Procedure

1. [Access the analysis](#) containing the DM that you want to evaluate.
2. In the workspace heading, select the **Degradation Mechanisms** tab.

The **Degradation Mechanisms** section appears, displaying a list of DMs associated with the analysis.

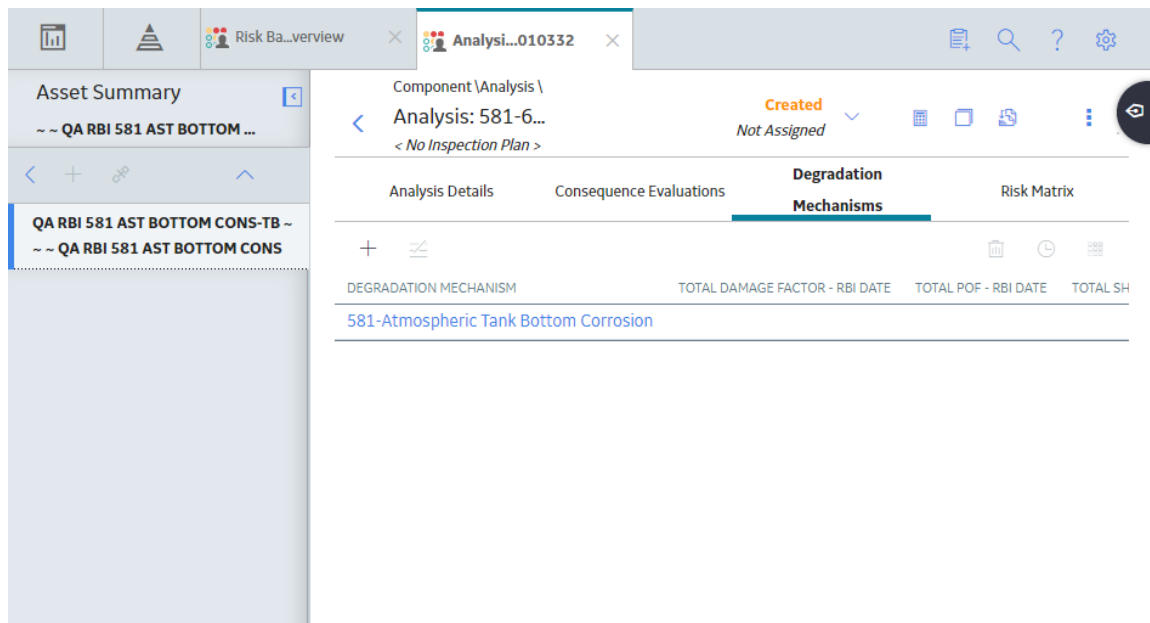

3. In the row containing the DM that you want to modify, select the link.
A blank datasheet of the corresponding Degradation Mechanism Evaluation (DME) appears.

4. Depending on the Degradation Mechanism Evaluation family that the DM belongs to, enter values in the available fields for the following records:
 - [RBI 581 Brittle Fracture Damage Evaluation](#)
 - [RBI 581 Cracking Damage Evaluation](#)
 - [RBI 581 External Cracking Damage Evaluation](#)
 - [RBI 581 External Damage Evaluation](#)
 - [RBI 581 HTHA Damage Evaluation](#)
 - [RBI 581 Mechanical Fatigue Damage Evaluation](#)
 - [RBI 581 Thinning and Lining Evaluation](#)
5. Select .

The DM is evaluated.

Assess the Unmitigated Risk of a Degradation Mechanism (DM)

Before You Begin

- Generate Recommendations for the analysis.
- **Tip:** For information about additional options available when working with the Recommendation records, refer to the Action Management section of the documentation.
- [Change the state of the analysis to Risk Completed.](#)

Procedure

1. [Access the analysis](#) containing the DM for which you want to assess the unmitigated risk.
2. In the workspace heading, select the **Degradation Mechanisms** tab.

The **Degradation Mechanisms** section appears, displaying a list of DMs associated with the analysis.

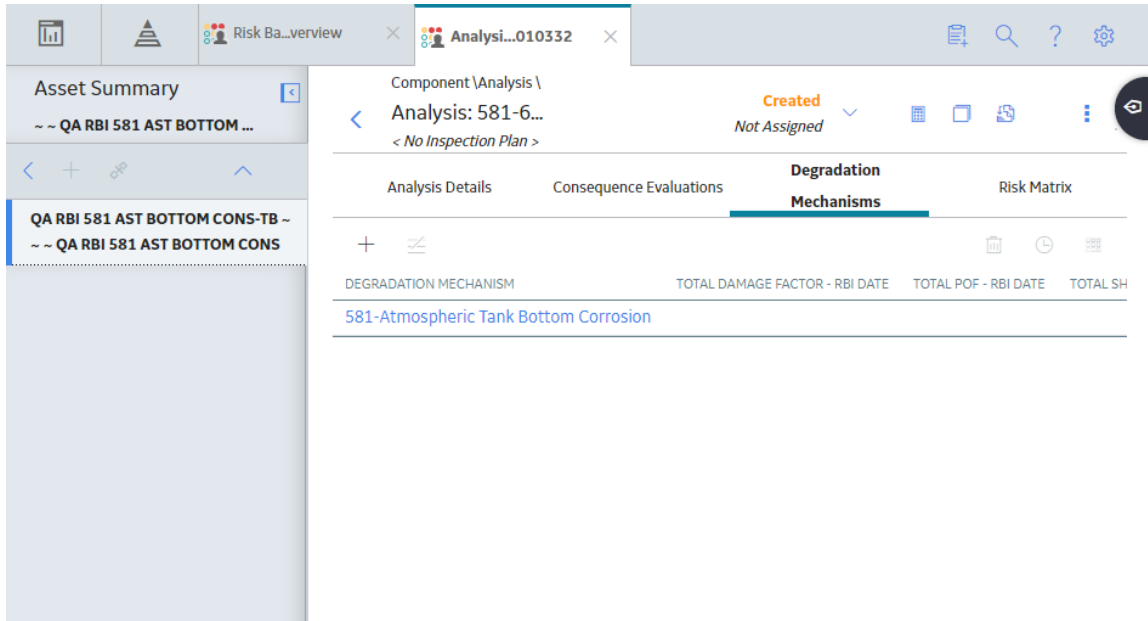

3. Select the row containing the DM that you want to assess, and then in the upper-right corner of the section, select .

The **Risk Matrix** window appears.

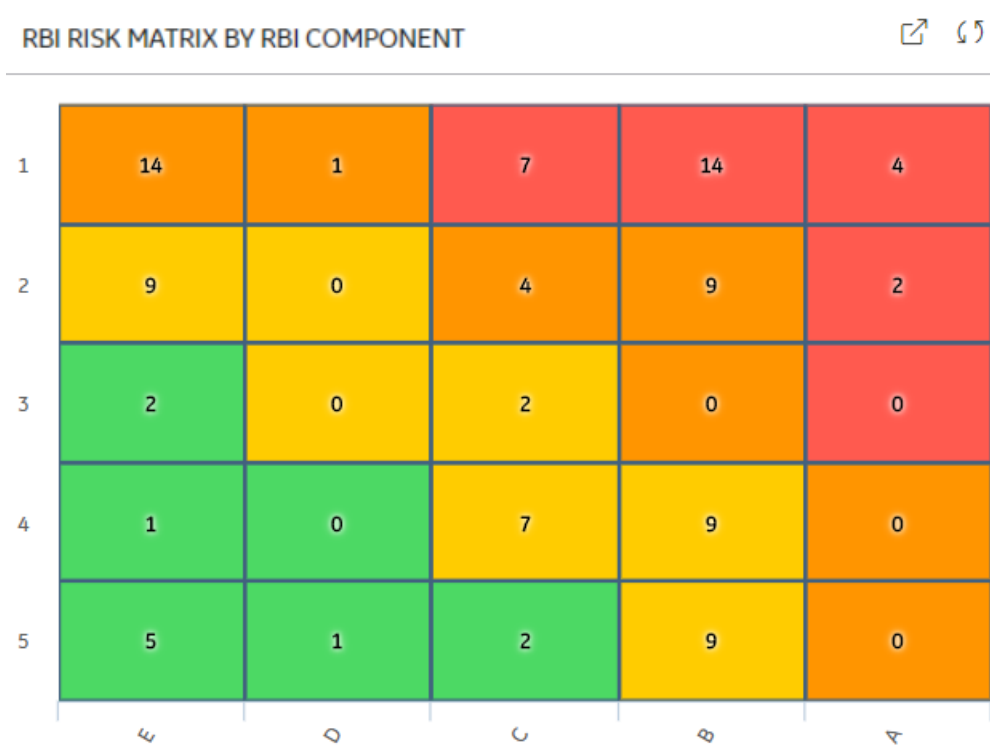

4. Select the cell that represents the risk rank for each category, and then select **Done**. These categories depend on the risk matrix that is defined by your organization. By default, these categories are Safety, Environment, Operations, and Financial.

The unmitigated risk and unmitigated financial risk values for the DM are saved.

Access the Inspection History of a Degradation Mechanism (DM)

Procedure

1. [Access the analysis](#) whose inspection history you want to access.
2. Below the graph, in the row containing the analysis whose Inspection History you want to access, select the link.

The **Analysis Details** section appears, displaying the analysis datasheet.

The screenshot displays the 'Analysis Details' section for analysis ID 581-64262810704. The interface includes a sidebar with 'Asset Summary' and 'QA RBI 581 AST BTM DF CALC METRIC-TB' components. The main area displays 'Analysis Details' with tabs for 'Analysis Details', 'Risk Results', and 'Technical Data'. The 'Analysis Details' tab is active, showing a 'Header Data' section with fields for Equipment ID, Analysis ID, Analysis Type, Scenario ID, Component, Data Confidence, RBI Date, Plan Date, Cracking Inspection Date, Date Criticality Calculated, and Component Description. Below this is a 'Risk Analysis Results' section with fields for Target Inspection Date, Inspection Will Mitigate, Risk Summary ID, and Risk Summary Description. A 'Planning Targets' section is also visible at the bottom.

3. In the workspace, select the **Degradation Mechanisms** tab.

The **Degradation Mechanisms** section appears, displaying a list of DMs associated with the analysis.

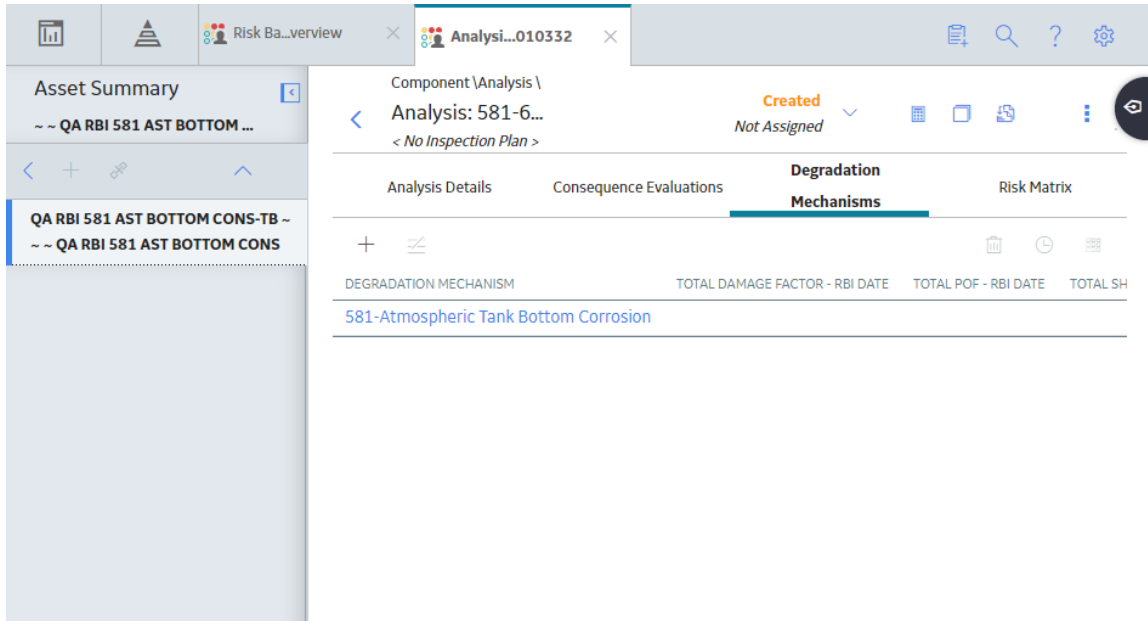

4. Select the row containing the DM whose inspection history you want to view, and then select . The inspection history for the selected DM appears.

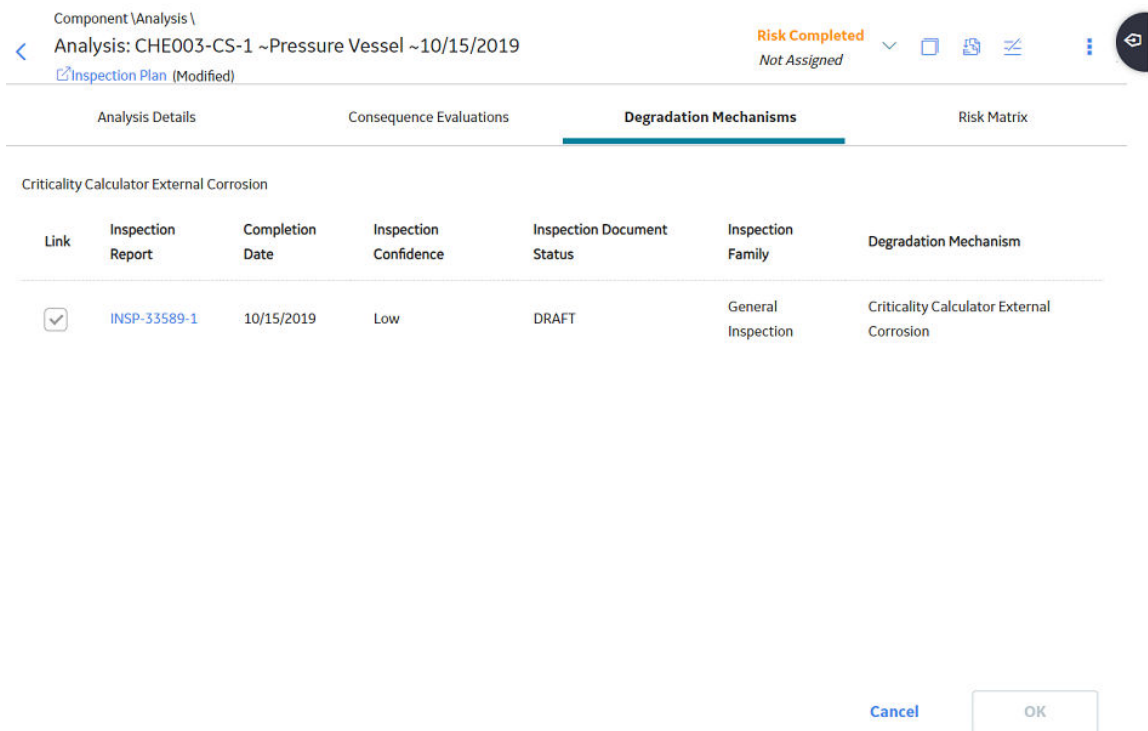

Tip: If you want to access the Inspection in Inspection Management, select the link in the Inspection Report column. The **Inspection Data** section appears, displaying the Inspection datasheet.

Assign Inspections to a Degradation Mechanism Evaluation (DME)

Before You Begin

- For RBI 581 Cracking Damage Evaluation and RBI 581 External Cracking Damage Evaluation, you can assign up to six Inspections.
- For 581-Atmospheric Tank Bottom Corrosion, you can assign only one Inspection.

About This Task

If the Inspection Auto-Selection feature is enabled, then Inspections are automatically assigned to a DME. You can, however, assign Inspections manually to the DME.

Procedure

1. [Access the inspection history](#) for the analysis containing the DME to which you want to assign Inspections.

Note: The listed inspections fall within a specified 20-year window.

2. In the row containing each Inspection that you want to assign, select the check box, and then select **OK**.

The selected Inspections are assigned to the DME.

Component \Analysis \
Analysis: CHE003-CS-1 ~Pressure Vessel ~10/15/2019
Risk Completed
Not Assigned
Inspection Plan (Modified)

Analysis Details Consequence Evaluations **Degradation Mechanisms** Risk Matrix

Criticality Calculator External Corrosion

Link	Inspection Report	Completion Date	Inspection Confidence	Inspection Document Status	Inspection Family	Degradation Mechanism
<input checked="" type="checkbox"/>	INSP-33589-1	10/15/2019	Low	DRAFT	General Inspection	Criticality Calculator External Corrosion

Cancel OK

Tip: To view the Inspection in Inspection Management, select the link in the Inspection Report column.

Link an Inspection Consequence Evaluation to an RBI Degradation Mechanism Evaluation (DME)

About This Task

Important: To link an Inspection Confidence Evaluation to an RBI DME, the Risk Based Inspection or the RBI 581 license must be active.

Procedure

1. Access the analysis containing the RBI DME to which you want to link an Inspection Confidence Evaluation.

Note: To link an Inspection Confidence Evaluation to an RBI DME, the associated RBI Analysis must be in the Active state. Only Active RBI Analyses will display current Inspection Reports in their corresponding Inspection History section.

2. Select the **Degradation Mechanism** tab.

The **Degradation Mechanism** section appears, displaying a list of PDMs linked to the selected RBI Analysis.

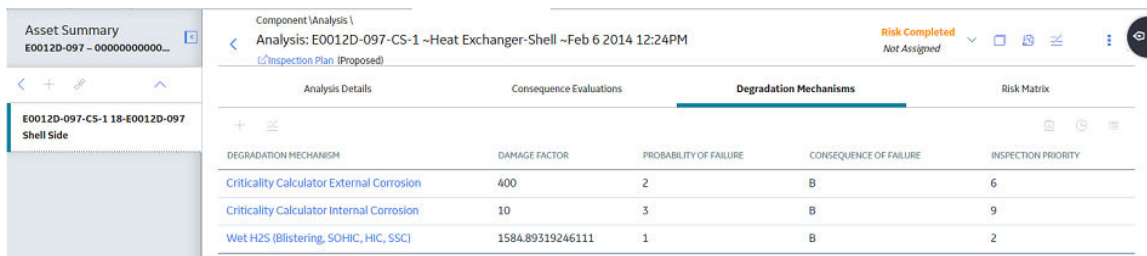

DEGRADATION MECHANISM	DAMAGE FACTOR	PROBABILITY OF FAILURE	CONSEQUENCE OF FAILURE	INSPECTION PRIORITY
Criticality Calculator External Corrosion	400	2	B	6
Criticality Calculator Internal Corrosion	10	3	B	9
Wet H2S (Blistering, SOHC, HIC, SSC)	1584.89319246111	1	B	2

3. In the grid, select the row containing the DME that you want to link to the Inspection Confidence Evaluation, and then select .

Note: The RBI DME that you select must also be the DME in the corresponding Inspection Confidence Evaluation.

A list of corresponding Inspection Reports appears in the grid.

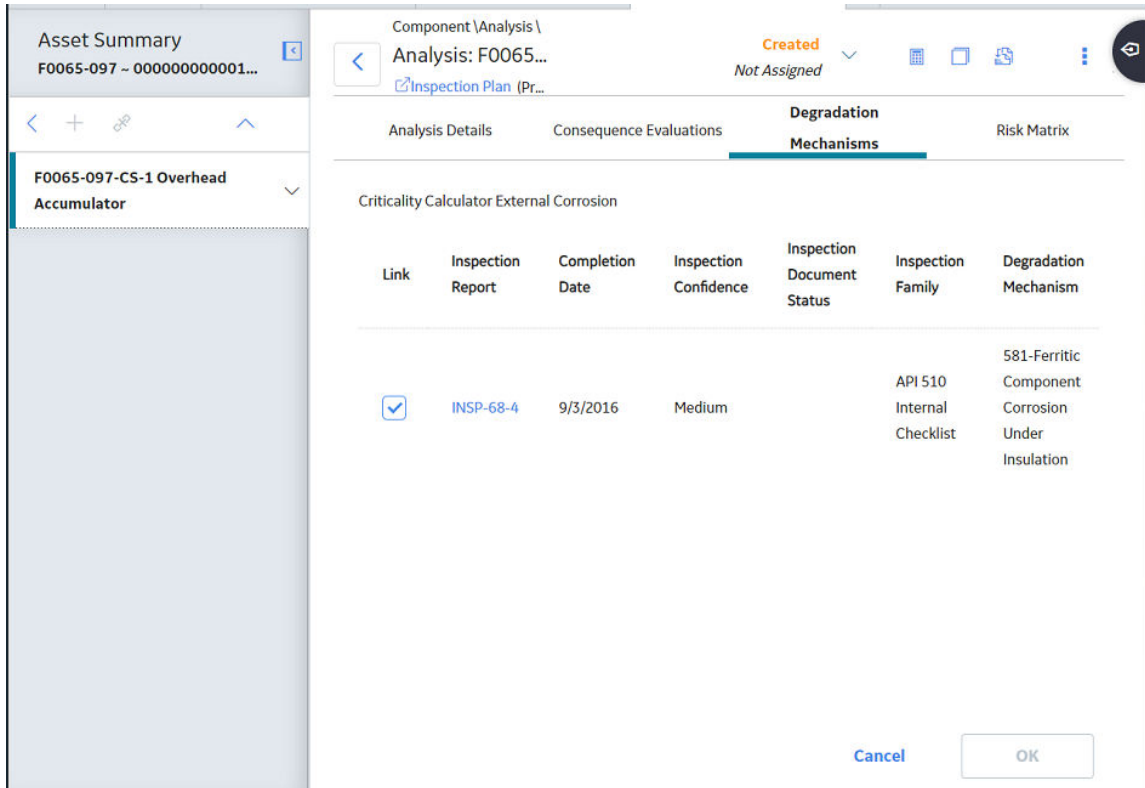

4. Next to the Inspection Report containing the Inspection Confidence Evaluation that you want to link to the RBI DME, select the check box.
5. In the lower-right corner of the section, select **OK**.

The Inspection Confidence Evaluation is linked to the RBI DME.

Delete Degradation Mechanisms (DMs)

Before You Begin

- When you delete a DM, the associated RBI Degradation Mechanism Evaluation (DME) and RBI Consequence Evaluation records are also deleted.
- You cannot delete a DM if the associated analysis is in Risk Completed state.

Procedure

1. [Access the analysis](#) that contains the DMs that you want to delete.
2. In the workspace heading, select the **Degradation Mechanisms** tab.

The **Degradation Mechanisms** section appears, displaying a list of DMs associated with the analysis.

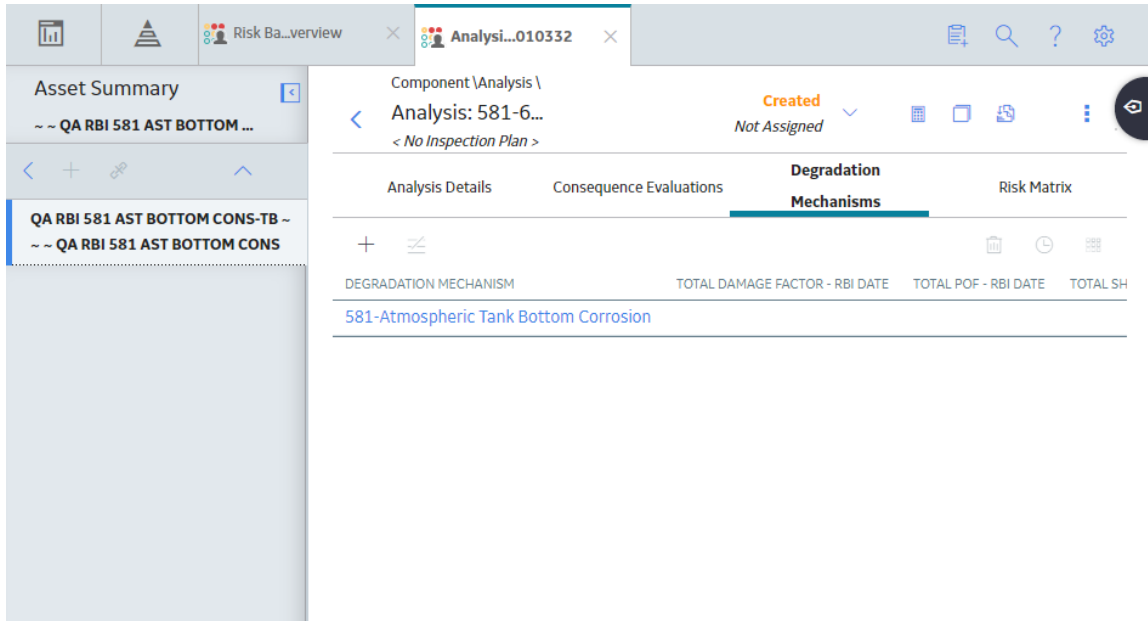

3. Select the row containing the DM that you want to delete, and then, in the upper-right corner of the section, select .

A message appears, asking you to confirm that you want to delete the selected DM.

4. Select **Yes**.

The DMs, along with the associated DMEs and RBI Consequence Evaluations, are deleted.

Chapter 10

RBI Recommendations

Topics:

- [About RBI Recommendations](#)
- [Access the Recommended Actions Pane](#)
- [View RBI Recommendations Linked to an Inspection Plan](#)
- [About Auto-Consolidating RBI Recommendations](#)
- [Create an RBI Recommendation Manually](#)
- [Generate Recommendations for a Single RBI Criticality Analysis](#)
- [Generate RBI Recommendations for Multiple RBI 581 Risk Analyses](#)
- [Generate Recommendations for all Analyses in an Asset Hierarchy Level](#)

About RBI Recommendations

An RBI Recommendation stores information about actions that should be performed to help mitigate the risk associated with a degradation mechanism (DM). Each RBI Recommendation is linked to:

- A Degradation Mechanisms record, which defines the type of failure that the recommended action can help mitigate.
- An Asset record, which defines the piece of asset to which the recommendation applies.
- An Inspection Plan, which is linked to the associated asset.
- An RBI 581 Risk Analysis record.

Generating Recommendations

GE Digital APM generates RBI Recommendations for:

- A single DM
- [Multiple RBI 581 Risk Analyses linked to a single Asset](#)

You can generate Recommendations based on the policies that are mapped to the RBI Strategy Mapping Configuration only if:

- The Damage Mechanism has a value in the field Recommended Inspection Effectiveness.
- The state of the analysis is Risk Completed.

Recommendations are generated for DMs that are related only to the following DMEs:

- RBI 581 Cracking Damage Evaluation
- RBI 581 External Cracking Damage Evaluation
- RBI 581 External Damage Evaluation
- RBI 581 Thinning and Lining Evaluation

Recommendations that are linked to approved Inspection Plans can be implemented as Inspection Tasks directly or from Asset Strategy Management (ASM) through the Action created during the Inspection Plan approval.

Policies Used to Generate RBI Recommendations

The following table provides a list of Policies that are used to generate RBI Recommendations.

Policy Name	Policy Input Node Name (Field)	Component Type	Valid DMs
RBI 581 Tank Shell Ext Corrosion Recommendation	Component Type (Field: Component Type, Family: RBI 581 Analysis)	Storage Tank	<ul style="list-style-type: none"> 581-Ferritic Component Atmospheric Corrosion 581-Ferritic Component Corrosion Under Insulation
	Inspection Will Mitigate (Field: Inspection Will Mitigate, Family: RBI 581 Risk Analysis). Note: This field is deprecated and no longer used.		
	Insulation Present (Field: Insulated, Family: RBI 581 Risk Analysis)		
	Target Inspection (Field: Recommended Inspection Effectiveness, Family: RBI Degradation Mechanisms)		
	Damage Mechanisms (Field: Degradation Mechanism, Family: RBI Degradation Mechanisms)		
RBI 581 Tank Shell Int Corrosion Recommendation	Component Type (Field: Component Type, Family: RBI 581 Risk Analysis)	Storage Tank	<ul style="list-style-type: none"> 581-Hydrochloric Acid Corrosion 581-High Temperature H2/H2S Corrosion 581-High Temperature Sulfidic and Naphthenic Acid 581-Sulfuric Acid Corrosion 581-Hydrofluoric Acid Corrosion 581-Alkaline Sour Water Corrosion 581-Amine Corrosion 581-High Temperature Oxidation 581-Acid Sour Water Corrosion 581-Cooling Water Corrosion 581-Soil Side Corrosion 581-Internal Component Lining Damage
	Target Inspection (Field: Recommended Inspection Effectiveness, Family: RBI Degradation Mechanisms)		
	Inspection Will Mitigate (Field: Inspection Will Mitigate, Family: RBI 581 Risk Analysis) Note: This field is deprecated and no longer used.		

Policy Name	Policy Input Node Name (Field)	Component Type	Valid DMs
RBI 581 Tank Bottom Insp Recommendation	Component Type (Field: Component Type, Family: RBI 581 Risk Analysis)	Storage Tank Bottom	<ul style="list-style-type: none"> 581-Atmospheric Tank Bottom Corrosion 581-Caustic Cracking 581-Amine Cracking 581-Sulfide Stress Cracking 581-Alkaline Carbonate Stress Corrosion Cracking 581-Hydrogen Stress Cracking 581-Polythionic Acid Cracking 581-Chloride Stress Corrosion Cracking 581-HIC/SOHIC - H2S 581-HIC/SOHIC - HF
	Target Inspection (Field: Recommended Inspection Effectiveness, Family: RBI Degradation Mechanisms)		
	Inspection Will Mitigate (Field: Inspection Will Mitigate, Family: RBI 581 Risk Analysis) Note: This field is deprecated and no longer used.		
RBI 581 Thinning and Lining Insp Recommendation	Component Type (Field: Component Type, Family: RBI 581 Analysis)	All component types except the following: <ul style="list-style-type: none"> Storage Tank Storage Tank Bottom Pilot-Operated PRD PRD with Rupture Disk Balanced Bellows PRD Rupture Disk Only Heat Exchanger-Tubes Heat Exchange -Bundle Heat Exchanger-Channel 	<ul style="list-style-type: none"> 581-Hydrochloric Acid Corrosion 581-High Temperature H2/H2S Corrosion 581-High Temperature Sulfidic and Naphthenic Acid 581-Sulfuric Acid Corrosion 581-Hydrofluoric Acid Corrosion 581-Alkaline Sour Water Corrosion 581-Amine Corrosion 581-High Temperature Oxidation 581-Acid Sour Water Corrosion 581-Cooling Water Corrosion 581-Soil Side Corrosion 581-Internal Component Lining Damage
	Is Intrusive (Field: Is Intrusive?, Family: RBI 581 Risk Analysis)		
	Inspection Will Mitigate (Field: Inspection Will Mitigate, Family: RBI 581 Risk Analysis) Note: This field is deprecated and no longer used.		
	Target Inspection (Field: Recommended Inspection Effectiveness, Family: RBI Degradation Mechanisms)		
	Liner Present (Field: Liner is Present, Family: RBI 581 Thinning and Lining Evaluation)		
	Thinning Type (Field: Thinning Type, Family: RBI 581 Thinning and Lining Evaluation)		

Policy Name	Policy Input Node Name (Field)	Component Type	Valid DMs
RBI 581 External Damage Inspection Recommendation	Damage Mechanism (Field: Degradation Mechanism, Family: RBI Degradation Mechanisms)	All component types except the following: <ul style="list-style-type: none"> Storage Tank Storage Tank Bottom Pilot-Operated PRD PRD with Rupture Disk Balanced Bellows PRD Rupture Disk Only Heat Exchanger-Tubes Heat Exchange -Bundle Heat Exchanger-Channel 	<ul style="list-style-type: none"> 581-Ferritic Component Atmospheric Corrosion 581-Ferritic Component Corrosion Under Insulation 581-Austenitic Component Atmospheric Cracking 581-Austenitic Component Cracking Under Insulation
	Target Inspection (Field: Recommended Inspection Effectiveness, Family: RBI Degradation Mechanisms)		
	Component Type (Field: Component Type, Family: RBI 581 Analysis)		
	Insulation Present (Field: Insulated, Family: RBI 581 Risk Analysis) Note: This field is deprecated and no longer used.		
	Inspection Will Mitigate (Field: Inspection Will Mitigate, Family: RBI 581 Risk Analysis) Note: This field is deprecated and no longer used.		
RBI 581 Env Cracking Insp Recommendation	Target Inspection (Field: Recommended Inspection Effectiveness, Family: RBI Degradation Mechanisms)	All component types except the following: <ul style="list-style-type: none"> Storage Tank Storage Tank Bottom Pilot-Operated PRD PRD with Rupture Disk Balanced Bellows PRD Rupture Disk Only Heat Exchanger-Tubes Heat Exchange -Bundle Heat Exchanger-Channel 	<ul style="list-style-type: none"> 581-Caustic Cracking 581-Amine Cracking 581-Sulfide Stress Cracking 581-Alkaline Carbonate Stress Corrosion Cracking 581-Hydrogen Stress Cracking 581-Polythionic Acid Cracking 581-Chloride Stress Corrosion Cracking 581-HIC/SOHIC - H2S 581-HIC/SOHIC - HF
	Damage Mechanism (Field: Degradation Mechanism, Family: RBI Degradation Mechanisms)		
	Component Type (Field: Component Type, Family: RBI 581 Analysis)		
	Is Intrusive (Field: Is Intrusive?, Family: RBI 581 Risk Analysis)		
	Inspection Will Mitigate (Field: Inspection Will Mitigate, Family: RBI 581 Risk Analysis) Note: This field is deprecated and no longer used.		

Access the Recommended Actions Pane

Procedure

1. [Access an RBI 581 Risk Analysis](#).

2. In the workspace, select 

The **Recommended Actions** pane appears, displaying any recommendations associated with the analysis.

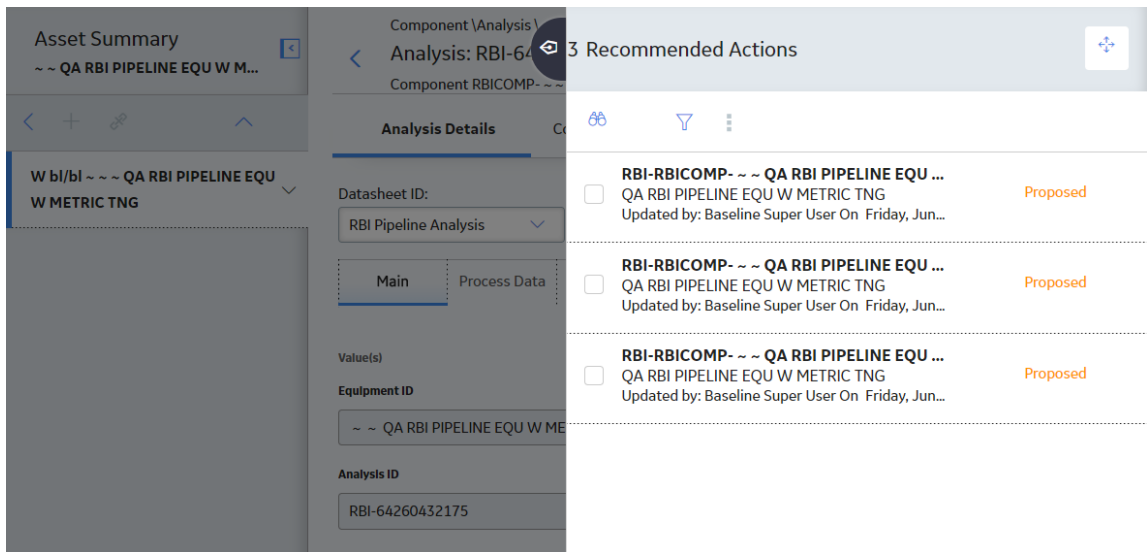

Results

- For a Recommendation that is promoted to Asset Strategy Management (ASM), you can access the associated Asset Strategy by selecting the link in the **Strategy ID** column.
- You can use the functionalities of the **Recommended Actions** pane.

Tip: For information about additional options available when working with the Recommendation records, refer to the Action Management section of the documentation.

View RBI Recommendations Linked to an Inspection Plan

Procedure

1. [Access an Inspection Plan](#).

The **Inspection Plan** workspace appears, displaying any Recommendations that are linked to the Inspection Plan.

Inspection Plan

Asset: ~ ~ RBI EQU FOR ASM TASK INTEGRATION | [Open Strategy](#) (Modified)

Approved
Not Assigned

RECOMMENDATION ID	STATE	SOURCE	RECOMMENDATION HEADLINE
<input type="checkbox"/> REC-10170	Accepted by ASM	RBI 580	RBI-RBICOMP- ~ ~ RBI EQU FOR ASM TASK INTEGRATION-CS-2143-Criticality
<input type="checkbox"/> REC-10171	Accepted by ASM	RBI 580	RBI-RBICOMP- ~ ~ RBI EQU FOR ASM TASK INTEGRATION-CS-2143-Criticality

Rows per page 10 50 100

1 - 2 of 2 Results

Results

- For Recommendations associated with approved Inspection Plans, you can access the associated Asset Strategy in Asset Strategy Manager (ASM) by selecting the **Open Strategy** link.
- In the **Recommended Actions** table, you can perform the following actions:
 - Modify the state of Recommendations to Supersede.
 - Modify the state of Recommendations to Not Required.
 - Delete Recommendations.
 - Implement Recommendations as Inspection Tasks.

About Auto-Consolidating RBI Recommendations

You can consolidate RBI Recommendations in:

- The **No Recommendations** section in the **RBI Overview** page.
- **RBI Asset Summary** page.

The auto-consolidation process consolidates RBI Recommendations that are associated with a single RBI Asset. This process consolidates all RBI Recommendations (both pre-existing and any new RBI Recommendations generated), if they contain the same values in the following fields:

- Damage Mechanism
- Task Type

When you consolidate:

- The state of the master RBI Recommendation is set to Proposed.
- The state of the source RBI Recommendations is set to Consolidated.
- The source RBI Recommendations are linked to the master RBI Recommendation through the Has Consolidate Recommendations relationship.

The following example explains how the fields in the master recommendation are mapped from the source recommendations.

Example: Recommendation Consolidation

Suppose you want to generate RBI Recommendations for a single RBI Asset that has two RBI Components with two RBI Recommendations for each component.

Field Name	Damage Mechanism (Field on RBI Recommendation)	Task Type (Field on RBI Recommendation)	Recommended Inspection Effectiveness (Field on RBI Degradation Mechanism)	Target Completion Date (Field on RBI Recommendation)
Recommendation for Analysis A	581-Amine Corrosion	RBI581 NON-INTRUSIVE	A	04/15/2025
Recommendation for Analysis B	581-Amine Corrosion	RBI581 NON-INTRUSIVE	A	04/15/2022
Recommendation for Analysis C	581-Amine Corrosion	RBI581 NON-INTRUSIVE	B	04/15/2021
Recommendation for Analysis D	581-Amine Corrosion	RBI581 NON-INTRUSIVE	B	04/15/2021

In this example, because the Damage Mechanism and Task Type have similar values for all RBI Recommendations, these RBI Recommendations qualify for consolidation. The system determines the driving RBI Recommendation based on the following field values:

- Inspection Effectiveness on RBI Degradation Mechanism linked to the RBI Recommendation
- Target Completion Date on RBI Recommendation

Recommendation for Analysis B is determined to be the driver based on the above points.

The Master RBI Recommendation field values are mapped as follows:

- Target Inspection Effectiveness is mapped from RBI Degradation Mechanism linked to the driving RBI Recommendation.
- Inspection Scope is mapped from the driving RBI Recommendation.

Note: Target Completion Date is the most conservative of all RBI Recommendations.

The state of the consolidated records is set to Consolidated, and the state of the master record is set to Proposed.

The following table lists the four RBI Recommendations that are consolidated into a master recommendation as a result of the automatic RBI Recommendation generation process.

RBI Recommendation	Damage Mechanism	Task Type	State	Recommended Inspection Effectiveness	Target Completion Date
Recommendation for Analysis A	581-Amine Corrosion	RBI581 INTRUSIVE	Consolidated	A	04/15/2025
Recommendation for Analysis B	581-Amine Corrosion	RBI581 INTRUSIVE	Consolidated	A	04/15/2022
Recommendation for Analysis C	581-Amine Corrosion	RBI581 INTRUSIVE	Consolidated	B	04/15/2021

RBI Recommendation	Damage Mechanism	Task Type	State	Recommended Inspection Effectiveness	Target Completion Date
Recommendation for Analysis D	581-Amine Corrosion	RBI581 INTRUSIVE	Consolidated	B	04/15/2021
Master RBI Recommendation	581-Amine Corrosion	RBI581 INTRUSIVE	Proposed	A	04/15/2021

In the master RBI Recommendation, the value in the Recommended Inspection Effectiveness field is set to A because this value is mapped from the related driving Degradation Mechanism for RBI Recommendation that exists in the Recommended Inspection Effectiveness field in the source RBI Recommendations. Similarly, the value in the Target Completion Date field is set to 04/15/2021 because this is the most conservative (that is, lowest) value that exists in the Target Completion Date field in the source RBI Recommendations.

Create an RBI Recommendation Manually

Before You Begin

- [Modify the state of the analysis to Risk Completed.](#)

About This Task

This topic describes how to create an RBI Recommendation manually for a Degradation Mechanism (DM). You can also [generate RBI Recommendations for all RBI Analyses linked to a single asset.](#)

Procedure

1. [Access the analysis](#) that contains the DM for which you want to create a recommendation.
2. In the workspace heading, select the **Degradation Mechanisms** tab.

The **Degradation Mechanisms** section appears, displaying a list of DMs associated with the analysis.

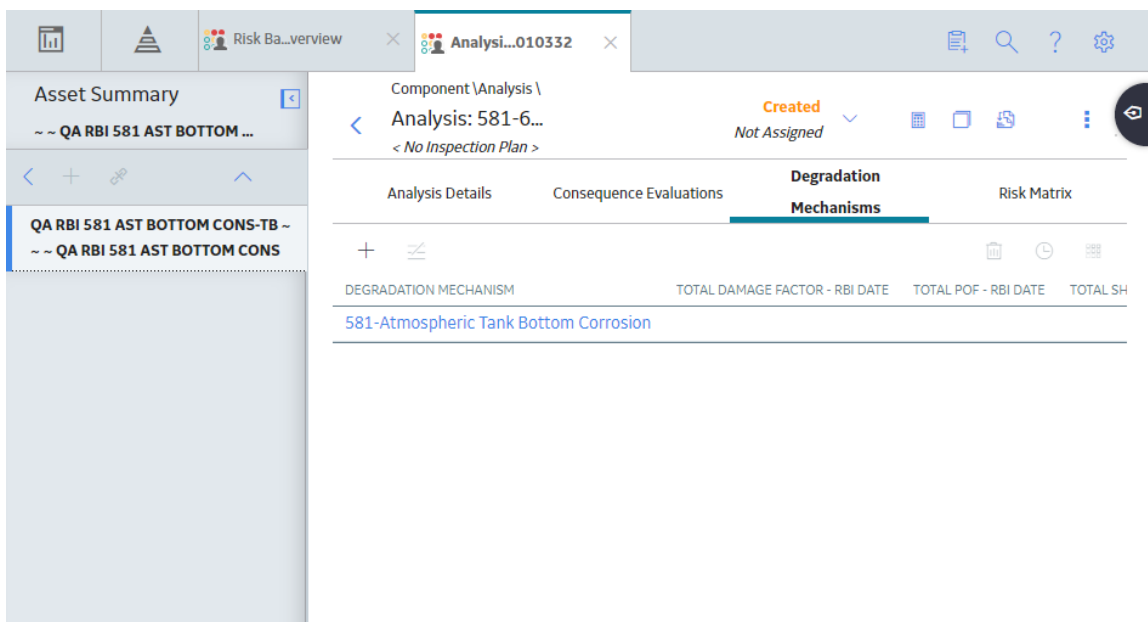

3. Select the row containing the DM to which you want to add a recommendation.
4. Select .

A message appears, confirming that you have created a recommendation for the DM.

Results

- The recommendation is linked to the Inspection Plan of the related RBI Asset.

Note:

- You can use the functionalities of the **Recommended Actions** pane.
- If, in the RBI Global Preference settings, the **Enable Recommendation To be Generated at Created State** check box is selected, recommendations will not be linked to the Inspection Plan until the related analysis is moved to the Risk Complete state and the Inspection Plan is generated.

Tip: For information about additional options available when working with the Recommendation records, refer to the Action Management section of the documentation.

Generate Recommendations for a Single RBI Criticality Analysis

Before You Begin

- Modify the state of the analysis to Risk Completed.

About This Task

This topic describes how to create RBI Recommendations for all Degradation Mechanisms (DMs) contained in an analysis. You can also:

- [Create an RBI Recommendation manually.](#)
- [Generate RBI Recommendations for all RBI Analyses linked to a single asset.](#)

Procedure

1. Access the analysis for which you want to generate recommendations.
2. Select , and then select **Generate Recommendations**.

The **Create Recommendations** window appears, asking you to confirm that you want to generate recommendations for the analysis.

3. Select **Yes**.

A message appears, confirming that you have generated recommendations for all the DMs contained in the analysis.

Results

The recommendations are linked to the Inspection Plan of the related RBI Asset.

Note:

- You can use the functionalities of the **Recommended Actions** pane.
- If, in the RBI Global Preference settings, the **Enable Recommendation To be Generated at Created State** check box is selected, recommendations will not be linked to the Inspection Plan until the related analysis is moved to the Risk Complete state and the Inspection Plan is generated.

Tip: For information about additional options available when working with the Recommendation records, refer to the Action Management section of the documentation.

Generate RBI Recommendations for Multiple RBI 581 Risk Analyses

About This Task

This topic describes how to generate recommendations for all RBI 581 Risk Analyses linked to components within a single asset. You can also [create an RBI Recommendation manually](#).

Procedure

1. Access the **Asset Summary workspace** for the asset for which you want to generate recommendations.
2. In the upper-right corner of the page, select , and then select **Generate Recommendations**.
The **Create Recommendations** window appears, asking you to confirm that you want to generate recommendations for the asset.
3. Select **Yes**.

A message appears, confirming that you have generated recommendations for all the RBI 581 Risk Analyses linked to all the components in the asset.

Results

- The recommendations are linked to the Inspection Plan of the related RBI Asset.

Note:

- You can use the functionalities of the **Recommended Actions** pane.
- If, in the RBI Global Preference settings, the **Enable Recommendation To be Generated at Created State** check box is selected, recommendations will not be linked to the Inspection Plan until the related analysis is moved to the Risk Complete state and the Inspection Plan is generated.

Tip: For information about additional options available when working with the Recommendation records, refer to the Action Management section of the documentation.

Generate Recommendations for all Analyses in an Asset Hierarchy Level

About This Task

This topic describes how to generate RBI Recommendations for assets linked to a Functional Location in the Asset Hierarchy. You can also:

- Create an RBI Recommendation manually.
- Generate Recommendations for a single RBI Analysis.
- Generate Recommendations for all RBI Analyses linked to a single asset.

Note: The consolidation of recommendations is supported only from the asset view when the **Enable Recommendation To be Generated at Created State** preference is set to True.

Procedure

1. Access the **Risk Based Inspection Overview** page for the Asset Hierarchy level for which you want to generate recommendations.
2. Select the **No Recommendations** tab.
The **No Recommendations** section appears, displaying assets that have at least one component with a Risk Completed analysis with no recommendations.

Y Risk Based Inspection Overview 🔗 📄 📊 📅

Asset: Home

349 Assets	90 Process Units	33 Pending Reassessment	116 No Recommendations	32 Inspection/TM Updates
----------------------	----------------------------	-----------------------------------	----------------------------------	------------------------------------

	EQUIPMENT TECHNICAL NUMBER	ASSET ID
<input type="checkbox"/>		~~ RBI EQU COMP ALL DATA
<input type="checkbox"/>		~~ Arch An, Crtd An, Arch W-If, PAppr An
<input type="checkbox"/>		~~ Arch Anlys, Rsk Cmpl Anlys, Crtd Anlys, No W-If
<input type="checkbox"/>		~~ Arch Anlys, Rsk Cmpl W-If
<input type="checkbox"/>		~~ Comp Anlyzd Every 5 Yrs
<input type="checkbox"/>		~~ Comp Has 10 Anlys
<input type="checkbox"/>		~~ COMP W ARCH, RC, and CR ANALYS
<input type="checkbox"/>		~~ COMP W W-IF ANALYS
<input type="checkbox"/>		~~ Crtd Anlys, Rsk Cmpl W-If
<input type="checkbox"/>		~~ EQU W 580 ANALYS FOR GRAPH /TABLE
<input type="checkbox"/>		~~ EQU W 581 ANALYS FOR GRAPH /TABLE
<input type="checkbox"/>		~~ EQU W INSPS

3. Select the check boxes next to the assets for which you want to generate recommendations.
Tip: You can generate recommendations for all listed assets in the **No Recommendations** section by selecting when all check boxes in the first column of the table are cleared. If you select the check box in the first row of the table, recommendations are generated for the analyses that appear in the current page in the **No Recommendations** section (up to 100 analyses can be displayed in a page). You cannot, however, generate RBI Recommendations for all analyses if the Asset Hierarchy level is set to Home. Generating recommendations will only apply to components that do not have recommendations.
4. Select .
The **Generate Recommendations** window appears, asking if you want to consolidate recommendations for each Degradation Mechanism and Task Type.

Recommendation Generation

Asset: ~ ~ EQU W 581 ANALYS FOR GRAPH /TABLE
2 new recommendations have been created for Analysis 581-64262922511 .
No recommendations have been consolidated based on Task Type and Damage Mechanism .
Generated Recommendations have been linked to the Inspection Plan.

Asset: ~ ~ QA RBI PIPELINE E2E WKFLW
3 new recommendations have been created for Analysis RBI-64258466767 .
No recommendations have been consolidated based on Task Type and Damage Mechanism .
Generated Recommendations have been linked to the Inspection Plan.

Close

- Tip:** If you choose to consolidate recommendations, the recommendations generated during this process will be consolidated with existing recommendations. For more information on consolidating recommendations, consult recommendation consolidation in RBI 580 and RBI 581.
5. Select **Yes**.
The recommendations are generated. The **Recommendation Generation** window appears, displaying the progress and number of recommendations generated and consolidated for each asset.

Recommendation Generation

Asset: ~ ~ EQU W 581 ANLYS FOR GRAPH /TABLE
2 new recommendations have been created for Analysis 581-64262922511 .
No recommendations have been consolidated based on Task Type and Damage Mechanism .
Generated Recommendations have been linked to the Inspection Plan.

Asset: ~ ~ QA RBI PIPELINE E2E WKFLW
3 new recommendations have been created for Analysis RBI-64258466767 .
No recommendations have been consolidated based on Task Type and Damage Mechanism .
Generated Recommendations have been linked to the Inspection Plan.

Close

Note: You can close the **Recommendation Generation** window before it is complete. You can view progress using the Schedule Logs.

6. Select **Close**.
7. Optionally, if you want to view the status of all bulk analyze operations, in the **Risk Based Inspection Overview** page, select .
The **Schedule Logs** page appears, displaying a list of all the operations in GE Digital APM that are in progress, along with the percentages of completion. You can also access a list of operations that have been successful or have failed.

Results

The recommendations are linked to the Inspection Plan of the related RBI Asset.

Note:

- You can use the functionalities of the **Recommended Actions** pane.
- If, in the RBI Global Preference settings, the **Enable Recommendation To be Generated at Created State** check box is selected, recommendations will not be linked to the Inspection Plan until the related analysis is moved to the Risk Complete state and the Inspection Plan is generated.

Chapter 11

Inspection Plans

Topics:

- [RBI Inspection Plans](#)
- [Inspection Plan Management](#)
- [Managing Recommended Actions in Inspection Plan](#)
- [Implement Recommended Actions to Inspection Tasks](#)
- [Inspection Plan Revision History](#)

RBI Inspection Plans

About Inspection Plans

An Inspection Plan allows you to view, manage, approve, and implement all RBI Recommended Actions related to an Asset. Inspection Plans are created for RBI Assets when one of the related components has an analysis that is moved to the Risk Completed state. When a user generates recommendations for RBI Analyses, the RBI Recommended Actions are added to Inspection Plans. An RBI Analyst can perform actions like supersede, mark as not required, or delete RBI Recommended Actions before approving the inspection plan.

After an Inspection Plan is approved, organizations can decide if they want to implement the approved RBI Recommended Actions through Inspection Plan or Asset Strategy Management. If an organization decides to implement the approved Recommended Actions through Inspection Plan, RBI Analysts can create a new inspection task or link an existing task to a Recommended Action. The Inspection Plan also displays the existing inspection tasks for an asset.

States of an Inspection Plan

Proposed

When an Inspection Plan is created, it will be in the Proposed state. An Inspection Plan is created for an RBI Asset when one of the related components has an analysis that is moved to the Risk Completed state. For Assets with multiple RBI Components, Inspection Plans are created when you finalize risk of an analysis for a single component.

Approved

After an analyst has reviewed all the Recommended Actions in an Inspection Plan, they can approve the Inspection Plan by transitioning it to the Approved state. This will also create or update the asset strategy for the Asset automatically, by creating or updating any Risks and Actions sourced from RBI. After an Inspection Plan is approved, all the related RBI Recommended Actions will move to the Approved state. An analyst can approve the Inspection Plan if all the RBI Components related to the asset have at least one active RBI Analysis.

Modified

An Inspection Plan is modified whenever reassessment or evergreening of RBI is done for the Asset. If the Inspection Plan is in the Approved state, and an analyst finalizes the risk for an analysis of an RBI Component, the Inspection Plan state is changed to Modified. When the state of an Inspection Plan is changed from Approved to Modified, GE Digital APM creates an Inspection Plan history record containing a snapshot of the Recommended Actions associated with the approved plan along with its implementation history.

About Inspection Plan Approval

An MI Inspection Plan Approver can approve Inspection Plans. Approving an Inspection Plan also integrates the related asset with Asset Strategy Manager (ASM). When an Inspection Plan is approved:

- Degradation Mechanisms (DMs) are used to create Risks in ASM.
- Recommendations are used to create Actions.

For more information on ASM Integration, see [About Asset Strategy Management \(ASM\) Integration](#).

When an Inspection Plan is in the Approved state, users can create or link Inspection Tasks to the related RBI Recommendations.

If the MI RBI Analyst transitions another RBI Criticality Analysis for an RBI Component linked to the asset related to the Inspection Plan to the Risk Completed state, the Inspection Plan will be moved to the Modified state.

An MI Inspection Plan Approver or MI Compliance Analyst can then delete, mark as not required, or supersede Compliance Recommendations.

Each time the Inspection Plan is changed from the Approved to Modified state, an Inspection Plan Revision record is created and linked to the existing Inspection Plan. For each existing RBI Recommendation record, a Recommendation Revision record is created and linked to the Inspection Plan Revision.

Additionally, the MI Inspection Plan Approver must change the state of the Inspection Plan to Approved before linking more Inspection Tasks to the plan.

About Modifying an Inspection Plan

An MI RBI Analyst can modify an Inspection Plan associated with an Asset by changing the state of an RBI Criticality Analysis for an RBI Component that is linked to the Asset to the Risk Completed state. This will archive the previous Risk Completed Analysis and its related RBI Recommendations. The archived RBI Recommendations will be unlinked from the Inspection Plan.

When an analyst modifies an Inspection Plan by finalizing the risk of an analysis for an RBI Component:

- Any existing RBI Recommendations on the active analysis of the component are unlinked from the Inspection Plan and moved to the Archived state.

Note: If the parent asset has multiple components, the RBI Recommendations linked to the other components are unaffected and remain in the Approved state.

- The Inspection Tasks previously linked to the recommendations are unlinked from the recommendations. However, the tasks remain linked to the asset.
- If RBI Recommendations are created or generated, the resulting recommendations populate the Inspection Plan.
- If the Inspection Plan is in the Approved State:
 - The plan is moved from the Approved to Modified state.
 - An Inspection Plan Revision record is created and linked to the existing Inspection Plan.
 - For each existing recommendation record linked to the Inspection Plan, a Recommendation Revision record is created and linked to the Inspection Plan Revision.

Access an Inspection Plan

You can access an Inspection Plan for an asset, component, and RBI Criticality Analysis.

Procedure

1. Access the **Asset Summary** workspace for the asset for which you want to access the Inspection Plan.
The **Asset Summary** workspace appears.



Asset Overview

Asset Details

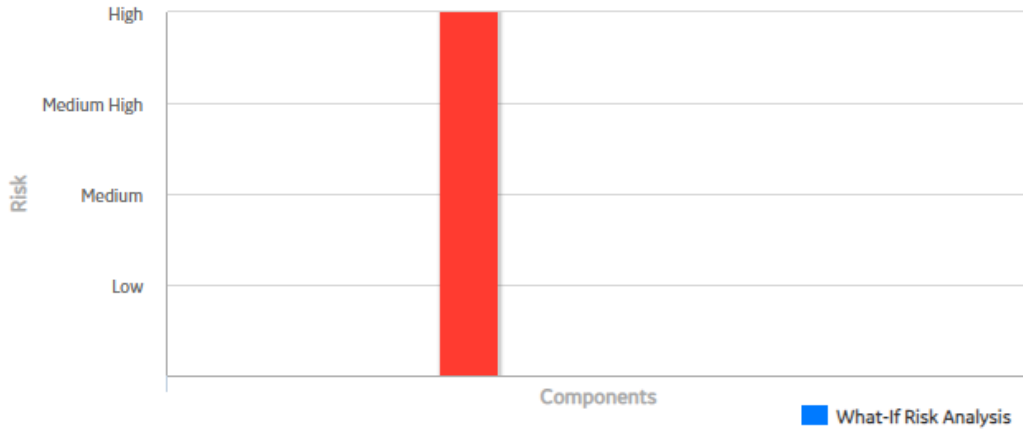

<input type="checkbox"/>	Components	Driving Inspection Priority (Unmitigated Risk)	Risk Category	Total SHE Risk – RBI Date	What- if Risk
<input type="checkbox"/>	QA RBI E2E WKFLW-TB ~ ~ ~ QA RBI E2E WKFLW	4	HIGH	---	---

Note: You can also access the related Inspection Plan for a component and Criticality Analysis.

2. Select the **Inspection Plan** link.
The **Inspection Plan** workspace appears.

Inspection Plan

Asset: -- QA RBI E2E WKFLW

Proposed
Administrator, Meridium

RECOMMENDATION ID	STATE	SOURCE	RECOMMENDATION HEADLINE	DAMAGE MECHANISM	TASK TYPE
REC-3683	Proposed	RBI 580	RBI-RBICOMP- -- QA RBI E2E WKFLW-TB-1851-Criticality Calculator Internal Corrosion	Criticality Calculator Internal Corrosion	FLOOD
REC-3684	Proposed	RBI 580	RBI-RBICOMP- -- QA RBI E2E WKFLW-TB-1851-Criticality Calculator External Corrosion	Criticality Calculator External Corrosion	FLOOD
REC-3685	Proposed	RBI 580	RBI-RBICOMP- -- QA RBI E2E WKFLW-TB-1851-Amine Cracking (ASCC)	Amine Cracking (ASCC)	ULTRASONIC

Rows per page 10 25 50 100 1 - 3 of 3 Results < 1 >

Existing Tasks

No Data

Rows per page 10 25 50 100 0 - 0 of 0 Results < 1 >

Note: If an Inspection Plan does not exist, a message stating so appears. Inspection Plans are created and linked to an asset when an analysis for at least one associated component is moved to the Risk Completed state.

Delete an Inspection Plan

You can delete Inspection Plans that are obsolete or unnecessary.

Before You Begin

You must have one of the following Security Roles:

- MI Inspection Plan Approver
- MI Compliance Analyst

Procedure

1. [Access the Inspection Plan](#) that you want to delete.
2. In the **Inspection Plan** page, select . The **Confirm Delete** window appears, asking you to confirm that you want to delete the Inspection Plan.
3. Select **Yes**. The Inspection Plan is deleted.

Note: An Inspection Plan cannot be deleted if it has recommendations.

Approve an Inspection Plan

Any user with the MI Inspection Plan Approver Security Role can move an Inspection Plan to the Approved state. After the Inspection Plan is approved, recommendations can be implemented as tasks.

About This Task

When an Inspection Plan is in the Approved state, you can create new Inspection Tasks or link existing Inspection Tasks to the related recommendations. The Inspection Tasks are transferred to the Inspection Management module.

Procedure

1. [Access the Inspection Plan](#) that you want to approve.
2. In the **Proposed** box, select **Approve**, and then select **Done**.
A message appears, stating that the Inspection Plan has been approved.

Note:

- After you approve an Inspection Plan, you cannot delete, supersede, or designate recommendations as Not Required. You must first move them to the Modified state.
- While the Inspection Plan is being modified, you cannot delete, supersede, or designate recommendations as Not Required.

Inspection Plan Management

Overview

The **Inspection Plan Management** page allows you to review multiple inspection plans and active recommended actions for any level in the Asset Hierarchy. In addition, you can approve or implement multiple Inspection Plans in bulk.

Note: Inspection plans can be created in either Risk Based Inspection or in Compliance Management.

Access Inspection Plan Management

Procedure

1. In the **Risk Based Inspection Overview** page, select the **Actions** button.
2. Select the **Inspection Plan Management** option.
The **Inspection Plan Management** page appears, displaying the **Inspection Plans** section.

The screenshot shows the 'Inspection Plan Management' interface. At the top, there are browser tabs for 'Inspect...verview', 'Complia...verview', and 'Inspect...agement'. The main header includes a search icon, a question mark, and a settings icon. Below the header, the page title is 'Inspection Plan Management' and the asset is 'Home'. The main content area is divided into two sections: 'Inspection Plans' and 'Active Recommended Actions'. The 'Inspection Plans' section contains a table with 17 rows, each representing an inspection plan. Each row has a checkbox on the left and a state label on the right. The states are: Approved (11 plans), Modified (2 plans), and Proposed (4 plans). The 'Active Recommended Actions' section has two buttons: 'Approve' and 'Implement'. Below the table, there is a pagination control showing 'Rows per page' with options 50, 100, 200, and 500. The current page is 1 of 2, and there are 145 results in total.

Inspection Plans	Active Recommended Actions
<input type="checkbox"/> INSPECTION PLAN	STATE ↑
<input type="checkbox"/> ~ ~ QA COMPLIANCE EQUIP1-Piping	Approved
<input type="checkbox"/> ~ ~ QA COMPLIANCE EQUIP2-Piping	Approved
<input type="checkbox"/> ~ ~ QA EQUIP COMP BULK CREATE NEW 01	Approved
<input type="checkbox"/> ~ ~ QA EQUIP COMP BULK CREATE NEW 02	Approved
<input type="checkbox"/> ~ ~ QA EQUIP COMP BULK CREATE NEW 03	Approved
<input type="checkbox"/> ~ ~ QA COMPLIANCE EQUIP4-Piping	Modified
<input type="checkbox"/> ~ ~ QA EQUIP COMP BULK CREATE NEW 04	Modified
<input type="checkbox"/> ~ ~ RBI EQU COMP ALL DATA	Proposed
<input type="checkbox"/> ~ ~ Arch An, Crted An, Arch W-If, PAppr An	Proposed
<input type="checkbox"/> ~ ~ Arch Anlys, Rsk Cmpl Anlys, Crted Anlys, No W-If	Proposed
<input type="checkbox"/> ~ ~ Arch Anlys, Rsk Cmpl W-If	Proposed
<input type="checkbox"/> ~ ~ Comp Anlyzd Every 5 Yrs	Proposed
<input type="checkbox"/> ~ ~ Comp Has 10 Anlys	Proposed
<input type="checkbox"/> ~ ~ COMP W ARCH, RC, and CR ANLYS	Proposed
<input type="checkbox"/> ~ ~ COMP W W-IF ANLYS	Proposed
<input type="checkbox"/> ~ ~ Crted Anlys, Rsk Cmpl W-If	Proposed

Rows per page: 50, 100, 200, 500. 1 - 100 of 145 Results. Page 1 of 2.

Next Steps

You can access Inspection Plans and Active Recommended Actions. You can also implement Inspection Plans that are in the Approved state in bulk.

Approve Inspection Plans in Bulk

Before You Begin

You must have one or more Inspection Plans that are in the Modified or Proposed state.

Procedure

1. Access the [Inspection Plan Management](#) page.

The **Inspection Plan Management** page appears, displaying the **Inspection Plans** section.

2. Select the check box next to each Inspection Plan in the **Inspection Plans** section.

The screenshot shows the 'Inspection Plan Management' interface. At the top, there are tabs for 'Compliance...view' and 'Inspect...agement'. Below the tabs, the page title is 'Inspection Plan Management' and the asset is 'Home'. The main content area is divided into two sections: 'Inspection Plans' and 'Active Recommended Actions'. The 'Inspection Plans' section contains a table with the following data:

INSPECTION PLAN	STATE
<input type="checkbox"/> ~ ~ QA Compliance Bulk Approval Process 03	Approved
<input type="checkbox"/> ~ ~ QA Compliance Bulk Approval Process 04	Approved
<input type="checkbox"/> ~ ~ QA Compliance Bulk Approval Process 05	Approved
<input checked="" type="checkbox"/> ~ ~ QA COMPLIANCE EQUIP1-Piping	Modified
<input type="checkbox"/> ~ ~ QA COMPLIANCE EQUIP2-Piping	Approved
<input checked="" type="checkbox"/> ~ ~ QA COMPLIANCE EQUIP3-Piping	Proposed
<input type="checkbox"/> ~ ~ QA COMPLIANCE EQUIP4-Piping	Modified
<input type="checkbox"/> ~ ~ QA EQUIP COMP BULK CREATE NEW 01	Approved
<input type="checkbox"/> ~ ~ QA EQUIP COMP BULK CREATE NEW 02	Approved
<input type="checkbox"/> ~ ~ QA EQUIP COMP BULK CREATE NEW 03	Approved
<input type="checkbox"/> ~ ~ QA EQUIP COMP BULK CREATE NEW 04	Modified
<input type="checkbox"/> ~ ~ QA EQUIP COMP BULK CREATE NEW 05	Proposed
<input type="checkbox"/> ~ ~ QA RBI 581 CONSIL RECOMM	Proposed
<input type="checkbox"/> ~ ~ QA RBI ACTIONS AND TASKS FOR REOCCURRING AND NONREOCCURRING RECOMMS	Proposed
<input type="checkbox"/> ~ ~ QA RBI ASM 581 WKFLOW	Approved
<input type="checkbox"/> ~ ~ QA RBI 2E WKFLOW	Approved

At the bottom of the table, there is a 'Rows per page' dropdown set to 100, and a pagination indicator showing '1 - 100 of 157 Results' with page numbers 1 and 2.

3. Select **Approve**.
4. The **Confirm Approval** window appears, asking you to confirm if you want to approve the selected Inspection Plans.
5. Select **Yes**.
The job status appears in the page heading, displaying the progress of the Inspection Plan approval for the selected plans. To review the progress, you can select to access the **Schedule Logs** page and search for Type Mechanical Integrity and Description Inspection Plan Approval to check the progress of the approval.

Note: The Recommended Actions linked to the Approved Inspection Plans can be accessed in the Active Recommended Actions section.

User can choose to implement the Recommended Actions to Tasks in Asset Strategy Management or in Inspection Plan Management page.

Implement Inspection Plans in Bulk by Creating New Inspection Tasks

Before You Begin

You must have one or more Inspection Plans that are in the Approved state.

Note: This option is only available when the following selection in the Inspection Configuration section of the IM Admin Preferences available in the Applications settings of the Inspection Management is set to false. Implement Recommended Actions to Tasks in ASM should be unchecked.

Procedure

1. Access the **Inspection Plan Management** page.
The **Inspection Plan Management** page appears, displaying the **Inspection Plans** section.
2. In the **Inspection Plans** section, next to each Approved Inspection Plan that you want to implement, select the check box.

The screenshot shows the 'Inspection Plan Management' page. At the top, there is a header with 'Inspection Plan Management' and 'Asset: Home'. On the right, there is a status indicator 'Approved' with a green checkmark and a calendar icon. Below the header, there is a table with two main sections: 'Inspection Plans' and 'Active Recommended Actions'. The 'Inspection Plans' section contains a list of plans, each with a checkbox and a state indicator. The 'Active Recommended Actions' section contains buttons for 'Approve' and 'Implement'. The table is as follows:

INSPECTION PLAN	STATE
<input type="checkbox"/> ~ ~ QA Compliance Bulk Approval Process 03	Approved
<input type="checkbox"/> ~ ~ QA Compliance Bulk Approval Process 04	Approved
<input type="checkbox"/> ~ ~ QA Compliance Bulk Approval Process 05	Approved
<input checked="" type="checkbox"/> ~ ~ QA COMPLIANCE EQUIP1-Piping	Approved
<input checked="" type="checkbox"/> ~ ~ QA COMPLIANCE EQUIP2-Piping	Approved
<input checked="" type="checkbox"/> ~ ~ QA COMPLIANCE EQUIP3-Piping	Approved
<input type="checkbox"/> ~ ~ QA COMPLIANCE EQUIP4-Piping	Modified
<input type="checkbox"/> ~ ~ QA EQUIP COMP BULK CREATE NEW 01	Approved
<input type="checkbox"/> ~ ~ QA EQUIP COMP BULK CREATE NEW 02	Approved
<input type="checkbox"/> ~ ~ QA EQUIP COMP BULK CREATE NEW 03	Approved
<input type="checkbox"/> ~ ~ QA EQUIP COMP BULK CREATE NEW 04	Modified
<input type="checkbox"/> ~ ~ QA EQUIP COMP BULK CREATE NEW 05	Proposed
<input type="checkbox"/> ~ ~ QA RBI 581 CONSL RECOMM	Proposed
<input type="checkbox"/> ~ ~ QA RBI ACTIONS AND TASKS FOR REOCCURRING AND NONREOCCURRING RECOMMS	Proposed
<input type="checkbox"/> ~ ~ QA RBI ASM 581 WKFLOW	Approved
<input type="checkbox"/> ~ ~ QA RBI 581 WKFLOW	Approved

At the bottom of the page, there is a pagination control showing 'Rows per page' with options 50, 100, 200, and 500. The current page is 1 of 2, and there are 157 results in total.

3. Select **Implement**, and then select **Create New**.
The **Create New** window appears, displaying the **Select Recommended Actions** section. This section displays all the Recommendations linked to the Inspection Plan that have not been implemented to Tasks.

Create New Inspection Tasks ✕

Select Recommended Actions / Edit Details

🔍

<input type="checkbox"/>	RECOMMENDATION ID	ASSET ID	RECOMMENDATION HEADLINE
<input type="checkbox"/>	REC-10364	QA COMPLIANCE EQUIP1-Piping	EXTERNAL VISUAL - NON-INSULATED ASSET-Critic
<input type="checkbox"/>	REC-10365	QA COMPLIANCE EQUIP1-Piping	ULTRASONIC THICKNESS TESTING-Criticality Calcu
<input type="checkbox"/>	REC-9984	QA COMPLIANCE EQUIP3-Piping	

Rows per page 100 ← 1 of 1 →

[Next](#)

4. Select each Recommended Action for which you want to create new Inspection Tasks.

Create New Inspection Tasks ✕

Select Recommended Actions / Edit Details

🔍

<input checked="" type="checkbox"/>	RECOMMENDATION ID	ASSET ID	RECOMMENDATION HEADLINE
<input checked="" type="checkbox"/>	REC-10364	QA COMPLIANCE EQUIP1-Piping	EXTERNAL VISUAL - NON-INSULATED ASSET-Critic
<input checked="" type="checkbox"/>	REC-10365	QA COMPLIANCE EQUIP1-Piping	ULTRASONIC THICKNESS TESTING-Criticality Calcu
<input checked="" type="checkbox"/>	REC-9984	QA COMPLIANCE EQUIP3-Piping	

Rows per page 100 ← 1 of 1 →

[Next](#)

5. Select **Next**.
The **Edit Details** section appears.

Create New Inspection Tasks



Select Recommended Actions Edit Details

Bulk Edit Last Date 8/12/2019

RECOMMENDATION ID	ASSET ID	RECOMMENDATION HEADLINE	LAST DATE
REC-9984	QA COM...		8/12/2019
REC-10364	QA COM...	EXTERNAL VISUAL - NON-INSULATED ASSET-Crit...	8/12/2019
REC-10365	QA COM...	ULTRASONIC THICKNESS TESTING-Criticality Cal...	8/12/2019

Rows per page 100 1 of 1

Previous Finish

- You can edit Last Date in bulk using the Bulk Edit Last Date or edit Last Date for individual records in edit details section for recurring recommendations only.

Note: For all non-recurring recommendations, one cannot edit the Last Date column in the Edit Details sections. Last Date is blank for non-recurring recommendations and is not updated when user edits the date in Bulk Edit Last Date field.

- Modify the details for the Recommended Actions that you selected.
- Select **Finish**.
The job status appears in the page heading, displaying the progress of the Inspection Task creation.
When the process is complete, you can select to access the **Schedule Logs** page.

Results

The newly created Inspection Tasks are linked to the selected Recommended Actions and linked to the Asset related to the Inspection Plan.

Implement Inspection Plans in Bulk by Linking Existing Inspection Tasks

Before You Begin

You must have one or more Inspection Plans that are in the Approved state.

Note: This option is only available when the Implement Recommended Actions to Tasks in ASM preference in the Inspection Configuration section of the IM Admin Preferences available in the Applications settings of the Inspection Management is unchecked.

Procedure

- Access the **Inspection Plan Management** page.
The **Inspection Plan Management** page appears, displaying the **Inspection Plans** section.
- In the **Inspection Plans** section, next to each Approved Inspection Plan that you want to implement, select the check box.

Inspection Plan Management

Asset: Home

Inspection Plans		Active Recommended Actions
<input type="checkbox"/>	INSPECTION PLAN	Starts ↑
<input type="checkbox"/>	-- QA Compliance Bulk Approval Process 05	Approved
<input type="checkbox"/>	-- QA COMPLIANCE EQUIP2-Piping	Approved
<input checked="" type="checkbox"/>	-- QA EQUIP COMP BULK CREATE NEW 01	Approved
<input checked="" type="checkbox"/>	-- QA EQUIP COMP BULK CREATE NEW 02	Approved
<input checked="" type="checkbox"/>	-- QA EQUIP COMP BULK CREATE NEW 03	Approved
<input type="checkbox"/>	bulkAction1 -- QA COMPLIANCE BULK CREATE RBI	Approved
<input type="checkbox"/>	testaction6 -- QA COMPLIANCE UNLINK ACTION	Approved
<input type="checkbox"/>	testaction5 -- QA COMPLIANCE IMPLEMENT ACTION	Approved
<input type="checkbox"/>	testfunction8 -- QA COMPLIANCE APPROVED BUTTON	Approved
<input type="checkbox"/>	-- QA Compliance Bulk Approval Process 03	Modified
<input type="checkbox"/>	-- QA Compliance Bulk Approval Process 04	Modified
<input type="checkbox"/>	-- QA COMPLIANCE EQUIP4-Piping	Modified
<input type="checkbox"/>	-- QA EQUIP COMP BULK CREATE NEW 04	Modified
<input type="checkbox"/>	-- RBI EQUI COMP ALL DATA	Proposed
<input type="checkbox"/>	-- Arch An, Crnd An, Arch W-R, Plogpr An	Proposed
<input type="checkbox"/>	-- Arch Anlys, Risk Compl Anlys, Crnd Anlys, No W-R	Proposed
<input type="checkbox"/>	-- Arch Anlys, Risk Compl W-R	Proposed
<input type="checkbox"/>	-- Comp Anlys@ Every 5 Yrs	Proposed

- Select **Implement**, and then select **Link Existing**. The **Link Existing Inspection Tasks** window appears, displaying the **Select Recommended Actions** section. This section displays all the Recommendations linked to the Inspection Plan that has not been implemented to Tasks.

Link Existing Inspection Tasks

Select Recommended Actions		Edit Details				
<input type="checkbox"/>	RECOMMENDATION ID	ASSET ID	RECOMMENDATION HEADLINE	SOURCE	TASK TYPE	RECOMMENDED INTERVAL SCOPE
<input type="checkbox"/>	REC-10127	QA EQUIP COMP BULK CREATE NEW 01		API 570	EXTERNAL VISUAL - NON-INSULATED ASSET	60
<input type="checkbox"/>	REC-10132	QA EQUIP COMP BULK CREATE NEW 01		API 570	ULTRASONIC THICKNESS TESTING	60
<input type="checkbox"/>	REC-10125	QA EQUIP COMP BULK CREATE NEW 02		API 570	EXTERNAL VISUAL - NON-INSULATED ASSET	60
<input type="checkbox"/>	REC-10130	QA EQUIP COMP BULK CREATE NEW 02		API 570	ULTRASONIC THICKNESS TESTING	60
<input type="checkbox"/>	REC-10123	QA EQUIP COMP BULK CREATE NEW 03		API 570	EXTERNAL VISUAL - NON-INSULATED ASSET	60
<input type="checkbox"/>	REC-10128	QA EQUIP COMP BULK CREATE NEW 03		API 570	ULTRASONIC THICKNESS TESTING	60

- Select each Recommended Action that you want to link to Inspection Tasks.

Link Existing Inspection Tasks

Select Recommended Actions		Edit Details				
<input checked="" type="checkbox"/>	RECOMMENDATION ID	ASSET ID	RECOMMENDATION HEADLINE	SOURCE	TASK TYPE	RECOMMENDED INTERVAL SCOPE
<input checked="" type="checkbox"/>	REC-10127	QA EQUIP COMP BULK CREATE NEW 01		API 570	EXTERNAL VISUAL - NON-INSULATED ASSET	60
<input checked="" type="checkbox"/>	REC-10132	QA EQUIP COMP BULK CREATE NEW 01		API 570	ULTRASONIC THICKNESS TESTING	60
<input checked="" type="checkbox"/>	REC-10125	QA EQUIP COMP BULK CREATE NEW 02		API 570	EXTERNAL VISUAL - NON-INSULATED ASSET	60
<input type="checkbox"/>	REC-10130	QA EQUIP COMP BULK CREATE NEW 02		API 570	ULTRASONIC THICKNESS TESTING	60
<input type="checkbox"/>	REC-10123	QA EQUIP COMP BULK CREATE NEW 03		API 570	EXTERNAL VISUAL - NON-INSULATED ASSET	60
<input type="checkbox"/>	REC-10128	QA EQUIP COMP BULK CREATE NEW 03		API 570	ULTRASONIC THICKNESS TESTING	60

Note: For optimal performance, no more than 100 recommended actions should be selected at one time.

- Select **Next**. The **Edit Details** section appears with the Recommended Actions and the existing task which will be linked. The task to link is matched, based on the task type and related asset.



Link Existing Inspection Tasks

Select Recommended Actions		Edit Details						
<input type="checkbox"/>	RECOMMENDATION ID	ASSET ID	SOURCE	RECOMMENDATION HEADLINE	NONRECURRING?	TASK TYPE	TASK ID	DESIRABLE IN
<input type="checkbox"/>	REC-10127	QA EQUIP COMP BULK CREATE NEW 01	API 570		<input type="checkbox"/>	EXTERNAL VISUAL - NON-INSULATED ASSET	Criticality Calculator External Corrosion EXTERNAL VISUAL - NON-INSULATED ASSET	60
<input type="checkbox"/>	REC-10132	QA EQUIP COMP BULK CREATE NEW 01	API 570		<input type="checkbox"/>	ULTRASONIC THICKNESS TESTING	Criticality Calculator Internal Corrosion ULTRASONIC THICKNESS TESTING	60
<input type="checkbox"/>	REC-10125	QA EQUIP COMP BULK CREATE NEW 02	API 570		<input type="checkbox"/>	EXTERNAL VISUAL - NON-INSULATED ASSET	Criticality Calculator External Corrosion EXTERNAL VISUAL - NON-INSULATED ASSET	60

Note: If no task with a matching task type or related asset is found or if the recommended action is recurring and the matching task is nonrecurring, an error will be displayed.

Link Existing Inspection Tasks ✕

Select Recommended Actions ↔ Edit Details

 ⚠ Could not find corresponding tasks for 3 Recommended Action(s). 

RECOMMENDATION ID	ASSET ID	SOURCE	RECOMMENDATION HEADLINE	NONREC
REC-10286	RBI EQU COMP ALL DATA	RBI 580	RBI-RBICOMP- -- RBI EQU COMP ALL DATA-CS-1181-Criticality Calculator Internal Corrosion	<input type="checkbox"/>

Rows per page: 50 200 500 1 - 1 of 1 Results ← →

Previous Finish

6. Select **Finish**.

The job status appears in the page heading, displaying the progress of the Inspection Task creation.

When the process is complete, you can select  to access the **Schedule Logs** page.

Results

The Inspection Tasks are linked to the selected Recommended Actions.

Review Active Recommended Actions

The Active Recommended Actions section displays all the recommended actions that have Inspection Plans in an Approved state.

Inspection Plans					Active Recommended Actions	
RECOMMENDATION ID	STATE ↑	INSPECTION PLAN	SOURCE	RECOMMENDATION HEADLINE	DAMAGE MECHANISM	
REC-10123	Approved	-- QA EQUIP COMP BULK CREATE NEW 03	API 570		Criticality Calculator External Corrosion	
REC-10125	Approved	-- QA EQUIP COMP BULK CREATE NEW 02	API 570		Criticality Calculator External Corrosion	
REC-10127	Approved	-- QA EQUIP COMP BULK CREATE NEW 01	API 570		Criticality Calculator External Corrosion	
REC-10128	Approved	-- QA EQUIP COMP BULK CREATE NEW 03	API 570		Criticality Calculator Internal Corrosion	
REC-10130	Approved	-- QA EQUIP COMP BULK CREATE NEW 02	API 570		Criticality Calculator Internal Corrosion	
REC-10132	Approved	-- QA EQUIP COMP BULK CREATE NEW 01	API 570		Criticality Calculator Internal Corrosion	
REC-10225	Approved	-- QA Compliance Bulk Approval Process 05	API 570		Criticality Calculator External Corrosion	
REC-10228	Approved	-- QA Compliance Bulk Approval Process 05	API 570		Criticality Calculator Internal Corrosion	
REC-10303	Approved	testfunction4 -- QA COMPLIANCE APPROVED BUTTON	API 570		Criticality Calculator External Corrosion	
REC-10304	Approved	testfunction4 -- QA COMPLIANCE APPROVED BUTTON	API 570		Criticality Calculator Internal Corrosion	
REC-10344	Approved	testaction5 -- QA COMPLIANCE IMPLEMENT ACTION	RBI 580	RBI-RBICOMP-testaction5 -- QA COMPLIANCE IMPLEMENT ACTION-EB-2624-Creep	Creep	
REC-10345	Approved	testaction4 -- QA COMPLIANCE UNLINK ACTION	RBI 580	RBI-RBICOMP-testaction4 -- QA COMPLIANCE UNLINK ACTION-EB-2622-Creep	Creep	
REC-10363	Approved	bulkAction1 -- QA COMPLIANCE BULK CREATE RBI	API 570		Criticality Calculator External Corrosion	
REC-10364	Approved	bulkAction1 -- QA COMPLIANCE BULK CREATE RBI	API 570		Criticality Calculator Internal Corrosion	
REC-10383	Approved	bulkAction1 -- QA COMPLIANCE BULK CREATE RBI	RBI 581	RBI-bulkAction1-EB -- bulkAction1 -- QA COMPLIANCE BULK CREATE RBI-581-Thinning Damage	581-Thinning Damage	
REC-10443	Approved	bulkAction1 -- QA COMPLIANCE BULK CREATE RBI	RBI 580	RBI-RBICOMP-bulkAction1 -- QA COMPLIANCE BULK CREATE RBI-HD-2628-Creep	Creep	
REC-10249	Implemented	testaction4 -- QA COMPLIANCE UNLINK ACTION	API 570		Criticality Calculator External Corrosion	
REC-10250	Implemented	testaction4 -- QA COMPLIANCE UNLINK ACTION	API 570		Criticality Calculator Internal Corrosion	
REC-10305	Implemented	testaction5 -- QA COMPLIANCE IMPLEMENT ACTION	API 570		Criticality Calculator External Corrosion	
REC-10306	Implemented	testaction5 -- QA COMPLIANCE IMPLEMENT ACTION	API 570		Criticality Calculator Internal Corrosion	
REC-9985	Implemented	-- QA COMPLIANCE EQUIP2-Piping	API 570		Criticality Calculator Internal Corrosion	
REC-9983	Not Required	-- QA COMPLIANCE EQUIP2-Piping	API 570		Criticality Calculator External Corrosion	

Managing Recommended Actions in Inspection Plan

Modify an RBI Recommendation



RBI Recommendations can be marked not required, superseded, or deleted from the **Inspection Plan** workspace.



Before You Begin

You must either belong to the MI RBI Analyst Security Group or have MI Inspection Plan Approver Security Role to modify an RBI Recommendation.

Procedure

1. [Access the Inspection Plan](#) that contains the RBI Recommendations that you want to modify.
2. Modify the RBI Recommendation in one of the following ways:

State	Action
Supersede ()	Changes the state of the RBI Recommendation to Superseded. To supersede recommendations: <ol style="list-style-type: none"> a. Next to two or more Recommendations, select the check boxes. b. Select  . The Supersede Recommended Actions window appears. c. Select the recommendation that you want to designate as the master recommendation. d. Select Supersede. The master recommendation supersedes the other recommendations and appears in the grid.

State	Action
<p>Not Required ()</p>	<p>Note: You can view the superseded recommendations by selecting the number in the Linked Actions column.</p> <p>Changes the state of the RBI Recommendation to Not Required.</p> <ol style="list-style-type: none"> Next to each Recommendation that you want to mark Not Required, select the check box. Select  . <p>A window appears, asking you to confirm that you want to mark the recommendation as Not Required.</p> <ol style="list-style-type: none"> Select Yes. <p>The Reason for Not Required window appears, asking you to state a reason for marking the recommendation as Not Required.</p> <ol style="list-style-type: none"> Enter a reason for marking the recommendation as Not Required, and then select Done. <p>The RBI Recommendation is moved to the Not Required state.</p>
<p>Unlink Superseded Recommendations</p>	<p>Changes the state of the recommendations from Superseded to Proposed. This unlinks superseded recommendations from the master recommendation.</p> <ol style="list-style-type: none"> In the row containing the recommendation that you want to modify, in the Linked Actions column, select the number. <p>The Linked Recommended Actions window appears, displaying the linked superseded and consolidated recommendations.</p> <ol style="list-style-type: none"> Next to each superseded recommendation that you want to unlink, select the check box. <p>Note: You can only unlink superseded recommendations from the Inspection Plan. To unlink consolidated recommendations, you must use the Recommended Actions pane from the Asset Summary workspace for the related asset.</p> <ol style="list-style-type: none"> Select Unlink. <p>The selected RBI Recommendations are unlinked from the master recommendation and appear in the grid. The RBI recommendations are moved to the Proposed state.</p>

Note: To consolidate RBI Recommendations, you must use the **Recommended Actions** pane from the **Asset Summary** workspace for the related asset.

Delete an RBI Recommendation

Procedure

1. [Access the Inspection Plan](#) that contains the RBI recommendation that you want to delete.

2. Next to each recommendation that you want to delete, select the check box.
3. Select .

A window appears, asking if you want to delete the selected records.
4. Select **Yes**.

The RBI Recommendations are deleted.

Implement Recommended Actions to Inspection Tasks

Implement an RBI Recommendation to an Inspection Task

You can create new Inspection Tasks or link existing Inspection Tasks to an RBI Recommendation that is in the Approved state in an Inspection Plan.

Before You Begin

- Ensure that the **Implement Recommended Actions to Tasks in ASM** setting is set to False in the **Global Preferences** section of the **RBI Admin Preferences** page.
- You must have an Inspection Plan that is in the Approved state.

Procedure

1. [Access the Inspection Plan](#) that contains the RBI Recommendations that you want to implement.
2. Next to the RBI Recommendation that you want to implement, select the check box.
3. Select **Implement**.

The **Implement as Inspection Task** window appears.

Implement as Inspection Task

Create New Link Existing

Select an Option to Implement as Task

Cancel
Implement

4. Select one of the following:

Action	Description
Create New	Creates a new task that is linked to the RBI Recommendation. The new task is assigned a Task ID, and the Task ID appears in the Task ID column for the respective RBI Recommendation.
Link Existing	Allows you to select an existing Inspection Task to link to the RBI Recommendation. The task uses the existing Task ID. Note: You cannot link non-reoccurring tasks to reoccurring recommendations.

5. Select **Implement**.

The Inspection Task is linked to the RBI Recommendation and appears in the **Existing Tasks** section of the **Inspection Plan** page.

The Inspection Task fields are populated with the following values from the RBI Recommendation:

Field	Value	Source
Desired Interval	<p>The least value among the following:</p> <ul style="list-style-type: none"> The value in the Interval field The value in the RBI Half-Life field in the associated Degradation Mechanism Evaluation The value in the TM Half-Life field in the associated Asset Corrosion Analysis Time-Based Inspection Settings <p>Note: If you are linking to an existing Inspection Task, this field is populated only if the value in the Override Interval field is False and the value in the Reoccurring field is True.</p>	RBI Recommendation
Desired Interval Basis	<p>The value of the Interval Basis that corresponds to the Interval field</p> <p>Note: If you are linking to an existing Inspection Task, this field is populated only if the value in the Override Interval field is False and the value in the Reoccurring field is True.</p>	RBI Recommendation
Next Date	<p>The value in the Target Completion Date field</p> <p>Note: This field is populated only when the RBI Recommendation field, NonRecurring? is true.</p>	RBI Recommendation
Next Date Basis	<p>RBI Recommendation or RBI 581 Recommendation</p> <p>Note: This field is populated only when the RBI Recommendation field, NonRecurring? is true.</p>	None
Override Interval	<p>False</p> <p>Note: If you are linking to an existing Inspection Task, this field is not populated.</p>	None
Reason	<p>RBI Recommendation or RBI 581 Recommendation</p>	None
Reoccurring	<p>The negated value of the NonRecurring? field</p>	RBI Recommendation
Task Details	<p>The value in the Recommended Inspection Scope field concatenated with the value in the Recommendation Basis field</p>	RBI Recommendation

Field	Value	Source
Task ID	The value in the Degradation Mechanism field concatenated with the value in the Task Type field Note: If you are linking to an existing Inspection Task, this field is not populated.	RBI Recommendation
Task Type	The value in the Task Type field	RBI Recommendation

Unlink an Inspection Task from an RBI Recommendation

You can unlink Inspection Tasks from Compliance Recommendations to remove them from the Linked Actions.

Procedure

1. [Access the Inspection Plan](#) that contains the RBI Recommendations from which you want to unlink tasks.
2. Next to the RBI Recommendation that contains the Inspection Task that you want to unlink, select the check box.
3. Select .
A message appears, asking if you want to unlink the selected recommendation from the task.
4. Select **Yes**.
The Inspection Task is unlinked from the RBI Recommendation.

Note: The Inspection Task will remain linked to the parent asset. The Desired Interval and Desired Interval Basis fields in the Inspection Task will remain populated based on the previously linked recommendation.

Inspection Plan Revision History

About Inspection Plan Revision History

An Inspection Plan Revision History record is created when the state of an Inspection Plan is changed from Approved to Modified.

You can modify an Inspection Plan in any of the following scenarios:

- For Compliance Management: When an MI Inspection Plan Approver or an MI Compliance Analyst updates the Compliance Recommendations.
- For Risk Based Inspection (RBI): When an RBI Risk Analysis is moved to the Risk Completed state.

You can [Access Inspection Plan Revision History](#) record through the Inspection Plan. Using this record, you can track the progress of an Inspection Plan and view the following details:

- The name of the user who modified or approved the Inspection Plan.
- The date of revision.
- The reason for revision.

Access Inspection Plan Revision History

You can access the revision history of an Inspection Plan that has been updated.

Procedure

1. [Access the Inspection Plan](#) for which you want to access the revision history.
2. In the **Inspection Plan** page, select . The **Inspection Plan Revision History** window appears, displaying an Inspection Plan Revision History record for each instance in which the Inspection Plan was updated.

Inspection Plan Revision History

REVISION DATE	REVISED BY	BASIS FOR REVISION
4/29/2019 8:04:03 AM	Super User, Baseline	updated

Rows per page 50 200 500 1 - 1 of 1 Results  

Close

3. In the **Revision Date** column, select the link in the row that contains the Inspection Plan Revision History record that you want to access. The Inspection Plan Revision History record appears.

Inspection Plan Revision History

 [8/9/2019 3:43:07 AM](#)

RECOMMENDATION ID	SOURCE	STATE	RECOMMENDED INTERVAL SCOPE	NONRECURRING?	TARGET COMPLETION DATE	TASK ID
REC-10285	RBI 581	Approved	60(Months)	<input checked="" type="checkbox"/>	8/1/2019	Criticality ...
REC-10286	RBI 580	Approved	60(Months)	<input type="checkbox"/>	8/1/2019	Criticality ...
REC-10287	API 570	Approved	72(Months)	<input type="checkbox"/>	8/1/2019	Criticality ...

Rows per page 5 5 1 - 3 of 3 Results  

Close

Chapter 12

ASM Integration

Topics:

- [About Asset Strategy Management \(ASM\) Integration](#)
- [Asset Strategy Management \(ASM\) Integration Workflow](#)
- [About Unmitigated Risk](#)
- [About Mitigated Risk](#)
- [Access Asset Strategy Manager \(ASM\) from an Inspection Plan](#)
- [Approving the Inspection Plan of an Asset](#)

About Asset Strategy Management (ASM) Integration

You can approve the Inspection Plan of an asset to ASM if all the RBI Components in the asset have an active RBI 581 Risk Analysis. When you approve the Inspection Plan, the asset is promoted to ASM. When an asset is promoted:

- Degradation Mechanisms (DMs) are used to create Risks in ASM.
- Recommendations are used to create Actions, which can be implemented as Inspection Tasks. These tasks are listed in Inspection Management.

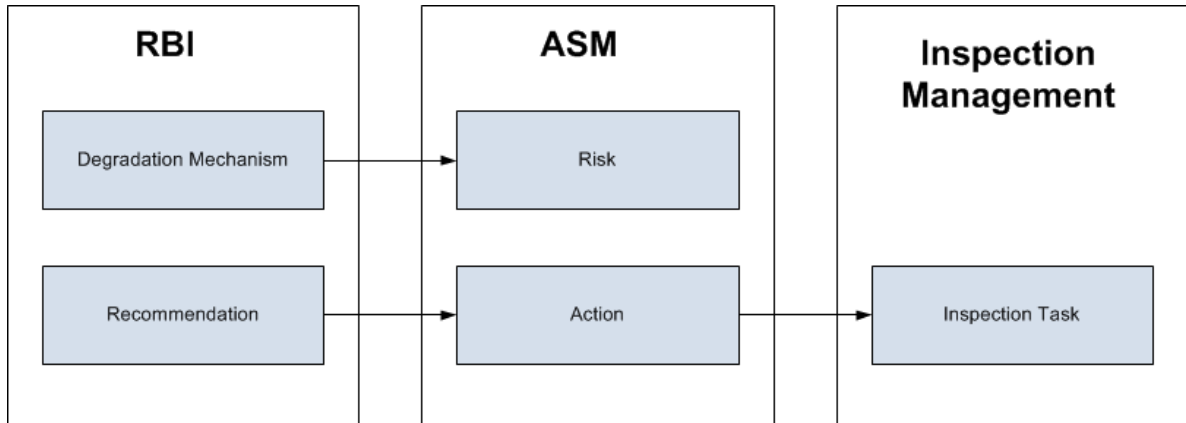

Note: The way in which you manage the unmitigated and mitigated risk values depends on how administrative settings are configured.

Details

You can decide how you want to track recommended actions based on the risk information in the DMs. You can choose either of the following options:

- You can create or generate RBI Recommendations to record the mitigated risk values and then approve the Inspection Plan of the asset. Approving the Inspection Plan will transfer the Degradation Mechanism and RBI Recommendations, along with unmitigated and mitigated risk values, to ASM. Risks are created for the Degradation Mechanism and Actions are created for the recommendation. You can implement either RBI Recommendations from an approved Inspection plan or Actions from an active Asset Strategy as an Inspection Task.
- You will not create RBI Recommendations. Instead, you will recommend a future action and manage mitigated risk values using Actions in ASM.

To transfer RBI Recommendations to Asset Strategies in ASM, you must approve the Inspection Plan of the corresponding asset.

Note: A single asset can have multiple RBI Components, and each RBI Component can have only one active RBI 581 Risk Analysis.

After you approve the Inspection Plan of the asset:

- All the RBI 581 Risk Analyses and RBI Recommendations linked to the RBI Components in the asset are set to the Accepted by ASM state. You cannot modify them.
- If you create another RBI 581 Risk Analysis for an RBI Component linked to the asset and modify the state of the new analysis to Risk Completed, the Inspection Plan will be moved to the Modified state. You can re-approve the Inspection Plan to promote the asset to ASM again.

- If you modify the state of the analysis to Re-evaluating, and if you want to approve the Inspection Plan again, you must first create an RBI 581 Risk Analysis, move the analysis to the Risk Completed state, and create RBI Recommendations for a component in the asset before promoting it.

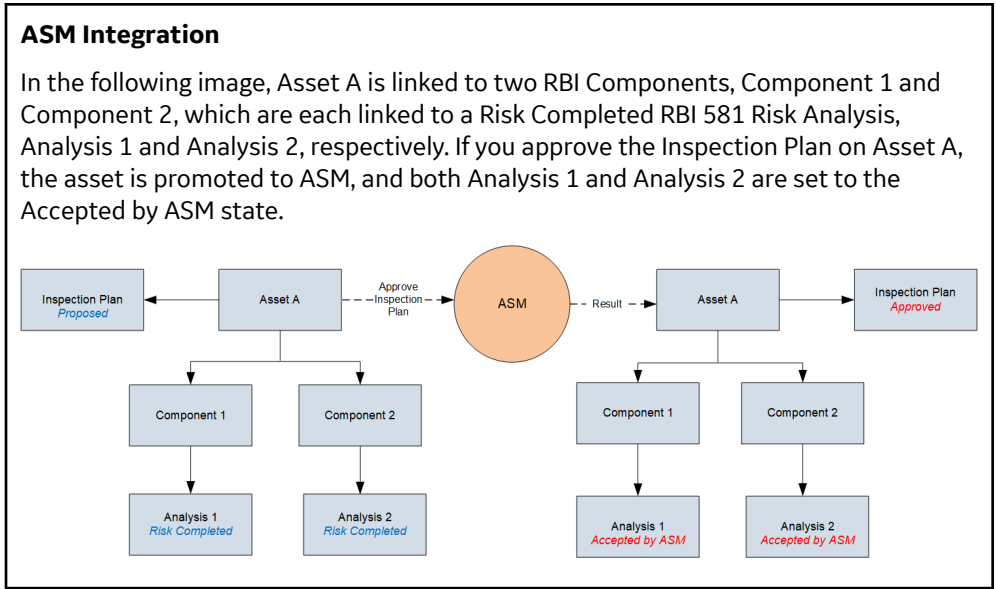

Managing Asset Strategies That Were Created from RBI

After an Asset Strategy has been created from RBI, you can manage the Asset Strategy using ASM. Some restrictions will apply to the Asset Strategy depending on how the administrative settings are configured.

The following table provides information about which Actions are always allowed and which ones are always restricted.

Always Allowed	Always Restricted
<ul style="list-style-type: none"> • Creating Risks. • Assigning new Actions to Risks that did not originate in RBI. • Managing Asset Strategy states. • In the Risk Analysis, clearing the Selected Actions check box for any Action that did not originate in RBI. • Assigning new Actions to any Risk that originated in RBI. • Assigning existing Actions that did not originate in RBI to any Risk that did originate in RBI. • Assigning new Risks to any Action that originated in RBI. • Assigning existing Risks that did not originate in RBI to any Action that did originate in RBI. • Accessing the Risk Matrix to view the unmitigated risk rank for any Risk that was created from RBI. • Accessing the Risk Matrix to view the mitigated risk rank for any Action that was created from RBI. • Copying a Risk that was created from RBI. • Copying a Risk that was created from RBI. 	<ul style="list-style-type: none"> • Risk Records • Undoing a Risk that was created from RBI. • Removing a Risk that was created from RBI. • Assigning Actions that originated in RBI to a Risk that originated in RBI. • For any Risk that was created from RBI, modifying values in the following fields in the Risk datasheet (listed in the order in which they appear on the datasheet, from top to bottom): <ul style="list-style-type: none"> ◦ Name ◦ Description ◦ Risk Basis ◦ Failure Mode ◦ Maintainable Item ◦ Failure Cause • Modifying the unmitigated risk rank or unmitigated financial risk rank for any Risk that was created from RBI. • Action Records <ul style="list-style-type: none"> ◦ Removing an Action that was created from RBI. ◦ Assigning Risks that originated in RBI to an Action that originated in RBI. ◦ For any Action that was created from RBI, modifying values in the following fields on the Action datasheet (listed in the order in which they appear in the datasheet, from top to bottom): <ul style="list-style-type: none"> ◦ Action Basis ◦ Name ◦ Action Type ◦ Interval ◦ Interval Units ◦ Nonrecurring ◦ Cost ◦ Shutdown Required ◦ Cost Basis ◦ Target Completion Date ◦ Modifying the mitigated risk rank for any Action that was created from RBI. ◦ In the Risk Analysis, clearing the Selected Actions check box for an Action that was created from RBI. • General <ul style="list-style-type: none"> ◦ Applying an Asset Strategy Template as a master template to the Asset Strategy

The following table describes Actions that are allowed for Asset Strategies that were created from RBI and the corresponding administrative setting that allows it.

Action	Corresponding Administration Action
Implement Actions as Tasks in ASM	<p>This action is allowed if the Implement Recommended Actions to Tasks in ASM check box is selected.</p> <p>If the Implement Recommended Actions to Tasks in ASM check box is cleared, recommendations can be implemented only as Inspection Tasks through the Inspection Plan of the related asset.</p>

Asset Strategy Management (ASM) Integration Workflow

Addressed

1. [Create an RBI Component](#) for each piece of Asset.
2. [Create an RBI 581 Risk Analysis](#) for the component.
3. [Assess the unmitigated risk](#) of the Degradation Mechanisms (DMs) that are linked to the RBI 581 Risk Analyses.
4. [Modify the state of all the RBI 581 Risk Analyses to Risk Completed.](#)
An Inspection Plan will be created and linked to the parent asset if one does not exist. If the Inspection Plan does exist and is approved, the state of the Inspection Plan will be updated to Modified.
5. [Generate Recommendations](#) for all the analyses within the asset, and assess the mitigated risk. Recommendations will be linked to the Inspection Plan of the asset.
6. [Access an Inspection Plan](#) for the asset.
7. [Approve the Inspection Plan.](#)
This will transition the Inspection Plan to the Approved state and promote all the RBI Recommendations and DMs associated with the asset to ASM.

Approving an Inspection Plan on an asset includes steps to analyze the risk associated with each component, recommend a future action based on the risks, and transfer the analysis data to ASM. You can recommend a future action in one of the following ways:

- Using RBI Recommendations in RBI: In this workflow, you will identify the mitigated risk of DMs in RBI.
- Using Actions in ASM: In this workflow, you will identify the mitigated risk of DMs in ASM.

In most cases, you will complete the steps in either workflow on a regular basis as you refine the operating conditions and environment. RBI Analyses are dynamic tools that help you refine your strategy for maintaining RBI Components.

About Unmitigated Risk

When you [calculate an RBI 581 Risk Analysis](#), the unmitigated SHE risk and unmitigated financial risk for each Degradation Mechanisms record (DM) are calculated automatically and stored in the DM. The calculation is performed using Risk Mapping Policies.

Unmitigated Risk

The unmitigated risk rank is plotted on a Risk Matrix. This value is the intersection of the consequence and probability that are calculated when you calculate an RBI 581 Risk Analysis.

Tip: For more information, refer to the Risk Matrix section of the documentation.

- Consequence of Failure: The consequence of failure is based on the following fields in the associated RBI 581 Consequence Evaluation:

- Safety Risk Category
 - Final Consequence Area
- Operations Risk Category
 - Calculated Total Financial Consequence
- Probability of Failure: This value is calculated and stored in the DM.

About Mitigated Risk

When you calculate an RBI 581 Risk Analysis, the **unmitigated risk and unmitigated financial risk** for each DM is calculated automatically and stored in the related Degradation Mechanisms record (DM).

By default, the mitigated risk values are set to the same values as the unmitigated risk values. You can modify the mitigated risk values manually using the risk matrix to indicate how the risk could be lowered if certain actions are taken.

Access Asset Strategy Manager (ASM) from an Inspection Plan

Procedure

1. [Access an Inspection Plan](#) for the asset which you want to access the Asset Strategy in Asset Strategy Manager (ASM).

The screenshot shows the 'Inspection Plan' interface for an asset named 'QA RBI PIPELINE EZE WKFLW'. The status is 'Approved' and 'Not Assigned'. Below the header, there is a table with the following data:

RECOMMENDATION ID	STATE	SOURCE	RECOMMENDATION HEADLINE
REC-10694	Accepted by ASM	RBI 580	RBI-RBICOMP - QA RBI PIPELINE EZE WKFLW2124-Third Party Damage
REC-10695	Accepted by ASM	RBI 580	RBI-RBICOMP - QA RBI PIPELINE EZE WKFLW2124-Criticality Calculator E
REC-10696	Accepted by ASM	RBI 580	RBI-RBICOMP - QA RBI PIPELINE EZE WKFLW2124-Criticality Calculator In

Below the table, there are pagination controls showing 'Rows per page' (10, 25, 50, 100) and '1 - 3 of 3 Results'. There is also a section for 'Existing Tasks' which currently shows 'No Data'.

2. In the workspace, select the **Open Strategy** link. The **Risks and Actions** workspace appears for the Asset Strategy in the Asset Strategy Manager (ASM). For more information, refer to the Asset Strategy Management documentation.

Note: The **Open Strategy** link will be available only if the Inspection Plan is in the Approved or Modified state and an Asset Strategy exists for the asset. The state of the asset strategy also appears next to the **Open Strategy** link.

Approving the Inspection Plan of an Asset

Before You Begin

- All the RBI Components linked to the asset must contain an active RBI 581 Risk Analysis (that is, an analysis in Risk Completed, Pending Approval, Approved, or Implemented state).

Procedure

1. Access the **Inspection Plan workspace** for the Inspection Plan that you want to approve.
2. Select the button that indicates the current state of the Inspection Plan (that is, Proposed or Modified).

A menu appears, displaying a list of operations that you can perform on the Inspection Plan to modify its state.

The screenshot shows the 'Inspection Plan' workspace for asset 'QA-RBI-EZE-WKFLW'. It features a table with columns for Recommendation ID, State, Source, and Recommendation Headline. Three rows are visible, all with a 'Proposed' state. An 'Approve' menu is open, showing options for 'Manage State' and 'Assignments', with a 'Done' button. Below the table, there are two sections for 'Existing Tasks', both showing 'No Data'.

RECOMMENDATION ID	STATE	SOURCE	RECOMMENDATION HEADLINE
REC-3683	Proposed	RBI-580	RBI-RBICOMP- -- QA-RBI-EZE-WKFLW-TB-1851-C
REC-3684	Proposed	RBI-580	RBI-RBICOMP- -- QA-RBI-EZE-WKFLW-TB-1851-C-Hydroxy-Lactosone-ester/mer/Lactat
REC-3685	Proposed	RBI-580	RBI-RBICOMP- -- QA-RBI-EZE-WKFLW-TB-1851-Amine Cracking (ASCI)

3. Select **Approve**, and then select **Done**.

The Inspection Plan is approved.

If the selected asset is not currently linked to an Asset Strategy, an Asset Strategy is created and linked to the asset.

Results

The selected asset, along with all the DMs and Recommendations linked to the asset, are **promoted to Asset Strategy Manager (ASM)**.

Next Steps

Access **ASM**.

Chapter 13

Admin

Topics:

- [Access the Global Preferences Workspace](#)
- [About Global Preferences](#)
- [About Evaluation of All Risk Targets in RBI 581](#)
- [About RBI 581 Admin Options](#)
- [About RBI 581 ISO-Risk Plot Preferences](#)
- [About Inspection Auto-Selection](#)
- [RBI 581 Inspection Auto-Selection Workflow](#)
- [RBI 581 Inventory Grouping Workflow](#)
- [Access the RBI 581 Admin Options Workspace](#)
- [Access the RBI 581 ISO-Risk Plot Preferences Workspace](#)
- [Access the Inspection Auto-Selection Workspace](#)
- [Access the RBI 581 Inventory Groups Workspace](#)
- [Create an Inventory Group Configuration Record](#)
- [Delete an Inventory Group Configuration Record](#)
- [Link Components to an Inventory Group](#)
- [Unlink Components from an Inventory Group](#)
- [Use the Upgrade APM Version 3 Active Analyses Utility](#)

Access the Global Preferences Workspace

Before You Begin

- You can access the **Global Preferences** workspace only if you are a member of the MI RBI Administrator Security Group or a super user.

Procedure



- In the module navigation menu, select **Admin > Application Settings > Risk Based Inspection**.

The **RBI Admin Preferences** page appears, displaying the **Global Preferences** workspace.

The screenshot shows the 'Global Preferences' workspace within the 'RBI Admin Preferences' page. The workspace contains several settings, each with a checkbox and a description:

- Use Interpolation for Stress Reference Tables**: . Description: If this option is selected, linear interpolation will be employed to determine stress as a function of temperature. This simply means that for a value of temperature, the corresponding value of stress can be solved by evaluating temperature between the tabulated values of stress and temperature. It is assumed that stress and temperature vary linearly between the tabulated values. If this option is not selected, stress will be determined by finding the tabulated stress that satisfies the specified temperature.
- Recommendation Creation Enabled**: . Description: Lets you create RBI Recommendation records.
- Enable Recommendation To be Generated at Created State**: . Description: Allows RBI Recommendations to be Generated on an Analysis in a Created State.
- Allow Override of Calculated Unmitigated Risk Values**: . Description: Lets you use the Risk Matrix to change calculated unmitigated risk values manually.
- Consider Half-Life when Determining Inspection Task Interval**: . Description: When enabled, while promoting an RBI 580 analysis to AGM, the Interval field on the AGM action compares the half life value calculated by TM module with the Recommended Interval Scope in the RBI Recommendation family.
- Evaluate all RBI 581 Risk Targets**: . Description: When enabled, while calculating a RBI 581 analysis, Safety Health and Environmental Risk, Financial Risk and Damage Factor targets will be considered for calculating Target Inspection Date. The most conservative date will be used.
- Implement Recommended Actions to Tasks in ASM**: . Description: When checked, recommended actions will be implemented to tasks within the ASM module.
- RBI Evergreening Preference**: A dropdown menu set to 'RBI 580'. Description: The type of analyses that should be used for evergreening.
- Upgrade APM Version 3 Active Analyses**: A button labeled 'Upgrade Analyses'. Description: Risk Assessment records will be created for all RBI 580 and RBI 581 active analyses which currently do not have related Risk Assessment records. This will also calculate and set Half Life for any Ext. Corr. Deg. Mech. Evaluations related to any RBI 580 active analyses. This will allow the RBI 580 and RBI 581 analyses to be promoted to AGM and for RBI Recommendations to be generated for RBI 580 active analyses.

- If you want to modify the value in a field:

- Select  .
All the fields in the workspace are enabled.
- As needed, modify values in the [available fields](#).
- Select  .

The value in the field is modified.

About Global Preferences

About RBI Preferences

The Global Preference settings for Risk Based Inspection contain items for the following settings:

- **Use Interpolation for Stress Reference Tables:** If you select this check box, linear interpolation is used to calculate the allowable stress based on the value in the Design Temperature field.

Note: In RBI 581 Risk Analysis, linear interpolation is also used to calculate the flow stress based on the value in the Yield Strength and Tensile Strength fields.

If you do not select this check box, and the value in the Design Temperature field is not an exact match of the metal temperature value available in the stress table, the value in the Allowable Stress is populated based on the following conditions:

- If the design temperature is less than the highest temperature available in the stress table, the next highest temperature value is used to determine the allowable stress value.
- If the design temperature is greater than the highest temperature available in the stress table, the allowable stress value for the highest temperature is populated from the stress table.

By default, this check box is cleared.

- **Recommendation Creation Enabled:** If you select this check box, you can create RBI Recommendation records in RBI. By default, this check box is selected. If you want to recommend actions and manage mitigated risk in ASM, you must modify the baseline configuration by clearing this check box.
- **Enable Recommendations to be Generated at Created State:** Ideally, you must generate Recommendations only for analyses in Risk Completed state. If, however, you want to generate Recommendations for analyses in Created state, you must select this check box.

If you select this check box:

- You can create Recommendations for an analysis in the Created state.
- You cannot create Recommendations for an analysis in the Risk Completed state.

By default, this check box is cleared. You can select it only if the **Recommendation Creation Enabled** check box is selected.

- **Allow Override of Calculated Unmitigated Risk Values:** By default, the unmitigated risk is calculated automatically and displayed on a Degradation Mechanism datasheet, and you cannot modify this value. If, however, you use a custom calculator to calculate unmitigated risk and display it on the Risk Matrix, and you want users to be able to modify the calculated unmitigated risk, then you must select this check box.
- **Hide RBI Risk Matrix:** This setting determines the visibility of the RBI Risk Matrix on RBI 580 Analyses.
- **Consider Half-Life when Determining Inspection Task Interval:** This setting determines how the Desired Interval field in ASM action is populated.

The value in the Desired Interval field in ASM action is determined by the minimum values of the following fields:

- RBI Recommendation Interval Scope Value
- RBI Half-Life from Criticality Calculator Internal Corrosion
- TM Half-Life of the Asset

You can select this check box only if the Thickness Monitoring license is active. By default, this check box is cleared.

- **Evaluate all RBI 581 Risk Targets:** This setting allows you to enable or disable Evaluation of All Risk Targets. When you enable the Evaluation of All Risk Targets feature and calculate an RBI 581 analysis, the Safety Health and Environmental (SHE) Risk, the Financial Risk, and the Damage Factor targets are evaluated to determine a new value in the Target Inspection Date field. The Target Inspection Date field is then used to determine the value in the Driving Risk Target field, and the value for Driving Risk Target field is set to the risk target that has the most conservative Target Inspection Date value. The resulting target and Target Inspection Date are also used to determine mitigation of risk.
- **Implement Recommended Actions to Tasks in ASM:** This setting allows you to specify where the recommended actions are implemented.
 - If you select this check box, the RBI sourced Recommended Actions are implemented in Tasks in ASM.
 - If you do not select this check box, the RBI sourced Recommended Actions are implemented in Tasks in **Inspection Plan** page for the Asset.

Note: This setting is mapped to the **Implement Recommended Actions to Tasks in ASM** setting in the Inspection Management module. Any change in this setting is updated to the corresponding setting in the Inspection Management module.

- **Enable Inspection Grouping:** If you select this check box, the Inspection Grouping workflow is enabled and the **Open Inspection Group** button appears in the **Process Units** section of the **Risk Based Inspection Overview** page.
- **RBI Analysis Type Preference:** This setting allows you to select the type of analyses that should be used for evergreening and data export.
- **Enable Release type calculation as per RFI-8388:** RBI 581 calculator is currently certified to API 581, 3rd edition, Addendum 1. A suggestion to change the release type calculation was presented in the 2021 API 581 sub-committee spring meeting. Since it will take time for the specification to be updated with the proposed changes, GE Digital is providing an optional setting to calculate the release type as per the proposed ballot. If you opt for this change, the calculation will not be certified to API 581, 3rd edition, Addendum 1.

Important: With the exception of modifying your administrative settings to use new functionality, you should not modify the administrative settings after you have configured them and users have started creating RBI Analyses using those settings.

About RBI Overview Preferences

The RBI Overview Preference settings for Risk Based Inspection contains the following settings:

- **RBI Overview Graph Preference:** This allows you to specify which type of analyses to be used to plot risk values on the graphs that appear in the Asset Overview, Component Overview, and Corrosion Loop Overview sections in RBI.

You can select one of the following values in the drop-down list box:

- **RBI 580:** If you select this value, the risk values of only RBI Criticality Analyses, RBI PRD Criticality Analyses, and RBI Pipeline Analyses are plotted.
- **RBI 581:** If you select this value, the risk values of only RBI 581 Risk Analyses are plotted.
- **580 and 581:** If you select this value, the risk values of all types of analyses in RBI are plotted.

About Evaluation of All Risk Targets in RBI 581

In an RBI 581 analysis, users can select a Driving Risk Target which is used to calculate a Target Inspection Date.

When you enable Evaluation of All Risk Targets in the Global Preferences and calculate an RBI 581 analysis, GE Digital APM will determine which risk target to use for a Target Inspection Date based on which risk target is exceeded first. The risk target that is used is also the Driving Risk Target.

Evaluation of All Risk Targets uses the following risk targets to calculate a Target Inspection Date:

- Safety, Health, and Environmental (SHE) Risk
- Financial Risk
- Damage Factor

After evaluation, the Target Inspection Date is used to determine the Driving Risk Target, and the value for Driving Risk Target is set to the risk target that had the most conservative Target Inspection Date.

If two or more risk targets have the same calculated Target Inspection Date, the risk targets are prioritized as follows:

1. Safety, Health, and Environmental (SHE) Risk
2. Damage Factor
3. Financial Risk

Applying Evaluation of All Risk Targets

To use this feature, the following fields must be added to the Planning Targets section in the 581 Risk Analysis datasheet:

- Target Inspection Date based on Damage Factor Maximum.
- Target Inspection Date based on Financial Risk.
- Target Inspection Date based on SHE Risk

If the user selects a Driving Risk Target in the analysis while this setting is enabled, their selection is overridden, and the Driving Risk Target is selected based on the Evaluation of All Risk Targets.

Note: This feature does not apply to Tank Bottoms. The Driving Risk Target for a Tank Bottom will always be the Financial Risk.

About RBI 581 Admin Options

The **RBI 581 Admin Options** workspace allows you to define default field values in the following families:

- RBI 581 Risk Analysis
- RBI 581 Consequence Evaluation
- RBI 581 Thinning and Lining Evaluation
- RBI 581 External Damage Evaluation
- RBI 581 External Cracking Damage Evaluation

You can define these settings to:

- All the records of a family (i.e., globally)
- or-
- Only the records in a specific process unit

A setting for a specific process unit will take precedence over a global setting. For example, if the global setting for Population Density for RBI 581 Consequence Evaluation records was set to 100, and another setting existed specifically for the FCC REACTOR & REGENERATOR Process Unit, which set Population Density to 80, RBI 581 Consequence Evaluation records created for RBI 581 Risk Analyses linked to the FCC REACTOR & REGENERATOR Process Unit would have the Population Density field set to 80.

Each individual setting appears as a node under the RBI581AdminOptions parent node. You will define the settings based on the specific requirements of your organization.

For each node, the following fields are available:

- **Target Family:** The family of records for which you want to define a default field value.
- **Target Field:** The field in the target family for which you want to define a default value.
Tip: The list of values in this field is not alphabetical. To search for a field, enter the name of the field directly into the Target Field field. The list will be filtered.
- **Data Type of Field:** The data type of the target field. This field is disabled and populated automatically.
- **Numeric Field Value:** The default value for the target field. This field is enabled only if the value in the Data Type of Field column is Numeric.
- **Process Unit:** The specific Process Unit to which this setting will apply. This property is enabled only if the **Is Global Setting** check box is cleared. The list is populated with Functional Locations for which the **Is a Process Unit?** check box is selected.
- **Is Global Setting:** When this check box is selected, this setting will apply to all the new records in the target family.
- **Character Field Value:** The absolute value for the target field. This property is enabled only if the value in the Data Type of Field field is Character.

Settings in the RBI 581 Admin Options Workspace

The following table provides a list of settings in the **RBI 581 Admin Options** workspace. For numeric fields, you must enter values only in English standard units.

Target Field	Is Global Setting	Field Value	Notes
Target Family: RBI 581 Consequence Evaluation			
Population Density	Selected	0.0001	This setting populates the Population Density field in all RBI 581 Consequence Evaluation records with the value 0.0001.
Target Family: RBI 581 Thinning and Lining Evaluation			
Thinning Variance	Selected	0.2	This setting populates the Thinning Variance field in all RBI 581 Thinning and Lining Evaluation records with the value 0.2.
Pressure Variance	Selected	0.05	This setting populates the Pressure Variance field in all RBI 581 Thinning and Lining Evaluation records with the value 0.05.

Target Field	Is Global Setting	Field Value	Notes
Flow Stress Variance	Selected	0.2	This setting populates the Flow Stress Variance field in all RBI 581 Thinning and Lining Evaluation records with the value 0.2.
Corrosion Rate Factor Damage State 3	Selected	4	This setting populates the Corrosion Rate Factor Damage State 3 field in all RBI 581 External Damage Evaluation records with the value 4.
Corrosion Rate Factor Damage State 2	Selected	2	This setting populates the Corrosion Rate Factor Damage State 2 field in all RBI 581 External Damage Evaluation records with the value 2.
Corrosion Rate Factor Damage State 1	Selected	1	This setting populates the Corrosion Rate Factor Damage State 1 field in all RBI 581 External Damage Evaluation records with the value 1.
Target Family: RBI 581 Risk Analysis			
Management Score	Selected	500	This setting populates the Management Score field in all the RBI 581 Risk Analysis records with the value 500.
Target Thinning and Lining Minimum Damage Factor	Selected	5	This setting populates the Target Thinning and Lining Minimum Damage Factor field in all the RBI 581 Risk Analysis records with the value 5.
Target External Minimum Damage Factor	Selected	5	This setting populates the Target External Minimum Damage Factor field in all the RBI 581 Risk Analysis records with the value 5.
Target Cracking Minimum Damage Factor	Selected	5	This setting populates the Target Cracking Minimum Damage Factor field in all the RBI 581 Risk Analysis records with the value 5.
Target Damage Factor Max	Selected	1000	This setting populates the Target Damage Factor Max field in all the RBI 581 Risk Analysis records with the value 1000.

Target Field	Is Global Setting	Field Value	Notes
Target SHE Risk	Selected	35	This setting populates the Target SHE Risk field in all the RBI 581 Risk Analysis records with the value 35.
Target Financial Risk	Selected	10000	This setting populates the Target Financial Risk field in all the RBI 581 Risk Analysis records with the value 10000.
Plan Period	Selected	10	This setting populates the Plan Period field in all the RBI 581 Risk Analysis records with the value 10.
Driving Risk Target	Selected	Safety, Health and Environmental Risk	This setting populates the Driving Risk Target field in all the RBI 581 Risk Analysis records with the value Safety, Health and Environmental Risk.
Data Confidence	Selected	Low Confidence Data	This setting populates the Data Confidence field in all the RBI 581 Risk Analysis records with the value Low Confidence Data.
Target Family: RBI 581 External Damage Evaluation			
Thinning Variance	Selected	0.2	This setting populates the Thinning Variance field in all the RBI 581 External Damage Evaluation records with the value 0.2.
Pressure Variance	Selected	0.05	This setting populates the Pressure Variance field in all the RBI 581 External Damage Evaluation records with the value 0.05.
Flow Stress Variance	Selected	0.2	This setting populates the Flow Stress Variance field in all the RBI 581 External Damage Evaluation records with the value 0.2.
Corrosion Rate Factor Damage State 3	Selected	4	This setting populates the Corrosion Rate Factor Damage State 3 field in all the RBI 581 External Damage Evaluation records with the value 4.

Target Field	Is Global Setting	Field Value	Notes
Corrosion Rate Factor Damage State 2	Selected	2	This setting populates the Corrosion Rate Factor Damage State 2 field in all the RBI 581 External Damage Evaluation records with the value 2.
Corrosion Rate Factor Damage State 1	Selected	1	This setting populates the Corrosion Rate Factor Damage State 1 field in all the RBI 581 External Damage Evaluation records with the value 1.
Atmospheric Condition	Selected	Temperate	This setting populates the Atmospheric Condition field in all the RBI 581 External Damage Evaluation records with the value Temperate.
Target Family: RBI 581 External Cracking Damage Evaluation			
Atmospheric Condition	Selected	Temperate	This setting populates the Atmospheric Condition field in all the RBI 581 External Cracking Damage Evaluation records with the value Temperature.

About RBI 581 ISO-Risk Plot Preferences

The **RBI 581 ISO-Risk Plot Preferences** workspace allows you to modify the default values of the following parameters that are used in the RBI 581 ISO Risk Plot.

The values that you enter must satisfy the following conditions:

- All values must be numeric.
- All values must be greater than 0 because the graph is plotted on a logarithmic scale.
- The lower limits must be less than the upper limits.
- The upper limits for each risk level must be in ascending order. For example, the upper limit for the Low risk level must be less than the upper limit for the Medium risk level.

Note: The units of measure can vary depending on the UOM Conversion Set that you use. For example, if you use the Metric conversion set, the Consequence of Failure will be measured in square meters instead of square feet.

Parameter	Description	Default Value
The SHE Risk section		
RBI 581 ISO-Risk Plot Minimum Probability (Events/Year)	The lower limit for the Probability of Failure values that are plotted on the vertical axis of the SHE Risk graph.	0.00000306
RBI 581 ISO-Risk Plot Maximum Probability (Events/Year)	The upper limit for the Probability of Failure values that are plotted on the vertical axis of the SHE Risk graph.	0.306

Parameter	Description	Default Value
RBI 581 ISO-Risk Plot Minimum Consequence (Square Feet)	The lower limit for the Consequence of Failure values that are plotted on the horizontal axis of the SHE Risk graph.	10
RBI 581 ISO-Risk Plot Maximum Consequence (Square Feet)	The upper limit for the Consequence of Failure values that are plotted on the horizontal axis of the SHE Risk graph.	1000000
RBI 581 ISO-Risk Plot Low Category Limit (Square Feet Per Year)	The upper limit for the risk level, Low.	0.1
RBI 581 ISO-Risk Plot Medium Category Limit (Square Feet Per Year)	The upper limit for the risk level, Medium.	10
RBI 581 ISO-Risk Plot Medium-High Category Limit (Square Feet Per Year)	The upper limit for the risk level, Medium High. If a data point contains a value higher than this limit, the risk level is High.	1000
The Financial Risk section		
RBI 581 ISO-Risk Plot Minimum Probability (Events/Year)	The lower limit for the Probability of Failure values that are plotted on the vertical axis of the Financial Risk graph.	0.00000306
RBI 581 ISO-Risk Plot Maximum Probability (Events/Year)	The upper limit for the Probability of Failure values that are plotted on the vertical axis of the Financial Risk graph.	0.306
RBI 581 ISO-Risk Plot Minimum Consequence (United States Dollar)	The lower limit for the Consequence of Failure values that are plotted on the horizontal axis of the Financial Risk graph.	1000
RBI 581 ISO-Risk Plot Maximum Consequence (United States Dollar)	The upper limit for the Consequence of Failure values that are plotted on the horizontal axis of the Financial Risk graph.	100000000
RBI 581 ISO-Risk Plot Low Category Limit (USD/Year)	The upper limit for the risk level, Low.	10
RBI 581 ISO-Risk Plot Medium Category Limit (USD/Year)	The upper limit for the risk level, Medium.	1000
RBI 581 ISO-Risk Plot Medium-High Category Limit (USD/Year)	The upper limit for the risk level, Medium High. If a data point contains a value higher than this limit, the risk level is High.	100000

About Inspection Auto-Selection

The Inspection Auto-Selection feature allows you to automatically assign an Inspection to a Degradation Mechanism Evaluation (DME) in RBI 581. By default, this feature is disabled. You can enable the feature by [accessing the Inspection Auto-Selection workspace](#).

For each DME for which you want GE Digital APM to assign Inspections automatically, an RBI Inspection Auto-Selection Criteria record must exist. This record stores the following details:

- The analysis that is performed on the DM
- The DM methodology of the DM
- The equivalent DM methodology
- The years of Inspection History to be considered while linking Inspections

The following table provides a list of baseline RBI Inspection Auto-Selection Criteria records and their field values. You can access these records only after you enable the Inspection Auto-Selection feature.

Analysis Family	DM Methodology	Equivalent DM Methodology	Degradation Mechanism	Years of Inspection History
RBI 581 Risk Analysis	RBI 581 External Cracking Damage Evaluation	Blank	Blank	20
RBI 581 Risk Analysis	RBI 581 External Damage Evaluation	Criticality Ext. Corr. Deg. Mech. Eval.	Blank	20
RBI 581 Risk Analysis	RBI 581 Thinning and Lining Evaluation	Criticality Int. Corr. Deg. Mech. Eval.	Blank	20
RBI 581 Risk Analysis	RBI 581 Cracking Damage Evaluation	Criticality Env. Crack. Deg. Mech. Eval.	Blank	20
RBI 581 Risk Analysis	RBI 581 Thinning and Lining Evaluation	Criticality Int. Corr. Deg. Mech. Eval.	581-Atmospheric Tank Bottom Corrosion	20

When you create, duplicate, or apply an RBI 581 Risk Analysis, all the Inspections that meet the criteria specified in the RBI Inspection Auto-Selection Criteria record are assigned to the DME automatically.

The maximum number of Inspections that can be assigned to RBI 581 Cracking Damage Evaluation or RBI 581 External Cracking Damage Evaluation is six. Therefore, among the Inspections that meet the criteria specified in the RBI Inspection Auto-Selection Criteria record, only the latest six Inspections are assigned to the DME. Similarly, the maximum number of Inspections that can be assigned to the 581-Atmospheric Tank Bottom Corrosion DM is one. Therefore, only the latest Inspection (among the ones that meet the criteria) is assigned to the corresponding DME.

Note: Inspections are also assigned automatically when you create an RBI 581 Risk Analysis using the Risk Based Inspection (RBI) 581 Data Loader.

Even after you delete an RBI Inspection Auto-Selection Criteria record, Inspections are automatically assigned to a DME. These Inspections, however, are not filtered based on the criteria specified in the record.

Example

Suppose you have created an RBI 581 Risk Analysis on 17th March, 2017, which is linked to the 581-Amine Corrosion DM.

The following RBI Criticality Auto-Selection Criteria record is used to assign Inspections to all the DMs that are linked to RBI 581 Thinning and Lining Evaluation (which includes 581-Amine Corrosion).

Field	Value
Analysis Family	RBI 581 Risk Analysis
DM Methodology	RBI 581 Thinning and Lining Evaluation
Equivalent DM Methodology	Criticality Int. Corr. Deg. Mech. Eval.
Degradation Mechanism	Blank
Years of Inspection History	20

Suppose the following Inspections appear in the Inspection History for 581-Amine Corrosion:

Inspection ID	Inspection Confidence	Degradation Mechanism	Completion Date
Insp-1	A	581-Amine Corrosion	06/15/2012 00:00:00
Insp-2	A	581-Cooling Water Corrosion	08/18/2014 10:30:00
Insp-3	B	Criticality Calculator Internal Corrosion	11/25/1995 05:00:00
Insp-4	C	581-Amine Corrosion	01/15/2000 06:00:00
Insp-5	C	581-Acid Sour Water Corrosion	01/28/1990 04:45:00
Insp-6	B	581-High Temperature Oxidation	06/02/2012 06:15:00
Insp-7	A	Criticality Calculator Internal Corrosion	10/13/2012 07:30:00

Among the Inspections in the previous table, the following Inspections are not assigned to 581-Amine Corrosion because they were completed more than 20 years ago:

- Insp-3
- Insp-5

The remaining Inspections are automatically assigned to 581-Amine Corrosion because they satisfy the following conditions:

- They are linked to a DM that belongs to either RBI 581 Thinning and Lining Evaluation or Criticality Int Corr. Deg. Mech. Eval.
- They were completed less than 20 years ago.

Now, suppose you have created an RBI Inspection Auto-Selection Criteria record with the following details:

Field	Value
Analysis Family	RBI 581 Risk Analysis
DM Methodology	RBI 581 Thinning and Lining Evaluation
Equivalent DM Methodology	Criticality Int. Corr. Deg. Mech. Eval.
Degradation Mechanism	581-Amine Corrosion
Years of Inspection History	10

Suppose you have created another RBI 581 Risk Analysis on 17th March, 2017, which is linked to 581-Amine Corrosion.

In this case, only Insp-1 will be assigned to 581-Amine Corrosion. Although Insp-4 is also linked to 581-Amine Corrosion, it will not be automatically assigned to the DM because the Inspection was completed more than 10 years ago.

RBI 581 Inspection Auto-Selection Workflow

This workflow provides the basic, high-level steps for the Inspection Auto-Selection feature. The steps and links in this workflow do not necessarily reference every possible procedure. For more procedures, see the links in the Related Information section.

1. Access the [Inspection Auto-Selection](#) workspace.
2. In the upper-right corner of the workspace, select the **Inspection Auto-Selection** check box.
3. Review [the baseline RBI Inspection Auto-Selection Criteria records](#).
4. In RBI, [create an RBI Component](#), and [link it to Potential Degradation Mechanisms \(PDMs\)](#).
5. [Create an RBI 581 Risk Analysis](#).

Inspections are automatically assigned to the DMEs based on the criteria in the RBI Inspection Auto-Selection Criteria record.

6. Review the Inspections assigned automatically to the DMEs.

For RBI 581 Thinning and Lining Evaluation (only if evaluating 581-Atmospheric Tank Bottom Corrosion), RBI 581 Cracking Damage Evaluation, and RBI 581 External Cracking Damage Evaluation, the following fields are populated automatically:

- Use Combined Confidence
- Number of Highest Effective Inspections
- Highest Effective Inspection Level

For RBI 581 Thinning and Lining Evaluation (if evaluating a Damage Mechanism (DM) other than 581-Atmospheric Tank Bottom Corrosion) and RBI 581 External Damage Evaluation, the following fields are populated automatically:

- Use Related Inspections
- Number of A Level Inspections
- Number of B Level Inspections
- Number of C Level Inspections
- Number of D Level Inspections

RBI 581 Inventory Grouping Workflow

The Inventory Grouping feature allows you to group RBI Components that belong to a process unit. After you group the components, GE Digital APM calculates the value in the Inventory Group Mass field for the inventory group.

This workflow provides the basic, high-level steps for the Inventory Grouping feature. The steps and links in this workflow do not necessarily reference every possible procedure. For more procedures, see the links in the Related Information section.

1. Access the [RBI 581 Inventory Groups](#) workspace.
2. [Create an Inventory Group Configuration record](#) for the appropriate process unit. This record stores the details of the name and description of the group, and the process unit that is associated with the group.
3. [Link RBI Components to the inventory group](#).
4. In RBI, [access the components that belong to the inventory group](#).
5. Create an RBI 581 Risk Analysis for each component linked to the inventory group.
6. Access the RBI 581 Consequence Evaluation record associated with each analysis that you have created in the previous step, and then, in the **Common** section of the datasheet, select the **Use Calculated Inventory** check box.

The Inventory Group and Inventory Group Mass fields in the RBI 581 Consequence Evaluation are populated automatically.

Tip: If the **Use Calculated Inventory** check box is already selected, clear the check box, and then select it. This will update the inventory group mass value.

Access the RBI 581 Admin Options Workspace

Before You Begin

- You can access the **RBI 581 Admin Options** workspace only if:
 - The RBI 581 license is active.
 - You are a member of the MI RBI Administrator Security Group or a super user.

Procedure

1. In the module navigation menu, select **Admin > Application Settings > Risk Based Inspection**. The **RBI Admin Preferences** page appears, displaying the **Global Preferences** workspace.

The screenshot shows a web application interface with a navigation menu on the left and a main content area. The navigation menu includes options like 'Global Preferences', 'RBI Overview Preferences', 'RBI 581 Admin Options', 'RBI 580 Flexible Calculation Preferences', 'RBI 581 ISO-Risk Plot Preferences', 'Inspection Auto-Selection', and 'RBI 581 Inventory Groups'. The 'Global Preferences' option is selected. The main content area is titled 'Global Preferences' and contains several settings:

- Use Interpolation for Stress Reference Tables**: . Description: If this option is selected, linear interpolation will be employed to determine stress as a function of temperature. This simply means that for a value of temperature, the corresponding value of stress can be solved by evaluating temperature between the tabulated values of stress and temperature. It is assumed that stress and temperature vary linearly between the tabulated values. If this option is not selected, stress will be determined by finding the tabulated stress that satisfies the specified temperature.
- Recommendation Creation Enabled**: . Description: Lets you create RBI Recommendation records.
- Enable Recommendation To be Generated at Created State**: . Description: Allows RBI Recommendations to be Generated on an Analysis in a Created State.
- Allow Override of Calculated Unmitigated Risk Values**: . Description: Lets you use the Risk Matrix to change calculated unmitigated risk values manually.
- Consider Half-Life when Determining Inspection Task Interval**: . Description: When enabled, while promoting an RBI 580 analysis to ASM, the Interval field on the ASM action compares the half-life value calculated by TM module with the Recommended interval Scope in the RBI Recommendation family.
- Evaluate all RBI 581 Risk Targets**: . Description: When enabled, while calculating a RBI-581 analysis, Safety Health and Environmental Risk, Financial Risk and Damage Factor targets will be considered for calculating Target Inspection Date. The most conservative date will be used.
- Implement Recommended Actions to Tasks in ASM**: . Description: When checked, recommended actions will be implemented to tasks within the ASM module.
- RBI Evergreening Preference**: A dropdown menu set to 'RBI 581'. Description: The type of analyses that should be used for evergreening.
- Upgrade APM Version 3 Active Analyses**: A button labeled 'Upgrade Analyses'. Description: Risk Assessment records will be created for all RBI 580 and RBI 581 active analyses which currently do not have related Risk Assessment records. This will also calculate and set Half-Life for any Ext. Corr. Deg. Mech. Evaluations related to any RBI 580 active analyses. This will allow the RBI 580 and RBI 581 analyses to be promoted to ASM and for RBI Recommendations to be generated for RBI 580 active analyses.

2. In the left pane, select **RBI 581 Admin Options**. The **RBI 581 Admin Options** workspace appears, allowing you to modify the [settings](#).

The screenshot shows a web application interface with a sidebar on the left containing a list of preference categories. The main content area displays the 'RBI 581 Admin Options' table. The table has four columns: 'Target Family - Value(s)', 'Target Field - Value(s)', 'Data Type Of Field - ...', and 'Numeric File'. Each row represents a specific preference setting, with a checkmark in the first column indicating it is active. The 'Data Type Of Field' column consistently shows 'Numeric'.

	Target Family - Value(s)	Target Field - Value(s)	Data Type Of Field - ...	Numeric File
✓	RBI 581 Consequence Evaluation	Population Density	Numeric	0.0001
✓	RBI 581 Thinning and Lining Evaluation	Thinning Variance	Numeric	0.2
✓	RBI 581 Thinning and Lining Evaluation	Pressure Variance	Numeric	0.05
✓	RBI 581 Thinning and Lining Evaluation	Flow Stress Variance	Numeric	0.2
✓	RBI 581 Thinning and Lining Evaluation	Corrosion Rate Factor Damage State 3	Numeric	4
✓	RBI 581 Thinning and Lining Evaluation	Corrosion Rate Factor Damage State 2	Numeric	2
✓	RBI 581 Thinning and Lining Evaluation	Corrosion Rate Factor Damage State 1	Numeric	1
✓	RBI 581 Risk Analysis	Management Score	Numeric	500
✓	RBI 581 Risk Analysis	Target Thinning And Lining Minimum Damage Factor	Numeric	5

Access the RBI 581 ISO-Risk Plot Preferences Workspace

Before You Begin

- You can access the **RBI 581 ISO-Risk Plot Preferences** workspace only if:
 - The RBI 581 license is active.
 - You are a member of the MI RBI Administrator Security Group or a super user.

Procedure



1. In the module navigation menu, select **Admin > Application Settings > Risk Based Inspection**.
The **RBI Admin Preferences** page appears, displaying the **Global Preferences** workspace.

The screenshot shows a web application window titled "RBI Admin Preferences". The left sidebar contains a list of preference categories: "Global Preferences" (selected), "RBI Overview Preferences", "RBI 581 Admin Options", "RBI 580 Flexible Calculation Preferences", "RBI 581 ISO-Risk Plot Preferences", "Inspection Auto-Selection", and "RBI 581 Inventory Groups". The main content area is titled "Global Preferences" and contains several settings:

- Use Interpolation for Stress Reference Tables**: . Description: If this option is selected, linear interpolation will be employed to determine stress as a function of temperature. This simply means that for a value of temperature, the corresponding value of stress can be solved by evaluating temperature between the tabulated values of stress and temperature. It is assumed that stress and temperature vary linearly between the tabulated values. If this option is not selected, stress will be determined by finding the tabulated stress that satisfies the specified temperature.
- Recommendation Creation Enabled**: . Description: Lets you create RBI Recommendation records.
- Enable Recommendation To be Generated at Created State**: . Description: Allows RBI Recommendations to be Generated on an Analysis in a Created State.
- Allow Override of Calculated Unmitigated Risk Values**: . Description: Lets you use the Risk Matrix to change calculated unmitigated risk values manually.
- Consider Half-Life when Determining Inspection Task Interval**: . Description: When enabled, while promoting an RBI 580 analysis to ASM, the Interval field on the ASM action compares the half-life value calculated by TM module with the Recommended Interval Scope in the RBI Recommendation family.
- Evaluate all RBI 581 Risk Targets**: . Description: When enabled, while calculating a RBI 581 analysis, Safety Health and Environmental Risk, Financial Risk and Damage Factor targets will be considered for calculating Target Inspection Date. The most conservative date will be used.
- Implement Recommended Actions to Tasks in ASM**: . Description: When checked, recommended actions will be implemented to tasks within the ASM module.
- RBI Evergreening Preference**: A dropdown menu currently set to "RBI 581". Description: The type of analyses that should be used for evergreening.
- Upgrade APM Version 3 Active Analyses**: A blue button labeled "Upgrade Analyses". Description: Risk Assessment records will be created for all RBI 580 and RBI 581 active analyses which currently do not have related Risk Assessment records. This will also calculate and set Half-Life for any Ext. Corr. Deg. Mech. Evaluations related to any RBI 580 active analyses. This will allow the RBI 580 and RBI 581 analyses to be promoted to ASM and for RBI Recommendations to be generated for RBI 580 active analyses.

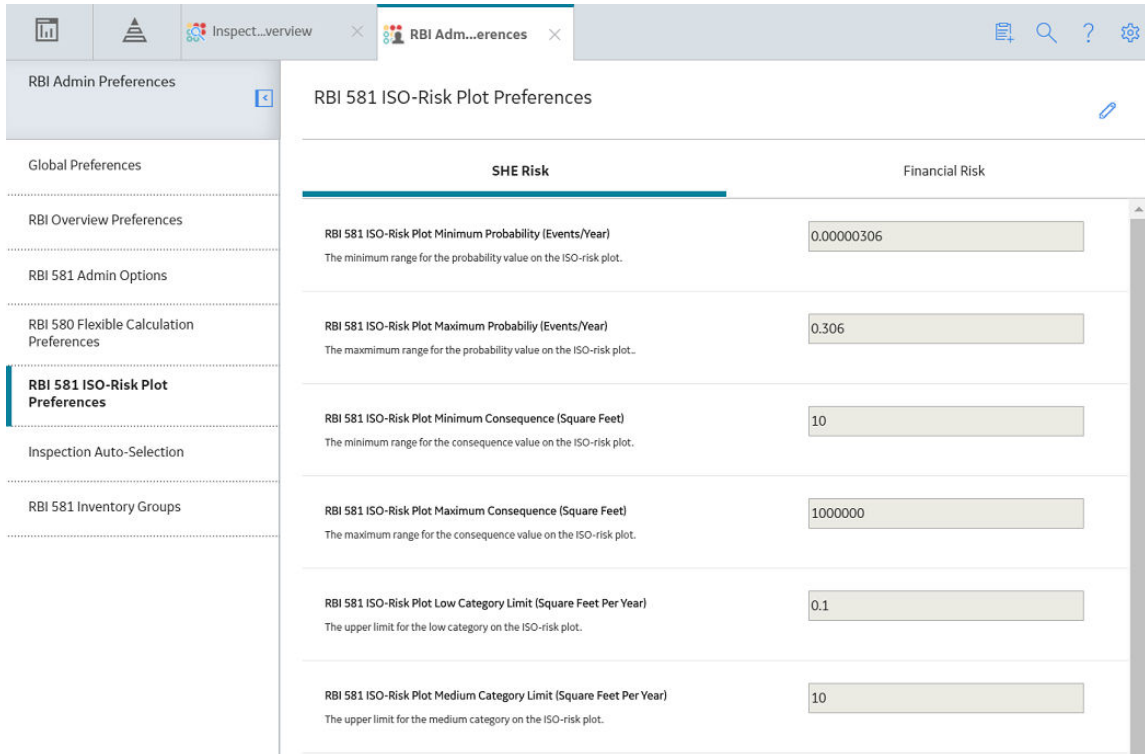
- In the left pane, select **RBI 581 ISO Risk Plot Preferences**.
The **RBI 581 ISO-Risk Plot Preferences** workspace appears.



3. If you want to modify any of the settings, then:
 - a. In the upper-right corner of the workspace, select .
 - b. As needed, modify values in the [available fields](#).
 - Note:** You must enter a numeric value greater than 0.
 - c. In the upper-right corner of the workspace, select .

The RBI 581 ISO-Risk Plot settings are modified.

Access the Inspection Auto-Selection Workspace

Before You Begin

- You can access the **Inspection Auto-Selection** workspace only if:
 - The RBI 581 license is active.
 - You are a member of the MI RBI Administrator Security Group or a super user.

Procedure

1. In the module navigation menu, select **Admin > Application Settings > Risk Based Inspection**.
The **RBI Admin Preferences** page appears, displaying the **Global Preferences** workspace.

The screenshot shows the 'RBI Admin Preferences' window with the 'Global Preferences' tab active. The left sidebar contains the following items:

- RBI Admin Preferences
- Global Preferences**
- RBI Overview Preferences
- RBI 581 Admin Options
- RBI 580 Flexible Calculation Preferences
- RBI 581 ISO-Risk Plot Preferences
- Inspection Auto-Selection
- RBI 581 Inventory Groups

The main content area of the 'Global Preferences' tab includes the following settings:

- Use Interpolation for Stress Reference Tables**: . Description: If this option is selected, linear interpolation will be employed to determine stress as a function of temperature. This simply means that for a value of temperature, the corresponding value of stress can be solved by evaluating temperature between the tabulated values of stress and temperature. It is assumed that stress and temperature vary linearly between the tabulated values. If this option is not selected, stress will be determined by finding the tabulated stress that satisfies the specified temperature.
- Recommendation Creation Enabled**: . Description: Lets you create RBI Recommendation records.
- Enable Recommendation To be Generated at Created State**: . Description: Allows RBI Recommendations to be Generated on an Analysis in a Created State.
- Allow Override of Calculated Unmitigated Risk Values**: . Description: Lets you use the Risk Matrix to change calculated unmitigated risk values manually.
- Consider Half-Life when Determining Inspection Task Interval**: . Description: When enabled, while promoting an RBI 580 analysis to ASM, the Interval field on the ASM action compares the half-life value calculated by TM module with the Recommended Interval Scope in the RBI Recommendation family.
- Evaluate all RBI 581 Risk Targets**: . Description: When enabled, while calculating a RBI-581 analysis, Safety Health and Environmental Risk, Financial Risk and Damage Factor targets will be considered for calculating Target Inspection Date. The most conservative date will be used.
- Implement Recommended Actions to Tasks in ASM**: . Description: When checked, recommended actions will be implemented to tasks within the ASM module.
- RBI Evergreening Preference**: A dropdown menu currently set to 'RBI 581'. Description: The type of analyses that should be used for evergreening.
- Upgrade APM Version 3 Active Analyses**: A button labeled 'Upgrade Analyses'. Description: Risk Assessment records will be created for all RBI 580 and RBI 581 active analyses which currently do not have related Risk Assessment records. This will also calculate and set Half-Life for any Ext. Corr. Deg. Mech. Evaluations related to any RBI 580 active analyses. This will allow the RBI 580 and RBI 581 analyses to be promoted to ASM and for RBI Recommendations to be generated for RBI 580 active analyses.

2. In the left pane, select the **Inspection Auto-Selection** tab.

The **Inspection Auto-Selection** workspace appears. By default, the **Inspection Auto-Selection** check box in the upper-right corner of the workspace is cleared.

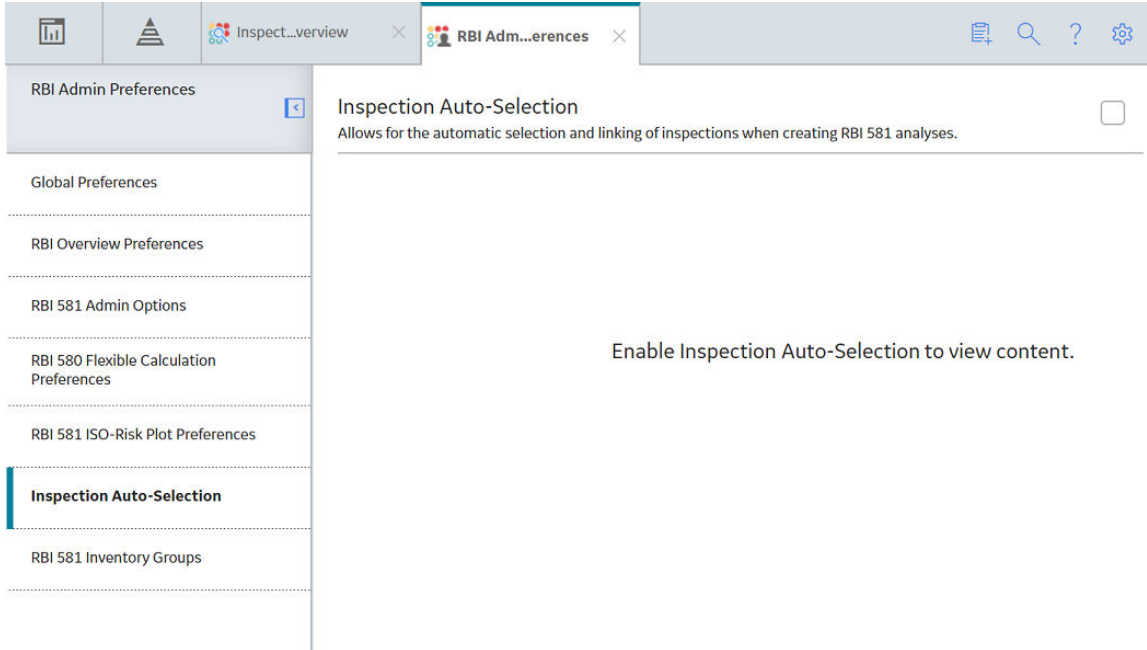

If you select the **Inspection Auto-Selection** check box, the Inspection Auto-Selection feature is enabled, and your preference is saved. A list of baseline RBI Inspection Auto-Selection Criteria records appears in a grid in the workspace.

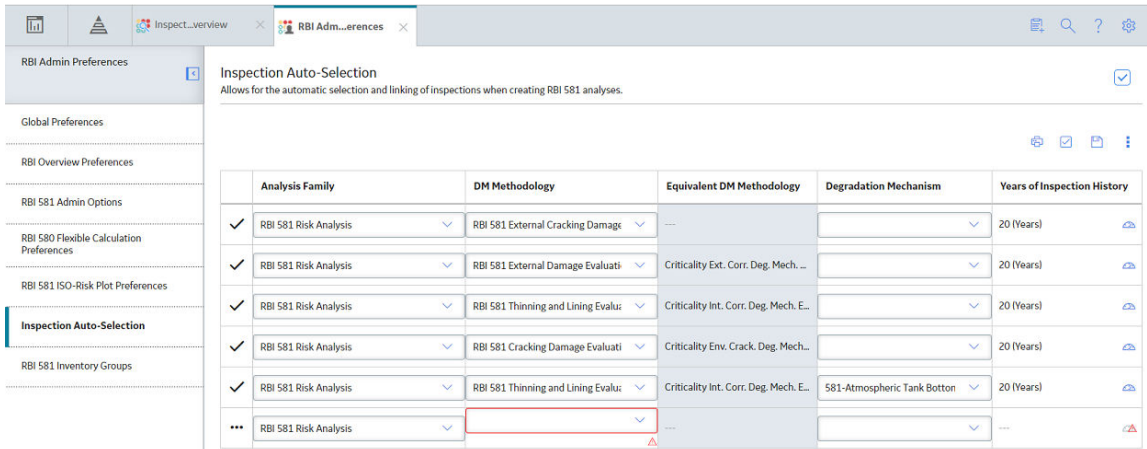

You can modify or delete the baseline records, or create a new one. If Inspection Auto-Selection Criteria records do not exist, then all the applicable Inspections are assigned to the DME automatically.

Access the RBI 581 Inventory Groups Workspace

Before You Begin

- You can access the **RBI 581 Inventory Groups** workspace only if the RBI 581 license is active.

Procedure

- In the module navigation menu, select **Admin > Application Settings > Risk Based Inspection**.

The **RBI Admin Preferences** page appears, displaying the **Global Preferences** workspace.

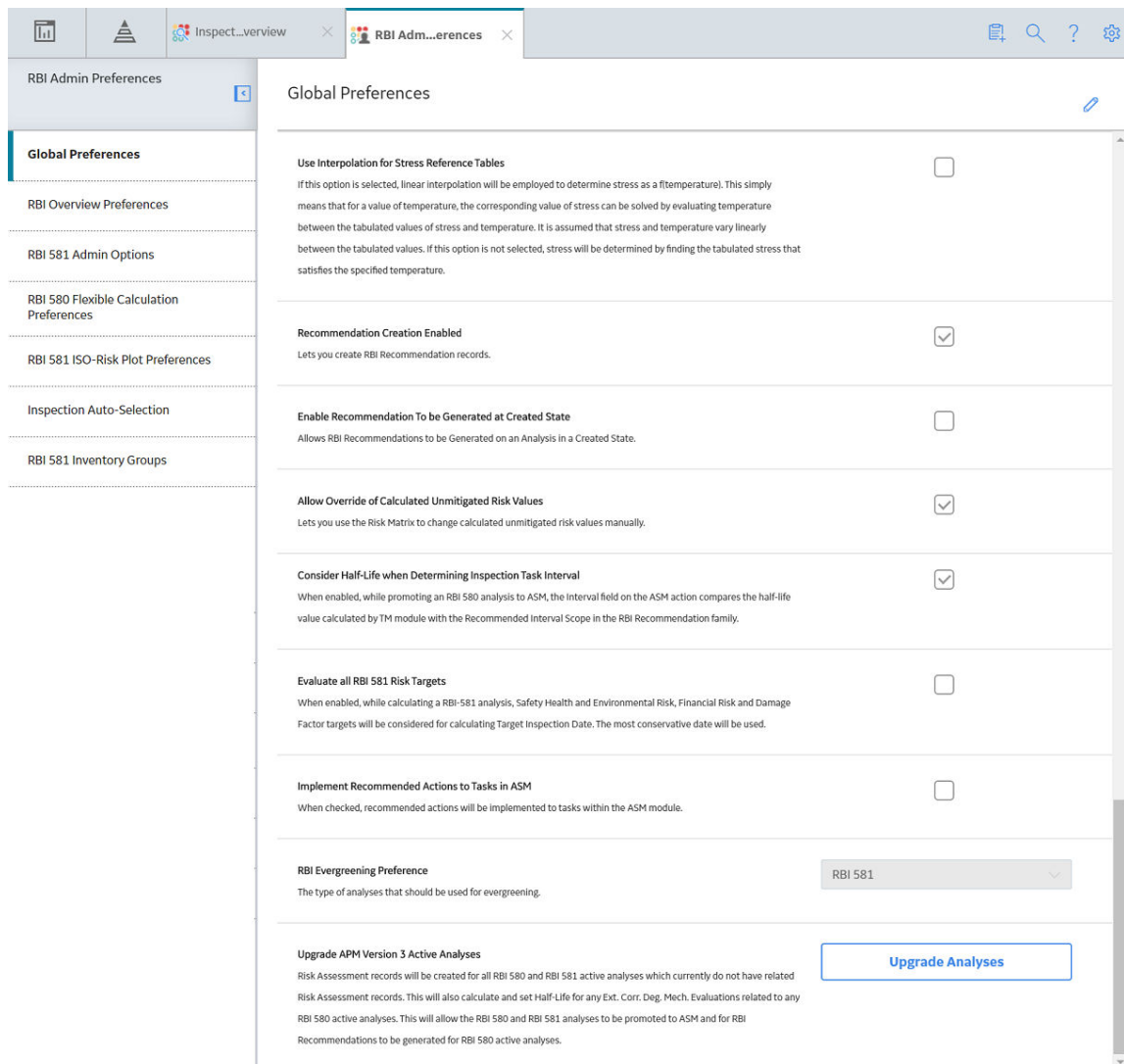

2. In the left pane, select the **RBI 581 Inventory Groups** tab.

The **RBI 581 Inventory Groups** workspace appears, displaying the following information:

- The left section: Provides a list of all the process units (i.e., Functional Location records in which the **Is Unit** check box is selected) in GE Digital APM. The  icon next to a process unit indicates that the process unit contains an inventory group. If you select a process unit, a list of inventory groups in the process unit appears in the left section.
- The details section: Displays the following information based on what you select in the left section:
 - If you select **Process Units** in the left section, the details section displays the **Process Units with Inventory Groups** graph, which plots the number of inventory groups in each process unit. If you pause on a bar on the graph, the name of the process unit and the number of inventory groups in the unit appear. If you select a bar on the graph, the datasheet for the associated Functional Location appears.
 - If you select a process unit in the left section, the details section displays the datasheet for the associated Functional Location.

- If you select an inventory group in the left section, then the details section displays the datasheet of the Inventory Group Configuration record. You can also access a list of components associated with the inventory group by selecting the **Linked Components** tab.

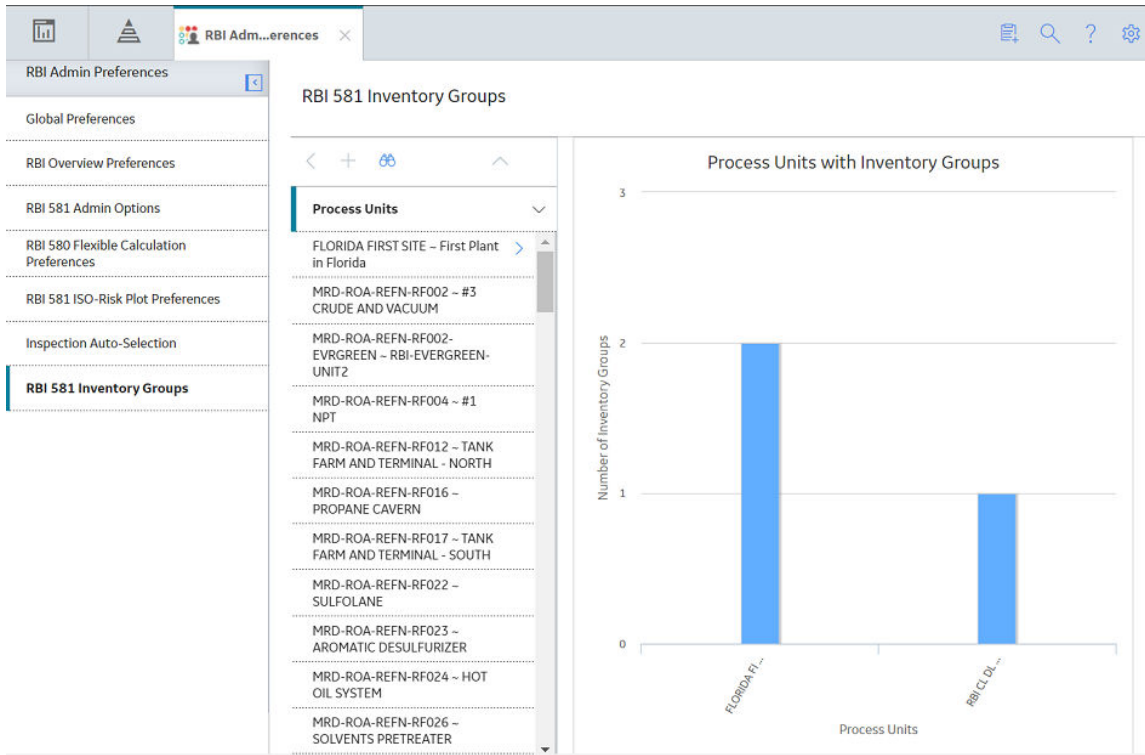

Next Steps

- [Create an Inventory Group Configuration Record.](#)

Create an Inventory Group Configuration Record

Before You Begin

- You can create or modify an Inventory Group Configuration record only if you are a super user or a member of the MI RBI Administrator Security Group.

Procedure

1. [Access the **RBI 581 Inventory Groups** workspace.](#)
2. In the list on the left side of the workspace, select the process unit in which you want to create an Inventory Group Configuration record.

The inventory groups in the process unit appear.

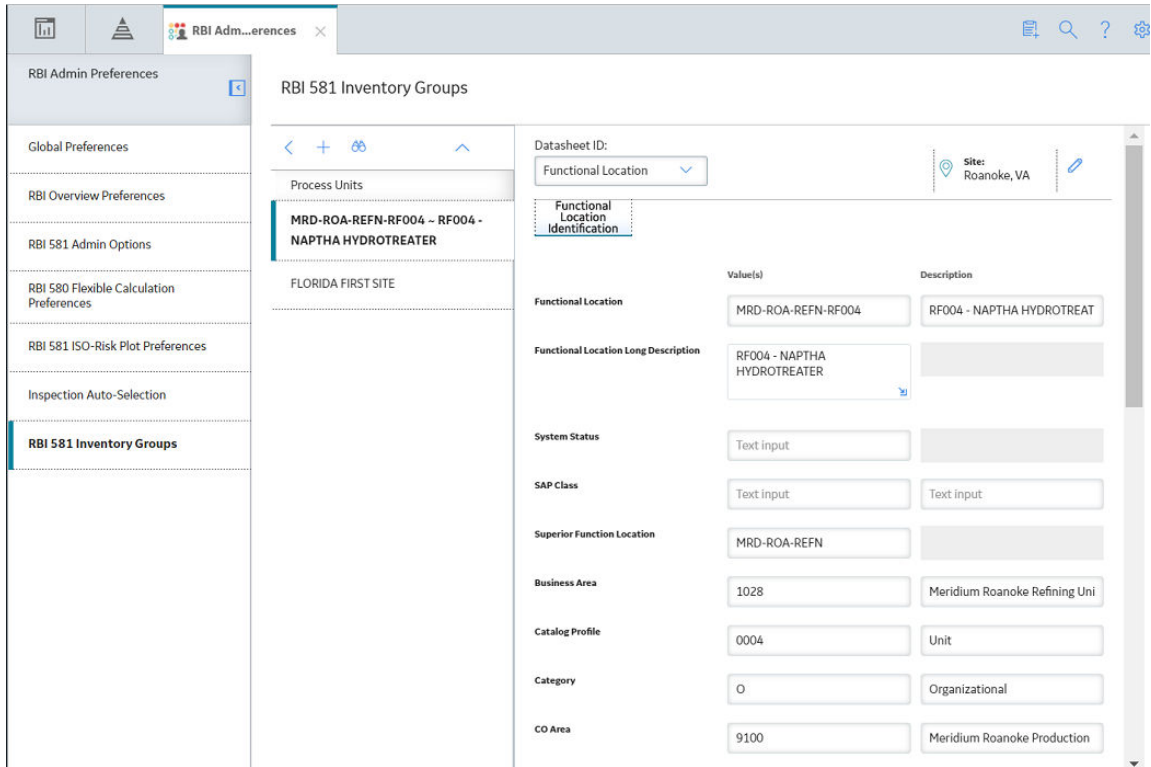

3. In the list on the left side of the workspace, select **+**.

A blank datasheet for the Inventory Group Configuration appears in the **Details** section.

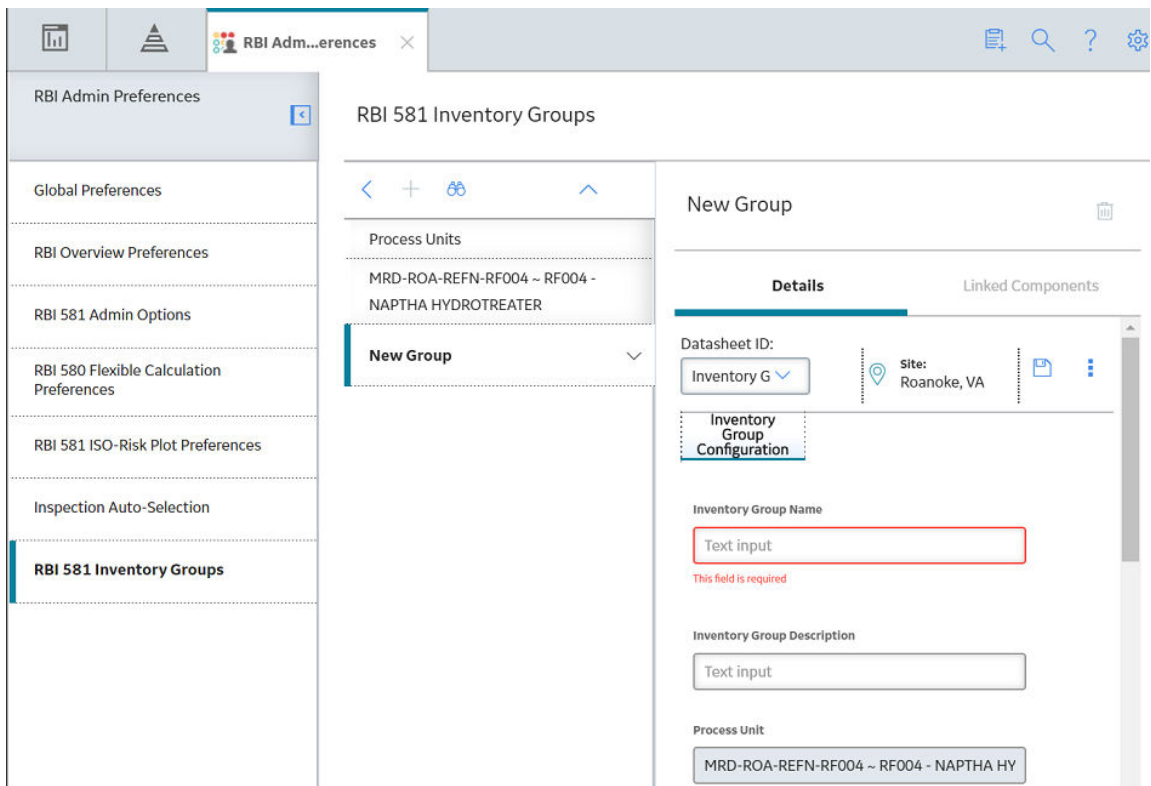

4. As needed, enter values in the **available fields**.

- In the upper-right corner of the datasheet, select .

The Inventory Group Configuration record is created. The newly created group is listed on the left side of the workspace.

Results

- The **Linked Components** tab is enabled.

Next Steps

- [Link components to the inventory group.](#)

Delete an Inventory Group Configuration Record

Before You Begin

- You can delete an Inventory Group Configuration record only if you are a super user or a member of the MI RBI Administrator Security Group.

Procedure

- Access the **RBI 581 Inventory Groups** workspace.
- In the list on the left side of the workspace, select the process unit that is linked to the Inventory Group Configuration record that you want to delete.

The inventory groups in the process unit appear.

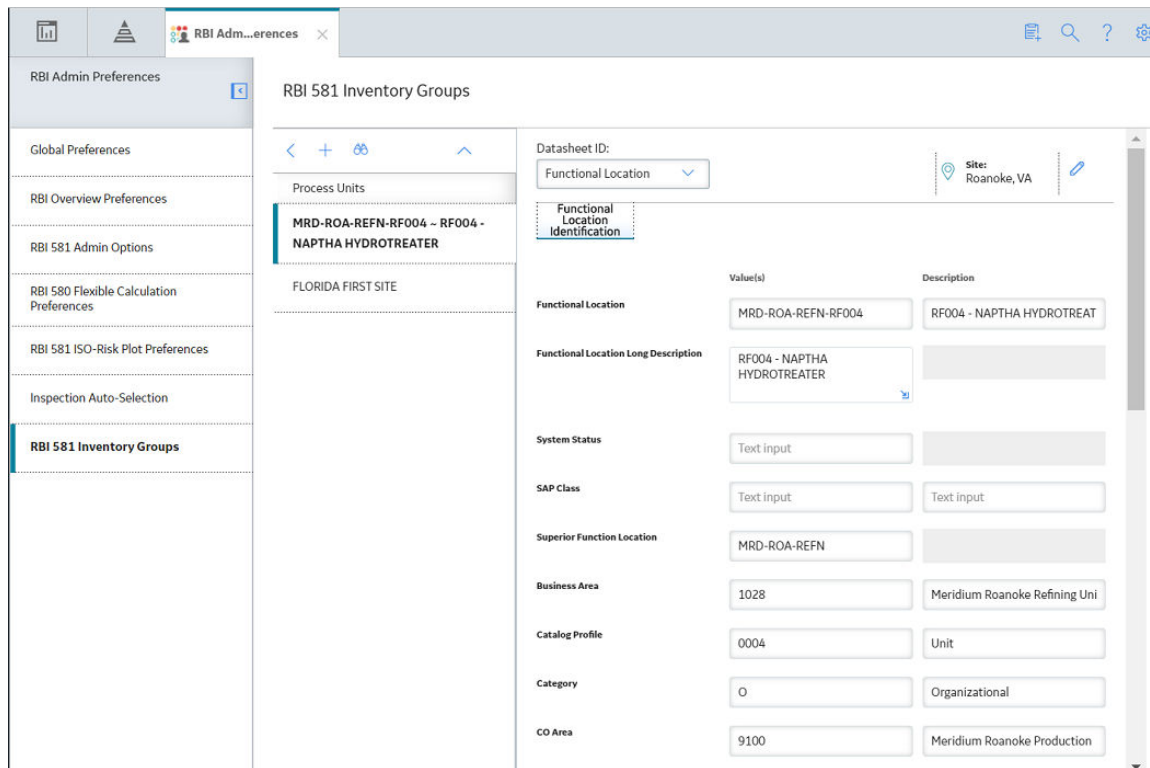

The screenshot shows the 'RBI 581 Inventory Groups' workspace. On the left, a sidebar lists various preferences, with 'RBI 581 Inventory Groups' selected. The main area displays a list of process units under 'Process Units':

- MRD-ROA-REFN-RF004 - RF004 - NAPTHA HYDROTREATER
- FLORIDA FIRST SITE

The 'MRD-ROA-REFN-RF004 - RF004 - NAPTHA HYDROTREATER' unit is selected, and its details are shown in a table:

Field	Value(s)	Description
Functional Location	MRD-ROA-REFN-RF004	RF004 - NAPTHA HYDROTREAT
Functional Location Long Description	RF004 - NAPTHA HYDROTREATER	
System Status	Text input	
SAP Class	Text input	Text input
Superior Function Location	MRD-ROA-REFN	
Business Area	1028	Meridium Roanoke Refining Uni
Catalog Profile	0004	Unit
Category	0	Organizational
CO Area	9100	Meridium Roanoke Production

- In the list on the left side of the workspace, select the Inventory Group Configuration that you want to delete.

The datasheet for the Inventory Group Configuration appears in the **Details** section.

4. In the upper-right corner of the datasheet, select .

The **Confirm Delete** dialog box appears, asking you to confirm that you want to delete the inventory group.

5. Select **Yes**.

The Inventory Group Configuration record is deleted.

Results

- If you create an RBI 581 Risk Analysis for components that once belonged to the deleted inventory group, the value in the Inventory Group Mass field will no longer be populated automatically.

Link Components to an Inventory Group

Before You Begin

- [Create an Inventory Group Configuration record.](#)

Procedure

1. [Access the RBI 581 Inventory Groups workspace.](#)
2. In the list on the left side of the workspace, select the process unit that is linked to the inventory group to which you want to link components.

A list of inventory groups in the process unit appears in the list on the left side of the workspace.

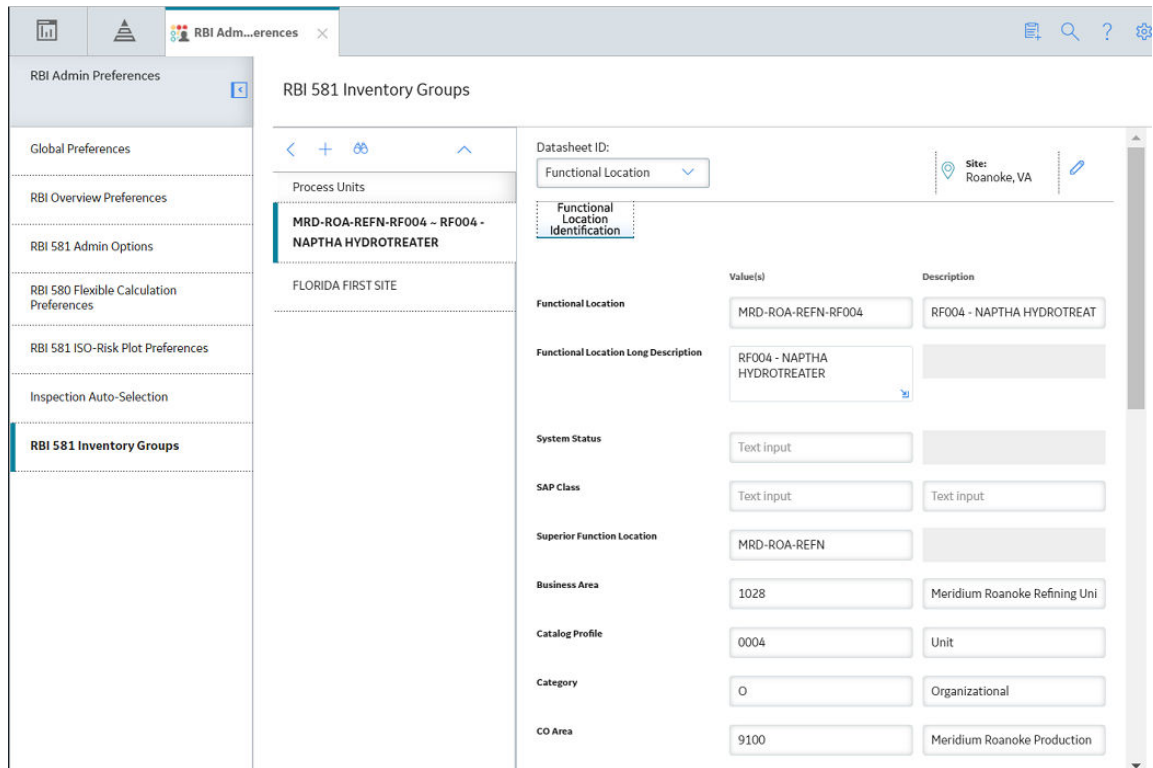

The screenshot shows the 'RBI 581 Inventory Groups' workspace. On the left, a sidebar lists various preferences, with 'RBI 581 Inventory Groups' selected. The main area displays a list of process units under 'Process Units', including 'MRD-ROA-REFN-RF004 - NAPHTHA HYDROTREATER' and 'FLORIDA FIRST SITE'. The 'MRD-ROA-REFN-RF004 - NAPHTHA HYDROTREATER' process unit is selected, and its details are shown in a 'Functional Location Identification' section. This section includes a 'Functional Location' dropdown menu and a table of values and descriptions.

Value(s)	Description
MRD-ROA-REFN-RF004	RF004 - NAPHTHA HYDROTREAT
RF004 - NAPHTHA HYDROTREATER	

Other fields in the details view include: System Status (Text input), SAP Class (Text input), Superior Function Location (MRD-ROA-REFN), Business Area (1028, Meridium Roanoke Refining Uni), Catalog Profile (0004, Unit), Category (0, Organizational), and CO Area (9100, Meridium Roanoke Production).

3. Select the inventory group to which you want to link components.

The datasheet of the Inventory Group Configuration appears in the **Details** section.

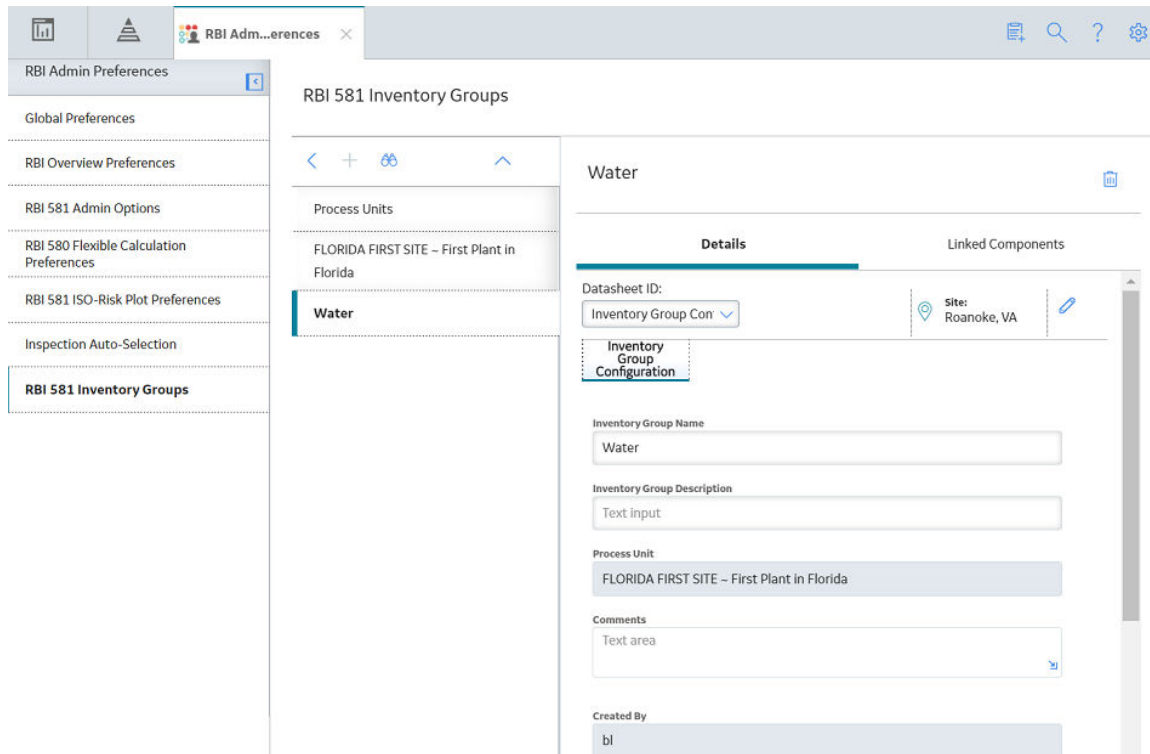

4. Select the **Linked Components** tab.

The **Linked Components** section appears, displaying a list of components linked to the inventory group.

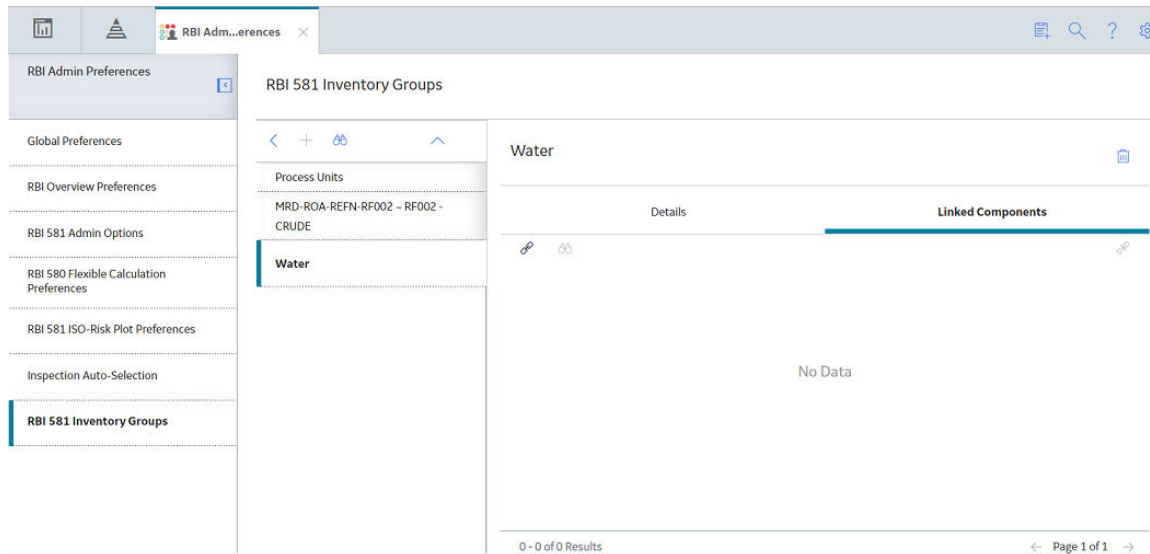

5. In the upper-left corner of the section, select .

The **Select RBI Components** window appears, displaying a list of components associated with the process unit.

Select RBI Components	
ASSET ID	COMPONENT
<input type="checkbox"/> ~ ~ RBI EQU COMP ALL DATA	RBICOMP- ~ ~ RBI EQU COMP ALL DATA-CS-1181
<input type="checkbox"/> ~ ~ EQU W PRD COMP TO BE LINKED TO UNIT	RBICOMP- ~ ~ EQU W PRD COMP TO BE LINKED TO UNIT-RV-2356
<input type="checkbox"/> ~ ~ QA RBI 581 AST BTM DF CALC METRIC	RBICOMP- ~ ~ QA RBI 581 AST BTM DF CALC METRIC-TB-2373
<input type="checkbox"/> ~ ~ QA RBI 581 CAUSTIC CRCK DF CALC	RBICOMP- ~ ~ QA RBI 581 CAUSTIC CRCK DF CALC-CS-1958
<input type="checkbox"/> ~ ~ QA RBI 581 CONS CALC	RBICOMP- ~ ~ QA RBI 581 CONS CALC-CS-1952
<input type="checkbox"/> ~ ~ QA RBI 581 CONS NFNT CALC	RBICOMP- ~ ~ QA RBI 581 CONS NFNT CALC-CS-2012
<input type="checkbox"/> ~ ~ QA RBI 581 EXT THNG CUI DF CALC	RBICOMP- ~ ~ QA RBI 581 EXT THNG CUI DF CALC-CS-1932
<input type="checkbox"/> ~ ~ RBI 580 EQUP FOR FLEXI DM & ANALYS ROLL UP	RBICOMP- ~ ~ RBI 580 EQUP FOR FLEXI DM & ANALYSIS ROLL UP-EB-2562
<input type="checkbox"/> ~ ~ RBI 580 EQUP FOR FLEXI DM & ANALYS ROLL UP	RBICOMP- ~ ~ RBI 580 EQUP FOR FLEXI DM & ANALYSIS ROLL UP-TB-2564
<input type="checkbox"/> ~ ~ 581 ALKLINE CRCK DF CALC	RBICOMP- ~ ~ 581 ALKLINE CRCK DF CALC-CS-2098
<input type="checkbox"/> ~ ~ 581 AMINE CRCK DF CALC	RBICOMP- ~ ~ 581 AMINE CRCK DF CALC-CS-2099
<input type="checkbox"/> ~ ~ 581 AMINE CRCK SUSCEPTBLTY	RBICOMP- ~ ~ 581 AMINE CRCK SUSCEPTBLTY-CS-2096
<input type="checkbox"/> ~ ~ 581 CAUSTIC CRCK DF CALC	RBICOMP- ~ ~ 581 CAUSTIC CRCK DF CALC-CS-2103
<input type="checkbox"/> ~ ~ 581 CONS & TOXIC CALC	RBICOMP- ~ ~ 581 CONS & TOXIC CALC-CS-2097
<input type="checkbox"/> ~ ~ 581 DL EQU1	F0065-097-CS-142

Rows per page: 50 200 500 1 - 100 of 502 Results < 1 2 3 4 5 6 >

[Cancel](#)

- In the row containing each component that you want to link, select the check box, and then select **Done**.

The RBI Components are linked to the inventory group, and appear in the **Linked Components** section.

- If you want to access the datasheet of a linked component, then select the link in the **Component ID** column.

The component datasheet appears on a new page.

Results

- In the RBI Component records that you have linked, the Inventory Group field is populated with the value in the Inventory Group Name field of the inventory group.
- If you create an RBI 581 Risk Analysis for a component that you have linked to the inventory group, then in the associated RBI 581 Consequence Evaluation, the **Use Calculated Inventory** check box is selected, and the value in the Inventory Group Mass field is **calculated**.
- The value in the Inventory Group Mass field in the RBI 581 Consequence Evaluation associated with the remaining components in the inventory group is updated.

Tip: To view the updated value in the Inventory Group Mass field, you must clear the **Use Calculated Inventory** check box, and then select it.

Unlink Components from an Inventory Group

Procedure

- Access the **RBI 581 Inventory Groups** workspace.
- In the list on the left side of the workspace, select the process unit that is linked to the inventory group from which you want to unlink components.

The inventory groups in the process unit appear in the list on the left side of the workspace.

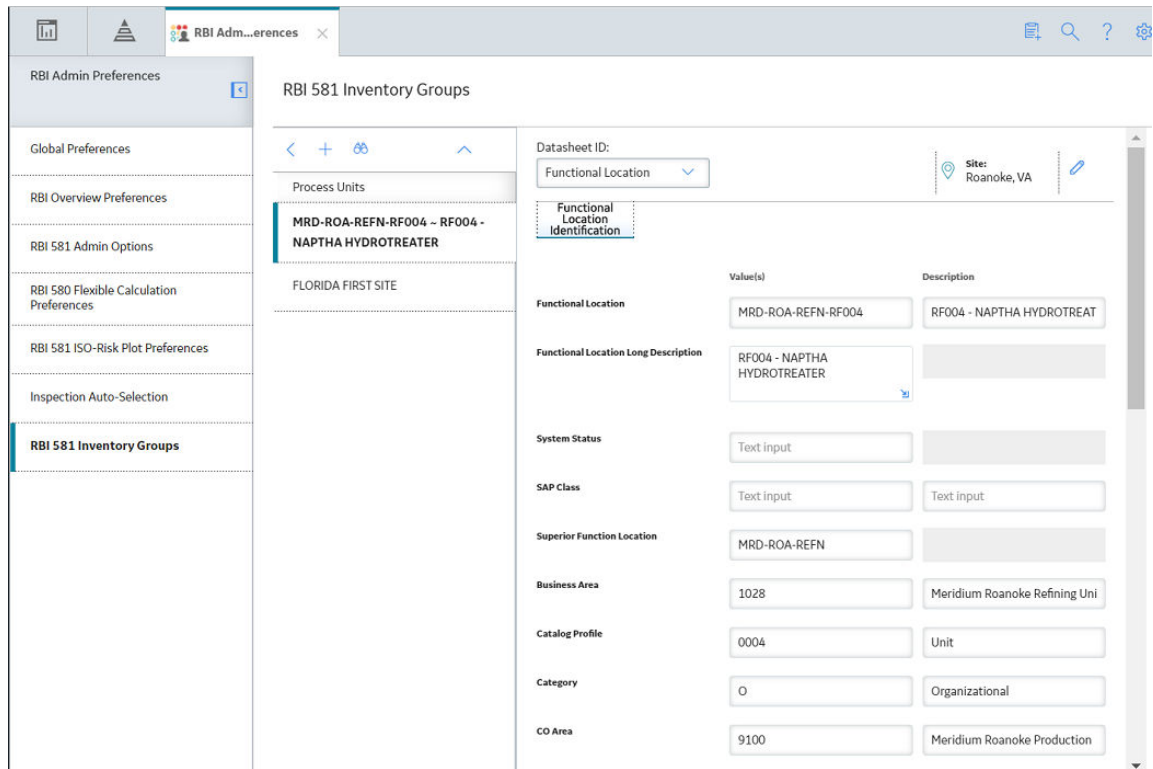

3. Select the inventory group from which you want to unlink a component.

The datasheet for the Inventory Group Configuration appears in the **Details** section.

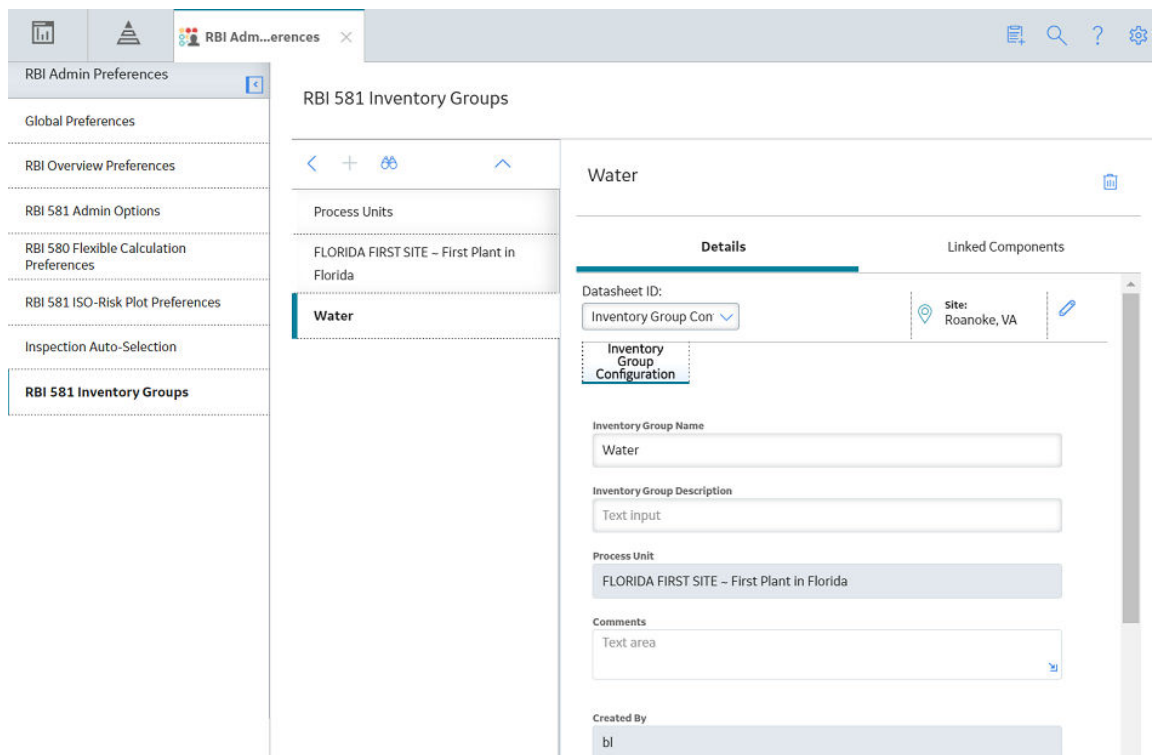

4. Select the **Linked Components** tab.

The **Linked Components** section appears, displaying a list of components linked to the inventory group.

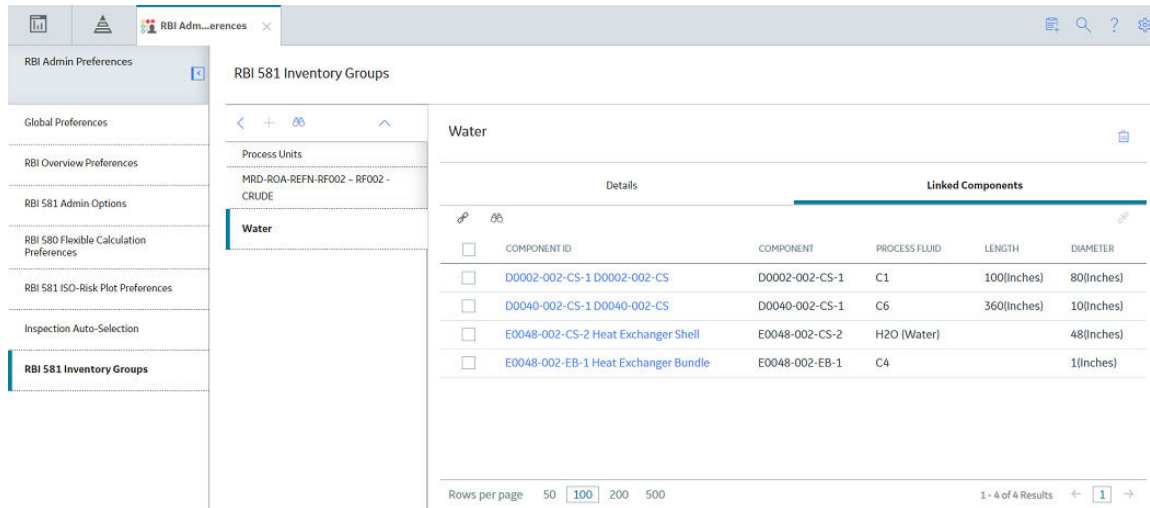

5. Select the check box that corresponds to each component that you want to unlink.
6. In the upper-right corner of the datasheet section, select .

The **Confirm Unlink** dialog box appears, asking you to confirm that you want to unlink the selected components.

7. Select **Yes**.

The components are unlinked from the inventory group.

Results

- The value in the Inventory Group Mass field in the RBI 581 Consequence Evaluation of the remaining components in the inventory group is updated.

Tip: To view the updated value in the Inventory Group Mass field, you must clear the **Use Calculated Inventory** check box, and then select it.

Use the Upgrade APM Version 3 Active Analyses Utility

Using the Upgrade APM Version 3 Active Analyses Utility, you can create Risk Assessment records for existing RBI 580 and RBI 581 analyses that are in [active state](#) and do not have existing Risk Assessment records. Also, for RBI 580 active analyses, the utility will calculate and set Half-Life for any related Ext. Corr. Deg. Mech Evaluations where the value is blank

Before You Begin

- You must be an administrator to perform the following steps.
- If you are using a custom Risk Matrix, you must configure your Risk Matrix mappings.

Procedure

1. In the module navigation menu, select **Admin > Application Settings > Risk Based Inspection**.
2. In the **Global Preferences** workspace, select **Upgrade Analyses**.
The **Upgrade Analyses Confirmation** window appears, asking you to confirm that you want to create Risk Assessment records for all RBI 580 and RBI 581 active analyses.

3. Select **Yes**.
The **Upgrade Analyses** window appears, stating the job was successfully scheduled.
4. Optional: Select **View Scheduling**.
The **Schedule Logs** page appears, displaying a list of all the operations in GE Digital APM that are in progress, along with the percentages of completion. You can also access a list of operations that have been successful or have failed.

Chapter 14

Deployment

Topics:

- [Deployment and Upgrade](#)

Deployment and Upgrade

Deployment and Upgrade content for various GE Digital APM modules has been consolidated into a single document. For more information, refer to the module-specific information in the APM Module Deployment and Upgrade document.

Chapter 15

Data Loaders

Topics:

- [RBI 581](#)
- [Corrosion Loop](#)
- [RBI Components to TML Groups Relationship Data Loader](#)

RBI 581

About RBI Data Loaders

GE Digital APM, through the Risk Based Inspection module, provides the functionality to carry out an RBI Analysis on various types of RBI components to calculate corrosion rate, and the probability and consequence of failure, and then develop intelligent strategies. Using the RBI Data Loaders, you can generate all components for a Process Unit along with the associated analyses.

About the Risk Based Inspection (RBI) 581 Data Loader

Using the Risk Based Inspection (RBI) 581 Data Loader, you can implement Risk Based Inspection when you have RBI data in a legacy system, which is not supported by GE Digital APM. To import data using the Risk Based Inspection (RBI) 581 Data Loader, GE Digital APM provides an Excel template, `RBI_581_Data_Loader.xlsx`, which supports baseline Risk Based Inspection GE Digital APM. You must export your legacy system so that the data can be used to populate the template. The data from the template will then be imported into GE Digital APM using the Risk Based Inspection (RBI) 581 Data Loader.

Note: The Excel template is referred to throughout this documentation as the data loader workbook.

The data loader workbook can be used in the following scenarios:

- Create or update components
- Create or update analyses
- Loading components and risk analysis data into GE Digital APM so that you can retain visibility into the analysis details and calculations, and generate recommendations.
- Calculate risk, probability and consequence of failure, and then utilize the Inspection Planning feature to mitigate the risk by the plan date.

After importing the data, the Risk Based Inspection (RBI) 581 Data Loader creates the following records in GE Digital APM:

- Criticality Calculator RBI Component
- RBI 581 Risk Analysis
- RBI Consequence Evaluation
- RBI 581 Thinning and Lining Evaluation
- RBI 581 External Damage Evaluation
- RBI 581 External Cracking Damage Evaluation
- RBI 581 Cracking Damage Evaluation
- RBI 581 HTHA Damage Evaluation
- RBI 581 Brittle Fracture Damage Evaluation

You cannot, however, create RBI 581 Mechanical Fatigue Damage Evaluation records using the Risk Based Inspection (RBI) 581 Data Loader.

The data on the (Picklist) worksheet is not loaded when you load data using the Risk Based Inspection (RBI) 581 Data Loader.

Note: This data loader workbook is not backward compatible to earlier versions of GE Digital APM.

About the Risk Based Inspection (RBI) 581 Data Loader Requirements

Before you use the Risk Based Inspection (RBI) 581 Data Loader, you must complete the following steps:

- Ensure that the RBI 581 module is deployed.
- Ensure that the following data is present:
 - Site Reference
 - Equipment Taxonomy
 - Equipment and Functional Location Families
 - RBI Data Mapping
 - Units of Measure Conversion Sets
 - Stress Tables (GE Digital APM provides Stress Tables for Pressure Vessels and Tanks. If you want to use values from these Stress Tables with the data load, you must ensure that the records are imported into your database prior to performing the data load. GE Digital APM does not provide Piping Stress Tables).
 - Representative Fluids
- If you have added custom fields to Risk Mapping families (e.g., RBI Risk Matrix Mapping, Risk Analysis Mapping), you must ensure that mappings exist for those fields, or data may not be populated as expected after the data load. This is because the Risk Based Inspection (RBI) 581 Data Loader relies on Risk Mapping families to ensure that fields on RBI 581 Risk Analysis and related records are correctly populated with data, and that resulting risk values can be mapped to the Default Risk Matrix.
- The Security User performing the data load operation must be associated with either the MI Data Loader User or MI Data Loader Admin Security Role, and must also be associated with the MI RBI Analyst Security Group or a Security Role that is associated with this Security Group.
- The data loader workbook contains sample data in each column. It is only for your reference. You must remove this data before using the data loader workbook.

About the Risk Based Inspection (RBI) 581 Data Loader Data Model

This topic has been intentionally excluded from the GE Digital APM product documentation website. This topic is available to you via the product documentation that is provided within the GE Digital APM system.

About the Risk Based Inspection (RBI) 581 Data Loader General Loading Strategy

The imported data must load in a specific sequence in order to successfully populate fields, to create records, and to link them to the predecessor and/or successor records.

Best Practices

When importing data using the Risk Based Inspection (RBI) 581 Data Loader, you must use the following best practices:

- ID fields must not include special characters or spaces.
- Columns (including columns representing custom fields) in the worksheets should be formatted as Text.
- Import a maximum of 500 assets in each data load. The maximum number of records that you can load per asset using the data loader is specified in the [Best Practices for Loading a Single Asset](#) on page 200 topic.
- Do not try to create and update a component in the same data loader workbook.
- Ensure that you enter values in cells that correspond to [fields required to calculate an analysis](#). Otherwise, warnings will be issued in the log for the analysis and related records with invalid data.
- When a field whose value is required based on the value in another field is blank, a warning is logged in the log file of the import job.
- You must consider the rules described in the [Workbook Layout and Use](#) section of this document while using the Risk Based Inspection (RBI) 581 Data Loader.

- If you have entered data related to an analysis or a DME, then you must always enter data of the associated component in the RBI_Component worksheet, even if the corresponding Criticality Calculator RBI Component record exists in the GE Digital APM database.
- You must enter a valid value in the following cells in the RBI_Component worksheet; Otherwise, the row that corresponds to that component is skipped:
 - Component ID
 - Component Type
 - Process Fluid

Note: If the value is left blank, a valid value must be provided for each associated RBI 581 Risk Analyses.

 - GFF Component Type

Note: If the value is left blank, a valid value must be provided for each associated RBI 581 Risk Analyses.
- When you use the data loader to create an analysis and a cell that requires a Boolean value is blank, the corresponding field in GE Digital APM is updated with the value False. When you use the data loader to update an analysis and a cell that requires a Boolean value is blank, the corresponding field in GE Digital APM is not updated. Therefore, to avoid ambiguity, we recommend that you enter the value True or False in the cell and not leave it blank.
- If you want to override the default values that you have specified in the **RBI 581 Admin Options** workspace, you can include those values in the Risk Based Inspection (RBI) 581 Data Loader. For example, if the value for the Atmospheric Condition field for an RBI 581 External Damage Evaluation record is set to Temperate in the **RBI 581 Admin Options** workspace. You can override this value by entering a different value in the Atmospheric Condition cell in the DME_ExternalDamage worksheet.
- If you want to override values that are populated from the associated component, you can include those values in the Risk Based Inspection (RBI) 581 Data Loader. For example, the value for the Operating Temperature field in an RBI 581 Risk Analysis is populated from the corresponding field in the associated RBI Component. If you want to override this value for the analysis, you must include a column for Operating Temperature in the RBI_581_Analysis worksheet in the data loader workbook, and enter the value in that cell.
- In addition to the fields included in the Risk Based Inspection (RBI) 581 Data Loader, if you want to add values for more fields for a record, you can add columns for those fields in the appropriate worksheet.

Note: The fields that you want to add to the data loader workbook must already exist in the corresponding family. If not, you must add the fields to the family via Configuration Manager.
- You should not add columns that correspond to fields in the **Outputs** and **Intermediate Outputs** sections of a datasheet; Otherwise, the calculations might not be correct.
- You should not add a column that corresponds to the Use Combined Confidence and Use Related Inspection fields to any of the following worksheets:
 - DME_Thinning
 - DME_ExternalCracking
 - DME_Cracking

The Use Combined Confidence field is part of the integration of the Risk Based Inspection and Inspection Management modules. A value should only be set in GE Digital APM.

Load Sequence

The data is loaded in the following sequence in order to create all necessary relationships between records:

1. The Assets worksheet is processed. The Data Loader searches for the asset that corresponds to the Asset ID, Asset CMMS System, Equipment Technical Number (only for an Equipment asset) and Asset Family information that you provide in the Assets worksheet.
If an asset specified on the worksheet does not exist, it will be skipped, as well as all entries in the subsequent worksheets corresponding to that asset.
2. The RBI_Component worksheet is processed. The Data Loader searches for the RBI Component based on the asset data and the values in the Component and Component Type cells.
If a component exists in the GE Digital APM database, it will be updated. If not, a new component will be created, and linked to the asset.
3. The RBI 581 Analysis worksheet is processed. For each row based on the cells specified in steps 1 and 2, a new analysis is created and linked to that component. You cannot update an analysis using the data loader workbook. The value in the Analysis Unique ID cell is not stored but will be used to identify all the Degradation Mechanism Evaluations and Consequence Evaluations specified on the subsequent worksheets that should be linked to the analysis.
If there is invalid data for calculating an analysis, the analysis will still be loaded, but warnings will be issued in the log for all fields with incorrect values.
4. The RBI 581 Consequence worksheet is processed. For each row based on the cells specified in steps 1 to 3, a Consequence Evaluation is created, and linked to the specified analysis.
5. The worksheets representing Degradation Mechanism Evaluations are processed. For each row based on the cells specified in steps 1 to 3, a Degradation Mechanism Evaluation is created, and linked to the specified analysis. Additionally, for each Damage Mechanism, a corresponding Potential Degradation Mechanism is created, and linked to the component, unless a Potential Degradation Mechanism of the same type is already linked to the same component.
When the Degradation Mechanism Evaluations are processed, if you have not included a Degradation Mechanism in the worksheet that corresponds to an existing Potential Degradation Mechanism on the component, that Potential Degradation Mechanism will be unlinked.

Data that you specify in the cells on each worksheet will be included in the records. Additionally, fields in the records will be populated with data based on your RBI Data Mapping. For example, an RBI 581 Risk Analysis will be populated with data from the RBI Component to which it is linked the same way it happens if you create the same records in GE Digital APM.

Best Practices for Loading a Single Asset

For optimal performance, we recommend that you load a maximum of 14 Components with three DMEs each or 9 Components with seven DMEs. To avoid performance degradation of the data loader, you must maintain the total number of records within this limit. If you want to load more number of DMEs, you must reduce the maximum number of components.

The following tables provide illustrations of the maximum number of records that you can load per Component or Analysis, as applicable. It also provides the maximum total number of records that you can load per Asset.

Important: The numbers shown in the table are for reference purpose only, and not the maximum number of records that the data loader is designed to load. These numbers are derived based on the test results obtained from the laboratory machines. However, the performance of the data loader may vary based on the database server configuration, application server configuration, load on the servers, network speed, and other performance factors. If you find a degradation in the data loader performance, we recommend that you reduce the number of records in a single batch and upload the records in multiple batches.

Record Name	An example of the maximum number of records you can load per Asset/Component/Analysis	An example of the total number of records you can load per Asset
RBI Component	9 per Asset	9
RBI 581 Risk Analysis	1 per Component	9
RBI 581 Consequence Evaluation	1 per Analysis	9
Internal DME	1 per Analysis	9
External DME	1 per Analysis	9
Cracking DME	1 per Analysis	9
Lining DME	1 per Analysis	9
External Cracking DME	1 per Analysis	9
HTHA DME	1 per Analysis	9
Brittle Fracture DME	1 per Analysis	9
Total number of records		90

About the Risk Based Inspection (RBI) 581 Data Loader Workbook Layout and Use

To import data using the Risk Based Inspection (RBI) 581 Data Loader, GE Digital APM provides an Excel workbook, *Risk Based Inspection (RBI) 581.xlsx*, which supports baseline Risk Based Inspection in GE Digital APM. This workbook must be used to perform the data load. You can modify the Excel workbook to include custom fields used by your organization.

Note: The Excel workbook is referred to throughout this documentation as the data loader workbook.

Worksheet	Description
Assets	This worksheet is used to specify existing Asset records to which components will be linked.
RBI_Components	This worksheet is used to specify the following types of RBI Component records that will be updated or created and linked to assets. <ul style="list-style-type: none"> • Cylindrical Shell • Exchanger Bundle • Exchanger Tube • Piping • Pump Compressor Casing • Tank Bottom
RBI_581_Analysis	This worksheet is used to define RBI 581 Analysis records that will be linked to components. You cannot update an RBI 581 Risk Analysis using the data loader workbook.
RBI_581_Consequence	This worksheet is used to define RBI 581 Consequence Evaluation records that will be linked to analyses. Each analysis can be linked to only one RBI 581 Consequence Evaluation.

Worksheet	Description
DME_Lining	<p>This worksheet is used to specify the 581-Internal Component Lining Damage DMs (which are or will be represented by the RBI 581 Thinning and Lining Evaluation records) that you want to create or update. These records will be linked to an RBI 581 Risk Analysis. You can specify these DMs only if the value in the Lining Present column is True in the RBI_Component worksheet for the associated component.</p>
DME_AST	<p>This worksheet is used to specify the 581-Atmospheric Tank Bottom Corrosion DMs (which are or will be represented by the RBI 581 Thinning and Lining Evaluation records) that you want to create or update. These records will be linked to an RBI 581 Risk Analysis.</p> <p>You can specify these DMs only if:</p> <ul style="list-style-type: none"> • The component family is Tank Bottom (i.e., the value in the Component Family column in the RBI_Component worksheet for the associated component is MI_CCRBICTB). • The value in the Is Intrusive column in the RBI_Component worksheet for the associated component is <i>True</i>.
DME_Thinning	<p>This worksheet is used to specify the following DMs that you want to create or update:</p> <ul style="list-style-type: none"> • 581-High Temperature Oxidation • 581-Cooling Water Corrosion • 581-High Temperature H2/H2S Corrosion • 581-Amine Corrosion • 581-Hydrofluoric Acid Corrosion • 581-Sulfuric Acid Corrosion • 581-Hydrochloric Acid Corrosion • 581-Acid Sour Water Corrosion • 581-High Temperature Sulfidic and Naphthenic Acid • 581-Alkaline Sour Water Corrosion • 581-Soil Side Corrosion • 581-Thinning Damage <p>These DMs belong to the RBI 581 Thinning and Lining Evaluation methodology. These records will be linked to an RBI 581 Risk Analysis.</p>
DME_ExternalDamage	<p>This worksheet is used to define the following DMs that you want to create or update:</p> <ul style="list-style-type: none"> • 581-Ferritic Component Atmospheric Corrosion • 581-Ferritic Component Corrosion Under Insulation <p>These DMs belong to the RBI 581 External Damage Evaluation methodology. These records will be linked to an RBI 581 Risk Analysis. You can specify these DMs only if the component type is <i>not</i> Tank Bottom (i.e., the value in the Component Family column in the RBI_Component worksheet is not <i>MI_CCRBICTB</i>).</p>

Worksheet	Description
DME_ExternalCracking	<p>This worksheet is used to define the following DMs that you want to create or update:</p> <ul style="list-style-type: none"> • 581-Austenitic Component Cracking Under Insulation • 581-Austenitic Component Atmospheric Cracking <p>These DMs belong to the RBI 581 External Cracking Damage Evaluation methodology. These records will be linked to an RBI 581 Risk Analysis. You can specify these DMs only if the component type is <i>not</i> Tank Bottom (i.e., the value in the Component Family column in the RBI_Component worksheet is not <i>MI_CCRBICTB</i>).</p>
DME_Cracking	<p>This worksheet is used to specify the following DMs that you want to create or update:</p> <ul style="list-style-type: none"> • 581-Amine Cracking • 581-Alkaline Carbonate Stress Corrosion Cracking • 581-HIC/SOHIC - HF • 581-HIC/SOHIC - H₂S • 581-Caustic Cracking • 581-Hydrogen Stress Cracking • 581-Other Cracking • 581-Sulfide Stress Cracking • 581-Chloride Stress Corrosion Cracking • 581-Polythionic Acid Cracking <p>These DMs belong to the RBI 581 Cracking Damage Evaluation methodology. These records will be linked to an RBI 581 Risk Analysis.</p>
DME_HTHA	<p>This worksheet is used to specify the 581-High Temperature Hydrogen Attack DMs (which are or will be represented by the RBI 581 HTHA Damage Evaluation records) that you want to create or update. These records will be linked to an RBI 581 Risk Analysis. You can specify these DMs only if the component type is <i>not</i> Tank Bottom (i.e., the value in the Component Family column in the RBI_Component worksheet is not <i>MI_CCRBICTB</i>).</p>

Worksheet	Description
DME_BrittleFracture	<p>This worksheet is used to specify the following DMs (which are or will be represented by the RBI 581 Brittle Fracture Damage Evaluation records) that you want to create or update.</p> <ul style="list-style-type: none"> • 581-Sigma Phase Embrittlement • 581-885F Embrittlement • 581-Brittle Fracture • 581-Low Alloy Steel Embrittlement <p>These records will be linked to an RBI 581 Risk Analysis. You can specify these DMs only if the component type is <i>not</i> Tank Bottom (i.e., the value in the Component Family column in the RBI_Component worksheet is not <i>MI_CCRBICTB</i>).</p>
(PickList)	<p>This worksheet contains a list of valid values that you can enter in each column (as applicable) in the aforementioned worksheets. When you load data using the data loader, the data on this worksheet is <i>not</i> loaded.</p> <p>The values in the some of the columns are filtered based on the values in other fields. For example, the values in the following columns are filtered based on the values in the Stress Lookup Table column:</p> <ul style="list-style-type: none"> • BM Code • BM Year • BM Spec • BM Grade <p>Also, if you select a value in the BM Code column, the values in the BM Year, BM Spec, and BM Grade columns are filtered accordingly.</p>

Important: The Risk Based Inspection (RBI) 581 Data Loader overrides the default values specified in the **RBI 581 Admin Options** workspace.

Color Coding

Certain columns on the worksheets have different functions and requirements. To illustrate this, certain columns are color-coded. The following table lists the colors and what they represent.

Color	Description	Comments
Grey	Lookup Fields	Indicates columns that contain values that are used by the Risk Based Inspection (RBI) 581 Data Loader to look up and create records. If these columns are removed from the worksheets, the data load will fail. While the worksheets require that these columns be present, values are not necessarily required in these columns.
Red	Fields Required for Calculation	Indicates columns that contain values that are required to perform calculations in Risk Based Inspection. Some cells only require values in certain cases. Such cases are found in parentheses in the first row of each worksheet.
Blue	Recommended Fields	Indicates columns that, according to GE Digital APM Best Practice for Risk Based Inspection, should contain values.
Green	Custom Fields	Indicates columns where you can specify custom fields.

Limitations

The Risk Based Inspection (RBI) 581 Data Loader has the following limitations:

- You must use the data loader workbook. If you modify the format of the values in columns in any of the worksheets, you will not be able to import data.
- Components of the Heat Exchanger - Bundle type are not supported as part of the baseline GE Digital APM, but you can enter data related to the component.
- The values that you enter in the data loader workbook are case-sensitive.
- You cannot import data related to a custom DME using the Risk Based Inspection (RBI) 581 Data Loader. You must import only those DMEs that are included in the data loader workbook.
- If you reimport data, the records that have been created by the Data Loader will be updated. Therefore, while reimporting data, if you remove the data for a field in the data loader workbook, the value for the corresponding field in GE Digital APM will be blank.
- You cannot create Inventory Group Configuration records, or link a Component to an inventory group using the data loader workbook.
- When you use the data loader to update an RBI 581 Analysis and the associated Consequence Evaluation, Damage Mechanisms, and Damage Mechanism Evaluations:
 - If a cell contains data, the value in the corresponding field will be updated in the database.
 - If a cell is blank, the value in the corresponding field will not be updated with a blank value in the database. The value that previously existed in the field is retained.
- You cannot delete the Consequence Evaluation and the Degradation Mechanism Evaluations associated with an RBI Analysis using the data loader.
- You cannot update a What-If analysis using the data loader.

Assets Worksheet

In the Assets worksheet, you will specify assets to which you want to link components. The columns that appear on this worksheet also appear on every subsequent worksheet, and are used to identify the records that will be linked, directly or indirectly, to the assets. The combination of values in the three columns on this worksheet must be unique.

Field Caption	Field ID	Data Type (Length)	Comments
Asset ID	MI_EQUIP000_EQUIP_ID_C	Character (255)	This column requires at least one cell to have a value. For a Functional Location asset, the field MI_FNCLOC00_FNC_LOC_C should be used.
Asset CMMS System	MI_EQUIP000_SAP_SYSTEM_C	Character (255)	If the Asset record has a value in the CMMS System field, enter that value in this column. For a Functional Location asset the field MI_FNCLOC00_SAP_SYSTEM_C should be used.
Equipment Technical Number	MI_EQUIP000_EQUIP_TECH_N BR_C	Character (255)	If you are required to enter a value for the CMMS System cell for an Equipment asset, and the Equipment has a value in the Equipment Technical Number field, enter that value in this column. If there is no value in the CMMS System field, this column can be blank, even if the Equipment record contains a value for the Equipment Technical Number field. Note: This field must be left blank for a Functional Location asset.
Asset Family	ASSET_FAMILY_ID	Character (255)	This field is required when loading Functional Location assets. If no value is provided, the asset will be considered an Equipment asset. Note: Following are the valid values: <ul style="list-style-type: none">• MI_EQUIP000• MI_FNCLOC00

RBI_Component Worksheet

In the RBI_Component worksheet, you will specify the components (which are or will be represented by RBI Component records) that you want to create or update.

Field Caption	Field ID	Data Type (Length)	Comments
Asset ID	MI_EQUIP000_EQUIP_ID_C	Character (255)	Values in this column must match values entered in the Assets worksheet. Multiple components can be linked to the same asset (i.e., rows may have the same value in this column).
Asset CMMS System	MI_EQUIP000_SAP_SYSTEM_C	Character (255)	Values in this column must match values entered in the Assets worksheet, if they exist. Multiple components can be linked to the same asset (i.e., rows may have the same value in this column).
Equipment Technical Number	MI_EQUIP000_EQUIP_TECH_N BR_C	Character (255)	Values in this column must match values entered in the Assets worksheet, if they exist. Multiple components can be linked to the same asset (i.e., rows may have the same value in this column).
Component	MI_RBICOMPO_COMPO_C	Character (250)	A value is required and must be unique. This value identifies the component.

Field Caption	Field ID	Data Type (Length)	Comments
Component Type	MI_RBICOMPO_COMPO_TYPE_ C	Character (60)	<p>A value is required.</p> <p>This cell may only contain one of the following values, which exist in the list in the Component Type field for RBI Component records:</p> <ul style="list-style-type: none"> • 1" Pipe • 1.25" Pipe • 1.5" Pipe • 1/2" Pipe • 10" Pipe • 102" Pipe • 12" Pipe • 14" Pipe • 16" Pipe • 18" Pipe • 2" Pipe • 2.5" Pipe • 20" Pipe • 24" Pipe • 26" Pipe • 28" Pipe • 3" Pipe • 3/4" Pipe • 30" Pipe • 32" Pipe • 34" Pipe • 36" Pipe • 4" Pipe • 40" Pipe • 42" Pipe • 48" Pipe • 5" Pipe • 54" Pipe • 56" Pipe • 6" Pipe • 60" Pipe • 8" Pipe • 90" Pipe • Air Cooled Exchanger-Header • Air Cooled Exchanger-Tbs • Balanced Bellows PRD • Column-Bottom • Column-Middle • Column-Tank Bottom • Column-Top • Compressor • Conventional PRD • Filter • Fin/Fan Cooler • Heat Exchanger Tubes

Field Caption	Field ID	Data Type (Length)	Comments														
Component Family	FAMILY_ID	Character (50)	<p>A value is required.</p> <p>This cell may only contain one of the following values:</p> <table border="1"> <thead> <tr> <th>Value</th> <th>Component Family</th> </tr> </thead> <tbody> <tr> <td>MI_CCRBICCS</td> <td>Cylindrical Shell</td> </tr> <tr> <td>MI_CCRBICEH</td> <td>Exchanger Header</td> </tr> <tr> <td>MI_CCRBICET</td> <td>Exchanger Tube</td> </tr> <tr> <td>MI_CCRBICPI</td> <td>Piping</td> </tr> <tr> <td>MI_CCRBIPCC</td> <td>Pump Compressor Casing</td> </tr> <tr> <td>MI_CCRBICTB</td> <td>Tank Bottom</td> </tr> </tbody> </table>	Value	Component Family	MI_CCRBICCS	Cylindrical Shell	MI_CCRBICEH	Exchanger Header	MI_CCRBICET	Exchanger Tube	MI_CCRBICPI	Piping	MI_CCRBIPCC	Pump Compressor Casing	MI_CCRBICTB	Tank Bottom
Value	Component Family																
MI_CCRBICCS	Cylindrical Shell																
MI_CCRBICEH	Exchanger Header																
MI_CCRBICET	Exchanger Tube																
MI_CCRBICPI	Piping																
MI_CCRBIPCC	Pump Compressor Casing																
MI_CCRBICTB	Tank Bottom																
Component Description	MI_RBICOMPO_COMPO_DESCR_C	Character (255)	None														
Component Start Date	MI_RBICOMPO_COMP_START_DATE_DT	Date	A value is required. Enter the value in the following format: YYYY-MM-DD hh:mm:ss														
Circuit From	MI_CCRBICPI_CIRCU_FROM_C	Character (250)	This value is applicable only if the component type is piping (i.e., the value in the Component Family cell is MI_CCRBICPI).														
Circuit To	MI_CCRBICPI_CIRCU_TO_C	Character (250)	This value is applicable only if the component type is piping (i.e., the value in the Component Family cell is MI_CCRBICPI).														
Component Comments	MI_RBICOMPO_COMPO_COMMENT_TX	Text	None														

Field Caption	Field ID	Data Type (Length)	Comments
Operating Pressure	MI_RBICOMPO_OPERA_PRESS_N	Numeric	<p>A value is required.</p> <p>The value in this cell is copied to the Operating Pressure field of the associated RBI Analysis.</p> <p>The value in this cell is compared with the value in the Design Pressure cell for the analysis to be created.</p> <p>The value in this cell must be greater than or equal to zero, and less than or equal to the value in the Design Pressure cell.</p>
Operating Temperature	MI_RBICOMPO_OPERA_TEMPE_N	Numeric	<p>A value is required.</p> <p>The value in this cell is copied to the Operating Temperature field of the associated RBI Analysis.</p> <p>The value in this cell is compared with the value in the Design Temperature cell for the analysis to be created.</p> <p>If the value in the Design Temperature cell is greater than or equal to zero, the value in this cell must be less than or equal to the value in the Design Temperature cell.</p> <p>If the value in the Design Temperature cell is less than zero, the analysis can be created with any value in this cell.</p>

Field Caption	Field ID	Data Type (Length)	Comments
Foundation Type	MI_CCRBICTB_FOUND_TYPE_C	Character (50)	<p>A value is required if the value in the Component Type cell is Storage Tank Bottom.</p> <p>In the baseline GE Digital APM system, this cell may only contain one of the following System Code IDs:</p> <ul style="list-style-type: none"> • Clay • Silt • Sand • Gravel • Concrete • Double Floor <p>The list in this field is populated by the FOUNDATION TYPES System Code Table. If the system code table has been customized, the valid values could be different. To verify which options are acceptable in your GE Digital APM system, via Configuration Manager, refer to the appropriate table.</p>
Initial Fluid Phase	MI_RBICOMPO_INIT_FLU_PHAS E_C	Character (20)	<p>A value is required.</p> <p>In the baseline GE Digital APM system, this cell may only contain one of the following System Code IDs:</p> <ul style="list-style-type: none"> • Liquid • Gas <p>The list in this field is populated by the FLUID TYPES System Code Table. If the system code table has been customized, the valid values could be different. To verify which options are acceptable in your GE Digital APM system, via Configuration Manager, refer to the appropriate table.</p>

Field Caption	Field ID	Data Type (Length)	Comments
Process Fluid	MI_RBICOMPO_PROCE_FLUID_C	Character (50)	<p>The field is required. If the value is left blank, a valid value must be provided on the related child analysis records.</p> <p>This cell may only contain a value that exists in the list in the Process Fluid field for RBI Component records. If you enter a value that is not valid for RBI 581, the Data Loader will skip that row.</p> <p>If the value in the Component Type is Storage Tank Bottom, then this cell may only contain a fluid with a Dynamic Viscosity greater than 0. In the baseline APM, the following fluids have a valid Dynamic Viscosity and are supported by the Storage Tank Bottom:</p> <ul style="list-style-type: none"> • C6-C8 • C9-C12 • C13-16 (Diesel) • C17-25 (Gas Oil) • C25+ (Resid) • H2O (Water)
Toxic Mixture	MI_RBICOMPO_TOXIC_MIX_F	Boolean	Enter True or False.
Toxic Fluid	MI_RBICOMPO_TOXIC_MODEL_C	Character (50)	<p>A value is required if the value in the Toxic Mixture cell is True.</p> <p>This cell may only contain a value that exists in the list in the Toxic Fluid field for RBI Component records.</p>
Percent Toxic	MI_RBICOMPO_PERCE_TOXIC_N	Numeric	A value is required if the value in the Toxic Mixture cell is True.
Inventory	MI_RBICOMPO_INVEN_N	Numeric	A value is required if component type is not Tank Bottom (i.e., the value in the Component Family cell is not MI_CCRBICTB).

Field Caption	Field ID	Data Type (Length)	Comments
Inventory Group	MI_RBICOMPO_INVEN_GROUP_C	Character (50)	<p>You cannot use this column to link the Component to an inventory group. You can link a component to an inventory group only by accessing the MI Admin Preferences page in GE Digital APM.</p> <p>If the Component is already linked to an inventory group, you can override the value in the Inventory Group field by entering a value in this column. However, the calculated value in the Inventory Group Mass field remains as is.</p>
Design Pressure	MI_RBICOMPO_DESIG_PRESS_N	Numeric	<p>A value is required if the component is linked to the following Potential Degradation Mechanisms (PDMs):</p> <ul style="list-style-type: none"> • RBI 581 Thinning and Lining Evaluation • RBI 581 External Damage Evaluation <p>The value in this cell is copied to the Design Pressure field of the associated RBI Analysis.</p> <p>The value in this cell is compared with the value in the Operating Pressure cell for the analysis to be created.</p> <p>The value in this cell must be greater than or equal to zero, and greater than or equal to the value in the Operating Pressure cell.</p>

Field Caption	Field ID	Data Type (Length)	Comments
Design Temperature	MI_RBICOMPO_DESIG_TEMPE_N	Numeric	<p>A value is required if the component is linked to a PDM that belongs to the following DMEs:</p> <ul style="list-style-type: none"> • RBI 581 Thinning and Lining Evaluation • RBI 581 External Damage Evaluation <p>The value in this cell is copied to the Design Temperature field of the associated RBI Analysis.</p> <p>The value in this cell is compared with the value in the Operating Temperature cell for the analysis to be created.</p> <p>If the value in this cell is greater than or equal to zero, the value in the Operating Temperature cell must be less than or equal to the value in this field.</p> <p>If the value in this cell is less than zero, the analysis is created with any value in the Operating Temperature cell.</p>
Diameter	MI_RBICOMPO_DIAME_INNER_N	Numeric	A value is required.
Length	MI_RBICOMPO LENGT_N	Numeric	A value is required if you want to calculate inventory.
Fill Height	MI_CCRBICTB_FILL_HEIGH_N	Numeric	A value is required if the value in the Component Type cell is Storage Tank Bottom or Storage Tank.

Field Caption	Field ID	Data Type (Length)	Comments
Nominal Thickness	MI_RBICOMPO_NOMIN_THICK_N	Numeric	<p>A value is required if the component is linked to an analysis that is linked to the following damage mechanisms (DMs):</p> <ul style="list-style-type: none"> • 581-Brittle Fracture • 581-Low Alloy Steel Embrittlement • All DMs that belong to RBI 581 Thinning and Lining Evaluation • All DMs that belong to RBI 581 External Damage Evaluation
Stress Lookup Table	MI_RBICOMPO_STRESS_TABLE_C	Character (50)	<p>A value is required if the component is linked to an analysis that is linked to the following damage mechanisms (DMs):</p> <ul style="list-style-type: none"> • 581-Brittle Fracture • 581-Low Alloy Steel Embrittlement • All DMs that belong to RBI 581 Thinning and Lining Evaluation • All DMs that belong to RBI 581 External Damage Evaluation <p>In the baseline GE Digital APM system, this cell may only contain one of the following values:</p> <ul style="list-style-type: none"> • Pressure Vessels • Tanks • Piping <p>If the family has been customized, the valid values could be different. This cell may only contain a value that exists in the list in the Stress Lookup Table field for RBI Component records.</p>

Field Caption	Field ID	Data Type (Length)	Comments
BM CODE	MI_RBICOMPO_BM_CODE_C	Character (30)	<p>A value is required if the component is linked to an analysis that is linked to the following damage mechanisms (DMs):</p> <ul style="list-style-type: none"> • 581-Brittle Fracture • 581-Low Alloy Steel Embrittlement • All DMs that belong to RBI 581 Thinning and Lining Evaluation • All DMs that belong to RBI 581 External Damage Evaluation <p>Refer to the (Picklist) worksheet in the excel workbook for valid values that you can enter in this cell.</p>
BM YEAR	MI_RBICOMPO_BM_YEAR_C	Character (50)	<p>A value is required if the component is linked to an analysis that is linked to the following damage mechanisms (DMs):</p> <ul style="list-style-type: none"> • 581-Brittle Fracture • 581-Low Alloy Steel Embrittlement • All DMs that belong to RBI 581 Thinning and Lining Evaluation • All DMs that belong to RBI 581 External Damage Evaluation <p>Refer to the (Picklist) worksheet in the excel workbook for valid values that you can enter in this cell.</p>

Field Caption	Field ID	Data Type (Length)	Comments
BM SPEC	MI_RBICOMPO_BM_SPEC_C	Character (50)	<p>A value is required if the component is linked to an analysis that is linked to the following damage mechanisms (DMs):</p> <ul style="list-style-type: none"> • 581-Brittle Fracture • 581-Low Alloy Steel Embrittlement • All DMs that belong to RBI 581 Thinning and Lining Evaluation • All DMs that belong to RBI 581 External Damage Evaluation <p>Refer to the (Picklist) worksheet in the excel workbook for valid values that you can enter in this cell.</p>
BM GRADE	MI_RBICOMPO_BM_GRADE_C	Character (50)	<p>A value is required if the component is linked to an analysis that is linked to the following damage mechanisms (DMs):</p> <ul style="list-style-type: none"> • 581-Brittle Fracture • 581-Low Alloy Steel Embrittlement • All DMs that belong to RBI 581 Thinning and Lining Evaluation • All DMs that belong to RBI 581 External Damage Evaluation

Field Caption	Field ID	Data Type (Length)	Comments
Weld Joint Effy	MI_RBICOMPO_WELD_JOINT_EFFY_N	Numeric	<p>A value is required if the component is linked to a PDM that belongs to the following DMEs:</p> <ul style="list-style-type: none"> • RBI 581 Thinning and Lining Evaluation • RBI 581 External Damage Evaluation <p>In the baseline GE Digital APM, this cell may only contain one of the following values:</p> <ul style="list-style-type: none"> • 0.35 • 0.4 • 0.45 • 0.5 • 0.55 • 0.6 • 0.65 • 0.7 • 0.75 • 0.8 • 0.85 • 0.9 • 0.95 • 1 <p>If the family has been customized, the valid values could be different. This cell may only contain a value that exists in the list in the Weld Joint Efficiency field for RBI Component records.</p>
Insulated?	MI_RBICOMPO_INSUL_F	Boolean	<p>Enter True or False. The value in this cell must be True if the an analysis in the component is linked to one of the following DMs:</p> <ul style="list-style-type: none"> • 581-Ferritic Component Corrosion Under Insulation • 581-Austenitic Component Cracking Under Insulation

Field Caption	Field ID	Data Type (Length)	Comments
Insulation Type	MI_RBICOMPO_INSUL_C	Character (200)	<p>A value is required if the value in the Insulated? cell is True.</p> <p>This cell may only contain one of the following values, which exist in the list in the Insulation Type field for RBI Component records:</p> <ul style="list-style-type: none"> • Asbestos • Calcium Silicate (Cl Free) • Calcium Silicate (Not Cl Free) • Foam/Cellular Glass • Mineral Wool/Fiber Glass • Pearlite • Unknown <p>If the family has been customized, the valid values could be different. This cell may only contain a value that exists in the list in the Insulation Type field for RBI Component records.</p>
Injection Point Data	MI_CCRBICPI_INJ_PT_CIR_C	Character (50)	<p>A value is required if the component type is Piping (i.e., the value in the Component Family cell is CCRBICPI).</p>
Piping Circuit Length	MI_CCRBICPI_PIP_CIR LENG_N	Numeric	<p>A value is required if:</p> <ul style="list-style-type: none"> • The component type is Piping (i.e., the value in the Component Family cell is MI_CCRBICPI). <p>-and-</p> <ul style="list-style-type: none"> • The value in the Use Calculate Inventory cell in the RBI_581_Consequence worksheet is True.
PWHT	MI_RBICOMPO_PWHT_F	Boolean	Enter True or False.

Field Caption	Field ID	Data Type (Length)	Comments
Internal Corrosion Type	MI_RBICOMPO_INTER_CORR_T YPE_C	Character (50)	<p>A value is required if component is linked to RBI 581 Thinning and Lining Evaluation.</p> <p>In the baseline GE Digital APM system, this cell may only contain one of the following System Code IDs:</p> <ul style="list-style-type: none"> • General • Localized • Pitting <p>The list in this field is populated by the CORROSION TYPES System Code Table. If the system code table has been customized, the valid values could be different. To verify which options are acceptable in your GE Digital APM system, via Configuration Manager, refer to the appropriate table.</p>
Predictable Int. Corr. Location	MI_CCRBICOM_PRED_INT_CORR _LOC_F	Boolean	Enter True or False.
Estimated Internal Corrosion Rate	MI_RBICOMPO_EXP_INT_CORR _RT_N	Numeric	<p>A value is required if:</p> <ul style="list-style-type: none"> • The component is linked to the 581 Internal Component Lining Damage DM. -and- • The value in the Selected Base Material Corrosion Rate cell in the linked DM is Estimated Rate.
Estimated External Corrosion Rate	MI_RBICOMPO_EXP_EXT_CORR _RT_N	Numeric	<p>A value is required if:</p> <ul style="list-style-type: none"> • The component is linked to a PDM that belongs to RBI 581 External Cracking Damage Evaluation or RBI 581 External Corrosion Damage Evaluation. -and- • The value in the Selected External Corrosion Rate cell for the associated DMs is Estimated.

Field Caption	Field ID	Data Type (Length)	Comments
Measured External Corrosion Rate	MI_RBICOMPO_MEAS_EXT_CO R_RT_N	Numeric	None
Source of Calculated Corrosion Rates	MI_CCRBICOM_CALC_CD_CR_SRC _C	Character (50)	<p>In the baseline GE Digital APM system, this cell may only contain one of the following System Code IDs:</p> <ul style="list-style-type: none"> • ASSET • COMPONENT • MANUAL <p>The list in this field is populated by the MI_RBI_CALC_CORRO_SRC System Code Table. If the system code table has been customized, the valid values could be different. To verify which options are acceptable in your GE Digital APM system, via Configuration Manager, refer to the appropriate table.</p>
Percent Liquid Volume	MI_RBICOMPO_PER_LIQ_VOL_ N	Numeric	A value is required if you want to calculate inventory.

Field Caption	Field ID	Data Type (Length)	Comments								
Detection System	MI_CCRBICOM_DETECTION_SY STEM_C	Character (4)	<p>A value is required.</p> <p>In the baseline GE Digital APM system, this cell may only contain one of the following System Code IDs:</p> <table border="1" data-bbox="1146 470 1419 831"> <thead> <tr> <th data-bbox="1146 470 1281 554">System Code ID</th> <th data-bbox="1281 470 1419 554">Detection System</th> </tr> </thead> <tbody> <tr> <td data-bbox="1146 554 1281 667">A</td> <td data-bbox="1281 554 1419 667">Loss Of Pressure Or Flow</td> </tr> <tr> <td data-bbox="1146 667 1281 747">B</td> <td data-bbox="1281 667 1419 747">Pressure Envelope</td> </tr> <tr> <td data-bbox="1146 747 1281 831">C</td> <td data-bbox="1281 747 1419 831">Visual Detection</td> </tr> </tbody> </table> <p>The list in this field is populated by the 581_Detection System Code Table. If the system code table has been customized, the valid values could be different. To verify which options are acceptable in your GE Digital APM system, via Configuration Manager, refer to the appropriate table.</p>	System Code ID	Detection System	A	Loss Of Pressure Or Flow	B	Pressure Envelope	C	Visual Detection
System Code ID	Detection System										
A	Loss Of Pressure Or Flow										
B	Pressure Envelope										
C	Visual Detection										

Field Caption	Field ID	Data Type (Length)	Comments								
Isolation System	MI_CCRBICOM_ISOLA_SYSTE_ CHR	Character (50)	<p>A value is required.</p> <p>In the baseline GE Digital APM system, this cell may only contain one of the following System Code IDs:</p> <table border="1" data-bbox="1146 472 1414 1180"> <thead> <tr> <th data-bbox="1146 472 1279 552">System Code ID</th> <th data-bbox="1279 472 1414 552">Isolation System</th> </tr> </thead> <tbody> <tr> <td data-bbox="1146 552 1279 632">A</td> <td data-bbox="1279 552 1414 632">Auto Shutdown</td> </tr> <tr> <td data-bbox="1146 632 1279 905">B</td> <td data-bbox="1279 632 1414 905">Leakage Shutdown (This value is valid only if the value in the Detection System cell is B or C).</td> </tr> <tr> <td data-bbox="1146 905 1279 1180">C</td> <td data-bbox="1279 905 1414 1180">Manual Shutdown (This value is valid only if the value in the Detection System cell is C).</td> </tr> </tbody> </table> <p>The list in this field is populated by the 581_Isolation System Code Table. If the system code table has been customized, the valid values could be different. To verify which options are acceptable in your GE Digital APM system, via Configuration Manager, refer to the appropriate table.</p>	System Code ID	Isolation System	A	Auto Shutdown	B	Leakage Shutdown (This value is valid only if the value in the Detection System cell is B or C).	C	Manual Shutdown (This value is valid only if the value in the Detection System cell is C).
System Code ID	Isolation System										
A	Auto Shutdown										
B	Leakage Shutdown (This value is valid only if the value in the Detection System cell is B or C).										
C	Manual Shutdown (This value is valid only if the value in the Detection System cell is C).										

Field Caption	Field ID	Data Type (Length)	Comments												
Mitigation System	MI_CCRBICOM_MITIGATION_S YSTM_C	Character (60)	<p>A value is required.</p> <p>In the baseline GE Digital APM system, this cell may only contain one of the following System Code IDs:</p> <table border="1" data-bbox="1146 470 1414 961"> <thead> <tr> <th data-bbox="1146 470 1281 552">System Code ID</th> <th data-bbox="1281 470 1414 552">Mitigation System</th> </tr> </thead> <tbody> <tr> <td data-bbox="1146 552 1281 634">1</td> <td data-bbox="1281 552 1414 634">Inventory blowdown</td> </tr> <tr> <td data-bbox="1146 634 1281 716">2</td> <td data-bbox="1281 634 1414 716">Fire water deluge system</td> </tr> <tr> <td data-bbox="1146 716 1281 798">3</td> <td data-bbox="1281 716 1414 798">Fire water monitors only</td> </tr> <tr> <td data-bbox="1146 798 1281 879">4</td> <td data-bbox="1281 798 1414 879">Foam spray system</td> </tr> <tr> <td data-bbox="1146 879 1281 961">5</td> <td data-bbox="1281 879 1414 961">No mitigation system</td> </tr> </tbody> </table> <p>The list in this field is populated by the 581_Mitigation_System System Code Table. If the system code table has been customized, the valid values could be different. To verify which options are acceptable in your GE Digital APM system, via Configuration Manager, refer to the appropriate table.</p>	System Code ID	Mitigation System	1	Inventory blowdown	2	Fire water deluge system	3	Fire water monitors only	4	Foam spray system	5	No mitigation system
System Code ID	Mitigation System														
1	Inventory blowdown														
2	Fire water deluge system														
3	Fire water monitors only														
4	Foam spray system														
5	No mitigation system														

Field Caption	Field ID	Data Type (Length)	Comments
Fluid Velocity	MI_CCRBICOM_FLUID_VELOCIT Y_N	Numeric	<p>A value is required if an analysis in the component is linked to any of the following DMs:</p> <ul style="list-style-type: none"> • 581-Acid Sour Water Corrosion • 581-Hydrofluoric Acid Corrosion • 581-Amine Corrosion • 581-Cooling Water Corrosion • 581-High Temperature Sulfidic and Naphthenic Acid • 581-Sulfuric Acid Corrosion • 581-Alkaline Sour Water Corrosion
pH of Water	MI_CCRBICOM_PH_OF_WATER _N	Numeric	<p>A value is required if an analysis in the component is linked to any of the following DMs:</p> <ul style="list-style-type: none"> • 581-Acid Sour Water Corrosion • 581-Cooling Water Corrosion • 581-Hydrochloric Acid Corrosion • 581-Alkaline Carbonate Stress Corrosion Cracking • 581-Chloride Stress Corrosion Cracking • 581-HIC/SOHIC - H2S • 581-Sulfide Stress Cracking

Field Caption	Field ID	Data Type (Length)	Comments														
Geometry Type	MI_CCRBICOM_GEOMETRY_TY PE_C	Character (60)	<p>A value is required if the component is linked to any of the following PDMs:</p> <ul style="list-style-type: none"> RBI 581 Thinning and Lining Evaluation RBI 581 External Corrosion Damage Evaluation <p>In the baseline GE Digital APM system, this cell may only contain one of the following System Code IDs:</p> <table border="1"> <thead> <tr> <th>System Code ID</th> <th>Geometry Type</th> </tr> </thead> <tbody> <tr> <td>CYL</td> <td>Cylinder</td> </tr> <tr> <td>SPH</td> <td>Spherical Head</td> </tr> <tr> <td>HEM</td> <td>Hemispherical Head</td> </tr> <tr> <td>PIPE</td> <td>Piping</td> </tr> <tr> <td>HEAD</td> <td>Head</td> </tr> <tr> <td>PLT</td> <td>PLT (only if the value in the Component Family cell is MI_CCRBICTB)</td> </tr> </tbody> </table> <p>The list in this field is populated by the MI_581_Component_Geometry_Types System Code Table. If the system code table has been customized, the valid values could be different. To verify which options are acceptable in your GE Digital APM system, via Configuration Manager, refer to the appropriate table.</p>	System Code ID	Geometry Type	CYL	Cylinder	SPH	Spherical Head	HEM	Hemispherical Head	PIPE	Piping	HEAD	Head	PLT	PLT (only if the value in the Component Family cell is MI_CCRBICTB)
System Code ID	Geometry Type																
CYL	Cylinder																
SPH	Spherical Head																
HEM	Hemispherical Head																
PIPE	Piping																
HEAD	Head																
PLT	PLT (only if the value in the Component Family cell is MI_CCRBICTB)																

Field Caption	Field ID	Data Type (Length)	Comments																																																				
GFF Component Type	MI_CCRBICOM_GFF_COMPO_T YPE_CHR	Character (50)	<p>A value is required.</p> <p>This cell may only contain one of the following values, which exist in the list in the GFF Component Type field for RBI Component records:</p> <table border="1"> <thead> <tr> <th>Value</th> <th>General Fail Frequency (GFF) Component Type</th> </tr> </thead> <tbody> <tr><td>COLBTM</td><td>Vessel/FinFan</td></tr> <tr><td>COLMID</td><td>Vessel/FinFan</td></tr> <tr><td>COLTOP</td><td>Vessel/FinFan</td></tr> <tr><td>COMPC</td><td>Compressor</td></tr> <tr><td>COMPR</td><td>Compressor</td></tr> <tr><td>COURSE-1-10</td><td>Tank650 (only for an AST Shell component)</td></tr> <tr><td>DRUM</td><td>Vessel/FinFan</td></tr> <tr><td>FILTER</td><td>Vessel/FinFan</td></tr> <tr><td>FINFAN</td><td>Vessel/FinFan</td></tr> <tr><td>HEXSS</td><td>Heat Exchanger</td></tr> <tr><td>HEXTS</td><td>Heat Exchanger</td></tr> <tr><td>KODRUM</td><td>Vessel/FinFan</td></tr> <tr><td>PIPE-1</td><td>Pipe</td></tr> <tr><td>PIPE-10</td><td>Pipe</td></tr> <tr><td>PIPE-12</td><td>Pipe</td></tr> <tr><td>PIPE-16</td><td>Pipe</td></tr> <tr><td>PIPE-2</td><td>Pipe</td></tr> <tr><td>PIPE-4</td><td>Pipe</td></tr> <tr><td>PIPE-6</td><td>Pipe</td></tr> <tr><td>PIPE-8</td><td>Pipe</td></tr> <tr><td>PIPEGT16</td><td>Pipe</td></tr> <tr><td>PUMP1S</td><td>Pump</td></tr> <tr><td>PUMP2S</td><td>Pump</td></tr> <tr><td>PUMPR</td><td>Pump</td></tr> <tr><td>REACTOR</td><td>Vessel/FinFan</td></tr> </tbody> </table>	Value	General Fail Frequency (GFF) Component Type	COLBTM	Vessel/FinFan	COLMID	Vessel/FinFan	COLTOP	Vessel/FinFan	COMPC	Compressor	COMPR	Compressor	COURSE-1-10	Tank650 (only for an AST Shell component)	DRUM	Vessel/FinFan	FILTER	Vessel/FinFan	FINFAN	Vessel/FinFan	HEXSS	Heat Exchanger	HEXTS	Heat Exchanger	KODRUM	Vessel/FinFan	PIPE-1	Pipe	PIPE-10	Pipe	PIPE-12	Pipe	PIPE-16	Pipe	PIPE-2	Pipe	PIPE-4	Pipe	PIPE-6	Pipe	PIPE-8	Pipe	PIPEGT16	Pipe	PUMP1S	Pump	PUMP2S	Pump	PUMPR	Pump	REACTOR	Vessel/FinFan
Value	General Fail Frequency (GFF) Component Type																																																						
COLBTM	Vessel/FinFan																																																						
COLMID	Vessel/FinFan																																																						
COLTOP	Vessel/FinFan																																																						
COMPC	Compressor																																																						
COMPR	Compressor																																																						
COURSE-1-10	Tank650 (only for an AST Shell component)																																																						
DRUM	Vessel/FinFan																																																						
FILTER	Vessel/FinFan																																																						
FINFAN	Vessel/FinFan																																																						
HEXSS	Heat Exchanger																																																						
HEXTS	Heat Exchanger																																																						
KODRUM	Vessel/FinFan																																																						
PIPE-1	Pipe																																																						
PIPE-10	Pipe																																																						
PIPE-12	Pipe																																																						
PIPE-16	Pipe																																																						
PIPE-2	Pipe																																																						
PIPE-4	Pipe																																																						
PIPE-6	Pipe																																																						
PIPE-8	Pipe																																																						
PIPEGT16	Pipe																																																						
PUMP1S	Pump																																																						
PUMP2S	Pump																																																						
PUMPR	Pump																																																						
REACTOR	Vessel/FinFan																																																						

Field Caption	Field ID	Data Type (Length)	Comments						
Cladding Present	MI_CCRBICOM_CLADDING_PRESSENT_L	Character (50)	<p>A value is required if an associated analysis is linked to any of the following DMs:</p> <ul style="list-style-type: none"> • 581-HIC/SOHIC – HF • 581-Hydrogen Stress Cracking • 581-Polythionic Acid Cracking • All DMs that belong to RBI 581 Thinning and Lining Evaluation <p>In the baseline GE Digital APM system, this cell may only contain one of the following System Code IDs:</p> <table border="1"> <thead> <tr> <th>System Code ID</th> <th>Cladding Present</th> </tr> </thead> <tbody> <tr> <td>Y</td> <td>Yes</td> </tr> <tr> <td>N</td> <td>No</td> </tr> </tbody> </table> <p>The list in this field is populated by the MI_YES_NO System Code Table. If the system code table has been customized, the valid values could be different. To verify which options are acceptable in your GE Digital APM system, via Configuration Manager, refer to the appropriate table.</p>	System Code ID	Cladding Present	Y	Yes	N	No
System Code ID	Cladding Present								
Y	Yes								
N	No								
Furnished Cladding Thickness	MI_CCRBICOM_CHR	Numeric	A value is required if the value in the Cladding Present cell is Y.						
Minimum Structural Thickness	MI_CCRBICOM_MNMM_STRUCT_THS_N	Numeric	<p>A value is required if the component is linked to any of the following PDMs:</p> <ul style="list-style-type: none"> • RBI 581 Thinning and Lining Evaluation • RBI 581 External Corrosion Damage Evaluation 						

Field Caption	Field ID	Data Type (Length)	Comments						
Liner Present	MI_CCRBICOM_LINER_PRESE_ CHR	Character (50)	<p>A value is required if the component is linked to the RBI 581 Thinning and Lining Evaluation PDM.</p> <p>In the baseline GE Digital APM system, this cell may only contain one of the following System Code IDs:</p> <table border="1"> <thead> <tr> <th>System Code ID</th> <th>Liner Present</th> </tr> </thead> <tbody> <tr> <td>Y</td> <td>Yes</td> </tr> <tr> <td>N</td> <td>No</td> </tr> </tbody> </table> <p>The list in this field is populated by the MI_YES_NO System Code Table. If the system code table has been customized, the valid values could be different. To verify which options are acceptable in your GE Digital APM system, via Configuration Manager, refer to the appropriate table.</p> <p>For the 581-Internal Component Lining Damage DM, the value in this cell must be Yes.</p>	System Code ID	Liner Present	Y	Yes	N	No
System Code ID	Liner Present								
Y	Yes								
N	No								

Field Caption	Field ID	Data Type (Length)	Comments														
Liner Type	MI_CCRBICOM_LINER_TP_C	Character (50)	<p>A value is required if the value in the Liner Present cell is Y.</p> <p>In the baseline GE Digital APM system, this cell may only contain one of the following System Code IDs:</p> <table border="1" data-bbox="1146 501 1416 1299"> <thead> <tr> <th data-bbox="1146 501 1281 583">System Code ID</th> <th data-bbox="1281 501 1416 583">Liner Type</th> </tr> </thead> <tbody> <tr> <td data-bbox="1146 583 1281 665">1</td> <td data-bbox="1281 583 1416 665">Strip Lined Alloy</td> </tr> <tr> <td data-bbox="1146 665 1281 842">2</td> <td data-bbox="1281 665 1416 842">Organic Coating (typically > 0.762mm / 30 mils)</td> </tr> <tr> <td data-bbox="1146 842 1281 1018">3</td> <td data-bbox="1281 842 1416 1018">Thermal Resistant Service - Castable Refractory</td> </tr> <tr> <td data-bbox="1146 1018 1281 1194">6</td> <td data-bbox="1281 1018 1416 1194">Severe/ Abrasive Service - Castable Refractory</td> </tr> <tr> <td data-bbox="1146 1194 1281 1247">8</td> <td data-bbox="1281 1194 1416 1247">Glass Linings</td> </tr> <tr> <td data-bbox="1146 1247 1281 1299">10</td> <td data-bbox="1281 1247 1416 1299">Fiberglass</td> </tr> </tbody> </table> <p>The list in this field is populated by the MI_581_Lining_Types_And_Resistance System Code Table. If the system code table has been customized, the valid values could be different. To verify which options are acceptable in your GE Digital APM system, via Configuration Manager, refer to the appropriate table.</p>	System Code ID	Liner Type	1	Strip Lined Alloy	2	Organic Coating (typically > 0.762mm / 30 mils)	3	Thermal Resistant Service - Castable Refractory	6	Severe/ Abrasive Service - Castable Refractory	8	Glass Linings	10	Fiberglass
System Code ID	Liner Type																
1	Strip Lined Alloy																
2	Organic Coating (typically > 0.762mm / 30 mils)																
3	Thermal Resistant Service - Castable Refractory																
6	Severe/ Abrasive Service - Castable Refractory																
8	Glass Linings																
10	Fiberglass																

Field Caption	Field ID	Data Type (Length)	Comments
Has Release Prevention Barrier?	MI_CCRBICTB_HAS_RELEA_PR EVE_F	Boolean	A value is required if the value in the Component Type cell is Storage Tank Bottom. Enter True or False. If you enter True, then after you load data, the value in the Maximum Fill Height in AST field is populated with the value 0.25 feet.
CM Corrosion Rate	MI_CCRBICOM_CM_COR_RT_C	Numeric	A value is required if: <ul style="list-style-type: none"> The value in the Cladding Present cell is Y. The value in the Cladding Material Corrosion Rate is Estimated.
Corrosion Allow	MI_RBICOMPO_CORRO_ALLO W_N	Numeric	None

Field Caption	Field ID	Data Type (Length)	Comments
Is Intrusive?	MI_RBICOMPO_IS_INTRU_CHR	Character (50)	<p>A value is required if an analysis in the component is linked to any of the following DMs:</p> <ul style="list-style-type: none"> • 581-High Temperature Oxidation • 581-Cooling Water Corrosion • 581-High Temperature H2/H2S Corrosion • 581-Amine Corrosion • 581-Hydrofluoric Acid Corrosion • 581-Sulfuric Acid Corrosion • 581-Hydrochloric Acid Corrosion • 581-Acid Sour Water Corrosion • 581-High Temperature Sulfidic and Naphthenic Acid • 581-Alkaline Sour Water Corrosion • 581-Soil Side Corrosion • 581-Thinning Damage • All DMs that belong to RBI 581 Cracking Damage Evaluation • All DMs that belong to RBI 581 External Cracking Damage Evaluation • All DMs that belong to RBI 581 External Damage Evaluation
Specified Tmin	MI_CCRBICOM_SPECIFIED_TMIN_N	Numeric	A value is required if the value in the Override Minimum Thickness cell is True.

Field Caption	Field ID	Data Type (Length)	Comments
Base Material	MI_CCRBICOM_BASE_MATER_ C	Character (50)	<p>A value is required if an analysis in the component is linked to any of the following DMs:</p> <ul style="list-style-type: none"> • 581-HIC/SOHIC – HF (only if the value in the Cladding Present field is No (N)) • 581-Hydrogen Stress Cracking (only if the value in the Cladding Present field is No (N)) • 581-Polythionic Acid Cracking (only if the value in the Cladding Present field is No (N)) • 581-High Temperature Hydrogen Attack • 581-Brittle Fracture • All DMs that belong to RBI 581 Thinning and Lining Evaluation <p>This cell may only contain one of the values that exist in the list in the Base Material field for RBI Component records.</p>

Field Caption	Field ID	Data Type (Length)	Comments
Cladding Material	MI_CCRBICOM_CLADDING_MATERIL_C	Character (50)	<p>A value is required if:</p> <ul style="list-style-type: none"> • The value in the Cladding Present cell is Y. • An analysis in the component is linked to one of the following DMs: <ul style="list-style-type: none"> ◦ 581-High Temperature Oxidation ◦ 581-Cooling Water Corrosion ◦ 581-High Temperature H2/H2S Corrosion ◦ 581-Amine Corrosion ◦ 581-Hydrofluoric Acid Corrosion ◦ 581-Sulfuric Acid Corrosion ◦ 581-Hydrochloric Acid Corrosion ◦ 581-Acid Sour Water Corrosion ◦ 581-High Temperature Sulfidic and Naphthenic Acid ◦ 581-Alkaline Sour Water Corrosion ◦ 581-Soil Side Corrosion 581-Thinning Damage <p>This cell may only contain one of the values that exist in the list in the Cladding Material field for RBI Component records.</p>
Total Acid Number	MI_CCRBICOM_TOTAL_ACID_NUMBR_N	Numeric	<p>A value is required if an analysis in the component is linked to the 581-High Temperature Sulfidic and Naphthenic Acid DM.</p>

RBI_581_Analysis Worksheet

In the RBI_581_Analysis worksheet, you will specify the analyses (which will be represented by RBI 581 Risk Analysis records) that you want to create. You cannot update an RBI 581 Risk Analysis using the data loader workbook.

Field Caption	Field ID	Data Type (Length)	Comments
Asset ID	MI_EQUIP000_EQUIP_ID_C	Character (255)	Values in this column must match values entered in the Assets worksheet. Multiple analyses can be linked to the same asset (i.e., rows may have the same value in this column).
Asset CMMS System	MI_EQUIP000_SAP_SYSTEM_C	Character (255)	Values in this column must match values entered in the Assets worksheet, if they exist. Multiple analyses can be linked to the same asset (i.e., rows may have the same value in this column).
Equipment Technical Number	MI_EQUIP000_EQUIP_TECH_N BR_C	Character (255)	Values in this column must match values entered in the Assets worksheet, if they exist. Multiple components can be linked to the same asset (i.e., rows may have the same value in this column).
Component	MI_RBICOMPO_COMPO_C	Character (250)	Values in this column must match values entered on the RBI_Component worksheet, if they exist. Multiple analyses can be linked to the same component (i.e., rows may have the same value in this column).
Component Type	MI_RBICOMPO_COMPO_TYPE_ C	Character (60)	Values in this column must match values that you entered in the Component Type column in the RBI_Component worksheet for the associated component.
Analysis Unique ID	MI_ANALYSIS_ID	Character (255)	A value is required and must be unique. This value identifies the analysis. However, in the RBI 581 Risk Analysis records that are created by the data loader in GE Digital APM, the value in the Analysis ID field is different from the value that you enter in this cell.
Scenario ID	MI_CRITANAL_TURNAROUND_I D_C	Character (50)	None

Field Caption	Field ID	Data Type (Length)	Comments										
Coefficient Y Material	MI_581RANAL_COEFFICNT_Y_MTRL_C	Character (255)	<p>A value is required if the component type is Piping (i.e., the value in the Component Family cell is MI_CCRBICPI).</p> <p>In the baseline GE Digital APM system, this cell may only contain one of the following System Code IDs:</p> <table border="1"> <thead> <tr> <th>System Code ID</th> <th>Coefficient Y Material</th> </tr> </thead> <tbody> <tr> <td>1</td> <td>Ferritic Steels</td> </tr> <tr> <td>2</td> <td>Austenitic Steels</td> </tr> <tr> <td>3</td> <td>Other Ductile Metals</td> </tr> <tr> <td>4</td> <td>Cast Iron</td> </tr> </tbody> </table> <p>The list in this field is populated by the MI_581_Coefficient_Materials System Code Table. If the system code table has been customized, the valid values could be different. To verify which options are acceptable in your GE Digital APM system, via Configuration Manager, refer to the appropriate table.</p>	System Code ID	Coefficient Y Material	1	Ferritic Steels	2	Austenitic Steels	3	Other Ductile Metals	4	Cast Iron
System Code ID	Coefficient Y Material												
1	Ferritic Steels												
2	Austenitic Steels												
3	Other Ductile Metals												
4	Cast Iron												
Stress Override	MI_581RANAL_STRES_OVER_F	Boolean	Enter True or False.										
Allowable Stress	MI_CRITANAL_MTL_ALLOW_STRESS_N	Numeric	A value is required if the value in the Stress Override cell is True.										
Flow Stress	MI_581RANAL_FLOW_STRESS_N	Numeric	A value is required if the value in the Stress Override cell is True.										

Field Caption	Field ID	Data Type (Length)	Comments
Override Minimum Required Thickness	MI_581RANAL_OVERR_MINIM_REQUI_THICK_FLG	Boolean	Enter True or False.
Course Number	MI_581RANAL_COURS_NUMBE_NBR	Numeric	A value is required if the analysis is linked to a component of type Storage Tank (i.e., the value in the Component Type cell in the RBI_Component worksheet for the associated component is Storage Tank).

RBI_581_Consequence Worksheet

In the RBI_581_Consequence worksheet, you will specify the consequences (which are or will be represented by RBI 581 Consequence Evaluation records) that you want to create or update. You can create only one RBI 581 Consequence Evaluation for an RBI 581 Risk Analysis.

Field Caption	Field ID	Data Type (Length)	Comments
Asset ID	MI_EQUIP000_EQUIP_ID_C	Character (255)	Values in this column must match values entered on the Assets worksheet. Multiple Consequence Evaluations can be linked to the same asset (i.e., rows may have the same value in this column).
Asset CMMS System	MI_EQUIP000_SAP_SYSTEM_C	Character (255)	Values in this column must match values entered on the Assets worksheet, if they exist. Multiple Consequence Evaluations can be linked to the same asset (i.e., rows may have the same value in this column).
Equipment Technical Number	MI_EQUIP000_EQUIP_TECH_NBR_C	Character (255)	Values in this column must match values entered on the Assets worksheet, if they exist. Multiple Consequence Evaluations can be linked to the same asset (i.e., rows may have the same value in this column).

Field Caption	Field ID	Data Type (Length)	Comments
Component	MI_RBICOMPO_COMPO_C	Character (250)	Values in this column must match values entered on the RBI_Component worksheet, if they exist. Multiple Consequence Evaluations can be linked to the same component (i.e., rows may have the same value in this column).
Component Type	MI_RBICOMPO_COMPO_TYPE_C	Character (60)	Values in this column must match values that you entered in the Component Type column on the RBI_Component worksheet for the associated component.
Analysis Unique ID	MI_ANALYSIS_ID	Character (255)	Values in this column must match values entered on the RBI_581_Analysis worksheet. Each analysis can have only one Consequence Evaluation.
Consequence	MI_RCONEVAL_CONS_C	Character (50)	A value is required in this cell if you are creating more than one Consequence Evaluation for the same analysis. If left blank, the Consequence field will be populated with the value RBI Consequence.
Use Calculated Inventory	MI_RBI_EVNO_USE_CAL_INV_L	Boolean	Enter True or False. If the value in this cell is True, values in the following cells in the RBI_Component worksheet for the associated component are required: <ul style="list-style-type: none"> • Length • Diameter • Piping Circuit Length
Inventory Group Mass	MI_RBI_EVNO_INV_GRP_MSS_N	Numeric	A value is required if the value in the Component Family cell is not Storage Tank Bottom.
Include Personnel Injury	MI_RBI_EVNO_INCLDPRSNLN_JRYG_L	Boolean	Enter True or False.
Injury Cost	MI_RCONEVAL_INJUR_COST_N	Numeric	A value is required if the value in the Include Personnel Injury cell is True.

Field Caption	Field ID	Data Type (Length)	Comments
Asset Cost	MI_RCONEVAL_EQU_COST_N	Numeric	A value is required if the value in the Component Type cell is not Storage Tank Bottom.
Production Cost	MI_RCONEVAL_PROD_COST_N	Numeric	A value is required.
Environmental Clean-up Costs	MI_RBI_EVNO_ENVIR_CLEAN_COSTS_NBR	Numeric	A value is required if the value in the Component Type cell is not Storage Tank Bottom.
Allow Override of Total Financial Consequence	MI_RBI_EVNO_ALW_OVE_OF_TFC_FLAG	Boolean	Enter True or False.
User Total Financial Consequences	MI_RBI_EVNO_USERTOTAL_FC_N	Numeric	A value is required if the value in the Allow Override of Total Financial Consequence cell is True.
Maximum Fill Height in AST	MI_RBI_EVNO_MXM_FLL_HGT_AST_N	Numeric	<p>A value is required if, on the RBI_Component worksheet:</p> <ul style="list-style-type: none"> The value in the Component Type cell is Storage Tank or Storage Tank Bottom. The value in the Has Release Prevention Barrier cell is False. <p>If, however, the value in the Has Release Prevention Barrier cell is True, after you load data, the Maximum Fill Height is AST field is populated with the value 0.25 feet irrespective of the value in this cell.</p>
Fluid Percent Leaving Dike	MI_RBI_EVNO_FLD_PRCT_LVG_DKE_N	Numeric	A value is required if the component type is Storage Tank or component type is Storage Tank Bottom and component family is Tank Bottom (i.e., the value in the Component Family column in the RBI_Component worksheet is MI_CCRBICTB).

Field Caption	Field ID	Data Type (Length)	Comments
Fluid Percent Onsite	MI_RBI_EVNO_FLUD_PRCNT_ONSTE_N	Numeric	A value is required if the component type is Storage Tank or component type is Storage Tank Bottom and component family is Tank Bottom (i.e., the value in the Component Family column in the RBI_Component worksheet is MI_CCRBICTB).
Fluid Percent Offsite	MI_RBI_EVNO_FLD_PRCNT_OFFSTE_N	Numeric	A value is required if the component type is Storage Tank or component type is Storage Tank Bottom and component family is Tank Bottom (i.e., the value in the Component Family column in the RBI_Component worksheet is MI_CCRBICTB).

Field Caption	Field ID	Data Type (Length)	Comments								
Environmental Sensitivity	MI_RBI_EVNO_ENVRNMENTL_S NSTVY_C	Character (50)	<p>A value is required if the component type is Storage Tank or component type is Storage Tank Bottom and component family is Tank Bottom (i.e., the value in the Component Family column in the RBI_Component worksheet is MI_CCRBICTB).</p> <p>In the baseline GE Digital APM system, this cell may only contain one of the following System Code IDs:</p> <table border="1"> <thead> <tr> <th>System Code ID</th> <th>Environmental Sensitivity</th> </tr> </thead> <tbody> <tr> <td>L</td> <td>Low</td> </tr> <tr> <td>M</td> <td>Medium</td> </tr> <tr> <td>H</td> <td>High</td> </tr> </tbody> </table> <p>The list in this field is populated by the MI_581_Environmental_Sensitivity System Code Table. If the system code table has been customized, the valid values could be different. To verify which options are acceptable in your GE Digital APM system, via Configuration Manager, refer to the appropriate table.</p>	System Code ID	Environmental Sensitivity	L	Low	M	Medium	H	High
System Code ID	Environmental Sensitivity										
L	Low										
M	Medium										
H	High										
Tank Course Height	MI_RBI_EVNO_TANK_COURSE_ HGHT_N	Numeric	A value is required if the value in the Component Type cell is Storage Tank.								

Field Caption	Field ID	Data Type (Length)	Comments																		
Distance from Tankbottom to Groundwater	MI_RBI_EVNO_DSE_FRM_TNM_GRR_N	Numeric	A value is required if the value in the Component Type cell is Storage Tank Bottom.																		
Soil Type under Tank bottom	MI_RBI_EVNO_SL_TYE_UNR_T_BTM_C	Character (50)	<p>A value is required if the value in the Component Type cell is Storage Tank Bottom.</p> <p>In the baseline GE Digital APM system, this cell may only contain one of the following System Code IDs:</p> <table border="1"> <thead> <tr> <th>System Code ID</th> <th>Soil Type</th> </tr> </thead> <tbody> <tr> <td>CL</td> <td>Clay</td> </tr> <tr> <td>CS</td> <td>Coarse Sand</td> </tr> <tr> <td>CA</td> <td>Concrete Asphalt</td> </tr> <tr> <td>FS</td> <td>Fine Sand</td> </tr> <tr> <td>GR</td> <td>Gravel</td> </tr> <tr> <td>SC</td> <td>Sandy Clay</td> </tr> <tr> <td>SL</td> <td>Slit</td> </tr> <tr> <td>VF</td> <td>Very Fine Sand</td> </tr> </tbody> </table> <p>The list in this field is populated by the MI_581_Soil_Types System Code Table. If the system code table has been customized, the valid values could be different. To verify which options are acceptable in your GE Digital APM system, via Configuration Manager, refer to the appropriate table.</p>	System Code ID	Soil Type	CL	Clay	CS	Coarse Sand	CA	Concrete Asphalt	FS	Fine Sand	GR	Gravel	SC	Sandy Clay	SL	Slit	VF	Very Fine Sand
System Code ID	Soil Type																				
CL	Clay																				
CS	Coarse Sand																				
CA	Concrete Asphalt																				
FS	Fine Sand																				
GR	Gravel																				
SC	Sandy Clay																				
SL	Slit																				
VF	Very Fine Sand																				

DME_Lining Worksheet

On the DME_Lining worksheet, you will specify the 581-Atmospheric Tank Bottom Corrosion DMs (which are or will be represented by the RBI 581 Thinning and Lining Evaluation records) that you want to create or update. You can specify these records only if the value in the Liner Present cell in the RBI_Component worksheet for the associated component is Y.

Field Caption	Field ID	Data Type (Length)	Comments
Asset ID	MI_EQUIP000_EQUIP_ID_C	Character (255)	Values in this column must match values entered in the Assets worksheet. Multiple DMs can be linked to the same asset (i.e., rows may have the same value in this column).
Asset CMMS System	MI_EQUIP000_SAP_SYSTEM_C	Character (255)	Values in this column must match values entered in the Assets worksheet, if they exist. Multiple DMs can be linked to the same asset (i.e., rows may have the same value in this column).
Equipment Technical Number	MI_EQUIP000_EQUIP_TECH_N BR_C	Character (255)	Values in this column must match values entered in the Assets worksheet, if they exist. Multiple DMs can be linked to the same asset (i.e., rows may have the same value in this column).
Component	MI_RBICOMPO_COMPO_C	Character (250)	Values in this column must match values entered in the RBI_Component worksheet, if they exist. Multiple DMs can be linked to the same component (i.e., rows may have the same value in this column).
Component Type	MI_RBICOMPO_COMPO_TYPE_ C	Character (60)	Values in this column must match values that you entered in the Component Type column in the RBI_Component worksheet for the associated component.
Analysis Unique ID	MI_ANALYSIS_ID	Character (255)	Values in this column must match values entered in the RBI_581_Analysis worksheet, if they exist. Multiple DMs can be linked to the same analysis (i.e., rows may have the same value in this column).
Damage Mechanism	MI_RBDEMEEV_DAM_MECH_C	Character (50)	Enter 581-Internal Component Lining Damage.
Last Known Inspection Date	MI_581DMCHE_LST_KNWN_IN N_DTE_D	Date	Enter a value in the following format: YYYY-MM-DD hh:mm:ss

Field Caption	Field ID	Data Type (Length)	Comments						
Online Monitoring Flag	MI_581DMCHE_ONLNE_MNTR NG_FLG_C	Character (50)	<p>A value is required.</p> <p>In the baseline GE Digital APM system, this cell may only contain one of the following System Code IDs:</p> <table border="1"> <thead> <tr> <th>System Code ID</th> <th>Online Monitoring Flag</th> </tr> </thead> <tbody> <tr> <td>Y</td> <td>Yes</td> </tr> <tr> <td>N</td> <td>No</td> </tr> </tbody> </table> <p>The list in this field is populated by the MI_YES_NO System Code Table. If the system code table has been customized, the valid values could be different. To verify which options are acceptable in your GE Digital APM system, via Configuration Manager, refer to the appropriate table.</p>	System Code ID	Online Monitoring Flag	Y	Yes	N	No
System Code ID	Online Monitoring Flag								
Y	Yes								
N	No								
Key Process Variable?	MI_581DMCHE_KEY_PROCCSS_ VRBLE_C	Character (3)	<p>A value is required if the value in the Online Monitoring Flag column is Y.</p> <p>In the baseline GE Digital APM system, this cell may only contain one of the following System Code IDs:</p> <table border="1"> <thead> <tr> <th>System Code ID</th> <th>Key Process Variable</th> </tr> </thead> <tbody> <tr> <td>Y</td> <td>Yes</td> </tr> <tr> <td>N</td> <td>No</td> </tr> </tbody> </table> <p>The list in this field is populated by the MI_YES_NO System Code Table. If the system code table has been customized, the valid values could be different. To verify which options are acceptable in your GE Digital APM system, via Configuration Manager, refer to the appropriate table.</p>	System Code ID	Key Process Variable	Y	Yes	N	No
System Code ID	Key Process Variable								
Y	Yes								
N	No								

Field Caption	Field ID	Data Type (Length)	Comments						
Electrical Resistance Probes?	MI_581DMCHE_ELCTRCL_RSS E_PRS_C	Character (3)	<p>A value is required if the value in the Online Monitoring Flag column is Y.</p> <p>In the baseline GE Digital APM system, this cell may only contain one of the following System Code IDs:</p> <table border="1" data-bbox="1146 533 1412 747"> <thead> <tr> <th data-bbox="1146 533 1279 646">System Code ID</th> <th data-bbox="1279 533 1412 646">Electrical Resistance Probes</th> </tr> </thead> <tbody> <tr> <td data-bbox="1146 646 1279 695">Y</td> <td data-bbox="1279 646 1412 695">Yes</td> </tr> <tr> <td data-bbox="1146 695 1279 743">N</td> <td data-bbox="1279 695 1412 743">No</td> </tr> </tbody> </table> <p>The list in this field is populated by the MI_YES_NO System Code Table. If the system code table has been customized, the valid values could be different. To verify which options are acceptable in your GE Digital APM system, via Configuration Manager, refer to the appropriate table.</p>	System Code ID	Electrical Resistance Probes	Y	Yes	N	No
System Code ID	Electrical Resistance Probes								
Y	Yes								
N	No								
Corrosion Coupons?	MI_581DMCHE_CORROSION_C OUPNS_C	Character (3)	<p>A value is required if the value in the Online Monitoring Flag column is Y.</p> <p>In the baseline GE Digital APM system, this cell may only contain one of the following System Code IDs:</p> <table border="1" data-bbox="1146 1377 1412 1562"> <thead> <tr> <th data-bbox="1146 1377 1279 1461">System Code ID</th> <th data-bbox="1279 1377 1412 1461">Corrosion Coupons</th> </tr> </thead> <tbody> <tr> <td data-bbox="1146 1461 1279 1514">Y</td> <td data-bbox="1279 1461 1412 1514">Yes</td> </tr> <tr> <td data-bbox="1146 1514 1279 1562">N</td> <td data-bbox="1279 1514 1412 1562">No</td> </tr> </tbody> </table> <p>The list in this field is populated by the MI_YES_NO System Code Table. If the system code table has been customized, the valid values could be different. To verify which options are acceptable in your GE Digital APM system, via Configuration Manager, refer to the appropriate table.</p>	System Code ID	Corrosion Coupons	Y	Yes	N	No
System Code ID	Corrosion Coupons								
Y	Yes								
N	No								

Field Caption	Field ID	Data Type (Length)	Comments
Liner Installation Date	MI_581THNL_LIN_INST_DT_D	Date	A value is required. Enter the value in the following format: YYYY-MM-DD hh:mm:ss

Field Caption	Field ID	Data Type (Length)	Comments								
Liner Condition	MI_581THNL_LINER_COND_C	Character (50)	<p>A value is required.</p> <p>In the baseline GE Digital APM system, this cell may only contain one of the following System Code IDs:</p> <table border="1" data-bbox="1144 472 1419 703"> <thead> <tr> <th data-bbox="1144 472 1279 552">System Code ID</th> <th data-bbox="1279 472 1419 552">Liner Condition</th> </tr> </thead> <tbody> <tr> <td data-bbox="1144 552 1279 604">A</td> <td data-bbox="1279 552 1419 604">Good</td> </tr> <tr> <td data-bbox="1144 604 1279 657">B</td> <td data-bbox="1279 604 1419 657">Average</td> </tr> <tr> <td data-bbox="1144 657 1279 703">C</td> <td data-bbox="1279 657 1419 703">Poor</td> </tr> </tbody> </table> <p>The list in this field is populated by the MI_581_Lining_Condition System Code Table. If the system code table has been customized, the valid values could be different. To verify which options are acceptable in your GE Digital APM system, via Configuration Manager, refer to the appropriate table.</p>	System Code ID	Liner Condition	A	Good	B	Average	C	Poor
System Code ID	Liner Condition										
A	Good										
B	Average										
C	Poor										

Field Caption	Field ID	Data Type (Length)	Comments								
Immersion Grade Coating Quality	MI_581THNL_IMMGN_GRE_CTG_QLY_C	Character (50)	<p>A value is required if the liner type is organic coating (i.e., the value in the Liner Type column in the RBI_Component worksheet for the associated component is 2).</p> <p>In the baseline GE Digital APM system, this cell may only contain one of the following System Code IDs:</p> <table border="1"> <thead> <tr> <th>System Code ID</th> <th>Immersion Grade Coating Quality</th> </tr> </thead> <tbody> <tr> <td>A</td> <td>High</td> </tr> <tr> <td>B</td> <td>Meridium</td> </tr> <tr> <td>C</td> <td>Low</td> </tr> </tbody> </table> <p>The list in this field is populated by the MI_581_Coating_Quality System Code Table. If the system code table has been customized, the valid values could be different. To verify which options are acceptable in your GE Digital APM system, via Configuration Manager, refer to the appropriate table.</p>	System Code ID	Immersion Grade Coating Quality	A	High	B	Meridium	C	Low
System Code ID	Immersion Grade Coating Quality										
A	High										
B	Meridium										
C	Low										

DME_AST Worksheet

In the DME_Lining worksheet, you will specify the 581-Atmospheric Tank Bottom Corrosion DM (which are or will be represented by the RBI 581 Thinning and Lining Evaluation records) that you want to create or update.

Field Caption	Field ID	Data Type (Length)	Comments
Asset ID	MI_EQUIP000_EQUIP_ID_C	Character (255)	Values in this column must match values entered in the Assets worksheet. Multiple DMs can be linked to the same asset (i.e., rows may have the same value in this column).
Asset CMMS System	MI_EQUIP000_SAP_SYSTEM_C	Character (255)	Values in this column must match values entered in the Assets worksheet, if they exist. Multiple DMs can be linked to the same asset (i.e., rows may have the same value in this column).
Equipment Technical Number	MI_EQUIP000_EQUIP_TECH_N BR_C	Character (255)	Values in this column must match values entered in the Assets worksheet, if they exist. Multiple components can be linked to the same asset (i.e., rows may have the same value in this column).
Component	MI_RBICOMPO_COMPO_C	Character (250)	Values in this column must match values entered in the RBI_Component worksheet, if they exist. Multiple DMs can be linked to the same component (i.e., rows may have the same value in this column).
Component Type	MI_RBICOMPO_COMPO_TYPE_ C	Character (60)	Values in this column must match values that you entered in the Component Type column in the RBI_Component worksheet for the associated component.
Analysis Unique ID	MI_ANALYSIS_ID	Character (255)	Values in this column must match values entered in the RBI_581_Analysis worksheet, if they exist. Multiple Consequences can be linked to the same analysis (i.e., rows may have the same value in this column).
Damage Mechanism	MI_RBDEMEEV_DAM_MECH_C	Character (50)	Enter 581-Atmospheric Tank Bottom Corrosion.

Field Caption	Field ID	Data Type (Length)	Comments
Selected Base Material Corrosion Rate	MI_581THNL_SELEC_BM_COR_R_C	Character (50)	<p>A value is required.</p> <p>In the baseline GE Digital APM system, this cell may only contain one of the following System Code IDs:</p> <ul style="list-style-type: none"> • Calculated Rate • Estimated Rate • Short Term Avg • Long Term Avg • Controlling Corrosion Rate <p>The list in this field is populated by the 581_CORR_TYPE System Code Table. If the system code table has been customized, the valid values could be different. To verify which options are acceptable in your GE Digital APM system, via Configuration Manager, refer to the appropriate table.</p>
Long Term Avg Corr Rate	MI_581THNL_LNG_TRM_AVG_COR_R_N	Numeric	<p>A value is required if:</p> <ul style="list-style-type: none"> • The value in the Selected Base Material Corrosion Rate column is Long Term Avg. -and- • The value in the Source of Calculated Corrosion Rates column in the RBI_Component worksheet for the associated component is MANUAL.

Field Caption	Field ID	Data Type (Length)	Comments
Short Term Avg Corr Rate	MI_581THNL_SHRT_TRM_AVG_COR_N	Numeric	<p>A value is required if:</p> <ul style="list-style-type: none"> The value in the Selected Base Material Corrosion Rate column is Short Term Avg. <p>-and-</p> <ul style="list-style-type: none"> The value in the Source of Calculated Corrosion Rates column in the RBI_Component worksheet for the associated component is MANUAL.
Selected Cladding Material Corrosion Rate	MI_581THNL_SELEC_CLADD_COR_R_C	Character (50)	<p>A value is required if the value in the Cladding Present column in the RBI_Component worksheet for the associated component is Y.</p> <p>In the baseline GE Digital APM system, this cell may only contain one of the following System Code IDs:</p> <ul style="list-style-type: none"> Calculated Rate Estimated Rate Short Term Avg Long Term Avg Controlling Corrosion Rate <p>The list in this field is populated by the 581_CORR_TYPE System Code Table. If the system code table has been customized, the valid values could be different. To verify which options are acceptable in your GE Digital APM system, via Configuration Manager, refer to the appropriate table.</p>

Field Caption	Field ID	Data Type (Length)	Comments
Thinning Type	MI_RBDEMEEV_THIN_TYPE_C	Character (50)	<p>A value is required.</p> <p>In the baseline GE Digital APM system, this cell may only contain one of the following System Code IDs:</p> <ul style="list-style-type: none"> • General • Localized • Pitting <p>The list in this field is populated by the CORROSION TYPES System Code Table. If the system code table has been customized, the valid values could be different. To verify which options are acceptable in your GE Digital APM system, via Configuration Manager, refer to the appropriate table.</p>

Field Caption	Field ID	Data Type (Length)	Comments												
Highest Effective Inspection Level	MI_RBDEMEEV_HIGH_EFF_INS_P_C	Character (25)	<p>A value is required.</p> <p>In the baseline GE Digital APM system, this cell may only contain one of the following System Code IDs:</p> <table border="1"> <thead> <tr> <th>System Code ID</th> <th>Highest Effective Inspection Level</th> </tr> </thead> <tbody> <tr> <td>A</td> <td>Highly Effective</td> </tr> <tr> <td>B</td> <td>Usually Effective</td> </tr> <tr> <td>C</td> <td>Fairly Effective</td> </tr> <tr> <td>D</td> <td>Poorly Effective</td> </tr> <tr> <td>E</td> <td>Ineffective (None)</td> </tr> </tbody> </table> <p>The list in this field is populated by the MI_581_Inspection_Effectiveness System Code Table. If the system code table has been customized, the valid values could be different. To verify which options are acceptable in your GE Digital APM system, via Configuration Manager, refer to the appropriate table.</p>	System Code ID	Highest Effective Inspection Level	A	Highly Effective	B	Usually Effective	C	Fairly Effective	D	Poorly Effective	E	Ineffective (None)
System Code ID	Highest Effective Inspection Level														
A	Highly Effective														
B	Usually Effective														
C	Fairly Effective														
D	Poorly Effective														
E	Ineffective (None)														
Number of Highest Effective Inspections	MI_RBDEMEEV_NO_HIGH_EFF_INS_N	Numeric	<p>A value is required.</p> <p>The value must be either 0 or 1. If you enter 0 in this column, then the value in the Highest Effective Inspection Level column must be E.</p>												

Field Caption	Field ID	Data Type (Length)	Comments						
Welded Construction Flag	MI_581DMCHE_WLDD_CNSTR CN_FLG_C	Character (50)	<p>A value is required.</p> <p>In the baseline GE Digital APM system, this cell may only contain one of the following System Code IDs:</p> <table border="1"> <thead> <tr> <th>System Code ID</th> <th>Welded Construction Flag</th> </tr> </thead> <tbody> <tr> <td>Y</td> <td>Yes</td> </tr> <tr> <td>N</td> <td>No</td> </tr> </tbody> </table> <p>The list in this field is populated by the MI_YES_NO System Code Table. If the system code table has been customized, the valid values could be different. To verify which options are acceptable in your GE Digital APM system, via Configuration Manager, refer to the appropriate table.</p>	System Code ID	Welded Construction Flag	Y	Yes	N	No
System Code ID	Welded Construction Flag								
Y	Yes								
N	No								
API 653 Maintenance Flag	MI_581THNL_API_653_MNTE_ FLG_L	Boolean	<p>A value is required. Enter True or False.</p>						
Foundation Type	MI_581DMCHE_FOUND_TYPE_ CHR	Character (50)	<p>A value is required.</p> <p>In the baseline GE Digital APM system, this cell may only contain one of the following System Code IDs:</p> <ul style="list-style-type: none"> • Clay • Silt • Sand • Gravel • Concrete • Double Floor <p>The list in this field is populated by the FOUNDATION TYPES System Code Table. If the system code table has been customized, the valid values could be different. To verify which options are acceptable in your GE Digital APM system, via Configuration Manager, refer to the appropriate table.</p>						

Field Caption	Field ID	Data Type (Length)	Comments						
Settlement Adjustment Flag	MI_581DMCHE_STTLMNT_ADJ T_FLG_C	Character (3)	<p>A value is required if the value in the Foundation Type column is not Concrete.</p> <p>In the baseline GE Digital APM system, this cell may only contain one of the following System Code IDs:</p> <table border="1" data-bbox="1146 533 1417 747"> <thead> <tr> <th data-bbox="1146 533 1279 648">System Code ID</th> <th data-bbox="1279 533 1417 648">Settlement Adjustment Flag</th> </tr> </thead> <tbody> <tr> <td data-bbox="1146 648 1279 699">Y</td> <td data-bbox="1279 648 1417 699">Yes</td> </tr> <tr> <td data-bbox="1146 699 1279 747">N</td> <td data-bbox="1279 699 1417 747">No</td> </tr> </tbody> </table> <p>The list in this field is populated by the MI_YES_NO System Code Table. If the system code table has been customized, the valid values could be different. To verify which options are acceptable in your GE Digital APM system, via Configuration Manager, refer to the appropriate table.</p>	System Code ID	Settlement Adjustment Flag	Y	Yes	N	No
System Code ID	Settlement Adjustment Flag								
Y	Yes								
N	No								

Field Caption	Field ID	Data Type (Length)	Comments								
Settlement Adjustment Inspection	MI_581DMCHE_STTLMNT_ADJ T_INN_C	Character (50)	<p>A value is required if the value in the Settlement Adjustment Flag column is Y.</p> <p>In the baseline GE Digital APM system, this cell may only contain one of the following System Code IDs:</p> <table border="1" data-bbox="1146 533 1414 863"> <thead> <tr> <th data-bbox="1146 533 1279 648">System Code ID</th> <th data-bbox="1279 533 1414 648">Settlement Adjustment Inspection</th> </tr> </thead> <tbody> <tr> <td data-bbox="1146 648 1279 699">1</td> <td data-bbox="1279 648 1414 699">Meets API 653</td> </tr> <tr> <td data-bbox="1146 699 1279 779">1.5</td> <td data-bbox="1279 699 1414 779">Never Evaluated</td> </tr> <tr> <td data-bbox="1146 779 1279 863">2</td> <td data-bbox="1279 779 1414 863">Exceeds API 653</td> </tr> </tbody> </table> <p>The list in this field is populated by the MI_581_Recorded_Settlement_Criteria System Code Table. If the system code table has been customized, the valid values could be different. To verify which options are acceptable in your GE Digital APM system, via Configuration Manager, refer to the appropriate table.</p>	System Code ID	Settlement Adjustment Inspection	1	Meets API 653	1.5	Never Evaluated	2	Exceeds API 653
System Code ID	Settlement Adjustment Inspection										
1	Meets API 653										
1.5	Never Evaluated										
2	Exceeds API 653										

Field Caption	Field ID	Data Type (Length)	Comments						
Online Monitoring Flag	MI_581DMCHE_ONLNE_MNTR NG_FLG_C	Character (50)	<p>A value is required.</p> <p>In the baseline GE Digital APM system, this cell may only contain one of the following System Code IDs:</p> <table border="1"> <thead> <tr> <th>System Code ID</th> <th>Online Monitoring Flag</th> </tr> </thead> <tbody> <tr> <td>Y</td> <td>Yes</td> </tr> <tr> <td>N</td> <td>No</td> </tr> </tbody> </table> <p>The list in this field is populated by the MI_YES_NO System Code Table. If the system code table has been customized, the valid values could be different. To verify which options are acceptable in your GE Digital APM system, via Configuration Manager, refer to the appropriate table.</p>	System Code ID	Online Monitoring Flag	Y	Yes	N	No
System Code ID	Online Monitoring Flag								
Y	Yes								
N	No								
Key Process Variable?	MI_581DMCHE_KEY_PROCCSS_ VRBLE_C	Character (3)	<p>A value is required if the value in the Online Monitoring Flag column is Y.</p> <p>In the baseline GE Digital APM system, this cell may only contain one of the following System Code IDs:</p> <table border="1"> <thead> <tr> <th>System Code ID</th> <th>Key Process Variable</th> </tr> </thead> <tbody> <tr> <td>Y</td> <td>Yes</td> </tr> <tr> <td>N</td> <td>No</td> </tr> </tbody> </table> <p>The list in this field is populated by the MI_YES_NO System Code Table. If the system code table has been customized, the valid values could be different. To verify which options are acceptable in your GE Digital APM system, via Configuration Manager, refer to the appropriate table.</p>	System Code ID	Key Process Variable	Y	Yes	N	No
System Code ID	Key Process Variable								
Y	Yes								
N	No								

Field Caption	Field ID	Data Type (Length)	Comments						
Electrical Resistance Probes?	MI_581DMCHE_ELCTRCL_RSS E_PRS_C	Character (3)	<p>A value is required if the value in the Online Monitoring Flag column is Y.</p> <p>In the baseline GE Digital APM system, this cell may only contain one of the following System Code IDs:</p> <table border="1"> <thead> <tr> <th>System Code ID</th> <th>Electrical Resistance Probes</th> </tr> </thead> <tbody> <tr> <td>Y</td> <td>Yes</td> </tr> <tr> <td>N</td> <td>No</td> </tr> </tbody> </table> <p>The list in this field is populated by the MI_YES_NO System Code Table. If the system code table has been customized, the valid values could be different. To verify which options are acceptable in your GE Digital APM system, via Configuration Manager, refer to the appropriate table.</p>	System Code ID	Electrical Resistance Probes	Y	Yes	N	No
System Code ID	Electrical Resistance Probes								
Y	Yes								
N	No								
Corrosion Coupons?	MI_581DMCHE_CORROSION_C OUPNS_C	Character (3)	<p>A value is required if the value in the Online Monitoring Flag column is Y.</p> <p>In the baseline GE Digital APM system, this cell may only contain one of the following System Code IDs:</p> <table border="1"> <thead> <tr> <th>System Code ID</th> <th>Corrosion Coupons</th> </tr> </thead> <tbody> <tr> <td>Y</td> <td>Yes</td> </tr> <tr> <td>N</td> <td>No</td> </tr> </tbody> </table> <p>The list in this field is populated by the MI_YES_NO System Code Table. If the system code table has been customized, the valid values could be different. To verify which options are acceptable in your GE Digital APM system, via Configuration Manager, refer to the appropriate table.</p>	System Code ID	Corrosion Coupons	Y	Yes	N	No
System Code ID	Corrosion Coupons								
Y	Yes								
N	No								

Field Caption	Field ID	Data Type (Length)	Comments
Soil Resistivity	MI_581THNL_SOIL_RESIS_C	Numeric	A value is required if the value in the Selected Base Material Corrosion Rate cell is Calculated Rate.
AST Pad	MI_581THNL_AST_PAD_C	Character (50)	<p>A value is required if the value in the Selected Base Material Corrosion Rate cell is Calculated Rate.</p> <p>In the baseline GE Digital APM system, this cell may only contain one of the following System Code IDs:</p> <ul style="list-style-type: none"> • Soil With High Salt • Crushed Limestone • Native Soil • Construction Grade Sand • Continuous Asphalt • Continuous Concrete • Oil Sand • High Resistivity Low Chloride Sand <p>The list in this field is populated by the 581_AST_PAD_MAT_TYPE System Code Table. If the system code table has been customized, the valid values could be different. To verify which options are acceptable in your GE Digital APM system, via Configuration Manager, refer to the appropriate table.</p>

Field Caption	Field ID	Data Type (Length)	Comments
AST Drainage	MI_581THNL_AST_DRAINAGE_ C	Character (50)	<p>A value is required if the value in the Selected Base Material Corrosion Rate cell is Calculated Rate.</p> <p>In the baseline GE Digital APM system, this cell may only contain one of the following System Code IDs:</p> <ul style="list-style-type: none"> • One Third Frequently Underwater • Storm Water Collects At AST Base • Storm Water Does Not Collect At AST Base <p>The list in this field is populated by the 581_AST_DRAINAGE_TYPE System Code Table. If the system code table has been customized, the valid values could be different. To verify which options are acceptable in your GE Digital APM system, via Configuration Manager, refer to the appropriate table.</p>
AST Steam Coil Heater	MI_581THNL_AST_STEAM_CL_ HTR_C	Character (50)	<p>A value is required if the value in the Selected Base Material Corrosion Rate cell is Calculated Rate.</p> <p>In the baseline GE Digital APM system, this cell may only contain one of the following System Code IDs:</p> <ul style="list-style-type: none"> • YES • NO <p>The list in this field is populated by the MI_581_AST_STEAMCOIL_WAT ERDRWASOFF System Code Table. If the system code table has been customized, the valid values could be different. To verify which options are acceptable in your GE Digital APM system, via Configuration Manager, refer to the appropriate table.</p>

Field Caption	Field ID	Data Type (Length)	Comments
AST Bottom Type	MI_581THNL_AST_BOTTOM_TY PE_C	Character (50)	<p>A value is required if the value in the Selected Base Material Corrosion Rate cell is Calculated Rate.</p> <p>In the baseline GE Digital APM system, this cell may only contain one of the following System Code IDs:</p> <ul style="list-style-type: none"> • RPB Not Per API 650 • RPB Per API 650 • Single Bottom <p>The list in this field is populated by the 581_AST_BOTTOM_TYPE System Code Table. If the system code table has been customized, the valid values could be different. To verify which options are acceptable in your GE Digital APM system, via Configuration Manager, refer to the appropriate table.</p>

Field Caption	Field ID	Data Type (Length)	Comments								
Cathodic Protection	MI_581THNL_CATHODIC_PRO TCTN_C	Character (50)	<p>A value is required if the value in the Selected Base Material Corrosion Rate cell is Calculated Rate.</p> <p>In the baseline GE Digital APM system, this cell may only contain one of the following System Code IDs:</p> <table border="1" data-bbox="1144 567 1416 861"> <thead> <tr> <th data-bbox="1144 567 1279 646">System Code ID</th> <th data-bbox="1279 567 1416 646">Cathodic Protection</th> </tr> </thead> <tbody> <tr> <td data-bbox="1144 646 1279 699">None</td> <td data-bbox="1279 646 1416 699">None</td> </tr> <tr> <td data-bbox="1144 699 1279 779">Yes Not Per API 651</td> <td data-bbox="1279 699 1416 779">Yes and Not Per API 651</td> </tr> <tr> <td data-bbox="1144 779 1279 861">Yes Per API 651</td> <td data-bbox="1279 779 1416 861">Yes and Per API 651</td> </tr> </tbody> </table> <p>The list in this field is populated by the 581_AST_Cathodic Protection System Code Table. If the system code table has been customized, the valid values could be different. To verify which options are acceptable in your GE Digital APM system, via Configuration Manager, refer to the appropriate table.</p>	System Code ID	Cathodic Protection	None	None	Yes Not Per API 651	Yes and Not Per API 651	Yes Per API 651	Yes and Per API 651
System Code ID	Cathodic Protection										
None	None										
Yes Not Per API 651	Yes and Not Per API 651										
Yes Per API 651	Yes and Per API 651										

Field Caption	Field ID	Data Type (Length)	Comments
Product Side Condition	MI_581THNL_PRODCT_SDE_C NDTN_C	Character (50)	<p>A value is required if the value in the Selected Base Material Corrosion Rate cell is Calculated Rate.</p> <p>In the baseline GE Digital APM system, this cell may only contain one of the following System Code IDs:</p> <ul style="list-style-type: none"> • Wet • Dry <p>The list in this field is populated by the 581_Product_Side_Condition System Code Table. If the system code table has been customized, the valid values could be different. To verify which options are acceptable in your GE Digital APM system, via Configuration Manager, refer to the appropriate table.</p>
Water Product Draws	MI_581THNL_WATER_PRDCT_ DRWS_C	Character (50)	<p>A value is required if the value in the Selected Base Material Corrosion Rate cell is Calculated Rate.</p> <p>In the baseline GE Digital APM system, this cell may only contain one of the following System Code IDs:</p> <ul style="list-style-type: none"> • YES • NO <p>The list in this field is populated by the MI_581_AST_STEAMCOIL_WAT ERDRWASOFF System Code Table. If the system code table has been customized, the valid values could be different. To verify which options are acceptable in your GE Digital APM system, via Configuration Manager, refer to the appropriate table.</p>

DME_Thinning Worksheet

In the DME_Thinning worksheet, you will specify the following DMs (which are or will be represented by the RBI 581 Thinning and Lining Evaluation records) that you want to create or update.

- 581-High Temperature Oxidation
- 581-Cooling Water Corrosion
- 581-High Temperature H2/H2S Corrosion
- 581-Amine Corrosion
- 581-Hydrofluoric Acid Corrosion
- 581-Sulfuric Acid Corrosion
- 581-Hydrochloric Acid Corrosion
- 581-Acid Sour Water Corrosion
- 581-High Temperature Sulfidic and Naphthenic Acid
- 581-Alkaline Sour Water Corrosion
- 581-Soil Side Corrosion

These DMs belong to the RBI 581 Thinning and Lining Evaluation methodology. You can specify these DMs only if the value in the Component Type cell in the RBI_Component worksheet for the associated component is not Storage Tank Bottom.

Field Caption	Field ID	Data Type (Length)	Comments
Asset ID	MI_EQUIP000_EQUIP_ID_C	Character (255)	Values in this column must match values entered in the Assets worksheet. Multiple DMs can be linked to the same asset (i.e., rows may have the same value in this column).
Asset CMMS System	MI_EQUIP000_SAP_SYSTEM_C	Character (255)	Values in this column must match values entered in the Assets worksheet, if they exist. Multiple DMs can be linked to the same asset (i.e., rows may have the same value in this column).
Equipment Technical Number	MI_EQUIP000_EQUIP_TECH_N BR_C	Character (255)	Values in this column must match values entered in the Assets worksheet, if they exist. Multiple DMs can be linked to the same asset (i.e., rows may have the same value in this column).
Component	MI_RBICOMPO_COMPO_C	Character (250)	Values in this column must match values entered in the RBI_Component worksheet, if they exist. Multiple DMs can be linked to the same component (i.e., rows may have the same value in this column).

Field Caption	Field ID	Data Type (Length)	Comments
Component Type	MI_RBICOMPO_COMPO_TYPE_C	Character (60)	Values in this column must match values that you entered in the Component Type column on the RBI_Component worksheet for the associated component.
Analysis Unique ID	MI_ANALYSIS_ID	Character (255)	Values in this column must match values entered in the RBI_581_Analysis worksheet, if they exist. Multiple DMs can be linked to the same analysis (i.e., rows may have the same value in this column).
Damage Mechanism	MI_RBDEMEEV_DAM_MECH_C	Character (50)	<p>In the baseline GE Digital APM system, this cell may only contain one of the following values, which exist in the list in the Damage Mechanism field in the Potential Degradation Mechanisms record:</p> <ul style="list-style-type: none"> • 581-High Temperature Oxidation • 581-Cooling Water Corrosion • 581-High Temperature H2/H2S Corrosion • 581-Amine Corrosion • 581-Hydrofluoric Acid Corrosion • 581-Sulfuric Acid Corrosion • 581-Hydrochloric Acid Corrosion • 581-Acid Sour Water Corrosion • 581-High Temperature Sulfidic and Naphthenic Acid • 581-Alkaline Sour Water Corrosion • 581-Soil Side Corrosion • 581-Thinning Damage

Field Caption	Field ID	Data Type (Length)	Comments
Governing Thinning Damage Mechanism	MI_581THNL_GOV_THIN_DMG_MECH_C	Character (50)	<p>In the baseline GE Digital APM system, this cell may only contain one of the following System Code IDs:</p> <ul style="list-style-type: none"> • Ammonium Bisulfide Corrosion (Alkaline Sour Water) • Cooling Water Corrosion • Dealloying • Decarburization • Erosion/Erosion-Corrosion • Flue Gas Dew Point Corrosion • Fuel Ash Corrosion • Galvanic Corrosion • Graphitic Corrosion • High Temperature H₂/H₂S • HCl Acid Corrosion • Ammonium Chloride Corrosion • Hydrofluoric Acid Corrosion • Oxidation • Metal Dusting • Microbiologically Induced Corrosion (MIC) • Naphthenic Acid Corrosion (NAC) • Nitriding • Phenol (Carbonic Acid) Corrosion • Phosphoric Acid Corrosion • Soil Corrosion • Sour Water Corrosion (Acidic) • Amine Corrosion • Sulfidation • Sulfuric Acid Corrosion • Other • Aqueous Organic Acid Corrosion • Boiler Water Condensate (BW/C) Corrosion • Carburization • Caustic Corrosion • Cavitation • CO₂ Corrosion <p>The list in this field is populated by the MI_581_GOV_THINNING_DAM AGE System Code Table. If the system code table has been customized, the valid values</p>

Field Caption	Field ID	Data Type (Length)	Comments
Last Known Inspection Date	MI_581DMCHE_LST_KNWN_IN N_DTE_D	Date	Enter a value in the following format: YYYY-MM-DD hh:mm:ss
Last Known Thickness	MI_581DMCHE_LST_KNWN_TH CKNSS_N	Numeric	A value is required if you entered a value in the Last Known Inspection Date cell.
Selected Base Material Corrosion Rate	MI_581THNL_SELEC_BM_COR_ R_C	Character (50)	A value is required. In the baseline GE Digital APM system, this cell may only contain one of the following System Code IDs: <ul style="list-style-type: none"> • Calculated Rate • Estimated Rate • Short Term Avg • Long Term Avg • Controlling Corrosion Rate The list in this field is populated by the 581_CORR_TYPE System Code Table. If the system code table has been customized, the valid values could be different. To verify which options are acceptable in your GE Digital APM system, via Configuration Manager, refer to the appropriate table.
Long Term Avg Corr Rate	MI_581THNL_LNG_TRM_AVG_ COR_R_N	Numeric	A value is required if: <ul style="list-style-type: none"> • The value in the Selected Base Material Corrosion Rate column is Long Term Avg. -and- • The value in the Source of Calculated Corrosion Rates column in the RBI_Component worksheet for the associated component is MANUAL.

Field Caption	Field ID	Data Type (Length)	Comments
Short Term Avg Corr Rate	MI_581THNL_SHRT_TRM_AVG_COR_N	Numeric	A value is required if: <ul style="list-style-type: none"> The value in the Selected Base Material Corrosion Rate column is Short Term Avg. -and- The value in the Source of Calculated Corrosion Rates column in the RBI_Component worksheet for the associated component is MANUAL.
Selected Cladding Material Corrosion Rate	MI_581THNL_SELEC_CLADD_COR_R_C	Character (50)	A value is required if the value in the Cladding Present column in the RBI_Component worksheet for the associated component is Y. In the baseline GE Digital APM system, this cell may only contain one of the following System Code IDs: <ul style="list-style-type: none"> Calculated Rate Estimated Rate Short Term Avg Long Term Avg Controlling Corrosion Rate The list in this field is populated by the 581_CORR_TYPE System Code Table. If the system code table has been customized, the valid values could be different. To verify which options are acceptable in your GE Digital APM system, via Configuration Manager, refer to the appropriate table.
Number of A Level Inspections	MI_581DMCHE_NMR_OF_A_LVL_INS_N	Numeric	A value is required.
Number of B Level Inspections	MI_581DMCHE_NMR_OF_B_LVL_INS_N	Numeric	A value is required.
Number of C Level Inspections	MI_581DMCHE_NMR_OF_C_LVL_INS_N	Numeric	A value is required.
Number of D Level Inspections	MI_581DMCHE_NMR_OF_D_LVL_INS_N	Numeric	A value is required.

Field Caption	Field ID	Data Type (Length)	Comments
Thinning Type	MI_RBDEMEEV_THIN_TYPE_C	Character (50)	<p>A value is required.</p> <p>In the baseline GE Digital APM system, this cell may only contain one of the following System Code IDs:</p> <ul style="list-style-type: none"> • General • Localized • Pitting <p>The list in this field is populated by the CORROSION TYPES System Code Table. If the system code table has been customized, the valid values could be different. To verify which options are acceptable in your GE Digital APM system, via Configuration Manager, refer to the appropriate table.</p>
Highest Effective Inspection Level	MI_RBDEMEEV_HIGH_EFF_INS_P_C	Character (25)	<p>This field is included as it is present on the Thinning Damage Mechanism Evaluation datasheet. However, this field is used only for 581-Atmospheric Tank Bottom Corrosion.</p>
Number of Highest Effective Inspections	MI_RBDEMEEV_NO_HIGH_EFF_INS_N	Numeric	<p>This field is included as it is present on the Thinning Damage Mechanism Evaluation datasheet. However, this field is used only for 581-Atmospheric Tank Bottom Corrosion.</p>

Field Caption	Field ID	Data Type (Length)	Comments						
Injection Point Flag	MI_581DMCHE_INJECTIN_PNT_FLG_C	Character (50)	<p>A value is required if the component type is piping (i.e., the value in the Component Family column in the RBI_Component worksheet for the associated component is MI_CCRBICPI).</p> <p>In the baseline GE Digital APM system, this cell may only contain one of the following System Code IDs:</p> <table border="1" data-bbox="1144 661 1416 844"> <thead> <tr> <th data-bbox="1144 661 1279 743">System Code ID</th> <th data-bbox="1279 661 1416 743">Injection Point Flag</th> </tr> </thead> <tbody> <tr> <td data-bbox="1144 743 1279 793">Y</td> <td data-bbox="1279 743 1416 793">Yes</td> </tr> <tr> <td data-bbox="1144 793 1279 844">N</td> <td data-bbox="1279 793 1416 844">No</td> </tr> </tbody> </table> <p>The list in this field is populated by the MI_YES_NO System Code Table. If the system code table has been customized, the valid values could be different. To verify which options are acceptable in your GE Digital APM system, via Configuration Manager, refer to the appropriate table.</p>	System Code ID	Injection Point Flag	Y	Yes	N	No
System Code ID	Injection Point Flag								
Y	Yes								
N	No								

Field Caption	Field ID	Data Type (Length)	Comments						
Injection Point Inspection	MI_581DMCHE_INJCTN_PNT_I NSPN_C	Character (50)	<p>A value is required if the value in the Injection Point Flag column is Y.</p> <p>In the baseline GE Digital APM system, this cell may only contain one of the following System Code IDs:</p> <table border="1" data-bbox="1146 533 1417 747"> <thead> <tr> <th data-bbox="1146 533 1281 648">System Code ID</th> <th data-bbox="1281 533 1417 648">Injection Point Inspection</th> </tr> </thead> <tbody> <tr> <td data-bbox="1146 648 1281 699">Y</td> <td data-bbox="1281 648 1417 699">Yes</td> </tr> <tr> <td data-bbox="1146 699 1281 747">N</td> <td data-bbox="1281 699 1417 747">No</td> </tr> </tbody> </table> <p>The list in this field is populated by the MI_YES_NO System Code Table. If the system code table has been customized, the valid values could be different. To verify which options are acceptable in your GE Digital APM system, via Configuration Manager, refer to the appropriate table.</p>	System Code ID	Injection Point Inspection	Y	Yes	N	No
System Code ID	Injection Point Inspection								
Y	Yes								
N	No								

Field Caption	Field ID	Data Type (Length)	Comments						
Deadleg Flag	MI_581DMCHE_DEADLEG_FLAG_C	Character (50)	<p>A value is required if the component type is piping (i.e., the value in the Component Family column in the RBI_Component worksheet for the associated component is MI_CCRBICPI).</p> <p>In the baseline GE Digital APM system, this cell may only contain one of the following System Code IDs:</p> <table border="1" data-bbox="1146 661 1414 844"> <thead> <tr> <th data-bbox="1146 661 1279 743">System Code ID</th> <th data-bbox="1279 661 1414 743">Deadleg Flag</th> </tr> </thead> <tbody> <tr> <td data-bbox="1146 743 1279 793">Y</td> <td data-bbox="1279 743 1414 793">Yes</td> </tr> <tr> <td data-bbox="1146 793 1279 844">N</td> <td data-bbox="1279 793 1414 844">No</td> </tr> </tbody> </table> <p>The list in this field is populated by the MI_YES_NO System Code Table. If the system code table has been customized, the valid values could be different. To verify which options are acceptable in your GE Digital APM system, via Configuration Manager, refer to the appropriate table.</p>	System Code ID	Deadleg Flag	Y	Yes	N	No
System Code ID	Deadleg Flag								
Y	Yes								
N	No								

Field Caption	Field ID	Data Type (Length)	Comments						
Deadleg Inspection	MI_581DMCHE_DEADLEG_INSPECTN_C	Character (50)	<p>A value is required if the value in the Deadleg Flag column is Y.</p> <p>In the baseline GE Digital APM system, this cell may only contain one of the following System Code IDs:</p> <table border="1"> <thead> <tr> <th>System Code ID</th> <th>Deadleg Inspection</th> </tr> </thead> <tbody> <tr> <td>Y</td> <td>Yes</td> </tr> <tr> <td>N</td> <td>No</td> </tr> </tbody> </table> <p>The list in this field is populated by the MI_YES_NO System Code Table. If the system code table has been customized, the valid values could be different. To verify which options are acceptable in your GE Digital APM system, via Configuration Manager, refer to the appropriate table.</p>	System Code ID	Deadleg Inspection	Y	Yes	N	No
System Code ID	Deadleg Inspection								
Y	Yes								
N	No								
Welded Construction Flag	MI_581DMCHE_WLDD_CNSTR CN_FLG_C	Character (50)	<p>In the baseline GE Digital APM system, this cell may only contain one of the following System Code IDs:</p> <table border="1"> <thead> <tr> <th>System Code ID</th> <th>Welded Construction Flag</th> </tr> </thead> <tbody> <tr> <td>Y</td> <td>Yes</td> </tr> <tr> <td>N</td> <td>No</td> </tr> </tbody> </table> <p>The list in this field is populated by the MI_YES_NO System Code Table. If the system code table has been customized, the valid values could be different. To verify which options are acceptable in your GE Digital APM system, via Configuration Manager, refer to the appropriate table.</p>	System Code ID	Welded Construction Flag	Y	Yes	N	No
System Code ID	Welded Construction Flag								
Y	Yes								
N	No								
API 653 Maintenance Flag	MI_581THNL_API_653_MNTE_FLG_L	Boolean	Enter True or False.						

Field Caption	Field ID	Data Type (Length)	Comments						
Foundation Type	MI_581DMCHE_FOUNDTYPE_CHR	Character (50)	<p>A value is required.</p> <p>In the baseline GE Digital APM system, this cell may only contain one of the following System Code IDs:</p> <ul style="list-style-type: none"> • Clay • Silt • Sand • Gravel • Concrete • Double Floor <p>The list in this field is populated by the FOUNDATION TYPES System Code Table. If the system code table has been customized, the valid values could be different. To verify which options are acceptable in your GE Digital APM system, via Configuration Manager, refer to the appropriate table.</p>						
Settlement Adjustment Flag	MI_581DMCHE_STTLMNT_ADJT_FLG_C	Character (3)	<p>A value is required if the value in the Foundation Type column is not Concrete.</p> <p>In the baseline GE Digital APM system, this cell may only contain one of the following System Code IDs:</p> <table border="1"> <thead> <tr> <th>System Code ID</th> <th>Settlement Adjustment Flag</th> </tr> </thead> <tbody> <tr> <td>Y</td> <td>Yes</td> </tr> <tr> <td>N</td> <td>No</td> </tr> </tbody> </table> <p>The list in this field is populated by the MI_YES_NO System Code Table. If the system code table has been customized, the valid values could be different. To verify which options are acceptable in your GE Digital APM system, via Configuration Manager, refer to the appropriate table.</p>	System Code ID	Settlement Adjustment Flag	Y	Yes	N	No
System Code ID	Settlement Adjustment Flag								
Y	Yes								
N	No								

Field Caption	Field ID	Data Type (Length)	Comments								
Settlement Adjustment Inspection	MI_581DMCHE_STTLMNT_ADJ T_INN_C	Character (50)	<p>A value is required if the value in the Settlement Adjustment Flag column is Y.</p> <p>In the baseline GE Digital APM system, this cell may only contain one of the following System Code IDs:</p> <table border="1" data-bbox="1146 533 1414 863"> <thead> <tr> <th data-bbox="1146 533 1279 648">System Code ID</th> <th data-bbox="1279 533 1414 648">Settlement Adjustment Inspection</th> </tr> </thead> <tbody> <tr> <td data-bbox="1146 648 1279 699">1</td> <td data-bbox="1279 648 1414 699">Meets API 653</td> </tr> <tr> <td data-bbox="1146 699 1279 779">1.5</td> <td data-bbox="1279 699 1414 779">Never Evaluated</td> </tr> <tr> <td data-bbox="1146 779 1279 863">2</td> <td data-bbox="1279 779 1414 863">Exceeds API 653</td> </tr> </tbody> </table> <p>The list in this field is populated by the MI_581_Recorded_Settlement_Criteria System Code Table. If the system code table has been customized, the valid values could be different. To verify which options are acceptable in your GE Digital APM system, via Configuration Manager, refer to the appropriate table.</p>	System Code ID	Settlement Adjustment Inspection	1	Meets API 653	1.5	Never Evaluated	2	Exceeds API 653
System Code ID	Settlement Adjustment Inspection										
1	Meets API 653										
1.5	Never Evaluated										
2	Exceeds API 653										

Field Caption	Field ID	Data Type (Length)	Comments						
Online Monitoring Flag	MI_581DMCHE_ONLNE_MNTR NG_FLG_C	Character (50)	<p>A value is required.</p> <p>In the baseline GE Digital APM system, this cell may only contain one of the following System Code IDs:</p> <table border="1"> <thead> <tr> <th>System Code ID</th> <th>Online Monitoring Flag</th> </tr> </thead> <tbody> <tr> <td>Y</td> <td>Yes</td> </tr> <tr> <td>N</td> <td>No</td> </tr> </tbody> </table> <p>The list in this field is populated by the MI_YES_NO System Code Table. If the system code table has been customized, the valid values could be different. To verify which options are acceptable in your GE Digital APM system, via Configuration Manager, refer to the appropriate table.</p>	System Code ID	Online Monitoring Flag	Y	Yes	N	No
System Code ID	Online Monitoring Flag								
Y	Yes								
N	No								
Key Process Variable?	MI_581DMCHE_KEY_PROCCSS_ VRBLE_C	Character (3)	<p>A value is required if the value in the Online Monitoring Flag column is Y.</p> <p>In the baseline GE Digital APM system, this cell may only contain one of the following System Code IDs:</p> <table border="1"> <thead> <tr> <th>System Code ID</th> <th>Key Process Variable</th> </tr> </thead> <tbody> <tr> <td>Y</td> <td>Yes</td> </tr> <tr> <td>N</td> <td>No</td> </tr> </tbody> </table> <p>The list in this field is populated by the MI_YES_NO System Code Table. If the system code table has been customized, the valid values could be different. To verify which options are acceptable in your GE Digital APM system, via Configuration Manager, refer to the appropriate table.</p>	System Code ID	Key Process Variable	Y	Yes	N	No
System Code ID	Key Process Variable								
Y	Yes								
N	No								

Field Caption	Field ID	Data Type (Length)	Comments						
Electrical Resistance Probes?	MI_581DMCHE_ELCTRCL_RSS E_PRS_C	Character (3)	<p>A value is required if the value in the Online Monitoring Flag column is Y.</p> <p>In the baseline GE Digital APM system, this cell may only contain one of the following System Code IDs:</p> <table border="1"> <thead> <tr> <th>System Code ID</th> <th>Electrical Resistance Probes</th> </tr> </thead> <tbody> <tr> <td>Y</td> <td>Yes</td> </tr> <tr> <td>N</td> <td>No</td> </tr> </tbody> </table> <p>The list in this field is populated by the MI_YES_NO System Code Table. If the system code table has been customized, the valid values could be different. To verify which options are acceptable in your GE Digital APM system, via Configuration Manager, refer to the appropriate table.</p>	System Code ID	Electrical Resistance Probes	Y	Yes	N	No
System Code ID	Electrical Resistance Probes								
Y	Yes								
N	No								
Corrosion Coupons?	MI_581DMCHE_CORROSION_C OUPNS_C	Character (3)	<p>A value is required if the value in the Online Monitoring Flag column is Y.</p> <p>In the baseline GE Digital APM system, this cell may only contain one of the following System Code IDs:</p> <table border="1"> <thead> <tr> <th>System Code ID</th> <th>Corrosion Coupons</th> </tr> </thead> <tbody> <tr> <td>Y</td> <td>Yes</td> </tr> <tr> <td>N</td> <td>No</td> </tr> </tbody> </table> <p>The list in this field is populated by the MI_YES_NO System Code Table. If the system code table has been customized, the valid values could be different. To verify which options are acceptable in your GE Digital APM system, via Configuration Manager, refer to the appropriate table.</p>	System Code ID	Corrosion Coupons	Y	Yes	N	No
System Code ID	Corrosion Coupons								
Y	Yes								
N	No								

Field Caption	Field ID	Data Type (Length)	Comments
Cl Concentration	MI_581THNL_HCL_CONCENTR ATIN_N	Numeric	A value is required if the value in the Damage Mechanism column is 581-Cooling Water Corrosion.
Is Air or Oxidant Present?	MI_581THNL_IS_AR_OR_OXN_ PRT_C	Character (50)	A value is required if the Damage Mechanism column contains one of the following values: <ul style="list-style-type: none"> • 581-Hydrochloric Acid Corrosion • 581-High Temperature Oxidation • 581-Sulfuric Acid Corrosion
Soil Resistivity	MI_581THNL_SOIL_RESIS_C	Numeric	A value is required if the value in the Damage Mechanism column is 581-Soil Side Corrosion.
H2S Content	MI_581THNL_H2_CONTENT_N	Numeric	A value is required if the value in the Damage Mechanism column is 581-High Temperature H2/H2S Corrosion.
Hydrocarbon Type	MI_581THNL_HYDROCARBON _TYPE_C	Character (50)	A value is required if the value in the Damage Mechanism column is 581-High Temperature H2/H2S Corrosion. In the baseline GE Digital APM system, this cell may only contain one of the following System Code IDs: <ul style="list-style-type: none"> • NAPTHA • GAS OIL The list in this field is populated by the MI_581_HYDROCARBON_TYPE S System Code Table. If the system code table has been customized, the valid values could be different. To verify which options are acceptable in your GE Digital APM system, via Configuration Manager, refer to the appropriate table.

Field Caption	Field ID	Data Type (Length)	Comments
Sulphur Concentration	MI_581THNL_SULPHUR_CNCRN TRTN_N	Numeric	A value is required if the value in the Damage Mechanism column is 581-High Temperature Sulfidic and Naphthenic Acid.
Cooling System Type	MI_581THNL_COOLI_SYSTE_TY PE_C	Character (50)	<p>A value is required if the value in the Damage Mechanism column is 581-Cooling Water Corrosion.</p> <p>In the baseline GE Digital APM system, this cell may only contain one of the following System Code IDs:</p> <ul style="list-style-type: none"> • Once-Through • Recirculating <p>The list in this field is populated by the MI_581_Cooling_System System Code Table. If the system code table has been customized, the valid values could be different. To verify which options are acceptable in your GE Digital APM system, via Configuration Manager, refer to the appropriate table.</p>
Water Type	MI_581THNL_WATER_TYPE_C	Character (50)	<p>A value is required if the value in the Cooling System Type column is Once-Through.</p> <p>In the baseline GE Digital APM system, this cell may only contain one of the following System Code IDs:</p> <ul style="list-style-type: none"> • Fresh Water • Sea Water <p>The list in this field is populated by the MI_581_Water_Type System Code Table. If the system code table has been customized, the valid values could be different. To verify which options are acceptable in your GE Digital APM system, via Configuration Manager, refer to the appropriate table.</p>

Field Caption	Field ID	Data Type (Length)	Comments
Water Treatment Type	MI_581THNL_WATER_TREAT_TYPE_C	Character (50)	<p>A value is required if:</p> <ul style="list-style-type: none"> • The value in the Cooling System Type column is Recirculating. <p style="text-align: center;">-or-</p> <ul style="list-style-type: none"> • The value in the Water Type column is Fresh Water. <p>In the baseline GE Digital APM system, this cell may only contain one of the following System Code IDs:</p> <ul style="list-style-type: none"> • Treated • Untreated <p>The list in this field is populated by the MI_581_Water_Treatment_Type System Code Table. If the system code table has been customized, the valid values could be different. To verify which options are acceptable in your GE Digital APM system, via Configuration Manager, refer to the appropriate table.</p>
Recirculating System Type	MI_581THNL_RECIR_SYSTE_TYPE_C	Character (50)	<p>A value is required if the value in the Cooling System Type column is Recirculating.</p> <p>In the baseline GE Digital APM system, this cell may only contain one of the following System Code IDs:</p> <ul style="list-style-type: none"> • Open • Closed <p>The list in this field is populated by the MI_581_Recirculating_System System Code Table. If the system code table has been customized, the valid values could be different. To verify which options are acceptable in your GE Digital APM system, via Configuration Manager, refer to the appropriate table.</p>

Field Caption	Field ID	Data Type (Length)	Comments
Calcium Hardness	MI_581THNL_CALCII_HARDN_N	Numeric	A value is required if: <ul style="list-style-type: none"> The value in the Cooling System Type column is Recirculating. -or- The value in the Water Type column is Fresh Water and the value in the Water Treatment Type column is Untreated.
Total Dissolved Solids	MI_581THNL_TOTAL_DISSO_S OLID_N	Numeric	A value is required if: <ul style="list-style-type: none"> The value in the Cooling System Type column is Recirculating. -or- The value in the Water Type column is Fresh Water and the value in the Water Treatment Type column is Untreated.
MO Alkalinity	MI_581THNL_MO_ALKAL_N	Numeric	A value is required if: <ul style="list-style-type: none"> The value in the Cooling System Type column is Recirculating. -or- The value in the Water Type column is Fresh Water and the value in the Water Treatment Type column is Untreated.
Oxygen in the Process Stream	MI_581THNL_OXYGN_ADJSTT_ FCR_N	Numeric	A value is required if the value in the Damage Mechanism column is 581-Acid Sour Water Corrosion.
Acid Concentration	MI_581THNL_ACID_CONCENT RATN_N	Numeric	A value is required if the value in the Damage Mechanism column is 581-Sulfuric Acid Corrosion.

Field Caption	Field ID	Data Type (Length)	Comments
Soil Type	MI_581THNL_SOIL_TYPE_C	Character (50)	<p>A value is required if the value in the Damage Mechanism column is 581-Soil Side Corrosion.</p> <p>In the baseline GE Digital APM system, this cell may only contain one of the following System Code IDs:</p> <ul style="list-style-type: none"> • Sand • Silt • Clay <p>The list in this field is populated by the 581_Primary_Soil_Type System Code Table. If the system code table has been customized, the valid values could be different. To verify which options are acceptable in your GE Digital APM system, via Configuration Manager, refer to the appropriate table.</p>

Field Caption	Field ID	Data Type (Length)	Comments												
Cathodic Protection Effectiveness	MI_581THNL_CATHO_PROTE_EFFEC_C	Character (50)	<p>A value is required if the value in the Damage Mechanism column is 581-Soil Side Corrosion.</p> <p>In the baseline GE Digital APM system, this cell may only contain one of the following System Code IDs:</p> <table border="1"> <thead> <tr> <th>System Code ID</th> <th>Cathodic Protection Effectiveness</th> </tr> </thead> <tbody> <tr> <td>Cathodic_Protection_exists_NONACE RP0169</td> <td>Cathodic Protection exists not per NACE RP0169</td> </tr> <tr> <td>No_Cathodic_Protection</td> <td>No Cathodic Protection</td> </tr> <tr> <td>Cathodic_Protection_Tested</td> <td>Cathodic Protection is tested annually</td> </tr> <tr> <td>No_CP_Structure</td> <td>No Cathodic Protection on Structure</td> </tr> <tr> <td>CP_Tested_NACE RP0169_Supported</td> <td>Tested Cathodic protection NACE RP0169 supported</td> </tr> </tbody> </table> <p>The list in this field is populated by the MI_581_Cathodic Protection Effectiveness Factors System Code Table. If the system code table has been customized, the valid values could be different. To verify which options are acceptable in your GE Digital APM system, via Configuration Manager, refer to the appropriate table.</p>	System Code ID	Cathodic Protection Effectiveness	Cathodic_Protection_exists_NONACE RP0169	Cathodic Protection exists not per NACE RP0169	No_Cathodic_Protection	No Cathodic Protection	Cathodic_Protection_Tested	Cathodic Protection is tested annually	No_CP_Structure	No Cathodic Protection on Structure	CP_Tested_NACE RP0169_Supported	Tested Cathodic protection NACE RP0169 supported
System Code ID	Cathodic Protection Effectiveness														
Cathodic_Protection_exists_NONACE RP0169	Cathodic Protection exists not per NACE RP0169														
No_Cathodic_Protection	No Cathodic Protection														
Cathodic_Protection_Tested	Cathodic Protection is tested annually														
No_CP_Structure	No Cathodic Protection on Structure														
CP_Tested_NACE RP0169_Supported	Tested Cathodic protection NACE RP0169 supported														

Field Caption	Field ID	Data Type (Length)	Comments						
Coating Present?	MI_581DMCHE_COATING_PRESENT_C	Character (3)	<p>A value is required if the value in the Damage Mechanism column is 581-Soil Side Corrosion.</p> <p>In the baseline GE Digital APM system, this cell may only contain one of the following System Code IDs:</p> <table border="1"> <thead> <tr> <th>System Code ID</th> <th>Coating Present?</th> </tr> </thead> <tbody> <tr> <td>Y</td> <td>Yes</td> </tr> <tr> <td>N</td> <td>No</td> </tr> </tbody> </table> <p>The list in this field is populated by the MI_YES_NO System Code Table. If the system code table has been customized, the valid values could be different. To verify which options are acceptable in your GE Digital APM system, via Configuration Manager, refer to the appropriate table.</p>	System Code ID	Coating Present?	Y	Yes	N	No
System Code ID	Coating Present?								
Y	Yes								
N	No								
Coating Age	MI_581DMCHE_COATING_AGE_N	Numeric	A value is required if the value in the Coating Present? column is Y.						

Field Caption	Field ID	Data Type (Length)	Comments						
Maximum Coating Temperature Rating Exceeded?	MI_581THNL_MAXCOTEMP_EX CEE_C	Character (50)	<p>A value is required if the value in the Coating Present? column is Y.</p> <p>In the baseline GE Digital APM system, this cell may only contain one of the following System Code IDs:</p> <table border="1" data-bbox="1146 533 1414 812"> <thead> <tr> <th data-bbox="1146 533 1281 711">System Code ID</th> <th data-bbox="1281 533 1414 711">Maximum Coating Temperature Rating Exceeded?</th> </tr> </thead> <tbody> <tr> <td data-bbox="1146 711 1281 762">Y</td> <td data-bbox="1281 711 1414 762">Yes</td> </tr> <tr> <td data-bbox="1146 762 1281 812">N</td> <td data-bbox="1281 762 1414 812">No</td> </tr> </tbody> </table> <p>The list in this field is populated by the MI_YES_NO System Code Table. If the system code table has been customized, the valid values could be different. To verify which options are acceptable in your GE Digital APM system, via Configuration Manager, refer to the appropriate table.</p>	System Code ID	Maximum Coating Temperature Rating Exceeded?	Y	Yes	N	No
System Code ID	Maximum Coating Temperature Rating Exceeded?								
Y	Yes								
N	No								

Field Caption	Field ID	Data Type (Length)	Comments						
Coating Maintenance Rare or None?	MI_581THNLCOATI_MAINT_NO NE_C	Character (50)	<p>A value is required if the value in the Coating Present? column is Y.</p> <p>In the baseline GE Digital APM system, this cell may only contain one of the following System Code IDs:</p> <table border="1" data-bbox="1146 533 1414 779"> <thead> <tr> <th data-bbox="1146 533 1279 680">System Code ID</th> <th data-bbox="1279 533 1414 680">Coating Maintenance Rare or None?</th> </tr> </thead> <tbody> <tr> <td data-bbox="1146 680 1279 730">Y</td> <td data-bbox="1279 680 1414 730">Yes</td> </tr> <tr> <td data-bbox="1146 730 1279 779">N</td> <td data-bbox="1279 730 1414 779">No</td> </tr> </tbody> </table> <p>The list in this field is populated by the MI_YES_NO System Code Table. If the system code table has been customized, the valid values could be different. To verify which options are acceptable in your GE Digital APM system, via Configuration Manager, refer to the appropriate table.</p>	System Code ID	Coating Maintenance Rare or None?	Y	Yes	N	No
System Code ID	Coating Maintenance Rare or None?								
Y	Yes								
N	No								

Field Caption	Field ID	Data Type (Length)	Comments																				
Coating Type	MI_581THNL_COATINGTYPE_C	Character (50)	<p>A value is required if the value in the Coating Present? column is Y.</p> <p>In the baseline GE Digital APM system, this cell may only contain one of the following System Code IDs:</p> <table border="1"> <thead> <tr> <th>System Code ID</th> <th>Coating Type</th> </tr> </thead> <tbody> <tr> <td>Fusn_Bnd_Epxy</td> <td>Fusion Bonded Epoxy</td> </tr> <tr> <td>Lqd_Epxy</td> <td>Liquid Epoxy</td> </tr> <tr> <td>Asphl_Enml</td> <td>Asphalt Enamel</td> </tr> <tr> <td>Asphlt_Mastic</td> <td>Asphalt Mastic</td> </tr> <tr> <td>Coat_Tar_Enml</td> <td>Coat Tar Enamel</td> </tr> <tr> <td>Extrd_Polythln_with_mastic_rubber</td> <td>Extruded Polyethylene with mastic rubber</td> </tr> <tr> <td>Mill_Appld_PE_Tape_with_mastic</td> <td>Mill Applied PE Tape with mastic</td> </tr> <tr> <td>Field_Appld_P E_Tape_with_mastic</td> <td>Field Applied PE Tape with mastic</td> </tr> <tr> <td>Three_Layer_P E_or_PP</td> <td>Three-Layer PE or PP</td> </tr> </tbody> </table> <p>The list in this field is populated by the 581_Coating_Type System Code Table. If the system code table has been customized, the valid values could be different. To verify which options are acceptable in your GE Digital APM system, via Configuration Manager, refer to the appropriate table.</p>	System Code ID	Coating Type	Fusn_Bnd_Epxy	Fusion Bonded Epoxy	Lqd_Epxy	Liquid Epoxy	Asphl_Enml	Asphalt Enamel	Asphlt_Mastic	Asphalt Mastic	Coat_Tar_Enml	Coat Tar Enamel	Extrd_Polythln_with_mastic_rubber	Extruded Polyethylene with mastic rubber	Mill_Appld_PE_Tape_with_mastic	Mill Applied PE Tape with mastic	Field_Appld_P E_Tape_with_mastic	Field Applied PE Tape with mastic	Three_Layer_P E_or_PP	Three-Layer PE or PP
System Code ID	Coating Type																						
Fusn_Bnd_Epxy	Fusion Bonded Epoxy																						
Lqd_Epxy	Liquid Epoxy																						
Asphl_Enml	Asphalt Enamel																						
Asphlt_Mastic	Asphalt Mastic																						
Coat_Tar_Enml	Coat Tar Enamel																						
Extrd_Polythln_with_mastic_rubber	Extruded Polyethylene with mastic rubber																						
Mill_Appld_PE_Tape_with_mastic	Mill Applied PE Tape with mastic																						
Field_Appld_P E_Tape_with_mastic	Field Applied PE Tape with mastic																						
Three_Layer_P E_or_PP	Three-Layer PE or PP																						

Field Caption	Field ID	Data Type (Length)	Comments
Amine Type	MI_581THNL_AMINE_TYPE_C	Character (50)	<p>A value is required if the value in the Damage Mechanism column is 581-Amine Corrosion.</p> <p>In the baseline GE Digital APM system, this cell may only contain one of the following System Code IDs:</p> <ul style="list-style-type: none"> • MEA • DEA • MDEA <p>The list in this field is populated by the MI_581_Amine_Types System Code Table. If the system code table has been customized, the valid values could be different. To verify which options are acceptable in your GE Digital APM system, via Configuration Manager, refer to the appropriate table.</p>
Heat Stable Amine Salts(HSAS)	MI_581THNL_HSAS_N	Numeric	A value is required if the value in the Damage Mechanism column is 581-Amine Corrosion.
Acid Gas Loading	MI_581THNL_ACID_GAS_LOADING_N	Numeric	A value is required if the value in the Damage Mechanism column is 581-Amine Corrosion.
Amine Concentration	MI_581THNL_AMINE_CONCENTRATION_N	Numeric	A value is required if the value in the Damage Mechanism column is 581-Amine Corrosion.
HF Concentration	MI_581THNL_HF_CONCENTRATION_NBR	Numeric	A value is required if the value in the Damage Mechanism column is 581-Hydrofluoric Acid Corrosion.
H2S Partial Pressure	MI_581THNL_H2S_PARTIAL_PRESSURE_NBR	Numeric	A value is required if the value in the Damage Mechanism column is 581-Alkaline Sour Water Corrosion.
NH4HS Concentration	MI_581THNL_NH4HS_CONCENTRATION_NBR	Numeric	A value is required if the value in the Damage Mechanism column is 581-Alkaline Sour Water Corrosion.

DME_ExternalDamage Worksheet

In the DME_ExternalDamage worksheet, you can specify the following DMs that you want to create or update:

- 581-Ferritic Component Atmospheric Corrosion
- 581-Ferritic Component Corrosion Under Insulation

These DMs belong to the RBI 581 External Damage Evaluation methodology. These records will be linked to an RBI 581 Risk Analysis. You can specify these DMs only if the component type is not Tank Bottom (i.e., the value in the Component Family column in the RBI_Component worksheet is not MI_CCRBICTB).

Field Caption	Field ID	Data Type (Length)	Comments
Asset ID	MI_EQUIP000_EQUIP_ID_C	Character (255)	Values in this column must match values entered in the Assets worksheet. Multiple DMs can be linked to the same asset (i.e., rows may have the same value in this column).
Asset CMMS System	MI_EQUIP000_SAP_SYSTEM_C	Character (255)	Values in this column must match values entered in the Assets worksheet, if they exist. Multiple DMs can be linked to the same asset (i.e., rows may have the same value in this column).
Equipment Technical Number	MI_EQUIP000_EQUIP_TECH_N BR_C	Character (255)	Values in this column must match values entered in the Assets worksheet, if they exist. Multiple DMs can be linked to the same asset (i.e., rows may have the same value in this column).
Component	MI_RBICOMPO_COMPO_C	Character (250)	Values in this column must match values entered in the RBI_Component worksheet, if they exist. Multiple DMs can be linked to the same component (i.e., rows may have the same value in this column).
Component Type	MI_RBICOMPO_COMPO_TYPE_ C	Character (60)	Values in this column must match values that you entered in the Component Type column on the RBI_Component worksheet for the associated component.

Field Caption	Field ID	Data Type (Length)	Comments
Analysis Unique ID	MI_ANALYSIS_ID	Character (255)	Values in this column must match values entered in the RBI_581_Analysis worksheet, if they exist. Multiple DMs can be linked to the same analysis (i.e., rows may have the same value in this column).
Damage Mechanism	MI_RBDEMEEV_DAM_MECH_C	Character (50)	In the baseline GE Digital APM system, this cell may only contain one of the following values, which exist in the list in the Damage Mechanism field in the Potential Degradation Mechanisms record: <ul style="list-style-type: none"> • 581-Ferritic Component Atmospheric Corrosion • 581-Ferritic Component Corrosion Under Insulation
Selected External Corrosion Rate	MI_581_XDME_SEL_EXT_CORR_RT_C	Character (50)	A value is required. In the baseline GE Digital APM system, this cell may only contain one of the following System Code IDs: <ul style="list-style-type: none"> • Estimated • Calculated • Measured The list in this field is populated by the MI_581_Corrosion_Rate System Code Table. If the system code table has been customized, the valid values could be different. To verify which options are acceptable in your GE Digital APM system, via Configuration Manager, refer to the appropriate table.
Base Material Measured Rate	MI_RBDEMEEV_BM_MEASU_RT_N	Numeric	A value is required if the value in the Selected External Corrosion Rate cell is Estimated.

Field Caption	Field ID	Data Type (Length)	Comments						
Thinning Type	MI_RBDEMEEV_THIN_TYPE_C	Character (50)	<p>A value is required.</p> <p>In the baseline GE Digital APM system, this cell may only contain one of the following System Code IDs:</p> <ul style="list-style-type: none"> • General • Localized • Pitting <p>The list in this field is populated by the CORROSION TYPES System Code Table. If the system code table has been customized, the valid values could be different. To verify which options are acceptable in your GE Digital APM system, via Configuration Manager, refer to the appropriate table.</p>						
Coating Present?	MI_581DMCHE_COATING_PRESENT_C	Character (3)	<p>In the baseline GE Digital APM system, this cell may only contain one of the following System Code IDs:</p> <table border="1"> <thead> <tr> <th>System Code ID</th> <th>Coating Present?</th> </tr> </thead> <tbody> <tr> <td>Y</td> <td>Yes</td> </tr> <tr> <td>N</td> <td>No</td> </tr> </tbody> </table> <p>The list in this field is populated by the MI_YES_NO System Code Table. If the system code table has been customized, the valid values could be different. To verify which options are acceptable in your GE Digital APM system, via Configuration Manager, refer to the appropriate table.</p>	System Code ID	Coating Present?	Y	Yes	N	No
System Code ID	Coating Present?								
Y	Yes								
N	No								
Coating Installation Date	MI_581DMCHE_CTNG_INSTALL_DTE_D	Date	<p>A value is required if the value in the Coating Present? cell is Y. Enter the value in the following format: YYYY-MM-DD hh:mm:ss</p>						

Field Caption	Field ID	Data Type (Length)	Comments
Coating Quality	MI_RBDEMEEV_COAT_QUAL_C	Character (50)	<p>A value is required if the value in the Coating Present? cell is Y.</p> <p>In the baseline GE Digital APM system, this cell may only contain one of the following System Code IDs:</p> <ul style="list-style-type: none"> • NONE • POOR • MEDIUM • HIGH <p>The list in this field is populated by the 581_Coating_Quality System Code Table. If the system code table has been customized, the valid values could be different. To verify which options are acceptable in your GE Digital APM system, via Configuration Manager, refer to the appropriate table.</p>
Insulation Condition	MI_RBDEMEEV_INSUL_CON_C	Character (50)	<p>A value is required if the value in the Damage Mechanism cell is 581-Ferritic Component Corrosion Under Insulation.</p> <p>This cell may only contain one of the following values:</p> <ul style="list-style-type: none"> • Above Average • Average • Below Average
Piping System Complexity	MI_RBDEMEEV_PIP_SYS_COMP_L_C	Character (50)	<p>A value is required if the value in the Damage Mechanism cell is 581-Ferritic Component Corrosion Under Insulation.</p> <p>This cell may only contain one of the following values:</p> <ul style="list-style-type: none"> • Above Average • Average • Below Average
Corrosion Rate Adjustment for bad Design/Fabrication	MI_581_XDME_ADJUST_FR_DSN_FBN_C	Boolean	Enter True or False.
Soil to Air Interface Present?	MI_581_XDME_SL_TO_AR_INE_PRT_L	Boolean	Enter True or False.

Field Caption	Field ID	Data Type (Length)	Comments
Atmospheric Condition	MI_581_XDME_ATMOSPHERC_CNDTN_C	Character (50)	<p>A value is required if the value in the Selected External Corrosion Rate cell is Calculated.</p> <p>In the baseline GE Digital APM system, this cell may only contain one of the following System Code IDs:</p> <ul style="list-style-type: none"> • MARINE • TEMPERATE • DRY • SEVERE <p>The list in this field is populated by the MI_ATMOSPHERIC_CONDITION System Code Table. If the system code table has been customized, the valid values could be different. To verify which options are acceptable in your GE Digital APM system, via Configuration Manager, refer to the appropriate table.</p>
Last Known Inspection Date	MI_581DMCHE_LST_KNWN_IN_N_DTE_D	Date	Enter a value in the following format: YYYY-MM-DD hh:mm:ss
Last Known Thickness	MI_581DMCHE_LST_KNWN_THCKNSS_N	Numeric	A value is required if you entered a value in the Last Known Inspection Date cell.
Number of A Level Inspections	MI_581DMCHE_NMR_OF_A_LVL_INS_N	Numeric	A value is required.
Number of B Level Inspections	MI_581DMCHE_NMR_OF_B_LVL_INS_N	Numeric	A value is required.
Number of C Level Inspections	MI_581DMCHE_NMR_OF_C_LVL_INS_N	Numeric	A value is required.
Number of D Level Inspections	MI_581DMCHE_NMR_OF_D_LVL_INS_N	Numeric	A value is required.

DME_ExternalCracking Worksheet

In the DME_ExternalCracking worksheet, you can specify the following DMs that you want to create or update:

- 581-Austenitic Component Cracking Under Insulation
- 581-Austenitic Component Atmospheric Cracking

These DMs belong to the RBI 581 External Cracking Damage Evaluation methodology. These records will be linked to an RBI 581 Risk Analysis. You can specify these DMs only if the component type is not Tank Bottom (i.e., the value in the Component Family column in the RBI_Component worksheet is not MI_CCRBICTB).

Field Caption	Field ID	Data Type (Length)	Comments
Asset ID	MI_EQUIP000_EQUIP_ID_C	Character (255)	Values in this column must match values entered in the Assets worksheet. Multiple DMs can be linked to the same asset (i.e., rows may have the same value in this column).
Asset CMMS System	MI_EQUIP000_SAP_SYSTEM_C	Character (255)	Values in this column must match values entered in the Assets worksheet, if they exist. Multiple DMs can be linked to the same asset (i.e., rows may have the same value in this column).
Equipment Technical Number	MI_EQUIP000_EQUIP_TECH_N BR_C	Character (255)	Values in this column must match values entered in the Assets worksheet, if they exist. Multiple DMs can be linked to the same asset (i.e., rows may have the same value in this column).
Component	MI_RBICOMPO_COMPO_C	Character (250)	Values in this column must match values entered in the RBI_Component worksheet, if they exist. Multiple DMs can be linked to the same component (i.e., rows may have the same value in this column).
Component Type	MI_RBICOMPO_COMPO_TYPE_ C	Character (60)	Values in this column must match values that you entered in the Component Type column on the RBI_Component worksheet for the associated component.
Analysis Unique ID	MI_ANALYSIS_ID	Character (255)	Values in this column must match values entered in the RBI_581_Analysis worksheet, if they exist. Multiple DMs can be linked to the same analysis (i.e., rows may have the same value in this column).

Field Caption	Field ID	Data Type (Length)	Comments
Damage Mechanism	MI_RBDEMEEV_DAM_MECH_C	Character (50)	<p>In the baseline GE Digital APM system, this cell may only contain one of the following values, which exist in the list in the Damage Mechanism field in the Potential Degradation Mechanism record:</p> <ul style="list-style-type: none"> • 581-Ferritic Component Atmospheric Corrosion • 581-Ferritic Component Corrosion Under Insulation
Number of Highest Effective Inspections	MI_RBDEMEEV_NO_HIGH_EFF_INS_N	Numeric	<p>A value is required, and must be between 0 and 6. If you enter 0 in this column, then the value in the Highest Effective Inspection Level column must be E.</p>

Field Caption	Field ID	Data Type (Length)	Comments												
Highest Effective Inspection Level	MI_RBDEMEEV_HIGH_EFF_INS P_C	Character (25)	<p>A value is required.</p> <p>In the baseline GE Digital APM system, this cell may only contain one of the following System Code IDs:</p> <table border="1"> <thead> <tr> <th>System Code ID</th> <th>Highest Effective Inspection Level</th> </tr> </thead> <tbody> <tr> <td>A</td> <td>Highly Effective</td> </tr> <tr> <td>B</td> <td>Usually Effective</td> </tr> <tr> <td>C</td> <td>Fairly Effective</td> </tr> <tr> <td>D</td> <td>Poorly Effective</td> </tr> <tr> <td>E</td> <td>Ineffective (None)</td> </tr> </tbody> </table> <p>The list in this field is populated by the MI_581_Inspection_Effectiveness System Code Table. If the system code table has been customized, the valid values could be different. To verify which options are acceptable in your GE Digital APM system, via Configuration Manager, refer to the appropriate table.</p>	System Code ID	Highest Effective Inspection Level	A	Highly Effective	B	Usually Effective	C	Fairly Effective	D	Poorly Effective	E	Ineffective (None)
System Code ID	Highest Effective Inspection Level														
A	Highly Effective														
B	Usually Effective														
C	Fairly Effective														
D	Poorly Effective														
E	Ineffective (None)														
Last Known Inspection Date	MI_581DMCHE_LST_KNWN_IN N_DTE_D	Date	Enter a value in the following format: YYYY-MM-DD hh:mm:ss												

Field Caption	Field ID	Data Type (Length)	Comments
Susceptibility Type	MI_581DMCHE_SUSCEPTBLTY_TYPE_C	Character (50)	<p>A value is required.</p> <p>In the baseline GE Digital APM system, this cell may only contain one of the following System Code IDs:</p> <ul style="list-style-type: none"> • Estimated • Detected • Calculated <p>The list in this field is populated by the MI_581_Cracking_Susceptibility_Types System Code Table. If the system code table has been customized, the valid values could be different. To verify which options are acceptable in your GE Digital APM system, via Configuration Manager, refer to the appropriate table.</p>
Atmospheric Condition	MI_581_XCDME_ATMOS_CONDITION_C	Character (50)	<p>A value is required if the value in the Susceptibility Type cell is Calculated.</p> <p>In the baseline GE Digital APM system, this cell may only contain one of the following System Code IDs:</p> <ul style="list-style-type: none"> • MARINE • TEMPERATE • DRY • SEVERE <p>The list in this field is populated by the MI_ATMOSPHERIC_CONDITION System Code Table. If the system code table has been customized, the valid values could be different. To verify which options are acceptable in your GE Digital APM system, via Configuration Manager, refer to the appropriate table.</p>

Field Caption	Field ID	Data Type (Length)	Comments						
Susceptibility	MI_581DMCHE_SUSCEPTIBILITY_C	Character (50)	<p>A value is required if the value in the Susceptibility Type cell is Estimated.</p> <p>In the baseline GE Digital APM system, this cell may only contain one of the following System Code IDs:</p> <ul style="list-style-type: none"> • High • Medium • Low • None <p>The list in this field is populated by the MI_581_Cracking_Susceptibility System Code Table. If the system code table has been customized, the valid values could be different. To verify which options are acceptable in your GE Digital APM system, via Configuration Manager, refer to the appropriate table.</p>						
Coating Present?	MI_581DMCHE_COATING_PRESENT_C	Character (3)	<p>A value is required.</p> <p>In the baseline GE Digital APM system, this cell may only contain one of the following System Code IDs:</p> <table border="1"> <thead> <tr> <th>System Code ID</th> <th>Coating Present?</th> </tr> </thead> <tbody> <tr> <td>Y</td> <td>Yes</td> </tr> <tr> <td>N</td> <td>No</td> </tr> </tbody> </table> <p>The list in this field is populated by the MI_YES_NO System Code Table. If the system code table has been customized, the valid values could be different. To verify which options are acceptable in your GE Digital APM system, via Configuration Manager, refer to the appropriate table.</p>	System Code ID	Coating Present?	Y	Yes	N	No
System Code ID	Coating Present?								
Y	Yes								
N	No								

Field Caption	Field ID	Data Type (Length)	Comments
Coating Installation Date	MI_581DMCHE_CTNG_INSTLL N_DTE_D	Date	A value is required if the value in the Coating Present? cell is Y. Enter the value in the following format: YYYY-MM-DD hh:mm:ss
Coating Quality	MI_RBDEMEEV_COAT_QUAL_C	Character (50)	<p>A value is required if the value in the Coating Present? cell is Y.</p> <p>In the baseline GE Digital APM system, this cell may only contain one of the following System Code IDs:</p> <ul style="list-style-type: none"> • NONE • POOR • MEDIUM • HIGH <p>The list in this field is populated by the 581_Coating_Quality System Code Table. If the system code table has been customized, the valid values could be different. To verify which options are acceptable in your GE Digital APM system, via Configuration Manager, refer to the appropriate table.</p>
Piping System Complexity	MI_RBDEMEEV_PIP_SYS_COMP L_C	Character (50)	<p>A value is required if the value in the Damage Mechanism cell is 581-Austenitic Component Cracking Under Insulation.</p> <p>This cell may only contain one of the following values:</p> <ul style="list-style-type: none"> • Above Average • Average • Below Average

Field Caption	Field ID	Data Type (Length)	Comments						
Insulation Condition	MI_RBDEMEEV_INSUL_CON_C	Character (50)	<p>A value is required if the value in the Damage Mechanism cell is 581-Austenitic Component Cracking Under Insulation.</p> <p>This cell may only contain one of the following values:</p> <ul style="list-style-type: none"> • Above Average • Average • Below Average 						
Chloride Free Insulation	MI_581_XCDME_CHL_FREE_IN SUL_C	Character (50)	<p>A value is required if the value in the Damage Mechanism cell is 581-Austenitic Component Cracking Under Insulation.</p> <p>In the baseline GE Digital APM system, this cell may only contain one of the following System Code IDs:</p> <table border="1"> <thead> <tr> <th>System Code ID</th> <th>Coating Present?</th> </tr> </thead> <tbody> <tr> <td>Y</td> <td>Yes</td> </tr> <tr> <td>N</td> <td>No</td> </tr> </tbody> </table> <p>The list in this field is populated by the ML_YES_NO System Code Table. If the system code table has been customized, the valid values could be different. To verify which options are acceptable in your GE Digital APM system, via Configuration Manager, refer to the appropriate table.</p>	System Code ID	Coating Present?	Y	Yes	N	No
System Code ID	Coating Present?								
Y	Yes								
N	No								

DME_Cracking Worksheet

In the DME_Cracking worksheet, you can specify the following DMs that you want to create or update:

- 581-Amine Cracking
- 581-Alkaline Carbonate Stress Corrosion Cracking
- 581-HIC/SOHIC - HF
- 581-HIC/SOHIC - H2S
- 581-Caustic Cracking
- 581-Hydrogen Stress Cracking
- 581-Other Cracking
- 581-Sulfide Stress Cracking
- 581-Chloride Stress Corrosion Cracking

- 581-Polythionic Acid Cracking

These DMs belong to the RBI 581 Cracking Damage Evaluation methodology. These records will be linked to an RBI 581 Risk Analysis.

Field Caption	Field ID	Data Type (Length)	Comments
Asset ID	MI_EQUIP000_EQUIP_ID_C	Character (255)	Values in this column must match values entered in the Assets worksheet. Multiple DMs can be linked to the same asset (i.e., rows may have the same value in this column).
Asset CMMS System	MI_EQUIP000_SAP_SYSTEM_C	Character (255)	Values in this column must match values entered in the Assets worksheet, if they exist. Multiple DMs can be linked to the same asset (i.e., rows may have the same value in this column).
Equipment Technical Number	MI_EQUIP000_EQUIP_TECH_N BR_C	Character (255)	Values in this column must match values entered in the Assets worksheet, if they exist. Multiple DMs can be linked to the same asset (i.e., rows may have the same value in this column).
Component	MI_RBICOMPO_COMPO_C	Character (250)	Values in this column must match values entered in the RBI_Component worksheet, if they exist. Multiple DMs can be linked to the same component (i.e., rows may have the same value in this column).
Component Type	MI_RBICOMPO_COMPO_TYPE_ C	Character (60)	Values in this column must match values that you entered in the Component Type column on the RBI_Component worksheet for the associated component.
Analysis Unique ID	MI_ANALYSIS_ID	Character (255)	Values in this column must match values entered in the RBI_581_Analysis worksheet, if they exist. Multiple DMs can be linked to the same analysis (i.e., rows may have the same value in this column).

Field Caption	Field ID	Data Type (Length)	Comments
Damage Mechanism	MI_RBDEMEEV_DAM_MECH_C	Character (50)	<p>In the baseline GE Digital APM system, this cell may only contain one of the following values, which exist in the list in the Damage Mechanism field in the Potential Degradation Mechanism record:</p> <ul style="list-style-type: none"> • 581-Amine Cracking • 581-Alkaline Carbonate Stress Corrosion Cracking • 581-HIC/SOHIC - HF • 581-HIC/SOHIC - H2S • 581-Caustic Cracking • 581-Hydrogen Stress Cracking • 581-Other Cracking • 581-Sulfide Stress Cracking • 581-Chloride Stress Corrosion Cracking • 581-Polythionic Acid Cracking
Number of Highest Effective Inspections	MI_RBDEMEEV_NO_HIGH_EFF_INS_N	Numeric	<p>A value is required, and must be between 0 and 6. If you enter 0 in this column, then the value in the Highest Effective Inspection Level column must be E.</p>

Field Caption	Field ID	Data Type (Length)	Comments												
Highest Effective Inspection Level	MI_RBDEMEEV_HIGH_EFF_INS P_C	Character (25)	<p>A value is required.</p> <p>In the baseline GE Digital APM system, this cell may only contain one of the following System Code IDs:</p> <table border="1"> <thead> <tr> <th>System Code ID</th> <th>Highest Effective Inspection Level</th> </tr> </thead> <tbody> <tr> <td>A</td> <td>Highly Effective</td> </tr> <tr> <td>B</td> <td>Usually Effective</td> </tr> <tr> <td>C</td> <td>Fairly Effective</td> </tr> <tr> <td>D</td> <td>Poorly Effective</td> </tr> <tr> <td>E</td> <td>Ineffective (None)</td> </tr> </tbody> </table> <p>The list in this field is populated by the MI_581_Inspection_Effectiveness System Code Table. If the system code table has been customized, the valid values could be different. To verify which options are acceptable in your GE Digital APM system, via Configuration Manager, refer to the appropriate table.</p>	System Code ID	Highest Effective Inspection Level	A	Highly Effective	B	Usually Effective	C	Fairly Effective	D	Poorly Effective	E	Ineffective (None)
System Code ID	Highest Effective Inspection Level														
A	Highly Effective														
B	Usually Effective														
C	Fairly Effective														
D	Poorly Effective														
E	Ineffective (None)														
Last Known Inspection Date	MI_581DMCHE_LST_KNWN_IN N_DTE_D	Date	Enter a value in the following format: YYYY-MM-DD hh:mm:ss												

Field Caption	Field ID	Data Type (Length)	Comments
Susceptibility Type	MI_581DMCHE_SUSCEPTBLTY_TYPE_C	Character (50)	<p>A value is required.</p> <p>In the baseline GE Digital APM system, this cell may only contain one of the following System Code IDs:</p> <ul style="list-style-type: none"> • Estimated • Detected • Calculated <p>The list in this field is populated by the MI_581_Cracking_Susceptibility_Types System Code Table. If the system code table has been customized, the valid values could be different. To verify which options are acceptable in your GE Digital APM system, via Configuration Manager, refer to the appropriate table.</p>
Susceptibility	MI_581DMCHE_SUSCEPTIBILITY_C	Character (50)	<p>A value is required only if the value in the Susceptibility Type cell is Estimated. If the value in the Susceptibility Type cell is Calculated or Detected, then GE Digital APM will not consider the value that you enter in this cell.</p> <p>In the baseline GE Digital APM system, this cell may only contain one of the following System Code IDs:</p> <ul style="list-style-type: none"> • High • Medium • Low • None <p>The list in this field is populated by the MI_581_Cracking_Susceptibility System Code Table. If the system code table has been customized, the valid values could be different. To verify which options are acceptable in your GE Digital APM system, via Configuration Manager, refer to the appropriate table.</p>

Field Caption	Field ID	Data Type (Length)	Comments						
Severity Index Adjustment Factor	MI_581DMCHE_SVRY_INX_ADT_FCR_N	Numeric	<p>A value is required if the value in the Damage Mechanism cell is 581-Other Cracking.</p> <p>In the baseline GE Digital APM system, this cell may only contain one of the following values:</p> <ul style="list-style-type: none"> • 1 • 0.2 • 0.02 <p>If the family has been customized, the valid values could be different. This cell may only contain a value that exists in the list in the Severity Index Adjustment Factor field for RBI 581 Cracking Damage Evaluation records.</p>						
Online Monitoring Flag	MI_581DMCHE_ONLNE_MNTRNG_FLG_C	Character (50)	<p>A value is required if the value in the Damage Mechanism cell is 581-HIC/SOHIC - H2S.</p> <p>In the baseline GE Digital APM system, this cell may only contain one of the following System Code IDs:</p> <table border="1" data-bbox="1146 1173 1414 1388"> <thead> <tr> <th>System Code ID</th> <th>Online Monitoring Flag</th> </tr> </thead> <tbody> <tr> <td>Y</td> <td>Yes</td> </tr> <tr> <td>N</td> <td>No</td> </tr> </tbody> </table> <p>The list in this field is populated by the MI_YES_NO System Code Table. If the system code table has been customized, the valid values could be different. To verify which options are acceptable in your GE Digital APM system, via Configuration Manager, refer to the appropriate table.</p>	System Code ID	Online Monitoring Flag	Y	Yes	N	No
System Code ID	Online Monitoring Flag								
Y	Yes								
N	No								

Field Caption	Field ID	Data Type (Length)	Comments						
Key Process Variable?	MI_581DMCHE_KEY_PROCSS_VRBLE_C	Character (3)	<p>A value is required if the value in the Online Monitoring Flag cell is Y.</p> <p>In the baseline GE Digital APM system, this cell may only contain one of the following System Code IDs:</p> <table border="1"> <thead> <tr> <th>System Code ID</th> <th>Key Process Variable</th> </tr> </thead> <tbody> <tr> <td>Y</td> <td>Yes</td> </tr> <tr> <td>N</td> <td>No</td> </tr> </tbody> </table> <p>The list in this field is populated by the MI_YES_NO System Code Table. If the system code table has been customized, the valid values could be different. To verify which options are acceptable in your GE Digital APM system, via Configuration Manager, refer to the appropriate table.</p>	System Code ID	Key Process Variable	Y	Yes	N	No
System Code ID	Key Process Variable								
Y	Yes								
N	No								
Hydrogen Probes	MI_581DMCHE_HYDROGEN_PROBES_C	Character (3)	<p>A value is required if the value in the Online Monitoring Flag cell is Y.</p>						

Field Caption	Field ID	Data Type (Length)	Comments						
Steam Out?	MI_581CRKEV_STEAM_OUT_C	Character (50)	<p>A value is required if:</p> <ul style="list-style-type: none"> The value in the Damage Mechanism cell is 581-Amine Cracking or 581-Caustic Cracking. -and- The value in the Susceptibility Type cell is Calculated. <p>In the baseline GE Digital APM system, this cell may only contain one of the following System Code IDs:</p> <table border="1" data-bbox="1146 747 1412 930"> <thead> <tr> <th data-bbox="1146 747 1279 831">System Code ID</th> <th data-bbox="1279 747 1412 831">Steam Out?</th> </tr> </thead> <tbody> <tr> <td data-bbox="1146 831 1279 884">Y</td> <td data-bbox="1279 831 1412 884">Yes</td> </tr> <tr> <td data-bbox="1146 884 1279 930">N</td> <td data-bbox="1279 884 1412 930">No</td> </tr> </tbody> </table> <p>The list in this field is populated by the MI_YES_NO System Code Table. If the system code table has been customized, the valid values could be different. To verify which options are acceptable in your GE Digital APM system, via Configuration Manager, refer to the appropriate table.</p>	System Code ID	Steam Out?	Y	Yes	N	No
System Code ID	Steam Out?								
Y	Yes								
N	No								

Field Caption	Field ID	Data Type (Length)	Comments
Sulfur Content of Steel	MI_581CRKEV_SLFR_CNTT_OF_STL_C	Character (50)	<p>A value is required if:</p> <ul style="list-style-type: none"> The value in the Damage Mechanism cell is 581-HIC/SOHIC - H2S. -and- The value in the Susceptibility Type cell is Calculated. <p>In the baseline GE Digital APM system, this cell may only contain one of the following System Code IDs:</p> <ul style="list-style-type: none"> High Sulfur Steel (>0.01% S) Low Sulfur Steel (<=0.01% S) <p>The list in this field is populated by the MI_581_Sulfur_Content_Of_Steel System Code Table. If the system code table has been customized, the valid values could be different. To verify which options are acceptable in your GE Digital APM system, via Configuration Manager, refer to the appropriate table.</p>
Maximum Brinnell Hardness	MI_581CRKEV_MAX_BRIN_HARD_N	Numeric	<p>A value is required if:</p> <ul style="list-style-type: none"> The value in the Damage Mechanism cell is 581-Hydrogen Stress Cracking or 581-Sulfide Stress Cracking. -and- The value in the Susceptibility Type cell is Calculated.

Field Caption	Field ID	Data Type (Length)	Comments						
Heat Traced?	MI_581CRKEV_HEAT_TRACED_C	Character (50)	<p>A value is required if:</p> <ul style="list-style-type: none"> The value in the Damage Mechanism cell is 581-Amine Cracking or 581-Caustic Cracking. -and- The value in the Susceptibility Type cell is Calculated. <p>In the baseline GE Digital APM system, this cell may only contain one of the following System Code IDs:</p> <table border="1"> <thead> <tr> <th>System Code ID</th> <th>Heat Traced?</th> </tr> </thead> <tbody> <tr> <td>Y</td> <td>Yes</td> </tr> <tr> <td>N</td> <td>No</td> </tr> </tbody> </table> <p>The list in this field is populated by the MI_YES_NO System Code Table. If the system code table has been customized, the valid values could be different. To verify which options are acceptable in your GE Digital APM system, via Configuration Manager, refer to the appropriate table.</p>	System Code ID	Heat Traced?	Y	Yes	N	No
System Code ID	Heat Traced?								
Y	Yes								
N	No								
H2S Water Content	MI_581DMCHE_H2S_WTR_CO NT_N	Numeric	<p>A value is required if:</p> <ul style="list-style-type: none"> The value in the Damage Mechanism cell is 581-HIC/SOHIC - H2S. -and- The value in the Susceptibility Type cell is Calculated. 						

Field Caption	Field ID	Data Type (Length)	Comments
Product Form	MI_581CRKEV_PRODUCT_FORM_C	Character (50)	<p>A value is required if:</p> <ul style="list-style-type: none"> • The value in the Damage Mechanism cell is 581-HIC/SOHIC - H2S. -and- • The value in the Susceptibility Type cell is Calculated. <p>In the baseline GE Digital APM system, this cell may only contain one of the following System Code IDs:</p> <ul style="list-style-type: none"> • Seamless/Extruded Pipe • Rolled Plate <p>The list in this field is populated by the MI_581_Product_Form System Code Table. If the system code table has been customized, the valid values could be different. To verify which options are acceptable in your GE Digital APM system, via Configuration Manager, refer to the appropriate table.</p>

Field Caption	Field ID	Data Type (Length)	Comments						
HF Present?	MI_581CRKEV_HF_PRESENT_C	Character (50)	<p>A value is required if:</p> <ul style="list-style-type: none"> The value in the Damage Mechanism cell is 581-HIC/SOHIC - HF or 581-Hydrogen Stress Cracking. -and- The value in the Susceptibility Type cell is Calculated. <p>In the baseline GE Digital APM system, this cell may only contain one of the following System Code IDs:</p> <table border="1" data-bbox="1146 747 1417 930"> <thead> <tr> <th data-bbox="1146 747 1281 831">System Code ID</th> <th data-bbox="1281 747 1417 831">HF Present?</th> </tr> </thead> <tbody> <tr> <td data-bbox="1146 831 1281 884">Y</td> <td data-bbox="1281 831 1417 884">Yes</td> </tr> <tr> <td data-bbox="1146 884 1281 930">N</td> <td data-bbox="1281 884 1417 930">No</td> </tr> </tbody> </table> <p>The list in this field is populated by the MI_YES_NO System Code Table. If the system code table has been customized, the valid values could be different. To verify which options are acceptable in your GE Digital APM system, via Configuration Manager, refer to the appropriate table.</p>	System Code ID	HF Present?	Y	Yes	N	No
System Code ID	HF Present?								
Y	Yes								
N	No								

Field Caption	Field ID	Data Type (Length)	Comments
Amine Solution Type	MI_581CRKEV_AMINE_SOLTN_TYPE_C	Character (50)	<p>A value is required if:</p> <ul style="list-style-type: none"> • The value in the Damage Mechanism cell is 581-Amine Cracking. -and- • The value in the Susceptibility Type cell is Calculated. <p>In the baseline GE Digital APM system, this cell may only contain one of the following System Code IDs:</p> <ul style="list-style-type: none"> • Fresh • Lean • Rich <p>The list in this field is populated by the MI_581_Amine_Solution_Types System Code Table. If the system code table has been customized, the valid values could be different. To verify which options are acceptable in your GE Digital APM system, via Configuration Manager, refer to the appropriate table.</p>

Field Caption	Field ID	Data Type (Length)	Comments
Amine Type	MI_581CRKEV_AMINE_TYPE_C	Character (50)	<p>A value is required if:</p> <ul style="list-style-type: none"> • The value in the Damage Mechanism cell is 581-Amine Cracking. -and- • The value in the Susceptibility Type cell is Calculated. <p>In the baseline GE Digital APM system, this cell may only contain one of the following System Code IDs:</p> <ul style="list-style-type: none"> • MEA • DIPA • DEA • Other Amine <p>The list in this field is populated by the MI_581_Amine_Types System Code Table. If the system code table has been customized, the valid values could be different. To verify which options are acceptable in your GE Digital APM system, via Configuration Manager, refer to the appropriate table.</p>
Cyanides	MI_RBDEMEEV_CYANI_F	Boolean	Enter True or False.

Field Caption	Field ID	Data Type (Length)	Comments
Caustic Type	MI_581CRKEV_CAUST_TYPE_C	Character (50)	<p>A value is required if:</p> <ul style="list-style-type: none"> The value in the Damage Mechanism cell is 581-Caustic Cracking. -and- The value in the Susceptibility Type cell is Calculated. <p>In the baseline GE Digital APM system, this cell may only contain one of the following System Code IDs:</p> <ul style="list-style-type: none"> Area A Area B Area C <p>The list in this field is populated by the MI_581_Caustic_Types System Code Table. If the system code table has been customized, the valid values could be different. To verify which options are acceptable in your GE Digital APM system, via Configuration Manager, refer to the appropriate table.</p>
NaOH Caustic Concentration	MI_581CRKEV_NH_CSTC_CNC_NTRTN_N	Numeric	<p>A value is required if:</p> <ul style="list-style-type: none"> The value in the Damage Mechanism cell is 581-Caustic Cracking. -and- The value in the Susceptibility Type cell is Calculated.
CO3 Concentration in Water	MI_581CRKEV_CO3_CONC_IN_WTR_N	Numeric	<p>A value is required if:</p> <ul style="list-style-type: none"> The value in the Damage Mechanism cell is 581-Alkaline Carbonate Stress Corrosion Cracking. -and- The value in the Susceptibility Type cell is Calculated.

Field Caption	Field ID	Data Type (Length)	Comments						
Chloride Concentration Water Process	MI_581CRKEV_CH_CNC_OF_PR_WTR_C	Numeric	<p>A value is required if:</p> <ul style="list-style-type: none"> The value in the Damage Mechanism cell is 581-Chloride Stress Corrosion Cracking. -and- The value in the Susceptibility Type cell is Calculated. 						
Exposure to Oxygen During Operation/Downtime	MI_581CRKEV_EXE_TO_OXN_D_OPE_C	Character (50)	<p>A value is required if:</p> <ul style="list-style-type: none"> The value in the Damage Mechanism cell is 581-Polythionic Acid Cracking. -and- The value in the Susceptibility Type cell is Calculated. <p>In the baseline GE Digital APM system, this cell may only contain one of the following System Code IDs:</p> <table border="1"> <thead> <tr> <th>System Code ID</th> <th>Exposure to Oxygen During Operation/Downtime</th> </tr> </thead> <tbody> <tr> <td>Y</td> <td>Yes</td> </tr> <tr> <td>N</td> <td>No</td> </tr> </tbody> </table> <p>The list in this field is populated by the MI_YES_NO System Code Table. If the system code table has been customized, the valid values could be different. To verify which options are acceptable in your GE Digital APM system, via Configuration Manager, refer to the appropriate table.</p>	System Code ID	Exposure to Oxygen During Operation/Downtime	Y	Yes	N	No
System Code ID	Exposure to Oxygen During Operation/Downtime								
Y	Yes								
N	No								

Field Caption	Field ID	Data Type (Length)	Comments						
Exposure to Sulfur During Operation/Downtime	MI_581CRKEV_EXE_TO_SLR_D_OPE_C	Character (50)	<p>A value is required if:</p> <ul style="list-style-type: none"> The value in the Damage Mechanism cell is 581-Polythionic Acid Cracking. -and- The value in the Susceptibility Type cell is Calculated. <p>In the baseline GE Digital APM system, this cell may only contain one of the following System Code IDs:</p> <table border="1" data-bbox="1146 716 1414 961"> <thead> <tr> <th data-bbox="1146 716 1279 863">System Code ID</th> <th data-bbox="1279 716 1414 863">Exposure to Sulfur During Operation/Downtime</th> </tr> </thead> <tbody> <tr> <td data-bbox="1146 863 1279 911">Y</td> <td data-bbox="1279 863 1414 911">Yes</td> </tr> <tr> <td data-bbox="1146 911 1279 961">N</td> <td data-bbox="1279 911 1414 961">No</td> </tr> </tbody> </table> <p>The list in this field is populated by the MI_YES_NO System Code Table. If the system code table has been customized, the valid values could be different. To verify which options are acceptable in your GE Digital APM system, via Configuration Manager, refer to the appropriate table.</p>	System Code ID	Exposure to Sulfur During Operation/Downtime	Y	Yes	N	No
System Code ID	Exposure to Sulfur During Operation/Downtime								
Y	Yes								
N	No								

Field Caption	Field ID	Data Type (Length)	Comments						
Exposure to Water During Operation/Shutdown	MI_581CRKEV_EXE_TO_WTR_D _OPN_C	Character (50)	<p>A value is required if:</p> <ul style="list-style-type: none"> The value in the Damage Mechanism cell is 581-Polythionic Acid Cracking. -and- The value in the Susceptibility Type cell is Calculated. <p>In the baseline GE Digital APM system, this cell may only contain one of the following System Code IDs:</p> <table border="1" data-bbox="1146 716 1412 961"> <thead> <tr> <th data-bbox="1146 716 1279 863">System Code ID</th> <th data-bbox="1279 716 1412 863">Exposure to Water During Operation/Shutdown</th> </tr> </thead> <tbody> <tr> <td data-bbox="1146 863 1279 915">Y</td> <td data-bbox="1279 863 1412 915">Yes</td> </tr> <tr> <td data-bbox="1146 915 1279 961">N</td> <td data-bbox="1279 915 1412 961">No</td> </tr> </tbody> </table> <p>The list in this field is populated by the MI_YES_NO System Code Table. If the system code table has been customized, the valid values could be different. To verify which options are acceptable in your GE Digital APM system, via Configuration Manager, refer to the appropriate table.</p>	System Code ID	Exposure to Water During Operation/Shutdown	Y	Yes	N	No
System Code ID	Exposure to Water During Operation/Shutdown								
Y	Yes								
N	No								

Field Caption	Field ID	Data Type (Length)	Comments						
Downtime Protection Used	MI_581CRKEV_DWNTME_PRTC N_USD_C	Character (50)	<p>A value is required if:</p> <ul style="list-style-type: none"> The value in the Damage Mechanism cell is 581-Polythionic Acid Cracking. -and- The value in the Susceptibility Type cell is Calculated. <p>In the baseline GE Digital APM system, this cell may only contain one of the following System Code IDs:</p> <table border="1" data-bbox="1146 716 1419 930"> <thead> <tr> <th data-bbox="1146 716 1279 831">System Code ID</th> <th data-bbox="1279 716 1419 831">Downtime Protection Used</th> </tr> </thead> <tbody> <tr> <td data-bbox="1146 831 1279 884">Y</td> <td data-bbox="1279 831 1419 884">Yes</td> </tr> <tr> <td data-bbox="1146 884 1279 930">N</td> <td data-bbox="1279 884 1419 930">No</td> </tr> </tbody> </table> <p>The list in this field is populated by the MI_YES_NO System Code Table. If the system code table has been customized, the valid values could be different. To verify which options are acceptable in your GE Digital APM system, via Configuration Manager, refer to the appropriate table.</p>	System Code ID	Downtime Protection Used	Y	Yes	N	No
System Code ID	Downtime Protection Used								
Y	Yes								
N	No								

Field Caption	Field ID	Data Type (Length)	Comments
Thermal History (Heat Treatment History)	MI_581CRKEV_THL_HSY_HT_T_HSY_C	Character (50)	<p>A value is required if:</p> <ul style="list-style-type: none"> The value in the Damage Mechanism cell is 581-Polythionic Acid Cracking. -and- The value in the Susceptibility Type cell is Calculated. <p>In the baseline GE Digital APM system, this cell may only contain one of the following System Code IDs:</p> <ul style="list-style-type: none"> Solution Annealed Stabilized Before Welding Stabilized After Welding <p>The list in this field is populated by the MI_581_Heat_Treatment_History System Code Table. If the system code table has been customized, the valid values could be different. To verify which options are acceptable in your GE Digital APM system, via Configuration Manager, refer to the appropriate table.</p>

DME_HTHA Worksheet

In the DME_HTHA worksheet, you can specify the 581-High Temperature Hydrogen Attack DM that you want to create or update. This DM, however, is not applicable for a component of type Storage Tank Bottom.

Field Caption	Field ID	Data Type (Length)	Comments
Asset ID	MI_EQUIP000_EQUIP_ID_C	Character (255)	Values in this column must match values entered in the Assets worksheet. Multiple DMs can be linked to the same asset (i.e., rows may have the same value in this column).
Asset CMMS System	MI_EQUIP000_SAP_SYSTEM_C	Character (255)	Values in this column must match values entered in the Assets worksheet, if they exist. Multiple DMs can be linked to the same asset (i.e., rows may have the same value in this column).

Field Caption	Field ID	Data Type (Length)	Comments
Equipment Technical Number	MI_EQUIP000_EQUIP_TECH_N BR_C	Character (255)	Values in this column must match values entered in the Assets worksheet, if they exist. Multiple DMs can be linked to the same asset (i.e., rows may have the same value in this column).
Component	MI_RBICOMPO_COMPO_C	Character (250)	Values in this column must match values entered in the RBI_Component worksheet, if they exist. Multiple DMs can be linked to the same component (i.e., rows may have the same value in this column).
Component Type	MI_RBICOMPO_COMPO_TYPE_ C	Character (60)	Values in this column must match values that you entered in the Component Type column on the RBI_Component worksheet for the associated component.
Analysis Unique ID	MI_ANALYSIS_ID	Character (255)	Values in this column must match values entered in the RBI_581_Analysis worksheet, if they exist. Multiple DMs can be linked to the same analysis (i.e., rows may have the same value in this column).
Damage Mechanism	MI_RBDEMEEV_DAM_MECH_C	Character (50)	Enter 581-High Temperature Hydrogen Attack.

Field Caption	Field ID	Data Type (Length)	Comments						
Is HTHA Damage Observed	MI_581_HTHA_IS_DAMAG_OBS_C	Character (50)	<p>A value is required.</p> <p>In the baselineGE Digital APM system, this cell may only contain one of the following System Code IDs:</p> <table border="1"> <thead> <tr> <th>System Code ID</th> <th>Is HTHA Observed</th> </tr> </thead> <tbody> <tr> <td>Y</td> <td>Yes</td> </tr> <tr> <td>N</td> <td>No</td> </tr> </tbody> </table> <p>The list in this field is populated by the MI_YES_NO System Code Table. If the system code table has been customized, the valid values could be different. To verify which options are acceptable in your GE Digital APM system, via Configuration Manager, refer to the appropriate table.</p>	System Code ID	Is HTHA Observed	Y	Yes	N	No
System Code ID	Is HTHA Observed								
Y	Yes								
N	No								
Is Component Replaced	MI_581_HTHA_IS_COMPO_REPLA_C	Character (50)	<p>A value is required if the value in the Is HTHA Damage Observed cell is Y.</p> <p>In the baseline GE Digital APM system, this cell may only contain one of the following System Code IDs:</p> <table border="1"> <thead> <tr> <th>System Code ID</th> <th>Is Component Replaced</th> </tr> </thead> <tbody> <tr> <td>Y</td> <td>Yes</td> </tr> <tr> <td>N</td> <td>No</td> </tr> </tbody> </table> <p>The list in this field is populated by the MI_YES_NO System Code Table. If the system code table has been customized, the valid values could be different. To verify which options are acceptable in your GE Digital APM system, via Configuration Manager, refer to the appropriate table.</p>	System Code ID	Is Component Replaced	Y	Yes	N	No
System Code ID	Is Component Replaced								
Y	Yes								
N	No								

Field Caption	Field ID	Data Type (Length)	Comments
Exposure Hydrogen Partial Pressure	MI_581_HTHA_HYDRO_PAR_P RESS_N	Numeric	A value is required if the value in the Is HTHA Damage Observed cell is N.
Delta Temperature	MI_581_HTHA_DELTA_TEMPE_ C	Character (50)	<p>A value is required if the value in the Is HTHA Damage Observed cell is N.</p> <p>In the baseline GE Digital APM system, this cell may only contain one of the following System Code IDs:</p> <ul style="list-style-type: none"> • >=0 • >= -50 and < 0 • >= -100 and < -50 • < -100 <p>The list in this field is populated by the MI_581_HTHA_Delta_Tempera- ture System Code Table. If the system code table has been customized, the valid values could be different. To verify which options are acceptable in your GE Digital APM system, via Configuration Manager, refer to the appropriate table.</p>

DME_BrittleFracture Worksheet

In the DME_BrittleFracture worksheet, you can specify the following DMs that you want to create or update:

- 581-Sigma Phase Embrittlement
- 581-885F Embrittlement
- 581-Brittle Fracture
- 581-Low Alloy Steel Embrittlement

Field Caption	Field ID	Data Type (Length)	Comments
Asset ID	MI_EQUIP000_EQUIP_ID_C	Character (255)	Values in this column must match values entered in the Assets worksheet. Multiple DMs can be linked to the same asset (i.e., rows may have the same value in this column).
Asset CMMS System	MI_EQUIP000_SAP_SYSTEM_C	Character (255)	Values in this column must match values entered in the Assets worksheet, if they exist. Multiple DMs can be linked to the same asset (i.e., rows may have the same value in this column).
Equipment Technical Number	MI_EQUIP000_EQUIP_TECH_N BR_C	Character (255)	Values in this column must match values entered in the Assets worksheet, if they exist. Multiple DMs can be linked to the same asset (i.e., rows may have the same value in this column).
Component	MI_RBICOMPO_COMPO_C	Character (250)	Values in this column must match values entered in the RBI_Component worksheet, if they exist. Multiple DMs can be linked to the same component (i.e., rows may have the same value in this column).
Component Type	MI_RBICOMPO_COMPO_TYPE_ C	Character (60)	Values in this column must match values that you entered in the Component Type column on the RBI_Component worksheet for the associated component.
Analysis Unique ID	MI_ANALYSIS_ID	Character (255)	Values in this column must match values entered in the RBI_581_Analysis worksheet, if they exist. Multiple DMs can be linked to the same analysis (i.e., rows may have the same value in this column).

Field Caption	Field ID	Data Type (Length)	Comments
Damage Mechanism	MI_RBDEMEEV_DAM_MECH_C	Character (50)	<p>In the baseline GE Digital APM system, this cell may only contain one of the following values, which exist in the list in the Damage Mechanism field in the Potential Degradation Mechanism record:</p> <ul style="list-style-type: none"> • 581-Sigma Phase Embrittlement • 581-885F Embrittlement • 581-Brittle Fracture • 581-Low Alloy Steel Embrittlement

Field Caption	Field ID	Data Type (Length)	Comments										
Material Exemption Curve	MI_581BRFRAC_MTRL_EXMPT NCRVE_N	Character (50)	<p>A value is required if the value in the Damage Mechanism cell is 581-Brittle Fracture or 581-Low Alloy Steel Embrittlement.</p> <p>In the baseline GE Digital APM system, this cell may only contain one of the following System Code IDs:</p> <table border="1"> <thead> <tr> <th>System Code ID</th> <th>Material Exemption Curve</th> </tr> </thead> <tbody> <tr> <td>A</td> <td>Temperature Exemption A Curve</td> </tr> <tr> <td>B</td> <td>Temperature Exemption B Curve</td> </tr> <tr> <td>C</td> <td>Temperature Exemption C Curve</td> </tr> <tr> <td>D</td> <td>Temperature Exemption D Curve</td> </tr> </tbody> </table> <p>The list in this field is populated by the MI_581_Material_Temperature_Exemption_Curves System Code Table. If the system code table has been customized, the valid values could be different. To verify which options are acceptable in your GE Digital APM system, via Configuration Manager, refer to the appropriate table.</p>	System Code ID	Material Exemption Curve	A	Temperature Exemption A Curve	B	Temperature Exemption B Curve	C	Temperature Exemption C Curve	D	Temperature Exemption D Curve
System Code ID	Material Exemption Curve												
A	Temperature Exemption A Curve												
B	Temperature Exemption B Curve												
C	Temperature Exemption C Curve												
D	Temperature Exemption D Curve												
Minimum Allowable Temperature	MI_581BRFRAC_MNMM_ALLW BLETME_N	Numeric	<p>A value is required if the Damage Mechanism cell contains one of the following values:</p> <ul style="list-style-type: none"> 581-Sigma Phase Embrittlement 581-885F Embrittlement 581-Low Alloy Steel Embrittlement 										

Field Caption	Field ID	Data Type (Length)	Comments
Minimum Design Metal Temperature (MDMT)	MI_581BRFRAC_MNM_DSN_MTL_MDT_N	Numeric	A value is required if the Damage Mechanism cell contains one of the following values: <ul style="list-style-type: none"> 581-885F Embrittlement 581-Low Alloy Steel Embrittlement
Critical Exposure Temperature(CET)	MI_581BRFRAC_CRTCLEXPRESRE_TMT_N	Numeric	A value is required if the value in the Damage Mechanism cell is 581-Brittle Fracture.
Is CET at the MAWP >= -29°C	MI_581BRIFRAC_IS_CT_PVPCRT_L	Boolean	Enter True or False.
Is Cyclic service Design Requirement	MI_581BRIFRAC_IS_CYC_SREFRQT_L	Boolean	Enter True or False.
Is Asset Or Circuit Subject to EVN Cracking	MI_581BRIFRAC_IS_EQT_CRCRG_L	Boolean	Enter True or False.
Is Asset Or Circuit Subject to Shock Chilling	MI_581BRIFRAC_IS_EQT_CR_SCHG_L	Boolean	Enter True or False.
Is Fabricated From P-1 and P-3 Steels	MI_581BRIFRAC_IS_FBD_FRMP65F_L	Boolean	Enter True or False.
Is Nominal Operating Conditions Changed	MI_581BRIFRAC_IS_NML_OPGCCHD_L	Boolean	Enter True or False.
Is Nominal Uncorroded Thickness < 50.8 mm (2 inch)	MI_581BRIFRAC_NML_UNDTHS_INH_L	Boolean	Enter True or False.
Is Satisfied All Requirements For Fabrication	MI_581BRIFRAC_IS_STD_ALLRFRN_L	Boolean	Enter True or False.

Field Caption	Field ID	Data Type (Length)	Comments																						
Fracture Appearance Transition Temperature(FATT)	MI_581BRFRAC_FRCEAPE_TRN_TME_N	Numeric	A value is required if the value in the Damage Mechanism cell is 581-Low Alloy Steel Embrittlement.																						
Sigma Percentage	MI_581BRIFRAC_SIGMA_AMO_UNT_N	Numeric	<p>A value is required if the value in the Damage Mechanism cell is 581-Sigma Phase Embrittlement.</p> <p>In the baseline GE Digital APM system, this cell may only contain one of the following System Code IDs:</p> <table border="1"> <thead> <tr> <th>System Code ID</th> <th>Sigma Percentage</th> </tr> </thead> <tbody> <tr><td>1</td><td>1</td></tr> <tr><td>2</td><td>2</td></tr> <tr><td>3</td><td>3</td></tr> <tr><td>4</td><td>4</td></tr> <tr><td>5</td><td>5</td></tr> <tr><td>6</td><td>6</td></tr> <tr><td>7</td><td>7</td></tr> <tr><td>8</td><td>8</td></tr> <tr><td>9</td><td>9</td></tr> <tr><td>10</td><td>>=10</td></tr> </tbody> </table> <p>The list in this field is populated by the MI_581_Sigma_Percentage System Code Table. If the system code table has been customized, the valid values could be different. To verify which options are acceptable in your GE Digital APM system, via Configuration Manager, refer to the appropriate table.</p>	System Code ID	Sigma Percentage	1	1	2	2	3	3	4	4	5	5	6	6	7	7	8	8	9	9	10	>=10
System Code ID	Sigma Percentage																								
1	1																								
2	2																								
3	3																								
4	4																								
5	5																								
6	6																								
7	7																								
8	8																								
9	9																								
10	>=10																								

About the Risk Based Inspection (RBI) 581 Data Loader Load Verification

About This Task

Following a data load, you should perform the following steps in GE Digital APM to confirm the integrity and accuracy of the data imported from the data loader workbook.

Procedure

1. Access the details of the import job. These details will indicate if any errors, minor or otherwise, were encountered during the import job. The log may help account for any records that are unexpectedly absent after the data load.
2. In Risk Based Inspection or Record Manager, access the assets specified in the data loader workbook, and then verify that the expected components are present or updated, and that any associated records that you expected to be created are also present in the database.

You can enter the following query in the **SQL** workspace of the **Query** page to review a list of components created after a specified date:

```
SELECT [MI_CCRBICOM].LAST_UPDT_DT "LAST_UPDT_DT", [MI_CCRBICOM].
[MI_RBICOMPO_COMPO_C] "Component", [MI_CCRBICOM].
[MI_RBICOMPO_COMPO_TYPE_C] "Component Type", [MI_CCRBICOM].
[MI_RBICOMPO_EQUIP_C] "Asset", [MI_CCRBICOM].ENTY_ID "ENTY_ID" FROM
[MI_CCRBICOM] WHERE [MI_CCRBICOM].LAST_UPDT_DT >=
CONVERT(VARCHAR(255), (? :d :caption='Enter a Date'), 110) ORDER BY
[MI_CCRBICOM].LAST_UPDT_DT Desc, [MI_CCRBICOM].[MI_RBICOMPO_EQUIP_C]
Asc
```

You can enter the following query in the **Oracle** workspace of the **Query** page to review a list of components created after a specified date:

```
SELECT [MI_CCRBICOM].LAST_UPDT_DT "LAST_UPDT_DT", [MI_CCRBICOM].
[MI_RBICOMPO_COMPO_C] "Component", [MI_CCRBICOM].
[MI_RBICOMPO_COMPO_TYPE_C] "Component Type", [MI_CCRBICOM].
[MI_RBICOMPO_EQUIP_C] "Asset", [MI_CCRBICOM].ENTY_ID "ENTY_ID" FROM
[MI_CCRBICOM] WHERE [MI_CCRBICOM].LAST_UPDT_DT >=
to_date(to_char( (? :d :caption='Enter a Date'), 'mm/dd/yyyy'), 'mm/dd/
yyyy') ORDER BY [MI_CCRBICOM].LAST_UPDT_DT Desc, [MI_CCRBICOM].
[MI_RBICOMPO_EQUIP_C] Asc
```

3. When prompted, enter the date on which the data load was performed.

Corrosion Loop

About the Risk Based Inspection (RBI) Corrosion Loop Data Loader

GE Digital APM, through the Risk Based Inspection module, provides the functionality to carry out a Semi-Quantitative Analysis (RBI Criticality Analysis) on Corrosion Loops, which are comprised of various types of linked RBI Components. Using the Risk Based Inspection (RBI) Corrosion Loop Data Loader, you can generate all Corrosion Loops for a Process Unit along with the related RBI Components and Reference Documents.

Using the Risk Based Inspection (RBI) Corrosion Loop Data Loader, you can create or update Corrosion Loops, link RBI Components, and Reference Documents.

About the Risk Based Inspection (RBI) Corrosion Loop Data Loader Requirements

This documentation assumes that your organization has completed fully the deployment of the Risk Based Inspection module. The Risk Based Inspection (RBI) Corrosion Loop Data Loader should only be used after the Risk Based Inspection module has been implemented.

The data loader can be used to set up an RBI program during implementation. Because the RBI Components must exist prior to the Corrosion Loop data load, the Risk Based Inspection (RBI) 580 Data Loader should be used before the Risk Based Inspection (RBI) Corrosion Loop Data Loader.

When you create or update a Corrosion Loop, it is linked to a Functional Location, which must already exist, and then linked to Criticality RBI Components and Reference Documents that you specify.

The following data must be defined prior to loading Corrosion Loop data:

- Site References
- Equipment Taxonomies
- Functional Location Families

Security Settings

The Security User performing the data load operation must be associated with either the MI Data Loader User or MI Data Loader Admin Security Role, and must also be associated with the MI RBI Analyst Security Group or a Security Role that is associated with this Security Group.

About the Risk Based Inspection (RBI) Corrosion Loop Data Loader Data Model

This topic has been intentionally excluded from the GE Digital APM product documentation website. This topic is available to you via the product documentation that is provided within the GE Digital APM system.

About the Risk Based Inspection (RBI) Corrosion Loop Data Loader General Loading Strategy

Best Practices

When importing data using the Risk Based Inspection (RBI) Corrosion Loop Data Loader, you must use the following best practices:

- ID fields (Row 2 of each worksheet) must not include special characters or spaces.
- The data loader workbook contains sample data in each column. It is only for your reference. You must remove this data before using the data loader workbook.
- Columns (including columns representing custom fields) in the worksheets should be formatted as Text.
- Import a maximum of 500 records in each data load.
- For Oracle databases, valid cell values are case-sensitive.
- For a Corrosion Loop to have associated RBI Components, the RBI Components that will be linked to the Corrosion Loop must already exist in the GE Digital APM system.
- If RBI Components do not exist, the Corrosion Loop Data Loader will create or update Corrosion Loop data, but it will not have any associated RBI Components.

Load Sequence

The RBI Corrosion Loop data load is performed in a specific sequence to create all necessary relationships between records:

Note: Prior to deploying the Risk Based Inspection (RBI) Corrosion Loop Data Loader, the [Risk Based Inspection \(RBI\) 580 Data Loader](#) must be implemented. The Corrosion Loop Data Loader uses the values in the Functional Location field, the Corrosion Loop field, the Asset field, and the Component field to look up the associated component record and to link said RBI Component to a Corrosion Loop. For RBI Components to be linked to a Corrosion Loop, the RBI Components must already exist and be present

in the Components worksheet. If RBI Components do not exist, the Corrosion Loop Data Loader will create or update Corrosion Loop data, but it will not have any associated RBI Components.

1. The Corrosion Loops worksheet is processed. An existing Functional Location will be looked up based on the Functional Location (MI_FNCLOC00_FNC_LOC_C) and the RBI Corrosion Loop ID (MI_RBI_SYSTEM_RBI_SYS_ID_C).
If a Corrosion Loop specified on the worksheets exists, it will be updated. If a Corrosion Loop cannot be found, then a new Corrosion Loop will be created.
2. The RBI Components worksheet is processed. An existing RBI Component is looked up based on the below fields:
 - Asset ID (For Equipment: MI_EQUIP000_EQUIP_ID_C and for Functional Location: MI_FNCLOC00_FNC_LOC_C)
 - Asset CMMS System (For Equipment: MI_EQUIP000_SAP_SYSTEM_C and for Functional Location: MI_FNCLOC00_SAP_SYSTEM_C)
 - Equipment Technical Number (MI_EQUIP000_EQUIP_Tech_NBR_C)
 - Asset Family
 - Component (MI_RBICOMPO_COMPO_C)
 - Component Type (MI_RBICOMPO_COMPO_TYPE_C)

If found, the RBI Component will be linked to the specified Corrosion Loop (MI_RBI_SYSTEM_RBI_SYS_ID_C). If no RBI Components exist, this worksheet is skipped.

If the RBI Component is specified in the worksheet, but that RBI Component cannot be looked up, an error is added to the log.

Note: When an RBI Component is linked to a Corrosion Loop, the Potential Degradation Mechanisms linked to the Corrosion Loop are added to the RBI Component.

3. The Reference Document worksheet is processed. The Corrosion Loop will be looked up by the Functional Location (MI_FNCLOC00_FNC_LOC_C), the RBI Corrosion Loop (MI_RBI_SYSTEM_RBI_SYS_ID_C), and the Reference Document ID (CTIT_ID).
If a Reference Document specified on the worksheet exists, it is updated. If a Reference Document cannot be found, then a new Reference Document is created.

Data that you specify in the field on each worksheet will be included in the new records.

About the Risk Based Inspection (RBI) Corrosion Loop Data Loader Workbook Layout and Use

In order to import data using the Risk Based Inspection (RBI) Corrosion Loop Data Loader, GE Digital APM provides an Excel workbook, Risk Based Inspection (RBI) Corrosion Loop.xlsx, which supports baseline Risk Based Inspection in GE Digital APM. This workbook must be used to perform the data load. You can modify the Excel workbook to include custom fields used by your organization.

Note: The Excel workbook is referred to throughout this documentation as the data loader workbook.

The following table lists the worksheets that are included in the data loader workbook.

Worksheet	Description
Corrosion_Loops	This worksheet is used to specify which Corrosion Loops the user wants to link to Functional Locations.
Components	This worksheet is used only to lookup fields for unique, existing RBI Components to link to Corrosion Loops.
Reference_Document	This worksheet is used to specify the Functional Location key fields as well as the Corrosion Loop key fields.

Color Coding

Certain columns on the worksheets have different functions and requirements. To illustrate this, certain columns are color-coded. The following table lists the colors and what they represent.

Color	Description	Comments
Gray	Required Key Fields	Indicates columns that contain values that are used by the Risk Based Inspection (RBI) Corrosion Loop Data Loader to look up and create records. If these columns are removed from the worksheets, the data load will fail. While the worksheets require that these columns be present, values are not necessarily required in these columns.
Red	Fields Required for Saving Records	Indicates columns that contain values that are required to save the record.
Blue	Recommended Fields	Indicates columns that, according to GE Digital APM Best Practice for Inspection Management, should contain values.
None	Custom Fields	Indicates columns in which you can specify custom fields.

Limitations

The Risk Based Inspection (RBI) Corrosion Loop Data Loader has the following limitations:

- The values that you enter in the data loader workbook are case-sensitive.
- If you reimport data, the records that have been created by the Data Loader will be updated. Therefore, while reimporting data, if you remove the data for a field in the data loader workbooks, the value for the corresponding field in GE Digital APM will be either a default value or blank.

Corrosion_Loops Worksheet

On the Corrosion_Loops worksheet, you will specify which Corrosion Loops the user wants to link to Functional Locations.

Field Caption	Field ID	Data Type (Length)	Comments
Functional Location	MI_FNCLOC00_FNC_LOC_C	Character (255)	The value in this column is used to break the data into smaller data loads.
CMMS System	MI_FNCLOC00_SAP_SYSTEM_C	Character (255)	A value is required for each row.
RBI Corrosion Loop ID	MI_RBI_SYSTEM_RBI_SYS_ID_C	Character (255)	If this column is populated, the Corrosion Loop referenced in this column will be identified by a combination of the Functional Locations and CMMS System.
RBI Corrosion Loop Description	MI_RBI_SYSTEM_RBI_SYS_DESC_C	Character (2000)	This column is not required for calculations; however, providing a value for this column is considered Best Practice.
RBI Corrosion Loop From	MI_RBI_SYSTEM_RBI_SYS_FROM_C	Character (255)	This column is not required for calculations; however, providing a value for this column is considered Best Practice.
RBI Corrosion Loop To	MI_RBI_SYSTEM_RBI_SYS_TO_C	Character (255)	This column is not required for calculations; however, providing a value for this column is considered Best Practice.

Components Worksheet

On the Components worksheet, you will use lookup fields to find unique, existing RBI Components to link to Corrosion Loops.

Field Caption	Field ID	Data Type (Length)	Comments
Functional Location	MI_FNCLOC00_FNC_LOC_C	Character (50)	Values in this column must match values entered on the Corrosion_Loop worksheet, if they exist.
CMMS System	MI_FNCLOC00_SAP_SYSTEM_C	Character (255)	Values in this column must match values entered on the Corrosion_Loop worksheet, if they exist.

Field Caption	Field ID	Data Type (Length)	Comments
RBI Corrosion Loop ID	MI_RBI_SYSTEM_RBI_SYS_ID_C	Character (255)	Values in this column must match values entered on the Corrosion_Loop worksheet, if they exist.
Asset ID	MI_EQUIP000_EQUIP_ID_C	Character (255)	A value is required for each row. For a Functional Location asset, the field MI_FNCLOC00_FNC_LOC_C should be used.
Asset CMMS System	MI_EQUIP000_SAP_SYSTEM_C	Character (255)	A value is required for each row. For a Functional Location asset, the field MI_FNCLOC00_SAP_SYSTEM_C should be used.
Equipment Technical Number	MI_EQUIP000_EQUIP_TECH_N BR_C	Character (255)	A value is required for each row. Note: This field must be left blank for a Functional Location asset.
Asset Family	ASSET_FAMILY_ID	Character (255)	This field is required when loading Functional Location assets. If no value is provided, the asset will be considered an Equipment asset. Note: Below are the valid values: <ul style="list-style-type: none"> • MI_EQUIP000 • MI_FNCLOC00
Component	MI_RBICOMPO_COMPO_C	Character (250)	A value is required for each row.
Component Type	MI_RBICOMPO_COMPO_TYPE_ C	Character (60)	A value is required for each row. This cell may only contain a value that exists in the list in the Component Type field for Criticality RBI Component records.

Reference_Document Worksheet

On the Reference_Document worksheet, you will specify the Functional Location key fields as well as the Corrosion Loop key fields.

Field Caption	Field ID	Data Type (Length)	Comments
Functional Location	MI_FNCLOC00_FNC_LOC_C	Character (255)	Values in this column must match values entered on the Corrosion_Loop worksheet, if they exist.
CMMS System	MI_FNCLOC00_SAP_SYSTEM_C	Character (255)	Values in this column must match values entered on the Corrosion_Loop worksheet, if they exist.
RBI Corrosion Loop ID	MI_RBI_SYSTEM_RBI_SYS_ID_C	Character (255)	Values in this column must match values entered on the Corrosion_Loop worksheet, if they exist.
Reference Document ID	CTIT_ID	Character (255)	A value is required for each row.
Description	CTIT_DESC_TX	Character (255)	This column is not required for calculations; however, providing a value for this column is considered Best Practice.
Document Path	MIRD_DOC_PATH_CHR	Character (1023)	This column is not required for calculations; however, providing a value for this column is considered Best Practice.

About the Risk Based Inspection (RBI) Corrosion Loop Data Loader Load Verification

About This Task

Following a data load, you should perform the following steps in GE Digital APM to confirm the integrity and accuracy of the data imported from the data loader workbook.

Procedure

1. Access the details of the import job. These details will indicate if any errors, minor or otherwise, were encountered during the import job. The log may help account for any records that are unexpectedly absent after the data load.
2. In Risk Based Inspection or Record Manager, access the Corrosion Loops specified in the data loader workbook, and then verify that the expected components are present or updated, and that any associated records that you expected to be created are also present in the database.

You can enter the following query in the **SQL** workspace of the **Query** page to review a list of components created after a specified date:

```
SELECT [MI_RBiSYS00].LAST_UPDT_DT "LAST_UPDT_DT", [MI_RBiSYS00].
[MI_RBI_SYSTEM_RBI_SYS_ID_C] "RBI Corrosion Loop ID", [MI_RBiSYS00].
[MI_RBI_SYSTEM_RBI_SYS_DESC_C] "RBI Corrosion Loop Description",
[MI_RBiSYS00].[MI_RBI_SYSTEM_RBI_SYS_TO_C] "RBI Corrosion Loop To",
```

```
[MI_RBISYS00].[MI_RBI_SYSTEM_RBI_SYS_FROM_C] "RBI Corrosion Loop
From", [MI_RBICOMPO].[MI_RBICOMPO_COMPO_C] "RBI Component ID",
[MI_RBICOMPO].[MI_RBICOMPO_COMPO_TYPE_C] "Component Type" FROM
[MI_RBISYS00] LEFT JOIN {MIR_HSRBICMP} JOIN [MI_RBICOMPO] ON
{MIR_HSRBICMP}.SUCC_ENTY_KEY = [MI_RBICOMPO].ENTY_KEY ON
[MI_RBISYS00].ENTY_KEY = {MIR_HSRBICMP}.PRED_ENTY_KEY WHERE
[MI_RBISYS00].LAST_UPDT_DT >= CONVERT (VARCHAR (255),
(? :d :caption='Enter a Date'), 110)
```

RBI Components to TML Groups Relationship Data Loader

About the RBI Components To TML Groups Relationship Data Loader

You can map the corrosion rates used in RBI analysis from the TM Analysis at the TML Group level. To do this, you must link the RBI Component to the TML Group. Using the RBI Components To TML Groups Relationship Data Loader, you can link RBI Components to TML Groups. You can link multiple RBI Components to a TML Group and multiple TML Groups to an RBI Component.

Note: The Corrosion rates are copied from TML Group to RBI analysis of the mapped component only if the Source of Calculated Corrosion Rate of the component is set to Component. If the Source of Calculated Corrosion Rate of the component is not set to Component, the Corrosion rates are not copied from the TML Group to the RBI analysis. However, the records are linked.

About the RBI Components To TML Groups Relationship Data Loader Requirements

Before you use the RBI Components To TML Groups Relationship Data Loader, you must complete the following steps:

- Ensure that the Risk Based Inspection and Thickness Monitoring modules are deployed.
- Ensure that the following records are available:
 - RBI Components
 - TML Groups
 - Corrosion data of TM Analysis
 - Asset records

Security Settings

The Security User performing the data load operation must be associated with either the MI Data Loader User or MI Data Loader Admin Security Role, and must also be associated with the MI RBI Analyst Security Group or a Security Role that is associated with this Security Group.

About the RBI Components To TML Groups Relationship Data Loader General Loading Strategy

Best Practices

When importing data using the RBI Components To TML Groups Relationship Data Loader, you must use the following best practices:

- ID fields must not include special characters or spaces.

- The data loader workbook contains sample data in each column. It is only for your reference. You must remove this data before using the data loader workbook.
- Columns (including columns representing custom fields) in the worksheets should be formatted as Text.
- Import a maximum of 500 records in each data load.

Load Sequence

The data is loaded in the following sequence to create all necessary relationships between records:

1. The Assets worksheet is processed. The Data Loader searches for the asset that corresponds to the Asset ID, Asset CMMS System, Equipment Technical Number and Asset Family information that you provide in the Assets worksheet. If an asset specified on the worksheet does not exist, the worksheet and all the entries in the subsequent worksheets corresponding to that asset is skipped.
2. The RBIComponents_To_TMLGroups worksheet is processed. An existing RBI Component is looked up based on the Asset ID, Asset CMMS System, Equipment Technical Number, Component, and Component Type. If found, that RBI Component will be linked to the specified TML Group. If you do not specify any RBI Component, this worksheet is skipped.

If any of the RBI Component or TML Group records specified in the worksheet is not available in the database, an error is added to the log, and the row is skipped.

About the RBI Components To TML Groups Relationship Data Loader Workbook Layout and Use

To import data using the RBI Components To TML Groups Relationship Data Loader, GE Digital APM provides an Excel workbook, RBI Components To TML Groups Relationship.xlsx, which supports baseline Risk Based Inspection in GE Digital APM. This workbook must be used to link RBI Components to TML Groups.

Note: The Excel workbook is referred to throughout this documentation as the data loader workbook.

The following table provides a list of the worksheets that are included in the data loader workbook.

Worksheet	Description
Assets	This worksheet is used to specify existing Asset records to which components are linked.
RBIComponents_To_TMLGroups	This worksheet is used to link RBI Components to TML Groups.
(PickList)	This worksheet details the valid values available for fields that have pick lists. When you load data using the data loader, the data on this worksheet is not loaded.

Color Coding

Certain columns on the worksheets have different functions and requirements. To illustrate this, certain columns are color-coded. The following table lists the colors and what they represent.

Color	Description	Comments
Gray	Required Key Fields	Indicates columns that contain values that are used by the Risk Based Inspection (RBI) Corrosion Loop Data Loader to look up and create records. If these columns are removed from the worksheets, the data load will fail. While the worksheets require that these columns be present, values are not necessarily required in these columns.
Red	Fields Required for Saving Records	Indicates columns that contain values that are required to save the record.
Blue	Recommended Fields	Indicates columns that, according to GE Digital APM Best Practice for Inspection Management, should contain values.
None	Custom Fields	Indicates columns in which you can specify custom fields.

Limitations

The RBI Components To TML Groups Relationship Data Loader has the following limitations:

- The values that you enter in the data loader workbook are case-sensitive.
- If there are multiple components with same ID within an asset, the TML group is mapped only to the first component and the remaining components are ignored.

Assets Worksheet

In the Assets worksheet, you can specify assets. You can link the RBI Components that belongs to the assets specified in this worksheet to the TML groups. The columns that appear on this worksheet also appear on every subsequent worksheet, and are used to identify the records that will be linked, directly or indirectly, to the assets.

Note: Each row in this worksheet represents a unique asset. You should not include the same asset more than once.

Field Caption	Field ID	Data Type (Length)	Comments
Asset ID	MI_EQUIP000_EQUIP_ID_C	Character (255)	This column requires at least one cell to have a value. For a Functional Location asset, the field MI_FNCLOC00_FNC_LOC_C should be used.
Asset CMMS System	MI_EQUIP000_SAP_SYSTEM_C	Character (255)	If the Asset record has a value in the CMMS System field, the same value is required in this cell. For a Functional Location asset the field MI_FNCLOC00_SAP_SYSTEM_C should be used.
Equipment Technical Number	MI_EQUIP000_EQUIP_TECH_N BR_C	Character (255)	If you are required to enter a value for the CMMS System cell for an Equipment asset, and the Equipment record has a value in the Equipment Technical Number field, that value is required in this cell. If there is no value in the CMMS System field, this cell can be blank, even if the Equipment record contains a value for the Equipment Technical Number field. Note: This field must be left blank for a Functional Location asset.
Asset Family	ASSET_FAMILY_ID	Character(255)	This column is required when loading Functional Location assets. If no value is provided, the asset will be considered an Equipment asset. Note: Following are the valid values: <ul style="list-style-type: none">• MI_EQUIP000• MI_FNCLOC00

RBIComponents_To_TMLGroups

In the RBIComponents_To_TMLGroups worksheet, you can specify the RBI Components and the corresponding TML Groups that you want to link.

Note: Each row represents a unique component, though multiple components may be related to the same asset.

Asset ID	MI_EQUIP000_EQUIP_ID_C	Character (255)	Values in this column must match values entered on the Assets worksheet.
Asset CMMS System	MI_EQUIP000_SAP_SYSTEM_C	Character (255)	Values in this column must match values entered on the Assets worksheet, if they exist.
Equipment Technical Number	MI_EQUIP000_EQUIP_TECH_N BR_C	Character (255)	Values in this column must match values entered on the Assets worksheet, if they exist.
Component	MI_RBICOMPO_COMPO_C	Character (250)	A value is required. Enter the RBI Component ID.
Component Type	MI_RBICOMPO_COMPO_TYPE_ C	Character (60)	A value is required. In the baseline GE Digital APM system, this cell may only contain one of the values available in the (Picklist) worksheet.
TML Group ID	MI_TMLGROUP_ID_C	Character (50)	A value is required. Enter the TML Group ID that you want to link to the specified RBI Component.

Chapter 16

Reference

Topics:

- [General Reference](#)
- [Data Models](#)
- [Family Field Descriptions](#)
- [Calculations](#)
- [Family Search Configuration](#)
- [ASM Integration](#)
- [Inspection Strategies](#)
- [RBI Policies](#)
- [Catalog Items](#)

General Reference

Fields Required to Calculate an RBI 581 Risk Analysis

This topic has been intentionally excluded from the GE Digital APM product documentation website. This topic is available to you via the product documentation that is provided within the GE Digital APM system.

Fields Required for Consequence of Failure (COF) Calculations

This topic has been intentionally excluded from the GE Digital APM product documentation website. This topic is available to you via the product documentation that is provided within the GE Digital APM system.

About Potential Degradation Mechanisms (PDM)

Potential Degradation Mechanisms (PDM) records are used to represent ways in which a component might fail (e.g., mechanical fatigue). These records can be linked to RBI Components and are used to predict and prevent mechanical failure. Each Potential Degradation Mechanisms record that is linked to a Corrosion Loop represents a degradation mechanism, or a way in which the components in that Corrosion Loop might fail.

After a Corrosion Loop is linked to PDMs, as you link RBI Components to the Corrosion Loop, those RBI Components will be linked automatically to all of the Potential Degradation Mechanisms that are linked to the Corrosion Loop. Each PDM that is linked to an RBI Component represents a way in which that component can fail.

Baseline Potential Degradation Mechanisms (PDMs)

GE Digital APM provides several quantitative Potential Degradation Mechanisms.

All of the PDMs apply to RBI Components.

GE Digital APM provides the following Potential Degradation Mechanisms:

- 581-885F Embrittlement
- 581-Acid Sour Water Corrosion
- 581-Alkaline Carbonate Stress Corrosion Cracking
- 581-Alkaline Sour Water Corrosion
- 581-Amine Corrosion
- 581-Amine Cracking
- 581-Atmospheric Tank Bottom Corrosion
- 581-Austenitic Component Atmospheric Cracking
- 581-Austenitic Component Cracking Under Insulation
- 581-Brittle Fracture
- 581-Caustic Cracking
- 581-Chloride Stress Corrosion Cracking
- 581-Cooling Water Corrosion
- 581-Ferritic Component Atmospheric Corrosion
- 581-Ferritic Component Corrosion Under Insulation
- 581-HIC/SOHIC - H₂S
- 581-HIC/SOHIC - HF
- 581-High Temperature H₂/H₂S Corrosion

- 581-High Temperature Hydrogen Attack
- 581-High Temperature Oxidation
- 581-High Temperature Sulfidic and Napthenic Acid
- 581-Hydrochloric Acid Corrosion
- 581-Hdrofluoric Acid Corrosion
- 581-Hydrogen Stress Cracking
- 581-Internal Component Lining Damage
- 581-Low Alloy Steel Embrittlement
- 581-Other Cracking
- 581-Piping Mechanical Fatigue
- 581-Polythionic Acid Cracking
- 581-Sigma Phase Embrittlement
- 581-Soil Side Corrosion
- 581-Sulfide Stress Cracking
- 581-Sulfuric Acid Corrosion

Valid Fluids for an RBI 581 Risk Analysis

This topic provides a list of valid representative fluids and toxic fluids for RBI 581. On the datasheet of an RBI 581 Risk Analysis, in the **Representative Fluid** and **Toxic Model** boxes, if you select a fluid that is not valid for RBI 581, an error message appears when you calculate the analysis.

When you select a Representative Fluid that is valid for RBI 581, the **Fluid Valid for 581 Analysis** check box is selected, indicating that you have selected a valid fluid. Similarly, when you select a toxic model that is valid for RBI 581, the **Toxic Fluid Valid for 581 Analysis** check box is selected, indicating that you have selected a valid toxic fluid.

Valid Representative Fluids

The following Representative Fluids are valid for RBI 581:

- Acid
- ALCL3
- C1-C2
- C3-C4
- C6-C8
- C9-C12
- C13-16 (Diesel)
- C17-25 (Gas Oil)
- C25+ (Resid)
- C5
- Chlorine
- CO
- DEE
- EE
- EEA
- EG
- EO
- H2
- H2O (Water)
- H2S

- HCl
- HF
- MEOH (Methanol)
- NH3
- Nitric Acid
- NO2
- Phosgene
- PO
- Pyrophoric
- Steam
- Styrene (Aromatic)
- TDI

Valid Toxic Models

The following Toxic Models are valid for RBI 581:

- ALCL3
- Chlorine
- CO
- EO
- EE
- HCl
- HF
- H2S
- NH3
- Nitric Acid
- NO2
- Phosgene
- Propylene Oxide
- TDI

RBI 581 Representative Fluids

New RBI 581 Representative Fluids

Fluid	MolWt	Liquid Density	BoilPt	Ambient State	Specific Heat Equation Reference	Ideal Gas Const A	Ideal Gas Const B	Ideal Gas Const C	Ideal Gas Const D	Ideal Gas Const E	AIT	Fluid Type 581	Is Valid for 581 Analysis	Is valid toxic model for 581
Acid-LP	18	62.3	212	Liquid	Note 3	2.76E+05	-2.09E+03	8.125	-1.41E-02	9.37E-06	0	Type0	Y	N
Acid-MP	18	62.3	212	Liquid	Note 3	2.76E+05	-2.09E+03	8.125	-1.41E-02	9.37E-06	0	Type0	Y	N

Fluid	MolWt	Liquid Density	BoilPt	Ambient State	Specific Heat Equation Reference	Ideal Gas Const A	Ideal Gas Const B	Ideal Gas Const C	Ideal Gas Const D	Ideal Gas Const E	AIT	Fluid Type 581	Is Valid for 581 Analysis	Is valid toxic model for 581
Acid-HP	18	62.3	212	Liquid	Note 3	2.76E+05	-2.09E+03	8.125	-1.41E-02	9.37E-06	0	Type0	Y	N
C1-C2	23	15.639	-193	Gas	Note 1	12.3	1.150E-01	-2.87E-05	-1.30E-09		1036	Type0	Y	N
C3-C4	51	33.61	-6.3	Gas	Note 1	2.632	0.3188	-1.347E-04	1.466E-08		696	Type0	Y	N
C6-C8	100	42.702	210	Liquid	Note 1	-5.146	6.762E-01	-3.65E-04	7.658E-08		433	Type0	Y	N
C9-C12	149	45.823	364	Liquid	Note 1	-8.5	1.01E+00	-5.56E-04	1.180E-07		406	Type0	Y	N

Updated RBI 581 Representative Fluid Contents in GE Digital APM Version V4.3.1.0.0

Fluid	MolWt	Liquid Density	BoilPt	Ambient State	Specific Heat Equation Reference	Ideal Gas Const A	Ideal Gas Const B	Ideal Gas Const C	Ideal Gas Const D	Ideal Gas Const E	AIT	Fluid Type 581	Is Valid for 581 Analysis	Is valid toxic model for 581
C13-16 (Diesel)	205	47.728	502	Liquid	Note 1	-11.7	1.39E+00	-7.72E-04	1.67E-07		396	Type0	Y	N
C17-25 (Gas Oil)	280	48.383	651	Liquid	Note 1	-22.4	1.94E+00	-1.12E-03	-2.53E-07		396	Type0	Y	N
C25+ (Resid)	422	56.187	981	Liquid	Note 1	-22.4	1.94E+00	-1.12E-03	-2.53E-07		396	Type0	Y	N
C5	72	39.03	97	Liquid	Note 1	-3.626	0.4873	-2.60E-04	5.30E-08		544	Type0	Y	N
CO	28	50	-312	Gas	Note 2	2.91E+04	8.77E+03	3.09E+03	8.46E+03	1.54E+03	1128	Type1	Y	Y
EO	44	55	51	Gas	Note 2	3.35E+04	1.21E+05	1.61E+03	8.24E+04	7.37E+02	804	Type1	Y	Y
H2	2	4.433	-423	Gas	Note 1	27.1	9.27E-03	-1.38E-05	7.65E-09	NULL	752	Type0	Y	N

Fluid	MolWt	Liquid Density	BoilPt	Ambient State	Specific Heat Equation Reference	Ideal Gas Const A	Ideal Gas Const B	Ideal Gas Const C	Ideal Gas Const D	Ideal Gas Const E	AIT	Fluid Type 581	Is Valid for 581 Analysis	Is valid toxic model for 581
H2O (Water)	18	62.3	212	Liquid	Note 3	2.76E+05	-2.09E+03	8.125	-1.41E-02	9.37E-06	0	Type0	Y	N
H2S	34	61.993	-75	Gas	Note 1	31.9	1.44E-03	2.43E-05	-1.18E-08	NULL	500	Type0	Y	Y
HCl	36	74	-121	Gas	Note 1	29.244	-2.62E-03	1.12E-06	4.97E-09	-2.50E-12	3200	Type0	Y	Y
HF	20	60.37	68	Gas	Note 1	29.1	6.61E-04	-2.03E-06	2.50E-09	NULL	0	Type0	Y	Y
MEOH (Methanol)	32	50	149	Liquid	Note 2	3.93E+04	8.79E+04	1.92E+03	5.37E+04	8.97E+02	867	Type1	Y	N
NH3	17.03	38.55	-28.2	Gas	Note 1	27.26	2.31E-04	2.24E-07	2.17E-10	5.41E-14	3200	Type0	Y	Y
Phosgene	99	86	181	Liquid	NULL	NULL	NULL	NULL	NULL	NULL	0	Type0	Y	Y
Steam	18	62.3	212	Gas	Note 2	3.34E+04	2.68E+04	2.61E+03	8.90E+03	1.17E+03	0	Type0	Y	N

RBI 581 Representative Fluid Contents in GE Digital APM Versions Older than V4.3.1.0.0

Fluid	MolWt	Liquid Density	BoilPt	Ambient State	Specific Heat Equation Reference	Ideal Gas Const A	Ideal Gas Const B	Ideal Gas Const C	Ideal Gas Const D	Ideal Gas Const E	AIT	Fluid Type 581	Is Valid for 581 Analysis	Is valid toxic model for 581
C13-16 (Diesel)	200	47	500	Liquid	Note 1	-11.7	1.39E+00	-7.72E-04	1.67E-07		400	Type0	Y	N
C17-25 (Gas Oil)	300	48	700	Liquid	Note 1	-22.4	1.94E+00	-1.12E-03	-2.53E-07		400	Type0	Y	N
C25+ (Resid)	400	49	800	Liquid	Note 1	-22.4	1.94E+00	-1.12E-03	-2.53E-07		400	Type0	Y	N

Fluid	MolWt	Liquid Density	BoilPt	Ambient State	Specific Heat Equation Reference	Ideal Gas Const A	Ideal Gas Const B	Ideal Gas Const C	Ideal Gas Const D	Ideal Gas Const E	AIT	Fluid Type 581	Is Valid for 581 Analysis	Is valid toxic model for 581
C5	71	40	92	Liquid	Note 1	-3.626	0.4873	-2.60E-04	5.30E-08		500	Type0	Y	N
CO	28	50.79	-312	Gas	Note 2	2.91E+04	8.77E+03	3.09E+03	8.46E+03	1.54E+03	0	Type1	Y	Y
EO	44	55.37	56	Gas	Note 2	3.35E+04	1.21E+05	1.61E+03	8.24E+04	7.37E+02	0		Y	Y
H2	2	4.4	-423	Gas	Note 1	27.1	9.27E-03	-1.38E-05	7.65E-09		500	Type0	Y	N
H2O (Water)	18	62.4	212	Liquid	Note 3	2.76E+05	-2.09E+03	8.125	-1.41E-02	9.37E-06	0	Type0	Y	N
H2S	34	6.64	-76	Gas	Note 1	31.9	1.44E-03	2.43E-05	-1.18E-08		0	Type0	Y	Y
HCl	36.47	74.5	-114	Gas							0	Type0	Y	Y
HF	20	61.65	67	Gas	Note 1	29.1	6.61E-04	-2.03E-06	2.50E-09		0	Type0	Y	Y
MEOH (Methanol)	32	49.6	148	Liquid	Note 2	3.93E+04	8.79E+04	1.92E+03	5.37E+04	8.97E+02	400	Type1	Y	N
NH3	17	50.9	-28	Gas							0	Type0	N	Y
Phosgene	99	86.86	47	Liquid							0	Type0	Y	Y
Steam	18	62.4	212	Gas	Note 3	3.34E+04	2.68E+04	2.61E+03	8.90E+03	1.17E+03	0		Y	N

New Component Damage Flammable Records

Fluid	Fluid Type	CAINLA	CAINLB	CAILA	CAILB	IAINLA	IAINLB	IAILA	IAILB
C1-C2	Gas	43	0.98	280	0.95	41	0.67	1079	0.62
C1-C2	Liquid	0	0	0	0	0	0	0	0
C3-C4	Gas	49.48	1	313.6	1	27.96	0.72	522.9	0.63
C3-C4	Liquid	0	0	0	0	0	0	0	0
C6-C8	Gas	29	0.98	312.4	1	13.98	0.66	275.7	0.61
C6-C8	Liquid	182	0.89	525	0.95	4.35	0.78	57	0.55

Fluid	Fluid Type	CAINLA	CAINLB	CAILA	CAILB	IAINLA	IAINLB	IAILA	IAILB
C9-C12	Gas	12	0.98	391	0.95	7.1	0.66	281	0.61
C9-C12	Liquid	130	0.9	560	0.95	3.3	0.76	6	0.53

Component Damage Flammable Fluid Contents in GE Digital APM Version V4.3.1.0.0

Fluid	Fluid Type	CAINLA	CAINLB	CAILA	CAILB	IAINLA	IAINLB	IAILA	IAILB
EE	Liquid	173.1	0	0	0	72.21	0	0	0
EEA	Liquid	117	0	0	0	69	1	0	0
EG	Gas	7.721	0.973	0	0	6.525	0.667	0	0
EG	Liquid	108	0	0	0	69	0	0	0
Styrene (Aromatic)	Liquid	103	0	0	0	70.12	0	701.2	0

Component Damage Flammable Fluid Contents in GE Digital APM Versions Older Than V4.3.1.0.0

Fluid	Fluid Type	CAINLA	CAINLB	CAILA	CAILB	IAINLA	IAINLB	IAILA	IAILB
EE	Liquid	173.1	1	0	0	72.21	1	0	0
EEA	Liquid	117	1	0	0	69	1	0	0
EG	Gas	7.721	0.973	0	0	6.524	0.667	0	0
EG	Liquid	108	1	0	0	69	1	0	0
Styrene (Aromatic)	Liquid	103	1	0	0	70.12	1	701.2	1

New Personal Injury Flammable CE Constants Records

Fluid	Fluid Type	CAINLA	CAINLB	CAILA	CAILB	IAINLA	IAINLB	IAILA	IAILB
Acid-HP	Gas	6690	0.2469	0	0	0	0	0	0
Acid-HP	Liquid	6690	0.2469	0	0	0	0	0	0
Acid-LP	Gas	2699.5	0.2024	0	0	0	0	0	0
Acid-LP	Liquid	2699.5	0.2024	0	0	0	0	0	0
Acid-MP	Gas	3366.2	0.2878	0	0	0	0	0	0
Acid-MP	Liquid	3366.2	0.2878	0	0	0	0	0	0
C1-C2	Gas	110	0.96	745	0.92	79	0.67	3100	0.63
C1-C2	Liquid	0	0	0	0	0	0	0	0
C3-C4	Gas	125.2	1	836.7	1	57.72	0.75	1769	0.63
C3-C4	Liquid	0	0	0	0	0	0	0	0

Fluid	Fluid Type	CAINLA	CAINLB	CAILA	CAILB	IAINLA	IAINLB	IAILA	IAILB
C6-C8	Gas	68	0.96	828.7	1	26.72	0.67	962.8	0.63
C6-C8	Liquid	516	0.89	1315	0.92	12.7	0.78	224	0.54
C9-C12	Gas	29	0.96	981	0.92	13	0.66	988	0.63
C9-C12	Liquid	373	0.89	1401	0.92	9.5	0.76	20	0.54

New Toxic Release Constants HFH2S Records

Fluid	Release Type	Continuous Release Duration	Constant C	Constant D
H2S	Continuous	0	0	0
HF	Continuous	0	0	0

Toxic Release Constants HFH2S in GE Digital APM Version V4.3.1.0.0

Fluid	Release Type	Continuous Release Duration	Constant C	Constant D
H2S	Continuous	1	0.228	0.7137
H2S	Continuous	2	0.456	1.4273
H2S	Continuous	3	0.6841	2.141
H2S	Continuous	4	0.9121	2.8546
H2S	Continuous	12.5	1.0977	3.908325
H2S	Continuous	15	1.0924	3.97355
H2S	Continuous	30	1.0879	4.21675
HF	Continuous	1	0.24822	0.79372
HF	Continuous	2	0.49644	1.58744
HF	Continuous	3	0.74466	2.38116
HF	Continuous	4	0.99288	3.17488
HF	Continuous	12.5	1.24	4.1306
HF	Continuous	15	1.239	4.1664
HF	Continuous	20	1.0816	4.104
HF	Continuous	30	1.23335	4.3003

Toxic Release Constants HFH2S in GE Digital APM Version Older Than V4.3.1.0.0

Fluid	Release Type	Continuous Release Duration	Constant C	Constant D
H2S	Continuous	1	0.24822	0.79372
H2S	Continuous	2	0.49644	1.58744
H2S	Continuous	3	0.74466	2.38116
H2S	Continuous	4	0.99288	3.17488
H2S	Continuous	12.5	1.24	4.1306
H2S	Continuous	15	1.239	4.1664
H2S	Continuous	30	1.23335	4.3003
HF	Continuous	1	0.228	0.7137
HF	Continuous	2	0.456	1.4273
HF	Continuous	3	0.6841	2.141
HF	Continuous	4	0.9121	2.8546
HF	Continuous	12.5	1.0977	3.908325
HF	Continuous	15	1.0924	3.97355
HF	Continuous	20	1.0879	4.21675
HF	Continuous	30	1.0816	4.104

New Toxic Consequence Equation Constants (Ammonia, Chlorine) Records

Fluid	Release Type	Continuous Release Duration	Constant C	Constant D
Chlorine	Continuous	0	0	0
Chlorine	Continuous	3.5	10605	0.7679
NH3	Continuous	0	0	0
NH3	Continuous	3.5	1883	0.8281

Toxic Consequence Equation Miscellaneous Chemicals in GE Digital APM Version V4.3.1.0.0

Chemical	Release Duration	Gas Release Constant E	Gas Release Constant F	Liquid Release Constant E	Liquid Release Constant F
EE	1.5	3.8	1.171	0	0
EO	1.5	2.083	1.222	0	0
Phosgene	1	4386.7	0.408	1161	0.3604

Chemical	Release Duration	Gas Release Constant E	Gas Release Constant F	Liquid Release Constant E	Liquid Release Constant F
Phosgene	2	8644.3	0.804	2287.9	0.7102
Phosgene	5	22976	1.29	6857.1	1.1

Toxic Consequence Equation Miscellaneous Chemicals in GE Digital APM Version Older Than V4.3.1.0.0

Chemical	Release Duration	Gas Release Constant E	Gas Release Constant F	Liquid Release Constant E	Liquid Release Constant F
EE	2	3.8	1.171	0	0
EO	2	2.1	1.222	0	0
Phosgene	1	4386.7	0.4	1161	0.4
Phosgene	2	8644.3	0.8	2287.9	0.7
Phosgene	5	22976	1.29	21215	1.12

New Toxic Consequence Equation Miscellaneous Chemicals Records

Chemical	Release Duration	Gas Release Constant E	Gas Release Constant F	Liquid Release Constant E	Liquid Release Constant F
CO	30	4131.4	1.1	0	0
EE	30	137.9	1	30.1	1.1
EO	30	2744.5	1.2	0	0
HCl	30	2457.3	1.2	0	0
Phosgene	30	176484	1.3	121101	1.2
Propylene Oxide	30	2.8	1.2	115	1.1
TDI	30	0	0	4865.4	1.1

RBI Risk Matrix Mapping

Note: The RBI Risk Matrix Mapping family supports RBI 581 Risk Analyses. These mappings support only the default Risk Matrix.

The records in the RBI Risk Matrix Mapping family are used to specify which Policies are used to populate the default Risk Matrix, using data contained in RBI 581 Risk Analyses and related records. The information in the following table reflects the baseline state and behavior of fields that exist in the RBI Risk Matrix Mapping family.

RBI Risk Matrix Mapping

Field ID	Field Caption	Data Type	Description	Behavior and Usage
MI_RMMPG_ANALY_FA MIL_C	Analysis Family	Character	The Family ID of the analysis. For baseline RBI Risk Matrix Mapping records, this will always correspond to MI_581RANAL (the RBI 581 Risk Analysis family).	This field is populated automatically in baseline RBI Risk Matrix Mapping records.
MI_RMMPG_POLICY_NM _C	Policy Name	Character	The name of the Policy that will be used to populate the default Risk Matrix.	This field is populated automatically in baseline RBI Risk Matrix Mapping records.
MI_RMMPG_RISK_CTG_ C	Risk Category	Character	The Risk Category that will be populated on the default Risk Matrix (Operations or Safety).	This field is populated automatically in baseline RBI Risk Matrix Mapping records.
MI_RMMPG_POLIC_IN_ NODE_NM_C	Policy Input Node Name	Character	The name of the input node that will be used to deliver values from the Source Field and Family to the Policy.	This field is populated automatically in baseline RBI Risk Matrix Mapping records.
MI_RMMPG_SOURCE_F ML_C	Source Family	Character	The Family ID of the family from which values will be taken.	This field is populated automatically in baseline RBI Risk Matrix Mapping records.
MI_RMMPG_SOURCE_FL D_C	Source Field	Character	The Field ID of the field that belongs to the Source Family from which values will be taken.	This field is populated automatically in baseline RBI Risk Matrix Mapping records.

The Policy Input Nodes that are used by the RBI Risk Matrix Mapping family to populate the default Risk Matrix depend on the Risk Category that you choose. The information in the following tables indicates which policy nodes and input fields will be used when populating the default Risk Matrix.

Risk Category - Operations

The following table provides a list of policy nodes and input fields that are used to plot risk on the default Risk Matrix for the risk category Operations.

Policy Input Node	Source Family ID	Source Family Caption	Source Field ID	Source Field Caption
Financial Consequence	MI_RBI_EVNO	RBI 581 Consequence Evaluation	MI_RBI_EVNO_CALCULATED_TTL_FC_N	Calculated Total Financial Consequence
POF	MI_RBDEMECH	RBI Degradation Mechanisms	MI_RBDEMECH_TOTAL_PF_RBI_DTE_N	Total POF - RBI Date
Risk Category	MI_RRSKMAP	Risk Analysis Mapping	MI_RRSKMAP_RISK_CTG_C	Risk Category

Consequence of Failure (COF) Mapping Values: The following table provides the COF value based on the Total Financial Consequence (FC) value.

Category	COF Value	Range
Very High	1000	FC > 10,000,000
High	500	1,000,000 < FC < 10,000,000
Medium	100	100,000 < FC < 1,000,000
Low	10	10,000 < FC < 100,000
Very Low	1	FC <= 10,000

Probability of Failure (POF) Mapping Values: The following table provides the POF value based on the POF value that is derived from Damage Mechanism records.

Category	POF Value	Range
Frequent	5	POF > 0.0306
Probable	1	0.0306 < POF < 0.00306
Possible	0.3	0.00306 < POF < 0.000306
Remote	0.1	0.000306 < POF < 0.0000306
Improbable	0.05	POF <= 0.0000306

Risk Category - Safety

The following table provides a list of policy nodes and input fields that are used to plot risk on the default Risk Matrix for the risk category Safety.

Policy Input Node	Source Family ID	Source Family Caption	Source Field ID	Source Field Caption
Consequence Area	MI_RBI_EVNO	RBI 581 Consequence Evaluation	MI_RBI_EVNO_FL_CEAREA_INJ_N	Final Consequence Area
POF	MI_RBDEMECH	RBI Degradation Mechanisms	MI_RBDEMECH_TOTAL_PF_RBI_DTE_N	Total POF - RBI Date
Risk Category	MI_RRSKMAP	Risk Analysis Mapping	MI_RRSKMAP_RISK_CTG_C	Risk Category

Consequence of Failure (COF) Mapping Values: The following table provides the COF value based on the Consequence Area (CA) value.

Category	COF Value	Range
Very High	1000	CA > 100,000
High	500	10,000 < CA < 100,000
Medium	100	1,000 < CA < 10,000
Low	10	100 < CA < 1,000
Very Low	1	CA <= 100

Probability of Failure (POF) Mapping Values: The following table provides the POF value based on the POF value derived from Damage Mechanism records.

Category	POF Value	Range
Frequent	5	POF > .0306
Probable	1	.0306 < POF < .00306
Possible	.3	.00306 < POF < .000306
Remote	.1	.000306 < POF < .0000306
Improbable	.05	POF <= .0000306

RBI Strategy Mapping Configuration

RBI Strategy Mapping Configuration Details

Field	Data Type	Description	Behavior and Usage
Degradation Mechanism	Character	The value in the Degradation Mechanism field linked to the RBI Analysis for which you are generating RBI Recommendations.	This field is populated by default in each RBI Strategy Mapping Configuration that is delivered to the baseline GE Digital APM database.
Policy Name	Character	The Record ID of the Policy used to generate an RBI Recommendation.	This field is populated by default in each RBI Strategy Mapping Configuration that is delivered to the baseline GE Digital APM database.

RBI Strategy Mapping Details define the Policy Input nodes that are used to generate RBI Recommendation records automatically from RBI Analyses. The information in the table reflects the baseline state and behavior of fields in the RBI Strategy Mapping Details family.

RBI Strategy Mapping Details

Field	Data Type	Description	Behavior and Usage
Policy Input Node Name	Character	The ID of the Input node in the Policy that is defined by the RBI Strategy Mapping Configuration to which the RBI Strategy Mapping Details is linked.	This field is populated by default in each RBI Policy that is delivered to the baseline GE Digital APM database.
Source Family	Character	The family of the source record whose values are used to determine the output of the Input node.	This field is populated by default in each RBI Strategy Mapping Details that is delivered to the baseline GE Digital APM database.
Source Field	Character	The field whose source value is used to determine the output of the Input node.	This field is populated by default in each RBI Strategy Mapping Details that is delivered to the baseline GE Digital APM database.

RBI 581 Security Groups

The following table lists the baseline Security Groups available for users within this module, as well as the baseline Roles to which those Security Groups are assigned.

Important: Assigning a Security User to a Role grants that user the privileges associated with all of the Security Groups that are assigned to that Role. To avoid granting a Security User unintended privileges, before assigning a Security User to a Role, be sure to review all of the privileges associated with the Security Groups assigned to that Role. Also, be aware that additional Roles, as well as Security Groups assigned to existing Roles, can be added via Security Manager.

Security Group	Roles
RBI Security Groups	
MI RBI Administrator	MI Mechanical Integrity Administrator
MI RBI Analyst	MI Mechanical Integrity Administrator MI Mechanical Integrity Power
MI RBI Viewer	MI APM Viewer MI Mechanical Integrity Viewer
RBI Policy Security Groups	
MI RBI Calculation Policy Designer	None
MI RBI Calculation Policy Viewer	MI Mechanical Integrity Administrator MI Mechanical Integrity Power
MI RBI Recommendation Policy Designer	None

Security Group	Roles
MI RBI Recommendation Policy Viewer	MI Mechanical Integrity Administrator MI Mechanical Integrity Power
MI RBI Risk Mapping Policy Designer	None
MI RBI Risk Mapping Policy Viewer	MI Mechanical Integrity Administrator MI Mechanical Integrity Power

The baseline family-level privileges that exist for these Security Groups are summarized in the following table.

Security Group	Privileges to the Policy Family
MI RBI Calculation Policy Designer	View, Update, Insert, Delete
MI RBI Calculation Policy Viewer	View
MI RBI Recommendation Policy Designer	View, Update, Insert, Delete
MI RBI Recommendation Policy Viewer	View
MI RBI Risk Mapping Policy Designer	View, Update, Insert
MI RBI Risk Mapping Policy Viewer	View

For more information about the State Management process for Inspection Plans, refer to [Compliance Management State Management](#).

The baseline family-level privileges that exist for the MI RBI Administrator, MI RBI Analyst, and MI RBI Viewer Security Groups are summarized in the following table.

Note: If you have activated only the RBI 581 license (and not the Risk Based Inspection license), then privileges to some of the following families do not exist for the MI RBI Administrator, MI RBI Analyst, and MI RBI Viewer Security Groups.

Family	MI RBI Administrator	MI RBI Analyst	MI RBI Viewer
Entity Families			
Asset Group	View, Update, Insert, Delete	View, Update, Insert, Delete	View
Compliance Recommendation	View	View, Update, Insert, Delete	View
Consequence Evaluation Factors	View, Update, Insert, Delete	View	View
Corrosion	View	View	View
Corrosion Analysis Settings	View	View	View
Criticality Consequence Evaluation	View, Update, Insert, Delete	View, Update, Insert, Delete	View
Criticality Env. Crack. Deg. Mech. Eval.	View, Update, Insert, Delete	View, Update, Insert, Delete	View
Criticality Ext. Corr. Deg. Mech. Eval.	View, Update, Insert, Delete	View, Update, Insert, Delete	View

Family	MI RBI Administrator	MI RBI Analyst	MI RBI Viewer
Criticality Int. Corr. Deg. Mech. Eval.	View, Update, Insert, Delete	View, Update, Insert, Delete	View
Criticality Other Damage Mech. Eval.	View, Update, Insert, Delete	View, Update, Insert, Delete	View
Criticality RBI Component - Cylindrical Shell	View, Update, Insert, Delete	View, Update, Insert, Delete	View
Criticality RBI Component - Exchanger Bundle	View, Update, Insert, Delete	View, Update, Insert, Delete	View
Criticality RBI Component - Exchanger Header	View, Update, Insert, Delete	View, Update, Insert, Delete	View
Criticality RBI Component - Exchanger Tube	View, Update, Insert, Delete	View, Update, Insert, Delete	View
Criticality RBI Component - Piping	View, Update, Insert, Delete	View, Update, Insert, Delete	View
Criticality RBI Component - Tank Bottom	View, Update, Insert, Delete	View, Update, Insert, Delete	View
Data Mapping Column-Field Pair	View, Update, Insert, Delete	View	View
Data Mapping Group	View, Update, Insert, Delete	View	View
Data Mapping Query	View, Update, Insert, Delete	View	View
Degradation Mechanisms Evaluation Factors	View, Update, Insert, Delete	View, Update, Insert, Delete	View
Equipment	View, Update, Insert, Delete	View, Update, Insert, Delete	View
Functional Location	View, Update, Insert, Delete	View, Update, Insert, Delete	View
Grouping Element	View, Update, Insert, Delete	View, Update, Insert, Delete	View
Inspection Plan	View	View, Update, Insert, Delete	View
Inspection Plan Revision	View	View, Update, Insert, Delete	View
Inspection Task	View, Update, Insert, Delete	View, Update, Insert, Delete	View
Inventory Group Configuration	View, Update, Insert, Delete	View	View
General Recommendation	View	View, Update, Insert, Delete	View
Meridium Reference Tables	View, Update, Insert, Delete	View	View
Policy	View	View	View
Potential Degradation Mechanisms	View, Update, Insert, Delete	View	View
RBI 581 Admin Options	View, Update, Insert, Delete	View	View
RBI 581 Brittle Fracture Damage Evaluation	View, Update, Insert, Delete	View, Update, Insert, Delete	View

Family	MI RBI Administrator	MI RBI Analyst	MI RBI Viewer
RBI 581 Consequence Evaluation	View, Update, Insert, Delete	View, Update, Insert, Delete	View
RBI 581 Cracking Damage Evaluation	View, Update, Insert, Delete	View, Update, Insert, Delete	View
RBI 581 Damage Mechanism Evaluation	View, Update, Insert, Delete	View, Update, Insert, Delete	View
RBI 581 External Cracking Damage Evaluation	View, Update, Insert, Delete	View, Update, Insert, Delete	View
RBI 581 External Damage Evaluation	View, Update, Insert, Delete	View, Update, Insert, Delete	View
RBI 581 HTHA Damage Evaluation	View, Update, Insert, Delete	View, Update, Insert, Delete	View
RBI 581 Mechanical Fatigue Damage Evaluation	View, Update, Insert, Delete	View, Update, Insert, Delete	View
RBI 581 Risk Analysis	View, Update, Insert, Delete	View, Update, Insert, Delete	View
RBI 581 Thinning and Lining Evaluation	View, Update, Insert, Delete	View, Update, Insert, Delete	View
RBI Criticality Analysis	View, Update, Insert, Delete	View, Update, Insert, Delete	View
RBI Custom DM Evaluation Configuration	View, Update, Insert, Delete	View	View
RBI Custom DM Evaluation Configuration Details	View, Update, Insert, Delete	View	View
RBI Custom DM Evaluation Validation	View, Update, Insert, Delete	View	View
RBI Custom DM Evaluation Validation Details	View, Update, Insert, Delete	View	View
RBI Degradation Mechanisms	View, Update, Insert, Delete	View, Update, Insert, Delete	View
RBI Inspection Auto-Selection Criteria	View, Update, Insert, Delete	View	View
RBI Recommendation	View, Update, Insert, Delete	View, Update, Insert, Delete	View
RBI Risk Matrix Mapping	View, Update, Insert, Delete	View, Update, Insert, Delete	View
RBI Strategy Mapping Configuration	View, Update, Insert, Delete	View, Update, Insert, Delete	View
RBI Strategy Mapping Details	View, Update, Insert, Delete	View, Update, Insert, Delete	View
RBI System	View, Update, Insert, Delete	View, Update, Insert, Delete	View
Recommendation Revision	View	View, Update, Insert, Delete	View
Reference Document	View, Update, Insert, Delete	View, Update, Insert, Delete	View

Family	MI RBI Administrator	MI RBI Analyst	MI RBI Viewer
Risk Assessment	View, Update, Insert, Delete	View, Update, Insert, Delete	View
Risk Rank	View, Update, Insert, Delete	View, Update, Insert, Delete	View
Risk Translation	View, Update, Insert, Delete	View, Update, Insert, Delete	View
SAP System	View	View	View
Strategy Logic Case	View, Update, Insert, Delete	View	View
Strategy Reference Table	View, Update, Insert, Delete	View, Update, Insert, Delete	View
Task Type	View, Update, Insert, Delete	View, Update, Insert, Delete	View
Time Based Inspection Interval	View, Update, Insert, Delete	View, Update, Insert, Delete	View
Time Based Inspection Setting	View, Update, Insert, Delete	View, Update, Insert, Delete	View
Relationship Families			
Asset Has Inspection Plan	View	View, Update, Insert, Delete	View
Belongs to a Unit	View, Update, Insert, Delete	View, Update, Insert, Delete	View
Data Mapping has Column-Field Pair	View, Update, Insert, Delete	View	View
Data Mapping has Query	View, Update, Insert, Delete	View	View
Data Mapping has Subgroup	View, Update, Insert, Delete	View	View
Has Asset Group	View, Update, Insert, Delete	View, Update, Insert, Delete	View
Has Child RBI Criticality Analysis	View, Update, Insert, Delete	View, Update, Insert, Delete	View
Has Consequence Evaluation	View, Update, Insert, Delete	View, Update, Insert, Delete	View
Has Consolidated Recommendations	View	View, Update, Insert, Delete	View
Has Corrosion Analyses	View	View	View
Has Corrosion Analysis Settings	View	View	View
Has Datapoints	View	View	View
Has Degradation Mechanisms	View, Update, Insert, Delete	View, Update, Insert, Delete	View
Has Inspections	View	View, Update, Insert, Delete	View
Has Inspection Plan Revision	View	View, Update, Insert, Delete	View
Has Inspection Scope	View	View	View
Has Potential Degradation Mechanisms	View, Update, Insert, Delete	View, Update, Insert, Delete	View
Has RBI Components	View, Update, Insert, Delete	View, Update, Insert, Delete	View
Has RBI Criticality Analysis	View, Update, Insert, Delete	View, Update, Insert, Delete	View

Family	MI RBI Administrator	MI RBI Analyst	MI RBI Viewer
Has RBI Custom DME Configuration	View, Update, Insert, Delete	View, Update, Insert, Delete	View
Has RBI Custom DME Validation	View, Update, Insert, Delete	View	View
Has RBI Degradation Mechanisms Evaluation	View, Update, Insert, Delete	View, Update, Insert, Delete	View
Has RBI Strategy Mapping Configuration	View, Update, Insert, Delete	View, Update, Insert, Delete	View
Has RBI Systems	View, Update, Insert, Delete	View, Update, Insert, Delete	View
Implements Compliance Recommendation	View	View, Update, Insert, Delete	View
Inspection Plan Has Recommendations	View	View, Update, Insert, Delete	View
Has Tasks	View, Update, Insert, Delete	View, Update, Insert, Delete	View

Note: Security privileges for all modules and catalog folders can be found in the APM documentation.

The following families are not used elsewhere in the RBI module. Privileges to these families support integration with the Inspection Management module:

- Has Inspection Scope
- Has Time Based Inspection Interval
- Time Based Inspection Interval
- Time Based Inspection Setting

Specifically, certain features of the Time-Based Inspection Settings functionality, which you can use if the Inspection Management license is active, are facilitated by these privileges.

State Management for Inspection Plans

The following state changes can be applied to the Inspection Plans based on user Security Roles.

The diagram below shows the workflow of the baseline State Management process as it applies to Inspection Plans.

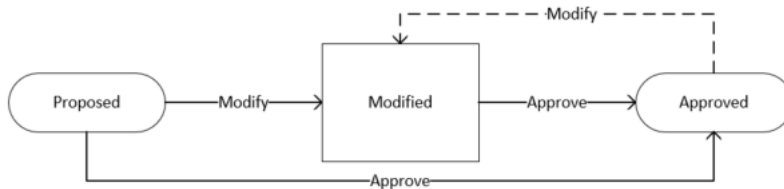

Details

- The Proposed state is the initial state of all Inspection Plans.
- When you change the state of an Inspection Plan from Approved to Modified, an Inspection Plan Revision History record is created.

Reserved States and Operations for Inspection Plans

The following tables indicate whether the baseline states and operations are reserved. You cannot remove or modify reserved states or operations.

State Caption	Reserved State	Security Roles
Approved	No	MI Inspection Plan Approver
Modified	Yes	<ul style="list-style-type: none"> MI Compliance Analyst MI Inspection Plan Approver
Proposed	No	<ul style="list-style-type: none"> MI Compliance Analyst MI Inspection Plan Approver

Operation ID	Reserved Operation	Predecessor	Successor
MI_APPROVE	No	Proposed	Approved
MI_APPV_MODIFIED	No	Modified	Approved
MI_MODIFY	Yes	Approved	Modified

RBI Recommendation State Management

The following state changes can be applied to RBI Recommendation.

The diagram below shows the workflow of the baseline State Management process as it applies to RBI Recommendations.

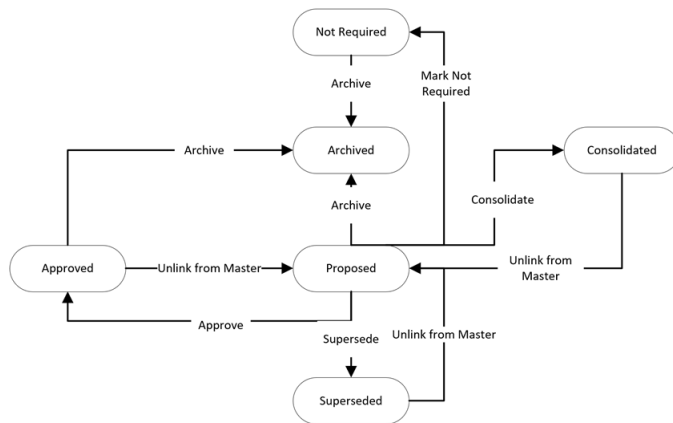

Reserved States and Operations for RBI Recommendations

State Caption	State ID	Reserved State
Proposed (Initial State)	MI_PENDING	Yes
Approved	MI_ACCEPTED	Yes
Consolidated	MI_CONSOLIDATED	Yes

State Caption	State ID	Reserved State
Superseded	MI_SUPERSEDED	Yes
Not Required	MI_NOTREQUIRED	Yes
Archived	MI_ARCHIVED	Yes

Operation	Operation ID	Reserved Operation	Predecessor State	Successor State
Approve	MI_PROMOTE	Yes	Proposed	Approved
Unlink from Master	MI_UN_PROMOTE	Yes	Approved	Proposed
Mark Not Required	MI_NOTREQUIRED	Yes	Proposed	Not Required
Supersede	MI_SUPERSEDE	Yes	Proposed	Superseded
Unlink from Master	MI_UN_SUPERSEDE	Yes	Superseded	Proposed
Consolidate	MI_CONSOLIDATE	Yes	Proposed	Consolidated
Unlink from Master	MI_UN_CONSOLIDATE	Yes	Consolidated	Proposed
Archived	MI_PARCHIVED	Yes	Proposed	Archived

RBI URLs

There is one URL route associated with Risk Based Inspection: rbi. The following table describes the various paths that build on the route, and the elements that you can specify for each.

Element	Description	Accepted Value(s)	Notes
rbi/unit : Opens the Risk Based Inspection Overview page.			
rbi/unit/<UnitEntityKey> : Displays the selected unit on the Risk Based Inspection Overview page.			
<UnitEntityKey>	Specifies the level of the Asset Hierarchy for the RBI unit that you want to view.	Any Unit Entity Key that corresponds to an asset in the Asset Hierarchy.	The Unit Entity Key must be present in the URL to display the correct page.
rbi/processunit/<ProcessUnitEntityKey> : Opens the Unit Summary page for the selected process unit.			
rbi/processunit/<ProcessUnitEntityKey>/corrosionloop/<CorrosionLoopEntityKey> : Displays the Corrosion Loop Overview section.			
rbi/processunit/<ProcessUnitEntityKey>/corrosionloop/<CorrosionLoopEntityKey>/component/<ComponentEntityKey> : Displays the selected Component Overview section.			
rbi/processunit/<ProcessUnitEntityKey>/corrosionloop/<CorrosionLoopEntityKey>/component/<ComponentEntityKey>/analysis/AnalysisEntityKey : Displays the selected Analysis Details section.			
rbi/processunit/<ProcessUnitEntityKey>/corrosionloop/<CorrosionLoopEntityKey>/component/<ComponentEntityKey>/protectedasset/<ProtectedAssetEntityKey> : Displays the selected protected asset on the Asset Summary page.			
rbi/processunit/<ProcessUnitEntityKey>/corrosionloop/<CorrosionLoopEntityKey>/component/<ComponentEntityKey>/protectedcomponent/<ProtectedComponentEntityKey> : Displays the Component Overview section for the selected protected component.			

Element	Description	Accepted Value(s)	Notes
<ProcessUnitKey>	Specifies the level of the Asset Hierarchy for the RBI Process Unit that you want to view.	Any Process Unit Entity Key that corresponds to an asset in the Asset Hierarchy.	The Process Unit Entity Key must be present in the URL to display the correct page.
<CorrosionLoopEntityKey>	Specifies the level of the Asset Hierarchy for the Corrosion Loop that you want to view.	Any Corrosion Loop Entity Key that corresponds to a Corrosion Loop in the Asset Hierarchy.	The Corrosion Loop Entity Key must be present in the URL to display the correct page.
<ComponentEntityKey>	Specifies the level of the Asset Hierarchy for the RBI Component that you want to view.	Any Component Entity Key that corresponds to an RBI Component in the Asset Hierarchy.	The Component Entity Key must be present in the URL to display the correct page.
<AnalysisEntityKey>>	Specifies the level of the Asset Hierarchy for the RBI Analysis that you want to view.	Any Analysis Entity Key that corresponds to an RBI Analysis in the Asset Hierarchy.	The Analysis Entity Key must be present in the URL to display the correct page.
<ProtectedAssetEntityKey>	Specifies the level of the Asset Hierarchy for the protected asset that you want to view.	Any Protected Asset Entity Key that corresponds to a protected asset in the Asset Hierarchy.	The Protected Asset Entity Key must be present in the URL to display the correct page.
<ProtectedComponentEntityKey>	Specifies the level of the Asset Hierarchy for the Protected Component that you want to view.	Any Protected Component Entity Key that corresponds to an Protected Component in the Asset Hierarchy.	The protected Component Entity Key must be present in the URL to display the correct page.
<p>rbi/asset/<AssetEntityKey> : Displays the selected asset on the Asset Summary page.</p> <p>rbi/asset/<AssetEntityKey>/component/<ComponentEntityKey> : Displays the selected Component Details section of the Asset Summary page.</p> <p>rbi/asset<AssetEntityKey>/component/<ComponentEntityKey>/analysis/<AnalysisEntityKey> :Displays the Analysis Details section of the Asset Summary page.</p> <p>rbi/analysis/<AnalysisEntityKey> : Displays the Analysis Details section of the Asset Summary page.</p>			
<AssetEntityKey>	Specifies the level of the Asset Hierarchy for the RBI asset that you want to view.	Any Asset Entity Key that corresponds to an asset in the Asset Hierarchy.	The Asset Entity Key must be present in the URL to display the correct page.
<ComponentEntityKey>	Specifies the level of the Asset Hierarchy for the RBI Component that you want to view.	Any Component Entity Key that corresponds to an RBI Component in the Asset Hierarchy.	The Component Entity Key must be present in the URL to display the correct page.
<AnalysisEntityKey>	Specifies the level of the Asset Hierarchy for the RBI Analysis that you want to view.	Any Analysis Entity Key that corresponds to an RBI Analysis in the Asset Hierarchy.	The Analysis Entity Key must be present in the URL to display the correct page.
<p>rbi/<Context>/<ContextEntityKey>/isorisk: Displays the RBI 581 ISO-Risk Plot page for the selected process unit, asset, or corrosion loop.</p>			
<Context>	Specifies whether the Entity Key that you have entered corresponds to a process unit, asset, or corrosion loop.	<ul style="list-style-type: none"> • unit • asset • corrosionloop 	None

Element	Description	Accepted Value(s)	Notes
<ContextEntityKey>	Specifies the Entity Key of the process unit (i.e., Functional Location), Asset, or the Corrosion Loop for which you want to access the RBI 581 ISO-Risk Plot page.	The Entity Key of a Functional Location (set as a process unit), Asset, or a Corrosion Loop in the Asset Hierarchy.	The Entity Key must be present in the URL to display the correct page.
rbi/<Context/<ContextEntityKey>/component/<ComponentEntityKey>/isorisk : Displays the RBI 581 ISO-Risk Plot page for the selected component linked to an asset or a corrosion loop.			
<Context>	Specifies whether the component is linked to an asset or a corrosion loop.	<ul style="list-style-type: none"> asset corrosionloop 	None
<ContextEntityKey>	Specifies the Entity Key of the Asset or the Corrosion Loop that is linked to the Component for which you want to view the RBI 581 ISO-Risk Plot page.	The Entity Key of a Functional Location (set as a process unit), Asset, or a Corrosion Loop in the Asset Hierarchy.	The Entity Key must be present in the URL to display the correct page.
<ComponentEntityKey>	Specifies the Entity Key of the Component for which you want to access the RBI 581 ISO-Risk Plot page.	The Entity Key of the component.	The Entity Key must be present in the URL to display the correct page.
rbi/corrosionloop/<CorrosionLoopEntityKey> :Displays the Corrosion Loop Summary page.			
<CorrosionLoopEntityKey>	Specifies the level of the Asset Hierarchy for the Corrosion Loop that you want to view.	Any Corrosion Loop Entity Key that corresponds to a Corrosion Loop in the Asset Hierarchy.	The Corrosion Loop Entity Key must be present in the URL to display the correct page.
rbi/evergreen/<ContextEntityKey> : Accesses the Ready for Evergreening tab in the Evergreening workspace.			
rbi/evergreen/<ContextEntityKey>/<JobKey> : Accesses the Created tab in the Evergreening workspace.			
<ContextEntityKey>	Specifies the Entity Key of the process unit or Functional Location.	The Entity Key of a Functional Location or process unit in the Asset Hierarchy.	The Entity Key must be present in the URL to display the correct page. A value of -1 can be used to access the home level of the Asset Hierarchy.
<JobKey>	Specifies the scheduled job that processes an RBI analysis duplication.	The Job Key of a scheduled job for an RBI analysis duplication.	None.

URLs

Example URL	Destination
rbi/unit	The Risk Based Inspection Overview page.
rbi/unit/2305330	The Risk Based Inspection Overview page for the specified unit.
rbi/processunit/64253024663	The Unit Overview section for the specified process unit.
rbi/processunit/64253024663/corrosionloop/64253024702	The Corrosion Loop Overview section for the specified process unit.
rbi/processunit/64253024663/corrosionloop/64253024702/component/64253024704	The Component Overview section for the specified process unit.
rbi/processunit/64253024663/corrosionloop/64253024702/component/64253024704/analysis/64253024712	The Analysis Details section for the specified process unit.
rbi/processunit/64253024663/corrosionloop/64253024702/component/64253024704/protectedasset/2509506	The protected Asset Summary page for the specified process unit.
rbi/processunit/64253024663/corrosionloop/64253024702/component/64253024704/protectedcomponent/64253024705	The protected Component Overview page for the specified process unit.
rbi/asset/2509505	The Asset Summary page for the specified asset.
rbi/asset/2509505/component/3476094	The Component Details section of the Asset Summary page for specified RBI Component.
rbi/asset/2509505/component/3476094/analysis/3221498 -or- rbi/analysis/3221498	The Analysis Details section of the Asset Summary page for the specified RBI Analysis.
rbi/corrosionloop/4842819	The Corrosion Loop Summary page for the specified Corrosion Loop.

Example URL	Destination
rbi/25926450/isoriskanalysis/corrosionloop	The RBI 581 ISO Risk Plot page for the specified Corrosion Loop.
rbi/evergreening/25926450	The Ready for Evergreening tab in the Evergreening workspace.
rbi/evergreening/25926450/5617a312-6b47-402c-8766-1c5d854aa87a	The Created tab in the Evergreening workspace.

Inspection Plan URLs

The following table describes the various paths that are used for the Inspection Plan workflow.

Element	Description	Accepted Value(s)	Notes
cm/asset/<assetKey>	Accesses the Inspection Plan for the specified asset.		
cm/plans	Accesses the Inspection Plan Management page.		
<assetKey>	Specifies the entity key of the asset record which you want to view.	Any asset key that is associated with an asset in the Asset Hierarchy	You should use the asset key of an asset that has an Inspection Plan created. If you select an asset that does not have an Inspection Plan, a warning message appears.

URLs	
Example URL	Destination
cm/asset/3290820029	The Inspection Plan for the selected asset.

RBI 581 System Code Tables

The following table lists the System Code Tables that are used by RBI 581.

Table ID	Table Description	Function
581_AST_BOTTOM_TYPE	581_AST_BOTTOM_TYPE	Populates the AST Bottom Type field in RBI 581 Thinning and Lining Evaluation records.
581_AST_Cathodic Protection	581_AST_Cathodic Protection	Populates the Cathodic Protection field in RBI 581 Thinning and Lining Evaluation records.

581_AST_DRAINAGE_TYPE	581_AST_DRAINAGE_TYPE	Populates the AST Drainage field in RBI 581 Thinning and Lining Evaluation records.
581_AST_PAD_MAT_TYPE	581_AST_PAD_MAT_TYPE	Populates the AST Pad field in RBI 581 Thinning and Lining Evaluation records.
581_Coating_Quality	581 Coating Quality	Populates the Coating Quality field in the following records: <ul style="list-style-type: none"> • RBI 581 External Cracking Damage Evaluation • RBI 581 External Damage Evaluation
581_Coating_Type	581_Coating_Type	Populates the Coating Type field in RBI 581 Thinning and Lining Evaluation records.
581_CORR_TYPE	581 Corrosion types	Populates the Selected Base Material Corrosion Rate and Selected Cladding Material Corrosion Rate fields in RBI 581 Thinning and Lining Evaluation records.
581_Detection	581 Detection System	Populates the Detection System field in the following records: <ul style="list-style-type: none"> • RBI 581 Consequence Evaluation • RBI Component
581_Isolation	581_Isolation	Populates the Isolation System field in the following records: <ul style="list-style-type: none"> • RBI 581 Consequence Evaluation • RBI Component
581_Mitigation_System	Mitigation System	Populates the Mitigation System field in the following records: <ul style="list-style-type: none"> • RBI 581 Consequence Evaluation • RBI Component
581_Primary_Soil_Type	581_Primary_Soil_Type	Populates the Soil Type field in RBI 581 Thinning and Lining Evaluation records.
581_Product_Side_Condition	581_Product_Side_Condition	Populates the Product Side Condition field in RBI 581 Thinning and Lining Evaluation records.
581_Release_Hole_Sizes	Release Hole Sizes	Provides the values for hole sizes in RBI 581 Consequence Evaluation records.
CORROSION TYPES	Corrosion Types	Populates the Thinning Type field in the following records: <ul style="list-style-type: none"> • RBI 581 External Damage Evaluation • RBI 581 Thinning and Lining Evaluation

FLUID TYPES	Fluid Types	Populates the Initial Fluid Phase field in the following records: <ul style="list-style-type: none"> RBI 581 Risk Analysis RBI Component
FOUNDATION TYPES	Foundation Types	Populates the Foundation Type field in the following records: <ul style="list-style-type: none"> RBI 581 Thinning and Lining Evaluation RBI Component
MI_581_Adjustment_Branch_Diameter	MI 581 Adjustment Branch Diameter	Populates the Branch Diameter field in RBI 581 Mechanical Fatigue Damage Evaluation records.
MI_581_Adjustment_Condition_for_Pipe	MI 581 Adjustment for Condition of Pipe	Populates the Pipe Condition field in RBI 581 Mechanical Fatigue Damage Evaluation records.
MI_581_Adjustment_Corrective_Action	MI 581 Adjustment Corrective Action	Populates the Corrective Action field in RBI 581 Mechanical Fatigue Damage Evaluation records.
MI_581_Adjustment_Joint_Type_Branch_Design	MI 581 Adjustment Joint Type Branch Design	Populates the Joint Type or Branch Design field in RBI 581 Mechanical Fatigue Damage Evaluation records.
MI_581_Adjustment_Pipe_Complexity	MI 581 Adjustment Pipe Complexity	Populates the Pipe Complexity field in RBI 581 Mechanical Fatigue Damage Evaluation records.
MI_581_AdminOption_Families	MI_581_AdminOption_Families	Populates the drop-down list box in the Target Family column in the RBI 581 Admin Options page.
MI_581_Amine_Solution_Types	RBI 581 Amine Solution Types	Populates the Amine Solution Type field in RBI 581 Cracking Damage Evaluation records.
MI_581_Amine_Types	RBI 581 Amine Types	Populates the Amine Type field in the following records: <ul style="list-style-type: none"> RBI 581 Cracking Damage Evaluation RBI 581 Thinning and Lining Evaluation
MI_581_AST_STEAMCOIL_WATERDRWAS OFF	MI_581_AST_STEAMCOIL_WATERDRWAS OFF	Populates the AST Steam Coil Heater field and Water Product Draws field in RBI 581 Thinning and Lining Evaluation records.
MI_581_Cathodic Protection Effectiveness Factors	MI 581 Cathodic Protection Effectiveness Factors	Populates the Cathodic Protection Effectiveness field in RBI 581 Thinning and Lining Evaluation records.
MI_581_Caustic_Types	RBI 581 Caustic Types	Populates the Caustic Type field in RBI 581 Cracking Damage Evaluation records.

MI_581_Coating_Quality	RBI 581 Coating Quality	Populates the Immersion Grade Coating Quality field in RBI 581 Thinning and Lining Evaluation records.
MI_581_Coefficient_Materials	RBI 581 Coefficient Y Materials List (Used to determine Coefficient Y)	Populates the Coefficient Y Material field in RBI 581 Risk Analysis records.
MI_581_Component_Geometry_Types	RBI 581 Component Geometry Types	Populates the Geometry Type field in the following records: <ul style="list-style-type: none"> • RBI 581 Risk Analysis • RBI Component
MI_581_Cooling_System	MI_581_Cooling_System	Populates the Cooling System Type field in RBI 581 Thinning and Lining Evaluation records.
MI_581_Corrosion_Rate	MI 581 Corrosion Rate	Populates the following fields: <ul style="list-style-type: none"> • Selected External Corrosion Rate field in RBI 581 External Damage Evaluation records • Selected Base Material Corrosion Rate field in RBI 581 Thinning and Lining Evaluation records
MI_581_Cracking_Susceptibility	RBI 581 Cracking Susceptibility	Populates the Susceptibility field in the following records: <ul style="list-style-type: none"> • RBI 581 Cracking Damage Evaluation • RBI 581 External Cracking Damage Evaluation
MI_581_Cracking_Susceptibility_Types	RBI 581 Cracking Susceptibility Types	Populates the Susceptibility Type field in the following records: <ul style="list-style-type: none"> • RBI 581 Cracking Damage Evaluation • RBI 581 External Cracking Damage Evaluation
MI_581_Damage_States	RBI 581 Damage States	Provides the damage states in the following records: <ul style="list-style-type: none"> • RBI 581 External Damage Evaluation • RBI 581 Thinning and Lining Evaluation
MI_581_Data_Confidence	RBI 581 Data Confidence Levels	Populates the Data Confidence field in RBI 581 Risk Analysis records.
MI_581_Driving_Risk_Target	RBI 581 Driving Risk Targets for Inspection Planning	Populates the Driving Risk Target field in RBI 581 Risk Analysis records.
MI_581_Environmental_Sensitivity	RBI 581 Environmental Sensitivity	Populates the Environmental Sensitivity field in RBI 581 Consequence Evaluation records.

MI_581_Environmental_Severity	RBI 581 Environmental Severity	Populates the Environmental Severity field in RBI 581 Cracking Damage Evaluation records.
MI_581_Environmental_Severity	RBI 581 Failure Hole Size (gff as a function of Hole Size in calculating failures/yr)	Displays the hole sizes that are used in an RBI 581 Consequence Evaluation.
MI_581_GOV_THINNING_DAMAGE	MI Gov Thinning Damage	Populates the Governing Thinning Damage Mechanism field in RBI 581 Thinning and Lining Evaluation records.
MI_581_H2S_Content_Of_Water	RBI 581 H2S Content of Water	Used to categorize H2S Content of Water based on a the value in the H2S Content of Water field in RBI 581 Cracking Damage Evaluation records.
MI_581_Heat_Treatment_History	RBI 581 Heat Treatment History	Populates the Thermal History (Heat Treatment History) field in RBI 581 Cracking Damage Evaluation records.
MI_581_HTHA_Delta_Temperature	MI_581_HTHA_Delta_Temperature	Populates the Delta Temperature field in RBI 581 HTHA Damage Evaluation records.
MI_581_HYDROCARBON_TYPES	MI 581 HYDROCARBON TYPES	Populates the Hydrocarbon Type field in RBI 581 Thinning and Lining Evaluation records.
MI_581_Inspection_Effectiveness	RBI 581 Inspection Effectiveness	Populates the Highest Effective Insp field in the following records: <ul style="list-style-type: none"> • RBI 581 Cracking Damage Evaluation • RBI 581 External Cracking Damage Evaluation Populates the Highest Effective Inspection Level field in RBI 581 Thinning and Lining Evaluation records.
MI_581_Lining_Condition	RBI 581 Lining Conditions	Populates the Liner Condition field in RBI 581 Thinning and Lining Evaluation records.
MI_581_Lining_Types_And_Resistance	RBI 581 Lining Types and Resistance	Populates the Liner Type field in the following records: <ul style="list-style-type: none"> • RBI 581 Thinning and Lining Evaluation • RBI Component
MI_581_Material_Groups	RBI 581 Material Groups	Used to categorize the material of the component based on the value in the Base Material field in RBI Components.
MI_581_Material_Temperature_Exemption_Curves	MI_581_Material_Temperature_Exemption_Curves	Populates the Material Exemption Curve field in RBI 581 Brittle Fracture Damage Evaluation records.

MI_581_Max_Brinnell_Hardness	RBI 581 Max Brinnell Hardness	Used to categorize the value in the Maximum Brinnell Hardness field in RBI 581 Cracking Damage Evaluation records.
MI_581_Mechanical_Fatigue_Cyclic>Loading	MI 581 Mechanical Fatigue Cyclic Loading	Populates the Cyclic Loading field in RBI 581 Mechanical Fatigue Damage Evaluation records.
MI_581_Mechanical_Fatigue_Failures	MI 581 Mechanical Fatigue Failures	Populates the Previous Failure field in RBI 581 Mechanical Fatigue Damage Evaluation records.
MI_581_Mechanical_Fatigue_Shaking	MI 581 Mechanical Fatigue Shaking	Populates the Visible/Audible Shaking field in RBI 581 Mechanical Fatigue Damage Evaluation records.
MI_581_Mechanical_Fatigue_Shaking>Duration	MI 581 Mechanical Fatigue Shaking Duration	Populates the Shaking Frequency field in RBI 581 Mechanical Fatigue Damage Evaluation records.
MI_581_No_High_Effec>Insp	Number of Highest Level Effective Inspections	Populates the Number of Highest Effective Inspections field in various records.
MI_581_ph>Water	RBI 581 pH Water	Used to categorize the values in the pH of Water field in RBI 581 Risk Analysis records.
MI_581_Product_Form	RBI 581 Product Form	Populates the Product Form field in RBI 581 Cracking Damage Evaluation records.
MI_581_Recirculating_System	MI_581_Recirculating_System	Populates the Recirculating System Type field in RBI 581 Thinning and Lining Evaluation records.
MI_581_Recorded>Settlement_Criteria	RBI 581 Recorded Settlement Criteria (API 653)	Populates the Settlement Adjustment Inspection field in RBI 581 Thinning and Lining Evaluation records.
MI_581>RISKSUMMARY	RBI 581 Risk Summary Type	Populates the Risk Summary for an RBI 581 Risk Analysis record.
MI_581_Sigma>Percentage	MI 581 Sigma Percentage	Populates the Sigma Percentage field in RBI 581 Brittle Fracture Damage Evaluation records.
MI_581>Soil_Condition	MI_581>Soil_Condition	Populates the Soil Condition field in RBI 581 Thinning and Lining records.
MI_581>Soil_Types	RBI 581 Soil Types	Populates the Soil Type under Tank bottom field in RBI 581 Consequence Evaluation records.
MI_581>Sulfur_Content>Of_Steel	RBI 581 Sulfur Content Of Steel	Populates the Sulfur Content of Steel field in RBI 581 Cracking Damage Evaluation records.

MI_581_Water_Treatment_Type	MI_581_Water_Treatment_Type	Populates the Water Treatment Type field in RBI 581 Thinning and Lining Evaluation records.
MI_581_Water_Type	MI_581_Water_Type	Populates the Water Type field in RBI 581 Thinning and Lining Evaluation records.
MI_ATMOSPHERIC_CONDITION	Atmospheric Condition	Populates the Atmospheric Condition field in the following records: <ul style="list-style-type: none"> RBI 581 External Cracking Damage Evaluation RBI 581 External Damage Evaluation
MI_DEGRADATION_MECHANISM_TYPES MI_DEGRADATION_MECHANISM_TYPES	Degradation Mechanism Types	Populates the Degradation Mechanism field in Potential Degradation Mechanism records.
MI_RBI_Area_Humidity	MI RBI Area Humidity	Populates the Area Humidity field in RBI Components.
MI_RBI_CALC_CORRO_SRC	RBI Calculated CR Source	Populates the Source of Calculated Corrosion Rates field in RBI Components.
MI_STRESS_LOOKUP_TABLE	MI_STRESS_LOOKUP_TABLE	Populates the Stress Lookup Table field in the following records: <ul style="list-style-type: none"> RBI Components RBI 581 Risk Analysis
MI_YES_NO	MI Core, Yes-No	Populates various fields in the RBI 581 module.

RBI 581 Risk Analysis State Assignments and Operations

The RBI 581 Risk Analysis uses specific states and operations from the baseline State Assignments of GE Digital APM.

In RBI, State Configuration is used in the following families:

- RBI 581 Risk Analyses
- RBI Recommendations

RBI State Assignments and Operations Diagram

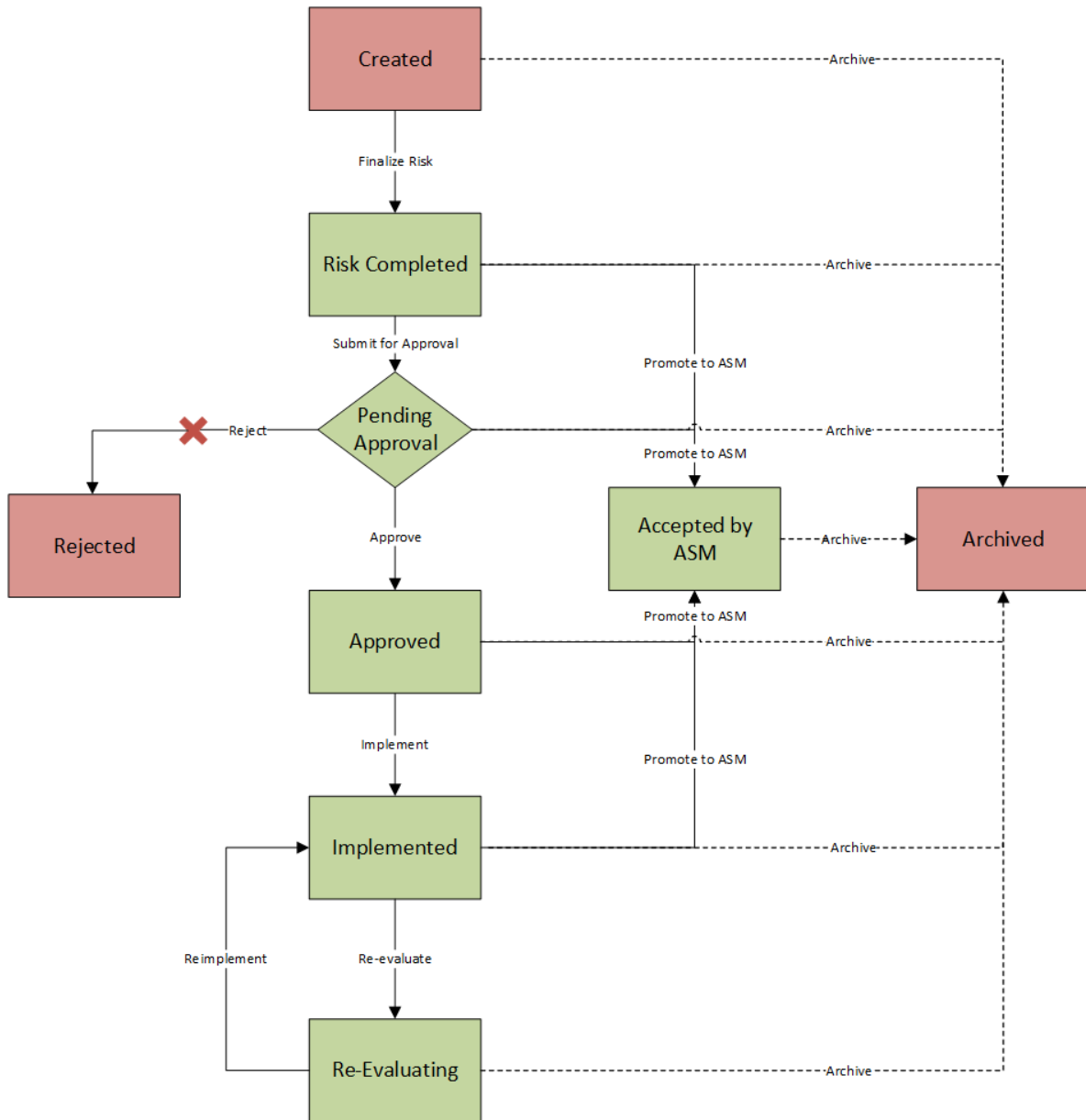

Notice that the some of the states are highlighted in Green. When an RBI Criticality Analysis is set to any of these states, the analysis is **active**. When an RBI Criticality Analysis is set to any of the states highlighted in Red, the analysis is inactive.

Additionally, in the diagram, you can see dotted lines and black lines.

- Dotted lines represent operations that are performed automatically when another RBI Criticality Analysis that is linked to the same RBI Component is set to Risk Completed.
- Black lines represent operations that you can perform manually.

Note: While the preceding image includes the Reject operation and the Rejected state, this state and operation are not valid in the RBI workflow and are, therefore, colored gray in the image. While they exist in the baseline State Configuration, if you try to reject an RBI 581 Risk Analysis, an error message appears, indicating that this operation is not valid.

Details

Initial State: The Created state is the initial state of all new RBI 581 Risk Analyses.

Datasheet Configuration: By default, states and operations will appear on the datasheet when you are viewing an RBI 581 Risk Analysis in RBI, the Record Manager, or the Bulk Data Form.

Reserved States and Operations: The following tables state whether or not the baseline states and operations are reserved. You cannot remove or modify reserved states or operations. You can, however, add your own states and operations to the State Assignment.

States and Operations	
States	Is Reserved?
Approved	Yes
Accepted by ASM	Yes
Archived	Yes
Created	No
Implemented	Yes
Pending Approval	Yes
Re-Evaluating	Yes
Rejected	No
Risk Completed	Yes
Operations	Is Reserved?
Archive (all Archive operations)	Yes
Implement	No
Finalize Risk	No
Reevaluate	No
Approve	No
Reject	No
Reimplement	No
Promote to ASM	Yes
Submit for Approval	No

State Assignment Roles: By default, no State Assignment Roles are assigned to any state in the RBI 581 Risk Analysis State Assignment.

Analysis Restrictions Based on State

The following table outlines the actions that you can perform on an RBI 581 RiskAnalysis based on its state.

Analysis State	Calculation is Allowed?	Analysis Can Be Deleted?	Analysis Fields Can Be Modified?	RBI Degradation Mechanisms Can Be Added or Deleted?	RBI Recommendations Can Be Created?
Created	Yes	Yes	Yes	Yes	No
Risk Completed	No	No	No	No	Yes
Pending Approval	No	No	No	No	No
Approved	No	No	No	No	No
Implemented	No	No	No	No	No
Archived	No	No	No	No	No
Rejected	No	No	No	No	No
Re-Evaluating	No	No	No	No	No
Accepted by ASM	No	No	No	No	No

If an RBI 581 Risk Analysis is set to Risk Completed, however, the value in the Mitigated Risk field in the RBI Degradation Mechanism to which it is linked can be modified.

RBI Site Filtering

The RBI Component family, and all the families that are linked to it, use the GE Digital APM Site Control. You can access or modify only the records in RBI that are assigned to the same site to which you are assigned.

Important: You cannot modify the site assignment for a record within the RBI user interface. You can change the site assignment by accessing an RBI record in Record Manager. Since it may lead to data integrity issues, however, RBI Best Practices warn against changing site assignments on created records.

Site Filtering

Consider an organization that has three sites, Site X, Site Y, and Site Z.

Scenario 1: User assigned to only Site X.

This user can access or modify records that are linked to assets only in Site X. However, this user can access all the Potential Degradation Mechanisms in the database.

Scenario 2: User assigned to only Site X and Site Y.

This user can access or modify records that are linked to assets only in Site X or Site Y. However, this user can access all the Potential Degradation Mechanisms in the database.

Scenario 3: Super User

This user can access or modify records that are linked to assets in Site X, Site Y, or Site Z.

Data Models

Data Models

This topic provides a listing of all the data models in the RBI 581 module.

Criticality Calculator RBI Component Data Model

This topic has been intentionally excluded from the GE Digital APM product documentation website. This topic is available to you via the product documentation that is provided within the GE Digital APM system.

RBI Corrosion Loop Data Model

This topic has been intentionally excluded from the GE Digital APM product documentation website. This topic is available to you via the product documentation that is provided within the GE Digital APM system.

RBI Data Model

This topic has been intentionally excluded from the GE Digital APM product documentation website. This topic is available to you via the product documentation that is provided within the GE Digital APM system.

RBI Recommendation Data Model

This topic has been intentionally excluded from the GE Digital APM product documentation website. This topic is available to you via the product documentation that is provided within the GE Digital APM system.

RBI 581 Risk Analysis Data Model

This topic has been intentionally excluded from the GE Digital APM product documentation website. This topic is available to you via the product documentation that is provided within the GE Digital APM system.

Family Field Descriptions

Criticality Calculator RBI Components Records

Criticality Calculator RBI Components

Criticality Calculator RBI Component records store information about the component on which you will perform an RBI 581 Risk Analysis.

This topic provides an alphabetical list and description of the fields that exist for the Criticality Calculator RBI Components family. The information in the table reflects the baseline state and behavior of these fields. If the component type is Exchanger Bundle, then, for each field on the RBI Component, there are two fields on the datasheet - one for the channel, and the other for the shell.

The following families are enabled for site filtering, which means that the records in these families can be assigned to a specific site, and will then only be accessible to users who are assigned to the same site and have the appropriate license and family privileges. See the Site Filtering section of the documentation for more information on using this feature.

Field	Data Type	Description	Behavior and Usage
The ID Section			
Component	Character	Identifies the RBI Component.	<p>This field is disabled and populated automatically with a value in the following format: RBICOMP-<Asset>-<Component Type>-<Number></p> <p>...where:</p> <ul style="list-style-type: none"> • <Asset> is the value in the Asset field. • <Component Type> is a value based on the type of the component, defined as follows: <ul style="list-style-type: none"> ◦ CS: Cylindrical Shell ◦ EB: Exchanger Bundle ◦ HD: Exchanger Header ◦ ET: Exchanger Tube ◦ PP: Piping ◦ TB: Tank Bottom ◦ RV: Relief Valves ◦ RD: Rupture Disks ◦ PC: Pump Compressor Casing • <Number> is the sequence number of the component.
Component Comments	Text	Comments about the component.	None
Component Date in Service	Date	The date on which the component was first put into service.	You can use the Calendar feature to select the date.
Component Description	Character	A description used to identify the Component.	None
Component Status	Character	Indicates whether a component is active or inactive.	This field is disabled and populated automatically with the value Active.
Component Type	Character	Identifies which part of the asset the component represents.	<p>The value in this field must be stored in the Criticality Item Type field in one of the Equipment Types records delivered in the GE Digital APM database.</p> <p>This field is disabled and populated automatically based on the component type selection when created.</p> <p>Note: You can use only the following component types with the component family Criticality RBI Component – Tank Bottom:</p> <ul style="list-style-type: none"> • Storage Tank Bottom

Field	Data Type	Description	Behavior and Usage
Asset	Character	Identifies the asset.	This field is populated automatically.
Asset Family	Character	Identifies the asset family.	This field is disabled and populated automatically.
Functional Location	Character	Identifies the Functional Location of the asset.	This field is disabled and populated automatically.
Operating and Process Section			
Area Humidity	Character	A value based on the geographical location in which the asset is operated.	This field contains the description of all the System Codes in the MI_RBI_Area_Humidity System Code Table. You can choose from the following baseline values: <ul style="list-style-type: none"> • Low • Medium • High
Calculated Inventory	Numeric	A calculated value based on process fluid properties and dimensions of the component.	This field is disabled and populated automatically. This value is derived from asset dimensions that have been entered in the system instead of an estimated volume.
Detection Time	Numeric	The time, in minutes, that is required to detect loss of containment.	None
Fluid Valid for 581 Analysis	Boolean	Indicates whether the process fluid is valid for an RBI 581 Risk Analysis.	This check box is disabled and selected if the fluid that you have selected in the Process Fluid field is valid for RBI 581. If this check box is cleared, and you perform an RBI 581 Risk Analysis, you will not be able to calculate the analysis.

Field	Data Type	Description	Behavior and Usage
Foundation Type	Character	If the component is a storage tank, then specify the foundation type of the tank.	<p>The value in this field is used to calculate an analysis if the component type is Storage Tank.</p> <p>This field contains the description of all the System Codes in the FOUNDATION TYPES System Code Table. You can choose from the following baseline values:</p> <ul style="list-style-type: none"> • Clay • Concrete • Double Floor • Gravel • Sand • Silt
Initial Fluid Phase	Character	The phase that the representative fluid is in while under containment in current operating conditions.	<p>The value in this field is used to populate the Initial Fluid Phase field on an associated RBI 581 Risk Analysis datasheet.</p> <p>This field contains the description of all the System Codes in the FLUID TYPES System Code Table. You can choose from the following baseline values:</p> <ul style="list-style-type: none"> • Liquid • Gas
Inventory	Numeric	The volume of the asset that could potentially be released in the event of a failure.	The value in this field is calculated and used to populate the Inventory Component Mass field in the RBI Consequence Evaluation that is linked to an analysis performed on this component.
Inventory Group	Character	The name of the inventory group to which the component is linked.	If the component is linked to an inventory group , then this field is disabled and populated with the value in the Inventory Group Name field in the associated Inventory Group Configuration record.
Isolation Time	Numeric	The time, in minutes, that is required to isolate loss of containment.	None

Field	Data Type	Description	Behavior and Usage
Operating Pressure	Numeric	The internal pressure of the asset under normal operating conditions. It is measured in pounds per square inch gauge.	The value in this field is used to populate the Operating Pressure field in the associated analysis.
Operating Temperature	Numeric	The temperature of the asset under normal operating conditions. It is measured in degrees Fahrenheit.	The value in this field is used to populate the Operating Temperature field in the associated analysis.
Percent Toxic	Numeric	The amount of toxic substances by volume in the process stream.	This field is enabled only if the Toxic Mixture check box is selected.

Field	Data Type	Description	Behavior and Usage
Process Fluid	Character	<p>The fluid that represents or makes up the greatest volume of the asset. In some cases, the fluid that represents the greatest cause of failure may be selected.</p> <p>Important: If you are going to perform an RBI Criticality Analysis, you must select a fluid that is valid for RBI 580. Similarly, if you are going to perform an RBI 581 Risk Analysis, you must select a fluid that is valid for RBI 581.</p>	<p>The value in this field must be stored in the Fluid field in one of the Representative Fluids records in the GE Digital APM database.</p> <p>If you select a fluid that is valid for RBI 581, the Fluid Valid for 581 Analysis check box is selected automatically.</p> <p>If the value in the Component Type field is Storage Tank Bottom, then this field must contain a fluid with a Dynamic Viscosity greater than 0. In the baseline APM, the following fluids have a valid Dynamic Viscosity and are supported by the Storage Tank Bottom:</p> <ul style="list-style-type: none"> • C6-C8 • C9-C12 • C13-16 (Diesel) • C17-25 (Gas Oil) • C25+ (Resid) • H2O (Water)
Toxic Fluid	Character	<p>The fluid that represents or makes up the greatest toxic volume of the asset. In some cases, the fluid that contributes to the greatest Consequence of Failure (CoF) may be selected.</p>	<p>This field is enabled only if the Toxic Mixture check box is selected.</p> <p>The value in this field must be stored in the Process Fluid field in one of the Representative Fluids records delivered in the GE Digital APM baseline database.</p>

Field	Data Type	Description	Behavior and Usage
Toxic Fluid Valid for 581 Analysis	Boolean	Indicates whether the toxic fluid is valid for an RBI 581 Risk Analysis.	This check box is disabled and selected if the fluid that you have selected in the Toxic Model field is valid for RBI 581.
Toxic Mixture	Boolean	Indicates whether or not the process stream contains toxic substances.	If you select this check box, the Toxic Fluid and Percent Fluid boxes are enabled.
Design Details Section			
Code Year	Character	The year in which the design code that corresponds to the component was defined.	The value in this field must be stored in the Code Year field in the GE Digital APM Reference Table that corresponds to the value in the Stress Lookup Table field in the RBI Component record. The value in this field is used to populate the Base Material Code Year field on the datasheet of the associated analysis.
Construction Code	Character	The code to which the component was originally constructed.	The value in this field is used to populate the Base Material Construction Code field on the datasheet of the associated analysis. The value in this field is used to calculate the values in the Allowable Stress, Flow Stress, and Material Yield Strength fields on the datasheet of the associated analysis, if the Stress Override check box is not selected, and if the analysis is linked to the following DMs: <ul style="list-style-type: none"> • 581-Brittle Fracture • 581-Low Alloy Steel Embrittlement • All DMs that belong to RBI 581 Thinning and Lining Evaluation • All DMs that belong to RBI 581 External Damage Evaluation
Design Pressure	Numeric	The pressure at which the component is designed to operate. It is measured in pounds per square inch gauge.	The value in this field is used to populate the Design Pressure field in the associated analysis. Tip: This value is provided by the manufacturer of the component. You can find it on the nameplate or the UI Form.

Field	Data Type	Description	Behavior and Usage
Design Temperature	Numeric	The temperature at which the component is designed to operate. It is measured in degrees Fahrenheit.	The value in this field is used to populate the Design Temperature field in the associated analysis. Tip: This value is provided by the manufacturer of the component. You can find it on the nameplate or the UI Form.
Inside Diameter	Numeric	The measurement of the inner diameter of a circular or cylindrical asset, in inches.	The value in this field is used to: <ul style="list-style-type: none"> • Populate the Diameter InnerDiameter field on the datasheet of an associated RBI 581 Risk Analysis. • Calculate the value in the Inventory Component Mass field on an RBI 581 Consequence Evaluation datasheet if you have selected the Use Calculated Inventory check box.
Insulated?	Boolean	Indicates whether or not the component is insulated.	If you select or clear this check box, the Insulated check box on the datasheet of an associated RBI Analysis is selected or cleared accordingly.
Insulation Type	Character	Identifies the insulating material used in the component.	This field is enabled only if the Insulated? check box is selected. The value in this field is used to populate the Insulation Type field on an associated RBI 581 Risk Analysis datasheet. This field must contain one of the following values: <ul style="list-style-type: none"> • Asbestos • Calcium Silicate (CI Free) • Calcium Silicate (Not CI Free) • Foam/Cellular Glass • Mineral Wool/Fiber Glass • Pearlite • Unknown
Is Entry Possible?	Boolean	Indicates whether it is possible to physically enter an asset for the purposes of performing an inspection.	This field contains the description of all the System Codes in the MI_YES_NO System Code Table. You can choose from the following baseline values: <ul style="list-style-type: none"> • Yes (Y) • No (N)

Field	Data Type	Description	Behavior and Usage
Length	Numeric	The total length, in inches, of an asset measured in a straight line from head seam to head seam.	This value is used to: <ul style="list-style-type: none"> Populate the Length field on the datasheet of an associated RBI 581 Risk Analysis. Calculate the value in the Inventory Component Mass field on an RBI 581 Consequence Evaluation datasheet if you have selected the Use Calculated Inventory check box.
Material Grade	Character	Identifies the grade of the material of the component provided by the manufacturer. You can find it on the nameplate or the U1 Form.	The value in this field must be stored in the Material Grade field in the GE Digital APM Reference Table that corresponds with the value the Stress Lookup Table field in the RBI Component. The value in this field is used to populate the Base Material Grade field on the datasheet of the associated analysis.
Material Spec	Character	Identifies the material of the component that is provided by the manufacturer. You can find it on the nameplate or the U1 Form.	The value in this field must be stored in the Material Spec field in the GE Digital APM Reference Table that corresponds with the value the Stress Lookup Table field in the RBI Component. The value in this field is used to populate the Base Material Spec field on the datasheet of the associated analysis.
Nominal Thickness	Numeric	An estimated or measured thickness used as the starting point for thickness based Remaining Life calculations.	The value in this field is used to populate the Furnished Base Material Thk (Nominal Thickness) field on the datasheet of an associated RBI 581 RiskAnalysis.

Field	Data Type	Description	Behavior and Usage
PWHT	Boolean	Indicates whether or not Post Weld Heat Treatment (PWHT) has been performed to relieve residual stresses from the construction of the asset.	The value in this field is used to populate the PWHT field on an associated RBI 581 Risk Analysis.
Stress Lookup Table	Character	Identifies the type of asset being assessed so that the appropriate design codes are used.	<p>This field contains the description of all the System Codes in the MI_STRESS_LOOKUP_TABLE System Code Table. You can choose from the following baseline values:</p> <ul style="list-style-type: none"> • Piping • Pressure Vessels • Tanks <p>The value in this field is used to populate the Stress Lookup Table field on the datasheet of the associated analysis.</p>
Weld Joint Efficiency	Numeric	Indicates the type of inspection used to ensure the quality of welds and the type of weld joints used during construction.	<p>This field is used to populate the Weld Joint Effy field on the datasheet of an RBI 581 Risk Analysis.</p> <p>This field must contain one of the following values:</p> <ul style="list-style-type: none"> • 0.35 • 0.4 • 0.45 • 0.5 • 0.55 • 0.6 • 0.65 • 0.7 • 0.75 • 0.8 • 0.85 • 0.9 • 0.95 • 1.0
Corrosion Data Section			

Field	Data Type	Description	Behavior and Usage
Corrosion Type	Character	The type of corrosion to which equipment is susceptible.	You can specify a value for this field using the datasheet.
Corrosive Product	Character	Identifies the elements in the process stream that are responsible for the most aggressive corrosion.	None
Estimated External Corrosion Rate	Numeric	The rate of external degradation given by the subject matter expert during the corrosion study. This value is used in the absence of quality data from the field.	The value in this field is used to populate the Base Material Estimated Corrosion Rate field on an associated RBI 581 External Damage Evaluation datasheet.
Estimated Internal Corrosion Rate	Numeric	The rate of internal degradation provided by the subject matter expert during the corrosion study. This value is used in the absence of quality data from the field.	The value in this field is used to populate the Base Material Estimated Corrosion Rate field on an associated RBI 581 Thinning and Lining Damage Evaluation datasheet.

Field	Data Type	Description	Behavior and Usage
Internal Corrosion Type	Character	Used in inspection planning to drive different activities for localized and general thinning mechanisms.	This field contains the descriptions of all the System Codes in the CORROSION TYPES System Code Table. You can choose from the following baseline values: <ul style="list-style-type: none"> • General • Localized • Pitting
Measured External Corrosion Rate	Numeric	The corrosion rate, in inches per year, identified by Ultrasonic Thickness or Profile Radiography in the field.	None
Predictable Corr. Location	Boolean	Indicates whether or not it is known where the most aggressive corrosion is happening in the asset.	None
Predictable Int. Corr. Location	Boolean	Indicates whether or not it is known where the most aggressive internal corrosion is happening in the asset.	None

Field	Data Type	Description	Behavior and Usage																
Source of Calculated Corrosion Rate	Character	The source of the Thickness Monitoring Calculated Corrosion Rate.	<p>The value in this field is used while integrating this module with Thickness Monitoring. This field contains the descriptions of all the System Codes in the MI_RBI_CALC_CORRO_SRC System Code Table. You can choose from the following baseline values:</p> <ul style="list-style-type: none"> Asset Component Manual Entry <p>The following table provides the behavior of the Controlling Corrosion Rate, Short Term Corrosion Rate, and Long Term Corrosion Rate fields in the associated RBI 581 Thinning and Lining Evaluation or Criticality Int. Corr. Deg. Mech. Eval. based on your selection in this field.</p> <table border="1"> <thead> <tr> <th>Source of Calculated Corrosion Rate</th> <th>Controlling Corrosion Rate</th> <th>Long Term Avg Corr Rate</th> <th>Short Term Avg Corr Rate</th> </tr> </thead> <tbody> <tr> <td>Asset</td> <td>Disabled and populated based on the value in the Controlling Corrosion Rate field in the associated Asset Corrosion Analysis</td> <td>Disabled and calculated</td> <td>Disabled and calculated</td> </tr> <tr> <td>Component</td> <td>Disabled and populated based on the highest value in the Controlling Corrosion Rate fields in the associated Asset Corrosion Analyses linked to the TML Groups.</td> <td>Disabled and calculated</td> <td>Disabled and calculated</td> </tr> <tr> <td>Manual Entry</td> <td>Disabled and blank</td> <td>Enabled</td> <td>Enabled</td> </tr> </tbody> </table>	Source of Calculated Corrosion Rate	Controlling Corrosion Rate	Long Term Avg Corr Rate	Short Term Avg Corr Rate	Asset	Disabled and populated based on the value in the Controlling Corrosion Rate field in the associated Asset Corrosion Analysis	Disabled and calculated	Disabled and calculated	Component	Disabled and populated based on the highest value in the Controlling Corrosion Rate fields in the associated Asset Corrosion Analyses linked to the TML Groups.	Disabled and calculated	Disabled and calculated	Manual Entry	Disabled and blank	Enabled	Enabled
Source of Calculated Corrosion Rate	Controlling Corrosion Rate	Long Term Avg Corr Rate	Short Term Avg Corr Rate																
Asset	Disabled and populated based on the value in the Controlling Corrosion Rate field in the associated Asset Corrosion Analysis	Disabled and calculated	Disabled and calculated																
Component	Disabled and populated based on the highest value in the Controlling Corrosion Rate fields in the associated Asset Corrosion Analyses linked to the TML Groups.	Disabled and calculated	Disabled and calculated																
Manual Entry	Disabled and blank	Enabled	Enabled																
RBI-581 Section																			
Base Material	Character	The base material that is used in the component.	This field contains a list of the types of base material that are generally used in a component. The value in this field is used to populate the Base Material field on the datasheet of an associated RBI 581 Risk Analysis.																
Cladding Material	Character	The material that is used in cladding.	<p>This field contains a list of the types of cladding material that are generally used for cladding.</p> <p>The value in this field is used to populate the Cladding Material field on the datasheet of an associated RBI 581 Risk Analysis.</p>																

Field	Data Type	Description	Behavior and Usage
Cladding Present	Character	Indicates whether cladding is present in the component.	<p>This field contains the description of all the System Codes in the MI_YES_NO System Code Table. You can choose from the following baseline values:</p> <ul style="list-style-type: none"> • Yes (Y) • No (N) <p>The value in this field is used to populate the Cladding is Present? field on the datasheet of an associated RBI 581 Risk Analysis.</p>
CM Corrosion Rate	Character	The corrosion rate of the cladding material.	The value in this field is used to calculate an analysis if the analysis is linked to a DM that belongs to the RBI 581 Thinning and Lining Evaluation family. This value is populated in the Cladding Material Estimated Corrosion Rate field on the associated RBI 581 Thinning and Lining Evaluation datasheet.
Corrosion Allow	Numeric	The metal thickness that is allowed considering metal loss due to corrosion.	The value in this field is used to populate the Corrosion Allow field on the datasheet of an associated RBI 581 Risk Analysis.
Detection System	Character	The safety system that is used to detect a failure of the component.	<p>The value in this field is populated in the Detection System field on the datasheet of the associated RBI 581 Consequence Evaluation.</p> <p>This field contains the description of all System Codes in the 581_Detection System Code Table. You can choose from the following baseline values:</p> <ul style="list-style-type: none"> • Loss of Pressure or Flow (A) • Pressure Envelope (B) • Visual Detection (C)
Is Intrusive?	Character	Indicates whether you can inspect the component from inside.	The value in this field is used to populate the Is Intrusive? field on the datasheet of an associated RBI 581 Risk Analysis.
Isolation System	Character	The safety system that is used to isolate the component in case of a leakage.	<p>The value in this field is used to calculate the consequence of failure. This value is populated in the Isolation System field on the datasheet of the associated RBI 581 Consequence Evaluation.</p> <p>This field contains the descriptions of all the System Codes in the 581_Isolation System Code Table. You can choose from the following baseline values:</p> <ul style="list-style-type: none"> • Auto Shutdown • Leakage Shutdown (This value appears only if the value in the Detection System field is Pressure Envelope (B) or Visual Detection (C)) • Manual Shutdown (This value appears only if the value in the Detection System field is Visual Detection (C))

Field	Data Type	Description	Behavior and Usage
Fluid Velocity	Character	The velocity, in feet per second, of the fluid that is used in the component.	This value is used to populate the Fluid Velocity field on an associated RBI 581 Risk Analysis.
Furnished Cladding Thickness	Character	The furnished thickness of the cladding material.	The value in this field is used to populate the Furnished Cladding material Thk (Nominal Thickness) in an RBI 581 Risk Analysis.
Geometry Type	Character	The geometry type of the component.	<p>The value in this field is used to populate the Geometry Type field on an associated RBI 581 Risk Analysis datasheet.</p> <p>This field contains the descriptions of all System Codes in the MI_581_Component_Geometry_Types System Code Table. You can choose from the following baseline values:</p> <ul style="list-style-type: none"> • Cylinder • Spherical Head • Hemispherical Head • Piping • Head • PLT (Only for Tank Bottom)

Field	Data Type	Description	Behavior and Usage																																																						
GFF Component Type	Character	The General Fail Frequency (GFF) component type.	<p>The value in this field is used to calculate an analysis.</p> <p>This field must contain one of the following values:</p> <table border="1"> <thead> <tr> <th>Value</th> <th>GFF Component Type</th> </tr> </thead> <tbody> <tr><td>COLBTM</td><td>Vessel/FinFan</td></tr> <tr><td>COLMID</td><td>Vessel/FinFan</td></tr> <tr><td>COLTOP</td><td>Vessel/FinFan</td></tr> <tr><td>COMPC</td><td>Compressor</td></tr> <tr><td>COMPR</td><td>Compressor</td></tr> <tr><td>COURSE-1-10</td><td>Tank650 (only for an AST Shell component)</td></tr> <tr><td>DRUM</td><td>Vessel/FinFan</td></tr> <tr><td>FILTER</td><td>Vessel/FinFan</td></tr> <tr><td>FINFAN</td><td>Vessel/FinFan</td></tr> <tr><td>HEXSS</td><td>Heat Exchanger</td></tr> <tr><td>HEXTS</td><td>Heat Exchanger</td></tr> <tr><td>KODRUM</td><td>Vessel/FinFan</td></tr> <tr><td>PIPE-1</td><td>Pipe</td></tr> <tr><td>PIPE-10</td><td>Pipe</td></tr> <tr><td>PIPE-12</td><td>Pipe</td></tr> <tr><td>PIPE-16</td><td>Pipe</td></tr> <tr><td>PIPE-2</td><td>Pipe</td></tr> <tr><td>PIPE-4</td><td>Pipe</td></tr> <tr><td>PIPE-6</td><td>Pipe</td></tr> <tr><td>PIPE-8</td><td>Pipe</td></tr> <tr><td>PIPEGT16</td><td>Pipe</td></tr> <tr><td>PUMP1S</td><td>Pump</td></tr> <tr><td>PUMP2S</td><td>Pump</td></tr> <tr><td>PUMPR</td><td>Pump</td></tr> <tr><td>REACTOR</td><td>Vessel/FinFan</td></tr> <tr><td>TANKBOTTOM</td><td>Tank650 (only if the value in the Component Family cell is ML_CCRBICTB)</td></tr> </tbody> </table>	Value	GFF Component Type	COLBTM	Vessel/FinFan	COLMID	Vessel/FinFan	COLTOP	Vessel/FinFan	COMPC	Compressor	COMPR	Compressor	COURSE-1-10	Tank650 (only for an AST Shell component)	DRUM	Vessel/FinFan	FILTER	Vessel/FinFan	FINFAN	Vessel/FinFan	HEXSS	Heat Exchanger	HEXTS	Heat Exchanger	KODRUM	Vessel/FinFan	PIPE-1	Pipe	PIPE-10	Pipe	PIPE-12	Pipe	PIPE-16	Pipe	PIPE-2	Pipe	PIPE-4	Pipe	PIPE-6	Pipe	PIPE-8	Pipe	PIPEGT16	Pipe	PUMP1S	Pump	PUMP2S	Pump	PUMPR	Pump	REACTOR	Vessel/FinFan	TANKBOTTOM	Tank650 (only if the value in the Component Family cell is ML_CCRBICTB)
Value	GFF Component Type																																																								
COLBTM	Vessel/FinFan																																																								
COLMID	Vessel/FinFan																																																								
COLTOP	Vessel/FinFan																																																								
COMPC	Compressor																																																								
COMPR	Compressor																																																								
COURSE-1-10	Tank650 (only for an AST Shell component)																																																								
DRUM	Vessel/FinFan																																																								
FILTER	Vessel/FinFan																																																								
FINFAN	Vessel/FinFan																																																								
HEXSS	Heat Exchanger																																																								
HEXTS	Heat Exchanger																																																								
KODRUM	Vessel/FinFan																																																								
PIPE-1	Pipe																																																								
PIPE-10	Pipe																																																								
PIPE-12	Pipe																																																								
PIPE-16	Pipe																																																								
PIPE-2	Pipe																																																								
PIPE-4	Pipe																																																								
PIPE-6	Pipe																																																								
PIPE-8	Pipe																																																								
PIPEGT16	Pipe																																																								
PUMP1S	Pump																																																								
PUMP2S	Pump																																																								
PUMPR	Pump																																																								
REACTOR	Vessel/FinFan																																																								
TANKBOTTOM	Tank650 (only if the value in the Component Family cell is ML_CCRBICTB)																																																								

Field	Data Type	Description	Behavior and Usage
Has Release Prevention Barrier?	Boolean	Indicates whether the component has a release prevention barrier.	This field is enabled only if the component type is Storage Tank Bottom. If you select this check box, then the value in the Maximum Fill Height in AST field in the associated RBI 581 Consequence Evaluation record is populated with the value 0.25 feet.
Liner Present	Character	Indicates whether the component has a liner.	The value in this field is used to populate the Liner is Present field on the datasheet of an associated RBI 581 Thinning and Lining Evaluation. This field contains the description of all the System Codes in the MI_YES_NO System Code Table. You can choose from the following baseline values: <ul style="list-style-type: none"> • Yes (Y) • No (N)
Liner Type	Character	The type of the liner that is used in the component.	This field is enabled only if the value in the Liner Present field is Yes (Y). The value in this field is used to populate the Liner Type field on an associated RBI 581 Thinning and Lining Evaluation datasheet. This field contains the descriptions of all System Codes in the MI_581_Lining_Types_And_Resistance System Code Table. You can choose from the following baseline values: <ul style="list-style-type: none"> • Strip Lined Alloy • Organic Coating (typically > 0.762mm / 30 mils) • Thermal Resistant Service - Castable Refractory • Severe/Abrasive Service - Castable Refractory • Glass Linings • Acid Brick • Fiberglass
Minimum Structural Thickness	Numeric	The minimum permissible structural thickness of the component.	The value in this field is used to populate the Minimum Structural Thickness field on an associated RBI 581 Risk Analysis datasheet.
Mitigation System	Character	The safety system that is used to mitigate the severity of a leakage.	The value in this field is used to calculate the consequence of failure. This value is populated in the Mitigation System field on the datasheet of the associated RBI 581 Consequence Evaluation. This field contains the descriptions of all the system codes in the 581_Mitigation_System System Code Table. You can choose from the following baseline values: <ul style="list-style-type: none"> • Inventory Blowdown • Fire water deluge system • Fire water monitors only • Foam spray system • No mitigation system

Field	Data Type	Description	Behavior and Usage
Percent Liquid Volume	Numeric	The percentage of liquid in the component.	The value in this field is used to calculate inventory.
pH of Water	Numeric	The pH of the water that is used in the component.	The value in the field is used to populate the pH of Water field on an associated RBI 581 Risk Analysis datasheet.
Specified Tmin	Numeric	The minimum thickness of the component that is specified by the user.	This value is used to populate the Specified Tmin field on the datasheet of an associated RBI 581 Risk Analysis.
Total Acid Number	Numeric	The total acid number of the process fluid that is used in the component.	This value is used to calculate an RBI 581 analysis if the analysis is linked to the 581-High Temperature Sulfidic and Naphthenic Acid DM.

Piping Stress Records

Records in the Piping Stress family make up the Piping Stress reference table, which GE Digital APM uses to locate the appropriate Allowable Stress value for RBI 581 Risk Analyses that are linked to RBI Components whose Stress Lookup Table field contains the value Piping. These values are used to calculate Pressure T-min values in RBI and Thickness Monitoring.

This topic provides an alphabetical list and description of the fields that exist in the Piping Stress family. The information in the table reflects the baseline state and behavior of these fields. The Material Type, Minimum Tensile Strength, and Minimum Tensile Yield fields exist in the Piping Stress family, but they are not used to determine the Allowable Stress value.

This family is not enabled for site filtering, which means that records in this family can be accessed by any user with the appropriate license and family privileges. For more information, refer to the Sites section of the documentation.

Field	Data Type	Description	Behavior and Usage
Allowable Stress Override	Numeric	The maximum amount of pressure that a component can safely withstand.	<p>This value in this field, in addition to the following other Piping Stress fields, is used to determine the value that is populated in the Allowable Stress field in the associated RBI 581 Risk Analysis:</p> <ul style="list-style-type: none"> • Base Material Code Year • Base Material Construction Code • Design Temperature • Base Material Grade • Base Material Spec • Stress Lookup Table
Code Year	Character	The year in which the design code that corresponds to the component was defined.	<p>The value in this field is used to populate the Base Material Code Year field in the associated RBI 581 Risk Analysis:</p> <p>This field must contain a value in order for GE Digital APM to retrieve:</p> <ul style="list-style-type: none"> • The value in the Allowable Stress field in the Piping Stress record from the Piping Stress reference table. • Values in the Base Material Spec list in the Piping Stress record.
Design Code	Character	The design code associated with the component.	<p>The value in this field is used to populate the Base Material Construction Code field in the associated RBI 581 Risk Analysis.</p> <p>This field must contain a value in order for GE Digital APM to retrieve the value in the Allowable Stress field in the Piping Stress record from the Piping Stress Reference table.</p>

Field	Data Type	Description	Behavior and Usage
Material Grade	Character	The material grade of the component.	<p>The value in this field is used to populate the Base Material Grade field in the associated RBI 581 Risk Analysis.</p> <p>This field must contain a value in order for GE Digital APM to retrieve the value in the Allowable Stress field in the Piping Stress record from the Piping Stress Reference table.</p> <p>If there is no material grade value in the specification, then this field is populated with the value NS, which implies not specified.</p> <p>For Construction Code B31.3 or B31.1 and Code Year 2014, if two or more Piping Stress records have the same values for Material Specification and Material Grade, then the value in this field is populated with a value in the following format: <Material Grade>-<Class>-<Size>-<Notes></p>

Field	Data Type	Description	Behavior and Usage
Material Specification	Character	The material specification of the component.	<p>The value in this field is used to populate the Base Material Spec field in the associated RBI 581 Risk Analysis.</p> <p>This field must contain a value in order for GE Digital APM to retrieve:</p> <ul style="list-style-type: none"> The value in the Allowable Stress field in the Piping Stress record from the Piping Stress reference table. Values in the Material Grade list in the Piping Stress record.
Metal Temperature	Numeric	The temperature of the metal of which the component is made.	<p>The value in this field is used to populate the Design Temperature field in the associated RBI 581 Risk Analysis.</p> <p>This field must contain a value in order for GE Digital APM to retrieve the value in the Allowable Stress field in the Piping Stress record from the Piping Stress reference table.</p>

PV Stress Records

Records in the PV Stress family make up the PV Stress reference table, which GE Digital APM uses to locate the appropriate Allowable Stress value for RBI 581 Risk Analyses that are linked to RBI Components whose Stress Lookup Table field contains the value Pressure Vessel.

This topic provides an alphabetical list and description of the fields that exist in the PV Stress family. The information in the table reflects the baseline state and behavior of these fields. The Material Type, Minimum Tensile Strength, and Minimum Tensile Yield fields exist in the PV Stress family, but they are not used to determine the Allowable Stress value.

This family is not enabled for site filtering, which means that records in this family can be accessed by any user with the appropriate license and family privileges. For more information, refer to the Sites section of the documentation.

Field	Data Type	Description	Behavior and Usage
Allowable Stress	Numeric	The maximum amount of pressure that can safely be withstood by a component.	<p>This value in this field, in addition to the following other PV Stress fields, is used to determine the value that is populated in the Allowable Stress field in the associated RBI 581 Risk Analysis:</p> <ul style="list-style-type: none"> • Base Material Code Year • Base Material Construction Code • Design Temperature • Base Material Grade • Base Material Spec • Stress Lookup Table
Code Year	Character	The year in which the design code that corresponds to the component was defined.	<p>The value in this field is used to populate the Code Year field in the associated RBI 581 Risk Analysis:</p> <p>This field must contain a value in order for GE Digital APM to retrieve:</p> <ul style="list-style-type: none"> • The value in the Allowable Stress field in the PV Stress record from the PV Stress reference table. • Values in the Base Material Spec list in the PV Stress record.
Design Code	Character	The design code associated with the component.	<p>The value in this field is used to populate the Base Material Construction Code field in the associated RBI 581 Risk Analysis.</p> <p>This field must contain a value in order for GE Digital APM to retrieve the value in the Allowable Stress field in the PV Stress record from the PV Stress Reference table.</p>

Field	Data Type	Description	Behavior and Usage
Material Grade	Character	The material grade of the component.	<p>The value in this field is used to populate the Base Material Grade field in the associated RBI 581 Risk Analysis.</p> <p>This field must contain a value in order for GE Digital APM to retrieve the value in the Allowable Stress field in the PV Stress record from the PV Stress Reference table.</p>
Material Specification	Character	The material specification of the component.	<p>The value in this field is used to populate the Base Material Spec field in the associated RBI 581 Risk Analysis.</p> <p>This field must contain a value in order for GE Digital APM to retrieve:</p> <ul style="list-style-type: none"> The value in the Allowable Stress field in the PV Stress record from the PV Stress reference table. Values in the Material Grade list in the PV Stress record.
Metal Temperature	Numeric	The temperature of the metal of which the component is made.	<p>The value in this field is used to populate the Design Temperature field in the associated RBI 581 Risk Analysis.</p> <p>This field must contain a value in order for GE Digital APM to retrieve the value in the Allowable Stress field in the PV Stress record from the PV Stress reference table.</p>
Minimum Tensile Strength	Numeric	The minimum tensile strength of the material of the component.	
Minimum Yield Strength	Numeric	The minimum yield strength of the material of the component.	

RBI Corrosion Loop Records

RBI Corrosion Loop records are used to identify the components contained in a Corrosion Loop. This topic provides an alphabetical list and description of the fields that exist for the RBI Corrosion Loop family. The information in the table reflects the baseline state and behavior of these fields.

This family is enabled for site filtering, which means that records in this family can be assigned to a specific site, and will only be accessible to users who are assigned to the same site and have the appropriate license and family privileges. For more information, refer to the Sites section of the documentation.

Field	Data Type	Description	Behavior and Usage
Comments	Text	Details about the corrosion loop.	None
Created By	Character	The name of the user who created the RBI Corrosion Loop.	This field is disabled and populated automatically with the name of the person logged in to GE Digital APM.
Created On	Date	The date on which the RBI Corrosion Loop was created.	This field is disabled and populated automatically.
Last Updated By	Character	The first and last name of the most recent user to update the RBI Corrosion Loop.	This field is disabled and populated automatically with the name of the person logged in to GE Digital APM while modifying the record.
Last Updated On	Date	The date on which the most recent update was made to the RBI Corrosion Loop.	This field is disabled and populated automatically.
RBI Corrosion Loop Description	Character	Information about the purpose and contents of the corrosion loop.	None
RBI Corrosion Loop From	Character	The origin designation of the corrosion loop.	This field identifies the asset or feed source of the corrosion loop.
RBI Corrosion Loop ID	Character	A unique value that identifies the RBI Corrosion Loop.	This field is disabled and populated automatically.
RBI Corrosion Loop To	Character	The termination designation of the RBI Corrosion Loop.	This field identifies the asset or landmark at which the corrosion loop ends.

RBI Degradation Mechanisms (DMs) Records

RBI Degradation Mechanisms records are used to determine the corrosion rate and damage factor caused on the component because of a particular DM. This topic provides an alphabetical list and description of the fields that exist for the Degradation Mechanisms family. The information in the table reflects the baseline state and behavior of these fields.

This family is enabled for site filtering, which means that records in this family can be assigned to a specific site, and will only be accessible to users who are assigned to the same site and have the appropriate license and family privileges. For more information, refer to the Sites section of the documentation.

Field	Data Type	Description	Behavior and Usage
Combined Consequence	Character	The category of the combined consequence of failure.	The value in this field is calculated by comparing the four consequence categories, and assigning the combined consequence category the same value as the most severe of the four. The value A indicates the most severe consequence category, and the value E indicates the least severe.
Deg Mech Comments	Character	Comments about the DM.	None
Degradation Mechanism	Character	A process that induces deleterious micro and macro material changes over time that are harmful to the material condition or mechanical properties.	This field contains the description of all the System Codes in the MI_DEGRADATION_MECHANIS M_TYPES System Code Table.
Degradation Mechanism Description	Character	A short description of the degradation mechanism.	None
Probability of Failure	Character	Extent to which an event is likely to occur within the time frame under consideration. The mathematical definition of probability is a real number in the scale 0 to 1 and is attached to a random event.	None

RBI Recommendation Records

RBI Recommendation records store information about the recommended actions to mitigate the risk. This topic provides an alphabetical list and description of the fields that exist for the RBI Recommendation family. The information in the table reflects the baseline state and behavior of these fields.

This family is enabled for site filtering, which means that records in this family can be assigned to a specific site, and will only be accessible to users who are assigned to the same site and have the appropriate license and family privileges. For more information, refer to the Sites section of the documentation.

Field	Data Type	Description	Behavior and Usage
Analysis ID	Character	The ID of the RBI 581 Risk Analysis that is linked to the RBI Recommendation.	This field is populated with the value in the Analysis ID field of the associated RBI 581 Risk Analysis.
Author Name	Character	The name of the user who created the RBI Recommendation.	This field is populated with the last and first names of the Security User that you represent.
Completion Comments	Text	Comments about the completion of an RBI Recommendation.	This field is required when superseding the RBI Recommendation.
Create Task?	Boolean	Indicates whether or not you want to create a task for the RBI Component.	None
Damage Mechanism	Character	A process that induces deleterious micro or macro material changes over time that are harmful to the material condition or mechanical properties.	This field is populated with the Degradation Mechanism that is linked to the associated RBI Criticality Analysis.
Functional Location	Character	The ID of the Functional Location that the RBI Component belongs to.	This field is populated with the value in the Equipment ID field in the associated RBI 581 Risk Analysis.
Inspection Confidence	Character	A value that indicates how effective prior inspections were at identifying the degradation mechanism and the rate of degradation.	This field does not appear on the datasheet. The value in this field appears on the Asset Risk Report.
Inspection Strategy ID	Character	The unique ID of the Inspection Strategy.	This field does not appear on the datasheet. This field is used to map the RBI Recommendation with the Inspection Strategy.
Intrusive/Non Intrusive	Character	Determines whether or not the asset can be inspected from the inside.	When you generate a Recommendation, this field is populated with the value in the Is Intrusive? field on the RBI 581 Risk Analysis datasheet.
Nonrecurring	Boolean	Indicates whether the inspection task that you create for the recommendation is recurring.	This check box is selected by default.

Field	Data Type	Description	Behavior and Usage
Originating Reference	Character	The ID of the RBI 581 Risk Analysis that is linked to the RBI Recommendation.	When you generate an RBI Recommendation, this field is populated with the ID of the RBI 581 Risk Analysis.
RBI Component	Character	The description of the component that is associated with the RBI Recommendation.	This field is populated with the value in the Component Description field of the associated RBI Component.
RBI Recommendation Methodology	Character	Indicates the methodology that is used to generate the RBI Recommendation.	This field is populated with the value RBI 581.
Recommendation Basis	Character	Defines what is driving the RBI Recommendation.	When you generate an RBI Recommendation, this field is populated with the value in the Inspection Strategy Description field in the associated Inspection Strategy.
Recommendation Headline	Character	Identifies the purpose of the recommendation.	This field is populated with a value in the following format: RBI - <Component> - <Damage Mechanism> ...where: <ul style="list-style-type: none"> <Component> is the value in the Component field in the RBI 581 Risk Analysis. <Damage Mechanism> is the value in the Damage Mechanism field in the RBI Recommendation.
Recommended Interval Scope	Numeric	Defines what should be done during this inspection event.	When you generate an RBI Recommendation, this field is populated with the value 0.

Field	Data Type	Description	Behavior and Usage
Recommended Interval	Text	Defines the time period between inspection events.	<p>When you generate an RBI Recommendation, this field is populated with one of the following values:</p> <ul style="list-style-type: none"> The value in the Recommended Inspection Interval field. This happens if the value in the Use Calculated Data field in the Inspection Strategy field is set to False. The value in the Estimated Half Life field. This happens if the value in the Use Calculated Data field in the Inspection Strategy field is set to True.
Status	Character	Defines the status of the recommendation in the process flow.	This field is populated with the value Created.
Superseded By Recommendation Number	Character	Identifies the recommendation that will be performed and tracked rather than the selected recommendation.	When you supersede this RBI Recommendation with another one, this field is populated with the ID of the latter.
Target Completion Date	Date	The date on which the recommendation has to be implemented.	<p>For an RBI Recommendation associated with an RBI 581 Cracking Damage Evaluation, this field is populated automatically with the earliest of the dates in the Cracking Inspection Date and Target Inspection Date fields on the RBI 581 Risk Analysis datasheet.</p> <p>For other DMEs, this field is populated automatically with the value in the Target Inspection Date field on the RBI 581 Risk Analysis datasheet.</p>
Task Type	Character	Defines the inspection methodology used.	When you generate an RBI Recommendation, this field is populated with the value in the Inspection Task Type field in the associated Inspection Strategy.

Recommendation Revision Records

The Recommendation Revision family stores information from the related RBI and Compliance Recommendation records and their related Inspection Tasks. These records store information when an Inspection Plan that is in the Approved state is moved to the Modified state.

This topic provides an alphabetical list and description of the fields that exist for the Recommendation Revision family and appear in the Recommendation Revision datasheet unless otherwise specified. This list is not comprehensive.

This family is enabled for site filtering, which means that records in this family can be assigned to a specific site, and will only be accessible to users who are assigned to the same site and have the appropriate license and family privileges. For more information, refer to the Sites section of the documentation.

Field	Data Type	Description	Behavior and Usage
Damage Mechanism	Character (50)	Stores the Damage Mechanism of the original Recommendation.	This field is disabled.
Inspection Strategy ID	Character (255)	Stores the ID of the Inspection Strategy record from which the original Recommendation was generated.	This field is disabled.
Inspection Task Type	Character (255)	Stores the Task Type from the related Inspection Task.	This field is disabled.
Non Recurring?	Boolean	Indicates whether the Recommendation is to recur.	This field is disabled.
RBI Recommendation Methodology	Character (255)	Indicates the methodology used to create the Recommendation.	<ul style="list-style-type: none"> For RBI Recommendations, the value in this field can be RBI 580 or RBI 581. For Compliance, the value in this field is set to the name of the Compliance Strategy Template.
Recommendation ID	Character (255)	Indicates the unique ID that is assigned to the Recommendation.	<p>This field is populated by automatically by business rules.</p> <p>This field is disabled.</p>
Recommended Inspection Scope	Text	Stores the Inspection Scope that populated the original Recommendation.	This field is disabled.
State	Character (255)	Stores the State ID of the original Recommendation.	<p>This field is populated by the caption of the state.</p> <p>The field is disabled and does not appear in the datasheet.</p>

Field	Data Type	Description	Behavior and Usage
Task Description	Text	Stores the description from the related Inspection Task.	This field is disabled.
Task Desired Interval	Numeric	Stores the Desired Interval field value from the related Inspection Task.	This field is disabled.
Task Desired Interval Basis	Character (1000)	Stores the Desired Interval Basis from the related Inspection Task.	The value in this field is the description of the corresponding system code from the INSM System Code Table. The field is disabled.
Task Desired Interval UOM	Character (50)	Stores the Desired Interval UOM from the related Inspection Task.	This field is disabled.
Task Details	Text	Stores the details from the related Inspection Task.	This field is disabled.
Task ID	Character (255)	Stores the Task ID from the related Inspection Task.	This field is disabled.
Task Last Date	Date	Stores the Last Date from the related Inspection Task.	This field is disabled.
Task Override Interval	Boolean	Stores the Override Interval from the related Inspection Task.	This field is disabled.
Task Next Date	Date	Stores the Next Date from the related Inspection Task.	This field is disabled.
Task Reoccurring	Boolean	Stores the Reoccurring flag value from the related Inspection Task.	This field is disabled.

RBI 581 Brittle Fracture Damage Evaluation Records

RBI 581 Brittle Fracture Damage Evaluation records store information about the evaluation that you have performed on the following degradation mechanisms (DMs):

- 581-Brittle Fracture
- 581-Low Alloy Steel Embrittlement
- 581-Sigma Phase Embrittlement
- 581-885F Embrittlement

This topic provides an alphabetical list and description of the fields that exist for the RBI 581 Brittle Fracture Damage Evaluation family. The information in the table reflects the baseline state and behavior of these fields. This list is not comprehensive.

This family is enabled for site filtering, which means that records in this family can be assigned to a specific site, and will only be accessible to users who are assigned to the same site and have the appropriate license and family privileges. For more information, refer to the Sites section of the documentation.

Field	Data Type	Description	Behavior and Usage
The 581 Brittle Fracture Section			
Critical Exposure Temperature (CET)	Numeric	The critical exposure temperature, in degrees Fahrenheit, to which the component is subject.	The value in this field is required to calculate the value in the CET - Tref field if you are evaluating the 581-Brittle Fracture DM.
Fracture Appearance Transition Temperature (FATT)	Numeric	The fracture appearance transition temperature, in degrees Fahrenheit, of the fracture.	The value in this field is required to calculate value in the Base Damage Factor field if you are evaluating the 581-Low Alloy Steel Embrittlement DM.
Is CET at the MAWP >= -29°C	Boolean	Indicates whether the critical exposure temperature at maximum allowable working pressure is greater than or equal to 29 degrees Centigrade for a pressure vessel.	The value in this field is used to calculate the value in the Damage Factor Adjustment Service Experience (FSE) field if you are evaluating the 581-Brittle Fracture DM.
Is Cyclic service Design Requirement	Boolean	Indicates whether cyclic service is a design requirement for the component.	The value in this field is used to calculate the value in the Damage Factor Adjustment Service Experience (FSE) field if you are evaluating the 581-Brittle Fracture DM.
Is Asset Or Circuit Subject to EVN Cracking	Boolean	Indicates whether the component is subject to environmental cracking.	The value in this field is used to calculate the value in the Damage Factor Adjustment Service Experience (FSE) field if you are evaluating the 581-Brittle Fracture DM.
Is Asset Or Circuit Subject to Shock Chilling	Boolean	Indicates whether the component is subject to shock chilling.	The value in this field is used to calculate the value in the Damage Factor Adjustment Service Experience (FSE) field if you are evaluating the 581-Brittle Fracture DM.
Is Fabricated From P-1 and P-3 Steels	Boolean	Indicates whether the component is fabricated from P-1 and P-3 steels, where the design temperature is less than or equal to 650 degrees Fahrenheit.	The value in this field is used to calculate the value in the Damage Factor Adjustment Service Experience (FSE) field if you are evaluating the 581-Brittle Fracture DM.

Field	Data Type	Description	Behavior and Usage
Is Nominal Operating Conditions Changed	Boolean	Indicates whether the normal operating conditions have changed for the component.	The value in this field is used to calculate the value in the Damage Factor Adjustment Service Experience (FSE) field if you are evaluating the 581-Brittle Fracture DM.
Is Nominal Uncorroded Thickness < 50.8 mm (2 inch)	Boolean	Indicates whether the nominal thickness of the component before corrosion is less than 2 inches.	The value in this field is used to calculate the value in the Damage Factor Adjustment Service Experience (FSE) field if you are evaluating the 581-Brittle Fracture DM.
Is Satisfied All Requirements For Fabrication	Boolean	Indicates whether the component satisfies all the requirements of a recognized code or a standard at the time of fabrication.	The value in this field is used to calculate the value in the Damage Factor Adjustment Service Experience (FSE) field if you are evaluating the 581-Brittle Fracture DM.
Material Exemption Curve	Character	The material exemption curve to which the base material of the component is related.	<p>The value in this field is required to calculate the value in the Reference Temperature field if you are evaluating the 581-Brittle Fracture or the 581-Low Alloy Steel Embrittlement DM.</p> <p>This field contains the descriptions of all the System Codes in the MI_581_Material_Temperature_Exemption_Curves System Code Table. You can choose from the following baseline values:</p> <ul style="list-style-type: none"> • Temperature Exemption A Curve • Temperature Exemption B Curve • Temperature Exemption C Curve • Temperature Exemption D Curve

Field	Data Type	Description	Behavior and Usage
Minimum Allowable Temperature	Numeric	The minimum temperature, in degrees Fahrenheit, that is allowed in the component.	The value in this field is required to calculate the analysis if you are evaluating any of the following DMs: <ul style="list-style-type: none"> • 581-Sigma Phase Embrittlement • 581-885F Embrittlement • 581-Low Alloy Steel Embrittlement
Minimum Design Metal Temperature (MDMT)	Numeric	The minimum design metal temperature of the component in degrees Fahrenheit.	The value in this field is required to calculate the damage factor for the 581-885F Embrittlement or the 581-Low Alloy Steel Embrittlement DM.
Sigma Percentage	Numeric	The percentage of sigma.	The value in this field is required to calculate the damage factor if you are evaluating the 581-Sigma Phase Embrittlement DM. This field contains the descriptions of all the System Codes in the MI_581_Sigma_Percentage System Code Table. You can choose from the following baseline values: <ul style="list-style-type: none"> • 1 • 2 • 3 • 4 • 5 • 6 • 7 • 8 • 9 • >=10
The Output Section			
Base Damage Factor	Numeric	The base damage factor of the component.	This field is disabled and calculated based on the values in the Brittle Fracture section.

Field	Data Type	Description	Behavior and Usage
CET-Tref	Numeric	The difference between the critical exposure temperature and reference temperature of the component.	<p>This field is disabled and calculated as follows:</p> <p>CET-Tref = Critical Exposure Temperature (CET) - Reference Temperature</p> <p>Note: The UOM used for calculation is Degrees Fahrenheit.</p>

Field	Data Type	Description	Behavior and Usage																		
Damage Factor Adjustment Service Experience (FSE)	Numeric	The adjustment factor based on the operating and design conditions of the component.	<p>This field is disabled and populated automatically.</p> <p>If the value in the Nominal Thickness field is less than or equal to 0.5 inches or the values in the following fields are as follows, then the value in this field is 0.01. Otherwise, it is 1.0.</p> <table border="1" data-bbox="1144 598 1414 1719"> <thead> <tr> <th data-bbox="1144 598 1279 646">Field</th> <th data-bbox="1279 598 1414 646">Value</th> </tr> </thead> <tbody> <tr> <td data-bbox="1144 646 1279 762">Is CET at the MAWP >= -29? C</td> <td data-bbox="1279 646 1414 762">True</td> </tr> <tr> <td data-bbox="1144 762 1279 877">Is Cyclic service Design Requirement</td> <td data-bbox="1279 762 1414 877">False</td> </tr> <tr> <td data-bbox="1144 877 1279 1020">Is Asset Or Circuit Subject to EVN Cracking</td> <td data-bbox="1279 877 1414 1020">False</td> </tr> <tr> <td data-bbox="1144 1020 1279 1163">Is Asset Or Circuit Subject to Shock Chilling</td> <td data-bbox="1279 1020 1414 1163">False</td> </tr> <tr> <td data-bbox="1144 1163 1279 1285">Is Fabricated From P-1 and P-3 Steels</td> <td data-bbox="1279 1163 1414 1285">True</td> </tr> <tr> <td data-bbox="1144 1285 1279 1428">Is Nominal Operating Conditions Changed</td> <td data-bbox="1279 1285 1414 1428">False</td> </tr> <tr> <td data-bbox="1144 1428 1279 1604">Is Nominal Uncorroded Thickness < 50.8 mm (2 inch)</td> <td data-bbox="1279 1428 1414 1604">True</td> </tr> <tr> <td data-bbox="1144 1604 1279 1719">Is Satisfied All Requirements For Fabrication</td> <td data-bbox="1279 1604 1414 1719">True</td> </tr> </tbody> </table>	Field	Value	Is CET at the MAWP >= -29? C	True	Is Cyclic service Design Requirement	False	Is Asset Or Circuit Subject to EVN Cracking	False	Is Asset Or Circuit Subject to Shock Chilling	False	Is Fabricated From P-1 and P-3 Steels	True	Is Nominal Operating Conditions Changed	False	Is Nominal Uncorroded Thickness < 50.8 mm (2 inch)	True	Is Satisfied All Requirements For Fabrication	True
Field	Value																				
Is CET at the MAWP >= -29? C	True																				
Is Cyclic service Design Requirement	False																				
Is Asset Or Circuit Subject to EVN Cracking	False																				
Is Asset Or Circuit Subject to Shock Chilling	False																				
Is Fabricated From P-1 and P-3 Steels	True																				
Is Nominal Operating Conditions Changed	False																				
Is Nominal Uncorroded Thickness < 50.8 mm (2 inch)	True																				
Is Satisfied All Requirements For Fabrication	True																				
Final Damage Factor	Numeric	The final damage factor of the component.	This field is disabled, and calculated based on the value in the Base Damage Factor field.																		

Field	Data Type	Description	Behavior and Usage
Material Yield Strength	Numeric	The material yield strength of the base material used in the component.	This field is disabled and populated automatically.
Reference Temperature	Numeric	The reference temperature of the component in degrees Fahrenheit.	This field is disabled and calculated based on the values in the Brittle Fracture section.
Tmin	Numeric	The minimum design metal temperature of the component in degrees Fahrenheit.	This field is disabled and populated automatically with the value in the Minimum Design Metal Temperature (MDMT) field.
Tmin-Tref	Numeric	The difference between the minimum design metal temperature and the reference temperature of the component in degrees Fahrenheit.	This field is disabled and calculated as follows: Tmin-Tref = Minimum Design Metal Temperature (MDMT) - Reference Temperature
Tmpt	Numeric	The minimum allowable temperature of the component in degrees Fahrenheit.	This field is disabled and populated automatically with the value in the Minimum Allowable Temperature field.
Tmpt-(Tref+FATT)	Numeric	The difference between the minimum allowable temperature and the sum of reference temperature and fracture appearance transition temperature in degrees Fahrenheit.	This field is disabled and calculated as follows: Tmpt-(Tref+FATT) = Minimum Design Metal Temperature (MDMT) - (Reference Temperature + Fracture Appearance Transition Temperature (FATT))

RBI 581 Consequence Evaluation Records

RBI 581 Consequence Evaluation records store information about the evaluation that you have performed on the consequence of failure.

This topic provides an alphabetical list and description of the fields that exist for the RBI 581 Consequence Evaluation family. The information in the table reflects the baseline state and behavior of these fields. This list is not comprehensive.

This family is enabled for site filtering, which means that records in this family can be assigned to a specific site, and will only be accessible to users who are assigned to the same site and have the appropriate license and family privileges. For more information, refer to the Sites section of the documentation.

Field	Data Type	Description	Behavior and Usage
The Common Section			
Allow override of Total Financial Consequence	Boolean	Indicates whether you want to override the total loss calculated by GE Digital APM (populated in the User Total Financial Consequences field).	If you select this check box, the User Total Financial Consequences field is enabled.
Detection System	Character	The safety system that is used to detect a failure of the component.	<p>The value in this field is populated with the value in the Detection System field on the datasheet of the associated component.</p> <p>This field contains the description of all System Codes in the 581_Detection System Code Table. You can choose from the following baseline values:</p> <ul style="list-style-type: none"> • Loss of Pressure or Flow (A) • Pressure Envelope (B) • Visual Detection (C)
Environmental Clean-up Costs	Numeric	The cost incurred because of cleaning up the damage done to the environment due to the failure.	The value in this field is used to calculate the value in the Financial Consequence Environmental Clean-up Cost field.
Asset Cost	Numeric	The cost incurred because of loss or damage of asset due to the failure.	The value in this field is used to calculate the value in the Damage Cost Surrounding Equipment field.
Include Personnel Injury	Boolean	Indicates whether there is cost of injury to personnel due to the failure.	If you select this check box, the Injury Cost field is enabled.
Injury Cost	Numeric	The cost incurred because of injury to personnel due to the failure.	This field is enabled only if the Include Personnel Injury check box is selected. The value in this field is used to calculate the value in the Financial Injury Cost field.
Inventory Component Mass	Numeric	The inventory mass, in pounds, of the associated component.	If the Use Calculated Inventory check box is selected, then this field is disabled and calculated automatically.

Field	Data Type	Description	Behavior and Usage
Inventory Group	Character	The name of the inventory group to which the component belongs.	This field is populated with the value in the corresponding field in the associated component.
Inventory Group Mass	Numeric	The total inventory mass, in pounds, of the components in an inventory group.	If the Use Calculated Inventory check box is selected, then this field is disabled and calculated automatically.
Isolation System	Character	The safety system that is used to isolate the component in case of a hazard.	<p>The value in this field is populated with the value in the Isolation System field on the datasheet of the associated component.</p> <p>This field contains the descriptions of all the System Codes in the 581_Isolation System Code Table. You can choose from the following baseline values:</p> <ul style="list-style-type: none"> • Auto Shutdown • Leakage Shutdown (This value appears only if the value in the Detection System field is Pressure Envelope (B) or Visual Detection (C)) • Manual Shutdown (This value appears only if the value in the Detection System field is Visual Detection (C))

Field	Data Type	Description	Behavior and Usage
Mitigation System	Character	The safety system that is used to mitigate the risk of a failure.	<p>The value in this field is populated with the value in the Mitigation System field on the datasheet of the associated component.</p> <p>This field contains the descriptions of all the system codes in the 581_Mitigation_System System Code Table. You can choose from the following baseline values:</p> <ul style="list-style-type: none"> • Inventory Blowdown • Fire water deluge system • Fire water monitors only • Foam spray system • No mitigation system
Population Density	Numeric	The density of population, per square foot, in the area that the process unit is set up.	This field is disabled and populated with the value in the Numeric Field Value column for Population Density on the RBI 581 Admin Options page.
Production Cost	Numeric	The cost incurred because of loss of production.	The value in this field is required to calculate the value in the Lost Production On the Unit field.
Use Calculated Inventory	Boolean	Indicates whether you want GE Digital APM to calculate the values in the Inventory Component Mass and Inventory Group Mass fields.	If the component is linked to an inventory group , and, if you create or apply an RBI 581 Risk Analysis, this check box is selected automatically. If this check box is selected, the Inventory Component Mass and Inventory Group Mass fields are disabled and populated automatically.
User Total Financial Consequences	Numeric	The total financial loss, in USD, that is incurred due to the failure.	This field is enabled only if the Allow override of Total Financial Consequence check box is selected. Otherwise, this field is disabled and calculated as the sum of the values in the Injury Cost, Asset Cost, Production Cost, and Environmental Clean-up Cost fields.

Field	Data Type	Description	Behavior and Usage
The AST Inputs Section			
Distance from Tankbottom to Groundwater	Numeric	The distance, in feet, from the tank bottom to ground water.	The value in this field is required to calculate the analysis if the component type is Storage Tank Bottom.
Environmental Sensitivity	Character	The sensitivity of the environment.	<p>The value in this field is required to calculate the financial environmental cost for a rupture if the component type is Storage Tank or Storage Tank Bottom.</p> <p>This field contains the descriptions of all the system codes in the MI_581_Environmental_Sensitivity System Code Table. You can choose from the following baseline values:</p> <ul style="list-style-type: none"> • Low • Medium • High
Fluid Percent Leaving Dike	Numeric	The percentage of fluid leaving dike.	None
Fluid Percent Offsite	Numeric	The percentage of fluid leaving dike but not entering the water near the tank.	None
Fluid Percent Onsite	Numeric	The percentage of fluid leaving dike that remains onsite.	None

Field	Data Type	Description	Behavior and Usage
Maximum Fill Height in AST	Numeric	The maximum fill height, in feet, in the tank bottom.	<p>If the Has Release Prevention Barrier? check box in the associated analysis is selected, this field is disabled and populated with the value 0.25 feet. Otherwise, this field is enabled and blank.</p> <p>The value in this field is required to calculate the analysis if:</p> <ul style="list-style-type: none"> The component type is Storage Tank -or- The component type is Storage Tank Bottom, and the Has Release Prevention check box on the datasheet of the component is cleared.
Soil Type under Tank bottom	Character	The type of soil under the storage tank bottom.	<p>The value in this field is required to calculate the analysis if the component type is Storage Tank Bottom.</p> <p>This field contains the descriptions of all the system codes in the MI_581_Soil_Types System Code Table. You can choose from the following baseline values:</p> <ul style="list-style-type: none"> Clay Coarse Sand Concrete Asphalt Fine Sand Gravel Sand Clay Silt Very Fine Sand
Tank Course Height	Numeric	The height of the tank course.	The value in this field is required to calculate the analysis. This field is enabled only if the component type is Storage Tank.
The Intermediate Outputs Section			

Field	Data Type	Description	Behavior and Usage
Adjusted Release Rate Large	Numeric	The rate of release of the fluid in the component through a large-sized hole after considering the release reduction factor.	This field is disabled and calculated as follows: Adjusted Release Rate Large = Release Rate Large * (1 - Release Reduction Factor)
Adjusted Release Rate Medium	Numeric	The rate of release of the fluid in the component through a medium-sized hole after considering the release reduction factor.	This field is disabled and calculated as follows: Adjusted Release Rate Medium = Release Rate Medium * (1 - Release Reduction Factor)
Adjusted Release Rate Rupture	Numeric	The rate of release of the fluid in the component through a rupture after considering the release reduction factor.	This field is disabled and calculated as follows: Adjusted Release Rate Rupture = Release Rate Rupture * (1 - Release Reduction Factor)
Adjusted Release Rate Small	Numeric	The rate of release of the fluid in the component through a small-sized hole after considering the release reduction factor.	This field is disabled and calculated as follows: Adjusted Release Rate Small = Release Rate Small * (1 - Release Reduction Factor)
Component Damage Cost	Numeric	The total damage cost, in USD, of the component.	This field is disabled and calculated automatically.
Damage Cost Large	Numeric	The damage cost, in USD, incurred because of a large-sized hole in the component.	This field is disabled and calculated automatically.
Damage Cost Medium	Numeric	The damage cost, in USD, incurred because of a medium-sized hole in the component.	This field is disabled and calculated automatically.
Damage Cost Rupture	Numeric	The damage cost, in USD, incurred because of a rupture in the component.	This field is disabled and calculated automatically.
Damage Cost Small	Numeric	The damage cost, in USD, incurred because of a small-sized hole in the component.	This field is disabled and calculated automatically.
Damage Cost Surrounding Asset	Numeric	The financial consequence of damage, in USD, to the surrounding asset in the unit.	This field is disabled and calculated as follows: Damage Cost Surrounding Asset = Weighted Component Damage Consequence Area * Asset Cost

Field	Data Type	Description	Behavior and Usage
Detection System Classification	Character	The classification of the detection system that is installed on the component.	This field is disabled and populated automatically.
Energy Efficiency Correction Factor Large	Numeric	The correction factor for energy efficiency to be applied on the consequence area for a large-sized hole in the component.	This field is disabled and calculated automatically.
Energy Efficiency Correction Factor Medium	Numeric	The correction factor for energy efficiency to be applied on the consequence area for a medium-sized hole in the component.	This field is disabled and calculated automatically.
Energy Efficiency Correction Factor Rupture	Numeric	The correction factor for energy efficiency to be applied on the consequence area for a rupture in the component.	This field is disabled and calculated automatically.
Energy Efficiency Correction Factor Small	Numeric	The correction factor for energy efficiency to be applied on the consequence area for a small-sized hole in the component.	This field is disabled and calculated automatically.
Asset Outage Large	Numeric	The number of days of downtime that is required to repair the asset in the case of a large-sized hole.	This field is disabled and calculated automatically. The value in this field is used to calculate the values in the Lost Production On the Unit and the Total Financial Consequence fields.
Asset Outage Medium	Numeric	The number of days of downtime that is required to repair the asset in the case of a medium-sized hole.	This field is disabled and calculated automatically. The value in this field is used to calculate the values in the Lost Production On the Unit and the Total Financial Consequence fields.
Asset Outage Multiplier	Numeric	The multiplier that is used to calculate the asset outage.	This field is disabled and populated automatically with the value 1. The value in this field is used to calculate the values in the Lost Production On the Unit and the Total Financial Consequence fields.

Field	Data Type	Description	Behavior and Usage
Asset Outage Rupture	Numeric	The number of days of downtime that is required to repair the asset in the case of a rupture.	This field is disabled and calculated automatically. The value in this field is used to calculate the values in the Lost Production On the Unit and the Total Financial Consequence fields.
Asset Outage Small	Numeric	The number of days of downtime that is required to repair the asset in the case of a small-sized hole.	This field is disabled and calculated automatically. The value in this field is used to calculate the values in the Lost Production On the Unit and the Total Financial Consequence fields.
Financial Consequence Environmental Clean-up Cost	Numeric	The cost, in USD, incurred because of cleaning up the environment after a hazard.	This field is disabled and calculated automatically. The value in this field is used to calculate the value in the Total Financial Consequence field.
Financial Injury Cost	Numeric	The potential loss, in USD, incurred due to personal injury.	This field is disabled and calculated as follows: $\text{Financial Injury Cost} = \text{Population Density} * \text{Weighted Personnel Injury Consequence Area} * \text{Injury Cost}$ The value in this field is used to calculate the value in the Total Financial Consequence field.
Isolation System Classification	Character	The classification of the isolation system that is installed on the component.	This field is disabled and populated automatically.

Field	Data Type	Description	Behavior and Usage												
Lost Production On the Unit	Numeric	The financial loss, in USD, incurred due to outage of the asset and the surrounding asset in repair.	<p>This field is disabled and calculated as follows:</p> <p>Lost production On the Unit = $(\text{Outage}_{\text{cmd}} + \text{Outage}_{\text{affa}}) * \text{Prodcost}$</p> <p>...where:</p> <ul style="list-style-type: none"> • $\text{Outage}_{\text{cmd}}$ is the asset outage. • $\text{Outage}_{\text{affa}}$ is the surrounding asset outage. • Prodcost is the value in the Production Cost field. <p>The value in this field is used to calculate the value in the Total Financial Consequence field.</p>												
Mitigation Factor	Numeric	The adjustment factor based on the mitigation system that is used in the component.	<p>This field is disabled and populated automatically. The following table provides the values of Mitigation Factor based on the value in the Mitigation System field.</p> <table border="1"> <thead> <tr> <th>Mitigation System</th> <th>Mitigation Factor</th> </tr> </thead> <tbody> <tr> <td>Inventory Blowdown</td> <td>0.25</td> </tr> <tr> <td>Fire water deluge system</td> <td>0.20</td> </tr> <tr> <td>Fire water monitors only</td> <td>0.05</td> </tr> <tr> <td>Foam spray system</td> <td>0.15</td> </tr> <tr> <td>No mitigation system</td> <td>0</td> </tr> </tbody> </table> <p>The value in this field is used to calculate the value in the Weighted Component Damage Consequence Area field.</p>	Mitigation System	Mitigation Factor	Inventory Blowdown	0.25	Fire water deluge system	0.20	Fire water monitors only	0.05	Foam spray system	0.15	No mitigation system	0
Mitigation System	Mitigation Factor														
Inventory Blowdown	0.25														
Fire water deluge system	0.20														
Fire water monitors only	0.05														
Foam spray system	0.15														
No mitigation system	0														
Release Hole Diameter (Large)	Numeric	The diameter, in inches, of a large-sized hole in the component.	This field is disabled and is populated with the value from API RBI 3rd Edition specification based on the component type.												

Field	Data Type	Description	Behavior and Usage
Release Hole Diameter (Medium)	Numeric	The diameter, in inches, of a medium-sized hole in the component.	This field is disabled and is populated with the value from API RBI 3rd Edition specification based on the component type.
Release Hole Diameter (Rupture)	Numeric	The diameter, in inches, of a rupture in the component.	This field is disabled and is populated with the value from API RBI 3rd Edition specification based on the component type.
Release Hole Diameter (Small)	Numeric	The diameter, in inches, of a small-sized hole in the component.	This field is disabled and is populated with the value from API RBI 3rd Edition specification based on the component type.
Release Mass Large	Numeric	The mass of the fluid that is released from a large-sized hole.	This field is disabled and calculated automatically. The value in this field is used to calculate the value in the Toxic Release Mass Large field.
Release Mass Medium	Numeric	The mass of the fluid that is released from a medium-sized hole.	This field is disabled and calculated automatically. The value in this field is used to calculate the value in the Toxic Release Mass Medium field.
Release Mass Rupture	Numeric	The mass of the fluid that is released from a rupture.	This field is disabled and calculated automatically. The value in this field is used to calculate the value in the Toxic Release Mass Rupture field.
Release Mass Small	Numeric	The mass of the fluid that is released from a small-sized hole.	This field is disabled and calculated automatically. The value in this field is used to calculate the value in the Toxic Release Mass Small field.
Release Rate Large	Numeric	The rate of release of the fluid in the component through a large-sized hole.	This field is disabled and calculated automatically. The value in this field is used to calculate the value in the Toxic Release Rate Large field.
Release Rate Medium	Numeric	The rate of release of the fluid in the component through a medium-sized hole.	This field is disabled and calculated automatically. The value in this field is used to calculate the value in the Toxic Release Rate Medium field.

Field	Data Type	Description	Behavior and Usage
Release Rate Rupture	Numeric	The rate of release of the fluid in the component through a rupture.	This field is disabled and calculated automatically. The value in this field is used to calculate the value in the Toxic Release Rate Rupture field.
Release Rate Small	Numeric	The rate of release of the fluid in the component through a small-sized hole.	This field is disabled and calculated automatically. The value in this field is used to calculate the value in the Toxic Release Rate Small field.
Release Reduction Factor	Numeric	The reduction factor that will be applied to the release rate or mass based on the type of detection and isolation systems.	This field is disabled and calculated automatically. The value in this field is used to calculate the values in the Adjusted Release Rate Large, Adjusted Release Rate Medium, Adjusted Release Rate Rupture, and Adjusted Release Rate Small fields.
Release Type Large	Numeric	Indicates whether the release from a large-sized hole is continuous or instantaneous.	This field is disabled and populated with the value I (Instantaneous) if the release time is less than or equal to 180 seconds, and the value in the Release Mass Large is greater than 10,000 pounds. Otherwise, the value in this field is C (Continuous).
Release Type Medium	Numeric	Indicates whether the release from a medium-sized hole is continuous or instantaneous.	This field is disabled and populated with the value I (Instantaneous) if the release time is less than or equal to 180 seconds, and the value in the Release Mass Medium is greater than 10,000 pounds. Otherwise, the value in this field is C (Continuous).
Release Type Rupture	Numeric	Indicates whether the release from a rupture is continuous or instantaneous.	This field is disabled and populated with the value I (Instantaneous) if the release time is less than or equal to 180 seconds, and the value in the Release Mass Rupture is greater than 10,000 pounds. Otherwise, the value in this field is C (Continuous).

Field	Data Type	Description	Behavior and Usage
Release Type Small	Numeric	Indicates whether the release from a small-sized hole is continuous or instantaneous.	This field is disabled and populated with the value I (Instantaneous) if the release time is less than or equal to 180 seconds, and the value in the Release Mass Small is greater than 10,000 pounds. Otherwise, the value in this field is C (Continuous).
Total Toxic Release Mass Large	Numeric	The mass of the release of a toxic fluid in the component from a large-sized hole.	This field is disabled and calculated as follows: $\text{Total Toxic Release Mass Large} = \text{Release Mass Large} * \text{Mass Fraction}$...where Mass Fraction is the toxic percentage of toxic component in the release fluid.
Total Toxic Release Mass Medium	Numeric	The mass of the release of a toxic fluid in the component from a medium-sized hole.	This field is disabled and calculated as follows: $\text{Total Toxic Release Mass Medium} = \text{Release Mass Medium} * \text{Mass Fraction}$...where Mass Fraction is the toxic percentage of toxic component in the release fluid.
Total Toxic Release Mass Rupture	Numeric	The mass of the release of a toxic fluid in the component from a rupture.	This field is disabled and calculated as follows: $\text{Total Toxic Release Mass Rupture} = \text{Release Mass Rupture} * \text{Mass Fraction}$...where Mass Fraction is the toxic percentage of toxic component in the release fluid.
Total Toxic Release Mass Small	Numeric	The mass of the release of a toxic fluid in the component from a small-sized hole.	This field is disabled and calculated as follows: $\text{Total Toxic Release Mass Small} = \text{Release Mass Small} * \text{Mass Fraction}$...where Mass Fraction is the toxic percentage of toxic component in the release fluid.

Field	Data Type	Description	Behavior and Usage
Toxic Release Rate Large	Numeric	The rate of release of a toxic fluid in the component from a large-sized hole.	This field is disabled and calculated as follows: Toxic Release Rate Large = Release Rate Large * Mass Fraction ...where Mass Fraction is the toxic percentage of toxic component in the release fluid.
Toxic Release Rate Medium	Numeric	The rate of release of a toxic fluid in the component from a medium-sized hole.	This field is disabled and calculated as follows: Toxic Release Rate Medium= Release Rate Medium * Mass Fraction ...where Mass Fraction is the toxic percentage of toxic component in the release fluid.
Toxic Release Rate Rupture	Numeric	The rate of release of a toxic fluid in the component from a rupture.	This field is disabled and calculated as follows: Toxic Release Rate Rupture= Release Rate Rupture * Mass Fraction ...where Mass Fraction is the toxic percentage of toxic component in the release fluid.
Toxic Release Rate Small	Numeric	The rate of release of a toxic fluid in the component from a small-sized hole.	This field is disabled and calculated as follows: Toxic Release Rate Large = Release Rate Small * Mass Fraction ...where Mass Fraction is the toxic percentage of toxic component in the release fluid.
The Output Data Section			

Field	Data Type	Description	Behavior and Usage
Final Consequence Area	Numeric	The final consequence are in square feet.	<p>This field is disabled and populated with the maximum value among the values in the following fields:</p> <ul style="list-style-type: none"> Weighted Component Damage Consequence Area Weighted NFNT Consequence Area Weighted Personnel Injury Consequence Area Weighted Toxic Consequence Area <p>The value in this field is used to plot the financial risk on the RBI 581 ISO Risk Plot.</p>
Total Financial Consequence	Numeric	The total financial loss, in USD, incurred due to the failure.	<p>This field is disabled and calculated as the sum of the following values:</p> <ul style="list-style-type: none"> Financial Injury Cost Lost Production On the Unit Financial Consequence Environmental Clean-up Cost Surrounding Equipment Outage Equipment Outage <p>The value in this field is used to plot the financial risk on the RBI 581 ISO Risk Plot.</p>
Weighted Component Damage Consequence Area	Numeric	The final component damage consequence area in square feet.	This field is disabled and calculated automatically.
Weighted NFNT Consequence Area	Numeric	The weighted asset damage consequence area for non-flammable, non-toxic releases such as steam or acids in square feet.	This field is disabled and calculated automatically.
Weighted Personnel Injury Consequence Area	Numeric	The weighted personnel injury flammable consequence area in square feet.	This field is disabled and calculated automatically.
Weighted Toxic Consequence Area	Numeric	The weighted personnel injury toxic consequence area in square feet.	This field is disabled and calculated automatically.

RBI 581 Cracking Damage Evaluation Records

RBI 581 Cracking Damage Evaluation records store information about the evaluation that you have performed on the following damage mechanisms (DMs):

- 581-Amine Cracking
- 581-Alkaline Carbonate Stress Corrosion Cracking
- 581-HIC/SOHIC - HF
- 581-HIC/SOHIC - H2S
- 581-Caustic Cracking
- 581-Hydrogen Stress Cracking
- 581-Other Cracking
- 581-Sulfide Stress Cracking
- 581-Chloride Stress Corrosion Cracking
- 581-Polythionic Acid Cracking

This topic provides an alphabetical list and description of the fields that exist for the RBI 581 Cracking Damage Evaluation family. The information in the table reflects the baseline state and behavior of these fields. This list is not comprehensive.

This family is enabled for site filtering, which means that records in this family can be assigned to a specific site, and will only be accessible to users who are assigned to the same site and have the appropriate license and family privileges. For more information, refer to the Sites section of the documentation.

Field	Data Type	Description	Behavior and Usage
The General Section			
Calculated Susceptibility	Character	The calculated susceptibility level for the damage mechanism.	This field is disabled and calculated automatically.
Damage Mechanism	Character	The damage mechanism that you want to evaluate.	This field is disabled and populated automatically.
Date in Service	Date	The date and time on which the component is in service.	This value is populated with the value in the Component Date in Service field on the RBI Component datasheet. You can, however, change this value using the calendar feature. The value in this field is used to calculate the Age for RBI Date and Without Plan calculations if there is no value in the Last Known Inspection Date field. The Age calculation for With Plan will always consider the Target Inspection Date field.

Field	Data Type	Description	Behavior and Usage
Highest Effective Inspection Level	Character	The highest level of effective inspections.	<p>The value in this field is required to calculate the value in the Base Damage Factor field. If you select the Use Combined Confidence check box, then the value in this field is calculated automatically.</p> <p>This field contains the descriptions of all the System Codes in the MI_581_Inspection_Effectiveness System Code Table. You can choose from the following baseline values:</p> <ul style="list-style-type: none"> • Highly Effective • Usually Effective • Fairly Effective • Poorly Effective • InEffective (None)
Hydrogen Probes	Character	Indicates whether hydrogen probes are present.	<p>This field is enabled only if the value in the Online Monitoring Flag is Yes (Y). The value in this field is used to calculate the value in the Online Monitoring Adjustment field.</p> <p>This field contains the descriptions of all System Codes in the MI_YES_NO System Code Table. You can choose from the following baseline values:</p> <ul style="list-style-type: none"> • Yes (Y) • No (N)

Field	Data Type	Description	Behavior and Usage
Key Process Variable?	Character	Indicates whether there are any key process variables monitored for the damage mechanism.	<p>This field is enabled only if the value in the Online Monitoring Flag is Yes (Y). The value in this field is used to calculate the value in the Online Monitoring Adjustment field.</p> <p>This field contains the descriptions of all System Codes in the MI_YES_NO System Code Table. You can choose from the following baseline values:</p> <ul style="list-style-type: none"> • Yes (Y) • No (N)
Last Known Inspection Date	Date	The date on which the component was last inspected for cracking.	<p>This field is populated by the value in the Completion Date field for the Inspection. If there is more than one linked Inspection, the latest date is used. If there are no linked Inspections, this field will be blank. You can also enter a value in this field manually.</p> <p>The value in this field is used to calculate the Age for RBI Date and Without Plan calculations. If there is no value, the Date In Service field will be used. The Age calculation for With Plan will always consider the Target Inspection Date field.</p>
Number of Highest Effective Inspections	Numeric	The number of inspections with the level that is specified in the Highest Effective Insp field.	<p>You can enter a value between 0 and 6. If you enter 0, then the Highest Effective Inspection Level field is disabled and populated with the value InEffective (None).</p> <p>The value in this field is required to calculate the value in the Base Damage Factor field. If you select the Use Combined Confidence check box, then the value in this field is calculated automatically.</p>

Field	Data Type	Description	Behavior and Usage
Online Monitoring Flag	Character	Indicates whether the component is monitored online to check for damage.	<p>This field is used to calculate the analysis if you are evaluating the 581-HIC/SOHIC - H2S or the 581-HIC/SOHIC - HF DM.</p> <p>This field contains the descriptions of all System Codes in the MI_YES_NO System Code Table. You can choose from the following baseline values:</p> <ul style="list-style-type: none"> • Yes (Y) • No (N)
Severity Index Adjustment Factor	Numeric	The adjustment factor for severity index.	<p>This field is enabled only if you are evaluating the 581-Other Cracking DM. Otherwise, this field is disabled and populated automatically. In the case of 581-Other Cracking, the value in this field is used to calculate the value in the Base Severity Index field.</p> <p>This field must contain one of the following values:</p> <ul style="list-style-type: none"> • 1 • 0.2 • 0.02

Field	Data Type	Description	Behavior and Usage
Susceptibility	Character	The susceptibility level for the damage mechanism.	<p>The value in this field is used to calculate the value in the Base Damage Factor field. This field contains the descriptions of all System Codes in the MI_581_Cracking_Susceptibility System Code Table. You can choose from the following baseline values:</p> <ul style="list-style-type: none"> • High • Medium • Low • None <p>If the value in the Susceptibility Type field is:</p> <ul style="list-style-type: none"> • Detected, then this field is disabled and populated with the value High. • Estimated, then this field is enabled, and you can select a value manually. • Calculated, then this field is disabled and blank.

Field	Data Type	Description	Behavior and Usage
Susceptibility Type	Character	Indicates whether you want to provide an estimated value of susceptibility or have GE Digital APM calculate the value.	<p>The value in this field is required to populate the value in the Susceptibility field.</p> <p>This field contains the descriptions of all System Codes in the MI_581_Cracking_Susceptibility_Types System Code Table. You can choose from the following baseline values:</p> <ul style="list-style-type: none"> • Estimated: If you select this value, then you can select a value in the Susceptibility field. • Detected: If you select this value, then the Susceptibility field is disabled, and populated with the value, High. • Calculated: If you select this value, then the value in the Susceptibility field is calculated based on the values in the fields in the Susceptibility Inputs section.
Use Combined Confidence	Boolean	Indicates whether you want GE Digital APM to calculate the highest effective inspection level and number.	If you select this check box, then the values in the Highest Effective Inspection Level and Number of Highest Effective Inspections fields are calculated automatically.
The Susceptibility Inputs Section			

Field	Data Type	Description	Behavior and Usage
Amine Solution Type	Character	The type of the amine solution that is used in the component.	<p>This field contains the descriptions of all System Codes in the MI_581_Amine_Solution_Types System Code Table. You can choose from the following baseline values:</p> <ul style="list-style-type: none"> • Fresh • Lean • Rich <p>The value in this field is used to calculate the value in the Susceptibility field if the following conditions are satisfied:</p> <ul style="list-style-type: none"> • You are evaluating the 581-Amine Cracking DM. • The value in the Susceptibility Type field is Calculated. <p>If the value in the Amine Type field is Fresh or Rich, then the value in the Final Susceptibility field is None. If the value in the Amine Type field is Lean, then the value in the Final Susceptibility field is calculated based on the value in the Amine Type field.</p>

Field	Data Type	Description	Behavior and Usage
Amine Type	Character	The type of amine that is used in the component.	<p>The value in this field is used to calculate the value in the Susceptibility field if:</p> <ul style="list-style-type: none"> • You are evaluating the 581-Amine Cracking DM. -and- • The value in the Susceptibility Type field is Calculated. <p>This field contains the descriptions of all System Codes in the MI_581_Amine_Types System Code Table. You can choose from the following baseline values:</p> <ul style="list-style-type: none"> • MEA • DIPA • DEA • Other Amine
Caustic Type	Character	Indicates the area that the component falls into as plotted on the Susceptibility of Caustic Cracking in Carbon Steel graph.	<p>The value in this field is used to calculate the value in the Susceptibility field if:</p> <ul style="list-style-type: none"> • You are evaluating the 581-Caustic Cracking DM. -and- • The value in the Susceptibility Type field is Calculated. <p>This field contains the descriptions of all System Codes in the MI_581_Caustic_Types System Code Table. You can choose from the following baseline values:</p> <ul style="list-style-type: none"> • Area A • Area B • Area C

Field	Data Type	Description	Behavior and Usage
Chloride Concentration Water Process	Numeric	The concentration of chloride, in ppm, in the water that is used in the component.	<p>The value in this field is used to calculate the value in the Susceptibility field if:</p> <ul style="list-style-type: none"> • You are evaluating the 581-Chloride Stress Corrosion Cracking DM. -and- • The value in the Susceptibility Type field is Calculated.
CO3 Concentration in Water	Numeric	The concentration of carbonate, in ppm, in the water that is used in the component.	<p>The value in this field is used to calculate the value in the Susceptibility field if:</p> <ul style="list-style-type: none"> • You are evaluating the 581-Alkaline Carbonate Stress Corrosion Cracking DM. -and- • The value in the Susceptibility Type field is Calculated.
Cyanides	Boolean	Indicates if cyanides are present in the fluid that is used in the component.	<p>The value in this field is used to calculate the value in the Susceptibility field if:</p> <ul style="list-style-type: none"> • You are evaluating the 581-Sulfide Stress Cracking or the 581-HIC/SOHIC - H2S DM. -and- • The value in the Susceptibility Type field is Calculated.

Field	Data Type	Description	Behavior and Usage
Downtime Protection Used	Character	Indicates if downtime protection is used in the component.	<p>The value in this field is used to calculate the value in the Susceptibility field if:</p> <ul style="list-style-type: none"> • You are evaluating the 581-Polythionic Acid Cracking DM. -and- • The value in the Susceptibility Type field is Calculated. <p>This field contains the descriptions of all System Codes in the MI_YES_NO System Code Table. You can choose from the following baseline values:</p> <ul style="list-style-type: none"> • Yes (Y) • No (N)
Exposure to Oxygen During Operation/Downtime	Character	Indicates whether the component is exposed to oxygen when the component is operating or when it is shut down.	<p>The value in this field is used to calculate the value in the Susceptibility field if:</p> <ul style="list-style-type: none"> • You are evaluating the 581-Polythionic Acid Cracking DM. -and- • The value in the Susceptibility Type field is Calculated. <p>This field contains the descriptions of all System Codes in the MI_YES_NO System Code Table. You can choose from the following baseline values:</p> <ul style="list-style-type: none"> • Yes (Y) • No (N)

Field	Data Type	Description	Behavior and Usage
Exposure to Sulfur During Operation/Downtime	Character	Indicates whether the component is exposed to sulfur when the component is operating or when it is shut down.	<p>The value in this field is used to calculate the value in the Susceptibility field if:</p> <ul style="list-style-type: none"> • You are evaluating the 581-Polythionic Acid Cracking DM. -and- • The value in the Susceptibility Type field is Calculated. <p>This field contains the descriptions of all System Codes in the MI_YES_NO System Code Table. You can choose from the following baseline values:</p> <ul style="list-style-type: none"> • Yes (Y) • No (N)
Exposure to Water During Operation/Shutdown	Character	Indicates whether the component is exposed to water when the component is operating or when it is shut down.	<p>The value in this field is used to calculate the value in the Susceptibility field if:</p> <ul style="list-style-type: none"> • You are evaluating the 581-Polythionic Acid Cracking DM. -and- • The value in the Susceptibility Type field is Calculated. <p>This field contains the descriptions of all System Codes in the MI_YES_NO System Code Table. You can choose from the following baseline values:</p> <ul style="list-style-type: none"> • Yes (Y) • No (N)
H2S Water Content	Numeric	The concentration of H2S, in ppm, in water that is used in the component.	<p>The value in this field is used to calculate the value in the Susceptibility field if:</p> <ul style="list-style-type: none"> • You are evaluating the 581-HIC/SOHIC - H2S DM. -and- • The value in the Susceptibility Type field is Calculated.

Field	Data Type	Description	Behavior and Usage
Heat Traced?	Character	Indicates whether heat tracing is used in the component.	<p>The value in this field is used to calculate the value in the Susceptibility field if:</p> <ul style="list-style-type: none"> You are evaluating the 581-Amine Cracking, 581-Alkaline Carbonate Stress Corrosion Cracking, or the 581-Caustic Cracking DM. -and- The value in the Susceptibility Type field is Calculated. <p>This field contains the descriptions of all System Codes in the MI_YES_NO System Code Table. You can choose from the following baseline values:</p> <ul style="list-style-type: none"> Yes (Y) No (N)
HF Present?	Character	Indicates whether HF is present in the fluid that is used in the component.	<p>The value in this field is used to calculate the value in the Susceptibility field if:</p> <ul style="list-style-type: none"> You are evaluating the 581-HIC/SOHIC - HF or the 581-Hydrogen Stress Cracking DM. -and- The value in the Susceptibility Type field is Calculated. <p>This field contains the descriptions of all System Codes in the MI_YES_NO System Code Table. You can choose from the following baseline values:</p> <ul style="list-style-type: none"> Yes (Y) No (N)

Field	Data Type	Description	Behavior and Usage
Maximum Brinnell Hardness	Numeric	The maximum brinnell hardness of the material used in the component.	<p>The value in this field is used to calculate the value in the Susceptibility field if:</p> <ul style="list-style-type: none"> You are evaluating the 581-Hydrogen Stress Cracking or the 581-Sulfide Stress Cracking DM. -and- The value in the Susceptibility Type field is Calculated.
NaOH Caustic Concentration	Numeric	The concentration, in weight percentage, of NaOH in the fluid used in the component.	<p>The value in this field is used to calculate the value in the Susceptibility field if:</p> <ul style="list-style-type: none"> You are evaluating the 581-Caustic Cracking DM. -and- The value in the Susceptibility Type field is Calculated.
Product Form	Character	The form of the material that is used in the component.	<p>The value in this field is used to calculate the value in the Susceptibility field if:</p> <ul style="list-style-type: none"> You are evaluating the 581-HIC/SOHIC - H2S DM. -and- The value in the Susceptibility Type field is Calculated. <p>This field contains the descriptions of all System Codes in the MI_581_Product_Form System Code Table. You can choose from the following baseline values:</p> <ul style="list-style-type: none"> Seamless/Extruded Pipe Rolled Plate

Field	Data Type	Description	Behavior and Usage
Steam Out?	Character	Indicates whether steam is released from the component.	<p>The value in this field is used to calculate the value in the Susceptibility field if:</p> <ul style="list-style-type: none"> • You are evaluating the 581-Amine Cracking, 581-Alkaline Carbonate Stress Corrosion Cracking, or the 581-Caustic Cracking DM. -and- • The value in the Susceptibility Type field is Calculated. <p>This field contains the descriptions of all System Codes in the MI_YES_NO System Code Table. You can choose from the following baseline values:</p> <ul style="list-style-type: none"> • Yes (Y) • No (N)
Sulfur Content of Steel	Character	The content of sulfur, in ppm, in the steel that is used in the component.	<p>The value in this field is used to calculate the value in the Susceptibility field if:</p> <ul style="list-style-type: none"> • You are evaluating the 581-HIC/SOHIC - H2S DM. -and- • The value in the Susceptibility Type field is Calculated. <p>This field contains the descriptions of all System Codes in the MI_581_Sulfur_Content_Of_Steel System Code Table. You can choose from the following baseline values:</p> <ul style="list-style-type: none"> • High Sulfur Steel (>0.01% S) • Low Sulfur Steel (<=0.01% S)

Field	Data Type	Description	Behavior and Usage
Thermal History (Heat Treatment History)	Character	The heat treatment that has been conducted on the component.	<p>The value in this field is used to calculate the value in the Susceptibility field if:</p> <ul style="list-style-type: none"> You are evaluating the 581-Polythionic Acid Cracking DM. -and- The value in the Susceptibility Type field is Calculated. <p>This field contains the descriptions of all System Codes in the MI_581_Heat_Treatment_History System Code Table. You can choose from the following baseline values:</p> <ul style="list-style-type: none"> Solution Annealed Stabilized Before Welding Stabilized After Welding
The Outputs Section			
Age	Numeric	The time, in years, since the last inspection was performed. If no inspection has been performed, then the value in the Date in Service field is used.	This field is disabled and populated automatically.
Base Damage Factor	Numeric	The damage factor of the component before considering adjustment factors.	This field is disabled and calculated automatically.
Base Severity Index	Numeric	The base severity index of the DM.	This field is disabled and calculated automatically.
Final Damage Factor	Numeric	The damage factor of the component after considering the adjustment factors.	This field is disabled and calculated automatically.
Final Susceptibility	Numeric	The susceptibility level that the component is subject to because of damage.	This field is disabled and calculated automatically.

Field	Data Type	Description	Behavior and Usage															
Online Monitoring Adjustment	Numeric	The adjustment factor for online monitoring.	<p>This field is disabled and populated automatically based on the values in the Key Process Variables and Hydrogen Probes fields:</p> <table border="1"> <thead> <tr> <th>Key Process Variables</th> <th>Hydrogen Probes</th> <th>Online Monitoring Adjustment</th> </tr> </thead> <tbody> <tr> <td>No (N)</td> <td>No (N)</td> <td>1</td> </tr> <tr> <td>Yes (Y)</td> <td>No (N)</td> <td>2</td> </tr> <tr> <td>No (N)</td> <td>Yes (Y)</td> <td>2</td> </tr> <tr> <td>Yes (Y)</td> <td>Yes (Y)</td> <td>4</td> </tr> </tbody> </table>	Key Process Variables	Hydrogen Probes	Online Monitoring Adjustment	No (N)	No (N)	1	Yes (Y)	No (N)	2	No (N)	Yes (Y)	2	Yes (Y)	Yes (Y)	4
Key Process Variables	Hydrogen Probes	Online Monitoring Adjustment																
No (N)	No (N)	1																
Yes (Y)	No (N)	2																
No (N)	Yes (Y)	2																
Yes (Y)	Yes (Y)	4																
Time Since Last Inspection	Numeric	The time since you last performed inspection for cracking on the component.	This field is disabled and populated automatically.															

RBI 581 External Cracking Damage Evaluation Records

RBI 581 External Cracking Damage Evaluation records store information about the evaluation that you have performed on the following damage mechanisms (DMs):

- 581-Austenitic Component Atmospheric Cracking
- 581-Austenitic Component Cracking Under Insulation

This topic provides an alphabetical list and description of the fields that exist for the RBI 581 External Cracking Damage Evaluation family. The information in the table reflects the baseline state and behavior of these fields. This list is not comprehensive.

This family is enabled for site filtering, which means that records in this family can be assigned to a specific site, and will only be accessible to users who are assigned to the same site and have the appropriate license and family privileges. For more information, refer to the Sites section of the documentation.

Field	Data Type	Description	Behavior and Usage
The General Section			
Damage Mechanism	Character	The damage mechanism that you want to evaluate.	This field is disabled and populated automatically.

Field	Data Type	Description	Behavior and Usage
Date in Service	Date	The date and time on which the component is in service.	<p>This value is populated with the value in the Component Date in Service field on the RBI Component datasheet. You can, however, change this value using the calendar feature.</p> <p>The value in this field is used to calculate the Age for RBI Date and Without Plan calculations if there is no value in the Last Known Inspection Date field. The Age calculation for With Plan will always consider the Target Inspection Date field.</p>
Highest Effective Inspection Level	Character	The highest level of effective inspections.	<p>The value in this field is required to calculate the value in the Base Damage Factor field. If you select the Use Combined Confidence check box, then the value in this field is calculated automatically.</p> <p>This field contains the descriptions of all the System Codes in the MI_581_Inspection_Effectiveness System Code Table. You can choose from the following baseline values:</p> <ul style="list-style-type: none"> • Fairly Effective • Highly Effective • Ineffective (None) • Poorly Effective • Usually Effective

Field	Data Type	Description	Behavior and Usage
Last Known Inspection Date	Date	The date on which the component was last inspected for external cracking. Ideally, the valid thickness is also measured on this date.	<p>This field is populated by the value in the Completion Date field for the Inspection. If there is more than one linked Inspection, the latest date is used. If there are no linked Inspections, this field will be blank. You can also enter a value in this field manually.</p> <p>The value in this field is used to calculate the Age for RBI Date and Without Plan calculations. If there is no value, the Date In Service field will be used. The Age calculation for With Plan will always consider the Target Inspection Date field.</p>
Number of Highest Effective Inspections	Numeric	The number of highest effective inspections.	<p>You can enter a value between 0 and 6.</p> <p>The value in this field is required to calculate the value in the Base Damage Factor field. If you select the Use Combined Confidence check box, then the value in this field is calculated automatically.</p>
Use Combined Confidence	Boolean	Indicates whether you want GE Digital APM to calculate the highest effective inspection level and number.	If you select this check box, the values in the Highest Effective Inspection Level and Number of Highest Effective Inspections fields are calculated automatically.
The Inputs Section			

Field	Data Type	Description	Behavior and Usage
Atmospheric Condition	Character	The atmospheric condition in which the component exists.	<p>The value in this field is used to calculate the value in the Calculated Susceptibility field if the value in the Selected External Corrosion Rate field is Calculated.</p> <p>This field contains the descriptions of all System Codes in the MI_ATMOSPHERIC_CONDITION System Code Table. You can choose from the following baseline values:</p> <ul style="list-style-type: none"> • Dry • Marine • Severe • Temperate
Calculated Susceptibility	Character	The susceptibility value that is calculated by GE Digital APM.	This field is disabled and calculated if the value in the Susceptibility Type field is Calculated.
Chloride Free Insulation	Character	Indicates whether the insulation contains chlorides.	<p>The value in this field is used to calculate the value in the Final Susceptibility field if the DM that you are evaluating is 581-Austenitic Component Cracking Under Insulation.</p> <p>This field contains the descriptions of all System Codes in the MI_YES_NO System Code Table. You can choose from the following baseline values:</p> <ul style="list-style-type: none"> • Yes (Y) • No (N)
Coating Installation Date	Date	The date and time on which coating has been installed on the component.	The value in this field is used to calculate the value in the Coating Age field. This field is enabled only if the value in the Coating Present? field is Yes (Y). You can use the Calendar feature to select the date and time.

Field	Data Type	Description	Behavior and Usage
Coating Present?	Character	Indicates if external coating is installed on the component.	<p>The value in this field is used to calculate the analysis.</p> <p>This field contains the descriptions of all System Codes in the MI_YES_NO System Code Table. You can choose from the following baseline values:</p> <ul style="list-style-type: none"> • Yes (Y) • No (N)
Coating Quality	Character	The quality of the coating that is installed on the component.	<p>The value in this field is used to calculate the value in the Coating Adjustment field. This field is enabled only if the value in the Coating present? field is Yes (Y).</p> <p>This field contains the descriptions of all System Codes in the 581_Coating_Quality System Code Table. You can choose from the following baseline values:</p> <ul style="list-style-type: none"> • High • Medium • Low • None
Insulation Condition	Character	The condition of the insulation.	<p>The value in this field is used to calculate the value in the Final Susceptibility field if the DM that you are evaluating is 581-Austenitic Component Cracking Under Insulation.</p> <p>This field must contain one of the following values:</p> <ul style="list-style-type: none"> • Above Average • Average • Below Average

Field	Data Type	Description	Behavior and Usage
Pipeline Segment Type	Character	The complexity of the piping system in the component.	<p>The value in this field is used to calculate the value in the Final Susceptibility field if the DM that you are evaluating is 581-Austenitic Component Cracking Under Insulation.</p> <p>This field must contain one of the following values:</p> <ul style="list-style-type: none"> • Above Average • Average • Below Average
Susceptibility	Character	The level of susceptibility to cracking that the component is subject to.	<p>The value in this field is used to calculate the analysis if the value in the Susceptibility Type is Estimated.</p> <p>This field contains the descriptions of all System Codes in the MI_581_Cracking_Susceptibility System Code Table. You can choose from the following baseline values:</p> <ul style="list-style-type: none"> • High • Medium • Low • None

Field	Data Type	Description	Behavior and Usage
Susceptibility Type	Character	Indicates whether you want to provide an estimated value of susceptibility or have GE Digital APM calculate the value.	<p>The value in this field is required to populate the value in the Susceptibility field.</p> <p>This field contains the descriptions of all System Codes in the MI_581_Cracking_Susceptibility_Types System Code Table. You can choose from the following baseline values:</p> <ul style="list-style-type: none"> • Estimated: If you select this value, you can select a value in the Susceptibility field. • Detected: If you select this value, the Susceptibility field is disabled, and populated with the value, High. • Calculated: If you select this value, the value in the Susceptibility field is calculated based on the values in the Atmospheric Condition and Operating Temperature fields.
The Intermediate Outputs Section			
Age	Numeric	The duration, in years, in which the component is subject to damage after the coating has been determined to be ineffective.	<p>This field is disabled and calculated as follows:</p> $\text{Age} = \text{Component Age} - \text{Coating Adjustment}$ <p>...where Component Age is the time since the date in the Last Known Inspection Date field. If this value is not specified, then the date in the Component Start Date field is considered.</p>
Base Damage Factor	Numeric	The damage factor of the component before considering adjustment factors.	This field is disabled and calculated automatically.
Coating Adjustment	Numeric	The adjustment factor for coating age.	This field is disabled and calculated automatically.

Field	Data Type	Description	Behavior and Usage
Coating Age	Numeric	The duration between the date on which coating was installed and the date on which you calculate the analysis (RBI Date or Plan Date).	This field is disabled and calculated as follows: Coating Age = Calculation Date - Coating Installation Date ...where Calculation Date is the value in the RBI Date field on the RBI 581 Risk Analysis datasheet.
Final Damage Factor	Numeric	The damage factor of the component after considering adjustment factors.	This field is disabled and calculated automatically.
Final Susceptibility	Numeric	The level of susceptibility to external cracking that the component is subject to, after considering the adjustment factors.	This field is disabled and calculated automatically.
Severity Index	Numeric	The severity index of the DM.	This field is disabled and calculated automatically.
Time Since Last Inspection	Numeric	The time since you have last performed inspection on external cracking on the component.	This field is disabled and populated automatically.

RBI 581 External Damage Evaluation Records

RBI 581 External Damage Evaluation records store information about the evaluation that you have performed on the following damage mechanisms (DMs):

- 581-Ferritic Component Atmospheric Corrosion
- 581-Ferritic Component Corrosion Under Insulation

This topic provides an alphabetical list and description of the fields that exist for the RBI 581 External Damage Evaluation family. The information in the table reflects the baseline state and behavior of these fields. This list is not comprehensive.

This family is enabled for site filtering, which means that records in this family can be assigned to a specific site, and will only be accessible to users who are assigned to the same site and have the appropriate license and family privileges. For more information, refer to the Sites section of the documentation.

Field	Data Type	Description	Behavior and Usage
The General Section			
Base Material Calculated Corrosion Rate	Numeric	The corrosion rate of the component that is calculated by GE Digital APM.	This field is disabled and populated automatically. The value in this field is used to calculate the value in the Final Corrosion Rate field if the value in the Selected External Corrosion Rate field is Calculated.
Base Material Estimated Corrosion Rate	Numeric	The corrosion rate of the component that is estimated by a subject matter expert.	This field is populated with the value in the Estimated External Corrosion Rate field on the RBI Component datasheet. The value in this field is used to calculate the value in the Final Corrosion Rate field if the value in the Selected External Corrosion Rate field is Estimated.
Base Material Measured Corrosion Rate	Numeric	The corrosion rate of the component measured while carrying out inspection.	The value in this field is used to calculate the value in the Final Corrosion Rate field if the value in the Selected External Corrosion Rate field is Measured.
Damage Mechanism	Character	The damage mechanism that you want to evaluate.	This field is disabled and populated automatically.
Date in Service	Date	The date and time on which the component is in service.	This value is populated with the value in the Component Date in Service field on the RBI Component datasheet. You can, however, change this value using the calendar feature. The value in this field is used to calculate the value in the Age field if there is no value in the Last Known Inspection Date and Last Known Thickness fields.

Field	Data Type	Description	Behavior and Usage
Selected External Corrosion Rate	Character	Indicates whether you want to enter measured or estimated corrosion rate manually, or you want GE Digital APM to calculate the corrosion rate.	<p>The value in this field is required to calculate the analysis.</p> <p>This field contains the descriptions of all System Codes in the MI_581_Corrosion_Rate System Code Table. You can choose from the following baseline values:</p> <ul style="list-style-type: none"> • Estimated • Calculated • Measured
Thinning Type	Character	The type of thinning in the component.	<p>The value in this field is required to calculate the value in the Final Damage Factor field.</p> <p>This field contains the descriptions of all System Codes in the CORROSION TYPES System Code Table. You can choose from the following baseline values:</p> <ul style="list-style-type: none"> • General • Localized
The External section			
Atmospheric Condition	Character	The atmospheric condition in which the component has been installed.	<p>The value in this field is used to calculate the value in the Base Material Calculated Rate if the value in the Selected External Corrosion Rate field is Calculated.</p> <p>This field contains the descriptions of all System Codes in the MI_ATMOSPHERIC_CONDITION System Code Table. You can choose from the following baseline values:</p> <ul style="list-style-type: none"> • Marine • Temperate • Dry • Severe

Field	Data Type	Description	Behavior and Usage
Coating Installation Date	Date	The date and time on which external coating has been installed on the component.	This field is enabled only if the value in the Coating Present? field is Yes (Y). The value in this field is used to calculate the value in the Coating Age field. You can use the calendar feature to select the date and time.
Coating Present?	Character	Indicates whether external coating is present on the component.	This field contains the descriptions of all System Codes in the MI_YES_NO System Code Table. You can choose from the following baseline values: <ul style="list-style-type: none"> • Yes (Y) • No (N)
Coating Quality	Character	The quality of the coating that has been installed on the component.	This field is enabled only if the value in the Coating present? field is Yes (Y). The value in this field is used to calculate the value in the Coating Adjustment field. <p>This field contains the descriptions of all System Codes in the 581_Coating_Quality System Code Table. You can choose from the following baseline values:</p> <ul style="list-style-type: none"> • None • Poor • Medium • High
Corrosion Rate Adjustment for bad Design/Fabrication	Boolean	Indicates if adjustment should be accounted for bad design or fabrication of the component.	The value in this field is required to calculate the value in the Corrosion rate Adjustment factor for bad asset design/fabrication field in the Outputs section of the datasheet.

Field	Data Type	Description	Behavior and Usage
Insulation Condition	Character	The condition of the insulation.	<p>The value in this field is used to populate the Corrosion rate adjustment factor for Insulation Condition field if the DM that you are evaluating is 581-Ferritic Component Corrosion Under Insulation.</p> <p>This field must contain one of the following values:</p> <ul style="list-style-type: none"> • Above Average • Average • Below Average
Last Known Inspection Date	Date	The date on which the component was last inspected for external corrosion. Ideally, the valid thickness is also measured on this date.	This field is populated by the value in the Completion Date field for the Inspection. If there is more than one linked Inspection, the latest date is used. If there are no linked Inspections, this field will be blank. You can also enter a value in this field manually.
Last Known Thickness	Numeric	The thickness of the component (in inches) that you have measured on the date specified in the last Known Inspection Date field.	This field is required if you selected a date in the Last Known Inspection Date field. The value in this field is used to calculate the value in the Expected Metal Loss Fraction (Art) field. If you do not enter a value in this field, the value in the Furnished Base Material Thk (Nominal Thickness) field on the RBI 581 Risk Analysis datasheet is used.
Number of A Level Inspections	Numeric	The number of highly effective inspections.	If you have assigned an Inspection to the DM , then this field is populated automatically. The value in this field is used to calculate the value in the Inspection Effectiveness - 1, Inspection Effectiveness - 2, and Inspection Effectiveness - 3 fields.

Field	Data Type	Description	Behavior and Usage
Number of B Level Inspections	Numeric	The number of usually effective inspections.	If you have assigned an Inspection to the DM , then this field is populated automatically. The value in this field is used to calculate the value in the Inspection Effectiveness - 1, Inspection Effectiveness - 2, and Inspection Effectiveness - 3 fields.
Number of C Level Inspections	Numeric	The number of fairly effective inspections.	If you have assigned an Inspection to the DM , then this field is populated automatically. The value in this field is used to calculate the value in the Inspection Effectiveness - 1, Inspection Effectiveness - 2, and Inspection Effectiveness - 3 fields.
Number of D Level Inspections	Numeric	The number of poorly effective inspections.	If you have assigned an Inspection to the DM , then this field is populated automatically. The value in this field is used to calculate the value in the Inspection Effectiveness - 1, Inspection Effectiveness - 2, and Inspection Effectiveness - 3 fields.
Piping System Complexity	Character	The complexity of the piping system (applicable only if the component type is Piping).	The value in this field is used to populate the Corrosion rate adjustment factor for Insulation Condition field if the DM that you are evaluating is 581-Ferritic Component Corrosion Under Insulation. This field must contain one of the following values: <ul style="list-style-type: none"> • Above Average • Average • Below Average

Field	Data Type	Description	Behavior and Usage
Soil to Air Interface Present?	Boolean	Indicates whether soil to air interface is present in the component.	The value in this field is required to calculate the value in the Corrosion rate adjustment factor for interface for soil and water field in the Outputs section of the datasheet.
Use Related Inspections	Boolean	Indicates whether you want GE Digital APM to consider inspections on related DMEs .	If you select this check box, and if you have assigned Inspections to the DM , then the values in the Number of A Level Inspections, Number of B Level Inspections, Number of C Level Inspections, and Number of D Level Inspections fields are populated automatically.
The Outputs Section			
Age	Numeric	Age is the duration in years, in which the time since last inspection was performed. In order to satisfy an inspection, there should be values in the Last Known Inspection Date and Last known Thickness fields. If the last inspection date or last known thickness value is null, then age will be calculated from the date in the Date in Service field.	This field is disabled and calculated as follows: $Age = Component\ Age - Coating\ Adjustment$...where Age is the time since the last inspection was performed. In order to satisfy an inspection, there should be values in the Last Known Inspection Date and Last Known Thickness fields. If the last inspection date or Last known thickness value is null, then the age will be calculated from the date in the Date in Service field.
Beta Reliability Indices 1	Numeric	The beta reliability index for damage state 1.	This field is disabled and calculated automatically.
Beta Reliability Indices 2	Numeric	The beta reliability index for damage state 2.	This field is disabled and calculated automatically.
Beta Reliability Indices 3	Numeric	The beta reliability index for damage state 3.	This field is disabled and calculated automatically.
Coating Adjustment	Numeric	The adjustment factor for coating age.	This field is disabled and calculated automatically.

Field	Data Type	Description	Behavior and Usage								
Coating Age	Numeric	The duration between the date on which coating has been installed and the date on which you calculate the analysis (RBI Date or Plan Date).	This field is disabled and calculated as follows: Coating Age = Calculation Date - Coating Installation Date ...where Calculation Date is the value in the RBI Date field on the RBI 581 Risk Analysis datasheet.								
Corrosion rate Adjustment factor for bad asset design/fabrication	Numeric	The adjustment factor that is accounted for bad asset design or fabrication.	This field is disabled and populated automatically with the following values: <ul style="list-style-type: none"> • 2 if the Corrosion Rate Adjustment for bad Design/Fabrication check box is selected. • 1 if the Corrosion Rate Adjustment for bad Design/Fabrication check box is cleared. The value in this field is used to calculate the value in the Final Corrosion Rate field.								
Corrosion rate adjustment factor for complexity	Numeric	The adjustment factor that is accounted for complexity.	This field is disabled and populated automatically based on the value in the Piping System Complexity field. The following table provides the values of Corrosion rate adjustment factor for complexity based on the values in the Piping System Complexity field. <table border="1" data-bbox="1149 1417 1416 1747"> <thead> <tr> <th>Piping System Complexity</th> <th>Corrosion rate adjustment factor for complexity</th> </tr> </thead> <tbody> <tr> <td>Above Average</td> <td>1.25</td> </tr> <tr> <td>Average</td> <td>1.0</td> </tr> <tr> <td>Below Average</td> <td>0.75</td> </tr> </tbody> </table> The value in this field is used to calculate the value in the Final Corrosion Rate field.	Piping System Complexity	Corrosion rate adjustment factor for complexity	Above Average	1.25	Average	1.0	Below Average	0.75
Piping System Complexity	Corrosion rate adjustment factor for complexity										
Above Average	1.25										
Average	1.0										
Below Average	0.75										

Field	Data Type	Description	Behavior and Usage								
Corrosion rate Adjustment factor for Insulation Condition	Numeric	The adjustment factor that is accounted for the insulation condition.	<p>This field is disabled and populated automatically based on the value in the Insulation Condition field. The following table provides the values of Corrosion rate adjustment factor for complexity based on the values in the Insulation Condition field.</p> <table border="1"> <thead> <tr> <th>Insulation Condition</th> <th>Corrosion rate Adjustment factor for Insulation Condition</th> </tr> </thead> <tbody> <tr> <td>Above Average</td> <td>0.75</td> </tr> <tr> <td>Average</td> <td>1.0</td> </tr> <tr> <td>Below Average</td> <td>1.25</td> </tr> </tbody> </table> <p>The value in this field is used to calculate the value in the Final Corrosion Rate field.</p>	Insulation Condition	Corrosion rate Adjustment factor for Insulation Condition	Above Average	0.75	Average	1.0	Below Average	1.25
Insulation Condition	Corrosion rate Adjustment factor for Insulation Condition										
Above Average	0.75										
Average	1.0										
Below Average	1.25										
Corrosion rate adjustment factor for interface for soil and water	Numeric	The adjustment factor that is accounted for the presence of soil to air interface in the component.	<p>This field is disabled and populated automatically with the following values:</p> <ul style="list-style-type: none"> • 2 if the Soil to Air Interface Present? check box is selected. • 1 if the Soil to Air Interface Present? check box is cleared. <p>The value in this field is used to calculate the value in the Final Corrosion Rate field.</p>								
Corrosion Rate Factor Damage State 1	Numeric	The corrosion rate factor for damage state 1.	This field is disabled and populated automatically with the value 1.								
Corrosion Rate Factor Damage State 2	Numeric	The corrosion rate factor for damage state 2.	This field is disabled and populated automatically with the value 2.								
Corrosion Rate Factor Damage State 3	Numeric	The corrosion rate factor for damage state 3.	This field is disabled and populated automatically with the value 4.								

Field	Data Type	Description	Behavior and Usage
Expected Metal Loss Fraction (Art)	Numeric	The expected metal loss fraction since last inspection.	This field is disabled and calculated as follows: Expected Metal Loss Fraction = (Corrosion Rate * Age) / Component Age ...where: <ul style="list-style-type: none"> Corrosion Rate is calculated based on the values in the Operating Temperature (RBI 581 Risk Analysis datasheet) and Atmospheric Condition fields. Age is the value in the Age field. Component Age is the time since the date in the Last Known Inspection Date field. If this value is not specified, then the date in the Component Start Date field is considered.
Final Corrosion Rate	Numeric	The final corrosion rate of the component after considering all the adjustment factors.	This field is disabled and calculated automatically.
Final Damage Factor	Numeric	The final damage factor of the component after considering all the adjustment factors.	This field is disabled and calculated automatically.
Flow Stress Variance	Numeric	The variance of the flow stress.	This field is disabled and populated automatically with the value 0.20.
Inspection Effectiveness 1	Numeric	The first order inspection effectiveness factor.	This field is disabled and calculated automatically.
Inspection Effectiveness 2	Numeric	The second order inspection effectiveness factor.	This field is disabled and calculated automatically.
Inspection Effectiveness 3	Numeric	The third order inspection effectiveness factor.	This field is disabled and calculated automatically.
Posterior Probability - 1	Numeric	The posterior probability for damage state 1.	This field is disabled and calculated automatically.
Posterior Probability - 2	Numeric	The posterior probability for damage state 2.	This field is disabled and calculated automatically.
Posterior Probability - 3	Numeric	The posterior probability for damage state 3.	This field is disabled and calculated automatically.

Field	Data Type	Description	Behavior and Usage
Pressure Variance	Numeric	The variance of pressure.	This field is disabled and populated automatically with the value 0.05.
Strength Ratio	Numeric	The strength ratio of the material of the component.	This field is disabled and calculated automatically.
Thinning Variance	Numeric	The variance of thinning.	This field is disabled and populated automatically with the value 0.20.
Time Since Last Inspection	Numeric	The time since you have last performed external inspection on the component.	This field is disabled and populated automatically.

RBI 581 HTHA Damage Evaluation Records

RBI 581 HTHA Damage Evaluation records store information about the evaluation that you have performed on the 581-High Temperature Hydrogen Attack damage mechanisms (DMs).

This topic provides an alphabetical list and description of the fields that exist for the RBI 581 HTHA Damage Evaluation family. The information in the table reflects the baseline state and behavior of these fields. This list is not comprehensive.

This family is enabled for site filtering, which means that records in this family can be assigned to a specific site, and will only be accessible to users who are assigned to the same site and have the appropriate license and family privileges. For more information, refer to the Sites section of the documentation.

Field	Data Type	Description	Behavior and Usage
The Inputs Section			
Delta Temperature	Character	The proximity of temperature, in degrees Fahrenheit, to the API 941 curve for materials of construction.	<p>The value in this field is required to calculate the value in the Susceptibility field.</p> <p>This field contains the descriptions of all System Codes in the MI_581_HTHA_Delta_Temperature System Code Table. You can choose from the following baseline values:</p> <ul style="list-style-type: none"> • ≥ 0 • ≥ -50 and < 0 • ≥ -100 and < -50 • < -100
Exposure Hydrogen Partial Pressure	Numeric	The partial pressure of hydrogen, in MPa (psia).	The value in this field is required to calculate the value in the Susceptibility field.

Field	Data Type	Description	Behavior and Usage
Is Component Replaced	Character	Indicates whether the component is replaced in case of a high temperature hydrogen attack.	This field is enabled only if the value in the Is HTHA Damage Observed field is Yes (Y). This field contains the descriptions of all System Codes in the MI_YES_NO System Code Table. You can choose from the following baseline values: <ul style="list-style-type: none"> • Yes (Y) • No (N)
Is HTHA Damage Observed	Character	Indicates whether high temperature hydrogen attack damage is observed on the component.	This field contains the descriptions of all System Codes in the MI_YES_NO System Code Table. You can choose from the following baseline values: <ul style="list-style-type: none"> • Yes (Y) • No (N)
The Outputs Section			
Damage Factor	Character	The damage factor of the component.	This field is disabled and calculated based on the value in the Susceptibility field.
Susceptibility	Character	The component's level of susceptibility to damage.	This field is disabled and calculated based on the values in the Inputs section.

RBI 581 Mechanical Fatigue Damage Evaluation Records

RBI 581 Mechanical Fatigue Damage Evaluation records store information about the evaluation that you have performed on the 581-Piping Mechanical Fatigue damage mechanism (DM).

This topic provides an alphabetical list and description of the fields that exist for the RBI 581 Mechanical Fatigue Damage Evaluation family. The information in the table reflects the baseline state and behavior of these fields. This list is not comprehensive.

This family is enabled for site filtering, which means that records in this family can be assigned to a specific site, and will only be accessible to users who are assigned to the same site and have the appropriate license and family privileges. For more information, refer to the Sites section of the documentation.

Field	Data Type	Description	Behavior and Usage
The RBI 581 Mechanical Fatigue Damage Evaluation Section			
Branch Diameter	Character	The category of the pipe based on the diameter of the branches.	<p>The value in this field is required to populate the Adjustment for Branch Diameter field.</p> <p>This field contains the descriptions of all System Codes in the MI_581_Adjustment_Branch_Diameter System Code Table. You can choose from the following baseline values:</p> <ul style="list-style-type: none"> • All branches less than or equal to 2 NPS • Any branch greater than 2 NPS
Corrective Action	Character	The corrective action that has been taken for the mechanical fatigue of the pipes.	<p>The value in this field is required to populate the Adjustment for Corrective Action field.</p> <p>This field contains the descriptions of all System Codes in the MI_581_Adjustment_Corrective_Action System Code Table. You can choose from the following baseline values:</p> <ul style="list-style-type: none"> • Modification - Complete Engineering Analysis • Modification based on experience • No modifications

Field	Data Type	Description	Behavior and Usage
Cyclic Loading	Character	The type of cyclic loading to which the pipe is subject.	<p>The value in this field is required to calculate the value in the Base Damage Factor field.</p> <p>This field contains the descriptions of all System Codes in the MI_581_Mechanical_Fatigue_Cyclic_Loading System Code Table. You can choose from the following baseline values:</p> <ul style="list-style-type: none"> • Reciprocating Machinery • PRV Chatter • Valve with high pressure drop • None
Joint Type or Branch Design	Character	The type of the joints that are used in the piping system.	<p>The value in this field is required to populate the Adjustment for Joint Type or Branch Design field.</p> <p>This field contains the descriptions of all System Codes in the MI_581_Adjustment_Joint_Type_Branch_Design System Code Table. You can choose from the following baseline values:</p> <ul style="list-style-type: none"> • Sweepolets • Piping tee • Weldolets • Saddle in fittings • Socketweld • Threaded • Saddle on

Field	Data Type	Description	Behavior and Usage
Pipe Complexity	Character	The category of the piping based on the number of pipe fittings.	<p>The value in this field is required to populate the Adjustment for Pipe Complexity field.</p> <p>This field contains the descriptions of all System Codes in the MI_581_Adjustment_Pipe_Complexity System Code Table. You can choose from the following baseline values:</p> <ul style="list-style-type: none"> • 0 to 5 total pipe fittings • 6 to 10 total pipe fittings • More than 10 total pipe fittings
Pipe Condition	Character	The condition of the pipe.	<p>The value in this field is required to populate the Adjustment for Condition of Pipe field.</p> <p>This field contains the descriptions of all System Codes in the MI_581_Adjustment_Condition_for_Pipe System Code Table. You can choose from the following baseline values:</p> <ul style="list-style-type: none"> • Missing or Damaged supports or Broken gussets • Good Condition
Previous Failure	Character	The number of previous failures that occurred in the pipe.	<p>The value in this field is required to calculate the value in the Base Damage Factor field.</p> <p>This field contains the descriptions of all System Codes in the MI_581_Mechanical_Fatigue_Failures System Code Table. You can choose from the following baseline values:</p> <ul style="list-style-type: none"> • No Failures • One Failure • Two or more Failures

Field	Data Type	Description	Behavior and Usage
Shaking Frequency	Character	The frequency of shaking that occurs in the pipe.	<p>The value in this field is required to calculate the value in the Base Damage Factor field.</p> <p>This field contains the descriptions of all System Codes in the MI_581_Mechanical_Fatigue_Shaking_Duration System Code Table. You can choose from the following baseline values:</p> <ul style="list-style-type: none"> • Shaking less than 2 weeks • Shaking between 2 and 13 weeks • Shaking between 13 and 52 weeks
Visible/Audible Shaking	Character	The severity of visible or audible shaking that occurs in the pipe.	<p>The value in this field is required to calculate the value in the Base Damage Factor field.</p> <p>This field contains the descriptions of all System Codes in the MI_581_Mechanical_Fatigue_Shaking System Code Table. You can choose from the following baseline values:</p> <ul style="list-style-type: none"> • Minor • Moderate • Severe
The Intermediate Outputs Section			

Field	Data Type	Description	Behavior and Usage						
Adjustment for Branch Diameter	Numeric	The adjustment factor based on the category of the branch diameter of the piping system.	<p>The value in this field is used to calculate the value in the Final Damage Factor field. This field is disabled and populated automatically as follows:</p> <table border="1" data-bbox="1144 457 1412 894"> <thead> <tr> <th data-bbox="1144 457 1279 667">If the value in the Branch Diameter field is...</th> <th data-bbox="1279 457 1412 667">...then the value in the Adjustment for Branch Diameter field is</th> </tr> </thead> <tbody> <tr> <td data-bbox="1144 667 1279 779">All branches less than or equal to 2 NPS</td> <td data-bbox="1279 667 1412 779">1</td> </tr> <tr> <td data-bbox="1144 779 1279 894">Any branch greater than 2 NPS</td> <td data-bbox="1279 779 1412 894">0.02</td> </tr> </tbody> </table>	If the value in the Branch Diameter field is...	...then the value in the Adjustment for Branch Diameter field is	All branches less than or equal to 2 NPS	1	Any branch greater than 2 NPS	0.02
If the value in the Branch Diameter field is...	...then the value in the Adjustment for Branch Diameter field is								
All branches less than or equal to 2 NPS	1								
Any branch greater than 2 NPS	0.02								
Adjustment for Condition of Pipe	Numeric	The adjustment factor based on the condition of the pipe.	<p>The value in this field is used to calculate the value in the Final Damage Factor field. This field is disabled and populated automatically as follows:</p> <table border="1" data-bbox="1144 1123 1412 1560"> <thead> <tr> <th data-bbox="1144 1123 1279 1297">If the value in the Pipe Condition field is...</th> <th data-bbox="1279 1123 1412 1297">...then the value in the Adjustment for Condition of Pipe is</th> </tr> </thead> <tbody> <tr> <td data-bbox="1144 1297 1279 1381">Good Condition</td> <td data-bbox="1279 1297 1412 1381">1</td> </tr> <tr> <td data-bbox="1144 1381 1279 1560">Missing or Damaged supports or Broken gussets</td> <td data-bbox="1279 1381 1412 1560">2</td> </tr> </tbody> </table>	If the value in the Pipe Condition field is...	...then the value in the Adjustment for Condition of Pipe is	Good Condition	1	Missing or Damaged supports or Broken gussets	2
If the value in the Pipe Condition field is...	...then the value in the Adjustment for Condition of Pipe is								
Good Condition	1								
Missing or Damaged supports or Broken gussets	2								

Field	Data Type	Description	Behavior and Usage																
Adjustment for Corrective Action	Numeric	The adjustment factor based on corrective action on the pipe.	<p>The value in this field is used to calculate the value in the Final Damage Factor field. This field is disabled and populated automatically as follows:</p> <table border="1" data-bbox="1146 457 1414 1010"> <thead> <tr> <th data-bbox="1146 457 1279 667">If the value in the Corrective Action field is...</th> <th data-bbox="1279 457 1414 667">...then the value in the Adjustment for Corrective Action field is</th> </tr> </thead> <tbody> <tr> <td data-bbox="1146 667 1279 814">Modification - Complete Engineering Analysis</td> <td data-bbox="1279 667 1414 814">0.002</td> </tr> <tr> <td data-bbox="1146 814 1279 926">Modification based on experience</td> <td data-bbox="1279 814 1414 926">0.2</td> </tr> <tr> <td data-bbox="1146 926 1279 1010">No modifications</td> <td data-bbox="1279 926 1414 1010">2</td> </tr> </tbody> </table>	If the value in the Corrective Action field is...	...then the value in the Adjustment for Corrective Action field is	Modification - Complete Engineering Analysis	0.002	Modification based on experience	0.2	No modifications	2								
If the value in the Corrective Action field is...	...then the value in the Adjustment for Corrective Action field is																		
Modification - Complete Engineering Analysis	0.002																		
Modification based on experience	0.2																		
No modifications	2																		
Adjustment for Joint Type or Branch Design	Numeric	The adjustment factor based on the joint type or branch design of the piping system.	<p>The value in this field is used to calculate the value in the Final Damage Factor field. This field is disabled and populated automatically as follows:</p> <table border="1" data-bbox="1146 1234 1414 1829"> <thead> <tr> <th data-bbox="1146 1234 1279 1444">If the value in the Joint Type or Branch Design field is...</th> <th data-bbox="1279 1234 1414 1444">...then the value in the Adjustment for Joint Type or Branch Design is</th> </tr> </thead> <tbody> <tr> <td data-bbox="1146 1444 1279 1497">Threaded</td> <td data-bbox="1279 1444 1414 1497">2</td> </tr> <tr> <td data-bbox="1146 1497 1279 1549">Socketweld</td> <td data-bbox="1279 1497 1414 1549">2</td> </tr> <tr> <td data-bbox="1146 1549 1279 1602">Saddle on</td> <td data-bbox="1279 1549 1414 1602">2</td> </tr> <tr> <td data-bbox="1146 1602 1279 1686">Saddle in fittings</td> <td data-bbox="1279 1602 1414 1686">1</td> </tr> <tr> <td data-bbox="1146 1686 1279 1738">Piping tee</td> <td data-bbox="1279 1686 1414 1738">0.2</td> </tr> <tr> <td data-bbox="1146 1738 1279 1791">Weldolets</td> <td data-bbox="1279 1738 1414 1791">0.2</td> </tr> <tr> <td data-bbox="1146 1791 1279 1829">Sweepolets</td> <td data-bbox="1279 1791 1414 1829">0.02</td> </tr> </tbody> </table>	If the value in the Joint Type or Branch Design field is...	...then the value in the Adjustment for Joint Type or Branch Design is	Threaded	2	Socketweld	2	Saddle on	2	Saddle in fittings	1	Piping tee	0.2	Weldolets	0.2	Sweepolets	0.02
If the value in the Joint Type or Branch Design field is...	...then the value in the Adjustment for Joint Type or Branch Design is																		
Threaded	2																		
Socketweld	2																		
Saddle on	2																		
Saddle in fittings	1																		
Piping tee	0.2																		
Weldolets	0.2																		
Sweepolets	0.02																		

Field	Data Type	Description	Behavior and Usage								
Adjustment for Pipe Complexity	Numeric	The adjustment factor based on the complexity of the piping system.	<p>The value in this field is used to calculate the value in the Final Damage Factor field. This field is disabled and populated automatically as follows:</p> <table border="1"> <thead> <tr> <th>If the value in the Pipe Complexity field is...</th> <th>...then the value in the Adjustment for Pipe Complexity field is</th> </tr> </thead> <tbody> <tr> <td>0 to 5 total pipe fittings</td> <td>0.5</td> </tr> <tr> <td>6 to 10 total pipe fittings</td> <td>1</td> </tr> <tr> <td>More than 10 total pipe fittings</td> <td>2</td> </tr> </tbody> </table>	If the value in the Pipe Complexity field is...	...then the value in the Adjustment for Pipe Complexity field is	0 to 5 total pipe fittings	0.5	6 to 10 total pipe fittings	1	More than 10 total pipe fittings	2
If the value in the Pipe Complexity field is...	...then the value in the Adjustment for Pipe Complexity field is										
0 to 5 total pipe fittings	0.5										
6 to 10 total pipe fittings	1										
More than 10 total pipe fittings	2										
The Outputs Section											
Base Damage Factor	Numeric	The damage factor of the pipe without considering the adjustment factors.	This field is disabled and calculated automatically.								
Final Damage Factor	Numeric	The damage factor of the pipe after considering the adjustment factors.	This field is disabled and calculated automatically.								

RBI 581 Risk Analysis Records

RBI 581 Risk Analysis records store information that is used to determine the results of RBI Analyses. This topic provides an alphabetical list and description of the fields that exist for the RBI 581 Risk Analysis family. The information in the table reflects the baseline state and behavior of these fields.

This family is enabled for site filtering, which means that records in this family can be assigned to a specific site, and will only be accessible to users who are assigned to the same site and have the appropriate license and family privileges. For more information, refer to the Sites section of the documentation.

Field	Data Type	Description	Behavior and Usage
Allowable Stress	Numeric	The maximum amount of pressure that a component can safely withstand.	If the Stress Override check box is cleared, then this field is disabled and the value is calculated .
Analysis ID	Character	Specifies the Record ID of the RBI 581 Risk Analysis.	This field is disabled and populated automatically. For a What-If Analysis, the value in this field is in the following format: W <Analysis ID of the main analysis> <Number> <Scenario ID> ...where <Number> is the sequential number of the What-If Analysis.
Analysis Type	Character	The type of the analysis that you have performed.	This field is disabled and populated with the value RBI 581.
Base Material	Character	The base material that is used in the component.	This field is populated with the value in the Base Material field in the associated component. It contains a list of the types of base material that are generally used in a component. This value is used to calculate the analysis if the component type is Tank Bottom, and if the analysis is linked the following DMs: <ul style="list-style-type: none"> • 581-HIC/SOHIC – HF (only if the value in the Cladding Present field is No (N)) • 581-Hydrogen Stress Cracking (only if the value in the Cladding Present field is No (N)) • 581-Polythionic Acid Cracking (only if the value in the Cladding Present field is No (N)) • 581-High Temperature Hydrogen Attack • All Damage Mechanisms (DMs) that belong to RBI 581 Thinning and Lining Evaluation

Field	Data Type	Description	Behavior and Usage
Base Material Code Year	Character	The year in which the design code that corresponds to the base material was defined.	<p>This field is populated with the value in the Code Year field in the associated component.</p> <p>The value in this field is used to calculate the analysis if the Stress Override check box is cleared.</p>
Base Material Construction Code	Character	The year in which the design code that corresponds to the component was defined.	<p>This field is populated with the value in the Construction Code field in the associated component.</p> <p>The value in this field is used to calculate the values in the Allowable Stress and Flow Stress fields if the Stress Override check box is cleared, and if the analysis is linked to the at least one of the following records:</p> <ul style="list-style-type: none"> • RBI 581 External Damage Evaluation • RBI 581 Thinning and Lining Evaluation
Base Material Grade	Character	The material grade of the component.	<p>This field is populated with the value in the Material Grade field in the associated component.</p> <p>The value in this field is used to calculate the values in the Allowable Stress and Flow Stress fields if the Stress Override check box is cleared, and if the analysis is linked to at least one of the following records:</p> <ul style="list-style-type: none"> • RBI 581 External Damage Evaluation • RBI 581 Thinning and Lining Evaluation

Field	Data Type	Description	Behavior and Usage
Base Material Spec	Character	The material specification of the component.	<p>This field is populated with the value in the Material Spec field in the associated component.</p> <p>The value in this field is used to calculate the values in the Allowable Stress and Flow Stress fields if the Stress Override check box is cleared, and if the analysis is linked to at least one of the following records:</p> <ul style="list-style-type: none"> • RBI 581 External Damage Evaluation • RBI 581 Thinning and Lining Evaluation
Calculated Tmin	Character	Indicates the pressure minimum thickness that is calculated depending on the geometry type of the component.	This field is disabled and populated automatically.
Cladding is Present?	Character	Indicates whether cladding is present in the component.	<p>This field is populated with the value in the Cladding Present field in the associated component.</p> <p>This field contains the description of all the System Codes in the MI_YES_NO System Code Table.</p>

Field	Data Type	Description	Behavior and Usage
Cladding Material	Character	The material that is used in cladding.	<p>This field is populated with the value in the Cladding Material field in the associated component. It contains a list of the types of cladding material that are generally used for cladding.</p> <p>The value in this field is used to calculate an RBI 581 analysis if it is linked to at least one of the following DMs:</p> <ul style="list-style-type: none"> • 581-Acid Sour Water Corrosion • 581-Alkaline Sour Water Corrosion • 581-Amine Corrosion • 581-Cooling Water Corrosion • 581-High Temperature H₂/H₂S Corrosion • 581-High Temperature Oxidation • 581-High Temperature Sulfidic and Naphthenic Acid • 581-Hydrochloric Acid Corrosion • 581-Hydrofluoric Acid Corrosion • 581-Soil Side Corrosion • 581-Sulfuric Acid Corrosion
Coefficient Y Material	Character	The Coefficient Y value of the material used in the component.	<p>The value in this field is used to calculate the analysis if the component type is Piping.</p> <p>This field contains the description of all the System Codes in the MI_581_Coefficient_Materials System Code Table.</p>
Component	Character	The component on which you have performed the analysis.	This field is populated with the value in the Component field in the associated component.
Component Comments	Character	Additional information about the component on which you have performed the analysis.	None

Field	Data Type	Description	Behavior and Usage
Component Description	Character	The description of the component on which you have performed the analysis.	This field is populated with the value in the Component Description field in the associated component.
Component Start Date	Date	The date on which the component was installed and put in service.	This field is populated with the value in the Component Start Date field in the associated component. You can enter or select a different date and time.
Component Type	Character	The type of the component on which you have performed the analysis.	This field is disabled and populated automatically.
Corrosion Allow	Character	The metal thickness that is allowed considering metal loss due to corrosion.	This field is populated with the value in the Corrosion Allow field in the associated component.
Course Number	Numeric	Identifies which shell course on the asset is being assessed. The course number will impact how the allowable stress data is used.	None
Cracking Inspection Date	Date	The projected date on which a cracking inspection is required during the plan period.	You can enter or select the date and time.
Data Confidence	Character	The level of confidence that you have on the data that is entered while performing the analysis.	<p>This field is disabled and populated with the value in the Character Field Value column in the Data Confidence row in the RBI 581 Admin Options workspace.</p> <p>The value in this field is used to calculate the values in the Posterior Probability - 1, Posterior Probability - 2, and Posterior Probability - 3 fields in the associated RBI 581 External Damage Evaluation and RBI 581 Thinning and Lining Evaluation.</p>
Date Criticality Calculated	Date	The date on which the analysis was calculated.	This field is disabled and populated with the date on which you calculate the analysis.

Field	Data Type	Description	Behavior and Usage
Design Pressure	Numeric	The pressure at which the component is designed to operate. It is measured in pounds per square inch gauge.	<p>This field is populated with the value in the Design Pressure field in the associated RBI Component.</p> <p>Tip: This value is provided by the manufacturer of the component. You can find it on the nameplate or the UI Form.</p> <p>The value in this field is used to calculate the analysis if it is linked to a DM that belongs to the following Damage Mechanism Evaluations (DMEs):</p> <ul style="list-style-type: none"> • RBI 581 External Damage Evaluation • RBI 581 Thinning and Lining Evaluation <p>The value in this field must be greater than or equal to zero, and greater than or equal to the value in the Operating Pressure field.</p>

Field	Data Type	Description	Behavior and Usage
Design Temperature	Numeric	The temperature at which the component is designed to operate. It is measured in degrees Fahrenheit.	<p>By default, this field is populated with the value in the Design Temperature field in the associated RBI Component.</p> <p>The value in this field must be greater than or equal to the value in the Operating Temperature field.</p> <p>Tip: This value is provided by the manufacturer of the component. You can find it on the nameplate or the UI Form.</p> <p>The value in this field is used to calculate the analysis if it is linked to a DM that belongs to the following DMEs:</p> <ul style="list-style-type: none"> • RBI 581 External Damage Evaluation • RBI 581 Thinning and Lining Evaluation <p>If the value in this field is greater than or equal to 0, the value in the Operating Temperature field must be less than or equal to the value in this field.</p> <p>If the value in this field is less than 0, you can calculate the analysis with any value in the Operating Temperature field.</p>
Diameter InnerDiameter	Numeric	The measurement of the full diameter of a circular or cylindrical asset , in inches.	This field is populated with the value in the Diameter field in the associated component.
Driving Risk Target	Character	The driving risk target.	This field is disabled and populated automatically.
Asset	Character	The asset that is associated with the component on which you are performing the analysis.	This field is disabled and populated automatically.

Field	Data Type	Description	Behavior and Usage
Event Type	Character	Indicates whether the analysis is a What-If Analysis.	For a What-If Analysis, this field is populated with the value W. For other types of analyses, this field is blank. By default, this field does not appear on the datasheet.
Financial COF - RBI Date	Numeric	The financial consequence of failure calculated on the RBI date.	This field is populated with the value in the Total Financial Consequence field in the associated RBI 581 Consequence Evaluation. By default, this field does not appear on the datasheet.
Financial COF - With Plan	Numeric	The financial consequence of failure calculated on the plan date after mitigating the risk.	This field is populated with the value in the Total Financial Consequence field in the associated RBI 581 Consequence Evaluation. The value in this field is same as the value in the Financial COF - RBI Date field. By default, this field does not appear on the datasheet.
Financial COF - Without Plan	Numeric	The financial consequence of failure calculated on the plan date before mitigating the risk.	This field is populated with the value in the Total Financial Consequence field in the associated RBI 581 Consequence Evaluation. The value in this field is same as the value in the Financial COF - RBI Date field. By default, this field does not appear on the datasheet.

Field	Data Type	Description	Behavior and Usage
Financial Risk Category - RBI Date	Character	The financial risk category calculated on the RBI date.	<p>This field is disabled and contains the description of the System Codes in the MI_RBI_RISK_CATEGORY System Code Table.</p> <p>The value in this field is determined based on the limits for each risk category that you have specified in the Financial Risk section in the RBI 581 ISO-Risk Plot Preferences workspace</p> <p>By default, this field does not appear on the datasheet.</p>
Financial Risk Category - With Plan	Character	The financial risk category calculated on the plan date after mitigating the risk.	<p>This field is disabled and contains the description of the System Codes in the MI_RBI_RISK_CATEGORY System Code Table.</p> <p>The value in this field is determined based on the limits for each risk category that you have specified in the Financial Risk section in the RBI 581 ISO-Risk Plot Preferences workspace</p> <p>By default, this field does not appear on the datasheet.</p>
Financial Risk Category - Without Plan	Character	The financial risk category calculated on the plan date before mitigating the risk.	<p>This field is disabled and contains the description of the System Codes in the MI_RBI_RISK_CATEGORY System Code Table.</p> <p>The value in this field is determined based on the limits for each risk category that you have specified in the Financial Risk section in the RBI 581 ISO-Risk Plot Preferences workspace</p> <p>By default, this field does not appear on the datasheet.</p>

Field	Data Type	Description	Behavior and Usage
Fluid Valid for 581 Analysis	Boolean	Indicates whether the process fluid is valid for an RBI 581 analysis.	<p>This check box is disabled and selected if the fluid that you have selected in the Process Fluid field is valid for RBI 581.</p> <p>If this check box is cleared, and if you calculate the analysis, an error message appears.</p>
Fluid Velocity	Character	Velocity of the fluid, in feet per second, that flows inside the component.	<p>This field is populated with the value in the Fluid Velocity field in the associated component.</p> <p>This field is used to calculate the analysis if the analysis is linked to the following DMs:</p> <ul style="list-style-type: none"> • 581-Acid Sour Water Corrosion • 581-Alkaline Sour Water Corrosion • 581-Amine Corrosion • 581-Cooling Water Corrosion • 581-High Temperature Sulfidic and Naphthenic Acid • 581-Hydrofluoric Acid Corrosion • 581-Sulfuric Acid Corrosion
Flow Stress	Character	The flow stress value of the fluid used in the component.	<p>This field is disabled and calculated if the Stress Override check box is cleared.</p> <p>This field is enabled if the Stress Override check box is selected.</p>

Field	Data Type	Description	Behavior and Usage
Furnished Nominal Thickness	Character	An estimated or measured base material thickness used as the starting point for thickness based Remaining Life calculations.	<p>This field is populated with the value in the Nominal Thickness field in the associated component.</p> <p>The value in this field is used to calculate the analysis if it is linked to a DM that belongs to the following DMs:</p> <ul style="list-style-type: none"> • 581-Brittle Fracture • 581-Low Alloy Steel Embrittlement • All DMs that belong to RBI 581 Thinning and Lining Evaluation • All DMs that belong to RBI 581 External Damage Evaluation
Furnished Cladding Thk	Character	An estimated or measured cladding material thickness used as the starting point for thickness based Remaining Life calculations.	<p>This field is populated with the value in the Nominal Thickness field in the associated component.</p> <p>The value in this field is used to calculate the analysis if:</p> <ul style="list-style-type: none"> • It is linked to RBI 581 Thinning and Lining Evaluation or RBI 581 Cracking Damage Evaluation. -and- • The value in the Cladding is Present? field is Yes(Y).
Generic Failure Frequency	Character	The generic failure frequency (GFF), per year, that occurs in the component.	This field is disabled and calculated based on the value in the GFF Component Type field.

Field	Data Type	Description	Behavior and Usage
Geometry Type	Character	The geometry type of the component on which you have performed the analysis.	<p>This field is populated with the value in the Geometry Type field in the associated component. This field contains the descriptions of all System Codes in the MI_581_Component_Geometry_Types System Code Table.</p> <p>The value in this field is used to calculate the analysis if it is linked to at least one of the following records:</p> <ul style="list-style-type: none"> • RBI 581 Thinning and Lining Evaluation • RBI 581 External Cracking Damage Evaluation

Field	Data Type	Description	Behavior and Usage
GFF Component Type	Character	The Generic Failure Frequency type of the component.	<p>The value in this field is required to calculate the analysis.</p> <p>This field must contain one of the following values:</p> <ul style="list-style-type: none"> • COLBTM • COLMID • COLTOP • COMPC • COMPR • COURSE-1-10 • DRUM • FILTER • FINFAN • HEXSS • HEXTS • KODRUM • PIPE-1 • PIPE-10 • PIPE-12 • PIPE-16 • PIPE-2 • PIPE-4 • PIPE-6 • PIPE-8 • PIPEGT16 • PUMP1S • PUMP2S • PUMPR • REACTOR • TANKBOTTOM
Governing Brittle Fracture Damage Factor - RBI Date	Numeric	The highest among the damage factor values of all the DMs in the analysis that belong to RBI 581 Brittle Fracture Damage Evaluation, calculated on the RBI date.	<p>This field is disabled and populated automatically with the highest among the following values:</p> <ul style="list-style-type: none"> • Damage factor for 581-885F Embrittlement • Damage Factor for 581-Sigma Phase Embrittlement • Sum of the damage factors for 581-Brittle Fracture and 581-Low Alloy Steel Embrittlement

Field	Data Type	Description	Behavior and Usage
Governing Brittle Fracture Damage Factor With Plan	Numeric	The highest among the damage factor values of all the DMs in the analysis that belong to RBI 581 Brittle Fracture Damage Evaluation, calculated on the plan date before mitigating the risk.	Since RBI 581 Brittle Fracture Damage Evaluation is not considered in inspection planning, this field is disabled and populated with the value in the Governing Brittle Fracture Damage Factor Without Plan field.
Governing Brittle Fracture Damage Factor Without Plan	Numeric	The highest among the damage factor values of all the DMs in the analysis that belong to RBI 581 Brittle Fracture Damage Evaluation, calculated on the plan date before mitigating the risk.	This field is disabled and populated with the highest among the following values: <ul style="list-style-type: none"> • Damage factor for 581-885F Embrittlement • Damage Factor for 581-Sigma Phase Embrittlement • Sum of the damage factors for 581-Brittle Fracture and 581-Low Alloy Steel Embrittlement
Governing Cracking Damage Factor - RBI Date	Numeric	The highest among the damage factor values of all the DMs in the analysis that belong to RBI 581 Cracking Damage Evaluation, calculated on the RBI date.	This field is disabled and populated automatically.
Governing Cracking Damage Factor With Plan	Numeric	The highest among the damage factor values of all the DMs in the analysis that belong to RBI 581 Cracking Damage Evaluation or RBI 581 External Cracking Damage Evaluation, calculated on the plan date after mitigating the risk.	This field is disabled and populated automatically.
Governing Cracking Damage Factor Without Plan	Numeric	The highest among the damage factor values of all the DMs in the analysis that belong to RBI 581 Cracking Damage Evaluation or RBI 581 External Cracking Damage Evaluation, calculated on the plan date before mitigating the risk.	This field is disabled and populated automatically.

Field	Data Type	Description	Behavior and Usage
Governing External Damage Factor - RBI Date	Numeric	The highest among the damage factor values of all the DMs in the analysis that belong to RBI 581 External Damage Evaluation or RBI 581 External Cracking Damage Evaluation, calculated on the RBI date.	This field is disabled and populated automatically.
Governing External Damage Factor With Plan	Numeric	The highest among the damage factor values of all the DMs in the analysis that belong to RBI 581 External Damage Evaluation or RBI 581 External Cracking Damage Evaluation, calculated on the plan date after mitigating the risk.	This field is disabled and populated automatically.
Governing External Damage Factor Without Plan	Numeric	The highest among the damage factor values of all the DMs in the analysis that belong to RBI 581 External Damage Evaluation or RBI 581 External Cracking Damage Evaluation, calculated on the plan date before mitigating the risk.	This field is disabled and populated automatically.
Governing HTHA Damage Factor - RBI Date	Numeric	The damage factor of the 581-High Temperature Hydrogen Attack DM, calculated on the RBI date.	This field is disabled and populated automatically.
Governing HTHA Damage Factor With Plan	Numeric	The damage factor of the 581-High Temperature Hydrogen Attack DM, calculated on the plan date after mitigating the risk.	Since RBI 581 HTHA Damage Evaluation is not considered in inspection planning, this field is disabled and populated with the value in the Governing HTHA Damage Factor Without Plan field.
Governing HTHA Damage Factor Without Plan	Numeric	The damage factor of the 581-High Temperature Hydrogen Attack DM, calculated on the plan date before mitigating the risk.	This field is disabled and populated automatically.
Governing Mechanical Fatigue Damage Factor - RBI Date	Numeric	The damage factor of the 581-Piping Mechanical Fatigue DM, calculated on the RBI date.	This field is disabled and populated automatically.

Field	Data Type	Description	Behavior and Usage
Governing Mechanical Fatigue Damage Factor With Plan	Numeric	The damage factor of the 581-Piping Mechanical Fatigue DM, calculated on the plan date after mitigating the risk.	Since RBI 581 Mechanical Fatigue Damage Evaluation is not considered in inspection planning, this field is disabled and populated with the value in the Governing Mechanical Fatigue Damage Factor Without Plan field.
Governing Mechanical Fatigue Damage Factor Without Plan	Numeric	The damage factor of the 581-Piping Mechanical Fatigue DM, calculated on the plan date before mitigating the risk.	This field is disabled and populated automatically.
Governing Thinning and Lining Damage Factor - RBI Date	Numeric	The highest among the damage factor values of all the thinning DMs in the analysis, calculated on the RBI date. If, however, in addition to the thinning DMs, you have evaluated 581-Internal Component Lining Damage, then the minimum of the damage factors between this DM and the thinning DM with the highest damage factor is considered.	This field is disabled and populated automatically.
Governing Thinning And Lining Damage Factor With Plan	Numeric	The highest among the damage factor values of all the DMs in the analysis that belong to RBI 581 Thinning and Lining Evaluation, calculated on the plan date after mitigating the risk.	This field is disabled and populated automatically.
Governing Thinning And Lining Damage Factor Without Plan	Numeric	The highest among the damage factor values of all the DMs in the analysis that belong to RBI 581 Thinning and Lining Evaluation, calculated on the plan date before mitigating the risk.	This field is disabled and populated automatically.

Field	Data Type	Description	Behavior and Usage
Has Release Prevention Barrier?	Boolean	Indicates whether the component has a release prevention barrier.	<p>This field is enabled only if the component type is Storage Tank Bottom. The value in this field is populated with the value in the corresponding field in the associated component.</p> <p>If you select this check box, then the value in the Maximum Fill Height in AST field in the associated RBI 581 Consequence Evaluation record is disabled and populated with the value 0.25 feet.</p>
Inspection Will Mitigate	Character	Indicates whether implementing the inspection plan will mitigate the risk to below the risk target before the plan date.	This field is disabled and populated with the value Yes or No.
Insulated	Boolean	Indicates whether the component is insulated.	<p>This field is populated with the value in the Insulated? field in the associated component.</p> <p>If the analysis is linked to the 581-Ferritic Component Corrosion Under Insulation or the 581-Austenitic Cracking Under Insulation DM, then this check box must be selected.</p>
Insulation Type	Character	Identifies the insulating material.	<p>This field is enabled only if the Insulated check box is selected. This field is populated with the value in the Insulation Type field in the associated component.</p> <p>You can select one of the following values:</p> <ul style="list-style-type: none"> • Asbestos • Calcium Silicate (CI Free) • Calcium Silicate (Not CI Free) • Foam/Cellular Glass • Mineral Wool/Fiber Glass • Pearlite • Unknown

Field	Data Type	Description	Behavior and Usage
Is Intrusive?	Character	Identifies whether there should be an intrusive or non-intrusive inspection for the component.	<p>This field is populated with the value in the Is Intrusive? field of the associated component. It is used to calculate the analysis if it is linked to a DM that belongs to the following DMEs:</p> <ul style="list-style-type: none"> • RBI 581 Cracking Damage Evaluation • RBI 581 External Cracking Damage Evaluation • RBI 581 External Damage Evaluation • RBI 581 Thinning and Lining Evaluation
Length	Numeric	The total length, in inches, of an asset measured in a straight line from head seam to head seam.	<p>This field is populated with the value in the Length field in the associated component.</p> <p>The value in this field is required to calculate the value in the Inventory Component Mass field in an RBI 581 Consequence Evaluation if the Use Calculated Inventory check box is selected.</p> <p>The value in this field will be required to calculate Inventory Component Mass for all Components Types except a Piping RBI Component Type.</p>
Management Factor	Character	The adjustment factor for the management system.	This field is disabled and calculated based on the value in the Management Score field.
Management Score	Numeric	The score obtained from the management systems evaluation.	This field is disabled and populated with the value in the Numeric Field Value column in the Management Score row in the RBI 581 Admin Options workspace .
Material Yield Strength	Numeric	The material yield strength value of the base material used in the component.	This field is disabled and populated automatically.

Field	Data Type	Description	Behavior and Usage
Minimum Structural Thickness	Character	The minimum structural thickness of the component.	<p>This field is populated with the value in the Minimum Structural Thickness field in the associated component.</p> <p>The value in this field is used to calculate the analysis if it is linked to a DM that belongs to the one of the following DMEs:</p> <ul style="list-style-type: none"> • RBI 581 External Damage Evaluation • RBI 581 Thinning and Lining Evaluation
Operating Pressure	Numeric	The internal pressure of the asset under normal operating conditions. It is measured in pounds per square inch gauge.	<p>A value is required in this field.</p> <p>By default, this field is populated with the value in the Operating Pressure field in the associated RBI Component.</p> <p>The value in this field must be less than or equal to the value in the Design Pressure field.</p>
Operating Temperature	Numeric	The temperature of the asset under normal operating conditions. It is measured in degrees Fahrenheit.	<p>A value is required in this field.</p> <p>By default, this field populated with the value in the Operating Temperature field in the associated RBI Component.</p> <p>If the value in the Design Temperature field is greater than or equal to zero, the value in this field must be less than or equal to the value in the Design Temperature field.</p> <p>If the value in the Design Temperature field is less than zero, you can calculate the analysis with any value in this field.</p>
Override Minimum Required Thickness	Boolean	Indicates whether you want to override the Calculated T-min value with the Specified T-min value.	None
Percent Liquid Volume	Character	The percentage of the liquid used in the component.	This field is populated with the value in the Percent Liquid Volume field on the datasheet of the associated component.

Field	Data Type	Description	Behavior and Usage
Percent Toxic	Character	The amount of toxic substances by volume in the process stream.	This field is populated with the Percent Toxic field in the associated component. This field is enabled only if the Toxic Mixture check box is selected.
pH of Water	Character	The pH of water that is used in the component.	This field is populated with the value in the pH of Water field in the associated component. This value is used to calculate an RBI 581 analysis if the analysis is linked to any of the following DMs: <ul style="list-style-type: none"> • 581-Acid Sour Water Corrosion • 581-Alkaline Carbonate Stress Corrosion Cracking • 581-Chloride Stress Corrosion Cracking • 581-Cooling Water Corrosion • 581-HIC/SOHIC - H2S • 581-Hydrochloric Acid Corrosion • 581-Sulfide Stress Cracking
Piping Length	Numeric	The length of the component if the component type is Piping.	This field is enabled only if the component type is Piping. The value in this field is populated with the Piping Circuit Length field in the associated component. It is used to calculate the value in the Inventory Component Mass field in the associated RBI 581 Consequence Evaluation if the Use Calculated Inventory check box is selected.
Plan Date	Date	The end date of the plan period.	By default, this is set to ten years from the RBI Date. You can enter or select a different date and time.
PWHT	Boolean	Indicates whether or not Post Weld Heat Treatment (PWHT) has been performed to relieve residual stresses from the construction of the asset.	This field is populated with the value in the PWHT field in the associated component.

Field	Data Type	Description	Behavior and Usage
RBI Date	Date	The date and time on which you have started conducting the analysis.	By default, it is set to the date on which you create the RBI Analysis. You can enter or select a different date and time.
Release Fluid Phase	Character	The phase of the fluid when it is released to atmosphere.	This field is disabled and populated automatically.
Representative Fluid	Character	The fluid that represents or makes up the greatest volume of the asset. In some cases, the fluid that represents the greatest cause of failure may be selected.	<p>This field is populated with the value in the Process Fluid field in the associated component.</p> <p>The value in this field must be stored in the Fluid field in one of the Representative Fluids records in the GE Digital APM database.</p> <p>If you select a fluid that is valid for RBI 581, the Fluid Valid for 581 Analysis check box is selected automatically.</p> <p>Important: You must select a fluid that is valid for RBI 581. Otherwise, an error message appears when you calculate the analysis.</p> <p>If the value in the Component Type field is Storage Tank Bottom, then this field must contain a fluid with a Dynamic Viscosity greater than 0. In the baseline APM, the following fluids have a valid Dynamic Viscosity and are supported by Storage Tank Bottom:</p> <ul style="list-style-type: none"> • C6-C8 • C9-C12 • C13-16 (Diesel) • C17-25 (Gas Oil) • C25+ (Resid) • H2O (Water)
Risk Summary Description	Character	A description of the risk summary that appears in the Risk Summary ID field.	This field is disabled and populated automatically.
Risk Summary ID	Character	A short description of the risk summary that is determined after mitigating the risk.	This field is disabled and populated automatically with one of the risk summaries defined in inspection planning .

Field	Data Type	Description	Behavior and Usage
Scenario ID	Character	The scenario for which you have conducted the analysis.	This field is used in the ID template of the RBI 581 Risk Analysis family. Therefore, we recommend that the value in this field be unique among all the RBI 581 Risk Analyses linked to an RBI Component.
SHE COF - RBI Date	Numeric	The consequence of failure for the Safety, Health, and Environment (SHE) category calculated on the RBI date.	This field is populated with the value in the Final Consequence Area field in the associated RBI 581 Consequence Evaluation.
SHE COF - With Plan	Numeric	The consequence of failure for the SHE category calculated on the plan date after mitigating the risk.	This field is populated with the value in the Final Consequence Area field in the associated RBI 581 Consequence Evaluation.
SHE COF - Without Plan	Numeric	The consequence of failure for the SHE category calculated on the plan date before mitigating the risk.	This field is populated with the value in the Final Consequence Area field in the associated RBI 581 Consequence Evaluation.
SHE Risk Category – RBI Date	Character	The category of the SHE risk calculated on the RBI date.	This field contains the description of all the System Codes in the MI_RBI_RISK_CATEGORY System Code Table. The value in this field is determined based on the limits for each risk category that you have specified in the SHE Risk section in the RBI 581 ISO-Risk Plot Preferences workspace
SHE Risk Category – With Plan	Character	The category of the SHE risk calculated on the plan date after mitigating the risk.	This field contains the description of all the System Codes in the MI_RBI_RISK_CATEGORY System Code Table. The value in this field is determined based on the limits for each risk category that you have specified in the SHE Risk section in the RBI 581 ISO-Risk Plot Preferences workspace

Field	Data Type	Description	Behavior and Usage
SHE Risk Category – Without Plan	Character	The category of the SHE risk calculated on the plan date before mitigating the risk.	<p>This field contains the description of all the System Codes in the MI_RBI_RISK_CATEGORY System Code Table.</p> <p>The value in this field is determined based on the limits for each risk category that you have specified in the SHE Risk section in the RBI 581 ISO-Risk Plot Preferences workspace</p>
Specified Tmin	Character	Minimum thickness of the component that is specified by the user.	This field is populated with the value in the Specified Tmin field in the associated component.
Stress Lookup Table	Character	Identifies the type of asset being assessed so that the appropriate design codes are used.	<p>This field is populated with the value in the Stress Lookup Table field in the associated component.</p> <p>This field must contain one of the following values:</p> <ul style="list-style-type: none"> • Piping • Pressure Vessel • TANKS <p>If the Stress Override check box is cleared, and if the analysis is linked to a DM that belongs to the following DMs, then the value in this field is used to calculate the values in the Allowable Stress and Flow Stress fields:</p> <ul style="list-style-type: none"> • 581-Brittle Fracture • 581-Low Alloy Steel Embrittlement • All DMs that belong to RBI 581 Thinning and Lining Evaluation • All DMs that belong to RBI 581 External Damage Evaluation
Stress Override	Boolean	Indicates whether you want to override the values in the Allowable Stress and Flow Stress fields calculated by GE Digital APM.	If you select this check box, the Allowable Stress and Flow Stress fields are enabled.

Field	Data Type	Description	Behavior and Usage
Target Cracking Minimum Damage Factor	Numeric	The target set for the minimum damage factor owing to cracking damage.	If you have specified a value in the Numeric Field Value column in the Target Cracking Minimum Damage Factor row in the RBI 581 Admin Options workspace , then this field is populated automatically with that value.
Target Damage Factor Max	Numeric	The maximum value among the targets set for the damage factor for each DME.	If you have specified a value in the Numeric Field Value column in the Target Maximum Damage Factor row in the RBI 581 Admin Options workspace , then this field is populated automatically with that value.
Target External Minimum Damage Factor	Numeric	The target set for the minimum damage factor owing to external damage.	If you have specified a value in the Numeric Field Value column in the Target External Minimum Damage Factor row in the RBI 581 Admin Options workspace , then this field is populated automatically with that value.
Target Financial Risk	Numeric	The financial risk target, in USD per year, that is set by the analyst.	If you have specified a value in the Numeric Field Value column in the Target Financial Risk row in the RBI 581 Admin Options page , then this field is populated automatically with that value.
Target Inspection Date	Date	The date on which the actual risk equals the risk target. Normally, this date is after the RBI date and before the plan date. If this date is after the plan date, however, the plan date is considered as the target inspection date.	This field is disabled and calculated automatically. This field is used to calculate age during Inspection Planning for RBI 581 External Cracking Damage Evaluations and RBI 581 Cracking Damage Evaluations.
Target SHE Risk	Numeric	The SHE risk target, in square feet per year, that is set by the analyst.	If you have specified a value in the Numeric Field Value column in the Target SHE Risk row in the RBI 581 Admin Options workspace , then this field is populated automatically with that value.

Field	Data Type	Description	Behavior and Usage
Target Thinning And Lining Minimum Damage Factor	Numeric	The target set for the minimum damage factor owing to thinning and lining damage.	If you have specified a value in the Numeric Field Value column in the Target Thinning And Lining Minimum Damage Factor row in the RBI 581 Admin Options workspace , then this field is populated automatically with that value.
Total Damage Factor - RBI Date	Numeric	The total damage factor for the component, calculated on the RBI date.	<p>If the value in the Thinning Type field is General, then this field is disabled and calculated as the sum of the values in the following fields:</p> <ul style="list-style-type: none"> • Governing Brittle Fracture Damage Factor - RBI Date • Governing Cracking Damage Factor - RBI Date • Governing External Damage Factor - RBI Date • Governing HTHA Damage Factor - RBI Date • Governing Mechanical Fatigue Damage Factor - RBI Date • Governing Thinning and Lining Damage Factor - RBI Date <p>If the value in the Thinning Type field is Localized, then this field is disabled and calculated as the sum of the values in the following fields:</p> <ul style="list-style-type: none"> • Governing Brittle Fracture Damage Factor - RBI Date • Governing Cracking Damage Factor - RBI Date • Governing HTHA Damage Factor - RBI Date • Governing Mechanical Fatigue Damage Factor - RBI Date • Governing Thinning and Lining Damage Factor - RBI Date or Governing External Damage Factor - RBI Date, whichever is higher.

Field	Data Type	Description	Behavior and Usage
Total Damage Factor With Plan	Numeric	The total damage factor for the component, calculated on the plan date after mitigating the risk.	<p>If the value in the Thinning Type field is General, then this field is disabled and calculated as the sum of the values in the following fields:</p> <ul style="list-style-type: none"> • Governing Brittle Fracture Damage Factor With Plan • Governing Cracking Damage Factor With Plan • Governing External Damage Factor With Plan • Governing HTHA Damage Factor With Plan • Governing Mechanical Fatigue Damage Factor With Plan • Governing Thinning And Lining Damage Factor With Plan <p>If the value in the Thinning Type field is Localized, then this field is disabled and calculated as the sum of the values in the following fields:</p> <ul style="list-style-type: none"> • Governing Brittle Fracture Damage Factor With Plan • Governing Cracking Damage Factor With Plan • Governing HTHA Damage Factor With Plan • Governing Mechanical Fatigue Damage Factor With Plan • Governing Thinning And Lining Damage Factor With Plan or Governing External Damage Factor With Plan, whichever is higher.

Field	Data Type	Description	Behavior and Usage
Total Damage Factor Without Plan	Numeric	The total damage factor for the component, calculated on the plan date before mitigating the risk.	<p>If the value in the Thinning Type field is General, then this field is disabled and calculated as the sum of the values in the following fields:</p> <ul style="list-style-type: none"> • Governing Brittle Fracture Damage Factor Without Plan • Governing Cracking Damage Factor Without Plan • Governing External Damage Factor Without Plan • Governing HTHA Damage Factor Without Plan • Governing Mechanical Fatigue Damage Factor Without Plan • Governing Thinning And Lining Damage Factor Without Plan <p>If the value in the Thinning Type field is Localized, then this field is disabled and calculated as the sum of the values in the following fields:</p> <ul style="list-style-type: none"> • Governing Brittle Fracture Damage Factor Without Plan • Governing Cracking Damage Factor Without Plan • Governing HTHA Damage Factor Without Plan • Governing Mechanical Fatigue Damage Factor Without Plan • Governing Thinning And Lining Damage Factor Without Plan or Governing External Damage Factor Without Plan, whichever is higher.

Field	Data Type	Description	Behavior and Usage
Total Financial Risk - RBI Date	Numeric	The total financial risk calculated on the RBI date.	This field is disabled and populated automatically. The value in this field is used to plot the financial risk on the RBI 581 ISO Risk Plot .
Total Financial Risk With Plan	Numeric	The total financial risk calculated on the plan date after mitigating the risk.	This field is disabled and populated automatically. The value in this field is used to plot the financial risk on the RBI 581 ISO Risk Plot .
Total Financial Risk Without Plan	Numeric	The total financial risk of the consequence, calculated on the plan date before mitigating the risk.	This field is disabled and populated automatically. The value in this field is used to plot the financial risk on the RBI 581 ISO Risk Plot .
Total POF - RBI Date	Numeric	The total probability of failure, calculated on the RBI date.	This field is disabled and calculated based on the values in the Generic Failure Frequency, Management Factor, and Total Damage Factor - RBI Date fields. The value in this field is used to plot the SHE risk and financial risk on the RBI 581 ISO Risk Plot .
Total POF With Plan	Numeric	The total probability of failure, calculated on the plan date after mitigating the risk.	This field is disabled and calculated based on the values in the Generic Failure Frequency, Management Factor, and Total Damage Factor With Plan fields. The value in this field is used to plot the SHE risk and financial risk on the RBI 581 ISO Risk Plot .
Total POF Without Plan	Numeric	The total probability of failure, calculated on the plan date before mitigating the risk.	This field is disabled and calculated based on the values in the Generic Failure Frequency, Management Factor, and Total Damage Factor Without Plan fields. The value in this field is used to plot the SHE risk and financial risk on the RBI 581 ISO Risk Plot .

Field	Data Type	Description	Behavior and Usage
Total SHE Risk - RBI Date	Numeric	The total SHE risk calculated on RBI date.	This field is disabled and populated automatically. The value in this value is used to plot the SHE risk on the RBI 581 ISO Risk Plot .
Total SHE Risk With Plan	Numeric	The total SHE risk calculated on the plan date after mitigating the risk.	This field is disabled and populated automatically. The value in this field is used to plot the SHE risk on the RBI 581 ISO Risk Plot .
Total SHE Risk Without Plan	Numeric	The total SHE risk calculated on the plan date before mitigating the risk.	This field is disabled and populated automatically. The value in this field is used to plot the SHE risk on the RBI 581 ISO Risk Plot .
Toxic Fluid Valid for 581 Analysis	Boolean	Indicates whether the toxic fluid is valid for an RBI 581 Risk Analysis.	This check box is disabled and selected if the fluid that you have selected in the Toxic Model field is valid for RBI 581. If this check box is cleared, and you calculate the analysis, an error message appears, stating that the toxic model is not valid.
Toxic Mixture	Boolean	Indicates whether or not the process stream contains toxic substances.	This field is populated with the value in the corresponding field in the associated component. If this check box is selected, the following fields are enabled: <ul style="list-style-type: none"> • Toxic Model • Percent Toxic

Field	Data Type	Description	Behavior and Usage
Toxic Model	Character	The fluid that represents or makes up the greatest toxic volume of the asset. In some cases, the fluid that contributes to the greatest Consequence of Failure (CoF) may be selected.	<p>This field is populated with the value in the Toxic Fluid field on the datasheet of the associated component. This field is enabled only if the Toxic Mixture check box is selected.</p> <p>Important: You must select a fluid that is valid for RBI 581. Otherwise, an error message appears when you calculate the analysis.</p>
Weld Joint Effy	Character	Indicates the type of inspection used to ensure the quality of welds and the type of weld joints used during construction.	<p>This field is populated with the value in the Weld Joint Efficiency field in the associated component.</p> <p>This field must contain one of the following values:</p> <ul style="list-style-type: none"> • 0.35 • 0.4 • 0.45 • 0.5 • 0.55 • 0.6 • 0.65 • 0.7 • 0.75 • 0.8 • 0.85 • 0.9 • 0.95 • 1.0 <p>The value in this field is used to calculate an analysis if the analysis is linked to a DM that belongs to the following DMEs:</p> <ul style="list-style-type: none"> • RBI 581 External Damage Evaluation • RBI 581 Thinning and Lining Evaluation

RBI 581 Thinning and Lining Evaluation Records

RBI 581 Thinning and Lining Evaluation records store information about the evaluation that you have performed on the following damage mechanisms (DMs):

- 581-High Temperature Oxidation

- 581-Cooling Water Corrosion
- 581-High Temperature H2/H2S Corrosion
- 581-Amine Corrosion
- 581-Hydrofluoric Acid Corrosion
- 581-Sulfuric Acid Corrosion
- 581-Hydrochloric Acid Corrosion
- 581-Acid Sour Water Corrosion
- 581-High Temperature Sulfidic and Naphthenic Acid
- 581-Alkaline Sour Water Corrosion
- 581-Soil Side Corrosion
- 581-Thinning Damage
- 581-Atmospheric Tank Bottom Corrosion
- 581-Internal Component Lining Damage

This topic provides an alphabetical list and description of the fields that exist for the RBI 581 Thinning and Lining Evaluation family, and appear on the RBI 581 Thinning and Lining datasheet. The information in the table reflects the baseline state and behavior of these fields. This list is not comprehensive.

This family is enabled for site filtering, which means that records in this family can be assigned to a specific site, and will only be accessible to users who are assigned to the same site and have the appropriate license and family privileges. For more information, refer to the Sites section of the documentation.

Field	Data Type	Description	Behavior and Usage
The General Section			
Base Material Calculated Corrosion Rate	Numeric	The corrosion rate of the base material of the component that is calculated by GE Digital APM.	This field is disabled and populated automatically. The value in this field is used to calculate the value in the Expected Metal Loss Fraction (Art) field if the value in the Selected Base Material Corrosion Rate field is Calculated Rate.
Base Material Estimated Corrosion Rate	Numeric	The corrosion rate of the base material of the component that is estimated by a subject matter expert.	This field is populated with the value in the Estimated Internal Corrosion Rate field on the RBI Component. The value in this field is used to calculate the value in the Expected Metal Loss Fraction (Art) field if the value in the Selected Base Material Corrosion Rate field is Estimated Rate.

Field	Data Type	Description	Behavior and Usage
Cladding Material Calculated Corrosion Rate	Numeric	The corrosion rate of the cladding material of the component that is calculated by GE Digital APM.	This field is disabled and populated automatically. The value in this field is used to calculate the value in the Expected Metal Loss Fraction (Art) field if the value in the Selected Cladding Material Corrosion Rate field is Calculated Rate.
Cladding Material Estimated Corrosion Rate	Numeric	The corrosion rate of the cladding material of the component that is estimated by a subject matter expert.	The value in this field is used to calculate the value in the Expected Metal Loss Fraction (Art) field if the value in the Selected Cladding Material Corrosion Rate field is Estimated Rate.

Field	Data Type	Description	Behavior and Usage
Controlling Corrosion Rate	Numeric	The controlling corrosion rate, in inches per year, of the Asset or the TML Group that is associated with the component.	<p>The value in this field is used to calculate the damage factor if the value in the Selected BM Corrosion Rate or Selected Cladding Corrosion Rate field is Controlling Corrosion Rate.</p> <p>This field is disabled. If the value in the Source of Calculated Corrosion Rates field in the associated Component is:</p> <ul style="list-style-type: none"> • Asset, then this field is populated based on the value in the Controlling Corrosion Rate field in the associated Asset Corrosion Analysis in Thickness Monitoring. • Component, then this field is populated based on the highest value in the Controlling Corrosion Rate fields in the associated Asset Corrosion Analyses linked to the TML Groups. • Manual Entry, then this field is blank because controlling corrosion rate is always specified in Thickness Monitoring. You cannot enter a value in this field. <p>Note: The value in the Controlling Corrosion Rate field in the Asset Corrosion Analysis is in mils per year. This value is converted to inches per year, and then used to populate this field.</p> <p>When you copy the analysis without copying the Recommendations, the value in this field is not copied. It is updated based on the Asset or TML Group that is linked to the component. When you copy the analysis along with the Recommendations, then the value in this field is copied.</p>

Field	Data Type	Description	Behavior and Usage
Date in Service	Date	The date and time on which the component is in service.	This value is populated with the value in the Component Date in Service field on the RBI Component datasheet. You can, however, change this value using the calendar feature. The value in this field is used to calculate the value in the Age field if there is no value in the Last Known Inspection Date field.
Damage Mechanism	Character	The damage mechanism that you want to evaluate.	This field is disabled and populated automatically.
Governing Thinning Damage Mechanism	Character	The damage mechanism of the highest impact in the case of thinning.	If the damage mechanism that you are evaluating is 581-Thinning Damage, then this field is enabled, and contains the description of all the System Codes in the MI_581_GOV_THINNING_DAMAGE System Code Table. For all the other damage mechanisms, this field is disabled and populated automatically.
Highest Effective Inspection Level	Character	The highest level of effective inspections.	The value in this field is required to calculate the value in the Base Damage Factor field. For 581-Atmospheric Tank Bottom Corrosion, if you select the Use Combined Confidence check box, then the value in this field is calculated automatically. This field contains the descriptions of all the System Codes in the MI_581_Inspection_Effectiveness System Code Table. You can choose from the following baseline values: <ul style="list-style-type: none"> • Highly Effective • Usually Effective • Fairly Effective • Poorly Effective • InEffective (None)

Field	Data Type	Description	Behavior and Usage
Last Known Inspection Date	Date	The date on which the component was last inspected for internal corrosion. Ideally, the valid thickness is also measured on this date.	This field is populated by the value in the Completion Date field for the Inspection. If there is more than one linked Inspection, the latest date is used. If there are no linked Inspections, this field will be blank. You can also enter a value in this field manually.
Last Known Thickness	Numeric	The thickness of the component (in inches) that you have measured on the date specified in the last Known Inspection Date field.	This field is enabled only if you select a date in the Last Known Inspection Date field. The value in this field is used to calculate the value in the Expected Metal Loss Fraction (Art) field. If you do not enter a value in this field, then the value in the Furnished Base Material Thk (Nominal Thickness) on the RBI 581 Risk Analysis datasheet is used.
Long Term Avg Corr Rate	Numeric	The measured corrosion rate as calculated in the Thickness Monitoring module.	<p>The value in this field is used to calculate the damage factor if the value in the Selected BM Corrosion Rate or Selected Cladding Material Corrosion Rate field is Long Term Avg.</p> <p>If the value in the Source of Calculated Corrosion Rates field in the associated Component is:</p> <ul style="list-style-type: none"> Asset, then this field is disabled and calculated. Component, then this field is disabled and calculated. Manual Entry, then this field is enabled. <p>When you copy the analysis without copying the Recommendations, the value in this field is not copied. It is updated based on the Asset or TML Group that is linked to the component. When you copy the analysis, along with the Recommendations, then the value in this field is copied.</p>

Field	Data Type	Description	Behavior and Usage
Number of A Level Inspections	Numeric	The number of highly effective inspections.	<p>If Inspections are assigned to the DM, then this field is populated automatically. The value in this field is used to calculate the value in the Inspection Effectiveness - 1, Inspection Effectiveness - 2, and Inspection Effectiveness - 3 fields.</p> <p>For 581-Atmospheric Tank Bottom Corrosion, if you select the Use Combined Confidence check box, then the value in this field is used to calculate the values in the Highest Effective Inspection Level and Number of Highest Effective Inspections fields.</p>
Number of B Level Inspections	Numeric	The number of usually effective inspections.	<p>If Inspections are assigned to the DM, then this field is populated automatically. The value in this field is used to calculate the value in the Inspection Effectiveness - 1, Inspection Effectiveness - 2, and Inspection Effectiveness - 3 fields.</p> <p>For 581-Atmospheric Tank Bottom Corrosion, if you select the Use Combined Confidence check box, then the value in this field is used to calculate the values in the Highest Effective Inspection Level and Number of Highest Effective Inspections fields.</p>

Field	Data Type	Description	Behavior and Usage
Number of C Level Inspections	Numeric	The number of fairly effective inspections.	<p>If Inspections are assigned to the DM, then this field is populated automatically. The value in this field is used to calculate the value in the Inspection Effectiveness - 1, Inspection Effectiveness - 2, and Inspection Effectiveness - 3 fields.</p> <p>For 581-Atmospheric Tank Bottom Corrosion, if you select the Use Combined Confidence check box, then the value in this field is used to calculate the values in the Highest Effective Inspection Level and Number of Highest Effective Inspections fields.</p>
Number of D Level Inspections	Numeric	The number of poorly effective inspections.	<p>If Inspections are assigned to the DM, then this field is populated automatically. The value in this field is used to calculate the value in the Inspection Effectiveness - 1, Inspection Effectiveness - 2, and Inspection Effectiveness - 3 fields.</p> <p>For 581-Atmospheric Tank Bottom Corrosion, if you select the Use Combined Confidence check box, then the value in this field is used to calculate the values in the Highest Effective Inspection Level and Number of Highest Effective Inspections fields.</p>

Field	Data Type	Description	Behavior and Usage
Number of Highest Effective Inspections	Numeric	The number of inspections with the level that is specified in the Highest Effective Insp field.	<p>You can enter a value between 0 and 6. If you enter 0, then the Highest Effective Inspection Level field is disabled and populated with the value InEffective (None).</p> <p>The value in this field is required to calculate the values in the Inspection Effectiveness - 1, Inspection Effectiveness - 2, and Inspection Effectiveness - 3 fields.</p> <p>For 581-Atmospheric Tank Bottom Corrosion, if you select the Use Combined Confidence check box, then the value in this field is calculated automatically.</p>

Field	Data Type	Description	Behavior and Usage
Selected BM Corrosion Rate	Character	Indicates whether you want to enter estimated corrosion rate manually, or you want GE Digital APM to calculate the corrosion rate.	<p>This field appears as a drop-down list box labeled Selected base Material Corrosion Rate on the datasheet. The value in this field is required to calculate the analysis.</p> <p>This field contains the descriptions of all System Codes in the 581_CORR_TYPE System Code Table. You can choose from the following baseline values:</p> <ul style="list-style-type: none"> • Estimated Rate: If you select this value, then the value in the Base Material Estimated Corrosion Rate field is used to calculate the damage factor. • Calculated Rate: If you select this value, then the value in the Base Material Calculated Corrosion Rate field is used to calculate the damage factor. • Short Term Avg: If you select this value, then the value in the Short Term Avg Corr Rate field is used to calculate the damage factor. • Long Term Avg: If you select this value, then the value in the Long Term Avg Corr Rate field is used to calculate the damage factor. • Controlling Corrosion Rate: If you select this value, then the value in the Controlling Corrosion Rate field is used to calculate the damage factor.

Field	Data Type	Description	Behavior and Usage
Selected Cladding Material Corrosion Rate	Character	Indicates whether you want to enter estimated corrosion rate of the cladding material manually, or you want GE Digital APM to calculate the corrosion rate.	<p>This field contains the descriptions of all System Codes in the 581_CORR_TYPE System Code Table. You can choose from the following baseline values:</p> <ul style="list-style-type: none"> • Estimated Rate: If you select this value, then the value in the Cladding Material Estimated Corrosion Rate field is used to calculate the damage factor. • Calculated Rate: If you select this value, then the value in the Cladding Material Calculated Corrosion Rate field is used to calculate the damage factor. • Short Term Avg: If you select this value, then the value in the Short Term Avg Corr Rate field is used to calculate the damage factor. • Long Term Avg: If you select this value, then the value in the Long Term Avg Corr Rate field is used to calculate the damage factor. • Controlling Corrosion Rate: If you select this value, then the value in the Controlling Corrosion Rate field is used to calculate the damage factor.

Field	Data Type	Description	Behavior and Usage
Short Term Avg Corr Rate	Numeric	The measured corrosion rate as calculated in the Thickness Monitoring module.	<p>The value in this field is used to calculate the damage factor if the value in the Selected BM Corrosion Rate or Selected Cladding Material Corrosion Rate field is Short Term Avg.</p> <p>If the value in the Source of Calculated Corrosion Rates field in the associated Component is:</p> <ul style="list-style-type: none"> Asset, then this field is disabled and calculated. Component, then this field is disabled and calculated. Manual Entry, then this field is enabled. <p>When you copy the analysis without copying the Recommendations, the value in this field is not copied. It is updated based on the Asset or TML Group that is linked to the component. When you copy the analysis, along with the Recommendations, then the value in this field is copied.</p>
Thinning Type	Character	The type of thinning in the component.	<p>The value in this field is required to calculate the value in the Final Damage Factor field.</p> <p>This field contains the descriptions of all System Codes in the CORROSION TYPES System Code Table. You can choose from the following baseline values:</p> <ul style="list-style-type: none"> General Localized
Use Combined Confidence	Boolean	Indicates whether you want GE Digital APM to calculate the highest effective inspection level and number.	If you select this check box, the values in the Highest Effective Inspection Level and Number of Highest Effective Inspections fields are calculated automatically.

Field	Data Type	Description	Behavior and Usage
Use Related Inspections	Boolean	Indicates whether you want GE Digital APM to consider inspections on related DMEs .	If you select this check box, and if you have assigned Inspections to the DM , then the values in the Number of A Level Inspections, Number of B Level Inspections, Number of C Level Inspections, and Number of D Level Inspections fields are populated automatically.
The Thinning Data Section			
API 653 Maintenance Flag	Boolean	Indicates whether the component is maintained in compliance with API 653.	The value in this field is used to calculate the value in the API 653 Maintenance Adjustment field.
Corrosion Coupons?	Character	Indicates whether corrosion coupons are used to monitor the corrosion in the component.	<p>This field is enabled only if the value in the Online Monitoring Flag is Yes (Y). The value in this field is used to calculate the value in the Online Monitoring Adjustment field.</p> <p>This field contains the descriptions of all System Codes in the MI_YES_NO System Code Table. You can choose from the following baseline values:</p> <ul style="list-style-type: none"> • Yes (Y) • No (N)
Deadleg Flag	Character	Indicates whether a deadleg is present in the component.	<p>The value in this field is used to calculate the value in the Deadleg Adjustment field if the component type is Piping.</p> <p>This field contains the descriptions of all System Codes in the MI_YES_NO System Code Table. You can choose from the following baseline values:</p> <ul style="list-style-type: none"> • Yes (Y) • No (N)

Field	Data Type	Description	Behavior and Usage
Deadleg Inspection	Character	Indicates whether a highly effective inspection method is used to address the potential of localized corrosion in the deadleg.	<p>The value in this field is used to calculate the value in the Deadleg Adjustment field. This field is enabled only if the value in the Deadleg Flag is Yes (Y).</p> <p>This field contains the descriptions of all System Codes in the MI_YES_NO System Code Table. You can choose from the following baseline values:</p> <ul style="list-style-type: none"> • Yes (Y) • No (N)
Electrical Resistance Probes?	Character	Indicates whether electrical resistance probes are used to monitor corrosion in the component.	<p>This field is enabled only if the value in the Online Monitoring Flag is Yes (Y). The value in this field is used to calculate the value in the Online Monitoring Adjustment field.</p> <p>This field contains the descriptions of all System Codes in the MI_YES_NO System Code Table. You can choose from the following baseline values:</p> <ul style="list-style-type: none"> • Yes (Y) • No (N)
Foundation Type	Character	The foundation type of the storage tank bottom.	<p>The value in this field is used to calculate the value in the Settlement Adjustment field if the component type is Storage Tank Bottom.</p> <p>This field contains the descriptions of all System Codes in the FOUNDATION TYPES System Code Table. You can choose from the following baseline values:</p> <ul style="list-style-type: none"> • Clay • Silt • Sand • Gravel • Concrete • Double Floor

Field	Data Type	Description	Behavior and Usage
Injection Point Flag	Character	Indicates whether the piping circuit contains an injection point.	<p>The value in this field is used to calculate the value in the Injection Point Adjustment field if the component type is Storage Tank Bottom. This field contains the descriptions of all System Codes in the MI_YES_NO System Code Table. You can choose from the following baseline values:</p> <ul style="list-style-type: none"> • Yes (Y) • No (N)
Injection Point Inspection	Character	Indicates the presence of a highly effective inspection for injection point corrosion within the injection point circuit.	<p>The value in this field is used to calculate the value in the Injection Point Adjustment field. This field is enabled only if the value in the Injection Point Flag is Yes (Y).</p> <p>This field contains the descriptions of all System Codes in the MI_YES_NO System Code Table. You can choose from the following baseline values:</p> <ul style="list-style-type: none"> • Yes (Y) • No (N)
Key Process Variable?	Character	Indicates if key process variables are used to monitor a thinning damage mechanism.	<p>This field is enabled only if the value in the Online Monitoring Flag is Yes (Y). The value in this field is used to calculate the value in the Online Monitoring Adjustment field.</p> <p>This field contains the descriptions of all System Codes in the MI_YES_NO System Code Table. You can choose from the following baseline values:</p> <ul style="list-style-type: none"> • Yes (Y) • No (N)

Field	Data Type	Description	Behavior and Usage
Online Monitoring Flag	Character	Indicates whether the component is monitored online to check for a damage.	<p>The value in this field is used to calculate the value in the Online Monitoring Adjustment field.</p> <p>This field contains the descriptions of all System Codes in the MI_YES_NO System Code Table. You can choose from the following baseline values:</p> <ul style="list-style-type: none"> • Yes (Y) • No (N)
Settlement Adjustment Flag	Character	Indicates whether settlement is applicable to the component of type Storage Tank Bottom.	<p>The value in this field is used to calculate the value in the Settlement Adjustment field.</p> <p>This field contains the descriptions of all System Codes in the MI_YES_NO System Code Table. You can choose from the following baseline values:</p> <ul style="list-style-type: none"> • Yes (Y) • No (N) <p>If the value in the Foundation Type field is Concrete, however, this field is disabled.</p>
Settlement Adjustment Inspection	Character	Indicates whether the recorded settlement meets or exceeds the API 653 criteria, or has never been evaluated.	<p>The value in this field is used to calculate the value in the Settlement Adjustment field.</p> <p>This field is enabled only if the value in the Settlement Adjustment Flag field is Yes (Y).</p> <p>This field contains the descriptions of all System Codes in the MI_581_Recorded_Settlement_Criteria System Code Table. You can choose from the following baseline values:</p> <ul style="list-style-type: none"> • Meets API 653 • Never Evaluated • Exceeds API 653

Field	Data Type	Description	Behavior and Usage
Welded Construction Flag	Character	Indicates whether the component is welded or riveted.	<p>The value in this field is used to calculate the value in the Welded Construction Adjustment field.</p> <p>This field contains the descriptions of all System Codes in the MI_YES_NO System Code Table. You can choose from the following baseline values:</p> <ul style="list-style-type: none"> • Yes (Y) • No (N)
The Thinning Supplements section			
Acid Concentration	Numeric	The concentration of the Sulfuric acid, in percentage, that is used in the component.	The value in this field is used to calculate the value in the Base Material Calculated Corrosion Rate field if you are evaluating the 581-Sulfuric Acid Corrosion DM.
Acid Gas Loading	Numeric	The rate, in Mole Acid/Mole Active Amine, at which acid gas loads in the component.	The value in this field is used to calculate the value in the Base Material Calculated Corrosion Rate field if you are evaluating the 581-Amine Corrosion DM.
Amine Concentration	Numeric	The concentration of the amine, in weight percentage, that is used in the component.	The value in this field is used to calculate the value in the Base Material Calculated Corrosion Rate field if you are evaluating the 581-Amine Corrosion DM.

Field	Data Type	Description	Behavior and Usage
Amine Type	Character	The type of the amine that is used in the component.	<p>The value in this field is used to calculate the value in the Base Material Calculated Corrosion Rate field if you are evaluating the 581-Amine Corrosion DM.</p> <p>This field contains the descriptions of all System Codes in the MI_581_Amine_Types System Code Table. You can choose from the following baseline values:</p> <ul style="list-style-type: none"> • MEA • DEA • MDEA
AST Bottom Type	Character	The type of the atmospheric tank bottom that the component represents.	<p>The value in this field is used to calculate the value in the Base Material Calculated Corrosion Rate field if the value in the Selected Base Material Corrosion Rate field is Calculated Rate.</p> <p>This field contains the descriptions of all System Codes in the 581_AST_BOTTOM_TYPE System Code Table. You can choose from the following baseline values:</p> <ul style="list-style-type: none"> • RPB Not Per API 650 • RPB Per API 650 • Single Bottom

Field	Data Type	Description	Behavior and Usage
AST Drainage	Character	The type of the drainage that is used in the atmospheric tank bottom component.	<p>The value in this field is used to calculate the value in the Base Material Calculated Corrosion Rate field if the value in the Selected Base Material Corrosion Rate field is Calculated Rate.</p> <p>This field contains the descriptions of all System Codes in the 581_AST_DRAINAGE_TYPE System Code Table. You can choose from the following baseline values:</p> <ul style="list-style-type: none"> • One Third Frequently Underwater • Storm Water Collects At AST Base • Storm Water Does Not Collect At AST Base
AST Pad	Character	The type of the material of which the atmospheric tank bottom pad is made.	<p>The value in this field is used to calculate the value in the Base Material Calculated Corrosion Rate field if the value in the Selected Base Material Corrosion Rate field is Calculated Rate.</p> <p>This field contains the descriptions of all System Codes in the 581_AST_PAD_MAT_TYPE System Code Table. You can choose from the following baseline values:</p> <ul style="list-style-type: none"> • Soil With High Salt • Crushed Limestone • Native Soil • Construction Grade Sand • Continuous Asphalt • Continuous Concrete • Oil Sand • High Resistivity Low Chloride Sand

Field	Data Type	Description	Behavior and Usage				
AST Steam Coil Heater	Character	Indicates whether the atmospheric tank bottom contains a steam coil heater.	<p>The value in this field is used to calculate the value in the Base Material Calculated Corrosion Rate field if the value in the Selected Base Material Corrosion Rate field is Calculated Rate.</p> <p>This field contains the descriptions of all System Codes in the MI_581_AST_STEAMCOIL_WAT ERDRWASOFF System Code Table. You can choose from the following baseline values:</p> <ul style="list-style-type: none"> • Yes (Y) • No (N) 				
Calcium Hardness	Numeric	The hardness of calcium, in milligrams per liter, in the cooling water that is used in the component.	<p>This field is enabled only if one of the following sets of conditions is satisfied:</p> <table border="1" data-bbox="1146 957 1414 1703"> <thead> <tr> <th data-bbox="1146 957 1281 1003">Set 1</th> <th data-bbox="1281 957 1414 1003">Set 2</th> </tr> </thead> <tbody> <tr> <td data-bbox="1146 1003 1281 1703"> <ul style="list-style-type: none"> • The value in the Cooling System Type field is Once-Through. • The value in the Water Treatment Type field is Fresh Water. • The value in the Water Treatment Type field is Untreated. </td> <td data-bbox="1281 1003 1414 1703"> <ul style="list-style-type: none"> • The value in the Cooling System Type field is Recirculating. • The value in the Water Treatment Type field is Untreated. </td> </tr> </tbody> </table>	Set 1	Set 2	<ul style="list-style-type: none"> • The value in the Cooling System Type field is Once-Through. • The value in the Water Treatment Type field is Fresh Water. • The value in the Water Treatment Type field is Untreated. 	<ul style="list-style-type: none"> • The value in the Cooling System Type field is Recirculating. • The value in the Water Treatment Type field is Untreated.
Set 1	Set 2						
<ul style="list-style-type: none"> • The value in the Cooling System Type field is Once-Through. • The value in the Water Treatment Type field is Fresh Water. • The value in the Water Treatment Type field is Untreated. 	<ul style="list-style-type: none"> • The value in the Cooling System Type field is Recirculating. • The value in the Water Treatment Type field is Untreated. 						

Field	Data Type	Description	Behavior and Usage
Cathodic Protection	Character	Indicates whether the component contains a cathodic protection, and if it complies with the standards in API 651.	<p>The value in this field is used to calculate the value in the Base Material Calculated Corrosion Rate field if the value in the Selected Base Material Corrosion Rate field is Calculated Rate.</p> <p>This field contains the descriptions of all System Codes in the 581_AST_Cathodic Protection System Code Table. You can choose from the following baseline values:</p> <ul style="list-style-type: none"> • None • Yes and Not Per API 651 • Yes and Per API 651
Cathodic Protection Effectiveness	Character	The effectiveness of the cathodic protection that is used in the component.	<p>The value in this field is used to calculate the value in the Base Material Calculated Corrosion Rate field if you are evaluating the 581-Soil Side Corrosion DM.</p> <p>This field contains the descriptions of all System Codes in the MI_581_Cathodic Protection Effectiveness Factors System Code Table. You can choose from the following baseline values:</p> <ul style="list-style-type: none"> • Cathodic Protection exists not per NACE RP0169 • No Cathodic Protection • Cathodic Protection is tested annually • No Cathodic Protection on Structure • Tested Cathodic protection NACE RP0169 supported
Cl Concentration	Numeric	The concentration of chlorine, in Weight parts per million, in the cooling water that is used in the component.	The value in this field is used to calculate the analysis if you are evaluating the 581-Cooling Water Corrosion and 581-Hydrochloric Acid Corrosion DMs.

Field	Data Type	Description	Behavior and Usage
Coating Age	Numeric	The time, in years, since coating has been installed on the component.	This field is enabled only if the value in the Coating present? field is Yes (Y).
Coating Maintenance Rare or None?	Character	Indicates whether coating maintenance is performed frequently or rarely.	<p>This field is enabled only if the value in the Coating present? field is Yes (Y).</p> <p>This field contains the descriptions of all System Codes in the MI_YES_NO System Code Table. You can choose from the following baseline values:</p> <ul style="list-style-type: none"> • Yes (Y) • No (N)
Coating Present?	Character	Indicates whether coating is installed on the component.	<p>The value in this field is used to calculate the value in the Base Material Calculated Corrosion Rate field if you are evaluating the 581-Soil Side Corrosion DM.</p> <p>This field contains the descriptions of all System Codes in the MI_YES_NO System Code Table. You can choose from the following baseline values:</p> <ul style="list-style-type: none"> • Yes (Y) • No (N)

Field	Data Type	Description	Behavior and Usage
Coating Type	Character	The type of the coating material on the component.	<p>This field is enabled only if the value in the Coating present? field is Yes (Y).</p> <p>This field contains the descriptions of all System Codes in the 581_Coating_Type System Code Table. You can choose from the following baseline values:</p> <ul style="list-style-type: none"> • Fusion Bonded Epoxy • Liquid Epoxy • Asphalt Enamel • Asphalt Mastic • Coat Tar Enamel • Extruded Polyethylene with mastic rubber • Mill Applied PE Tape with mastic • Field Applied PE Tape with mastic • Three-Layer PE or PP
Cooling System Type	Character	Indicates whether or not the cooling water used in the component is recirculating.	<p>The value in this field is used to calculate the value in the Base Material Calculated Corrosion Rate field if you are evaluating the 581-Cooling Water Corrosion DM.</p> <p>This field contains the descriptions of all System Codes in the MI_581_Cooling_System System Code Table. You can choose from the following baseline values:</p> <ul style="list-style-type: none"> • Once-Through • Recirculating
Heat Stable Amine Salts (HSAS)	Numeric	The concentration, in weight percentage, of heat stable amine salts in the amine solution that is used in the component.	The value in this field is used to calculate the value in the Base Material Calculated Corrosion Rate field if you are evaluating the 581-Amine Corrosion DM.

Field	Data Type	Description	Behavior and Usage
HF Concentration	Numeric	The concentration of Hydrogen Fluoride, in ppm, that is used in the component.	The value in this field is used to calculate the value in the Base Material Calculated Corrosion Rate field if you are evaluating the 581-Hydrofluoric Acid Corrosion DM.
Hydrocarbon Type	Character	The type of the hydrocarbon that is used in the component.	<p>The value in this field is used to calculate the value in the Base Material Calculated Corrosion Rate field if you are evaluating the 581-High Temperature H₂/H₂S Corrosion DM.</p> <p>This field contains the descriptions of all System Codes in the MI_581_HYDROCARBON_TYPE S System Code Table. You can choose from the following baseline values:</p> <ul style="list-style-type: none"> • NAPTHA • GAS OIL
H ₂ /H ₂ S Content	Numeric	The mole percentage of H ₂ /H ₂ S in the component.	The value in this field is used to calculate the value in the Base Material Calculated Corrosion Rate field if you are evaluating the 581-High Temperature H ₂ /H ₂ S Corrosion DM.
H ₂ S Partial Pressure	Numeric	The partial pressure of Hydrogen Sulfide, in pounds per square inch gage, that is used in the component.	The value in this field is used to calculate the value in the Base Material Calculated Corrosion Rate field if you are evaluating the 581-Alkaline Sour Water Corrosion DM.

Field	Data Type	Description	Behavior and Usage
Is Air or Oxidant Present?	Character	Indicates whether air or oxidant is present in the component.	<p>The value in this field is used to calculate the value in the Base Material Calculated Corrosion Rate field if you are evaluating any of the following DMs:</p> <ul style="list-style-type: none"> • 581-Hydrochloric Acid Corrosion • 581-High Temperature Oxidation • 581-Sulfuric Acid Corrosion <p>This field contains the descriptions of all System Codes in the MI_YES_NO System Code Table. You can choose from the following baseline values:</p> <ul style="list-style-type: none"> • Yes (Y) • No (N)
Maximum Coating Temperature Rating Exceeded?	Character	Indicates whether the maximum coating temperature rating has exceeded.	<p>This field is enabled only if the value in the Coating Present? field is Yes (Y).</p> <p>This field contains the descriptions of all System Codes in the MI_YES_NO System Code Table. You can choose from the following baseline values:</p> <ul style="list-style-type: none"> • Yes (Y) • No (N)

Field	Data Type	Description	Behavior and Usage				
MO Alkalinity	Numeric	The concentration, in milligrams per liter, of Methyl Orange alkalinity in the component.	<p>This field is enabled only if one of the following sets of conditions is satisfied:</p> <table border="1"> <thead> <tr> <th>Set 1</th> <th>Set 2</th> </tr> </thead> <tbody> <tr> <td> <ul style="list-style-type: none"> The value in the Cooling System Type field is Once-Through. The value in the Water Treatment Type field is Fresh Water. The value in the Water Treatment Type field is Untreated. </td> <td> <ul style="list-style-type: none"> The value in the Cooling System Type field is Recirculating. The value in the Water Treatment Type field is Untreated. </td> </tr> </tbody> </table>	Set 1	Set 2	<ul style="list-style-type: none"> The value in the Cooling System Type field is Once-Through. The value in the Water Treatment Type field is Fresh Water. The value in the Water Treatment Type field is Untreated. 	<ul style="list-style-type: none"> The value in the Cooling System Type field is Recirculating. The value in the Water Treatment Type field is Untreated.
Set 1	Set 2						
<ul style="list-style-type: none"> The value in the Cooling System Type field is Once-Through. The value in the Water Treatment Type field is Fresh Water. The value in the Water Treatment Type field is Untreated. 	<ul style="list-style-type: none"> The value in the Cooling System Type field is Recirculating. The value in the Water Treatment Type field is Untreated. 						
NH4HS Concentration	Numeric	The concentration of Ammonium Hydrosulfide, in weight percentage, that is used in the component.	The value in this field is used to calculate the value in the Base Material Calculated Corrosion Rate field if you are evaluating the 581-Alkaline Sour Water Corrosion DM.				
Oxygen in the Process Stream	Numeric	The amount of oxygen, in parts per billion, in the process stream used in the component.	The value in this field is used to calculate the value in the Base Material Calculated Corrosion Rate field if you are evaluating the 581-Acid Sour Water Corrosion DM.				

Field	Data Type	Description	Behavior and Usage
Product Side Condition	Character	The condition of the product side.	<p>The value in this field is used to calculate the value in the Base Material Calculated Corrosion Rate field if:</p> <ul style="list-style-type: none"> • You are evaluating the 581-Atmospheric Tank Bottom Corrosion DM. -and- • The value in the Selected Base Material Corrosion Rate field is Calculated Rate. <p>This field contains the descriptions of all System Codes in the 581_Product_Side_Condition System Code Table. You can choose from the following baseline values:</p> <ul style="list-style-type: none"> • Wet • Dry
Recirculating System Type	Character	Indicates whether the recirculating system of the cooling water is open or closed.	<p>This field is enabled only if the value in the Cooling System Type field is Recirculating.</p> <p>This field contains the descriptions of all System Codes in the MI_581_Recirculating_System System Code Table. You can choose from the following baseline values:</p> <ul style="list-style-type: none"> • Open • Closed
Soil Resistivity	Numeric	The resistivity, in Ohm-cm, of the soil that is used in the component.	<p>The value in this field is used to calculate the value in the Base Material Calculated Corrosion Rate field if the value in the Selected Base Material Corrosion Rate field is Calculated Rate.</p>

Field	Data Type	Description	Behavior and Usage
Soil Type	Character	The type of the soil that is used in the component.	<p>The value in this field is used to calculate the value in the Base Material Calculated Corrosion Rate field if you are evaluating the 581-Soil Side Corrosion DM.</p> <p>This field contains the descriptions of all System Codes in the 581_Primary_Soil_Type System Code Table. You can choose from the following baseline values:</p> <ul style="list-style-type: none"> • Sand • Silt • Clay
Sulphur Concentration	Numeric	The concentration of sulphur, in weight percentage, in the Sulfidic and Naphthenic acid that is used in the component.	The value in this field is used to calculate the value in the Base Material Calculated Corrosion Rate field if you are evaluating the 581-High Temperature Sulfidic and Naphthenic Acid DM.
TAN	Numeric	The Total Acid Number value, in milligrams per gram, of the acid that is used in the component.	The value in this field is used to calculate the value in the Base Material Calculated Corrosion Rate field if you are evaluating the 581-High Temperature Sulfidic and Naphthenic Acid DM.

Field	Data Type	Description	Behavior and Usage				
Total Dissolved Solids	Numeric	The amount of the total dissolved salts, in milligrams per liter, in the cooling water that is used in the component.	<p>This field is enabled only if one of the following sets of conditions is satisfied:</p> <table border="1" data-bbox="1146 394 1412 1138"> <thead> <tr> <th data-bbox="1146 394 1279 447">Set 1</th> <th data-bbox="1279 394 1412 447">Set 2</th> </tr> </thead> <tbody> <tr> <td data-bbox="1146 447 1279 1138"> <ul style="list-style-type: none"> • The value in the Cooling System Type field is Once-Through. • The value in the Water Type field is Fresh Water. • The value in the Water Treatment Type field is Untreated. </td> <td data-bbox="1279 447 1412 1138"> <ul style="list-style-type: none"> • The value in the Cooling System Type field is Recirculating. • The value in the Water Treatment Type field is Untreated. </td> </tr> </tbody> </table>	Set 1	Set 2	<ul style="list-style-type: none"> • The value in the Cooling System Type field is Once-Through. • The value in the Water Type field is Fresh Water. • The value in the Water Treatment Type field is Untreated. 	<ul style="list-style-type: none"> • The value in the Cooling System Type field is Recirculating. • The value in the Water Treatment Type field is Untreated.
Set 1	Set 2						
<ul style="list-style-type: none"> • The value in the Cooling System Type field is Once-Through. • The value in the Water Type field is Fresh Water. • The value in the Water Treatment Type field is Untreated. 	<ul style="list-style-type: none"> • The value in the Cooling System Type field is Recirculating. • The value in the Water Treatment Type field is Untreated. 						
Water Product Draws	Character	Indicates whether water product draws exist in the component.	<p>The value in this field is used to calculate the value in the Base Material Calculated Corrosion Rate field if the value in the Selected Base Material Corrosion Rate field is Calculated Rate.</p> <p>This field contains the descriptions of all System Codes in the MI_581_AST_STEAMCOIL_WAT ERDRWASOFF System Code Table. You can choose from the following baseline values:</p> <ul style="list-style-type: none"> • Yes (Y) • No (N) 				

Field	Data Type	Description	Behavior and Usage
Water Treatment Type	Character	Indicates whether the water used in the cooling system is treated or untreated.	<p>This field is enabled only if:</p> <ul style="list-style-type: none"> • The value in the Cooling System Type field is Once-Through. -and- • The value in the Water Type field is Fresh Water. <p>This field contains the descriptions of all System Codes in the MI_581_Water_Treatment_Type System Code Table. You can choose from the following baseline values:</p> <ul style="list-style-type: none"> • Treated • Untreated
Water Type	Character	Indicates whether the type of water that is used in the cooling system is fresh water or sea water.	<p>This field is enabled only if the value in the Cooling System Type field is Once-Through.</p> <p>This field contains the descriptions of all System Codes in the MI_581_Water_Type System Code Table. You can choose from the following baseline values:</p> <ul style="list-style-type: none"> • Fresh Water • Sea Water
The Lining Data Section			

Field	Data Type	Description	Behavior and Usage
Immersion Grade Coating Quality	Character	The quality of the organic coating.	<p>This field is enabled only if:</p> <ul style="list-style-type: none"> • The value in the Liner is Present field is Yes (Y). -and- • The value in the Liner Type field is Organic Coating (typically > 0.762mm / 30 mils). <p>The value in this field is used to calculate the value in the Base Damage Factor field if the value in the Liner Type field is Organic Coating (typically > 0.762mm / 30 mils). This field contains the descriptions of all System Codes in the MI_581_Coating_Quality System Code Table. You can choose from the following baseline values:</p> <ul style="list-style-type: none"> • High • Medium • Low
Liner Condition	Character	The condition of the liner.	<p>The value in this field is used to calculate the value in the Final Damage Factor field. This field is enabled only if the value in the Liner is Present field is Yes (Y). It contains the descriptions of all System Codes in the MI_581_Lining_Condition System Code Table. You can choose from the following baseline values:</p> <ul style="list-style-type: none"> • Good • Average • Poor
Liner Installation Date	Date	The date and time on which the liner has been installed in the component.	<p>The value in this field is used to calculate the value in the Age field. This field is enabled only if the value in the Liner is Present field is Yes (Y). You can use the Calendar feature to select the date and time.</p>

Field	Data Type	Description	Behavior and Usage
Liner is Present	Character	Indicates whether liner is present in the component.	<p>This field is populated with the value in the Liner Present field on the datasheet of the associated component. It contains the descriptions of all System Codes in the MI_YES_NO System Code Table. You can choose from the following baseline values:</p> <ul style="list-style-type: none"> • Yes (Y) • No (N) <p>If you select Yes (Y), the following fields are enabled:</p> <ul style="list-style-type: none"> • Liner Installation Date • Liner Condition • Liner Type • Immersion Grade Coating Quality (only if the value in the Liner Type field is Organic Coating (typically > 0.762mm / 30 mils))
Liner Type	Character	The type of the liner that is used in the component.	<p>This field is populated with the value in the Liner Type field on the datasheet of the associated component. It is enabled only if the value in the Liner is Present field is Yes (Y). The value in this field is used to calculate the value in the Base Damage Factor field.</p> <p>This field contains the descriptions of all System Codes in the MI_581_Lining_Types_And_Resistance System Code Table. You can choose from the following baseline values:</p> <ul style="list-style-type: none"> • Strip Lined Alloy • Organic Coating (typically > 0.762mm / 30 mils) • Thermal Resistant Service - Castable Refractory • Severe/Abrasive Service - Castable Refractory • Glass Linings • Acid Brick • Fiberglass

Field	Data Type	Description	Behavior and Usage
The Outputs Section			
Age	Numeric	Age is the time since the last inspection was performed. In order to satisfy an inspection, there should be values in the Last Known Inspection Date and Last known Thickness fields. If the last known inspection date or last known thickness value is null, then the age will be calculated from the date in the Date in Service field.	This field is disabled and calculated automatically. The value in this field is used to calculate the value in the Expected Metal Loss Fraction (Art) field.
API 653 Maintenance Adjustment	Numeric	The adjustment factor based on whether the component is maintained in compliance with API 653.	<p>If you are evaluating 581-Atmospheric Tank Bottom Corrosion, this field is disabled and populated automatically with the value:</p> <ul style="list-style-type: none"> • 1 if the API 653 Maintenance Flag check box is selected. • 5 if the API 653 Maintenance Flag check box is cleared. <p>The value in this field is used to calculate the value in the Final Damage Factor field.</p>
Base Damage Factor	Numeric	The damage factor of the component before considering the adjustment factors.	This field is disabled and calculated automatically. The value in this field is used to calculate the value in the Final Damage Factor field.
Beta Reliability Indices 1	Numeric	The beta reliability index for damage state 1.	This field is disabled and calculated automatically. The value in this field is used to calculate the value in the Base Damage Factor field.
Beta Reliability Indices 2	Numeric	The beta reliability index for damage state 2.	This field is disabled and calculated automatically. The value in this field is used to calculate the value in the Base Damage Factor field.
Beta Reliability Indices 3	Numeric	The beta reliability index for damage state 3.	This field is disabled and calculated automatically. The value in this field is used to calculate the value in the Base Damage Factor field.

Field	Data Type	Description	Behavior and Usage
Corrosion Rate Factor Damage State 1	Numeric	The corrosion rate factor for damage state 1.	This field is disabled and populated automatically with the value 1. The value in this field is used to calculate the values in the Beta Reliability Indices 1, Beta Reliability Indices 2, and Beta Reliability Indices 3 fields.
Corrosion Rate Factor Damage State 2	Numeric	The corrosion rate factor for damage state 2.	This field is disabled and populated automatically with the value 2. The value in this field is used to calculate the values in the Beta Reliability Indices 1, Beta Reliability Indices 2, and Beta Reliability Indices 3 fields.
Corrosion Rate Factor Damage State 3	Numeric	The corrosion rate factor for damage state 3.	This field is disabled and populated automatically with the value 4. The value in this field is used to calculate the values in the Beta Reliability Indices 1, Beta Reliability Indices 2, and Beta Reliability Indices 3 fields.
Deadleg Adjustment	Numeric	The adjustment factor for the presence of a deadleg.	<p>This field is disabled and populated automatically with the value:</p> <ul style="list-style-type: none"> • 1 if the value in the Deadleg Flag field is No (N). • 3 if the value in the Deadleg Flag field is Yes (Y) and the value in the Deadleg Inspection field is No (N). • 1 if the value in the Deadleg Flag and Deadleg Inspection fields is Yes (Y). <p>The value in this field is used to calculate the value in the Final Damage Factor field.</p>
Expected Metal Loss Fraction (Art)	Numeric	The expected metal loss fraction since last inspection.	This field is disabled and calculated automatically. The value in this field is used to calculate the values in the Beta Reliability Indices 1, Beta Reliability Indices 2, and Beta Reliability Indices 3 fields.

Field	Data Type	Description	Behavior and Usage
Final Damage Factor	Numeric	The final damage factor of the component after considering all the adjustment factors.	This field is disabled and calculated automatically.
Flow Stress Variance	Numeric	The variance of flow stress.	This field is disabled and populated with the value 0.20. The value in this field is used to calculate the values in the Beta Reliability Indices 1, Beta Reliability Indices 2, and Beta Reliability Indices 3 fields.
Injection Point Adjustment	Numeric	The adjustment factor for injection point.	<p>This field is disabled and populated with the value:</p> <ul style="list-style-type: none"> • 1 if the value in the Injection Point Flag and Injection Point Inspection fields is Yes (Y). • 3 if the value in the Injection Point Flag field is set to Yes (Y) and the value in the Injection Point Inspection field is No (N). • 1 if the value in the Injection Point Flag field is No (N). <p>The value in this field is used to calculate the value in the Final Damage Factor field.</p>
Inspection Effectiveness 1	Numeric	The first order inspection effectiveness factor.	This field is disabled and calculated automatically. The value in this field is used to calculate the values in the Posterior Probability - 1, Posterior Probability - 2, and Posterior Probability - 3 fields.
Inspection Effectiveness 2	Numeric	The second order inspection effectiveness factor.	This field is disabled and calculated automatically. The value in this field is used to calculate the values in the Posterior Probability - 1, Posterior Probability - 2, and Posterior Probability - 3 fields.

Field	Data Type	Description	Behavior and Usage
Inspection Effectiveness 3	Numeric	The third order inspection effectiveness factor.	This field is disabled and calculated automatically. The value in this field is used to calculate the values in the Posterior Probability - 1, Posterior Probability - 2, and Posterior Probability - 3 fields.
Online Monitoring Adjustment	Numeric	The adjustment factor for the presence of online monitoring.	This field is disabled and calculated automatically. The value in this field is used to calculate the value in the Final Damage Factor field.
Posterior Probability - 1	Numeric	The posterior probability for damage state 1.	This field is disabled and calculated automatically. The value in this field is used to calculate the value in the Base Damage Factor field.
Posterior Probability - 2	Numeric	The posterior probability for damage state 2.	This field is disabled and calculated automatically. The value in this field is used to calculate the value in the Base Damage Factor field.
Posterior Probability - 3	Numeric	The posterior probability for damage state 3.	This field is disabled and calculated automatically. The value in this field is used to calculate the value in the Base Damage Factor field.
Pressure Variance	Numeric	The variance of pressure.	This field is disabled and populated automatically with the value 0.05. The value in this field is used to calculate the values in the Beta Reliability Indices 1, Beta Reliability Indices 2, and Beta Reliability Indices 3 fields.

Field	Data Type	Description	Behavior and Usage												
Settlement Adjustment Flag	Numeric	The adjustment factor for settlement.	<p>This field is disabled and populated automatically based on the values in the Settlement Adjustment Flag and Settlement Adjustment Inspection fields as follows if the value in the Foundation Type field is not Concrete.</p> <table border="1"> <thead> <tr> <th>Settlement Adjustment Flag</th> <th>Settlement Adjustment Inspection</th> <th>Settlement Adjustment</th> </tr> </thead> <tbody> <tr> <td>Yes (Y)</td> <td>Meets API 653</td> <td>1</td> </tr> <tr> <td>Yes (Y)</td> <td>Never Evaluated</td> <td>1.5</td> </tr> <tr> <td>Yes (Y)</td> <td>Exceeds API 653</td> <td>2</td> </tr> </tbody> </table> <p>If the value in the Foundation Type field is Concrete, however, the value in the Settlement Adjustment field is 1.</p> <p>The value in this field is used to calculate the value in the Final Damage Factor field.</p>	Settlement Adjustment Flag	Settlement Adjustment Inspection	Settlement Adjustment	Yes (Y)	Meets API 653	1	Yes (Y)	Never Evaluated	1.5	Yes (Y)	Exceeds API 653	2
Settlement Adjustment Flag	Settlement Adjustment Inspection	Settlement Adjustment													
Yes (Y)	Meets API 653	1													
Yes (Y)	Never Evaluated	1.5													
Yes (Y)	Exceeds API 653	2													
Strength Ratio	Numeric	The strength ratio of the material of the component.	<p>This field is disabled and calculated automatically. The value in this field is used to calculate the values in the Beta Reliability Indices 1, Beta Reliability Indices 2, and Beta Reliability Indices 3 fields.</p>												

Field	Data Type	Description	Behavior and Usage
Thinning Variance	Numeric	The variance of thinning.	This field is disabled and populated automatically with the value 0.20. The value in this field is used to calculate the values in the Beta Reliability Indices 1, Beta Reliability Indices 2, and Beta Reliability Indices 3 fields.
Welded Construction Flag	Numeric	The adjustment factor for the presence of a welded construction in a tank bottom.	<p>If you are evaluating 581-Atmospheric Tank Bottom Corrosion, this field is disabled and populated automatically with the value:</p> <ul style="list-style-type: none"> • 1 if the value in the Welded Construction Flag field is Yes (Y). • 10 if the value in the Welded Construction Flag field is No (N). <p>The value in this field is used to calculate the value in the Final Damage Factor field.</p>

Tank Stress Records

Tank Stress records are used in the Tank Stress reference table, which is used to determine the Allowable Stress value for RBI 581 Risk Analyses linked to storage tank components (i.e., RBI Components whose Stress Lookup Table field contains the value Tank). This topic provides a list and description of the fields that exist in the Tank Stress family. The information in the table reflects the baseline state and behavior of these fields.

This family is not enabled for site filtering, which means that records in this family can be accessed by any user with the appropriate license and family privileges. For more information, refer to the Sites section of the documentation.

Field	Data Type	Description	Behavior and Usage
Allowable Stress	Numeric	The maximum amount of pressure that the component can withstand.	<p>The value in this field is calculated using values in the following fields:</p> <ul style="list-style-type: none"> Stress Lookup Table Construction Code Code Year Material Spec Material Grade Course Number Tensile Strength Yield Strength <p>The value in this field is used to populate the Allowable Stress field in the associated RBI 581 Risk Analysis.</p>
Code Year	Character	The year in which the design code that corresponds to the component was defined.	<p>The value in this field is used to:</p> <ul style="list-style-type: none"> Determine the value in the Allowable Stress field. Filter the list of values in the Material Specification field. Populate the Code Year field in the associated RBI 581 Risk Analysis.
Design Code	Character	The design code associated with the component.	<p>The value in this field is used to:</p> <ul style="list-style-type: none"> Determine the value in the Allowable Stress field. Populate the Construction Code field in the associated RBI 581 Risk Analysis.
Material Grade	Character	The material grade of the component.	<p>The value in this field is used to:</p> <ul style="list-style-type: none"> Determine the value in the Allowable Stress field. Populate the Material Grade field in the associated RBI 581 Risk Analysis.

Field	Data Type	Description	Behavior and Usage
Material Specification	Character	The material specification of the component.	The value in this field is used to: <ul style="list-style-type: none"> Determine the value in the Allowable Stress field. Filter the list of values in the Material Grade field. Populate the Material Spec field in the associated RBI 581 Risk Analysis.
Minimum Tensile Strength	Numeric	The minimum tensile strength of the material of the component.	None
Minimum Yield Strength	Numeric	The minimum yield strength of the material of the component.	None

Tank Stress records are used in the Tank Stress reference table, which is used to determine the Allowable Stress value for RBI 581 Risk Analyses linked to storage tank components (i.e., RBI Components whose Stress Lookup Table field contains the value Tank). This topic provides a list and description of the fields that exist in the Tank Stress family. The information in the table reflects the baseline state and behavior of these fields.

This family is not enabled for site filtering, which means that records in this family can be accessed by any user with the appropriate license and family privileges. For more information, refer to the Sites section of the documentation.

Field	Data Type	Description	Behavior and Usage
Allowable Stress	Numeric	The maximum amount of pressure that the component can withstand.	The value in this field is calculated and used to populate the Allowable Stress field in the associated RBI 581 Risk Analysis.
Code Year	Character	The year in which the design code that corresponds to the component was defined.	The value in this field is used to: <ul style="list-style-type: none"> Determine the value in the Allowable Stress field. Filter the list of values in the Material Specification field. Populate the Code Year field in the associated RBI 581 Risk Analysis.

Field	Data Type	Description	Behavior and Usage
Design Code	Character	The design code associated with the component.	The value in this field is used to: <ul style="list-style-type: none"> Determine the value in the Allowable Stress field. Populate the Construction Code field in the associated RBI 581 Risk Analysis.
Material Grade	Character	The material grade of the component.	The value in this field is used to: <ul style="list-style-type: none"> Determine the value in the Allowable Stress field. Populate the Material Grade field in the associated RBI 581 Risk Analysis.
Material Specification	Character	The material specification of the component.	The value in this field is used to: <ul style="list-style-type: none"> Determine the value in the Allowable Stress field. Filter the list of values in the Material Grade field. Populate the Material Spec field in the associated RBI 581 Risk Analysis.
Minimum Tensile Strength	Numeric	The minimum tensile strength of the material of the component.	None
Minimum Yield Strength	Numeric	The minimum yield strength of the material of the component.	None

Inventory Group Configuration Records

Inventory Group Configuration records store information about the process unit that an inventory group belongs to and the components that are linked to the group. This topic provides an alphabetical list and description of the fields that exist for the Inventory Group Configuration family. The information in the table reflects the baseline state and behavior of these fields.

This family is enabled for site filtering, which means that records in this family can be assigned to a specific site, and will then only be accessible to users who are assigned to the same site and have the appropriate license and family privileges.

Tip: For more information, refer to the Site Filtering section of the documentation.

Field	Data Type	Description	Behavior and Usage
Comments	Text	Comments about the inventory group.	You can enter a value manually.
Created By	Character	The ID of the user who created the inventory group.	This field is disabled and populated automatically.
Created Date	Date	The date on which the inventory group has been created.	This field is disabled and populated automatically.
Inventory Group Description	Character	Description of the inventory group.	You can enter a value manually.
Inventory Group Name	Character	The name of the inventory group.	A value is required and must be unique among all the inventory groups in the process unit. The value in this field is used to populate the Inventory Group field in each component linked to the group.
Last Updated	Date	The date on which the inventory group was last modified.	This field is disabled and populated automatically.
Last Updated By	Character	The ID of the user who last modified the inventory group.	This field is disabled and populated automatically.
Process Unit	Character	The process unit in which the inventory group is created.	This field is disabled and populated automatically.

RBI Inspection Auto-Selection Criteria Records

RBI Inspection Auto-Selection Criteria records store details about the criteria that must be used to assign Inspections automatically to a Damage Mechanism Evaluation (DME). This topic provides an alphabetical list and description of the fields that exist for the RBI Inspection Auto-Selection Criteria family. The information in the table reflects the baseline state and behavior of these fields.

This family is not enabled for site filtering, which means that records in this family can be accessed by any user with the appropriate license and family privileges. For more information, refer to the Sites section of the documentation.

Field	Data Type	Description	Behavior and Usage
Analysis Family	Character	The type of the analysis for which Inspections must be automatically assigned to the DME.	The value in this field is RBI 581 Risk Analysis. You cannot modify this value.
Degradation Mechanism	Character	The DM that is related to the analysis.	<p>If you create, duplicate, or apply an RBI 581 Risk Analysis, and if the analysis is linked to the DM specified in this field, then Inspections linked to the same DM are automatically assigned to the DME based on the criteria in this record.</p> <p>If this field is blank, all the DMs related to the DME specified in the DM Methodology and Equivalent DM Methodology are considered while assigning Inspections to the DME.</p>
DM Methodology	Character	The Degradation Mechanism Evaluation (DME) record to which the DM belongs.	Inspections that must be assigned to a DME are filtered based on the values in the DM Methodology and Equivalent DM Methodology fields.

Field	Data Type	Description	Behavior and Usage										
Equivalent DM Methodology	Character	The equivalent (or related) DME that is associated with the DME specified in the DM Methodology field.	<p>This field is disabled and populated based on the value in the DM Methodology field as follows:</p> <table border="1"> <thead> <tr> <th>DM Methodology</th> <th>Equivalent DM Methodology</th> </tr> </thead> <tbody> <tr> <td>RBI 581 Cracking Damage Evaluation</td> <td>Criticality Env. Crack. Deg. Mech. Eval.</td> </tr> <tr> <td>RBI 581 External Cracking Damage Evaluation</td> <td>N/A</td> </tr> <tr> <td>RBI 581 External Damage Evaluation</td> <td>Criticality Ext. Corr. Deg. Mech. Eval.</td> </tr> <tr> <td>RBI 581 Thinning and Lining Evaluation</td> <td>Criticality Int. Corr. Deg. Mech. Eval.</td> </tr> </tbody> </table>	DM Methodology	Equivalent DM Methodology	RBI 581 Cracking Damage Evaluation	Criticality Env. Crack. Deg. Mech. Eval.	RBI 581 External Cracking Damage Evaluation	N/A	RBI 581 External Damage Evaluation	Criticality Ext. Corr. Deg. Mech. Eval.	RBI 581 Thinning and Lining Evaluation	Criticality Int. Corr. Deg. Mech. Eval.
DM Methodology	Equivalent DM Methodology												
RBI 581 Cracking Damage Evaluation	Criticality Env. Crack. Deg. Mech. Eval.												
RBI 581 External Cracking Damage Evaluation	N/A												
RBI 581 External Damage Evaluation	Criticality Ext. Corr. Deg. Mech. Eval.												
RBI 581 Thinning and Lining Evaluation	Criticality Int. Corr. Deg. Mech. Eval.												
Years of Inspection History	Numeric	The duration, in years, that should be considered while assigning Inspections to a DME. If an Inspection is completed before the duration specified in this field, it is not assigned to the DME.	If the difference between the date on which the analysis is created and the value in the Completion Date field in an Inspection is greater than the value in this field, then the Inspection is not assigned to the DME.										

Calculations

Calculating Combined Confidence

This topic has been intentionally excluded from the GE Digital APM product documentation website. This topic is available to you via the product documentation that is provided within the GE Digital APM system.

Calculating Flow Stress

This topic has been intentionally excluded from the GE Digital APM product documentation website. This topic is available to you via the product documentation that is provided within the GE Digital APM system.

Allowable Stress Calculation

This topic has been intentionally excluded from the GE Digital APM product documentation website. This topic is available to you via the product documentation that is provided within the GE Digital APM system.

Calculating Inventory Component Mass

The inventory component mass of a component is calculated using the values in the following fields in the Criticality Calculator RBI Component record:

- Operating Pressure (P)
- Operating Temperature (T)
- Diameter (d)
- Length (L)

Note: If the component type is Piping, then the value in the Piping Length field is used instead of the value in the Length field.

- Percent Liquid Volume (pc)
- Molwt (This value is stored in the RepresentativeFluids reference table for the fluid specified in the Process Fluid field in the Criticality Calculator RBI Components record)
- Fluid Density (This value is specified in the RepresentativeFluids reference table for the fluid specified in the Process Fluid field in the Criticality Calculator RBI Components record)

Note: If the component is linked to an RBI 581 Risk Analysis, then these values are taken from the corresponding fields in the analysis record instead of the component record.

The inventory component mass of a component is calculated as follows:

$$\text{Inventory Component Mass} = (\text{Liquid Volume} \times \text{Fluid Density}) + (\text{Vapor Volume} \times \text{Vapor Density})$$

Where:

- Liquid Volume = $(pc/100) \times \text{Volume of the cylinder}$

Note: The volume of the cylinder is calculated from the values in the Diameter and Length fields in the Criticality Calculator RBI Component record.

- Vapor Volume = $(1-(pc/100)) \times \text{Volume of the cylinder}$
- Vapor Density = $(\text{Molwt} \times (P + 14.7)) / (10.73 \times (T + 459.15) \times z)$

This value is populated in the Inventory Component Mass field in the **Common** section of the associated RBI 581 Consequence Evaluation.

Example for Calculating Inventory Component Mass

Suppose a component has the following specifications:

- Component Type: Heat Exchanger (Shell)
- Process Fluid : C6-C8
- Operating Pressure: 101 Pounds/Sq Inch Gage
- Operating Temperature: 121 Degrees Fahrenheit
- Molwt of CO: 28
- Diameter: 97.625 inches
- Length: 360 inches
- Percent Liquid Volume: 50 percent
- Fluid Density: 42.704

Given these values:

- Volume of the cylinder = $(\pi \times (d/12) \times (d/12) \times (L/12)) / 4$
 Volume of the cylinder = $((22/7) \times (97.625/12) \times (97.625/12) \times (360/12)) / 4$
 Volume of the cylinder = 1560.075 Cubic feet
- Liquid volume = $(pc/100) \times \text{Volume of the cylinder}$
 Liquid volume = $(50/100) \times 1560.075$
 Liquid volume = 780.038 Cubic feet
- Vapor volume = $(1 - (pc/100)) \times \text{volume of the cylinder}$
 Vapor volume = $(1 - (50/100)) \times 1560.075$
 Vapor volume = 780.038 Cubic feet
- Vapor Density = $(\text{Molwt} \times (P + 14.7)) / (10.73 \times (T + 459.15) \times z)$
 Vapor Density = $(100 \times (101 + 14.7)) / (10.73 \times (121 + 459.15) \times 1)$
 Vapor Density = 1.859 Pounds per cubic feet
- Inventory Component Mass = $(\text{Liquid Volume} \times \text{Fluid Density}) + (\text{Vapor Volume} \times \text{Vapor Density})$
 Inventory Component Mass = $(780.038 \times 42.704) + (780.038 \times 1.859)$
 Inventory Component Mass = 34760.526 Pounds

Note: The value in the Inventory Component Mass field on the RBI Component datasheet may slightly differ from the value that is shown in the example. This happens because of rounding off some of the values.

Calculating Inventory Group Mass

The inventory group mass is calculated as the sum of the inventory component mass values of all the individual components in an inventory group. This value is populated in the Inventory Group Mass field in the **Common** section in the associated RBI 581 Consequence Evaluation record. If the component is not linked to an inventory group, then the value in the Inventory Group Mass field is the same as the value in the Inventory Component Mass field.

Note: The value in the Calculated Inventory field in a component datasheet is calculated only for RBI 580. It is not used in calculating inventory group mass.

For example, suppose you have created an inventory group, Group 1, and linked it to three components, Component 1, Component 2, and Component 3. The inventory component mass values for each of these components are shown in parentheses.

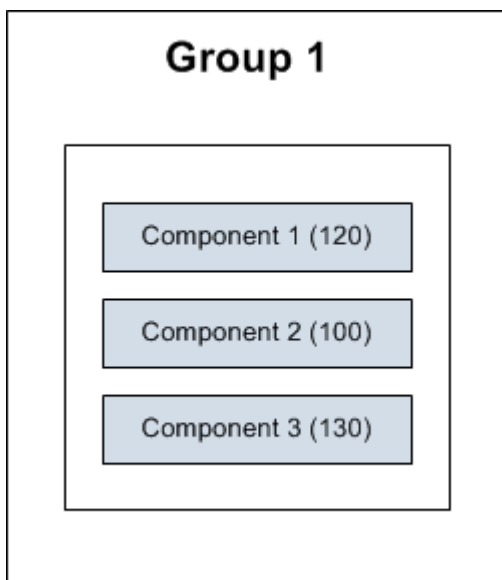

In this case, the inventory group mass is calculated as follows:

Inventory Group Mass of Group 1 = Inventory Component Mass of Component 1 + Inventory Component Mass of Component 2 + Inventory Component Mass of Component 3

Inventory Group Mass of Group 1 = 120 + 100 + 130

Inventory Group Mass of Group 1 = 350 Pounds

Suppose you have created an RBI 581 Risk Analysis, Analysis 1, for Component 1. GE Digital APM then calculates the inventory component mass of Component 1 based on the input values in Analysis 1. In the following diagram, this value is shown in parentheses next to Analysis1.

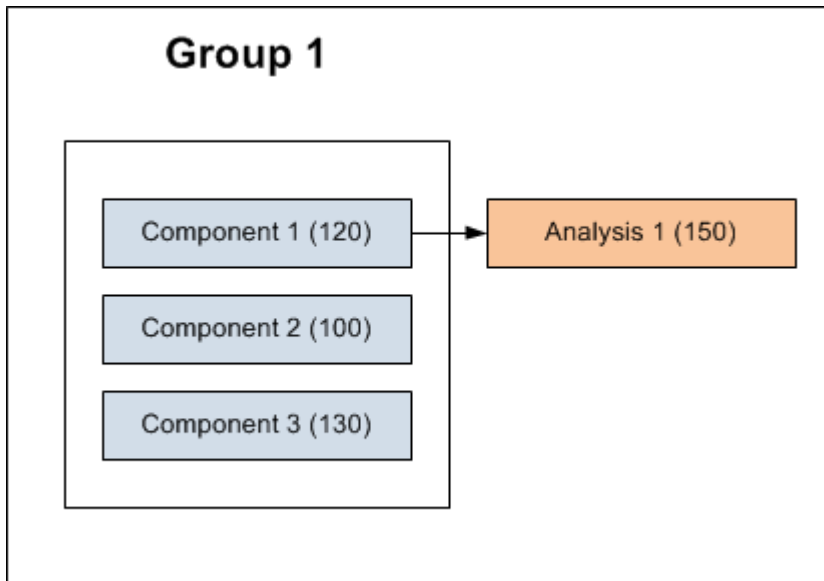

In this case, the inventory group mass is calculated as follows:

Inventory Group Mass of Group 1 = Inventory Component Mass calculated based on input values from Analysis 1 + Inventory Component Mass of Component 2 + Inventory Component Mass of Component 3

Inventory Group Mass of Group 1 = 150 + 100 + 130

Inventory Group Mass of Group 1 = 380 Pounds

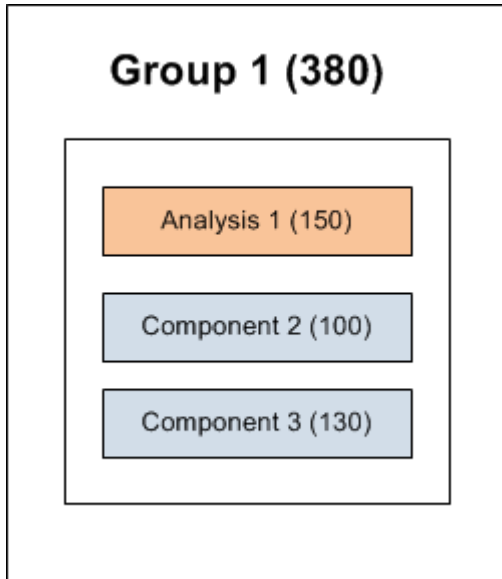

About Tmin Calculations

This topic has been intentionally excluded from the GE Digital APM product documentation website. This topic is available to you via the product documentation that is provided within the GE Digital APM system.

Family Search Configuration

Family Search Configuration

All families from Risk Based Inspection (RBI) 581 have been excluded from the global search except the following:

- Equipment Types
- Representative Fluids
- Piping Stress
- PV Stress
- Tank Stress
- Potential Degradation Mechanisms
- All Analysis families
- All Component families

Note:

You can use search configuration to enable or disable Global Search for families.

ASM Integration

About Values Mapped to RBI Recommendations

When you generate RBI Recommendations, the fields in RBI Recommendations are populated with values from:

- The RBI 581 Risk Analysis to which the RBI Recommendation is linked.
- The RBI Components that are linked to the associated RBI 581 Risk Analysis.
- The Asset that is linked to the associated RBI Components.
- The Degradation Mechanisms record that is linked to the associated RBI 581 Risk Analysis.
- The Inspection Strategy that was used to generate the RBI Recommendation.

RBI Recommendation Fields Populated from Related Records

The following table lists the RBI Recommendation fields that are populated automatically from these sources.

Note: Some of the fields listed in the table are not available on any of the datasheets that are configured for the RBI Recommendation family.

This RBI Recommendation field:	...is populated with:	...from the following record:
Analysis ID	The value in the Analysis ID field.	The associated RBI 581 Risk Analysis.
Asset ID	The value in the Asset ID field.	The related Asset.
Author Name	The last and first name of the Security User who created the RBI Recommendation.	The Security User who initiated the generation of the RBI Recommendation.
Damage Mechanism	The value in the Degradation Mechanism field.	The RBI Degradation Mechanism that is linked to the associated RBI 581 Risk Analysis.
Functional Location ID	The value in the Equipment ID field.	The associated RBI 581 Risk Analysis.
Intrusive/Non Intrusive	The value in the Is Intrusive? field.	The associated RBI 581 Risk Analysis.
Nonrecurring?	TRUE	None
Originating Reference	The Recommendation ID.	The associated RBI 581 Risk Analysis.
RBI Component	The value in the Component Description field.	The associated RBI Component.
RBI Recommendation Methodology	The value RBI 581.	The associated RBI 581 Risk Analysis.
Recommendation Basis	The value in the Inspection Strategy Description field.	The Inspection Strategy that generated the RBI Recommendation.

This RBI Recommendation field:	...is populated with:	...from the following record:
Recommendation Headline	<p>The value RBI- <RBI Components Record ID>-<Damage Mechanism></p> <p>...where:</p> <ul style="list-style-type: none"> <RBI Components Record ID> is the Record ID of the associated RBI Component. <Damage Mechanism> is the value in the Damage Mechanism field in the RBI Recommendation. <p>For example, given the following values:</p> <ul style="list-style-type: none"> RBI Components Record ID = Storage Tank Damage Mechanism = Brittle Fracture <p>The Recommendation Headline would be: RBI- Storage Tank- Brittle Fracture</p>	The associated RBI Component.
Recommended Inspection Scope	The value in the Recommended Inspection Scope field.	The Inspection Strategy that generated the RBI Recommendation.
Recommended Interval Scope	The value 0.	
Status	The value Created.	None
Target Completion Date	<ul style="list-style-type: none"> The date specified in the Cracking Inspection Date or the Target Inspection Date field, whichever is the earliest, if the DM is related to RBI 581 Cracking Damage Evaluation. The date specified in the Target Inspection Date field if the DM is not related to RBI 581 Cracking Damage Evaluation. 	The associated RBI 581 Risk Analysis.
Task Type	The value in the Inspection Task Type field.	The Inspection Strategy that generated the RBI Recommendation.

About Values Mapped to Risk

When you promote an asset to Asset Strategy Management (ASM), a Risk is created in ASM for each Degradation Mechanisms record (DM) in active RBI 581 Risk Analyses. This Risk contains the details of unmitigated and mitigated risks defined in the DM.

The following table provides a list of fields on the Risk datasheet that are populated from the DM or the associated RBI 581 Risk Analysis.

This Risk field:	...is populated with:	...from the following associated records:
Name	A value in the following format: <Equipment Description> ~ <Degradation Mechanism> If there is no value in the Equipment Description field, then the value in the Equipment Type field is used.	RBI 581 Risk Analysis and DM
Description	A value in the following format: <Equipment Description> ~ <Degradation Mechanism> If there is no value in the Equipment Description field, then the value in the Equipment Type field is used.	RBI 581 Risk Analysis and DM
Failure Mode	The value in the Degradation Mechanism field	DM
Maintainable Item	A value in the following format: <RBI Component Entity ID> ~ <Equipment Description or Equipment Type>	RBI 581 Risk Analysis and Criticality Calculator RBI Component
Failure Cause	The value in the Degradation Mechanism field	DM
Unmitigated Financial Risk	The value in the Unmitigated Financial Risk Rank field	DM
Risk Basis	The value Risk Based Inspection	None

About Values Mapped to Action

When you promote an asset to Asset Strategy Management (ASM), an Action is created in ASM for each RBI Recommendation in active RBI 581 Risk Analyses. This Action contains the details of the Recommendation.

The following table provides a list of the fields on an Action datasheet that are populated from the RBI Recommendation.

This Action field:	...is populated with:
Action Basis	The value RBI 581 Recommendation.
Action Source	The value RBI.
Action Task Type	The value in the Task Type field.
Action Basis	The value in the Action Type field.
Cost	The value in the Estimated Cost field.
Cost Basis	The value in the Estimated Cost Basis field.
Description	<Recommendation Inspection Scope> ~ <Recommendation Basis>

This Action field:	...is populated with:
Interval	The value 0.
Interval Basis	Undefined.
Interval Units	The value Months.
Name	<Damage Mechanism> ~ <Task Type>
Nonrecurring	The value in the NonRecurring? field.
Shutdown Required	The value in the Asset Shutdown Required? field.
Target Completion Date	The value in the Target Completion Date field.

About Values Mapped to Inspection Task

When you promote an asset to Asset Strategy Management (ASM), and create an Inspection Task based on an Action, the fields in the Inspection Task are populated with the values in the various records. The following table provides a list of fields on an Inspection Task datasheet that are populated automatically from these sources.

This Inspection Task field:	...is populated with:	...from the following record:
Asset ID	The entity key of the Asset that is associated with the Asset Strategy.	Asset Strategy
Asset Key	The entity key of the Asset that is associated with the Asset Strategy.	Asset Strategy
Desired Interval	The value 0.	<ul style="list-style-type: none"> RBI Recommendation Degradation Mechanism Evaluation Asset Corrosion Analysis
Desired Interval Basis	Undefined.	Action
Next Date	The earliest date among all the Target Completion Date values of all RBI Recommendations.	RBI Recommendation
Next Date Basis	The value RBI 581 Recommendation.	RBI Recommendation
Override Interval	FALSE	None
Reason	The value in the Action basis field	Action
Rejectable	<ul style="list-style-type: none"> The value False if the value in the Mandatory field is set to True. The value True if the value in the Mandatory field is set to False. 	Action
Reoccurring	FALSE .	None
Task Details	The value in the Description field.	Action

This Inspection Task field:	...is populated with:	...from the following record:
Task ID	The value in the Name field.	Action
Task Type	The value in the Action Task Type field.	Action

Inspection Strategies

Inspection Strategies

This topic has been intentionally excluded from the GE Digital APM product documentation website. This topic is available to you via the product documentation that is provided within the GE Digital APM system.

About Inspection Strategies for Generating RBI Recommendations

This topic has been intentionally excluded from the GE Digital APM product documentation website. This topic is available to you via the product documentation that is provided within the GE Digital APM system.

Inspection Strategies for a Tank Bottom Component

This topic has been intentionally excluded from the GE Digital APM product documentation website. This topic is available to you via the product documentation that is provided within the GE Digital APM system.

Inspection Strategies used for Environmental Cracking Damage Mechanisms

This topic has been intentionally excluded from the GE Digital APM product documentation website. This topic is available to you via the product documentation that is provided within the GE Digital APM system.

Inspection Strategies used for External Cracking Damage Mechanisms

This topic has been intentionally excluded from the GE Digital APM product documentation website. This topic is available to you via the product documentation that is provided within the GE Digital APM system.

Inspection Strategies used for External Damage Mechanisms

This topic has been intentionally excluded from the GE Digital APM product documentation website. This topic is available to you via the product documentation that is provided within the GE Digital APM system.

Inspection Strategies used for Thinning and Lining Damage Mechanisms

This topic has been intentionally excluded from the GE Digital APM product documentation website. This topic is available to you via the product documentation that is provided within the GE Digital APM system.

RBI Policies

RBI Policies

An RBI Policy allows you to develop and execute strategies based on historical data and dynamic data, which is obtained by monitoring conditions in real time. The policies used in RBI are categorized as follows:

- [Policies used to calculate an analysis](#)
- [Policies used to generate recommendations](#)
- [Policies used in risk mapping](#)

These policies appear in the **Module Workflow Policies** section of the **Policy Designer Overview** page.

Policies used to Calculate an RBI 581 Risk Analysis

This topic provides a list of Policies used by each family in RBI 581 to calculate an RBI 581 Risk Analysis.

If you want to design a policy, you must be a member of the following Security Groups:

- MI Policy Designer
- and-
- MI RBI Calculation Policy Designer

If you want to view a policy, you must be a member of the following Security Groups:

- MI Policy Viewer
- and-
- MI RBI Calculation Policy Viewer

Family: RBI 581 Cracking Damage Evaluation

The following table provides a list of Policies that are used by RBI 581 Cracking Damage Evaluation.

Degradation Mechanism	Policy
581-Sulfide Stress Cracking 581-HIC/SOHIC-H2S	RBI 581 Calculate Environmental Severity
581-HIC/SOHIC-H2S	RBI 581 Calculate Susceptibility - HIC/SOHIC H2S
581-Alkaline Carbonate Stress Corrosion Cracking	RBI 581 Calculate Susceptibility - Alkaline
581-Amine Cracking	RBI 581 Calculate Susceptibility - Amine Cracking
581-Caustic Cracking	RBI 581 Calculate Susceptibility - Caustic
581-Chloride Stress Corrosion Cracking	RBI 581 Calculate Susceptibility - CISCC
581-HIC/SOHIC-HF	RBI 581 Calculate Susceptibility - HIC/SOHIC HF
581-Hydrogen Stress Cracking 581-HIC/SOHIC-HF	RBI 581 Calculate Susceptibility - HSC HF
581-Polythionic Acid Cracking	RBI 581 Calculate Susceptibility - PASCC
581-Sulfide Stress Cracking	RBI 581 Calculated Susceptibility - SSC

Family: RBI 581 External Cracking Damage Evaluation

The following table provides a list of Policies that are used by RBI 581 External Cracking Damage Evaluation.

Degradation Mechanism	Policy
581-Austenitic Component Cracking Under Insulation	RBI 581 Calculate Susceptibility - Austenitic CUI
581-Austenitic Component Atmospheric Cracking	RBI 581 Calculate Susceptibility - Austenitic

Family: RBI 581 Mechanical Fatigue Damage Evaluation

The following table provides a list of Policies that are used by RBI 581 Mechanical Fatigue Damage Evaluation.

Degradation Mechanism	Policy
581-Piping Mechanical Fatigue	RBI 581 Mechanical Fatigue Pipe Damage Evaluation

Family: RBI 581 Thinning and Lining Evaluation

The following table provides a list of Policies that are used by RBI 581 Thinning and Lining Evaluation.

Degradation Mechanism	Policy
581-Amine Corrosion	RBI 581 Amine Corrosion Rate
581-Acid Sour Water Corrosion	RBI 581 Acid Sour Corrosion Rate
581-Alkaline Sour Water Corrosion	RBI 581 Alkaline Sour Water Corrosion Rate
581-Atmospheric Tank Bottom Corrosion	RBI 581 AST Bottom Corrosion Rate
	RBI 581 Damage Factor - AST Bottom Thinning
581-Cooling Water Corrosion	RBI 581 Cooling Water Corrosion Rate Estimation
581-Soil Side Corrosion	RBI 581 Soil Side Corrosion Rate Calculation
581-High Temperature H ₂ /H ₂ S Corrosion	RBI 581 H ₂ -H ₂ S Corrosion Rate
581-Sulfuric Acid Corrosion	RBI 581 H ₂ SO ₄ Corrosion Rate
581-Hydrochloric Acid Corrosion	RBI 581 HCL Corrosion Rate
581-High Temperature Oxidation	RBI 581 HT Oxidation Corrosion Rate
581-Hydrofluoric Acid Corrosion	RBI 581 Hydrofluoric Acid Corrosion Rate
581-High Temperature Sulfidic and Naphthenic Acid Corrosion	RBI 581 Sulfidic and Naphthenic Corrosion Rate

Policies used to Generate Recommendations

This topic has been intentionally excluded from the GE Digital APM product documentation website. This topic is available to you via the product documentation that is provided within the GE Digital APM system.

Policies used in Risk Mapping

This following policies are used in risk mapping in RBI 581:

- 581-DEF-RISK_MAPPING-OPERATIONS
- 581-DEF-RISK_MAPPING-SAFETY

If you want to design a policy, you must be a member of the following Security Groups:

- MI Policy Designer
- and-
- RBI Risk Mapping Policy Designer

If you want to view a policy, you must be a member of the following Security Groups:

- MI Policy Viewer
- and-
- RBI Risk Mapping Policy Viewer

Policies and Fields Used to Calculate Corrosion Rate

This topic has been intentionally excluded from the GE Digital APM product documentation website. This topic is available to you via the product documentation that is provided within the GE Digital APM system.

Policies and Fields Used to Calculate Susceptibility

This topic has been intentionally excluded from the GE Digital APM product documentation website. This topic is available to you via the product documentation that is provided within the GE Digital APM system.

Catalog Items

RBI 581 Queries Folder

The Catalog folder `\\Public\Meridium\Modules\Risk Based Inspection - 581\Queries` contains the following items.

Item Name	Behavior and Usage
Active Analyses for Evergreening - 581	<p>Returns a list of the RBI 581 Risk Analysis records for RBI Components linked to RBI assets that satisfy the following conditions:</p> <ul style="list-style-type: none"> • Are related to the given Functional Location or Process Unit key. • Are in the active state. • Have an evergreening Batch ID. <p>This query is used on the RBI Bulk Evergreening page, in the Active section when the RBI Analysis Type Preference is set to RBI 581.</p>
Analyses Created For Evergreening - 581	<p>Returns a list of the RBI 581 Risk Analysis records for RBI Components linked to RBI assets that satisfy the following conditions:</p> <ul style="list-style-type: none"> • Are related to the given Functional Location or Process Unit key. • Are in the Created state. • Have an evergreening Batch ID. <p>This query is used on the RBI Bulk Evergreening page, in the Created section when the RBI Analysis Type Preference is set to RBI 581.</p> <p>Important: Do not modify the following columns: Analysis ID, Component, Component Entity Key, Asset ID, ENTY_KEY, Analysis Entity Key, and Risk Category. Modifying these columns may affect the Calculate functionality during the evergreening process.</p>
Analyses Ready for Evergreening -581	<p>Returns a list of the RBI 581 Risk Analysis records for RBI Components linked to RBI assets that satisfy the following conditions:</p> <ul style="list-style-type: none"> • Are related to the given Functional Location or Process Unit key. • Are in the active state. • Have not been evergreened. • Have not been calculated in the last five years. <p>This query is used on the Risk Based Inspection Overview page, in the Pending Reassessment section when the RBI Analysis Type Preference is set to RBI 581.</p> <p>Important: Do not modify the ENTY_KEY column. Modifying this column may affect the duplicate functionality during the evergreening process.</p>

Item Name	Behavior and Usage
Analyses Ready for Evergreening for Unit - 581	<p>Returns a list of the RBI 581 Risk Analysis records for RBI Components linked to RBI assets that satisfy the following conditions:</p> <ul style="list-style-type: none"> • Are related to the given Functional Location or Process Unit key. • Are in the active state. • Have not been evergreened. <p>This query is used on the RBI Bulk Evergreening page, in the Pending Evergreening section when the RBI Analysis Type Preference is set to RBI 581.</p> <p>Important: Do not modify the ENTY_KEY column. Modifying this column may affect the duplicate functionality during the evergreening process.</p>
Asset Corrosion Analysis More Current Than RBI 581 Analyses	<p>Returns a list of all the assets linked to a Functional Location that have a TM Asset Corrosion Analysis more current than the active RBI analysis in the component.</p> <p>This query is used on the Risk Based Inspection Overview page, in the Inspection/TM Updates pane if you do not have an active RBI 580 license.</p>
Assets with No Recommendations (581 Only)	<p>Returns a list of all assets linked to a Functional Location that have no RBI Recommendations and have at least one component with a Risk Completed analysis.</p> <p>This query is used on the Risk Based Inspection Overview page, in the No Recommendations pane if you do not have an active RBI 580 license.</p> <p>Important: Do not modify the Asset Entity Key field. Modifying this field may affect the generate recommendation functionality.</p>
Data Export Analyses - 581	<p>Returns a list of the RBI 581 Risk Analyses available for export and that meets the following conditions:</p> <ul style="list-style-type: none"> • Are related to the given Functional Location or Process Unit key. • Are in the active state. • Are in the Created state. <p>This query is used on the RBI Analysis Export page, when the RBI Analysis Type Preference is set to RBI 581.</p>
Display RBI Components for Inventory Group	<p>Return a list of RBI Components related to Inventory Groups.</p> <p>Important: Do not modify the ENTY_KEY column. Modifying this column may affect the functionality.</p>

Item Name	Behavior and Usage
Inspections More Current Than RBI 581 Analysis	<p>Returns a list of all the assets linked to a Functional Location that have Inspections more current than the active RBI analysis in the component.</p> <p>This query is used on the Risk Based Inspection Overview page, in the Inspection/TM Updates pane if you do not have an active RBI 580 license.</p>
Process Units with Inventory Groups	<p>Returns a list of process units that are linked to at least one inventory group and a count of how many inventory groups are related. This query is used to display the Process Units with Inventory Groups graph under the RBI Admin Preferences for Inventory Groups.</p> <p>This query is used to display the Process Units with Inventory Groups graph under the RBI Admin Preferences for Inventory Groups.</p>
RBI 581 Consequence Evaluation	<p>Returns the RBI 581 Consequence Evaluation records that are associated with the RBI 581 Analysis. This query is used on the Consequence Evaluations tab when viewing an RBI 581 Analysis.</p> <p>Important: Do not modify the ENTY_KEY column. Modifying this column may affect the functionality.</p>
RBI Components for Inventory Group	<p>Returns a list of RBI Components related to Inventory Groups.</p> <p>Important: Do not modify the ENTY_KEY column. Modifying this column may affect the functionality.</p>
RBI-581 DM Query	<p>Returns a list of Degradation Mechanism records that are linked to an RBI 581 Analysis. This query is used on the Degradation Mechanisms tab when viewing an RBI 581 Analysis.</p> <p>Important: Do not modify the following columns:</p> <ul style="list-style-type: none"> • UnmitigatedRiskKey • MitigatedRiskkey • DMEntityKey <p>Modifying these columns may affect the functionality.</p>

Inspection Plan Queries

The Catalog folder `\\Public\Meridium\Modules\Inspection\Compliance\Queries` contains the following queries used in the Inspection Plan workflow.

Query	Behavior and Usage																						
Compliance Recommendations by Plan	<p>Displays Recommendations based on the Inspection Plan.</p> <p>The following columns in the query must be used, and the aliases must contain the following values.</p> <table border="1" data-bbox="852 401 1414 1423"> <thead> <tr> <th data-bbox="857 405 1133 447">Column</th> <th data-bbox="1133 405 1409 447">Alias</th> </tr> </thead> <tbody> <tr> <td data-bbox="857 447 1133 531">[MI_COMP_RECOMM].ENTY_ID AND [MI_RBIRECOM].ENTY_ID</td> <td data-bbox="1133 447 1409 531">REC_ENTY_ID</td> </tr> <tr> <td data-bbox="857 531 1133 615">[MI_COMP_RECOMM].ENTY_KEY AND [MI_RBIRECOM].ENTY_KEY</td> <td data-bbox="1133 531 1409 615">REC_ENTY_KEY</td> </tr> <tr> <td data-bbox="857 615 1133 667">[MI_TASKINSP].[MI_TASK_ID]</td> <td data-bbox="1133 615 1409 667">Task ID</td> </tr> <tr> <td data-bbox="857 667 1133 720">a."SUCC_ENTY_KEY"</td> <td data-bbox="1133 667 1409 720">Linked Actions</td> </tr> <tr> <td data-bbox="857 720 1133 772">[MI_TASKINSP].ENTY_KEY</td> <td data-bbox="1133 720 1409 772">TASK KEY</td> </tr> <tr> <td data-bbox="857 772 1133 989"> (MIR_RBICRAN).PRED_ENTY_KEY Note: For Compliance Recommendations, the column must be set to NULL. For RBI Consolidated Recommendations, the column must be set to 0. </td> <td data-bbox="1133 772 1409 989">Comp Key</td> </tr> <tr> <td data-bbox="857 989 1133 1205"> PRED_ENTY_KEY Note: For Compliance Recommendations, the column must be set to NULL. For RBI Consolidated Recommendations, the column must be set to 0. </td> <td data-bbox="1133 989 1409 1205">Analysis Key</td> </tr> <tr> <td data-bbox="857 1205 1133 1257">MI_SM_STATES.SMST_ID</td> <td data-bbox="1133 1205 1409 1257">STATE_ID</td> </tr> <tr> <td data-bbox="857 1257 1133 1341">[MI_COMP_RECOMM].FMLY_KEY AND [MI_RBIRECOM].FMLY_KEY</td> <td data-bbox="1133 1257 1409 1341">FMLY_KEY</td> </tr> <tr> <td data-bbox="857 1341 1133 1423">[MI_RBIRECOM]. [MI_RBIRECOM_NONRE_FLG]</td> <td data-bbox="1133 1341 1409 1423">NonRecurring?</td> </tr> </tbody> </table> <p>Important: \\Public\Meridium\Modules\Inspection\Compliance\Queries\Compliance Superseded Recommendation Counts is a subquery and must not be removed from the parent query. In this subquery, the SUCC_ENTY_KEY column is required, and the alias must not be modified.</p>	Column	Alias	[MI_COMP_RECOMM].ENTY_ID AND [MI_RBIRECOM].ENTY_ID	REC_ENTY_ID	[MI_COMP_RECOMM].ENTY_KEY AND [MI_RBIRECOM].ENTY_KEY	REC_ENTY_KEY	[MI_TASKINSP].[MI_TASK_ID]	Task ID	a."SUCC_ENTY_KEY"	Linked Actions	[MI_TASKINSP].ENTY_KEY	TASK KEY	(MIR_RBICRAN).PRED_ENTY_KEY Note: For Compliance Recommendations, the column must be set to NULL. For RBI Consolidated Recommendations, the column must be set to 0.	Comp Key	PRED_ENTY_KEY Note: For Compliance Recommendations, the column must be set to NULL. For RBI Consolidated Recommendations, the column must be set to 0.	Analysis Key	MI_SM_STATES.SMST_ID	STATE_ID	[MI_COMP_RECOMM].FMLY_KEY AND [MI_RBIRECOM].FMLY_KEY	FMLY_KEY	[MI_RBIRECOM]. [MI_RBIRECOM_NONRE_FLG]	NonRecurring?
Column	Alias																						
[MI_COMP_RECOMM].ENTY_ID AND [MI_RBIRECOM].ENTY_ID	REC_ENTY_ID																						
[MI_COMP_RECOMM].ENTY_KEY AND [MI_RBIRECOM].ENTY_KEY	REC_ENTY_KEY																						
[MI_TASKINSP].[MI_TASK_ID]	Task ID																						
a."SUCC_ENTY_KEY"	Linked Actions																						
[MI_TASKINSP].ENTY_KEY	TASK KEY																						
(MIR_RBICRAN).PRED_ENTY_KEY Note: For Compliance Recommendations, the column must be set to NULL. For RBI Consolidated Recommendations, the column must be set to 0.	Comp Key																						
PRED_ENTY_KEY Note: For Compliance Recommendations, the column must be set to NULL. For RBI Consolidated Recommendations, the column must be set to 0.	Analysis Key																						
MI_SM_STATES.SMST_ID	STATE_ID																						
[MI_COMP_RECOMM].FMLY_KEY AND [MI_RBIRECOM].FMLY_KEY	FMLY_KEY																						
[MI_RBIRECOM]. [MI_RBIRECOM_NONRE_FLG]	NonRecurring?																						

Query	Behavior and Usage						
Compliance Recommendations to Supersede	<p>Displays Recommendations for a given entity keys. This query is used to select the master Recommended Action while superseding Compliance Recommendations in the Recommendation section of the Inspection Plan page.</p> <p>Important: The [MI_RBIRECOM].ENTY_KEY column must not be removed, and the alias REC_ENTY_KEY must not be modified.</p>						
Compliance Superseded Recommendations	<p>Displays a list of Consolidated and Superseded Recommendations. This query is used to access the linked actions in the Inspection Plan page.</p> <p>Note: The [MI_RBIRECOM].ENTY_KEY column must not be removed, and the alias REC_ENTY_KEY must not be modified.</p>						
Inspection Tasks for Asset	<p>Displays the Inspection Tasks for an asset. This query is used to access the Existing Tasks in the Inspection Plan page.</p> <p>Important: In the WHERE criteria, the ID of the parameter must be ASSET_ENTY_KEY.</p>						
Compliance Superseded Recommendation Counts	<p>Returns the count of Consolidated and Superseded Recommendations. This query is used in the Recommendation section of the Inspection Plan page.</p>						
Inspection Tasks Available to Implement	<p>Displays the Inspection Tasks available to implement for a Compliance Recommendation. This query is used to access the Inspection tasks after selecting the Implement button in the Inspection Plan page.</p>						
Recommended Actions by Selected Plans	<p>Displays unimplemented actions from a given Inspection Plan. This query is used in the Inspection Plan page. The following columns in the query must be used, and the aliases must not be changed.</p> <table border="1" data-bbox="852 1262 1412 1476"> <thead> <tr> <th data-bbox="852 1262 1133 1308">Column</th> <th data-bbox="1133 1262 1412 1308">Alias</th> </tr> </thead> <tbody> <tr> <td data-bbox="852 1308 1133 1392">[MI_COMP_RECOMM].ENTY_ID AND [MI_RBIRECOM].ENTY_ID</td> <td data-bbox="1133 1308 1412 1392">REC_ENTY_ID</td> </tr> <tr> <td data-bbox="852 1392 1133 1476">{MIR_ASST_HAS_INSP_PLAN}.PRED_ENTY_KEY</td> <td data-bbox="1133 1392 1412 1476">ASSET_KEY</td> </tr> </tbody> </table> <p>Important: In the WHERE clause, the ID of the parameter must be ENTY_KEYS.</p>	Column	Alias	[MI_COMP_RECOMM].ENTY_ID AND [MI_RBIRECOM].ENTY_ID	REC_ENTY_ID	{MIR_ASST_HAS_INSP_PLAN}.PRED_ENTY_KEY	ASSET_KEY
Column	Alias						
[MI_COMP_RECOMM].ENTY_ID AND [MI_RBIRECOM].ENTY_ID	REC_ENTY_ID						
{MIR_ASST_HAS_INSP_PLAN}.PRED_ENTY_KEY	ASSET_KEY						

Query	Behavior and Usage				
Link Existing Task to Recommended Action	<p>Returns an Inspection Task to link to a given Recommendation based on Asset and Task Type. This query is used in the Inspection Plan page. The following columns in the query must be used, and the aliases must not be changed.</p> <table border="1" data-bbox="852 417 1414 516"> <thead> <tr> <th data-bbox="852 422 1133 470">Column</th> <th data-bbox="1133 422 1414 470">Alias</th> </tr> </thead> <tbody> <tr> <td data-bbox="852 470 1133 516">[MI_TASKINSP].ENTY_KEY</td> <td data-bbox="1133 470 1414 516">ENTY_KEY</td> </tr> </tbody> </table> <p>Important: In the WHERE clause, the following parameter IDs must be provided and not modified:</p> <ul style="list-style-type: none"> • TASK_TYPE • ASSET_KEY 	Column	Alias	[MI_TASKINSP].ENTY_KEY	ENTY_KEY
Column	Alias				
[MI_TASKINSP].ENTY_KEY	ENTY_KEY				
All Inspection Plans for Unit	Returns all Inspection Plans for the selected location in the hierarchy. This query is used to access all the Inspection plans in the Inspection Plan Management page.				
Active Recommendations of Plans for Unit	Returns all active recommendations for Inspection Plans for the selected location in the hierarchy. This query is used to view active recommendations in the Inspection Plan Management page.				
Inspection Plan Revisions	<p>Displays the Inspection Plan Revisions for a given Inspection Plan. This query is used to retrieve the revisions for an Inspection Plan.</p> <p>Important:</p> <ul style="list-style-type: none"> • The column [MI_INSP_PLAN_REV].[MI_INSP_PLAN_REV_REVI_DATE_D] must not be removed and its alias must not be changed. • In the WHERE clause, the ID of the parameter must be PLAN_ENTY_KEY. 				
Compliance Recommendation Revisions for Inspection Plan	<p>Displays the Recommendation Revision records for a given Inspection Plan Revision. This query is used in the Inspection Plan page to view the revisions for a Recommendation.</p> <p>Important:</p> <ul style="list-style-type: none"> • The column [MI_COMP_REC_REV].[MI_REC_ID] must not be removed and its alias must not be changed. • In the WHERE clause, the ID of the parameter must be PLAN_REV_ENTY_KEY. 				

Risk Based Inspection Queries Folder

The Catalog folder \\Public\Meridium\Modules\Risk Based Inspection\Queries contains the following queries which are relevant to the RBI 581 workflow.

Query	Behavior and Usage
Asset Corrosion Analysis More Current than All Analyses	<p>Returns a list of all the assets linked to a Functional Location that have a TM Asset Corrosion Analysis more current than the active RBI analysis in the component.</p> <p>This query is used on the Risk Based Inspection Overview page under the Inspection/TM Updates pane when both Risk Based Inspection and RBI 581 are licensed.</p>
Assets with No Recommendations	<p>Returns a list of all the assets linked to a Functional Location that have no RBI Recommendations and have at least one component with a Risk Completed analysis.</p> <p>This query is used on the Risk Based Inspection Overview page under the No Recommendations pane when both Risk Based Inspection and RBI 581 are licensed.</p> <p>Important: Do not modify the Asset Entity Key field. Modifying this field may affect the generate recommendation functionality.</p>
Current Risk	<p>Returns a list of the current rolled-up risk for each asset linked to a Functional Location.</p> <p>This query is used under the Current Risk query widget on the Risk Based Inspection Overview page.</p>
Current Risk Overview	<p>Returns a list of the highest Risk Category for each asset linked to a Functional Location and gives a count.</p> <p>This query is used under the Current Risk Overview graph widget on the Risk Based Inspection Overview page.</p>
Inspections More Current Than All Analysis	<p>Returns a list of all the assets linked to a Functional Location that have Inspections more current than the active RBI analysis in the component.</p> <p>This query is used on the Risk Based Inspection Overview under the Inspection/TM Updates tile when both Risk Based Inspection and RBI 581 licenses are active.</p>
Past Risk	<p>Returns a list of the past rolled-up risk for each asset under a Functional Location.</p> <p>This query is used under the Past Risk query widget on the Risk Based Inspection Overview page.</p>
Past Risk Overview	<p>Returns a list of the highest Risk Category for each asset Under a Functional Location and gives a count.</p> <p>This query is used under the Past Risk Overview graph widget on the Risk Based Inspection Overview page.</p>
Process Unit Query	<p>Returns a list of the underlying Process Units for the selected level of the asset hierarchy.</p> <p>This query is used on the Risk Based Inspection Overview page under the Process Units tile.</p>

Query	Behavior and Usage
RBI Assets for a Functional Location	Returns a list of all the assets linked to a Functional Location. This query is used on the Risk Based Inspection Overview under the Assets tile.
RBI Components for an Asset	Returns a list of all the RBI Components for a given asset. This query is used under the Asset Hierarchy Navigation menu to display the count of components on the Risk Based Inspection hyperlink.
Review Analyses by Asset 581	Returns a list of all the RBI 581 Risk Analysis records that are calculated in the Created state for the Equipment or Functional Location record for which you accessed the RBI asset. This query is used when Finalizing Risk from the Risk Based Inspection Overview page under the Assets pane.
Review Analysis by Corrosion Loop 581	Returns a list of all the RBI 581 Risk Analysis records that are calculated in Created state for the Corrosion Loop record for which you accessed the RBI asset. This query is used when Finalizing Risk from the Process Unit Overview page.
Select RBI Components	Returns a list of the RBI Components that are: <ul style="list-style-type: none"> • Linked to Asset records. • Not linked to Corrosion Loop record. This query is used to display available components which can be linked to corrosion loops.