



SIS Management



Contents

Chapter 1: Overview	1
Overview of the Safety Instrumented System (SIS) Management Module	2
About the Components in a Safety Instrumented System (SIS)	2
Access the SIS Management Overview Page for all Hierarchy Levels	4
Access the SIS Management Overview Page for a Hierarchy Level	5
SIS Management Workflow	8
Chapter 2: Workflows	9
SIL Assessment	10
SIL Verification	12
SIL Validation	15
SIS Trip Reporting	17
Custom Device	18
SRS	19
Chapter 3: SIL Analysis	22
About Safety Integrity Level (SIL) Analysis	23
About Revision History	23
About the SIL Analysis Team	23
Access an SIL Analysis	24
Create an SIL Analysis	26
Access the SIL Analysis Summary	28
Access the Revision History of an SIL Analysis	30
Access the SIL Analysis Team Members Section	32
Access the Reference Documents in SIS Management	33
Access the Recommended Actions Pane	34
Access the Mitigated Risk	34
Change the State of an SIL Analysis	38
Generate a Report for an SIL Analysis	39
Delete an SIL Analysis	40

Chapter 4: Logic Solvers	43
About Logic Solver	44
Access a Logic Solver	44
Create a Logic Solver	45
Set a Default Logic Solver	47
Remove Default Logic Solver Settings	49
Delete a Logic Solver	51
Chapter 5: Instrumented Functions	53
About Instrumented Function	54
Access an Instrumented Function	54
Create an Instrumented Function	55
Copy an Instrumented Function	56
Create a Recommendation	57
Access the Health Summary Page of an Asset	60
Generate a Report of an Instrumented Function	60
Delete an Instrumented Function	61
Chapter 6: Common Cause Failures	62
About Common Cause Failure	63
Access a Common Cause Failure	63
Create a Common Cause Failure	65
Link a Common Cause Failure	67
Unlink a Common Cause Failure	70
Delete a Common Cause Failure	71
Chapter 7: Concurrent Safe State Hazards	73
About Concurrent Safe State Hazards	74
Create a Concurrent Safe States Record	74
Delete a Concurrent Safe States Record	76
Chapter 8: SIL Assessment	78
About Safety Integrity Level (SIL) Assessment	79

Safety Integrity Level (SIL) Assessment Workflow	79
About Safety Integrity Level (SIL) Assessment Using a Risk Matrix	79
About Safety Integrity Level (SIL) Assessment Using a Hazards Analysis	80
About SIL Assessment Using LOPA	80
Assess the Safety Integrity Level (SIL) via a Layer of Protection Analysis (LOPA)	82
Assess the Safety Integrity Level (SIL) via a Risk Matrix	84
Assess the Safety Integrity Level (SIL) via a Process Hazards Analysis (PHA)	88
Assess the Safety Integrity Level (SIL) via an External Method	92
Associate an SIL Assessment with an Instrumented Function	94

Chapter 9: SIL Verification **97**

About Safety Integrity Level (SIL) Verification	101
About Protective Instrument Loops	101
About Protective Instrument Loop Calculation Engine	102
Safety Integrity Level (SIL) Verification Workflow	102
About Asset Groups in SIS Management	102
About Validation Failure Rate Reference Data	103
About Copying a Protective Instrument Loop Element	103
About Dangerous Combination of Outputs	105
Access a Protective Instrument Loop	106
Create a Protective Instrument Loop	107
Create a Proven In Use Justification Record	109
Apply a Template to a Protective Instrument Loop	110
Delete a Protective Instrument Loop	111
Upgrade a Protective Instrument Loop	113
Access a Protective Instrument Loop Sensor System	115
Copy a Protective Instrument Loop Sensor System	117
Link a Protective Instrument Loop Sensor System	119
Unlink a Protective Instrument Loop Sensor System	121
Access a Protective Instrument Loop Sensor Group	121
Create a Protective Instrument Loop Sensor Group	123
Copy a Protective Instrument Loop Sensor Group	126
Link a Protective Instrument Loop Sensor Group	127
Unlink a Protective Instrument Loop Sensor Group	130
Delete a Protective Instrument Loop Sensor Group	130

Access a Protective Instrument Loop Sensor	131
Create a Protective Instrument Loop Sensor	133
Copy a Protective Instrument Loop Sensor	134
Link a Protective Instrument Loop Sensor	136
Unlink a Protective Instrument Loop Sensor	138
Delete a Protective Instrument Loop Sensor	138
Access a Protective Instrument Loop Final Element System	139
Copy a Protective Instrument Loop Final Element System	141
Link a Protective Instrument Loop Final Element System	143
Unlink a Protective Instrument Loop Final Element System	145
Access a Protective Instrument Loop Final Element Group	145
Create a Protective Instrument Loop Final Element Group	147
Copy a Protective Instrument Loop Final Element Group	150
Link a Protective Instrument Loop Final Element Group	151
Unlink a Protective Instrument Loop Final Element Group	154
Delete a Protective Instrument Loop Final Element Group	154
Access a Protective Instrument Loop Final Element	155
Create a Protective Instrument Loop Final Element	157
Copy a Protective Instrument Loop Final Element	159
Link a Protective Instrument Loop Final Element	161
Unlink a Protective Instrument Loop Final Element	163
Define a Dangerous Combination of Outputs	163
Unlink a Dangerous Combination of Outputs	166
Delete a Protective Instrument Loop Final Element	166
Access a Protective Instrument Loop Logic Solver	167
Copy a Protective Instrument Loop Logic Solver	170
Link a Protective Instrument Loop Logic Solver	171
Unlink a Protective Instrument Loop Logic Solver	174
Access a Protective Instrument Loop Logic Solver Channel	174
Create a Protective Instrument Loop Logic Solver Channel	176
Delete a Protective Instrument Loop Logic Solver Channel	178
Access a Protective Instrument Loop Template	179
Create a Protective Instrument Loop Template	181
Copy a Protective Instrument Loop Template	182
Access a Sensor in the Protective Instrument Loop Template	182
Access a Protective Instrument Loop Final Element	184

Delete a Protective Instrument Loop Template	186
Upgrade a Protective Instrument Loop Template	187
Access a Custom Device	189
Create a Custom Device	190
Approve a Custom Device	192
Revoke the Approval of a Custom Device	192
Delete a Custom Device	192
Access the Results of a Protective Instrument Loop	193

Chapter 10: SIL Validation **195**

About Safety Integrity Level (SIL) Validation	197
About Mobile Proof Tests	198
About Synchronizing Mobile Proof Tests	198
Safety Integrity Level (SIL) Validation Workflow	198
Access the SIL Validation Page for an Instrumented Function	199
Access the SIL Validation Page for a Logic Solver	201
Access a Proof Test Template	204
Create a Proof Test Template	205
Change the State of a Proof Test Template	206
Generate a Report of the Proof Test Template	207
Delete a Proof Test Template	207
Access a Proof Test Template Detail	208
Create a Proof Test Template Detail	209
Copy a Proof Test Template Detail	210
Delete a Proof Test Template Detail	212
Access a List of all Proof Test Tasks	213
Access a Proof Test Task Linked to a Logic Solver	214
Access a Proof Test Task Linked to an Instrumented Function	215
Create a Proof Test Task	216
Assign an Existing Proof Test Task	217
Download Proof Test Task For Offline Access	218
Modify Offline Datasheets for Proof Test And Template Details	220
View the Error Log for Offline Proof Test Task	223
Delete a Proof Test Task	225
Access a Proof Test	225

Create a Proof Test	226
Apply a Proof Test Template and a Proof Test Task to a Proof Test	228
Generate a Report of the Proof Test	228
Close a Proof Test	229
Delete a Proof Test	230
Chapter 11: SIS Trip Reports	232
About SIS Trip Report	233
Access an SIS Trip Report	233
Create an SIS Trip Report	234
Create an SIS Trip Report Detail	236
Delete an SIS Trip Report	238
Chapter 12: SRS Templates	240
About SRS Templates	241
Create an SRS Template	241
Update an SRS Template	242
Copy an SRS Template	244
Set an SRS Template as Default	244
View the Revision History of an SRS Template	246
Change the State of an SRS Template	248
Compare the Revision Records of an SRS Template	250
Delete an SRS Template	251
Chapter 13: SRS Projects	253
About SRS Project	254
Access an SRS Project	254
Create an SRS Project	255
Access the List of Linked Records in an SRS Project	257
Change the State of an SRS Project	258
Access the Revision History of an SRS Project	259
Change the SRS Template that is Defined for an SRS Category in an SRS Project	259
Compare the Revision Records of an SRS Project	261
Link an SRS Project to Instrumented Function, SIL Analysis, Protective Loop, and Logic Solver	262

Download an SRS Project Report	268
Delete an SRS Project	269
Chapter 14: SRS Categories	270
About SRS Category	271
About Administration Settings to Define Required Categories	271
Create an SRS Category	271
Add an SRS Category to an SRS Project	274
Change the SRS Template that is Defined for an SRS Category in an SRS Project	274
Update a Particular SRS Category in an SRS Project	276
Delete an SRS Category from an SRS Project	276
Chapter 15: Exida Project Files	278
About Exida Project Files	279
Import Data From Exida	279
Export Data To Exida	282
Chapter 16: Admin	285
Specify Search Queries	286
Specify the Required SRS Categories for an SRS Project	287
Chapter 17: Deployment	290
Deployment and Upgrade	291
Chapter 18: Reference	292
General Reference	293
Family Field Descriptions	326
Catalog Items	427
Calculations	440

Copyright Digital, part of GE Vernova

© 2024 GE Vernova and/or its affiliates.

GE Vernova, the GE Vernova logo, and Predix are either registered trademarks or trademarks of GE Vernova. All other trademarks are the property of their respective owners.

This document may contain Confidential/Proprietary information of GE Vernova and/or its affiliates. Distribution or reproduction is prohibited without permission.

THIS DOCUMENT AND ITS CONTENTS ARE PROVIDED "AS IS," WITH NO REPRESENTATION OR WARRANTIES OF ANY KIND, WHETHER EXPRESS OR IMPLIED, INCLUDING BUT NOT LIMITED TO WARRANTIES OF DESIGN, MERCHANTABILITY, OR FITNESS FOR A PARTICULAR PURPOSE. ALL OTHER LIABILITY ARISING FROM RELIANCE UPON ANY INFORMATION CONTAINED HEREIN IS EXPRESSLY DISCLAIMED.

Access to and use of the software described in this document is conditioned on acceptance of the End User License Agreement and compliance with its terms.

Chapter 1

Overview

Topics:

- [Overview of the Safety Instrumented System \(SIS\) Management Module](#)
- [About the Components in a Safety Instrumented System \(SIS\)](#)
- [Access the SIS Management Overview Page for all Hierarchy Levels](#)
- [Access the SIS Management Overview Page for a Hierarchy Level](#)
- [SIS Management Workflow](#)

Overview of the Safety Instrumented System (SIS) Management Module

The SIS Management module lets you manage the logic solvers and instrumented functions that are in place in a facility to monitor and maintain controlled processes and ensure the efficiency and safety of those processes.

Using SIS Management, you can conduct a Safety Integrity Level (SIL) analysis, which you can use to assess the integrity of the safety instrumented systems and to uncover areas that may require further safeguarding. An SIL analysis (pronounced S-I-L) lets you assign a numeric rating to the instrumented functions that you are analyzing. This numeric rating represents the level of protection that those systems provide.

To conduct an SIL analysis in SIS Management, a team will:

- Define the function of the safety instrumented systems that will be assessed.
- Identify the undesirable consequences that the safety instrumented systems are designed to prevent.
- Test the components of the safety instrumented systems to determine if its performance is meeting the specified requirements and identify failures that may be occurring within those systems.
- Based on the test results, determine where further improvements are needed within the safety instrumented systems.

In addition, the SIS Management module provides the tools necessary for compliance with the standard specified in International Electrotechnical Commission (IEC) 61511.

Safety Instrumented System

Consider a heating element that heats the temperature of a room to reach and maintain the desired temperature (e.g., 20 degrees Celsius). If the temperature increases too rapidly, the temperature change could lead to a chain of events that may result in equipment failure or a catastrophic event. To prevent a rapid temperature increase during the heating process, a sensor within the thermometer continually measures the temperature, and relays that information to a computer. The computer decides whether the temperature is increasing at intervals that are in line with the specified safe limits for this process. If the data transmitted to the computer indicates that the temperature is increasing too rapidly, it will send a command to the heating element to decrease the temperature.

Together, the sensor within the thermometer, the computer, and the heating element act as a safety instrumented system that monitors the process of heating a room to ensure that it is performed safely and efficiently.

About the Components in a Safety Instrumented System (SIS)

A safety instrumented system (SIS) comprises of instruments that are designed specifically to:

- Monitor the conditions of a process
- Recognize conditions that are indicative of failure
- Prevent consequences

A given process can have more than one SIS in place to monitor and safeguard its conditions.

- Each SIS contains one or more protective instrument loops per instrumented function. The protective instrument loop is a series of interconnected instruments. Each loop is designed to maintain a defined condition within the process, meaning that it serves a specific purpose or a function. In other words, for every instrumented function that exists for a safety instrumented system, there is one protective instrument loop in place to fulfill that function.
- Each SIS contains one logic solver to interpret the readings from the components of the protective instrument loop and instruct those elements to take action if necessary. The logic solver measures that information against predefined criteria to determine whether that system needs to make adjustments to mitigate the risk associated with the instrumented functions of each protective instrument loop.

Functions of Individual Components in an SIS

Assume that Unit A provides steam to Unit B, and SIS-A is in place on Unit A and Unit B to maintain the pressure levels during that process to prevent loss of pressure or excess pressure beyond the defined safe and productive levels. Maintaining safe and productive pressure levels are the instrumented functions of the protective instrument loops within SIS-A. The logic solver within SIS-A receives data from the components of the protective instrument loops and decides whether the pressure levels are normal, or if they exceed or are lower than the safe and productive pressure levels. If the current pressure levels indicate the possibility of a process failure, which includes scenarios like loss of productivity or explosion, the logic solver sends signal to the components of the SIS to do something to mitigate the current condition. For example, if the current condition of the process indicates that the pressure is too low, the logic solver will tell an element of the protective instrument loop to increase the pressure so the levels are within the safe and productive levels defined for that process.

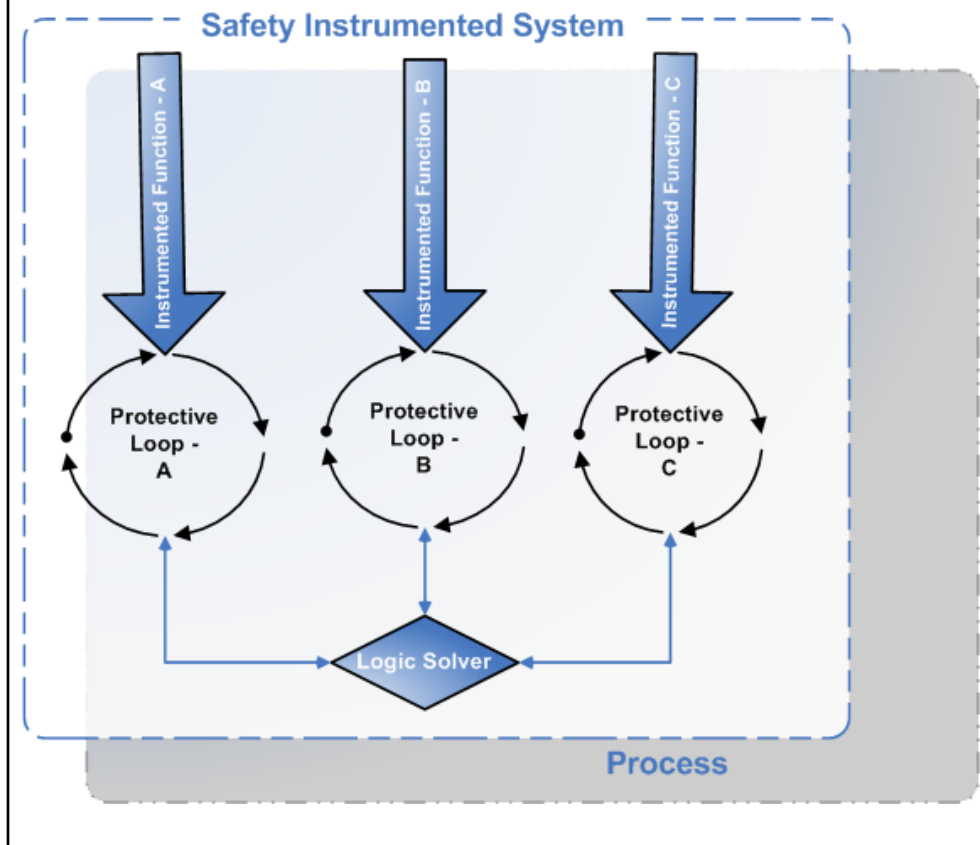

Access the SIS Management Overview Page for all Hierarchy Levels

Before You Begin

- You can access the **SIS Management Overview** page only if you are a member of one of the following Security Groups:
 - MI SIS Administrator
 - MI SIS Engineer
 - MI SIS User

You can perform the various tasks on this page based on the privileges granted to these Security Groups.

This topic describes how to access the **SIS Management Overview** page, on which you can access all the information and perform various tasks related to a safety instrumented system (SIS) for *all* hierarchy levels. If you want to access SIS information related to a *particular* hierarchy level, you can [access the SIS Management Overview page for a particular hierarchy level](#).

Procedure

In the module navigation menu, select **Integrity > SIS Management**.

The **SIS Management Overview** page appears.

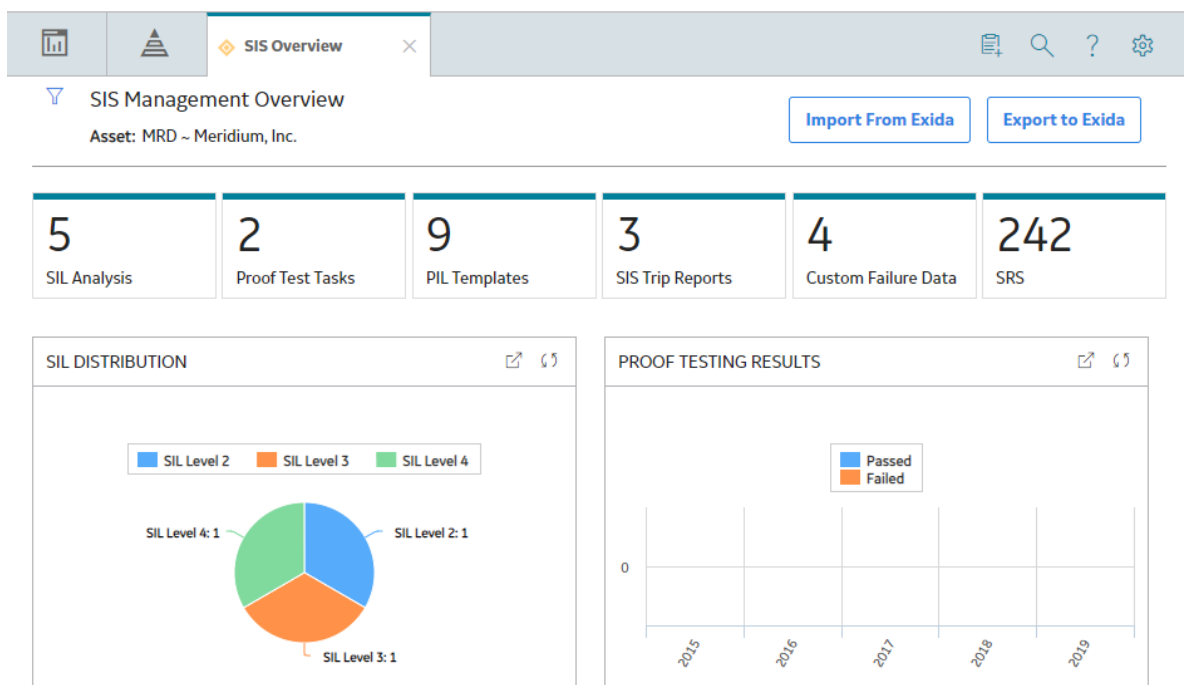

The following information related to all hierarchy levels appears on the page:

- The **SIL Analysis** tab: Displays a list of SIL Analyses. You can create a new analysis, or access an existing one. The number on the tab indicates the number of SIL Analyses.

- The **Proof Test Tasks** tab: Displays a list of Proof Test Tasks that are linked to an Instrumented Function or a Logic Solver. The Proof Test Tasks that are created in Asset Strategy Management also appear in the list. The number on the tab indicates the number of Proof Test Tasks.
- The **PIL Templates** tab : Displays a list of Protective Instrument Loop Templates. You can create a new template, or access or delete an existing one. The number on the tab indicates the number of Protective Instrument Loop Templates.
- The **SIS Trip Reports** tab: Displays a list of SIS Trip Reports. You can create a new one, or access or delete an existing one. The number on the tab indicates that number of SIS Trip Reports.
- The **Custom Failure Data** tab: Displays a list of Failure Rate Reference Data records for Sensors, Logic Solvers, and Final Elements. You can create a new one, or access or delete an existing one. The number on the tab indicates the number of Custom Devices.
- The **SRS (SRS)** tab: Displays a list of SRS Projects. You can create a new SRS Template. The number on the tab indicates that number of SRS Projects.

The page displays the following graphs that correspond to all hierarchy levels:

- **SIL Distribution** : Plots the number of Protective Instrument Loops with Safety Integrity Levels (SIL) of 1, 2, 3, and 4.
- **Proof Testing Results** : Plots the number of passed and failed proof tests for the current year and past four years.

By default, the hierarchy level is set to Home and the information that appears on the **SIS Management Overview** page is related to all Hierarchy Levels, including records that are not associated with any Asset.

You can filter the information that appears on the page based on a specific Asset by selecting  in the upper-left corner of the page.

Access the SIS Management Overview Page for a Hierarchy Level

Before You Begin

- You can access the **SIS Management Overview** page only if you are a member of one of the following Security Groups:
 - MI SIS Administrator
 - MI SIS Engineer
 - MI SIS User

You can perform the various tasks on this page based on the privileges granted to these Security Groups.

This topic describes how to select a hierarchy level (an Equipment or a Functional Location), and then access the **SIS Management Overview** page for that hierarchy level. You can also [access the SIS Management Overview page for all hierarchy levels](#).

Procedure

1. In the top navigation bar, select  .
The **Asset Hierarchy** page appears.

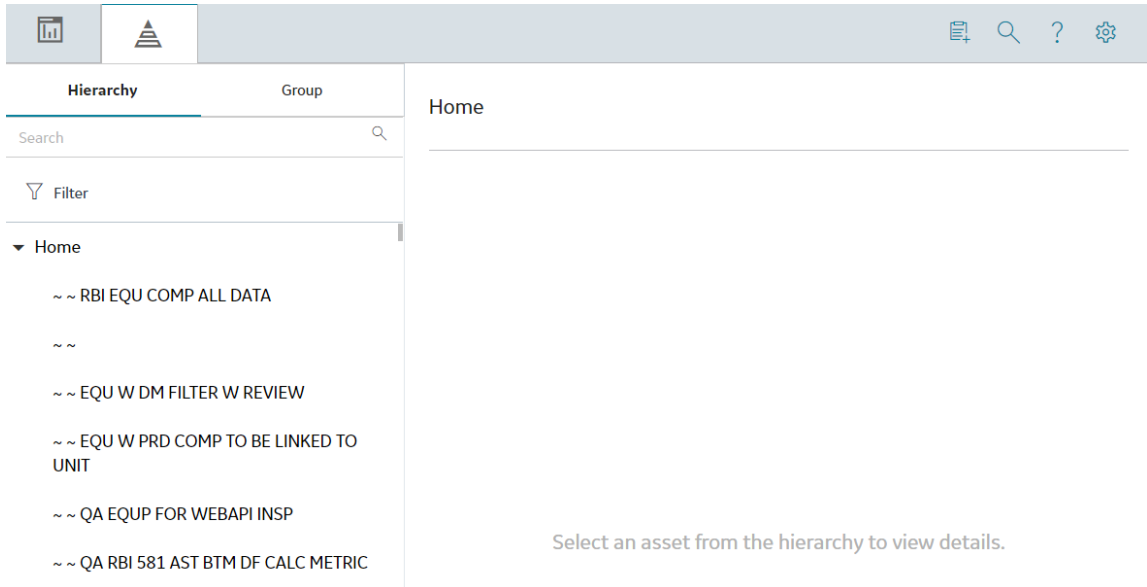

2. In the left pane, navigate to the hierarchy level for which you want to access the **SIS Management Overview** page.

A list of types of analyses performed on the selected hierarchy level appears in the workspace, in the **Health** section.

3. In the workspace, select the **Integrity** tab.

The **Integrity** section appears.

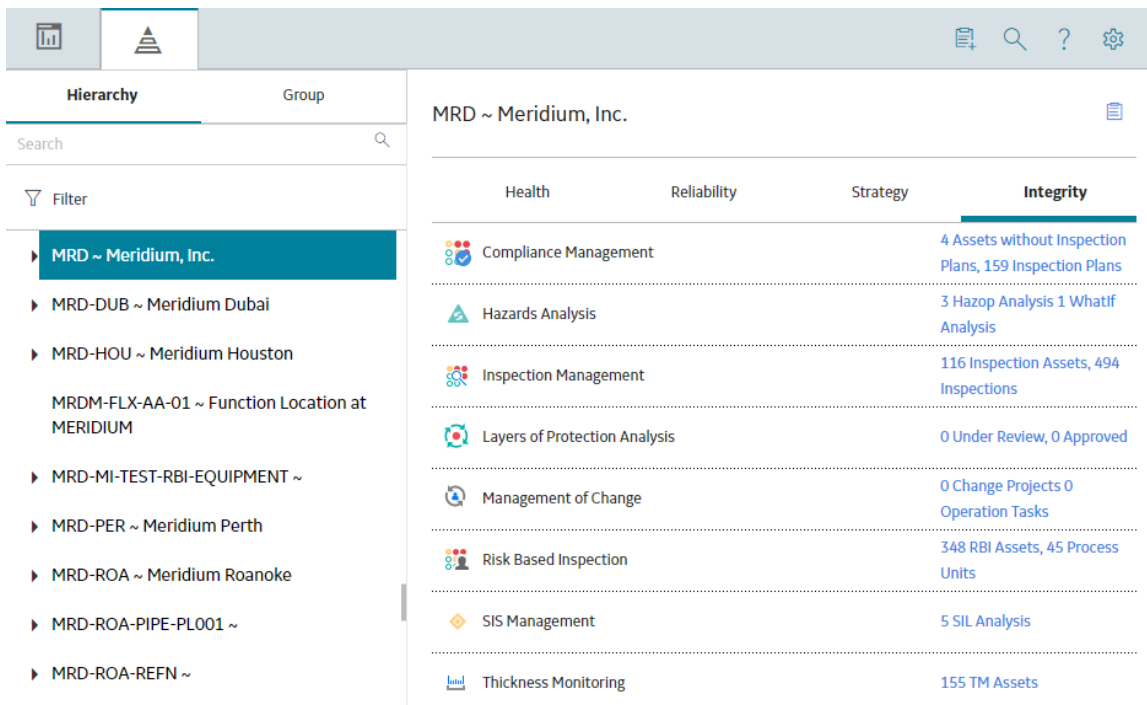

4. In the section, in the **SIS Management** row, select the link.

The **SIS Management Overview** page for the selected hierarchy level appears.

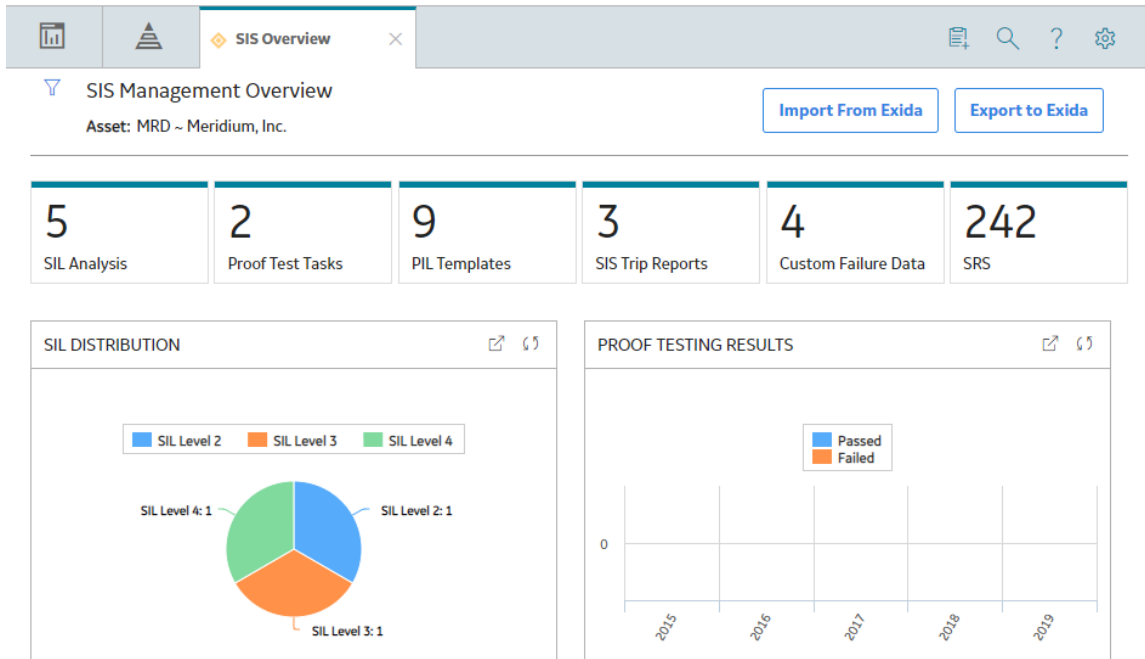

The following information appears on the page:

- The **SIL Analysis** tab: Displays a list of SIL Analyses only for the selected asset and all assets within the selected hierarchy. You can create a new SIL Analysis, or access an existing one. The number on the tab indicates the number of SIL Analysis related to the selected Asset.
- The **Proof Test Tasks** tab: Displays a list of Proof Test Tasks that are linked to an Instrumented Function or a Logic Solver. The Proof Test Tasks that are created in Asset Strategy Management also appear in the list. The number on the tab indicates the number of Proof Test Tasks.
- The **PIL Templates** tab: Displays a list of Protective Instrument Loop Templates. You can create a new one, or access or delete an existing one. The number on the tab indicates the number of Proof Test Templates.
- The **SIS Trip Reports** tab: Displays a list of SIS Trip Reports. You can create a new one, or access or delete an existing one. The number on the tab indicates that number of SIS Trip Reports.
- The **Custom Failure Data** tab : Displays a list of Failure Rate Reference Data records for Sensors, Logic Solvers, and Final Elements. You can filter based on the type, create a new one, or access or delete an existing one. The number on the tab indicates the number of Custom Devices.
- The **SRS (SRS)** tab: Displays a list of SRS Projects. You can create a new SRS Template. The number on the tab indicates that number of SRS Projects.

The workspace displays the following graphs that correspond only to the selected hierarchy level:

- **SIL Distribution** : Plots the number of Protective Instrument Loops with Safety Integrity Levels (SIL) of 1, 2, 3, and 4. These are the Protective Instrument Loops that are related to the selected hierarchy level.
- **Proof Testing Results** : Plots the number of passed and failed proof tests for the past four years. These are the Proof Tests that are related to the selected hierarchy level.

By default, the hierarchy level is set to Home and the information that appears on the **SIS Management Overview** page is related to all Hierarchy Levels, including records that are not associated with any Asset. You can filter the information that appears on the page based on a specific Asset by selecting  in the upper-left corner of the page.

SIS Management Workflow

This workflow provides the basic, high-level steps for using this module. The steps and links in this workflow do not necessarily reference every possible procedure.

Conducting an SIL analysis includes completing the following steps:

1. [Create an SIL Analysis](#), to store the details of the SIL analysis that you want to perform, including the start and end dates for the analysis.
2. Define the SIL analysis team , who will conduct the analysis.
3. [Define the logic solvers](#) that will monitor the process associated with the instrumented functions and protective instrument loops within the SIL analysis.
4. [Define the instrumented functions](#) that will be used to maintain safety integrity level within tolerable limits.
5. [Perform SIL Assessment](#) to determine the target SIL value for each instrumented function in the analysis.
6. [Perform SIL Verification](#) by creating a Protective Instrument Loop and defining its elements. APM then performs the SIL calculations for the loop, and allows you to verify if the target SIL is achieved.
7. [Perform SIL Validation](#) to ensure that the system is functioning to the standards for which it is designed.
8. Link the SIL Analysis to reference documents , which contain reference material relevant to the analysis.
9. [Propose a Recommendation](#). Recommendations can be used strategically to propose an action that will mitigate a risk that has been assessed, or tactically to alert another user or create a work request to resolve an issue.

Chapter 2

Workflows

Topics:

- [SIL Assessment](#)
- [SIL Verification](#)
- [SIL Validation](#)
- [SIS Trip Reporting](#)
- [Custom Device](#)
- [SRS](#)

SIL Assessment

SIS Management: SIL Assessment Workflow

This workflow describes the process of performing a Safety Integrity Level (SIL) assessment by defining the instrumented functions and the target SIL for each instrumented function.

In the following workflow diagram, the blue text in a shape indicates that a corresponding description has been provided in the sections that follow the diagram. For more information, refer to the topic [Interpreting the Workflow Diagrams](#).

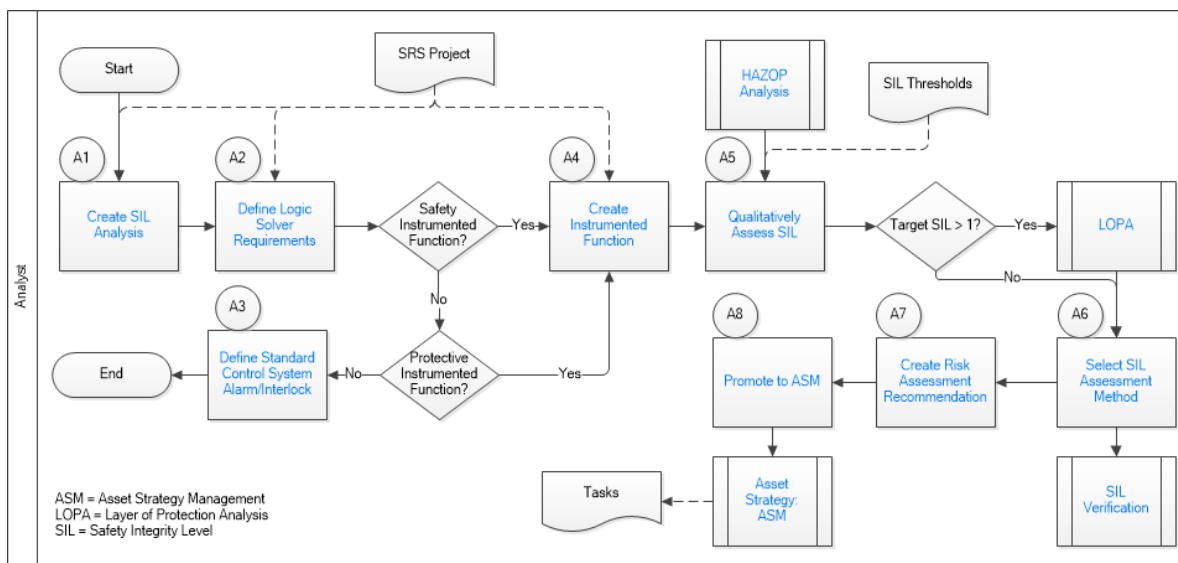

1. [Create SIL Analysis](#) on page 10
2. [Define Logic Solver Requirements](#) on page 11
3. [Safety Instrumented Function?](#) on page 11
4. [Create Instrumented Function](#) on page 11
5. [Protective Instrumented Function?](#) on page 11
6. [Define Standard Control System Alarm/Interlock](#) on page 11
7. [Qualitatively Assess SIL](#) on page 12
8. [Select SIL Assessment Method](#) on page 12
9. [SIL Verification](#) on page 21
10. [LOPA](#) on page 12
11. [HAZOP Analysis](#) on page 11
12. [Promote to ASM](#) on page 17
13. [Asset Strategy Management](#) on page 17
14. [Create Risk Assessment Recommendation](#) on page 12

Create SIL Analysis

Persona: Analyst

Create an SIL Analysis record to store the details of the SIL Analysis that you want to conduct.

Define Logic Solver Requirements

Persona: Analyst

Identify the logic solver that you want to use in the SIL Analysis. Create a Logic Solver to store the details of the logic solver.

Safety Instrumented Function?

Persona: Analyst

Determine if the instrumented function is critical to operational, health, and environmental aspects of safety, and assemble all the background information. You must assess the Safety Integrity level (SIL) and the logic solver requirements that you need to maintain for the instrumented function to keep the process safe.

Protective Instrumented Function?

Persona: Analyst

Determine if the instrumented function is not critical to safety, but is required to minimize the economic impact in the event of a failure.

Define Standard Control System Alarm/Interlock

Persona: Analyst

If the instrumented function is not critical to safety or is not protective, then you must install a standard control system interlock to warn an operator in case of a failure. However, you need not perform SIL assessment for the control system.

Create Instrumented Function

Persona: Analyst

Create an Instrumented Function to record the details of the instrumented function such as the initiating event, safe state, and response time.

HAZOP Analysis

Persona: Analyst

Go to the HAZOP Analysis workflow.

SIL Thresholds

Persona: Analyst

If you will perform SIL assessment using a Risk Matrix, you must refer to the SIL threshold values defined in a SIL Threshold record. The risk rank that you specify in the Risk Matrix will be compared with these SIL threshold values to calculate the target SIL value.

Asset Strategy Management

Persona: Analyst

Go to the Asset Strategy Management workflow.

Qualitatively Assess SIL

Persona: Analyst

If you will perform SIL assessment using a Hazards Analysis, and then link the Hazards Analysis to the Instrumented Function. If you will perform SIL assessment using a Risk Matrix, specify the risk rank for the various aspects of the Risk Matrix (e.g., Safety, Operational, Environment). You can also perform an external SIL assessment.

Select SIL Assessment Method

Persona: Analyst

After performing various types of SIL assessment (i.e., LOPA, Risk Matrix, PHA, External), you must associate one of them with the Instrumented Function. The SIL calculations related to the selected record will be associated with the Instrumented Function. These calculations are used to compare the achieved SIL values (from SIL Verification).

Create Risk Assessment Recommendation

Persona: Analyst

Create a Risk Assessment Recommendation to provide suggestions on how to achieve the target SIL.

Promote to ASM

Persona: Analyst

Promote the Recommendation to Asset Strategy Management (ASM), where the associated action can be implemented as an Inspection Task of the task type Proof Test.

LOPA

Persona: Analyst

Go to the LOPA workflow.

SIL Verification

Persona: Analyst

Go to the [SIL Verification workflow](#).

SIL Verification

SIS Management: SIL Verification Workflow

This workflow describes the process of verifying that the Safety Integrity Level (SIL) value for an Instrumented Function meets the target SIL defined in SIL assessment.

In the following workflow diagram, the blue text in a shape indicates that a corresponding description has been provided in the sections that follow the diagram. For more information, refer to the topic [Interpreting the Workflow Diagrams](#).

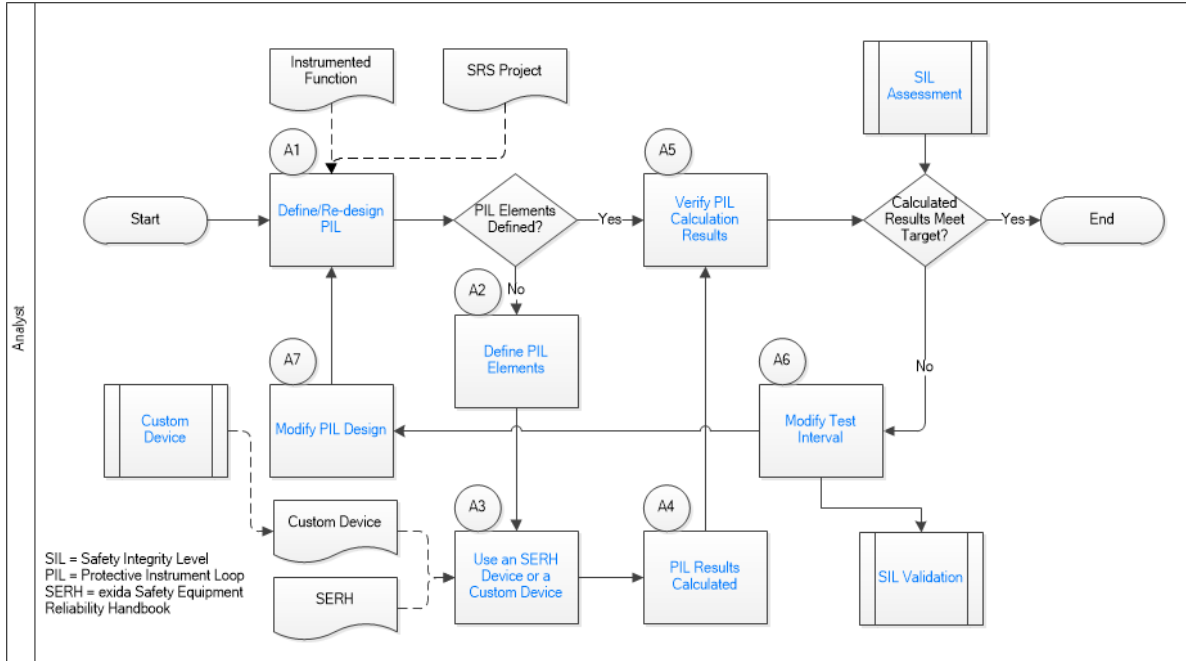

1. [Define/Re-design PIL](#) on page 13
2. [Define PIL Elements](#) on page 13
3. [Verify PIL Calculation Results](#) on page 14
4. [SIL Verification](#) on page 21
5. [Use an SERH Device or a Custom Device](#) on page 14
6. [PIL Results Calculated](#) on page 14
7. [Modify Test Interval](#) on page 14
8. [About Exida Project Files](#) on page 279
9. [SIL Validation](#) on page 14
10. [Custom Device](#) on page 14

Define/Re-design PIL

Persona: Analyst

Determine if there is a Protective Instrument Loop (PIL) for the Instrumented Function. If one exists, redesign the loop based on the requirement. If one does not exist, define the PIL.

PIL Elements Defined?

Persona: Analyst

Determine if there are sensors, logic solvers, and final elements in the PIL.

Define PIL Elements

Persona: Analyst

After you identify the elements of the PIL, enter the details of each element in the corresponding record that is created when you create a PIL, such as the type, manufacturer, model number, and the failure rate.

Use an SERH Device or a Custom Device

Persona: Analyst

You can link a custom device or an element from SERH. This will populate the interfaces, modules, and channels for the element as needed. Alternatively, you can use the failure rate data provided by the manufacturer of the device, failure distributions, or other failure rate databases.

PIL Results Calculated

Persona: Analyst

After you select an element from SERH, the details of the element such as the mean time to repair and mission time are populated. Based on these values, the probability of failure, spurious trip limit, and other values are calculated. APM then calculates the SIL value, spurious trip limit, and other values for the entire loop using the Markov calculation engine.

Verify PIL Calculation Results

Persona: Analyst

Verify if the loop calculations meet the target SIL requirement specified in SIL Assessment.

Modify Test Interval

Persona: Analyst

You can modify the proof test intervals of each element to ensure that the SIL value meets the target SIL value. You can manage proof testing in SIL Validation.

SIL Validation

Persona: Analyst

Go to the [SIL Validation workflow](#).

Modify PIL Design

Persona: Analyst

Elements with better failure rates can be substituted or additional elements can be added in voted scenarios to improve performance.

SIL Assessment

Persona: Analyst

Go to the [SIL Assessment workflow](#).

Custom Device

Persona: Analyst

Go to the [Custom Device workflow](#).

SIL Validation

SIS Management: SIL Validation Workflow

This workflow describes the process of validating the function of the safety equipment (sensors, logic solvers, and final elements) installed to safeguard an instrumented function.

In the following workflow diagram, the blue text in a shape indicates that a corresponding description has been provided in the sections that follow the diagram. For more information, refer to the topic *Interpreting the Workflow Diagrams*.

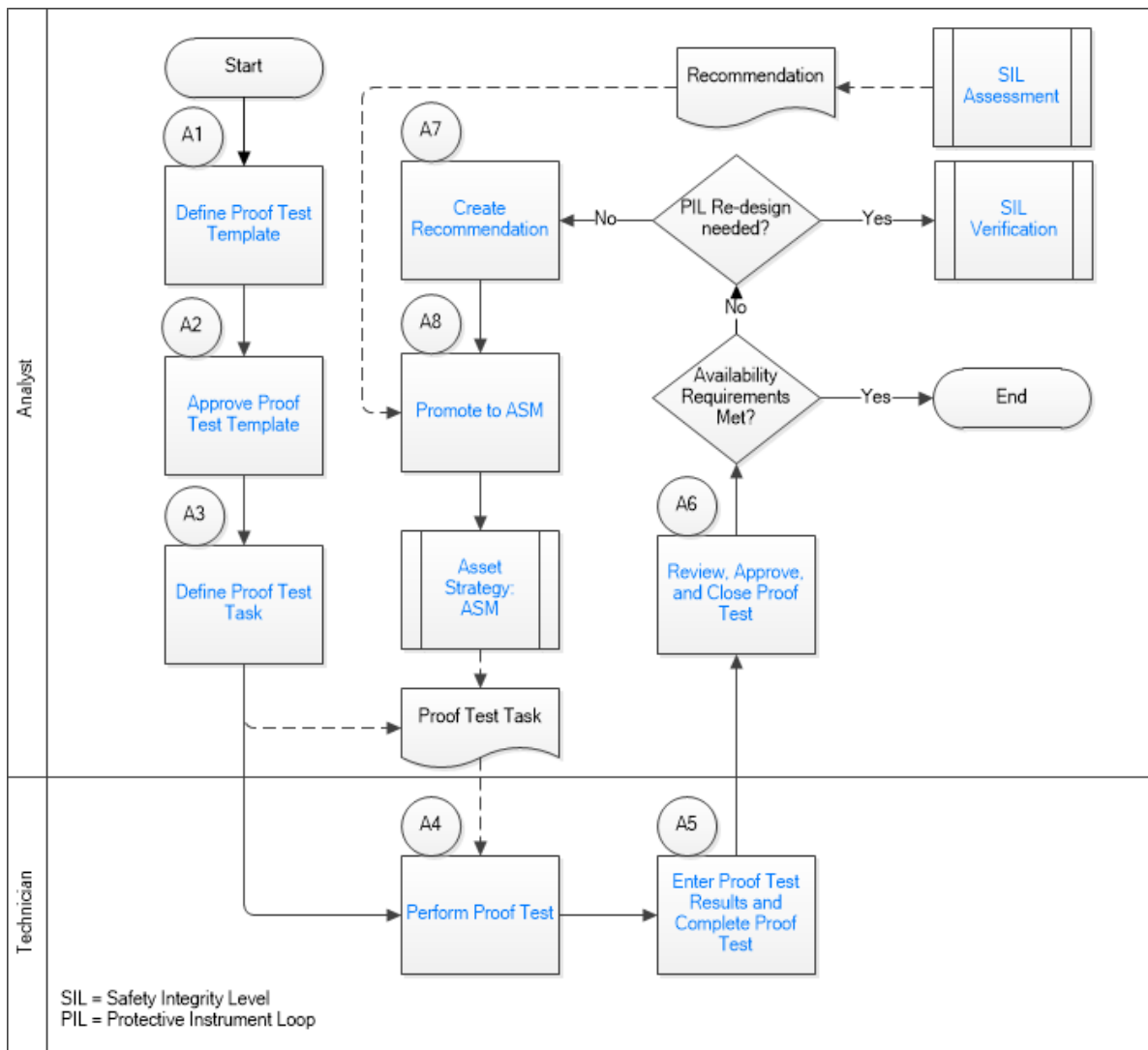

1. [Define Proof Test Template](#) on page 16
2. [Approve Proof Test Template](#) on page 16
3. [Define Proof Test Task](#) on page 16
4. [Perform Proof Test](#) on page 16
5. [Promote to ASM](#) on page 17
6. [Asset Strategy Management](#) on page 17

7. [Perform Proof Test](#) on page 16
8. [Review, Approve, and Close Proof Test](#) on page 16
9. [Enter Proof Test Results and Complete Proof Test](#) on page 16
10. [SIL Verification](#) on page 21
11. [SIL Verification](#) on page 21

Define Proof Test Template

Persona: Analyst

Create a Proof Test Template and Proof Test Template Details to specify the trip points and error limits for each element in the PIL.

Approve Proof Test Template

Persona: Analyst

Approve the Proof Test Template by selecting Approved in the Template Status field.

Define Proof Test Task

Persona: Analyst

Create a Proof Test Task record to schedule the proof test and assign the task to a user. You can also use Inspection Tasks (of the type Proof Test) created in Asset Strategy Management, which are listed in the **Proof Test Tasks** section of the **SIS Management Overview** page.

Perform Proof Test

Persona: Technician

Print the Proof Test Template. Perform the proof test in the field as per the instructions provided in the Proof Test Template.

Enter Proof Test Results and Complete Proof Test

Persona: Technician

Create a Proof Test to enter the readings taken while performing the proof test in the field. Link the Proof Test to the Proof Test Template and the Proof Test Task. APM indicates whether each step in the proof test has passed or failed.

Review, Approve, and Close Proof Test

Persona: Analyst

Review the proof test results, and then close it by selecting Closed in the Functional Test Status field.

Create Recommendation

Persona: Analyst

You can create a Recommendation to provide suggestions to improve the proof test results or to prevent overt failures such as broken electrical conduit, failure of a protective element, rusted wires, or the presence of excess moisture.

Promote to ASM

Persona: Analyst

Promote the Recommendation to Asset Strategy Management (ASM), where the associated action can be implemented as an Inspection Task of the task type Proof Test.

Asset Strategy Management

Persona: Analyst

Go to the Asset Strategy Management workflow.

SIL Assessment

Persona: Analyst

Go to the [SIL Assessment workflow](#).

SIL Verification

Persona: Analyst

Go to the [SIL Verification workflow](#).

SIS Trip Reporting

SIS Management: Trip Reporting Workflow

This workflow describes the process of saving and analyzing trip reports.

In the following workflow diagram, the blue text in a shape indicates that a corresponding description has been provided in the sections that follow the diagram. For more information, refer to the topic [Interpreting the Workflow Diagrams](#).

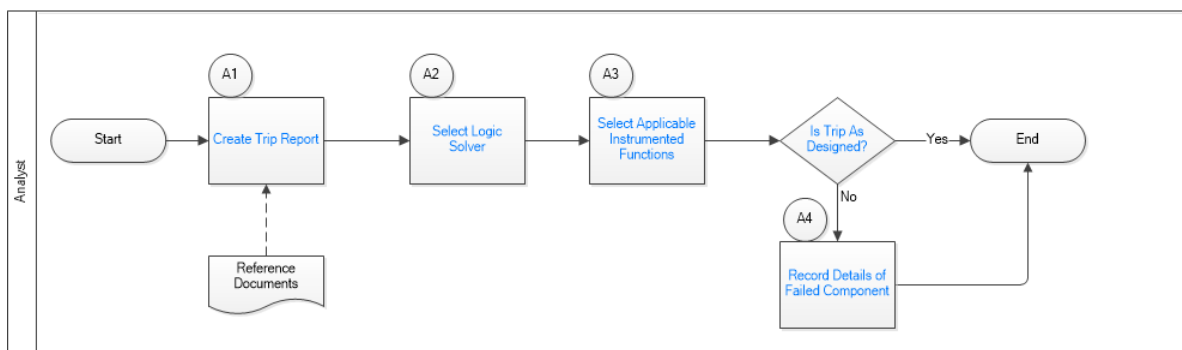

1. [SIS Management: Trip Reporting Workflow](#) on page 17
2. [Create Trip Report](#) on page 18
3. [Select Logic Solver](#) on page 18
4. [Select Applicable Instrumented Functions](#) on page 18
5. [Is Trip As Designed?](#) on page 18

Create Trip Report

Persona: Analyst

Create a Trip Report record to store the details of the trip that occurred.

Select Logic Solver

Persona: Analyst

Select the Logic Solver that is associated with the Instrumented Functions for which the trip occurred.

Select Applicable Instrumented Functions

Persona: Analyst

Select the Instrumented Functions that are associated with the trip that occurred.

Is Trip As Designed?

Persona: Analyst

Determine whether the trip was as designed, spurious, or dangerous.

Record Details of Failed Component

Persona: Analyst

If the trip was not as designed (i.e., spurious or dangerous), then enter the details of the Protective Instrument Loop element that caused the trip. For example, if a trip was caused when a sensor indicated high pressure even when the pressure level was normal, enter the details of the sensor. For that example, the trip type would be Spurious.

Custom Device

SIS Management: Custom Device Workflow

This workflow describes the process of defining a custom device.

In the following workflow diagram, the blue text in a shape indicates that a corresponding description has been provided in the sections that follow the diagram. For more information, refer to the topic Interpreting the Workflow Diagrams.

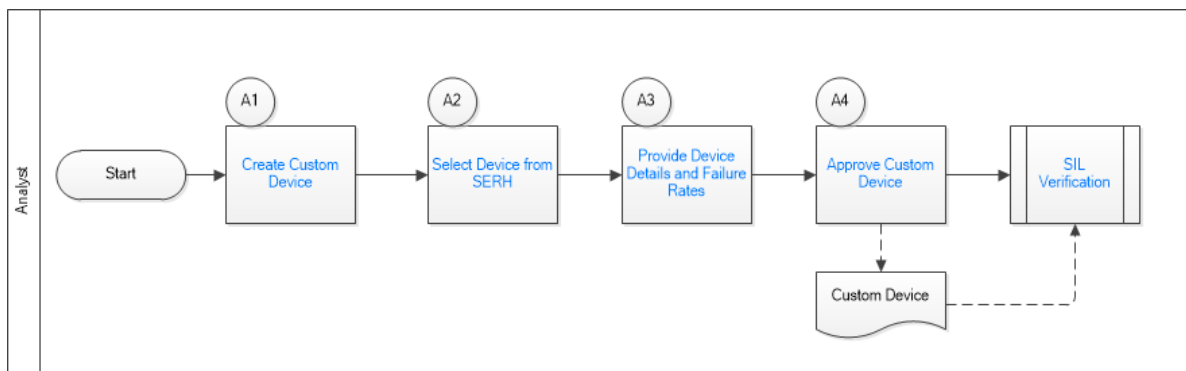

1. [Create Custom Device](#) on page 19
2. [Select Device from SERH](#) on page 19
3. [Provide Device Details and Failure Rates](#) on page 19
4. [Approve Custom Device](#) on page 19
5. [SIL Verification](#) on page 21

Create Custom Device

Persona: Analyst

Create a Custom Device to store the details of the sensor, logic solver, or final element that you want to use.

Select Device from SERH

Persona: Analyst

Select the devices from SERH that make up the custom device. You can create a device with failure rates based on the operating data in your facility. You can also add multiple elements (e.g., valve, solenoid, actuator, quick exhaust) to a device that you plan to reuse in the design of other protective loops.

Provide Device Details and Failure Rates

Persona: Analyst

Provide the custom device details and failure rates.

Approve Custom Device

Persona: Analyst

Approve the custom device so that it can be used in a Protective Instrument Loop.

SIL Verification

Persona: Analyst

Go to the [SIL Verification workflow](#).

SRS

SIS Management: SRS Workflow

This workflow describes the process of creating an SRS Template, approving it, and adding it to the SRS Project, after which the SRS Project is approved and linked to an SIL Analysis, Instrumented Function, Logic Solver, and Protective Loop.

In the following workflow diagram, the blue text in a shape indicates that a corresponding description has been provided in the sections that follow the diagram. For more information, refer to the topic [Interpreting the Workflow Diagrams](#).

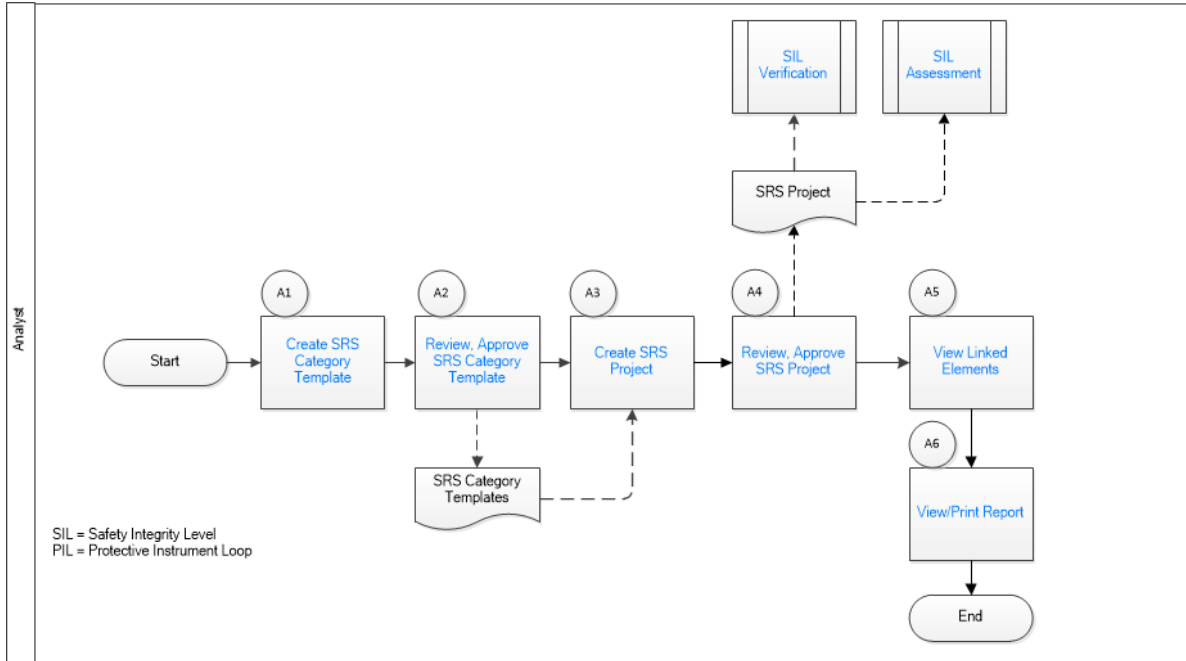

1. [Create SRS Category Template](#) on page 20
2. [Review, Approve SRS Category Template](#) on page 20
3. [Create SRS Project](#) on page 20
4. [Review, Approve SRS Project](#) on page 20
5. [View Linked Elements](#) on page 21
6. [View/Print Report](#) on page 21
7. [SIL Verification](#) on page 21
8. [SIL Assessment](#) on page 21

Create SRS Category Template

Persona: Analyst

Create an SRS Template for any SRS Template category.

Review, Approve SRS Category Template

Persona: Analyst

Review an SRS template and move it through the approval process.

Create SRS Project

Persona: Analyst

Create a new SRS Project to select one or many of the SRS templates. Once you have made the selection of templates, a copy of the collection of templates will be made.

Review, Approve SRS Project

Persona: Analyst

Review an SRS Project and move it through the approval process.

View Linked Elements

Persona: Analyst

Link an existing, approved SRS project to an SIL Analysis, Instrumented Function, Logic Solver, and Protective Instrument Loop.

View/Print Report

Persona: Analyst

View or print an SRS project report.

SIL Verification

Persona: Analyst

Go to the [SIL Verification workflow](#).

SIL Assessment

Persona: Analyst

Go to the [SIL Assessment workflow](#).

Chapter

3

SIL Analysis

Topics:

- [About Safety Integrity Level \(SIL\) Analysis](#)
- [About Revision History](#)
- [About the SIL Analysis Team](#)
- [Access an SIL Analysis](#)
- [Create an SIL Analysis](#)
- [Access the SIL Analysis Summary](#)
- [Access the Revision History of an SIL Analysis](#)
- [Access the SIL Analysis Team Members Section](#)
- [Access the Reference Documents in SIS Management](#)
- [Access the Recommended Actions Pane](#)
- [Access the Mitigated Risk](#)
- [Change the State of an SIL Analysis](#)
- [Generate a Report for an SIL Analysis](#)
- [Delete an SIL Analysis](#)

About Safety Integrity Level (SIL) Analysis

A Safety Integrity Level (SIL) analysis lets you assess the safety instrumented systems in your facility to ensure that they are adequately safeguarding your equipment, locations, and processes.

When you conduct an SIL analysis, you will:

- Assess the level of safety integrity per instrumented function, using the APM Risk Matrix interface or via a Layer of Protection Analysis (LOPA). Based on the defined risks, the APM system calculates the overall SIL for the safety instrumented system.
- Verify the SIL of the safety instrumented system using the SIL Verification feature, which lets you make up the safety instrumented system and calculate the ability of a protective instrument loop to meet the required SIL for that process. The APM system uses equations defined by International Electrotechnical Commission (IEC) to calculate the probability of failure on Demand average (PFD Avg) or probability of failure per hour (PFH).
- Determine whether further safeguarding is necessary, based on the SIL maintained by those safety instrumented systems.

About Revision History

The Revision History feature allows you to manage the revisions made for an entire analysis. When you create an SIL Analysis, you link records in multiple families to the SIL Analysis. When you complete an analysis (i.e., it has been approved), you will change the state of the SIL Analysis to Complete. When you do so, a snapshot is taken of the SIL Analysis and each record linked to it.

When the state of an SIL Analysis is changed to Complete, one record in each of the following families will be created:

- SIL Analysis Revision
- Logic Solver Revision
- Instrumented Function Revision
- LOPA Revision
- PHA Internal Assessment Revision
- Risk Matrix Internal Assessment Revision
- External Assessment Revision

Each Revision record stores a snapshot of the source record as it appeared when the state of the SIL Analysis was changed.

If you re-evaluate the SIL Analysis, the state of the SIL Analysis will change again to the Complete. A second set of Revision records will be created, and so on.

About the SIL Analysis Team

The Safety Integrity Level (SIL) analysis team is a group of members who will complete the SIL analysis. You can add APM users and non-APM users to the SIL analysis team.

- APM users will have an existing APM Security User and an associated Human Resource record that was created automatically when the Security User was created.
- Non-APM users will not have a APM Security User or a Human Resource record. To add a non-APM user to the SIL analysis team, you will need to create a Human Resource record for that user. You can do so via the SIL Analysis Team Members page or using APM Tools.

Note: A APM Security User record is required for logging in to the APM application and using SIS Management. SIL analysis team members who do not have a Security User account may participate in and contribute to the analysis but will not be able to use APM.

Team Member Roles

SIL analysis team member roles serve as a reference of which SIL analysis team member is responsible for a given task related to the SIL analysis. Any member of the SIL analysis team can be assigned a role within the SIL analysis team. The following roles are available for an SIL analysis:

- **Owner :** The team member who is responsible for assets represented in the SIL analysis. After you assign a team member the role of Owner, that team member's name will appear in the Owner field in the SIL Analysis.
- **Facilitator :** The team member who is in charge of conducting the analysis and organizing the team.

There can be only one Process Owner and one Facilitator per analysis.

Access an SIL Analysis

Procedure

1. Access the [SIS Management Overview](#) page.

Tip: You can also [access the SIS Management Overview](#) page for a selected hierarchy level.

2. In the workspace, select the **SIL Analysis** tab.

The **SIL Analysis** section appears, displaying a list of SIL Analyses.

SIS Management Overview
Asset: MRD ~ Meridium, Inc. Import From Exida Export to Exida

5 SIL Analysis	2 Proof Test Tasks	9 PIL Templates	3 SIS Trip Reports	4 Custom Failure Data	242 SRS
-------------------	-----------------------	--------------------	-----------------------	--------------------------	------------

<input type="checkbox"/>	ANALYSIS ID ↑	EQUIPMENT ID
<input type="checkbox"/>	AQA Copy Analysis	~ ~ QA TM Dfit T-min
<input type="checkbox"/>	ASF SIL Analysis	~ AQA EQUIPMENT ~ MBJ-EQUIPMENT-00002
<input type="checkbox"/>	Copy SIL Analysis	~ ~ QA TM Apply CCR
<input type="checkbox"/>	PHA-Internal	~ ~ QA TM EQUIPMENT W/ TML GROUPS
<input type="checkbox"/>	V3.5.0 SP1 - SIL-09	~ MAIN COLUMN O.H. TRIM COOLER ~ HXST 78

Rows per page 50 200 500 1 - 5 of 5 Results ← 1 →

3. In the **Analysis ID** column, select the SIL Analysis that you want to access.

The summary of the SIL Analysis appears. A list of Instrumented Functions in the SIL Analysis appears in the left pane.

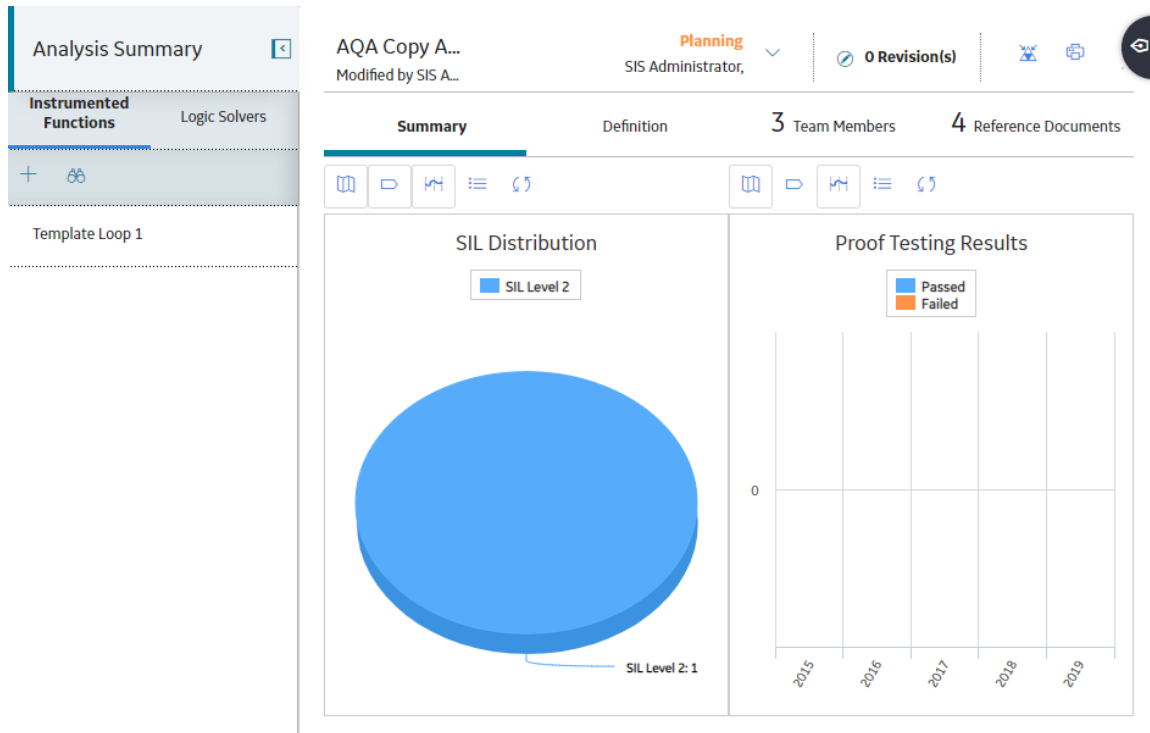

4. In the workspace, select the **Definition** tab.
The datasheet for the SIL Analysis appears.

The screenshot shows the 'SIL Analysis' configuration page. At the top, the analysis ID is 'B0007-00...' and it is in the 'Planning' state, modified by the 'SIS Administrator'. There are 0 revisions. The page has tabs for 'Summary', 'Definition', '3 Team Members', and '4 Reference Documents'. The 'Definition' tab is active, showing a 'Datasheet ID' dropdown set to 'SIL Analysis' and a location pin for 'Site: Site EUR'. Below this, the 'SIL Analysis' section is expanded to show several fields: 'Analysis ID' (B0007-009 Steam Boiler SIS), 'Analysis Description' (B0007-009 Steam Boiler SIS Analysis), 'SRS Project ID' (empty), 'Long Description' (Based on results of updated HAZOP conducted on B0007-009 Steam Boiler. Assess all target SIL values to ensure that corporate risk requirements have been met.), and 'Unit ID' (Boiler Condenser Unit).

5. If needed, modify values in the [available fields](#).
Note: You can modify values in the SIL Analysis only if the analysis is in the Planning state.
6. In the upper-right corner of the datasheet, select .
 The changes made to the SIL Analysis are saved.





Create an SIL Analysis

Procedure

1. Access the [SIS Management Overview](#) page.
Tip: You can also access the [SIS Management Overview](#) page for a selected hierarchy level.
2. In the workspace, select the **SIL Analysis** tab.
 The **SIL Analysis** section appears, displaying a list of SIL Analyses.

Import From Exida

Export to Exida

5 SIL Analysis	2 Proof Test Tasks	9 PIL Templates	3 SIS Trip Reports	4 Custom Failure Data	242 SRS
+  					
<input type="checkbox"/>	ANALYSIS ID ↑	EQUIPMENT ID			
<input type="checkbox"/>	AQA Copy Analysis	~ ~ QA TM Dfit T-min			
<input type="checkbox"/>	ASF SIL Analysis	~ AQA EQUIPMENT ~ MBJ-EQUIPMENT-00002			
<input type="checkbox"/>	Copy SIL Analysis	~ ~ QA TM Apply CCR			
<input type="checkbox"/>	PHA-Internal	~ ~ QA TM EQUIPMENT W/ TML GROUPS			
<input type="checkbox"/>	V3.5.0 SP1 - SIL-09	~ MAIN COLUMN O.H. TRIM COOLER ~ HXST 78			
Rows per page 50 <input type="text" value="100"/> 200 500					
1 - 5 of 5 Results <input type="text" value="1"/>  					

- In the upper-left corner of the section, select .
A blank datasheet for the SIL Analysis appears.

Create a new SIL Analysis

Datasheet ID:

Site: Roanoke, VA

SIL Analysis

Analysis ID:
This field is required

Analysis Description:

SRS Project ID:

Long Description:

Unit ID:

4. As needed, enter values in [available fields](#).
5. In the lower-right corner of the datasheet, select **Save**.

The SIL Analysis is created.

Next Steps

- Add Team Members to the SIL Analysis

Access the SIL Analysis Summary

Before You Begin

- You can access the SIL Analysis summary only if you are a member of one of the following Security Groups:
 - MI SIS Administrator
 - MI SIS Engineer
 - MI SIS User

You can perform the various tasks on this page based on the privileges granted to these Security Groups.

Procedure

1. Access the **SIS Management Overview** page.

Tip: You can also access the **SIS Management Overview** page for a selected hierarchy level.

2. In the workspace, select the **SIL Analysis** tab.

The **SIL Analysis** section appears, displaying a list of SIL Analyses.

The screenshot shows the 'SIS Management Overview' page for 'Asset: MRD - Meridium, Inc.'. At the top right, there are two buttons: 'Import From Exida' and 'Export to Exida'. Below these are six summary cards: 'SIL Analysis' (5), 'Proof Test Tasks' (2), 'PIL Templates' (9), 'SIS Trip Reports' (3), 'Custom Failure Data' (4), and 'SRS' (242). The main content area is a table with columns 'ANALYSIS ID ↑' and 'EQUIPMENT ID'. The table contains five rows of data, each with a checkbox in the first column. The rows are: 'AQA Copy Analysis' (~ ~ QA TM Dflt T-min), 'ASF SIL Analysis' (~ AQA EQUIPMENT ~ MBJ-EQUIPMENT-00002), 'Copy SIL Analysis' (~ ~ QA TM Apply CCR), 'PHA-Internal' (~ ~ QA TM EQUIPMENT W/ TML GROUPS), and 'V3.5.0 SP1 - SIL-09' (~ MAIN COLUMN O.H. TRIM COOLER ~ HXST 78). At the bottom, there is a pagination control showing 'Rows per page' with options 50, 100 (selected), 200, and 500. On the right, it shows '1 - 5 of 5 Results' with navigation arrows and a page number '1'.

3. In the **Analysis ID** column, select the SIL Analysis whose summary you want to access.
The SIL Analysis summary appears.

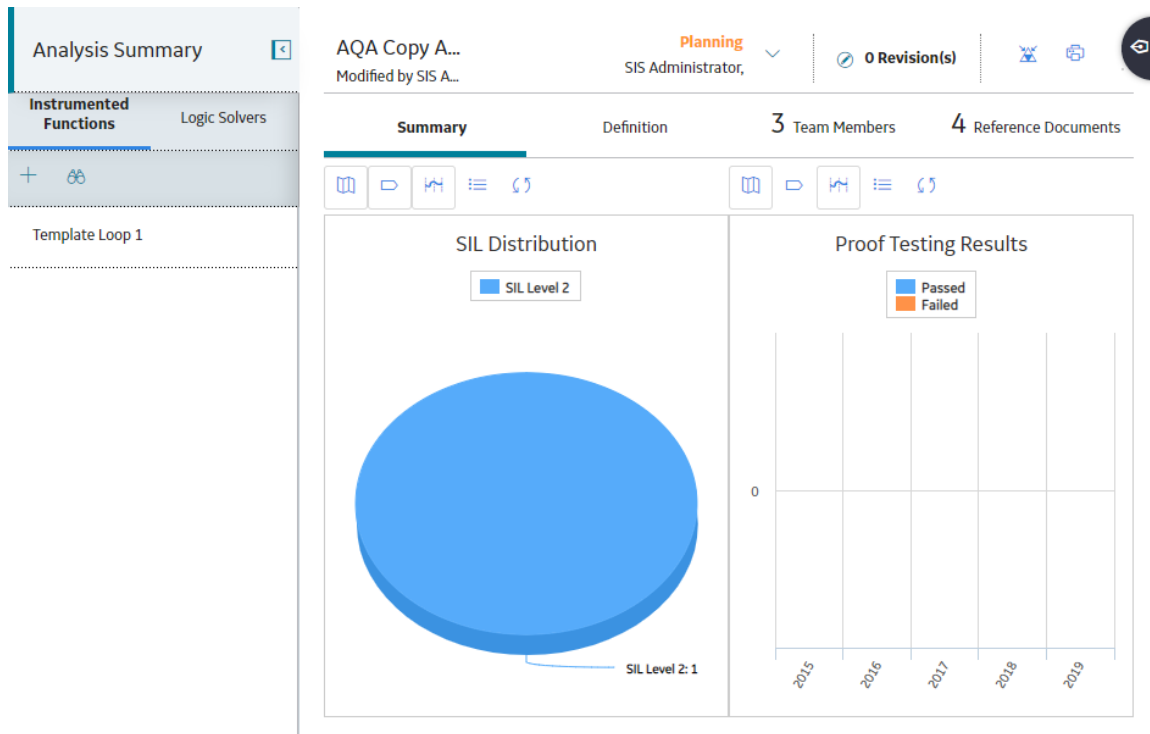

The following information appears on the page:

- The left pane displays a list of Instrumented Functions and Logic Solvers in the SIL Analysis.
- The workspace displays the following tabs:
 - **Summary:** Displays various graphs for the SIL Analysis.
 - **Definition:** Displays the SIL Analysis datasheet, allowing you to modify the SIL Analysis.
 - **Team Members:** Displays a list of Team Members in the SIL Analysis, allowing you to add a new Team Member, or access, modify, or remove an existing one. You can also assign or modify a Team Member's role.
 - **Reference Documents:** Displays a list of Reference Documents in the SIL Analysis, allowing you to add a new one, or access, modify, or remove an existing one.
- The **Summary** section displays the following graphs:
 - **Proof Testing Results:** Plots the number of passed and failed proof tests conducted on the Instrumented Functions and Logic Solvers in the SIL Analysis for the current year and the past four years.
 - **SIL Distribution:** Plots the number of Protective Instrument Loops (associated with each Instrumented Function in the SIL Analysis) with Safety Integrity Levels (SIL) of 1, 2, 3, and 4.

Access the Revision History of an SIL Analysis

Procedure

1. [Access the SIL Analysis](#) whose revision history you want to access.
2. In the upper-right corner of the page, select **Revisions**.

The **Revision History** page appears, displaying a list of revisions for the analysis.

No	Revision Name	Last Modified
0	PHA-Internal - 0	18 Oct 2019
1	PHA-Internal - 1	18 Oct 2019

3. Select the revision that you want to access.

The datasheet of the SIL Analysis for the selected revision appears. The left pane displays the Instrumented Functions, SIL Assessments, and Logic Solvers in the analysis.

PHA-Internal - 0 Revision History Show Changes

Field	Value
Datasheet ID:	SIL Analysis Revision
Site:	Roanoke, VA
Analysis ID:	PHA-Internal
Analysis Description:	PHA-Internal-Analysis Description
Long Description:	Long Description
Unit ID:	PHA-Internal-Unit ID
Functional Location ID:	MRD-MI-TEST-TM-EQ020 ~ QA TM EQUIPMENT W/ TML GROUPS
Equipment ID:	~ ~ QA TM EQUIPMENT W/ TML GROUPS
Hazards Analysis Reference:	

4. If you want to view the changes that have been made for a particular record in that revision, select the record in the left pane, and then, in the upper-right corner of the page, select **Show Changes**.

The **Changes For Selected Datasheet** window appears, displaying a list of old values (i.e., values in the preceding revision) and new values (i.e., values in the selected revision) for all the fields that were modified in the selected revision for the selected record.

Changes For Selected Datasheet

No	Field	Old Value	New Value
1	Unit ID		Boiler Condenser Unit
2	Analysis End Date		04/25/2017 15:19:43

OK

Access the SIL Analysis Team Members Section

About This Task

This topic describes how to access the **Team Members** section of an SIL Analysis, from where you can access the list of team members in the analysis, add new ones, assign roles to team members, or modify or delete them.

Procedure

1. [Access the SIL Analysis](#) whose Team Members you want to access.
2. In the workspace, select the **Team Members** tab.

The **Team Members** section appears, displaying a list of Team Members in the analysis.

Tip: For details about working with teams and the **Team Members** section, refer to the Teams section of the documentation.

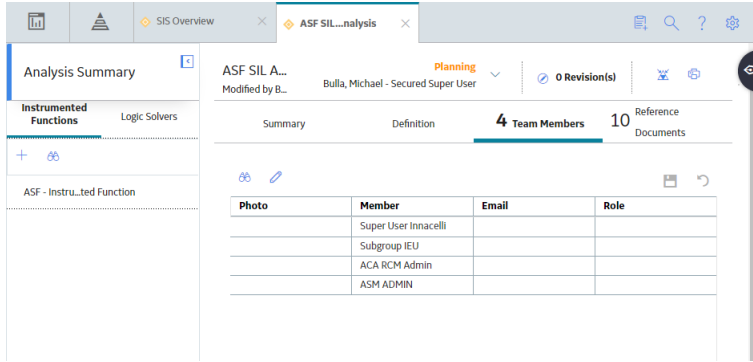

Access the Reference Documents in SIS Management

About This Task

This topic describes how to access the **Reference Documents** section in SIS Management, from where you can access a list of Reference Documents linked to an SIL Analysis, create a new one, or modify or delete an existing one.

Procedure

1. [Access the SIL Analysis](#) whose Reference Documents you want to access.
2. In the workspace, select the **Reference Documents** tab.

The **Reference Documents** section appears, displaying a list of Reference Documents linked to the SIL Analysis.

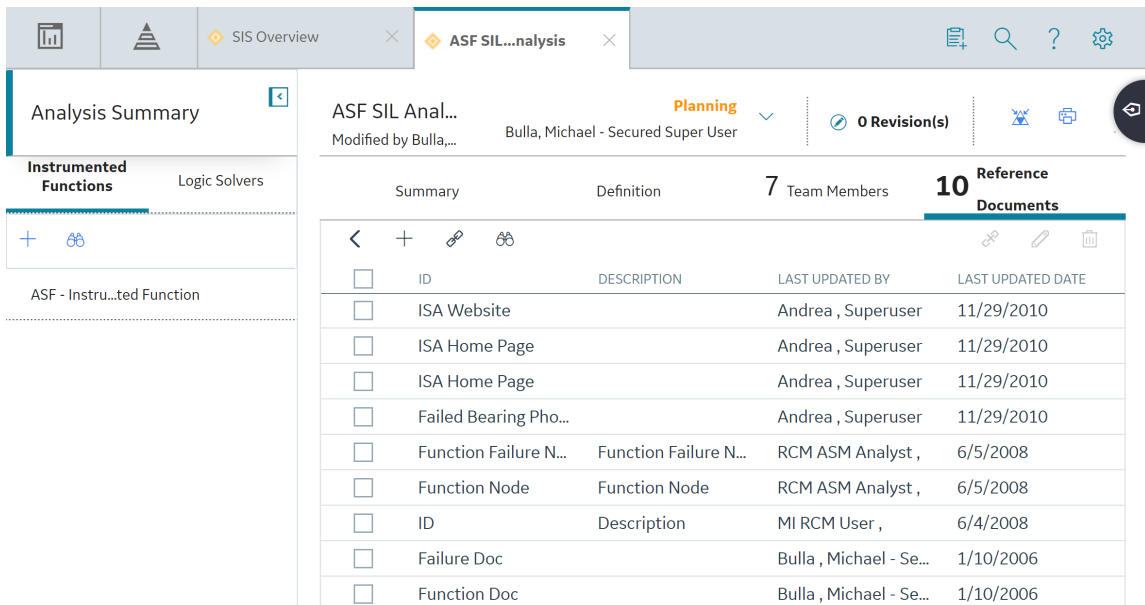

Tip: For more information, refer to the Reference Documents section of the documentation.

Access the Recommended Actions Pane

About This Task

The Recommendations that appear on the **Recommended Actions** pane are filtered based on your selection.

- If you access an SIL Analysis, the **Recommended Actions** pane displays a list of Recommendations linked to all the Instrumented Functions in the SIL Analysis.
- If you access an Instrumented Function, the **Recommended Actions** pane displays a list of Recommendations linked only to that Instrumented Function.

Important: You can create a Recommendation only for an Instrumented Function. If you want to create a Recommendation, you must first select the Instrumented Function, and then access the **Recommended Actions** pane.

Procedure

1. Access the [SIL Analysis](#) or the [Instrumented Function](#) that is linked to the Recommendation.
2. In the upper-right corner of the page, select .

The **Recommended Actions** pane appears, displaying a list of Recommendations.

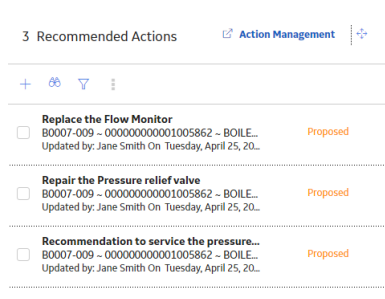

Tip: For information about additional options available when working with the Recommendation records, refer to the Action Management section of the documentation.

Note: If the Instrumented Function for which you created the Recommendation is associated with a Risk Assessment, when you access the Recommendation, a **Mitigated Risk** section appears, displaying the details of the Risk Assessment.

Next Steps

- [Assess the Mitigated Risk for the Instrumented Function](#)

Access the Mitigated Risk

Before You Begin

- Assess the SIL value of the Instrumented Function using one of the following SIL Assessments:
 - [LOPA Assessment](#)
 - [Risk Matrix Internal Assessment](#)

- [PHA Internal Assessment](#)
- [Associate the SIL Assessment with the Instrumented Function](#). The Risk Assessment associated with the SIL Assessment will be linked to the Instrumented Function.
- [Create a Recommendation for the Instrumented Function](#).

About This Task

This topic describes how to perform a mitigated risk assessment for an Instrumented Function in an SIL Analysis.

Procedure

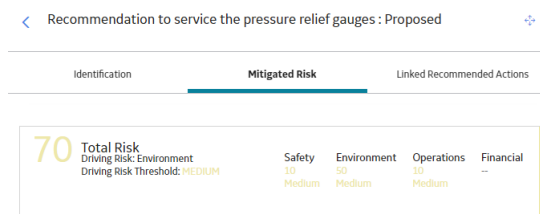

1. [Access the Recommendation](#) that is associated with the Instrumented Function for which you want to assess the mitigated risk.
2. Select the **Mitigated Risk** tab.

The **Mitigated Risk** section appears, displaying the overall risk rank and the risk ranks for each risk category.



3. Select the section that displays the risk rank.

The **Mitigated Risk Assessment** window appears. The window contains a tab for each risk category configured for the Risk Matrix, which you can select to access the Risk Matrix for the category. By

default, the  icon appears in the cell in which the  icon appears.

Note: You cannot modify the unmitigated risk assessment in the Risk Matrix.

Mitigated Risk Assessment

Total Risk 70

	Probability	Consequence				
		Very Low 1	Low 10	Medium 100	High 500	Very High 1,000
Safety 10	Frequent 5	5	50	500	2,500	5,000
Environment 50	Probable 1	1	10	100	500	1,000
Operations 10	Possible 0.3	0.3	3	30	150	300
Financial	Remote 0.1	0.1	1	10	50	100
	Improbable 0.05	0.05	0.5	5	25	50

Not Applicable Mitigated Risk Unmitigated Risk

Basis for Assessment

Cancel

Save

4. Select the tab corresponding to the category for which you want to assess the mitigated risk. For example, if you want to assess the mitigated risk for the Environment category, select **Environment**.

The Risk Matrix for the selected category appears.

5. On the matrix, select the cell whose value represents the mitigated risk for the selected category.

In the cell that you selected, the  icon appears.

Total Risk 23

Category	Probability	Consequence				
		Very Low	Low	Medium	High	Very High
Safety 10		1	10	100	500	1,000
Environment 3	Frequent 5	5	50	500	2,500	5,000
	Probable 1	1	10	100	500	1,000
Operations 10	Possible 0.3	0.3	3	30	150	300
	Remote 0.1	0.1	1	10	50	100
Financial	Improbable 0.05	0.05	0.5	5	25	50

Not Applicable
 Mitigated Risk
 Unmitigated Risk

Basis for Assessment

Cancel

Save

- For each category for which you want to assess the mitigated risk, repeat steps 4 and 5.
- In the lower-right corner of the **Mitigated Risk Assessment** window, select **Save**.

The mitigated risk for the Instrumented Risk Function is assessed. The **Mitigated Risk** section appears, displaying the overall mitigated risk rank and risk ranks for individual categories. Depending on the configuration of the Risk Matrix, the overall risk rank can be the highest or the sum of all the ranks for all the categories.

< Recommendation to service the pressure relief gauges : Proposed >

Identification	Mitigated Risk	Linked Recommended Actions
<p>25 Total Risk Driving Risk: Operations Driving Risk Threshold: MEDIUM</p>	<p>Safety: Low Environment: Medium Operations: Medium Financial: --</p>	

Note: See the Overview of the Risk Matrix section of the documentation for additional options when working with the Risk Matrix.

Results

- A Risk Assessment record that stores the details of the mitigated risk is created and linked with the Instrumented Function.

Change the State of an SIL Analysis

About This Task

This topic describes how to change the state of an SIL Analysis starting from Planning to Complete, while assigning each state to a user.

Important: You can modify an SIL Analysis in a particular state only if you are an administrator or the assignee for that state.

Procedure

1. [Access the SIL Analysis](#) for which you want to change the state.
2. In the upper-right corner of the workspace, select the button that indicates the current state of the analysis. For example, if the current state of the analysis is Planning, select **Planning**.

A menu appears, displaying the list of operations that you can perform on the analysis to change its state.

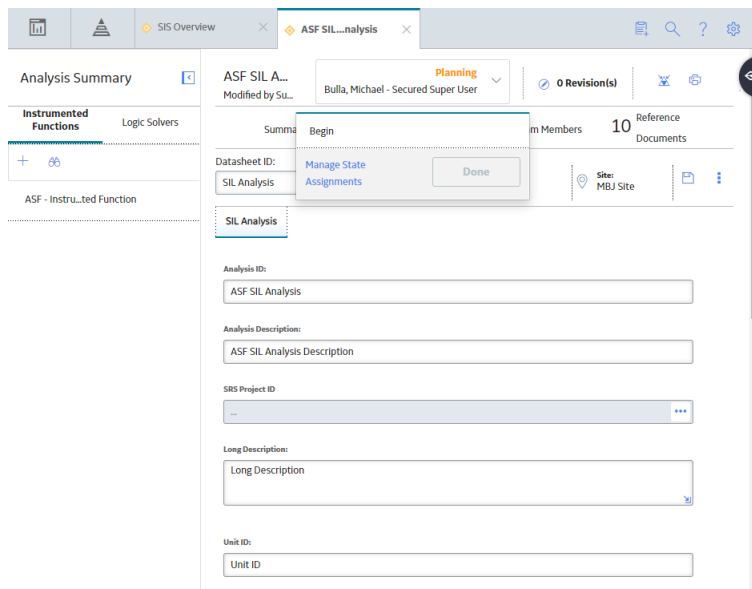

Note: You can view the states assigned to various users by selecting the **Manage State Assignments** link. If not already done, you can assign the next state of the analysis to the appropriate user, and then select **Done**.

3. Select the [necessary operation](#) that will change the state of the analysis, and then select **Done**. For example, if you want to change the state of the analysis from Planning to Active, select **Begin**, and then select **Done**.

The state of the SIL Analysis is changed.

Generate a Report for an SIL Analysis

About This Task

This topic describes how to generate the following [reports for an SIL Analysis](#):

- SIL Analysis report
- Instrumented Function report
- Protective Instrument Loop report

Procedure

1. [Access the SIL Analysis](#) for which you want to generate the report.
2. On the upper-right corner of the page, select .

A menu appears, displaying the different types of reports that you can generate.

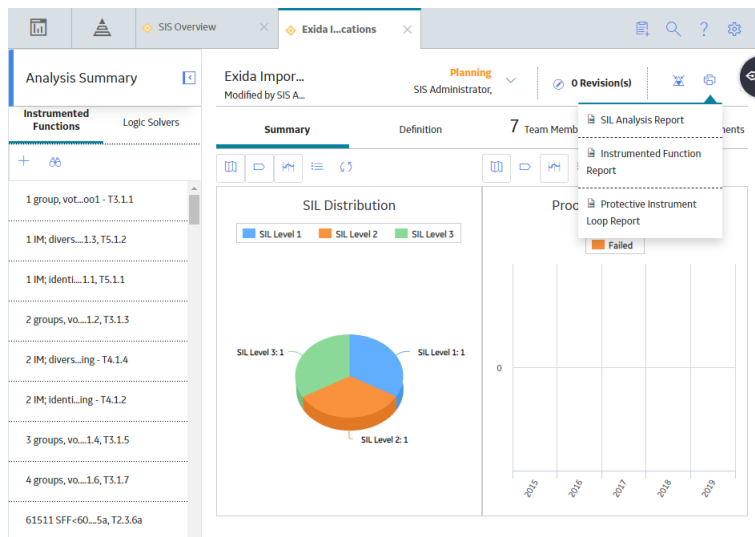

3. Select one of the following options:
 - If you want to generate a SIL Analysis report, select **SIL Analysis Report**.
 - If you want to generate an Instrumented Function report, select **Instrumented Function Report**.
The **Select an Instrumented Function** window appears, displaying a list of Instrumented Functions associated with the SIL Analysis.
 - a. Select the Instrumented Function for which you want to generate the report, and then select **OK**.
 - If you want to generate a Protective Instrument Loop (PIL) report, select **Protective Instrument Loop Report**.
The **Select Protective Loop** window appears, displaying a list of Protective Instrument Loops associated with the SIL Analysis.
 - a. Select the Protective Instrument Loop for which you want to generate the report, and then select **OK**.

The selected report is generated and appears on a new page. The following image shows a Protective Instrument Loop report.

Protective Instrument Loop			
Loop ID:	exSILentia Tag - T1.25	Description:	
Long Description:			
Loop Class:	SAFETY	Loop Type:	
SIL Validation Method:	Internal Calculation	Test Architectural Constraints:	IEC 61508 : 2000
SIL Demand Mode:	DemandHigh	Systematic Capability Validation:	False
Mission Time:	1	Startup Time:	24
Required SIL:	0	Meets SIL Requirements:	Yes
Achieved SIL:	1	Evaluated Architectural Constraints:	-1

Delete an SIL Analysis

Procedure

1. Access the [SIS Management Overview](#) page.
Tip: You can also access the [SIS Management Overview](#) page for a selected hierarchy level.
2. In the workspace, select the **SIL Analysis** tab.
 The **SIL Analysis** section appears, displaying a list of SIL Analyses.

SIS Management Overview
Asset: MRD ~ Meridium, Inc.

Import From Exida Export to Exida

5 SIL Analysis	2 Proof Test Tasks	9 PIL Templates	3 SIS Trip Reports	4 Custom Failure Data	242 SRS
-------------------	-----------------------	--------------------	-----------------------	--------------------------	------------

ANALYSIS ID ↑	EQUIPMENT ID
<input type="checkbox"/> AQA Copy Analysis	~ ~ QA TM Dfit T-min
<input type="checkbox"/> ASF SIL Analysis	~ AQA EQUIPMENT ~ MBJ-EQUIPMENT-00002
<input type="checkbox"/> Copy SIL Analysis	~ ~ QA TM Apply CCR
<input type="checkbox"/> PHA-Internal	~ ~ QA TM EQUIPMENT W/ TML GROUPS
<input type="checkbox"/> V3.5.0 SP1 - SIL-09	~ MAIN COLUMN O.H. TRIM COOLER ~ HXST 78

Rows per page 50 100 200 500 1 - 5 of 5 Results 1

- In the row for the SIL Analysis that you want to delete, In the **Analysis ID** column, select the link. The **Analysis Summary** workspace appears, displaying the summary for the selected the SIL Analysis.

Analysis Summary AQA Copy A... Planning 0 Revision(s)

Modified by SIS A... SIS Administrator, 3 Team Members 4 Reference Documents

Instrumented Functions Logic Solvers

Template Loop 1

SIL Distribution

SIL Level 2

SIL Level 2: 1

Proof Testing Results

Passed Failed

- In the workspace, select the **Definition** tab.

The datasheet for the SIL Analysis appears.

Analysis Summary

B0007-00...
Modified by SL...

Planning
SIS Administrator, ✓

0 Revision(s)

Summary Definition 3 Team Members 4 Reference Documents

Datasheet ID:
SIL Analysis

Site:
Site EUR

SIL Analysis

Analysis ID:
B0007-009 Steam Boiler SIS

Analysis Description:
B0007-009 Steam Boiler SIS Analysis

SRS Project ID
...

Long Description:
Based on results of updated HAZOP conducted on B0007-009 Steam Boiler. Assess all target SIL values to ensure that corporate risk requirements have been met.

Unit ID:
Boiler Condenser Unit

5. In the upper-right corner of the datasheet, select , and then select **Delete**.

The **Alert** dialog box appears, asking you to confirm that you want to delete the selected SIL Analysis.

6. Select **Yes**.

The SIL Analysis is deleted.

Results

- When you delete the SIL Analysis, the following related records are also deleted:
 - Instrumented Functions
 - Logic Solvers
 - Inspection Tasks
 - Risk Assessments
 - SIL Assessments
 - Protective Instrument Loops: They are deleted only if the elements in the loop are not shared with other loops belonging to different SIL Analyses.
- The following records associated with the SIL Analysis are required as part of standard audit procedure and are not deleted when the SIL Analysis is deleted:
 - Proof Test Templates
 - Proof Tests
 - Proof Test Details
 - Recommendations

Chapter 4

Logic Solvers

Topics:

- [About Logic Solver](#)
- [Access a Logic Solver](#)
- [Create a Logic Solver](#)
- [Set a Default Logic Solver](#)
- [Remove Default Logic Solver Settings](#)
- [Delete a Logic Solver](#)

About Logic Solver

A logic solver is a hardware device or a software system whose inputs and outputs are connected to safety critical devices. The safety critical devices along with the logic solver form the Protective Instrument Loop. The loop is designed to meet the needs of the Instrumented Function, which is used to define requirements of the Protective Instrument Loop in maintaining process safety.

Access a Logic Solver

Procedure

1. [Access the SIL Analysis](#) that is linked to the Logic Solver that you want to access.
2. In the left pane, select **Logic Solvers**.

A list of Logic Solvers appears.

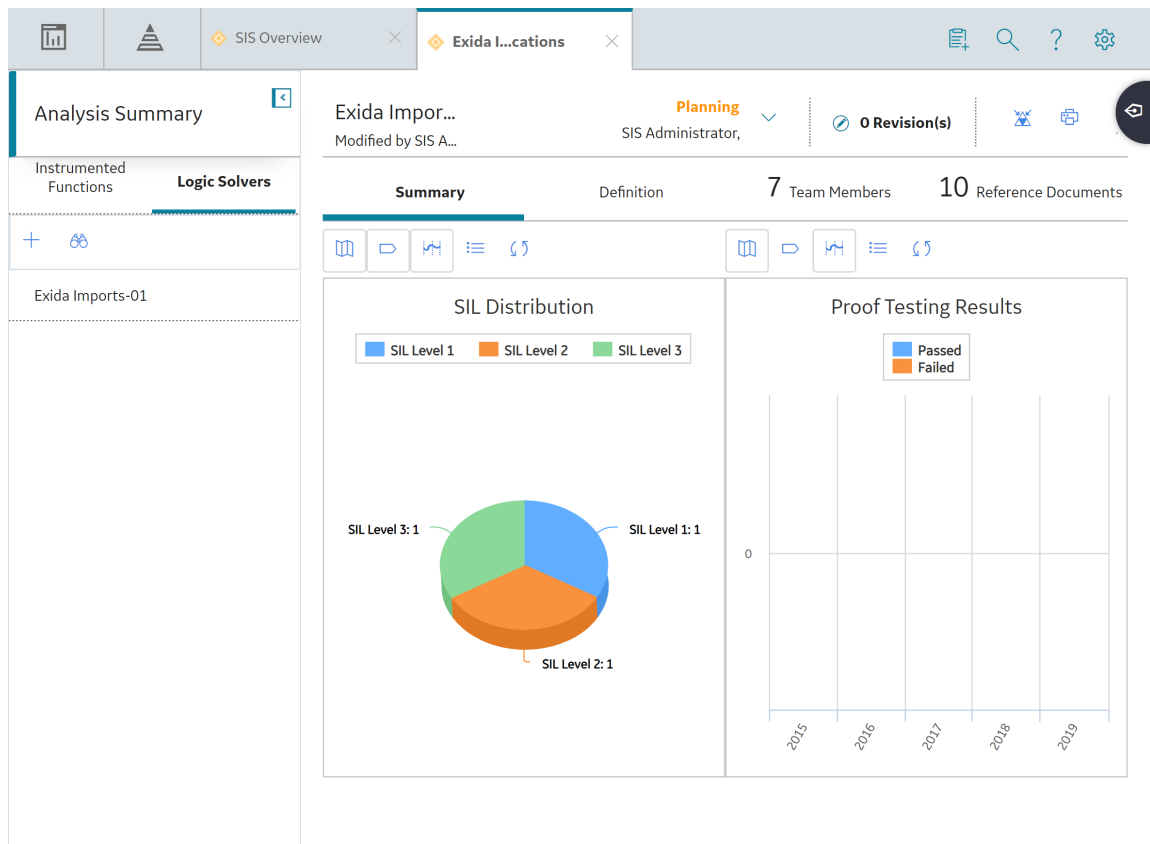

3. Select the Logic Solver that you want to access.

The datasheet for the Logic Solver appears in the workspace.

Analysis Summary

Instrumented Functions **Logic Solvers**

ASF Safety I...ented System

ASF SIL Analysis
Modified by Bulla, Michael - Secured Super User On 10 Sep 2010

Definition Validation Proof Test Tasks

Remove Default

Datasheet ID:
Safety Instrumented System

Site:
MBJ Site

Logic Solver ID:
ASF Safety Instrumented System

Logic Solver Description:
SIS Description

Long Description:
Long Description

SRS Project ID:
...

Unit ID:
Unit ID

Logic Solver Type:
Relay

Target Logic Solver Test Interval:
24 (Months)

Mission Time:
12 (Years)

Manual Shutdown Description:

4. If needed, modify values in the [available fields](#).
5. In the upper-right corner of the datasheet, select .
The changes made to the Logic Solver are saved.

Create a Logic Solver

Before You Begin

- [Create an SIL Analysis](#)

Procedure

1. [Access the SIL Analysis](#) for which you want to create a Logic Solver.
2. In the left pane, select **Logic Solvers**.

A list of Logic Solvers linked to the SIL Analysis appears.

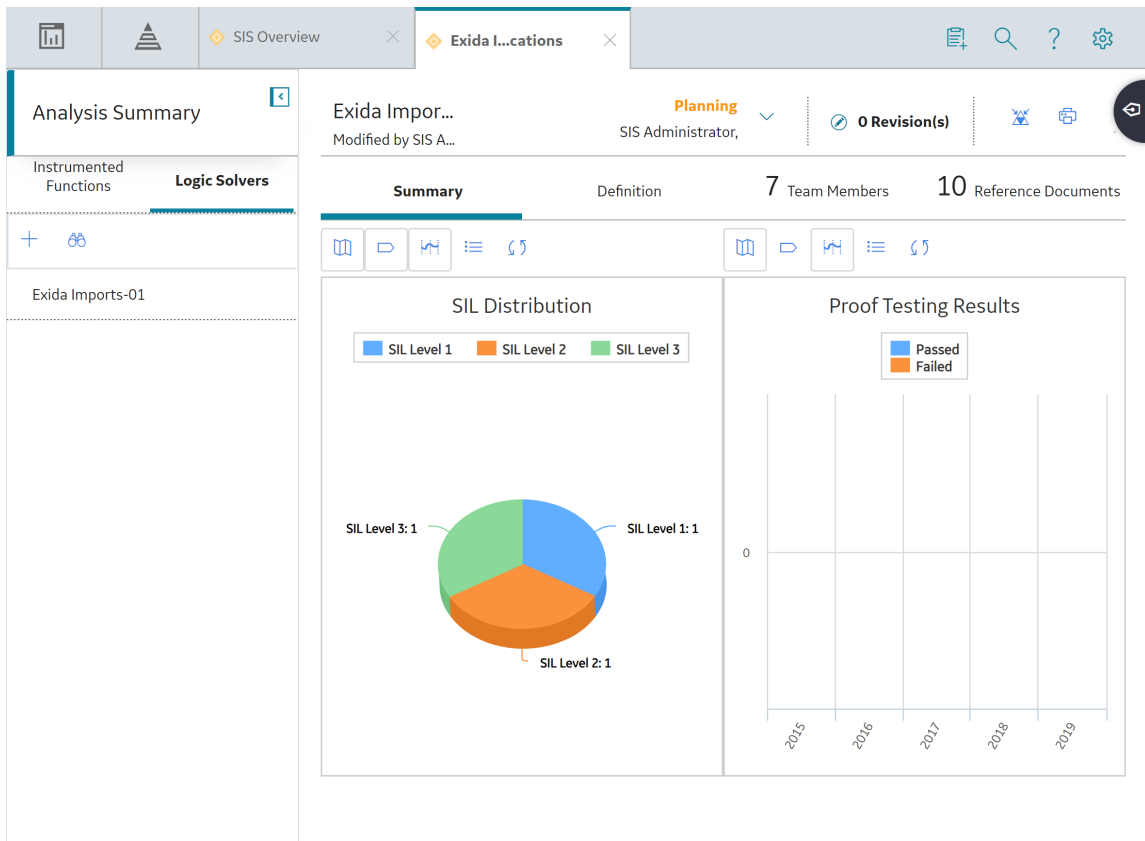

3. Select **+**, and then select **Create New**.
A blank datasheet for the Logic Solver appears.

Create a new Logic Solver

Datasheet ID:
Safety Instrumented System

Site:
Roanoke, VA

Logic Solver ID:
Text input
This field is required

Logic Solver Description:
Text input

Long Description:
Text area

SRS Project ID
...

Unit ID:
Text input

Cancel Save

4. As needed, enter values in the [available fields](#).
5. In the lower-right corner of the datasheet, select **Save**.

The Logic Solver is created.

Next Steps

- [Create an Instrumented Function](#)

Set a Default Logic Solver

This topic describes how to set a default Logic Solver from among those linked to an SIL Analysis.

Before You Begin

- [Create a Logic Solver](#).

About This Task

Note: You can set only one Logic Solver as default. If an analysis already has a default Logic Solver and you set another Logic Solver as default, then the latter one becomes the default Logic Solver.

When you create an Instrumented Function, the default Logic Solver is linked automatically to that Instrumented Function. You can, however, link a different Logic Solver to that Instrumented Function.

Procedure

1. [Access the SIL Analysis](#) that is linked to the Logic Solver that you want to set as the default one.
2. In the left pane, select **Logic Solvers**.

A list of Logic Solvers appears.

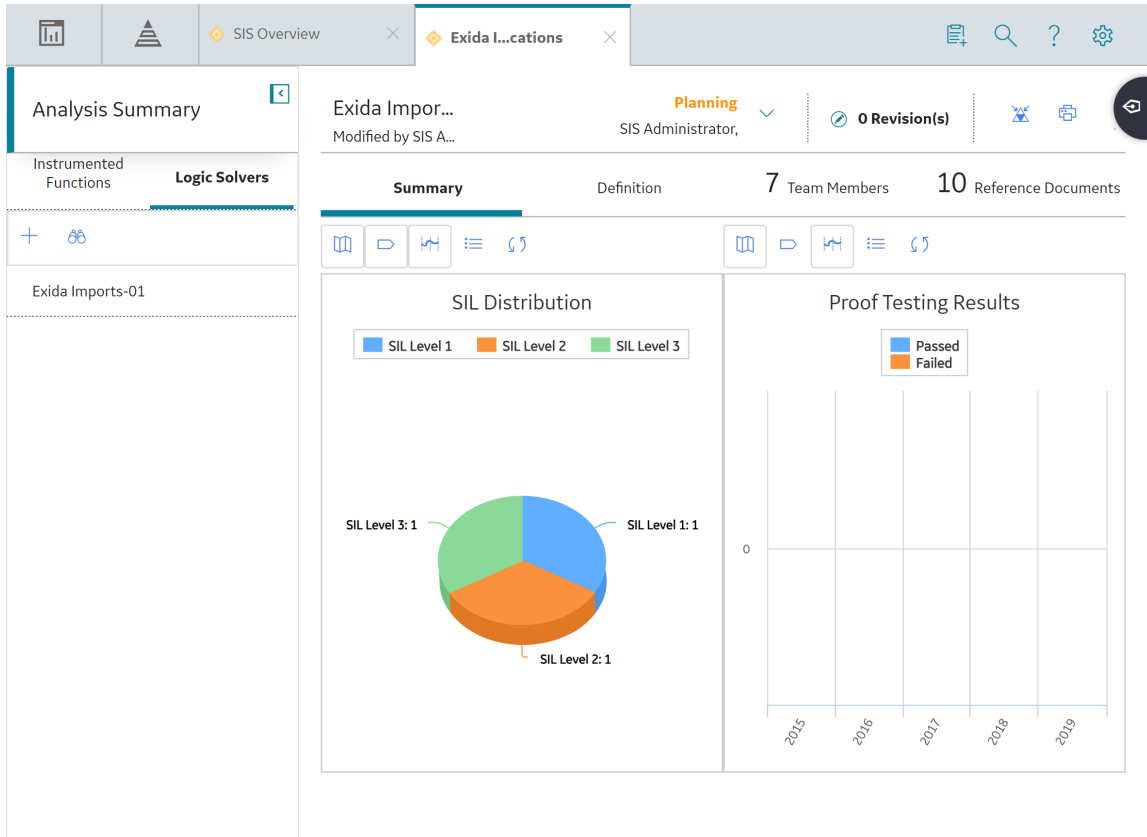

3. Select the Logic Solver that you want to set as the default one.
The datasheet for the Logic Solver appears in the workspace.

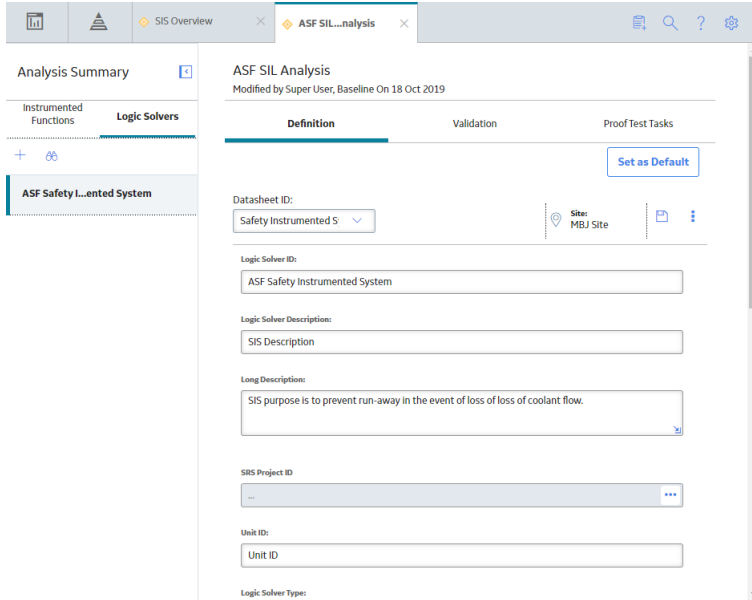

4. In the upper-right corner of the datasheet, select **Set as Default**.

Note: If the selected Logic Solver is already set as default, then the **Set as Default** button does not appear.

The selected Logic Solver is set as the default one for the SIL Analysis.

Results

- When you create an Instrumented Function for the SIL Analysis, the ID of the default Logic Solver is populated in the **SIS System ID** field on the Instrumented Function datasheet. You can, however, select a different logic solver from the Logic Solver list.

Remove Default Logic Solver Settings

Procedure

1. [Access the SIL Analysis](#) that is linked to the Logic Solver.
2. In the left pane, select **Logic Solvers**.

A list of Logic Solvers appears.

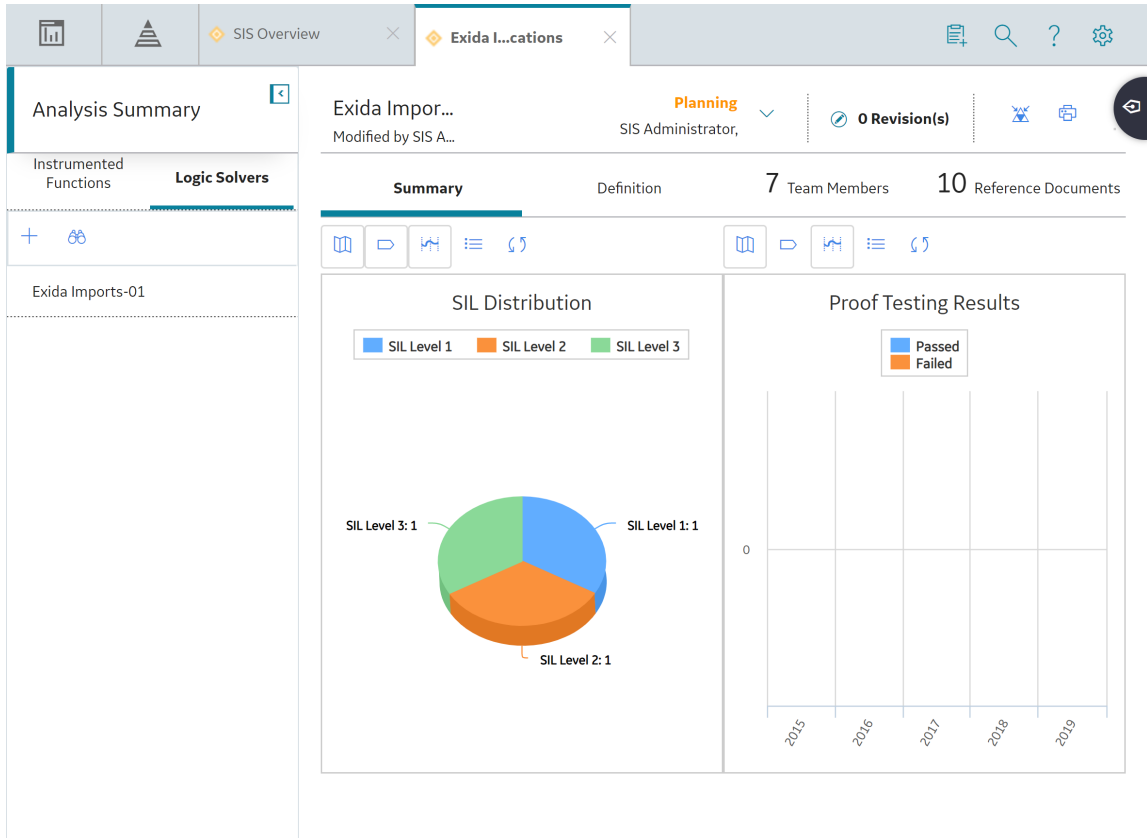

3. Select the default Logic Solver.

The datasheet for the Logic Solver appears in the workspace.

The screenshot shows the 'ASF SIL Analysis' workspace. The 'Definition' tab is active, displaying the Logic Solver datasheet. The 'Remove Default' button is visible in the upper-right corner. The datasheet includes fields for Datasheet ID, Logic Solver ID, Logic Solver Description, Long Description, SIS Project ID, and Unit ID.

4. In the upper-right corner of the datasheet, select **Remove Default**.

Note: If the selected Logic Solver is not the default one, then the **Remove Default** button does not appear.

The selected Logic Solver is no longer the default one for the SIL Analysis.

Results

- When you create an Instrumented Function, the SIS System ID field is no longer populated. The SIS System ID field is blank, and you can select a Logic Solver ID from the list.

Delete a Logic Solver

Procedure

1. [Access the SIL Analysis](#) that is linked to the Logic Solver that you want to delete.
2. In the left pane, select **Logic Solvers**.

A list of Logic Solvers appears.

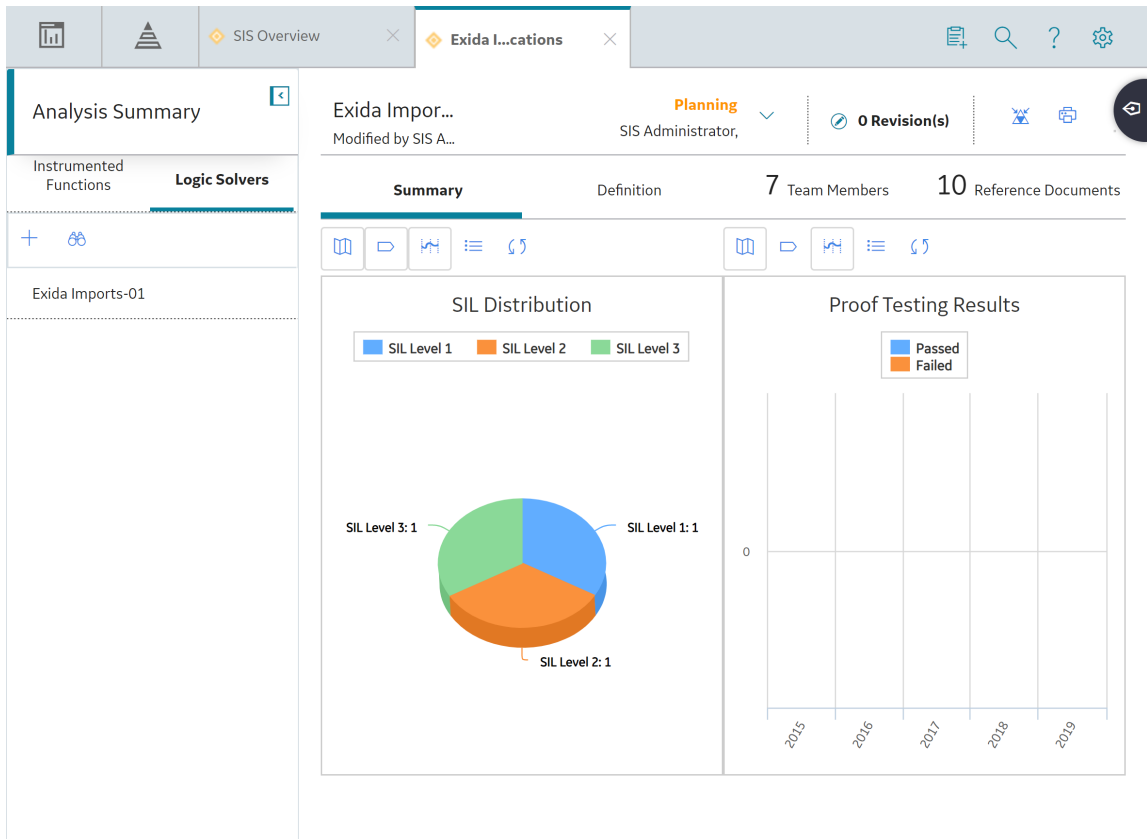

3. Select the Logic Solver that you want to delete.

The datasheet for the Logic Solver appears in the workspace.

The screenshot shows the 'ASF SIL Analysis' interface. The left sidebar contains 'Analysis Summary' and 'Logic Solvers' with a sub-entry for 'ASF Safety Instrumented System'. The main area is titled 'ASF SIL Analysis' and 'Modified by Bulla, Michael - Secured Super User On 10 Sep 2010'. It features three tabs: 'Definition' (selected), 'Validation', and 'Proof Test Tasks'. A 'Remove Default' button is in the top right. The 'Definition' tab contains the following fields:

- Datasheet ID: Safety Instrumented System (dropdown)
- Site: MBJ Site (location pin icon)
- Logic Solver ID: ASF Safety Instrumented System
- Logic Solver Description: SIS Description
- Long Description: Long Description
- SRS Project ID: ... (dropdown)
- Unit ID: Unit ID
- Logic Solver Type: Relay (dropdown)
- Target Logic Solver Test Interval: 24 (Months)
- Mission Time: 12 (Years)
- Manual Shutdown Description: (empty field)

4. In the upper-right corner of the datasheet, select , and then select **Delete**.
A message appears, asking if you really want to delete the Logic Solver.
5. Select **Yes**.
The Logic Solver is deleted.

Chapter 5

Instrumented Functions

Topics:

- [About Instrumented Function](#)
- [Access an Instrumented Function](#)
- [Create an Instrumented Function](#)
- [Copy an Instrumented Function](#)
- [Create a Recommendation](#)
- [Access the Health Summary Page of an Asset](#)
- [Generate a Report of an Instrumented Function](#)
- [Delete an Instrumented Function](#)

About Instrumented Function

An instrumented function is a specific need of a safety instrumented system to monitor the conditions of a process. For each instrumented function defined for a safety instrumented system, at least one protective instrument loop (PIL) will exist to satisfy that need.

When you create an Instrumented Function, it will be linked automatically to the current SIL Analysis. When you create the Instrumented Function, in addition to details about the instrumented function, you can specify the following records linked to the Instrumented Function:

- Logic Solver
- Equipment and Functional Location
- SIF Common Cause Failures
- Hazardous events that may occur if the safe state associated with the current instrumented function occurs at the same time as the safe state associated with a different instrumented function.

Access an Instrumented Function

Procedure

1. [Access the SIL Analysis](#) that is linked to the Instrumented Function that you want to access.
2. In the left pane, select the Instrumented Function that you want to access.

The datasheet for the Instrumented Function appears in the workspace.

The screenshot shows the 'ASF SIL A...' analysis window. The left sidebar is titled 'Analysis Summary' and contains a list of 'Instrumented Functions' with a sub-section for 'Logic Solvers'. The main content area is divided into tabs: 'Definition', 'SIL Assessment', 'SIL Verification', 'SIL Validation', and 'Proof Test Tasks'. The 'Definition' tab is active and contains the following fields:

- Datasheet ID:** Instrumented Function
- IF ID:** ASF - Instrumented Function
- Function Type:** Safety
- IF Description:** ASF Instrumented Function
- SRS Project ID:** ...
- Unit ID:** Unit ID
- Logic Solver ID:** ASF Safety Instrumented System
- Functional Location ID:** ...
- Equipment ID:** ...

3. If needed, modify values in the [available fields](#).
4. In the upper-right corner of the datasheet, select . The changes made to the Instrumented Function are saved.

Create an Instrumented Function

About This Task

This topic describes how to create an Instrumented Function using a blank datasheet. You can also [copy an Instrumented Function](#).

Procedure

1. [Access the SIL Analysis](#) for which you want to create an Instrumented Function.
2. In the left pane, select , and then select **Create New**. A blank datasheet for the Instrumented Function appears.

Create a new Instrumented Function

Datasheet ID:
Instrumented Function

Site:
Roanoke, VA

IF ID:
Text input
This field is required

Function Type:
Safety

IF Description:
Text input

SRS Project ID
...

Unit ID:
Text input

Logic Solver ID:
Alky Reactor SIS

Functional Location ID:
...

Cancel Save

3. As needed, enter values in the [available fields](#).
4. In the lower-right corner of the datasheet, select **Save**.

The Instrumented Function is created.

Next Steps

- [Perform an SIL Assessment](#)

Copy an Instrumented Function

About This Task

You can create an Instrumented Function by copying the details from another Instrumented Function linked to a SIL Analysis.

When you copy an Instrumented Function, the SIL Assessment that is associated with the Instrumented Function is also copied.

However, the values of the following fields are not copied:

- **IF ID:** After you copy an Instrumented Function, this field has the value copy. You can modify this value as needed.

- **SIS System ID:** This field is populated with the ID of the default Logic Solver, instead of the value in the SIS ID field of the Instrumented Function that you want to copy.
- **Hazards Analysis Reference:** This field is blank after you copy an Instrumented Function.
- **Hazards Analysis Date:** This field is blank after you copy an Instrumented Function.

You can also create an Instrumented Function [using a blank datasheet](#).

Procedure

1. [Access the SIL Analysis](#) into which you want to copy an Instrumented Function.
2. In the left pane, select , and then select **Copy Existing**.

The **Search** window appears.

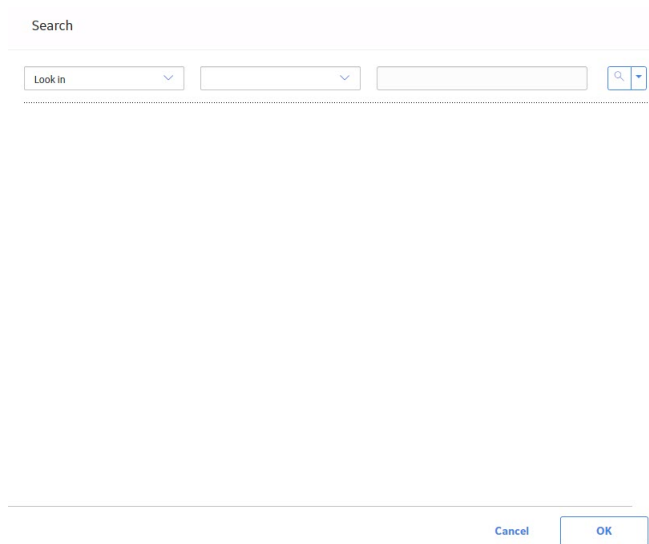

3. In the upper-right corner of the window, select .

A list of Instrumented Functions appears.
4. Select the check box that corresponds to the Instrumented Function that you want to copy, and then in the lower-right corner of the window, select **OK**.

A copy of the Instrumented Function is created, and listed in the left pane.
5. If needed, select the copied Instrumented Function, and modify the values in the [available fields](#).
6. In the upper-right corner of the datasheet, select .

The changes made to the Instrumented Function are saved.

Create a Recommendation

Procedure

1. [Access the Instrumented Function](#) for which you want to create a Recommendation.



2. In the upper-right corner of the page, select .

The **Recommended Actions** pane appears, displaying a list of Recommendations linked to the Instrumented Function.

3 Recommended Actions		Action Management
+ [Filter] [Sort] [More]		
<input type="checkbox"/>	Replace the Flow Monitor B0007-009 - 000000000011005862 - BOILE... Updated by: Jane Smith On Tuesday, April 25, 20...	Proposed
<input type="checkbox"/>	Repair the Pressure relief valve B0007-009 - 000000000011005862 - BOILE... Updated by: Jane Smith On Tuesday, April 25, 20...	Proposed
<input type="checkbox"/>	Recommendation to service the pressure... B0007-009 - 000000000011005862 - BOILE... Updated by: Jane Smith On Tuesday, April 25, 20...	Proposed

3. In the upper-left corner of the pane, select **+**.

A blank datasheet of the Recommendation appears.



New Recommendation: Draft

Identification
Linked Recommendations

Recommendation

Datasheet ID:

Site:
 Roanoke, VA

General Information
Alert

Recommendation ID:

Recommendation Headline:

Recommendation Description:

Recommendation Basis:

- As needed, enter values in the available fields, and then in the upper-right corner of the datasheet, select .

The Recommendation is created.

Tip: For information about additional options available when working with the Recommendation records, refer to the Action Management section of the documentation.

Results

- The Recommendation that you have created is listed in the **Recommended Actions** pane for the Instrumented Function and the related SIL Analysis.

Access the Health Summary Page of an Asset

This topic describes how to access the **Health Summary** page of the Asset that is being protected by an Instrumented Function.

Before You Begin

- Ensure that the Equipment ID or the Functional Location ID fields in the Instrumented Function datasheet are populated with the values that correspond to the Asset that is being protected by the Instrumented Function.

Procedure

1. [Access the Instrumented Function](#) that protects the Asset for which you want to access the **Health Summary** page.
2. In the upper-right corner of the page, select .

The **Health Summary** page for the Asset appears, displaying the health indicators for the Asset.

Note: If there is no value in the Equipment ID or the Functional Location ID fields of the Instrumented Function, then the  button is disabled.

Note:

Policies and other health indicator sources can be leveraged to provide a holistic view of the asset which include but are not limited to the following:

- Proof Test Schedule Compliance
- Sensor or Final Element detected failure
- Instrumented Function bypass
- Instrumented Function trips
- Proof testing results (e.g., Pass or fail ratios)

Generate a Report of an Instrumented Function

Procedure

1. [Access the Instrumented Function](#) whose report you want to generate.
2. In the upper-right corner of the datasheet, select .

The report is generated. You can print, save, or export the report, or attach it to an email.

Delete an Instrumented Function

About This Task

Note: You can delete an Instrumented Function only if the SIL Analysis with which it is associated is in the Planning state.

Procedure

1. [Access the SIL Analysis](#) that is linked to the Instrumented Function that you want to delete.
2. In the left pane, select the Instrumented Function that you want to delete.

The datasheet for the Instrumented Function appears.

The screenshot shows a software interface with a top navigation bar containing 'SIS Overview' and 'ASF SIL...analysis' tabs. On the left, a sidebar lists 'Instrumented Functions' and 'Logic Solvers', with 'ASF - Instru...ted Function' selected. The main area displays the 'Definition' tab of the 'ASF SIL A...' analysis, showing fields for 'Datasheet ID', 'IF ID', 'Function Type', 'IF Description', 'SRS Project ID', 'Unit ID', 'Logic Solver ID', 'Functional Location ID', and 'Equipment ID'. The 'Function Type' is set to 'Safety' and the 'Logic Solver ID' is 'ASF Safety Instrumented System'.

3. In the upper-right corner of the datasheet, select  , and then select **Delete**.
A message appears, asking if you really want to delete the Instrumented Function.
4. Select **Yes**.

The Instrumented Function and all the related successor records are deleted.

Important: Deleting an Instrumented Function also deletes the following successor records: LOPA Assessment, Risk Matrix Internal Assessment, PHA Internal Assessment, External Assessment, and Protective Instrument Loop (along with the Protective Instrument Loop Elements). The associated recommendations, Proof Test Templates, and Proof Tests are not deleted.

Chapter 6

Common Cause Failures

Topics:

- [About Common Cause Failure](#)
- [Access a Common Cause Failure](#)
- [Create a Common Cause Failure](#)
- [Link a Common Cause Failure](#)
- [Unlink a Common Cause Failure](#)
- [Delete a Common Cause Failure](#)

About Common Cause Failure

A common cause failure is a failure or condition within a plant that can affect the operation of multiple instrumented functions. SIF Common Cause Failures must be linked to at least two Instrumented Functions. In other words, for every SIF Common Cause Failure, there will be at least two Instrumented Function records that represent the instrumented functions that are affected by the common cause failure defined in the SIF Common Cause Failure record.

You can manage SIF Common Cause Failure records via the **Common Cause Failures** section of the Instrumented Function. Using the **Common Cause Failures** section, you can specify the common cause failures that exist for the current instrumented function and other instrumented functions that are defined in the APM database. More specifically, to define a common cause failure, you will need to:

- Link SIF Common Cause Failure records to the current Instrumented Function.
- Link additional Instrumented Function records to those SIF Common Cause Failure records.

The following illustration shows the records that will exist for a given common cause failure scenario.

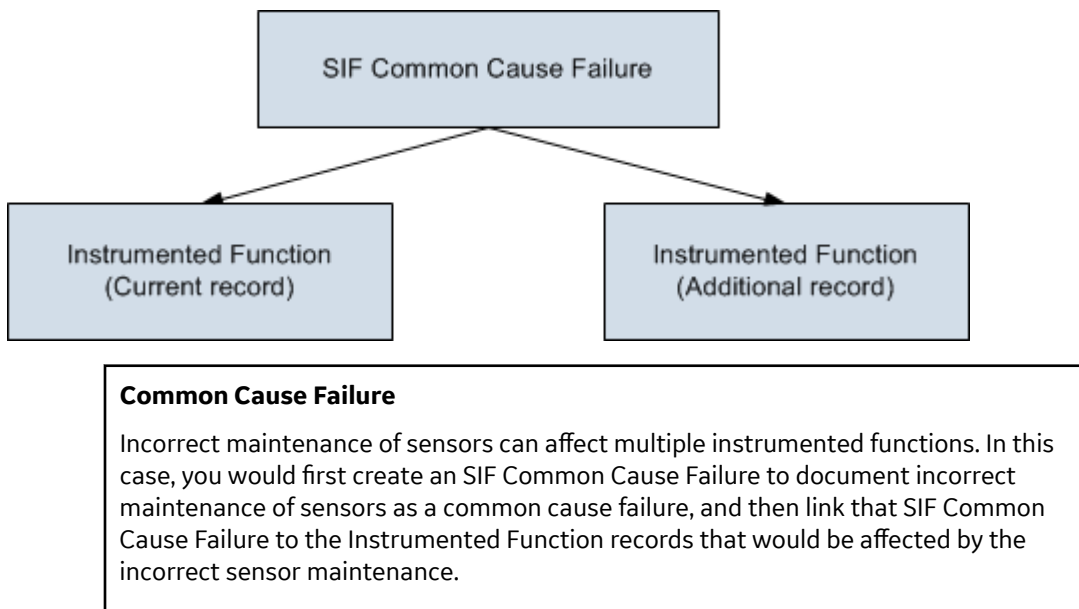

Access a Common Cause Failure

About This Task

This topic describes how to access a Common Cause Failure that is linked to one or more Instrumented Functions.

Procedure

1. [Access the Instrumented Function](#) that is linked to the Common Cause Failure that you want to access.
2. In the workspace, select the **SIL Assessment** tab, and then select **Common Cause Failures**.

The **Common Cause Failures** section appears, displaying a list of Common Cause Failures for the Instrumented Function.

3. Select the Common Cause Failure that you want to access.

The datasheet for the Common Cause Failure appears.

Common Cause Failures

Site: Roanoke, VA

CCF ID:

CCF Description:

CCF Mitigation:

4. If needed, modify values in the [available fields](#).

5. In the lower-right corner of the datasheet, select **Save**.

The changes made to the Common Cause Failure are saved.

Results

- The changes made to the Common Cause Failure are reflected in all the Instrumented Functions linked to the Common Cause Failure.

Create a Common Cause Failure

This topic describes how to create a Common Cause Failure, and link it to the related Instrumented Functions. You can link a Common Cause Failure to as many Instrumented Functions as needed.

Before You Begin

- [Create an Instrumented Function.](#)

Procedure

1. [Access the Instrumented Function](#) for which you want to create a Common Cause Failure.
2. In the workspace, select the **SIL Assessment** tab, and then select **Common Cause Failures**.

The **Common Cause Failures** subsection appears, displaying a list of Common Cause Failures for the Instrumented Function.

The screenshot displays the software interface for creating a Common Cause Failure. The top navigation bar shows two tabs: 'SIS Overview' and 'ASF SIL...analysis'. The left sidebar contains 'Analysis Summary' with 'Instrumented Functions' and 'Logic Solvers' sections. The main content area is titled 'ASF SIL A...' and shows a 'Common Cause Failures' section. The 'Common Cause Failures' section contains a table with the following data:

No	Common Cause ID	Common Cause Description	Common Cause Mitigation
1	CCF ID - IF-2010-V3.5.0 SP1	CCF ID - IF-2010-V3.5.0 SP1	CCF ID - IF-2010-V3.5.0 SP1

Below the 'Common Cause Failures' table is a 'Related Instrumented Function' section with a table containing the following data:

No	Function ID	Description	Selected SIL Level
1	PIF-1005	Low Steam Drum Level	2

A plus sign icon is visible in the upper right corner of the 'Common Cause Failures' section, indicating where to click to create a new entry.

3. In the upper-right corner of the section, select **+**, and then select **Create New**.
A blank datasheet for the Common Cause Failure appears.

Create a new Common Cause Failure

Datasheet ID:
SIF Common Cause Failures

Site:
MBJ Site

CCF ID:
Text input
*This field is required

CCF Description:
Text area
*This field is required

CCF Mitigation:
Text area
*This field is required

Cancel Save

- As needed, enter values in [available fields](#).
- In the lower-right corner of the datasheet, select **Save**.

The Common Cause Failure and the Instrument Function are listed in the workspace. A message appears, prompting you to link the Common Cause Failure to another Instrumented Function.

- In the **Related Instrumented Function** section, select **+**.

The **Search** window appears.

Search

Look in

Cancel OK

- In the upper-right corner of the window, select .
- A list of Instrumented Functions appears.

Search

Look in ▼

🔍 ▼

SIF-1002

Instrumented Function [Risk Assessment](#) [Hazards Analysis](#) [Safety Instrumented System](#) [SIL](#)
[Analysis](#) [Protective Instrument Loop](#) [SIF Common Cause Failure](#) [Risk Matrix Internal](#)
[Assessment](#) [SRS Project](#)

SIF-1003

Instrumented Function [Risk Assessment](#) [Hazards Analysis](#) [Hazards Analysis Safeguard](#) [Safety](#)
[Instrumented System](#) [SIL Analysis](#) [SIF Common Cause Failure](#) [Risk Matrix Internal Assessment](#) [SRS](#)
[Project](#)

SIF-1004

Instrumented Function [Risk Assessment](#) [Hazards Analysis](#) [Safety Instrumented System](#) [SIL](#)
[Analysis](#) [SIF Common Cause Failure](#) [Risk Matrix Internal Assessment](#) [SRS Project](#)

SIF-1005

Instrumented Function [Risk Assessment](#) [Equipment](#) [Hazards Analysis](#) [Hazards Analysis](#)
[Safeguard](#) [Safety Instrumented System](#) [SIL Analysis](#) [SIF Common Cause Failure](#) [Risk Matrix Internal](#)
[Assessment](#) [SRS Project](#)

SIF-1006

Instrumented Function [Risk Assessment](#) [Hazards Analysis](#) [Safety Instrumented System](#) [SIL](#)
[Analysis](#) [SIF Common Cause Failure](#) [Risk Matrix Internal Assessment](#) [SRS Project](#)

[Cancel](#)

OK

8. Select the Instrumented Function that you want to link to the Common Cause Failure, and then select **OK**.

The Common Cause Failure is linked to the two Instrumented Functions listed in the **Related Instrumented Function** section.

Results

- The Common Cause Failure is listed in the **Common Cause Failures** section for all the Instrumented Functions that you have linked.

Link a Common Cause Failure

This topic describes how to link an Instrumented Function to a Common Cause Failure that is already linked to one or more Instrumented Functions.

Before You Begin

- [Create an Instrumented Function.](#)

Procedure

1. [Access the Instrumented Function](#) that is linked to the Common Cause Failure that you want to link to another Instrumented Function.
2. In the workspace, select the **SIL Assessment** tab, and then select **Common Cause Failures**.

The **Common Cause Failures** section appears, displaying a list of Common Cause Failures for the Instrumented Function.

ASF SIL A...
Modified by B...
Bulla, Michael - Secured Super User

Planning

Definition SIL Assessment SIL Verification SIL Validation Proof Test Tasks

Assessment Details **Common Cause Failures** Concurrent Safe States

Common Cause Failures

No	Common Cause ID	Common Cause Description	Common Cause Mitigation
1	CCF ID - IF-2010-V3.5.0 SP1	CCF ID - IF-2010-V3.5.0 SP1	CCF ID - IF-2010-V3.5.0 SP1

Related Instrumented Function

No	Function ID	Description	Selected SIL Level
1	PIF-1005	Low Steam Drum Level	2

3. Select the row that corresponds to the Common Cause Failure that you want to link to another Instrumented Function.

The Instrumented Functions that are linked to the selected Common Cause Failure are listed in the **Related Instrumented Function** section.

4. In the **Related Instrumented Function** section, select **+**.
The **Search** window appears.

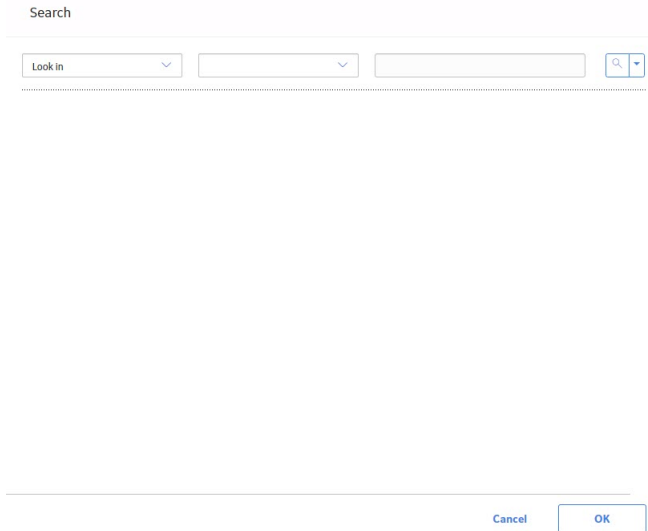

- In the upper-right corner of the window, select . A list of Instrumented Functions appears.

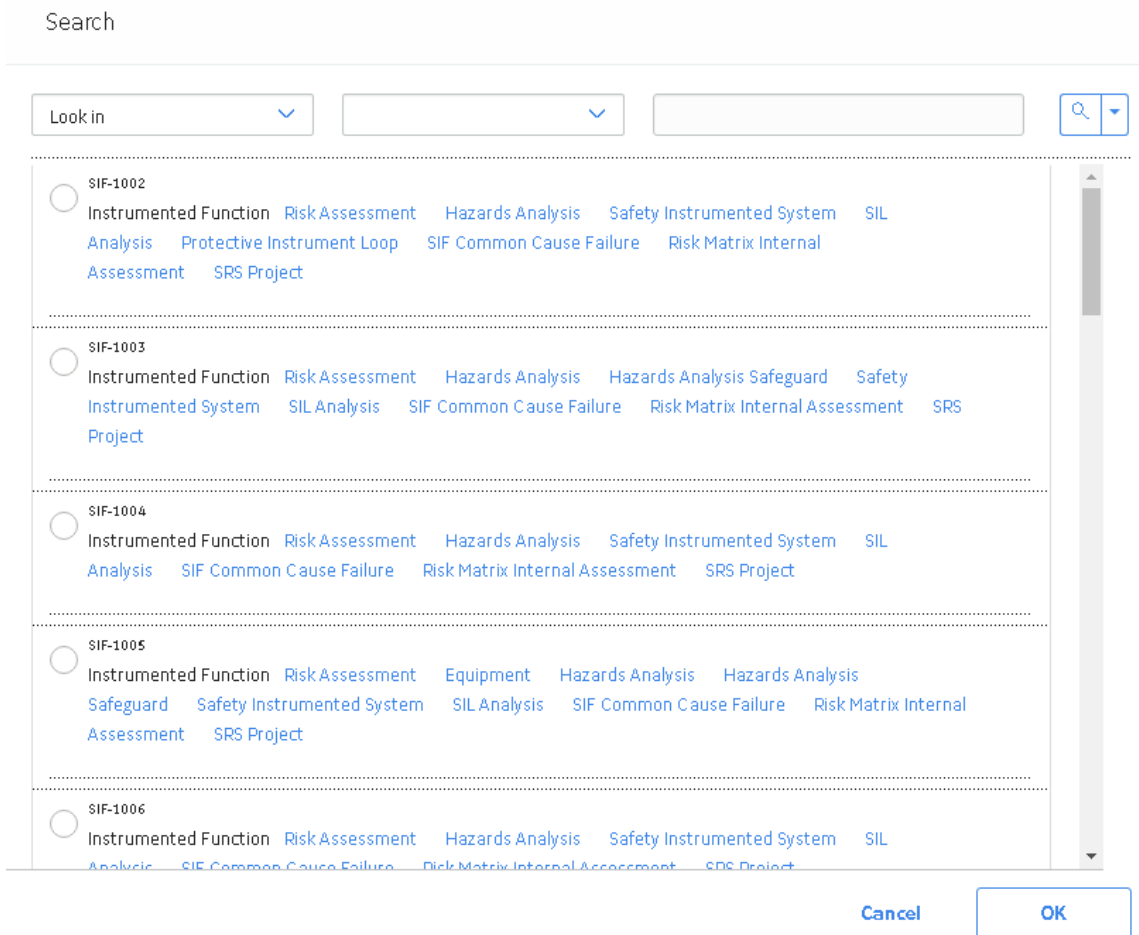

- Select the check box that corresponds to the Instrumented Function that you want to link to the Common Cause Failure, and then select **OK**.

The Common Cause Failure is linked to the Instrumented Function.

Results

- The Instrumented Function that you have linked is listed in the **Related Instrumented Function** section.

Unlink a Common Cause Failure

This topic describes how to unlink a Common Cause Failure that is linked to one or more Instrumented Functions.

Before You Begin

- [Create an Instrumented Function.](#)

Procedure

1. [Access the Instrumented Function](#) that is linked to the Common Cause Failure that you want to access.
2. In the workspace, select the **SIL Assessment** tab, and then select **Common Cause Failures**.

The **Common Cause Failures** section appears, displaying a list of Common Cause Failures for the Instrumented Function.

No	Common Cause ID	Common Cause Description	Common Cause Mitigation
1	CCF ID - IF-2010-V3.5.0 SP1	CCF ID - IF-2010-V3.5.0 SP1	CCF ID - IF-2010-V3.5.0 SP1

No	Function ID	Description	Selected SIL Level
1	PIF-1005	Low Steam Drum Level	2

3. Select the row that corresponds to the Common Cause Failure that you want to unlink from an Instrumented Function.

The Instrumented Functions that are linked to the selected Common Cause Failure are listed in the **Related Instrumented Function** section.

4. In the **Related Instrumented Function**, select the  button that corresponds to the Instrumented Function that you want to unlink from the Common Cause Failure.

A confirmation message appears, asking if you really want to delete the Common Cause related Instrumented Function.

5. Select **OK**.

The Common Cause Failure is unlinked from the Instrumented Function.

Delete a Common Cause Failure

About This Task

You can delete a Common Cause Failure only if it is linked to a single Instrumented Function. Otherwise, you can only unlink it from the selected Instrumented Function. In this case, you must first [unlink the Common Cause Failure](#) from all the other Instrumented Functions, and then delete it.

Procedure

1. [Access the Instrumented Function](#) that is linked to the Common Cause Failure that you want to delete.
2. In the workspace, select the **SIL Assessment** tab, and then select **Common Cause Failures**.

The **Common Cause Failures** subsection appears, displaying a list of Common Cause Failures linked to the Instrumented Function.

Analysis Summary

ASF SIL A...
Modified by B... Bulla, Michael - Secured Super User

Definition SIL Assessment SIL Verification SIL Validation Proof Test Tasks

Assessment Details **Common Cause Failures** Concurrent Safe States

Common Cause Failures

No	Common Cause ID	Common Cause Description	Common Cause Mitigation
1	CCF ID - IF-2010-V3.5.0 SP1	CCF ID - IF-2010-V3.5.0 SP1	CCF ID - IF-2010-V3.5.0 SP1

Related Instrumented Function

No	Function ID	Description	Selected SIL Level
1	PIF-1005	Low Steam Drum Level	2

3. Select the  button next to the Common Cause Failure that you want to delete.
A confirmation message appears, asking if you really want to delete the Common Cause Failure.
4. Select **Yes**.
The Common Cause Failure is deleted.

Chapter 7

Concurrent Safe State Hazards

Topics:

- [About Concurrent Safe State Hazards](#)
- [Create a Concurrent Safe States Record](#)
- [Delete a Concurrent Safe States Record](#)

About Concurrent Safe State Hazards

When you create an Instrumented Function, you will define the safe state of the instrumented function, which is responsible for modifying the process in the event that the condition of the process is in an unsafe state. In other words, if a given process is approaching an unsafe condition, the instrumented function that monitors that process will change the process to a condition that is specified as the safe state for that process.

In some cases, if a given process is in its associated safe state at the same time as a different Instrumented Function, while the individual processes are in a safe state, the combination of these conditions could trigger a hazardous event. For example, assume that to reach a safe state in a Flare system, the process valve needs to vent. Now assume that two process valves need to vent at the same time. In this case, the Flare system can become overloaded due to both processes reaching their safe states concurrently.

In APM, the combinations of safe states that can lead to hazardous events are referred to as concurrent safe state hazards. You can document the concurrent safe state hazards that exist for instrumented functions via the Instrumented Function record. In other words, for each instrumented function that participates in a potentially hazardous relationship, you will need to define the concurrent safe state hazard(s) for that instrumented function.

The **Concurrent Safe States** section of the Instrumented Function allows you to manage all the concurrent safe state hazards that exist for an instrumented function. To define concurrent safe state hazards for an instrumented function, you will need to:

- Link the Instrumented Function to the other Instrumented Function whose concurrent safe state can cause a hazard. Instrumented Functions can be linked to one or more other Instrumented Functions through the Has Hazardous Event relationship.
- Describe the hazardous event that can occur when the safe state conditions occur concurrently. Since some instrumented functions can participate in multiple concurrent safe state scenarios, in each Instrumented Function, you will need to describe the hazardous events that are associated with that instrumented function. In other words, describing the hazardous event in one Instrumented Function will not automatically populate the linked Instrumented Function with the same description. You will need to access the linked Instrumented Function and enter the description of the concurrent safe state hazard.

Create a Concurrent Safe States Record

Before You Begin

- [Create an Instrumented Function](#).

Procedure

1. [Access the Instrumented Function](#) to which you want to create a Concurrent Safe States record.
2. In the workspace, select the **SIL Assessment** tab, and then select **Concurrent Safe States**.

The **Concurrent Safe States** section appears, displaying a list of Concurrent Safe States for the Instrumented Function.

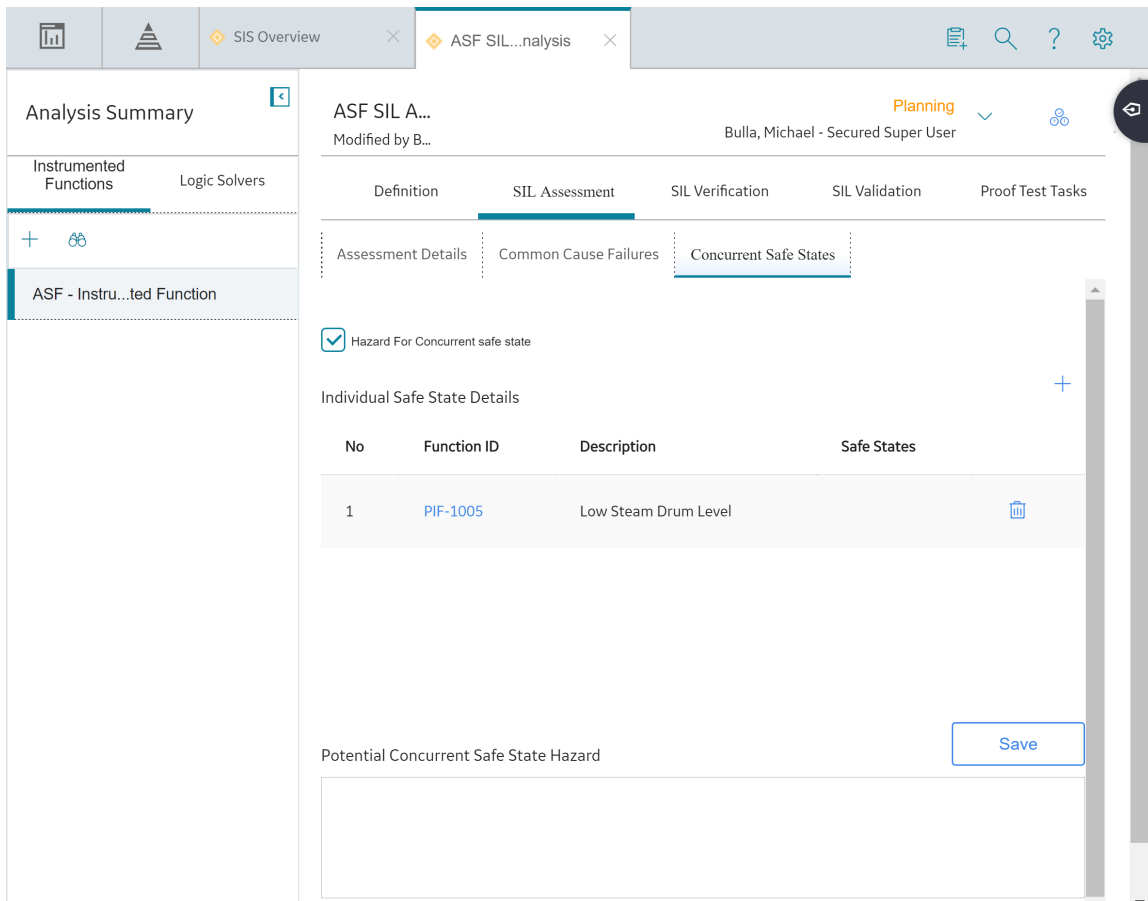

Note: If the fields in the **Concurrent Safe States** section do not appear on the datasheet, select the **Hazard for Concurrent Safe State** check box.

3. In the upper-right corner of the section, select .

The **Search** window appears.

Search

Look in

4. In the upper-right corner of the window, select .

A list of Instrumented Functions appears.

Search

<input type="radio"/>	SIF-1002	Instrumented Function	Risk Assessment	Hazards Analysis	Safety Instrumented System	SIL	Analysis	Protective Instrument Loop	SIF Common Cause Failure	Risk Matrix Internal Assessment	SRS Project
<input type="radio"/>	SIF-1003	Instrumented Function	Risk Assessment	Hazards Analysis	Hazards Analysis Safeguard	Safety Instrumented System	SIL Analysis	SIF Common Cause Failure	Risk Matrix Internal Assessment	SRS Project	
<input type="radio"/>	SIF-1004	Instrumented Function	Risk Assessment	Hazards Analysis	Safety Instrumented System	SIL Analysis	SIF Common Cause Failure	Risk Matrix Internal Assessment	SRS Project		
<input type="radio"/>	SIF-1005	Instrumented Function	Risk Assessment	Equipment	Hazards Analysis	Hazards Analysis Safeguard	Safety Instrumented System	SIL Analysis	SIF Common Cause Failure	Risk Matrix Internal Assessment	SRS Project
<input type="radio"/>	SIF-1006	Instrumented Function	Risk Assessment	Hazards Analysis	Safety Instrumented System	SIL Analysis	SIF Common Cause Failure	Risk Matrix Internal Assessment	SRS Project		

5. Select the check box that corresponds to the Instrumented Function whose output can be hazardous if combined with the output of the current Instrumented Function.
6. Select **OK**.

The ID, description, and safe states description of the selected Instrumented Function are listed in the **Individual Safe State Details** grid. A message appears, asking you to provide a description for the concurrent safe state hazard.

7. Provide a description in the **Potential Concurrent safe State Hazard** box, and then select **Save**.
The Concurrent Safe States record is created and linked to the Instrumented Function.

Results

- The Concurrent Safe States record is linked to both the Instrumented Functions that you have selected.

Delete a Concurrent Safe States Record

Procedure

1. [Access the Instrumented Function](#) that is linked to the Concurrent Safe States record.

2. In the workspace, select the **SIL Assessment** tab, and then select **Concurrent Safe States**.

The **Concurrent Safe States** section appears, displaying a list of Concurrent Safe States for the Instrumented Function.

The screenshot displays the software interface for SIL Assessment. The main window is titled 'ASF SIL A...' and is modified by 'Bulla, Michael - Secured Super User'. The interface is in 'Planning' mode. The 'SIL Assessment' tab is selected, showing the 'Concurrent Safe States' section. A checkbox labeled 'Hazard For Concurrent safe state' is checked. Below this is a table titled 'Individual Safe State Details' with the following data:

No	Function ID	Description	Safe States
1	PIF-1005	Low Steam Drum Level	

At the bottom of the interface, there is a 'Potential Concurrent Safe State Hazard' section with a 'Save' button.

Note: If the fields in the **Concurrent Safe States** section do not appear on the datasheet, select the **Hazards for Concurrent Safe State** check box.

3. In the **Individual Safe State Details** grid, select the button next to the Instrumented Function that is related to the Concurrent Safe States record that you want to remove.

A confirmation message appears, asking if you really want to remove the Instrumented Function.

4. Select **OK**.

The selected Instrumented Function is unlinked and removed from the **Individual Safe State Details** grid, thus deleting the Concurrent Safe States record.

Results

- The Concurrent Safe States record is deleted from both the Instrumented Functions that you have selected.

Chapter

8

SIL Assessment

Topics:

- [About Safety Integrity Level \(SIL\) Assessment](#)
- [Safety Integrity Level \(SIL\) Assessment Workflow](#)
- [About Safety Integrity Level \(SIL\) Assessment Using a Risk Matrix](#)
- [About Safety Integrity Level \(SIL\) Assessment Using a Hazards Analysis](#)
- [About SIL Assessment Using LOPA](#)
- [Assess the Safety Integrity Level \(SIL\) via a Layer of Protection Analysis \(LOPA\)](#)
- [Assess the Safety Integrity Level \(SIL\) via a Risk Matrix](#)
- [Assess the Safety Integrity Level \(SIL\) via a Process Hazards Analysis \(PHA\)](#)
- [Assess the Safety Integrity Level \(SIL\) via an External Method](#)
- [Associate an SIL Assessment with an Instrumented Function](#)

About Safety Integrity Level (SIL) Assessment

Before the Safety Integrity Level (SIL) analysis team can make recommendations for actions that should be taken to mitigate risk for a given safety instrumented system, the team must first assign a numeric rating to each instrumented function within that safety instrumented system. The SIL is a numeric value that represents an overall rating for the instrumented function. This rating tells you to what degree the instrumented function meets its requirements to mitigate risk. After you have assigned an SIL value to each instrumented function within a safety instrumented system, the combination of these values indicates the overall safety integrity of the safety instrumented system to which the instrumented functions belong.

SIL Assessment Methods

You can use the following methods to assess the SIL value for an instrumented system:

- [Risk Matrix](#)
- [Layer of Protection Analysis \(LOPA\)](#)
- [Hazards Analysis Risk Assessment](#)

You can use more than one assessment method to determine the SIL value for an instrumented function. The list of SIL assessments performed on the instrumented function are listed in the **SIL Assessment** section of the Instrumented Function workspace. However, you can [associate only one SIL Assessment with the Instrumented Function](#).

Safety Integrity Level (SIL) Assessment Workflow

This workflow provides the basic, high-level steps for performing a Safety Integrity Level (SIL) assessment. The steps and links in this workflow do not necessarily reference every possible procedure.

Performing an SIL assessment includes the following steps:

1. Assess the required SIL value for an Instrumented Function by creating the following SIL Assessment records:
 - [Layer of Protection Analysis \(LOPA\)](#)
 - [Risk Matrix](#)
 - [Process Hazards Analysis \(PHA\)](#)
 - [External](#)

Note: You can create only one Risk Matrix and PHA SIL Assessment records for an Instrumented Function.

2. [Associate the appropriate SIL Assessment with the Instrumented Function](#).

About Safety Integrity Level (SIL) Assessment Using a Risk Matrix

You can assess the Safety Integrity Level (SIL) of an instrumented function using the standard APM Risk Matrix interface to select the risk rank values for specific categories of risk.

To determine the SIL value using a Risk Matrix, you must:

1. Specify the SIL Threshold values. An [SIL Threshold record](#) stores the upper and lower boundary values for each SIL.
2. Select the risk assessment that you want to use to assess the SIL value. You can use the baseline Risk Matrix or a custom Risk Matrix.
3. Select the unmitigated risk rank values for each category in the Risk Matrix. APM then calculates the overall unmitigated risk rank by adding the unmitigated risk rank values for each category. This value is stored in the **Unmitigated Risk Rank** box above the Risk Matrix on the Risk Assessment Interface.

The category that has been assigned with the highest risk rank in the Risk Matrix is called the Driving Risk, and the corresponding risk rank is called the Driving Risk Rank. Depending on the range in which the driving risk rank value falls, the system determines the SIL, and then populates the Selected SIL Level field with this value.

Note: If the driving risk rank value falls on the boundary value of two SIL thresholds, APM populates the Selected SIL Level field with the higher SIL value. For example, suppose that the SIL Threshold contains SIL value 1 for the risk range 0 through 10, and SIL value 2 for the risk range 10 through 100. If the driving risk in the risk assessment is 10, the Selected SIL Level field is populated with the SIL value 2.

About Safety Integrity Level (SIL) Assessment Using a Hazards Analysis

If you have already performed risk assessments for a Hazards Analysis via the Hazards Analysis module, you can use one of those risk assessments to assess the Safety Integrity Level (SIL) for an instrumented function.

To determine SIL using a PHA Internal assessment, you must:

1. Specify the SIL Threshold values. An [SIL Threshold record](#) stores the upper and lower boundary values for each SIL.
2. Select the Hazards Analysis and the Cause-Consequence pair that you want to use to assess the SIL value.

The category that has been assigned with the highest risk rank in the risk assessment is called the Driving Risk, and the corresponding risk rank is called the Driving Risk Rank.

The system determines which risk rank values to use based on the following criteria:

- If the risk from the Hazards Analysis has not been mitigated, the Driving Risk Rank of the unmitigated risk assessment is used to calculate SIL.
- If the risk from the Hazards Analysis has been mitigated, then the Driving Risk Rank of the mitigated risk assessment is used to calculate SIL.

Depending on the range in which the driving risk rank value falls, APM determines the SIL, and then populates the Selected SIL Level field with this value.

Note: If the driving risk rank value falls on the boundary value of two SIL thresholds, APM populates the Selected SIL Level field with the higher SIL value. For example, suppose that the SIL Threshold contains SIL value 1 for the risk range 0 through 10, and SIL value 2 for the risk range 10 through 100. If the driving risk in the risk assessment is 10, the Selected SIL Level field is populated with the SIL value 2.

About SIL Assessment Using LOPA

A Layer of Protection Analysis (LOPA) is a type of risk assessment that lets you determine the SIL value that is associated with the protective instruments that exist to mitigate the same risks for which the instrumented function exists. When you use a LOPA to assess the SIL value for an instrumented function,

you examine the granular portions of the scenario and assess the risk associated with each portion, and then those individual risk values are used to calculate the SIL value for the instrumented function.

You can conduct one LOPA per risk that is associated with an instrumented function. Refer to the LOPA documentation for further information on managing LOPA and related record.

To assess the SIL value for an Instrumented Function using LOPA, you must link the LOPA to the LOPA Assessment of the Instrumented Function.

LOPA

When you create a LOPA record, it will be linked to the corresponding Instrumented Function record.

LOPA records can be linked to records in the following families:

- **Conditional Modifier:** Stores details about the consequences of the risk described in the LOPA.
- **Hazards Analysis Safeguard:** Stores details about the safeguards and independent layers of protection that exist to mitigate the risk associated with the consequences described in the Conditional Modifiers. Independent Layers of Protection can be linked to Equipment and Functional Locations, which store details about the equipment or location with which the independent layers of protection are associated.

These families also store numeric values that represent probability and failure rates. These values are used to calculate the SIL value of the instrumented function whose risks you are assessing through the LOPA. The calculated SIL value is stored in the Calculated SIL field in the LOPA.

When you create a LOPA, you will define the following items in the record:

- The risk for which you are conducting the LOPA.
- The consequences that may occur if that risk is not prevented from proceeding into an undesirable scenario.
- The events or conditions that can initiate the undesirable event.
- How often the event may occur.
- How often it is acceptable for the event to occur.

Independent Layers of Protection

An independent layer of protection is a device, system, or action that exists to prevent a risk, and that is independent of the event that initiates the scenario. An independent layer of protection is external to any other layer of protection or safety instrumented system. The effectiveness of an independent layer of protection is quantified in terms of its probability of failure data (PFD), which is a numeric value that represents the probability that the independent layer of protection will fail to perform its specified function.

You can use the values in the **Type** list to populate an Independent Layer of Protection automatically with values from an IPL Type record. IPL Type records are provided in the baseline database, and can be defined by an SIS Administrator or SIS Engineer.

You should create one Safeguard record per layer of protection that exists. Via the Safeguard datasheet, you can link the Independent Layer of Protection to the Equipment or Functional Location for which the layer of protection exists.

Conditional Modifier

A conditional modifier is an action or event that can increase or decrease the probability that a risk may occur if the action is not mitigated and proceeds into an undesirable event. Details about a conditional modifier are stored in Conditional Modifier records, which are linked to LOPA records.

For example, assume that the SIL analysis team is conducting a LOPA to investigate the risk scenario illustrated in the following diagram, where each box represents a portion of the scenario, and each label indicates the family that stores the relevant information:

When Valve A-1001 fails, flammable gas is released into an explosive atmosphere. If the flame ignites, causing a vapor cloud explosion in the vicinity of the operator, it could cause a fatal injury.

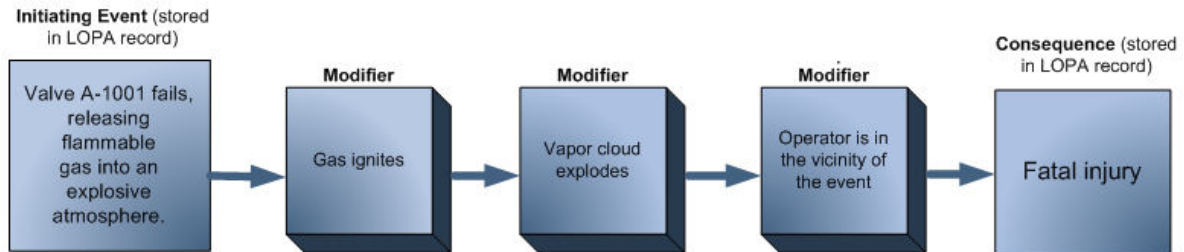

In this risk scenario, the fatal injury is a consequence of the valve failure, and the following events or actions are the conditional modifiers:

- The flame igniting
- The vapor cloud exploding
- The operator being in the vicinity of the explosion

Since these actions and events appear within the risk scenario, the probability associated with the consequence occurring is increased exponentially. In other words, if the operator was not in the vicinity of the blast, the probability of fatal injury would be less. By examining the granular events that are associated with a risk, the SIL analysis team can more accurately assess the SIL value for the instrumented function.

Assess the Safety Integrity Level (SIL) via a Layer of Protection Analysis (LOPA)

This topic describes how to assess the SIL level for an Instrumented Function using a LOPA.

Before You Begin

- Create a LOPA to define the risk that you are assessing. For more information, refer to the Layers of Protection Analysis section of the documentation.

Procedure

1. [Access the Instrumented Function](#) for which you want to assess the SIL value.
2. In the workspace, select the **SIL Assessment** tab.

The **SIL Assessment** section appears. The **Assessment Details** tab is selected by default.

The screenshot shows the 'ASF SIL Analysis' interface. The left sidebar contains 'Analysis Summary' with 'Instrumented Functions' and 'Logic Solvers' tabs. The main area is titled 'ASF SIL Anal...' and shows 'Modified by Bulla, Michael - Secured Super User'. Below this, there are tabs for 'Definition', 'SIL Assessment', 'SIL Verification', 'SIL Validation', and 'Proof Test Tasks'. The 'Assessment Details' subsection is active, showing 'Common Cause Failures' and 'Concurrent Safe States'. A 'Linked Assessment Details' section lists various parameters like 'Selected SIL Level', 'Required Probability of Failure', 'Spurious Trip Limit(Per Year)', and 'Availability Target'. At the bottom, there is a table of 'All SIL Assessments' with one entry: 'Risk Matrix Internal' with a SIL Level of 2 and a Risk Reduction Factor of 1000. The 'Add Assessment' button is highlighted in the lower-right corner of the 'Assessment Details' subsection.

3. In the lower-right corner of the **Assessment Details** subsection, select **Add Assessment** , and then select **LOPA Internal**.

A blank LOPA Assessment datasheet appears.

The screenshot shows the 'New LOPA' interface. The left sidebar is the same as in the previous screenshot. The main area is titled 'New LOPA' and contains a form for creating a new LOPA assessment. The form has a 'LOPA Definition' section with a 'Datasheet ID' dropdown menu set to 'LOPA Assessment'. Below this, there are three input fields: 'LOPA Assessment ID' (Text input), 'Linked LOPA ID' (Text input), and 'LOPA Description' (Text input). Each input field has a red border and a red error message below it: 'This field is required'. The 'LOPA Assessment ID' field is currently empty, and the 'Linked LOPA ID' field contains three dots. The 'LOPA Description' field is also empty.

4. As needed, enter values in the **available fields**.

Note: In the Linked LOPA ID field, you can only link LOPA records that are in Complete state.

5. In the upper-right corner of the datasheet, select .

The LOPA Assessment is saved, and the SIL level for the Instrumented Function is assessed using LOPA.

Results

- In the **Assessment Details** subsection, the LOPA that you have created appears in list of SIL assessments.
- In the **Assessment Details** subsection, for the row that contains the LOPA that you created, the SIL level that is calculated in the LOPA appears in the **SIL Level** column.
- A copy of the Risk Assessment associated with the LOPA is created and linked with the LOPA Assessment.
- Any change to the linked LOPA will reflect in the associated LOPA Assessment when the state of the LOPA is changed to Complete.

Next Steps

- [Associate an SIL Assessment with an Instrumented Function](#)

Assess the Safety Integrity Level (SIL) via a Risk Matrix

Before You Begin

- [Create an Instrumented Function](#).
- Configure the Risk Matrix. For information, refer to the Risk Matrix section of the documentation.

Note: You can create only one Risk Matrix Internal for an Instrumented Function.

Procedure

1. [Access the Instrumented Function](#) for which you want to assess the Safety Integrity Level (SIL).
2. In the workspace, select the **SIL Assessment** tab.

The **SIL Assessment** section appears.

ASF SIL Anal...
Modified by Bulla,...



Definition | **SIL Assessment** | SIL Verification | SIL Validation | Proof Test Tasks

Assessment Details | Common Cause Failures | Concurrent Safe States

Linked Assessment Details:

Selected SIL Level : Risk Reduction Factor :
 Required Probability of Failure : Failure Rate UOM :
 Spurious Trip Limit(Per Year) : Last Modified : Friday, 23 August 2019
 Availability Target :

All SIL Assessments: Add Assessment

No	SIL Method	Assessment Name	SIL Level	Risk Reduction Factor	Link
1	Risk Matrix Internal	Risk Matrix Assessment 1	2	1000	 

- In the **SIL Assessment** section, in the upper-right corner of the **All SIL Assessments** subsection, select **Add Assessment**, and then select **Risk Assessment Internal**.

A blank datasheet for the Risk Matrix Internal assessment appears.

New Risk Assessment Internal

Risk Matrix Internal

Datasheet ID:
Risk Matrix Internal Asse

Risk Assessment Internal ID:
Text Input
This field is required

SIL Mode:
Low Demand

Selected SIL Level:
Numeric Input

Risk Reduction Factor (RRF):
Numeric Input

Failure Rate UOM:
PFD Avg.

Required Probability of Failure:
Numeric Input

Availability Target:

- As needed, enter values in the available fields.
- In the upper-right corner of the datasheet, select .

The Risk Assessment section appears above the datasheet.

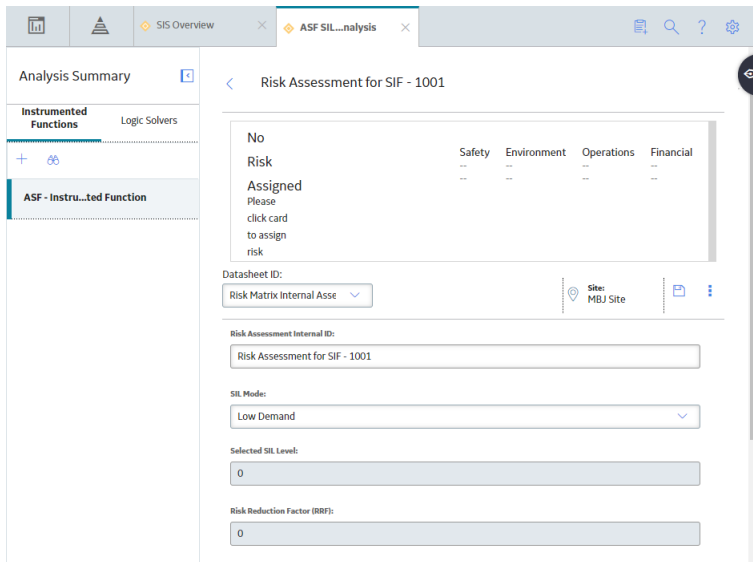

6. Select the Risk Assessment section.

The **Mitigated Risk Assessment** window appears, displaying the risk matrix for each category.

Total Risk

		Consequence					
		Very Low	Low	Medium	High	Very High	
Safety	Environment						
	Operations						
	Financial						
	Probability		1	10	100	500	1,000
	Frequent 5	5	50	500	2,500	5,000	
	Probable 1	1	10	100	500	1,000	
Possible 0.3	0.3	3	30	150	300		
Remote 0.1	0.1	1	10	50	100		
Improbable 0.05	0.05	0.5	5	25	50		

Not Applicable
 Mitigated Risk
 Unmitigated Risk

Basis for Assessment

- Specify the risk ranks for each category by selecting the appropriate cell on the risk matrix interface, and then select **Save**.

Note: You can also provide financial details, if applicable. These details, however, are not used in SIL calculations.

Based on the risk ranks that you have defined on the risk matrix interface, the APM system calculates the following values:

- [Safety Integrity Level \(SIL\)](#)
- [Risk Reduction Factor \(RRF\)](#)
- [Required Probability of Failure](#)
- Failure Rate UOM
- Availability Target

Results

- The Risk Matrix Internal assessment that you have created is listed in the **SIL Assessment** section.

Next Steps

- [Associate an SIL Assessment with an Instrumented Function](#)

Assess the Safety Integrity Level (SIL) via a Process Hazards Analysis (PHA)

Before You Begin

- [Create an Instrumented Function.](#)

About This Task

This topic describes how to assess the Safety Integrity Level (SIL) of an Instrumented Function using the risk assessment of a Process Hazards Analysis (PHA), which has been mitigated by one or more safeguards. If a risk has not been mitigated, then the unmitigated risk assessment is used instead.

Procedure

1. [Access the Instrumented Function](#) for which you want to assess the SIL value.
2. In the workspace, select the **SIL Assessment** tab.

The **SIL Assessment** section appears.

No	SIL Method	Assessment Name	SIL Level	Risk Reduction Factor	Link
1	Risk Matrix Internal	Risk Matrix Assessment 1	2	1000	

3. In the **SIL Assessment** section, in the upper-right corner of the **All SIL Assessments** subsection, select **Add Assessment**, and then select **PHA Internal**.

A blank datasheet for the PHA Internal assessment appears.

Analysis Summary

Instrumented Functions Logic Solvers

ASF - Instru...ted Function

New PHA Internal

PHA Internal

Datasheet ID: PHA Internal Assessment

Site: MBJ Site

PHA ID: Text input

This field is required

Hazards Analysis ID: ...

This field is required

Selected SIL Level: Numeric input

SIL Mode: Low Demand

Risk Reduction Factor (RRF): Numeric input

Required Probability of Failure: Numeric input

Failure Rate UOM: PFD Avg.

Availability Target: Numeric input

Spurious Trip Limit (per yr): 0.01

PHA Internal Risk Assessment

- Next to the **Hazards Analysis ID** field, select .

The **Search** window appears.

Search

Look in

Search

Cancel OK

- In the upper-right corner of the window, select .

A list of Hazards Analysis appears.

Search

Look in

- B0007-009 Steam Boiler Analysis
Hazards Analysis [Human Resource](#) [Equipment](#) [Functional Location](#) [Hazards Analysis System/Node](#) [Instrumented Function](#) [SIL Analysis](#) [Hazards Analysis Revision](#)
- B0007-009 Steam Boiler What-If Hazards Analysis
Hazards Analysis [Human Resource](#) [Hazards Analysis System/Node](#) [Hazards Analysis Revision](#)
- Alkylation Reactor R-1 Hazards Analysis
Hazards Analysis [Reference Document](#) [Human Resource](#) [Equipment](#) [Hazards Analysis System/Node](#) [SIL Analysis](#) [Hazards Analysis Revision](#)
- FCCU Process Hazards Analysis
Hazards Analysis [Reference Document](#) [Human Resource](#) [Equipment](#) [Hazards Analysis System/Node](#) [Instrumented Function](#) [SIL Analysis](#) [Hazards Analysis Revision](#)
- Steam System "B" PHA
Hazards Analysis [Human Resource](#) [Hazards Analysis Revision](#)
- Steam System "A" PHA
Hazards Analysis [Human Resource](#) [Hazards Analysis Revision](#)

6. Select the Hazards Analysis that you want to link to the PHA Internal Assessment, and then select **OK**.
7. In the upper-right corner of the datasheet, select .

The list of Cause-Consequence pairs linked to the selected Hazards Analysis appears in the **PHA Internal Risk Assessment** subsection below the datasheet.

PHA Internal Risk Assessment

No	Node ID	Cause ID	Consequence ID	
1	Gas Fired Combustor	Supply Regulator Fails	Loss of Flame	<input type="checkbox"/>
2	Steam Drum	Power Failure	Tube Failure	<input type="checkbox"/>
3	Steam Drum	Feed Water Control Fails	Tube Failure	<input type="checkbox"/>
4	Steam Drum	Blocked Outlet	Steam Drum Over-Pressurization	<input type="checkbox"/>
5	Combustion Air	Mechanical Failure, or Power Loss	Loss of combustion air	<input type="checkbox"/>

[View Risk Matrix](#)

8. Select the check box that corresponds to the Cause-Consequence pair that you want to use for SIL assessment.

PHA Internal Risk Assessment

No	Node ID	Cause ID	Consequence ID	
1	Gas Fired Combustor	Supply Regulator Fails	Loss of Flame	<input type="checkbox"/>
2	Steam Drum	Power Failure	Tube Failure	<input checked="" type="checkbox"/>
3	Steam Drum	Feed Water Control Fails	Tube Failure	<input type="checkbox"/>
4	Steam Drum	Blocked Outlet	Steam Drum Over-Pressurization	<input type="checkbox"/>
5	Combustion Air	Mechanical Failure, or Power Loss	Loss of combustion air	<input type="checkbox"/>

[View Risk Matrix](#)

Note: You can access the risk matrix associated with the selected Consequence by selecting **View Risk Matrix**.

The APM system calculates the following values in the PHA - Internal datasheet based on the selected Consequence and its overall risk rank:

- [Safety Integrity Level \(SIL\)](#)
- [Risk Reduction Factor \(RRF\)](#)
- [Required Probability of Failure](#)
- Failure Rate UOM
- Availability Target

Results

- The PHA - Internal record that you have created is listed in the **SIL Assessment** section.

Next Steps

- [Associate an SIL Assessment with an Instrumented Function](#)

Assess the Safety Integrity Level (SIL) via an External Method

Before You Begin

- [Create an Instrumented Function](#).

Procedure

1. [Access the Instrumented Function](#) for which you want to assess the Safety Integrity Level (SIL).
2. In the workspace, select the **SIL Assessment** tab.

The **SIL Assessment** section appears.

ASF SIL Anal...
Modified by Bulla,...



Definition **SIL Assessment** SIL Verification SIL Validation Proof Test Tasks

Assessment Details Common Cause Failures Concurrent Safe States

Linked Assessment Details:

Selected SIL Level : Risk Reduction Factor :
 Required Probability of Failure : Failure Rate UOM :
 Spurious Trip Limit(Per Year) : Last Modified : Friday, 23 August 2019
 Availability Target :

All SIL Assessments: Add Assessment ▼

No	SIL Method	Assessment Name	SIL Level	Risk Reduction Factor	Link
1	Risk Matrix Internal	Risk Matrix Assessment 1	2	1000	 

- In the **SIL Assessment** section, in the upper-right corner of the **All SIL Assessments** subsection, select **Add Assessment**, and then select **External**.

The External datasheet appears.

4. As needed, enter values in available fields.
5. In the upper-right corner of the datasheet, select . The SIL assessment is performed.

Results

- The External SIL Assessment that you have created is listed in the **SIL Assessment** section.

Next Steps

- [Associate an SIL Assessment with an Instrumented Function](#)

Associate an SIL Assessment with an Instrumented Function

When you associate an SIL Assessment with an Instrumented Function, the APM system performs the SIL calculations for the Instrumented Function based on the values that you have provided in the associated SIL Assessment. You can associate only one SIL Assessment with an Instrumented Function.

Before You Begin

- [Perform an SIL assessment.](#)

About This Task

This topic describes how to associate the following SIL Assessments with an Instrumented Function:

- LOPA Assessment
- Risk Matrix Internal Assessment
- PHA Internal Assessment
- External Assessment

Procedure



1. [Access the Instrumented Function](#) with which you want to associate an SIL Assessment.
2. In the workspace, select the **SIL Assessment** tab.

The **SIL Assessment** section appears, displaying a list of SIL Assessments performed on the Instrumented Function.

The screenshot shows a software interface with a top navigation bar containing 'SIS Overview' and 'ASF SIL...nalysis' tabs. On the left, there is a sidebar with 'Analysis Summary' and 'Instrumented Functions' selected. The main content area is titled 'ASF SIL Anal...' and shows a user 'Bulla, Michael - Secured Super User'. Below this, there are tabs for 'Definition', 'SIL Assessment', 'SIL Verification', 'SIL Validation', and 'Proof Test Tasks'. The 'SIL Assessment' tab is active, displaying 'Assessment Details' with sub-sections for 'Common Cause Failures' and 'Concurrent Safe States'. Below this, there is a 'Linked Assessment Details' section with the following information:

Selected SIL Level	:	Risk Reduction	:
Required Probability of Failure	:	Factor	:
Spurious Trip Limit(Per Year)	:	Failure Rate UOM	:
Availability Target	:	Last Modified	: Friday, 23 August 2019

Below the linked details, there is an 'Add Assessment' button. At the bottom, there is a table titled 'All SIL Assessments:' with the following data:

No	SIL Method	Assessment Name	SIL Level	Risk Reduction Factor	Link
1	Risk Matrix Internal	Risk Matrix Assessment 1	2	1000	 

3. In the **Link** column, select the option button that corresponds to the SIL Assessment that you want to associate.

The SIL Assessment is associated with the Instrumented Function.

Analysis Summary

ASF SIL A...
Modified by B... Bulla, Michael - Secured Super User

Definition | **SIL Assessment** | SIL Verification | SIL Validation | Proof Test Tasks

Assessment Details | Common Cause Failures | Concurrent Safe States

Linked Assessment Details:

Selected SIL Level	: 2	Risk Reduction Factor	: 1,000
Required Probability of Failure	: 0.001	Failure Rate UOM	: PFD AVG
Spurious Trip Limit(Per Year)	: 0.01	Last Modified	: Friday, 23 August 2019
Availability Target	: 99.90		

All SIL Assessments: [Add Assessment](#)

No	SIL Method	Assessment Name	SIL Level	Risk Reduction Factor	Link
1	LOPA	LOPA-01	4	14400	
2	Risk Matrix Internal	Risk Matrix Assessment 1	2	1000	

Results

- Based on the values that you have entered in the SIL Assessment, APM system populates the following values in the Instrumented Function datasheet :
 - Selected SIL Value
 - Required Probability of Failure
 - Risk Reduction Factor
 - Spurious Trip Limit (per year)
 - Failure Rate UOM
 - Availability Target
 - Last Modified
- If you associated a LOPA Assessment, Risk Matrix Internal Assessment, or a PHA Internal Assessment with the Instrumented Function, then the Risk Assessment record associated with the corresponding SIL Assessment is also linked with the Instrumented Function.

Chapter 9

SIL Verification

Topics:

- [About Safety Integrity Level \(SIL\) Verification](#)
- [About Protective Instrument Loops](#)
- [About Protective Instrument Loop Calculation Engine](#)
- [Safety Integrity Level \(SIL\) Verification Workflow](#)
- [About Asset Groups in SIS Management](#)
- [About Validation Failure Rate Reference Data](#)
- [About Copying a Protective Instrument Loop Element](#)
- [About Dangerous Combination of Outputs](#)
- [Access a Protective Instrument Loop](#)
- [Create a Protective Instrument Loop](#)
- [Create a Proven In Use Justification Record](#)
- [Apply a Template to a Protective Instrument Loop](#)
- [Delete a Protective Instrument Loop](#)
- [Upgrade a Protective Instrument Loop](#)
- [Access a Protective Instrument Loop Sensor System](#)
- [Copy a Protective Instrument Loop Sensor System](#)
- [Link a Protective Instrument Loop Sensor System](#)

- [Unlink a Protective Instrument Loop Sensor System](#)
- [Access a Protective Instrument Loop Sensor Group](#)
- [Create a Protective Instrument Loop Sensor Group](#)
- [Copy a Protective Instrument Loop Sensor Group](#)
- [Link a Protective Instrument Loop Sensor Group](#)
- [Unlink a Protective Instrument Loop Sensor Group](#)
- [Delete a Protective Instrument Loop Sensor Group](#)
- [Access a Protective Instrument Loop Sensor](#)
- [Create a Protective Instrument Loop Sensor](#)
- [Copy a Protective Instrument Loop Sensor](#)
- [Link a Protective Instrument Loop Sensor](#)
- [Unlink a Protective Instrument Loop Sensor](#)
- [Delete a Protective Instrument Loop Sensor](#)
- [Access a Protective Instrument Loop Final Element System](#)
- [Copy a Protective Instrument Loop Final Element System](#)
- [Link a Protective Instrument Loop Final Element System](#)
- [Unlink a Protective Instrument Loop Final Element System](#)
- [Access a Protective Instrument Loop Final Element Group](#)
- [Create a Protective Instrument Loop Final Element Group](#)
- [Copy a Protective Instrument Loop Final Element Group](#)
- [Link a Protective Instrument Loop Final Element Group](#)
- [Unlink a Protective Instrument Loop Final Element Group](#)
- [Delete a Protective Instrument Loop Final Element Group](#)
- [Access a Protective Instrument Loop Final Element](#)

- [Create a Protective Instrument Loop Final Element](#)
- [Copy a Protective Instrument Loop Final Element](#)
- [Link a Protective Instrument Loop Final Element](#)
- [Unlink a Protective Instrument Loop Final Element](#)
- [Define a Dangerous Combination of Outputs](#)
- [Unlink a Dangerous Combination of Outputs](#)
- [Delete a Protective Instrument Loop Final Element](#)
- [Access a Protective Instrument Loop Logic Solver](#)
- [Copy a Protective Instrument Loop Logic Solver](#)
- [Link a Protective Instrument Loop Logic Solver](#)
- [Unlink a Protective Instrument Loop Logic Solver](#)
- [Access a Protective Instrument Loop Logic Solver Channel](#)
- [Create a Protective Instrument Loop Logic Solver Channel](#)
- [Delete a Protective Instrument Loop Logic Solver Channel](#)
- [Access a Protective Instrument Loop Template](#)
- [Create a Protective Instrument Loop Template](#)
- [Copy a Protective Instrument Loop Template](#)
- [Access a Sensor in the Protective Instrument Loop Template](#)
- [Access a Protective Instrument Loop Final Element](#)
- [Delete a Protective Instrument Loop Template](#)
- [Upgrade a Protective Instrument Loop Template](#)
- [Access a Custom Device](#)
- [Create a Custom Device](#)
- [Approve a Custom Device](#)
- [Revoke the Approval of a Custom Device](#)

- [Delete a Custom Device](#)
- [Access the Results of a Protective Instrument Loop](#)

About Safety Integrity Level (SIL) Verification

After you assess the SIL level of an instrumented function, you must verify if the safety instrumented system meets the targeted SIL level. To facilitate this verification, the SIL Verification feature allows you to create a protective instrument loop, and then calculate the SIL level for the loop.

About Protective Instrument Loops

A protective instrument loop consists of interconnected instruments that work together to serve a function that is defined for the safety instrumented system within which they exist.

When you create a protective instrument loop in SIS Management, you are creating a Protective Instrument Loop record. When you define the elements of the protective instrument loop (i.e., the interconnected instruments), you are creating records in the Protective Instrument Loop Element family and its subfamilies, and linking them to the Protective Instrument Loop. Throughout this documentation, when we refer to the protective instrument loop, we are referring to the Protective Instrument Loop and all the records that are linked to it. When we refer to Protective Instrument Loop Elements, we are referring to the records that are linked to the Protective Instrument Loop.

Protective Instrument Loop Elements

Each instrument in a protective instrument loop is called an element. The following protective instrument loop elements are defined in the APM system:

- Logic Solver
- Sensor System
- Sensor Group
- Sensor
- Final Element System
- Final Element Group
- Final Element

By default, every protective instrument loop consists of at least one of each element. When you create a Protective Instrument Loop, the APM system creates one record for each of these elements, and links to the Protective Instrument Loop as shown in the [data model](#).

Protective Instrument Loop Diagram

A protective instrument loop diagram is a visual representation of the number of each type of elements in the protective instrument loop. The following image shows the baseline protective instrument loop diagram.

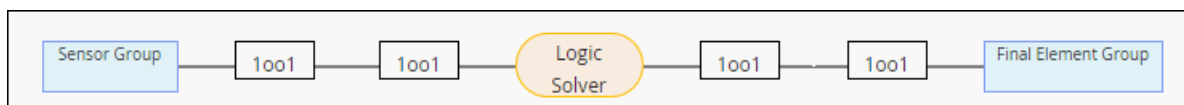

To access or modify the datasheet of a protective instrument loop element, you must select the corresponding node in the diagram.

Important: If you have provided incorrect or insufficient information for a protective instrument loop element, then the APM system cannot calculate the loop results. This is indicated by a  icon that

appears in the diagram for that element. You must then review the details of the element in the datasheet.

About Protective Instrument Loop Calculation Engine

APM supports the following calculation engines for the calculation of loop results in an SIL analysis:

- exSILentia v3
- exSILentia v4

The usage of exSILentia v4 calculation engine in APM provides improved accuracy in the calculated results. In addition, the following functionalities are provided:

- You can specify if redundant I/O channels must be on separate modules for an instrumented function.
- You can specify group level Mission Time for a Sensor Group, Logic Solver, and Final Element Group.

The ability to specify a Proof Test Scope for Final Elements is available. The exSILentia v4 calculation engine includes updates as per the latest revision of IEC 61511. The basis for Architectural Constraints only includes IEC 61511:2016 and IEC 61508:2010.

To enable a Protective Instrument Loop or Protective Instrument Loop Template to use the exSILentia v4 calculation engine, you must [upgrade the loop](#).

Safety Integrity Level (SIL) Verification Workflow

This workflow provides the basic, high-level steps for performing a Safety Integrity Level (SIL) verification. The steps and links in this workflow do not necessarily reference every possible procedure.

Performing an SIL Verification includes the following steps:

1. [Create a Protective Instrument Loop](#). After you create a Protective Instrument Loop, the APM system creates one record for each of its elements.
2. Provide the details of the following elements of the loop in the corresponding records:
 - Sensor System
 - Sensor Group
 - Sensor
 - Logic Solver
 - Final Element System
 - Final Element Group
 - Final Element
3. If there are additional elements in the loop apart from the default ones, create records for them. The APM system builds the diagram based on the elements that you have added.
4. [Compare the calculated results of the loop](#) to verify if the Safety Integrity Level (SIL) target is achieved.

About Asset Groups in SIS Management

When you create an Instrumented Function in SIS Management, you can associate it with a piece of Equipment and a Functional Location. The piece of Equipment and the Functional Location together form an Asset. The Asset that is associated with the Instrumented Function is the asset that you are protecting.

Similarly, when you create a Protective Instrument Loop, you can associate each element in the loop with a piece of Equipment and a Functional Location. The Assets that are associated with the individual

Protective Instrument Loops are the ones that are required to protect the Asset associated with the Instrumented Function.

The APM system creates an asset group for each Protective Instrument Loop. This group contains all the Equipment and Functional Locations associated with each sensor, logic solver, and final element in the loop. This group is named in the following format: <**The ID of the SIL Analysis ID**>/<**ID of the Instrumented Function**>/<**ID of the Protective Instrument Loop**> **Asset Group**. The APM system updates this group when you add a new element to the loop, remove an element from the loop, or associate an existing element with a new Equipment or Functional Location.

You can search for these groups on the **Assets** page.

About Validation Failure Rate Reference Data

Failure rate reference data refers to data that exists to record trends in failure rates for categories of elements that exist in a protective instrument loop. These elements can be categorized by application, technology, size, or any other technical characteristic.

Before you add an element to a protective instrument loop, you can consider the failure rate reference data that is associated with that element type, and then make a decision on whether or not to use that particular element.

Validation failure rate reference data is available for the following records:

- Sensor
- Logic Solver
- Final Element

The **Is Reference Data** check box in these records is set to True.

Note: By default, the **Is Reference Data** check box is not included on the datasheet. This field is used by the APM system, and is not meant to be modified manually.

When you create a Protective Instrument Loop Element via the Validation Failure Rate Reference Data feature, the APM system will automatically select the **Is Reference Data** check box in that record.

About Approving a Device for Use

You can use the Validation Failure Rate Reference Data feature to determine which elements are approved for use with a protective instrument loop. After you have determined that a given element is approved, you can select the **Approve** button in the upper-right corner of the datasheet. When you do so, the APM system will automatically select the **Approved Custom Device** check box in that record, and it will be available for selection in the SIL Verification feature.

If you later determine that an element is no longer approved for use in a protective instrument loop, you can [revoke that approval](#) in the record.

Note: To approve a Protective Instrument Loop Element, you must be a member of the SIS Administrator or SIS Engineer Security Group.

About Copying a Protective Instrument Loop Element

When you copy a Protective Instrument Loop Element:

- The values in each field of the copied record are overwritten by those of the original record that you copy.
- The value in the Element ID field in the copied record is appended with 1.

- All the child records linked to the original record also become a part of the record that you copy, replacing the existing ones.

For example, consider two protective instrument loops, Loop 1 and Loop 2, with the following sensor systems, sensor groups, and sensors:

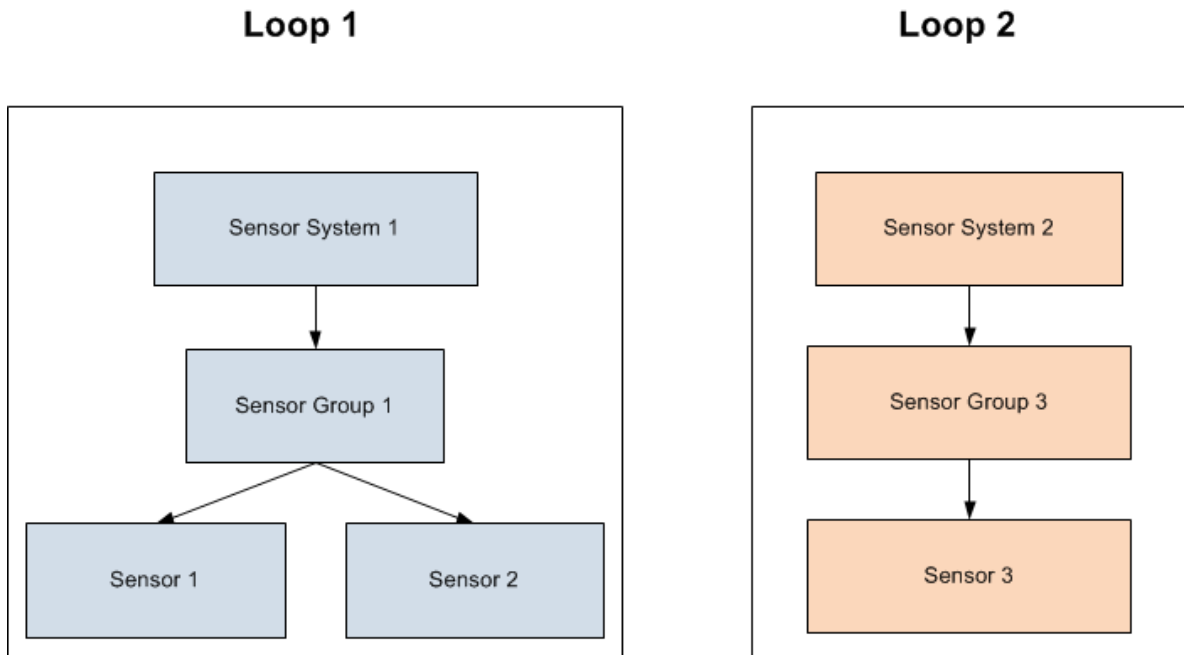

Suppose you copy Sensor Group 3 into Sensor Group 1:

- The values for all the fields in Sensor Group 1 are overwritten by those in Sensor Group 3.
- The ID for Sensor Group 1 becomes Sensor Group 3 1.
- Sensor 1 and Sensor 2 are replaced by Sensor 3. If Sensor 1 and Sensor 2 are not part of another protective instrument loop, they are deleted. Otherwise, they are unlinked from Loop 1.

The following image illustrates the changes in Loop 1 after you copy Sensor Group 3 :

Loop 1

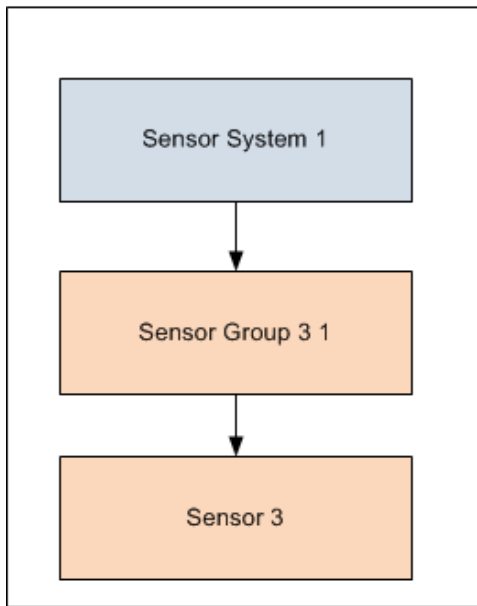

Loop 2

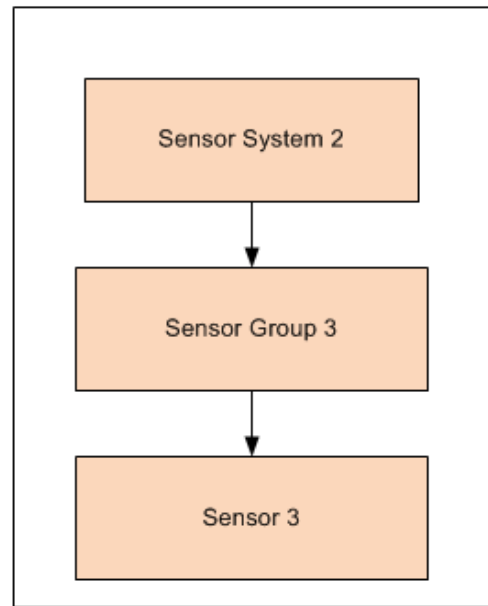

About Dangerous Combination of Outputs

When you define a Protective Instrument Loop Final Element, you must define the potential hazards that can occur if the output state associated with the final element is combined with the output state associated with another final element. While the output state associated with individual final elements is safe, in some cases, when output states associated with multiple final elements are combined, a hazardous event can occur. For example, if the output state associated with Final Element A has the potential to fill a tank half full, and the output state associated with Final Element B has the potential to fill the same tank half full, these combined output states have the potential to overflow the tank. In this way, Final Element A and Final Element B have a combined output state hazard.

You can document combined output state hazards that exist for final elements in the **Dangerous Combination of Outputs** section in the Protective Instrument Loop Final Element. In other words, for each final element that participates in a potentially hazardous relationship, you will need to define the combined output state hazard(s) for that final element.

Steps in Defining Dangerous Combination of Outputs

To define combined output state hazards for a final element, you must:

- Link the Protective Instrument Loop Final Element to the other Protective Instrument Loop Final Element representing the final element whose output state can cause a hazard when combined with the output state of the current final element. Protective Instrument Loop Final Elements can be linked to one or more other Protective Instrument Loop Final Elements through the Has Hazardous Event relationship.
- Describe the hazardous event that can occur when the output states are combined. Since some final elements can participate in multiple combined output state hazard scenarios, in each Protective Instrument Loop Final Element, you will need to describe the hazardous events that are associated with that final element. In other words, describing the hazardous event in one Protective Instrument

Loop Final Element will not populate the linked Protective Instrument Loop Final Element with the same description.

Access a Protective Instrument Loop

Procedure

1. [Access the Instrumented Function](#) that is linked to the Protective Instrument Loop that you want to access.
2. In the workspace, select the **SIL Verification** tab.

The **SIL Verification** section appears, displaying a list of Protective Instrument Loops in the Instrumented Function.

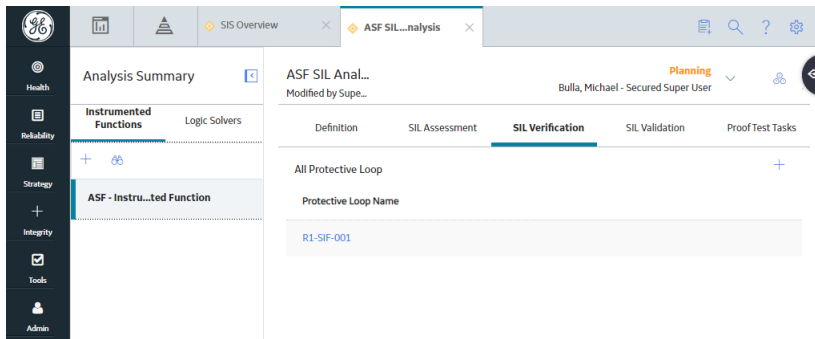

3. Select the Protective Instrument Loop that you want to access.

The datasheet for the Protective Instrument Loop appears.

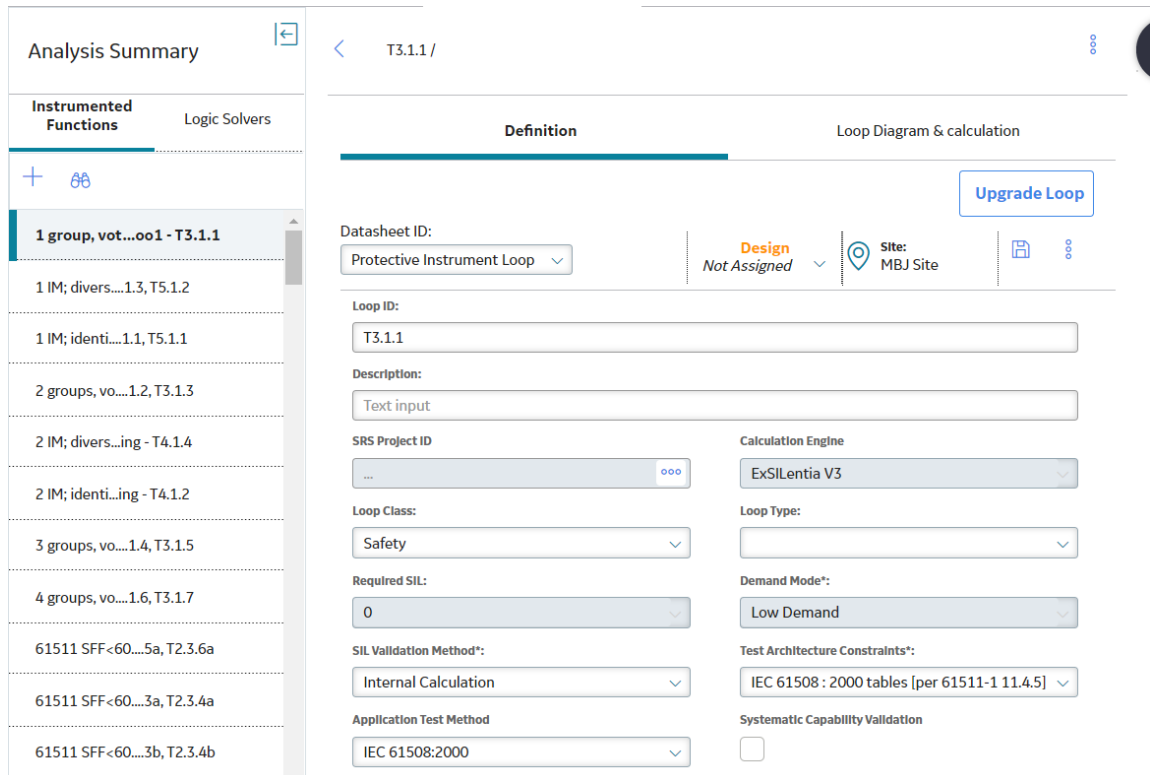

- If needed, modify values in the [available fields](#).
- In the upper-right corner of the datasheet, select .
The changes made to the Protective Instrument Loop are saved.
- If you want to access the loop diagram and calculations, in the upper-right corner of the workspace, select **Loop Diagram & calculation**.

The loop diagram and calculations appear.

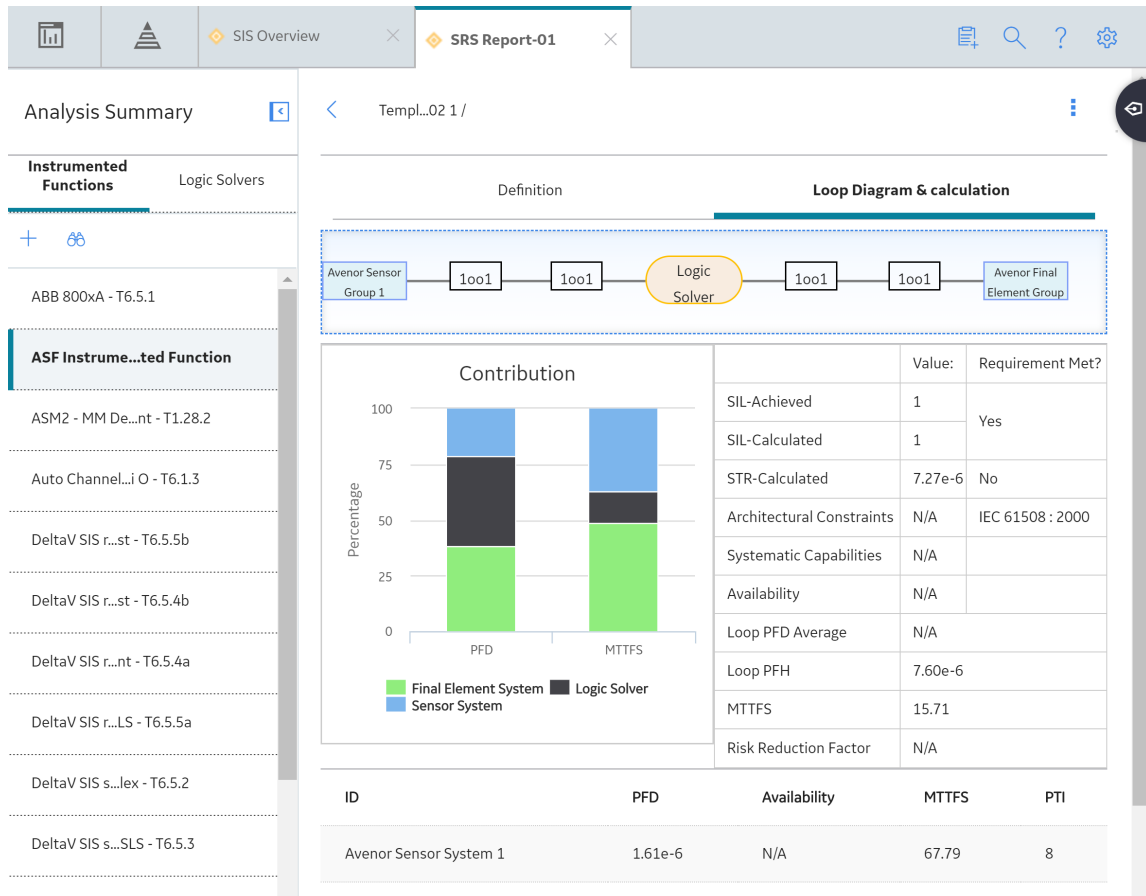

The screenshot displays the 'Loop Diagram & calculation' tab in the software. The diagram shows a sequence of components: Avenor Sensor Group 1, two 1oo1 sensors, a Logic Solver, two more 1oo1 sensors, and an Avenor Final Element Group. Below the diagram is a 'Contribution' bar chart and a table of metrics.

Contribution Chart Data:

Metric	Final Element System (%)	Logic Solver (%)	Sensor System (%)
PFD	~40	~35	~25
MTTFS	~50	~10	~40

Table of Metrics:

Metric	Value	Requirement Met?
SIL-Achieved	1	Yes
SIL-Calculated	1	
STR-Calculated	7.27e-6	No
Architectural Constraints	N/A	IEC 61508 : 2000
Systematic Capabilities	N/A	
Availability	N/A	
Loop PFD Average	N/A	
Loop PFH	7.60e-6	
MTTFS	15.71	
Risk Reduction Factor	N/A	

Table of System Metrics:

ID	PFD	Availability	MTTFS	PTI
Avenor Sensor System 1	1.61e-6	N/A	67.79	8

Create a Protective Instrument Loop

Before You Begin

- Assess the Safety Integrity Level (SIL) for the Instrumented Function.

Procedure

- Access the Instrumented Function for which you want to create a Protective Instrument Loop.
- In the workspace, select the **SIL Verification** tab.

The **SIL Verification** section appears, displaying a list of Protective Instrument Loops in the

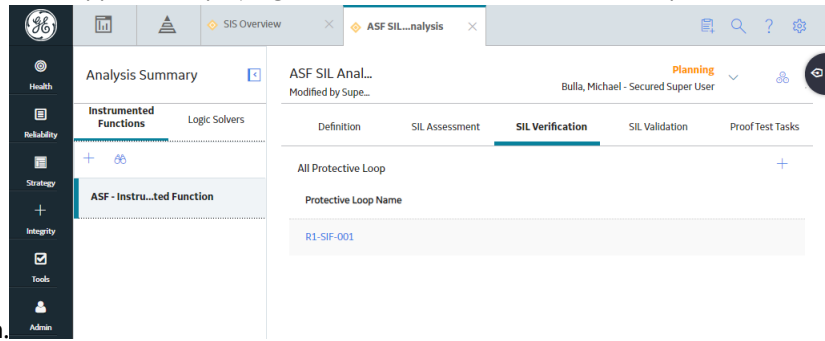

Instrumented Function.

3. In the upper-right corner of the section, select . A blank datasheet for the Protective Instrument Loop appears.

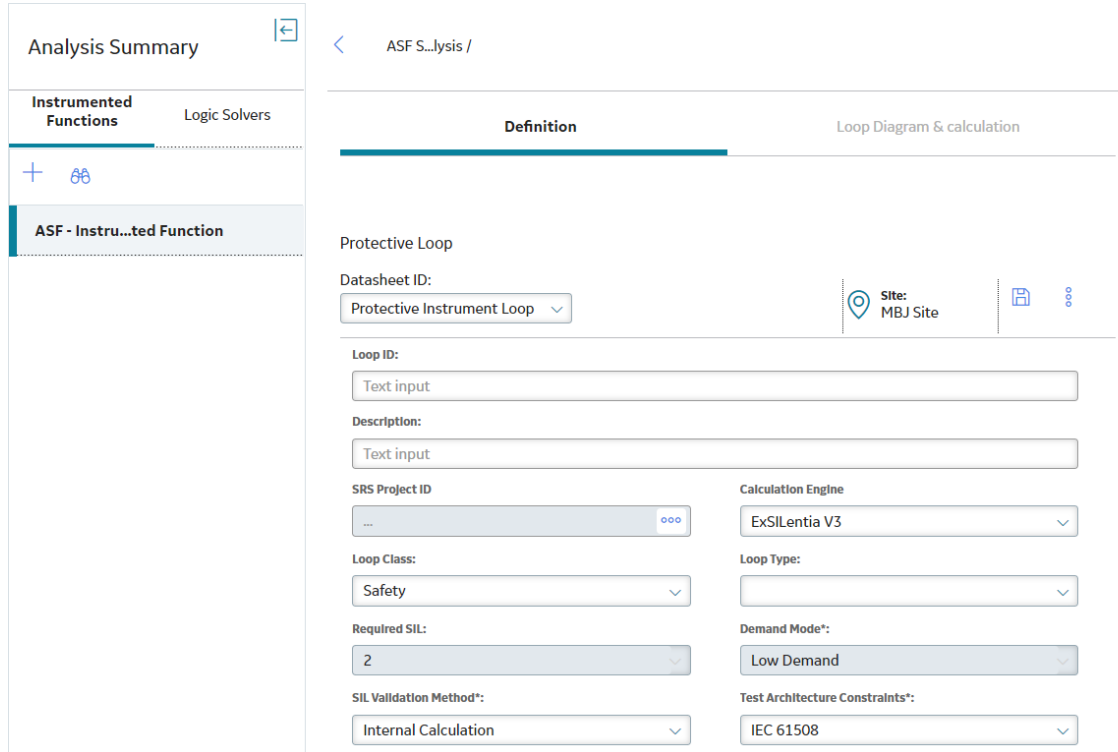

4. As needed, enter values in the [available fields](#).
5. In the upper-right corner of the datasheet, select . The Protective Instrument Loop is created.

Results

- The APM system creates one record for each of the following elements:
 - Sensor System
 - Sensor Group
 - Sensor
 - Logic Solver
 - Final Element System
 - Final Element Group

- Final Element

Next Steps

- If there are additional elements in the loop apart from the ones created by the APM system, create records for them.
- Provide the details of the elements in the corresponding records.

Create a Proven In Use Justification Record

Procedure

1. Access one of the following subsystems associated with the device for which you want to create the Proven In Use Justification record:
 - [A Sensor in a Protective Instrument Loop](#)
 - [A Final Element in a Protective Instrument Loop](#)
 - [A Custom Device](#) (i.e., a Custom Sensor or a Custom Final Element)
 - [A Sensor in a Protective Instrument Loop Template](#)
 - [A Final Element in a Protective Instrument Loop Template](#)
2. At the end of the datasheet for the selected subsystem, in the section that contains the list of associated Protective Instrument Devices, select the link in the **ID** column.

The **Device Details** window appears, displaying the datasheet for the selected Protective Instrument Device.

The screenshot shows a 'Device Details' window with a title bar and a 'Datasheet ID' dropdown menu set to 'Protective Instrument Device (F)'. Below the title bar are three tabs: 'Device Details' (selected), 'Parameters', and 'Failure Data Reference'. The main content area contains several input fields: 'Device ID' with the value 'Final Element Device ID 22 Template', 'Device Name' with 'Generic Alarm Siren', 'Description' with 'Text Input', 'Functional Location' with a dropdown menu showing '--', and 'Equipment' with a dropdown menu showing '--'. At the bottom of the window are three buttons: 'Justification Details', 'Cancel', and 'Save'.

3. In the lower-right corner of the window, select **Justification Details**.
The datasheet for Proven In Use Justification appears.

Device Details

<

Datasheet ID:
Proven In Use Justification

Site:
Roanoke, VA

Application:
Text input

Device Type:
Text input

Comment:
Text area

Prepared By:
Text input

Prepared Date:
Calendar icon

Cancel Save

4. As needed, enter values in the [available fields](#).
5. In the lower-right corner of the window, select **Save**.

The Proven In Use Justification record is created and associated with the device.

Tip: In the upper-right corner of the window, select < to view the datasheet for the Protective Instrument Device.

Apply a Template to a Protective Instrument Loop

This topic describes how to apply a Protective Instrument Loop Template while creating or modifying a loop.

Before You Begin

- [Create a Protective Instrument Loop Template](#).

About This Task

When you apply a template to a Protective Instrument Loop, the APM system overwrites the information of the loop with that of the template.

Note: After you apply the template, any subsequent changes made to the template will not be reflected in the loop.

Procedure

1. [Access the Protective Instrument Loop](#) to which you want to apply a template.
2. In the upper-right corner of the page, select , and then select **Apply Template**.
A window appears, displaying a list of Protective Instrument Loop templates.

Select The Protective Instrument Loop Template.

- Alky Reactor Low Coolant Flow~R1-SIF-001 Template
- Compressor Low Lube Oil Pressure Template
- Axial Displacement Trip Template
- High Radial Vibration Template
- Main Fractionator HIPPS~MFC-SIF-001 Template

Cancel

OK

3. Select the check box that corresponds to the template that you want to apply, and then select **OK**.
The template is applied to the Protective Instrument Loop.

Results

- The APM system overwrites the information of the loop with that of the template.

Delete a Protective Instrument Loop

About This Task

Important: Deleting a Protective Instrument Loop also deletes all the Protective Instrument Loop Elements that are linked to the loop. Deleting a Protective Instrument Loop Element that is shared across

other loops results in a change in the related SIL calculations. In that case, you must review the calculations.

Procedure

1. Access the Instrumented Function that is linked to the Protective Instrument Loop that you want to delete.
2. In the workspace, select the **SIL Verification** tab.

The **SIL Verification** section appears, displaying a list of Protective Instrument Loops in the Instrumented Function.

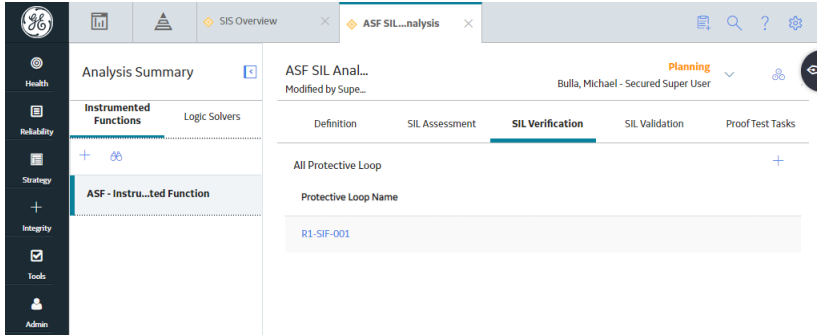

3. Select the Protective Instrument Loop that you want to delete.
The datasheet for the Protective Instrument Loop appears.

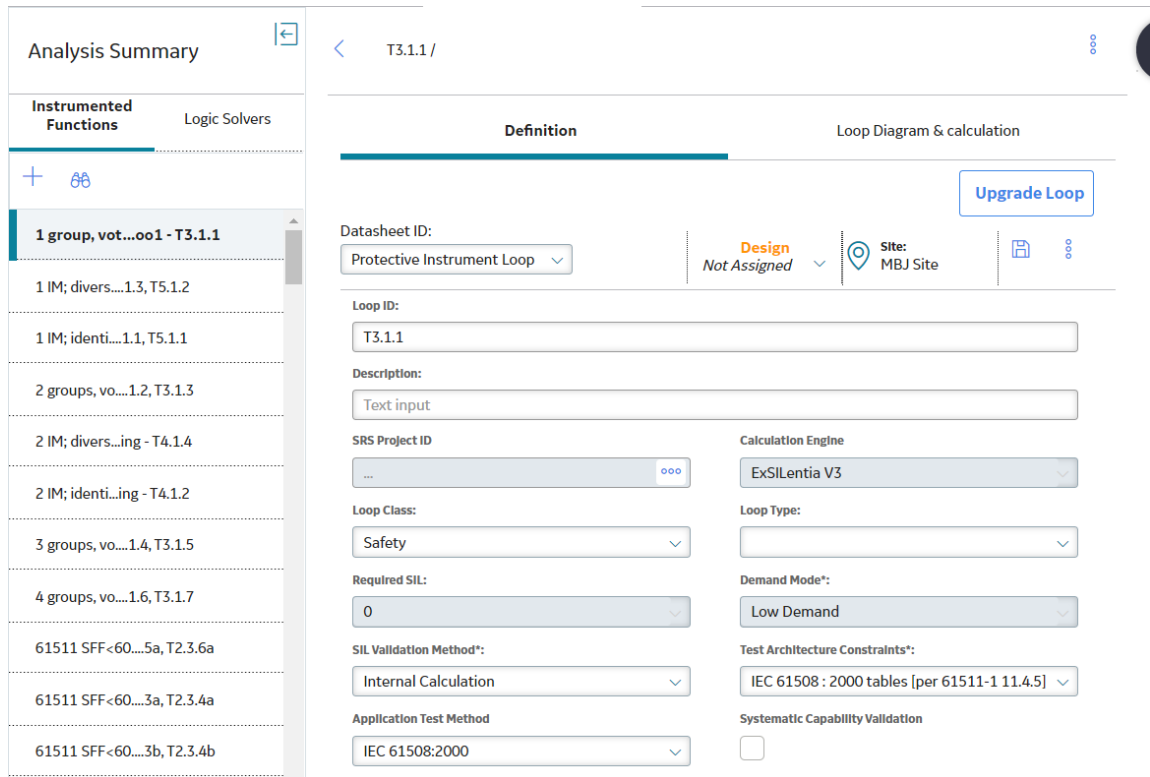

4. In the upper-right corner of the datasheet, select , and then select **Delete**.
A message appears, asking you if you really want to delete the Protective Instrument Loop.
5. Select **Yes**.

The Protective Instrument Loop is deleted.

Upgrade a Protective Instrument Loop

This topic describes how to upgrade a Protective Instrument Loop to support the exSILentia v4 Calculation Engine.

About This Task

Important: After you upgrade a Protective Instrument Loop to exSILentia v4, you cannot revert the loop to exSILentia v3.

Procedure

1. [Access the Instrumented Function](#) that is linked to the Protective Instrument Loop that you want to upgrade.
2. In the workspace, select the **SIL Verification** tab.

The **SIL Verification** section appears, displaying a list of Protective Instrument Loops in the Instrumented Function.

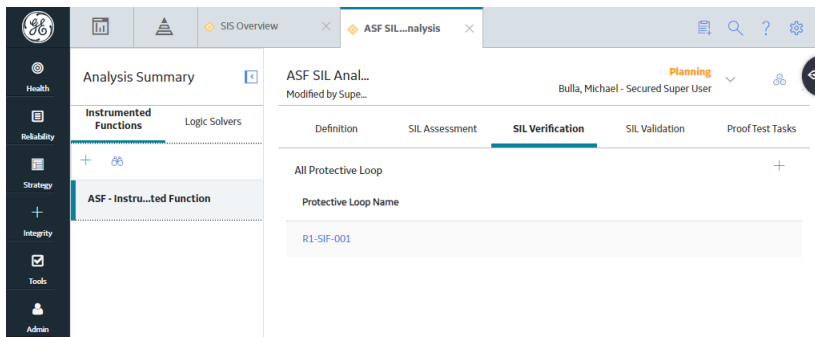

3. Select the Protective Instrument Loop that you want to upgrade.

The datasheet for the Protective Instrument Loop appears.

The screenshot shows a software interface for configuring a Protective Instrument Loop. On the left is a sidebar with a list of instrumented functions, including '1 group, vot...oo1 - T3.1.1'. The main area is titled 'Definition' and contains various configuration fields: 'Datasheet ID' (Protective Instrument Loop), 'Design' (Not Assigned), 'Site' (MBJ Site), 'Loop ID' (T3.1.1), 'Description' (Text input), 'SRS Project ID' (empty), 'Calculation Engine' (ExSILentia V3), 'Loop Class' (Safety), 'Loop Type' (empty), 'Required SIL' (0), 'Demand Mode*' (Low Demand), 'SIL Validation Method*' (Internal Calculation), 'Test Architecture Constraints*' (IEC 61508 : 2000 tables [per 61511-1 11.4.5]), 'Application Test Method' (IEC 61508:2000), and 'Systematic Capability Validation' (checkbox). An 'Upgrade Loop' button is visible in the top right corner.

4. Select **Upgrade Loop**.

Note: The **Upgrade Loop** button is only available for loops that use the exSILentia v3 Calculation Engine.

The **Upgrade Loop?** window appears asking you to confirm if you want to upgrade the Protective Instrument Loop.

The dialog box is titled 'Upgrade Loop?' and contains the following text: 'You are about to upgrade this Protective Instrument Loop to use 'ExSILentia V4' calculation engine. As part of this upgrade, fields in the Protective Instrument Loop Data Model will be updated to support this change. Please refer to product documentation for additional details. This change cannot be reverted. Do you wish to proceed?'. At the bottom, there are two buttons: 'Yes' and 'No'.

5. Select **Yes**.
The Protective Instrument Loop is upgraded to exSILentia v4.

Results

After the loop is upgraded, the value in the IO channels on separate module field of the Protective Instrument Loop record is set to False. In addition, for the associated Sensor Group, Logic Solver, and Final Element Group records, the value in the Has Independent Mission Time field is set to False, and any value in the Group Mission Time field is reset, and populated from the value in the Mission Time field of the Protective Instrument Loop record. The value in the Proof Test Duration field is populated with a default value of 1 hour.

Access a Protective Instrument Loop Sensor System

Before You Begin

- [Create a Protective Instrument Loop](#).

About This Task

Note:

There is only *one* sensor system in a Protective Instrument Loop. When you create a Protective Instrument Loop, a Protective Instrument Loop Sensor System is created automatically and added to the loop. You cannot delete this record.

Procedure

1. [Access the Protective Instrument Loop](#) that is linked to the Protective Instrument Loop Sensor System that you want to access.
2. In the workspace, select the **Loop Diagram & calculation** tab.

The **Loop Diagram & calculation** section appears.

Definition **Loop Diagram & calculation**

```

    graph LR
      A[Avenor Sensor Group 1] --> B[1001]
      B --> C[1001]
      C --> D((Logic Solver))
      D --> E[1001]
      E --> F[1001]
      F --> G[Avenor Final Element Group]
  
```

Contribution

Metric	Final Element System	Logic Solver	Sensor System
PFD	~40%	~35%	~25%
MTTFS	~50%	~15%	~35%

	Value:	Requirement Met?
SIL-Achieved	1	Yes
SIL-Calculated	1	
STR-Calculated	7.27e-6	No
Architectural Constraints	N/A	IEC 61508 : 2000
Systematic Capabilities	N/A	
Availability	N/A	
Loop PFD Average	N/A	
Loop PFH	7.60e-6	
MTTFS	15.71	
Risk Reduction Factor	N/A	

ID	PFD	Availability	MTTFS	PTI
Avenor Sensor System 1	1.61e-6	N/A	67.79	8

- In the diagram, select the Sensor System node, which is represented by the voting architecture. The datasheet for the Sensor System appears, along with a list of Sensor Groups in the Sensor System.

Sensor System Details Sensor Groups

Link Unlink Copy

Datasheet ID: Protective Instrument Lc Site: MBJ Site

System ID: Sensor System 17

Voting Between Groups*: 1001 Number of Groups: 1

Common Cause(Beta)*: Numeric input

Calculated Results

Calculated PFD Avg: Numeric input Calculated PFH: Numeric input

- If needed, modify values in the [available fields](#).
- In the upper-right corner of the datasheet, select . The changes made to the Protective Instrument Loop Sensor System are saved.

Results

- The changes you have made may alter the calculated results for the SIL analysis. The APMsystem calculates the results again.

Next Steps

- [Access the Results of a Protective Instrument Loop](#)

Copy a Protective Instrument Loop Sensor System

Before You Begin

- [Create a Protective Instrument Loop.](#)

About This Task

Note: Copying a Protective Instrument Loop Sensor System alters the calculations of the loop. Therefore, you must verify the calculations again in the APM system.

Procedure

1. [Access the Protective Instrument Loop Sensor System](#) into which you want to copy another Sensor System.
2. In the upper-right corner of the datasheet, select **Copy**.

The **Search** window appears.

Search

Look in

Cancel

OK

3. In the upper-right corner of the window, select .

A list of Protective Instrument Loop Sensor Systems appears.

Search

Look in

<input type="radio"/>	Final Element System 1- Protective Instrument Loop System	Protective Instrument Loop Group	Protective Instrument Loop
<input type="radio"/>	Sensor System 1- Protective Instrument Loop System	Protective Instrument Loop Group	Protective Instrument Loop
<input type="radio"/>	PT-101A/B Sensor System- Protective Instrument Loop System	Protective Instrument Loop Group	Protective Instrument Loop
<input type="radio"/>	FT-0113A/B/C System- Protective Instrument Loop System	Protective Instrument Loop Group	Protective Instrument Loop
<input type="radio"/>	FCCU SIF-001 Final Element System- Protective Instrument Loop System	Protective Instrument Loop Group	Protective Instrument Loop
<input type="radio"/>	PT-004B/C System- Protective Instrument Loop System	Protective Instrument Loop Group	Protective Instrument Loop
<input type="radio"/>	PT-005B/C System- Protective Instrument Loop System	Protective Instrument Loop Group	Protective Instrument Loop

[Cancel](#) [OK](#)

4. Select the check box that corresponds to the Sensor System that you want to copy, and then select **OK**.

The Protective Instrument Loop Sensor System is copied.

Results

- The values in each field of the copied record are overwritten by those of the original record that you copied.
- The value in the Sensor System ID field in the copied record is appended with a 1.
- All the Sensor Groups and Sensors linked to the original Sensor System also become a part of the Sensor System that you copied, replacing the existing ones. If these existing records are not part of another protective instrument loop, they are deleted. Otherwise, they are just unlinked from the loop.
- Copying a record alters the calculations for the loop. The APM system performs the calculations again.

Next Steps

- [Access the Results of a Protective Instrument Loop](#)

Link a Protective Instrument Loop Sensor System

Before You Begin

- [Create a Protective Instrument Loop.](#)

About This Task

Important: If you modify a Protective Instrument Loop Element that is linked to more than one Protective Instrument Loop, the changes that you have made are reflected in all the associated loops.

Note: Linking a Protective Instrument Loop Sensor System alters the calculations of the loop. Therefore, you must verify the calculations again in the APM system.

Procedure

1. [Access the Protective Instrument Loop Sensor System](#) to which you want to link another Sensor System.
2. In the upper-right corner of the datasheet, select **Link**.

The **Search** window appears.

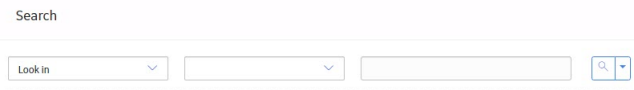

Cancel

OK

3. In the upper-right corner of the datasheet, select .

A list of Protective Instrument Loop Sensor Systems appears.

Search

Look in [] [] [] []

<input type="radio"/>	Final Element System 1-	Protective Instrument Loop System	Protective Instrument Loop Group	Protective Instrument Loop
<input type="radio"/>	Sensor System 1-	Protective Instrument Loop System	Protective Instrument Loop Group	Protective Instrument Loop
<input type="radio"/>	PT-101A/B Sensor System-	Protective Instrument Loop System	Protective Instrument Loop Group	Protective Instrument Loop
<input type="radio"/>	FT-0113A/B/C System-	Protective Instrument Loop System	Protective Instrument Loop Group	Protective Instrument Loop
<input type="radio"/>	FCCU SIF-001 Final Element System-	Protective Instrument Loop System	Protective Instrument Loop Group	Protective Instrument Loop
<input type="radio"/>	PT-004B/C System-	Protective Instrument Loop System	Protective Instrument Loop Group	Protective Instrument Loop
<input type="radio"/>	PT-005B/C System-	Protective Instrument Loop System	Protective Instrument Loop Group	Protective Instrument Loop

Cancel OK

4. Select the check box that corresponds to the Protective Instrument Loop Sensor System that you want to link, and then select **OK**.
5. If the Protective Instrument Loop Sensor System that you want to replace is also linked to another loop, select **Proceed**.

Note: If you want to access a list of Protective Instrument Loops linked to the Protective Instrument Loop Sensor System that you want to replace, select **Show Details**.

-or-

If the Protective Instrument Loop Sensor System that you want to replace is not linked to any other loop, a message appears, indicating that the Protective Instrument Loop Sensor System will be deleted. Select **OK**.

The original Protective Instrument Loop Sensor System is replaced by the one that you have selected.

Results

- The existing Protective Instrument Loop Sensor System is replaced by the one that you have linked. If the existing Sensor System is not a part of another loop, then the record is deleted. Otherwise, the record is unlinked from the loop.
- In addition to the Sensor System that you have linked, all the Sensor Groups and Sensors in the loop also become a part of the loop, replacing the existing ones. If these existing records are not part of another loop, then they are deleted. Otherwise, the records are unlinked from the loop.
- Linking a record alters the calculations for the loop. The APM system performs the calculations again.

Next Steps

- [Access the Results of a Protective Instrument Loop](#)

Unlink a Protective Instrument Loop Sensor System

About This Task

Note: Unlinking a Protective Instrument Loop Sensor System record alters the calculations of the loop. Hence, you must verify the calculations again in the APM system.

Procedure

1. [Access the Protective Instrument Loop Sensor System](#) from which you want to unlink a Protective Instrument Loop Sensor System.
2. In the upper-right corner of the datasheet, select **Unlink**.

Note: The **Unlink** button is enabled only if the Sensor System is a linked element.

If the Protective Instrument Loop Sensor System that you want to replace is not linked to any other loop, a message appears, indicating that the Protective Instrument Loop Sensor System will be deleted. Select **OK**.

3. Select **OK**.

The Protective Instrument Loop Sensor System is replaced by a default record.

Results

- The existing Protective Instrument Loop Sensor System is replaced by a default record. If the existing Sensor System is not a part of another loop, then the record is deleted. Otherwise, the record is unlinked from the loop.
- In addition to the Sensor System that you have unlinked, all the Sensor Groups and Sensors in the loop are also unlinked, and replaced by default records. If these Sensor Groups and Sensors are not part of another loop, then the records are deleted. Otherwise, the records are unlinked from the loop.
- Unlinking a record alters the calculations for the loop. The APM system performs the calculations again.

Next Steps

- [Access the Results of a Protective Instrument Loop](#)

Access a Protective Instrument Loop Sensor Group

Procedure

1. [Access the Protective Instrument Loop](#) that is linked to the Protective Instrument Loop Sensor Group that you want to access.
2. In the workspace, select the **Loop Diagram & calculation** tab.

The **Loop Diagram & calculation** section appears.

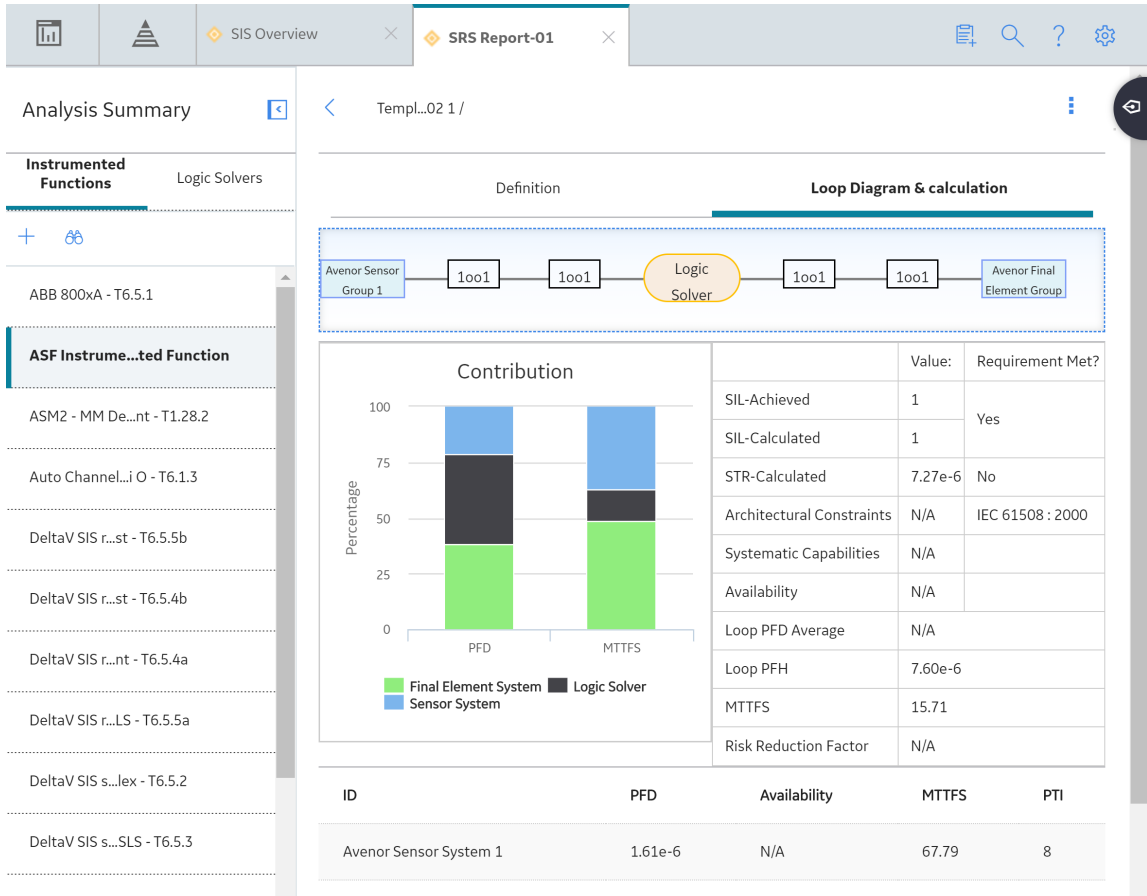

3. In the diagram, select the Sensor Group node that represents the Protective Instrument Loop Sensor Group that you want to access.

The datasheet for the Sensor Group appears.

Sensor Group Details

Group ID: Sensor Group 21

Voting*: 1003

MTR*: Numeric Input

Custom Vote M*: 1

Custom Vote N*: 3

Proof Test Interval*: Numeric Input

Proof Test Coverage*: 0 (PCT)

Common Cause (Beta)*: Numeric Input

Diverse:

4. If needed, modify values in the available fields.

5. In the upper-right corner of the datasheet, select .

The changes made to the Protective Instrument Loop Sensor Group are saved.

Results

- The changes you have made may alter the calculated results for the SIL analysis. The APM system calculates the results again.

Next Steps

- [Access the Results of a Protective Instrument Loop](#)

Create a Protective Instrument Loop Sensor Group

Before You Begin

- [Create a Protective Instrument Loop](#).

About This Task

This topic describes how to create a Protective Instrument Loop Sensor Group as part of SIL verification. You can also [copy](#) or [link](#) a Protective Instrument Loop Sensor Group that is associated with another loop.

Note: By default, when you create a Protective Instrument Loop, a Protective Instrument Loop Sensor Group is already created. You can, however, create a maximum of four Protective Instrument Loop Sensor Groups in a loop.

Procedure

1. [Access the Protective Instrument Loop](#) in which you want to add a Protective Instrument Loop Sensor Group.
2. In the workspace, select the **Loop Diagram & calculation** tab.

The **Loop Diagram & calculation** section appears.

Contribution

Metric	Value	Requirement Met?
SIL-Achieved	1	Yes
SIL-Calculated	1	
STR-Calculated	7.27e-6	No
Architectural Constraints	N/A	IEC 61508 : 2000
Systematic Capabilities	N/A	
Availability	N/A	
Loop PFD Average	N/A	
Loop PFH	7.60e-6	
MTTFS	15.71	
Risk Reduction Factor	N/A	

ID	PFD	Availability	MTTFS	PTI
Avenor Sensor System 1	1.61e-6	N/A	67.79	8

- In the diagram, select the Sensor System node, which is represented by the voting architecture. The datasheet for the Sensor System appears.

Sensor System Details

Datasheet ID: Protective Instrument Lc

System ID: Sensor System 17

Voting Between Groups*: 1oo1

Number of Groups: 1

Common Cause(Beta)*: Numeric input

Calculated Results

Calculated PFD Avg: Numeric input

Calculated PFH: Numeric input

- In the workspace, select **Sensor Groups**. The **Sensor Groups** section appears, displaying a list of Sensor Groups in the Sensor System.

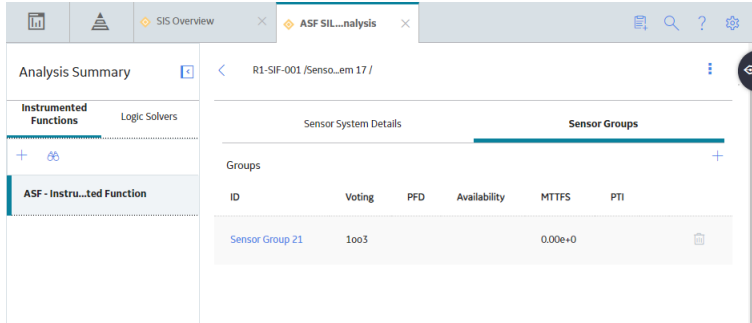

5. In the upper-right corner of the section, select .

A new Protective Instrument Loop Sensor Group is added to the list of Sensor Groups with a default ID.

6. Select the newly added record.

A blank datasheet for the Sensor Group appears.

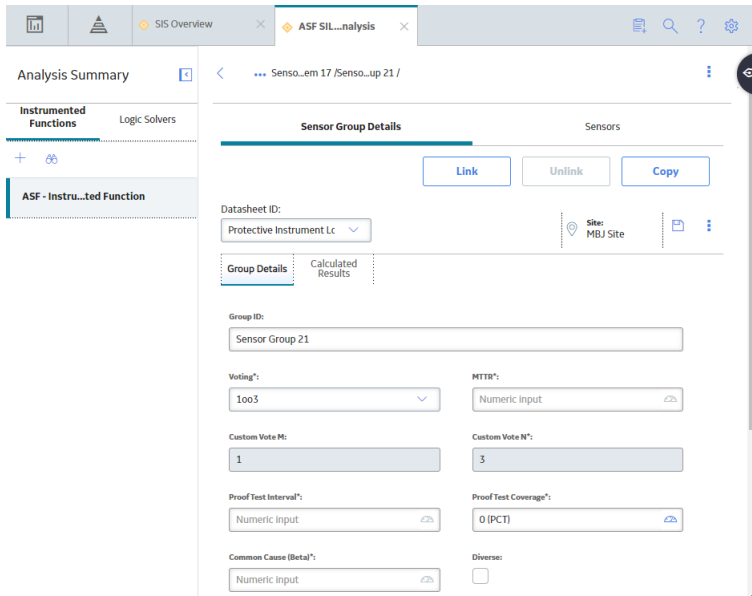

7. As needed, enter values in the [available fields](#).

8. In the upper-right corner of the datasheet, select .

The Protective Instrument Loop Sensor Group is created.

Results

- Along with the Protective Instrument Loop Sensor Group, a Protective Instrument Loop Sensor is also created.
- The newly created Protective Instrument Loop Sensor Group and Protective Instrument Loop Sensor are shown in the diagram.
- The voting architecture in the Protective Instrument Loop Sensor System is updated both in the datasheet and also in the diagram.

Copy a Protective Instrument Loop Sensor Group

Before You Begin

- [Create a Protective Instrument Loop.](#)

About This Task

Note: Copying a Protective Instrument Loop Sensor Group alters the calculations for the protective instrument loop. Hence, you must view the calculations again.

Procedure

1. [Access the Protective Instrument Loop Sensor Group](#) into which you want to copy another Sensor Group.
2. In the upper-right corner of the datasheet, select **Copy**.

The **Search** window appears.

Search

Look in			🔍
---------	--	--	---

Cancel OK

3. In the upper-right corner of the datasheet, select .
A list of Protective Instrument Loop Sensor Groups appears.

Search

Look in

<input type="radio"/>	Final Element Group- Protective Instrument Loop Group	Protective Instrument Loop System	Protective Instrument Loop Final Element
<input type="radio"/>	Sensor Group 1- Protective Instrument Loop Group	Protective Instrument Loop System	Protective Instrument Loop Sensor
<input type="radio"/>	Final Element Group 1- Protective Instrument Loop Group	Protective Instrument Loop System	Protective Instrument Loop Final Element
<input type="radio"/>	PT-101A/B Sensor Group- Protective Instrument Loop Group	Protective Instrument Loop System	Protective Instrument Loop Sensor
<input type="radio"/>	FT-0113A/B/C Group- Protective Instrument Loop Group	Protective Instrument Loop System	Protective Instrument Loop Sensor
<input type="radio"/>	Spent and Regen Slide Valve Group- Protective Instrument Loop Group	Protective Instrument Loop System	Protective Instrument Loop Final Element

- Select the record that you want to copy, and then select **OK**.

The Protective Instrument Loop Sensor Group is copied.

Results

- The values in each field of the copied record are overwritten by those of the original record that you copy.
- The value in the Sensor Group ID field in the copied record is appended with 1.
- All the Sensors linked to the original Sensor Group also become a part of the Sensor Group that you copy, replacing the existing ones. If these existing records are not part of another loop, they are deleted. Otherwise, they are unlinked from the loop.
- Copying a record alters the calculations for the loop. The APM system performs the calculations again.

Next Steps

- [Access the Results of a Protective Instrument Loop](#)

Link a Protective Instrument Loop Sensor Group

Before You Begin

- [Create a Protective Instrument Loop.](#)

About This Task

Important: If you modify a Protective Instrument Loop Element that is linked to more than one loop, the changes that you have made are reflected in all the associated loops.

Note: Linking a Protective Instrument Loop Sensor Group alters the calculations of the loop. Therefore, you must verify the calculations again.

Procedure

1. [Access the Protective Instrument Loop Sensor Group](#) to which you want to link another Sensor Group.
2. In the upper-right corner of the datasheet, select **Link**.

The **Search** window appears.

Search

Look in

Cancel

OK

3. In the upper-right corner of the window, select .

A list of Protective Instrument Loop Sensor Group appears.

Search

Look in ▼
 ▼
 ▼
🔍 ▼

<input type="radio"/>	Final Element Group- Protective Instrument Loop Group Protective Instrument Loop System Protective Instrument Loop Final Element	
<input type="radio"/>	Sensor Group 1- Protective Instrument Loop Group Protective Instrument Loop System Protective Instrument Loop Sensor	
<input type="radio"/>	Final Element Group 1- Protective Instrument Loop Group Protective Instrument Loop System Protective Instrument Loop Final Element	
<input type="radio"/>	PT-101A/B Sensor Group- Protective Instrument Loop Group Protective Instrument Loop System Protective Instrument Loop Sensor	
<input type="radio"/>	FT-0113A/B/C Group- Protective Instrument Loop Group Protective Instrument Loop System Protective Instrument Loop Sensor	
<input type="radio"/>	Spent and Regen Slide Valve Group- Protective Instrument Loop Group Protective Instrument Loop System Protective Instrument Loop Final Element	

Cancel
OK

4. Select the check box that corresponds to the Sensor Group that you want to link, and then select **OK**.
5. Depending on the message that appears, select **Proceed** or **OK**.

If the Protective Instrument Loop Sensor Group that you want to replace is also linked to another loop, select **Proceed**.

Note: If you want to access the list of Protective Instrument Loops linked to the Protective Instrument Loop Sensor Group that you want to replace, select **Show Details**.

-or-

If the Protective Instrument Loop Sensor Group that you want to replace is not linked to any other loop, a message appears, indicating that the Protective Instrument Loop Sensor Group will be deleted. Select **OK**.

The original Protective Instrument Loop Sensor Group is replaced by the one that you have selected.

Results

- The existing Protective Instrument Loop Sensor Group is replaced by the one that you have linked. If the existing sensor group is not a part of another loop, then it is deleted. Otherwise, it is just unlinked from the loop.
- In addition to the sensor group that you have linked, all the sensors in the group also become a part of the loop, replacing the existing ones. If these sensors are not part of another loop, then they are deleted. Otherwise, they are just unlinked from the loop.
- Linking a record alters the calculations for the loop. The APM system performs the calculations again.

Next Steps

- [Access the Results of a Protective Instrument Loop](#)

Unlink a Protective Instrument Loop Sensor Group

About This Task

Note: Unlinking a Protective Instrument Loop Sensor Group alters the calculations of the loop. Hence, you must access the calculations again.

Procedure

1. [Access the Protective Instrument Loop Sensor Group](#) from which you want to unlink a Protective Instrument Loop Sensor Group.
2. In the upper-right corner of the datasheet, select **Unlink**.
Note: The **Unlink** button is enabled only if the sensor group is a linked element.
3. If the Protective Instrument Loop Sensor Group that you want to replace is not linked to any other loop, a message appears, indicating that the Protective Instrument Loop Sensor Group will be deleted. Select **OK**.

The Protective Instrument Loop Sensor Group is replaced by a default record.

Results

- If the Protective Instrument Loop Sensor Group that you have unlinked is the only one in the loop, it is replaced by a default record.
- If the Sensor Group is not a part of another loop, then it is deleted. Otherwise, it is unlinked from the loop.
- In addition to the Sensor Group that you have unlinked, all the Sensors in the loop are also unlinked, replaced by a default record. If these Sensors are not part of another loop, then they are deleted. Otherwise, they are just unlinked from the loop.
- Unlinking a record alters the calculations for the loop. The APM system performs the calculations again.

Next Steps

- [Access the Results of a Protective Instrument Loop](#)

Delete a Protective Instrument Loop Sensor Group

About This Task

Important: Deleting a Protective Instrument Loop Sensor Group also deletes all the associated Protective Instrument Loop Sensors. Protective Instrument Loops must contain at least one sensor, sensor group, and sensor system. If the Protective Instrument Loop Sensor Group that you want to delete is the only Sensor Group in the loop, then you cannot delete it.

Note: Deleting a Protective Instrument Loop Sensor Group alters the calculations of the loop. Hence, you may need to review the calculations again.

Procedure

1. [Access the Protective Instrument Loop Sensor System](#) associated with the Protective Instrument Loop Sensor Group that you want to delete.
2. In the workspace, select the **Sensor Groups** tab.

The **Sensor Groups** section appears, displaying a list of Sensor Groups in the Sensor System.

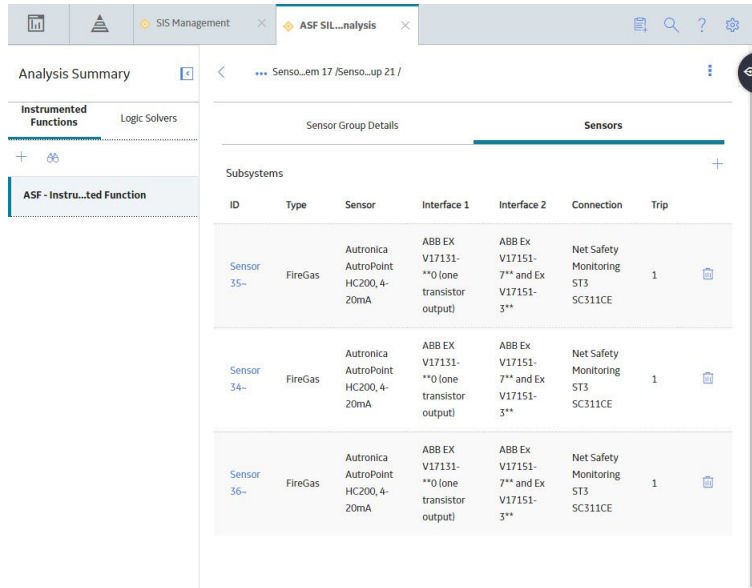

3. Select the  button next to the Protective Instrument Loop Sensor Group that you want to delete. A message appears, asking if you really want to delete the Sensor Group.
4. Select **OK**. The Protective Instrument Loop Sensor Group is deleted.

Results

- The Sensors that are linked to the Sensor Group are also deleted.
- The [voting architecture](#) is changed to reflect the updated number of Sensor Groups.
- The APM system calculates the results for the loop again.

Next Steps

- [Access the Results of a Protective Instrument Loop](#)

Access a Protective Instrument Loop Sensor

Procedure

1. [Access the Protective Instrument Loop Sensor Group](#) that is linked to the Protective Instrument Loop Sensor that you want to access.
2. In the workspace, select the **Sensors** tab.

The **Sensors** section appears, displaying a list of Sensors in the Sensor Group.

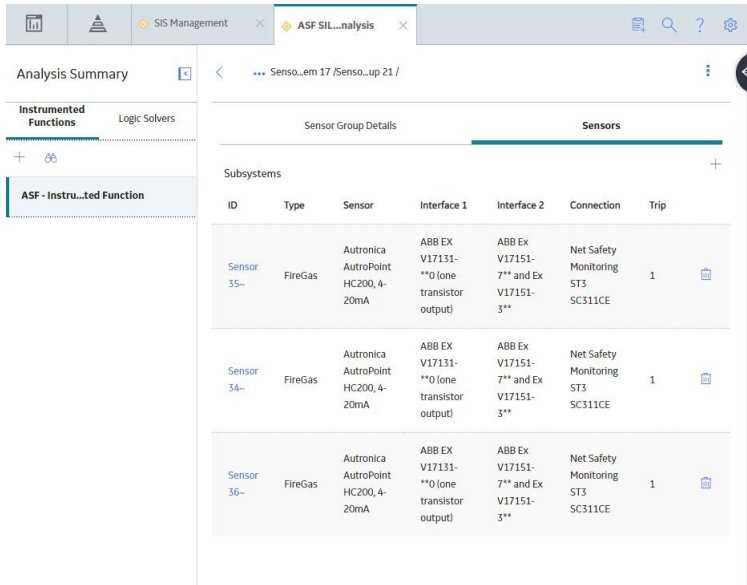

3. Select the Protective Instrument Loop Sensor that you want to access. The datasheet for the Sensor appears.

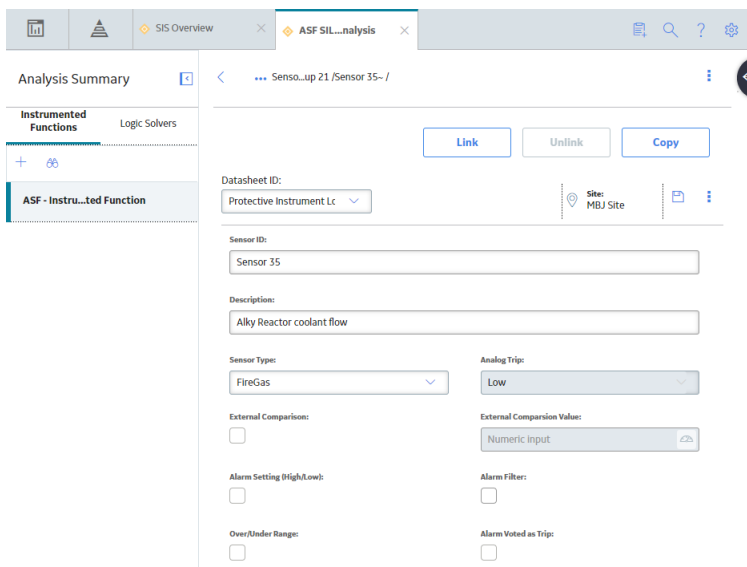

4. As needed, modify values in the available fields.
5. In the upper-right corner of the datasheet, select . The changes made to the Protective Instrument Loop Sensor are saved.

Results

- If the Diverse field in the Sensor Group is cleared, the modifications to values in the sensor are reflected in other Sensors within the Sensor Group.
- The changes you have made may alter the calculated results for the loop. The APM system calculates the results again.

Next Steps

- [Access the Results of a Protective Instrument Loop](#)

Create a Protective Instrument Loop Sensor

Before You Begin

- [Create a Protective Instrument Loop.](#)

About This Task

This topic describes how to create a Protective Instrument Loop Sensor as part of Safety Integrity Level (SIL) verification. You can also [copy](#) or [link](#) a Protective Instrument Loop Sensor that is associated with another loop.

Note: By default, when you create a Protective Instrument Loop or a Protective Instrument Loop Sensor Group, a Protective Instrument Loop Sensor is already created. You can, however, create as many Protective Instrument Loop Sensors as required.

Procedure

1. [Access the Protective Instrument Loop Sensor Group](#) in which you want to create a Protective Instrument Loop Sensor.
2. In the workspace, select the **Sensors** tab.

The **Sensors** section appears, displaying a list of Sensors in the Sensor Group.

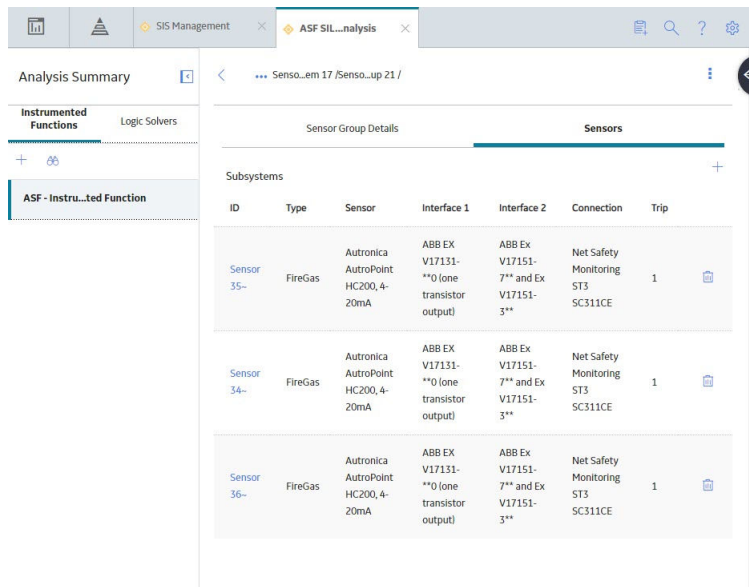

Sensor Group Details		Sensors				
ID	Type	Sensor	Interface 1	Interface 2	Connection	Trip
Sensor 35	FireGas	Autronica AutoPoint HC200, 4-20mA	ABB EX V17131-1**D (one transistor output)	ABB Ex V17151-7** and Ex V17151-3**	Net Safety Monitoring ST3 SC311CE	1
Sensor 34	FireGas	Autronica AutoPoint HC200, 4-20mA	ABB EX V17131-1**D (one transistor output)	ABB Ex V17151-7** and Ex V17151-3**	Net Safety Monitoring ST3 SC311CE	1
Sensor 36	FireGas	Autronica AutoPoint HC200, 4-20mA	ABB EX V17131-1**D (one transistor output)	ABB Ex V17151-7** and Ex V17151-3**	Net Safety Monitoring ST3 SC311CE	1

3. In the upper-right corner of the section, select **+**.

A Protective Instrument Loop Sensor is created and added to the list of Sensors. If the Diverse field in the Sensor Group is cleared, the sensor will contain the same values as those in the default record.

4. For the newly added record, in the **ID** column, select the link.

A blank datasheet for the Sensor appears.

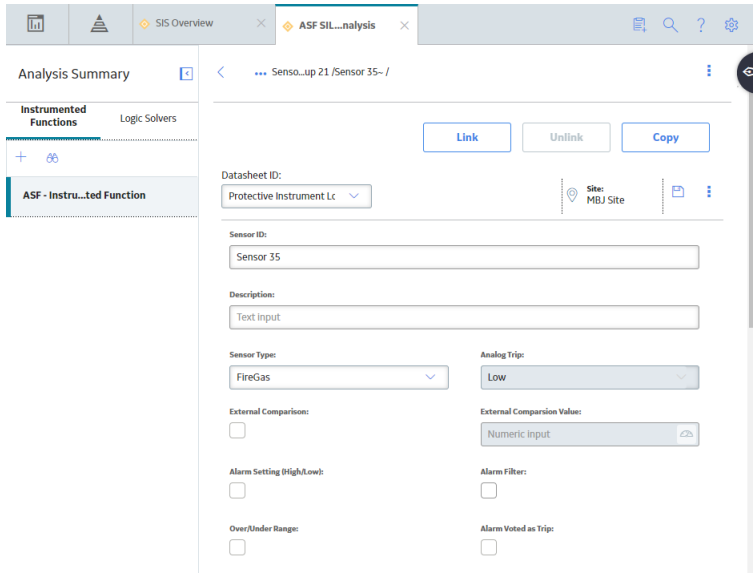

5. As needed, enter values in the available fields.
6. In the upper-right corner of the datasheet, select . The Protective Instrument Loop Sensor is created.

Results

- The [voting architecture](#) in the Protective Instrument Loop Sensor Group record is updated both in the datasheet and also in the diagram.
- If the Diverse field in the Sensor Group is cleared, the modifications to values in the sensor are reflected in other Sensors within the Sensor Group.
- The APM system calculates the results again.

Next Steps

- [Access the Results of a Protective Instrument Loop](#)
- [Create a Proven In Use Justification record](#)

Copy a Protective Instrument Loop Sensor

Before You Begin

- [Create a Protective Instrument Loop](#).

About This Task

Note: Copying a Protective Instrument Loop Sensor alters the calculations for the protective instrument loop. Therefore, you must verify the calculations again.

Procedure

1. [Access the Protective Instrument Loop Sensor](#) that you want to replace.
2. In the upper-right corner of the datasheet, select **Copy**. The **Search** window appears.

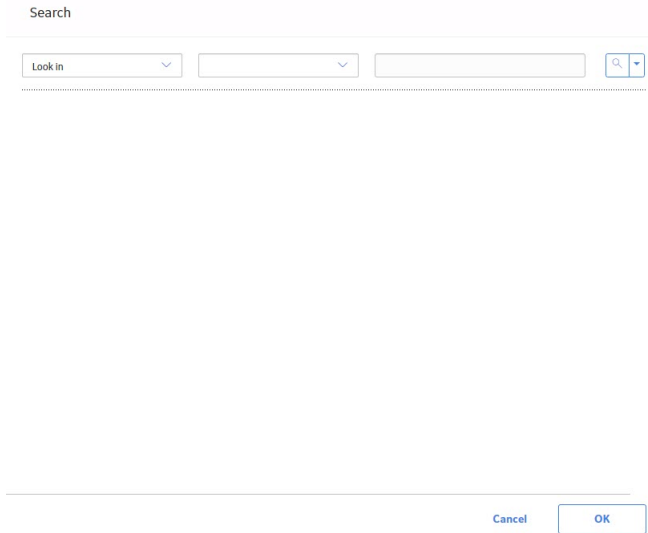

- In the upper-right corner of the window, select . A list of Protective Instrument Loop Sensors appears.

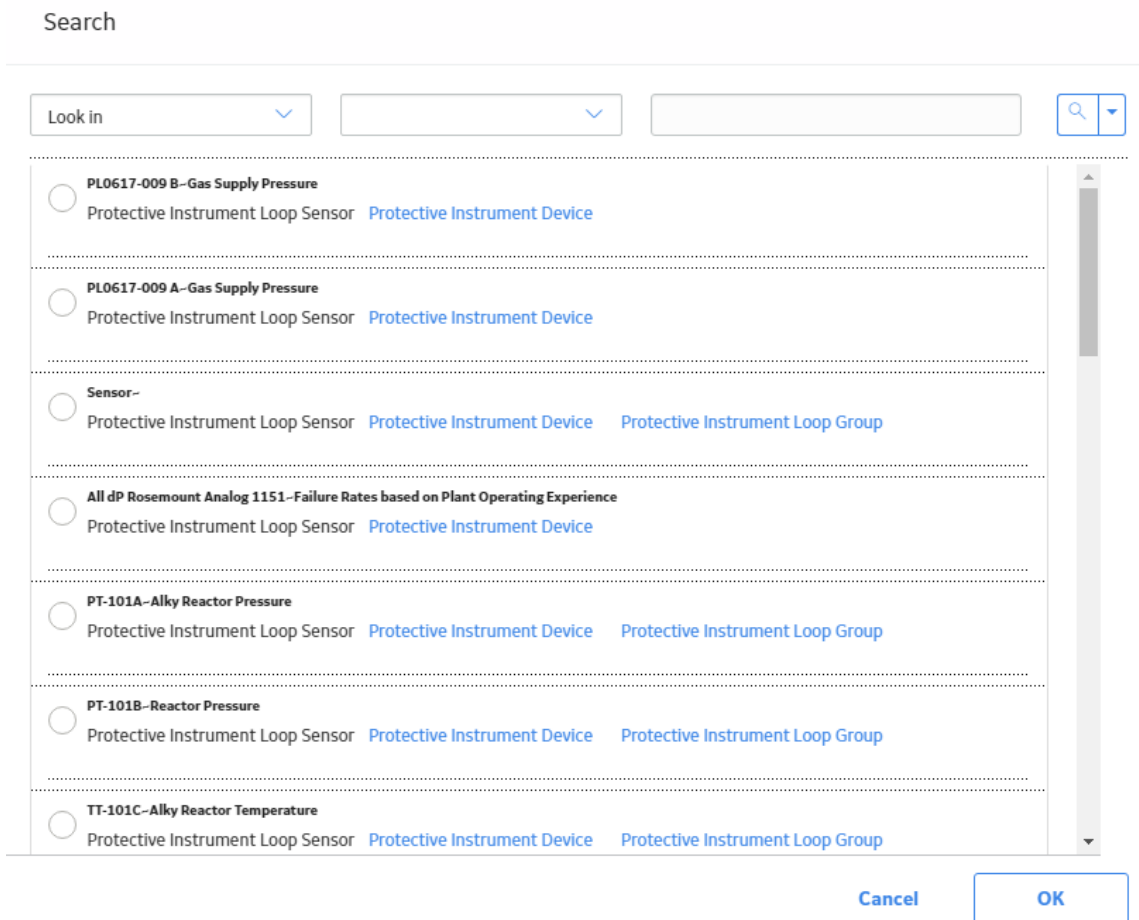

- Select the check box that corresponds to the Sensor that you want to copy, and then select **OK**. The Protective Instrument Loop Sensor is copied.

Results

- The values in each field of the copied record are overwritten by those of the original record that you copied.
- The value in the Sensor ID field in the copied record is appended with a 1.
- Copying a record alters the calculations for the loop. The APM system performs the calculations again.

Next Steps

- [Access the Results of a Protective Instrument Loop](#)

Link a Protective Instrument Loop Sensor

Before You Begin

- [Create a Protective Instrument Loop](#).

About This Task

Important: If you modify a Protective Instrument Loop Element that is linked to more than one loop, the changes that you have made are reflected in all the associated loops.

Note: Linking a Protective Instrument Loop Sensor alters the calculations for the loop. Therefore, you must verify the calculations again.

Procedure

1. [Access the Protective Instrument Loop Sensor](#) to which you want to link another Sensor.
2. In the upper-right corner of the datasheet, select **Link**.

The **Search** window appears.

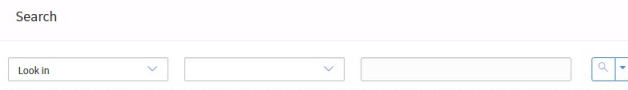

The image shows a search window titled "Search". It contains a "Look in" dropdown menu, followed by two empty input fields, and a search icon with a dropdown arrow.



The image shows the bottom of the search window with "Cancel" and "OK" buttons.

3. In the upper-right corner of the window, select .
- A list of Protective Instrument Loop Sensors appears.

Search

Look in ▼

🔍 ▼

<input type="radio"/>	PL0617-009 B-Gas Supply Pressure	Protective Instrument Loop Sensor Protective Instrument Device
<hr/>		
<input type="radio"/>	PL0617-009 A-Gas Supply Pressure	Protective Instrument Loop Sensor Protective Instrument Device
<hr/>		
<input type="radio"/>	Sensor-	Protective Instrument Loop Sensor Protective Instrument Device Protective Instrument Loop Group
<hr/>		
<input type="radio"/>	All dP Rosemount Analog 1151-Failure Rates based on Plant Operating Experience	Protective Instrument Loop Sensor Protective Instrument Device
<hr/>		
<input type="radio"/>	PT-101A-Alky Reactor Pressure	Protective Instrument Loop Sensor Protective Instrument Device Protective Instrument Loop Group
<hr/>		
<input type="radio"/>	PT-101B-Reactor Pressure	Protective Instrument Loop Sensor Protective Instrument Device Protective Instrument Loop Group
<hr/>		
<input type="radio"/>	TT-101C-Alky Reactor Temperature	Protective Instrument Loop Sensor Protective Instrument Device Protective Instrument Loop Group

Cancel
OK

4. Select the check box that corresponds to the Sensor that you want to link, and then select **OK**.
5. Depending on the message that appears, select **Proceed** or **OK**.

If the Protective Instrument Loop Sensor that you want to replace is also linked to another loop, select **Proceed**.

Note: If you want to access the list of Protective Instrument Loops linked to the Protective Instrument Loop Sensor that you want to replace, select **Show Details**.

-or-

If the Protective Instrument Loop Sensor that you want to replace is not linked to any other loop, a message appears, indicating that the Protective Instrument Loop Sensor will be deleted. Select **OK**.

The original Protective Instrument Loop Sensor is replaced by the one that you have selected.

Results

- The existing Protective Instrument Loop Sensor is replaced by the one that you have linked. If the existing Sensor is not a part of another loop, then the record is deleted. Otherwise, the record is just unlinked from the loop.
- Linking a record alters the calculations for the loop. The APM system performs the calculations again.

Next Steps

- [Access the Results of a Protective Instrument Loop](#)

Unlink a Protective Instrument Loop Sensor

About This Task

Note: Unlinking a Protective Instrument Loop Sensor alters the calculations of the loop. Hence, you must access the calculations again.

Procedure

1. [Access the Protective Instrument Loop Sensor](#) that you want to unlink.
2. In the upper-right corner of the datasheet, select **Unlink**.

Note: The **Unlink** button is enabled only if the Sensor that you have selected is in a linked element.

3. If the Protective Instrument Loop Sensor that you want to replace is not linked to any other loop, a message appears, indicating that the Protective Instrument Loop Sensor will be deleted. Select **OK**.

The Protective Instrument Loop Sensor is unlinked.

Results

- If the existing Protective Instrument Loop Sensor is the only one in the group, it is replaced by a default one.
If the existing Sensor is not a part of another loop, then the record is deleted. Otherwise, the record is unlinked from the loop.
- Unlinking a record alters the calculations for the loop. The APM system performs the calculations again.

Next Steps

- [Access the Results of a Protective Instrument Loop](#)

Delete a Protective Instrument Loop Sensor

About This Task

Important: Protective Instrument Loops must contain at least one sensor, sensor group, and sensor system. If the Protective Instrument Loop Sensor that you want to delete is the only Sensor in the Sensor Group, then you cannot delete it.

Note: Deleting a Protective Instrument Loop Sensor alters the calculations of the loop. Hence, you may need to access the calculations again.

Procedure

1. [Access the Protective Instrument Loop Sensor Group](#) that is linked to the Protective Instrument Loop Sensor that you want to delete.
2. In the workspace, select the **Sensors** tab.

The **Sensors** section appears, displaying a list of Sensors in the Sensor Group.

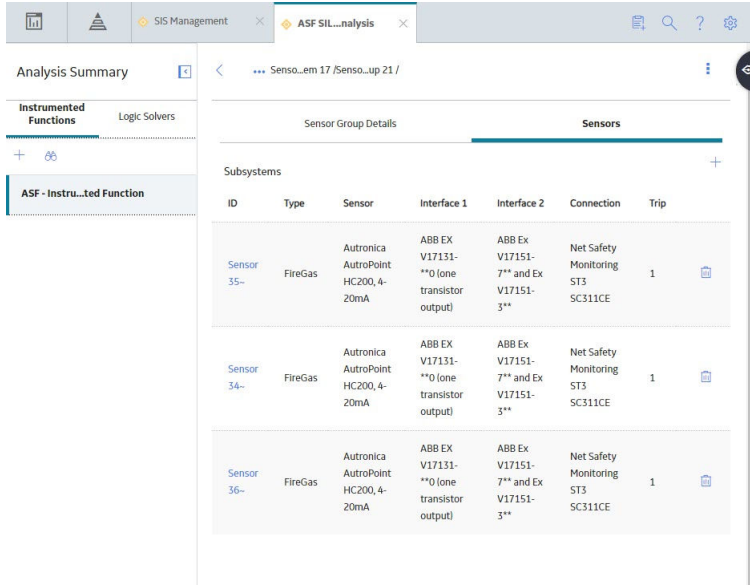

3. Select the  button next to the Protective Instrument Loop Sensor that you want to delete. A message appears, asking if you really want to delete the Protective Instrument loop Sensor.
4. Select **OK**. The Protective Instrument Loop Sensor is deleted.

Results

- The [voting architecture](#) is changed to reflect the updated number of Sensors.
- The APM system calculates the results for the loop again.

Next Steps

- [Access the Results of a Protective Instrument Loop](#)

Access a Protective Instrument Loop Final Element System

Before You Begin

- [Create a Protective Instrument Loop](#).

About This Task

Note:

There is only *one* final element system in a Protective Instrument Loop. When you create a Protective Instrument Loop, a Protective Instrument Loop Final Element System is automatically created and added to the loop. You cannot delete this record.

Procedure

1. [Access the Protective Instrument Loop](#) that is linked to the Protective Instrument Loop Final Element System that you want to access.
2. In the workspace, select the **Loop Diagram & calculation** tab.

The **Loop Diagram & calculation** section appears, displaying the diagram for the Protective Instrument Loop.

The screenshot displays the 'Loop Diagram & calculation' section. On the left, a list of instrumented functions is visible, including 'ABB 800xA - T6.5.1' and 'ASF Instru...ted Function'. The main area shows a logic solver diagram with a central 'Logic Solver' node connected to 'Avenor Sensor Group 1' and 'Avenor Final Element Group' via '1001' nodes. Below the diagram is a 'Contribution' bar chart showing the percentage contribution of the Final Element System (green), Logic Solver (black), and Sensor System (blue) to PFD and MTTFS. To the right of the chart is a table of calculated values.

	Value:	Requirement Met?
SIL-Achieved	1	Yes
SIL-Calculated	1	
STR-Calculated	7.27e-6	No
Architectural Constraints	N/A	IEC 61508 : 2000
Systematic Capabilities	N/A	
Availability	N/A	
Loop PFD Average	N/A	
Loop PFH	7.60e-6	
MTTFS	15.71	
Risk Reduction Factor	N/A	

ID	PFD	Availability	MTTFS	PTI
Avenor Sensor System 1	1.61e-6	N/A	67.79	8

- In the diagram, select the Final Element System node, which is represented by the voting architecture. The datasheet for the Final Element System appears, along with a list of Final Element Groups in the Final Element System.

The screenshot shows the 'Final Element System Details' datasheet. It includes fields for 'Datasheet ID' (Protective Instrument Lc), 'System ID' (Final Element System 17), 'Voting Between Groups' (1001), and 'Number of Groups' (1). There are also sections for 'Calculated Results' with input fields for 'Calculated PFD Avg' and 'Calculated PFH'.

- If needed, modify values in the [available fields](#).
- In the upper-right corner of the datasheet, select .

The changes made to the Protective Instrument Loop Final Element System are saved.

Results

- The changes you have made may alter the calculated results for the loop. The APM system calculates the results again.

Next Steps

- [Access the Results of a Protective Instrument Loop](#)

Copy a Protective Instrument Loop Final Element System

Before You Begin

- [Create a Protective Instrument Loop](#).

About This Task

Note: Copying a Protective Instrument Loop Final Element System alters the calculations of the loop. Therefore, you must verify the calculations again in the APM system.

Procedure

- [Access the Protective Instrument Loop Final Element System](#) into which you want to copy another Final Element System.
- In the upper-right corner of the datasheet, select **Copy**.

The **Search** window appears.

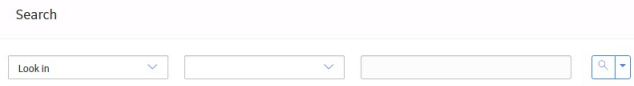

Cancel OK

- In the upper-right corner of the window, select .

A list of Protective Instrument Loop Final Element Systems appears.

Search

Protective Instrument Loop! Linked to

<input type="radio"/>	Final Element System 1- Protective Instrument Loop System	Protective Instrument Loop Group	Protective Instrument Loop
<input type="radio"/>	Sensor System 1- Protective Instrument Loop System	Protective Instrument Loop Group	Protective Instrument Loop
<input type="radio"/>	PT-101A/B Sensor System- Protective Instrument Loop System	Protective Instrument Loop Group	Protective Instrument Loop
<input type="radio"/>	FT-0113A/B/C System- Protective Instrument Loop System	Protective Instrument Loop Group	Protective Instrument Loop
<input type="radio"/>	FCCU SIF-001 Final Element System- Protective Instrument Loop System	Protective Instrument Loop Group	Protective Instrument Loop
<input type="radio"/>	PT-004B/C System- Protective Instrument Loop System	Protective Instrument Loop Group	Protective Instrument Loop
<input type="radio"/>	PT-005B/C System- Protective Instrument Loop System	Protective Instrument Loop Group	Protective Instrument Loop

4. Select the check box that corresponds to the Final Element System that you want to copy, and then select **OK**.

The Protective Instrument Loop Final Element System is copied.

Results

- The values in each field of the copied record are overwritten by those of the original record that you copied.
- The value in the Final Element System ID field in the copied record is appended with a 1.
- All the Final Element Groups and Final Elements linked to the original Final Element System also become a part of the Final Element System that you copied, replacing the existing ones. If these existing records are not part of another protective instrument loop, they are deleted. Otherwise, they are just unlinked from the loop.
- Copying a record alters the calculations for the loop. The APM system performs the calculations again.

Next Steps

- [Access the Results of a Protective Instrument Loop](#)

Link a Protective Instrument Loop Final Element System

Before You Begin

- [Create a Protective Instrument Loop.](#)

About This Task

Important: If you modify a Protective Instrument Loop Element that is linked to more than one Protective Instrument Loop, the changes that you have made are reflected in all the associated loops.

Note: Linking a Protective Instrument Loop Final Element System alters the calculations of the loop. Therefore, you must verify the calculations again in the APM system.

Procedure

1. [Access the Protective Instrument Loop Final Element System](#) that you want to replace.
2. In the upper-right corner of the datasheet, select **Link**.

The **Search** window appears.

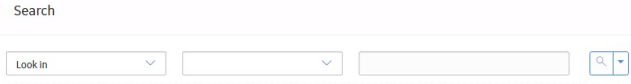

Search

Look in [dropdown] [input] [search button]

Cancel OK

3. In the upper-right corner of the datasheet, select .
- A list of Protective Instrument Loop Final Element Systems appears.

Search

Protective Instrument Loop! Linked to

<input type="radio"/>	Final Element System 1- Protective Instrument Loop System	Protective Instrument Loop Group	Protective Instrument Loop
<input type="radio"/>	Sensor System 1- Protective Instrument Loop System	Protective Instrument Loop Group	Protective Instrument Loop
<input type="radio"/>	PT-101A/B Sensor System- Protective Instrument Loop System	Protective Instrument Loop Group	Protective Instrument Loop
<input type="radio"/>	FT-0113A/B/C System- Protective Instrument Loop System	Protective Instrument Loop Group	Protective Instrument Loop
<input type="radio"/>	FCCU SIF-001 Final Element System- Protective Instrument Loop System	Protective Instrument Loop Group	Protective Instrument Loop
<input type="radio"/>	PT-004B/C System- Protective Instrument Loop System	Protective Instrument Loop Group	Protective Instrument Loop
<input type="radio"/>	PT-005B/C System- Protective Instrument Loop System	Protective Instrument Loop Group	Protective Instrument Loop

Cancel

4. Select the check box that corresponds to the Protective Instrument Loop Final Element System that you want to link, and then select **OK**.
5. Depending on the message that appears, select **Proceed** or **OK**.

If the Protective Instrument Loop Final Element System that you want to replace is also linked to another loop, select **Proceed**.

Note: If you want to access a list of Protective Instrument Loops linked to the Protective Instrument Loop Final Element System that you want to replace, select **Show Details**.

-or-

If the Protective Instrument Loop Final Element System that you want to replace is not linked to any other loop, a message appears, indicating that the Protective Instrument Loop Final Element System will be deleted. Select **OK**.

The original Protective Instrument Loop Final Element System is replaced by the one that you have selected.

Results

- The existing Protective Instrument Loop Final Element System is replaced by the one that you have linked. If the existing Final Element System is not a part of another loop, then the record is deleted. Otherwise, the record is unlinked from the loop.
- In addition to the Final Element System that you have linked, all the Final Element Groups and Final Elements in the loop also become a part of the loop, replacing the existing ones. If these existing

records are not part of another loop, then they are deleted. Otherwise, the records are just unlinked from the loop.

- Linking a record alters the calculations for the loop. The APM system performs the calculations again.

Next Steps

- [Access the Results of a Protective Instrument Loop](#)

Unlink a Protective Instrument Loop Final Element System

About This Task

Note: Unlinking a Protective Instrument Loop Final Element System record alters the calculations of the loop. Hence, you must verify the calculations again in the APM system.

Procedure

1. [Access the Protective Instrument Loop Final Element System](#) that you want to unlink.
2. In the upper-right corner of the datasheet, select **Unlink**.

Note: The **Unlink** button is enabled only if the Final Element System is a linked element.

3. If the Protective Instrument Loop Final Element System that you want to replace is not linked to any other loop, a message appears, indicating that the Protective Instrument Loop Final Element System will be deleted. Select **OK**.

The Protective Instrument Loop Final Element System is replaced by a default record.

Results

- The existing Protective Instrument Loop Final Element System is replaced by a default record. If the existing Final Element System is not a part of another loop, then the record is deleted. Otherwise, the record is unlinked from the loop.
- In addition to the Final Element System that you have unlinked, all the Final Element Groups and Final Elements in the loop are also unlinked, replaced by default records. If these Final Element Groups and Final Elements are not part of another loop, then the records are deleted. Otherwise, the records are unlinked from the loop.
- Unlinking a record alters the calculations for the loop. The APM system performs the calculations again.

Next Steps

- [Access the Results of a Protective Instrument Loop](#)

Access a Protective Instrument Loop Final Element Group

Procedure

1. [Access the Protective Instrument Loop](#) that is linked to the Protective Instrument Loop Final Element Group that you want to access.
2. In the workspace, select the **Loop Diagram & calculation** tab.

The **Loop Diagram & calculation** section appears.

SIS Overview | SRS Report-01

Analysis Summary < Templ...02 1 /

Instrumented Functions Logic Solvers

ABB 800xA - T6.5.1

ASF Instru...ted Function

ASM2 - MM De...nt - T1.28.2

Auto Channel...i O - T6.1.3

DeltaV SIS r...st - T6.5.5b

DeltaV SIS r...st - T6.5.4b

DeltaV SIS r...nt - T6.5.4a

DeltaV SIS r...LS - T6.5.5a

DeltaV SIS s...lex - T6.5.2

DeltaV SIS s...SLS - T6.5.3

Definition Loop Diagram & calculation

Contribution

	Value:	Requirement Met?
SIL-Achieved	1	Yes
SIL-Calculated	1	
STR-Calculated	7.27e-6	No
Architectural Constraints	N/A	IEC 61508 : 2000
Systematic Capabilities	N/A	
Availability	N/A	
Loop PFD Average	N/A	
Loop PFH	7.60e-6	
MTTFS	15.71	
Risk Reduction Factor	N/A	

ID	PFD	Availability	MTTFS	PTI
Avenor Sensor System 1	1.61e-6	N/A	67.79	8

- In the diagram, select the Final Element Group node that represents the Protective Instrument Loop Final Element Group that you want to access.

The datasheet for the Final Element Group appears.

ASF SIL...analysis

Analysis Summary < ... Final Lem 17 /Final...up 20 /

Instrumented Functions Logic Solvers

ASF - Instru...ted Function

Final Element Group Details Final Elements

Link Unlink Copy

Datasheet ID: Protective Instrument Loop (v) Site: MBL Site

Group Details Calculated Results

Group ID: Final Element Group 20

Voting: 1oo2 MTR: Numeric input

Custom Vote M: 1 Custom Vote N: 2

Proof Test Interval: 1 (Months) Proof Test Coverage: 12 (PCT)

Common Cause (Beta): 1 (PCT) Diverse:

ATI /PVST Enabled

ATI /PVST Coverage: Numeric input Use Custom PVST Coverage (Final Element Group only)

- If needed, modify values in the available fields.

5. In the upper-right corner of the datasheet, select .

The changes made to the Protective Instrument Loop Final Element Group are saved.

Results

- The changes you have made may alter the calculated results for the SIL analysis. The APM system calculates the results again.

Next Steps

- [Access the Results of a Protective Instrument Loop](#)

Create a Protective Instrument Loop Final Element Group

Before You Begin

- [Create a Protective Instrument Loop](#).

About This Task

This topic describes how to create a Protective Instrument Loop Final Element Group using a blank datasheet as part of SIL verification. You can also [copy](#) or [link](#) a Protective Instrument Loop Final Element Group that is associated with another loop.

Note: By default, when you create a Protective Instrument Loop, a Protective Instrument Loop Final Element Group is already created. You can, however, create as maximum of four Protective Instrument Loop Final Element Groups in a loop.

Procedure

1. [Access the Protective Instrument Loop](#) in which you want to add a Protective Instrument Loop Final Element Group.
2. In the workspace, select the **Loop Diagram & calculation** tab.

The **Loop Diagram & calculation** section appears.

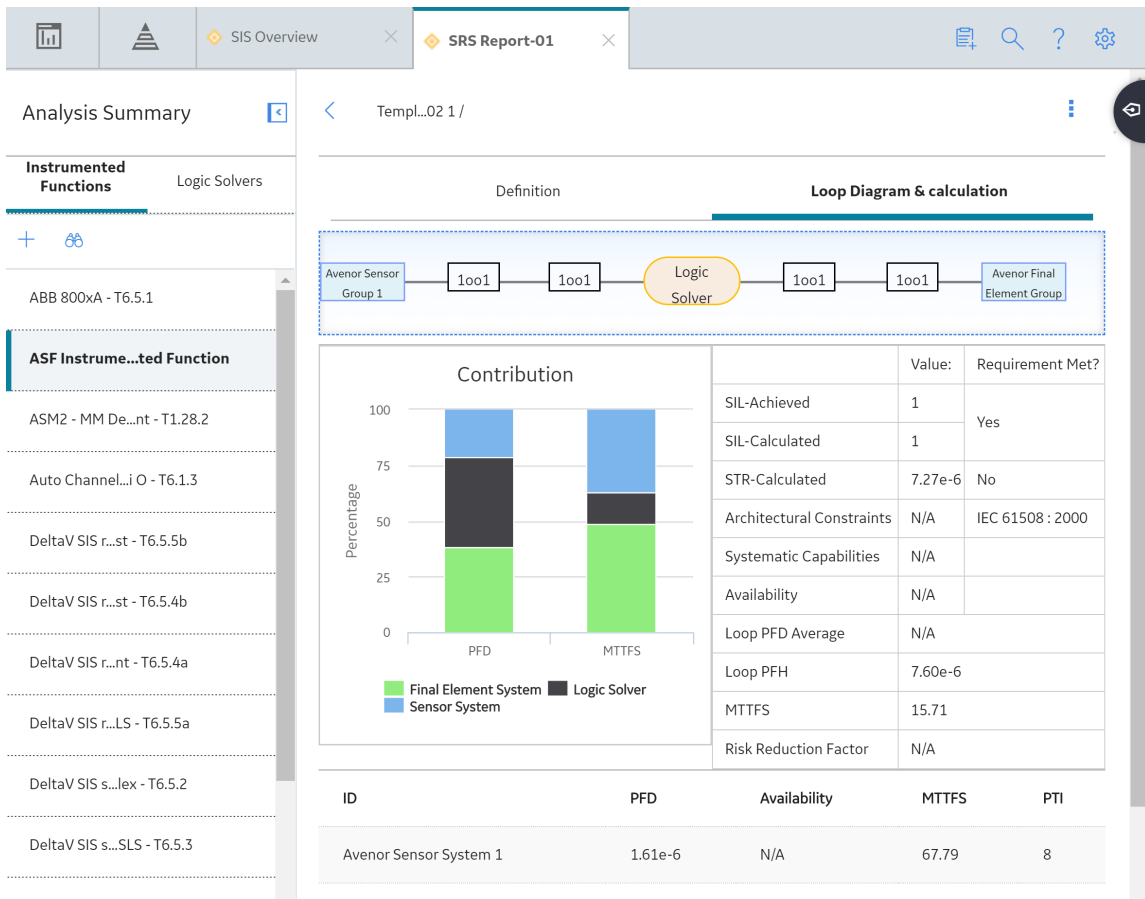

- In the diagram, select the Final Element System node, which is represented by the voting architecture. The datasheet for the Final Element System appears.

Final Element System Details

Datasheet ID: Protective Instrument Lc

System ID: Final Element System 17

Voting Between Groups*: 1oo1

Number of Groups: 1

Common Cause(Beta)*: Numeric Input

Calculated Results

Calculated PFD Avg: Numeric Input

Calculated PFH: Numeric Input

- In the workspace, select **Final Element Groups**. The **Final Element Groups** section appears, displaying a list of Final Element Groups in the Final Element System.

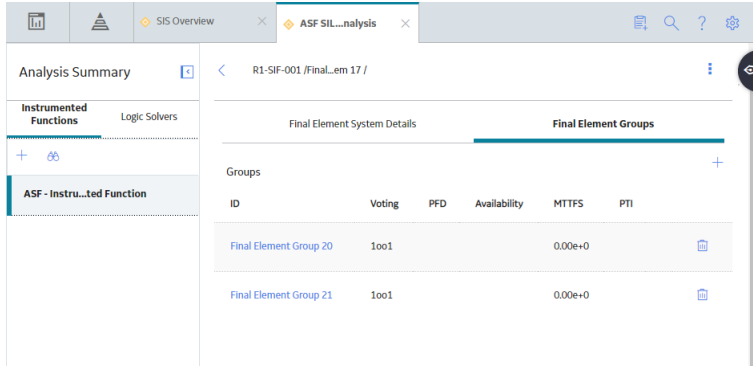



5. In the upper-right corner of the section, select .

A new Protective Instrument Loop Final Element Group is added to the list of Final Element Groups with a default ID.

6. Select the newly added record.

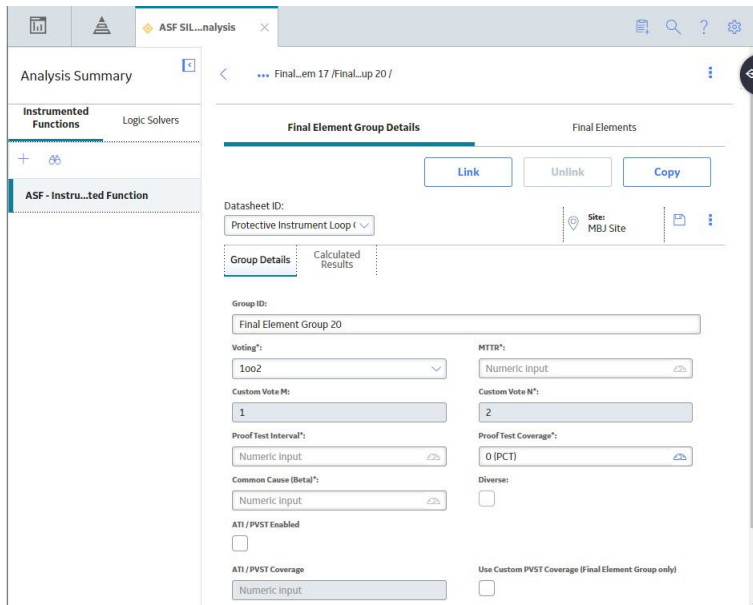
A blank datasheet for the Final Element Group appears.



7. As needed, enter values in the [available fields](#).
8. In the upper-right corner of the datasheet, select .

The Protective Instrument Loop Final Element Group is created.

Results

- Along with the Protective Instrument Loop Final Element Group, a Protective Instrument Loop Final Element is also created.
- The newly created Protective Instrument Loop Final Element Group and Protective Instrument Loop Final Element are shown in the diagram.
- The voting architecture in the Protective Instrument Loop Final Element System is updated both in the datasheet and also in the diagram.

Copy a Protective Instrument Loop Final Element Group

Before You Begin

- [Create a Protective Instrument Loop.](#)

About This Task

Note: Copying a Protective Instrument Loop Final Element Group alters the calculations for the protective instrument loop. Hence, you must review the calculations.

Procedure

1. [Access the Protective Instrument Loop Final Element Group](#) into which you want to copy another Final Element Group.
2. In the upper-right corner of the datasheet, select **Copy**.

The **Search** window appears.

Search

Look in			Q
---------	--	--	---

Cancel OK

3. In the upper-right corner of the datasheet, select .

A list of Protective Instrument Loop Final Element Groups appears.

Search

Look in ▼
 ▼
 ▼
🔍 ▼

<input type="radio"/>	Final Element Group-	Protective Instrument Loop Group	Protective Instrument Loop System	Protective Instrument Loop Final Element
<input type="radio"/>	Sensor Group 1-	Protective Instrument Loop Group	Protective Instrument Loop System	Protective Instrument Loop Sensor
<input type="radio"/>	Final Element Group 1-	Protective Instrument Loop Group	Protective Instrument Loop System	Protective Instrument Loop Final Element
<input type="radio"/>	PT-101A/B Sensor Group-	Protective Instrument Loop Group	Protective Instrument Loop System	Protective Instrument Loop Sensor
<input type="radio"/>	FT-0113A/B/C Group-	Protective Instrument Loop Group	Protective Instrument Loop System	Protective Instrument Loop Sensor
<input type="radio"/>	Spent and Regen Slide Valve Group-	Protective Instrument Loop Group	Protective Instrument Loop System	Protective Instrument Loop Final Element

Cancel
OK

4. Select the record that you want to copy, and then select **OK**.
The Protective Instrument Loop Final Element Group is copied.

Results

- The values in each field of the copied record are overwritten by those of the original record that you copy.
- The value in the Final Element Group ID field in the copied record is appended with 1.
- All the Final Elements linked to the original Final Element Group also become a part of the Final Element Group that you copy, replacing the existing ones. If these existing records are not part of another loop, they are deleted. Otherwise, they are unlinked from the loop.
- Copying a record alters the calculations for the loop. The APM system performs the calculations again.

Next Steps

- [Access the Results of a Protective Instrument Loop](#)

Link a Protective Instrument Loop Final Element Group

Before You Begin

- [Create a Protective Instrument Loop.](#)

About This Task

Important: If you modify a Protective Instrument Loop Element that is linked to more than one loop, the changes that you have made are reflected in all the associated loops.

Note: Linking a Protective Instrument Loop Final Element Group alters the calculations of the loop. Therefore, you must verify the calculations again.

Procedure

1. [Access the Protective Instrument Loop Final Element Group](#) that you want to replace.
2. In the upper-right corner of the datasheet, select **Link**.

The **Search** window appears.

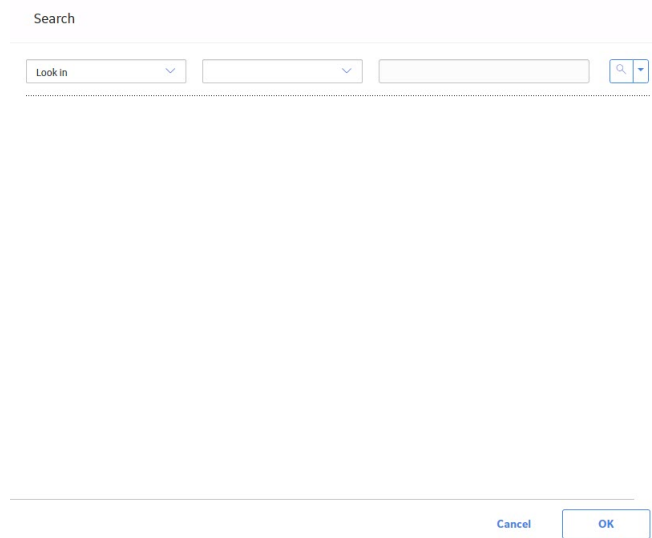

The image shows a 'Search' window with a title bar. Below the title bar, there are three input fields: a dropdown menu labeled 'Look in', an empty text box, and another empty text box. To the right of the second text box is a search icon (magnifying glass) and a dropdown arrow. At the bottom right of the window, there are two buttons: 'Cancel' and 'OK'.

3. In the upper-right corner of the window, select .

A list of Protective Instrument Loop Final Element Group appears.

Search

Look in

<input type="radio"/>	Final Element Group- Protective Instrument Loop Group	Protective Instrument Loop System	Protective Instrument Loop Final Element
<input type="radio"/>	Sensor Group 1- Protective Instrument Loop Group	Protective Instrument Loop System	Protective Instrument Loop Sensor
<input type="radio"/>	Final Element Group 1- Protective Instrument Loop Group	Protective Instrument Loop System	Protective Instrument Loop Final Element
<input type="radio"/>	PT-101A/B Sensor Group- Protective Instrument Loop Group	Protective Instrument Loop System	Protective Instrument Loop Sensor
<input type="radio"/>	FT-0113A/B/C Group- Protective Instrument Loop Group	Protective Instrument Loop System	Protective Instrument Loop Sensor
<input type="radio"/>	Spent and Regen Slide Valve Group- Protective Instrument Loop Group	Protective Instrument Loop System	Protective Instrument Loop Final Element

Cancel

4. Select the check box that corresponds to the Final Element Group that you want to link, and then select **OK**.
5. Depending on the message that appears, select **Proceed** or **OK**.

If the Protective Instrument Loop Final Element Group that you want to replace is also linked to another loop, a message appears. Select **Proceed**.

Note: If you want to access the list of Protective Instrument Loops linked to the Protective Instrument Loop Final Element Group that you want to replace, select **Show Details**.

-or-

If the Protective Instrument Loop Final Element Group that you want to replace is not linked to any other loop, a message appears, indicating that the Protective Instrument Loop Final Element Group will be deleted. Select **OK**.

The original Protective Instrument Loop Final Element Group is replaced by the one that you have selected.

Results

- The existing Protective Instrument Loop Final Element Group is replaced by the one that you have linked. If the existing final element group is not a part of another loop, then it is deleted. Otherwise, it is just unlinked from the loop.

- In addition to the final element group that you have linked, all the final elements in the group also become a part of the loop, replacing the existing ones. If these final elements are not part of another loop, then they are deleted. Otherwise, they are just unlinked from the loop.
- Linking a record alters the calculations for the loop. The APM system performs the calculations again.

Next Steps

- [Access the Results of a Protective Instrument Loop](#)

Unlink a Protective Instrument Loop Final Element Group

About This Task

Note: Unlinking a Protective Instrument Loop Final Element Group alters the calculations of the loop. Hence, you must review the calculations.

Procedure

1. [Access the Protective Instrument Loop Final Element Group](#) that you want to unlink.
2. In the upper-right corner of the datasheet, select **Unlink**.

Note: The **Unlink** button is enabled only if the sensor group is a linked element.

3. If the Protective Instrument Loop Final Element Group that you want to replace is not linked to any other loop, a message appears, indicating that the Protective Instrument Loop Final Element Group will be deleted. Select **OK**.

The Protective Instrument Loop Final Element Group is replaced by a default record.

Results

- If the Protective Instrument Loop Final Element Group that you have unlinked is the only one in the loop, it is replaced by a default record.
- If the Final Element Group is not a part of another loop, then it is deleted. Otherwise, it is unlinked from the loop.
- In addition to the Final Element Group that you have unlinked, all the Final Elements in the loop are also unlinked, replaced by a default record. If these Final Elements are not part of another loop, then they are deleted. Otherwise, they are just unlinked from the loop.
- Unlinking a record alters the calculations for the loop. The APM system performs the calculations again.

Next Steps

- [Access the Results of a Protective Instrument Loop](#)

Delete a Protective Instrument Loop Final Element Group

About This Task

Important: Deleting a Protective Instrument Loop Final Element Group also deletes all the associated Protective Instrument Loop Final Elements. Protective Instrument Loops must contain at least one final element, final element group, and final element system. If the Protective Instrument Loop Final Element Group that you want to delete is the only Final Element Group in the loop, then you cannot delete it.

Note: Deleting a Protective Instrument Loop Final Element Group alters the calculations of the loop. Hence, you may need to review the calculations again.

Procedure

1. [Access the Protective Instrument Loop Final Element System](#) associated with the Final Element Group you want to delete.
2. In the workspace, select the **Final Element Groups** tab.

The **Final Element Groups** section appears, displaying a list of Final Element Groups.

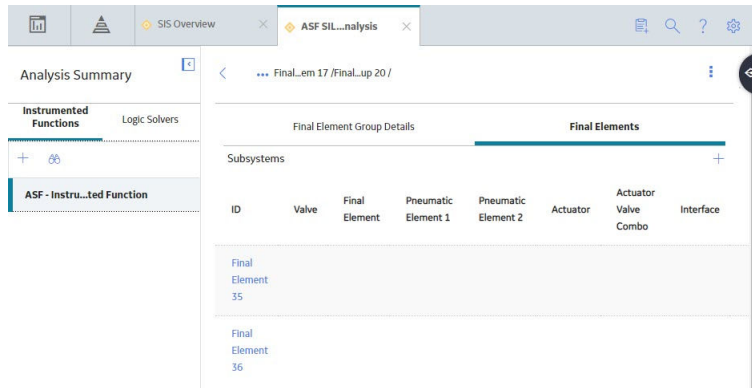

3. Select the  button next to the Protective Instrument Loop Final Element Group that you want to delete.

A message appears, asking if you really want to delete the Final Element Group.

4. Select **OK**.

The Protective Instrument Loop Final Element Group is deleted.

Results

- The Final Elements that are linked to the Final Element Group are also deleted.
- The [voting architecture](#) is changed to reflect the updated number of Final Element Groups.
- The APM system calculates the results for the loop again.

Next Steps

- [Access the Results of a Protective Instrument Loop](#)

Access a Protective Instrument Loop Final Element

Procedure

1. [Access the Protective Instrument Loop Final Element Group](#) that is linked to the Protective Instrument Loop Final Element that you want to access.
2. In the workspace, select the **Final Elements** tab.

The **Final Elements** section appears, displaying a list of Final Elements in the Final Element Group.

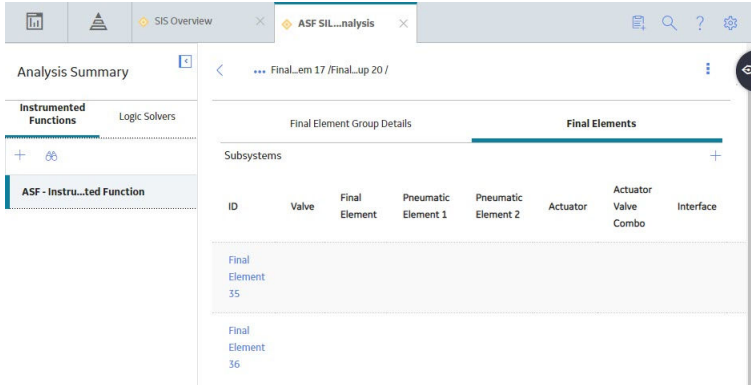

3. Select the Protective Instrument Loop Final Element that you want to access.
The datasheet for the Final Element appears.

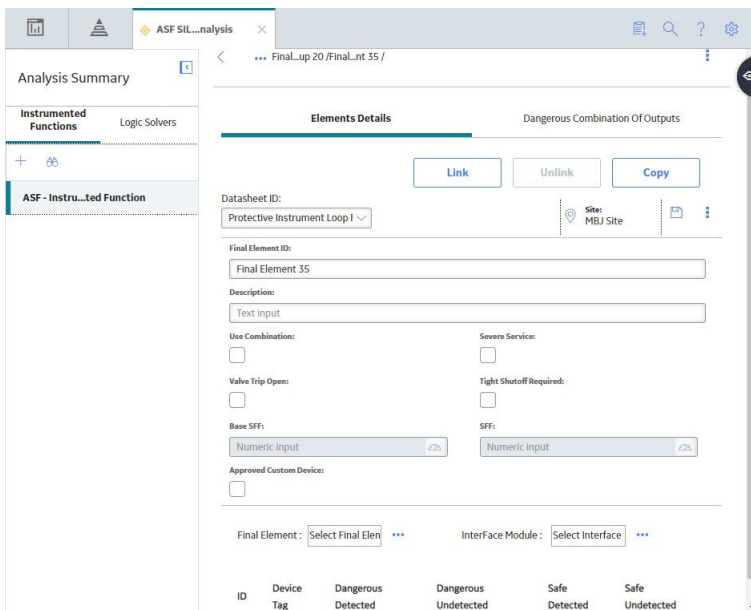

4. If needed, modify values in the [available fields](#).
5. In the upper-right corner of the datasheet, select .
The changes made to the Protective Instrument Loop Final Element are saved.

Results

- If the Diverse field in the Final Element Group is cleared, the modifications to values in the Final Element are reflected in other Final Elements within the Final Element Group.
- The changes you have made may alter the calculated results for the Protective Instrument Loop. The APM system calculates the results again.

Next Steps

- [Access the Results of a Protective Instrument Loop](#)

Create a Protective Instrument Loop Final Element

Before You Begin

- [Create a Protective Instrument Loop.](#)

About This Task

This topic describes how to create a Protective Instrument Loop Final Element using a blank datasheet as part of Safety Integrity Level (SIL) verification. You can also [copy](#) or [link](#) a Protective Instrument Loop Final Element that is associated with another loop.

Note: By default, when you create a Protective Instrument Loop or a Protective Instrument Loop Final Element Group, a Protective Instrument Loop Final Element is already created. You can, however, create as many Protective Instrument Loop Final Elements as required.

Procedure

1. [Access the Protective Instrument Loop](#) in which you want to create a Protective Instrument Loop Final Element.
2. In the workspace, select the **Loop Diagram & calculation** tab.

The **Loop Diagram & calculation** section appears.

The screenshot displays the 'Loop Diagram & calculation' section of the software. The diagram shows a sequence of components: Avenor Sensor Group 1, two 1oo1 nodes, a Logic Solver, another two 1oo1 nodes, and an Avenor Final Element Group. Below the diagram is a 'Contribution' bar chart and a table of calculated values.

Contribution Chart Data:

Metric	Final Element System (%)	Logic Solver (%)	Sensor System (%)
PFD	~40	~35	~25
MTTFS	~50	~15	~35

Table of Values:

Metric	Value	Requirement Met?
SIL-Achieved	1	Yes
SIL-Calculated	1	
STR-Calculated	7.27e-6	No
Architectural Constraints	N/A	IEC 61508 : 2000
Systematic Capabilities	N/A	
Availability	N/A	
Loop PFD Average	N/A	
Loop PFH	7.60e-6	
MTTFS	15.71	
Risk Reduction Factor	N/A	

Table of Loop Data:

ID	PFD	Availability	MTTFS	PTI
Avenor Sensor System 1	1.61e-6	N/A	67.79	8

3. In the diagram, select the Final Element Group node in which you want to create a Final Element.

The datasheet for the Final Element Group appears.

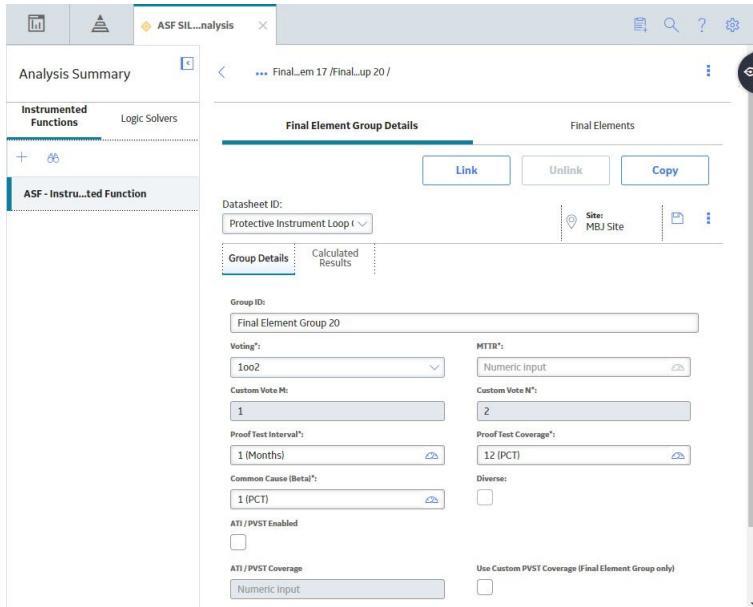

4. In the workspace, select the **Final Elements** tab.

The **Final Elements** section appears, displaying a list of Final Elements in the Final Element Group.

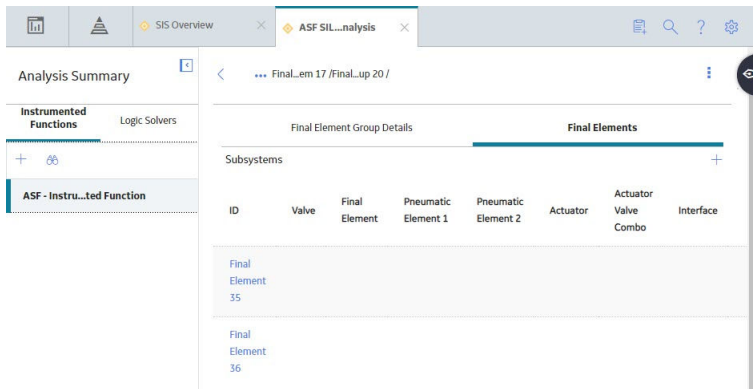



5. In the upper-right corner of the section, select **+**.

A Protective Instrument Loop Final Element is created and added to the list of Final Elements. If the Diverse field in the Final Element Group is cleared, the final element will contain the same values as those in the default record.

6. Select the newly added record.

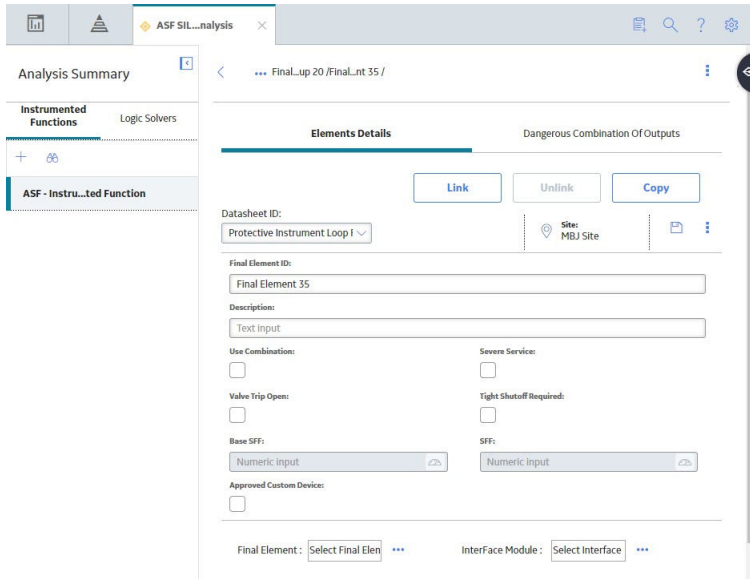
A blank datasheet for the Final Element appears.



7. As needed, enter values in the available fields.
8. In the upper-right corner of the datasheet, select . The Protective Instrument Loop Final Element Group is created.

Results

- The [voting architecture](#) in the Protective Instrument Loop Final Element Group record is updated both in the datasheet and also in the diagram.
- If the Diverse field in the Final Element Group is cleared, the modifications to values in the Final Element are reflected in other Final Elements within the Final Element Group.
- The APM system automatically recalculates the results.

Next Steps

- [Access the Results of a Protective Instrument Loop](#)
- [Create a Proven In Use Justification record](#)

Copy a Protective Instrument Loop Final Element

Before You Begin

- [Create a Protective Instrument Loop](#).

About This Task

Note: Copying a Protective Instrument Loop Final Element alters the calculations for the protective instrument loop. Therefore, you must verify the calculations again.

Procedure

1. [Access the Protective Instrument Loop Final Element](#) into which you want to copy another Final Element.
2. In the upper-right corner of the datasheet, select **Copy**.

The **Search** window appears.

The screenshot shows the top portion of a search window. At the top left, the word "Search" is displayed. Below it, there are three input fields: a dropdown menu labeled "Look in", an empty text box, and another empty text box. To the right of these fields is a search icon (magnifying glass) and a dropdown arrow. At the bottom right of the window, there are two buttons: "Cancel" and "OK".

3. In the upper-right corner of the window, select .
A list of Protective Instrument Loop Final Elements appears.

This screenshot shows the search results within the search window. The "Search" title is at the top left. Below it are the same search criteria fields as in the previous screenshot. The main area contains a list of search results, each with a radio button on the left and descriptive text on the right. The results are separated by horizontal dotted lines. At the bottom right, there are "Cancel" and "OK" buttons.

Item	Protective Instrument Device	Protective Instrument Loop Group
<input type="radio"/> XL0615-009 B- Protective Instrument Loop Final Element	Protective Instrument Device	Protective Instrument Loop Group
<input type="radio"/> XL0615-009 A- Protective Instrument Loop Final Element	Protective Instrument Device	Protective Instrument Loop Group
<input type="radio"/> Final Element- Protective Instrument Loop Final Element	Protective Instrument Device	Protective Instrument Loop Group
<input type="radio"/> Spent Cat Slide Valve-Spent Cat Slide Valve Protective Instrument Loop Final Element	Protective Instrument Device	
<input type="radio"/> Final Element 2- Protective Instrument Loop Final Element		
<input type="radio"/> LV-0001-Spent Cat Slide Valve Protective Instrument Loop Final Element	Protective Instrument Device	Protective Instrument Loop Group
<input type="radio"/> G0008-Fresh Feed Pump Protective Instrument Loop Final Element	Protective Instrument Device	Protective Instrument Loop Group

4. Select the check box that corresponds to the Final Element that you want to copy, and then select **OK**.

The Protective Instrument Loop Final Element is copied.

Results

- The values in each field of the copied record are overwritten by those of the original record that you copied.
- The value in the Final Element ID field in the copied record is appended with a 1.
- Copying a record alters the calculations for the loop. The APM system performs the calculations again.

Next Steps

- [Access the Results of a Protective Instrument Loop](#)

Link a Protective Instrument Loop Final Element

Before You Begin

- [Create a Protective Instrument Loop](#).

About This Task

Important: If you modify a Protective Instrument Loop Element that is linked to more than one loop, the changes that you have made are reflected in all the associated loops.

Note: Linking a Protective Instrument Loop Final Element alters the calculations for the loop. Therefore, you must verify the calculations again.

Procedure

1. [Access the Protective Instrument Loop Final Element](#) to which you want to replace.
2. In the upper-right corner of the datasheet, select **Link**.

The **Search** window appears.

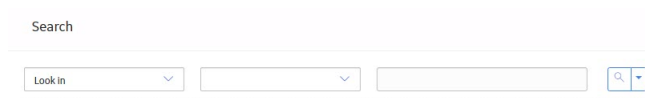

The image shows a search window titled "Search". It contains a "Look in" dropdown menu, a text input field, and a search button with a magnifying glass icon. Below the search bar, there are "Cancel" and "OK" buttons.

3. In the upper-right corner of the window, select .

A list of Protective Instrument Loop Final Elements appears.

Search

Look in [dropdown] [dropdown] [input] [search icon]

- XL0615-009 B-**
Protective Instrument Loop Final Element [Protective Instrument Device](#) [Protective Instrument Loop Group](#)
- XL0615-009 A-**
Protective Instrument Loop Final Element [Protective Instrument Device](#) [Protective Instrument Loop Group](#)
- Final Element-**
Protective Instrument Loop Final Element [Protective Instrument Device](#) [Protective Instrument Loop Group](#)
- Spent Cat Slide Valve-Spent Cat Slide Valve**
Protective Instrument Loop Final Element [Protective Instrument Device](#)
- Final Element 2-**
Protective Instrument Loop Final Element
- LV-0001-Spent Cat Slide Valve**
Protective Instrument Loop Final Element [Protective Instrument Device](#) [Protective Instrument Loop Group](#)
- G0008-Fresh Feed Pump**
Protective Instrument Loop Final Element [Protective Instrument Device](#) [Protective Instrument Loop Group](#)

[Cancel](#) [OK](#)

4. Select the check box that corresponds to the Final Element that you want to link, and then select **OK**.
5. Depending on the message that appears, select **Proceed** or **OK**.

If the Protective Instrument Loop Final Element that you want to replace is also linked to another loop, select **Proceed**.

Note: If you want to access the list of Protective Instrument Loops linked to the Protective Instrument Loop Final Element that you want to replace, select **Show Details**.

-or-

If the Protective Instrument Loop Final Element that you want to replace is not linked to any other loop, a message appears, indicating that the Protective Instrument Loop Final Element will be deleted. Select **OK**.

The original Protective Instrument Loop Final Element is replaced by the one that you have selected.

Results

- The existing Protective Instrument Loop Final Element is replaced by the one that you have linked. If the existing Final Element is not a part of another loop, then the record is deleted. Otherwise, the record is unlinked from the loop.
- Linking a record alters the calculations for the loop. The APM system performs the calculations again.

Next Steps

- [Access the Results of a Protective Instrument Loop](#)

Unlink a Protective Instrument Loop Final Element

About This Task

Note: Unlinking a Protective Instrument Loop Final Element alters the calculations of the loop. Hence, you must access the calculations again.

Procedure

1. [Access the Protective Instrument Loop Final Element](#) that you want to unlink.
2. In the upper-right corner of the datasheet, select **Unlink**.

Note: The **Unlink** button is enabled only if the Final Element that you have selected in a linked element.

3. If the Protective Instrument Loop Final Element that you want to replace is not linked to any other loop, a message appears, indicating that the Protective Instrument Loop Final Element will be deleted. Select **OK**.

The Protective Instrument Loop Final Element is unlinked.

Results

- If the existing Protective Instrument Loop Final Element is the only one in the group, it is replaced by a default one.
If the existing Final Element is not a part of another loop, then the record is deleted. Otherwise, the record is unlinked from the loop.
- Unlinking a record alters the calculations for the loop. The APM system performs the calculations again.

Next Steps

- [Access the Results of a Protective Instrument Loop](#)

Define a Dangerous Combination of Outputs

Before You Begin

- [Create a Protective Instrument Loop Final Element](#) for each of the final elements that form a dangerous combination.

About This Task

This topic describes how to link two or more final elements, which can be hazardous when their outputs are combined. For example, if a pump was functioning (i.e., output) and the downstream valve was closed (i.e., second output) the pump runs the risk of mechanical damage due to overheating, cavitating, or vibrating. If left unattended, the pump could develop a leak which could lead to a larger hazard. This can be defined as a dangerous combination of outputs.

Procedure

1. Access the [Protective Instrument Loop Final Element](#).
2. Select the **Dangerous Combination of Outputs** tab.

The **Dangerous Combination of Outputs** section appears.

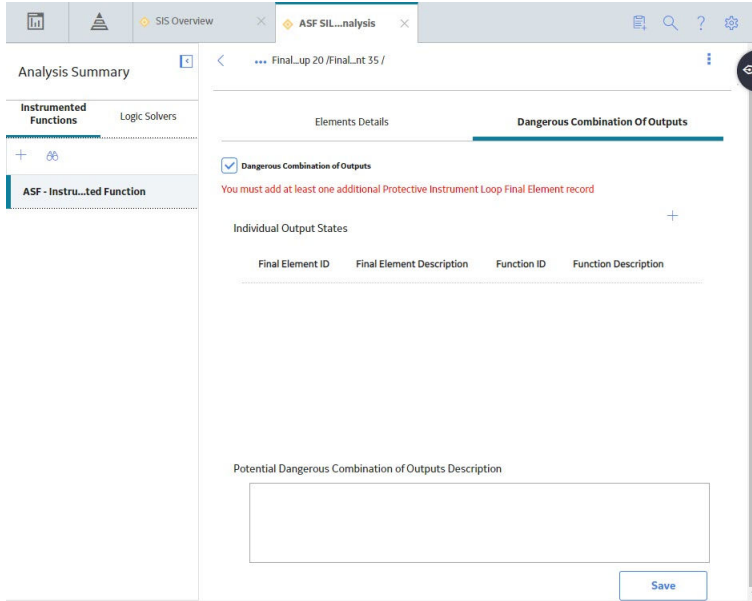

3. In the upper-right corner of the section, select .

The **Search** window appears.

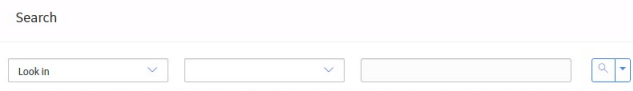

4. In the upper-right corner of the window, select .
- A list of Protective Instrument Loop Final Elements appears.

Search

Look in

- XL0615-009 B-**
Protective Instrument Loop Final Element [Protective Instrument Device](#) [Protective Instrument Loop Group](#)

- XL0615-009 A-**
Protective Instrument Loop Final Element [Protective Instrument Device](#) [Protective Instrument Loop Group](#)

- Final Element-**
Protective Instrument Loop Final Element [Protective Instrument Device](#) [Protective Instrument Loop Group](#)

- Spent Cat Slide Valve-Spent Cat Slide Valve**
Protective Instrument Loop Final Element [Protective Instrument Device](#)

- Final Element 2-**
Protective Instrument Loop Final Element

- LV-0001-Spent Cat Slide Valve**
Protective Instrument Loop Final Element [Protective Instrument Device](#) [Protective Instrument Loop Group](#)

- G0008-Fresh Feed Pump**
Protective Instrument Loop Final Element [Protective Instrument Device](#) [Protective Instrument Loop Group](#)

[Cancel](#) [OK](#)

5. Select the check box that corresponds to the Final Element that you want to link, and then select **OK**.

The selected Protective Instrument Loop Final Element is listed in the **Individual Output States** section.

Analysis Summary

Instrumented Functions Logic Solvers

ASF - Instru...ted Function

Elements Details **Dangerous Combination Of Outputs**

Dangerous Combination of Outputs

Individual Output States

Final Element ID	Final Element Description	Function ID	Function Description
T1.34 - Final Element1		ASF - Instrumented Function	ASF Instrumented Function
T1.3, T1.4, T1.17 - Final Element3		ASF - Instrumented Function	ASF Instrumented Function

Potential Dangerous Combination of Outputs Description

[Save](#)

6. In the **Potential Dangerous Combination of Outputs Description** box, provide a description of the dangerous output, and then select **Save**.

The two Protective Instrument Loop Final Elements are linked to each other as a dangerous combination of outputs. To link another record to this combination, repeat steps 7-10.

Unlink a Dangerous Combination of Outputs

About This Task

This topic describes how to unlink two or more final elements, that have been linked together as a dangerous combination of outputs.

Procedure

1. [Access the Protective Instrument Loop Final Element](#).
2. In the workspace, select the **Dangerous Combination of Outputs** tab.

The **Individual Output States** section appears, displaying a list of Final Elements that are linked to the selected one.

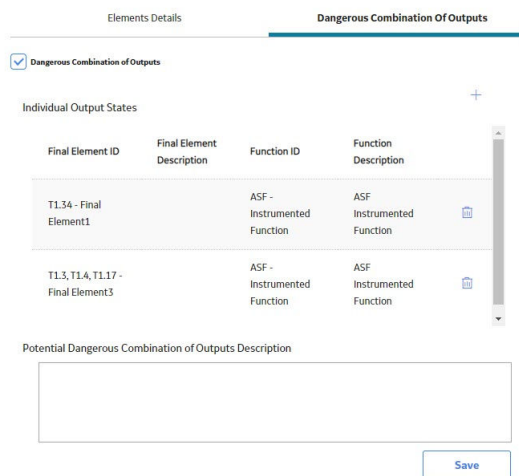

3. In the **Individual Output States** section, select the  button that corresponds to the Final Element that you want to unlink.

A confirmation message appears, asking if you really want to remove the Protective Instrument Loop Final Element.

4. Select **OK**.

The selected Protective Instrument Loop Final Element is unlinked from the current record.

Delete a Protective Instrument Loop Final Element

About This Task

Important: Protective Instrument Loops must contain at least one final element, final element group, and final element system. If the Protective Instrument Loop Final Element that you want to delete is the only Final Element in the Final Element Group, then you cannot delete it.

Note: Deleting a Protective Instrument Loop Final Element alters the calculations of the loop. Hence, you may need to access the calculations again.

Procedure

1. [Access the Protective Instrument Loop Final Element Group](#) that is linked to the Final Element that you want to delete.
2. In the workspace, select the **Final Elements** tab.

The **Final Elements** section appears, displaying a list of Final Elements in the Final Element Group.

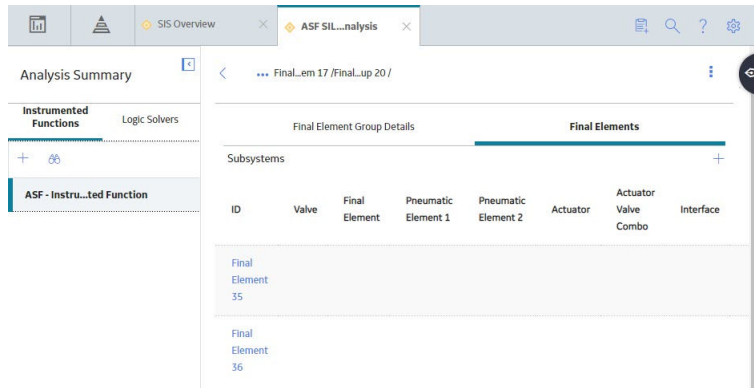

3. Select the  button next to the Protective Instrument Loop Final Element that you want to delete. A message appears, asking if you really want to delete the Protective Instrument loop Final Element.
4. Select **OK**. The Protective Instrument Loop Final Element is deleted.

Results

- The [voting architecture](#) is changed to reflect the updated number of Final Elements.
- The APM system calculates the results for the loop again.

Next Steps

- [Access the Results of a Protective Instrument Loop](#)

Access a Protective Instrument Loop Logic Solver

Before You Begin

- [Create a Protective Instrument Loop](#).

About This Task

Note:

There is only *one* logic solver in a protective instrument loop. When you create a Protective Instrument Loop, a Protective Instrument Loop Logic Solver is automatically created and added to the loop. You cannot delete this record.

Procedure

1. Access the [Protective Instrument Loop](#) that is linked to the Protective Instrument Loop Logic Solver that you want to access.
2. In the workspace, select the **Loop Diagram & calculation** tab.

The **Loop Diagram & calculation** section appears.

The screenshot displays the 'Loop Diagram & calculation' section of the software. The diagram shows a sequence of components: Avenor Sensor Group 1, two 1oo1 nodes, a Logic Solver node, another 1oo1 node, and Avenor Final Element Group. Below the diagram is a 'Contribution' bar chart and a data table.

Contribution Chart Data:

Metric	Final Element System (%)	Logic Solver (%)	Sensor System (%)
PFD	~40	~35	~25
MTTFS	~50	~10	~40

Table Data:

	Value:	Requirement Met?
SIL-Achieved	1	Yes
SIL-Calculated	1	
STR-Calculated	7.27e-6	No
Architectural Constraints	N/A	IEC 61508 : 2000
Systematic Capabilities	N/A	
Availability	N/A	
Loop PFD Average	N/A	
Loop PFH	7.60e-6	
MTTFS	15.71	
Risk Reduction Factor	N/A	

Summary Table:

ID	PFD	Availability	MTTFS	PTI
Avenor Sensor System 1	1.61e-6	N/A	67.79	8

3. In the diagram, select the Logic Solver node.
The datasheet for the Logic Solver appears.

- If needed, modify values in the [available fields](#).

Note:

To select a logic solver device from Exida's Safety Equipment Reliability Handbook (SERH):

- In the upper-right corner of the **Logic Solver Details** section, select **Set Logic Solver Device**. The **Select a Logic Solver** window appears, displaying a list of logic solvers from Exida's Safety Equipment Reliability Handbook (SERH).
- Select the logic solver that you want to apply for the Protective Instrument Loop Logic Solver, and then select **OK**.
The [fields in the Logic Solver datasheet](#) are updated with the values for the selected logic solver device.

- In the upper-right corner of the datasheet, select .

The changes made to the Protective Instrument Loop Logic Solver are saved.

Results

- The changes you have made may alter the calculated results for the SIL analysis. The APM system calculates the results again.

Next Steps

- [Access the Results of a Protective Instrument Loop](#)

Copy a Protective Instrument Loop Logic Solver

Before You Begin

- [Create a Protective Instrument Loop.](#)

About This Task

Note: Copying a Protective Instrument Loop Logic Solver alters the calculations for the protective instrument loop. Therefore, you must access the calculations again.

Procedure

1. [Access the Protective Instrument Loop Logic Solver](#) into which you want to copy another Logic Solver.
2. In the upper-right corner of the datasheet, select **Copy**.

The **Search** window appears.

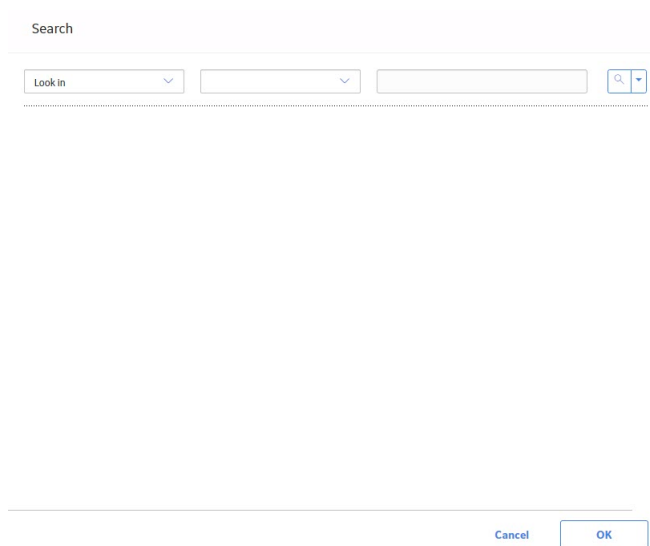

The image shows a search window titled "Search". It contains a "Look in" dropdown menu, followed by two empty text input fields, and a search button with a magnifying glass icon. At the bottom right of the window, there are "Cancel" and "OK" buttons.

3. In the upper-right corner of the window, select .

A list of Protective Instrument Loop Logic Solvers appears.

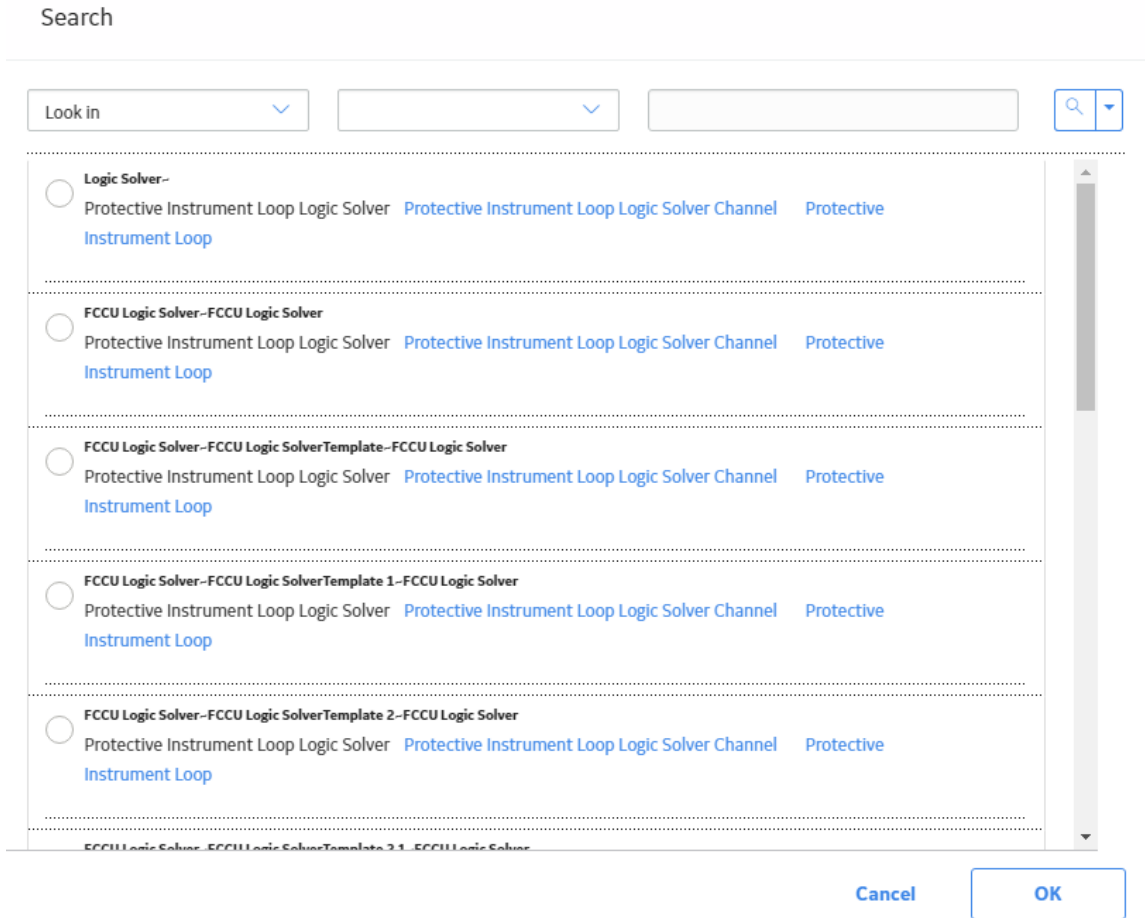

4. Select the check box that correspond to the Logic Solver that you want to copy, and then select **OK**.
The Protective Instrument Loop Logic Solver is copied.

Results

- The values in each field of the copied record are overwritten by those of the original record that you copied.
- The value in the Logic Solver ID field in the copied record is appended with a 1.
- Copying a record alters the calculations for the loop. The APM system performs the calculations again.

Next Steps

- [Access the Results of a Protective Instrument Loop](#)

Link a Protective Instrument Loop Logic Solver

Before You Begin

- [Create a Protective Instrument Loop](#).

About This Task

Important: If you modify a Protective Instrument Loop Element that is linked to more than one protective instrument loop, the changes that you have made are reflected in all the associated protective instrument loops.

Note: Linking a Protective Instrument Loop Logic Solver alters the calculations for the protective instrument loop. Therefore, you must access the calculations again.

Procedure

1. [Access the Protective Instrument Loop Logic Solver](#) that you want to replace.
2. In the upper-right corner of the datasheet, select **Link**.

The **Search** window appears.

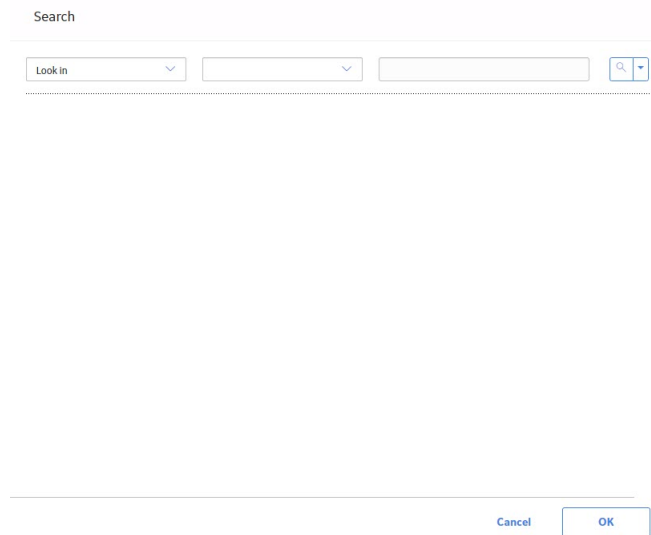

The screenshot shows a search window titled "Search". It contains a "Look in" dropdown menu, followed by two empty text input fields, and a search button with a magnifying glass icon. At the bottom right of the window, there are "Cancel" and "OK" buttons.

3. In the upper-right corner of the window, select .

A list of Protective Instrument Loop Logic Solvers appears.

Search

Look in [dropdown] [dropdown] [dropdown] [search icon]

<input type="radio"/>	Logic Solver-	Protective Instrument Loop Logic Solver	Protective Instrument Loop Logic Solver Channel	Protective
<input type="radio"/>	FCCU Logic Solver-FCCU Logic Solver	Protective Instrument Loop Logic Solver	Protective Instrument Loop Logic Solver Channel	Protective
<input type="radio"/>	FCCU Logic Solver-FCCU Logic SolverTemplate-FCCU Logic Solver	Protective Instrument Loop Logic Solver	Protective Instrument Loop Logic Solver Channel	Protective
<input type="radio"/>	FCCU Logic Solver-FCCU Logic SolverTemplate 1-FCCU Logic Solver	Protective Instrument Loop Logic Solver	Protective Instrument Loop Logic Solver Channel	Protective
<input type="radio"/>	FCCU Logic Solver-FCCU Logic SolverTemplate 2-FCCU Logic Solver	Protective Instrument Loop Logic Solver	Protective Instrument Loop Logic Solver Channel	Protective
<input type="radio"/>	FCCU Logic Solver-FCCU Logic SolverTemplate 3-FCCU Logic Solver	Protective Instrument Loop Logic Solver	Protective Instrument Loop Logic Solver Channel	Protective

Cancel OK

4. Select the check box that corresponds to the Logic Solver that you want to link, and then select **OK**.
5. Depending on the message that appears, select **Proceed** or **OK**.

If the Protective Instrument Loop Logic Solver that you want to replace is also linked to another loop, select **Proceed**.

Note: If you want to access the list of Protective Instrument Loops linked to the Protective Instrument Loop Logic Solver that you want to replace, select **Show Details**.

-or-

If the Protective Instrument Loop Logic Solver that you want to replace is not linked to any other loop, a message appears, indicating that the Protective Instrument Loop Logic Solver will be deleted. Select **OK**.

The original Protective Instrument Loop Logic Solver is replaced by the one that you have selected.

Results

- The existing Protective Instrument Loop Logic Solver is replaced by the one that you have linked. If the existing logic solver is not a part of another protective instrument loop, then the record is deleted. Otherwise, the record is unlinked from the protective instrument loop.
- Linking a record alters the calculations for the loop. The APM system performs the calculations again.

Next Steps

- [Access the Results of a Protective Instrument Loop](#)

Unlink a Protective Instrument Loop Logic Solver

Before You Begin

- [Create a Protective Instrument Loop](#).

About This Task

Note: Unlinking a Protective Instrument Loop Logic Solver alters the calculations for the protective instrument loop. Hence, you must review the calculations again.

Procedure

1. [Access the Protective Instrument Loop Logic Solver](#) that you want to unlink.
2. In the upper-right corner of the datasheet, select **Unlink**.
Note: The **Unlink** button is enabled only if the logic solver is a linked element.
3. If the Protective Instrument Loop Logic Solver that you want to replace is not linked to any other loop, a message appears, indicating that the Protective Instrument Loop Logic Solver will be deleted. Select **OK**.

The Protective Instrument Loop Logic Solver is unlinked.

Results

- The Protective Instrument Loop Logic Solver that you have unlinked is replaced by a default one.
- If the logic solver is not a part of another protective instrument loop, then the record is deleted. Otherwise, the record is unlinked from the protective instrument loop.
- Unlinking a record alters the calculations for the loop. The APM system performs the calculations again.

Next Steps

- [Access the Results of a Protective Instrument Loop](#)

Access a Protective Instrument Loop Logic Solver Channel

Procedure

1. [Access the Protective Instrument Loop Logic Solver](#) that is linked to the Protective Instrument Loop Logic Solver Channel that you want to access.
2. In the workspace, select the **Channels/Modules** tab.

The **Channels/Modules** section appears, displaying a list of Protective Instrument Loop Logic Solver Channels.

SIS Overview x ~Multip...emplate x

< ~Multiple Calculations - External Template

~Mult...plate /Logic...late- /

Logic Solver Details Channel/Modules

Protective Loop Logic Solver Channel

⊞

<input type="checkbox"/>	ID	CHANNEL/MODEL NAME	CHANNEL TYPE	CHANNELS	DANGEROUS D
<input type="checkbox"/>	Analog In Module 12 1 Template~	Analog In Module 12 1 Template	AI_COM	1	9.00e-7
<input type="checkbox"/>	Analog In Channel 12 1 Template~	Analog In Channel 12 1 Template	AI_CH	1	4.80e-8
<input type="checkbox"/>	Digital Out Low Channel 12 1 Template~	Digital Out Low Channel 12 1 Template	DOLOW_CH	1	5.70e-8
<input type="checkbox"/>	Digital Out High Module 12 1 Template~	Digital Out High Module 12 1 Template	DOHIGH_COM	0	1.90e-7
<input type="checkbox"/>	Digital Out Low Module 12 1 Template~	Digital Out Low Module 12 1 Template	DOLOW_COM	1	1.90e-7
<input type="checkbox"/>	Digital In Module 12 1 Template~	Digital In Module 12 1 Template	DI_COM	0	3.80e-7
<input type="checkbox"/>	Digital In Channel 12 1 Template~	Digital In Channel 12 1 Template	DI_CH	0	6.70e-8
<input type="checkbox"/>	Main Processor 12 1 Template~	Main Processor 12 1 Template	CPU	1	2.85e-6
<input type="checkbox"/>	Digital Out High Channel 12 1 Template~	Digital Out High Channel 12 1 Template	DOHIGH_CH	0	1.14e-7
<input type="checkbox"/>	Analog Out Channel 12 1 Template~	Analog Out Channel 12 1 Template	AO_CH	0	9.50e-8
<input type="checkbox"/>	Analog Out Module 12 1 Template~	Analog Out Module 12 1 Template	AO_COM	0	1.19e-7
<input type="checkbox"/>	Power Supply 12 1 Template~	Power Supply 12 1 Template	PS	1	2.50e-7

3. Select the Protective Instrument Loop Logic Solver Channel that you want to access.
The datasheet for the Protective Instrument Loop Logic Solver Channel appears.

Site: MBJ Site

Details Failure Data Reference

Channel/Module ID:

Device Name:

Channel Type:

Description:

Channels: Manual Entry

Parameters

4. As needed, modify values in the available fields.
5. In the lower-right corner of the datasheet, select **Save**.

The changes made to the Protective Instrument Loop Logic Solver are saved.

Create a Protective Instrument Loop Logic Solver Channel

About This Task

Note: You can create a Protective Instrument Loop Logic Solver Channel only if the **Manual Entry** check box in the Protective Instrument Loop Logic Solver datasheet is selected.

Procedure

1. [Access the Protective Instrument Loop Logic Solver](#) for which you want to create a Protective Instrument Loop Logic Solver Channel.
2. In the workspace, select the **Channel/Modules** tab.

The **Channel/Modules** section appears, displaying a list of Protective Instrument Loop Logic Solver Channels.

~Multiple Calculations - External Template

~Mult...plate /Logic...late- /

Logic Solver Details Channel/Modules

Protective Loop Logic Solver Channel 📄 +

🔍

<input type="checkbox"/>	ID	CHANNEL/MODEL NAME	CHANNEL TYPE	CHANNELS	DANGEROUS D
<input type="checkbox"/>	Analog In Module 12 1 Template~	Analog In Module 12 1 Template	AI_COM	1	9.00e-7
<input type="checkbox"/>	Analog In Channel 12 1 Template~	Analog In Channel 12 1 Template	AI_CH	1	4.80e-8
<input type="checkbox"/>	Digital Out Low Channel 12 1 Template~	Digital Out Low Channel 12 1 Template	DOLOW_CH	1	5.70e-8
<input type="checkbox"/>	Digital Out High Module 12 1 Template~	Digital Out High Module 12 1 Template	DOHIGH_COM	0	1.90e-7
<input type="checkbox"/>	Digital Out Low Module 12 1 Template~	Digital Out Low Module 12 1 Template	DOLOW_COM	1	1.90e-7
<input type="checkbox"/>	Digital In Module 12 1 Template~	Digital In Module 12 1 Template	DI_COM	0	3.80e-7
<input type="checkbox"/>	Digital In Channel 12 1 Template~	Digital In Channel 12 1 Template	DI_CH	0	6.70e-8
<input type="checkbox"/>	Main Processor 12 1 Template~	Main Processor 12 1 Template	CPU	1	2.85e-6
<input type="checkbox"/>	Digital Out High Channel 12 1 Template~	Digital Out High Channel 12 1 Template	DOHIGH_CH	0	1.14e-7
<input type="checkbox"/>	Analog Out Channel 12 1 Template~	Analog Out Channel 12 1 Template	AO_CH	0	9.50e-8
<input type="checkbox"/>	Analog Out Module 12 1 Template~	Analog Out Module 12 1 Template	AO_COM	0	1.19e-7
<input type="checkbox"/>	Power Supply 12 1 Template~	Power Supply 12 1 Template	PS	1	2.50e-7

3. In the upper-right corner of the section, select **+**.

A blank datasheet for the Protective Instrument Loop Logic Solver Channel appears.

Datasheet ID:
Protective Instrument Loop Logic So

Site:
Roanoke, VA

Details Failure Data Reference

Channel/Module ID:
Text input
This field is required

Device Name:
Text input

Channel Type:
Text input

Description:
Text input

Channels: 0 Manual Entry

Parameters

Dangerous Detected: OE+00 (FRPH)

Dangerous Undetected: OE+00 (FRPH)

Cancel Save

- As needed, enter values in the available fields.
 - In the lower-right corner of the datasheet, select **Save**.
- The Protective Instrument Loop Logic Solver is created.

Delete a Protective Instrument Loop Logic Solver Channel

About This Task

Note: You can delete a Protective Instrument Loop Logic Solver Channel only if the **Manual Entry** check box in the Protective Instrument Loop Logic Solver datasheet is selected.

Procedure

- [Access the Protective Instrument Loop Logic Solver](#) that is linked to Protective Instrument Loop Logic Solver Channel that you want to delete.
- In the workspace, select the **Channels/Modules** tab.

The **Channels/Modules** section appears, displaying a list of Protective Instrument Loop Logic Solver Channels.

~Multiple Calculations - External Template
~Mult...plate /Logic...late- /

Logic Solver Details Channel/Modules

Protective Loop Logic Solver Channel 🗑️ +

<input type="checkbox"/>	ID	CHANNEL/MODEL NAME	CHANNEL TYPE	CHANNELS	DANGEROUS L
<input type="checkbox"/>	Analog In Module 12 1 Template~	Analog In Module 12 1 Template	AI_COM	1	9.00e-7
<input type="checkbox"/>	Analog In Channel 12 1 Template~	Analog In Channel 12 1 Template	AI_CH	1	4.80e-8
<input type="checkbox"/>	Digital Out Low Channel 12 1 Template~	Digital Out Low Channel 12 1 Template	DOLOW_CH	1	5.70e-8
<input type="checkbox"/>	Digital Out High Module 12 1 Template~	Digital Out High Module 12 1 Template	DOHIGH_COM	0	1.90e-7
<input type="checkbox"/>	Digital Out Low Module 12 1 Template~	Digital Out Low Module 12 1 Template	DOLOW_COM	1	1.90e-7
<input type="checkbox"/>	Digital In Module 12 1 Template~	Digital In Module 12 1 Template	DI_COM	0	3.80e-7
<input type="checkbox"/>	Digital In Channel 12 1 Template~	Digital In Channel 12 1 Template	DI_CH	0	6.70e-8
<input type="checkbox"/>	Main Processor 12 1 Template~	Main Processor 12 1 Template	CPU	1	2.85e-6
<input type="checkbox"/>	Digital Out High Channel 12 1 Template~	Digital Out High Channel 12 1 Template	DOHIGH_CH	0	1.14e-7
<input type="checkbox"/>	Analog Out Channel 12 1 Template~	Analog Out Channel 12 1 Template	AO_CH	0	9.50e-8
<input type="checkbox"/>	Analog Out Module 12 1 Template~	Analog Out Module 12 1 Template	AO_COM	0	1.19e-7
<input type="checkbox"/>	Power Supply 12 1 Template~	Power Supply 12 1 Template	PS	1	2.50e-7

- For each row that contains the Protective Instrument Loop Logic Solver Channel that you want to delete, select the check box.
 - In the upper-right corner of the section, select .
- A message appears, asking if you really want to delete the Logic Solver Channel.
- Select **OK**.
- Each selected Protective Instrument Loop Logic Solver Channel is deleted.

Access a Protective Instrument Loop Template

Procedure

- Access the [SIS Management Overview](#) page.
 - In the workspace, select the **PIL Templates** tab.
- The **PIL Templates** appears, displaying a list of Protective Instrument Loop Templates.

SIS Management Overview
Asset: Home

Import From Exida Export to Exida

31	11	9	3	4	242
SIL Analysis	Proof Test Tasks	PIL Templates	SIS Trip Reports	Custom Failure Data	SRS

ID	DESCRIPTION	STATE
<input type="checkbox"/>	SIL Validation = External 1	Design
<input type="checkbox"/>	SIL Validation = External 2	Design
<input type="checkbox"/>	SIL Validation = External 3	Design
<input type="checkbox"/>	Switch from Internal to external	Design
<input type="checkbox"/>	Template Loop-02	T2.5.3 High Demand Mode Design

3. Select the template that you want to access.

The datasheet for the template appears.

V3.5.0 SP1 - New SIL Validation 3~V3.5.0 SP1 - New SIL Validation 3 Template

Definition Loop Diagram & calculation

Upgrade Loop

Datasheet ID: Protective Instrument Loop

Loop ID: V3.5.0 SP1 - New SIL Validation 3 Template

Description: V3.5.0 SP1 - New SIL Validation 3

SRS Project ID: ...

Loop Class: Safety

Required SIL: 3

SIL Validation Method*: Internal Calculation

Application Test Method: IEC 61508:2000

Calculation Engine: ExSILentia V3

Loop Type: Pressure

Demand Mode*: Low Demand

Test Architecture Constraints*: IEC 61508 : 2000 tables [per 61511-1 11.4.5]

Systematic Capability Validation:

4. If needed, modify values in the [available fields](#).

5. In the upper-right corner of the datasheet, select .

The changes made to the Protective Instrument Loop Template are saved.

6. If you want to access the diagram of the template, select the **Loop Diagram & calculation** tab.

The **Loop Diagram & calculation** section appears.

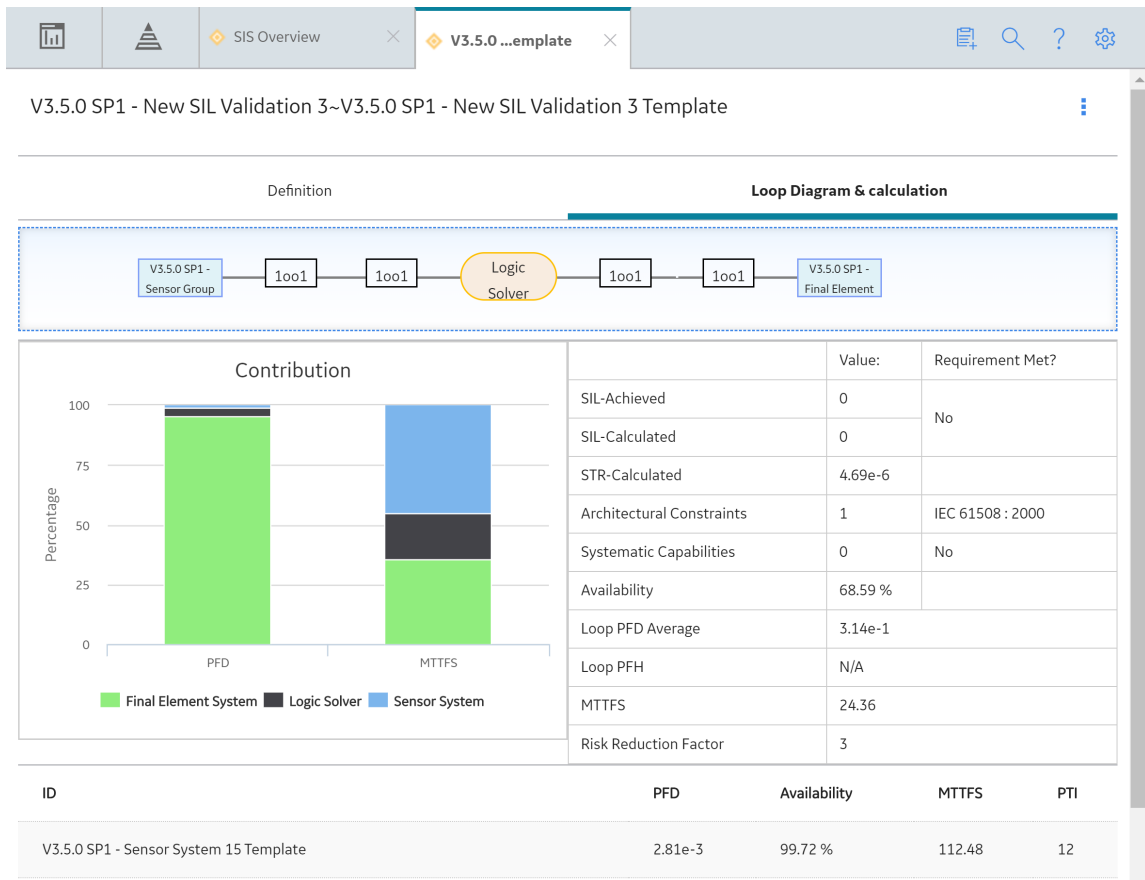

7. If you want to access the datasheets of the elements of the template, select the corresponding element in the diagram.

Create a Protective Instrument Loop Template

Before You Begin

- [Create a Protective Instrument Loop.](#)

About This Task

To create a Protective Instrument Loop Template, you must first create a Protective Instrument Loop, and then save it as a template.

When you save a Protective Instrument Loop as a template, the APM system:

- Creates a copy of each record in the loop (including the elements).
- Appends the word Template to the ID of the loop and all the elements.

Note: Any changes made to the original Protective Instrument Loop do not reflect in the copied record that you have saved as a template.

Procedure

1. [Access the Protective Instrument Loop](#) that you want to save as a template.
2. In the upper-right corner of the page, select , and then select **Save As Template**.

The Protective Instrument Loop is saved as a template.

Results

- The APM system:
 - Creates a copy of each record in the loop (including the elements).
 - Appends the word Template next to the ID of the loop and all the elements.
 - Lists the newly created template in the **PIL Templates** section of the **SIS Management Overview** page.

Next Steps

- [Apply a Template to a Protective Instrument Loop](#)

Copy a Protective Instrument Loop Template

Procedure

1. [Access the Protective Instrument Loop Template](#) that you want to copy.
2. In the upper-right corner of the datasheet, select , and then select **Save As**.

A copy of the template is created. The ID of the copied template is in the following format: <ID of the original template> - Copy.

Note: If you create another copy of the same template, the ID of the copied template will be in the following format: <ID of the original template> - Copy 1.

Access a Sensor in the Protective Instrument Loop Template

Procedure

1. [Access the Protective Instrument Loop Template](#) with which the Protective Instrument Loop Sensor that you want to access is linked.
2. In the diagram, select the Sensor Group node associated with the Sensor that you want to access.

The datasheet for the Sensor Group appears.

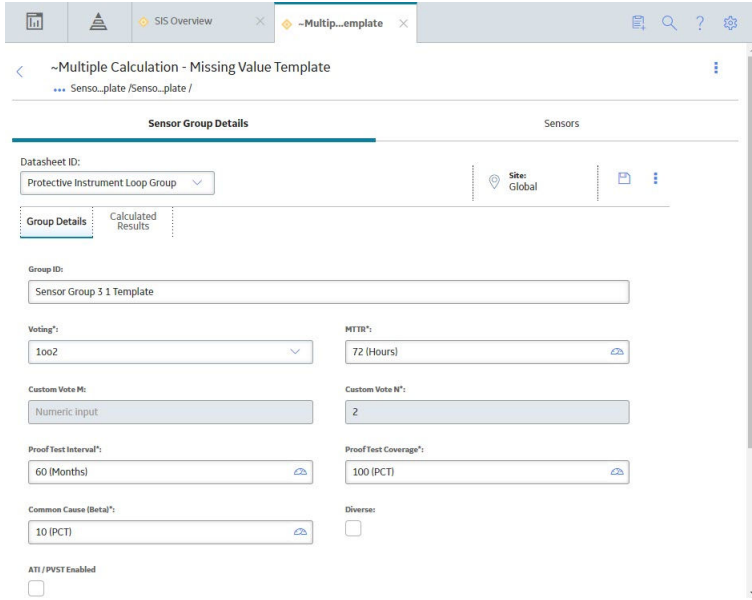

3. In the workspace, select the **Sensors** tab.

The **Sensors** section appears, displaying a list of Sensors in the Sensor Group.

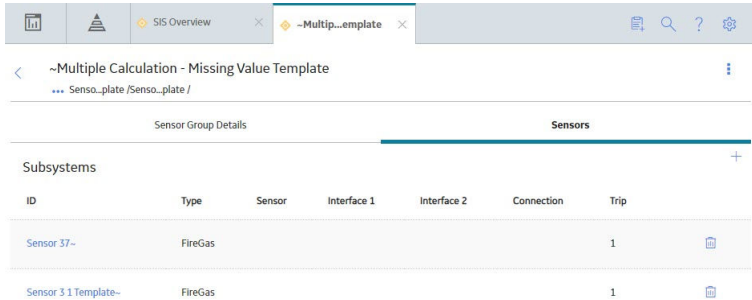

4. Select the Protective Instrument Loop Sensor that you want to access.

The datasheet for the Sensor appears.

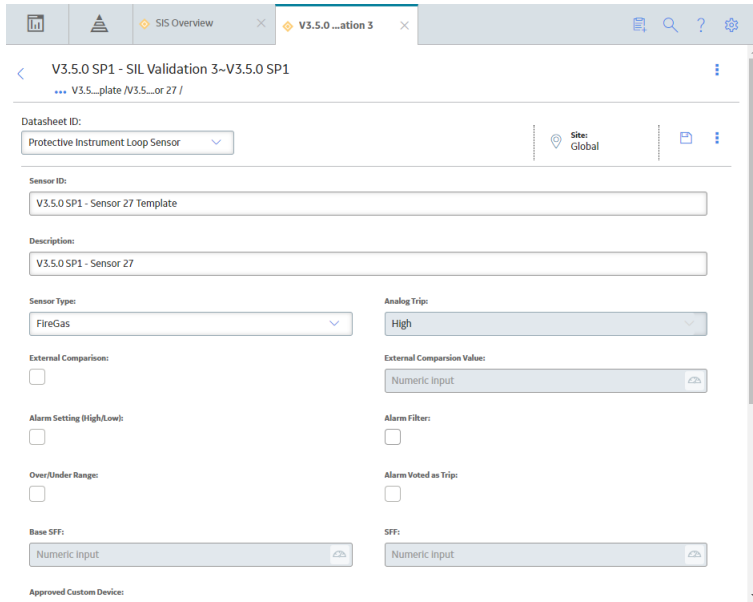

5. As needed, modify values in the [available fields](#).

6. In the upper-right corner of the datasheet, select .

The changes made to the Protective Instrument Loop Sensor are saved.

Access a Protective Instrument Loop Final Element

Procedure

1. [Access the Protective Instrument Loop Template](#) with which the Protective Instrument Loop Final Element that you want to access is linked.
2. In the diagram, select the Final Element Group node associated with the Final Element that you want to access.

The datasheet for the Final Element Group appears.

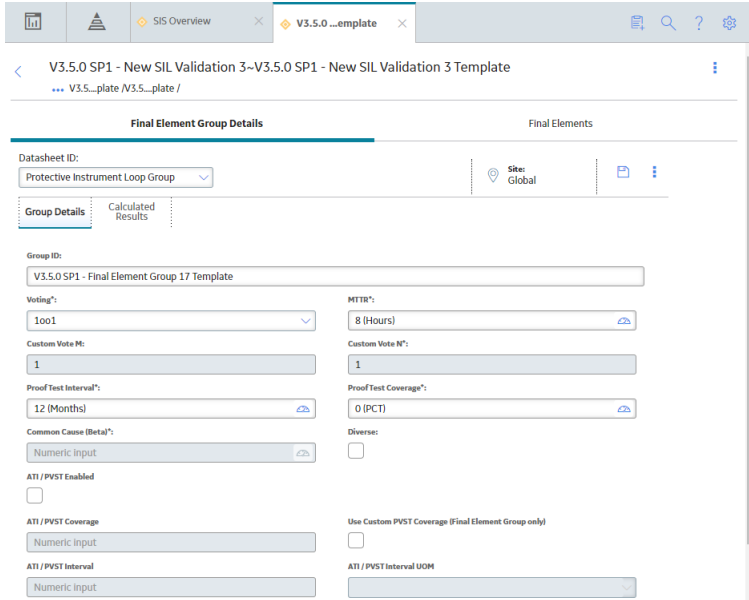

3. In the workspace, select the **Final Elements** tab.

The **Final Elements** section appears, displaying a list of Final Elements in the Final Element Group.

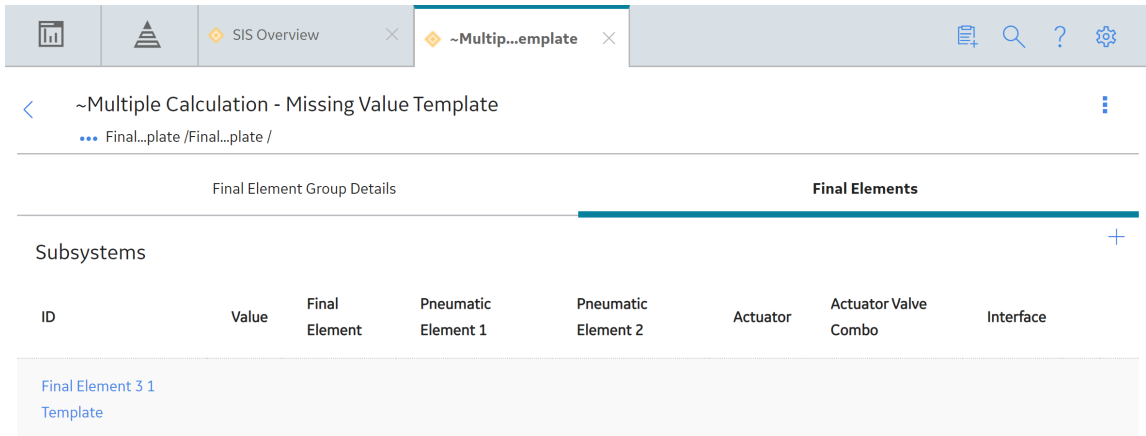

4. Select the Protective Instrument Loop Final Element that you want to access.

The datashheet for the Final Element appears.

The screenshot shows the configuration page for a Protective Instrument Loop Final Element. The Datasheet ID is 'Protective Instrument Loop Final Element' and the Site is 'Global'. The Final Element ID and Description are both 'Final Element 3 1 Template'. The Use Combination, Severe Service, Valve Trip Open, and Tight Shutoff Required checkboxes are all unchecked. The Base SFF and SFF are both set to 'Numeric input'. The Final Element is 'Generic MCC - interrupt function' and the InterFace Module is 'Generic Relay'. A table at the bottom shows the configuration for two devices:

ID	Device Tag	Dangerous Detected	Dangerous Undetected	Safe Detected	Safe Undetected
Final Element Device ID 25-	FEIM	0.00e+0	6.00e-7	0.00e+0	9.00e-7
Final Element Device ID 24-	FE	0.00e+0	6.20e-7	0.00e+0	1.00e-6

5. If needed, modify values in the [available fields](#).
6. In the upper-right corner of the datasheet, select .

The changes made to the Protective Instrument Loop Final Element are saved.

Delete a Protective Instrument Loop Template

Procedure

1. Access the [SIS Management Overview](#) page.
2. In the workspace, select the **PIL Templates** tab.

The **PIL Templates** section appears, displaying a list of Protective Instrument Loop Templates.

SIS Management Overview
Asset: Home

Import From Exida Export to Exida

31 SIL Analysis 11 Proof Test Tasks 9 PIL Templates 3 SIS Trip Reports 4 Custom Failure Data 242 SRS

ID	DESCRIPTION	STATE
<input type="checkbox"/>	SIL Validation = External 1	Design
<input type="checkbox"/>	SIL Validation = External 2	Design
<input type="checkbox"/>	SIL Validation = External 3	Design
<input type="checkbox"/>	Switch from Internal to external	Design
<input type="checkbox"/>	Template Loop-02	T2.5.3 High Demand Mode Design

- For each row that contains the template that you want to delete, select the check box.

In the upper-right corner of the section, the button is enabled.

- Select .

A confirmation message appears, asking if you really want to delete the protective instrument loop template.

- Select **OK**.

The Protective Instrument Loop Template is deleted.

Upgrade a Protective Instrument Loop Template

This topic describes how to upgrade a Protective Instrument Loop Template to support the exSILentia v4 Calculation Engine.

About This Task

Important: After you upgrade a Protective Instrument Loop Template to exSILentia v4, you cannot revert the template to exSILentia v3.

Procedure

- Access the [Protective Instrument Loop Template](#) that you want to upgrade.

The datasheet for the template appears.

V3.5.0 SP1 - New SIL Validation 3~V3.5.0 SP1 - New SIL Validation 3 Template ⋮

Definition Loop Diagram & calculation

Upgrade Loop

Datasheet ID:
Protective Instrument Loop ⋮

Site: Global ⋮

Loop ID:
V3.5.0 SP1 - New SIL Validation 3 Template

Description:
V3.5.0 SP1 - New SIL Validation 3

SRS Project ID: ... ⋮

Calculation Engine:
ExSILentia V3 ⋮

Loop Class:
Safety ⋮

Loop Type:
Pressure ⋮

Required SIL:
3 ⋮

Demand Mode*:
Low Demand ⋮

SIL Validation Method*:
Internal Calculation ⋮

Test Architecture Constraints*:
IEC 61508 : 2000 tables [per 61511-1 11.4.5] ⋮

Application Test Method:
IEC 61508:2000 ⋮

Systematic Capability Validation

2. Select **Upgrade Loop**.

Note: The **Upgrade Loop** button is only available for templates that use the exSILentia v3 Calculation Engine.

The **Upgrade Template?** window appears asking you to confirm if you want to upgrade the Protective Instrument Loop Template.

Upgrade Template?

You are about to upgrade this Protective Instrument Loop Template to use 'ExSILentia V4' calculation engine. As part of this upgrade, fields in the Protective Instrument Loop Template Data Model will be updated to support this change. Please refer to product documentation for additional details. This change cannot be reverted. Do you wish to proceed?

Yes **No**

3. Select **Yes**.
The Protective Instrument Loop Template is upgraded to exSILentia v4.

Access a Custom Device

About This Task

This topic describes how to access the following types of custom devices:

- Sensors
- Logic Solvers
- Final Elements

Procedure

1. Access the [SIS Management Overview](#) page.
2. In the workspace, select the **Custom Failure Data** tab.

The **Custom Failure Data** section appears, displaying a list of custom devices.

The screenshot shows the SIS Management Overview page. At the top, there is a navigation bar with a tab labeled 'SIS Overview'. Below the navigation bar, there is a section titled 'SIS Management Overview' with the asset 'Home'. To the right of this section are two buttons: 'Import From Exida' and 'Export to Exida'. Below these buttons is a dashboard with six cards showing counts for different categories: SIL Analysis (31), Proof Test Tasks (11), PIL Templates (9), SIS Trip Reports (3), Custom Failure Data (4), and SRS (242). Below the dashboard is a table with columns: ID, DESCRIPTION, APPROVED CUSTOM DEVICE, and LAST MODIFIED D. The table contains four rows of data:

ID	DESCRIPTION	APPROVED CUSTOM DEVICE	LAST MODIFIED D
<input type="checkbox"/> MERIDIUM APPROVED LOGIC SOLVER 1	MERIDIUM APPROVED LOGIC SOLVER 1	<input checked="" type="checkbox"/>	05/26/2010 11
<input type="checkbox"/> MERIDIUM APPROVED SENSOR 1	MERIDIUM APPROVED SENSOR 1	<input checked="" type="checkbox"/>	05/26/2010 10
<input type="checkbox"/> MERIDIUM FINAL ELEMENT 1	MERIDIUM FINAL ELEMENT 1	<input checked="" type="checkbox"/>	05/26/2010 11
<input type="checkbox"/> V3.5.0 SP1 - Logic Solver 5	Logic Solver 5	<input checked="" type="checkbox"/>	09/09/2013 10

Tip: You can filter the list by selecting a particular type of custom devices from the drop-down list box in the upper-right corner of the section.

3. Select the custom device that you want to access.

The datasheet for the selected custom device appears.

Final Element Subsystem Revoke Approval

Datasheet ID: Protective Instrument Loop Final Elen Site: Global

Final Element ID: MERIDIUM FINAL ELEMENT 1

Description: MERIDIUM FINAL ELEMENT 1

Use Combination: Severe Service:

Valve Trip Open: Tight Shutoff Required:

Base SFF: Numeric input SFF: Numeric input

Approved Custom Device:

Final Element : Generic Alarm Siren InterFace Module : ABB V17153-115 and V17153-5

- If needed, modify values in the available fields for the [Sensor](#), [Logic Solver](#), or the [Final Element](#).

Note: Modifying the details of a custom device that is linked to a Protective Instrument Loop may alter the calculations of the loop. Therefore, you must verify the calculations again.

- In the upper-right corner of the datasheet, select **Save**.

The changes made to the selected custom device are saved.

Create a Custom Device

About This Task

This topic describes how to create Failure Rate Reference Data for the following types of custom devices:

- Sensors
- Logic Solvers
- Final Elements

Procedure

- Access the [SIS Management Overview](#) page.
- In the workspace, select the **Custom Failure Data** tab.

The **Custom Failure Data** section appears, displaying a list of Failure Rate Reference Data records for all types of custom devices.

SIS Management Overview
Asset: Home

Import From Exida Export to Exida

31 SIL Analysis 11 Proof Test Tasks 9 PIL Templates 3 SIS Trip Reports 4 Custom Failure Data 242 SRS

ID	DESCRIPTION	APPROVED CUSTOM DEVICE	LAST MODIFIED DATE
<input type="checkbox"/>	MERIDIUM APPROVED LOGIC SOLVER 1	<input checked="" type="checkbox"/>	05/26/2010 11
<input type="checkbox"/>	MERIDIUM APPROVED SENSOR 1	<input checked="" type="checkbox"/>	05/26/2010 10
<input type="checkbox"/>	MERIDIUM FINAL ELEMENT 1	<input checked="" type="checkbox"/>	05/26/2010 11
<input type="checkbox"/>	V3.5.0 SP1 - Logic Solver 5	<input checked="" type="checkbox"/>	09/09/2013 10

- In the upper-left corner of the section, select **+**, and then select the type of the custom device that you want to create.

A blank custom device datasheet of the selected type appears. The following image shows the datasheet for a Custom Sensor.

Custom Sensor

Datasheet ID: Protective Instrument Loop Sen

Site: Global

Sensor ID:
This field is required

Description:

Sensor Type: FireGas

Analog Trip: Low

External Comparison:

External Comparison Value: Numeric input

Alarm Setting (High/Low):

Alarm Filter:

Over/Under Range:

Alarm Voted as Trip:

Cancel Save

4. As needed, enter values in the available fields for the [Sensor](#), [Logic Solver](#), or [Final Element](#).
5. Select the interfaces, connections, channels, and elements as applicable, and then select **Save**.

The custom device is created.

Next Steps

- [Create a Proven In Use Justification record](#)
- [Approve a Custom Device](#)

Approve a Custom Device

About This Task

This topic describes how to approve the following types of custom devices:

- Sensors
- Logic Solvers
- Final Elements

Procedure

1. [Access the Custom Device](#) that you want to approve.
2. In the upper-right corner of the datasheet, select **Approve**.

The custom device is approved.

Revoke the Approval of a Custom Device

About This Task

Note: If you revoke the approval of a custom device that is part of a protective instrument loop, it does not affect the loop.

Procedure

1. [Access the Custom Device](#) whose approval you want to revoke.
2. In the upper-right corner of the datasheet, select **Revoke Approval**.

The approval of the custom device is revoked.

Delete a Custom Device

About This Task

This topic describes how to delete the following types of custom devices:

- Sensors
- Logic Solvers
- Final Elements

Important: Deleting a custom device that is linked to a Protective Instrument Loop alters the calculations of the loop. Therefore, you must review the calculations again.

Procedure

1. Access the [SIS Management Overview](#) page.

Tip: You can also access the [SIS Management Overview](#) page for a selected hierarchy level.

2. In the workspace, select the **Custom Failure Data** tab.

The **Custom Failure Data** section appears, displaying a list of custom devices.

The screenshot shows the SIS Management Overview page. At the top, there is a navigation bar with a tree icon, a tab labeled 'SIS Overview', and utility icons for list, search, help, and settings. Below the navigation bar, the page title is 'SIS Management Overview' and the asset is 'Home'. There are two buttons: 'Import From Exida' and 'Export to Exida'. The main content area features a dashboard with six summary cards: '31 SIL Analysis', '11 Proof Test Tasks', '9 PIL Templates', '3 SIS Trip Reports', '4 Custom Failure Data', and '242 SRS'. Below the dashboard is a table of custom devices with a filter dropdown set to 'All'. The table has columns for ID, DESCRIPTION, APPROVED CUSTOM DEVICE, and LAST MODIFIED DATE.

ID	DESCRIPTION	APPROVED CUSTOM DEVICE	LAST MODIFIED DATE
<input type="checkbox"/> MERIDIUM APPROVED LOGIC SOLVER 1	MERIDIUM APPROVED LOGIC SOLVER 1	<input checked="" type="checkbox"/>	05/26/2010 11
<input type="checkbox"/> MERIDIUM APPROVED SENSOR 1	MERIDIUM APPROVED SENSOR 1	<input checked="" type="checkbox"/>	05/26/2010 10
<input type="checkbox"/> MERIDIUM FINAL ELEMENT 1	MERIDIUM FINAL ELEMENT 1	<input checked="" type="checkbox"/>	05/26/2010 11
<input type="checkbox"/> V3.5.0 SP1 - Logic Solver 5	Logic Solver 5	<input checked="" type="checkbox"/>	09/09/2013 10

Tip: You can filter the list by selecting a particular type of custom devices from the drop-down list box in the upper-right corner of the section.

3. Select the check box that corresponds to the custom device that you want to delete.

In the upper-right corner of the section, the button is enabled.

4. Select .

A confirmation message appears, asking if you really want to delete the custom device.

5. Select **OK**.

The custom device is deleted.

Access the Results of a Protective Instrument Loop

Procedure

1. Access the [Protective Instrument Loop](#) for which you want to access the results.
2. In the workspace, select the **Loop Diagram & calculation** tab.

The **Loop Diagram & calculation** section appears, displaying the loop calculations and results for the Protective Instrument Loop.

SIS Overview | SRS Report-01

Analysis Summary < Templ...02 1 /

Instrumented Functions Logic Solvers

ABB 800xA - T6.5.1

ASF Instrume...ted Function

ASM2 - MM De...nt - T1.28.2

Auto Channel...i O - T6.1.3

DeltaV SIS r...st - T6.5.5b

DeltaV SIS r...st - T6.5.4b

DeltaV SIS r...nt - T6.5.4a

DeltaV SIS r...LS - T6.5.5a

DeltaV SIS s...lex - T6.5.2

DeltaV SIS s...SLS - T6.5.3

Definition

Loop Diagram & calculation

Contribution

	Value:	Requirement Met?
SIL-Achieved	1	Yes
SIL-Calculated	1	
STR-Calculated	7.27e-6	No
Architectural Constraints	N/A	IEC 61508 : 2000
Systematic Capabilities	N/A	
Availability	N/A	
Loop PFD Average	N/A	
Loop PFH	7.60e-6	
MTTFS	15.71	
Risk Reduction Factor	N/A	

ID	PFD	Availability	MTTFS	PTI
Avenor Sensor System 1	1.61e-6	N/A	67.79	8

Chapter 10

SIL Validation

Topics:

- [About Safety Integrity Level \(SIL\) Validation](#)
- [About Mobile Proof Tests](#)
- [About Synchronizing Mobile Proof Tests](#)
- [Safety Integrity Level \(SIL\) Validation Workflow](#)
- [Access the SIL Validation Page for an Instrumented Function](#)
- [Access the SIL Validation Page for a Logic Solver](#)
- [Access a Proof Test Template](#)
- [Create a Proof Test Template](#)
- [Change the State of a Proof Test Template](#)
- [Generate a Report of the Proof Test Template](#)
- [Delete a Proof Test Template](#)
- [Access a Proof Test Template Detail](#)
- [Create a Proof Test Template Detail](#)
- [Copy a Proof Test Template Detail](#)
- [Delete a Proof Test Template Detail](#)
- [Access a List of all Proof Test Tasks](#)
- [Access a Proof Test Task Linked to a Logic Solver](#)
- [Access a Proof Test Task Linked to an Instrumented Function](#)
- [Create a Proof Test Task](#)

- [Assign an Existing Proof Test Task](#)
- [Download Proof Test Task For Offline Access](#)
- [Modify Offline Datasheets for Proof Test And Template Details](#)
- [View the Error Log for Offline Proof Test Task](#)
- [Delete a Proof Test Task](#)
- [Access a Proof Test](#)
- [Create a Proof Test](#)
- [Apply a Proof Test Template and a Proof Test Task to a Proof Test](#)
- [Generate a Report of the Proof Test](#)
- [Close a Proof Test](#)
- [Delete a Proof Test](#)

About Safety Integrity Level (SIL) Validation

Safety instrumented systems and each instrumented function within that system must be tested to ensure that those systems is functioning to the standards for which they are designed. A proof test consists of a set of steps that you need to perform to test safety instrumented systems and instrumented functions. The conditions under which the test is conducted should represent the normal conditions under which the system is intended to operate.

Depending on the group of equipment or devices that make up a safety instrumented system, you will want to define a set of test steps that apply to a given group of equipment or devices. In other words, you will need to define one set of test steps that you can reuse when you test similar systems.

Creating Records in Proof Testing

For each proof test that you want to conduct, you should create at least one record in each of the following families:

- **SIS Proof Test Template** : Stores details about a given proof test, including the steps that need to be performed. For each unique set of test steps that exists, you will need to create one SIS Proof Test Template to store those details.
- **SIS Proof Test Template Detail** : Stores the details on each specific step that needs to be performed for the test. These records are linked to SIS Proof Test Templates through the Has Template Detail relationship. You should create one SIS Proof Test Template Detail for each step that is required for that test.
- **Inspection Task** : Stores the details of the proof test task, which specifies the schedule for the proof test. These records are linked to the asset on which you will perform the proof test and to the Proof Test through the Has Task relationship. After you perform the proof test and the Proof Test that is linked to the asset is closed, the Proof Test Task is updated automatically to reflect the date on which the proof test was performed and the next date on which the proof test is due for that asset. Proof Tests Tasks are also created in Asset Strategy Management (ASM) after you promote a Recommendation to ASM.
- **SIS Proof Test** : Stores details about a proof test that you perform, including the test results. When you create an SIS Proof Test, you will need to specify the SIS Proof Test Template that contains the details about the proof test you want to perform. When you select the SIS Proof Test Template, one Functional Test Detail will be created for each SIS Proof Test Template Detail that is linked to the SIS Proof Test Template. For each proof test that you want to perform, you will need to create one SIS Proof Test. You can, however, reuse SIS Proof Test Templates.

You can think of the SIS Proof Test Template and SIS Proof Test Template Details as the specifications for how the test should be performed, and the SIS Proof Test and Functional Test Details as a record of the test occurring.

Steps Involved in Conducting a Proof Test

To conduct a proof test, you will need to complete the following steps:

1. **Define the proof test steps** that need to be performed for a given safety instrumented system by creating one Proof Test Template for each type of test that will need to be performed. Creating an SIS Proof Test Template includes linking SIS Proof Test Template Details to the SIS Proof Test Template.
2. **Create one SIS Proof Test**, which serves as a record of the test event and stores the results of that test.

This topic provides details on SIS Proof Test Template and SIS Proof Tests. For details on how these families participate in the SIS Management data model, see the [SIS Management data model](#).



About Mobile Proof Tests



You can use Mobile Proof Testing on the APM mobile application to run test procedures and collect proof testing data using mobile devices, such as a tablet. You can [record values for the Proof Test](#) and [create recommendations](#) (e.g., a maintenance follow-up) for the proof test, directly from the mobile device even if the mobile device is disconnected from the network.

When you download a Proof Test Task for offline access, on the **Mobile Proof Testing** page, the  icon appears on the downloaded Proof Test Task, indicating that the Proof Test Task is downloaded to the mobile device that you will use for recording values for the Proof Test.

About Synchronizing Mobile Proof Tests

When you reconnect the mobile device to the network, the values that you recorded in the Proof Tests and the Recommendations that you created are uploaded automatically to the APM database.

The color of the  icon that appears on the upper-right corner of the Proof Test in the **Mobile Proof Testing** page, indicates the status of synchronization. The  icon changes to one of the following:

-  : Indicates that the synchronization is completed successfully. The values that you recorded in the Proof Test and the associated Recommendations are uploaded to the database.
-  : Indicates that the synchronization failed. When you select , a message appears, describing the error that has caused the synchronization to fail. The error may be either in the Proof Test or in the Recommendation.

On successful synchronization, APM copies the values in the Proof Tests that you executed in the mobile device to the corresponding Proof Tests in the database. You can access these Proof Tests from the SIS Management module.

APM system creates copies of the Recommendations that you created in the mobile device, and then links them to the Instrumented Functions with which the Proof Test Tasks are associated. The images attached to the Recommendations that you created for the Proof Test appear as Reference Documents in the Recommendations created for the Instrumented Function.

Tip: For more information, refer to the Reference Documents section of the documentation.

Safety Integrity Level (SIL) Validation Workflow

This workflow provides the basic, high-level steps for performing an SIL validation. The steps and links in this workflow do not necessarily reference every possible procedure.

Performing an SIL Verification includes the following steps:

1. [Create a Proof Test Template](#), which stores the details of the pass/fail criteria and error limits.
2. [Create a Proof Test Task](#), which stores the schedule for the task.
3. Perform the proof test.
4. [Create a Proof Test](#).
5. [Apply the Proof Test Template and the Proof Test Task to the Proof Test](#).
6. In the Proof Test record, provide the results of the proof test that you have performed.

7. The APM system performs the error calculations and provides the pass/fail results.

Access the SIL Validation Page for an Instrumented Function

Before You Begin

- You can access the **SIL Validation** page only if you are a member of one of the following Security Groups:
 - MI SIS Administrator
 - MI SIS Engineer
 - MI SIS User

You can perform the various tasks on this page based on the privileges granted to these Security Groups.

Procedure

1. Access the **SIS Management Overview** page.

Tip: You can also access the **SIS Management Overview** page for a selected hierarchy level.

2. In the workspace, select the **SIL Analysis** tab.

The **SIL Analysis** section appears, displaying a list of SIL Analyses.

The screenshot shows the 'SIS Management Overview' page for 'Asset: MRD ~ Meridium, Inc.'. At the top right, there are two buttons: 'Import From Exida' and 'Export to Exida'. Below these are six summary cards: 'SIL Analysis' (5), 'Proof Test Tasks' (2), 'PIL Templates' (9), 'SIS Trip Reports' (3), 'Custom Failure Data' (4), and 'SRS' (242). The 'SIL Analysis' card is selected and expanded to show a table with columns 'ANALYSIS ID' and 'EQUIPMENT ID'. The table contains five rows of analysis entries, each with a checkbox on the left. At the bottom, there is a pagination control showing 'Rows per page' with options 50, 100, 200, and 500, and a result indicator '1 - 5 of 5 Results' with a page number '1' and navigation arrows.

ANALYSIS ID	EQUIPMENT ID
<input type="checkbox"/> AQA Copy Analysis	~ ~ QA TM Dflit T-min
<input type="checkbox"/> ASF SIL Analysis	~ ~ AQA EQUIPMENT ~ MBJ-EQUIPMENT-00002
<input type="checkbox"/> Copy SIL Analysis	~ ~ QA TM Apply CCR
<input type="checkbox"/> PHA-Internal	~ ~ QA TM EQUIPMENT W/ TML GROUPS
<input type="checkbox"/> V3.5.0 SP1 - SIL-09	~ MAIN COLUMN O.H. TRIM COOLER ~ HXST 78

3. Select the SIL Analysis that is linked to the Instrumented Function for which you want to perform SIL validation.

The **SIL Analysis Summary** section appears.

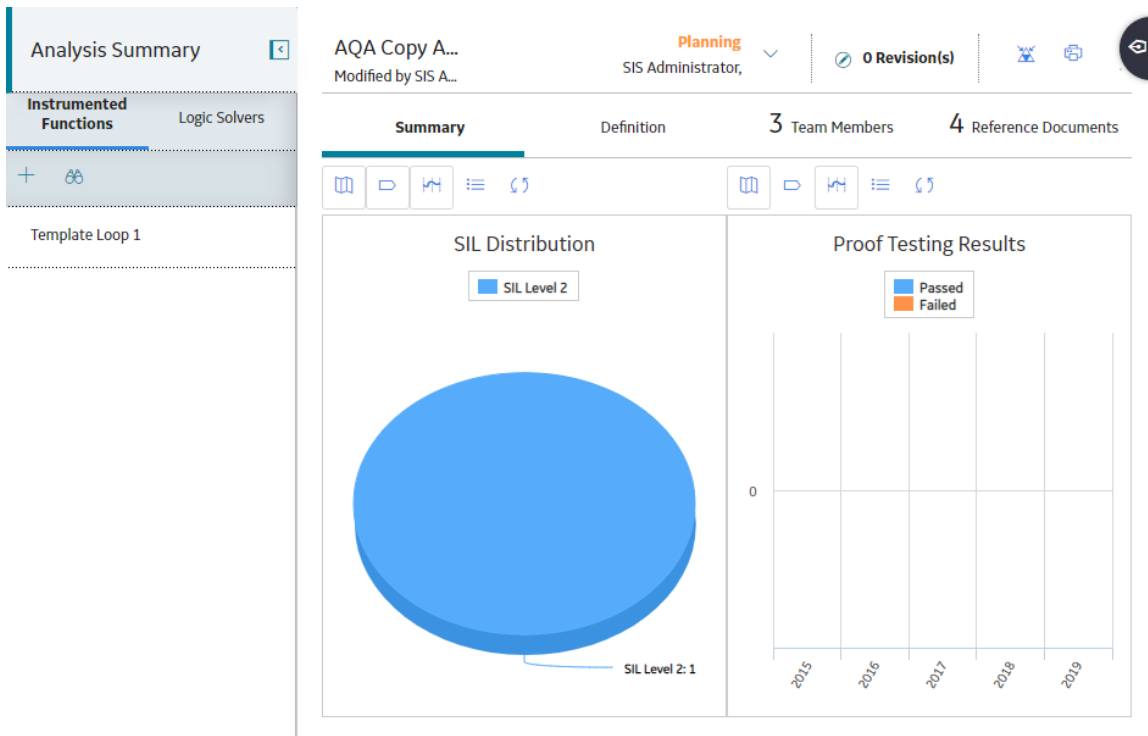

4. In the left pane, select the Instrumented Function for which you want to perform SIL validation.
The datasheet for the Instrumented Function appears.

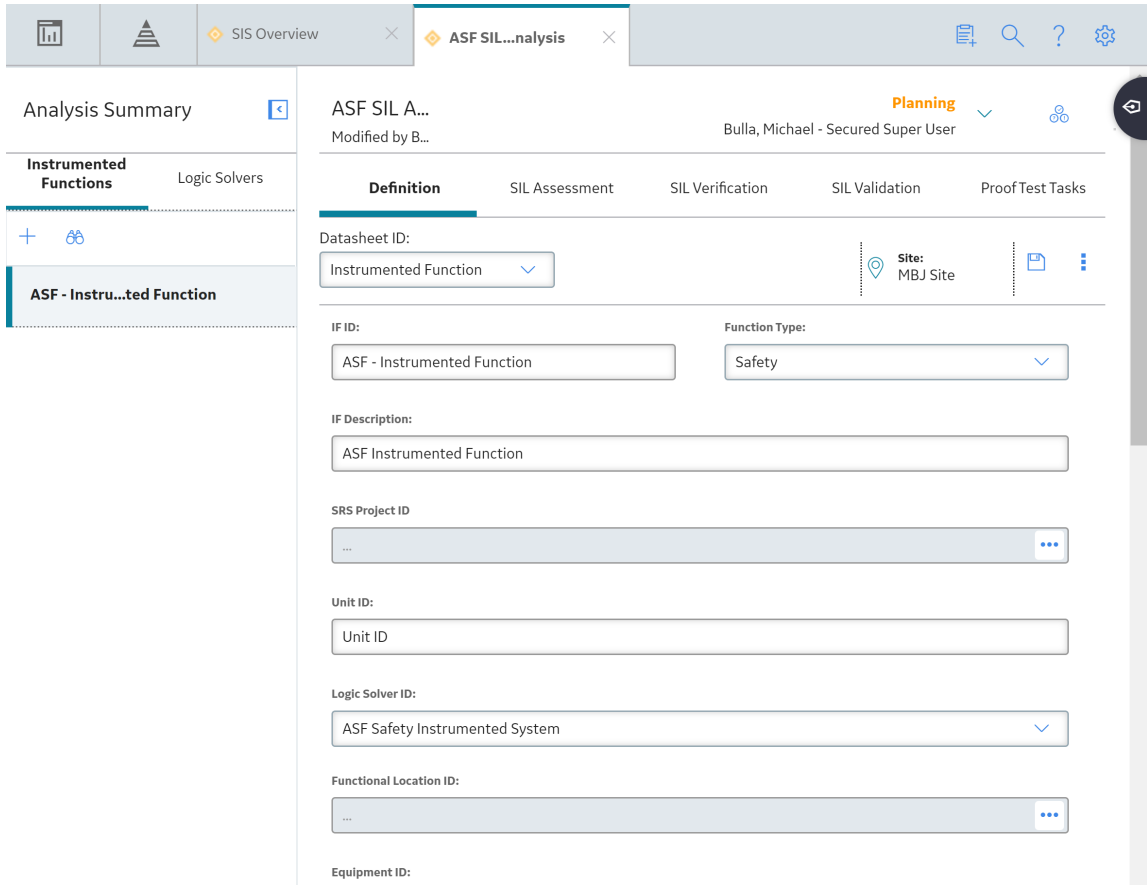

5. In the workspace, select the **SIL Validation** tab.

The **SIL Validation** section appears, displaying a list of the Proof Test Templates linked to the Instrumented Function.

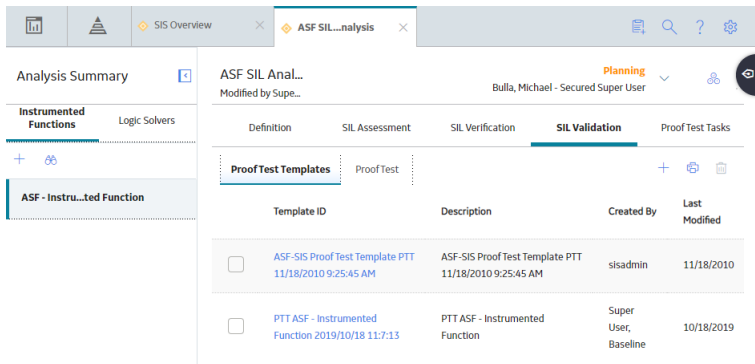

Access the SIL Validation Page for a Logic Solver

Before You Begin

- You can access the **SIL Validation** page only if you are a member of one of the following Security Groups:
 - MI SIS Administrator

- MI SIS Engineer
- MI SIS User

You can perform the various tasks on this page based on the privileges granted to these Security Groups.

Procedure

1. Access the **SIS Management Overview** page.
Tip: You can also access the **SIS Management Overview** page for a selected hierarchy level.
2. In the workspace, select the **SIL Analysis** tab.

The **SIL Analysis** section appears, displaying a list of SIL Analyses.

SIS Management Overview
Asset: MRD ~ Meridium, Inc. Import From Exida Export to Exida

5 SIL Analysis	2 Proof Test Tasks	9 PIL Templates	3 SIS Trip Reports	4 Custom Failure Data	242 SRS
-------------------	-----------------------	--------------------	-----------------------	--------------------------	------------

<input type="checkbox"/>	ANALYSIS ID ↑	EQUIPMENT ID
<input type="checkbox"/>	AQA Copy Analysis	~ ~ QA TM Dfit T-min
<input type="checkbox"/>	ASF SIL Analysis	~ AQA EQUIPMENT ~ MBJ-EQUIPMENT-00002
<input type="checkbox"/>	Copy SIL Analysis	~ ~ QA TM Apply CCR
<input type="checkbox"/>	PHA-Internal	~ ~ QA TM EQUIPMENT W/ TML GROUPS
<input type="checkbox"/>	V3.5.0 SP1 - SIL-09	~ MAIN COLUMN O.H. TRIM COOLER ~ HXST 78

Rows per page 50 200 500 1 - 5 of 5 Results ← 1 →

3. Select the SIL Analysis that is linked to the Logic Solver for which you want to perform SIL validation.
The **SIL Analysis Summary** section appears.

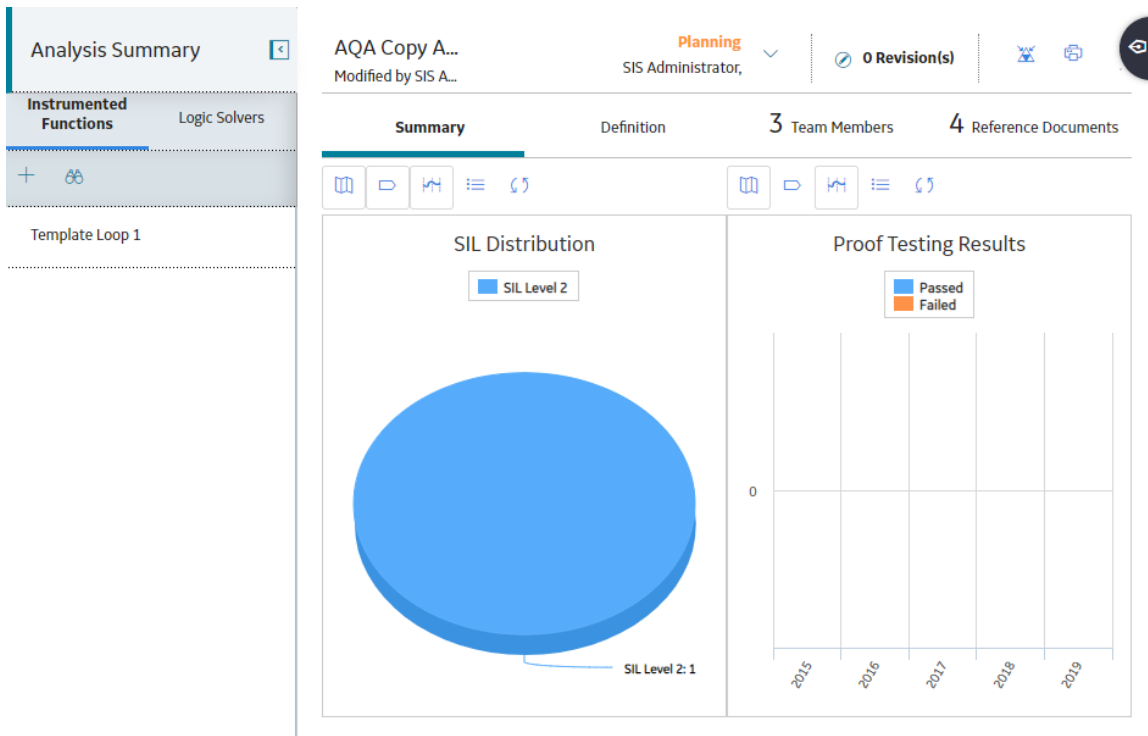

4. In the left pane, select **Logic Solvers**.

The **Logic Solvers** section appears, displaying a list of Logic Solvers in the SIL Analysis.

5. Select the Logic Solver for which you want to perform SIL validation.

The datasheet for the Logic Solver appears.

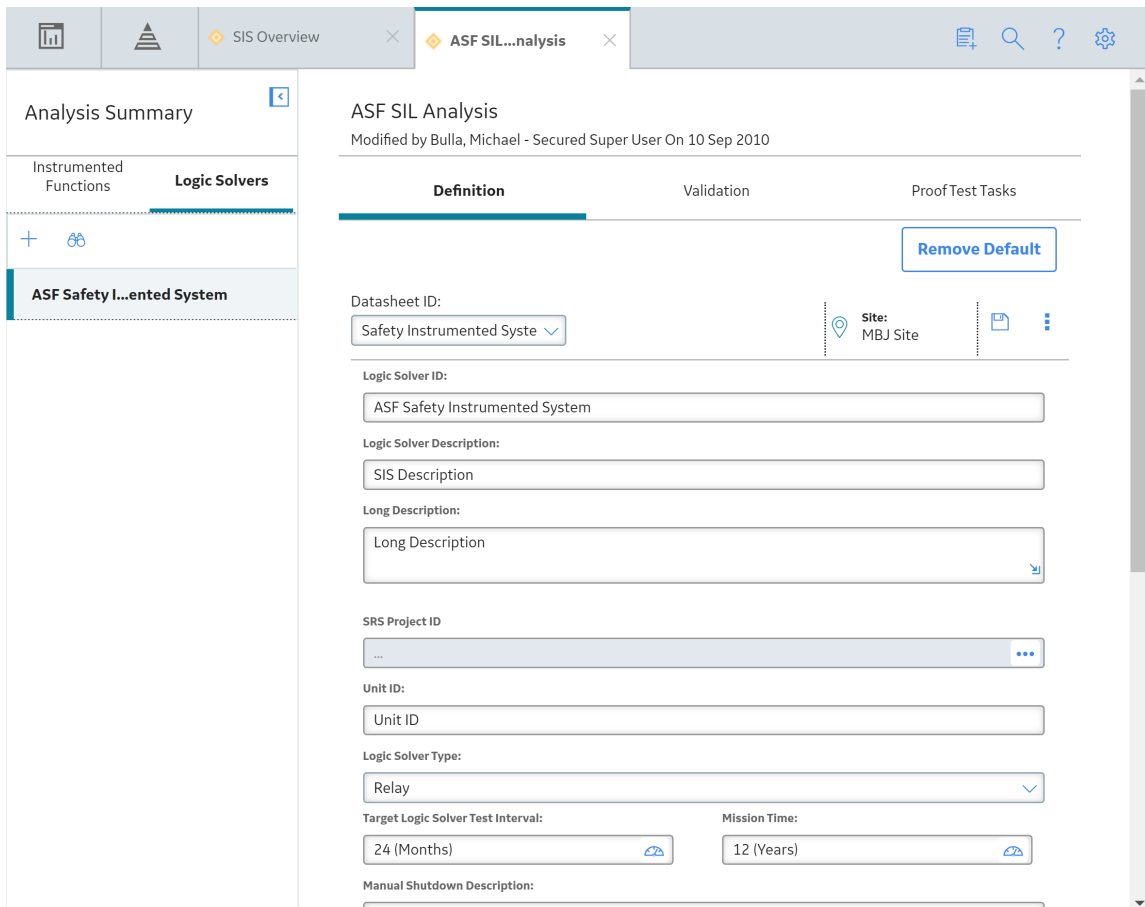

6. In the workspace, select the **Validation** tab.

The **Validation** section appears, displaying a list of Proof Test Templates linked to the Logic Solver.

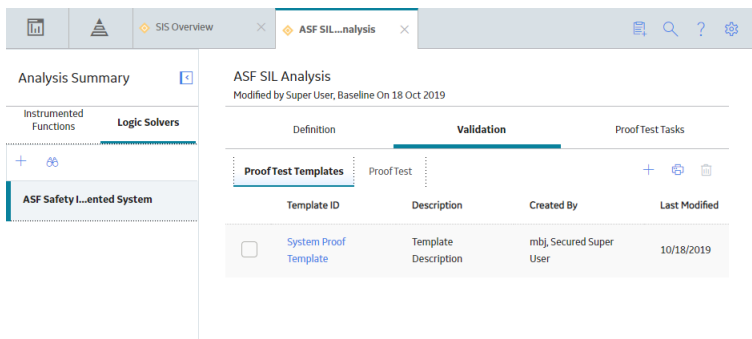



Access a Proof Test Template

Procedure

1. Access the **SIL Validation** page for the **Instrumented Function** or the **Logic Solver** that is linked to the Proof Test Template.
2. Select the Proof Test Template that you want to access.

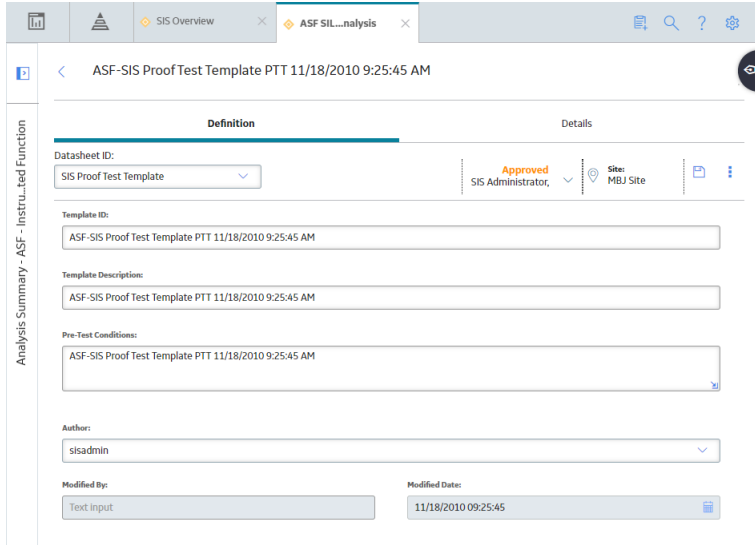
The datasheet for the Proof Test Template appears.



3. If needed, modify values in the [available fields](#).
4. In the upper-right corner of the datasheet, select .

The changes made to the Proof Test Template are saved.

Note: The changes made to the Proof Test Template does not affect the Proof Tests that have used the template prior to modifications.

Create a Proof Test Template

Procedure

1. Access the **SIL Validation** page for the [Instrumented Function](#) or the [Logic Solver](#).
2. In the upper-right corner of the workspace, select .

A blank datasheet for the Proof Test Template appears.

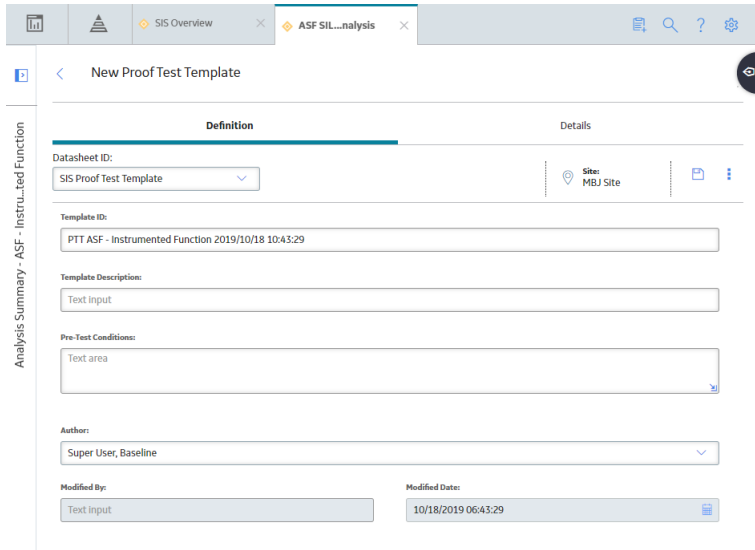

3. As needed, in the **Definition** section, enter values in the [available fields](#).

4. As needed, in the **Details** section, enter values in the [available fields](#).
 5. In the upper-right corner of the datasheet, select .
- The Proof Test Template is created.

Next Steps

- [Create a Proof Test Template Detail](#)
- [Approve the Proof Test Template](#)

Change the State of a Proof Test Template

About This Task

Note: You can apply approved templates on a Proof Test.

Procedure

1. [Access the Proof Test Template](#) for which you want to change the state.
2. In the upper-right corner of the datasheet, select the button that indicates the current state of the Proof Test Template. For example, if the current state of the template is Development, select the **Development** button.

A menu appears, displaying a list of operations that you can perform on the template to change its state.

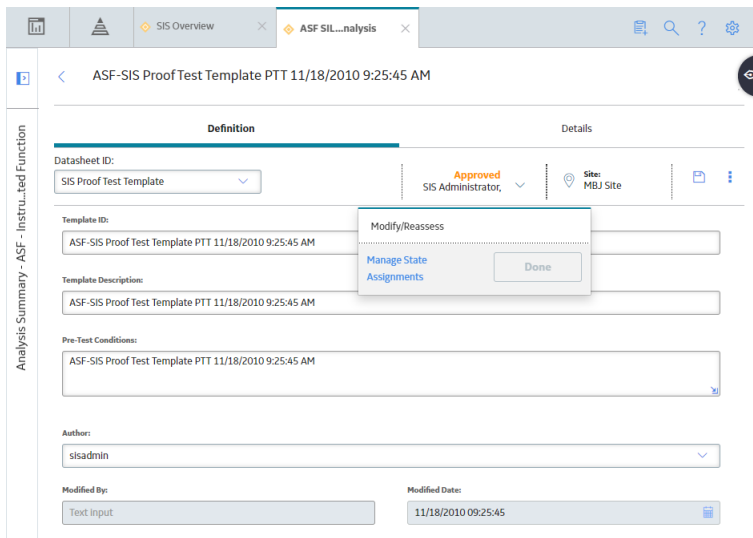

3. Select **Manage State Assignments**.
- The **State Assignments** window appears.

State Assignments

State	Assignee
Approved	Smith, Jane
Development	Smith, Jane
Pending Approval	

Done Cancel

4. If not already done, assign the next state of the template to the appropriate user, and then select **Done**.
The **State Assignments** window closes.
5. Select the operation to change the state of the template, and then select **Done**. For example, if you want to change the state of a template from Approved to Development, select **Modify/Reassess**, and then select **Done**.
The state of the Proof Test Template is changed.

Generate a Report of the Proof Test Template

Procedure

1. Access the **SIL Validation** page for the [Instrumented Function](#) or the [Logic Solver](#).
2. Select the check box that corresponds to the template whose report you want to generate.
3. In the upper-right corner of the section, select .

The Proof Test Template report is generated. You can print, save, or export the report, or attach it to an email.

Delete a Proof Test Template

Procedure

1. Access the **SIL Validation** page for the [instrumented function](#) or the [logic solver](#) that is linked to the Proof Test Template.

2. Select the check box that corresponds to the Proof Test Template that you want to delete.
3. In the upper-right corner of the section, select  .
A confirmation message appears, asking if you really want to delete the Proof Test Template.
4. Select **OK**.
The Proof Test Template is deleted.

Access a Proof Test Template Detail

Procedure

1. [Access the Proof Test Template](#) that is linked to the Proof Test Template Detail that you want to access.
2. In the workspace, select the **Details** tab.

The **Details** section appears, displaying a list of Proof Test Template Details linked to the Proof Test Template.

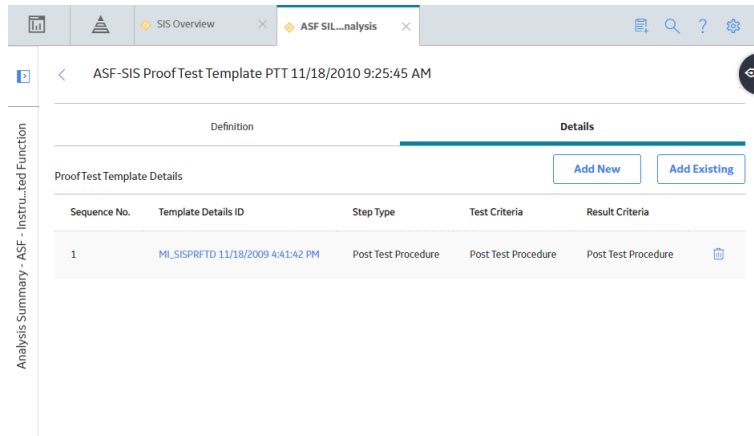

3. Select the Proof Test Template Detail that you want to access.
A datasheet for the Proof Test Template Detail appears.

Proof Test Template Details

 Site:
Roanoke, VA

Template Detail ID:

Step Sequence Number: **Step Type:**

Test Criteria:

Result Criteria:

Location ID:

4. If needed, modify values in the [available fields](#).
5. In the lower-right corner of the datasheet, select **Save**.

The changes made to the Proof Test Template Detail are saved.

Note: The changes made to the Proof Test Template does not affect the Proof Tests that have used the template prior to modifications.

Create a Proof Test Template Detail

This topic describes how to create Proof Test Template Detail. You can also copy one or more Proof Test Template Details.

Before You Begin

- [Create a Proof Test Template](#).

Procedure

1. [Access the Proof Test Template](#) for which you want to add a Proof Test Template Detail.
2. In the workspace, select the **Details** tab.

The **Details** section appears, displaying a list of Proof Test Template Details linked to the Proof Test Template.

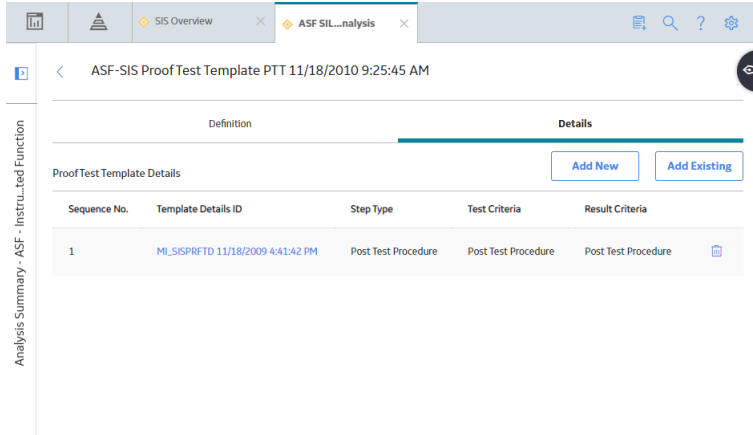

3. In the upper-right corner of the section, select **Add New**.
A blank datasheet for the Proof Test Template Detail appears.

4. As needed, enter values in the [available fields](#).
5. In the lower-right corner of the datasheet, select **Save**.

The Proof Test Template Detail is created.

Note: The changes made to the Proof Test Template does not affect the Proof Tests that have used the template prior to modifications.

Copy a Proof Test Template Detail

This topic describes how to create Proof Test Template Detail by copying an existing one. You can also create a Proof Test Template Detail using a blank datasheet.

Before You Begin

- [Create a Proof Test Template](#).

Procedure

1. [Access the Proof Test Template](#) for which you want to add a Proof Test Template Detail.
2. In the workspace, select the **Details** tab.

The **Details** section appears, displaying a list of Proof Test Template Details linked to the Proof Test Template.

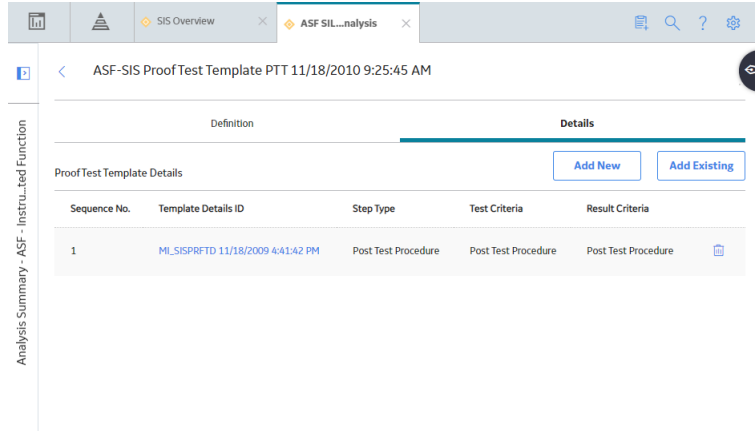

3. In the upper-right corner of the section, select **Add Existing**.
The **Search** window appears.

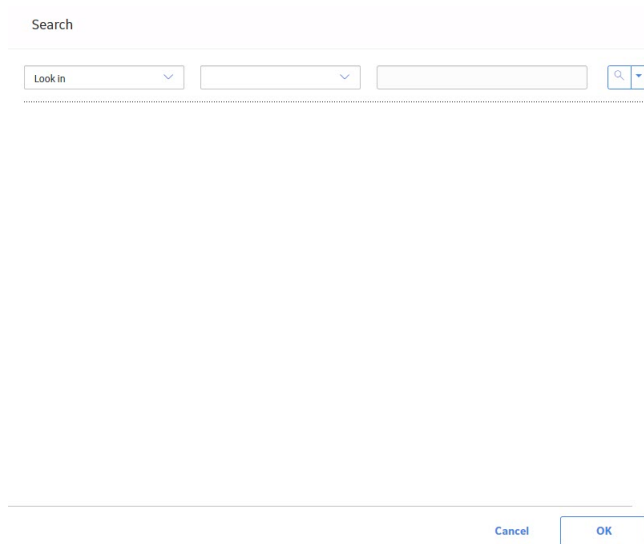

4. In the upper-right corner of the window, select .
A list of Proof Test Template Details appears.

Search

The screenshot shows a search window with the following elements:

- Search filters: "Look in" dropdown, two empty search input fields, and a search icon.
- Search results: A list of seven entries, each with a radio button, a timestamp, and a title "SIS Proof Test Template Detail".
- Buttons: "Cancel" and "OK" buttons at the bottom right.

Timestamp	Title	Links
MI_SISPRFTD 2/5/2011 10:29:07 PM	SIS Proof Test Template Detail	Equipment Functional Location SIS Proof Test Template
MI_SISPRFTD 2/5/2011 10:34:23 PM	SIS Proof Test Template Detail	SIS Proof Test Template
MI_SISPRFTD 2/5/2011 10:35:46 PM	SIS Proof Test Template Detail	SIS Proof Test Template
MI_SISPRFTD 2/5/2011 10:39:48 PM	SIS Proof Test Template Detail	Equipment Functional Location SIS Proof Test Template
MI_SISPRFTD 2/5/2011 10:41:57 PM	SIS Proof Test Template Detail	SIS Proof Test Template
MI_SISPRFTD 11/29/2012 4:08:23 PM	SIS Proof Test Template Detail	Equipment SIS Proof Test Template
MI_SISPRFTD 11/29/2012 4:10:55 PM	SIS Proof Test Template Detail	SIS Proof Test Template

5. Select the check box that corresponds to the Proof Test Template Detail that you want to copy, and then select **OK**.

The APM system creates a copy of the selected Proof Test Template Detail and links to the Proof Test Template.

Note: The changes made to the Proof Test Template does not affect the Proof Tests that have used the template prior to modifications.

Delete a Proof Test Template Detail

Procedure

1. [Access the Proof Test Template](#) that is linked to the Proof Test Template Detail that you want to delete.
2. In the workspace, select the **Details** tab.

The **Details** section appears, displaying a list of Proof Test Template Details linked to the Proof Test Template.

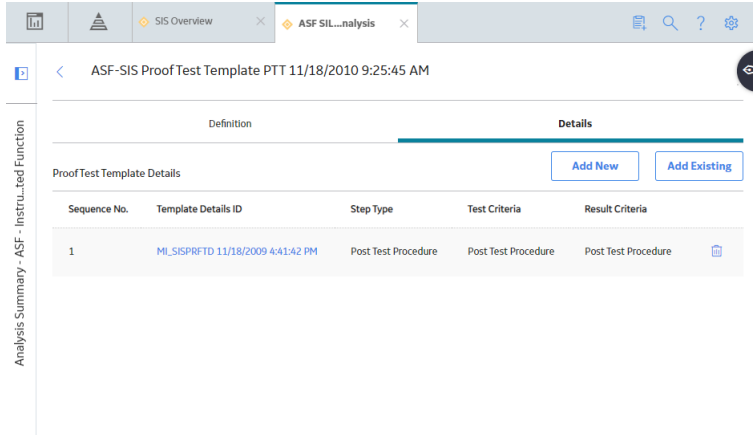

3. Next to the Proof Test Template Detail that you want to delete, select .

The **Delete Template Details** dialog box appears, asking you to confirm that you want to delete the Proof Test Template Detail.

4. Select **OK**.

The Proof Test Template Detail is deleted.

Note: The changes made to the Proof Test Template does not affect the Proof Tests that have used the template prior to modifications.

Access a List of all Proof Test Tasks

This topic describes how to access a list of Proof Test Tasks linked to all the SIL Analysis in SIS Management. The tasks that are listed here are created either in SIS Management or in Asset Strategy Management.

Procedure

1. Access the [SIS Management Overview](#) page.

Tip: You can also [access the SIS Management Overview](#) page for a selected hierarchy level.

2. In the workspace, select the **Proof Test Tasks** tab.

The **Proof Test Tasks** section appears, displaying a list of Proof Test Tasks.

SIS Management Overview
Asset: Home

Import From Exida Export to Exida

31	11	9	3	4	242
SIL Analysis	Proof Test Tasks	PIL Templates	SIS Trip Reports	Custom Failure Data	SRS

TASK ID	TASK DESCRIPTION	DESIRED INTERVAL	DESIRED INTERVAL UOM
ASF SIL Inspection Task	ASF SIL Inspection Task Description	5	MON
ASF Task	ASF Task Description	6	MON
ASMTask	Proof Test	15	MON
IF TASK-03		0	MON
IF-CCF ID - IF-2010-V3.5.0 SP1		0	MON
PTT 9/9/2013 9:27:04 AM - SIS - V350 SP1	PTT 9/9/2013 9:27:04 AM - SIS - V350 SP1	0	MON

3. If you want to access the datasheet of a Proof Test Task, select the Proof Test Task.
 4. If needed, modify values in the [available fields](#).
 5. In the upper-right corner of the datasheet, select .
- The changes made to the Proof Test Task are saved.

Access a Proof Test Task Linked to a Logic Solver

About This Task

This topic describes how to access a Proof Test Task that you have created for a Logic Solver either in SIS Management or in Asset Strategy (after promoting a Recommendation to ASM).

Procedure

1. [Access the Logic Solver](#) that is linked to the Proof Test Task that you want to access.
2. In the workspace, select the **Tasks** tab.

The **Proof Test Tasks** section appears, displaying a list of Proof Test Tasks.

Multiple Calculations
Modified by Bulla, Michael - Secured Super User On 18 Jul 2011

Definition	Validation	Proof Test Tasks
TASK ID	TASK TYPE	TASK STATE
V3.5.0 SP1	PROOF TEST	SCHEDULED WITHOUT CHANGE

3. Select the Proof Test Task that you want to access.
- The datasheet for the Proof Test Task appears.

4. If needed, modify values in the [available fields](#).
5. In the upper-right corner of the datasheet, select . The changes made to the Proof Test Task are saved.

Access a Proof Test Task Linked to an Instrumented Function

About This Task

This topic describes how to access a Proof Test Task that you have created for an Instrumented Function either in SIS Management or in Asset Strategy (after promoting a Recommendation to ASM).

Procedure

1. [Access the Instrumented Function](#) that is linked to the Proof Test Task that you want to access.
2. In the workspace heading, select the **Proof Test Tasks** tab.

The **Proof Test Tasks** section appears, displaying a list of Proof Test Tasks.

TASK ID	TASK TYPE	TASK STATE	TASK ASSIGNED TO	NEXT D
V3.5.0 SP1	PROOF TEST	SCHEDULED WITHOUT CHANGE		09/09

3. Select the Proof Test Task that you want to access. The datasheet for the Proof Test Task appears.

4. If needed, modify values in the [available fields](#).
5. In the upper-right corner of the datasheet, select . The changes made to the Proof Test Task are saved.

Create a Proof Test Task

This topic describes how to create a Proof Test Task for an Instrumented Function or a Logic Solver using a blank datasheet.

Procedure

1. Access the [Logic Solver](#) or the [Instrumented Function](#) for which you want to create a Proof Test Task.
2. In the workspace, select the **Proof Test Tasks** tab.

The **Proof Test Tasks** section appears, displaying a list of Proof Test Tasks for the Logic Solver or the Instrumented Function.

Definition	Validation	Proof Test Tasks
TASK ID	TASK TYPE	TASK STATE
V3.5.0.SP1	PROOF TEST	SCHEDULED WITHOUT CHANGE

3. Select , and then select **Create New Task**. The **New Proof Test Task** page containing a blank datasheet for the Proof Test Task appears.

4. Enter values in the [available fields](#) in the datashheet.

Note: The value PROOF TEST must appear in the **Task Type** box. If it does not appear, you must select that value in the box.

5. Select .

The Proof Test Task is created.

Note: In order to complete the Proof Test workflow, the Equipment should be linked to the Instrumented Function before creating a Proof Test Task record.

Next Steps

- Perform the proof test, and [create a Proof Test Event](#) to store the results.

Assign an Existing Proof Test Task



This topic describes how to assign an existing Proof Test Task for an Instrumented Function or a Logic Solver.

Procedure

1. Access the [Logic Solver](#) or the [Instrumented Function](#) for which you want to create a Proof Test Task.
2. In the workspace, select the **Proof Test Tasks** tab.

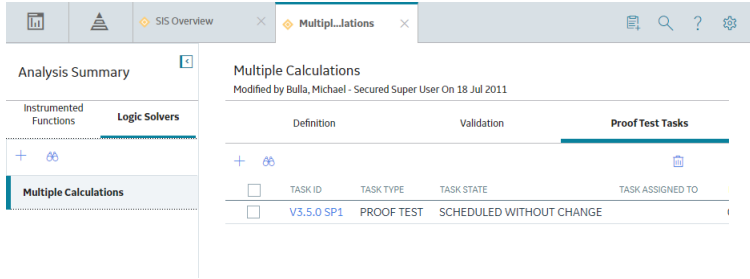
The **Proof Test Tasks** section appears, displaying a list of Proof Test Tasks for the Logic Solver or the Instrumented Function.



3. Select , and then select **Assign Existing Task**.
The **Search** window appears.
4. Select .
A list of Proof Test Tasks appears.

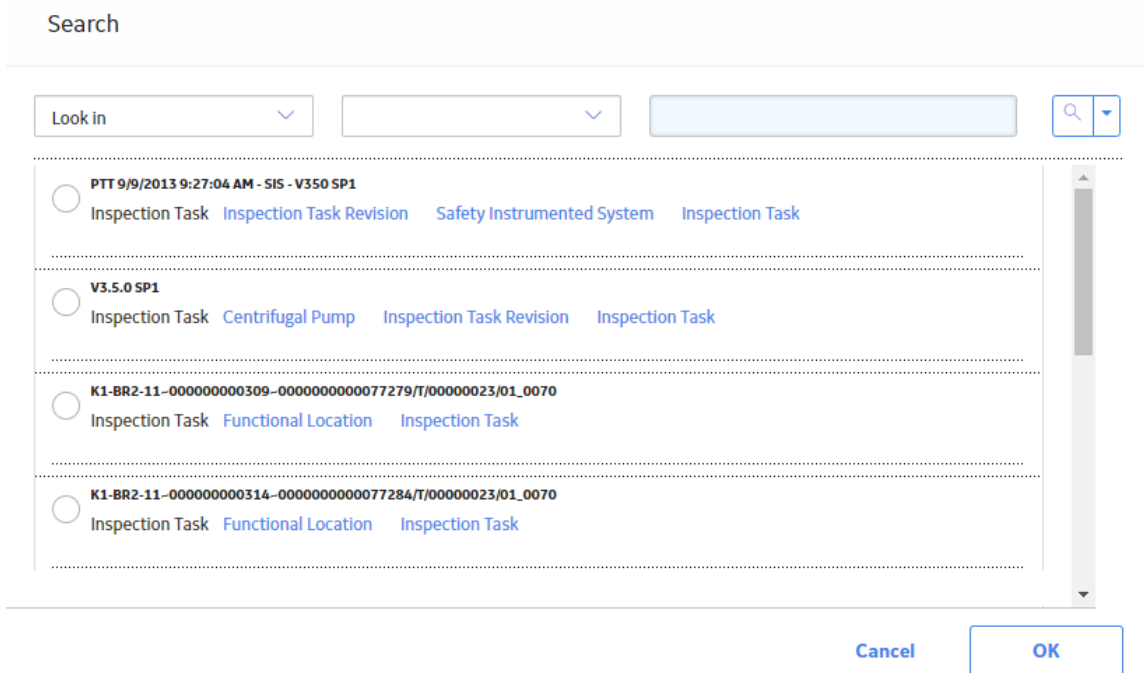

5. Select the task that you want to assign, and then select **OK**.
The Proof Test Task is assigned, and it appears in the list of Proof Test Tasks.

Note: In order to complete the Proof Test workflow, the Equipment should be linked to the Instrumented Function before assigning an existing Proof Test Task record.

Download Proof Test Task For Offline Access

Before You Begin

- [Create a Proof Test Task](#) .
- [Create a Proof Test Template](#).

Procedure

1. [Access the SIS Management Overview](#) page.

Tip: You can also [access the SIS Management Overview](#) page for a selected hierarchy level.

- In the workspace, select the **Proof Test Tasks** tab.

The list of proof test tasks appears.

TASK ID	TASK DESCRIPTION	DESIRED INTERVAL	DESIRED INTERVAL UOM
<input type="checkbox"/> ASF SIL Inspection Task	ASF SIL Inspection Task Description	5	MON
<input type="checkbox"/> ASF Task	ASF Task Description	6	MON
<input type="checkbox"/> ASMTask	Proof Test	15	MON
<input type="checkbox"/> IF TASK-03		0	MON
<input type="checkbox"/> IF-CCF ID - IF-2010-V3.5.0 SP1		0	MON
<input type="checkbox"/> PTT 9/9/2013 9:27:04 AM - SIS - V350 SP1	PTT 9/9/2013 9:27:04 AM - SIS - V350 SP1	0	MON

- For each Proof Test Task that you want to download, select the check box next to the **Task ID** column.

- In the upper-right corner of the section, select .

The **Assign Template for Download** window appears.

Assign Template for Download



Task ID	Template
SIF-1001-1	SIF-1001 - Protective Loop Test
Alky Reactor SIS PVST	Alky Reactor SIS PVST

Cancel

Download

- From the **Template** drop-down list box, select the Proof Test Template which you want to use for the Proof Test, and then select **Download**.

A confirmation message appears, indicating that the proof test task(s) have been successfully downloaded to the offline store.

Results

- The Proof Test Task that you downloaded appears on the [Mobile Proof Testing](#) page.

Modify Offline Datasheets for Proof Test And Template Details

About This Task

You can modify datasheets only if you are a Super User or a user with administrative privileges.

Procedure

- Modify Offline Proof Test Forms
 - On the left navigation menu, select **Admin**, and then select **Configuration Manager**.
The **Data Configuration** window appears in a new tab.

2. On the **Configuration Manager** page, select **Family Management**.

The **Family Management** page appears, displaying the list of already existing families. The **Home** family is selected by default. In the left pane, below the **Home** tab, all of the families in the hierarchy appear in alphabetical order. Note that you cannot change the order of the families. You can expand a family hierarchy by selecting the  button in the tab for that family.

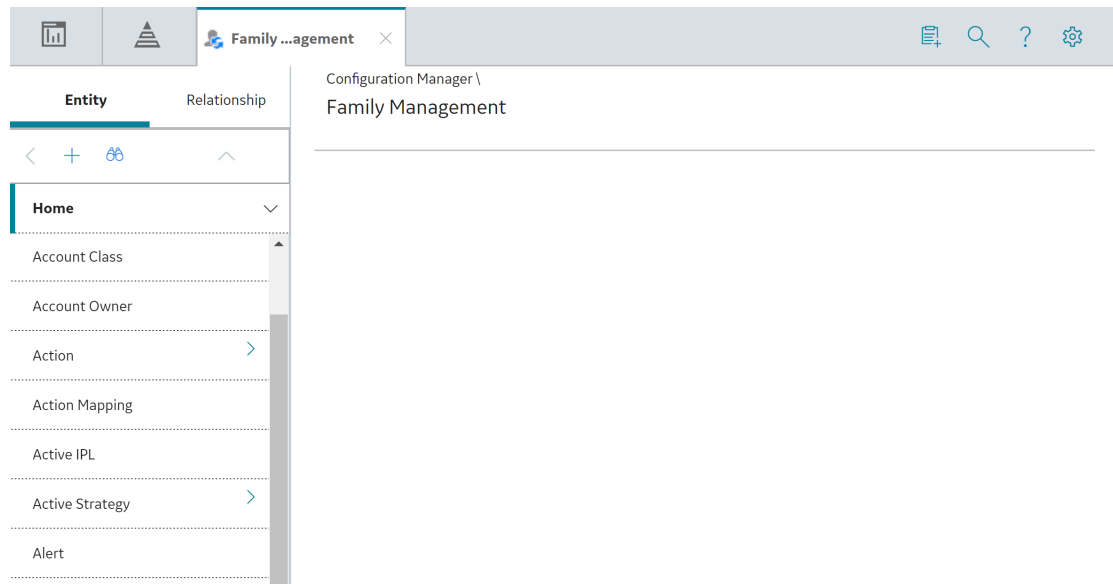



3. Select  and enter **SIS Proof Test**.

The search results appear in the left pane.

4. Select the **SIS Proof Test** family, select the **Datasheets** tab, and then select **Manage Offline Forms**.

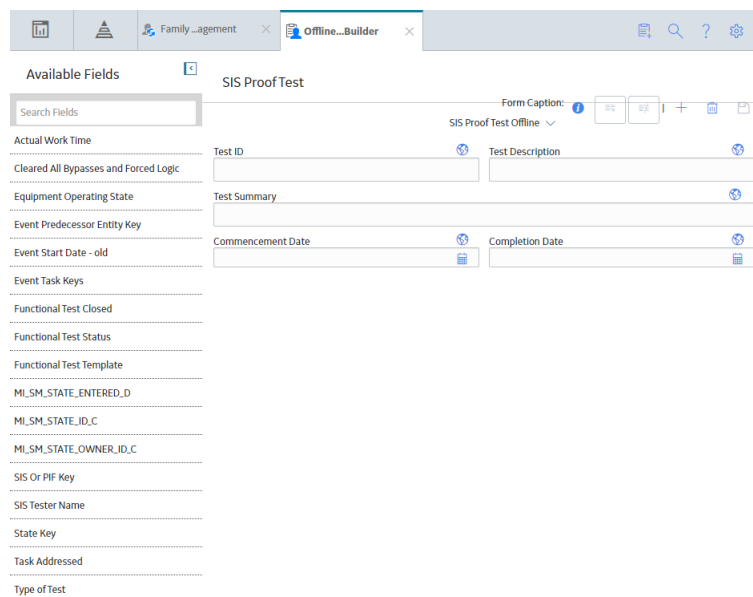
The **Proof Test offline** page appears.



5. To add a field, drag the field from the left panel and drop in the workspace and vice versa.
6. In the upper-right corner of the datasheet, select .

- A confirmation message appears, indicating that the form saved successfully.
- Modify Offline Proof Test Details Forms
 1. On the left navigation menu, select **Admin**, and then select **Configuration Manager**.

The **Data Configuration** window appears in a new tab.

2. On the **Configuration Manager** page, select **Family Management**.

The **Family Management** page appears, displaying the list of already existing families. The **Home** family is selected by default. In the left pane, below the **Home** tab, all of the families in the hierarchy appear in alphabetical order. Note that you cannot change the order of the families. You can expand a family hierarchy by selecting the  button in the tab for that family.

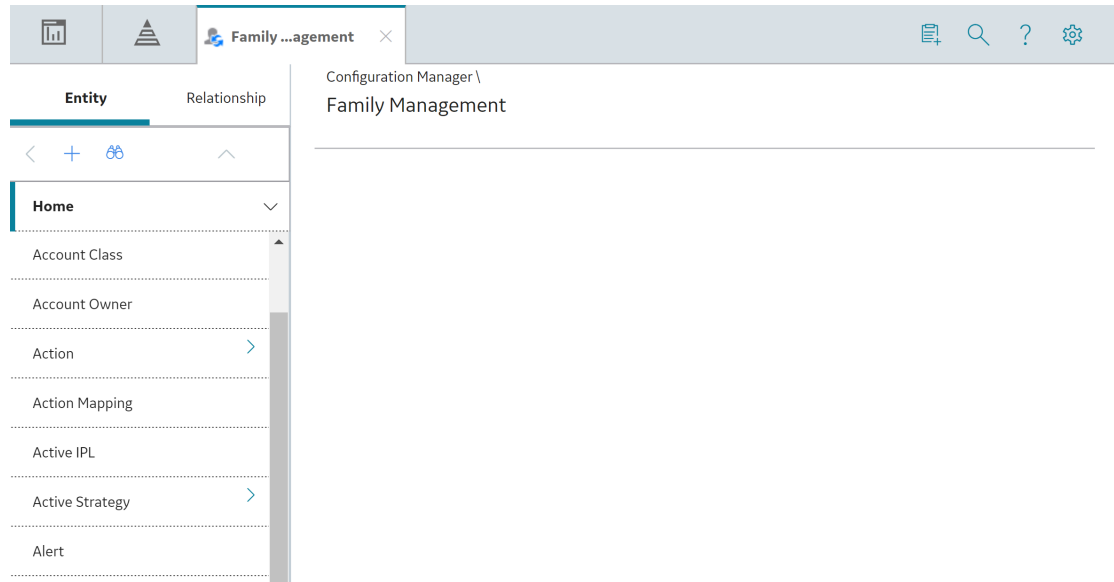

3. Select  and enter **Functional Test Detail**.
The search results appear in the left pane.
4. Select the **Functional Test Detail** family, select the **Datasheets** tab, and then select **Manage Offline Forms**.

The **Functional Test Detail Offline** page appears.

5. To add a field, drag the field from the left panel and drop in the workspace and vice versa.
6. In the upper-right corner of the datasheet, select .
 - A confirmation message appears, indicating that the form saved successfully.

View the Error Log for Offline Proof Test Task

Procedure

1. Access the [SIS Management Overview](#) page.
 - Tip:** You can also access the [SIS Management Overview](#) page for a selected hierarchy level.
2. In the workspace, select the **Proof Test Tasks** tab.
 - The **Proof Test Tasks** section appears, displaying a list of Proof Test Tasks.

TASK ID	TASK DESCRIPTION	DESIRED INTERVAL	DESIRED INTERVAL UOM
ASF SIL Inspection Task	ASF SIL Inspection Task Description	5	MON
ASF Task	ASF Task Description	6	MON
ASMTask	Proof Test	15	MON
IF TASK-03		0	MON
IF-CCF ID - IF-2010-V3.5.0 SP1		0	MON
PTT 9/9/2013 9:27:04 AM - SIS - V350 SP1	PTT 9/9/2013 9:27:04 AM - SIS - V350 SP1	0	MON

3. Select the check box that corresponds to the Proof Test Task(s) that you want to download.
4. In the upper-right corner of the section, select .
The **Assign Template for Download** window appears.

Assign Template for Download ✕













Task ID	Template
IF TASK-03	IF TEMPLATES-03 ▼
ASMTask	ASMTemplate ▼
ASF Function Task 1	Function Proof Test Template ▼
ASF Function Task 2	Function Proof Test Template ▼
ASF Task	ASF-SIS Proof Test Template PTT 11/18/2010 9:25:45 AM ▼

Cancel
Download

5. Select **Download**.
A confirmation message appears, indicating that the proof test event has been successfully downloaded to the offline store.
6. On the left navigation menu, select **Integrity**, and then select **Mobile Proof Testing**.
The list of downloaded proof test task appears, displaying the [status of the synchronization](#).

SIS Overview Mobile ...Testing

Mobile Proof Testing

PTE 2019/10/15 12:26:47.564	Asset ID: ASF Instrumented Function	Task ID: ASF Function Task 1	  
PTE 2019/10/15 12:30:41.293	Asset ID: IF-03	Task ID: IF TASK-03	  
PTE 2019/10/15 12:31:24.774	Asset ID: Promote To ASM	Task ID: ASMTask	  
PTE 2019/10/15 12:31:53.418	Asset ID: SIS - V350 SP1	Task ID: PTT 9/9/2013 9:27:04 AM - SIS - V350 SP1	  

7. Select the  icon, to view the error log of the respective proof test task.

Note: The  icon appears only if there is an error in the downloaded proof test task.

Delete a Proof Test Task

About This Task

This topic describes how to delete a Proof Test Task either from the **SIS Management Overview** page or from the list of tasks that are linked to a Logic Solver or an Instrumented Function.

Procedure

1. Access the list of Proof Test Tasks that are linked to a [Logic Solver](#) or an [Instrumented Function](#).
2. Select the check box that corresponds to the Proof Test Task that you want to delete, and then in the upper-right corner of the section, select .

The **Delete Proof Test Task(s)** dialog box appears, indicating that deleting the Proof Test Task will also delete the related records.

3. Select **OK**.

The Proof Test Task is deleted.

Access a Proof Test

Procedure

1. Access the **SIL Validation** page for the [Instrumented Function](#) or the [Logic Solver](#).
2. In the **SIL Validation** workspace, select **Proof Test**.

A list of Proof Tests appears.

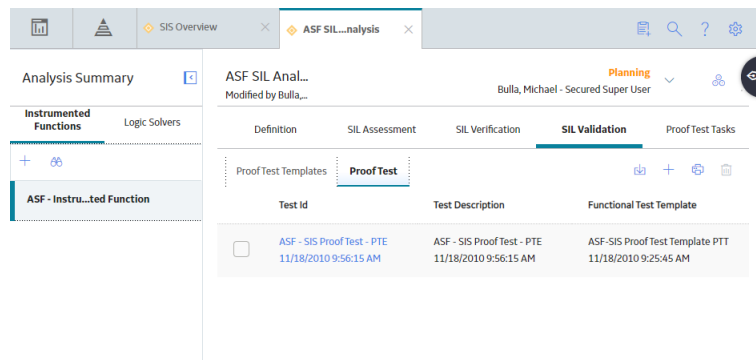

The screenshot shows a software interface with a sidebar on the left and a main content area. The sidebar has a section for 'Instrumented Functions' with a sub-section for 'ASF - Instru...ted Function'. The main content area has a top navigation bar with 'ASF SIL...nalysis' and a user profile 'Bulla, Michael - Secured Super User'. Below this is a tabbed interface with 'SIL Validation' selected. Under 'SIL Validation', there is a 'Proof Test' section with a table of Proof Test Templates.

Test Id	Test Description	Functional Test Template
<input type="checkbox"/> ASF - SIS Proof Test - PTE 11/18/2010 9:56:15 AM	ASF - SIS Proof Test - PTE 11/18/2010 9:56:15 AM	ASF-SIS Proof Test.Template PTT 11/18/2010 9:25:45 AM

3. Select the Proof Test that you want to access.

The datasheet for the Proof Test appears.

4. If needed, modify values in the [available fields](#).
5. In the upper-right corner of the datasheet, select . The changes made to the Proof Test are saved.

Create a Proof Test

This topic describes how to create a Proof Test for an Instrumented Function or a Logic Solver.

Before You Begin

- [Create a Proof Test Template](#).
- Perform the proof test.

Procedure

1. Access the **SIL Validation** page for the [Instrumented Function](#) or the [Logic Solver](#).
2. In the **SIL Validation** section, select **Proof Test**.

A list of Proof Tests appears.

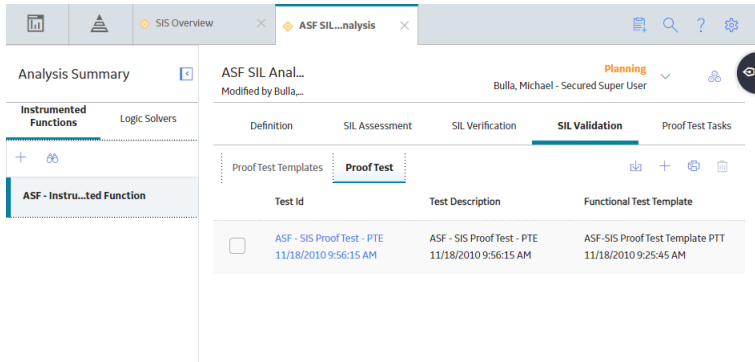

3. In the upper-right corner of the workspace, select  .
A blank datasheet for the Proof Test appears.

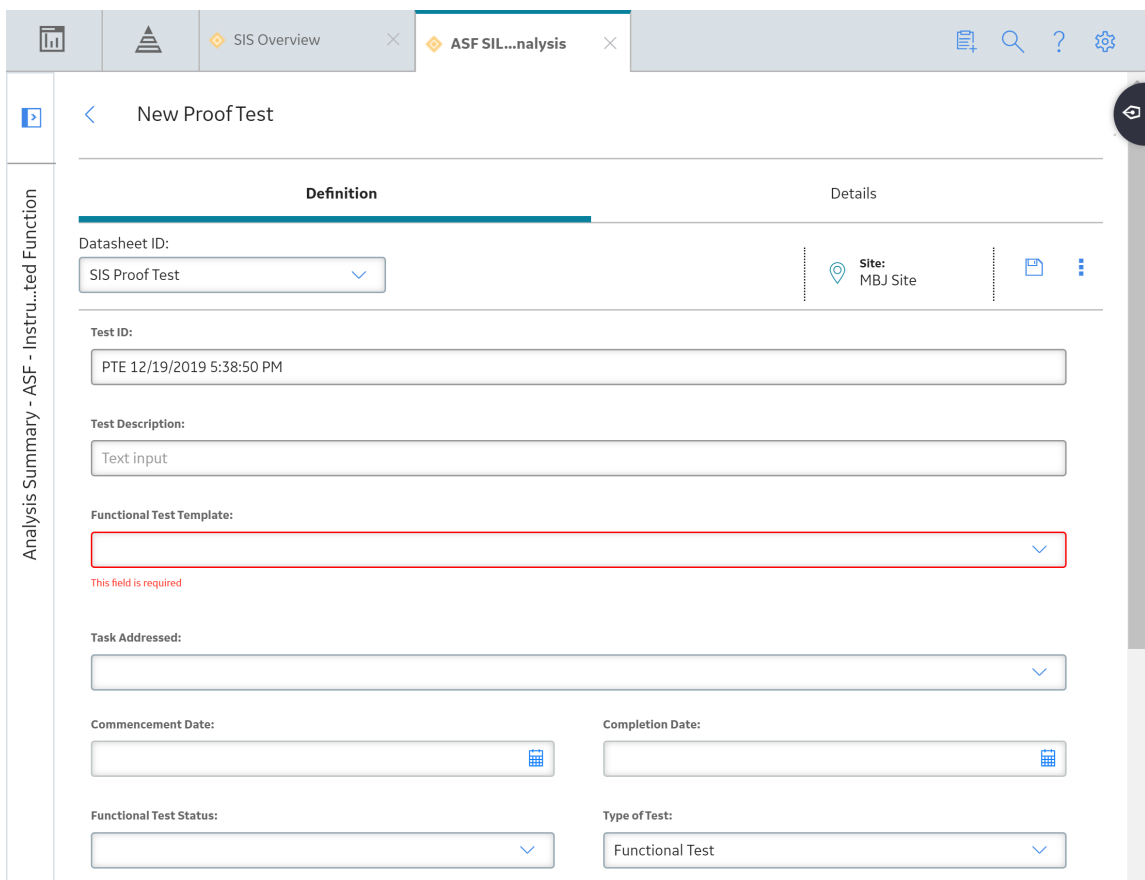

4. As needed, enter values in the [available fields](#).
5. In the upper-right corner of the datasheet, select  .
The Proof Test is created.

Apply a Proof Test Template and a Proof Test Task to a Proof Test

Before You Begin

- [Create a Proof Test Template.](#)
- [Approve the Proof Test Template.](#)
- [Create a Proof Test Task.](#)
- [Create a Proof Test.](#)

About This Task

When you apply a Proof Test Template to a Proof Test, a Functional Test Detail is created for each Proof Test Template Detail. The pass/fail criteria, step sequence number, and other details in the Proof Test Template Detail are populated in the corresponding fields in the Functional Test Detail.

Procedure

1. [Access the Proof Test](#) to which you want to apply a template.
2. In the **Functional Test Template** drop-down list box, select the template that you want to apply.

Note: You can select only from the list of templates that are approved and linked to the same Instrumented Function or Logic Solver.

3. In the **Task Addressed** box, select the task that is addressed by the Proof Test.

Note: You can select only from the list of tasks that are linked to the same Instrumented Function or Logic Solver.

4. In the upper-right corner of the datasheet, select .

The Proof Test Task and the Proof Test Template are linked to the Proof Test.

Results

- A Functional Test Detail is created for each Proof Test Template Detail. These Functional Test Details are listed in the **Details** section. Each row in this grid corresponds to each step in the Proof Test as specified in the template.

Next Steps

- Perform the Proof Test, and enter the readings for each step in the corresponding Proof Test Detail. The APM system then calculates the error values and provides the results of the proof test.

Generate a Report of the Proof Test

Procedure

1. Access the **SIL Validation** page for the [Instrumented Function](#) or the [Logic Solver](#).
2. In the **SIL Validation** section, select **Proof Test**.

A list of Proof Tests appears.

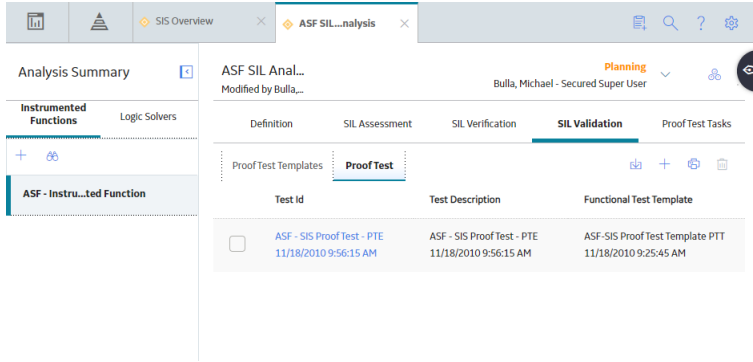

3. Select the check box that corresponds to the Proof Test whose report you want to generate.
4. In the upper-right corner of the section, select .
The Proof Test report is generated. You can print, save, or export the report, or attach it to an email.

Close a Proof Test

This topic describes how to close a Proof Test for an Instrumented Function or a Logic Solver.

Before You Begin

- [Create a Proof Test Template.](#)
- Perform the proof test.
- [Create a Proof Test.](#)

Procedure

1. Access the **SIL Validation** page for the [Instrumented Function](#) or the [Logic Solver](#).
2. In the **SIL Validation** section, select the **Proof Test** tab.
The **Proof Test** section appears, displaying a list of proof tests.

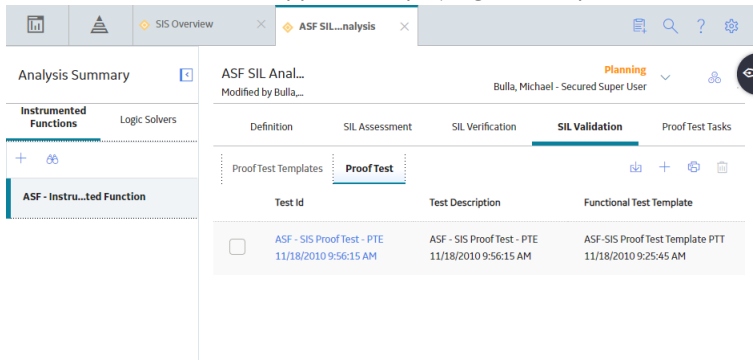

3. Select the proof test that you want to close.

The SIS Proof Test datasheet appears for the selected proof test.

4. In the SIS Proof Test datasheet, perform the following actions:
 - a) In the **Completion Date** box, enter or select the completion date for the proof test.
 - b) In the **Functional Test Status** box, enter or select Closed or Complete.
 - c) In the **Actual Work Time** box, enter the number of hours required to complete the proof test.
Note: A value is required in this field only if integration with Work Management Interface is enabled.
 - d) Select the **Functional Test Closed** check box.
5. Select .
Your changes are saved, and the proof test is closed.
Note: After the proof test is closed, the fields in the SIS Proof Test datasheet will be disabled.

Delete a Proof Test

Procedure

1. Access the **SIL Validation** page for the [Instrumented Function](#) or the [Logic Solver](#).
2. In the **SIL Validation** section, select **Proof Test**.

A list of Proof Tests appears.

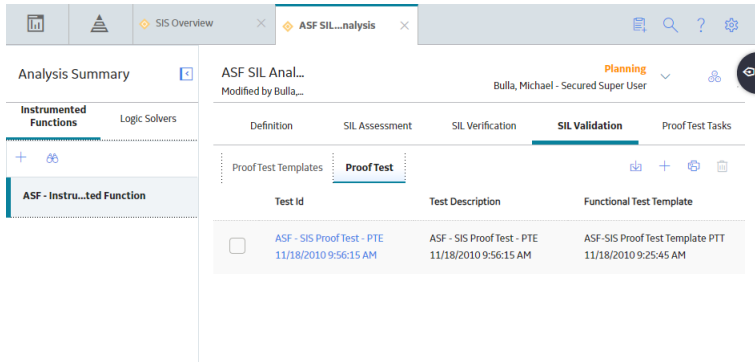

3. Select the check box that corresponds to the Proof Test that you want to delete, and then select  .
A confirmation message appears, asking if you really want to delete the Proof Test.
4. Select **OK**.
The Proof Test is deleted.

Chapter 11

SIS Trip Reports

Topics:

- [About SIS Trip Report](#)
- [Access an SIS Trip Report](#)
- [Create an SIS Trip Report](#)
- [Create an SIS Trip Report Detail](#)
- [Delete an SIS Trip Report](#)

About SIS Trip Report

SIS Trip Reports are records that store details on events, which occurred on a safety instrumented system, such as a trip alarm. For example, if during a process, the gas pressure level increased to an unmanageable level and the safety instrumented system turned off the gas feed, you would create one SIS Trip Report to record the details of that trip alarm event.

When you create an SIS Trip Report, you will link it to a Logic Solver. When you create an SIS Trip Report Detail, you will select an Instrumented Function from among the ones that are linked to the Logic Solver. APM creates an SIS Trip Report Detail for each Instrumented Function that you have selected.

SIS Trip Report Details store details of the Instrumented Function with which it is associated. They also contain the decision that is made around the particular trip event, which is stored in the Action box. For example, you can specify a trip event as Dangerous or Safe.

Access an SIS Trip Report

Procedure

1. Access the [SIS Management Overview](#) page.

Tip: You can also [access the SIS Management Overview](#) page for a selected hierarchy level.

2. In the workspace, select the **SIS Trip Reports** tab.

The **SIS Trip Reports** section appears, displaying a list of SIS Trip Reports.

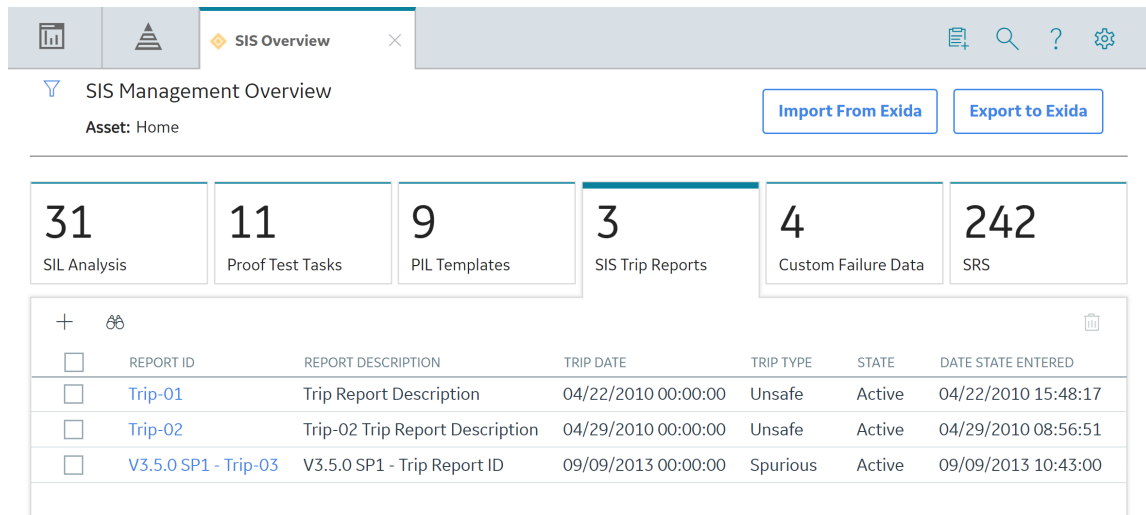

The screenshot shows the SIS Management Overview workspace. At the top, there is a navigation bar with a tree icon, a tab labeled 'SIS Overview', and utility icons for list, search, help, and settings. Below the navigation bar, the workspace title is 'SIS Management Overview' with the asset name 'Home'. There are two buttons: 'Import From Exida' and 'Export to Exida'. The main content area features a dashboard with six summary cards: '31 SIL Analysis', '11 Proof Test Tasks', '9 PIL Templates', '3 SIS Trip Reports' (highlighted), '4 Custom Failure Data', and '242 SRS'. Below the dashboard is a table with columns: REPORT ID, REPORT DESCRIPTION, TRIP DATE, TRIP TYPE, STATE, and DATE STATE ENTERED. The table contains three rows of trip reports.

REPORT ID	REPORT DESCRIPTION	TRIP DATE	TRIP TYPE	STATE	DATE STATE ENTERED
Trip-01	Trip Report Description	04/22/2010 00:00:00	Unsafe	Active	04/22/2010 15:48:17
Trip-02	Trip-02 Trip Report Description	04/29/2010 00:00:00	Unsafe	Active	04/29/2010 08:56:51
V3.5.0 SP1 - Trip-03	V3.5.0 SP1 - Trip Report ID	09/09/2013 00:00:00	Spurious	Active	09/09/2013 10:43:00

3. Select the SIS Trip Report that you want to access.

Tip: You can also filter and search for the piece of test equipment by selecting  in the upper-left corner of the workspace. The search results appear as you enter values.

The datasheet for the SIS Trip Report appears.

V3.5.0 SP1 - Trip-03

Definition Trip Report Details 1 Reference Documents

Datasheet ID:
SIS Trip Report

Trip Report ID:
V3.5.0 SP1 - Trip-03

Trip Report Description:
V3.5.0 SP1 - Trip Report ID

Trip Date:
09/09/2013 09:30:00

Trip Type:
Spurious Trip (Spurious)

LPO Costs:
158 (Pound)

System Down Time:
12 (Hours)

Initiating Event Description:
Initiating Event Description

Created By:
sisadmin

Created Date:
09/09/2013 20:13:00

Modified By:
Modified Date:

4. If needed, modify values in the [available fields](#).
5. In the upper-right corner of the datasheet, select .
The changes made to the SIS Trip Report are saved.

Create an SIS Trip Report

Procedure

1. [Access the SIS Management Overview page](#).
Tip: You can also [access the SIS Management Overview page](#) for a selected hierarchy level.
2. Select the **SIS Trip Reports** tab.
The **SIS Trip Reports** section appears, displaying a list of SIS Trip Reports.

SIS Management Overview
Asset: Home

Import From Exida Export to Exida

31	11	9	3	4	242
SIL Analysis	Proof Test Tasks	PIL Templates	SIS Trip Reports	Custom Failure Data	SRS

REPORT ID	REPORT DESCRIPTION	TRIP DATE	TRIP TYPE	STATE	DATE STATE ENTERED
Trip-01	Trip Report Description	04/22/2010 00:00:00	Unsafe	Active	04/22/2010 15:48:17
Trip-02	Trip-02 Trip Report Description	04/29/2010 00:00:00	Unsafe	Active	04/29/2010 08:56:51
V3.5.0 SP1 - Trip-03	V3.5.0 SP1 - Trip Report ID	09/09/2013 00:00:00	Spurious	Active	09/09/2013 10:43:00

3. In the upper-left corner of the section, select **+**.

A blank datasheet for the SIS Trip Report appears.

New SIS Trip Report

Definition Trip Report Details 0 Reference Documents

Protective Loop

Datasheet ID:
SIS Trip Report

Site:
Roanoke, VA

Trip Report ID:
Text input
This field is required

Trip Report Description:
Text input

Trip Date:
Calendar icon

Trip Type:
Dropdown menu
This field is required

LPO Costs:
Numeric input

System Down Time:
Numeric input



Initiating Event Description:
Text input

4. Next to the **Logic Solver ID** box, select **☰**.

The **Search** window appears.

Search

Look in

5. In the upper-right corner of the window, select .
A list of Logic Solvers appears.
6. Select the check box that corresponds to the Logic Solver that you want to select, and then in the lower-right corner of the window, select **OK**.
The Logic Solver is selected.
7. As needed, enter values in the other [available fields](#).
8. In the upper-right corner of the datasheet, select .
The SIS Trip Report is created.

Next Steps

- [Create an SIS Trip Report Detail](#)

Create an SIS Trip Report Detail

Before You Begin

- [Create an SIS Trip Report](#).

Procedure

1. [Access the SIS Trip Report](#) for which you want to create an SIS Trip Report Detail.
2. In the workspace, select the **Trip Report Details** tab.
The **SIS Trip Report Details** section appears.

Trip-01

Definition	Trip Report Details	75 Reference Documents
Add Trip Details		
TRIP REPORT DETAILS ID	INSTRUMENTED FUNCTION ID	ACTION
<input type="checkbox"/> TRIP-01 - Auto Channel, An I / Di O - T6.1.3	Auto Channel, An I / Di O - T6.1.3	Safe
<input type="checkbox"/> TRIP-01 - DeltaV SIS redundant - T6.5.4a	DeltaV SIS redundant - T6.5.4a	Safe
<input type="checkbox"/> TRIP-01 - GE Mark VleS TMR 2oo3 - T6.4.9	GE Mark VleS TMR 2oo3 - T6.4.9	Safe
<input type="checkbox"/> TRIP-01 - DeltaV SIS red + test - T6.5.4b	DeltaV SIS red + test - T6.5.4b	Safe
<input type="checkbox"/> TRIP-01 - DeltaV SIS simplex - T6.5.2	DeltaV SIS simplex - T6.5.2	Safe
<input type="checkbox"/> TRIP-01 - ProSafe-RS VMR-S - T6.4.2	ProSafe-RS VMR-S - T6.4.2	Safe
<input type="checkbox"/> TRIP-01 - GE Mark VleS Simples 1oo1 - T6.4.6	GE Mark VleS Simples 1oo1 - T6.4.6	Safe
<input type="checkbox"/> TRIP-01 - RTP 2500 1oo2/1oo1D - T6.4.4	RTP 2500 1oo2/1oo1D - T6.4.4	Safe
<input type="checkbox"/> TRIP-01 - RTP 2500 2oo3/2oo2D - T6.4.5	RTP 2500 2oo3/2oo2D - T6.4.5	Safe
<input type="checkbox"/> TRIP-01 - MII SPA 1oo1 with AO - T6.3.7 1	MII SPA 1oo1 with AO - T6.3.7 1	Safe
<input type="checkbox"/> TRIP-01 - MII SPA 1oo1 with DI - T6.3.6	MII SPA 1oo1 with DI - T6.3.6	Safe
<input type="checkbox"/> TRIP-01 - MII SPA 1oo2 > 4 DO - T6.3.9	MII SPA 1oo2 > 4 DO - T6.3.9	Safe
<input type="checkbox"/> TRIP-01 - MII SPA 1oo2 > 2 AI - T6.3.8 1	MII SPA 1oo2 > 2 AI - T6.3.8 1	Safe
<input type="checkbox"/> TRIP-01 - MII SPA 1oo1 > 1 AI - T6.3.4	MII SPA 1oo1 > 1 AI - T6.3.4	Safe
<input type="checkbox"/> TRIP-01 - MII SPA 1oo1 > 2 DO - T6.3.5	MII SPA 1oo1 > 2 DO - T6.3.5	Safe

3. In the upper-left corner of the section, select **Add Trip Details**.

The **Trip Details** window appears, displaying a list of Instrumented Functions. These are the Instrumented Functions that are linked to the Logic Solver whose ID is populated in the Logic Solver ID field in the SIS Trip Report datasheet.

Trip Details

<input type="checkbox"/>	PIF ID	PIF DESCRIPTION	FUNCTION TYPE	SIL MOI
<input type="checkbox"/>	ASM2 - MM DeltaV_Redundant - T1.28.2	SIF used to test Markov ...	SAFETY	Dema
<input type="checkbox"/>	ASM2- MM DeltaV Redundant -T1.28.2		SAFETY	Dema
<input type="checkbox"/>	DeltaV SIS red + SLS + test - T6.5.5b	SIF used to test Markov ...	SAFETY	Dema
<input type="checkbox"/>	DeltaV SIS redundant + SLS - T6.5.5a	SIF used to test Markov ...	SAFETY	Dema
<input type="checkbox"/>	DeltaV SIS simplex + SLS - T6.5.3	SIF used to test Markov ...	SAFETY	Dema
<input type="checkbox"/>	GE Mark VIeS Dual 2oo2 - T6.4.8	SIF used to test Markov ...	SAFETY	Dema

Rows per page 100 ▾

← 1 of 1 →

Cancel

Add

4. Select the check box that corresponds to the Instrumented Function for which you want to create an SIS Trip Report Detail.
5. In the lower-right corner of the window, select **Add**.
The SIS Trip Report Detail is created.
6. Select the SIS Trip Report Detail, and in the datasheet that appears, modify the details as needed, and select **Save**.
The SIS Trip Report Detail is saved.

Delete an SIS Trip Report

About This Task

Important: Deleting an SIS Trip Report also deletes the linked SIS Trip Report Details.

Procedure

1. Access the [SIS Management Overview](#) page.
2. In the workspace, select the **SIS Trip Reports** tab.
The **SIS Trip Reports** section appears, displaying a list of SIS Trip Reports.

SIS Management Overview
Asset: Home

Import From Exida Export to Exida

31 SIL Analysis 11 Proof Test Tasks 9 PIL Templates 3 SIS Trip Reports 4 Custom Failure Data 242 SRS

REPORT ID	REPORT DESCRIPTION	TRIP DATE	TRIP TYPE	STATE	DATE STATE ENTERED
<input type="checkbox"/> Trip-01	Trip Report Description	04/22/2010 00:00:00	Unsafe	Active	04/22/2010 15:48:17
<input type="checkbox"/> Trip-02	Trip-02 Trip Report Description	04/29/2010 00:00:00	Unsafe	Active	04/29/2010 08:56:51
<input type="checkbox"/> V3.5.0 SP1 - Trip-03	V3.5.0 SP1 - Trip Report ID	09/09/2013 00:00:00	Spurious	Active	09/09/2013 10:43:00

3. Select the check box that corresponds to the SIS Trip Report that you want to delete.

4. In the upper-right corner of the section, select .

The SIS Trip Report, along with all the related SIS Trip Report Details, is deleted.

Chapter 12

SRS Templates

Topics:

- [About SRS Templates](#)
- [Create an SRS Template](#)
- [Update an SRS Template](#)
- [Copy an SRS Template](#)
- [Set an SRS Template as Default](#)
- [View the Revision History of an SRS Template](#)
- [Change the State of an SRS Template](#)
- [Compare the Revision Records of an SRS Template](#)
- [Delete an SRS Template](#)

About SRS Templates

The IEC61511 standard is a performance-based standard that is all about the performance of the SIS and reducing risk, and defines what the SRS should contain all the requirements for the Safety Instrumented System and its associated Safety Instrumented Functions (SIFs).

The SIS consists of one or more Safety Instrumented Functions (SIFs), which can consist of a combination of sensor(s), logic solver(s) and final element(s), including all interfaces and sources of power. Therefore, the SRS needs to define a number of criteria for each SIF: a set of Functional Requirements and a set of Integrity Requirements (Safety Integrity Level target), indicating the amount of risk reduction required to be achieved (i.e. a measure of its dependability), as well as failure modes, operations and maintenance related information. The SRS templates account for these functional and integrity requirements.

Create an SRS Template

Procedure

1. Access the [SIS Management Overview](#) page.

Tip: You can also [access the SIS Management Overview page for a selected hierarchy level](#).

2. In the workspace, select the **SRS** tab, and then select the **SRS Template** button.

The **SRS Template** page appears.

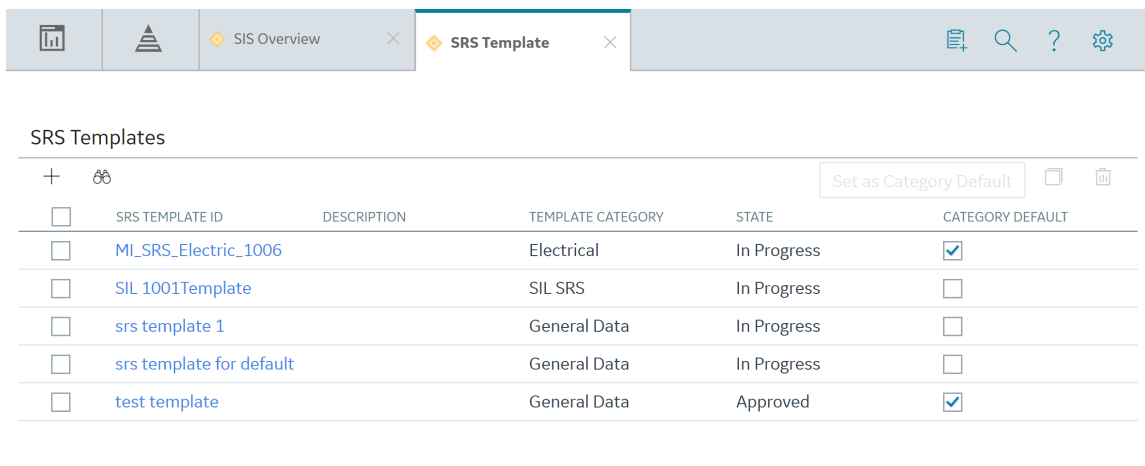

SRS Templates					
<input type="checkbox"/>	SRS TEMPLATE ID	DESCRIPTION	TEMPLATE CATEGORY	STATE	CATEGORY DEFAULT
<input type="checkbox"/>	MI_SRS_Electric_1006		Electrical	In Progress	<input checked="" type="checkbox"/>
<input type="checkbox"/>	SIL 1001Template		SIL SRS	In Progress	<input type="checkbox"/>
<input type="checkbox"/>	srs template 1		General Data	In Progress	<input type="checkbox"/>
<input type="checkbox"/>	srs template for default		General Data	In Progress	<input type="checkbox"/>
<input type="checkbox"/>	test template		General Data	Approved	<input checked="" type="checkbox"/>

3. Select **+**.

The **Select Category** window appears.

Select Category

The screenshot shows a 'Select Category' dialog box with a list of categories. The categories are: IF SRS, SIL SRS, Electrical, Environment, General Data, Hardware, Interfaces, Operations, and Performance Data. Below the list are two buttons: 'Cancel' and 'OK'.

4. Select any category, and then select **OK**.
The SRS Template page appears, displaying a blank datasheet for the SRS Template.
5. Enter values in the [available fields](#), and then select .
The SRS Template is created.

Update an SRS Template

Procedure

1. Access the [SIS Management Overview](#) page.
Tip: You can also [access the SIS Management Overview](#) page for a selected hierarchy level.
2. In the workspace, select the **SRS** tab and then select **SRS Template**.
The **SRS Templates** page appears, displaying a list of SRS Templates.

<input type="checkbox"/>	SRS TEMPLATE ID	DESCRIPTION	TEMPLATE CATEGORY	STATE	CATEGORY DEFAULT
<input type="checkbox"/>	MI_SRS_Electric_1006		Electrical	In Progress	<input checked="" type="checkbox"/>
<input type="checkbox"/>	SIL 1001Template		SIL SRS	In Progress	<input type="checkbox"/>
<input type="checkbox"/>	srs template 1		General Data	In Progress	<input type="checkbox"/>
<input type="checkbox"/>	srs template for default		General Data	In Progress	<input type="checkbox"/>
<input type="checkbox"/>	test template		General Data	Approved	<input checked="" type="checkbox"/>

- In the SRS Template ID column, select the link for the SRS Template that you want to update. The <SRS Template> page appears.

IF SRS Reactor R1 Template Set as Category Default In Progress Not Assigned 0 Revision(s)

Datasheet ID:

SRS Template ID:

SRS Template Description:

Reset Requirement:

Normal Operation Mode:

Process Variable Unit:

Min Process Variable:

- Modify the values in the fields that need to be updated, and then select . A confirmation message appears, indicating that the datasheet has been saved successfully.

Copy an SRS Template

Procedure

1. Access the [SIS Management Overview](#) page.

Tip: You can also [access the SIS Management Overview page](#) for a selected hierarchy level.

2. In the workspace, select the **SRS** tab and then select the **SRS Template** button.

The **SRS Templates** page appears.

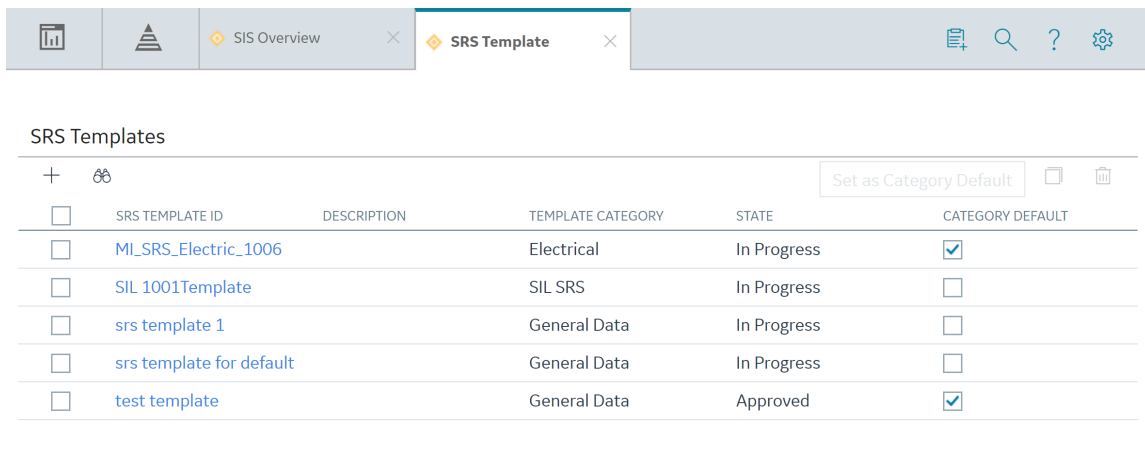

<input type="checkbox"/>	SRS TEMPLATE ID	DESCRIPTION	TEMPLATE CATEGORY	STATE	CATEGORY DEFAULT
<input type="checkbox"/>	MI_SRS_Electric_1006		Electrical	In Progress	<input checked="" type="checkbox"/>
<input type="checkbox"/>	SIL 1001Template		SIL SRS	In Progress	<input type="checkbox"/>
<input type="checkbox"/>	srs template 1		General Data	In Progress	<input type="checkbox"/>
<input type="checkbox"/>	srs template for default		General Data	In Progress	<input type="checkbox"/>
<input type="checkbox"/>	test template		General Data	Approved	<input checked="" type="checkbox"/>

3. Select the check box to the left of the SRS Template(s) that you want to copy.

4. In the upper-right corner of the workspace, select .

A confirmation message appears, indicating that the SRS Template(s) has been saved successfully. The SRS Template ID of the copied template is created by appending the term Copy to the SRS Template ID if the template that was copied.

Set an SRS Template as Default

Procedure

- Set an SRS Template as Default from the SRS Template Page

1. Access the [SIS Management Overview](#) page.

Tip: You can also [access the SIS Management Overview page](#) for a selected hierarchy level.

2. In the workspace, select the **SRS** tab and then select the **SRS Template** button.

The **SRS Templates** page appears.

SRS Templates

<input type="checkbox"/>	SRS TEMPLATE ID	DESCRIPTION	TEMPLATE CATEGORY	STATE	CATEGORY DEFAULT
<input type="checkbox"/>	MI_SRS_Electric_1006		Electrical	In Progress	<input checked="" type="checkbox"/>
<input type="checkbox"/>	SIL 1001Template		SIL SRS	In Progress	<input type="checkbox"/>
<input type="checkbox"/>	srs template 1		General Data	In Progress	<input type="checkbox"/>
<input type="checkbox"/>	srs template for default		General Data	In Progress	<input type="checkbox"/>
<input type="checkbox"/>	test template		General Data	Approved	<input checked="" type="checkbox"/>

3. In the row for the SRS Template that you want to set as default, next to the **SRS Template ID**, select the check box.
4. In the upper-right corner of the workspace, select **Set as Category Default**.

A confirmation message appears, asking if you really want to set the selected SRS Template as default.

5. Select **OK**.

The selected SRS Template is set as default.

- Set an SRS Template as Default from Inside an SRS Template

1. Access the [SIS Management Overview](#) page.

Tip: You can also [access the SIS Management Overview page for a selected hierarchy level](#). In the workspace, select the **SRS** tab and then select the **SRS Template** button.

The **SRS Templates** page appears.

SRS Templates

<input type="checkbox"/>	SRS TEMPLATE ID	DESCRIPTION	TEMPLATE CATEGORY	STATE	CATEGORY DEFAULT
<input type="checkbox"/>	MI_SRS_Electric_1006		Electrical	In Progress	<input checked="" type="checkbox"/>
<input type="checkbox"/>	SIL 1001Template		SIL SRS	In Progress	<input type="checkbox"/>
<input type="checkbox"/>	srs template 1		General Data	In Progress	<input type="checkbox"/>
<input type="checkbox"/>	srs template for default		General Data	In Progress	<input type="checkbox"/>
<input type="checkbox"/>	test template		General Data	Approved	<input checked="" type="checkbox"/>

2. For the SRS Template that you want to set as default, select the link.

The workspace for the selected SRS Template appears.

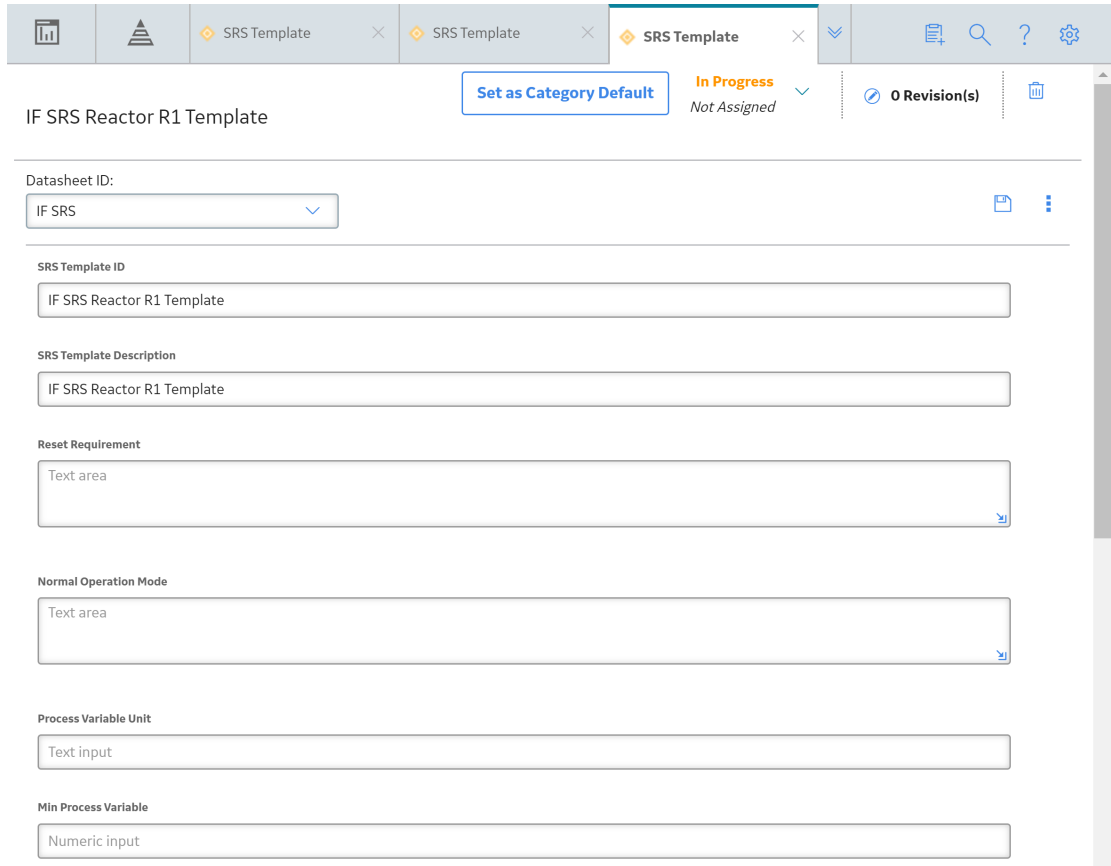

IF SRS Reactor R1 Template

Set as Category Default In Progress Not Assigned 0 Revision(s)

Datasheet ID: IF SRS

SRS Template ID: IF SRS Reactor R1 Template

SRS Template Description: IF SRS Reactor R1 Template

Reset Requirement: Text area

Normal Operation Mode: Text area

Process Variable Unit: Text input

Min Process Variable: Numeric input

3. In the upper-right corner of the workspace, select **Set as Category Default**.
A confirmation message appears, asking if you really want to set the SRS Template as default.
4. Select **OK**.
The selected SRS Template is set as default.

View the Revision History of an SRS Template

Procedure

1. Access the [SIS Management Overview](#) page.
Tip: You can also [access the SIS Management Overview](#) page for a selected hierarchy level.
2. In the workspace, select the **SRS** tab and then select the **SRS Template** button.
The **SRS Templates** page appears, displaying the list of SRS Templates.

<input type="checkbox"/>	SRS TEMPLATE ID	DESCRIPTION	TEMPLATE CATEGORY	STATE	CATEGORY DEFAULT
<input type="checkbox"/>	MI_SRS_Electric_1006		Electrical	In Progress	<input checked="" type="checkbox"/>
<input type="checkbox"/>	SIL 1001Template		SIL SRS	In Progress	<input type="checkbox"/>
<input type="checkbox"/>	srs template 1		General Data	In Progress	<input type="checkbox"/>
<input type="checkbox"/>	srs template for default		General Data	In Progress	<input type="checkbox"/>
<input type="checkbox"/>	test template		General Data	Approved	<input checked="" type="checkbox"/>

3. Select the SRS Template for which you want to view the revision history.

The <SRS Template> page appears.

IF SRS Reactor R1 Template

Set as Category Default In Progress Not Assigned 0 Revision(s)

Datasheet ID: IF SRS

SRS Template ID: IF SRS Reactor R1 Template

SRS Template Description: IF SRS Reactor R1 Template

Reset Requirement: Text area

Normal Operation Mode: Text area

Process Variable Unit: Text input

Min Process Variable: Numeric input

4. In the upper-right corner of the workspace, select **Revisions**.

The **Revision History** page appears, displaying the list of revisions done on the SRS Template.

No	Revision Name	Last Modified
0	IF SRS	16 May 2018

- In the **Revision Name** column, select the link for the revision that you want to view. The page for the selected revision record appears.

< IF SRS Revision History Show Changes

Datasheet ID:

SRS Template ID

SRS Template Description

Reset Requirement

Normal Operation Mode

Process Variable Unit

Min Process Variable

Change the State of an SRS Template

Procedure

- Access the [SIS Management Overview](#) page.
Tip: You can also [access the SIS Management Overview page for a selected hierarchy level](#).
- In the workspace, select the **SRS** tab and then select the **SRS Template** button. The **SRS Templates** page appears, displaying the list of available SRS templates.

SRS Templates

<input type="checkbox"/>	SRS TEMPLATE ID	DESCRIPTION	TEMPLATE CATEGORY	STATE	CATEGORY DEFAULT
<input type="checkbox"/>	MI_SRS_Electric_1006		Electrical	In Progress	<input checked="" type="checkbox"/>
<input type="checkbox"/>	SIL 1001Template		SIL SRS	In Progress	<input type="checkbox"/>
<input type="checkbox"/>	srs template 1		General Data	In Progress	<input type="checkbox"/>
<input type="checkbox"/>	srs template for default		General Data	In Progress	<input type="checkbox"/>
<input type="checkbox"/>	test template		General Data	Approved	<input checked="" type="checkbox"/>

3. Select an SRS Template for which you want to change the state.

The **SRS Template** page for the selected template appears, displaying the current state in the upper-right corner of the page.

IF SRS Reactor R1 Template

In Progress
Not Assigned

0 Revision(s)

Datasheet ID:
IF SRS

SRS Template ID
IF SRS Reactor R1 Template

SRS Template Description
IF SRS Reactor R1 Template

Reset Requirement
Text area

Normal Operation Mode
Text area

Process Variable Unit
Text input

Min Process Variable
Numeric input

4. In the upper-right corner of the workspace, select **In Progress**, select **Propose**, and then select **Done**.
The state of the SRS Template is changed to **Pending Review** and the datasheet is disabled.
5. In the upper-right corner of the workspace, select **Pending Review**, select **Rework**, and then select **Done**.
The state of the SRS Template is changed to **In Progress** and the datasheet is enabled.

6. In the upper-right corner of the workspace, select **In Progress**, select **Propose**, and then select **Done**.
The state of the SRS Template is changed to **Pending Review** and the datasheet is disabled.
7. In the upper-right corner of the workspace, select **Pending Review**, select **Approve**, and then select **Done**.
The state of the SRS Template is changed to **Approved** and the datasheet is disabled. At this stage, The revision number is incremented.
8. In the upper-right corner of the workspace, select **Approved**, select **Reassess**, and then select **Done**.
The state of the SRS Template is changed to **In Progress** and the datasheet is enabled.

Compare the Revision Records of an SRS Template

Procedure

1. [Access the Revision History of the SRS Template for which you want to compare the revisions.](#)
2. Select the revision record which you want to compare with the previous revision record.

The **Revision History** page displays the details of the selected revision record.

The screenshot shows the 'IF SRS Revision History' page. At the top, there is a navigation bar with tabs for 'SIS Overview', 'SRS Template', and 'IF SRS'. A 'Show Changes' button is located in the top right corner. Below the navigation bar, the page title 'IF SRS Revision History' is displayed. The main content area contains several input fields for SRS Template details:

- Datasheet ID:** A dropdown menu with 'IF SRS' selected.
- SRS Template ID:** A text input field containing 'IF SRS'.
- SRS Template Description:** A text input field containing 'Text input'.
- Reset Requirement:** A text area containing 'Text area'.
- Normal Operation Mode:** A text area containing 'Text area'.
- Process Variable Unit:** A text input field containing 'Text input'.
- Min Process Variable:** A numeric input field containing 'Numeric input'.

3. In the upper-right corner of the workspace, select **Show Changes**.

The **Changes For Selected Datasheet** page appears, displaying the comparison details.

Changes For Selected Datasheet

No	Field	Old Value	New Value
1	SRS Template Description		This template is for SIL 1001
2	I/O Power Redundancy Requirements		As an initial step in the process of compliance with IEC 61511, the analysis has drawn on experience from internal experts and used this in conjunction with a HAZOP workshop to identify potential incidents, their causes and consequences, and the preventative and mitigative safeguards already in place. Where the HAZOP team felt it was necessary, additional safeguards were recommended. The SIL determination workshop used the results of the HAZOP to evaluate the performance requirements of the identified SIF.
3	Revision Number	0	1

OK

Delete an SRS Template

Procedure

1. Access the [SIS Management Overview](#) page.

Tip: You can also access the [SIS Management Overview](#) page for a selected hierarchy level.

2. In the workspace, select the **SRS** tab and then select the **SRS Template** button.

The **SRS Templates** page appears.

SRS Templates					
<input type="checkbox"/>	SRS TEMPLATE ID	DESCRIPTION	TEMPLATE CATEGORY	STATE	CATEGORY DEFAULT
<input type="checkbox"/>	MI_SRS_Electric_1006		Electrical	In Progress	<input checked="" type="checkbox"/>
<input type="checkbox"/>	SIL 1001Template		SIL SRS	In Progress	<input type="checkbox"/>
<input type="checkbox"/>	srs template 1		General Data	In Progress	<input type="checkbox"/>
<input type="checkbox"/>	srs template for default		General Data	In Progress	<input type="checkbox"/>
<input type="checkbox"/>	test template		General Data	Approved	<input checked="" type="checkbox"/>

3. Select the SRS Template(s) that you want to delete, and then select  .
A confirmation message appears, asking if you really want to delete the SRS Template(s).
4. Select **OK**.
The selected SRS Template(s) are deleted.

Chapter 13

SRS Projects

Topics:

- [About SRS Project](#)
- [Access an SRS Project](#)
- [Create an SRS Project](#)
- [Access the List of Linked Records in an SRS Project](#)
- [Change the State of an SRS Project](#)
- [Access the Revision History of an SRS Project](#)
- [Change the SRS Template that is Defined for an SRS Category in an SRS Project](#)
- [Compare the Revision Records of an SRS Project](#)
- [Link an SRS Project to Instrumented Function, SIL Analysis, Protective Loop, and Logic Solver](#)
- [Download an SRS Project Report](#)
- [Delete an SRS Project](#)

About SRS Project

Creation of an SRS Project allows the user to select one or many of the SRS templates. Once the user has made the selection of templates, a copy of the collection of templates will be made.

The user can link the SRS Project to zero or many of the following elements:

- SIL Analysis
- Logic Solver
- Instrumented Function
- Protective Loop

The linkage takes place in the context of a linkable item (for example, instrumented function) where the user can search and select an approved SRS Project.

Access an SRS Project

Procedure

1. Access the [SIS Management Overview](#) page.

Tip: You can also [access the SIS Management Overview page](#) for a selected hierarchy level.

2. Select the **SRS** tab.

The **SRS** section appears, displaying a list of SRS Projects.

The screenshot shows the SIS Management Overview page. At the top, there is a navigation bar with a 'SIS Overview' tab. Below the navigation bar, there are two buttons: 'Import From Exida' and 'Export to Exida'. The main content area displays a summary of SRS Projects with six cards: SIL Analysis (31), Proof Test Tasks (11), PIL Templates (9), SIS Trip Reports (3), Custom Failure Data (4), and SRS (242). Below the summary cards is a table of SRS Projects. The table has columns for SRS PROJECT ID, DESCRIPTION, STATE, and LAST MODIFIED DATE. The table contains 16 rows of SRS Projects, all in 'In Progress' state, with last modified dates ranging from 10/05/2016 14:57:17 to 10/05/2016 14:57:48.

SRS PROJECT ID	DESCRIPTION	STATE	LAST MODIFIED DATE
<input type="checkbox"/>	IF All Systematic Capability > 0 - T2.6.1	In Progress	10/05/2016 14:57:44
<input type="checkbox"/>	IF AO with FSC 2oo4D - T6.3.1	In Progress	10/05/2016 14:57:51
<input type="checkbox"/>	IF AO with S7-400F - T6.3.2	In Progress	10/05/2016 14:57:32
<input type="checkbox"/>	IF AO with S7-400FH - T6.3.3	In Progress	10/05/2016 14:57:23
<input type="checkbox"/>	IF ASF - Instrumented Function	In Progress	10/05/2016 14:57:27
<input type="checkbox"/>	IF ASF Instrumented Function	In Progress	10/05/2016 14:57:31
<input type="checkbox"/>	IF ASM - MM DeltaV_Redundant - T1.28.2	In Progress	10/05/2016 14:57:22
<input type="checkbox"/>	IF ASM2 - MM DeltaV_Redundant - T1.28.2	In Progress	10/05/2016 14:57:48
<input type="checkbox"/>	IF ASM2 - MM DeltaV_Redundant -T1.28.2	In Progress	10/05/2016 14:57:51
<input type="checkbox"/>	IF Auto Channel, An I / Di I/O - T6.1.4	In Progress	10/05/2016 14:57:17
<input type="checkbox"/>	IF Auto Channel, An I / Di O - T6.1.3	In Progress	10/05/2016 14:57:42
<input type="checkbox"/>	IF Auto Channel, Analog I/O - T6.1.1	In Progress	10/05/2016 14:57:31
<input type="checkbox"/>	IF Auto Channel, Digital I/O - T6.1.2	In Progress	10/05/2016 14:57:21
<input type="checkbox"/>	IF Beta factor 0% - 100% - T3.2.3	In Progress	10/05/2016 14:57:46

3. In the **SRS Project Id** column, select the SRS Project that you want to access.

The **SRS Project** page appears, displaying the **Project Summary** workspace for the selected SRS Project. The **Definition** tab is selected by default.

Note: As needed, you can modify the values in the [available fields](#), and then select  to save your changes.

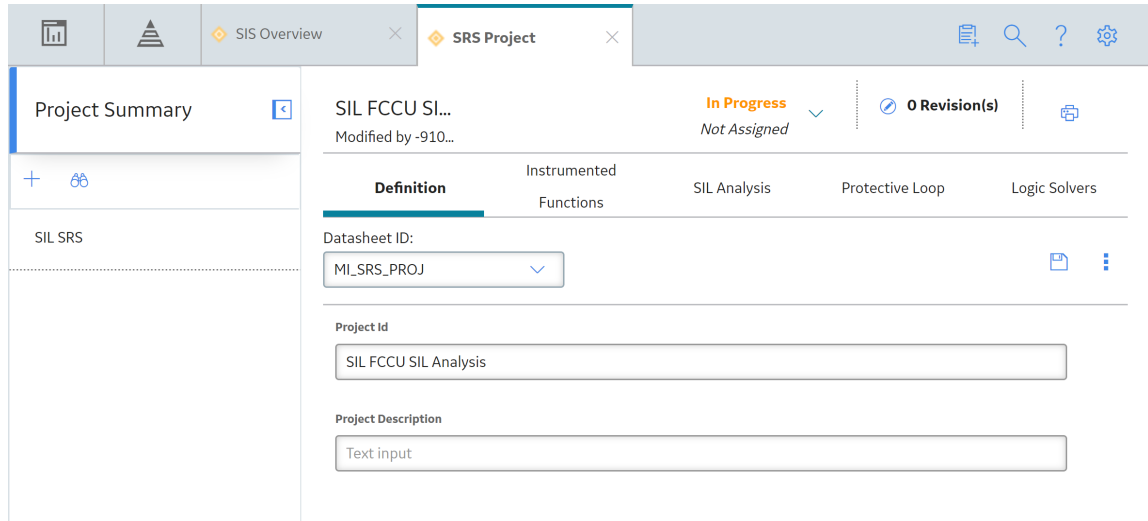

The screenshot shows a web application interface for an SRS Project. At the top, there are two tabs: 'SIS Overview' and 'SRS Project'. The 'SRS Project' tab is active. Below the tabs, there is a header area with 'Project Summary' on the left and 'SIL FCCU SI...' on the right. The 'SIL FCCU SI...' section includes a status indicator 'In Progress' (with a dropdown arrow) and 'Not Assigned', and a revision count '0 Revision(s)' with a refresh icon. Below this is a navigation bar with tabs: 'Definition' (selected), 'Instrumented Functions', 'SIL Analysis', 'Protective Loop', and 'Logic Solvers'. The main content area under the 'Definition' tab contains a 'Datasheet ID' dropdown menu with 'ML_SRS_PROJ' selected, a 'Project Id' text input field containing 'SIL FCCU SIL Analysis', and a 'Project Description' text input field containing 'Text input'. There are also icons for saving and a menu on the right side of the Datasheet ID field.

Create an SRS Project

Before You Begin

- [Create an SRS Template.](#)

Procedure

1. Access the **SIS Management Overview** page.

Tip: You can also [access the SIS Management Overview](#) page for a selected hierarchy level.

2. In the workspace, select the **SRS** tab.

The **SRS** section appears, displaying a list of SRS Projects.

SIS Management Overview
Asset: Home

Import From Exida Export to Exida

31 SIL Analysis	11 Proof Test Tasks	9 PIL Templates	3 SIS Trip Reports	4 Custom Failure Data	242 SRS
--------------------	------------------------	--------------------	-----------------------	--------------------------	------------

SRS PROJECT ID	DESCRIPTION	STATE	LAST MODIFIED DATE
<input type="checkbox"/>	IF All Systematic Capability > 0 - T2.6.1	In Progress	10/05/2016 14:57:44
<input type="checkbox"/>	IF AO with FSC 2oo4D - T6.3.1	In Progress	10/05/2016 14:57:51
<input type="checkbox"/>	IF AO with S7-400F - T6.3.2	In Progress	10/05/2016 14:57:32
<input type="checkbox"/>	IF AO with S7-400FH - T6.3.3	In Progress	10/05/2016 14:57:23
<input type="checkbox"/>	IF ASF - Instrumented Function	In Progress	10/05/2016 14:57:27
<input type="checkbox"/>	IF ASF Instrumented Function	In Progress	10/05/2016 14:57:31
<input type="checkbox"/>	IF ASM - MM DeltaV_Redundant - T1.28.2	In Progress	10/05/2016 14:57:22
<input type="checkbox"/>	IF ASM2 - MM DeltaV_Redundant - T1.28.2	In Progress	10/05/2016 14:57:48
<input type="checkbox"/>	IF ASM2 - MM DeltaV_Redundant -T1.28.2	In Progress	10/05/2016 14:57:51
<input type="checkbox"/>	IF Auto Channel, An & DI I/O - T6.1.4	In Progress	10/05/2016 14:57:17
<input type="checkbox"/>	IF Auto Channel, An I / Di O - T6.1.3	In Progress	10/05/2016 14:57:42
<input type="checkbox"/>	IF Auto Channel, Analog I/O - T6.1.1	In Progress	10/05/2016 14:57:31
<input type="checkbox"/>	IF Auto Channel, Digital I/O - T6.1.2	In Progress	10/05/2016 14:57:21
<input type="checkbox"/>	IF Beta factor 0% - 100% - T3.2.3	In Progress	10/05/2016 14:57:46

3. In the upper-left corner of the SRS section, select .

The **SIS Management** page appears, displaying the **Project Summary** workspace for the SRS Project.

SIS Management

Project Summary

New Srs Proj...

Definition Instrumented Functions SIL Analysis Protective Loop Logic Solvers

Datasheet ID:
MI_SRS_PROJ

Project Id
Text input
This field is required

Project Description
Text input

4. Enter values in the **Project ID** and **Project Description** boxes for the new SRS Project, and then select . The **Project ID** is a required field.

A confirmation message appears, indicating that the datasheet has been saved successfully.

Results

- The SRS Project that you created appears in the **SRS** section of the SIS Management Overview page.

Next Steps

- [Add an SRS Category to an SRS Project](#)

Access the List of Linked Records in an SRS Project

Procedure

1. [Access the SRS Project](#) for which you want to view the list of linked records.

The **SRS Project** page appears, displaying the **Project Summary** workspace for the selected SRS Project. The following tabs appear in the workspace:

- **Definition:** Contains the datasheet for the SRS Project. This tab is selected by default.
- **Instrumented Functions:** Contains a list of Instrumented Functions that are associated with the SRS Project.
- **SIL Analysis:** Contains a list of SIL Analyses that are associated with the SRS Project.
- **Protective Loop:** Contains a list of Protective Loops that are associated with the SRS Project.
- **Logic Solvers:** Contains a list of Logic Solvers that are associated with the SRS Project.

The screenshot shows the SRS Project workspace. At the top, there are tabs for 'SIS Overview' and 'SRS Project'. The 'SRS Project' tab is active. Below the tabs, there is a 'Project Summary' section with a left sidebar containing 'SIL SRS'. The main content area displays the following information:

- Project Name:** SIL FCCU SI... (Status: In Progress, Not Assigned)
- Modified by:** -910...
- Revisions:** 0 Revision(s)
- Navigation Tabs:** Definition (selected), Instrumented Functions, SIL Analysis, Protective Loop, Logic Solvers
- Datasheet ID:** ML_SRS_PROJ
- Project Id:** SIL FCCU SIL Analysis
- Project Description:** Text input

2. Select the tab containing the records that you want to view.

The following image shows the **SIL Analysis** section, which contains the list of SIL Analyses that are associated with the SRS Project.

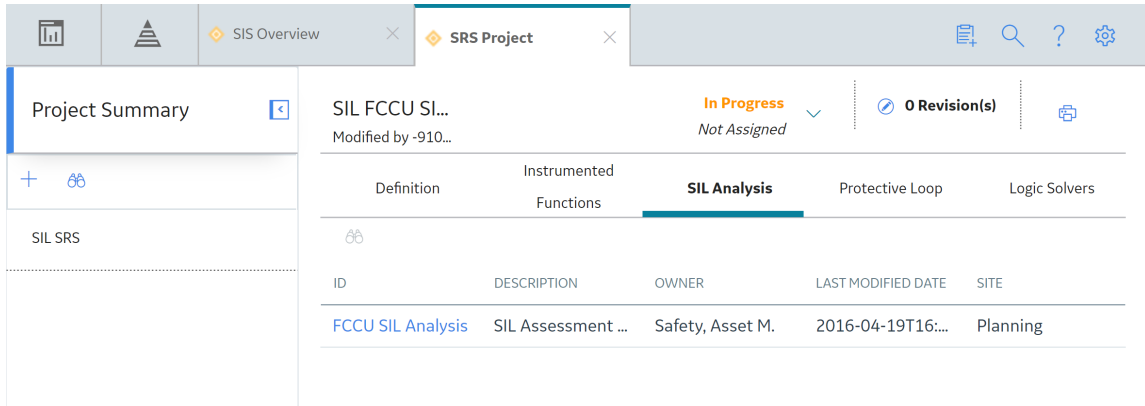

Change the State of an SRS Project

Procedure

1. Access the SRS Project for which you want change the state.
2. In the upper-right corner of the workspace, select the button that indicates the current state of the SRS Project. For example, if the current state of the project is In Progress, select **In Progress**.

A menu appears, displaying the list of operations that you can perform on the SRS Project to change its state.

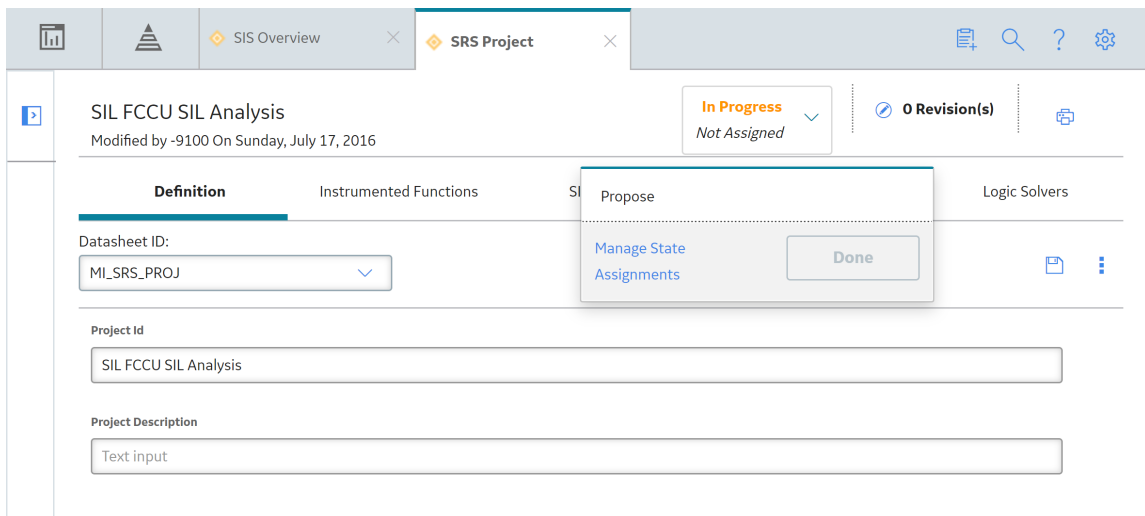

3. Select the [necessary operation](#) that will change the state of the project, and then select **Done**. For example, if you want to change the state of the analysis from Planning to Active, select **Begin**, and then select **Done**.

Note: You can view the states assigned to various users by selecting the **Manage State Assignments** link. If not already done, you can assign the next state to the appropriate user, and then select **Done**.

The state of the SRS Project is changed.

Results

- Based on the state of the SRS Project, the datasheet is either enabled or disabled for modification:

- If the state of the SRS Project is changed to **Pending Review**, the datasheet is disabled.
- If the state of the SRS Project is changed to **In Progress**, the datasheet is enabled.
- If the state of the SRS Project is changed to **Pending Review**, the datasheet is disabled.
- If the state of the SRS Project is changed to **Approved**, the datasheet is disabled. At this stage, the revision number is incremented.

Access the Revision History of an SRS Project

Procedure

1. [Access the SRS Project for which you want view the revision history.](#)
2. In the upper-right corner of the workspace, select **Revisions**.

The **Revision History** page appears, displaying the list of revisions done on the SRS Project.

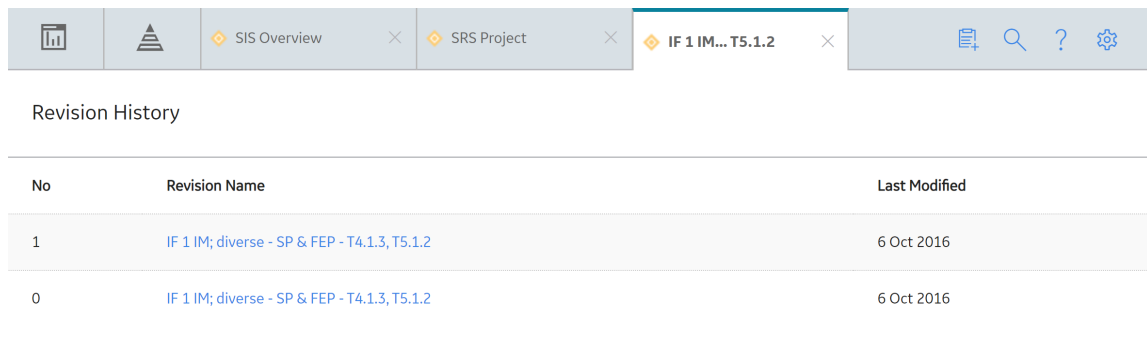

No	Revision Name	Last Modified
1	IF 1 IM; diverse - SP & FEP - T4.1.3, T5.1.2	6 Oct 2016
0	IF 1 IM; diverse - SP & FEP - T4.1.3, T5.1.2	6 Oct 2016

Change the SRS Template that is Defined for an SRS Category in an SRS Project

Procedure

1. [Access the SRS Project for which you want to change the template used in an SRS Category.](#)
2. In the left pane, select the SRS Category in which the SRS Template needs to be changed.

The **SRS Category** page appears.

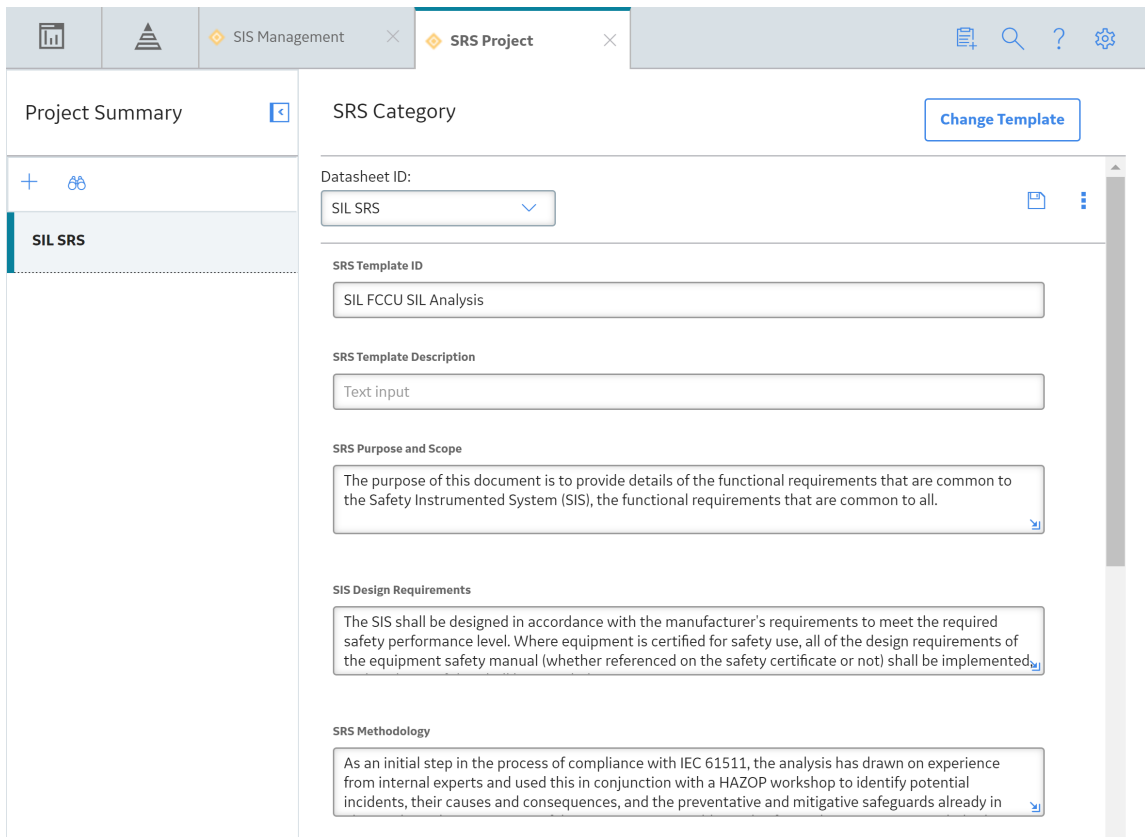

3. In the upper-right corner of the workspace, select **Change Template**.

The **Create new SRS category** window appears, displaying a list of available SRS templates.

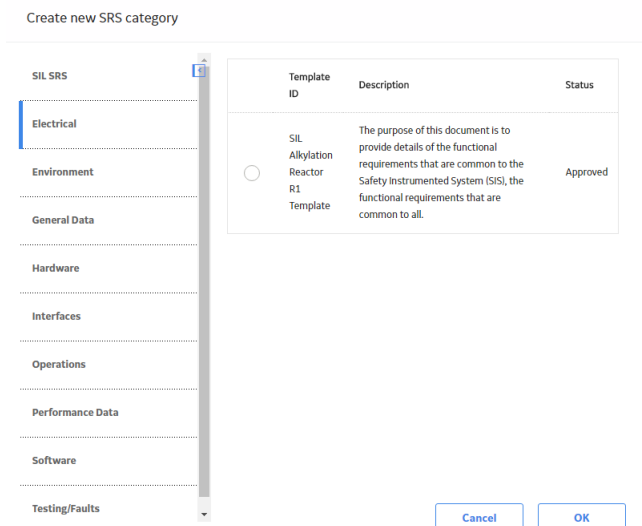

4. Select the <SRS Template> radio button, and then select **OK**.

The new SRS template is added to the list of SRS categories displayed in the left pane of the <SRS Project> page.

Compare the Revision Records of an SRS Project

Procedure

1. [Access the revision history of the SRS Project.](#)
2. Select the revision record which you want to compare with the previous revision record.

The **Revision History** page displays the details of the selected revision record.

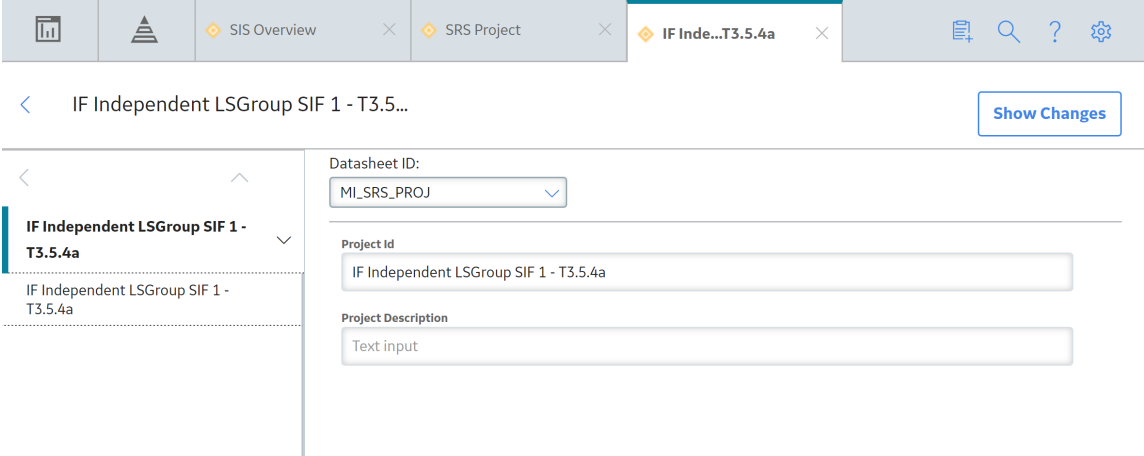

3. In the upper-right corner of the workspace, select **Show Changes**.
The **Changes For Selected Datasheet** page appears, displaying the comparison details.

Changes For Selected Datasheet

No	Field	Old Value	New Value
1	Revision Number	0	1

OK

Link an SRS Project to Instrumented Function, SIL Analysis, Protective Loop, and Logic Solver

Before You Begin

- [Create an SRS Project.](#)

Procedure

- Link an SRS Project to Instrumented Function
 1. [Access the Instrumented Function](#) to which you want to link the SRS Project.
 2. In the **Definition** section, in the **SIS Project ID** box, select .The **Search** window appears.

Search

Look in

- In the **Look in** box, select **SRS Project**.

The list of SRS projects appears.

Search

Look in

<input type="radio"/>	SIL Alkylation Reactor R1 SIL Analysis SRS Project SIL Analysis SRS Project SIL SRS Electrical
<input type="radio"/>	SIL B0007-009 Steam Boiler SIS SRS Project SRS Project SIL SRS

- Select the SRS Project that you want to associate with the Instrumented Function, and then select **OK**.

In the **SRS Project ID** box, the SRS Project ID appears as a link.

5. In the upper-right corner of the **Definition** section, select .

The selected SRS Project is linked to the Instrumented Function.

- Link an SRS Project to SIL Analysis

1. [Access the SIL Analysis](#) to which you want to link the SRS Project.

2. In the **Definition** section, in the **SIS Project ID** box, select .

The **Search** window appears.

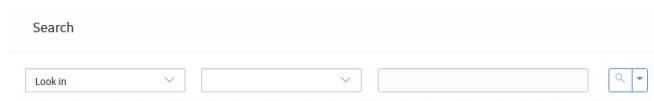

Cancel

OK

3. In the **Look in** box, select **SRS Project**.

The list of SRS projects appears.

Search



Look in

SIL Alkylation Reactor R1 SIL Analysis
SRS Project [SIL Analysis](#) [SRS Project](#) [SIL SRS](#) [Electrical](#)

SIL B0007-009 Steam Boiler SIS
SRS Project [SRS Project](#) [SIL SRS](#)

Cancel

OK

4. Select the SRS Project that you want to associate with the SIL Analysis, and then select **OK**.
In the **SRS Project ID** box, the SRS Project ID appears as a link.
 5. In the upper-right corner of the **Definition** section, select .
- Link an SRS Project to Protective Loop
 1. [Access the protective loop](#) to which you want to link the SRS Project.
 2. In the **Definition** section, in the **SIS Project ID** box, select .The **Search** window appears.

Search

Look in

Cancel

OK

3. In the **Look in** box, select **SRS Project**.

The list of SRS projects appears.

Search

Look in

SIL Alkylation Reactor R1 SIL Analysis
SRS Project [SIL Analysis](#) [SRS Project](#) [SIL SRS](#) [Electrical](#)

SIL B0007-009 Steam Boiler SIS
SRS Project [SRS Project](#) [SIL SRS](#)

Cancel

OK

4. Select the SRS Project that you want to associate with the protective loop, and then select **OK**.

In the **SRS Project ID** box, the SRS Project ID appears as a link.

5. In the upper-right corner of the **Definition** section, select .

The selected SRS Project is linked to the protective loop.

- Link an SRS Project to Logic Solver

1. [Access the Logic Solver](#) to which you want to link the SRS Project.

2. In the **Definition** section, in the **SIS Project ID** box, select .

The **Search** window appears.

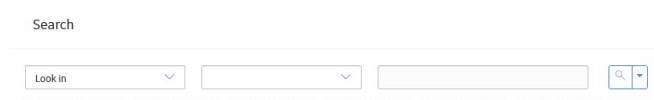

Cancel

OK

3. In the **Look in** box, select **SRS Project**.

The list of SRS Projects appears.

Search

Look in

SIL Alkylation Reactor R1 SIL Analysis
SRS Project [SIL Analysis](#) [SRS Project](#) [SIL SRS](#) [Electrical](#)

SIL B0007-009 Steam Boiler SIS
SRS Project [SRS Project](#) [SIL SRS](#)

Cancel

OK

4. Select the SRS Project that you want to associate with the Logic Solver, and then select **OK**.
In the **SRS Project ID** box, the SRS Project ID appears as a link.
 5. In the upper-right corner of the **Definition** section, select .
- The selected SRS Project is linked to the Logic Solver.

Download an SRS Project Report

Procedure

1. [Access the SRS Project](#) for which you want to print an SRS Project report.
 2. On the upper-right corner of the page, select .
 3. Navigate to the location where you want to save the report, and then select **Save**.
- The report is downloaded and saved as a .pdf file.

Note: The actions required in steps 2 and 3 may differ slightly depending on the browser that you use and the browser settings.

Delete an SRS Project

Procedure

1. Access the [SIS Management Overview](#) page.
Tip: You can also access the [SIS Management Overview](#) page for a selected hierarchy level.
2. In the workspace, select the **SRS** tab.

The **SRS** section appears, displaying a list of SRS Projects.

The screenshot shows the SIS Management Overview page. At the top, there is a navigation bar with a 'SIS Overview' tab and a search icon. Below the navigation bar, there are two buttons: 'Import From Exida' and 'Export to Exida'. The main content area displays a summary of SRS Projects with six cards: SIL Analysis (31), Proof Test Tasks (11), PIL Templates (9), SIS Trip Reports (3), Custom Failure Data (4), and SRS (242). Below the summary cards is a table of SRS Projects. The table has columns for SRS PROJECT ID, DESCRIPTION, STATE, and LAST MODIFIED DATE. The table contains 15 rows of SRS Projects, all in the 'In Progress' state. A trash icon is visible in the upper right corner of the table area.

SRS PROJECT ID	DESCRIPTION	STATE	LAST MODIFIED DATE
<input type="checkbox"/>	IF All Systematic Capability > 0 - T2.6.1	In Progress	10/05/2016 14:57:44
<input type="checkbox"/>	IF AO with FSC 2oo4D - T6.3.1	In Progress	10/05/2016 14:57:51
<input type="checkbox"/>	IF AO with S7-400F - T6.3.2	In Progress	10/05/2016 14:57:32
<input type="checkbox"/>	IF AO with S7-400FH - T6.3.3	In Progress	10/05/2016 14:57:23
<input type="checkbox"/>	IF ASF - Instrumented Function	In Progress	10/05/2016 14:57:27
<input type="checkbox"/>	IF ASF Instrumented Function	In Progress	10/05/2016 14:57:31
<input type="checkbox"/>	IF ASM - MM DeltaV_Redundant - T1.28.2	In Progress	10/05/2016 14:57:22
<input type="checkbox"/>	IF ASM2 - MM DeltaV_Redundant - T1.28.2	In Progress	10/05/2016 14:57:48
<input type="checkbox"/>	IF ASM2 - MM DeltaV Redundant -T1.28.2	In Progress	10/05/2016 14:57:51
<input type="checkbox"/>	IF Auto Channel, An & DI I/O - T6.1.4	In Progress	10/05/2016 14:57:17
<input type="checkbox"/>	IF Auto Channel, An I / Di O - T6.1.3	In Progress	10/05/2016 14:57:42
<input type="checkbox"/>	IF Auto Channel, Analog I/O - T6.1.1	In Progress	10/05/2016 14:57:31
<input type="checkbox"/>	IF Auto Channel, Digital I/O - T6.1.2	In Progress	10/05/2016 14:57:21
<input type="checkbox"/>	IF Beta factor 0% - 100% - T3.2.3	In Progress	10/05/2016 14:57:46

3. Select the row that contains the SRS Project that you want to delete.
4. In the upper-right corner of the section, select .

Note: SRS Projects that are in the Approved state cannot be deleted.

A confirmation message appears, asking if you really want to delete the SRS Project(s).

5. Select **OK**.

The SRS Project, along with all the related SRS Project details, is deleted.

Note: When you delete a SRS Project, the relationships with the associated Instrumented Functions, Logic Solvers, Protective Instrument Loops, and SIL Analyses are removed.

Chapter 14

SRS Categories

Topics:

- [About SRS Category](#)
- [About Administration Settings to Define Required Categories](#)
- [Create an SRS Category](#)
- [Add an SRS Category to an SRS Project](#)
- [Change the SRS Template that is Defined for an SRS Category in an SRS Project](#)
- [Update a Particular SRS Category in an SRS Project](#)
- [Delete an SRS Category from an SRS Project](#)

About SRS Category

A user can use the SRS Category feature to create a new SRS Category family with the required fields and datasheets that are not covered in the existing Baseline Categories.

About Administration Settings to Define Required Categories

A user can use the SRS Project administration settings to create a custom selection of required categories when an SRS Project is created. New SRS Projects will automatically contain all default SRS Categories.

Create an SRS Category

You can create an SRS Category only if you are a Super User or a user with administrative privileges.

Procedure

1. On the left navigation menu, select **Admin**, and then select **Configuration Manager**.

The **Configuration Manager page** appears.

2. On the **Configuration Manager** page, select **Family Management**.

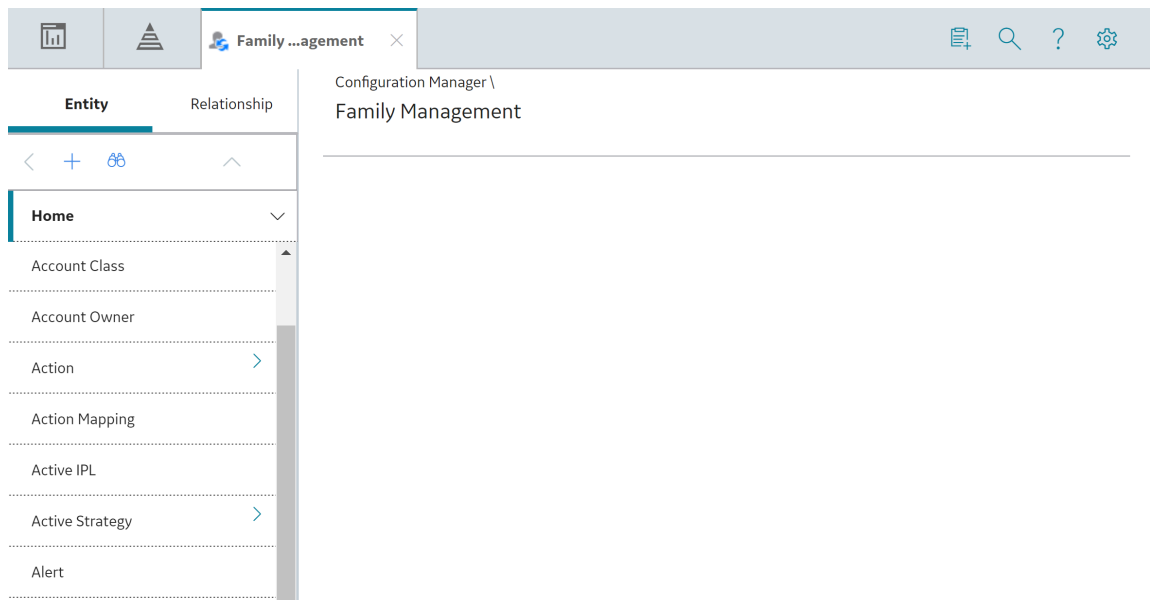

The **Family Management** page appears, displaying the list of already existing families. The **Home** family is selected by default. In the left pane, below the **Home** tab, all of the families in the hierarchy appear in alphabetical order. Note that you cannot change the order of the families. You can expand a family hierarchy by selecting the  button in the tab for that family.



3. Select  and enter **SRS Template**.

The search results appear in the left pane.

4. Select the **SRS Template** family, and then in the upper-left corner of the left pane, select .

- As required, enter values in the [available fields](#).
- Select .
- Select the **Fields** tab, and then in the upper-right corner of the **Fields** section, select . The **New Field** workspace appears.

- As required, enter values in the available fields, and then select **Save**. A confirmation message appears, indicating that the field has been created successfully and the new field appears in the **Fields** tab.

You can repeat steps 7 – 8 to add more fields to the custom category.

- Select the **Datasheets** tab, and then select **Manage Datasheets**. The **Information** dialog box appears, indicating that the family does not have any datasheets and stating that you must create a new datasheet.
- Select **OK**.

The **Datasheet Builder** page appears.

- In the upper-right corner of the page, select , and then select **Custom datasheet**.

The **Create New Datasheet** window appears.

- Enter a caption, default ID, and description for the new datasheet, and then select **OK**.

Note: If you want your datasheet to be the default datasheet for this family, select the **Default Datasheet** check box.

The new datasheet appears.

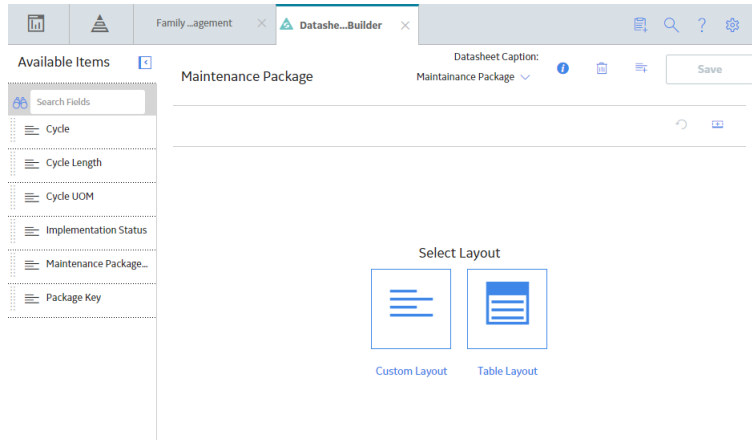

13. Select , and then select **Custom Layout**.

The new section is added.

14. Drag and drop the fields from the left panel that has to be added to the new custom datasheet, and then select **Save**.

15. Select the **Family Management** page, and then select the **State Configuration** tab.

16. Select the **Use Parent's Configuration** check box, select **Enable State Functionality**.

The State Configuration diagram for the new SRS Template family appears.

17. In the left pane, select the **Relationship** tab.

18. Select  and enter **Has SRS References**.

The search results appear in the left pane.

19. Select the **Has SRS References** relationship, select the **Relationship Definition** tab, and then select .

The **Manage Relationship Definition** window appears.

20. Select **SRS Template** in the **Predecessor(s)** drop-down list box.

21. Select the template category family in the **Successor(s)** drop-down list box. By default, the **One To One** cardinality is selected.

22. Select **Add**, and select .

The new relationship is added to the list of **Has SRS References** relationships.

23. In the left pane, select  and enter **Has SRS Template Revisions**.

The search results appear in the left pane.

24. Select the **Has SRS Template Revisions** relationship, select the **Relationship Definition** tab, and then select .

The **Manage Relationship Definition** window appears.

25. Select the template category family in the **Predecessor(s)** and **Successor(s)** drop-down list boxes.

26. Select the **One To Many** cardinality, and then select **Add**.

27. Select .

The new relationship is added to the list of **Has SRS Template Revisions** relationships and the new custom category appears in the **SRS Templates** page.

Add an SRS Category to an SRS Project

Procedure

1. [Access the SRS Project for which you want to create an SRS Category.](#)
2. In the left pane, select .

The **Create new SRS category** window appears, displaying a list of SRS Categories in the left pane.

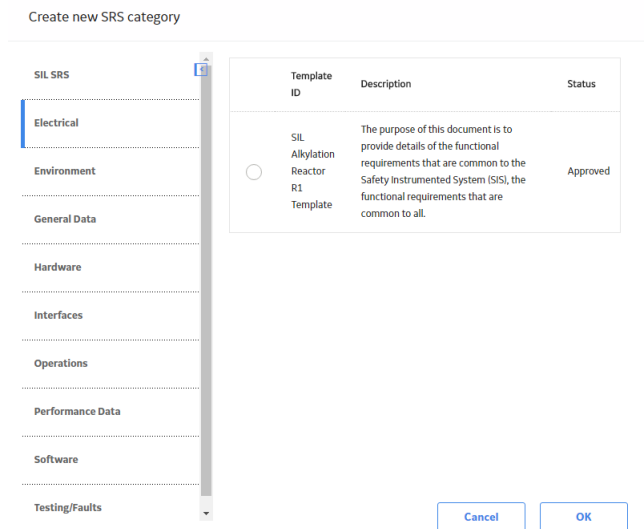

3. Select the required SRS category from the list.

In the Create new SRS category window, a list of SRS Templates associated with the SRS Category appears.

4. From the list of templates, select the template that you want to use for the SRS Project, and then select **OK**.

The SRS Category is added to the SRS Project.

Change the SRS Template that is Defined for an SRS Category in an SRS Project

Procedure

1. [Access the SRS Project for which you want to change the template used in an SRS Category.](#)
2. In the left pane, select the SRS Category in which the SRS Template needs to be changed.

The **SRS Category** page appears.

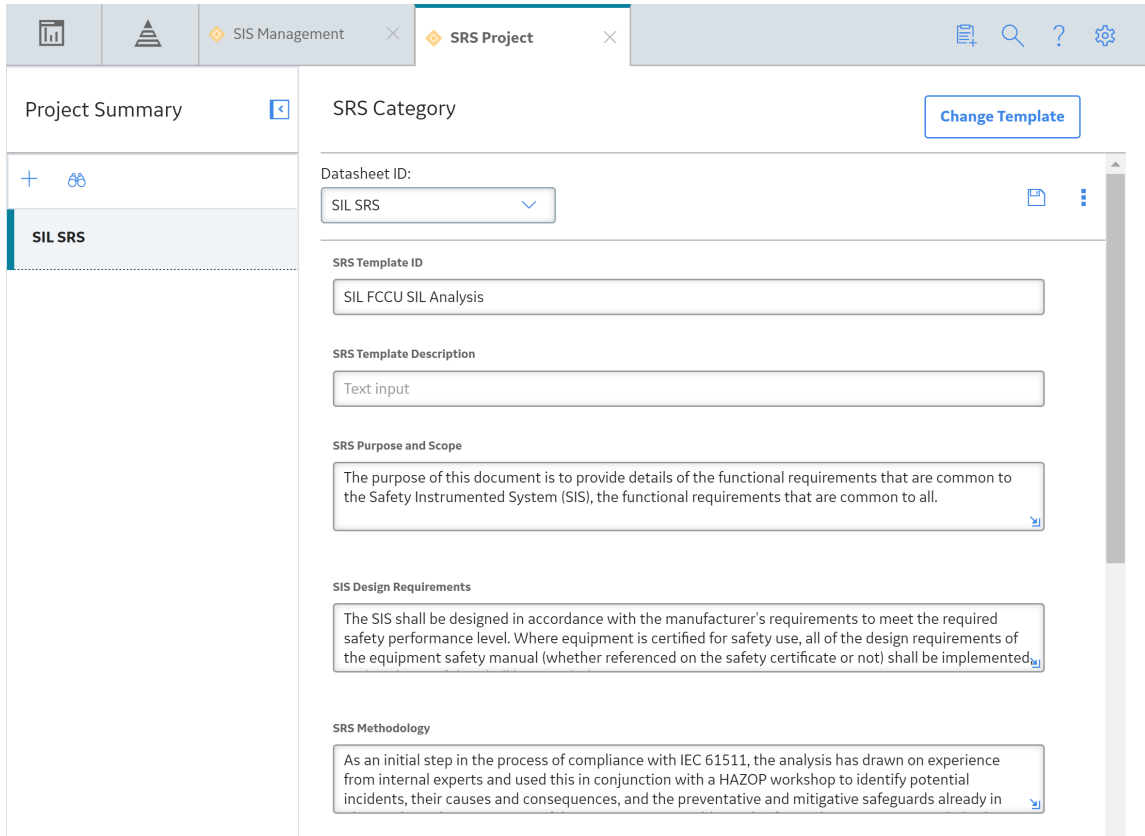

3. In the upper-right corner of the workspace, select **Change Template**.

The **Create new SRS category** window appears, displaying a list of available SRS templates.

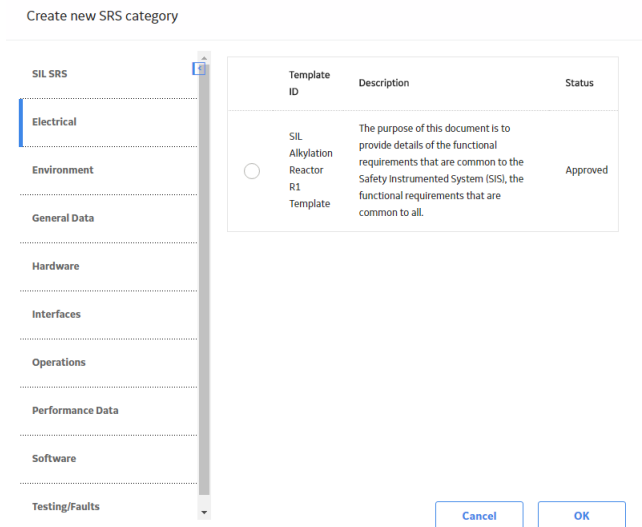

4. Select the <SRS Template> radio button, and then select **OK**.

The new SRS template is added to the list of SRS categories displayed in the left pane of the <SRS Project> page.

Update a Particular SRS Category in an SRS Project

Procedure

1. Access the SRS Project for which you want to update the SRS Category.
2. In the left pane, select the SRS Category that you want to update.

The **SRS Category** page appears.

The screenshot shows the 'SRS Category' page in a software application. The interface is divided into a left-hand navigation pane and a main content area. The left pane has 'Project Summary' and 'SIL SRS' options. The main area is titled 'SRS Category' and contains several form fields: 'Datasheet ID' (a dropdown menu showing 'SIL SRS'), 'SRS Template ID' (a text input field containing 'SIL FCCU SIL Analysis'), 'SRS Template Description' (a text input field containing 'Text input'), 'SRS Purpose and Scope' (a text area containing a paragraph about functional requirements), 'SIS Design Requirements' (a text area containing a paragraph about manufacturer requirements), and 'SRS Methodology' (a text area containing a paragraph about IEC 61511 compliance). A 'Change Template' button is located in the top right corner of the main area.

3. Modify the values in the fields, as required.
4. In the upper-right corner of the workspace, select .

A confirmation message appears, indicating that the datasheet has been saved successfully.

Delete an SRS Category from an SRS Project

Procedure

1. Access the SRS Project for which you want to create an SRS Category.
2. In the left pane, select the SRS Category which you want to delete.

The **SRS Category** page appears, displaying the datasheet for the SRS Category.

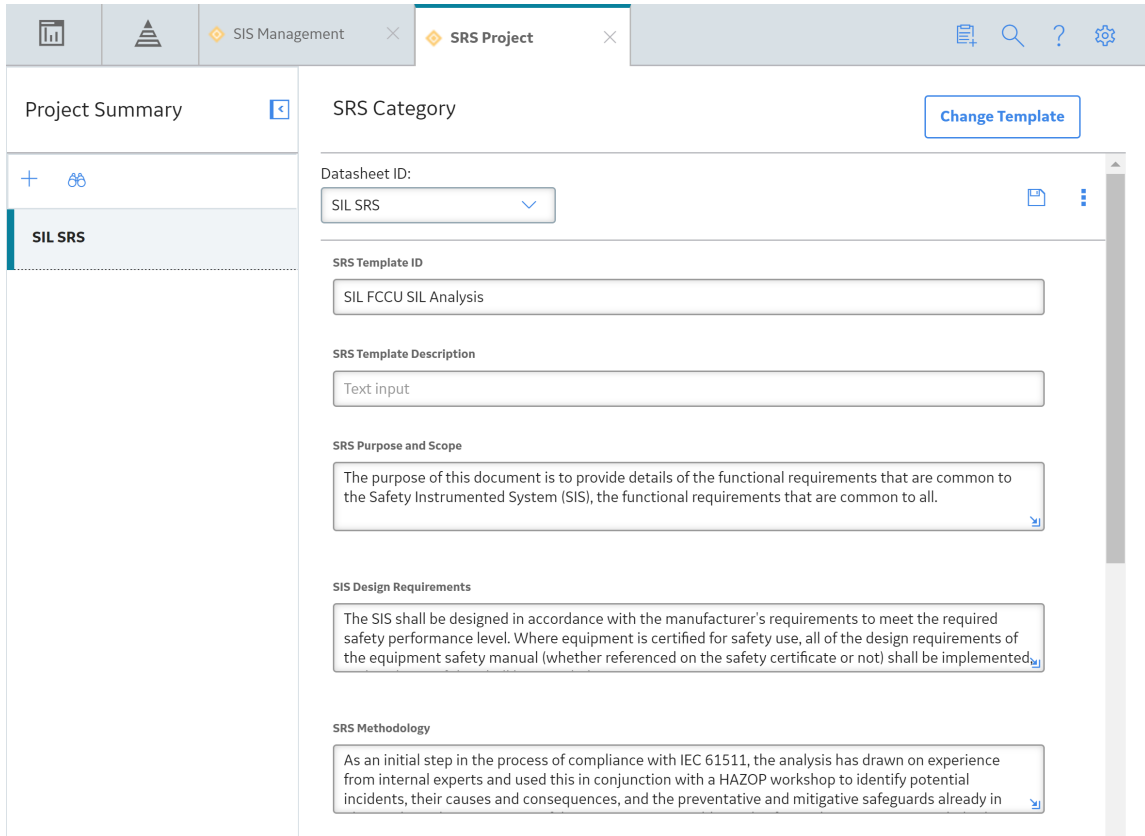

3. In the upper-right corner of the datasheet, select , and then select **Delete**.

Note: You can delete an SRS Category only if the SRS Project is in the In Progress state.

The **Confirm Delete** dialog box appears, asking you to confirm that you want to delete the selected category.

4. Select **Yes**.

The SRS Category is deleted from the SRS Project.

Chapter 15

Exida Project Files

Topics:

- [About Exida Project Files](#)
- [Import Data From Exida](#)
- [Export Data To Exida](#)

About Exida Project Files

You can import data from an Exida project file (.exi or .exp) to APM. You can also export the data from APM as an .exi file. It stores data related to one or more Protective Instrument Loops in an SIL analysis.

Note: Importing and exporting project files to and from exSILentia is not supported on mobile devices (for example, tablets or mobile phones).

Import Data From Exida

About This Task

This topic describes how to import an exSILentia file from Exida. APM supports exSILentia v3 (.exi file) and exSILentia v4 (.exp file). The exSILentia file stores data related to one or more Protective Instrument Loops in an SIL analysis.

Note:

Importing and exporting project files to and from exSILentia is not supported on mobile devices (for example, tablets or mobile phones).

Procedure

1. [Access the SIS Management Overview page.](#)

Tip: You can also [access the SIS Management Overview page](#) for a selected hierarchy level.

2. Select **Import from Exida**.

The **Import from Exida Project** window appears.

Import From Exida Project

Select exSILentia File Select Instrumented Functio... Import Options

Select the exsientia file that you want to import.

No file chosen

Choose .exi or .exp file.

3. Provide the path to the exSILentia file that you want to import, and then select **Next**.

A list of Instrumented Functions appears.

Import From Exida Project

Select exSILentia File **Select Instrumented Functio...** Import Options

Select Instrumented Function records that you want to import.

SIFtag/ Function ID	
<input type="checkbox"/>	T3.1.1
<input type="checkbox"/>	T4.1.1, T5.1.1
<input type="checkbox"/>	T4.1.3, T5.1.2

4. Select the Instrumented Functions whose data you want to import, and then select **Next**.

A list of SIL Analyses in the APM system appears.

Import From Exida Project

Select exSILentia File / Select Instrumented Functio... / Import Options

<input type="radio"/>	XOM SIS	XOM Site			
<input type="radio"/>	toLinkRiskMatIntToInstFun	Roanoke, VA			
<input type="radio"/>	Exida Imports - Safety Requirement Specifications	MBJ Site	Bulla, Michael	Exida Imports	- #4 SULFUR CONDENSER - HXST 129
<input type="radio"/>	ASF SIL Analysis	MBJ Site	Bulla, Secured Super User	Unit ID	- AQA EQUIPMENT - MBJ- EQUIPMENT- 00002
<input type="radio"/>	SIL Validation Method	Roanoke, VA			
<input type="radio"/>	sill	Roanoke, VA			

Cancel Previous Finish

- If you want to include the selected Instrumented Functions in an existing analysis, select the analysis from the list, and then select **Finish**.

The selected Instrumented Functions are appended to the selected SIL Analysis.

-or-

If you want to create a new SIL analysis to include the selected Instrumented Functions:

- Select **Create New Analysis**.

A blank datasheet for an SIL Analysis appears.

Import From Exida Project

Select exSILentia File / Select Instrumented Functio... / Import Options

How do you want to import selected instrumented functions.

Create New Analysis Append to Existing Analysis

Site: Roanoke, VA

Analysis ID:
Text Input
This field is required

Analysis Description:
Text Input

SRS Project ID:
--

Long Description:
Text area

Unit ID:
Text Input

Functional Location ID:

Cancel Previous Finish

- As needed, enter values in the [available fields](#), and then select .

The SIL Analysis is created, and the selected Instrumented Functions are linked to it.

Export Data To Exida

About This Task

This topic describes how to export data to Exida. The data is related to one or more Protective Instrument Loops that are part of an SIL analysis.

Note:

Importing and exporting project files to and from exSILentia is not supported on mobile devices (e.g., tablets or mobile phones).

Procedure

1. Access the [SIS Management Overview](#) page.

Tip: You can also [access the SIS Management Overview page](#) for a selected hierarchy level.

2. In the upper-right corner of the page, select **Export to Exida**.

The **Export to Exida Project** window appears, displaying a list of SIL Analyses.

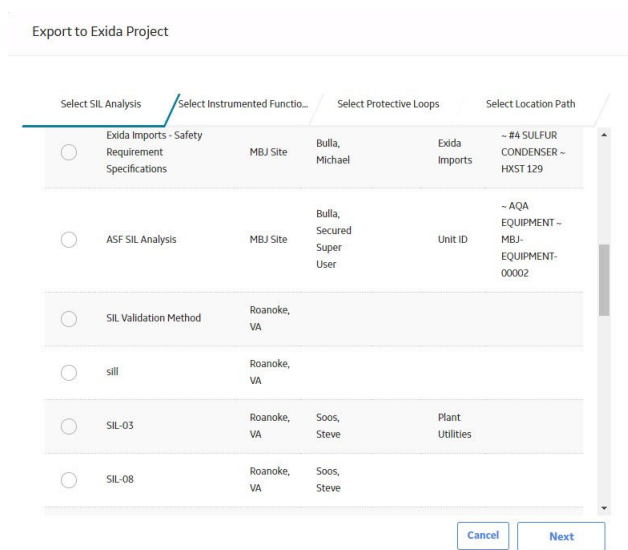

3. Select the SIL Analysis that is linked to the Instrumented Functions that you want to export, and then select **Next**.

A list of Instrumented Functions linked to the selected SIL Analysis appears.

Export to Exida Project

Select SIL Analysis / **Select Instrumented Function...** / Select Protective Loops / Select Location Path

Select Instrumented Function records that you want to export.

Function ID	Description	SIL Mode
<input type="checkbox"/> 1 group, voting 1oo1 - T3.1.1	SIF used to test General Part / Group Options	DemandLow
<input type="checkbox"/> 1 IM; diverse - SP & FEP - T4.1.3, T5.1.2	SIF used to test Sensor Part Options & Final Element Part Options	DemandLow
<input type="checkbox"/> 1 IM; identical - SP & FEP - T4.1.1, T5.1.1	SIF used to test Sensor Part Options & Final Element Part Options	DemandLow
<input type="checkbox"/> 2 groups, voting 1oo2 / Zoo2 - T3.1.2, T3.1.3	SIF used to test General Part / Group Options	DemandLow
<input type="checkbox"/> 2 IM; diverse voting - T4.1.4	SIF used to test Sensor Part Options	DemandLow
<input type="checkbox"/> 2 IM; identical voting - T4.1.2	SIF used to test Sensor Part Options	DemandLow
<input type="checkbox"/> 2 groups, voting 1oo2 / Zoo2 - T3.1.2, T3.1.3	SIF used to test General Part / Group Options	DemandLow

- Select the Instrumented Functions that you want to export, and then select **Next**.
A list of Protective Instrument Loops linked to the selected Instrumented Functions appears.

Export to Exida Project

Select SIL Analysis / Select Instrumented Function... / **Select Protective Loops** / Select Location Path

How do you want to export selected instrumented functions.

Function ID	Protective Loop ID	Description	State
<input type="checkbox"/> 1 IM; diverse - SP & FEP - T4.1.3, T5.1.2	T4.1.3, T5.1.2		Design

- Select the Protective Instrument Loops that you want to export, and then select **Next**.
The **Select Location Path** tab appears, displaying the **File Name** box.

Export to Exida Project

Select SIL Analysis Select Instrumented Functio... Select Protective Loops **Select Location Path**

File Name.

6. Provide the file name, and then select **Finish**.

The **Save As** window appears

7. Navigate to the location where you want to save the report, and then select **Save**.
The data related to the selected loops is exported into a .exi file.

Note: The actions required in steps 6 and 7 may differ slightly depending on the browser that you use and the browser settings.

Chapter 16

Admin

Topics:

- [Specify Search Queries](#)
- [Specify the Required SRS Categories for an SRS Project](#)

Specify Search Queries

About This Task

On the **SIS Management Overview** page, when you select the tabs in the workspace, the following queries are executed:

- **SIL_Analysis_Search:** Returns a list of SIL Analyses. This query is executed when you select **SIL Analysis** on the **SIS Management Overview** page.
- **All SIL Analyses Tasks:** Returns a list of Proof Test Tasks that are linked to Instrumented Functions or Logic Solvers or created in Asset Strategy Management. This query is executed when you select **Proof Test Tasks** on the **SIS Management Overview** page.
- **Safety_Loop_Template_Search:** Returns a list of Protective Instrument Loop Templates. This query is executed when you select **PIL Templates** on the **SIS Management Overview** page.
- **Final_Element_Reference_Data_Search:** Returns a list of Final Element Custom Devices. This query is executed when you select **Final Elements** from the drop-down list box in the upper-right corner of the **Custom Failure Data** section.
- **Logic_Solver_Reference_Data_Search:** Returns a list of Logic Solver Custom Devices. This query is executed when you select **Logic Solvers** from the drop-down list box in the upper-right corner of the **Custom Failure Data** section.
- **Sensor_Reference_Data_Search:** Returns a list of Sensor Custom Devices. This query is executed when you select **Sensors** from the drop-down list box in the upper-right corner of the **Custom Failure Data** section.
- **SIS_Trip_Report_Search:** Returns a list of SIS Trip Reports. This query is executed when you select **SIS Trip Reports** on the **SIS Management Overview** page.
- **SRS_Project_ALL:** Returns a list of SRS Projects. This query is executed when you select **SRS** on the **SIS Management Overview** page.

This topic describes how to specify search queries for SIS Management, replacing the default ones. You can specify different search queries if you want to modify the columns or rearrange the columns that appear when you select the tabs in SIS Management.

Note: You can access application settings for SIS Management only if you are a Super User or belong to the MI SIS Administrator Security Group.

Procedure

1. In the module navigation menu, select **Admin > Application Settings > SIS Management**.
The **SIS Admin Preferences** page appears, displaying the **Query Paths** workspace. The default search queries in SIS Management are listed in the workspace.

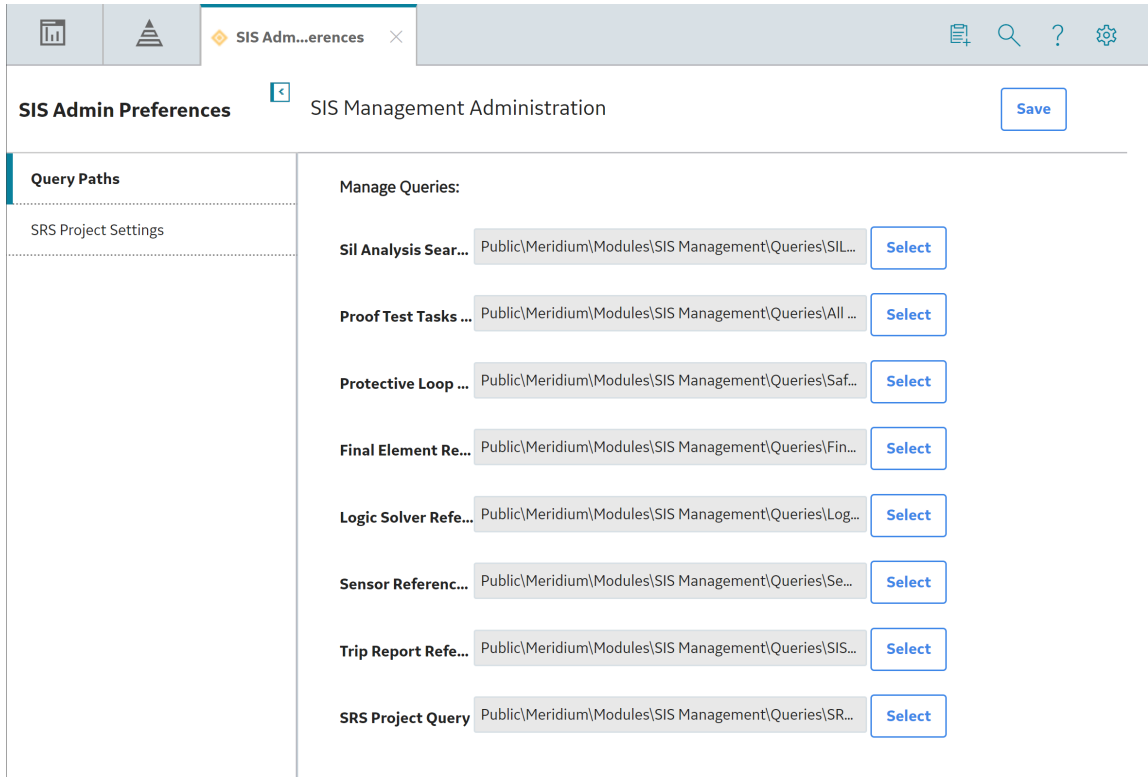

2. Select the **Select** button next to the query that you want to replace.

The baseline catalog folder appears.

3. Navigate to the folder that contains the query that you want to specify.
4. Select the query that you want to specify, and then select **Open**.
5. Repeat steps 3 - 5 for all the other queries that you want to replace.
6. In the upper-right corner of the page, select **Save**.

The default queries are replaced by the ones that you have selected.

Results

- On the **SIS Management Overview** page, when you select the tabs in the workspace, the queries that you have specified are executed.

Specify the Required SRS Categories for an SRS Project

About This Task

This topic describes how to specify the required categories that appear when an SRS Project is created. You can access application settings for SIS Management only if you are a Super User or belong to the MI SIS Administrator Security Group.

Procedure

1. In the module navigation menu, select **Admin > Application Settings > SIS Management**. The **SIS Admin Preferences** page appears, displaying the **Query Paths** workspace.

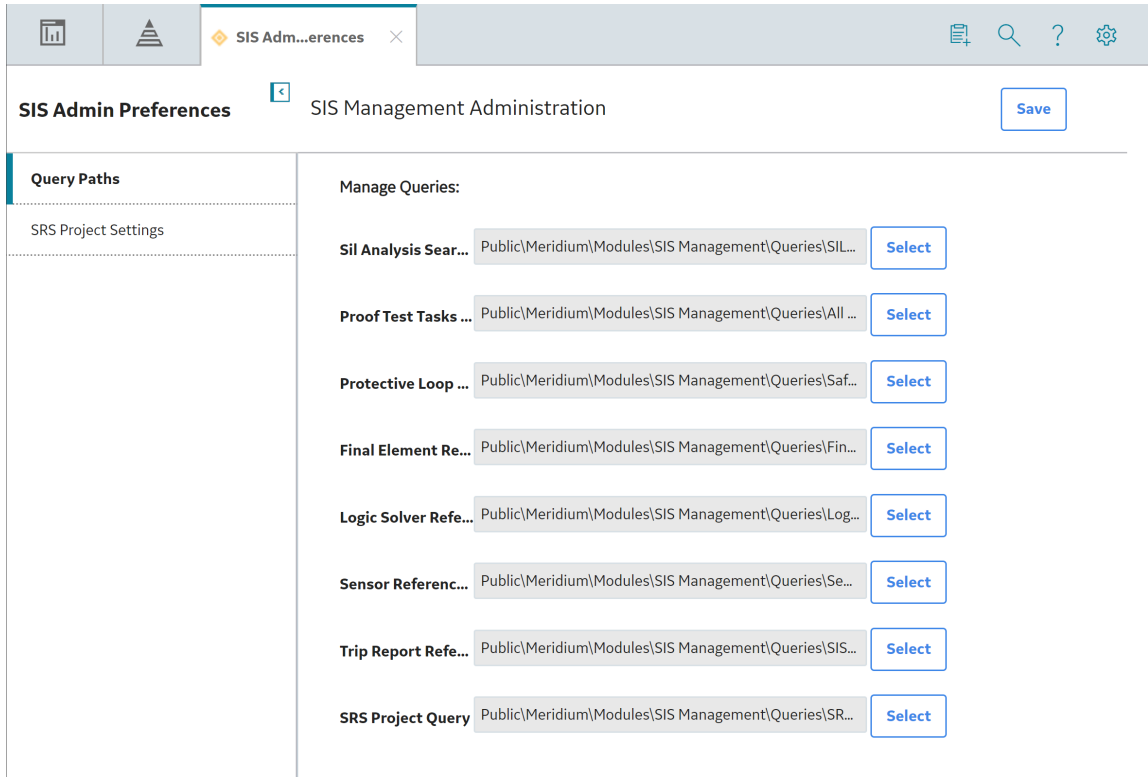

2. In the left pane, select **SRS Project Settings**.
The **SRS Project Settings** workspace appears.

The screenshot shows the 'SIS Admin Preferences' window with the 'SRS Project Settings' section active. The 'Required Categories for SRS Project' list is as follows:

Category	Checked
IF SRS	<input type="checkbox"/>
SIL SRS	<input type="checkbox"/>
Electrical	<input checked="" type="checkbox"/>
Environment	<input checked="" type="checkbox"/>
General Data	<input checked="" type="checkbox"/>
Hardware	<input checked="" type="checkbox"/>
Interfaces	<input checked="" type="checkbox"/>
Operations	<input checked="" type="checkbox"/>
Performance Data	<input checked="" type="checkbox"/>

3. Next to the categories that you want to specify as required, select the check box, and then select **Save**.

The selected categories are saved as the default categories for an SRS Project. When you create SRS Projects, the SRS Projects will contain all the default categories.

Chapter 17

Deployment

Topics:

- [Deployment and Upgrade](#)

Deployment and Upgrade

Deployment and Upgrade content for various APM modules has been consolidated into a single document. For more information, refer to the module-specific information in the APM Module Deployment and Upgrade document.

Chapter 18

Reference

Topics:

- [General Reference](#)
- [Family Field Descriptions](#)
- [Catalog Items](#)
- [Calculations](#)

General Reference

SIS Management Data Model

The following diagram shows how the families used in SIS Management are related to one another.

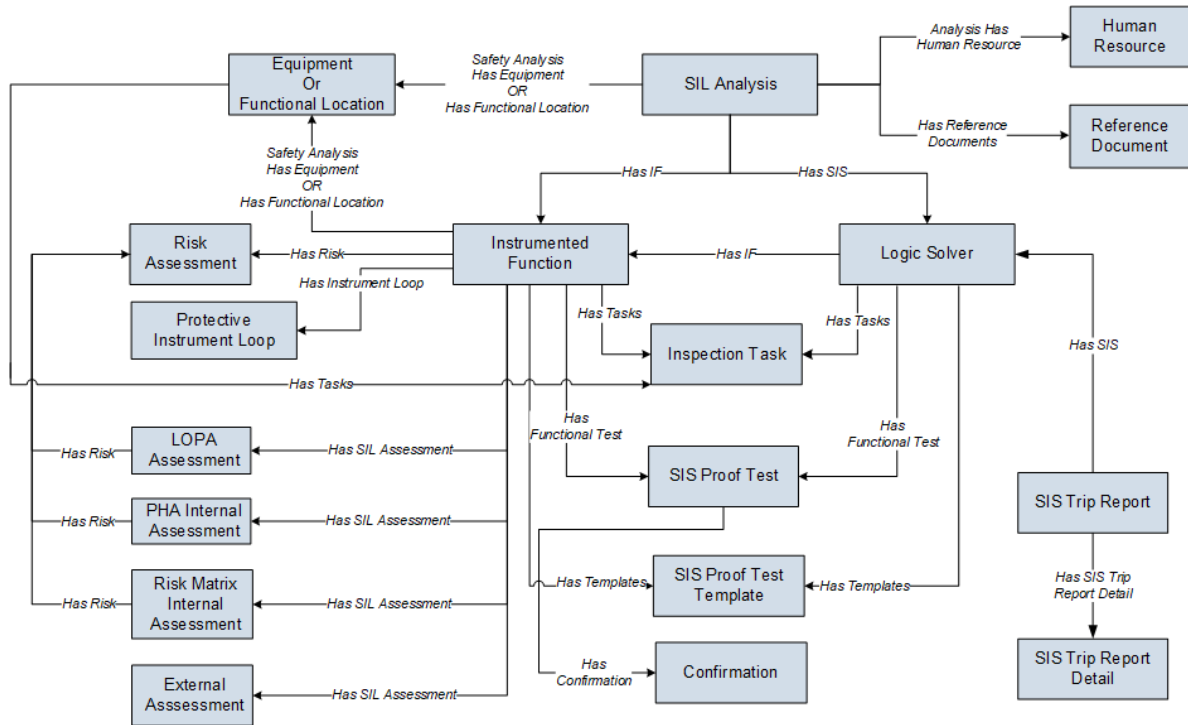

Note: In the diagram, boxes represent entity families and arrows represent relationship families that are configured in the baseline database. You can determine the direction of each relationship definition from the direction of the arrow head: the box from which the arrow originates is the predecessor. The box to which the arrow head points is the successor.

All SIL Analyses begin with an SIL Analysis record. Each SIL Analysis can be linked to:

- One Equipment or Functional Location record.
- One or more Human Resource records.
- One or more Reference Document records.
- One or more Instrumented Function records.
- One or more Logic Solver records.

Each Logic Solver is linked to:

- One or more Instrumented Function records.
- One or more SIS Proof Test records.
- One or more SIS Proof Test Template records.

Each Instrumented Function is linked to:

- One Equipment or Functional Location record.
- One or more Protective Instrument Loop records.
- One or more Inspection Task records.

- One Risk Assessment record.
- One LOPA Assessment record.
- One Process Hazards Analysis (PHA) Assessment record.
- One or more External Assessment records.
- One or more SIS Proof Test records.
- One or more SIS Proof Test Template records.

To simplify the data model images, the following families are not included:

- **Risk Assessment Recommendation:** Within the SIS Management data model, the Risk Assessment Recommendation family participates as the successor in the Has Recommendations relationship definition with the following families:
 - Instrumented Function
 - Protective Instrument Loop
 - SIS Proof Test
 - SIS Proof Test Template
- **Hazards Analysis:** The Hazards Analysis family participates as the successor in the Has HAZOP Reference relationship definition with the SIL Analysis and Instrumented Function families.

SIL Analysis Data Model

The following diagram shows how the families used in an SIL Analysis are related to one another.

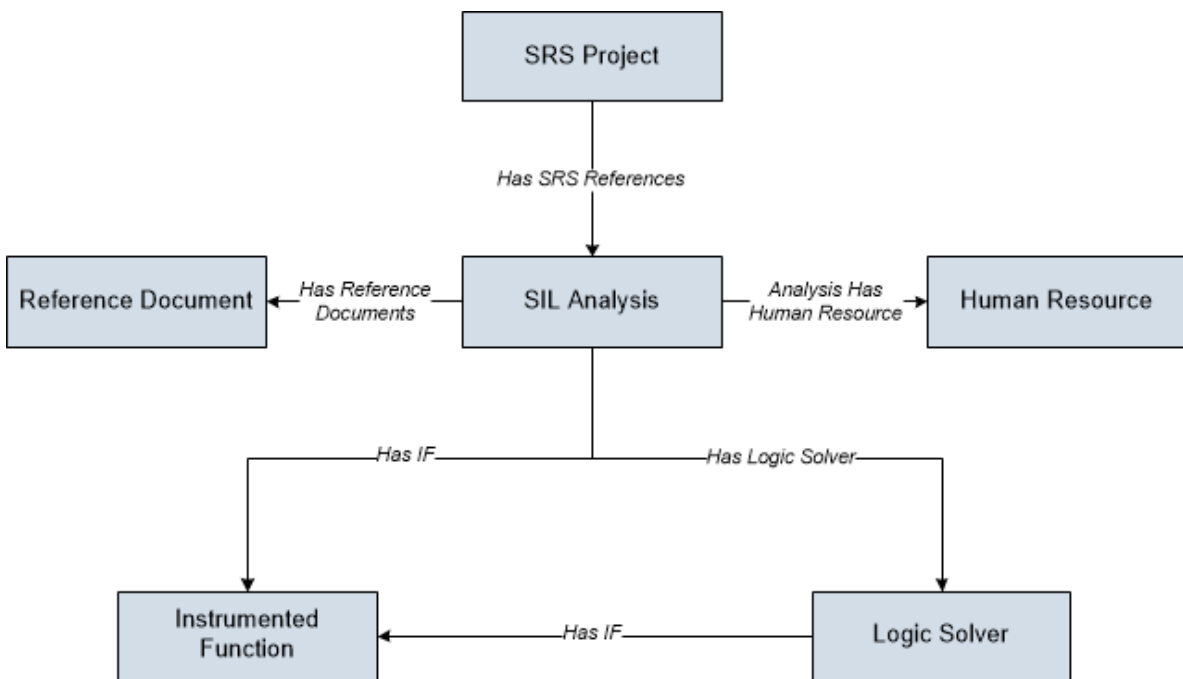

Note: In the diagram, boxes represent entity families and arrows represent relationship families that are configured in the baseline database. You can determine the direction of the each relationship definition from the direction of the arrow head: the box from which the arrow originates is the predecessor, and the box to which the arrow head points is the successor.

You can see that records in the following families are linked directly to an SIL Analysis:

- **Human Resource :** Stores information about the people who will participate in the analysis as SIL analysis team members.

- **Reference Document** : Stores the URL path to a document that is external to APM and contains reference information related to the SIL analysis.
- **Instrumented Function** : Stores information about the instrumented functions of the safety instrumented system that you are analyzing.
- **Logic Solver** : Stores information about the safety instrumented systems that you are analyzing.

Additionally, Logic Solver) records and Instrumented Function) records are linked to one another through the Has IF relationship. In addition to the relationships described above, an SIL analysis includes records in the families that are linked to the Logic Solvers and Instrumented Functions.

Instrumented Function Data Model

The following diagram shows how the families used to create an Instrumented Function are related to one another.

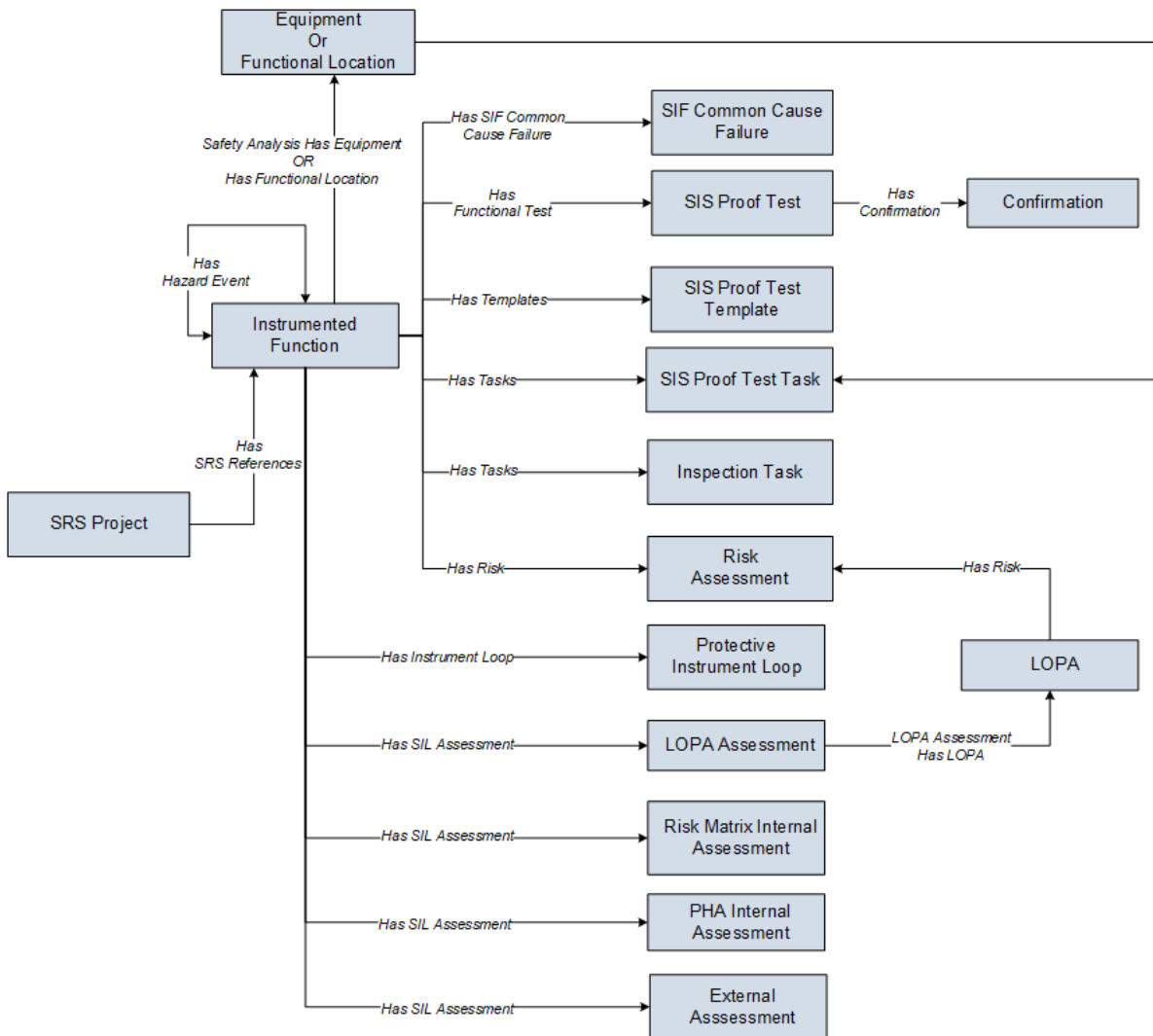

Note: In the diagram, boxes represent entity families and arrows represent relationship families that are configured in the baseline database. You can determine the direction of each relationship definition from the direction of the arrow head: the box from which the arrow originates is the predecessor, and the box to which the arrow head points is the successor.

Instrumented Function records are linked directly to records in the following families:

- **Inspection Task:** Stores details on when a proof test should be performed on the Equipment that is linked to the Inspection Task, including the due date for the task.
- **SIS Proof Test:** Stores details about a test that is performed on a logic solver or an instrumented function and serves as a record of the event.
- **SIS Proof Test Template:** Stores details about the steps that should be taken when testing an instrumented function. When you create an SIS Proof Test, you must select an SIS Proof Test Template, and the details from the SIS Proof Test Template will be populated in the SIS Proof Test.
- **SIS Proof Test Task:** Stores details of proof test tasks that are scheduled for logic solvers or instrumented functions. SIS Proof Test Tasks can be linked to SIS Proof Tests.
- **Risk Assessment:** Stores the unmitigated risk associated with the item represented by the record to which the Risk Assessment record is linked.
- **Protective Instrument Loop:** Stores the details of the protective instrument loop and its components, including the calculated results of the proof test associated with the Logic Solver that is linked to the Protective Instrument Loop.
- **LOPA Assessment:** Stores the details of the Layer of Protection Analysis (LOPA) that conducted, including a description of the initiating event that is indicative of a process failure. The LOPA stores details of the risk assessment that is determined after conducting the Layer of Protection Analysis. The LOPA Assessment is linked to a LOPA record and the LOPA records are linked to Risk Assessment record.
- **PHA Internal Assessment:** Stores the details of the Process Hazards Analysis (PHA) assessment that you want to conduct, including the target Safety Integrity Level (SIL), Required Probability of Failure, Risk Reduction Factor, and the SIL Mode. These values are calculated based on the overall risk rank of the selected Hazards Analysis Consequence.
- **Risk Matrix Internal Assessment:** Stores the details of the risk matrix assessment that you want to conduct, including the target Safety Integrity Level (SIL), Required Probability of Failure, Risk Reduction Factor, and the SIL Mode. These values are calculated based on the risk rank that you specify using the risk matrix.
- **External Assessment:** Stores the details of the external assessment that you want to conduct, including the target SIL, Required Probability of Failure, Risk Reduction Factor, and the SIL Mode.
- **SIF Common Cause Failure:** Stores the details of a failure that affects the operation of multiple instrumented functions.
- **Instrumented Function:** Indicates that if both the instrumented functions represented by the two records are in their safe states at the same time, a hazardous event may occur.

Logic Solver Data Model

The following diagram shows how the families used to create a Logic Solver are related to one another.

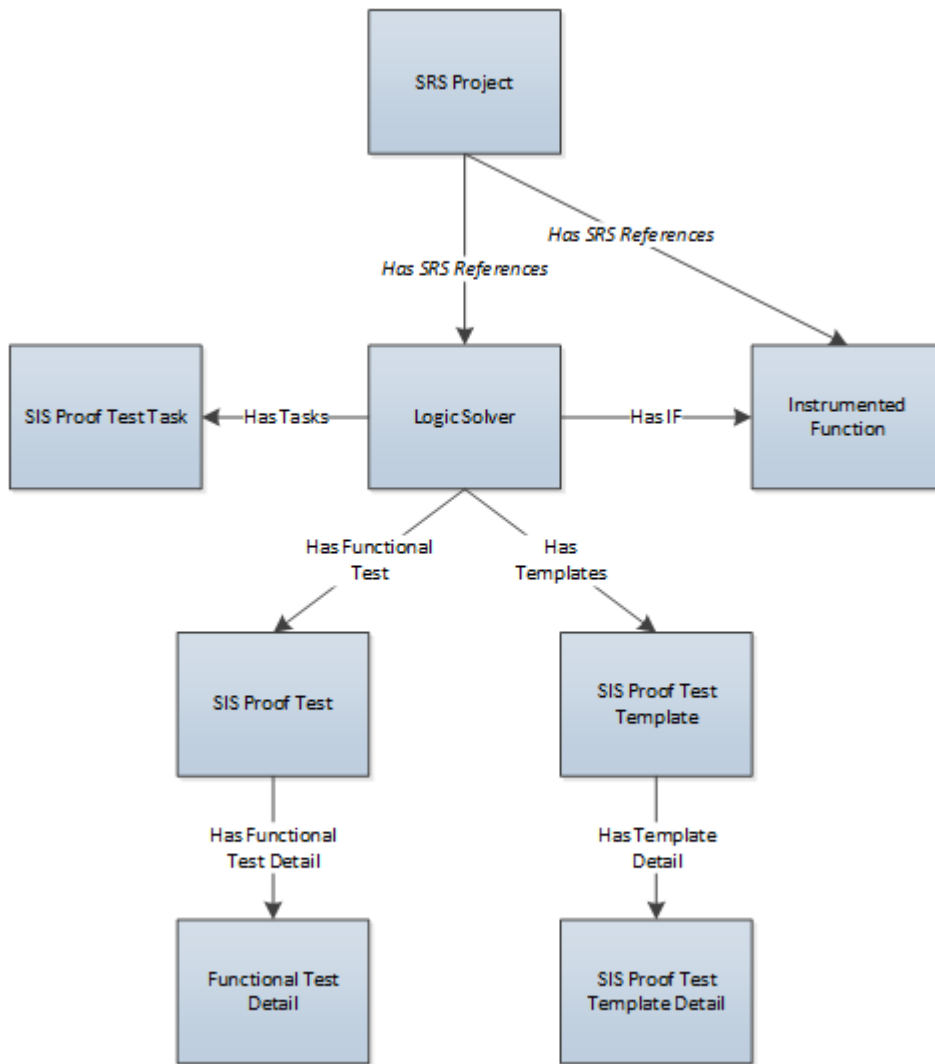

In the diagram, the relationships between the Instrumented Function family and the SIS Proof Test, SIS Proof Test Task, and SIS Proof Test Template families are not included.

Note: In the diagram, boxes represent entity families and arrows represent relationship families that are configured in the baseline database. You can determine the direction of the each relationship definition from the direction of the arrow head: the box from which the arrow originates is the predecessor, and the box to which the arrow head points is the successor.

As shown in the image, Logic Solvers are linked to Instrumented Functions, which store information about the specific functions associated with the Logic Solver. Logic Solvers are also linked to records in the following families:

- **SIS Proof Test :** Stores details of proof tests that are performed on logic solvers or instrumented functions. SIS Proof Tests can be linked to Functional Test Details, which store the detailed steps that need to be performed during proof tests.
- **SIS Proof Test Task :** Stores details of proof test tasks that are scheduled for logic solvers or instrumented functions. SIS Proof Test Tasks can be linked to SIS Proof Tests.
- **SIS Proof Test Template :** Stores details of the steps that should be taken when testing a logic solver or an instrumented function. When you create an SIS Proof Test, you can select an SIS Proof Test Template and the details from the SIS Proof Test Template will be populated in the SIS Proof Test.

SIS Proof Test Template) records can be linked to SIS Proof Test Template Detail) records, which store details on the steps that need to be performed during the proof test.

The SIS Proof Test, SIS Proof Test Template, and Reference Document families participate as successors in other relationships within the SIS Management data model. This means that these families appear in another portion of the data model.

Protective Instrument Loop Data Model

The following diagram shows how the families used in a Protective Instrument Loop are related to one another.

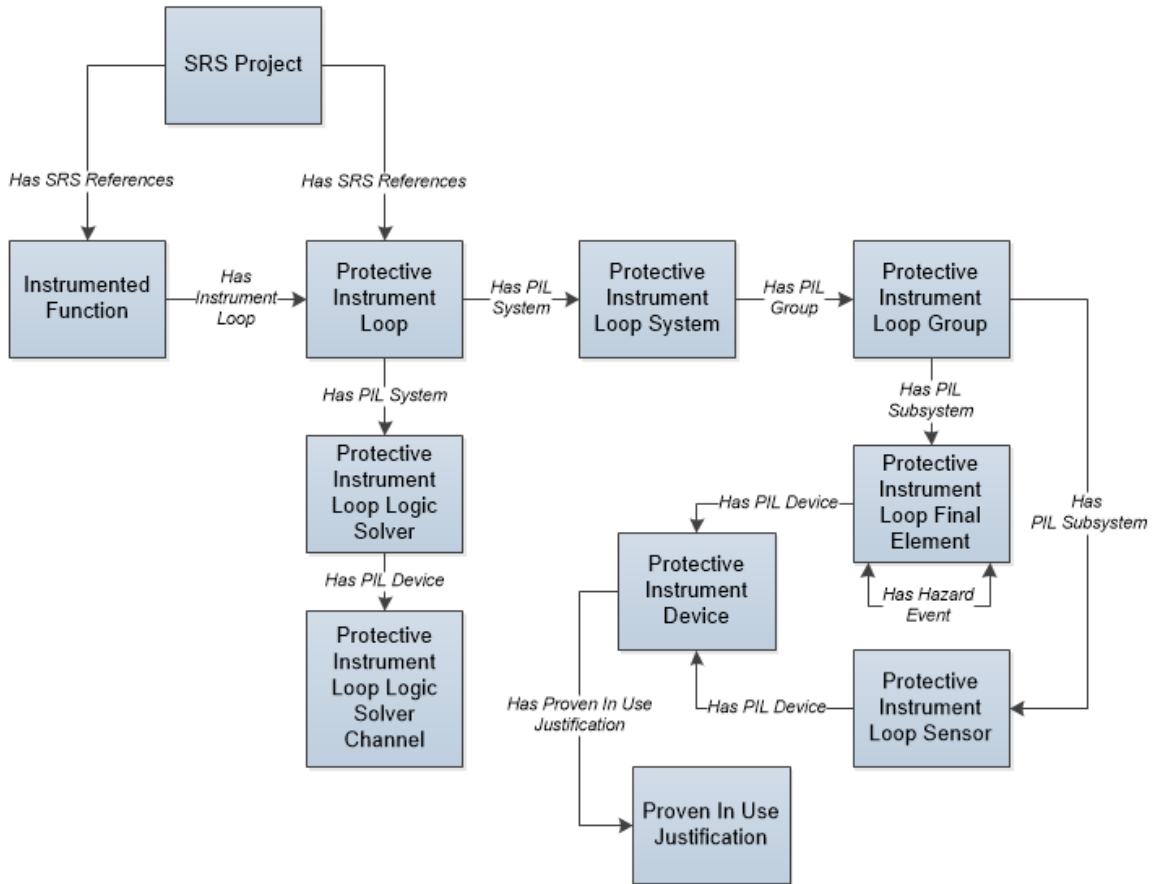

Note: In the diagram, boxes represent entity families and arrows represent relationship families that are configured in the baseline database. You can determine the direction of the each relationship definition from the direction of the arrow head: the box from which the arrow originates is the predecessor, and the box to which the arrow head points is the successor.

The following protective instrument loop elements are defined in the APM system:

- Logic Solver
- Sensor System
- Sensor Group
- Sensor
- Final Element System
- Final Element Group

- Final Element

By default, every protective instrument loop consists of at least one of each element. When you create a Protective Instrument Loop, the APM system creates one record for each of these elements, and links to the Protective Instrument Loop as shown in the data model.

SRS Project Data Model

The following diagram shows how the families used in an SRS Project are related to one another.

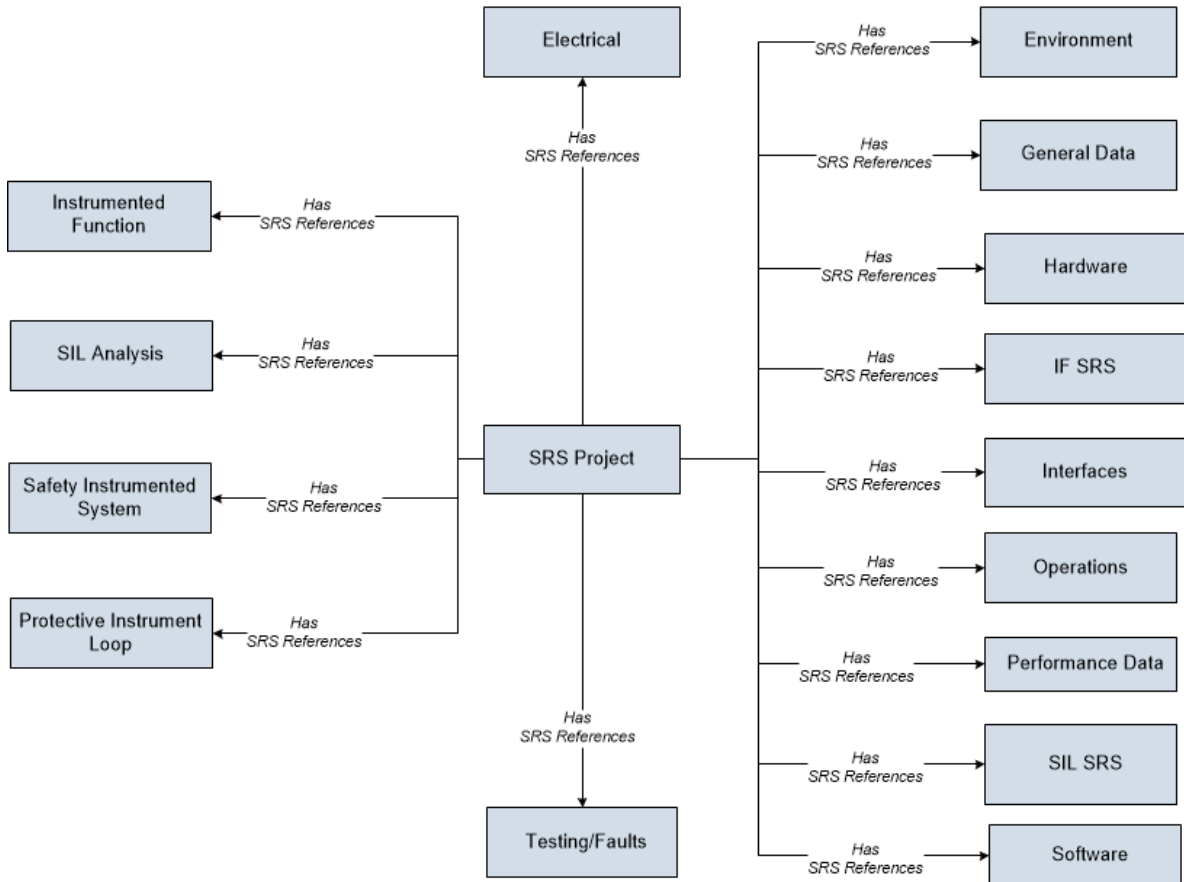

Note: In the diagram, boxes represent entity families and arrows represent relationship families that are configured in the baseline database. You can determine the direction of the each relationship definition from the direction of the arrow head: the box from which the arrow originates is the predecessor, and the box to which the arrow head points is the successor.

SRS Project records are linked directly to records in the following families:

- Environment
- General Data
- Electrical
- Hardware
- IF SRS
- Interfaces
- Operations
- Performance Data
- SIL SRS

- Software
- Testing/Faults
- SIL Analysis
- Instrumented Function
- Logic Solver
- Protective Instrument Loop

SIS Management Security Groups

The following table lists the baseline Security Groups available for users within this module, as well as the baseline Roles to which those Security Groups are assigned.

Important: Assigning a Security User to a Role grants that user the privileges associated with all of the Security Groups that are assigned to that Role. To avoid granting a Security User unintended privileges, before assigning a Security User to a Role, be sure to review all of the privileges associated with the Security Groups assigned to that Role. Also, be aware that additional Roles, as well as Security Groups assigned to existing Roles, can be added via Security Manager.

Security Group	Roles
MI SIS Administrator	MI Safety Admin MI SIS Administrator
MI SIS Engineer	MI Safety Admin MI Safety Power MI Safety User MI SIS Engineer
MI SIS User	MI Safety Admin MI Safety Power MI Safety User MI SIS User
MI SIS Viewer	MI APM Viewer MI Safety Admin MI Safety Power MI Safety User MI SIS Engineer MI SIS Viewer

The baseline family-level privileges that exist for these Security Groups are summarized in the following table.

Note: The baseline family-level privileges available in the LOPA module are also applicable to Security Groups in SIS Management module.

Family	MI SIS Administrator	MI SIS Engineer	MI SIS User	MI SIS Viewer
Entity Families				
Asset Criticality Analysis	View	None	None	View
Asset Criticality Analysis System	View	None	None	View
Consequence	View, Update, Insert, Delete	View	View	View
Equipment	View	View	View	View
External Assessment	View, Update, Insert, Delete	View, Update, Insert, Delete	None	View
Functional Location	View	View	View	View
Functional Systems	View, Update, Insert, Delete	View, Update, Insert, Delete	View	View
Functional Test Detail	View, Update, Insert, Delete	View, Update, Insert, Delete	View, Update, Insert, Delete	View
Human Resource	View, Update, Insert, Delete	View, Update, Insert, Delete	View	View
Instrumented Function	View, Update, Insert, Delete	View, Update, Insert, Delete	View	View
LOPA Assessment	View, Update, Insert, Delete	View, Update, Insert, Delete	View	View
Proven In Use Justification	View, Update, Insert, Delete	View, Update, Insert, Delete	View	View
Safety Integrity Level	View, Update, Insert, Delete	View	View	View
Relationship Families				
Analysis Has Human Resource	View, Update, Insert, Delete	View, Update, Insert, Delete	View	View
Asset Criticality Analysis Has System	View	None	View	View
Equipment Has Equipment	View	View	View	View
Functional Location Has Equipment	View	View	View	View
Functional Location Has Functional Location	View	View	View	View
Has Equipment	View, Update, Insert, Delete	View, Update, Insert, Delete	View	View

Family	MI SIS Administrator	MI SIS Engineer	MI SIS User	MI SIS Viewer
Has Functional Location	View, Update, Insert, Delete	View, Update, Insert, Delete	View	View
Has Functional Location Detail	View, Update, Insert, Delete	View, Update, Insert, Delete	View	View
Has Functional Test	View, Update, Insert, Delete	View, Update, Insert, Delete	View, Update, Insert, Delete	View
Has_Functional_Test_Detail	View, Update, Insert, Delete	View, Update, Insert, Delete	View, Update, Insert, Delete	View
Has Hazard Event	View, Update, Insert, Delete	View, Update, Insert, Delete	View	View
Has HAZOP Reference	View, Update, Insert, Delete	View, Update, Insert, Delete	View, Update, Insert, Delete	View
Has IF	View, Update, Insert, Delete	View, Update, Insert, Delete	View	View
Has Instrumented Function Revision	View, Update, Insert, Delete	View, Update, Insert, Delete	View	View
Has Instrument Loop	View, Update, Insert, Delete	View, Update, Insert, Delete	View	View
Has Instrument Loop Revision	View, Update, Insert, Delete	View, Update, Insert, Delete	View	View
Has LOPA	View, Update, Insert, Delete	View, Update, Insert, Delete	View	View
Has LOPA Revision	View, Update, Insert, Delete	View, Update, Insert, Delete	View	View
Has PIL Device	View, Update, Insert, Delete	View, Update, Insert, Delete	View	View
Has PIL Device Revision	View, Update, Insert, Delete	View, Update, Insert, Delete	View	View
Has PIL Group	View, Update, Insert, Delete	View, Update, Insert, Delete	View	View
Has PIL Group Revision	View, Update, Insert, Delete	View, Update, Insert, Delete	View	View
Has PIL Subsystem	View, Update, Insert, Delete	View, Update, Insert, Delete	View	View
Has PIL Subsystem Revision	View, Update, Insert, Delete	View, Update, Insert, Delete	View	View
Has Proven In Use Justification	View, Update, Insert, Delete	View, Update, Insert, Delete	View	View
Has RBI Components	View, Update, Insert, Delete	View, Update, Insert, Delete	View	View

Family	MI SIS Administrator	MI SIS Engineer	MI SIS User	MI SIS Viewer
Has Recommendations	View, Update, Insert, Delete	View, Update, Insert, Delete	View	View
Has Reference Documents	View, Update, Insert, Delete	View, Update, Insert, Delete	View, Insert	View
Has Reference Values	View, Update, Insert, Delete	View, Update, Insert, Delete	View	View
Has Risk	View, Update, Insert, Delete	View, Update, Insert, Delete	View	View
Has Risk Category	View, Update, Insert, Delete	View, Update, Insert, Delete	View	View
Has Risk Matrix	View, Update, Insert, Delete	View, Update, Insert, Delete	View	View
Has SIF Common Cause Failures	View, Update, Insert, Delete	View, Update, Insert, Delete	View	View
Has SIL Assessment	View, Update, Insert, Delete	View, Update, Insert, Delete	None	View
Has SIS Analysis Revision	View, Update, Insert, Delete	View, Update, Insert, Delete	View	View
Has SIS Revision	View, Update, Insert, Delete	View, Update, Insert, Delete	View	View
Has SIS Trip Report Detail	View, Update, Insert, Delete	View, Update, Insert, Delete	View	View
Has Site Reference	View, Update, Insert, Delete	View, Update, Insert, Delete	View	View
Has Task History	View, Update, Insert, Delete	View, Update, Insert, Delete	View, Insert	View
Has Tasks	View, Update, Insert, Delete	View, Update, Insert, Delete	View	View
Has Task Revision	View	View	View	View
Has Template Detail	View, Update, Insert, Delete	View, Update, Insert, Delete	View	View
Has Templates	View, Update, Insert, Delete	View, Update, Insert, Delete	View	View
Has Time Based Inspection Interval	View	View	View	View
Migrates Risk	View, Update, Insert, Delete	View, Update, Insert, Delete	View	View
Was Promoted to ASM	View, Update, Insert, Delete	View, Update, Insert, Delete	View	View

Security Permissions for SRS Families

The security permissions for the SRS Project and SRS Template families are summarized in the following table.

Security Group	Type	Permissions
MI SIS Administrator	Group	View, Update, Insert, Delete
MI SIS Engineer	Group	View, Update, Insert, Delete
MI SIS User	Group	View

SIS Management URLs

There is one URL route associated with SIS Management: `asset-safety/sis`. The following table describes the various paths that build on the route, and the elements that you can specify for each.

Tip: For more information, refer to the URLs section of the documentation.

Element	Description	Accepted Value(s)	Notes
asset-safety/sis/overview: Displays the SIS Management Overview page.			
asset-safety/sis/sil/<EntityKey>: Displays the Analysis Summary workspace of the SIL Analysis with the specified Entity Key.			
<EntityKey>	Specifies the Entity Key of the analysis that you want to access.	Any numeric Entity Key that corresponds to an existing analysis.	Opens the specified SIL Analysis in a new tab. This value is required to access an existing analysis from a URL.
asset-safety/sis/sil/prooftesttask/<EntityKey1>/<EntityKey2>: Displays the Proof Test Task datasheet with the specified Entity Key and linked to the the specified Instrumented Function or the Logic Solver.			
<EntityKey1>	Specifies the Entity Key of the Instrumented Function or the Logic Solver that is linked to the Proof Test Task that you want to access.	Any numeric Entity Key that corresponds to an existing Instrumented Function or Logic Solver.	None
<EntityKey2>	Specifies the Entity Key of the Proof Test Task that you want to access.	0	Opens the blank datasheet of a Proof Test Task, allowing you to create a new one.
		Any numeric Entity Key that corresponds to an existing Proof Test Task.	Opens the specified Proof Test Task in a new tab. This value is required to access an existing Proof Test Task from a URL.
asset-safety/sis/sil/verification/<EntityKey>: Displays the Protective Instrument Loop Template with the specified Entity Key.			

Element	Description	Accepted Value(s)	Notes
<EntityKey>	Specifies the Entity Key of the Protective Instrument Loop Template that you want to access.	Any numeric Entity Key that corresponds to an existing Protective Instrument Loop Template.	Opens the specified Protective Instrument Loop Template in a new tab. This value is required to access an existing Protective Instrument Loop Template from a URL.
asset-safety/sis/FDM/<CustomDeviceType>/<EntityKey>: Displays the datasheet of a Custom Device of the specified type and Entity Key.			
<CustomDeviceType>	Specifies the type of the Custom Device whose Failure Data you want to access.	All sensor logic-solver final-element	None
<EntityKey>	Specifies the Entity Key of the Custom Device whose Failure Data you want to access.	Any numeric Entity Key that corresponds to an existing Custom Device.	Opens the specified Custom Device in a new tab. This value is required to access an existing Custom Device from a URL.

Example URL	Destination
asset-safety/sis/overview	The SIS Management Overview page
asset-safety/sis/sil/2355677	The Analysis Summary workspace of the SIL Analysis with the Entity Key 2355677
asset-safety/sis/sil/ prooftesttask/73443556/34545566	The Proof Test Task datasheet with the Entity Key 34545566, linked to an Instrumented Function or a Logic Solver with the Entity Key 73443556
asset-safety/sis/sil/ verification/35945456	The Protective Instrument Loop Template datasheet with the Entity Key 35945456
asset-safety/sis/FDM/sensor/ 75334565	The Sensor Custom Device datasheet with the Entity Key 75334565

SIS Management System Code Tables

The following table lists the System Code Tables that are used by SIS Management.

Table ID	Table Description	Function
MI_IPL_TYPE	LOPA IPL TYPE	Populates the Type field in an Independent Layer of Protection.
MI_SIL_ASSESSMENT_METHOD	SIL Assessment Method	Populates the SIL Assessment Method field in an Instrumented Function.
MI_SIL_FINALELEMVOTE	SIL FinalElement Vote	Populates the Voting field in a Protective Instrument Loop Final Element Group.
MI_SIL_SENSORVOTE	SIL Sensor Vote	Populates the Voting field in a Protective Instrument Loop Sensor Group.
UOME	Unit of Measure	Populates the Trip Point Units field in a SIS Proof Test Template Detail.

About SIL Analysis State Configuration

This topic describes attributes of the State Configuration that is defined for the SIL Analysis family in the baseline APM database.

The following baseline states are defined in the APM application:

- Planning
- Active
- Review
- Pending Approval
- Complete

The following baseline operations are defined in the APM application:

- Begin
- Propose
- Submit
- Accept
- Reject
- Modify/Reassess

These baseline states and operations are reserved, which means you cannot modify or remove them. You can, however, add your own states and operations to the state configuration.

The following flow diagram illustrates the State Configuration for the SIL Analysis family. In this image, a box represents a state, and an arrow represents an operation. The state to which an arrow points represents a successor state.

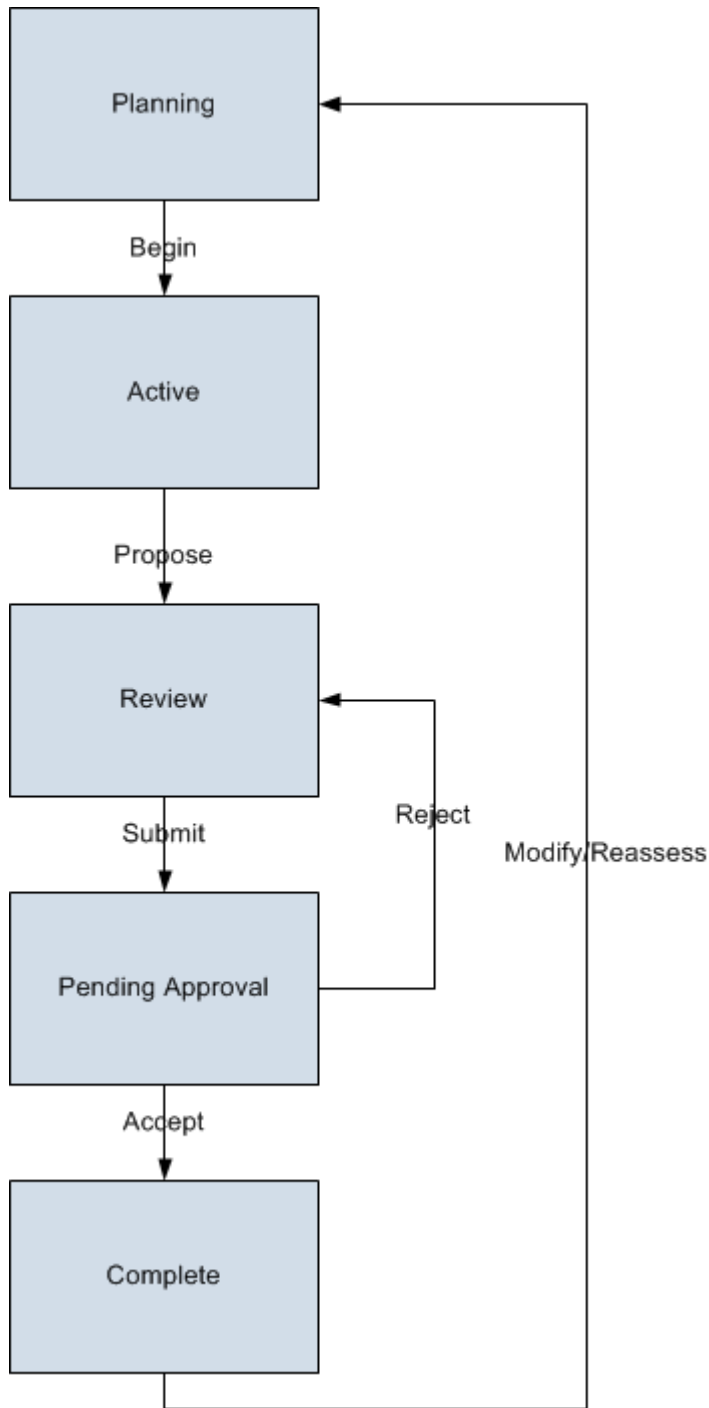

By default, the MI SIS Administrator and MI SIS Engineer State Configuration roles are assigned to all states in the SIL analysis state configuration. You can assign State Configuration roles to any state. In addition, for each state, the **Require a specific user to be assigned to a state** check box is selected.

About Protective Instrument Loop State Configuration

This topic describes attributes of the State Configuration that is defined for the Protective Instrument Loop family in the baseline APM database.

The following baseline states are defined in the APM application:

- Design
- Pending Approval
- Approval
- In Service
- Out of Service

The following baseline operations are defined in the APM application:

- Submit
- Accepted
- Rejected
- Commissioned
- Modify
- Reinstate

These baseline states and operations are reserved, which means you cannot modify or remove them. You can, however, add your own states and operations to the state configuration.

The following flow diagram illustrates the State Configuration for the SIL Analysis family. In this image, a box represents a state, and an arrow represents an operation. The state to which an arrow points represents a successor state.

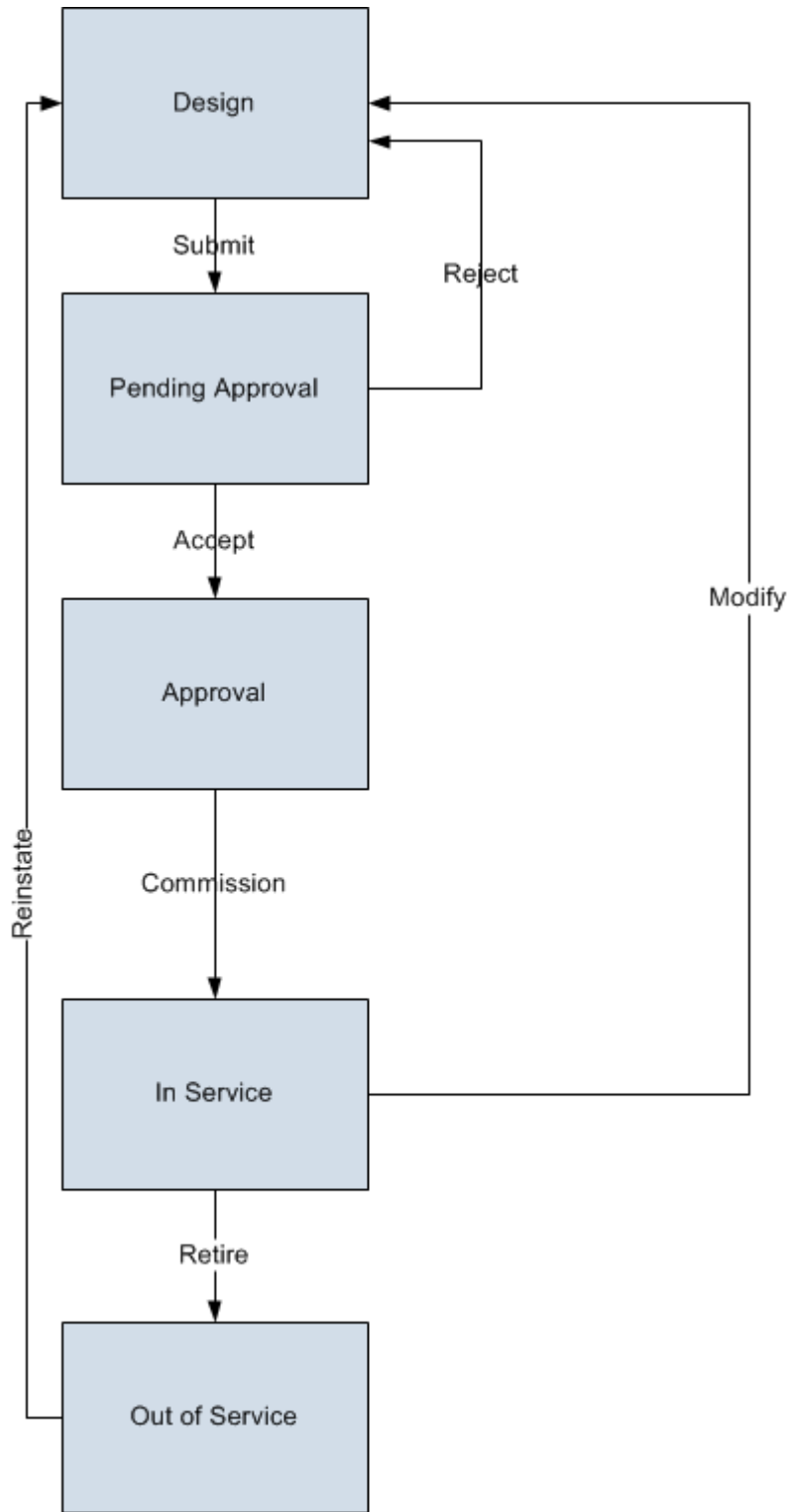

By default, the MI SIS Administrator and MI SIS Engineer State Configuration roles are assigned to all states in the SIL analysis State Sonfiguration. You can assign State Configuration roles to any state.

Note:

- If Baseline or Custom State Management is used, the Protective Instrument Family Datasheet is enabled only in the Initial state defined in the State Machine Configuration. Datasheet is disabled for editing in the subsequent states. Additionally, the related records exhibit the following behaviour:
 - **Link** and **Copy** buttons for Sensor Group details tab is disabled
 - Protected Instrument Loop Sensor Datasheet is disabled
 - **Link** and **Copy** buttons for Protective loop Sensor is disabled
 - **Link** and **Copy** buttons for Final Element group details tab is disabled
 - Protected Instrument Loop Final Element Datasheet is disabled
 - **Link** and **Copy** buttons for Protective Instrument Loop Final Element is disabled
 - Protective Instrument Device Datasheet is disabled
 - Proven In Use Justification Datasheet is disabled
- If State Management is disabled for Protective Instrumented Loop family, the restriction to modify the Protected Instrument Loop and related records based on the state is removed.

About the SIS Trip Report State Configuration

This topic describes attributes of the State Configuration that is defined for the SIS Trip Report family in the baseline APM database.

The following State Configuration is defined for the SIS Trip Report family. In this image, a box represents a state, and an arrow represents an operation. The state to which an arrow points represents a successor state.

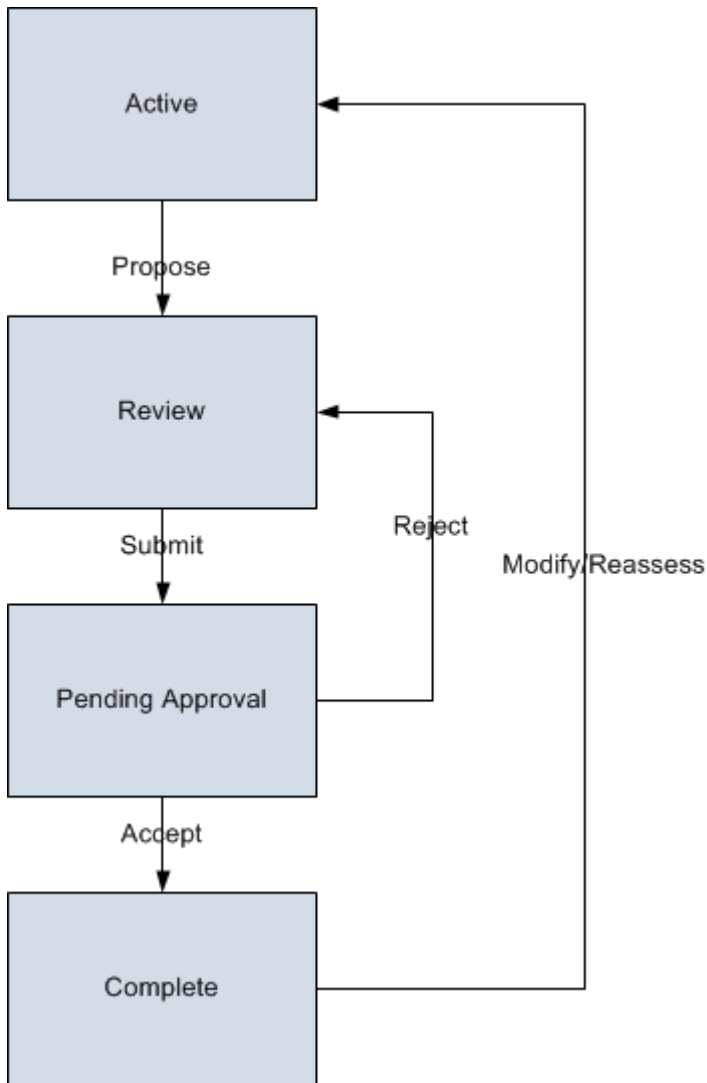

None of these states and operations are reserved, which means you can remove or modify any of them. You can also add your own states and operations to the state configuration.

State Configuration Roles

By default, the MI SIS Administrator and MI SIS Engineer State Configuration roles are assigned to all states in the SIS Trip Report state configuration. You can assign State Configuration roles to any state. In addition, for each state, the **Require a specific user to be assigned to a state** check box is selected.

About State Management of an SRS Project

The following states are configured for an SRS Project:

1. **In Progress:** Indicates that the SRS Project is in progress or yet to be sent for approval. You can modify an SRS Project only if it is in the In Progress state. After you have entered all the required information in the SRS Project, you can send it for approval by changing the state to Pending Approval.
2. **Pending Approval:** Indicates that the SRS Project has been sent for approval. If you approve the SRS Project, the state of the SRS Project changes to Approved. If you reject the SRS Project, the state of the SRS Project changes to In Progress.

3. **Approved:** Indicates that the SRS Project has been approved. After the state of an SRS Project is set to Approved:
 - The associated SRS Project is cycled. That is, the Last Date field is set to the date on which the state of the SRS Project is set to Approved. The Next Date field is set to the date on which the SRS Project must be performed again (in case of a recurring task).

Illustration of the State Management of SRS Projects

By default, the following states exist for an SRS Project:

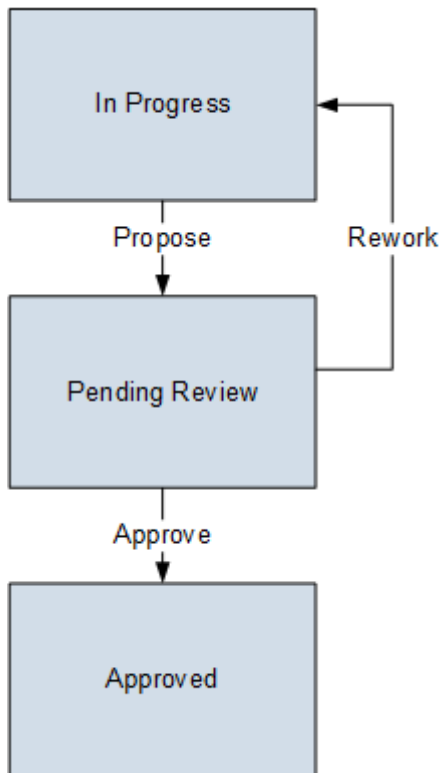

About State Management of SRS Templates

The following states are configured for SRS templates:

1. **In Progress:** Indicates that the SRS Template is in progress or yet to be sent for approval. You can modify an SRS Template only if it is in the In Progress state. After you have entered all the required information in the SRS Template, you can send it for approval by changing the state to Pending Approval.
2. **Pending Approval:** Indicates that the SRS Template has been sent for approval. If you approve the SRS Template, the state of the SRS Template changes to Approved. If you reject the SRS Template, the state of the SRS Template changes to In Progress.
3. **Approved:** Indicates that the SRS Template has been approved. After the state of an SRS Template is set to Approved:
 - The associated SRS Template is cycled. That is, the Last Date field is set to the date on which the state of the SRS Template is set to Approved. The Next Date field is set to the date on which the SRS Template must be performed again (in case of a recurring task).

Illustration of the State Management of SRS Templates

By default, the following states exists for SRS Templates:

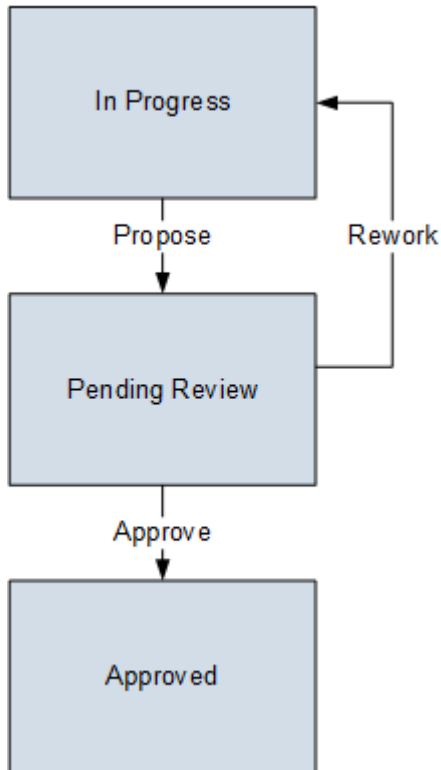

SIS Management Site Filtering

In SIS Management, an SIL Analysis is assigned a site on the Definition workspace and spread to all the related records, such as Instrumented Function records and Logic Solver records.

Tip: For more information, refer to the Site Filtering section of the documentation.

In SIS Management, users will see only SIL Analysis that are assigned to their site(s) or that are global records.

Consider an organization that has three sites, Site X, Site Y, and Site Z. The following SIL Analysis records exist:

- SIL Analysis A: Assigned to Site X
- SIL Analysis B: Assigned to Site Y
- SIL Analysis C: Assigned to Site Z
- SIL Analysis D: No site assigned (global records)

Scenario 1: User assigned to only Site X

This user will see SIL Analysis A and SIL Analysis D.

Scenario 2: User assigned to both Site X and Site Y

This user will see SIL Analysis A, B and D.

Scenario 3: Super User

This user will see SIL Analysis A, B, C and D.

Important: If a multi-site user, or a Super User, links child records from multiple sites to a parent record designated as **Global**, another user who does not have access to all sites may only see a portion of the data associated with that record. In the example above, if a child record assigned to Site X and a child record assigned to Site Y are linked to SIL Analysis D, the Site X user will not be able to see all the records associated with SIL Analysis D.

About Reports in SIS Management

The SIS Management module provides the following types of baseline reports.

SIL Analysis Report

The SIL Analysis report contains the information from the following fields stored in the [SIL Analysis records](#):

Report Column	Field Name in SIL Analysis Record
Analysis Description	Analysis Description
Analysis ID	Analysis ID
Analysis Long Description	Long Description
Analysis Owner Name	Owner
End Date	Analysis End Date
Last Modified By	Last Modified By
Last Modified Date	Last Modified Date
Process Hazards Analysis Reference	Hazards Analysis Reference
Process Hazards Analysis Rev Date	Hazards Analysis Date
Process Hazards Analysis Rev No	Hazards Analysis Revision
Site Description	Site Description
Site ID	Site ID
Start Date	Analysis Start Date
Unit Description	Unit Description
Unit ID	Unit ID

SRS Project Report

The SRS report contains all the details from an SIL Analysis that are required to meet compliance for IEC standard 61511. You can use this report to:

- Provide proof of compliance with IEC 61511.
- Identify gaps in compliance with IEC 61511.

The SRS report displays values that are stored in the [SIL Analysis records](#), and [related records](#) that comprise an SIL Analysis. Information in the SRS report is organized in the following sections:

- Introduction

- General Requirements for the Safety Instrumented System
- General Requirements for the Safety Instrumented Functions
- Summary of Safety Instrumented Functions
- SIF Safety Requirement Specification
- Process & Operational Requirements
- Loop Components
 - Sensor Part
 - Logic Solver Part
 - Final Element Part

Instrumented Function Report

The Instrumented Function report contains information from the following fields stored in the [Instrumented Function records](#):

Report Column	Field Name in Instrumented Function Record
Availability Target	Availability Target
Consequence Description	Consequence Description
Failure Rate UOM	Failure Rate UOM
Frequency of Initiating Event (per yr)	Frequency of Initiating Event (per yr)
Function Type	Function Type
Hazardous Event	Hazardous Event
Hazards Analysis Ref	Hazards Analysis Reference
Hazards Analysis Rev Date	Hazards Analysis Date
IF Description	PIF Description
IF ID	PIF ID
Initiating Event	Initiating Event
Initiating Event Description	Initiating Event Description
Last Modified By	Last Modified By
Last Modified Date	Last Modified Date
Maximum Probability of Failure	Required Probability of Failure
Process Speed	Process Speed
Response Time	Response Time
Risk Reduction Factor	Risk Reduction Factor
Safe State Description	Safe State Description
Selected SIL Level	Selected SIL Level
SIL Assessment Method	SIL Assessment Method
SIL Mode	SIL Mode

Report Column	Field Name in Instrumented Function Record
SIS System ID	SIS System ID
Site ID	Site ID
Spurious Trip Limit	Spurious Trip Limit (per yr)
Unit ID	Unit ID

Protective Instrument Loop Report

The Protective Instrument Loop report contains a summary of results for the selected Protective Instrument Loop (PIL). This report also includes a summary of calculated results for the Logic Solver, Sensor System, and Final Element System associated with the Protective Instrument Loop.

The PIL report displays the following information from the [Protective Instrument Loop records](#):

Report Column	Field Name in Protective Instrument Loop Record
Achieved SIL	Achieved SIL
Evaluated Systematic Capabilities	Calculated SIL Systematic Capabilities
Last Modified By	Last Modified By
MTTS (years)	MTTFS
Status Changed By	Status By
Systematic Capability Validation	Systematic Capability Validation
Description	Description
Evaluated Architectural Constraints	Calculated SIL Architectural Constraints
Last Modified Date	Last Modified Date
Long Description	Long Description
Loop Class	Loop Class
Loop ID	ID
Loop Type	Loop Type
Meets SIL Requirements	Meets SIL Requirement?
Mission Time	Mission Time
Probability of Failure	Loop PFH
Required SIL	Required SIL
Risk Reduction Factor	Risk Reduction Factor
SIL Demand Mode	Demand Mode
SIL Validation Method	SIL Validation Method
Startup Time	Startup Time
Status	Status

Report Column	Field Name in Protective Instrument Loop Record
Status Changed Date	Status Date
Test Architectural Constraints	Test Architecture Constraints

The Protective Instrument Loop report also includes a table, which contains the following information that is stored in the [Protective Instrument Loop Logic Solver records](#), and [Protective Instrument Loop System records](#) linked to the Protective Instrument Loop record:

Report Column	Field Name in Protective Instrument Loop Logic Solver Record	Field Name in Protective Instrument Loop System Record	
		for Sensor System	for Final Element System
Arch Cons	SIL Architectural Constraints	SIL Architectural Constraints	SIL Architectural Constraints
Avail	Availability	Availability	Availability
MTTFS	MTTFS	MTTFS	MTTFS
MTTFS Cont	MTTFS Contribution	MTTFS Contribution	MTTFS Contribution
PFD Avg	Calculated PFD Avg	Calculated PFD Avg	Calculated PFD Avg
PFD Cont	PFD Contribution	PFD Contribution	PFD Contribution
PFH	Calculated PFH	Calculated PFH	Calculated PFH
PTI	Proof Test Interval	N/A	N/A
Sys Cap	SIL Systematic Capability	SIL Systematic Capability	SIL Systematic Capability

Family Fields that are Updated While Importing Data from Exida

This topic maps the exSILentia fields with the corresponding Family Fields that gets updated when you import data from Exida.

The Protective Instrument Loop family

Property Name	Field ID	Field Caption	exSILentia Class/Field
Calculator	None	None	None
Diagram	MI_PRE_I_LP_DIAGRAM_B	Diagram	None
DemandMode	MI_PRE_I_LP_DEMAND_MODE_C	Demand_Mode	clsSILverData_DemandMode
LoopID	MI_FNCL_SYS_ID_C	ID	None
MissionTime	MI_PRE_I_LP_MISSION_TIME_N	Mission_Time	clsSILverData_calctime
StartupTime	MI_PRE_I_LP_STARTUP_TIME_N	Startup_Time	clsSILverData_startup
TestArchitectureConstraints	MI_PRE_I_LP_TST_ARCHTCTE_CNS_C	Test_Architecture_Constraints	None
SystematicCapabilityValidation	MI_PRE_I_LP_SYSTMTC_CPB_Y_VLN_L	Systematic_Capability_Validation	clsSILverData_ConsiderSILCapability

Property Name	Field ID	Field Caption	exSILentia Class/Field
SensorMCI	MI_PRE_I_LP_SENSOR_MCI_N	Sensor_MCI	clsSILverData_MCI_Sensors
FinalElementMCI	MI_PRE_I_LP_FINALELEMENT_MCI_N	Final_Element_MCI	clsSILverData_MCI_FinalElements
LogicSolverMCI	MI_PRE_I_LP_LOGICSOLVER_MCI_N	Logic_Solver_MCI	clsSILverData_MCI_LogicSolver
RequiredSIL	MI_PRE_I_LP_REQUIRED_SIL_N	Required_SIL	clsSILverData_TargetSILV

The Protective Instrument Loop Final Element family

Property Name	Field ID	Field Caption	exSILentia Class/Field
GUID	MI_PRE_ELTO_GUID_C	GUID	None
RAV	MI_PRE_FLTO_RAV_L	Remote_Actuated_Valve	clsFinalElemLegData_RAV_
TightShutOffRequired	MI_PRE_FLTO_TIGHT_SHTFF_RQRD_L	Tight_Shutoff_Required	clsFinalElemLegData_TShutoffReq_
UncleanService	MI_PRE_FLTO_UNCLEAN_SERVICE_L	Severe_Service	clsFinalElemLegData_UncleanService
UseCombination	MI_PRE_FLTO_USE_COMBINATION_L	Use_Combination	clsFinalElemLegData_UseActValCombo
UsePVST	MI_PRE_FLTO_USE_PVST_L	Partial_Valve_Stroke_Testing	clsFinalElemLegData_UsePVST_
UsePVSTCov	MI_PRE_FLTO_USE_PVSTCOV_L	Use_Custom_PVST_Coverage	clsFinalElemLegData_UsePVSTCov
ValveTripOpen	MI_PRE_FLTO_VALVE_TRIP_OPEN_L	Valve_Trip_Open	clsFinalElemLegData_ValveTripOpen
CustomPVSTCoverage	MI_PRE_FLTO_CUSTM_PVST_COVERAGE_N	Custom_PVST_Coverage	clsFinalElemLegData_AT_Coverage_
CustomPVSTInterval	MI_PRE_FLTO_PVST_INTERVAL_N	PVST_Interval	clsFinalElemLegData_AT_Interval
CustomPVSTIntervalUOM	MI_PRE_FLTO_PVST_INTERVAL_UOM_C	PVST_Interval_UOM	None

The Protective Instrument Loop System family

Property Name	Field ID	Field Caption	exSILentia Class/Field
SystemType	MI_PRE_SYMO_SYSTEM_TYPE_C	System_Type	None
GUID	MI_PRE_ELTO_GUID_C	GUID	None
Parent	None	None	None

Property Name	Field ID	Field Caption	exSILentia Class/Field
CommonCauseBetweenGroupsBeta	MI_PRE_SYMO_COMMON_CAUSE_N	Common_Cause_(Beta)	clsSILverData_GroupBetaSens
NumberOfGroups	MI_PRE_SYMO_NUMBEROF_GROUPS_N	Number_of_Groups	clsSILverData_numsensors
GroupVoting	MI_PRE_SYMO_VOTING_BTWN_GRP_C	Voting_Between_Groups	clsSILverData_sensorvote_

The Protective Instrument Loop Sensor family

Property Name	Field ID	Field Caption	exSILentia Class/Field
GUID	MI_PRE_ELTO_GUID_C	GUID	None
IsAnalog	MI_PRE_SNR0_ISANALOG_L	Analog_Input	None
AnalogTrip	MI_PRE_SNR0_ANALOG_TRIP_N	Analog_Trip	clsSensorLegData_AnalogTrip
ExternalComparison	MI_PRE_SNR0_EXTERNAL_COMP_RSN_L	External_Comparison	clsSensorLegData_ExternalComp_
ExternalComparisonValue	MI_PRE_SNR0_EXTER_COMP_VALUE_N	External_Comparison_Value	clsSensorLegData_ExternalCompCov
AlarmSetting	MI_PRE_SNR0_HIGH_ALARM_L	Alarm_Setting(High/Low)	clsSensorLegData_Jumper
RangeChecking	MI_PRE_SNR0_RANGE_CHECKING_L	Over/Under_Range	clsSensorLegData_RangeChecking
InputFilters	MI_PRE_SNR0_INPUT_FILTER_L	Alarm_Filter	clsSensorLegData_InputFiltering
SensorTripOnAlarm	MI_PRE_SNR0_SNSR_TRP_ON_ALARM_L	Alarm_Voted_as_Trip	clsSensorLegData_TripOnAlarm
SensorType	MI_PRE_SNR0_SENSOR_TYPE_C	Sensor_Type	clsSensorLegData_SensType
EnableTrip	MI_PRE_SNR0_ENABLETRIP_L	EnableTrip	None

The Protective Instrument Loop Group family

Property Name	Field ID	Field Caption	exSILentia Class/Field
GUID	MI_PRE_ELTO_GUID_C	GUID	None
Parent	None	None	None
GroupType	MI_PRE_GRP0_GROUP_TYPE_C	Group_Type	None
LegsNumber	MI_PRE_GRP0_SUBSYSTEM_NUMBER_N	Subsystem_Number	None
N	MI_PRE_GRP0_N_N	Custom_Vote_N	clsFinalElemGroupData_CustVoteN

Property Name	Field ID	Field Caption	exSILentia Class/Field
M	MI_PRE_GRP0_M_N	Custom_Vote_M	clsFinalElemGroupData_CustVoteM_
FinalElementVote	MI_PRE_GRP0_VOTING_C	Voting	clsFinalElemGroupData_Vote
CommonCauseBeta	MI_PRE_GRP0_COMMON_CAUSE_BTA_N	Common_Cause_(Beta)	clsFinalElemGroupData_Beta
MTTR	MI_PRE_GRP0_MTTR_N	MTTR	clsFinalElemGroupData_MTTR -
ProofTestCoverage	MI_PRE_GRP0_PROOF_TEST_COVERAGE_N	Proof_Test_Coverage	clsFinalElemGroupData_ProofTestCov
PrrofTestInterval	MI_PRE_GRP0_PROOF_TST_INTERVAL_N	Proof_Test_Interval	clsFinalElemGroupData_ProofTestInt
VoteType	MI_PRE_GRP0_DIVERSE_L	Diverse	clsFinalElemGroupData_IsVoteDiverse

The Protective Instrument Loop Logic Solver Channel family

Property Name	Field ID	Field Caption	exSILentia Class/Field
Parent	None	None	None
Entity	None	None	None
ChannelType	MI_PRE_CHL0_CHANNEL_TYPE_C	Channel_Type	clsLogicSolverPartData_ChannelType
ExidaID	MI_PRE_DVE0_EXIDA_ID_N	Exida_ID	clsLogicSolverPartData_EID
DangerousDetected	MI_PRE_DVE0_DANGEROUS_DETECTED_N	Dangerous_Detected	clsLogicSolverPartData_FailDD
DangeroudUndetected	MI_PRE_DVE0_DANGEROUS_UNDETECTED_N	Dangerous_Undetected	clsLogicSolverPartData_FailDU
FailureAnnunciationDetected	MI_PRE_DVE0_FLRE_ANNUNCIATION_DETCTED_N	Failure_Annunciation_Detected	clsLogicSolverPartData_FailAD
FailureAnnunciationUndetected	MI_PRE_DVE0_FLRE_ANNUNCIATION_UNDETECTED_N	Failure_Annunciation_undetected	clsLogicSolverPartData_FailAU
FailureDetected	MI_PRE_DVE0_FAILURE_DETECTED_N	Failure_Detected	clsLogicSolverPartData_FailDetected
FailureHigh	MI_PRE_DVE0_FAILURE_HIGH_N	Failure_high	clsLogicSolverPartData_FailHigh
FailureLow	MI_PRE_DVE0_FAILURE_LOW_N	Failure_Low	clsLogicSolverPartData_FailLow
Residual	MI_PRE_DVE0_RESIDUAL_N	Residual	clsLogicSolverPartData_FailNoEffect

Property Name	Field ID	Field Caption	exSILentia Class/Field
SafeDetected	MI_PRE_DVE0_SAFE_DETECTE D_N	Safe_Detected	clsLogicSolverPartData_FailSD
SafeFailureFraction	MI_PRE_DVE0_SSF_N	Safe_Failure_Fraction	clsLogicSolverPartData_SFF
SafeUndetected	MI_PRE_DVE0_SAFE_UNDETEC TED_N	Safe_Undetected	clsLogicSolverPartData_FailSU
Channels	None	None	clsLogicSolverPartData_Chann els
Name	MI_PRE_DVE0_NAME_C	Module_Name	clsLogicSolverPartData_Model
ReferenceDataSourceTitle	MI_PRE_ELTO_REFRNCE_DTA_ SRCE_C	Reference_Data_Source	None
ReferenceDataSource	MI_PRE_ELTO_RFRNCE_DTA_R FRNE_C	Reference_Data_Reference	None
ReferenceDataDate	MI_PRE_ELTO_REFERNCE_DTA_ _DTE_D	Reference_Data_Date	None
ReferenceRevision	MI_PRE_ELTO_REFRNCE_DTA_ RVS_N_C	Reference_Data_Revision	None

The Protective Instrument Loop Logic Solver family

Property Name	Field ID	Field Caption	exSILentia Class/Field
GroupType	MI_PRE_GRP0_GROUP_TYPE_C	Group_Type	None
GUID	MI_PRE_ELTO_GUID_C	GUID	None
Parent	None	None	None
MTTR	MI_PRE_GRP0_MTTR_N	MTTR	.clsSILverData_LogicSolver.MT TR
ProofTestCoverage	MI_PRE_GRP0_PROOF_TEST_C VRGE_N	Proof_Test_Coverage	clsSILverData_LogicSolver.Pro ofTestCoverage
ProofTestInterval	MI_PRE_GRP0_PROOF_TST_INT RVL_N	Proof_Test_Interval	clsSILverData_LogicSolver.Pro ofTestInterval
EnableAutoPTS	MI_PRE_SLR0_ATMTC_PRFTST_ SWR_L	Automatic_Prooftest_Switcho ver	clsSILverData_LogicSolver.AT_ Enabled
AutoPTSI	MI_PRE_SLR0_ATMTC_PRT_SWR _INL_N	Automatic_Prooftest_Switcho ver_Interval	clsSILverData_LogicSolver.AT_ Interval
AutoPTSICov	MI_PRE_SLR0_ATMTC_PRT_SWR _INL_N	Automatic_Prooftest_Switcho ver_Convergence	clsSILverData_LogicSolver.AT_ Coverage
ArchitecturalConstraints	MI_PRE_GRP0_SL_ARCHCTRL _CNS_N	SIL_Architectural_Constraints	clsSILverData_LogicSolver.HFT
EquipmentFailureModeTypeAs PerIEC61508	MI_PRE_SLR0_EQUIPMENT_TY PE_C	Architectural_Type	clsSILverData_LogicSolver.Arc hType

Property Name	Field ID	Field Caption	exSILentia Class/Field
CommonCauseBeta	MI_PRE_GRP0_COMMON_CAUSE_BTA_N	Common_Cause_(Beta)	clsSILverData_LogicSolver.Beta
SILCapability	MI_PRE_GRP0_SIL_CAPABILITY_N	SIL_Systematic_Capability	clsSILverData_LogicSolver.LimitingSIL
Voting	MI_PRE_GRP0_VOTING_C	Voting	clsSILverData_LogicSolver.MyVoting
IsCustomerized	MI_PRE_SLR0_ISCUSTOMERIZED_L	Manual_Entry	None
ExidaID	MI_PRE_SLR0_EXIDA_ID_N	Exida_ID	clsSILverData_LogicSolver.EquipmentID
ExidaName	MI_PRE_SLR0_EXIDA_NAME_C	Exida_Name	clsSILverData_LogicSolver.exidaName
ReferenceDateSourceTitle	MI_PRE_ELTO_REFRNCESOURCE_C	Reference_Data_Source	None
ReferenceDateSource	MI_PRE_ELTO_REFRNCESOURCE_C	Reference_Data_Reference	None
ReferenceDataDate	MI_PRE_ELTO_REFRNCESOURCEDATE_D	Reference_Data_Date	clsSILverData_LogicSolver.SERHVer
ReferenceRevision	MI_PRE_ELTO_REFRNCESOURCE_REVISION_C	Reference_Data_Revision	clsSILverData_LogicSolver.SERHVer
Automatic	MI_PRE_SLR0_AUTOMATIC_L	Automatic_Channel_Count	clsSILverData_LogicSolver.Automatic
LogicSolverChannels	None	None	None

The Protective Instrument Device family

Property Name	Field ID	Field Caption	exSILentia Class/Field
ExidaID	MI_PRE_DVE0_EXIDA_ID_N	Exida_ID	clsSILverDeviceData_EquipmentID
IsCustomerized	MI_PRE_DVE0_ISCUSTOMED_L	Manual_Entry	None
Tag	MI_PRE_DVE0_DEVICE_TAG_C	Device_Tag	None
IsApproved	MI_PRE_ELTO_APPROVEDTOUSE_L	Approved_Custom_Device	None
AnalogAI_AO	MI_PRE_DVE0_ANALOG_CHANNELS_N	Analog_Channels	clsSILverDeviceData_ChannelCount
DigitalDI_DOHigh	MI_PRE_DVE0_DIGITL_HGH_CHANNELS_N	Digital_High_Channels	clsSILverDeviceData_ChannelCount
DigitalDI_DOLow	MI_PRE_DVE0_DIGITL_LW_CHANNELS_N	Digital_Low_Channels	clsSILverDeviceData_ChannelCount

Property Name	Field ID	Field Caption	exSILentia Class/Field
Name	MI_PRE_DVE0_NAME_C	Exida_Name	clsSILverDeviceData_exidaName
ArchitecturalType	MI_PRE_DVE0_ARCHITECTRL_T YPE_C	Architectural_Type	clsSILverDeviceData_ArchType
CertifiedSIL	MI_PRE_DVE0_CERTIFIED_SIL_ N	Certified_SIL	clsSILverDeviceData_CertifiedF orSIL
DangerousDetected	MI_PRE_DVE0_DANGEROUS_D ETCTD_N	Dangerous_Detected	clsSILverDeviceData_FailDD
DangerousUndetected	MI_PRE_DVE0_DANGEROUS_UN DTCTD_N	Dangerous_Undetected	clsSILverDeviceData_FailDU
DeviceType	MI_PRE_DVE0_DEVICE_TYPE_C	Device_Type	clsSILverDeviceData_DeviceTy pe
FailureAnnunciationDetected	MI_PRE_DVE0_FLRE_ANNCT N_DTD_N	Failure_Annunciation_Detecte d	clsSILverDeviceData_FailAD
FailureAnnunciationUndetecte d	MI_PRE_DVE0_FLRE_ANNCT N_UND_N	Failure_Annunciation_undetec ted	clsSILverDeviceData_FailAU
FailureDetected	MI_PRE_DVE0_FAILURE_DETE CTED_N	Failure_Detected	clsSILverDeviceData_FailDete cted
FailureHigh	MI_PRE_DVE0_FAILURE_HIGH_ N	Failure_high	clsSILverDeviceData_FailHigh
FailureLow	MI_PRE_DVE0_FAILURE_LOW_ N	Failure_Low	clsSILverDeviceData_FailLow
Residual	MI_PRE_DVE0_RESIDUAL_N	Residual	clsSILverDeviceData_FailNoEff ect
SafeDetected	MI_PRE_DVE0_SAFE_DETECTE D_N	Safe_Detected	clsSILverDeviceData_FailSD
SafeUndetected	MI_PRE_DVE0_SAFE_UNDETEC TED_N	Safe_Undetected	clsSILverDeviceData_FailSU
SuggestedPTC	MI_PRE_DVE0_SUGGESTEDPT C_N	Suggested_PTC	clsSILverDeviceData_SuggestP TC
TripRestrict	MI_PRE_DVE0_TRIPRESTRICT_C	Trip_Restrict	clsSILverDeviceData_TripRestri ct
ReferenceDataSourceTitle	MI_PRE_ELTO_REFRNCE_DTA_ SRCE_C	Reference_Data_Source	None
ReferenceDataDate	MI_PRE_ELTO_REFERNCE_DTA _DTE_D	Reference_Data_Date	clsSILverDeviceData_SERHVer
ReferenceRevision	MI_PRE_ELTO_REFRNCE_DTA_ RVS_N_C	Reference_Data_Revision	clsSILverDeviceData_SERHVer

The Protective Instrument Loop Element family

Property Name	Field ID	Field Caption	exSILentia Class/Field
Parent	None	None	None
Constantine	None	None	None
DisplayInfo	MI_PRE_ELTO_VISUAL_ATTRIB UTS_T	Visual_Attributes	None

The Instrumented Function family

Property Name	Field ID	Field Caption	exSILentia Class/Field
SafetyLoops	None	None	None
UnitID	MI_PIF00000_UNIT_ID_C	Unit_ID	clsSILverData_UnitName
DescriptionVS)	MI_PIF00000_DESC_C	PIF_Description	clsSILverData_SIFDesc
HazardousEvent	MI_PIF00000_HAZAR_EVENT_ C	Hazardous_Event	clsSILverData_HazardDesc
ConsequenceDescription	MI_PIF00000_CONS_DESC_T	Consequence_Description	clsSILverData_ConseqDesc
SafeStateDescription	MI_PIF00000_SAFE_STATE_DE SCR_T	Safe_State_Description	clsSILverData_SafeState
ResponseTime	MI_PIF00000_RESPO_TIME_N	Response_Time	clsSILverData_RespTime
SpuriousTripLimit	MI_PIF00000_SPURI_TRIP_LIMI T_N	Spurious_Trip_Limit_(per_yr)	clsSILverData_ReqSTR_
SelectedSILLevel	MI_PIF00000_SELEC_SIL_LEVE L_N	Selected_SIL_Level	clsSILverData_TargetSIL
SILMode	MI_PIF00000_SIL_MODE_C	SIL_Mode	None
SILAssessmentMethod	MI_PIF00000_SIL_ASSES_MET HO_C	SIL_Assessment_Method	None
ProcessHazardsAnalysisRefere nce	MI_PIF00000_PROC_HAZ_AN_ REF_C	Hazards_Analysis_Reference	None
ProcessHazardsAnalysisDate	MI_PIF00000_PROC_HAZ_AN_ DATE_D	Hazards_Analysis_Date	None
SiteID	MI_PIF00000_SITE_ID_C	Site_ID	None
SILAnalysisKey	MI_PIF00000_SIL_ANALY_KEY_ N	SIL_Analysis_Key	None

About Upgrade of LOPA and Safeguards to V4.3.0.0.0

In versions prior to V4.3.0.0.0, you could create a LOPA to assess SIL value for an Instrumented Function from the SIL Analysis. In V4.3.0.0.0, you can create and manage LOPAs using the Layers of Protection Analysis module. To assess the SIL value for an Instrumented Function using LOPA, you can create a LOPA Assessment record for the Instrumented Function by linking the LOPA.

When you upgrade the module to V4.3.0.0.0, LOPA Assessment records are created automatically by copying values from the existing LOPAs. The LOPA Assessments are then linked to the corresponding

Instrumented Functions and LOPAs. The following table contains the fields in LOPA that are mapped to fields in LOPA Assessment:

Values in the Following Fields in the LOPA...	Copied to the following fields in the LOPA Assessment
LOPA ID	LOPA Assessment ID
LOPA ID	Linked LOPA ID
Entity Key	Linked LOPA Key
Frequency of Initiating Event	Frequency of Initiating Event
Mitigated Consequence Frequency	Mitigated Consequence Frequency
Required Mitigated Consequence Frequency	Required Mitigated Consequence Frequency
Required PIF PFD	Required Probability of Failure
Required PIF Risk Reduction Factor	Risk Reduction Factor (RRF)
Unmitigated Consequence Frequency	Unmitigated Consequence Frequency
Total IPL PFD	Total IPL PFD
Calculated SIL	Selected SIL Level

Also, in V4.3.0.0.0, the Hazards Analysis Safeguard records is used to store the details of Independent Layer of Protection. Hence, when you upgrade to V4.3.0.0.0, Hazards Analysis Safeguards records are created by copying values from the Independent Layer of Protection records associated with the existing LOPA records. The Safeguards created are then associated with the corresponding LOPA.

Values in the Following Fields in the Independent Layer of Protection ...	Copied to the following fields in the associated Hazards Analysis Safeguard
PFD	PFD
IPL ID	Safeguard ID
Type	IPL Type

In V4.3.0.0.0, for each Safeguard, IPL Checklist records are created to store your selection for the criteria that are used to determine if a Safeguard is an IPL. When you upgrade to V4.3.0.0.0, for each previously existing Independent Layer of Protection record, IPL Checklist records are created and associated with the corresponding Safeguard in V4.3.0.0.0.

Supported SERH/SERHx Library Versions

The following table lists the supported versions of the SERH/SERHx library provided by Exida.

APM Version	exSILentia Calculation Engine v3	exSILentia Calculation Engine v4	SERH Version	SERHx Version
APM V4.5.1.0.0	v3.0.5.3	v1.0	2020.04.01	2020.04.01
APM V4.5.0.0.0	v3.0.5.3	v1.0	2019.04.01	2019.04.01
APM V4.4.0.0.0	v3.0.5.3	N/A	2020.1.01	N/A
APM V4.3.0.0.0	v3.0.5.3	N/A	2017.4.01	N/A

APM Version	exSILentia Calculation Engine v3	exSILentia Calculation Engine v4	SERH Version	SERHx Version
APM V4.2.0.0	v3.0.5.3	N/A	2015.3.01	N/A
APM V4.1.0.0	v3.0.5.1	N/A	2015.2.01	N/A
APM V3.6.0.11.3	v3.0.5.1	N/A	2012.4.01	N/A

Family Field Descriptions

Electrical Records

This topic provides an alphabetical list and description of the fields that exist for the Electrical family and appear on the Electrical datasheet, unless otherwise specified. The information in the table reflects the baseline state and behavior of these fields.

Field	Data Type	Description	Behavior and Usage
I/O Power Redundancy Requirements	Text	Describes if redundant power supplies are feeding power to the SIS.	On the datasheet, this field appears as a text box, in which you can enter a true or false and then the description of the redundancy (dual or triple redundant).
I/O Power Requirements	Text	I/O power provided for the SIS.	On the datasheet, this field appears as a text box labeled Description, in which you can enter a description of the I/O power provided (for example: 24V DC)
I/O Power Sources	Text	The source of the I/O power (for example, clean power from a UPS, batter power, etc)	On the datasheet, this field appears as a text box, in which you can enter a true or false and then the description of the source (for example: from UPS A, or battery bank B)
Is Default	Logical	Indicates whether the record is the default one.	If set true, then the SRS Template is a default template for the category supplied by GE Vernova.
Last Modified By	Character	The name of the user who last modified the record.	On the datasheet, this field is disabled and updated automatically whenever the record is modified.
Last Modified Date	Date	The date on which the record was last modified.	On the datasheet, this field is disabled and populated automatically.

Field	Data Type	Description	Behavior and Usage
Loss of SIS Energy Sources	Text	The consequences, if one or more SIS energy (power) sources are disabled.	On the datasheet, this field appears as a text box, in which you can enter the description of consequence if one more sources is disabled.
Revision Number	Numeric	A number that represents the number of times the record has been revised.	On the datasheet, this field is disabled and populated.
SRS Template Description	Character	A description of the record.	On the datasheet, this field appears as a text box labeled Description , in which you can enter a description of the record.
SRS Template ID	Character	The ID of the record.	On the datasheet, this field appears as a text box labeled Field ID , in which you can type the ID.

Environment Records

This topic provides an alphabetical list and description of the fields that exist for the Environment family and appear on the Environment datasheet, unless otherwise specified. The information in the table reflects the baseline state and behavior of these fields.

Field	Data Type	Description	Behavior and Usage
Is Default	Logical	Indicates whether the record is the default one.	If set true, then the SRS Template is a default template for the category supplied by GE Vernova.
Last Modified By	Character	The name of the user who last modified the record.	On the datasheet, this field is disabled and updated automatically whenever the record is modified.
Last Modified Date	Date	The date on which the record was last modified.	On the datasheet, this field is disabled and populated automatically.
Revision Number	Numeric	A number that represents the number of times the record has been revised.	On the datasheet, this field is disabled and populated.

Field	Data Type	Description	Behavior and Usage
SIS Environment - Electrical Classification	Text	Describes if the SIS is approved for hazardous area. CSA, FM, ATEX and IECx certification will be described here. Also, electrical housing holding the SIS will be described here.	On the datasheet, this field appears as a text box, in which you can enter the hazardous area approval details.
SIS Environment - Humidity	Text	The relative humidity specification for the SIS control system will be described here. (for example, 5 to 95% non-condensing)	On the datasheet, this field appears as a text box, in which you can enter the relative humidity specifications that the SIS is designed to handle.
SIS Environment- Temperature	Text	The operating temperature range and the storage temperature range will be described here. (for example, -40 to 70 C operating temperature range and -40 to 85 C storage temperature range).	On the datasheet, this field appears as a text box, in which you can enter the operating temperature range specifications and storage temperature specification range that the SIS is designed to handle.
SIS Environmental Conditions	Text	The environmental fields describes the airborne contaminants, shock and vibration conditions. (for example, airborne contaminants: ISA-S71.04-1985 Airborne Contaminants Class G3 Conformal coating, shock: 10 g ½-sine wave for 11 ms and vibration: 1 mm peak-to-peak from 2 to 13.2 Hz)	On the datasheet, this field appears as a text box, in which you can enter the environmental specifications that the SIS is designed to handle.
SRS Template Description	Character	A description of the record.	On the datasheet, this field appears as a text box labeled Description , in which you can enter a description of the record.
SRS Template ID	Character	The ID of the record.	On the datasheet, this field appears as a text box labeled Field ID , in which you can type the ID.

SIS Functional Test Detail Records

This topic provides an alphabetical list and description of the fields that exist in the SIS Functional Test Detail family. When you apply a Proof Test Template to a Proof Test, a Functional Test Detail is created for each Proof Test Template Detail. The values in most of these fields are populated with the values in the corresponding fields in the related Proof Test Template Detail. This list is not comprehensive.

This family is enabled for site filtering, which means that records in this family can be assigned to a specific site, and will only be accessible to users who are assigned to the same site and have the appropriate license and family privileges. For more information, refer to the Sites section of the documentation.

Field	Data Type	Description	Behavior and Usage
As Found Travel Time	Numeric	The time taken by the Final Element to reach the safe state from its normal operating state. This value is measured in seconds.	This field is enabled only if the value in the Step Type field is Final Element. If the value in this field exceeds the value in the Travel Time Limit field, then the proof test step fails.
As Found Trip Point	Numeric	A number that defines when the element has activated an SIS shutdown.	This value is used to calculate the As Found Trip Point Error.
As Found Trip Point Error	Numeric	The error value calculated for the value that you have entered in the As Found Trip Point field.	This value is disabled and calculated as follows: As Found Trip Point Error = [(As Found Trip Point - Trip Point) *100] / Trip Point If this value is less than the value in the Trip Point Error Limit field, then the proof test step has passed. Otherwise, it has failed.
As Left Travel Time	Numeric	The time taken by the Final Element to reach the safe state from its normal operating state, after repairing the element. This value is measured in seconds.	This field is enabled only if the value in the Step Type field is Final Element.
As Left Trip Point	Numeric	A number that defines when the element has activated an SIS shutdown after repairing the element.	This value is used to calculate the As Left Trip Point Error.
As Left Trip Point Error	Numeric	The error value calculated for the value that you have entered in the As Left Trip Point field.	This value is disabled and calculated as follows: As Left Trip Point Error = [(As Left Trip Point - Trip Point) *100] / Trip Point
Comments	Character	Comments about the proof test.	None

Field	Data Type	Description	Behavior and Usage
Equipment ID	Character	The ID of the Equipment against which the step is performed.	This field is disabled and populated with the value in the Equipment ID field in the corresponding Proof Test Template Detail.
Executed By	Character	The ID of the user who conducted the proof test.	This field is disabled and populated with the ID of the current user.
Execution Date	Date	The date on which the proof test was conducted.	This field is disabled and populated with the date and time on which the Functional Test Detail is saved.
Failure Condition	Character	The condition in which the proof test step failed.	None
Failure Type	Character	The type of the failure.	This field contains the following values: <ul style="list-style-type: none"> • Safe • Dangerous • No Effect
Location ID	Character	The ID of the Functional Location against which the step is performed.	This field is disabled and populated with the value in the Location ID field in the corresponding Proof Test Template Detail.
Pass/Fail	Character	Indicates whether the proof test step has passed or failed based on the pass/fail criteria that you have specified in the corresponding Proof Test Template Detail.	This field contains the following values: <ul style="list-style-type: none"> • Pass • Fail • Skip • Complete
Result Criteria	Text	A description of what is considered to be an acceptable result of the step.	This field is disabled and populated with the value in the Result Criteria field in the corresponding Proof Test Template Detail.
Step Sequence Number	Numeric	A number that represents the order in which the step should be performed, relative to other steps.	This field is disabled and populated with the value in the Step Sequence Number field in the corresponding Proof Test Template Detail.
Step Type	Character	The type of the step.	This field is disabled and populated with the value in the Step Type field in the Proof Test Template Detail.

Field	Data Type	Description	Behavior and Usage
Template Detail ID	Character	An alphanumeric value that identifies the SIS Functional Test Detail.	This field is disabled and populated with the value in the Template Detail ID field in the corresponding Proof Test Template Detail.
Test Criteria	Character	The criteria or conditions for conducting the proof test.	This field is disabled and populated with the value in the Test Criteria field in the corresponding Proof Test Template Detail.
Travel Time Limit	Numeric	A number that quantifies the maximum acceptable travel time for this step, in seconds.	This field is enabled only in SIS Proof Test Template Details that are linked to records representing final elements.
Trip Point	Numeric	A number that defines when the element should activate an SIS shutdown.	This field is enabled only in SIS Proof Test Template Details that are linked to records representing sensors, final elements, or logic solvers.
Trip Point Direction	Character	The trend of Trip Point values.	This field is disabled and populated with the value in the Trip Point Direction field in the corresponding Proof Test Template Detail.
Trip Point Error Limit	Numeric	A value that defines the range, plus or minus, within which the Trip Point value must fall to be acceptable.	This field is disabled and populated with the value in the Trip Point Error Limit field in the corresponding Proof Test Template Detail.
Trip Point Units	Character	The unit of measure associated with the value in the Trip Point field.	This field is disabled and populated with the value in the Trip Point Units field in the corresponding Proof Test Template Detail.

General Data Records

This topic provides an alphabetical list and description of the fields that exist for the General Data family and appear on the General Data datasheet, unless otherwise specified. The information in the table reflects the baseline state and behavior of these fields.

Field	Data Type	Description	Behavior and Usage
Emergency Requirement	Text	This field describes the details of handling the failure of SIS in case of emergency.	On the datasheet, this field appears as a text box, in which you can enter the SIS handling in case of emergency. The description may detail manual override of SIS.
Is Default	Logical	Indicates whether the record is the default one.	If set true, then the SRS Template is a default template for the category supplied by GE Vernova.
Last Modified By	Character	The name of the user who last modified the record.	On the datasheet, this field is disabled and updated automatically whenever the record is modified.
Last Modified Date	Date	The date on which the record was last modified.	On the datasheet, this field is disabled and populated automatically.
Normal Operation Requirement	Text	The behavior of the SIS during normal operation.	On the datasheet, this field appears as a text box, in which you can enter the normal operating behavior that the SIS is designed to handle.
Revision Number	Numeric	A number that represents the number of times the record has been revised.	On the datasheet, this field is disabled and populated.
SIF Demand Mode of operation	Text	The demand rate exerted on the safety system. <ul style="list-style-type: none"> • Low Demand Mode: Safety Function demand rate is less than or equal to once a year. • High Demand Mode: Safety Function demand rate is greater than once a year. • Continuous Mode: Safety Function is operating as a continuous control function. 	On the datasheet, this field appears as a text box, in which you can enter the demand rate on the SIS that the SIS is designed to handle.
SIF Protection Mode	Text	The SIL level used for protecting the asset. (for example, SIL 1, SIL2 or SIL3)	On the datasheet, this field appears as a text box, in which you can enter the SIL specifications that the SIS is designed to handle. (example: SIL 1, SIL2 or SIL3)

Field	Data Type	Description	Behavior and Usage
SRS Methodology	Text	The methodology used to allocate the safety integrity requirements, depending the necessary risk reduction. (for example, quantitative method (numeric risk reduction) or qualitative method (risk matrix, risk graph))	On the datasheet, this field appears as a text box, in which you can enter the methodology used for allocating the safety integrity requirements that the SIS is designed to handle.
SRS Purpose and Scope	Text	The purpose of the SIS and the details of the coverage.	On the datasheet, this field appears as a text box, in which you can enter the SIL purpose and what SIF it is targeted to cover are described.
SRS Standards Used	Text	The standards used in designing the SRS.	On the datasheet, this field appears as a text box, in which you can enter the SIL standard that the SIS design is based on (IEC 61508 or ISA 84).
SRS Template Description	Character	A description of the record.	On the datasheet, this field appears as a text box labeled Description , in which you can enter a description of the record.
SRS Template ID	Character	The ID of the record.	On the datasheet, this field appears as a text box labeled Field ID , in which you can type the ID.
System Definition	Text	The system under consideration.	On the datasheet, this field appears as a text box, in which you can enter the system specifications that the SIS is designed to handle.

Hardware Records

This topic provides an alphabetical list and description of the fields that exist for the Hardware family and appear on the Hardware datasheet, unless otherwise specified. The information in the table reflects the baseline state and behavior of these fields.

Field	Data Type	Description	Behavior and Usage
Inputs Accuracy	Text	This field describes the accuracy of the input hardware.	On the datasheet, this field appears as a text box, in which you can enter the input point signal accuracy specifications that the SIS input point is designed to handle.
Inputs Certification Requirements	Text	This field describes the certifications for the input hardware.	On the datasheet, this field appears as a text box, in which you can enter the input point certifications (design basis).
Inputs Response Time	Text	This field describes the response time of the input hardware.	On the datasheet, this field appears as a text box, in which you can enter the input point response time specifications that the SIS input point is designed for.
Inputs Trip Set Points	Text	This field describes the trip setpoint used for the input hardware.	On the datasheet, this field appears as a text box, in which you can enter the input point trip setpoints that the SIS input point is designed to handle.
Is Default	Logical	Indicates whether the record is the default one.	If set true, then the SRS Template is a default template for the category supplied by GE Vernova.
Last Modified By	Character	The name of the user who last modified the record.	On the datasheet, this field is disabled and updated automatically whenever the record is modified.
Last Modified Date	Date	The date on which the record was last modified.	On the datasheet, this field is disabled and populated automatically.
Outputs Certification Requirements	Text	This field describes the certifications of the output hardware.	On the datasheet, this field appears as a text box, in which you can enter the design basis for the output point certifications.
Outputs Stroke Times	Text	This field describes the stroke times of the output hardware.	On the datasheet, this field appears as a text box, in which you can enter the design basis for the output point stroke times.

Field	Data Type	Description	Behavior and Usage
Outputs leakage requirements	Text	This field describes the leakage requirements of the output hardware.	On the datasheet, this field appears as a text box, in which you can enter the design basis for the output point leakage requirements.
Revision Number	Numeric	A number that represents the number of times the record has been revised.	On the datasheet, this field is disabled and populated.
SIS Input (sensor) Module Requirements	Text	This field describes the requirements for the input hardware module.	On the datasheet, this field appears as a text box, in which you can enter the input module design basis, typically supplied by the OEM of the input module.
SIS Logic Solver Requirements	Text	This field describes the requirements for the logic solver hardware module.	On the datasheet, this field appears as a text box, in which you can enter the logic solver design basis, typically supplied by the OEM of the input module.
SIS Output (final element) Module Requirements	Text	This field describes the requirements for the output hardware module.	On the datasheet, this field appears as a text box, in which you can enter the output module design basis, typically supplied by the OEM of the input module.
SRS Template Description	Character	A description of the record.	On the datasheet, this field appears as a text box labeled Description , in which you can enter a description of the record.
SRS Template ID	Character	The ID of the record.	On the datasheet, this field appears as a text box labeled Field ID , in which you can type the ID.

Instrumented Function Records

Instrumented Function records store details about a specific function of a safety instrumented system. This topic provides an alphabetical list and description of the fields that exist for the Instrumented Function family. The information in this table reflects the baseline state and behavior of these fields. This list is not comprehensive.

This family is enabled for site filtering, which means that records in this family can be assigned to a specific site, and will only be accessible to users who are assigned to the same site and have the appropriate license and family privileges. For more information, refer to the Sites section of the documentation.

Field	Data Type	Description	Behavior and Usage
Abnormal State	Character	A short description of the specific abnormal state of the operation.	This field does not appear on the datasheet.
Availability Target	Number	The percentage of time that the instrumented function must be operational.	Provide a value between 0 and 100. This value is compared with the availability of a Protective Instrument Loop to determine if the loop meets the availability target.
Concurrent Safe State Hazard	Text	A description of the hazardous event that could occur if the safe state associated with the instrumented function occurs simultaneously with the safe state of a different instrumented function.	This field appears on the Concurrent Safe State Hazard datasheet without a field caption, and a value is set by default. You can remove this value and enter your own value.
Concurrent Safe State Hazard?	Logical	Indicates whether the safe state associated with the instrumented function can cause a hazardous event if it occurs concurrently with the safe state of a different instrumented function.	This field appears on the Concurrent Safe State Hazard datasheet, which you can select to indicate that the safe state for the instrumented function can lead to a hazardous event if that safe state occurs simultaneously with the safe state of a different instrumented function.
Consequence Description	Text	A description of the risk that is associated with the hazardous event that exists in the Hazardous Event field.	If the value in the SIL Assessment Method field is PHA - Internal, after you select a Risk Assessment record from a Hazards Analysis, this field is populated with the value in the Consequence Description field in the Hazards Analysis Consequence record that is linked to the Risk Assessment record you selected.
Demand Rate (Source)	Character	The demand rate for the instrumented function (i.e., Low demand or High demand).	This field appears on the Safety Requirement Specification datasheet, and contains the text Low Demand by default. You can modify this value.

Field	Data Type	Description	Behavior and Usage
Equipment ID	Character	The ID of the Equipment that you want to link to the Instrumented Function.	On the datasheet, this field contains a  button, which you can select to search for the Equipment. After you select an Equipment, a link is created between the selected Equipment and this Instrumented Function. This field needs to be set in order to perform the Proof Test task workflow.
Equipment Key	Number	The Entity Key of the Equipment that is linked to this Instrumented Function.	The APM system uses this value to populate the Equipment ID field that appears on the Instrumented Function datasheet.
Failure Rate UOM	Character	The unit of measure that is associated with the value in the Required Probability of Failure field.	This field contains the following values: <ul style="list-style-type: none"> • PFD Avg. • PFH When the value in the SIL Mode field is High Demand or Continuous, this field is disabled and populated with PFH. When the value in the SIL Mode field is Low Demand, this field is disabled and populated with PFD Avg.
Frequency of Initiating Event (Per yr)	Number	The number of times per year that the initiating event occurs.	If the value in the SIL Assessment Method field is PHA - Internal, after you select a Risk Assessment record from a Hazards Analysis, this field is populated with the value in the Cause Frequency (per year) field in the Hazards Analysis Cause record that is linked to the Hazards Analysis Consequence record that is linked to the Risk Assessment record you selected.
Function Type	Character	The type of the instrumented function.	This field contains a list with the following baseline values: <ul style="list-style-type: none"> • Safety • Protective

Field	Data Type	Description	Behavior and Usage
Functional Location ID	Character	The ID of the Functional Location that is linked to the Instrumented Function.	On the datasheet, this field a  button, which you can select to search for the Functional Location.
Functional Location Key	Number	The Entity Key of the Functional Location that is linked to this Instrumented Function.	The APM system uses this value to populate the Functional Location ID field.
Hazardous Event	Character	A description of the event for which the instrumented function exists to prevent or mitigate risk.	If the value in the SIL Assessment Method field is PHA - Internal, after you select a Risk Assessment record from a Hazards Analysis, this field is populated with the value in the Consequence Type field in the Hazards Analysis Consequence record that is linked to the Risk Assessment record you selected.
Hazards Analysis Date	Date	The date the Hazards Analysis to which this Instrumented Function is linked was last modified.	On the datasheet, this field is disabled and populated automatically with the value stored in the Last Modified Date field in the Hazards Analysis that is linked to this Instrumented Function and whose ID appears in the Hazards Analysis Reference field.
Hazards Analysis Reference	Character	The ID of the Hazards Analysis that is linked to this Instrumented Function.	This field does not appear on the datasheet.
Hazards Analysis Reference Key	Number	The Entity Key for the Hazards Analysis that is linked to this Instrumented Function.	This field is used by the APM system to populate this Instrumented Function record with information from the Hazards Analysis that is linked to this Instrumented Function.

Field	Data Type	Description	Behavior and Usage
Initiating Event	Character	A short description of the initiating event whose description exists in the Initiating Event Description field.	If the value in the SIL Assessment Method field is PHA - Internal, after you select a Risk Assessment record from a Hazards Analysis, this field is populated automatically with the value in the Cause Type field in the Hazards Analysis Cause record that is linked to the Hazards Analysis Consequence record that is linked to the Risk Assessment record you selected.
Initiating Event Description	Text	A description of the event which could initiate a series of events that present the risk whose description exists in the Consequence Description field.	If the value in the SIL Assessment Method field is PHA - Internal, after you select a Risk Assessment record from a Hazards Analysis, this field is populated automatically with the value in the Cause Description field in the Hazards Analysis Cause record that is linked to the Hazards Analysis Consequence record that is linked to the Risk Assessment record you selected.
I/O Functional Relationship Details	Text	A description of the relationship between the inputs and outputs for the process, including details such as logic and mathematical functions.	This field appears on the Safety Requirement Specification datasheet.
Last Modified By	Character	The name of the user who last modified the record.	On the datasheet, this field is disabled and updated automatically whenever the record is modified.
Last Modified Date	Date	The date on which the record was last modified.	On the datasheet, this field is disabled and populated automatically.
Maintenance and Test Requirements	Text	A description of the requirements for maintenance and testing procedures for the instrumented function.	This field appears on the Safety Requirement Specification datasheet, and a value is set by default. You can remove this value and enter your own values.

Field	Data Type	Description	Behavior and Usage
Maintenance Override	Logical	A logical field that stores the value True or False and indicates whether the process requires override procedures for maintenance activities.	By default, this field does not appear on the datasheet.
Manual Shutdown	Logical	A logical field that stores the value True or False and indicates whether the process requires manual shutdown.	By default, this field does not appear on the datasheet.
Max Process Variable	Number	A number representing the upper value for the process variable range.	This field appears on the Safety Requirement Specification datasheet. This value combined with the value stored in the Min Process Variable field make up the process variable range.
Min Process Variable	Number	A number representing the lower value for the process variable range.	This field appears on the Safety Requirement Specification datasheet. This value combined with the value stored in the Max Process Variable field make up the process variable range.
Normal Operation Mode	Text	A description of the normal operating mode for the instrumented function.	By default, this field appears on the Safety Requirement Specification datasheet and a value is set. You can remove this text and enter your own values.
Operation Mode Description	Character	The description of the abnormal mode of operation.	This field appears on the Safety Requirement Specification datasheet and is enabled only if the value for the Operation Modes field is ABNORMAL. If the value in the Operation Modes field is NORMAL, this field is disabled.

Field	Data Type	Description	Behavior and Usage
Operation Modes	Character	The mode of operation for the instrumented function.	This field appears on the Safety Requirement Specification datasheet and contains the following values: <ul style="list-style-type: none"> • Normal : By default, this is the value that is selected. • Abnormal : If you select this value, the following fields are enabled: <ul style="list-style-type: none"> ◦ Abnormal States ◦ Operation Mode Description
Operator Interface Requirement	Text	A description of the Operator Interface requirements.	This field appears on the Safety Requirement Specification datasheet, and a value is set by default. You can remove this text and enter your own values.
PIF Description	Character	Stores a description of the instrumented function.	On the datasheet, this field appears as a text box labeled IF Description , in which you can enter your own value.
PIF ID	Character	An ID for the instrumented function.	On the datasheet, this field appears as a text box labeled IF ID, in which you can enter your own value. This value will appear in the list of Instrumented Functions on the left pane on the SIL Analysis Summary page. This field is required.
Pre Alarm	Number	A number representing the point on the process variable range at which the pre-alarm should be triggered.	This field appears on the Safety Requirement Specification datasheet.
Process Service Description	Text	A description of the specifications for the process service.	This field appears on the Safety Requirement Specification datasheet.
Process Speed	Number	A number representing the time in seconds that the process for which the instrumented function takes to complete.	None

Field	Data Type	Description	Behavior and Usage
Required Probability of Failure	Number	A number that represents the target probability that an instrumented function failure will occur.	<ul style="list-style-type: none"> • If the value in the SIL Assessment Method field is Risk Matrix - Internal, this field is disabled and populated automatically based on the SIL requirements from the Risk Matrix. • If the value in the SIL Assessment field is Layer of Protection Analysis Internal, this field is disabled and populated automatically with the difference between the values in the Mitigated Consequence Frequency field and the Required Mitigated Consequence Frequency field on the LOPA datasheet. For all other SIL Assessment methods, you can type a value manually in the Required Probability of Failure field. Note that: <ul style="list-style-type: none"> ◦ The value that you type must fall within a certain range, which is determined by the value in the Selected SIL Level field. If you modify the value in the Selected SIL Level field, the value in this field will be updated automatically to fall within the correct range of values for that level. ◦ If you try to type a value into the Required Probability of Failure field without first selecting a value from the Selected SIL Level list or you type a value that is outside of the acceptable range, an error message will appear. ◦ If the value in the SIL Mode field is Low Demand, when you type a value in the Required Probability of Failure field, the value in the Risk

Field	Data Type	Description	Behavior and Usage
Required SIF Action	Text	A description of the action that the instrumented function performs in response to a triggered alarm.	This field appears on the Safety Requirement Specification datasheet.
Reset Requirement	Text	A description of the requirements for resetting a process after it has been tripped.	This field appears on the Safety Requirement Specification datasheet and a value is set by default. You can remove this text and enter your own value.
Response Time	Number	A numeric value that represents the time in seconds that it takes for the instrumented function to respond to the initiating event and bring the process to a safe state.	None

Field	Data Type	Description	Behavior and Usage
Risk Reduction Factor (RRF)	Number	A number representing the factor by which the risk should be reduced for the instrumented function.	<p>If the value in the SIL Mode field is Low Demand and the value in the SIL Assessment Method field is Layer of Protection Analysis - Internal or Risk Matrix - Internal, this field is disabled and populated automatically with the inverse of the value in the Required Probability of Failure field.</p> <p>For all the other SIL Assessment methods, when the value in the SIL Mode field is Low Demand and the value in the SIL Assessment Method field is not Layer of Protection Analysis - Internal or Risk Matrix - Internal, this field is enabled and you can type a value directly into the Risk Reduction Factor field. Note that:</p> <ul style="list-style-type: none"> The value that you type must fall within a certain range, which is determined by the value in the Selected SIL Level field. If you modify the value in the Selected SIL Level field, the value in this field will be updated automatically to fall within the correct range of values for that level. If you try to type a value in the Risk Reduction Factor field without first selecting a value from the Selected SIL Level list or you type a value that is outside of the acceptable range, an error message will appear. If you type a value in the Risk Reduction Factor field, the value in the Required Probability of Failure field will be populated automatically with the inverse of the value that you type. Likewise, if you type a value into the Required Probability of Failure field, the value in the Risk Reduction Factor field will be populated automatically with the

Field	Data Type	Description	Behavior and Usage
Safe State Description	Text	A description of the safe state to which the process should be taken via the instrumented function.	None
Selected SIL Level	Number	A number representing the SIL value that is required for the instrumented function.	<p>On the datasheet, this field is disabled and populated automatically if the value in the SIL Assessment Method field is anything other than External.</p> <p>If the SIL Assessment Method field contains an External value, this field is enabled and appears as a list that is populated with values from the MI SAFETY INDEX LEVEL System Code Table. You can select a value from the list.</p> <p>If a value exists in the Required Probability of Failure field and you try to delete the value in the Selected SIL Level field, an error message appears, and you will not be able to delete the value.</p>
SIL Analysis Key	Number	The Entity Key of the SIL Analysis to which the Instrumented Function is linked.	This field is used internally by the APM system.
SIL Assessment Method	Character	The method used to assess the risk that is associated with the instrumented function.	<p>This field contains the following values:</p> <ul style="list-style-type: none"> • Risk Matrix - Internal • Layer of Protection Analysis Internal • PHA Internal • External <p>These values are defined in the MI_SIL_ASSESSMENT_METHOD system code table. If you select the PHA - Internal option, there must be a value in the Hazards Analysis Reference field. Otherwise, an error message will appear.</p>

Field	Data Type	Description	Behavior and Usage
SIL Mode	Character	The SIL mode that is defined for this instrumented function.	This field contains the following baseline values: <ul style="list-style-type: none"> • Low Demand • High Demand • Continuous
SIS System ID	Character	The ID of the Logic Solver to which the Instrumented Function is linked.	On the datasheet, this field appears as a list labeled SIS ID and contains the values that exist in the SIS ID field in the Logic Solvers that are linked to the SIL Analysis with which you are currently working. If a logic solver has been set as default, then the ID of the same logic solver is populated in the SIS System ID field.
Site Description	Character	A description of the site that is specified in the Site ID field.	None
Site ID	Character	The ID of the site that is associated with the instrumented function.	On the datasheet, this field is disabled and populated automatically with the value in the Site ID field of the associated SIL Analysis.
Spurious Trip Limit (per yr)	Number	A number representing the number of times per year it is acceptable for a spurious trip to occur for this instrumented function.	This value is used to determine the value in the Meets STR Limit field in a Protective Instrument Loop that is linked to the Instrumented Function.
Startup And Restart Procedure	Text	A detailed description of the start up and restart procedures for the process.	This field appears on the Safety Requirement Specification datasheet and a value is set by default. You can remove this text and enter your own value.
Survival Requirement	Text	A description of the requirements for the instrumented function to survive a catastrophic event, such as an earthquake.	This field appears on the Safety Requirement Specification datasheet and a value is set by default. You can remove this text and enter your own value.

Field	Data Type	Description	Behavior and Usage
Trip Mode	Character	A short description of the trip mode (i.e., energize to trip or de-energize to trip).	This field appears on the Safety Requirement Specification datasheet and the value is set to de-energize to trip by default. You can remove this value and enter your own value.
Trip Point	Number	A number representing the point on the process variable range at which the trip alarm should be triggered.	This field appears on the Safety Requirement Specification datasheet.
Unit Description	Character	A description of the unit that is specified in the Unit ID field.	None
Unit ID	Character	The ID for the unit where the instrumented function exists.	You can enter your own value.
UOM	Character	Units of measure for values such as Trip Point, Min Process Variable, Max Process Variable, Pre-alarm.	None

Interfaces Records

This topic provides an alphabetical list and description of the fields that exist for the Interfaces family and appear on the Interfaces datasheet, unless otherwise specified. The information in the table reflects the baseline state and behavior of these fields.

Field	Data Type	Description	Behavior and Usage
Is Default	Logical	Indicates whether the record is the default one.	If set true, then the SRS Template is a default template for the category supplied by GE Vernova.
Last Modified By	Character	The name of the user who last modified the record.	On the datasheet, this field is disabled and updated automatically whenever the record is modified.
Last Modified Date	Date	The date on which the record was last modified.	On the datasheet, this field is disabled and populated automatically.
Revision Number	Numeric	A number that represents the number of times the record has been revised.	On the datasheet, this field is disabled and populated.

Field	Data Type	Description	Behavior and Usage
SIF Process Interfaces	Text	All the interfaces to and from the SIS.	On the datasheet, this field appears as a text box, in which you can enter the interfaces (in and out) to and from the SIS.
SIS Sequence of Events Recording	Text	The sequence of events recording for the events in a SIS.	On the datasheet, this field appears as a text box, in which you can enter the SOE design details, typically supplied by the OEM of the SER. (Sequence of events recorder)
SIS to BPCS Interface Details	Text	The interface to a DCS or BPCS.	On the datasheet, this field appears as a text box, in which you can enter the BPCS interface design details.
SIS to Historian Interface Details	Text	The interfaces to a process historian.	On the datasheet, this field appears as a text box, in which you can enter the process historian interface design details.
SRS Template Description	Character	A description of the record.	On the datasheet, this field appears as a text box labeled Description , in which you can enter a description of the record.
SRS Template ID	Character	The ID of the record.	On the datasheet, this field appears as a text box labeled Field ID , in which you can type the ID.

LOPA Assessment Records

LOPA Assessment records store information that is mapped from the LOPA that you use to assess the SIL level of an Instrumented Function. This topic provides an alphabetical list and description of the fields that exist for the LOPA Assessment family and appear on the LOPA Assessment datasheet. The information in the table reflects the baseline state and behavior of these fields. This list is not comprehensive.

This family is enabled for site filtering, which means that records in this family can be assigned to a specific site, and will only be accessible to users who are assigned to the same site and have the appropriate license and family privileges. For more information, refer to the Sites section of the documentation.

Field	Data Type	Description	Behavior and Usage
LOPA Assessment ID	Character	Indicates the identification for the LOPA.	This field is required and must be unique among all the LOPA records linked to an Instrumented Function. Otherwise, an error message appears. You can enter a value manually. The value will appear in the list of assessments for an Instrumented Function and is used to distinguish the LOPA from the others.
LOPA Description	Character	Specifies a description for the LOPA.	This field appears on the LOPA Assessment datasheet.
Linked LOPA ID	Character	Indicates the identification of the LOPA that is linked to the instrumented function.	You can select a LOPA to associate with the LOPA Assessment record. You can link only LOPA records that are in Approved state.
Frequency of Initiating Event	Numeric	Indicates the number of times in a year an initiating event specified in the Initiating Event Type field in the LOPA record will occur.	This field is automatically populated with the value in the Frequency of Initiating Event field in the LOPA record that is associated with the Instrumented Function. This field does not appear on the datasheet.
Mitigated Consequence Frequency	Numeric	Indicates the frequency of the mitigated consequence (i.e., the frequency of consequence after layers of protection have been added).	This field is automatically populated with the value in the Mitigated Consequence Frequency field in the LOPA record that is associated with the Instrumented Function. This field does not appear on the datasheet.
Required Mitigated Consequence Frequency	Numeric	Indicates the maximum allowable frequency at which the initiating event can occur for the risk that is described in the Unacceptable Consequence field in the LOPA record.	This field is automatically populated with the value in the Required Mitigated Consequence Frequency field in the LOPA that is associated with the Instrumented Function. This field does not appear on the datasheet.

Field	Data Type	Description	Behavior and Usage
Required Probability of Failure	Numeric	Indicates the target probability that a failure will occur.	This field is automatically populated with the value in the Required PIF PFD field in the LOPA that is associated with the Instrumented Function. This field does not appear on the datasheet.
Risk Reduction Factor (RRF)	Numeric	Indicates the factor by which the risk should be reduced.	This field is automatically populated with the value in the Required PIF Risk Reduction Factor field in the LOPA that is associated with the Instrumented Function.
Selected SIL	Numeric	The SIL value that is required to mitigate the risk that is associated with the Instrumented Function to which this LOPA is linked.	This field is automatically populated with the value in the Calculated SIL field in the LOPA that is associated with the Instrumented Function.
Total IPL PFD	Numeric	The PFD value that is associated with all the IPLs associated with the LOPA.	This field is automatically populated with the value in the Total IPL PFD field in the LOPA record that is associated with the Instrumented Function. This field does not appear on the datasheet.
Unmitigated Consequence Frequency	Numeric	Indicates the frequency of unmitigated consequence (i.e, the frequency consequence before the layers of protection have been added).	This field is automatically populated with the value in the Unmitigated Consequence Frequency field in the LOPA record that is associated with the Instrumented Function. This field does not appear on the datasheet.

Logic Solver Records

Logic Solver records store details about the safety instrumented system that they represent. This topic provides an alphabetical list and description of the fields that exist for the Logic Solver family. Unless otherwise specified, the fields appear on the Logic Solver datasheet. The information in this table reflects the baseline state and behavior of these fields. This list is not comprehensive.

This family is enabled for site filtering, which means that records in this family can be assigned to a specific site, and will only be accessible to users who are assigned to the same site and have the appropriate license and family privileges. For more information, refer to the Sites section of the documentation.

Field	Data Type	Description	Behavior and Usage
Abnormal Mode Description	Text	A detailed description of the abnormal mode of operation.	This field is enabled only if Abnormal is selected in the Plant Operation Mode list. Otherwise, this field is disabled.
Abnormal State	Character	A short description of the specific abnormal state of the operation.	This field contains a list with the following values: <ul style="list-style-type: none"> • Start-Up • Shutdown • Bypass • Maintenance • Emergency • Other This field is enabled and required only if Abnormal is selected in the Plant Operation Mode list. Otherwise, this field is disabled.
Communication Links	Character	The type of communication link that exists between components within the logic solver and any other network device (e.g., Ethernet).	None
Is Default SIS	Logical	Indicates whether the Logic Solver is the default one.	This field does not appear on the datasheet by default.
Last Modified By	Character	The name of the user who last modified the record.	On the datasheet, this field is disabled and updated automatically whenever the record is modified.
Last Modified Date	Date	The date on which the record was last modified.	On the datasheet, this field is disabled and populated automatically.
Logic Solver ID	Character	The ID for the logic solver that is associated with the safety instrumented system.	This value should correspond to the value stored in the Logic Solver ID field in the Protective Instrument Loop Logic Solver that represents the desired logic solver.

Field	Data Type	Description	Behavior and Usage
Logic Solver Type	Character	The type of logic solver.	This field contains the following baseline System Codes in the MI LOGIC SOLVER TYPE System Code Table: <ul style="list-style-type: none"> • PLC • BPCS • Relay
Long Description	Text	A statement describing the purpose of the safety instrumented system.	None
Manual Shutdown Description	Text	A description of the method by which the safety instrumented system can be manually shut down.	None
Mission Time	Number	A numeric value (in years) that represents the time that the safety instrumented system will be in use before it is replaced or remanufactured.	On the datasheet, this field appears as a text box labeled Mission Time with an additional label, Years , to the right of the text box. You can enter your own value, which should be equal to or greater than the length of time specified in the Target SIS Test Interval field.
Operation Mode	Character	The mode of operation for the safety instrumented system.	On the datasheet, this field appears as a list labeled Plant Operation Mode and contains the following values: <ul style="list-style-type: none"> • Normal : This is the value that is selected by default. • Abnormal : If you select this value, the following fields are enabled : <ul style="list-style-type: none"> ◦ Abnormal State ◦ Abnormal Mode Description
Plant ID	Character	The ID of the plant in which the safety instrumented system exists.	By default, this field does not appear on the datasheet.
Plant Operation Mode	Character	The operational mode of the process for which the logic solver is expected to operate.	This field contains a list with following values: <ul style="list-style-type: none"> • Normal • Abnormal

Field	Data Type	Description	Behavior and Usage
Power Source	Character	A description of the power supply to the safety instrumented system.	None
Remove Default	Logical	Allows you to remove the default logic solver settings.	<p>After you remove the default logic solver settings:</p> <ul style="list-style-type: none"> No logic solver is marked as default in the list of logic solvers in the left section. If you create an Instrumented Function, the SIS ID field is blank, and you can select a logic solver from the list.
Reset Procedure	Text	A description of the method by which the safety instrumented system can be reset.	None
Set as Default	Logical	Allows you to set the selected logic solver as default.	<p>After you set a logic solver as default:</p> <ul style="list-style-type: none"> The logic solver is marked as default in the list of logic solvers in the left pane. If you create an Instrumented Function, the SIS ID field is automatically populated with the ID of the default logic solver. <p>Note: If the selected logic solver is already set as default, the Remove Default button is displayed instead of the Set as Default button.</p>
SIS Description	Character	A description for the safety instrumented system.	None
SIS ID	Character	A name for the safety instrumented system.	This field is required, and must be unique. If the value that you enter is already specified for an existing Logic Solver, a message will appear, indicating that the value is already in use. You will need to specify a different value before you can save the record.

Field	Data Type	Description	Behavior and Usage
Site Description	Character	A description of the site that is specified in the Site ID field.	This field does not appear on the datasheet by default.
Site ID	Character	The ID of the Site that is associated with the safety instrumented system.	On the datasheet, this field is disabled and populated automatically with the value stored in the Site ID field in the associated SIL Analysis. You should not modify this value.
Target SIS Test Interval	Number	A number that represents the interval in months by which regular testing will be performed on the safety instrumented system.	None
Unit Description	Character	A description of the unit specified in the Unit ID field.	This field does not appear on the datasheet by default.
Unit ID	Character	A description of the area in which the safety instrumented system exists.	None

Operations Records

This topic provides an alphabetical list and description of the fields that exist for the Operations family and appear on the Operations datasheet, unless otherwise specified. The information in the table reflects the baseline state and behavior of these fields.

Field	Data Type	Description	Behavior and Usage
Interlocks that are used for bypassing SIFs during start up or other operations	Text	The interlock used to bypass the SIF during startup or other unique operations such as proof testing.	On the datasheet, this field appears as a text box, in which you can enter the interlocks bypass design basis (used during startup, proof testing or overrides).
Is Default	Logical	Indicates whether the record is the default one.	If set true, then the SRS Template is a default template for the category supplied by GE Vernova.
Last Modified By	Character	The name of the user who last modified the record.	On the datasheet, this field is disabled and updated automatically whenever the record is modified.
Last Modified Date	Date	The date on which the record was last modified.	On the datasheet, this field is disabled and populated automatically.

Field	Data Type	Description	Behavior and Usage
Revision Number	Numeric	A number that represents the number of times the record has been revised.	On the datasheet, this field is disabled and populated.
SIF Bypass Requirements	Text	The bypass requirements the SIF during startup or other unique operations such as proof testing.	On the datasheet, this field appears as a text box, in which you can enter the SIF bypass design basis (used during startup, proof testing or overrides).
SIF Manual Shutdown	Text	The method of manually shutting down an SIF.	On the datasheet, this field appears as a text box, in which you can enter the methodology to manually shut down SIF. (during emergency situations).
SIF Proof Test Interval	Text	The proof test interval.	On the datasheet, this field appears as a text box, in which you can enter the proof testing interval (for example 24 months).
SIF Start Up Requirements	Text	The sequence and method of starting up an SIF.	On the datasheet, this field appears as a text box, in which you can enter the sequence and method of startup of a SIF.
SRS Template Description	Character	A description of the record.	On the datasheet, this field appears as a text box labeled Description , in which you can enter a description of the record.
SRS Template ID	Character	The ID of the record.	On the datasheet, this field appears as a text box labeled Field ID , in which you can type the ID.

Performance Data Records

This topic provides an alphabetical list and description of the fields that exist for the Performance Data family and appear on the Performance Data datasheet, unless otherwise specified. The information in the table reflects the baseline state and behavior of these fields.

Field	Data Type	Description	Behavior and Usage
Allowable Demand Rates	Text	Defines allowable demand rates based on the demand mode.	On the datasheet, this field appears as a text box, in which you can enter the design basis for allowable demand rates on the SIF.
Allowable Spurious Trips	Text	The safe failure rate commonly referred to as the false trip, nuisance trip, or spurious trip rate.	On the datasheet, this field appears as a text box, in which you can enter the design basis for allowable spurious trip rates on the SIF.
Is Default	Logical	Indicates whether the record is the default one.	If set true, then the SRS Template is a default template for the category supplied by GE Vernova.
Last Modified By	Character	The name of the user who last modified the record.	On the datasheet, this field is disabled and updated automatically whenever the record is modified.
Last Modified Date	Date	The date on which the record was last modified.	On the datasheet, this field is disabled and populated automatically.
Requirement for SRS Review	Text	The requirements for the SRS review based on the organizational practices and standards.	On the datasheet, this field appears as a text box, in which you can enter the organizational requirements for SRS review.
Revision Number	Numeric	A number that represents the number of times the record has been revised.	On the datasheet, this field is disabled and populated.
SIF Response Time	Text	The typical response time by the SIF for a dangerous detected failure.	On the datasheet, this field appears as a text box, in which you can enter the design response time on the SIF, when a dangerous failure is detected.
SIS Design Requirements	Text	The design requirements for the SIS.	On the datasheet, this field appears as a text box, in which you can enter the design for requirements on the SIF.
SIS Mission Time	Text	The mission time (typically in years) for an SIS.	On the datasheet, this field appears as a text box, in which you can enter the mission time typically in years for the SIS.

Field	Data Type	Description	Behavior and Usage
SRS Template Description	Character	A description of the record.	On the datasheet, this field appears as a text box labeled Description , in which you can enter a description of the record.
SRS Template ID	Character	The ID of the record.	On the datasheet, this field appears as a text box labeled Field ID , in which you can type the ID.

Protective Instrument Loop Records

Protective Instrument Loop records store details about a protective instrument loop that you have created as part of SIL verification. This topic provides an alphabetical list and description of the fields that exist for the Protective Instrument Loop family and appear on the Protective Instrument Loop datasheet by default. The information in this table reflects the baseline state and behavior of these fields.

This family is enabled for site filtering, which means that records in this family can be assigned to a specific site, and will only be accessible to users who are assigned to the same site and have the appropriate license and family privileges. For more information, refer to the Sites section of the documentation.

Field	Data Type	Description	Behavior and Usage
Achieved SIL	Number	A number representing the overall SIL value for the protective instrument loop.	<p>This list appears in the Calculated Results section and contains the following options:</p> <ul style="list-style-type: none"> • 0 (zero) • 1 • 2 • 3 • 4 • When the value in the SIL Verification Method field is External Calculation, this field is enabled. • When the value in the SIL Verification Method field is Internal Calculation, this field is disabled and populated automatically with the lowest value of the values stored in the following fields: <ul style="list-style-type: none"> ◦ Calculated SIL ◦ Calculated SIL Architectural Constraints ◦ Calculated SIL Systematic Capabilities <p>For example, if the value in each of these fields is 2, the value in the Achieved SIL field will be 2. If the value in two of the fields is 2 and the value in one of the fields is 1, the value in the Achieved SIL field will be 1.</p>

Field	Data Type	Description	Behavior and Usage
Application Test Method	Character	The application test method that is used in the loop.	<p>This list contains the following options:</p> <ul style="list-style-type: none"> • IEC 61508 • IEC 61508 : 2010 tables [per 61511-1 11.4.5] • IEC 61508 : 2000 tables [per 61511-1 11.4.5] • IEC 61511 [ignore 11.4.3 for Type A devices] • IEC 61511 • IEC 61511 [ignore 11.4.3 for Type A devices] <p>These values are defined in the MI_ARCHITECTURE_CONSTRAINT System Code Table.</p>
Availability	Number	A number representing the percentage of time that the protective instrument loop is expected to be available in the case of a demand.	<p>This field appears in the Calculated Results section and is enabled or disabled based on the following criteria:</p> <ul style="list-style-type: none"> • When the value in the SIL Verification Method field is External Calculation, this field is enabled. • When the value in the SIL Verification Method field is Internal Calculation, the APM system calculates this value automatically as follows: <p>Availability = (1-PFD Avg.) *100</p>

Field	Data Type	Description	Behavior and Usage
Calculated SIL	Number	A number representing the SIL value for the protective instrument loop, which is the value stored in the Loop PFD Avg field.	<p>This field appears in the Calculated Results section and is enabled or disabled based on the following criteria:</p> <ul style="list-style-type: none"> • When the value in the SIL Verification Method field is External Calculation, this field is enabled. • When the value in the SIL Verification Method field is Internal Calculation, the APM system calculates this value automatically, based on the value in the Loop PFD Avg field, and displays one of the following values as read-only: <ul style="list-style-type: none"> ◦ 0 (zero) ◦ 1 ◦ 2 ◦ 3 ◦ 4
Calculated SIL Architectural Constraints	Number	The SIL value for the protective instrument loop, which is based on architectural constraints defined in the Test Architecture Constraints field.	<p>This field appears in the Calculated Results section on the datasheet and is enabled or disabled based upon the following criteria:</p> <ul style="list-style-type: none"> • When the value in the SIL Verification Method field is External Calculation, this field is enabled. • When the value in the SIL Verification Method field is Internal Calculation, the APM system calculates this value automatically, based on the value in the Test Architecture Constraints field, and displays one of the following values as read-only: <ul style="list-style-type: none"> ◦ 0 (zero) ◦ 1 ◦ 2 ◦ 3 ◦ 4

Field	Data Type	Description	Behavior and Usage
Calculated SIL Systematic Capabilities	Number	<p>The SIL value for the protective instrument loop, which is based on systematic capabilities defined in the failure rate data associated with each protective instrument loop element. This is the lowest SIL value among the SIL values of all the elements in the loop. For example, assume that the elements in the loop are capable to achieve the following SIL values:</p> <ul style="list-style-type: none"> • Logic Solver - 3 • Sensor - 2 • Final Element - 1 <p>Then the SIL value for the entire protective instrument loop is 1.</p>	<p>This field appears in the Calculated Results section and is enabled or disabled based on the following criteria:</p> <ul style="list-style-type: none"> • When the value in the SIL Verification Method field is External Calculation, this field is enabled. • When the value in the SIL Verification Method field is Internal Calculation, the APM system calculates this value automatically, based on the systematic capabilities defined in the failure rate data associated with each protective instrument loop element, and displays one of the following values as read-only: <ul style="list-style-type: none"> ◦ 0 (zero) ◦ 1 ◦ 2 ◦ 3 ◦ 4
Calculated STR	Number	<p>A number representing the spurious trip rate for the protective instrument loop.</p>	<p>This field appears in the Calculated Results section and is enabled or disabled based on the following criteria:</p> <ul style="list-style-type: none"> • When the value in the SIL Verification Method field is External Calculation, this field is enabled. • When the value in the SIL Verification Method field is Internal Calculation, the APM system calculates this value automatically and displays that value as read-only.
Calculation Engine	Character	<p>Stores the exSILentia Calculation Engine version (that is, exSILentia V3 or exSILentia V4) used by the Protective Instrument Loop.</p>	<p>This field is disabled and populated automatically when the Protective Instrument Loop is upgraded.</p>

Field	Data Type	Description	Behavior and Usage
Demand Mode	Character	Represents the estimated probability that a dangerous condition will exist where the instrumented function is required to take the process to its safe state. For instance, if the demand rate is more than once a year, the hazard rate must not be higher than the failure rate. In this case, the SIL mode is high demand or continuous.	This field is disabled and populated automatically with the value stored in the SIL Mode field in the Instrumented Function that is linked to the Protective Instrument Loop.
Description	Character	A brief description of the protective instrument loop.	None
Final Element MCI	Number	A percentage that represents the Maintenance Capability Index.	This field contains the following options: <ul style="list-style-type: none"> MCI 0 (0%) : Indicates that repair actions are never performed. MCI 1 (60%) : Indicates that repair actions are effective 60 percent of the time. MCI 2 (90%) : Indicates that repair actions are effective 90 percent of the time. MCI 3 (99%) : Indicates that repair actions are effective 99 percent of the time. MCI 4 (100%) : Indicates that repair actions are always performed perfectly.
IO channels on separate module	Boolean	Specifies whether the redundant I/O channels should be on separate modules.	This field is only applicable to exSILentia v4 loops. If this field is set to True, the value in this field is reset to False when the protective instrument loop is upgraded to exSILentia v4.
Last Modified By	Character	The name of the user who last modified the record.	This field is disabled and populated with the name of the APM Security User who last modified the Protective Instrument Loop.

Field	Data Type	Description	Behavior and Usage
Last Modified Date	Date	The date on which the record was last modified.	This field is disabled and populated with the date on which the Protective Instrument Loop was last modified.
Logic Solver MCI	Number	A percentage that represents the Maintenance Capability Index.	This field contains the following options: <ul style="list-style-type: none"> • MCI 0 (0%) : Indicates that repair actions are never performed. • MCI 1 (60%) : Indicates that repair actions are effective 60 percent of the time. • MCI 2 (90%) : Indicates that repair actions are effective 90 percent of the time. • MCI 3 (99%) : Indicates that repair actions are effective 99 percent of the time. • MCI 4 (100%) : Indicates that repair actions are always performed perfectly.
Loop Class	Character	A value that indicates whether the protective instrument loop is designed to mitigate safety risks or commercial risks.	This list contains the following options: <ul style="list-style-type: none"> • Safety : Indicates that the protective instrument loop is designed to mitigate risks related to safety. For example, a safety loop might prevent a high motor current from causing a fire. • Protective : Indicates that the protective instrument loop is designed to mitigate commercial risks only. For example, a protective loop might prevent low lube pressure from causing a mechanical failure where there is no safety risk involved.

Field	Data Type	Description	Behavior and Usage
Loop ID	Character	The ID of the protective instrument loop.	This value is required and must be unique.
Loop PFD Avg	Number	A number representing the probability that the protective instrument loop will fail in the event of a demand while operating in low demand mode.	This field appears in the Calculated Results section, which is enabled or disabled based on the following criteria: <ul style="list-style-type: none"> When the value in the SIL Verification Method field is External Calculation, this field is enabled. When the value in the SIL Verification Method field is Internal Calculation, the APM system calculates this value automatically and displays that value as read-only.
Loop PFH	Number	A number representing the probability per hour that the protective instrument loop will fail in the event of a demand while operating in high demand or continuous mode.	This field appears in the Calculated Results section, which is enabled or disabled based on the following criteria: <ul style="list-style-type: none"> When the value in the SIL Verification Method field is External Calculation, this field is enabled. When the value in the SIL Verification Method field is Internal Calculation, the APM system calculates this value automatically and displays that value as read-only.
Loop Type	Character	A value representing the category of the protective instrument loop, based on the type of data that the sensor is measuring.	This field contains the following options: <ul style="list-style-type: none"> Analysis Flow Level Load Pressure Speed Temperature

Field	Data Type	Description	Behavior and Usage
Meets Architectural Constraints?	Character	A value that indicates whether the protective instrument loop's architectural constraints, specified by the standard in the Test Architectural Constraints field, meet the requirement defined by the value in the Required SIL field.	<p>This list appears in the Calculated Results section and contains the following options:</p> <ul style="list-style-type: none"> • Incomplete • Yes • No • N/A <p>By default, this value is set to Incomplete.</p> <ul style="list-style-type: none"> • When the value in the SIL Verification Method field is External Calculation, this field is enabled. • When the value in the SIL Verification Method field is Internal Calculation, this field is disabled and populated automatically using the following logic: <ul style="list-style-type: none"> ◦ If the value in the Calculated SIL Architectural Constraints field is greater than or equal to the value in the Required SIL field, this value is set to Yes. ◦ Otherwise, this value is set to No. <p>If the value in the Test Architectural Constraints field is Not Consider, this value is set to NA.</p>

Field	Data Type	Description	Behavior and Usage
Meets Availability Target?	Character	A value that indicates whether the protective instrument loop's availability meets the availability requirement defined in the Instrumented Function that is linked to the Protective Instrument Loop.	<p>This list appears in the Calculated Results section and contains the following options:</p> <ul style="list-style-type: none"> • Incomplete • Yes • No • N/A <p>By default, this value is set to Incomplete.</p> <ul style="list-style-type: none"> • When the value in the SIL Verification Method field is External Calculation, this field is enabled. • When the value in the SIL Verification Method field is Internal Calculation, the Meets Availability Target field is disabled and populated automatically. After you calculate the SIL Verification results, this field is populated using the following logic: <ul style="list-style-type: none"> ◦ If the value in the Demand Mode field is Low Demand, and the value in the Availability field is greater than or equal to the value stored in the Availability Target field in the Instrumented Function that is linked to the Protective Instrument Loop this value is set to Yes. ◦ Otherwise, this value is set to No. <p>If the value in the Demand Mode field is High Demand or Continuous, this value is N/A.</p>

Field	Data Type	Description	Behavior and Usage
Meets SIL Requirement?	Character	<p>A value that indicates whether the protective instrument loop's SIL value meets the SIL requirement defined in the Required SIL field.</p> <p>In order to meet the SIL requirement, the values in the following fields must be greater than or equal to the value in the Required SIL field:</p> <ul style="list-style-type: none"> • Achieved SIL • Calculated SIL Architectural Constraints • Calculated SIL Systematic Capabilities 	<p>This list appears in the Calculated Results section and contains the following options:</p> <ul style="list-style-type: none"> • Incomplete • Yes • No • N/A <p>By default, this value is set to Incomplete.</p> <ul style="list-style-type: none"> • When the value in the SIL Verification Method field is External Calculation, this field is enabled. • When the value in the SIL Verification Method field is Internal Calculation, this field is disabled and populated automatically using the following logic: <ul style="list-style-type: none"> ◦ If the value in the Achieved SIL field is greater than or equal to the value in the Required SIL field, this value is set to Yes. ◦ Otherwise, this value is set to No.

Field	Data Type	Description	Behavior and Usage
Meets STR Limit?	Character	A value that indicates whether the protective instrument loop's spurious trip rate meets the spurious trip rate requirement defined in the Instrumented Function that is linked to the Protective Instrument Loop.	<p>This list in the Calculated Results section and contains the following options:</p> <ul style="list-style-type: none"> • Incomplete • Yes • No • N/A <p>By default, this value is set to Incomplete.</p> <ul style="list-style-type: none"> • When the value in the SIL Verification Method field is External Calculation, the Meets STR Limit field is enabled. • When the value in the SIL Verification Method field is Internal Calculation, the Meets STR Limit field is disabled and populated using the following logic: <ul style="list-style-type: none"> ◦ If the inverse of the value stored in the MTTs field is greater than or equal to the value stored in the Spurious Trip Limit (per yr) field in the Instrumented Function that is linked to the Protective Instrument Loop, this value is set to No. ◦ Otherwise, this value is set to Yes. <p>If the Protective Instrument Loop is part of a protective instrument loop template, this value is set to N/A.</p>

Field	Data Type	Description	Behavior and Usage
Meets Systematic Capabilities?	Character	A value that indicates whether the protective instrument loop's systematic capability meets the systematic capability requirement defined in the Required SIL field.	<p>This list appears in the Calculated Results section and contains the following options:</p> <ul style="list-style-type: none"> • Incomplete • Yes • No • N/A <p>This value is set to Incomplete by default.</p> <ul style="list-style-type: none"> • When the value in the SIL Verification Method field is External Calculation, this field is enabled. • When the value in the SIL Verification Method field is Internal Calculation, this field is disabled and populated automatically using the following logic: <ul style="list-style-type: none"> ◦ If the value in the Calculated SIL Systematic Capabilities field is greater than or equal to the value in the Required SIL field, this value is set to Yes. ◦ Otherwise, this value is set to No. <p>If the value in the Systematic Capability Validation field is False, this value is set to N/A.</p>
Mission Time	Number	A number that represents the time that the protective instrument loop or the element will be in use before it is replaced.	This value is measured in years. This value is determined by the least mission time value among the values for all the elements of the protective instrument loop. For example, if the mission time values for the logic solver, final element, and sensor are 10 years, 5 years, and 20 years respectively, then the mission time for the entire loop is 5 years.

Field	Data Type	Description	Behavior and Usage
MTTFS	Number	A number that represents the Mean Time To Fail Spuriously (i.e., the mean time until a failure of the loop causes a process trip when a hazard was not present).	<p>This field appears in the Calculated Results section, which is enabled or disabled based on the following criteria:</p> <ul style="list-style-type: none"> When the value in the SIL Verification Method field is External Calculation, this field is enabled. When the value in the SIL Verification Method field is Internal Calculation, the APM system calculates this value automatically and displays that value as read-only. <p>This value is measured in years.</p>
Required SIL	Number	A number representing the SIL value that is required for the protective instrument loop.	This field is disabled and populated with the value stored in the Selected SIL Level field in the Instrumented Function that is linked to the Protective Instrument Loop.
Risk Reduction Factor	Number	A number representing the factor by which the risk should be reduced for the protective instrument loop.	<p>This field appears in the Calculated Results section and is enabled or disabled based on the following criteria:</p> <ul style="list-style-type: none"> When the value in the SIL Verification Method field is External Calculation, this field is enabled. When the value in the SIL Verification Method field is Internal Calculation, the APM system calculates this value automatically and displays that value as read-only.

Field	Data Type	Description	Behavior and Usage
Sensor MCI	Number	A value that represents the Maintenance Capability Index.	<p>This field contains the following options:</p> <ul style="list-style-type: none"> • MCI 0 (0%) : Indicates that repair actions are never performed. • MCI 1 (60%) : Indicates that repair actions are effective 60 percent of the time. • MCI 2 (90%) : Indicates that repair actions are effective 90 percent of the time. • MCI 3 (99%) : Indicates that repair actions are effective 99 percent of the time. • MCI 4 (100%) : Indicates that repair actions are always performed perfectly.

Field	Data Type	Description	Behavior and Usage
SIL Verification Method	Character	A value that represents the type of method used to calculate the SIL verification results for the protective instrument loop.	<p>This field contains the following options:</p> <ul style="list-style-type: none"> • Internal Calculation : Indicates that the APM system will calculate the SIL verification results using the IEC 61508 and the IEC 61511 functional safety standards. When this option is selected, the APM system calculates the values in all fields in the Calculated Results section automatically and displays them as read-only. • External Calculation : Indicates that you will enter SIL verification results directly into the fields on the Protective Instrument Loop datasheet. When this option is selected, all the fields in the Calculated Results section are enabled, and you can enter values directly into those fields.
Startup Time	Number	A number representing the amount of time the protective instrument loop has been bypassed since it was in the startup mode.	This value is measured in hours.

Field	Data Type	Description	Behavior and Usage
Systematic Capability Validation	Boolean	A value that indicates whether the SIL value for the protective instrument loop will account for systematic capabilities, which are defined in the failure data for each protective instrument loop element.	If you select this check box, the protective instrument loop will use systematic capabilities. If you clear this check box, the protective instrument loop will not use systematic capabilities.
Test Architecture Constraints	Character	A value that indicates the level of safety certification that is associated with the elements in the protective instrument loop.	This field contains the following options: <ul style="list-style-type: none"> • IEC 61508 : Indicates that the elements in the protective instrument loop have been certified according to the IEC 61508 standard. • IEC 61511 : Indicates that the elements in the protective instrument loop have been certified according to the IEC 61511 standard. • Not Consider : Indicates that the architectural constraints will not be considered in the SIL calculation.

Protective Instrument Loop Final Element Group Records

Protective Instrument Loop Final Element Group records store details about a protective instrument loop final element group that you have created as part of SIL verification. This topic provides an alphabetical list and description of the fields that exist for the Protective Instrument Loop Final Element Group family and appear on the Protective Instrument Loop Final Element Group datasheet by default. The information in this table reflects the baseline state and behavior of these fields.

This family is enabled for site filtering, which means that records in this family can be assigned to a specific site, and will only be accessible to users who are assigned to the same site and have the appropriate license and family privileges. For more information, refer to the Sites section of the documentation.

Field	Data Type	Description	Behavior and Usage
ATI / PVST Automatic/Manual	Character	Indicates whether partial valve stroke testing (PVST) is automatic or manual.	You can select one of the following values: <ul style="list-style-type: none"> • Automatic • Manual
ATI / PVST Coverage	Number	The percentage of failures expected detected by PVST.	None

Field	Data Type	Description	Behavior and Usage
ATI / PVST Enabled	Logical	Indicates if PVST is performed on the final elements in the group.	If this field is selected, then the following fields are enabled: <ul style="list-style-type: none"> ATI / PVST Automatic/ Manual ATI / PVST Interval ATI / PVST Interval UOM
ATI / PVST Interval	Number	The interval at which the PVST is performed on the final elements in the group.	It is recommended that the partial valve stroke test interval is performed at least an order of magnitude more frequent than the proof test. For example, if you perform the proof test once a year, you must perform the PVST at least once a month.
ATI / PVST Interval UOM	Character	The units of the PVST interval that you have specified in the ATI / PVST Interval field.	You can select one of the following values: <ul style="list-style-type: none"> Months Days
Availability	Number	A number representing the percentage of time that the final element in the group are expected to be available in the case of a demand.	The APM system calculates this value automatically as follows: Availability = (1-PFD Avg.) *100
Calculated PFD Avg	Number	A number representing the probability that the final element group will fail to react during a demand when the loop is operating in a low demand mode.	This field is disabled. The APM system calculates and populates this value. This value depends on the failure rate of the final element group.
Calculated PFH	Number	A number representing the probability that the final element group will fail to react during a demand when the loop is operating in high demand or continuous mode of operation.	This field is disabled. The APM system calculates and populates this value. This value depends on the failure rate of the final element group.
Calculated STR	Number	A number representing the spurious trip rate for the final element group.	This field is disabled. The APM system calculates and populates this value.

Field	Data Type	Description	Behavior and Usage
Common Cause (Beta)	Number	A number representing the percentage of failure that would affect the functioning of multiple devices. For example, a power supply failure for a final element group that is shared across multiple loops can cause all the loops to fail. In this case, the beta factor is the probability that the loops fail in case of a power supply failure to the final element group.	<p>If the value in the Voting field is 1001, this value is not applicable. This value is populated automatically when you select a device.</p> <p>If the Final Element Group contains multiple Final Elements, then you can enter a value manually in this field.</p>
Custom Vote M	Number	The minimum number of final elements that should trip when the final element detects a potential hazard.	You must use this option if you want to add more than six final elements in the group. If the number of final elements in the group is less than or equal to six, then this field is disabled and populated with the minimum number of final elements that should trip in the event of a potential hazard (the first digit in the Voting field).
Custom Vote N	Number	The number of final elements in the group.	You must use this option if you want to add more than six final elements in the group. If the number of final elements in the group is less than or equal to six, then this field is disabled and populated with the number of final elements (the last digit in the Voting field).

Field	Data Type	Description	Behavior and Usage
Diverse	Logical	Indicates whether the final elements in the group are similar or diverse.	<p>If you clear this check box, all the final elements in the group are similar. Hence, all the final elements in the group will have datasheets with the same values, except for the Final Element ID. If you modify the details of a final element, the same change is reflected in all the final element datasheets. By default, the check box is cleared.</p> <p>If you select this check box, each final element in the group will have a datasheet with different values.</p> <p>If there are more than three final elements in the group, this field is cleared. If there is only one final element in the group, this field is disabled.</p>
Group ID	Character	The ID of the protective instrument loop.	This value is required and must be unique. The APM system provides a default value, which you can modify if required.
Group Mission Time	Number	Specifies a numeric value (in years) that represents the Mission Time at the group level.	<p>This field is only applicable to exSILentia v4 loops.</p> <p>If a value is specified in this field, the value is reset to the value in the Mission Time field of the Protective Instrument Loop record when the protective instrument loop is upgraded to exSILentia v4.</p>
Has Independent Mission Time	Boolean	Specifies whether or not the group has an independent mission time.	<p>This field is only applicable to exSILentia v4 loops.</p> <p>If this field is set to True, the value in this field is reset to False when the protective instrument loop is upgraded to exSILentia v4.</p>
MTTFS	Number	Mean Time To Fail Spuriously. It is the average amount of time between failures of final elements in the group that occur during safe scenarios.	This field appears in the Calculated Results section and is disabled. This value is measured in years.

Field	Data Type	Description	Behavior and Usage
MTRR	Number	Mean Time To Repair. It is the average time that is required to repair the final elements in the group.	This value is measured in hours and is required.
Proof Test Coverage	Number	The percentage of failures that are detected by the proof test (i.e., how effectively the proof test identifies failures). For example, 100% proof test coverage indicates that the proof test would identify 100% of the failures that occurred.	By default, this value is required and is set to 0.
Proof Test Duration	Number	Specifies the duration of the Proof Test.	This field is populated with a default value of 1 hour when the protective instrument loop is upgraded to ExSILentia v4.
Proof Test Interval	Number	A numeric value representing the frequency at which the proof test should be performed.	This value is set to 12 by default. You can, however, change this value if required. This value is required and is measured in months.
SIL Architectural Constraints	Number	A number that represents the SIL value for the final element group, which is based on the architectural constraints that are defined in the Test Architecture Constraints field.	This field is disabled. The APM system calculates and populates this value.
SIL Systematic Capability	Number	A number that represents the SIL value for the final element group, which is based on the systematic capability that is defined in the Test Architecture Constraints field.	This field is disabled. The APM system calculates and populates this value.

Field	Data Type	Description	Behavior and Usage
Use Custom PVST Coverage	Logical	Indicates whether custom PVST coverage is considered.	None
Voting	Character	The voting architecture that represents the minimum number of final elements that should trip (in the event of a failure) and the number of final elements available in the group. For example, if the voting is 1oo2, then for the logic solver to detect a failure, at least one final element should trip out of the two final elements that are available in the group.	<p>This field is updated automatically when you add or remove a final element from the group.</p> <p>The following combinations are available:</p> <ul style="list-style-type: none"> • 1oo1 • 1oo2 • 2oo2 • 1oo3 • 2oo3 • 3oo3 • 1oo4 • 2oo4 [2oo(1oo2)] • 4oo4 • 5oo5 • 6oo6 • MooN <p>This value is required. These values are defined in the MI_SIL_FINAL_ELEM_VOTE system code table.</p>

Protective Instrument Loop Final Element Records

Protective Instrument Loop Final Element records store details about final elements for a protective instrument loop. This topic provides an alphabetical list and description of the fields that exist for the Protective Instrument Loop Final Element family. The information in this table reflects the baseline state and behavior of these fields. This list is not comprehensive.

This family is enabled for site filtering, which means that records in this family can be assigned to a specific site, and will only be accessible to users who are assigned to the same site and have the appropriate license and family privileges. For more information, refer to the Sites section of the documentation.

Field	Data Type	Description	Behavior and Usage
Approved Custom Device	Logical	Indicates whether the final element is approved to be used.	This field is disabled and selected if the final element has been approved to use via the Validation Failure Rate Reference Data feature.
Base SFF	Number	Safe Failure Fraction without diagnostic detection.	This field is disabled. The APM system calculates this value based on the final element, the interfaces, and the pneumatic elements for the final element.
Custom PVST Coverage	Number	A numeric value representing the percentage of possible failures that could be detected by the partial valve stroke test.	This field is enabled only if the Partial Valve Stroke Testing check box is selected.
Dangerous combination of outputs?	Logical	Indicates whether the output associated with the final element can lead to a hazardous event if it occurs simultaneously with the output associated with another final element.	By default, this check box is cleared. When you select this check box: <ul style="list-style-type: none"> The Potential Dangerous Combination of Outputs Description field is enabled and required. You must link another final element whose output can be hazardous if it occurs simultaneously with the output of this final element. You can clear this check box only if no final element is linked to the current final element as a dangerous combination of outputs.
Description	Character	A description for the final element.	None

Field	Data Type	Description	Behavior and Usage
Final Element	Character	The name of the final element.	The values in this list are from Exida's Safety Equipment Reliability Handbook (SERH) and approved custom devices in the APM system. After you select a value from the list, the following details about the final element appear in the Devices pane: <ul style="list-style-type: none"> • ID • Device Tag • Dangerous Detected • Dangerous Undetected • Safe Detected • Safe Undetected
Final Element ID	Character	An ID for the final element.	This value is displayed in the diagram to identify the final element. This field is required.
Interface Module	Character	The interface between the final element and the logic solver.	The values in this list are from Exida's Safety Equipment Reliability Handbook (SERH) and approved custom devices in the APM system and are based on the value in the Final Element field.
Potential Dangerous Combination of Outputs Description	Text	A description of the hazard that can occur based on the position or combination of two or more final elements.	This field is enabled and required only if the Dangerous Combination of Outputs? check box is selected. Otherwise, this field is disabled.
Severe Service	Logical	Indicates that the final element is exposed to severe service conditions such as heat, corrosion, fluid composition, and so on, which can influence the effectiveness of the final element.	This is applicable only if the final element is a valve.
SFF	Number	Safe Failure Fraction after applying diagnostics for the final element.	This field is disabled. The APM system calculates this value, which is used to calculate MTTFs.
Tight Shutoff Required	Logical	Indicates that a tight shut off is required to achieve a safe state.	This is applicable only if the final element is a valve.

Field	Data Type	Description	Behavior and Usage
Use Combination	Logical	Indicates that remotely operated valves are used to include common valve and actuator combinations.	This is applicable only if the final element is a valve.
Valve Trip Open	Logical	Indicates that the valve, which is the final element, will trip open to achieve a safe state.	This is applicable only if the final element is a valve.

Protective Instrument Loop Final Element System Records

Protective Instrument Loop Final Element System records store details about a protective instrument loop final element system that you have created as part of SIL verification. This topic provides an alphabetical list and description of the fields that exist for the Protective Instrument Loop Final Element System family and appear on the Protective Instrument Loop datasheet by default. The information in this table reflects the baseline state and behavior of these fields.

This family is enabled for site filtering, which means that records in this family can be assigned to a specific site, and will only be accessible to users who are assigned to the same site and have the appropriate license and family privileges. For more information, refer to the Sites section of the documentation.

Field	Data Type	Description	Behavior and Usage
Availability	Number	A number representing the percentage of time between proof tests that the final element system is expected to be available.	The APM system calculates this value using the following calculation: $Availability = (1 - PFD) * 100$
Calculated PFD Avg	Number	A number representing the probability that the final element system will fail to react during a demand when the loop is operating in a low demand mode.	This field is disabled. The APM system calculates and populates this value. This value depends on the failure rate of the final element system.
Calculated PFH	Number	A number representing the probability that the final element system will fail to react during a demand when the loop is operating in high demand or continuous mode of operation.	This field is disabled. The APM system calculates and populates this value. This value depends on the failure rate of the final element system.
Calculated STR	Number	A number representing the spurious trip rate for the logic solver.	This field is disabled. The APM system calculates and populates this value.

Field	Data Type	Description	Behavior and Usage
Common Cause (Beta)	Number	A number representing the percentage of failure that would affect the functioning of multiple devices. For example, a power supply failure for a final element system that is shared across multiple loops can cause all the loops to fail. In this case, the beta factor is the probability that the loops fail in case of a power supply failure to the final element system.	If the value in the Voting field is 1oo1 or 1001D, this value is not applicable. This value is populated automatically when you select a device.
HFT	Number	A number representing the hardware fault tolerance, or the number of failures the final element system can tolerate before failing.	For example, a final element system with 1oo2 redundancy has a HFT of 1 because it can tolerate one failure and can still continue to operate.
MTTFS	Number	A number representing Mean Time To Fail Spuriously for a Final Element. For example, suppose a final element system senses a hazard that does not exist. In this case, MTTFS is the expected time that the process fails spuriously.	This field is disabled. The APM system calculates and populates this value.
Number of Groups	Number	The number of final element groups in the system.	This field is disabled and populated with the number of final element groups in the system.
SIL Architectural Constraints	Number	A number that represents the SIL value for the final element system, which is based on the architectural constraints that are defined in the Test Architecture Constraints field.	This field is disabled. The APM system calculates and populates this value.
SIL Systematic Capability	Number	A number that represents the SIL value for the final element system, which is based on the systematic capability that is defined in the Test Architecture Constraints field.	This field is disabled. The APM system calculates and populates this value.

Field	Data Type	Description	Behavior and Usage
System ID	Character	The ID of the final element system.	This value is required and is populated with a default value. You can, however, provide a different value.
Voting Between Groups	Character	The voting architecture that represents the minimum number of final element groups that should trip (in the event of a failure) and the number of final element groups available in the system. For example, if the voting is 1002, then for the logic solver to detect a failure, at least one final element group should trip out of the two final element groups that are available in the group.	This field is updated automatically when you add or remove a final element group from the system. The following options are available: <ul style="list-style-type: none"> • 1001 • 1002 • 2002 • 1003 • 2003 • 3003 • 1004 • 4004 This value is required.

Protective Instrument Loop Logic Solver Records

Protective Instrument Loop Logic Solver records store details about logic solvers for a protective instrument loop. This topic provides an alphabetical list and description of the fields that exist for the Protective Instrument Loop Logic Solver family and appear on the Protective Instrument Loop Logic Solver datasheet. The information in this table reflects the baseline state and behavior of these fields. This list is not comprehensive.

This family is enabled for site filtering, which means that records in this family can be assigned to a specific site, and will only be accessible to users who are assigned to the same site and have the appropriate license and family privileges. For more information, refer to the Sites section of the documentation.

Field	Data Type	Description	Behavior and Usage
App Diagnostic Test	Boolean	Indicates whether application diagnostic testing is considered for the logic solver.	None
Approved Custom Device	Boolean	Indicates whether the logic solver that is identified in the Exida Name field is approved for use in the protective instrument loop.	This field is disabled and selected if the logic solver has been approved to use via the Validation Failure Rate Reference Data feature.

Field	Data Type	Description	Behavior and Usage
Architectural Type	Character	Indicates whether the device is a simplex or a complex device.	If the Manual Entry check box is cleared, this value is disabled and populated with one of the following values based on the device identified in the Exida Name field: <ul style="list-style-type: none"> A (simplex device) B (complex device) If the Manual Entry check box is selected, this field is enabled.
Automatic Channel Count	Boolean	Indicates whether the number of each type of channel is counted.	If you select this check box, the Channels column in the Channels/Modules pane is populated with the number of channels.
Automatic Prooftest Switchover	Boolean	Indicates whether the logic solver performs proof tests automatically.	If you select this check box, the logic solver performs proof tests automatically.
Automatic Prooftest Switchover Interval	Numeric	A numeric value representing the frequency at which proof tests are performed by the logic solver.	This value is measured in months.
Availability	Numeric	A number representing the percentage of time between proof tests that the logic solver is expected to be available.	The APM system calculates this value using the following calculation: Availability = (1 - PFD) * 100
Calculated PFD Avg	Numeric	A number representing the probability that the logic solver will fail to react during a demand when the loop is operating in a low demand mode.	This field is disabled. The APM system calculates and populates this value. This value depends on the failure rate of the logic solver.
Calculated PFH	Numeric	A number representing the probability that the logic solver will fail to react during a demand when the loop is operating in high demand or continuous mode of operation.	This field is disabled. The APM system calculates and populates this value. This value depends on the failure rate of the logic solver.
Calculated STR	Numeric	A number representing the spurious trip rate for the logic solver.	This field is disabled. The APM system calculates and populates this value.

Field	Data Type	Description	Behavior and Usage
Common Cause (Beta)	Numeric	A number representing the percentage of failure that would affect the functioning of multiple devices. For example, a power supply failure for a logic solver that is shared across multiple loops can cause all the loops to fail. In this case, the beta factor is the probability that the loops fail in case of a power supply failure to the logic solver.	If the value in the Voting field is 1oo1 or 1001D, this value is not applicable. This value is populated automatically when you select a device.
Description	Character	A brief description of the logic solver.	None
Device Name	Character	The name of the logic solver device.	This field is disabled and populated when you link or apply a logic solver from Exida's Safety Equipment Reliability Handbook (SERH).
Diagnostic Test Automatic/Manual	Character	Indicates whether the application diagnostic test is automatic or manual.	You can select one of the following values: <ul style="list-style-type: none"> • Automatic • Manual
Diagnostic Test Coverage	Numeric	The percentage of failures that could be detected as part of automatic diagnostic test coverage.	None
Diagnostic Test Interval	Numeric	The application diagnostic test interval for the logic solver.	None
Diagnostic Test Interval UOM	Character	The units for the application diagnostic test interval that you have specified in the Diagnostic Test Interval field.	You can select one of the following values: <ul style="list-style-type: none"> • Months • Days
Equipment	Character	The ID of the Equipment to which the Protective Instrument Loop Logic Solver is linked.	This field contains a  button, which you can select to search for the desired Equipment. You can link only one Equipment. This field is disabled and populated when you link or apply a logic solver from Exida's Safety Equipment Reliability Handbook (SERH) or from the approved custom devices in the APM system.

Field	Data Type	Description	Behavior and Usage
Functional Location	Character	The ID of the Functional Location that is linked to the Protective Instrument Loop Logic Solver record.	This field contains a  button, which you can select to search for the desired Functional Location. You can link to only one Functional Location. This field is disabled and populated when you link or apply a logic solver from Exida's Safety Equipment Reliability Handbook (SERH) or from approved custom devices in the APM system.
Group Mission Time	Number	Specifies a numeric value (in years) that represents the Mission Time at the group level.	This field is only applicable to exSILentia v4 loops.
Has Independent Mission Time	Boolean	Specifies whether or not the group has an independent mission time.	This field is only applicable to exSILentia v4 loops. If this field is set to True, the value in this field is reset to False when the protective instrument loop is upgraded to ExSILentia v4.
HFT	Numeric	A number representing the hardware fault tolerance, or the number of failures the logic solver can tolerate before failing.	For example, a logic solver with 1oo2 redundancy has a HFT of 1 because it can tolerate one failure and can still continue to operate.
Is Proof Test Performed Online	Boolean	Specifies whether or not the Proof Test is performed online.	None
Logic Solver ID	Character	An ID for the logic solver.	This value is required and is populated with a default value. You can, however, provide a different value. This value must be unique.
Manual Entry	Boolean	Indicates whether you will enter data in a Protective Instrument Loop Logic Solver Channel manually or the APM system will populate this values.	If this check box is selected, the  button in the Channels/Modules section appears. Once you select this check box, you cannot clear it.

Field	Data Type	Description	Behavior and Usage
MTTFS	Numeric	A number representing Mean Time To Fail Spuriously for a logic solver. For example, suppose a logic solver senses a hazard that does not exist. In this case, MTTFS is the expected time that the process fails spuriously.	The APM system calculates this number automatically and displays it as read-only. This value is measured in years.
MTTR	Numeric	A number representing Mean Time To Repair, or the time it takes to repair the logic solver after a failure is detected.	This value is measured in hours. The value that you enter must be between 4 and 336. Otherwise, an error message will appear. This value is required.
Proof Test Alternative Protection	Boolean	Specifies whether or not an alternative protection exists during the proof test.	None
Proof Test Coverage	Numeric	A number representing the percentage of failures that are detected by the proof test (i.e., how effectively the proof test identifies failures). For example, 100% proof test coverage indicates that the proof test would identify 100% of the failures that could have occurred.	The number that you enter must be between 0 and 100. Otherwise, an error message will appear. This value is required.
Proof Test Duration	Number	Specifies the duration of the Proof Test.	This field is populated with a default value of 1 hour when the protective instrument loop is upgraded to ExSILentia v4.
Proof Test Interval	Numeric	A number representing the monthly intervals at which the proof test should be performed.	The number that you enter must be between 1 and 360, or an error message will appear. This value is required.
Reference Data Date	Date	The date on which that the reference data was published for the device that is identified in the Exida Name field.	This field displays the Calendar feature. When the Manual Entry check box is selected, this field is enabled. When the Manual Entry check box is cleared, this value is disabled and populated with the date on which the reference data was published for the device that is identified in the Exida Name field.

Field	Data Type	Description	Behavior and Usage
Reference Data Reference	Character	The specific failure data reference as it appears in the Exida data source that is identified in the Reference Data Source field.	When the Manual Entry check box is selected, this value is enabled. When the Manual Entry check box is cleared, this field is disabled and populated with the data reference for the device that is identified in the Exida Name field.
Reference Data Revision	Character	A number that represents the number of times the reference data has been revised in the Exida database.	When the Manual Entry check box is selected, this value is enabled. When the Manual Entry check box is cleared, this field is disabled and populated with the data revision for the device identified in the Exida Name field.
Reference Data Source	Character	The source of the reference data (e.g., Exida).	When the Manual Entry check box is selected, this value is enabled. When the Manual Entry check box is cleared, this field is disabled and populated with the data source for the device identified in the Exida Name field.
SERH Library Version	Character	Specifies the SERH library version for determining the Failure Rates.	None
SIL Architectural Constraints	Numeric	A number that represents the SIL value for the logic solver, which is based on the architectural constraints that are defined in the Test Architecture Constraints field.	This field is disabled. The APM system calculates and populates this value.

Field	Data Type	Description	Behavior and Usage
SIL Systematic Capability	Numeric	A number that represents the SIL value for the logic solver which is based on the systematic capabilities that are defined in the failure rate data.	<p>This field is enabled or disabled based on the following criteria:</p> <ul style="list-style-type: none"> When the Manual Entry check box is selected, the SIL Sytematic Capabilities field is enabled. When the Manual Entry check box is cleared, the APM system calculates the number automatically, based on the systematic capabilities that are defined in the failure rate data associated with the logic solver device, and displays one of the following values as read-only in the SIL Systematic Capability field: <ul style="list-style-type: none"> 0 (zero) 1 2 3 4
Voting	Character	The configuration of the logic solver that help achieve the target SIL value.	<p>This list contains the following options:</p> <ul style="list-style-type: none"> 1oo1 1oo1D 1oo2 1oo2D 1oo3 2oo3 3oo3 <p>This value is populated automatically when you select a device.</p>
With Enhanced Diagnostics	Boolean	Specifies whether or not the Logic Solver supports enhanced diagnostics.	None

Protective Instrument Loop Sensor Group Records

Protective Instrument Loop Sensor Group records store details about a protective instrument loop sensor group that you have created as part of SIL verification. This topic provides an alphabetical list and description of the fields that exist for the Protective Instrument Loop Sensor Group family and appear on

the Protective Instrument Loop Sensor Group datasheet by default. The information in this table reflects the baseline state and behavior of these fields.

This family is enabled for site filtering, which means that records in this family can be assigned to a specific site, and will only be accessible to users who are assigned to the same site and have the appropriate license and family privileges. For more information, refer to the Sites section of the documentation.

Field	Data Type	Description	Behavior and Usage
ATI / PVST Automatic/Manual	Character	Indicates whether application testing is automatic or manual.	You can select one of the following values: <ul style="list-style-type: none"> Automatic Manual
ATI / PVST Coverage	Number	The percentage of failures that could be detected by application testing coverage.	None
ATI / PVST Enabled	Logical	Indicates if application testing is enabled for the sensors in the group.	If this field is selected, then the following fields are enabled: <ul style="list-style-type: none"> ATI / PVST Automatic/Manual ATI / PVST Interval ATI / PVST Interval UOM
ATI / PVST Interval	Number	The interval at which the application testing is performed on the sensors in the group.	None
ATI / PVST Interval UOM	Character	The units of the application testing interval that you have specified in the ATI / PVST Interval field.	You can select one of the following values: <ul style="list-style-type: none"> Months Days
Availability	Number	A number representing the percentage of time that the sensors in the group are expected to be available in the case of a demand.	The APM system calculates this value automatically as follows: $Availability = (1 - PFD Avg) * 100$
Calculated PFD Avg	Number	A number representing the probability that the sensor group will fail to react during a demand when the loop is operating in a low demand mode.	This field is disabled. The APM system calculates and populates this value. This value depends on the failure rate of the sensor group.

Field	Data Type	Description	Behavior and Usage
Calculated PFH	Number	A number representing the probability that the sensor group will fail to react during a demand when the loop is operating in high demand or continuous mode of operation.	This field is disabled. The APM system calculates and populates this value. This value depends on the failure rate of the sensor group.
Calculated STR	Number	A number representing the spurious trip rate for the sensor group.	This field is disabled. The APM system calculates and populates this value.
Common Cause (Beta)	Number	A number representing the percentage of failure that would affect the functioning of multiple devices. For example, a power supply failure for a sensor group that is shared across multiple loops can cause all the loops to fail. In this case, the beta factor is the probability that the loops fail in case of a power supply failure to the sensor group.	If the value in the Voting field is 1oo1 or 1001D, this value is not applicable. This value is populated when you select a device.
Custom Vote M	Number	The minimum number of sensors that should trip when the sensor detects a potential hazard.	You must use this option if you want to add more than four sensors in the group. If the number of sensors in the group is less than or equal to four, then this field is disabled and populated with the minimum number of sensors that should trip in the event of a potential hazard (the first digit in the Voting field).
Custom Vote N	Number	The number of sensors in the group.	You must use this option if you want to add more than four sensors in the group. If the number of sensors in the group is less than or equal to four, then this field is disabled and populated with the number of sensors (the last digit in the Voting field).

Field	Data Type	Description	Behavior and Usage
Diverse	Logical	Indicates whether the sensors in the group are similar or diverse.	<p>If you clear this check box, all the sensors in the group are similar. Hence, all the sensors in the group will have datasheets with the same values, except for the Sensor ID. If you modify the details of a sensor, the same change is reflected in all the sensor datasheets. By default, the check box is cleared.</p> <p>If you select this check box, each sensor in the group will have a datasheet with different values.</p> <p>If there are more than three sensors in the group, this field is cleared. If there is only one sensor in the group, this field is disabled.</p>
Group ID	Character	The ID of the protective instrument loop.	This value is required and must be unique. The APM system provides a default value, which you can modify if required.
Group Mission Time	Number	Specifies a numeric value (in years) that represents the Mission Time at the group level.	<p>This field is only applicable to exSILentia v4 loops.</p> <p>If a value is specified in this field, the value is reset to the value in the Mission Time field of the Protective Instrument Loop record when the protective instrument loop is upgraded to exSILentia v4.</p>
Has Independent Mission Time	Boolean	Specifies whether or not the group has an independent mission time.	<p>This field is only applicable to exSILentia v4 loops.</p> <p>If this field is set to True, the value in this field is reset to False when the protective instrument loop is upgraded to exSILentia v4.</p>
MTTFS	Number	Mean Time To Fail Spuriously. (that is, Mean time for a sensor to detect a hazard when an unsafe condition is not present.)	This field appears in the Calculated Results section and is disabled. This value is measured in years.

Field	Data Type	Description	Behavior and Usage
MTRR	Number	Mean Time To Repair. It is the average time that is required to repair the sensors in the group.	This value is measured in hours and is required.
Proof Test Coverage	Number	The percentage of failures that are detected by the proof test (that is, how effectively the proof test identifies failures). For example, 100% proof test coverage indicates that the proof test would identify 100% of the failures that occurred.	This value is required and is set to 0 by default.
Proof Test Duration	Number	Specifies the duration of the Proof Test.	This field is populated with a default value of 1 hour when the protective instrument loop is upgraded to ExSILentia v4.
Proof Test Interval	Number	A numeric value representing the frequency at which the proof test should be performed.	This value is set to 12 by default. You can, however, change this value if required. This value is required and is measured in months.
SIL Architectural Constraints	Number	A number that represents the SIL value for the sensor group, which is based on the architectural constraints that are defined in the Test Architecture Constraints field.	This field is disabled. The APM system calculates and populates this value.

Field	Data Type	Description	Behavior and Usage
SIL Systematic Capability	Number	A number that represents the SIL value for the sensor group, which is based on the systematic capability that is defined in the Test Architecture Constraints field.	This field is disabled. The APM system calculates and populates this value.
Voting	Character	The voting architecture that represents the minimum number of sensors that should trip (in the event of a failure) and the number of sensors available in the group. For example, if the voting is 1oo2, then for the logic solver to detect a failure, at least one sensor should trip out of the two sensors that are available in the group.	<p>This field is updated automatically when you add or remove a sensor from the group.</p> <p>The following combinations are available:</p> <ul style="list-style-type: none"> • 1oo1 • 1oo1D • 1oo2 • 1oo2D • 2oo2 • 1oo3 • 2oo3 • 3oo3 • 1oo4 • 2oo4 • 3oo4 • 4oo4 • MooN <p>This value is required. These values are defined in the MI_SIL_SENSORVOTE system code table.</p>

Protective Instrument Loop Sensor Records

Protective Instrument Loop Sensor records store details about a protective instrument loop sensor that you have created as part of SIL verification. This topic provides an alphabetical list and description of the fields that exist for the Protective Instrument Loop Sensor family and appear on the Protective Instrument Loop datasheet by default. The information in this table reflects the baseline state and behavior of these fields.

This family is enabled for site filtering, which means that records in this family can be assigned to a specific site, and will only be accessible to users who are assigned to the same site and have the appropriate license and family privileges. For more information, refer to the Sites section of the documentation.

Field	Data Type	Description	Behavior and Usage
Alarm Filter	Logical	Indicates whether alarm filtering will be used.	Select this check box if the sensor reports the origin of a failure. This should be used in conjunction with Alarm Setting (High/Low) and is applicable only for diagnostic selection.
Alarm Setting(High/Low)	Logical	Indicates the direction of the alarm.	If the alarm setting is high, select this check box. If the alarm setting is low, clear this check box. This should be used in conjunction with Alarm Filter and is applicable only for diagnostic selection.
Alarm Voted as Trip	Logical	Indicates whether the alarm is voted as a trip.	If the alarm is voted as a trip, select this check box. This is applicable only for diagnostic selection.
Analog Trip	Character	Indicates the direction of the trip.	The following options are available: <ul style="list-style-type: none"> • High • Low This is applicable only for diagnostic selection.
Approved Custom Device	Logical	Indicates whether the sensor is approved to be used.	This field is disabled and selected if the sensor has been approved to use via the Validation Failure Rate Reference Data feature .
Base SFF	Number	Safe Failure Fraction without diagnostic detection.	This field is disabled. The APM system calculates this value based on the sensor, the interfaces, and the connections for the sensor.
Connection	Character	The type of physical connection between the sensor and the process.	The values in this list are based on the value in the Sensor Type field.
Description	Character	A brief description of the sensor.	None
External Comparison	Logical	Indicates whether the sensor is compared with another similar sensor.	Select this check box if you will use another device for comparative measurement. This is applicable only for diagnostic selection.

Field	Data Type	Description	Behavior and Usage
External Comparison Value	Number	The percentage of failure detected by external comparison.	This field is enabled only if the External Comparison check box is selected. This is applicable only for diagnostic selection.
Interface A	Character	The interface between the sensor and the logic solver.	The values in this list are from Exida's Safety Equipment Reliability Handbook (SERH) and are based on the value in the Sensor field.
Interface B	Character	A second interface between the sensor and the logic solver.	The values in this list are from Exida's Safety Equipment Reliability Handbook (SERH) and are based on the values in the Sensor and Interface A fields.
Over/Under Range	Logical	Indicates the direction of failure detected by the sensor.	If the sensor detects a failure for over range, select this check box. If the sensor detects a failure for under range, clear this check box. This is applicable only for diagnostic selection.
Sensor	Character	The name of the sensor.	The values in this list are from Exida's Safety Equipment Reliability Handbook (SERH) and are based on the value in the Sensor Type field.
Sensor ID	Character	The ID of the sensor.	This value is required and is populated with a default value. You can, however, provide a different value. This value must be unique.
Sensor Type	Character	A value representing the measurement type of the sensor.	This field contains the following options: <ul style="list-style-type: none"> • FireGas • Flow • Level • Other • Pressure • Proximity
SFF	Number	Safe Failure Fraction after applying diagnostics for the sensor.	This field is disabled. The APM system calculates this value, which is used to calculate MTTFs.

Protective Instrument Loop Sensor System Records

Protective Instrument Loop Sensor System records store details about a protective instrument loop sensor system that you have created as part of SIL verification. This topic provides an alphabetical list and description of the fields that exist for the Protective Instrument Loop Sensor System family and appear on the Protective Instrument Loop datasheet by default. The information in this table reflects the baseline state and behavior of these fields.

This family is enabled for site filtering, which means that records in this family can be assigned to a specific site, and will only be accessible to users who are assigned to the same site and have the appropriate license and family privileges. For more information, refer to the Sites section of the documentation.

Field	Data Type	Description	Behavior and Usage
Availability	Number	A number representing the percentage of time between proof tests that the logic solver is expected to be available.	The APM system calculates this value using the following calculation: Availability = (1 - PFD) * 100
Calculated PFD Avg	Number	A number representing the probability that the sensor system will fail to react during a demand when the loop is operating in a low demand mode.	This field is disabled. The APM system calculates and populates this value. This value depends on the failure rate of the sensor system.
Calculated PFH	Number	A number representing the probability that the sensor system will fail to react during a demand when the loop is operating in high demand or continuous mode of operation.	This field is disabled. The APM system calculates and populates this value. This value depends on the failure rate of the sensor system.
Calculated STR	Number	A number representing the spurious trip rate for the sensor system.	This field is disabled. The APM system calculates and populates this value.
Common Cause (Beta)	Number	A number representing the percentage of failure that would affect the functioning of multiple devices. For example, a power supply failure for a sensor system that is shared across multiple loops can cause all the loops to fail. In this case, the beta factor is the probability that the loops fail in case of a power supply failure to the sensor system.	If the value in the Voting field is 1oo1 or 1001D, this value is not applicable. This value is populated automatically when you select a device.

Field	Data Type	Description	Behavior and Usage
HFT	Number	A number representing the hardware fault tolerance, or the number of failures the sensor system can tolerate before failing.	For example, a sensor system with 1oo2 redundancy has a HFT of 1 because it can tolerate one failure and can still continue to operate.
MTTFS	Number	A number representing Mean Time To Fail Spuriously for a Sensor System.	This field is disabled. The APM system calculates and populates this value.
Number of Groups	Number	The number of sensor groups in the system.	This field is disabled and populated with the number of sensor groups in the system.
SIL Architectural Constraints	Number	A number that represents the SIL value for the sensor system, which is based on the architectural constraints that are defined in the Test Architecture Constraints field.	This field is disabled. The APM system calculates and populates this value.
SIL Systematic Capability	Number	A number that represents the SIL value for the sensor system, which is based on the systematic capability that is defined in the Test Architecture Constraints field.	This field is disabled. The APM system calculates and populates this value.
System ID	Character	The ID of the sensor system.	This value is required and is populated with a default value. You can, however, provide a different value. This value must be unique.
Voting Between Groups	Character	The voting architecture that represents the minimum number of sensor groups that should trip (in the event of a failure) and the number of sensor groups that are available in the system. For example, if the voting is 1oo2, then for the logic solver to detect a failure, at least one sensor group should trip out of the two sensor groups that are available in the group.	<p>This field is updated automatically when you add or remove a sensor group from the system.</p> <p>The following combinations are available:</p> <ul style="list-style-type: none"> • 1oo1 • 1oo2 • 2oo2 • 1oo3 • 2oo3 • 3oo3 • 1oo4 • 4oo4 <p>This value is required.</p>

Proven In Use Justification Records

Proven In Use Justification records store information about the basis for use of a device (i.e., a Sensor or a Final Element). This topic provides an alphabetical list and description of the fields that exist for the Proven In Use Justification family and appear on the Proven In Use Justification datasheet. The information in the table reflects the baseline state and behavior of these fields.

This family is enabled for site filtering, which means that records in this family can be assigned to a specific site, and will only be accessible to users who are assigned to the same site and have the appropriate license and family privileges. For more information, refer to the Sites section of the documentation.

Field	Data Type	Description	Behavior and Usage
Application	Character	Describes how and where you plan to use the device.	You can enter a value manually.
Comment	Text	Additional information on the basis of justification to use the device in the loop.	You can enter a value manually.
Device Type	Character	The type of device for which the Proven In Use Justification is defined.	You can enter a value manually.
Prepared By	Character	The name of the person who created the justification.	You can enter a value manually.
Prepared Date	Date	The date when the justification was created.	You can select a date in this field.
Subsystem ID	Character	The identification of the subsystem with which the device is associated.	This field does not appear on the datasheet.

Risk Assessment Recommendation Records

Recommendation records store details about the recommendation that you have proposed to mitigate the risk. This topic provides an alphabetical list and description of the fields that exist for the Recommendation family. These fields appear on the Recommendation datasheet, unless otherwise specified. The information in this table reflects the baseline state and behavior of these fields. This list is not comprehensive.

This family is enabled for site filtering, which means that records in this family can be assigned to a specific site, and will only be accessible to users who are assigned to the same site and have the appropriate license and family privileges. For more information, refer to the Sites section of the documentation.

Field	Data Type	Description	Behavior and Usage
Alert Assignee When Due?	Logical	Indicates whether an email notification must be sent to the user selected in the Assigned To Name field when the recommendation is due.	This field appears in the Alert datasheet.
Assigned To Name	Character	The name of the user who is assigned the Recommendation.	You can select a user from the list.
Author Name	Character	The first and last name of the Security User who created the Recommendation.	This field is populated with the name of the user who was logged in while creating the Recommendation.
Business Impact	Character	The impact to the business if the recommended action is performed.	This field contains a list of System Codes that exist in the MI BUSINESS IMPACT System Code Table. You can choose from the following baseline values: <ul style="list-style-type: none"> • Facility Shutdown (FACILITY SHUTDOWN) • Facility Slowdown (FACILITY SLOWDOWN) • Unit Shutdown (UNIT SHUTDOWN) • Unit Slowdown (UNIT SLOWDOWN) • System Shutdown (SYSTEM SHUTDOWN) • System Slowdown (SYSTEM SLOWDOWN)
Completed Date	Date	The date on which the recommended action was performed.	This field contains a  button, which you can select to access the Calendar feature.
Create SAP Notification?	Logical	Indicates whether a notification should be created in an external EAM system when this Recommendation is saved.	None
Days Before Due Date to be Notified	Numeric	The number of days before the Target Completion Date that an email notification must be sent to the user selected in the Assigned To Name field.	This field appears in the Alert datasheet. This field is required when the Alert Assignee When Due check box is selected.

Field	Data Type	Description	Behavior and Usage
Equipment ID	Character	The Equipment that is associated with the Instrumented Function for which you are proposing the Recommendation.	This field is disabled and populated with the value stored in the Equipment ID field in the Instrumented Function datasheet.
Final Approver Name	Character	The name of the user who must grant the final approval for the Recommendation.	You can select a user from the list.
Frequency of Alert After Due Date	Numeric	Specifies how often email messages will be sent after the completion date has passed.	<p>You can choose any of the following options:</p> <ul style="list-style-type: none"> • Never • Daily • Weekly • Monthly • Yearly <p>This field appears in the Alert datasheet. This field is required when the Alert Assignee When Due check box is selected.</p>
Functional Location ID	Character	The Functional Location that is associated with the Instrumented Function for which you are proposing the Recommendation.	This field is disabled and populated with the value stored in the Functional Location ID field in the Instrumented Function datasheet.
Implementation Alert Text	Character	The text that will be included in the email notification sent to the approver.	This field appears in the Alert datasheet.
Interval	Numeric	The interval at which the Action related to the Recommendation needs to be performed. This Action is created as part of an Asset Strategy after the Recommendation is promoted to ASM.	For example, if the value in this field is 4, and if the value in the Interval Units field is Days, then that Action must be performed every four days.
Interval Units	Character	The units of the interval at which the Action related to the Recommendation needs to be performed. This Action is created as part of an Asset Strategy after the Recommendation is promoted to ASM.	For example, if the value in this field is Days, and if the value in the Interval field is 4, then that Action must be performed every four days.

Field	Data Type	Description	Behavior and Usage
Mandatory Date	Date	The date by which the recommended action must be completed if it was not completed by the target completion date.	This field contains a  button, which you can select to access the Calendar feature.
Recommendation Basis	Character	The basis for the Recommendation.	None
Recommendation Description	Character	A description of the Recommendation.	None
Recommendation Headline	Character	A short description of the Recommendation.	If you select the Alert Assignee When Due check box, the value that you provide in the Recommendation Headline field becomes the subject of the alert email.
Recommendation ID	Character	The ID for the Recommendation	This value must be unique.
Recommendation Priority	Character	The priority of the recommended action.	This field contains a list of System Codes that exist in the MI_PRIORITY System Code Table. You can choose from the following baseline values: <ul style="list-style-type: none"> • High (HIGH) • Medium (MEDIUM) • Low (LOW)
Reevaluate?	Logical	Indicates whether you want to reevaluate the Recommendation.	This field appears in the Alert datasheet.
Reevaluation Alert Body Text	Character	The text that will be included in the reevaluation email message.	This field appears in the Alert datasheet. This field is enabled only when the Reevaluate? check box is selected.
Reevaluation Date	Date	The date on which a reevaluation email message will be sent to the users selected in the Reevaluation Notification List field.	This field appears in the Alert datasheet. This field is required when the Reevaluate? check box is selected.
Reevaluation Notification List	Character	The users to whom the reevaluation email message will be sent.	This field appears in the Alert datasheet. This field is enabled and is required when the Reevaluate? check box is selected.

Field	Data Type	Description	Behavior and Usage
Required Equipment Status	Character	The state in which the equipment should exist before performing the recommended action against it.	This field contains a list of System Codes that exist in the MI_STATUS System Code Table. You can choose from the following baseline values: <ul style="list-style-type: none"> • ON-LINE (ON-LINE) • Off-Line (OFF-LINE) • Not Applicable (N/A)
Reviewer Name	Character	The name of the user who will review the Recommendation.	You can select a user from the list.
Status	Character	The status of the Recommendation.	This field contains a list of the following states: <ul style="list-style-type: none"> • Created (CREATED) • Pending Review (PENDING REVIEW) • Reviewed (REVIEWED) • Rejected (REJECTED) • Cancelled (CANCELLED) • Superseded (SUPERSEDED)
Target Completion Date	Date	The date by which the recommended action should be completed.	This field contains a  button, which you can select to access the Calendar feature.
Work Request Equipment	Character	The work request number when a recommendation is converted from a notification within the EAM to a work order. (e.g., using functionality provided with the SAP Interfaces, Oracle EBS eAM Interfaces, and Maximo Interfaces).	This field is disabled and populated after the external work request is created.

Field	Data Type	Description	Behavior and Usage
Work Request Functional Location	Character	The work request number when a recommendation is converted from a notification within the EAM to a work order. (e.g., using functionality provided with the SAP Interfaces, Oracle EBS eAM Interfaces, and Maximo Interfaces).	This field is disabled and populated after the external work request is created.
Work Request Reference	Character	The ID of the external work request that was created from this Recommendation(e.g., using functionality provided with the SAP Interfaces, Oracle EBS EAM Interfaces, and Maximo Interfaces).	This field is disabled and populated after the SAP Notification or Oracle EBS EAM Work Request is created.

SIF Common Cause Failure Records

SIF Common Cause Failure records store details about a failure or a condition within a plant that can affect the operation of multiple instrumented functions (i.e., common cause failures). This topic provides an alphabetical list and description of the fields that exist for the SIF Common Cause Failure family and appear on the SIF Common Cause Failures datasheet. The information in the table reflects the baseline state and behavior of these fields.

This family is enabled for site filtering, which means that records in this family can be assigned to a specific site, and will only be accessible to users who are assigned to the same site and have the appropriate license and family privileges. For more information, refer to the Sites section of the documentation.

Field	Data Type	Description	Behavior and Usage
CCF Description	Text	The description of the common cause failure.	This field is required. On the SIF Common Cause Failure datasheet, you can select the button to define this value manually via the CCF Description dialog box.
CCF ID	Character	The ID for the common cause failure.	This field is required. On the Common Cause Failures tab on the <Record ID> (Instrumented Function) window, this value appears as a hyperlink that you can select to access the contents of the corresponding SIF Common Cause Failure in a new window.
CCF Mitigation	Text	A brief description of ways to mitigate the effect of the common cause failure.	This field is required. On the SIF Common Cause Failure datasheet, you can select the button to define this value manually via the CCF Mitigation window.

SIL Analysis Records

SIL Analysis records store details about an SIL analysis. This topic provides an alphabetical list and description of the fields that exist for the SIL Analysis family. The information in this table reflects the baseline state and behavior of these fields. This list is not comprehensive.

This family is enabled for site filtering, which means that records in this family can be assigned to a specific site, and will only be accessible to users who are assigned to the same site and have the appropriate license and family privileges. For more information, refer to the Sites section of the documentation.

Field	Data Type	Description	Behavior and Usage
Analysis Description	Character	A brief description for the SIL analysis.	None
Analysis End Date	Date	The date on which the SIL analysis will end.	You can enter or select the appropriate date. The start date must be later than the date in the Analysis Start Date field, or an error message will appear. When you copy an SIL Analysis, the value in this field is not copied to the new record.

Field	Data Type	Description	Behavior and Usage
Analysis ID	Character	The ID for the SIL analysis.	This field is required and must be unique. If you access an existing SIL Analysis and delete the value in the Analysis ID field, if you then re-enter that same value and try to save the record, an error message will appear, indicating that the Analysis ID already exists.
Analysis Re-evaluation	Number	A number indicating how many years after the completion of the Hazards Analysis that is associated with the SIL analysis that the Hazards Analysis should be re-evaluated.	On the datasheet, this field appears as a text box that is labeled Hazards Next Reevaluation Interval with an additional label, Years, to the right of the text box. If the SIL Analysis is linked to a Hazards Analysis, this field is populated automatically with the value in the Reevaluation Interval field in the Hazards Analysis that is linked to this SIL Analysis. If this SIL Analysis is not linked to a Hazards Analysis, this field is enabled and you can populate it manually.
Analysis Start Date	Date	The date on which this SIL analysis was started.	You can enter or select the appropriate date. The analysis start date must be earlier than the end date of the analysis, or an error message will appear. When you copy an SIL Analysis, this field is populated automatically with the current date.
Equipment ID	Character	The ID for the Equipment that is linked to this SIL analysis. This is the equipment for which the SIS exists to mitigate the risk of failure on that equipment.	On the datasheet, this field is disabled and contains a  button, which you can select to search for an existing Equipment to link to the SIL Analysis.
Equipment Key	Number	The Entity Key of the Equipment that is linked to the SIL Analysis.	By default, this field does not appear on the SIL Analysis datasheet.

Field	Data Type	Description	Behavior and Usage
Facilitator	Character	The name of the SIL analysis team member who is specified as the Facilitator on the SIL Analysis Team page.	By default, this field does not appear on the SIL Analysis datasheet.
Functional Location ID	Character	The ID for the Functional Location that is linked to this SIL Analysis.	On the datasheet, this field is disabled and contains a  button, which you can select to search for an existing Functional Location to link to the SIL Analysis.
Functional Location ID	Number	The Entity Key of the Functional Location that is linked to the SIL Analysis.	By default, this field does not appear on the SIL Analysis datasheet.
Hazards Analysis Date	Date	The value that exists in the Last Modified Date field in the Hazards Analysis whose record ID appears in the Hazards Analysis Reference field.	If the SIL Analysis is linked to a Hazards Analysis, this field is populated with the value in the Last Modified Date field in that Hazards Analysis. If the SIL Analysis is not linked to a Hazards Analysis, this field is enabled, and you can enter a value.
Hazards Analysis Reference	Character	The ID of the Hazards Analysis that is linked to the SIL Analysis.	On the datasheet, this field is disabled and contains a  button, which you can select to search for an existing Hazards Analysis to link to the SIL Analysis. After you select the Hazards Analysis, the Hazards Analysis Reference field is populated automatically with the Record ID from the corresponding Hazards Analysis. The Hazards Analysis ID appears as a hyperlink, which opens in a new window the Hazards Analysis with that ID. Note: In order to link a Hazards Analysis to an SIL Analysis, you must have at least View privileges to the Hazards Analysis family.
Hazards Analysis Reference Key	Number	The Entity Key for the Hazards Analysis that is linked to the SIL Analysis.	By default, this field does not appear on the SIL Analysis datasheet.

Field	Data Type	Description	Behavior and Usage
Hazards Analysis Reevaluation Date	Date	The date on which the Hazards Analysis that is associated with the SIL analysis should be re-evaluated.	This field is populated automatically with the output of the following calculation: Hazards Reevaluation Date = Hazards Analysis Date + Analysis Re-evaluation If the SIL Analysis is not linked to a Hazards Analysis (i.e., the record from which the values in the calculation shown above are mapped), this field is enabled, and you can enter a value manually. On the datasheet, this field is labeled HAZOPS Reevaluation Date.
Hazards Analysis Revision	Character	The numeric value that exists in the Revision Number field in the Hazards Analysis whose Record ID appears in the Hazards Analysis Reference field.	If the SIL analysis is linked to a Hazards Analysis, this field is populated with the value in the Revision Number field in that Hazards Analysis. If the SIL Analysis is not linked to a Hazards Analysis, this field is enabled, and you can populate it manually.
Hazards Analysis State	Character	The current state of the Hazards Analysis that is linked to the SIL Analysis.	If the SIL Analysis is linked to a Hazards Analysis, this field is populated with the state of that Hazards Analysis. If the SIL Analysis is not linked to a Hazards Analysis, this field is enabled, and you can enter a value.
Is Deleted	Logical	Specifies whether the SIL Analysis has been removed from the SIL Analysis search results.	The value in this field is used by the APM system. You should not modify this value. By default, this field does not appear on the SIL Analysis datasheet.
Last Modified By	Character	The name of the APM Security User who last modified the record.	This field is disabled and populated with the name of the user who was logged in when the record was last modified. When you copy an SIL Analysis, the value in this field is not copied.

Field	Data Type	Description	Behavior and Usage
Last Modified Date	Date	The date on which the record was last modified.	This field is disabled and populated. When you copy an SIL Analysis, the value in this field is not copied.
Logic Solver Failure Response	Text	A description of how the logic solver responds to a failure.	The value in this field is set by default. You can remove the default value and enter your own values. This field contains a button, which you can select to access the Text Editor.
Long Description	Text	A detailed explanation of the SIL analysis that you want to conduct.	None
Loss of SIS Energy Sources	Text	A description of how the safety instrumented system responds to a loss of energy.	The value in this field is set by default. You can remove the default text and enter your own values.
Normal Operation Requirement	Text	A description of the requirements for the normal mode of the instrumented function.	The value in this field is set by default. You can remove the default value and enter your own values.
Owner	Character	The name of the SIL analysis team member who is specified as the Process Owner of the SIL Analysis.	This field is disabled and populated automatically with the first and last name of the team member as it appears in the First Name and Last Name fields in the user's Human Resource record.
Process Owner	Character	The name of the SIL analysis team member who is specified as the Process Owner of the SIL Analysis.	This value is used to populate the Owner field and does not appear on the SIL Analysis datasheet by default.
Requirement for SRS Review	Text	A description of the requirement for the safety requirement review.	The value in this field is set by default. You can remove the default value and enter your own values.
SIF Bypass Requirements	Text	A description of the bypass requirements for the instrumented function.	The value in this field is set by default. You can remove the default value and enter your own values.
SIF Common Cause Sources	Text	A description of the sources for common cause failures in instrumented functions.	The value in this field is set by default. You can remove the default value and enter your own values.

Field	Data Type	Description	Behavior and Usage
SIF Demand Mode of operation	Text	A description of the demand mode associated with an instrumented function.	The value in this field is set by default. You can remove the default value and enter your own values.
SIF Diagnostics	Text	A description of component diagnostics for an instrumented function.	The value in this field is set by default. You can remove the default value and enter your own values.
SIF Emergency Requirement	Text	A description of the requirement for an instrumented function in the case of emergency.	The value in this field is set by default. You can remove the default value and enter your own values.
SIF Failure Modes	Text	A description of the configuration of instrumented function failure modes.	The value in this field is set by default. You can remove the default value and enter your own values.
SIF Maintenance Overrides	Text	A description of the manual override procedures needed for maintenance on an instrumented function.	The value in this field is set by default. You can remove the default value and enter your own values.
SIF Manual Shutdown	Text	A description of the manual shutdown operation for an instrumented function.	The value in this field is set by default. You can remove the default value and enter your own values..
SIF Pre-Alarms	Text	A description of the pre-alarms for an instrumented function.	The value in this field is set by default. You can remove the default value and enter your own values.
SIF Process Interfaces	Text	A description of process interfaces for instrumented functions.	The value in this field is set by default. You can remove the default value and enter your own values.
SIF Proof Test Interval	Text	The interval, in years, for which proof tests are conducted for an instrumented function.	The value in this field is set by default. You can remove the default value and enter your own values.
SIF Proof Test Procedures	Text	A detailed description of the proof test procedures associated with an instrumented function.	The value in this field is set by default. You can remove the default value and enter your own values.
SIF Protection Mode	Text	A description of the way in which the instrumented function will respond in protection mode.	The value in this field is set by default. You can remove the default value and enter your own values.

Field	Data Type	Description	Behavior and Usage
SIF Regulations and Standards	Text	A description of all the regulations and standards associated with an instrumented function.	For example, if you have a low flow SIF, you will not be able to start the process because the flow will already be low. In this case, you may specify that a low flow bypass shall be implemented where the minimum flow set point must be exceeded for 30 seconds before the instrumented function is activated. The value in this field is set by default. You can remove the default value and enter your own values.
SIF Response Time	Text	The maximum time that the instrumented function can take to detect a hazard and take the process to a safe state.	Also referred to as process safety time.
SIF Start Up Requirements	Text	Special requirements for the instrumented function that only apply when the process is being started.	The value in this field is set by default. You can remove the default value and enter your own values.
SIF Spurious Trip Rate	Text	A description of the acceptable spurious trip rate for an instrumented function.	The value in this field is set by default. You can remove the default value and enter your own values.
SIF Trip Reset	Text	A description of the reset procedures in the case of a tripped instrumented function.	The value in this field is set by default. You can remove the default value and enter your own values.
SIS Design Requirements	Text	A description of the design requirements for the safety instrumented system.	The value in this field is set by default. You can remove the default value and enter your own values.
SIS Electrical Power	Text	A description of the specific electrical requirements for the safety instrumented system.	The value in this field is set by default. You can remove the default value and enter your own values.
SIS Environmental Conditions	Text	A description of the environmental operating conditions of the safety instrumented system.	The value in this field is set by default. You can remove the default value and enter your own values.

Field	Data Type	Description	Behavior and Usage
SIS Interfaces	Text	A description of the interfaces for the safety instrumented system.	The value in this field is set by default. You can remove the default value and enter your own values.
SIS Logic Solver Failure Response	Text	The state to which the process must be taken in case of a logic solver failure (e.g., a recurring diagnostic message must be sent to the operator every four hours indicating that the logic solver has a detected failure).	The value in this field is set by default. You can remove the default value and enter your own values.
SIS Mission Time	Number	A numeric value (in years) that represents the time that the safety instrumented system will be in use.	None
SIS Sequence of Events Recording	Text	A description of sequence of event recordings that exist for the safety instrumented system.	This field is populated automatically. You can remove the default value and enter your own values if needed.
SIS Software Requirements	Text	A description of the software programming languages that are permitted for use.	This field is populated automatically. You can remove the default value and enter your own values if needed.
Site Description	Character	A description of the site specified in the Site ID field.	By default, this field does not appear on the SIL Analysis datasheet.
Site ID	Character	The ID of the site that is associated with the SIL analysis.	This field contains IDs taken from the Name field for each existing Site Reference records. The record that you select here is used to identify which risk matrix to display when you create Risk Assessment records in SIS Management. If this field is empty, the default risk matrix will be used.
SRS Methodology	Text	A long description of the methodology for the Safety Requirement Specification report.	The value in this field is set by default. You can remove the default value and enter your own values.
SRS Purpose and Scope	Text	A long description of the purpose and scope of the Safety Requirement Specification report for the SIL analysis.	The value in this field is set by default. You can remove the default value and enter your own values.

Field	Data Type	Description	Behavior and Usage
SRS Standards Used	Text	A description of the standards that are used within the Safety Requirement Specification report.	The value in this field is set by default. You can remove the default value and enter your own values.
System Definition	Text	A description of the safety instrumented system.	The value in this field is set by default. You can remove the default value and enter your own values.
Unit Description	Character	A description of the unit that is specified in the Unit ID field.	By default, this field does not appear on the SIL Analysis datasheet.
Unit ID	Character	The ID for the unit where the safety instrumented system for which you are conducting the SIL analysis exists.	None

SIL Threshold Records

SIL Threshold records store information about the numeric range for risk value for each Safety Integrity level, and are used when assessing SIL value using Risk Matrix or PHA. This topic provides an alphabetical list and description of the fields that exist for the SIL Threshold family. The information in the table reflects the baseline state and behavior of these fields.

Important: The records in this family can be modified only by users who belong to the Security Groups MI SIS Administrator.

This family is not enabled for site filtering, which means that records in this family can be accessed by any user with the appropriate license and family privileges. For more information, refer to the Sites section of the documentation.

Field	Data Type	Description	Behavior and Usage
Lower Boundary	Numeric	The lower boundary value of risk rank for the SIL value identified in the SIL level field.	You can enter a value manually.
Mitigated Risk Factor	Numeric	A number indicating the tolerable risk probability for an Instrumented Function.	<p>You can enter a value greater than 0 and less than or equal to 1.</p> <p>The value in this field is divided by the Driving Risk Rank value in the Risk Matrix of the SIL Assessment to determine the Required Probability of Failure.</p> <p>If this field is blank, a default value of 1 will be used in the calculation.</p>

Field	Data Type	Description	Behavior and Usage
SIL Level	Numeric	The Safety Integrity Level for which the unmitigated risk range is defined.	You can enter a value manually.
Upper Boundary	Numeric	The upper boundary value of risk rank for the SIL value identified in the SIL level field.	You can enter a value manually.

SIS Proof Test Records

SIS Proof Test records store details about a proof test that is executed, including the results of the proof test. This topic provides an alphabetical list and description of the fields that exist for the SIS Proof Test family and appear on the SIS Proof Test datasheet, unless otherwise specified. The information in the table reflects the baseline state and behavior of these fields.

This family is enabled for site filtering, which means that records in this family can be assigned to a specific site, and will only be accessible to users who are assigned to the same site and have the appropriate license and family privileges. For more information, refer to the Sites section of the documentation.

Field	Data Type	Description	Behavior and Usage
Actual Work Time	Numeric	The number of hours required to complete the SIS Proof Test.	If the SIS Proof Test is integrated with Work Management, the value in this field is used to create a confirmation record when the SIS Proof Test is closed.
Cleared All Bypasses and Forced Logic	Logical	Indicates whether or not you have cleared all bypasses and forced logic while performing the proof test.	None
Commencement Date	Date	The date on which the proof test was started.	None
Completion Date	Date	The date on which you completed the proof test.	None
Equipment Operating State	Character	The current state of the equipment that you are testing.	This field contains the System Codes that exist in the MI EQUIP OP STATE System Code Table. You can choose from the following baseline values: <ul style="list-style-type: none"> ON-LINE (ON-LINE) Off-Line (OFF-LINE) Not Applicable (NA)
Functional Test Closed	Logical	A value that indicates whether or not the proof test has been completed.	If you select this check box, all fields on the SIS Proof Test datasheet are disabled.

Field	Data Type	Description	Behavior and Usage
Functional Test Status	Character	Stores the current status of the proof test.	This field contains the System Codes that exist in the MI FUNCTIONAL TEST STATUS System Code Table. You can choose from the following baseline values: <ul style="list-style-type: none"> Active Complete Closed
Functional Test Template	Character	The ID of the SIS Proof Test Template that was used to create the SIS Proof Test.	This field contains a list of proof test templates that are approved and linked to the instrumented function on which you are conducting the proof test. This field is required. After you select a template from the list and save the record, this field is disabled. The Proof Test Template Detail records linked to the selected template are listed in the Analysis Details section.
SIS Or PIF Key	Numeric	The Entity Key of the Instrumented Function or the Logic Solver to which the SIS Proof Test record is linked.	This field does not appear on the datasheet by default.
SIS Tester Name	Character	The name of the user who is responsible for performing the proof test.	This field contains the names of: <ul style="list-style-type: none"> The Security User who created the SIS Proof Test -and- Members of the MI SIS Administrator, MI SIS Engineer, or MI SIS User Security Groups
Task Addressed	Numeric	The inspection task that is addressed by the proof test.	This field contains the inspection tasks that are linked to the instrumented function or the logic solver on which you have performed the proof test.
Test Description	Character	A description of the proof test.	None
Test ID	Character	The ID for the proof test.	None

Field	Data Type	Description	Behavior and Usage
Test Summary	Text	A summary of the proof test that you have performed.	None
Type of Test	Character	The type of the proof test that you have performed.	This field contains the following baseline values: <ul style="list-style-type: none"> • Functional Test • System Validation

SIS Proof Test Task Records

SIS Proof Test Task records store details about an inspection task of the type proof test. This topic provides an alphabetical list and description of the fields that exist for the SIS Proof Test family and appear on the SIS Proof Test datasheet, unless otherwise specified. The information in the table reflects the baseline state and behavior of these fields.

This family is enabled for site filtering, which means that records in this family can be assigned to a specific site, and will only be accessible to users who are assigned to the same site and have the appropriate license and family privileges. For more information, refer to the Sites section of the documentation.

Field	Data Type	Description	Behavior and Usage
Coverage	Number	A number that indicates how confident you are that the proof test will be able to detect failures.	Enter a value between 0 and 100.
Desired Interval	Number	A number indicating how often the task should be completed.	This number must be between the Min Interval and Max Interval values. Before you can save a value in this field, the Last Date field must contain a value. The next date is calculated automatically using both the last date and desired interval. The units that you select for the desired interval are also applicable to the Max Interval and Min Interval.
Desired Interval Basis	Character	The basis on which you have specified the desired interval.	None

Field	Data Type	Description	Behavior and Usage
Last Date	Date	The date on which the associated Proof Test Event is closed.	By default, this field contains the date on which the Proof Test Task is created. After you close the Proof Test Event linked to this Proof Test Task, this field is disabled and populated with the date on which the Proof Test Event is closed. This value is also populated in the Date Executed field in the Task Execution record that is linked to this Proof Test Task.
Max Date	Date	The latest date by when you must perform the task.	This field is disabled and calculated as follows: Max Date = Last Date + Max Interval
Max Interval	Number	The maximum interval to perform the task. For example, if the value in this field is 30 days, it implies that you must perform the task within 30 days from the day you last performed the task.	None
Min Date	Date	The earliest date on which you can perform the task.	This field is disabled and calculated as follows: Min Date = Last Date + Min Interval
Min Interval	Number	The minimum interval to perform the task. For example, if the value in this field is 15 days, it implies that you must perform the task after 15 days from the day you last performed this task.	None
Modifiable	Logical	Indicates whether the Task can be modified.	This check box is selected automatically when you create a Proof Test Task and cleared after you save the record.

Field	Data Type	Description	Behavior and Usage
Next Date	Date	The suggested date by when you must perform the task. For example, if the value in this field is 20 days, it is suggested that you perform the proof test task after 20 days from the day you last performed this task.	This field is disabled and calculated as follows: Next Date = Last Date + Desired Interval
Next Date Basis	Character	The basis on which you have specified the next date for performing the task.	None
Override Interval	Logical	Indicates whether you can override the value in the Desired Interval field.	If you select this check box, you can modify the value in the Desired Interval field.
Rejectable	Logical	Indicates whether the task can be rejected.	If you clear this check box, you will not be able to reject the task.
Related Entity ID	Character	The ID of the Asset that is linked to the task.	None
Reoccurring	Logical	Indicates whether the task is recurring.	None
Source Type	Character	The type of the source for the proof test (e.g., Hazards Analysis, SIS, FMEA).	None
Task Assigned To	Character	The name of the person who has been assigned the task.	None
Task Description	Character	A description for the task.	None
Task Details	Character	The details of the task.	None
Task ID	Character	The ID for the task.	This field must be unique.
Task State	Character	The state associated with the Calibration Task. By default this field contains the value Proposed.	This field contains a list of states. After you save a new Calibration Task, this value is changed automatically from Proposed to Scheduled without change.

Field	Data Type	Description	Behavior and Usage
Task Type	Character	The type of task.	This field appears contains a list of values from the Task Type family that correspond to types of calibrations (e.g., CALIBRATION: AUTOMATED, ANALOG, 11 UP/DN, LINEAR, DCV/DCV). You must select the value PROOF TEST.
Unconstrain Min/Max Dates	Logical	Indicates whether you can override the next date.	When you select this check box, the values in the Min Date and Max Date fields are cleared.

SIS Proof Test Template Records

SIS Proof Test Template records store details about the proof test template that they represent. This topic provides a list of the fields that exist in the SIS Proof Test Template family.

This family is enabled for site filtering, which means that records in this family can be assigned to a specific site, and will only be accessible to users who are assigned to the same site and have the appropriate license and family privileges. For more information, refer to the Sites section of the documentation.

Field	Data Type	Description	Behavior and Usage
Author	Character	The name of the user who defined the proof test template.	This field contains a list of all the users in the APM system. When you create a Proof Test Template, this field is populated with the name of the user who is currently logged in.
Modified By	Character	The name of the user who last modified the SIS Proof Test Template.	This field is disabled and populated with the name of the person who is currently logged in.
Modified Date	Date	The date on which the Proof Test Template was last modified.	This field is disabled and populated.
Pre-Test Conditions	Text	A description of the required conditions of the equipment or system on which the proof test will be performed.	None

Field	Data Type	Description	Behavior and Usage
Template Description	Character	A brief description of the proof test.	None
Template ID	Character	The ID for the proof test template.	This field is populated with a default value in this format: PTT - <ID of the Instrumented Function or the Logic Solver> - <date and time of creating the template> You can modify this value if required. This value must be unique.

SIS Proof Test Template Detail Records

This topic provides a list of the fields that exist in the SIS Proof Test Template Detail family. This list is not comprehensive.

This family is enabled for site filtering, which means that records in this family can be assigned to a specific site, and will only be accessible to users who are assigned to the same site and have the appropriate license and family privileges. For more information, refer to the Sites section of the documentation.

Field	Data Type	Description	Behavior and Usage
Comments	Character	Comments about the proof test.	This field does not appear in the Proof Test Template datasheet. However, it appears in the Functional Test Detail datasheet when you link this Proof Test Template to a Proof Test. This field also appears when you print the Proof Test Template.
Equipment ID	Character	The ID of the Equipment against which the step should be performed.	You can select the associated Equipment by selecting the in the Equipment ID field.
Location ID	Character	The ID of the Functional Location against which the step should be performed.	You can select the associated Functional Location by selecting the Location ID field.
Result Criteria	Text	A description of what is considered to be an acceptable result of the step.	None

Field	Data Type	Description	Behavior and Usage
Step Sequence Number	Number	A number that represents the order in which the step should be performed, relative to other steps.	When you create a new SIS Proof Test Template Detail this value is set automatically based upon the values in existing SIS Proof Test Template Details. You can modify this value manually in both new and existing records.
Step Type	Character	The type of step.	On the datasheet, you can select the step type from a list of the following options: <ul style="list-style-type: none"> • Pretest Setup • Sensor • Logic Solver • Final Element • Post Test Procedure
Template Detail ID	Character	An alphanumeric value that identifies the SIS Proof Test Template Detail.	This field is populated with a default value appended with the step number and the step type. You can modify this value if required. This value must be unique.
Travel Time Limit	Number	A number that quantifies the maximum acceptable travel time for this step, in seconds.	This field is enabled only in SIS Proof Test Template Details where the step type is Final Element.
Trip Point	Number	A number that defines when the element will activate an SIS shutdown.	This field is enabled only in SIS Proof Test Template Details where the step type is either Sensor, Final Element, or Logic Solver.
Trip Point Direction	Character	The trend of Trip Point values.	This field is enabled only in SIS Proof Test Template Details where the step type is either Sensor, Final Element, or Logic Solver.

Field	Data Type	Description	Behavior and Usage
Trip Point Error Limit	Number	A value that defines the range, plus or minus, within which the Trip Point value must fall to be acceptable.	This field is enabled only in SIS Proof Test Template Details where the step type is either Sensor, Final Element, or Logic Solver.
Trip Point Units	Character	The unit of measure associated with the value in the Trip Point field.	This field is populated with a list of System Codes that exist in the UOME system code table. This field is enabled only in SIS Proof Test Template Details where the step type is either Sensor, Final Element, or Logic Solver.

SIS Trip Report Records

This topic provides a list of the fields that exist in the SIS Trip Report family. This list is not comprehensive.

This family is enabled for site filtering, which means that records in this family can be assigned to a specific site, and will only be accessible to users who are assigned to the same site and have the appropriate license and family privileges. For more information, refer to the Sites section of the documentation.

Field	Data Type	Description	Behavior and Usage
Created By	Character	The ID of the user who created the SIS Trip Report.	This field is disabled and populated.
Created Date	Date	The date on which you have created the SIS Trip Report.	This field is disabled and populated.
Initiating Event Description	Character	The description of the event that initiated the trip.	None
Logic Solver ID	Character	The ID and description of the Logic Solver which is linked to the SIS Trip Report.	This field is required. When you add an SIS Trip Report Detail, you can select an Instrumented Function from among those that are linked to this Logic Solver.
LPO Costs	Number	Lost Profit Opportunity (LPO) costs represents the approximate profits that are lost because of the trip.	You can enter a value manually.
Modified By	Character	The ID of the user who modified the SIS Trip Report.	This field is disabled and populated.
Modified Date	Date	The date on which the SIS Trip Report has been modified.	This field is disabled and populated.

Field	Data Type	Description	Behavior and Usage
System Down Time	Number	The duration, in hours, for which the safety instrumented system has been shut down because of the trip.	None
Trip Date	Date	The date on which the trip occurred.	This field contains a  button, which you can select to access the Calendar feature.
Trip Report Description	Character	The description of the SIS Trip Report.	None
Trip Report ID	Character	The ID of the SIS Trip Report.	This field is required and must be unique.
Trip Type	Character	The type of the trip.	This field contains the following values: <ul style="list-style-type: none"> Spurious Trip (Spurious) Unsafe Demand (Unsafe)

Software Records

This topic provides an alphabetical list and description of the fields that exist for the Software family and appear on the Software datasheet, unless otherwise specified. The information in the table reflects the baseline state and behavior of these fields.

Field	Data Type	Description	Behavior and Usage
Is Default	Logical	Indicates whether the record is the default one.	If set true, then the SRS Template is a default template for the category supplied by GE Vernova.
Last Modified By	Character	The name of the user who last modified the record.	On the datasheet, this field is disabled and updated automatically whenever the record is modified.
Last Modified Date	Date	The date on which the record was last modified.	On the datasheet, this field is disabled and populated automatically.
Revision Number	Numeric	A number that represents the number of times the record has been revised.	On the datasheet, this field is disabled and populated.
SIS Firmware 61508 Certificate	Text	Certificate location and certifying agency for the SIS firmware (typically from exida or TUV)	On the datasheet, this field appears as a text box, in which you can enter the certifying agency for the SIS firmware, as well as the location and validity of the certificate.

Field	Data Type	Description	Behavior and Usage
SIS Firmware Version	Text	The firmware version of the SIS from the OEM.	On the datasheet, this field appears as a text box, in which you can enter the firmware version for the SIS firmware, typically supplied by the OEM.
SIS Maintenance Software Name	Text	The name of the SIS maintenance software (for example: GE ToolboxST)	On the datasheet, this field appears as a text box, in which you can enter the name and version of the SIS maintenance software and other licensing details.
SIS Maintenance Software Version Number	Text	The software version compatible with the SIS hardware.	On the datasheet, this field appears as a text box, in which you can enter the version of the SIS maintenance software compatible with the SIS hardware.
SIS Programming Software Name	Text	The name of the SIS maintenance software (for example: GE ToolboxST)	On the datasheet, this field appears as a text box, in which you can enter the name and version of the SIS programming software and other licensing details.
SIS Programming Software Version Number	Text	The software version compatible with the SIS hardware.	On the datasheet, this field appears as a text box, in which you can enter the version of the SIS programming software compatible with the SIS hardware.
SIS Software Requirements	Text	The workstation and other platform requirements for the software.	On the datasheet, this field appears as a text box, in which you can enter the workstation and other platform requirements (such as Windows 10 profession version) for the SIS maintenance software and SIS programming software.
SRS Template Description	Character	A description of the record.	On the datasheet, this field appears as a text box labeled Description , in which you can enter a description of the record.
SRS Template ID	Character	The ID of the record.	On the datasheet, this field appears as a text box labeled Field ID , in which you can type the ID.

SRS Project Records

This topic provides an alphabetical list and description of the fields that exist for the SRS Project family and appear on the SRS Project datasheet, unless otherwise specified. The information in the table reflects the baseline state and behavior of these fields.

Field	Data Type	Description	Behavior and Usage
Last Modified By	Character	The name of the user who last modified the record.	On the datasheet, this field is disabled and updated automatically whenever the record is modified.
Last Modified Date	Date	The date on which the record was last modified.	On the datasheet, this field is disabled and populated automatically.
Project Description	Character	A description of the record.	On the datasheet, this field appears as a text box labeled Description , in which you can enter a description of the record.
Project ID	Character	The ID of the record.	On the datasheet, this field appears as a text box labeled ID , in which you can type the ID.
Revision Number	Numeric	A number that represents the number of times the record has been revised.	On the datasheet, this field is disabled and populated.

SRS Template Records

This topic provides an alphabetical list and description of the fields that exist for the SRS Template family, unless otherwise specified. The information in the table reflects the baseline state and behavior of these fields.

Field	Data Type	Description	Behavior and Usage
Is Default	Logical	Indicates whether the record is the default one.	If set true, then the SRS Template is a default template for the category supplied by GE Vernova.
Last Modified By	Character	The name of the user who last modified the record.	On the datasheet, this field is disabled and updated automatically whenever the record is modified.
Last Modified Date	Date	The date on which the record was last modified.	On the datasheet, this field is disabled and populated automatically.

Field	Data Type	Description	Behavior and Usage
Revision Number	Numeric	A number that represents the number of times the record has been revised.	On the datasheet, this field is disabled and populated.
SRS Template Description	Character	A description of the record.	On the datasheet, this field appears as a text box labeled Description , in which you can enter a description of the record.
SRS Template ID	Character	The ID of the record.	On the datasheet, this field appears as a text box labeled Field ID , in which you can type the ID.

Testing/Faults Records

This topic provides an alphabetical list and description of the fields that exist for the Testing/Faults family and appear on the Testing/Faults datasheet, unless otherwise specified. The information in the table reflects the baseline state and behavior of these fields.

Field	Data Type	Description	Behavior and Usage
Design Requirements to Support Testing	Text	The design details for testing the SIS.	On the datasheet, this field appears as a text box, in which you can enter the SIS testing details.
Fault or Failure Alarms or Status Indicators	Text	The failure, diagnostics, faults and other indicators.	On the datasheet, this field appears as a text box, in which you can enter the SIS failures, faults, diagnostics and other indicators that are available during testing.
Is Default	Logical	Indicates whether the record is the default one.	If set true, then the SRS Template is a default template for the category supplied by GE Vernova.
Last Modified By	Character	The name of the user who last modified the record.	On the datasheet, this field is disabled and updated automatically whenever the record is modified.
Last Modified Date	Date	The date on which the record was last modified.	On the datasheet, this field is disabled and populated automatically.
Revision Number	Numeric	A number that represents the number of times the record has been revised.	On the datasheet, this field is disabled and populated.

Field	Data Type	Description	Behavior and Usage
SIF Common Cause Sources	Text	The common cause failure possible for SIS.	On the datasheet, this field appears as a text box, in which you can enter the common cause failures that can trigger the SIS operation.
SIF Pre-Alarms	Text	The alarms.	On the datasheet, this field appears as a text box, in which you can enter the SIS alarms.
SIF Trip Reset	Text	The method and steps to reset an SIS after a trip.	On the datasheet, this field appears as a text box, in which you can describe the method to reset SIS after a trip.
SRS Template Description	Character	A description of the record.	On the datasheet, this field appears as a text box labeled Description , in which you can enter a description of the record.
SRS Template ID	Character	The ID of the record.	On the datasheet, this field appears as a text box labeled Field ID , in which you can type the ID.
Testing interval	Text	The field describes how often the safety system is expected to be tested (proof testing interval)	On the datasheet, this field appears as a text box, in which you can enter the SIS proof testing interval details including partial proof testing interval details.
Testing methods	Text	The field describes the methodology for the safety system proof testing.	On the datasheet, this field appears as a text box, in which you can enter the SIS proof testing step details including partial proof testing step details.

Catalog Items

Dashboards Folder

The Catalog folder \\Public\Meridium\Modules\SIS Management\Dashboards contains the following items:

Item Name	Behavior and Usage
Asset Safety Dashboard	Displays the Asset Safety Dashboard.
SIL Summary	Displays a prompt for the Entity Key of an SIL Analysis, and then displays the Safety Integrity Level (SIL) distribution for all the Instrumented Functions in the analysis.
SIS Overview	Displays the following graphs: <ul style="list-style-type: none"> • SIL Distribution : Plots the number of Protective Instrument Loops with Safety Integrity Levels (SIL) of 1, 2, 3, and 4. • Proof Testing Results : Plots the number of passed and failed proof tests for the current year and past four years.
Graphs	Contains the following graphs: <ul style="list-style-type: none"> • Proof Tests Pass Fail • Proven In Use Devices by Type • Quantity of Protective Instrumented Loops • Quantity of SIF Trips • View SIL Distribution

LOPA Folder

The Catalog folder \\Public\Meridium\Modules\SIS Management\LOPA contains the following sub-folders:

- **Queries** : The following table displays the queries that exist in the Queries sub-folder.

Query Name	Behavior and Usage
LOPA Conditional Modifiers Search	A search that displays a prompt for the Entity Key for a LOPA, and then displays a list of conditional modifiers that are linked to the specified LOPA. The results of this query appear on the Conditional Modifiers section of the LOPA.
LOPA ILP Search	A search that displays a prompt for the Entity Key for a LOPA, and then displays a list of Independent Layers of Protection that are linked to the specified LOPA. The results of this query appear by default in the Independent Protective Layers section of the LOPA.
LOPA_Analysis_Search	A search that displays a prompt for the Entity Key for a LOPA, and then displays the LOPA records that are linked to a given Instrumented Function.

- **Reports** : The following table displays the items that exist in the Reports subfolder.

Item Name	Behavior and Usage
LOPA Report	Displays a prompt for the Entity Key for a LOPA, and then displays information about the Layer of Protection Analysis that exists in the LOPA and linked records.
Subreports	A sub-folder that contains the reports with the following names: <ul style="list-style-type: none"> ◦ LOPA Consequence Modifiers Report: Supports the LOPA Report. ◦ LOPA ILP Report: Supports the LOPA Report.

PIF Folder

The Catalog folder `\\Public\Meridium\Modules\SIS Management\PIF` contains the following subfolders:

- **Queries:** The following table displays the queries that exist in the Queries subfolder.

Query Name	Behavior and Usage
PIF Query	Displays a prompt for the Entity Key for an Instrumented Function, and then displays information that is stored in the fields in that Instrumented Function.
PIF Risk Matrix Result Query	Displays a prompt for the Entity Key for an Instrumented Function, and then displays the risk rank values that are linked to that Instrumented Function.

- **Reports:** The following table displays the reports that exist in the Reports subfolder.

Report Name	Behavior and Usage
IF Report	Displays a prompt for the Entity Key for an Instrumented Function, and then displays information about the instrumented function and linked records.
IF Risk Matrix Result Report	Supports the IF Report when the SIL Assessment used is Risk Matrix Internal.

Proof Test Templates Folder

The Catalog folder `\\Public\Meridium\Modules\SIS Management\Proof Test Template` contains the following subfolders:

- **Queries:** The following table displays the query that exists in the Queries subfolder.

Query Name	Behavior and Usage
Proof Test Template Query	Displays a prompt for the Entity Key for an SIS Proof Test Template, and then displays information that is stored in that SIS Proof Test Template.

- **Reports:** The following table displays the report that exists in the Reports subfolder.

Report Name	Behavior and Usage
Proof Test Template Report	Displays a prompt for the Entity Key for an SIS Proof Test Template, and then displays summary information that is stored in that SIS Proof Test Template.

Proof Tests Folder

The Catalog folder `\\Public\Meridium\Modules\SIS Management\Proof Tests` contains the following sub-folders:

- **Queries:** The following table displays the queries that exist in the Queries sub-folder.

Query Name	Behavior and Usage
SIS Proof Test Query	Displays a prompt for the Entity Key for an SIS Proof Test, and then displays information that is stored in that SIS Proof Test.
SIS Proof Test Query UNION	Supports the SIS Proof Test Query.

- **Reports:** The following table displays the report that exists in the Reports subfolder.

Report Name	Behavior and Usage
Proof Test Report	Displays a prompt for the Entity Key for an SIS Proof Test, and then displays summary information that is stored in that SIS Proof Test.

Protective Instrument Loop Folder

The Catalog folder `\\Public\Meridium\Modules\SIS Management\Protective Instrument Loop` contains the following subfolders:

- **Queries:** The following table displays the queries that exist in the Queries subfolder.

Query Name	Behavior and Usage
Protective Instrument Loop Query	Displays a prompt for the Entity Key for a Protective Instrument Loop, and then displays information that is stored in that Protective Instrument Loop. This query supports the Protective Instrument Loop Report that is stored in the Reports folder.
Protective Instrument Loop Sensor System Subquery	Displays a prompt for the Entity Key for a Protective Instrument Loop, and then displays information that is stored in the Protective Instrument Loop System that are linked to the Protective Instrument Loop. This query supports the Protective Instrument Loop Report that is stored in the Reports folder.

- **Reports:** The following table displays the items that exist in the Reports subfolder.

Item Name	Behavior and Usage
Protective Instrument Loop Report	Displays a prompt for the Entity Key for a Protective Instrument Loop, and then displays summary information that is stored in that Protective Instrument Loop.
Subreports	A subfolder that contains the PIL Sensor System Report, which supports the Protective Instrument Loop Report.

Queries Folder

The Catalog folder \\Public\Meridium\Modules\SIS Management\Queries contains:

- Queries that support various features with the SIS Management module, including those that support the reports that make up the SRS Report.
- A subfolder, Dashboard Queries, that contains queries that are used to display content on the Asset Safety dashboard.

To simplify the documentation, the items that are stored in this folder are split up into the following groups:

Queries that Support Module-Specific Pages

The following queries are stored in the Catalog folder \\Public\Meridium\Modules\SIS Management\Queries and support module-specific pages within SIS Management.

Query Name	Behavior and Usage	Notes
Add_SIS_Trip_Report_Detail_Search	A search that displays prompts for the Entity Key for a Logic Solver and an SIS Trip Report, and then displays information that is stored in both records.	None
ALL SIL Analysis Recommendations	Displays a list of all the Risk Assessment Recommendation records that are linked to any SIL Analysis.	None
ALL SIL Analysis Tasks	Displays the following prompts, and then displays a list of all the Tasks that meet the specified criteria: <ul style="list-style-type: none"> • Asset ID : The IDs for the Equipment and Functional Location families in the APM database. • Task Family : The names of the Task families that exist in the APM database. 	The results of this query appear in the Proof Test Tasks section of an SIL Analysis.

Query Name	Behavior and Usage	Notes
Export_SIL_Analysis_Search	<p>Displays a prompt for the record state of an SIL Analysis, and then displays a list of SIL Analysis that meet the specified criteria. The State prompt contains a list of record states that are configured for the SIL Analysis family. This list contains the following baseline values by default:</p> <ul style="list-style-type: none"> • All • Active • Complete • Pending Approval • Planning • Review 	This query is used by the SIS Management Export Builder.
Final_Element_Reference_Data_Search	A search that displays a prompt, and then displays a list of Final Elements whose Is Reference Data field value is set to True.	The results of this query appear in the Final Elements section on the SIS Management Overview page.
IF_Safety_Loop_Search	<p>A search that displays a prompt for the record state of a Protective Instrument Loop, and then displays a list of Protective Instrument Loops that are linked to a particular Instrumented Function. The State prompt contains a list of record states that are configured for the Protective Instrument Loop family. This list contains the following baseline values:</p> <ul style="list-style-type: none"> • All • Approval • Design • In Service • Out of Service • Pending Approval 	None
Logic_Solver_Reference_Data_Search	A search that displays a prompt and then displays a list of Logic Solvers whose Is Reference Data field value is set to True.	The results of this query appear in the Logic Solvers section on the SIS Management Overview page.

Query Name	Behavior and Usage	Notes
Safety_Loop_Search	<p>A search that displays a prompt for the record state of a Protective Instrument Loop, and then displays a list of Protective Instrument Loops that meet the specified criteria. The State prompt contains a list of record states that are configured for the Protective Instrument Loop family. By default, the list contains the following baseline values:</p> <ul style="list-style-type: none"> • All • Approval • Design • In Service • Out of Service • Pending Approval 	None
Safety_Loop_Template_Search	<p>A search that displays a prompt for the record state of a Protective Instrument Loop, where the Is Template field value in that record is Yes, and then displays a list of Protective Instrument Loops that are specified as templates and meet the specified criteria.</p>	<p>The results of this query appear on the PIL Templates section on the SIS Management Overview page.</p>
Sensor_Reference_Data_Search	<p>A search that displays a prompt, and then displays a list of Logic Solvers whose Is Reference Data field value is set to True.</p>	<p>The results of this query appear by default in the Sensors section on the SIS Management Overview page.</p>
SIL Analysis Recommendations	<p>Displays a prompt for the Entity Key for an SIL Analysis, and then displays a list of Risk Assessment Recommendation records that are linked to the specified SIL Analysis.</p>	None
SIL_Analysis_Search	<p>A search that displays the following prompts, and then displays a list of SIL Analyses that meet the specified criteria:</p> <ul style="list-style-type: none"> • State : The record states that have been configured for the SIL Analysis family. This list contains the following values: <ul style="list-style-type: none"> ◦ All ◦ Active ◦ Complete ◦ Pending Approval ◦ Planning ◦ Review • SIL Analysis Owner : The names of the users whose names appear in the Owner field in an SIL Analysis. 	<p>The results of this query appears in the SIL Analysis section on the SIS Management Overview page.</p>

Query Name	Behavior and Usage	Notes
SIS Find ASM Actions for IF	Displays a prompt for the Entity Key for an Instrumented Function and is used to find ASM Actions that were created when the specified Instrumented Function was promoted to ASM.	None
SIS Find ASM Risk for IF	Displays a prompt for the Entity Key for an Instrumented Function and is used to find ASM Risks that were created when the specified Instrumented Function was promoted to ASM.	None

Queries that Support the SRS Report

The following queries are stored in the Catalog folder \\Public\Meridium\Modules\SIS Management\Queries, and support the SRS Report and subreports stored in the \SIL\Reports folder.

Query Name	Behavior and Usage
Final_Element_Hazardous_Event_Comb	Displays a prompt for the PIF ID for the Instrumented Function, and then displays values stored in records that make up a protective instrument loop. This query supports the subreport, Final_Element_Subreport.
Final_Element_Query	Displays a prompt for the PIF ID for an Instrumented Function, and then displays values stored in records that make up a protective instrument loop. This query supports the subreport, Loop_Report.
IF_Common_Cause_Failures	Displays a prompt for the PIF ID for an Instrumented Function to which SIF Common Cause Failures are linked, and then displays the values stored in the following fields in the SIF Common Cause Failures that are linked to the specified Instrumented Function: <ul style="list-style-type: none"> • CCF ID • CCF Description • CCF Mitigation This query supports the subreport, IF Subreport.
IF_Concurrent_Safe_State	Displays a prompt for the PIF ID for the Instrumented Function to which Instrumented Functions are linked, and then displays the values stored in the following fields in the Instrumented Function: <ul style="list-style-type: none"> • Concurrent Safe State Hazard • PIF Description • Safe State Description • PIF ID This query supports the subreport IF Subreport.

Query Name	Behavior and Usage
SIL_Analysis_Doc_Query	Displays a prompt for the Entity Key of the SIL Analysis to which all the records that make up an SIL analysis are linked, and then displays all the Reference Documents that are linked to that record. This query supports the subreport, SIL_Doc_Report.
SRS_Report_Query	Displays a prompt for the Entity Key of the SIL Analysis to which all the records that make up an SIL analysis are linked, and then displays values stored in fields that are required in the following records: <ul style="list-style-type: none"> Instrumented Function Safety Instrumented System SIL Analysis This query supports the main SRS Report.
SRS_Sensor_Query	Displays a prompt for the PIF ID for an Instrumented Function, and then displays values stored in records that make up a protective instrument loop. This query supports the subreport, Loop_Report.
SRS_SubReport_Query	Displays a prompt for the PIF ID for an Instrumented Function, and then displays values stored in records that make up a protective instrument loop. This query supports the subreport, Loop_Report.

Dashboard Queries Folder

The queries listed in the following table are stored in the Catalog location \\Public\Meridium\Modules\SIS Management\Queries\Dashboard Queries. In this table, the values listed in the **Query** column refer to the query names. The baseline query captions are the same as the query names.

Query Name	Behavior and Usage
Analysis States	Used to return results that are displayed in the Hazards Analysis Schedule section on the Asset Safety dashboard. In the baseline database, this query is configured to return Hazards Analysis records by state.
Calibration Recommendations	Used to return results that are displayed in the Calibration Recommendations section on the Asset Safety dashboard.
Calibration Recommendations - All	Used by the Calibration Recommendations source query to display content on the Asset Safety dashboard.
Calibration Results - Fail	Used by the Calibration Results for Graph source query to display content on the Asset Safety dashboard.
Calibration Results - Pass as Found	Used by the Calibration Results for Graph source query to display content on the Asset Safety dashboard.
Calibration Results - Pass as Left	Used by the Calibration Results for Graph source query to display content on the Asset Safety dashboard.

Query Name	Behavior and Usage
Calibration Results All	Used by the Calibration Results for Graph source query to display content on the Asset Safety dashboard.
Calibration Results for Graph	Used to return results that are displayed in the Calibration Pass/Fail Results for Last 12 Months section on the Asset Safety dashboard.
Calibration Tasks	Used to return results that are displayed in the Calibration Schedule section on the Asset Safety dashboard.
Calibration Tasks - All	Used by the Calibration Tasks source query to display content on the Asset Safety dashboard.
Filter Widget	Used to return results that are displayed in the Content Filter section on the Asset Safety dashboard.
HAZOP Analysis	Used by one or more source queries to the Asset Safety dashboard.
Last 5 Years	Used by one or more source queries to the Asset Safety dashboard.
Overdue Hazards Analysis	Used to return results that are displayed in the Hazards Analysis Schedule section on the Asset Safety dashboard.
Overdue Proof Test Tasks	Used to return results that are displayed in the Proof Test Schedule section on the Asset Safety dashboard. Asset Safety dashboard.
Proof Tests States	Used by one or more source queries to the Asset Safety dashboard.
Proof Tests States by State	Used by one or more source queries to the Asset Safety dashboard.
Proof Tests States for Graph	Used by one or more source queries to the Asset Safety dashboard.
Proof Test States with Functional Location	Used by one or more source queries to the Asset Safety dashboard.
Protective Instrument Loop States	Used by the Quantity of protective instrument loops by State for Graph source query to display content on the Asset Safety dashboard.
Proven In Use Device Types	Used by the Proven In Use Devices by Type for Graph source query to display content on the Asset Safety dashboard.
Proven In Use Devices by Type	Used by the Proven In Use Devices by Type for Graph source query to display content on the Asset Safety dashboard.
Proven In Use Devices by Type for Graph	Used to return results that are displayed in the Proven in Use Devices by Type section on the Asset Safety dashboard.
Quantity of Hazards Analysis	Used by one or more source queries to the Asset Safety dashboard.

Query Name	Behavior and Usage
Quantity of Protective Instrumented Loops	Used by the Quantity of Protective Instrumented Loops by State for Graph source query to display content on the Asset Safety dashboard. Asset Safety dashboard.
Quantity of Protective Instrumented Loops by State	Used by the Quantity of Protective Instrumented Loops by State for Graph source query to display content on the Asset Safety dashboard.
Quantity of Protective Instrumented Loops by State for Graph	Used to return results that are displayed in the Quantity of Protective Instrumented Loops section Quantity of Protective Instrumented Loops section on the Asset Safety dashboard.
Quantity of SIF Trips	Used to display results that are displayed in the Quantity of SIF Trips sectionQuantity of SIF Trips section on the Asset Safety dashboard.
Quantity of SIL Analysis	Used by one or more source queries to the Asset Safety dashboard.
Quantity of SIL Analysis by State	Used by one or more source queries to the Asset Safety dashboard.
SIF Spurious Trip Reports	Used by one or more source queries to the Asset Safety dashboard.
SIF Trip Report Types	Used by the Quantity of SIF Trips source query to display content on the Asset Safety dashboard.
SIF Unsafe Trip Reports	Used by one or more source queries to the Asset Safety dashboard.
SIL Analysis States	Used by one or more source queries to the Asset Safety dashboard.
SIL Distribution	Used by the SIL Distribution for Graph source query to display content on the Asset Safety dashboard.
SIL Distribution for Graph	Used to return results that are displayed in the View SIL Distribution section on the Asset Safety dashboard.
SIS Proof Test Pass Fail	Used to return results that are displayed in the Proof Tests Pass/Fail section on the Asset Safety dashboard.
SIS Proof Tests Failed	Used by the SIS Proof Test Pass Fail source query to display content on the Asset Safety dashboard.
SIS Proof Tests Passed	Used by the SIS Proof Test Pass Fail source query to display content on the Asset Safety dashboard.
What If Analysis	Used by one or more source queries to the Asset Safety dashboard.

SIL Folder

The Catalog folder \\Public\Meridium\Modules\SIS Management\SIL contains the following sub-folders:

- **Graphs:** The following table displays the graphs that exist in the Graphs sub-folder.

Graph Name	Behavior and Usage	Notes
SIL Analysis Risk Graph	A bar chart that displays a summary of the Risk Rank values that are associated with each Instrumented Function that is linked to the specified SIL analysis. When you access this graph from the SIL Analysis Summary page, the value for the SIL analysis that you are currently accessing is passed in to the ENTY_KEY prompt to return the results for that analysis.	None
SIL Assignment Summary Graph	A pie chart that shows a breakdown of the Selected SIL Level values in the Instrumented Functions that are linked to the specified SIL analysis. This graph is based on the query SIL Assignment Summary Query, which is stored in the folder \\Public\Meridium\Modules\SIS Management\SIL\Queries, and returns a count for each Selected SIL Level value. For example, if five Instrumented Functions that are linked to the SIL Analysis contain the value 2 in the Selected SIL Level field, the count for level 2 would be 5. Each count is displayed as a percentage in the SIL Assignment Summary Graph.	When you access this graph from the SIL Analysis Summary page, the value for the SIL analysis that you are currently accessing is passed in to the ENTY_KEY prompt to return the results for that analysis.

- **Queries:** The following table displays the queries that exist in the Queries sub-folder.

Query Name	Behavior and Usage
SIL Analysis Mitigated Risk Query	Displays risk assessment details that are associated with all SIL Analysis .
SIL Analysis Query	Displays a prompt for the Entity Key for an SIL Analysis, and then displays information that is stored in the specified SIL Analysis.
SIL Analysis Risk Query	Displays a prompt for the Entity Key for an SIL analysis, and then displays risk rank details for the instrumented functions that are linked to the specified SIL Analysis.
SIL Assignment Summary Query	Supports the graph SIL Assignment Summary Graph, and returns a count for each Selected SIL Level value in the Instrumented Functions that are linked to the specified SIL analysis.

- **Reports:** The following table displays the items that exist in the Reports sub-folder.

Report Name	Behavior and Usage
SIL Analysis Report	Displays a prompt for the Entity Key for an SIL Analysis, and then displays in the Report Viewer summary information for the specified SIL Analysis.
SRS Report	Displays a prompt for the Entity Key for the SIL Analysis to which all the records that make up an SIL analysis are linked, and then displays in the Report Viewer the Safety Requirement Specifications report for the specified SIL analysis. While you can run the report from the Catalog and manually enter the Entity Key for the SIL Analysis, we recommend that you access the report only from within the SIS Management module. You should not modify the SRS Report or any of the supporting queries and sub-reports.
Subreports	The SubReports folder stores the following reports that support the SRS Report, and are supported by queries stored in the Queries folder: <ul style="list-style-type: none"> ◦ Final Element Subreport ◦ IF Subreport ◦ Loop Report ◦ SIL Doc Report

SIS Trip Report Folder

The Catalog folder `\\Public\Meridium\Modules\SIS Management\SIS Trip Report` contains the following sub-folders:

- **Queries:** The following table displays the queries that exist in the Queries subfolder.

Query Name	Behavior and Usage
SIS Trip Report Recommendations	Displays a prompt for the Entity Key for an SIS Trip Report record and then displays the list of Risk Assessment Recommendation records that are linked to the specified SIS Trip Report record.
SIS Trip Reports Query	Displays a prompt for the Entity Key for an SIS Trip Report record and then displays the list of SIS Trip Report records and information that is stored in each record.

- **Reports:** The following table displays the report that exists in the Reports sub-folder.

Report Name	Behavior and Usage
SIS Trip Report	Displays a prompt for the Entity Key for an SIS Trip Report record and then displays summary information that is associated with the specified SIS Trip Report record and the records that are linked to that SIS Trip Report record.

Calculations

About the Required Probability of Failure

The required probability of failure is a number representing the probability that an instrumented function will fail in a dangerous scenario. This value is represented as a probability value (e.g., .001), and is an indicator of whether the instrumented function is meeting its requirements to mitigate risk. The required probability of failure value is based on the following values stored in the Instrumented Function:

- The SIL value, which is stored in the Selected SIL Level field. The higher the SIL value for an instrumented function, the lower the probability that the instrumented function will fail.
- The method used to determine the SIL value, which is stored in the SIL Assessment Method field (e.g., Risk Matrix).
- The demand rate, which is stored in the SIL Mode field and represents the estimated probability that a dangerous condition will exist where the instrumented function is required to take the process to its safe state. For instance, if the demand rate is more than once a year, the hazard rate must not be higher than the failure rate. In this case, the SIL mode is high demand or continuous.

The following sections describe how the required probability of failure is calculated based on the SIL value, assessment method, and demand rate.

SIL Mode: Low Demand

In an Instrumented Function, when the value in the SIL Mode field is Low Demand, the APM system assumes that the demand rate of the instrumented function is less frequent than once per year. In these cases, the failure rate is measured by the average probability of failure on demand (PFD Avg).

SIL Value	Required Probability of Failure (PFD Avg)
4	$\geq 10^{-5}$ to $< 10^{-4}$
3	$\geq 10^{-4}$ to $< 10^{-3}$
2	$\geq 10^{-3}$ to $< 10^{-2}$
1	$\geq 10^{-2}$ to $< 10^{-1}$

SIL Mode: High Demand or Continuous

In an Instrumented Function, when the value in the SIL Mode field is High Demand or Continuous, the APM system assumes that the demand rate of the instrumented function is more frequent than once per year. In this case, the failure rate is measured by the average probability of dangerous failures per hour (PFH). The required probability of failure is defined by an industry standard that is associated with the SIL.

The required probability of failure is defined by the industry standard that is associated with each SIL. The following table contains the standard PFD Avg values for each SIL. The following table contains the standard PFH values for each SIL.

SIL Value	Required Probability of Failure (PFH)
4	$\geq 10^{-9}$ to $< 10^{-8}$
3	$\geq 10^{-8}$ to $< 10^{-7}$

SIL Value	Required Probability of Failure (PFH)
2	$\geq 10^{-7}$ to $< 10^{-6}$
1	$\geq 10^{-6}$ to $< 10^{-5}$

SIL Assessment Method: Internal

If you use a Risk Matrix (internal) in SIL assessment, the value in the Required Probability of Failure field is disabled and populated with the lowest (i.e., the most conservative) value as the targeted probability. For example, if the SIL value is 2, the Required Probability of Failure field will be populated automatically with $1E-07$ (i.e., 10^{-7}) in case of a Low Demand SIL mode.

If you use an Layer of Protection Analysis (internal) in SIL assessment, the value in the Required Probability of Failure field is disabled and populated with the difference between the values in the Mitigated Consequence Frequency field and the Required Mitigated Consequence Frequency field in the LOPA.

SIL Assessment Method: External

If you use any external SIL Assessment method, the Required Probability of Failure field will be enabled, and you can enter the probability value manually. In this case:

- If you modify the value in the Selected SIL Level field, the value in the Required Probability of Failure field will be updated automatically to fall within the correct range of values for that level.
- If you type a value that does not fall within the range defined in the table, an error message will appear.
- If you type a value in the Required Probability of Failure field without first typing a value in the Selected SIL Level field, an error message will appear.

Risk Reduction Factor

Risk reduction factor can also be used to indicate the probability of failure for an instrumented function when the SIL mode is low demand. The risk reduction factor is the inverse of the required probability of failure, which is represented in years. For example, a required probability of failure value of .001 would equal a risk reduction factor of 1,000, meaning that the instrumented function would fail during a dangerous scenario about once every 1,000 years.

Calculating Risk Reduction Factor

The required probability of failure is defined by the industry standard that is associated with each SIL. The following table contains the standard PFD Avg values for each SIL.

SIL Value	Required Probability of Failure (PFD Avg)	Target Risk Reduction Factor
4	$\geq 10^{-5}$ to $< 10^{-4}$	$> 10,000$ to $\leq 100,000$
3	$\geq 10^{-4}$ to $< 10^{-3}$	$> 1,000$ to $\leq 10,000$
2	$\geq 10^{-3}$ to $< 10^{-2}$	> 100 to $\leq 1,000$
1	$\geq 10^{-2}$ to $< 10^{-1}$	> 10 to ≤ 100

If you use an internal SIL Assessment method, the Risk Reduction Factor field is disabled, and populated with the inverse of the value in the Required Probability of Failure field.

If you use an external SIL Assessment method, the Risk Reduction Factor field is enabled and populated with the inverse of the value in the Required Probability of Failure field. If you modify the value in the Risk

Reduction Factor field, the Required Probability of Failure field is populated with the inverse of the value in the Risk Reduction Factor field.