



# SEMIPOL® D4.2 Controller Upgrade

Advanced technology injected into existing asset

## Many reasons to upgrade now

SEMIPOL D3 has now become obsolete. GE Power Conversion can offer a cost effective solution to extend the lifecycle of your drive and also improve its performance.

If you are currently relying on vintage controls of the SEMIPOL, obsolescence is a risk that can not be ignored. You can avoid obsolescence and save time and expense of a complete system replacement with a reliable and cost effective standardized controller upgrade of your SEMIPOL.

The efficient upgrade will modernize your controls and data interfaces and substantially improve control capabilities and performance. Extensive diagnostics can make your system easier to maintain and GE's service products can help you get the most value out of SEMIPOL.

It's time to upgrade - now!



## Controller upgrade process

### Status Check

Site intervention – record SEMIPOL D3 system status

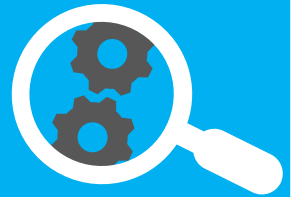

### Order Upgrade

Define project specific details and technical specifications



### Engineering

Apply standardized developed solution for SEMIPOL D3 generation with tested interface between control components and existing power modules



### Installation and Commissioning

Replace legacy controller components with pre-assembled mounting plate of new controller. Commissioning and 1to1 adaption of old system settings



### Increased lifetime

Rely on increased performance and advanced service products





# SEMIPOL® D4.2 Controller Upgrade

Advanced technology injected into existing asset

## Controller upgrade - benefits and features

We understand your industry and designed SEMIPOL's features to match your specific requirements.

- **State of the art** D4.2 technology with sophisticated tools (PECe\* based)
- Controller upgrade allows **interfacing with all supplementary GE products** (Visor Remote Monitoring, 24x7 Tech Support, Predictive Maintenance)
- **Lifecycle extension** of SEMIPOL
- **Spare parts** availability for the new controller components as for the old power stacks. D3 controller parts are obsolete.
- **Performance enhancement** of SEMIPOL.
- **Easy and intuitive use** for the operators
- **Cost-effective** solution – compared to a complete replacement
- **No civil works required** for controller upgrade
- **Reduced maintenance** and downtimes
- Integration of SEMIPOL to **modern power plant control systems**

## Proven D4.2 technology for tomorrow's challenges

Our controller upgrade combines sophisticated hardware control components with high reliability based on the HPCi\* with PECe.

The Power Electronics Controller offers daisy chained component with real time processing without buffering or storing, such as:

- **Controller:** Industrial PCs ensuring use of up to date processor technology
- **PIBe\*:** Power Interface Boards with high reliability on actual values processing and firing pulses for the power stacks.
- **I/Os:** Each automatic channel has its dedicated I/O module ensuring maximum redundancy
- **HMI:** Powerful industrial PC with 15" touchscreen for comfortable operation and diagnostic pages for easy and efficient troubleshooting
- **Power Supply:** Advanced redundancy with complete channel separation using electronically short circuit limiting CB's
- **Visor:** Connectivity via VISOR BOX and **immediate generated auto-notifications** to the experts for faults and alarms (24/7)

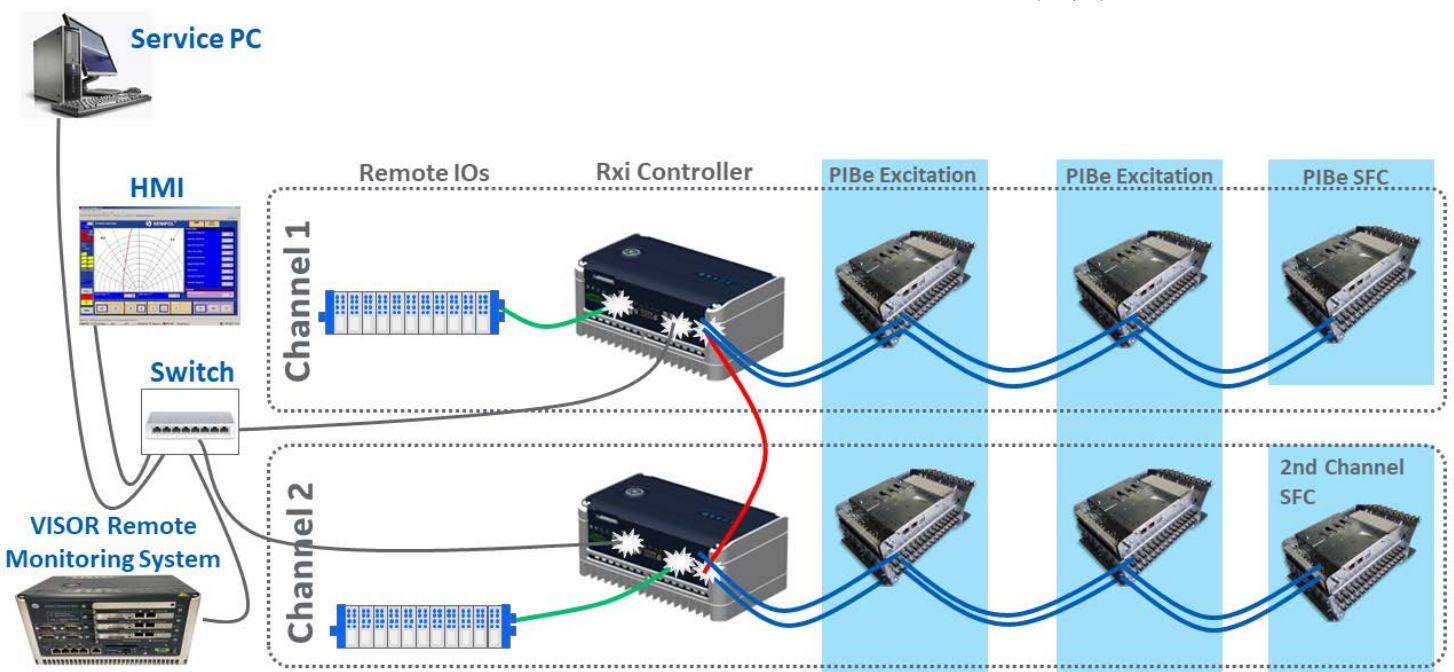



# SEMIPOL® D4.2 Controller Upgrade

Advanced technology injected into existing asset

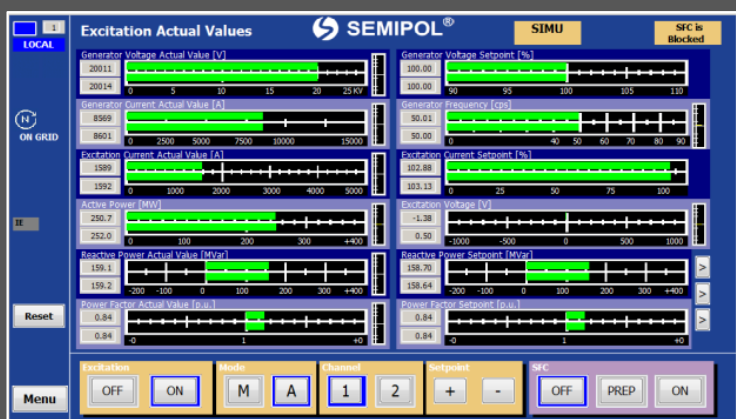

Actual Value Monitoring Page

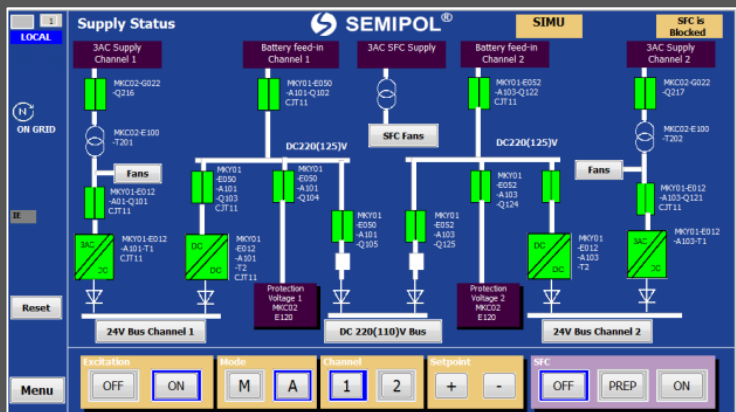

Power Supply monitoring page

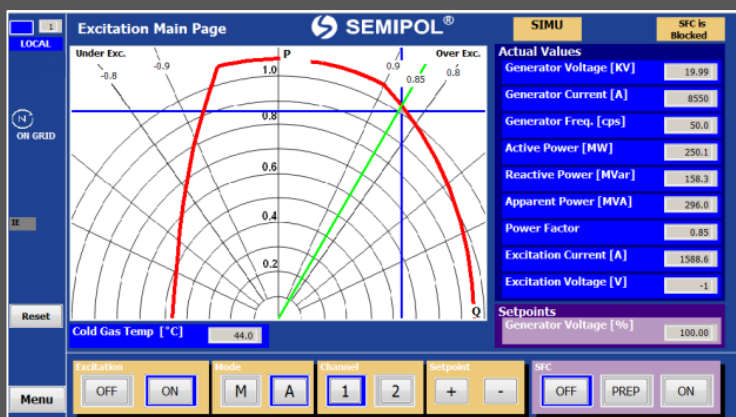

Operators main SEMIPOL screen

## Intuitive HMI Operator Screen

Easy to use – optimized for troubleshooting  
Comprehensive diagnostic possibilities featuring simple handling, without complex and confusing fault messages. Designed for operators to troubleshoot faster and most efficiently:

- Extended time of signal recorder
- Real time online scope
- Power supply monitoring pages
- Live single line drawing
- HMI based commissioning tools for pulse /voltage / current testing without needing to handle complex software logic for performing simple tests.

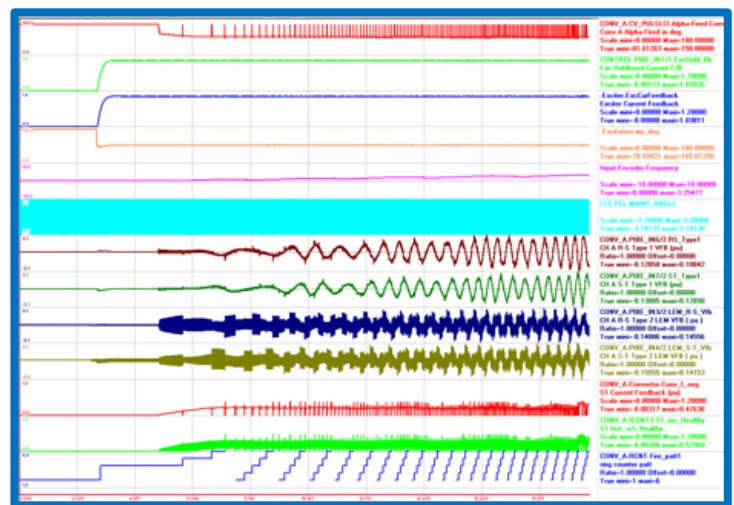

Real time online scope (pertu).



# SEMIPOL® D4.2

## Controller Upgrade

Advanced technology injected into existing asset

### SEMIPOL D4.2

#### Controller Upgrade Key Features

The advanced redundancy will increase the reliability of your SEMIPOL system – reducing the downtimes and unexpected shutdowns.

- “State of the Art” PCE system with Industrial PCs and PIBe minimizing the number of different components installed in the system
- Advanced redundancy up to the power electronics and dedicated I/Os in each channel
- Modern and accurate actual value processing boards
- Sophisticated cross monitoring between the 2 automatic channels
- PSS2B for active power optimization
- Bumpless channel change over due to fast link high speed connection.
- Parts and service availability
- Advanced configuration and diagnostics software
- Extended capability for grid compliance testing

### SEMIPOL D3

#### Legacy Solution Limitations

Spare parts for the legacy solution technology are limited.

- VME Bus based control rack (different type of boards for every function i.e. control, thyristor firing, actual values processing etc.)
- Limited redundancy with both channels sharing the modules
- Low resolution actual value measurement
- Simple channel monitoring
- PSS2A

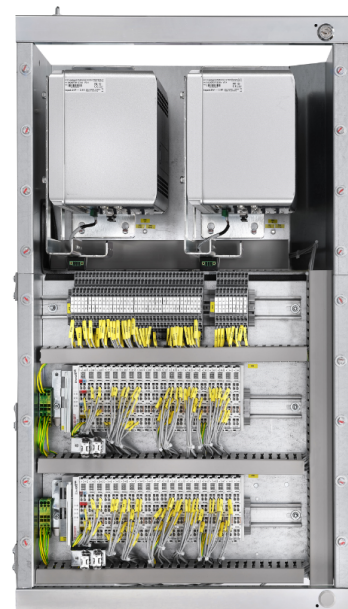

#### This smart upgrade will:

Avoid time and expense of complete systems replacements

Improve control capabilities and performance

Improve reliability and service ability

Extend life of critical control components

#### Please contact our Sales Team:

#### **Dimitrios Kokidis**

Fleet Manager Semipol Drives

dimitrios.kokidis@ge.com

+49 (0)30 7622-2528