

EnerVista Viewpoint Monitoring

Easy to Use Monitoring and Data Recording

EnerVista™ Viewpoint Monitoring is an easy to setup, powerful and simple to use data monitoring and recording software application for electrical systems.

With minimal configuration required to communicate with field devices directly, Viewpoint Monitoring provides an overall view of the entire power system and collects critical real-time and historical disturbance data to assist with analyzing past or impending power system events.

Key Benefits

- Easy start up and configuration saves time and cost by integrating devices using pre-programmed memory maps
- Automatically generated, user friendly monitoring screens provide instant remote equipment visibility
- Reduced integration time through automatic detection and configuration of UR devices
- Reduced fault analysis effort by centralizing critical fault data digitally
- Perform load analysis by recording and trending power equipment load levels
- Remote viewing of Viewpoint Monitoring systems using ViewNodes

Key Features

- Monitor up to 1000 devices (20000 data points) or 5000 devices (65000 data points)
- User friendly drag-and-drop construction of single-line monitoring screens
- Pre-configured memory maps of GE Multilin devices
- Single-line monitoring and control
- Trending of up to 500 power system data points with 1 minute resolution
- Communicate with third-party Modbus compliant field devices
- Plug-and-Play analysis of power system equipment
- Automatic collection of events and waveforms from GE Multilin devices
- Annunciator alarming with visual, audio and email notification
- Diagnose waveform fault data recorded in power system devices



Plug-and-Play Monitoring

Instantly View Device and Asset Monitoring Screens

EnerVista Viewpoint Monitoring's Plug-and-Play screens are a series of pre-configured modules for analyzing the health and status of your power system equipment. Viewpoint Monitoring will detect the devices you are using and automatically generate monitoring screens that are tailored to your devices as well as wiring configurations. This saves hours of engineering effort and enables quick setup to monitor protection devices.

Auto-Discovery of Devices

Viewpoint Monitoring reduces integration time and decreases errors when configuring devices by automatically detecting and configuring UR devices.

Viewpoint Monitoring Advantage

Viewpoint Monitoring Reduces Commissioning Effort Saving Time and Cost

The following is an example of connecting and communicating with a 469 Motor Protection Relay to monitor relay and motor data:

OVERVIEW

- Operating condition of your motor
- Status of your GE Multilin Relay

METERING

- All metering quantities (Amps, Volts, Power, Demand)
- Motor temperature monitored by the RTD's

ALARMS

- Active Alarms detected by the relay
- Latched Alarms that require clearing

TRIP

- Cause of the last motor trip
- Pre-trip data

LEARNED

- Learned motor and RTD data
- Learned motor load

MAINTENANCE

- Trip counters and motor starts
- Total motor running hours

With other HMIs

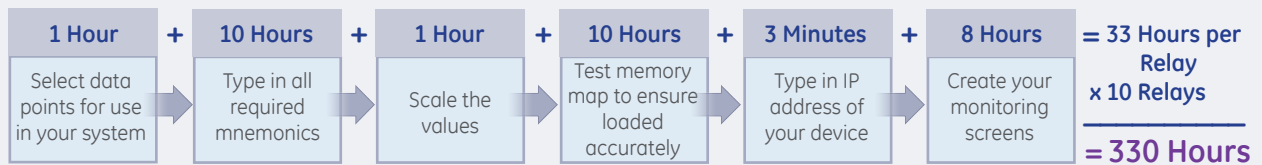

With Viewpoint Monitoring

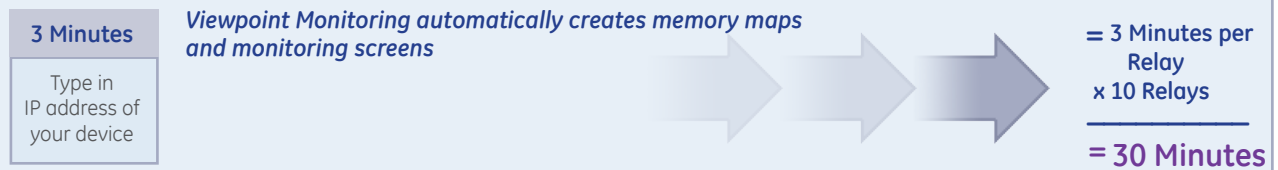

Plug-and-Play Motor Monitoring

Use Viewpoint Monitoring to Monitor Motor Protection Equipment

Instantly created overview screens provide insight on motor operating conditions and the status of Multilin™ relays. There are additional available monitoring screens that show the value of all metering quantities, the motor temperature monitored by the RTDs and any alarms that have been detected by the relay. Vital information and insight such as the cause of the last motor trip, operating information the relay has learned about the motor and any maintenance issues that may need addressing can be determined using historical data shown on available screens.



Instantly view critical information such as:

- Number of motor starts
- Learned motor starting current
- Motor running hours
- History of motor trips
- Real time power quantities (amps, motor load)
- Motor temperature



View motor status using digital inputs, analog inputs and RTD inputs.

Supported Devices:

- M60 Motor Protection System
- 469 Motor Protection System
- 369 Motor Protection System
- 269 Motor Protection System
- 239 Motor Protection System
- MM200/MM300 Motor Management System
- MM2/MM3 Intelligent MCC Controller
- SPM Synchronous Motor Protection System
- RRTD Remote RTD Module

Plug-and-Play Transformer Monitoring

Use Viewpoint Monitoring to Monitor Transformer Protection Equipment

The operating condition of the transformer and the status of the GE Multilin relay are shown through instantly pre-created overview screens. Additional monitoring screens allow further analysis of transformer status by viewing the metering, power, demand, energy and harmonic data that is being measured by the associated relay.



Instantly view critical information such as:

- Transformer energization status
- Real time power quantities (amps, transformer loading, demand)
- Current harmonic analysis
- Accumulated loss of life
- Tap changer position
- Hottest transformer winding temperature

Supported Devices:

- T60 Transformer Protection System
- T35 Transformer Protection System
- 745 Transformer Protection System

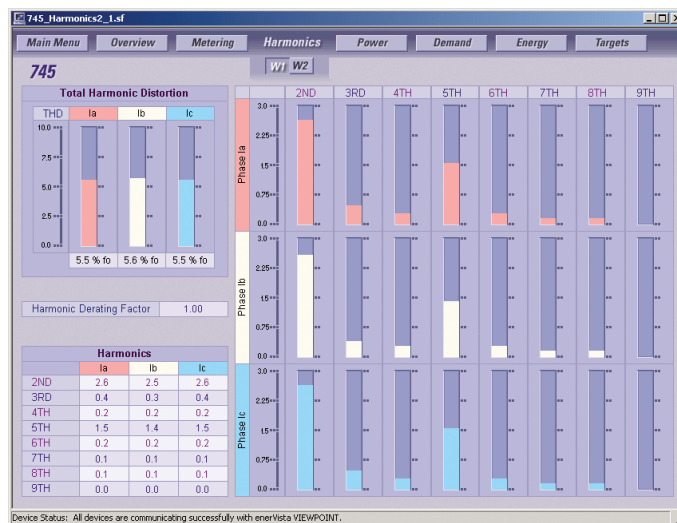

Monitor total harmonic content in each phase for all windings.

Plug-and-Play Generator Monitoring

Use Viewpoint Monitoring to Monitor Generator Protection Equipment

Instantly created overview screens provide insight on generator operating conditions and the status of GE Multilin relays. Further generator analysis can be performed with additional monitoring screens that monitor the value of all metered quantities, the generator temperature monitored by RTD's and any alarms that have been detected by the relay. Additional screens also provide historical information indicating cause of the last generator trip, operating information the relay has learned about the generator and any maintenance issues that may need addressing.



Instantly view critical information such as:

- Generator loading
- Real time power quantities (amps, volts)
- Cause of trip data
- Generator running hours
- History of generator trips
- Generator temperature

Supported Devices:

- G60 Generator Protection System
- 489 Generator Protection System
- G30 Generator Protection System

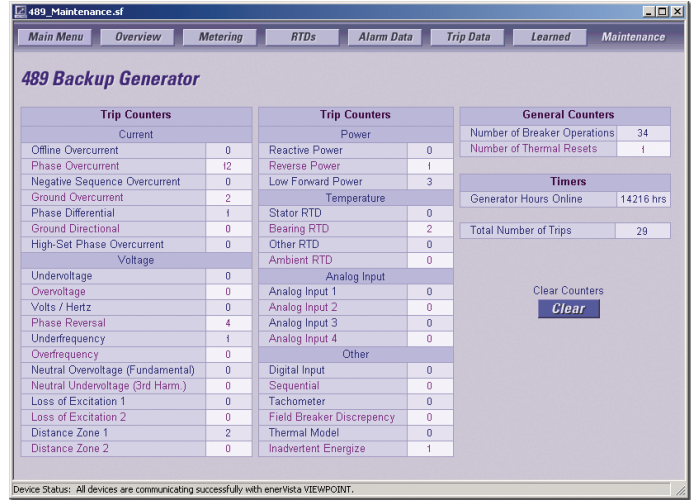

Improve maintenance efficiency by analyzing trip operations.

Plug-and-Play Feeder Monitoring

Use Viewpoint Monitoring to Monitor Feeder Protection Equipment

Instantly created overview screens provide insight on feeder operating conditions and the status of GE Multilin relays. Additional monitoring screens are available for analyzing all metering quantities, along with the power, demand and energy values that may be measured by the relay. If supported by the relay, synchronism screens will also be available for helping to determine if it is safe to close the breaker and energize the feeder.



Instantly view critical information such as:

- Breaker status
- Accumulated breaker arcing current
- Real time power quantities (amps, volts, demand, energy)
- Synchronism data

Supported Devices:

- 850 Feeder Protection System
- F650 Feeder Protection System
- F60 Feeder Protection System
- 735/737 Feeder Protection System
- F35 Multiple Feeder Protection System
- MIFII Feeder Protection with Recloser
- 750/760 Feeder Protection System
- 350 Feeder Protection System



Easily monitor synchronism levels needed for reclosing of circuit breakers.

Plug-and-Play Breaker Monitoring

Use Viewpoint Monitoring to Monitor Breaker Equipment

Predefined screens allow instant setup and viewing of critical breaker information such as:

- Breaker status
- Number of breaker trip operations
- Real time current, voltage and power levels

Supported Devices:

- MVT MicroVersa Trip Unit
- GTU EntelliGuard TU Trip Unit
- EMVT Enhanced MicroVersa Trip unit
- Entellisys Low-Voltage Switchgear

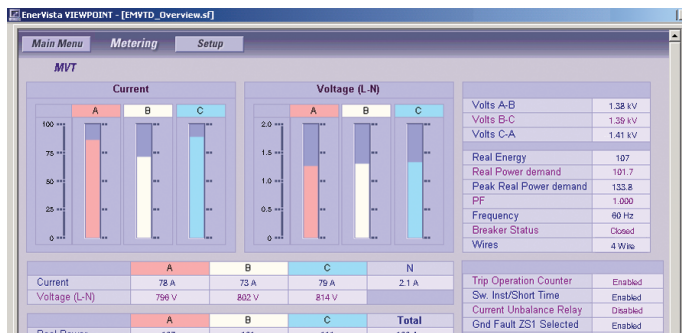

Monitor breaker equipment with predefined screens.

Plug-and-Play Power Quality Monitoring

Use Viewpoint Monitoring to Monitor Power Quality Equipment and Measure Usage

Instantly view critical information such as:

- Power quality and equipment status
- Load unbalances using real time and maximum and minimum values
- Consumption and cost of energy using inputs from revenue meters
- Amount of total harmonic distortion on the power system

Supported Devices:

- PQM / PQM II Power Quality Meter
- EPM 7000/7100 Electronic Power Meter
- EPM 2000/2200 Electronic Power Meter
- EPM 9450/9650 Electronic Power Meter
- EPM 5200/5300/5350 Electronic Power Meter
- EPM 9800 Electronic Power Meter
- EPM 6000/6100 Electronic Power Meter
- EPM 9900 Electronic Power Meter

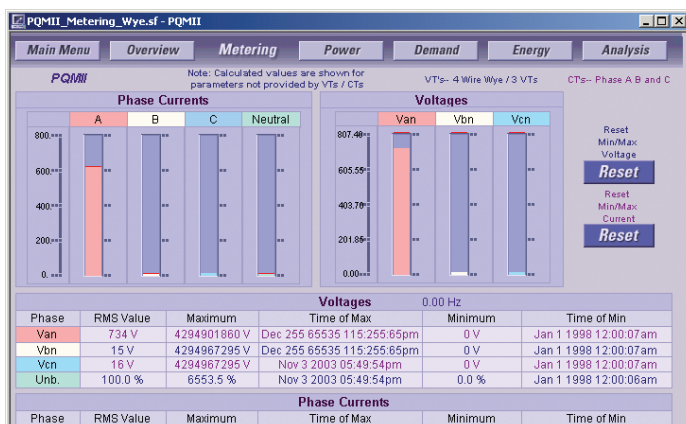
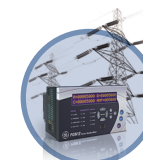

Instantly view the power quality status for critical devices.

Plug-and-Play Backup Power Monitoring

Use Viewpoint Monitoring to Monitor Critical Backup Assets

Instantly view critical information such as:

- Availability of normal and emergency power sources
- Status of power source connections
- Real time voltages and frequency
- Switch status, timer settings and control switch position
- Stored events and exerciser schedules

Supported Devices:

- MX150 Controller
- MX350 Controller
- MX200 Controller
- Lan Pro UPS
- MX250 Controller
- SG-Series UPS

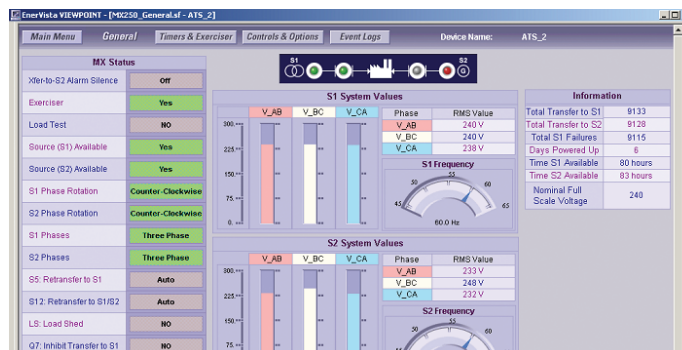

Monitor the status of critical backup assets.

Single-Line Monitoring and Control

View the Power System Status on Customizable Single-Line Diagrams

Viewpoint Monitoring provides the tools to easily create customized single-line diagrams providing monitoring and control. This powerful tool will communicate with supported devices and put the facility's energy system at your fingertips from either a local or a remote location.

Easily Create Customized Single-Line Monitoring Screens

- Create single-line diagrams using user-friendly, drag-and-drop tools with standardized symbols and components representing power system assets (transformers, breakers, CT's and PT's)
- Import graphics to customize single-line diagrams and increase usability
- Display power system values and status with minimal configuration through pre-loaded memory maps
- Create customized or "virtual" monitoring points using the powerful Formula Editor

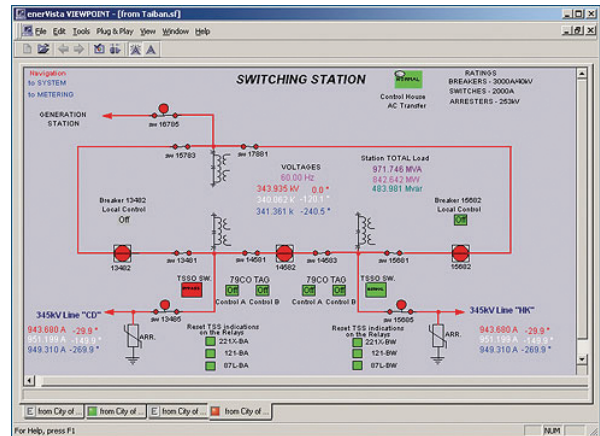

Easily create customized screens to monitor the power system state.

Monitor Power System Devices

- Provide a system-wide view of the power system on one single-line monitoring screen
- Analyze the magnitude of all critical power quantities measured by devices
- Generate alarm warnings when measured values exceed configurable critical levels
- Create links to multiple monitoring screens to analyze power system equipment with greater detail

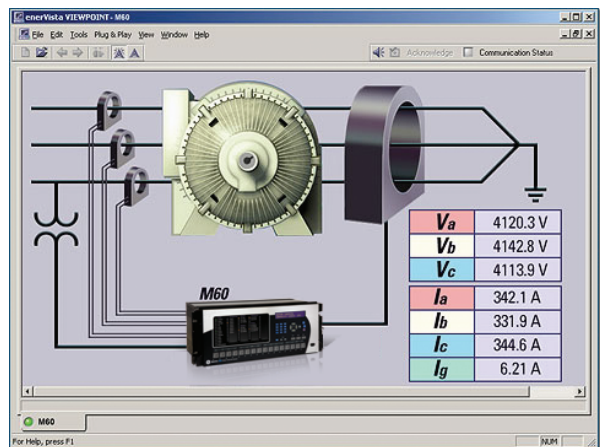

Monitor the motors status and loading throughout the facility from a centralized location locally or remotely.

Control Power System Equipment from Remote Locations

- Send commands to devices to control and change the status of power system equipment (breakers, switches, isolators)
- Enforces required two-step verification process to the operator sending the command
- Validates user's permissions by requiring passwords to be sent to protection relays or other devices before operation occurs

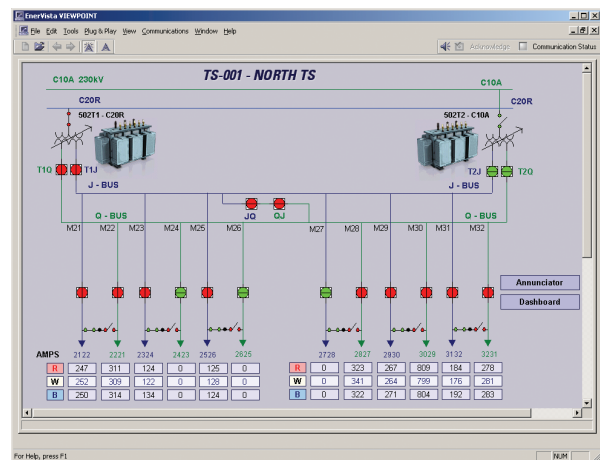

Monitor the status of the entire power system and control components from one screen.

Automatic Event and Waveform Retrieval

Automated archiving of event and waveform data from GE Multilin devices ensures availability of detailed information for diagnosing power system events.

Event Logging

The event records from GE Multilin devices can be automatically downloaded from each device and stored in a centralized, system-wide, sequence of event record. Viewpoint Monitoring will continually poll each GE Multilin device to see if any new events have been added to that device's event record. Once a new event has been detected, the event record will be downloaded and the new events will be stored in the system-wide sequence of events record.

Waveform Archiving

The waveform (oscillography) files from GE Multilin devices can be automatically downloaded from each device and stored on your hard drive. Similar to Event Logging, Viewpoint Monitoring will continually poll each GE Multilin device to see if any new waveform files have been created. Once a new waveform has been detected, the file will be downloaded by Viewpoint Monitoring to the centralized data repository.

Event Viewing

The Event Viewer centrally stores and displays information about preset and configured systems events. Each event in the record contains the following information:

- Event Time
- Event Type
- Source Name
- Source Type
- Event Cause

This data can be sorted by any of the fields indicated above.

Created Time	Event Type	Source Name	Source Type	Event	Event Code	Acknowledge
10/02/2005 13:41:27.749493	Alarm	T60_4	UR	Contact Input 2 On	1005	Alarm Information - Unacknowledged
10/02/2005 13:41:27.737480	Alarm	T60_4	UR	Contact Input 2 Off	1538	Alarm Information - Unacknowledged
10/02/2005 13:39:37.249200	Alarm	T60_2	UR	PHASE TOC1 DPO A	42000	Alarm Information - Unacknowledged
10/02/2005 13:39:37.232654	Alarm	T60_2	UR	PHASE TOC1 PKP A	34832	Alarm Information - Unacknowledged
10/02/2005 13:39:37.166192	Alarm	T60_2	UR	PHASE TOC1 DPO A	42000	Alarm Information - Unacknowledged
10/02/2005 13:39:37.166192	Alarm	T60_2	UR	PHASE TOC1 DPO C	44048	Alarm Information - Unacknowledged
10/02/2005 13:39:37.121770	Alarm	T60_4	UR	PHASE TOC2 DPO B	43025	Alarm Information - Unacknowledged
10/02/2005 13:39:37.113444	Alarm	T60_4	UR	PHASE TOC1 DPO C	44048	Alarm Information - Unacknowledged
10/02/2005 13:39:37.113444	Alarm	T60_4	UR	PHASE TOC1 DPO B	43024	Alarm Information - Unacknowledged
10/02/2005 13:39:37.113444	Alarm	T60_4	UR	PHASE TOC2 DPO A	42001	Alarm Information - Unacknowledged
10/02/2005 13:39:37.113444	Alarm	T60_4	UR	PHASE TOC2 DPO C	44049	Alarm Information - Unacknowledged
10/02/2005 13:39:37.113444	Alarm	T60_4	UR	PHASE TOC1 DPO A	42000	Alarm Information - Unacknowledged
10/02/2005 13:39:37.029708	Alarm	T60_2	UR	Virtual Output 16 Off	3600	Alarm Information - Unacknowledged
10/02/2005 13:39:37.029708	Alarm	T60_2	UR	PHASE IOC2 DPO A	41985	Alarm Information - Unacknowledged
10/02/2005 13:39:37.024542	Alarm	T60_2	UR	PHASE IOC2 DPO B	43009	Alarm Information - Unacknowledged
10/02/2005 13:39:37.024542	Alarm	T60_2	UR	PHASE IOC2 DPO C	44033	Alarm Information - Unacknowledged
10/02/2005 13:39:37.005794	Alarm	T60_2	UR	PHASE IOC2 PKP B	35841	Alarm Information - Unacknowledged

Create comprehensive, centralized, system-wide sequence of event records for analysis of power system faults.

Waveform Viewing

View and analyze waveform fault data that has been recorded from a power system device in a time-based, phasor quantity or tabular view. This Waveform View utility provides functionality to:

- Convert waveforms that were stored in Comma Separated Value (.CSV) format to COMTRADE compatible files (e.g. SR Family, PQM)
- Merge and overlay waveforms that were recorded from multiple devices
- Identify the harmonic content in the monitored parameters



View and analyze waveform fault data retrieved from devices.

Trending Reports

Create a Historical Archive of Monitored Data from Multiple Devices

Data Logging

- Log and trend the value of monitored analog or digital points
- View logged data for a pre-configured, customized recorded time period

Records

- Create up to 100 customized records
- Store up to 50 points per record for 5000 points logged in total

Chart

- View logged data in a pre-configured, customized date range for trending analysis

Archiving Data

- Manually archive recorded data for storage onto network data repositories to reduce risk of data loss and decrease data storage requirements on local workstations

Exporting and Printing Data

- Export data into an Excel format for easy data manipulation and analysis
- Print data that is logged in trending reports in a printer-friendly format

Historical Record of Monitored Data

- Trend up to 5000 data points
- Record data with 1 minute resolution
- View data in time based graphical or tabular format

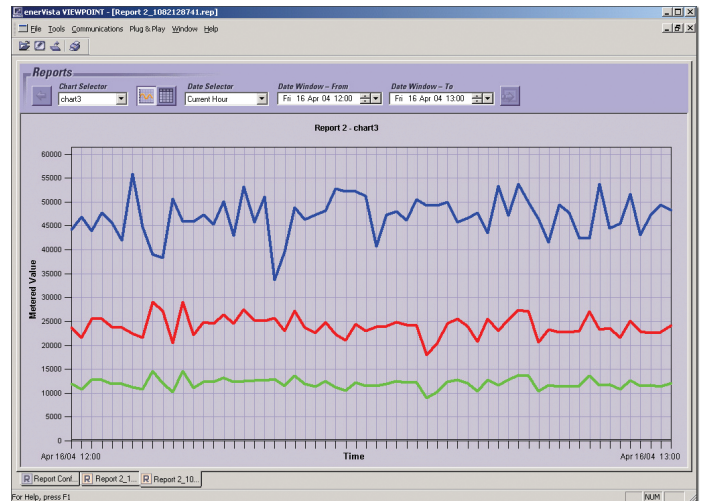

Log power level data from multiple devices at one time.

Third-Party Device Support

Viewpoint Monitoring supports communication with third-party devices that use Modbus RTU or Modbus TCP/IP communications protocols. This flexibility allows the use and provides monitoring functionality for other non-GE Multilin devices that may be found in the facility.

Viewpoint Monitoring provides support for third-party devices as follows:

Single-Line Diagrams

- Read the status of digital point
- Read the value of analog data
- Send commands to control power system equipment

Annunciator Panel

- Present an alarm when analog value surpasses a preset level or condition
- Present an alarm when a digital point(s) change state

Trending Reports

- Log the value of analog points over prolonged time periods
- Log the status of digital points on a device

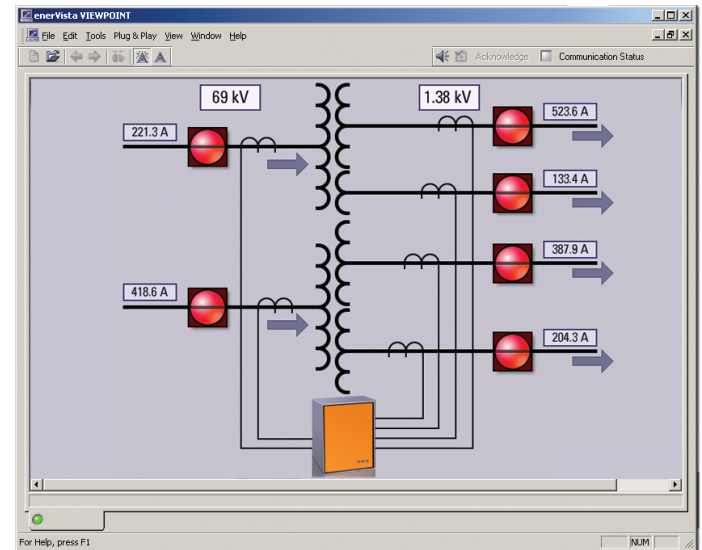

Easily integrate third-party devices into single-line diagrams, annunciator alarms, and trending reports.

Annunciator Alarming

Receive Instant, Reliable Notification of System Alarms from Devices on the Network

Viewpoint Monitoring Annunciator Alarming actively monitors measured values and generates alarms. Alarms can be configured to be activated whenever a digital status changes state, or an analog value changes beyond any programmed threshold. Alarms can be delivered through multiple visual, audio, or e-mail notification channels. Furthermore, the Monitoring and Alarm Sentry ensures annunciators and alarms are always active.

Audio Notification

- Separate sounds for alert status and alarm status
- Audio notification of alarms and alerts continue until the alarm state is acknowledged by an operator

Visual Notification

- Annunciator screen shows the status of the monitored point
- The alarmed point will flash in a color chosen by the user until the alarm is reset by the operator

Email Notification

- Alarming of any monitored point can automatically generate an email to notify users of the alarm
- A different email address can be entered for each monitored point

Monitoring and Alarm Sentry

- Ensures annunciators and alarms are always active, even when the annunciator screens or the Viewpoint Monitoring software is closed in error

Reliable, Instant Alarm Notification

- Create alarms on monitored digital and/or analog data points
- Configured alarm warnings delivered through audio, visual or email notification channels

Instant Alarm Notification

- Create alarms on any monitored analog or digital data point
- Receive alarm warnings through audio, visual or email notification

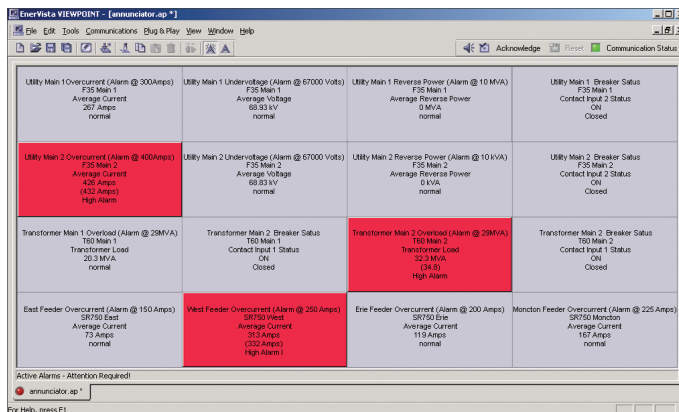

Reliable, instant notification of system alarms in a single visual dashboard view.

EnerVista Viewpoint Monitoring ViewNodes – Remote Monitoring and Control

Remotely monitor and control Viewpoint Monitoring using EnerVista Viewpoint Monitoring ViewNodes

- Connect remotely to a Viewpoint Monitoring system over a network
- Implement security access and control by thorough user accounts with configurable permissions
- Provide complete access to:
 - Plug-and-Play screens
 - One-Line diagrams
 - Annunciator panels / trending reports
 - Events
 - Waveforms
- Connect up to 10 ViewNodes to a single Viewpoint Monitoring system

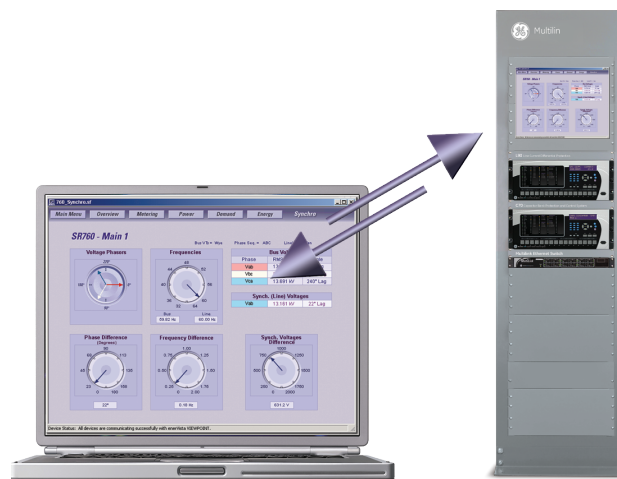

OPC Server Option

Viewpoint Monitoring can send the data that is being read from the relays and meters to any third-party OPC compliant automation or monitoring system. With Viewpoint Monitoring's pre-configured memory maps of GE Multilin devices the time, effort and cost required to import essential data into your monitoring, automation and control systems is significantly reduced.

Integrate the data retrieved by Viewpoint Monitoring into a larger monitoring or automation system.

- Send up to 65000 data points to an OPC Client
- Supports the entire library of devices that comes with Viewpoint Monitoring
- Provides the ability to send data from third-party devices added to the Viewpoint Monitoring database

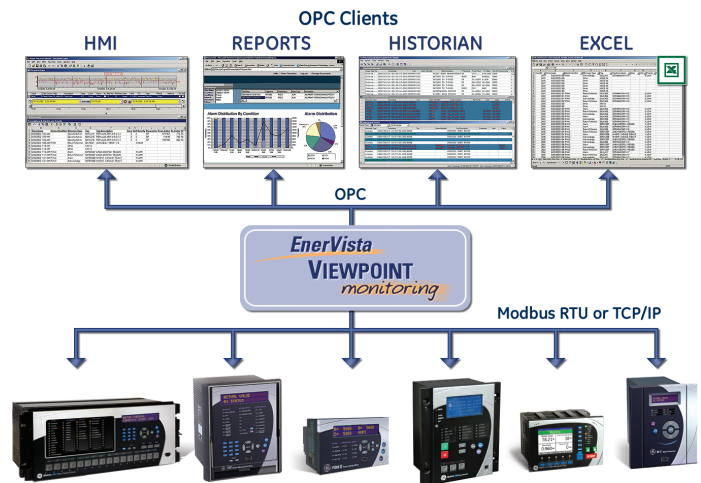

Integrate the data retrieved by Viewpoint Monitoring into a larger monitoring or automation system.

Technical Specifications

System Requirements - EnerVista Viewpoint Monitoring v7.10

COMPONENT	REQUIREMENT
Supported Operating Systems	<ul style="list-style-type: none"> • Windows 7 (SP1 or later) - 32 or 64 bit • Windows Server 2008 R2 (SP1 or later) - 64 bit
Supported Databases	<ul style="list-style-type: none"> • SQL Server 2012 • SQL Server 2012 Express
Computer and Processor	Recommended workstation: <ul style="list-style-type: none"> • Intel® Core™ 2 Duo CPU or higher • CD-ROM drive • Mouse (minimum two buttons) • Keyboard • Speakers (to support audible alarms)
Memory	2 GB of RAM (minimum)
Hard Disk	500 MB of free hard disk space for installation (additional space required for project configuration)
Display	17" monitor, minimum resolution 1280 x 1024, minimum 16-bit color
Connectivity	Ethernet (10BASE-T)
Other	N/A

Technical Specifications (Cont)

Supported Devices

DEVICE FAMILY	DEVICE	FIRMWARE
ATS	MX150	5.4x, 6.0x
	MX250	5.4x, 6.0x
	MX350	1.2x
UPS	UPS, UPS LP, UPS SG	1.0
Trip Units/Switchgear	Spectra MicroVersa Trip	5.1x
	Enhanced MicroVersa Trip C	4.1x
	Enhanced MicroVersa Trip D	4.1x
	GTU (EntelliGuard TU Trip Unit)	7.0x
	ELVS (Entellisys)	4.0x to v5.0x
	MET	12.02.02
Meters/Switches	PQM	3.3x to 3.6x
	PQMII	1.0x to 2.2x
	EPM 1000	3.8x
	EPM 2000	1.0x
	EPM 2200	1.0x
	EPM 4000	3.8x
	EPM 5000P	2.4x
	EPM 5200P	2.4x
	EPM 5300P	2.4x
	EPM 5350P	2.4x
	EPM 6000	1.0x
	EPM 6000T	1.0x
	EPM 6100	1.0x
	EPM 7000	1.0x
	EPM 7000T	1.0x
	EPM 7100	1.0x
	EPM 9900	1.0x
	EPM 9450Q	2.1x
	EPM 9650Q	2.1x
	EPM 9800	6.1x
ML 2400	3.0x	
Distribution Feeder	350	1.2x to 1.5x
	F35	2.6x to 7.2x
	F60	2.6x to 7.2x
	F650	1.6x to 5.4x
	MIF 2	4.0
	735/737	1.5x
	750/760	3.6x to 7.4x
	850 Feeder	1.10x
	G30	4.4x to 7.2x
	G60	2.6x to 7.2x

DEVICE FAMILY	DEVICE	FIRMWARE
Generator	489	1.3x to 4.03x
	D30	3.0x to 7.2x
	D60	2.6x to 7.2x
	D90Plus	1.8x
Line Current Differential Protection	L30	5.6x to 7.2x
	L60	2.6x to 7.2x
	L90	2.6x to 7.2x
Transformer	745	2.4x to 5.2x
	T35	2.6x to 7.2x
	T60	2.6x to 7.2x
	345	1.3x to 1.5x
Motor	239	2.3x to 2.7x
	269+	6.0x
	339	1.3x to 1.5x
	369	1.6x to 3.6x
	469	2.5x to 5.2x
	MM200	1.0x to 1.2x
	MM300	1.2x to 1.5x
	MMII	4.0x to 5.2x
	MMIII	1.0x to 1.2x
	RRTD	1.4x, 1.5x
	SPM	2.0x, 2.1x
	M60	2.6x to 7.2x
	Network	N60
Bus	B30	2.6x to 7.2x
	B90	4.8x to 7.2x
Specialized	C30	2.6x to 7.2x
	C60	2.6x to 7.2x
	C90Plus	1.6x to 1.8x
Misc.	MRPO	1.0
	FIRETRACER	1.0
	VERSAMAX	1.0

EnerVista Viewpoint Monitoring v7.10 Software Selection Guide

EnerVista Viewpoint Monitoring

	VP	-	*	*	*	*	-	*	-	*	-	*	Description
Package	-	X	X	X	X								None
		0	1	0	0								100 Devices / 5000 Points License, Version 7.10
		0	3	0	0								300 Devices / 30000 Points License, Version 7.10
		0	5	0	0								500 Devices / 65000 Points License, Version 7.10
		1	0	0	0								1000 Devices / 20000 Points License, Version 7.10
		U	1	0	3								Device/Point Upgrade 100 Devices / 5000 Points to 300 / 30000 Points, Version 7.10
		U	1	0	5								Device/Point Upgrade 100 Devices / 5000 Points to 500 / 65000 Points, Version 7.10
		U	1	1	0								Device/Point Upgrade 100 Devices / 5000 Points to 1000 / 20000 Points, Version 7.10
		U	3	0	5								Device/Point Upgrade 300 Devices / 30000 Points to 500 / 65000 Points, Version 7.10
		U	3	1	0								Device/Point Upgrade 300 Devices / 30000 Points to 1000 / 20000 Points, Version 7.10
		U	5	1	0								Device/Point Upgrade 500 Devices / 65000 Points to 1000 / 20000 Points, Version 7.10
Server Installation							-	X					None
									S				Windows Server Installation
OPC										-	X		None
												O	OPC Option
Version Upgrade										-	X		None
												U	1 Additional Year of Version Upgrades

EnerVista Viewpoint Monitoring ViewNodes

	VP	-	*	*	*	*	-	*	-	*	-	*	Description
ViewNodes	V	I	E	W	-	X	-	X	-	X	-	X	EnerVista Viewpoint Monitoring Version 7.10 ViewNode

EnerVista Viewpoint Monitoring 61850*

	VP	-	*	*	*	*	-	*	-	*	-	*	Description
61850	-	I	6	1	8	-	X						VP Monitoring 61850 - 50 Devices
OPC										-	X		None
												O	OPC Option
Version Upgrade										-	X		None
												U	1 Year Version Upgrades

*NOTE:

- EnerVista Viewpoint Monitoring 61850 is a separate application from EnerVista VP Monitoring and provides support for 61850 protocol only.
- OS Compatibility: Windows XP - 32 bit
- Devices: Supports up to 50 devices; up to UR v5.5x. For complete details refer to EnerVista Viewpoint Monitoring 61850 release notes.

GEDigitalEnergy.com

Windows is a registered trademark of Microsoft.

Pentium is a registered trademark of Intel.

GE, the GE monogram, MultiIn and EnerVista are trademarks of General Electric Company.

GE reserves the right to make changes to specifications of products described at any time without notice and without obligation to notify any person of such changes.

Copyright 2015, General Electric Company. All Rights Reserved.



imagination at work

GEA-12809(E)
English
150211