



HITACHI

GE Hitachi Nuclear Energy

005N9751

Revision F

December 2023

BWRX-300 General Description

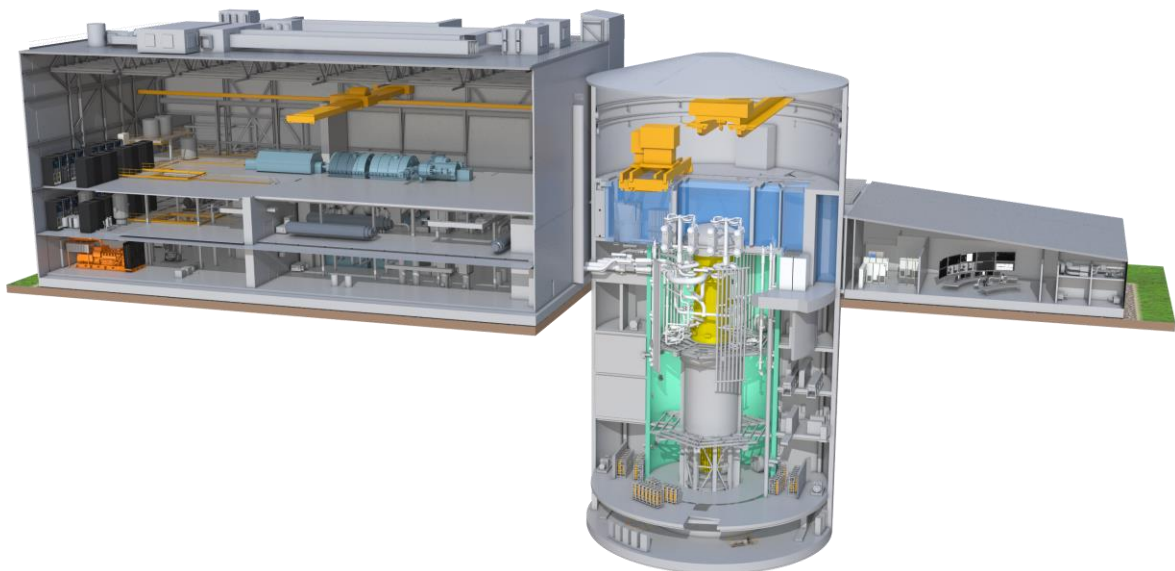



DISCLAIMER OF RESPONSIBILITY

This document was prepared by GE-Hitachi Nuclear Energy Americas LLC (GEH) for the purpose of providing general information about its BWRX-300 nuclear power plant. No other use, direct or indirect, of the document or the information it contains is authorized. Neither GEH nor any of the contributors to this document:

- Makes any representation or warranty (express or implied) as to the completeness, accuracy, or usefulness of the information contained in this document or that such use of any information may not infringe privately owned rights; or
- Assumes any responsibility for liability or damage of any kind that may result from any use of such information.



TABLE OF CONTENTS

1.0 INTRODUCTION 7

1.1 Limitation on Use 7

1.2 Sixty Years in the Making 7

1.3 BWR Experience 11

1.4 Safety Concept and Defense-in-Depth 15

1.5 Classification of Structures, Systems, and Components 19

1.6 BWRX-300 Status 20

2.0 PLANT OVERVIEW 22

2.1 Unique Design Features 25

2.2 Key Features 25

3.0 NUCLEAR STEAM SUPPLY SYSTEMS AND COMPONENTS 27

3.1 Nuclear Boiler System 27

3.2 Control Rod Drive System 35

3.3 Isolation Condenser System 37

3.4 Containment 38

3.5 Containment Cooling System 40

3.6 Passive Containment Cooling System 40

3.7 Boron Injection System 41

3.8 Reactor Water Cleanup System 42

3.9 Shutdown Cooling System 42

3.10 Isolation Condenser System Pool Cooling and Cleanup System 43

3.11 Fuel Pool Cooling and Cleanup System 43

4.0 FUEL AND FUEL CYCLE 44

4.1 Core Configuration 44

4.2 Fuel Assembly Description 44

4.3 Fuel Handling and Refueling Process 45

5.0 BALANCE OF PLANT 47

5.1 Steam and Power Conversion System 47

5.2 Balance of Plant Auxiliary Systems 51

6.0 INSTRUMENTATION AND CONTROL SYSTEMS 53

6.1 Instrumentation and Control Design Architecture 53



6.2 Main Control Room.....56

6.3 Secondary Control Room58

7.0 ELECTRICAL SYSTEMS 59

8.0 RADIOACTIVE WASTE MANAGEMENT SYSTEMS..... 61

8.1 Discharges During Normal Operation61

8.2 Liquid Waste Management System61

8.3 Solid Waste Management System.....62

8.4 Offgas System.....62

9.0 PLANT LAYOUT AND ARRANGEMENT..... 63

10.0 SITE CONSIDERATIONS AND GRID INTEGRATION..... 67

10.1 Site Considerations During Operation.....67

10.2 Grid Integration.....67

10.3 Research, Development, and Testing.....69

11.0 TECHNOLOGY MATURITY/READINESS..... 70

11.1 Technical Development Needs70

12.0 PLANT OPERATIONS AND MAINTENANCE..... 71

13.0 SAFEGUARDS AND SECURITY 72

13.1 Safeguards.....72

13.2 Physical Security73

13.3 Cyber Security Capabilities.....73

13.4 Resistance to Electromagnetic Pulse and Geomagnetic Disturbances73

13.5 Electromagnetic Compatibility.....74

14.0 OTHER PLANT CHARACTERISTICS 75

14.1 Load Following75

14.2 Lower Waste Yields.....75

14.3 Ability to Integrate with Electric and Non-Electric Applications75

14.4 Energy Resilience.....75

15.0 REACTOR END-OF-LIFE 77

15.1 BWRX-300 Design Life.....77

15.2 BWRX-300 Decommissioning.....77

16.0 MANUFACTURING AND CONSTRUCTION..... 78

16.1 General Plans for Construction79

16.2 Improved Construction Approaches81



16.3 Approaches to Component Manufacture.....82

16.4 Procurement Plans83

17.0 ACRONYMS, DEFINITIONS, AND SYMBOLS 85

17.1 Acronyms85

17.2 Definitions.....88

17.3 Symbols88

18.0 REFERENCES 90

19.0 APPENDIX A – BWRX-300 PARAMETERS OF INTEREST 92

LIST OF TABLES

Table 1-1: Evolution of the GE Boiling Water Reactor 8

Table 1-2: GE BWRs Worldwide 12

Table 1-3: Non-GE BWRs Worldwide 14

Table 2-1: Comparison of Key Features.....26

Table 19-1: Draft BWRX-300 General Parameters of Interest..... 92

Table 19-2: Draft BWRX-300 Detailed Parameters of Interest..... 92

LIST OF FIGURES

Figure 1-1: Boiling Water Reactor Design Evolution..... 10

Figure 1-2: GEH Containment Designs 11

Figure 1-3: BWRX-300 Defense-in-Depth Concept..... 16

Figure 2-1: BWRX-300 Reactor Building and Containment Design 23

Figure 2-2: BWRX-300 Major Systems 24

Figure 3-1: BWRX-300 Reactor Pressure Vessel and Internals 28

Figure 3-1: Cutaway View of Reactor Core 31

Figure 3-2: BWRX-300 Reactor Pressure Vessel Isolation Valve Design..... 32

Figure 3-3: Core Map and Instrumentation Layout 34

Figure 3-4: Fine Motion Control Rod Drive 36

Figure 3-5: Isolation Condenser System 37

Figure 3-6: BWRX-300 Dry Containment 39

Figure 3-8: Passive Containment Cooling System 41



Figure 4-1: GNF2 Lattice.....44
Figure 4-2: GNF2 Fuel Bundle45
Figure 5-1: Main Steam Piping.....48
Figure 5-2: BWRX-300 Turbine Building Main Steam Top 3D View48
Figure 5-3: GE Steam Turbine49
Figure 5-4: GE TOPAIR Generator50
Figure 6-1: Instrumentation and Controls Architecture55
Figure 6-2: Main Control Room and Surrounding Areas Layout (Top View)57
Figure 6-3: Group View Display System Concept (Front View)58
Figure 7-1: Electrical System Architecture.....59
Figure 9-1: Reactor Building.....64
Figure 9-2: BWRX-300 Plant Layout65
Figure 9-2: BWRX-300 Site Arrangement66
Figure 10-1: BWRX-300 Switchyard Interface68
Figure 16-1: Existing Technology Use in BWRX-300 Reactor79
Figure 16-2: Preliminary Crane Plan81

1.0 INTRODUCTION

GE Hitachi Nuclear Energy's (GEH's) BWRX-300 is a designed-to-cost 300 MWe water-cooled natural circulation Small Modular Reactor (SMR) utilizing simple natural phenomena-driven safety systems. It is the tenth generation of the Boiling Water Reactor (BWR) and represents the simplest BWR design since General Electric (GE), GEH's predecessor in the nuclear business, began developing nuclear reactors in 1955. The BWRX-300 is an evolution of the U.S. Nuclear Regulatory Commission (USNRC) licensed 1,520 MWe Economic Simplified Boiling Water Reactor (ESBWR) (26A6642AD, *ESBWR Design Control Document, Tier 2 – Chapter 1: Introduction and General Description of Plant Sections 1.1-1.11 (1)*). It is designed to provide clean, flexible energy generation that is cost-competitive with natural gas fired plants. Target applications include base load electricity generation, load following electrical generation generally within a range of 50 to 100% power, hydrogen production, district heating, and other process heat applications.

The BWRX-300 design optimizes the cost of construction, operation, maintenance, staffing, and decommissioning. Costs are minimized while maintaining world class safety by implementing a safety assessment framework structured on the five Defense Lines (DLs) of the International Atomic Energy Agency's (IAEA's) Defense-in-Depth (D-in-D) methodology report (IAEA SSR-2/1, *Safety of Nuclear Power Plants: Design (10)*). GEH's focus on minimizing all aspects of cost was driven by discussions with multiple GEH customers who indicated that new nuclear is only expected to be built in significant quantities if it is cost-competitive with all forms of new energy generation.

Focusing on cost was also borne out as the only path to significant new nuclear generation in a 2018 Electric Power Research Institute report (EPRI 3002011803, *Exploring the Role of Advanced Nuclear in Future Energy Markets: Economic Drivers, Barriers, and Impacts in the United States (3)*) and the Massachusetts Institute of Technology (MIT) research (*The Future of Nuclear Energy in a Carbon-Constrained World (15)*).

A study by the International Energy Agency (*Nuclear Power in a Clean Energy System (12)*) and a study commissioned by Energy Northwest (*Pacific Northwest Zero-Emitting Resources Study (2)*) concluded that significant deployments of SMRs are critical to moving to a low carbon economy. Deploying cost-competitive new nuclear significantly reduces the overall cost of a low carbon future.

The goal of GEH's BWRX-300 is to meet these capital cost targets while significantly improving the plant Levelized Cost of Electricity (LCOE) and levelized cost of heat while maintaining world class safety. By achieving these goals, GEH anticipates deploying a fleet of BWRX-300 reactors to provide a dispatchable carbon free economical source of power for decades to come.

1.1 Limitation on Use

This document is preliminary and will be updated as the design advances.

1.2 Sixty Years in the Making

The BWR has its origins in technology developed in the 1950s by Argonne National Laboratory and GE. The first BWR plant built by GE was the 5 MWe Vallecitos plant (1957) located near San Jose, California. The Vallecitos plant confirmed the ability of the BWR concept to produce electricity successfully and safely for a grid. The Vallecitos test facility success led to building the Dresden 1 plant located near Morris, Illinois. Construction of this 180 MWe plant began in 1956

with commercial power production achieved in 1960. The BWR design has subsequently undergone a series of evolutionary changes. Early changes focused on increasing power density and overall power output. Later changes focused on simplification.

While the BWR had its genesis in the United States, it also sparked beginnings in other countries under the Eisenhower administration's "Atoms for Peace" initiative. As examples, the Japan Power Demonstration Reactor (JPDR) BWR introduced nuclear power to Japan, and the KAHL Nuclear Power Plant, which employed an indirect-cycle BWR using steam generators to produce turbine steam, was the first commercial nuclear power plant built in Germany.

The advantage of the indirect-cycle was to avoid radioactive carryover from steam to the turbine, but operations from single (direct) and dual-cycle plants demonstrated that the process of boiling itself provided a natural separation process that tended to leave activated radioactive impurities in the vessel water, and this process was further enhanced with the introduction of in-vessel steam separation and a reactor water cleanup system.

And so, during the 1950s and into the 1960s, when the BWR was in its infancy, it grew by exploring different options and design configurations and feeding back operating experience gained. As a result, standardization did not exist to the extent that it would for future product lines of the Generation II reactors. While the various Generation I BWR configurations successfully operated for many years, operating experience along with improvements in manufacturing capabilities eventually drove toward forced circulation, internal vessel steam separation, and direct-cycle BWRs as a standard configuration.

The ever-evolving BWR design has been simplified in two key areas – the reactor systems and the containment design. Table 1-1, *Evolution of the GE Boiling Water Reactor* chronicles the development of the BWR.

Table 1-1: Evolution of the GE Boiling Water Reactor

Product Line	First Commercial Operation Date	Representative Plant/Characteristics
BWR/1	1960	Dresden1 - Initial commercial-size BWR
BWR/2	1969	Oyster Creek – Turnkey project purchased solely on economics. Large direct cycle External recirculation pumps
BWR/3	1971	Dresden 2 – First jet pump application Improved Emergency Core Cooling System (ECCS) Core spray and flood capability
BWR/4	1972	Vermont Yankee – Increased power density (20%)
BWR/5	1978	Tokai 2 – Improved ECCS Valve flow control for recirculation system

Table 1-1: Evolution of the GE Boiling Water Reactor

Product Line	First Commercial Operation Date	Representative Plant/Characteristics
BWR/6	1981	Kuosheng 1 – Compact control room Solid-state nuclear system protection system Advanced containment design
ABWR	1996	Kashiwazaki-Kariwa 6 – Reactor internal pumps Fine Motion Control Rod Drives (FMCRDs) Advanced control room, digital and fiber optic technology Improved ECCS: high/low-pressure flooders
SBWR		Natural circulation Passive ECCS Passive containment cooling
ESBWR		Natural circulation Passive ECCS Passive containment cooling
BWRX-300		Loss-of-Coolant Accident (LOCA) mitigation through integral isolation valves Natural circulation Passive heat removal systems Reactor Building (RB) built from steel-concrete composite modules with diaphragm plates

Dresden 1 was based on a dual steam cycle rather than the direct steam cycle that characterizes later generation BWRs. Steam was generated in the reactor and flowed to an elevated steam drum and secondary steam generator before reaching the turbine. The first step in BWR simplification was elimination of the external steam drum. This was achieved by two technical innovations, the internal steam separator, and the steam dryer at Gundremmingen (KRB-A, 1967). The simplification of the design using technical innovations has been repeated with each new iteration.

The first large direct cycle BWRs (e.g., Oyster Creek) appeared in the late-1960s and were characterized by elimination of steam generators and the use of five external recirculation loops. Later plants were simplified by the introduction of internal jet pumps. These pumps boosted recirculation flow so that only two external recirculation loops were needed. Jet pumps first appeared in the Dresden-2 BWR/3 plant. BWR/4, BWR/5, and BWR/6 designs continued the path to simplification with the changes shown in Table 1-1 above.

The use of reactor internal pumps in the Advanced Boiling Water Reactor (ABWR) design represents another simplification. By using pumps attached directly to the vessel, jet pumps and external recirculation systems (with associated pumps, valves, piping, and snubbers) were eliminated. The ESBWR and its smaller predecessor the Simplified Boiling Water Reactor

(SBWR) are a result of the logical simplification of using a taller vessel and shorter core to achieve natural recirculation flow without the use of any pumps.

BWRX-300 continues the cost-saving advances of the SBWR and ESBWR with a tall vessel design to achieve natural circulation but without the need for a shorter core. This allows the BWRX-300 to use the same fuel bundle designs in use in the operating BWR fleet. Challenges to the integrity of the system are minimized by the large water inventory above the core in the Reactor Pressure Vessel (RPV).

Figure 1-1, *Boiling Water Reactor Design Evolution* illustrates the evolution of the reactor system design. Most BWRs deployed to date have used forced circulation including the BWR/1s through BWR/6s and the ABWR. Natural circulation plants have a separate lineage from the Vallecitos plant through Humboldt Bay and Dodewaard to the SBWR, ESBWR, and BWRX-300.

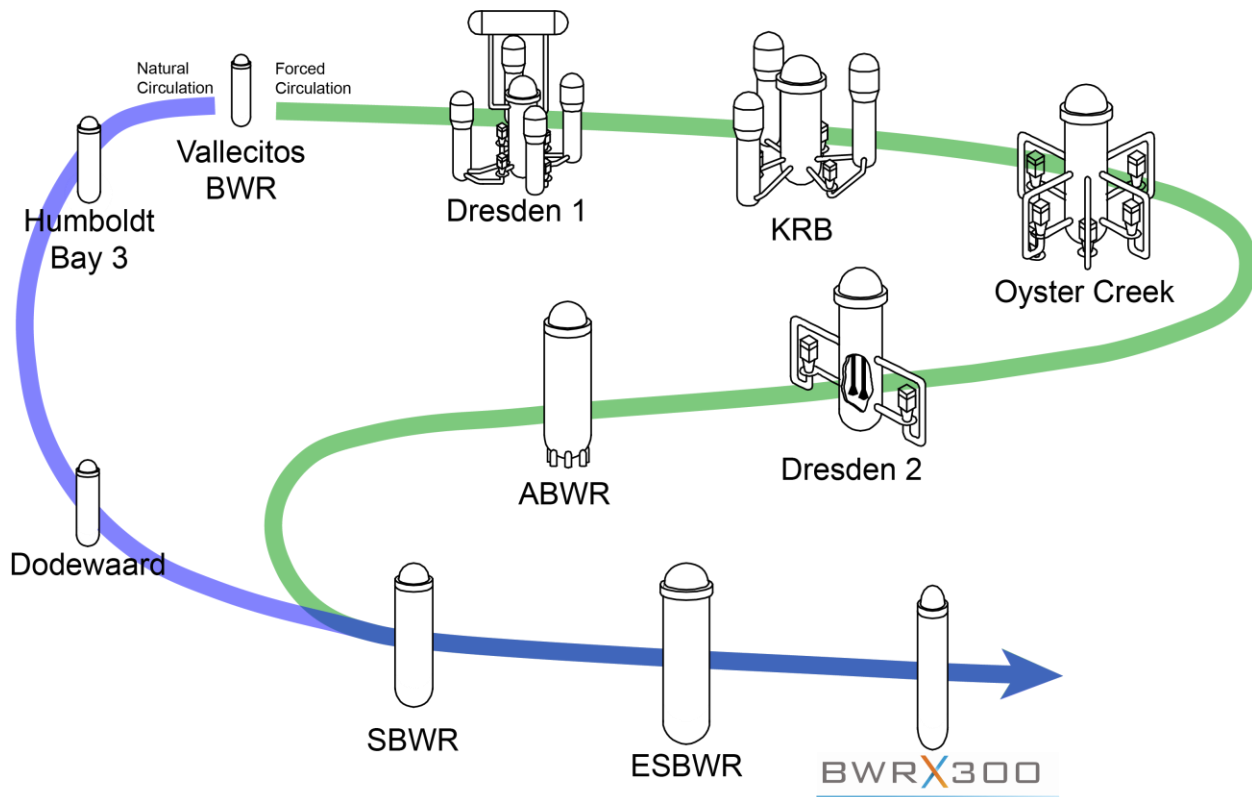

Figure 1-1: Boiling Water Reactor Design Evolution

The first BWR containments were spherical “dry” structures. Dry spherical and cylindrical containments are still used today in Pressurized Water Reactor designs. Future BWR’s including the ABWR and ESBWR utilized a pressure suppression containment design that allowed for a smaller size and the ability to accommodate rapid depressurization of the RPV. The BWRX-300 has gone back to the dry containment configuration because Isolation Condensers (ICs) manage RPV pressure and Safety Relief Valves have been eliminated as described in Sections 2.0 and 3.0 of in this document.

The Mark I containment used for BWR/3 and most BWR/4 plants was the first of the pressure suppression containment designs. The Mark I design has a characteristic “inverted” light bulb configuration for the steel drywell surrounded by a steel torus housing the large pool of water for pressure suppression. The conical Mark II design used for some late BWR/4 and BWR/5 plants is a less-complicated arrangement allowing simplified construction. The Mark III containment

design in BWR/6 plants represented a further improvement in simplicity; the containment structure is a right-circular cylinder that is easy to construct while providing access to equipment and space for maintenance activities.

The ABWR containment is smaller than the Mark III containment because the elimination of the recirculation loops translates into a more compact containment and RB. The ESBWR containment is similar in design to the ABWR but is larger to accommodate the passive ECCS systems.

The BWRX-300 containment is small and simple and is achieved with surface-mounted integral RPV isolation valves to rapidly isolate the flow from a downstream pipe break to minimize pressure and temperature buildup in the containment and an Isolation Condenser System (ICS) to remove energy from the RPV rather than directing that energy into a suppression pool. Figure 1-2, *GEH Containment Designs* illustrates the history of BWR containment (outlined in red) and RB development.

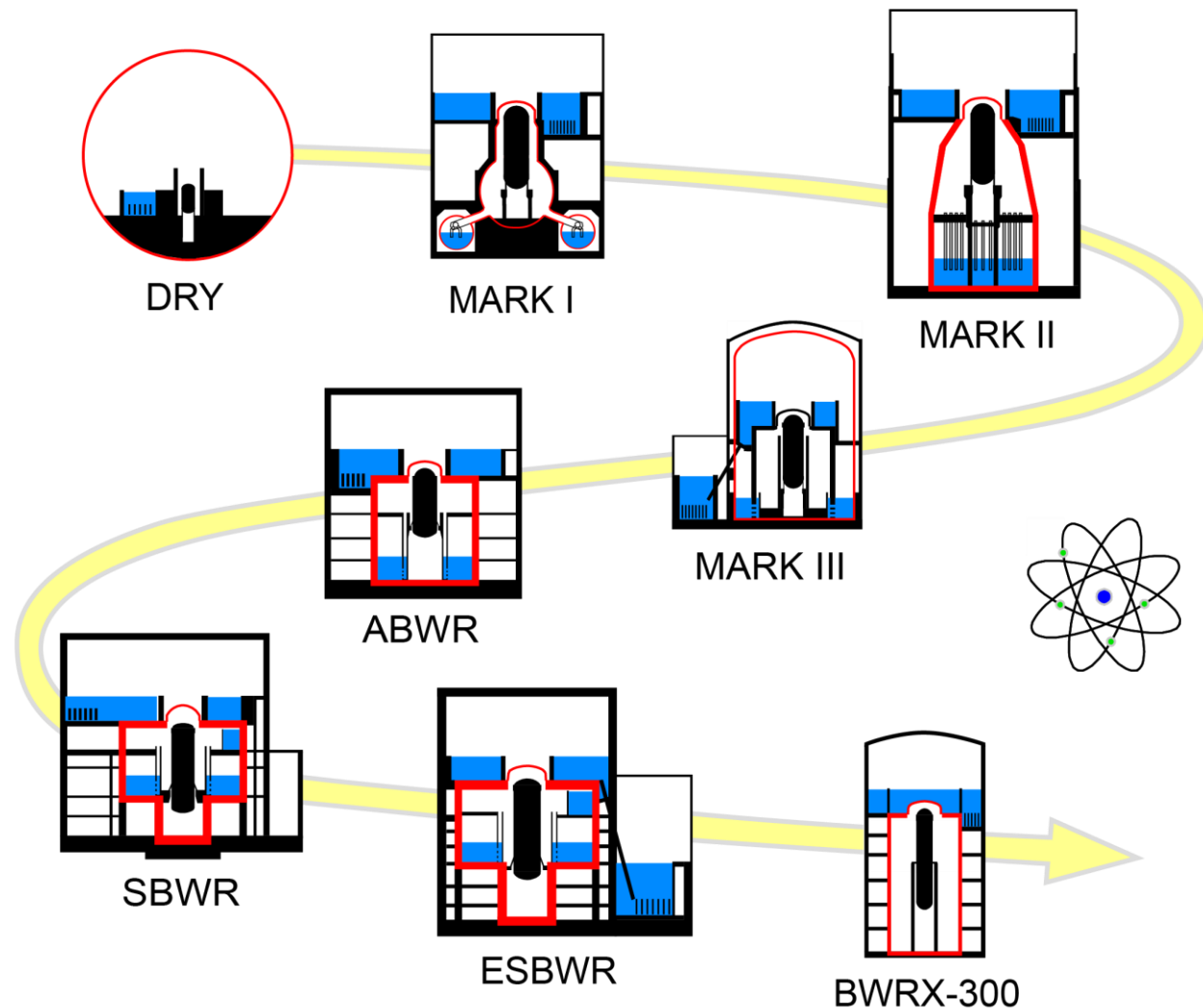

Figure 1-2: GEH Containment Designs

1.3 BWR Experience

There have been over 100 BWRs built and operated around the world with two ABWRs currently under construction. The highest concentration of BWRs is in the U.S. where roughly one-third of

the operating reactors are BWRs. Many BWRs are among the best operating plants in the world, performing in the “best of class” category. See Table 1-2 for a list of GE BWRs that have been built and Table 1-3 for a list of Non GE BWRs that have been built.

Table 1-2: GE BWRs Worldwide

Country	Plant Name	Unit No.	Model	Capacity (MW)	Begin Building	Commercial Operation
Germany	Gundremmingen	A	GE BWR-1	237	1962-12-12	1967-04-12
	Kahl	1	GE BWR	15	1958-07-01	1962-02-01
India	Tarapur	1	GE BWR-1	150	1964-10-01	1969-10-28
	Tarapur	2	GE BWR-1	150	1964-10-01	1969-10-28
Italy	Caorso	1	GE BWR-4	860	1970-01-01	1981-12-01
	Garigliano	1	GE BWR-1	150	1959-11-01	1964-06-01
Japan	Fukushima Daiichi	1	GE BWR-3	439	1967-07-25	1971-03-26
	Fukushima Daiichi	2	GE BWR-4	760	1969-06-09	1974-07-18
	Fukushima Daiichi	6	GE BWR-5	1067	1973-10-26	1979-10-24
	Kashiwazaki-Kariwa	6	GE ABWR	1315	1992-11-03	1996-11-07
	Kashiwazaki-Kariwa	7	GE ABWR	1315	1993-07-01	1997-07-02
	JPDR	1	GE BWR	11	1960	1962
	Tōkai	2	GE BWR-5	1060	1973-10-03	1978-11-28
Mexico	Tsuruga	1	GE BWR-2	340	1966-11-24	1970-03-14
	Laguna Verde	1	GE BWR-5	777	1976-10-01	1990-07-28
	Laguna Verde	2	GE BWR-5	775	1977-06-01	1995-04-10
Netherlands	Dodewaard	1	GE BWR-2	55	1965-05-01	1969-03-26
Spain	Cofrentes	1	GE BWR-6	1064	1975-09-09	1985-03-11
Switzerland	Leibstadt	1	GE BWR-6	1220	1974-01-01	1984-12-15
	Mühleberg	1	GE BWR-4	373	1967-03-01	1972-11-06
Taiwan	Jinshan	1	GE BWR-4	636	1972-06-02	1978-12-10
	Jinshan	2	GE BWR-4	636	1973-12-07	1979-07-15
	Kuosheng	1	GE BWR-6	985	1975-11-19	1981-12-28
	Kuosheng	2	GE BWR-6	985	1976-03-15	1983-03-16
	Lungmen	1	GE ABWR	1350	1999-03-31	TBD
	Lungmen	2	GE ABWR	1350	1999-08-30	TBD
USA	Big Rock Point	1	GE BWR-1	67	1960-05-01	1963-03-29
	Browns Ferry	1	GE BWR-4	1200	1967-05-01	1974-08-01
	Browns Ferry	2	GE BWR-4	1200	1967-05-01	1975-03-01
	Browns Ferry	3	GE BWR-4	1210	1968-07-01	1977-03-01
	Brunswick	1	GE BWR-4	938	1970-02-07	1977-03-18
	Brunswick	2	GE BWR-4	932	1970-02-07	1975-11-03

Clinton	1	GE BWR-6	1062	1975-10-01	1987-11-24
Columbia	1	GE BWR-5	1131	1972-08-01	1984-12-13
Cooper	1	GE BWR-4	769	1968-06-01	1974-07-01
Dresden	1	GE BWR-1	197	1956-05-01	1960-07-04
Dresden	2	GE BWR-3	894	1966-01-10	1970-06-09
Dresden	3	GE BWR-3	879	1966-10-14	1971-11-16
Duane Arnold	1	GE BWR-4	601	1970-05-22	1975-02-01
Edwin I. Hatch	1	GE BWR-4	924	1968-09-30	1975-12-31
Edwin I. Hatch	2	GE BWR-4	924	1972-02-01	1979-09-05
Fermi	2	GE BWR-4	1115	1972-09-26	1988-01-23
Grand Gulf	1	GE BWR-6	1401	1974-05-04	1985-07-01
Hope Creek	1	GE BWR-4	1172	1976-03-01	1986-12-20
Humboldt Bay	1	GE BWR-1	63	1960-11-01	1963-08-01
James A. Fitzpatrick	1	GE BWR-4	813	1968-09-01	1975-07-28
LaSalle County	1	GE BWR-5	1137	1973-09-10	1984-01-01
LaSalle County	2	GE BWR-5	1140	1973-09-10	1984-10-19
Limerick	1	GE BWR-5	1134	1974-06-19	1986-02-01
Limerick	2	GE BWR-5	1134	1974-06-19	1990-01-08
Millstone	1	GE BWR-3	641	1966-05-01	1970-12-28
Monticello	1	GE BWR-3	628	1967-06-19	1971-06-30
Nine Mile Point	1	GE BWR-2	613	1965-04-12	1969-12-01
Nine Mile Point	2	GE BWR-5	1277	1975-08-01	1988-03-11
Oyster Creek	1	GE BWR-2	619	1964-12-15	1969-12-23
Peach Bottom	2	GE BWR-4	1300	1968-01-31	1974-07-05
Peach Bottom	3	GE BWR-4	1331	1968-01-31	1974-12-23
Perry	1	GE BWR-6	1240	1974-10-01	1987-11-18
Pilgrim	1	GE BWR-3	677	1968-08-26	1972-12-09
Quad Cities	1	GE BWR-4	908	1967-02-15	1973-02-18
Quad Cities	2	GE BWR-4	911	1967-02-15	1973-03-10
River Bend	1	GE BWR-6	967	1977-03-25	1986-06-16
Shoreham	1	GE BWR-4	820	1972-11-01	1986-08-01
Susquehanna	1	GE BWR-5	1257	1973-11-02	1982-11-12
Susquehanna	2	GE BWR-5	1257	1973-11-02	1984-06-27
Vallecitos	1	GE VBWR	25	1956-01-01	1957-10-19
Vermont Yankee	1	GE BWR-4	605	1967-12-11	1972-11-30

Table 1-3: Non-GE BWRs Worldwide

Country	Plant Name	Unit No.	Model	Capacity (MW)	Begin Building	Commercial Operation
Canada	Gentilly	1	CANDU BLWR 250	250	1966-09-01	1972-05-01
Finland	Olkiluoto	1	ASEA-III, BWR-2500	890	1974-02-01	1979-10-10
	Olkiluoto	2	ASEA-III, BWR-2500	890	1975-11-01	1982-07-10
Germany	Brunsbüttel	1	BWR-69	771	1970-04-15	1977-02-09
	Grosswelzheim	1	BWR	25	1965-01-01	1970-08-02
	Gundremmingen	B	BWR-72 (KWU)	1284	1976-07-20	1984-07-19
	Gundremmingen	C	BWR-72 (KWU)	1288	1976-07-20	1985-01-18
	Isar	1	BWR-69	878	1972-05-01	1979-03-21
	Krümmel	1	BWR-69 (KWU)	1346	1974-04-05	1984-03-28
	Lingen	1	BWR	183	1964-10-01	1968-10-01
	Philippsburg	1	BWR-69	890	1970-10-01	1980-03-26
	Würgassen	1	BWR-69 (AEG)	640	1968-01-26	1975-11-11
Japan	Fukushima Daiichi	3	Toshiba BWR-4	760	1970-12-28	1976-03-27
	Fukushima Daiichi	4	Hitachi BWR-4	760	1973-02-12	1978-10-12
	Fukushima Daiichi	5	Toshiba BWR-4	760	1972-05-22	1978-04-18
	Fukushima Daini	1	Toshiba BWR-5	1067	1976-03-16	1982-04-20
	Fukushima Daini	2	Hitachi BWR-5	1067	1979-05-25	1984-02-03
	Fukushima Daini	3	Toshiba BWR-5	1067	1981-03-23	1985-06-21
	Fukushima Daini	4	Hitachi BWR-5	1067	1981-05-28	1987-08-25
	Hamaoka	1	BWR-4	515	1971-06-10	1976-03-17
	Hamaoka	2	BWR-4	806	1974-06-14	1978-11-29
	Hamaoka	3	BWR-5	1056	1983-04-18	1987-08-28
	Hamaoka	4	BWR-5	1092	1989-10-13	1993-09-03
	Hamaoka	5	ABWR	1325	2000-07-12	2005-01-18
	Higashidōri (Tōhoku)	1	BWR-5	1067	2000-11-07	2005-12-08
	Higashidōri (Tokyo)	1	ABWR	1350	2011-01-25	TBD
	Kashiwazaki-Kariwa	1	BWR-5	1067	1980-06-05	1985-09-18
	Kashiwazaki-Kariwa	2	BWR-5	1067	1985-11-18	1990-09-28
	Kashiwazaki-Kariwa	3	BWR-5	1067	1989-03-07	1993-08-11
	Kashiwazaki-Kariwa	4	BWR-5	1067	1990-03-05	1994-08-11
Kashiwazaki-Kariwa	5	BWR-5	1067	1985-06-20	1990-04-10	

	Öma	1	ABWR	1325	2010-05-07	TBD
	Onagawa	1	BWR-4	498	1980-07-08	1984-06-01
	Onagawa	2	BWR-5	796	1991-04-12	1995-07-28
	Onagawa	3	BWR-5	796	1998-01-23	2002-01-30
	Shika	1	BWR-5	505	1989-07-01	1993-07-30
	Shika	2	ABWR	1108	2001-08-20	2006-03-15
	Shimane	1	BWR-3	439	1970-07-02	1974-03-29
	Shimane	2	BWR-5	789	1985-02-02	1989-02-10
	Shimane	3	ABWR	1325	2007-10-12	TBD
Spain	Santa María de Garoña	1	BWR-3	446	1971-05-11	1975-02-15
	Marviken	1	R4	196	1965-04-01	TBD
	Barsebäck	1	ASEA-II	600	1971-02-01	1975-07-01
	Barsebäck	2	ASEA-II	600	1973-01-01	1977-07-01
	Forsmark	1	ASEA-III, BWR-2500	986	1973-06-01	1980-12-10
	Forsmark	2	ASEA-III, BWR-2500	1116	1975-01-01	1981-07-07
	Forsmark	3	ASEA-IV, BWR-3000	1167	1979-01-01	1985-08-18
	Oskarshamn	1	ASEA-I	473	1966-08-01	1972-02-06
	Oskarshamn	2	ASEA-II	638	1969-09-01	1975-01-01
	Oskarshamn	3	ASEA-IV, BWR-3000	1450	1980-05-01	1985-08-15
	Ringhals	1	ASEA-I	881	1969-02-01	1976-01-01
	Elk River	1	ACF BWR	22	1959-01-01	1964-07-01
USA	La Crosse	1	Allis-Chalmers BWR	48	1963-03-01	1969-11-07
	Pathfinder	1	Allis-Chalmers BWR	59	1959-01-01	1966-08-01

1.4 Safety Concept and Defense-in-Depth

The BWRX-300 is designed for international deployment and is, therefore, utilizing standards published by the IAEA, in lieu of specific regulatory requirements for any given country. The IAEA Safety Standards represent an international consensus on what measures constitute a high level of protection and safety and utilize D-in-D as “the primary means of preventing accidents in a Nuclear Power Plant (NPP) and mitigating the consequences of accidents if they do occur”. The BWRX-300 design is in alignment with this international framework irrespective of licensing requirements in any specific region. Region-specific adaptations can be made for specific design or analysis elements (e.g., region-specific acceptance criteria for dose releases), but the role of that element should not change.

The concept of D-in-D involves the provision of multiple layers of defense against some undesirable outcome rather than a single, strong defensive layer. In the case of an NPP, the undesirable outcome is the exposure of workers or the public to radioactivity that exceeds a safe level.

To understand the principle of D-in-D, it is important to differentiate two types of defensive layering:

1. Physical barriers in place to prevent release of radioactivity: the fuel cladding, Reactor Coolant Pressure Boundary (RCPB), and containment. The integrity of one or more physical barriers must be maintained to prevent unacceptable releases.
2. Features, functions, and practices used to minimize challenges to the physical barriers, to maintain the integrity of the barriers and, in case a barrier is breached, to ensure the integrity of the remaining barriers.

The physical barriers themselves represent multiple layers of defense against radioactive releases. In the BWRX-300 D-in-D concept, shown in Figure 1-3: BWRX-300 Defense-in-Depth Concept, the physical barriers are not themselves referred to as “defense lines.” That term is reserved for the layers of defense comprising features, functions, and practices that protect the integrity of the barriers. In fact, the D-in-D concept is largely focused on identifying and organizing features, functions, and activities into DL without explicit acknowledgment of the physical barriers. It should, however, be understood that the fundamental purpose of the layered DLs is to ensure the integrity of the layered physical barriers.

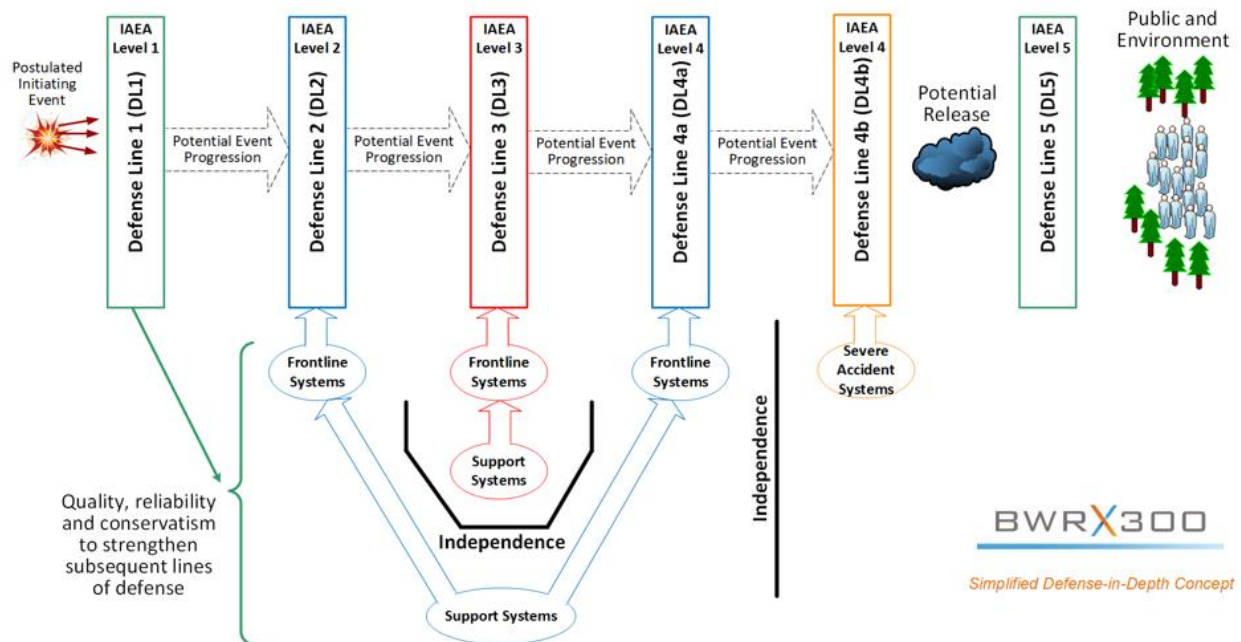

Figure 1-3: BWRX-300 Defense-in-Depth Concept

The BWRX-300 D-in-D concept uses Fundamental Safety Functions (FSFs) to define the interface between the DLs and the physical barriers.

NOTE: In each plant scenario, if the FSFs are performed successfully, then the corresponding physical barriers remain effective.

The FSFs for the BWRX-300 are:

1. Control of reactivity

2. Removal of heat from the fuel (in the reactor, during fuel storage and handling, and including long-term heat removal)
3. Confinement of radioactive materials, shielding against radiation, and control of planned radioactive releases, as well as limitation of accidental releases.

The first two FSFs support the fuel cladding and the RCPB physical barriers. The third FSF supports the containment physical barrier.

If a manual action is credited to perform an FSF, the monitoring and display of plant parameters necessary to perform the manual action successfully are also considered part of the FSF. Therefore, monitoring and display of parameters are not treated as a stand-alone FSF.

Five DLs in the BWRX-300 Safety Strategy specification are consistent with these five International Nuclear Safety Group (INSAG) defined levels of D-in-D (INSAG-10, *Defence in Depth in Nuclear Safety* (11)).

- Level 1: Prevention of abnormal operation and failures.
- Level 2: Control of abnormal operation and detection of failures.
- Level 3: Control of accidents within the design basis.
- Level 4: Control of severe plant conditions, including prevention of accident progression and mitigation of the consequences of severe accidents (divided into DL4a and DL4b in the BWRX-300 as shown in Figure 1-3).
- Level 5: Mitigation of radiological consequences of significant releases of radioactive material.

Five DLs are adopted and consistent with the IAEA approach.

DL1 is centered on preventing failures by design and other conservative measures taken to minimize the potential for failures to occur in subsequent lines of defense. These design functions and conservative measures cover the design, construction, operation, and maintenance of the plant in accordance with appropriate safety margins, engineering practices, and quality levels. DL1 also includes the use of appropriate conservatism in analyses.

DL2 contains plant functions designed to control or initiate responses to Postulated Initiating Events (PIE)s, especially Anticipated Operational Occurrences (AOOs) before any plant parameters exceed conditions allowed in AOOs. Functions that normally operate to actively control plant parameters are part of DL2. Other functions, such as blocking control rod motion and anticipatory plant trips, are also part of DL2. Functions in DL2 are assigned to Safety Category 3 and are performed by at least Safety Class (SC) 3 equipment. Functions in DL2 must be performed independently from DL3 functions, and any portion of DL2 functions subject to a Common Cause Failure (CCF) must be performed diversely from corresponding portions of functions in DL3.

DL3 contains plant functions that act to mitigate a PIE by preventing core damage, when possible. These functions are to provide a level of assurance for maintaining integrity of the physical barriers that prevent radiological release and to place the plant in a safe state.

DL2 and DL4a functions provide independence and diversity, to the extent practicable, from DL3 functions in mitigating events caused by a single failure and many CCFs. Because of requirements for redundancy in DL3 functions, a CCF in DL3 is generally a failure of two or more redundant and similar components occurring concurrently. These DL3 CCFs may result from

causes such as errors in design or manufacturing, inadequate maintenance or surveillance, environmental factors exceeding design margins, or internal or external hazards.

DL3 also includes functions that maintain the plant in a safe condition following mitigation of PIEs until normal operations are resumed. DL3 functions typically include reactor scram and actuation of engineered safety features.

DL3 functions are needed when DL2 is not effective at intercepting a PIE or when a PIE is beyond the capabilities of DL2 functions. DL3 functions needed during the first 24 hours following a PIE are assigned to Safety Category 1 and are performed by SC1 equipment. After the first 24 hours of the event, this equipment can be classified as SC2. Structures, Systems, and Components (SSCs) that are needed only after the first seven days of the event can be classified as SC3. This graded approach allows SSCs that are used, for example, to replenish DL3 functions for long-term heat recovery to be classified at a reduced Safety Category, given the time available post-accident to ensure those functions are available.

By eliminating the need for active support systems such as power supplies, ventilation, or cooling water, and minimizing the need for active control functions such as pumps and actively controlled valves during the first 24 hours of an event, systems and equipment involved in performance of DL3 functions needed during the first 24 hours of a PIE are designed for highest reliability.

DL4 represents the boundary between Design Basis Accident (DBA) and Beyond Design Basis Accident (BDBA). DL4 comprises two subsets of functions that are designated as DL4a and DL4b functions. DL4a functions are for Design Extension Conditions (DECs) that occur without core damage, and functions for DECs progressing to core damage are DL4b functions.

DL4a and DL4b safety features specifically designed to prevent core damage and mitigate the consequences of accidents involving significant core damage are, as far as practicable, independent from DL3 systems, with a few, justified exceptions.

DL4a functions are backups to DL3 functions, in the unlikely event a DL3 function fails. DL4a functions are intended to be available to place and maintain the plant in a safe state in case of PIEs that could lead to BDBAs, such that core damage is prevented.

DL4b functions are performed in scenarios leading to core damage. DL4b functions are provided to limit the radiological releases in case of core damage and are aimed at maintaining the containment functions for extreme events, multiple events, or multiple failures that defeat DL2, DL3, and DL4a. The DL4b functions intended for mitigating DEC are functionally and physically separated from the systems intended for other DL functions. Note that safety features designated for DEC with core damage may, if practicable and available, also be used for preventing or minimizing significant core damage if it can be demonstrated that such use does not undermine the ability of these systems to perform their primary functions if conditions evolve into a severe accident.

DL4b capabilities are provided to mitigate the effects from a damaged core, to preserve the FSF of confinement of radioactive material, and to limit radioactive releases to within acceptable levels. DL4b features specifically designed to mitigate the consequences of accidents with core damage are independent from systems used in normal operation or used to mitigate AOOs, as far as practicable, with justified exceptions.

DL5 includes emergency preparedness measures to cope with potential unacceptable radiological releases in case the first four DLs are not effective. These are largely off-site measures taken to protect the public in a scenario involving substantial release of radiation.

The adequacy of the DLs is assessed and demonstrated using layered, deterministic safety analyses that are designed to exercise the different DLs. The PIEs to be considered in these analyses are supported based on rigorous and systematic failure modes and effects analyses of the plant systems, as well as internal and external hazard evaluations, and a human operation hazards evaluation.

Functional and design requirements are derived from the deterministic safety analyses and D-in-D concept itself, to ensure that the DL functions are implemented in the design consistent with their role in the D-in-D concept, and the credit taken for them in the safety analyses.

1.5 Classification of Structures, Systems, and Components

The BWRX-300 approach to classifying SSCs is consistent with IAEA SSR-2/1 (10) and IAEA SSG-30, *Safety Classification of Structures, Systems and Components in Nuclear Power Plants* (8). Classification of SSC is conducted to identify the importance of the SSC with respect to safety.

Classification of SSCs provides a means for applying appropriate design requirements and establishes a graded approach in the selection of materials, and application of codes and standards used in design, manufacturing, construction, testing and inspection of individual SSCs.

The BWRX-300 approach to classifying SSCs by SC is based primarily on deterministic methods and is directly traceable to the safety functions performed by the SSC. A fundamental element of the BWRX-300 SSC classification approach is the direct correlation between the DLs in which an SSC performs a function, and the relative safety importance of that function. Functions are categorized into three safety categories, Safety Category 1, Safety Category 2, and Safety Category 3, with Safety Category 1 being the most important.

Primary functions are those that directly perform the FSFs in support of DL2, DL3, DL4a, or DL4b. Safety Categories are applied to the primary functions as follows:

1. Safety Category 1 is assigned to DL3 primary functions. DL3 functions assure the integrity of the barriers to release, place, and maintain the plant in a safe state, and provide independence and diversity for all DL2 and DL4a functions caused by a single failure (and many CCFs). Accordingly, DL3 primary functions are the most important from a safety standpoint.
2. Safety Category 2 is assigned to DL4a primary functions. Both DL2 and DL4a provide a redundant means to address PIEs (generally independent of DL3 functions) and are therefore important from a safety standpoint, although less important than DL3 functions. DL4a functions are a backup to DL3 functions, in the unlikely event a DL3 functions fails, and therefore have a higher consequence of failure than DL2 functions and are more important from a safety standpoint than DL2 functions.
3. Safety Category 3 is assigned to DL2 and DL4b primary functions as they are relatively the least important. DL4b functions address severe accidents, which are extremely unlikely because failure of both DL3 and DL2 or DL4a functions would have to occur. Accordingly, DL4b functions are considered relatively the least important defense line functions, despite the high consequence of failure.
4. Non-Safety Category is assigned to all other functions.

1.6 BWRX-300 Status

1.6.1 Design Progress

GEH is currently finalizing the basic plant and system designs for BWRX-300. The basic design includes establishing fundamental safety design and analysis cases and completing major design decisions and Three-Dimensional (3D) modeling of SSCs. Basic design supports the creation of bills of material for estimating purposes. A Preliminary Safety Analysis Report has been prepared collaboratively between GEH and Ontario Power Generation and in accordance with the guidance of the IAEA as documented in their Specific Safety Guide No. SSG-61, *Format and Content of the Safety Analysis Report for Nuclear Power Plants*.

1.6.2 Licensing Strategy

GEH is developing a BWRX-300 standard plant design that can be licensed in the U.S., Canada, and Europe. Therefore, the BWRX-300 standard plant design is based wherever possible on meeting the requirements and guidance of the IAEA Safety Standards consisting of the three basic sets of IAEA publications: the Safety Fundamentals, the Safety Requirements, and the Safety Guides. While the first one of these establishes the fundamental safety objective and principles of protection and safety, the second set out the requirements that must be met to ensure the protection of people and the environment, both now and in the future. The Safety Guides provide recommendations and guidance on how to comply with the requirements.

BWRX-300 standard plant design incorporates D-in-D in the design of the plant in conformance with INSAG-10 (11). The BWRX-300 Safety Strategy is based on the IAEA Safety Requirement SSR-2/1 (10). Some of the IAEA Safety Guides that are a part of the BWRX-300 Safety Strategy include the following:

- IAEA SSG-2, *Deterministic Safety Analysis for Nuclear Power Plants* (7).
- IAEA SSG-30, *Safety Classification of Structures, Systems and Components in Nuclear Power Plants* (8).
- IAEA SSG-53, *Design of the Reactor Containment and Associated Systems for Nuclear Power Plants* (9).

Although every attempt is made to conform to the IAEA Safety Standards, there are cases where alternate approaches or exceptions are incorporated into the BWRX-300 standard plant design. Some of these are based on meeting more limiting country-specific regulations or guidance, while others are based on the specifics of the BWRX-300 technology where requirements or guidance are either not applicable or are not necessary to meet the applicable safety goals. In addition, the BWRX-300 utilizes a design-to-cost approach that evaluates design alternatives that achieve the required safety goals to determine the most cost-effective design, construction, commissioning, operations, maintenance, inspection, testing, and decommissioning approaches for the BWRX-300 standard plant design.

1.6.3 License Progress

The BWRX-300 has undergone a preapplication review with the United Kingdom (U.K.) Office for Nuclear Regulation (ONR) and is in the process of preapplication reviews by the USNRC and the Canadian Nuclear Safety Commission (CNSC). The purpose of these licensing preapplication activities is to present a standard design approach that meets regulatory requirements and guidance while increasing regulatory certainty. The review activities introduce the innovative

design features and analysis methods used for the BWRX-300 prior to actual submittal of complete license applications.

In Canada, the Vendor Design Review process confirms that there are no fundamental barriers to licensing based on Canadian regulations and regulatory guidance. The Vendor Design Review process was completed in March 2023. There have been no significant issues representing barriers to licensing identified by CNSC to date. A License to Construct application for a BWRX-300 project was filed with CNSC in October 2022.

In the U.S., a decision was made during the licensing preapplication process to submit Licensing Topical Reports (LTRs) for design features and analysis methods considered to have lower regulatory certainty. GEH has submitted a series of LTRs to increase the risk certainty of the licensing process for the BWRX-300 in the U.S. LTRs are used to obtain regulatory approval of key enabling technologies prior to performing detailed design activities. Additional LTRs are to be submitted to support other aspects of the BWRX-300 design. Preapplication LTRs may also be prepared to support U.S. operating utility partner plans currently in development. The intent of further LTRs is to streamline the review process for plant-specific licensing applications. GEH expects a submittal for a Construction Permit to be filed with the USNRC in 2024.

In the U.K., the BWRX-300 has undergone an evaluation by the U.K. Department for Business, Energy and Industrial Strategy funded Mature Technology. This included workshops between ONR and GEH to discuss and obtain feedback on unique design features of the BWRX-300 and the proposed international licensing strategy. No major issues were identified by the regulator during the evaluation. In December 2022, GEH submitted a Generic Design Assessment (GDA) entry application for the BWRX-300 SMR.

GEH is supporting potential deployment of the BWRX-300 in Poland with partners. GEH, along with our partners, is in preapplication discussions with the National Atomic Energy Agency (PAA). PAA has also communicated to GEH that discussions regarding development of a collaborative agreement with both the USNRC and CNSC are in progress. As Poland does not have existing commercial NPPs, GEH and our partners have been in discussions with the PAA for consideration of using country-of-origin licensing from either or both Canada and the U.S. to supplement the country's existing nuclear regulations, including acceptance of use of IAEA Safety Standards. CNSC in Canada has adopted many of the IAEA Safety Standards in their regulatory requirements and guidance.

In support of potential deployment of the BWRX-300 in the Czech Republic, GEH, along with our partners, is in preapplication discussions with the State Office for Nuclear Safety (SÚJB) and the Radioactive Waste Repository Authority (SURA). SÚJB and SURA have also communicated to GEH that discussions regarding development of a collaborative agreement with both the USNRC and CNSC are in progress. Although there are existing commercial NPPs in the Czech Republic, the existing nuclear regulations are not as mature as in Canada and the U.S. Therefore, GEH and our partners have been in discussions with the SÚJB and SURA for consideration of using country-of-origin licensing from either or both Canada and the U.S. to supplement the country's existing nuclear regulations, including acceptance of use of IAEA Safety Standards.

2.0 PLANT OVERVIEW

The BWRX-300 builds on the success and lessons learned from over 60 years of BWR operating history. The important characteristics of the BWRX-300 include:

- 10th generation BWR.
- Evolved from USNRC licensed ESBWR.
- Design-to-cost approach.
- Significant capital cost reduction per MW
- World class safety.
- Capable of load following.
- Suitable for electricity generation and industrial applications, including hydrogen production.
- Constructability integrated into design.
- Reduced on-site staff and security.
- Intended to be licensable internationally.

The BWRX-300 optimizes innovation with technology readiness. It relies on fuel that is already licensed and currently in use globally and used by the majority of the BWR fleet. The design optimizes material and manufacturing techniques while incorporating breakthrough passive and simple concepts. The result is a cost-effective advanced reactor design with world class safety and economic performance that can be licensed and constructed in the near term. It offers low risk in comparison to historical large Light Water Reactor (LWR) projects in the U.S., Europe, and Asia, and promises to be highly competitive in the worldwide energy market.

The key simplifications of the BWRX-300 are the use of integral RPV isolation valves that mitigate the impacts of LOCAs, and large capacity ICs that provide over pressure protection without the need for safety relieve valves. The ICs also act as the ECCS, utilize natural circulation, and require no Alternating Current (AC) power to perform their functions.

A cutaway of the BWRX-300 RB is shown in Figure 2-1, *BWRX-300 Reactor and Containment Design*. An artist's rendering of the major systems and how those systems interconnect is shown in Figure 2-2, *BWRX-300 Major Systems*.

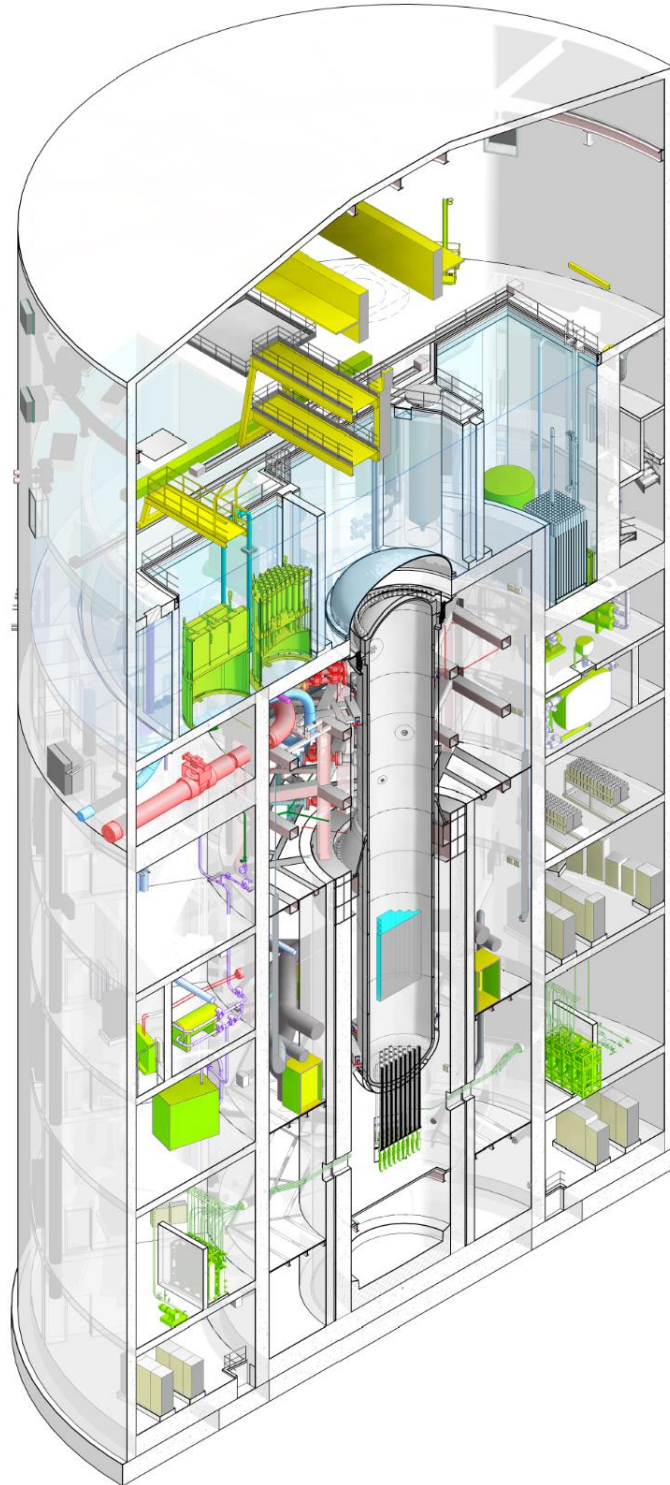

Figure 2-1: BWRX-300 Reactor Building and Containment Design

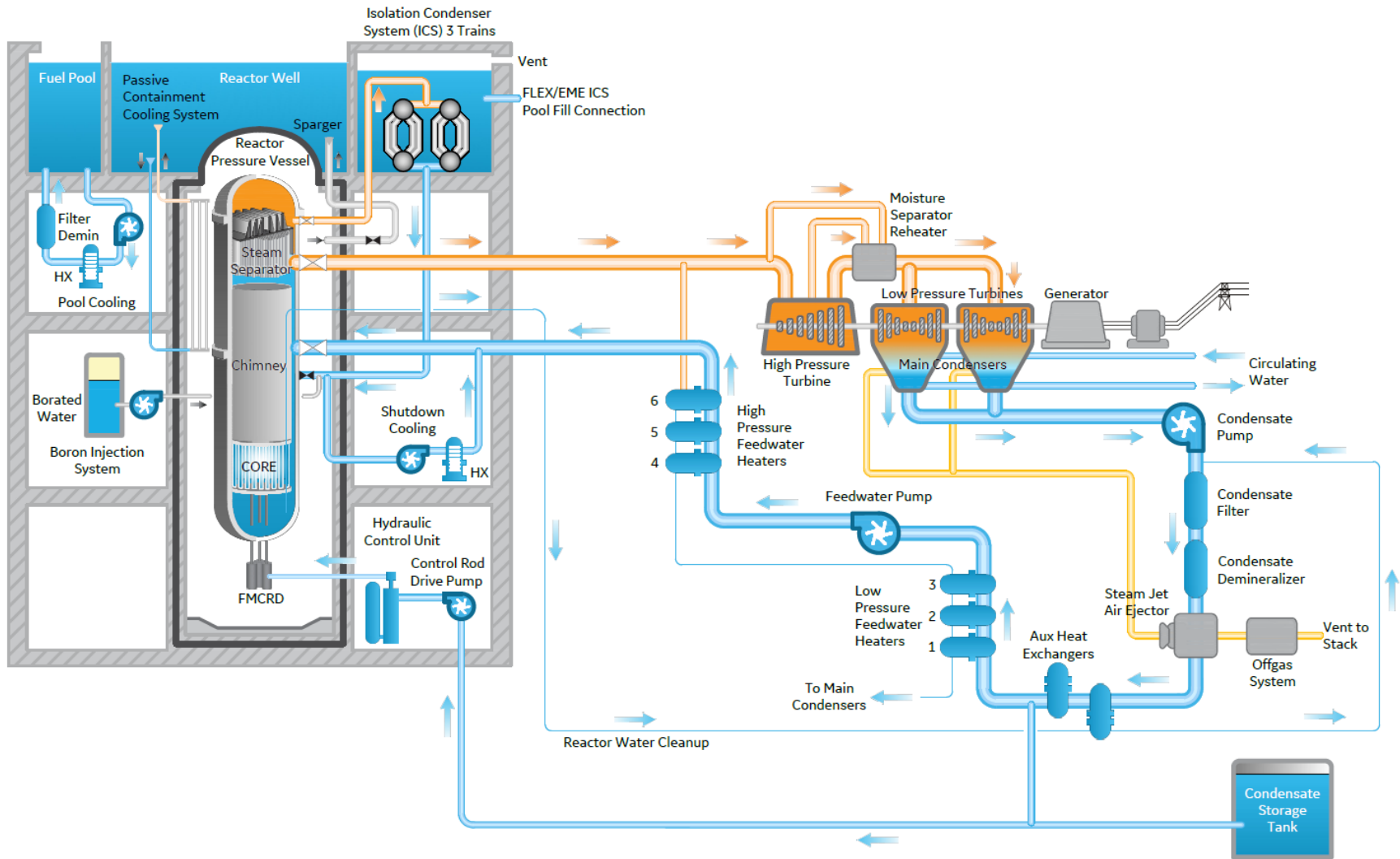

Figure 2-2: BWRX-300 Major Systems

2.1 Unique Design Features

Though mostly traditional in BWR design, the BWRX-300 includes several design features that simplify the design and support reduced costs. These features include:

1. Integral RPV isolation valves: The BWRX-300 RPV is equipped with isolation valves that are integral to the RPV that rapidly isolate a ruptured pipe to help mitigate the effects of an LOCA. All large fluid pipes with RPV penetrations are equipped with double isolation valves that are integral to the RPV.
2. No Safety Relief Valves (SRVs): SRVs have been eliminated from the BWRX-300 design. The large capacity ICS in conjunction with the large steam volume in the RPV provides overpressure protection in accordance with American Society of Mechanical Engineers (ASME) Boiler and Pressure Vessel Code (BPVC), Section III, Class 1 equipment. Historically, BWR SRVs have been the most likely cause of an LOCA but have been eliminated from the BWRX-300 design.
3. Dry containment: The BWRX-300 has a dry containment. This has been proven to effectively contain the releases of steam, water, and fission products after an LOCA.
4. Design-to-cost: The BWRX-300 has been designed with cost and constructability in mind from the start, beginning with a simplified system layout that requires fewer safety systems and safety-related pools of water. This concept has also been adapted to fit with commercial building standards and cost and labor-efficient construction techniques for underground structures. The design has been optimized for constructability.
5. Use of commercial off-the-shelf equipment: Due to its smaller size, the BWRX-300 has been designed to use more commercial off-the-shelf equipment than previous BWRs. For instance, the turbine and generator models have been used on many fossil plant projects such as combined-cycle combustion turbine sites and can be used for this plant with small modifications. This leads to lower cost.

2.2 Key Features

Key features of the BWRX-300 compared to the ABWR and ESBWR are shown in Table 2-1, *Comparison of Key Features*.

Table 2-1: Comparison of Key Features

Feature	ABWR	ESBWR	BWRX-300
Plant Type	Direct Cycle BWR	Direct Cycle BWR	Direct Cycle BWR
Plant Gross Electrical Output	~1,350 MWe	~1,600 MWe	~300 MWe
Reactor Thermal Output	3,926 MWth	4,500 MWth	870 MWth
Reactor Coolant Recirculation	Reactor Internal Pumps	Natural Circulation	Natural Circulation
Reactor Operating Pressure	7.2 MPa (abs)	7.2 MPa (abs)	7.2 MPa (abs)
Reactor Vessel	Extensive use of forged rings	Extensive use of forged rings	Extensive use of forged rings; integrated isolation valves
RPV Diameter (ID)	7.1 m	7.1 m	4 m
RPV Height (Inside)	21.0 m	27.6 m	26 m
Fuel Type	GE14	GNF2e	GNF2
Number of Fuel Bundles	872	1,132	240
Control Blade Type	Cruciform B ₄ C or Hf	Cruciform B ₄ C or Hf	Cruciform B ₄ C or Hf
Control Rod Drive (CRD) Type	FMCRD	FMCRD	FMCRD
Number of Control Rods	205	269	57
Steam Conditioning	AS-2B Steam Separators Chevron Steam Dryer	AS-2B Steam Separators Chevron Steam Dryer	AS-2B Steam Separators Chevron Steam Dryer
Primary Containment Vessel Type	Reinforced Concrete Containment Vessel	Reinforced Concrete Containment Vessel	Steel-plate Composite Containment Vessel
ECCS	3-Divisional	Passive	Passive
Isolation Makeup	Reactor Core Isolation Cooling System	Isolation Condensers, Passive	Isolation Condensers, Passive
Shutdown Cooling	3-Division Residual Heat Removal System Safety-related	Non-Safety related	SC3
Primary Containment Vessel Cooling System	3-Division Residual Heat Removal System	Passive	Passive
Emergency AC Power	3 Safety-related diesel generators	Non-Safety related	Two SC3 diesel generators
Control & Instrumentation	Digital, Multiplex, Fiber Optics, Multiple Channel	Digital, Multiplex, Fiber Optics, Multiple Channel, Diverse Analog DL4a System	Digital, Multiplex, Fiber Optics, Multiple Channel, Diverse Analog DL4a System
In-Core Monitor Calibration	Traversing In-core Probe System	Fixed, In-Core Gamma Thermometers (GTs)	Fixed, In-Core GTs
Control Room	Operator Tasked-Based	Operator Tasked-Based	Operator Tasked-Based

3.0 NUCLEAR STEAM SUPPLY SYSTEMS AND COMPONENTS

The BWRX-300 plant is composed of several mechanical systems which are optimized for cost and performance to meet the project design-to-cost objectives.

3.1 Nuclear Boiler System

BWRX-300 is designed with the proven supply chain of the ABWR (*Status Report 98 – Advanced Boiling Water Reactor II (ABWR II)*, Section 2.2 (13)) and predesigned features from the ESBWR (*Status Report 100 – Economic Simplified Boiling Water Reactor*, Sections 2.4, 2.5, 7.3, and 7.4 (14)) for its primary circuit or Nuclear Boiler System (NBS). The NBS consists of three subsystems: RPV and internals, Main Steam (MS), and RPV Instrumentation.

The primary functions of the NBS are to:

- Deliver steam from the RPV to the turbine MS system.
- Receive Feedwater (FW) from the Condensate and Feedwater Heating System (CFS) to the RPV.
- Provide overpressure protection of the RCPB.
- Provide core support structure to enable the control rods to stop the nuclear reaction when driven in the core by their respective Hydraulic Control Units (HCUs).
- Provide the flow path to enable the core coolant to keep the core cooled using natural circulation.

The NBS supports the safety design philosophy for the mitigation of LOCAs. It is built on utilization of inherent margins (e.g., larger water inventory) to eliminate system challenges and reduce number and size of RPV nozzles as compared to predecessor designs. All nozzles are located significantly above the level of active fuel and the flanged Reactor Isolation Valves (RIVs) are closer to the RPV compared to predecessor designs. The relatively large RPV volume, along with the relatively tall chimney region, provides a substantial reservoir of water above the core. This ensures the reactor water level is maintained or above top of active fuel and fuel cladding temperature is maintained within normal operating temperature range following transients involving FW flow interruptions or LOCAs. These design features preserve reactor coolant inventory to ensure that adequate core cooling is maintained. The large RPV volume enhances safety by reducing the rate at which reactor pressurization occurs if the reactor is suddenly isolated from its Normal Heat Sink (NHS).

3.1.1 Reactor Pressure Vessel

The RPV forms a major part of the RCPB, contains the path for reactor coolant flow through the fuel, and generates steam to drive the High Pressure (HP) and Low Pressure (LP) turbines. Flow through the core is by natural circulation; pumps are not required to force reactor coolant through the RPV. Natural circulation is enabled by a tall chimney between the top of the core at the top guide to the bottom of the steam separators. The RPV design is such that the level of all nozzles is located significantly above the top of active fuel.

The RPV is a vertical, cylindrical pressure vessel fabricated with forged rings and rolled plate welded together, with a removable top head, head flange, seals, and bolting. The vessel also includes penetrations, nozzles, and the shroud support. The RPV has a minimum inside diameter of approximately 4 m, a wall thickness of about 136 mm with cladding, and a height of

approximately 26 m. The bottom of the active fuel elevation is approximately 5.2 m from the bottom of the vessel and the active core is 3.8 m high.

The BWRX-300 RPV assembly, shown in Figure 3-1, *BWRX-300 Reactor Pressure Vessel and Internals*, consists of the RPV with nozzle, integral RIVs, and its other appurtenances, a removable head, the reactor internals, and supports.

The RPV instrumentation monitors the conditions within the RPV over the full range of reactor power operation and shutdown conditions. The RPV, together with its internals, provides guidance and support for FMCRDs.

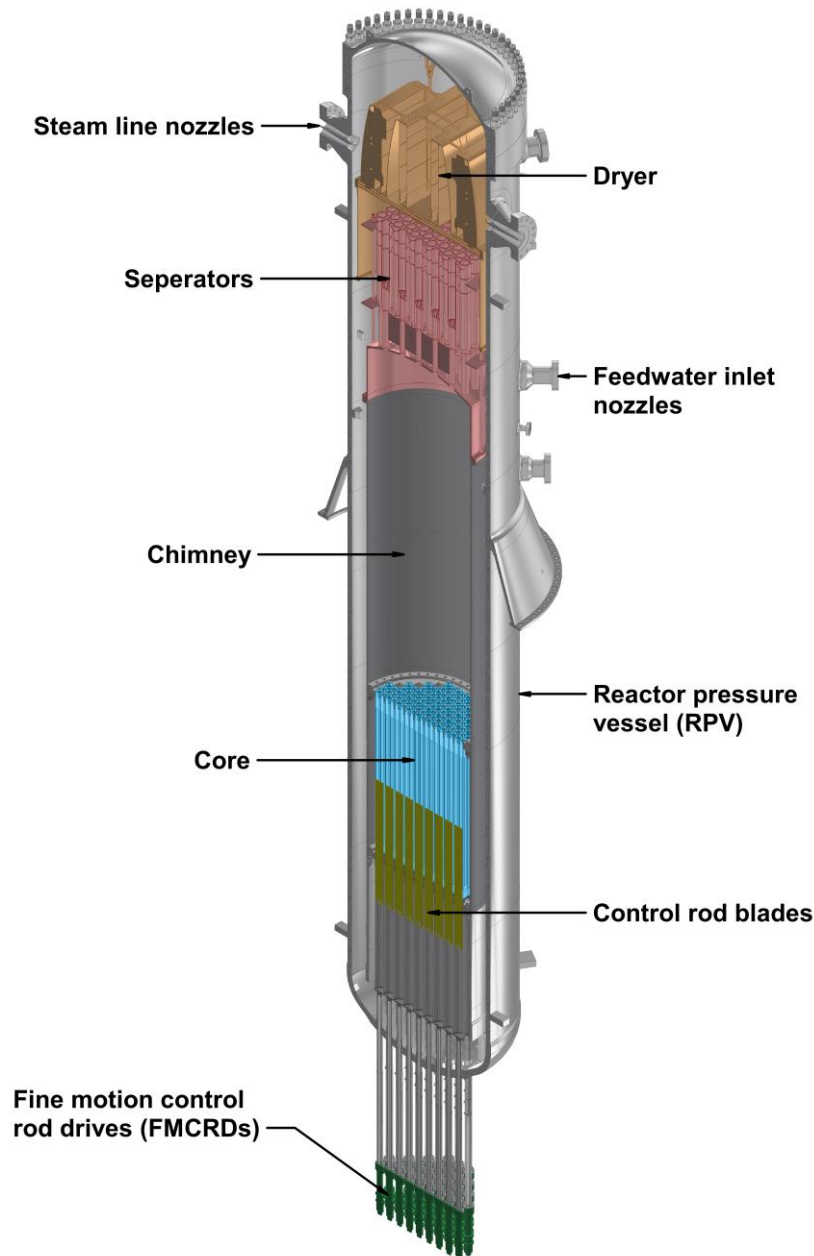

Figure 3-1: BWRX-300 Reactor Pressure Vessel and Internals

3.1.1.1 Reactor Internals

The major reactor internal components include:

- Core (control rods and nuclear instrumentation).
- Core support and alignment structures (shroud, shroud support, top guide, core plate, control rod guide tube, and orificed fuel support).
- Chimney.
- Chimney head and steam separator assembly.
- Steam dryer assembly.

Except for the Zircaloy in the reactor core, these reactor internals are stress corrosion resistant stainless steel or other high alloy steels.

The fuel assemblies (including fuel rods and channels), control rods, chimney head, steam separators, steam dryer, and in-core instrumentation assemblies are removable when the reactor vessel is opened for refueling or maintenance.

The RPV internals are described from the bottom to the top of the RPV.

The Control Rod Drive Housings (CRDHs) provides the extension of the RPV pressure boundary at the bottom head for installation of FMCRDs. They also support the weight of an FMCRD, control rod, control rod guide tube, thermal sleeve, orificed fuel support, and four fuel assemblies. Finally, they provide the ports for the attachment of FMCRD hydraulic supply lines.

The control rod guide tube fits in holes in the core plate and rests on the CRDHs that are welded to the reactor bottom head. They provide the lateral support and channel water to the control rods as they move up and down within the core to change the reactor power levels. The control rod guide tube also provides vertical support to the orificed fuel supports and to four fuel bundles landed on the orificed fuel supports.

The orificed fuel supports rest inside the respective control rod guide tube with a flanged top that sets down onto the control rod guide tube top end to transfer vertical load. They provide a seat for the lower end of each fuel assembly to rest and provide cruciform slots to maintain alignment engagement of a fully withdrawn control rod and guide the control rod blade as it raises or lowers to respectively decrease or increase reactor power. The orificed fuel support slots are crucial to keeping the control blades properly aligned between the four bundles for rapid insertion into the core from fully withdrawn.

The shroud support is a circular assembly with vertical legs that are welded to the reactor bottom head. The shroud support provides the vertical and lateral support for the shroud and other components like the top guide and core plate. It also supports the chimney and chimney head and steam separator assembly.

The core plate is at the bottom of the reactor core area. It provides the lateral support for the fuel assemblies and control rods through the orificed fuel support, provides vertical and lateral support for the nuclear instrumentation, and provides vertical and lateral support the startup sources and for the peripheral fuel supports and fuel bundles. The core plate is between the shroud support and the shroud, and these three pieces are bolted together.

The shroud and chimney make up a stainless steel, cylindrical assembly that provides a partition to separate the upward flow of coolant through the core from the downward recirculation flow. This partition separates the core region from the downcomer annulus. The volume enclosed by this assembly is characterized by three regions.

The shroud provides the horizontal support for the core. The top guide is at the top of the reactor core. It provides the lateral support for the fuel assemblies, nuclear instrumentation, startup sources, and control rods. The top guide is between the shroud and the chimney barrel, and these three pieces are bolted together.

The chimney is a long cylinder mounted to the top guide that supports the steam separator assembly. The chimney provides additional downcomer height for the driving head necessary to sustain the natural circulation flow. The chimney forms the annulus separating the subcooled recirculation downward flow from the upward steam-water mixture flow exiting the core. The recirculation flow consists of reactor coolant returning from the steam separators and FW makeup. The chimney cylinder is flanged at the bottom and top for attachment to the top guide and the chimney head, respectively.

The chimney head and steam separators assembly form the top of the core discharge mixture plenum. The discharge plenum provides a mixing chamber to homogenize the steam/water mixture before it enters the steam separators. Individual stainless steel axial flow steam separators are supported on and attached to the top of standpipes that are welded onto the chimney head. The steam separators have no moving parts. In each separator, the steam/water mixture rising through the standpipe passes through vanes to separate the water from the steam. The separated water flows from the lower portion of the steam separator into the downcomer region. The separator assembly is removable from the RPV for refueling and other in-vessel activities.

The steam dryer assembly completes the task of removing the moisture from the steam before it exits the reactor. The SD is supported by a set of four brackets equally spaced around the vessel shell internal wall. The dryer support ring rests on these brackets. Additional hold-down brackets are mounted inside the vessel head to restrain vertical movement of the dryer under seismic or dynamic loads. These four hold-down brackets are installed so that they are over the lifting lugs of the SD. Horizontal motion due to seismic or dynamic loads is limited by a set of four seismic blocks mounted to the SD support ring. The moisture content is lower than 0.1% at 100% reactor power when the steam leaves the reactor on its way to the turbine.

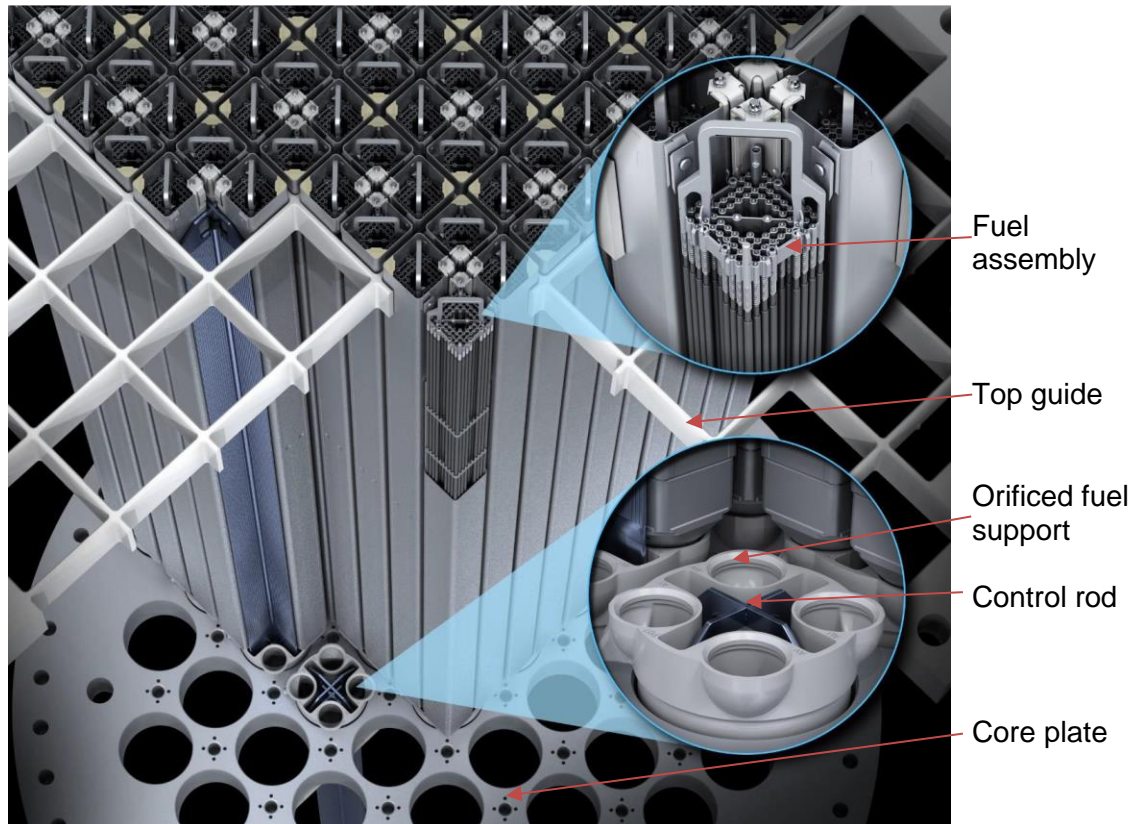

Figure 3-2: Cutaway View of Reactor Core

3.1.1.2 Reactor Isolation Valves

The BWRX-300 RIV design is a critical part of the overall LOCA mitigation strategy for the BWRX-300 design. A fundamental design goal of the BWRX-300 is to be designed and licensed to eliminate the non-isolable LOCA for pipe breaks greater than 19 mm (3/4 inch) nominal pipe size. This innovation enables simpler passive safety systems, a more compact containment that is dry, and a simpler RB compared to prior LWR designs.

The BWRX-300 design eliminates the traditional non-isolable large break LOCA by utilizing novel, redundant RIVs integral to the RPV. This feature allows the reactor vessel to be isolated automatically, quickly stopping leakage from the vessel following a downstream pipe break. The BWRX-300 RPV isolation valve design has the following design features:

- Dual quarter turn isolation valves integrally attached to each RPV process nozzle > 19 mm.
- Redundant, leak proof valves which are CCF proof and fail-safe in that loss of power or hydraulics/air results in the valves closing.
- No failure of a single component prevents the RIVs from performing their designed function.
- Automatically actuated using SC1 controls.

SCs for Instrumentation and Control (I&C) are described in Section 6.0 below.

The RIVs are on the RPV nozzles for the MS subsystem, the Reactor Water Cleanup System (CUW), the supply and return lines of the ICS system, the Head Vent, and the FW System.

The RIVs close to limit the loss of coolant from large and medium pipe breaks. The RIV concept consists of two RIVs in series. Each of the RIVs is independently able to isolate the line. Generally, upon loss of power, the RPV isolation valves fail in the closed position. However, the RIVs for the ICS steam supply and condensate return lines are exceptions. The ICS RIVs fail as-is because they perform safety functions during many transient and LOCA events. The fail-as-is RIVs for the ICS steam supply and condensate return piping automatically close on indication of a break in the ICS train in which the RIV is located.

The RIVs are mounted in a double valve body made from an integral assembly connected via a flange. The valve body or bodies are attached to the RPV using flanged connections. The valve body or bodies are within the ASME B&PV Code Section III, Class 1 RPV assembly. For piping that have RIVs, the closest piping terminal end (high stress and fatigue location) to the RPV assembly is located outboard of each set of two in-series RPV isolation valves. Figure 3-3 shows Reactor Isolation Valve views using a flanged connection.

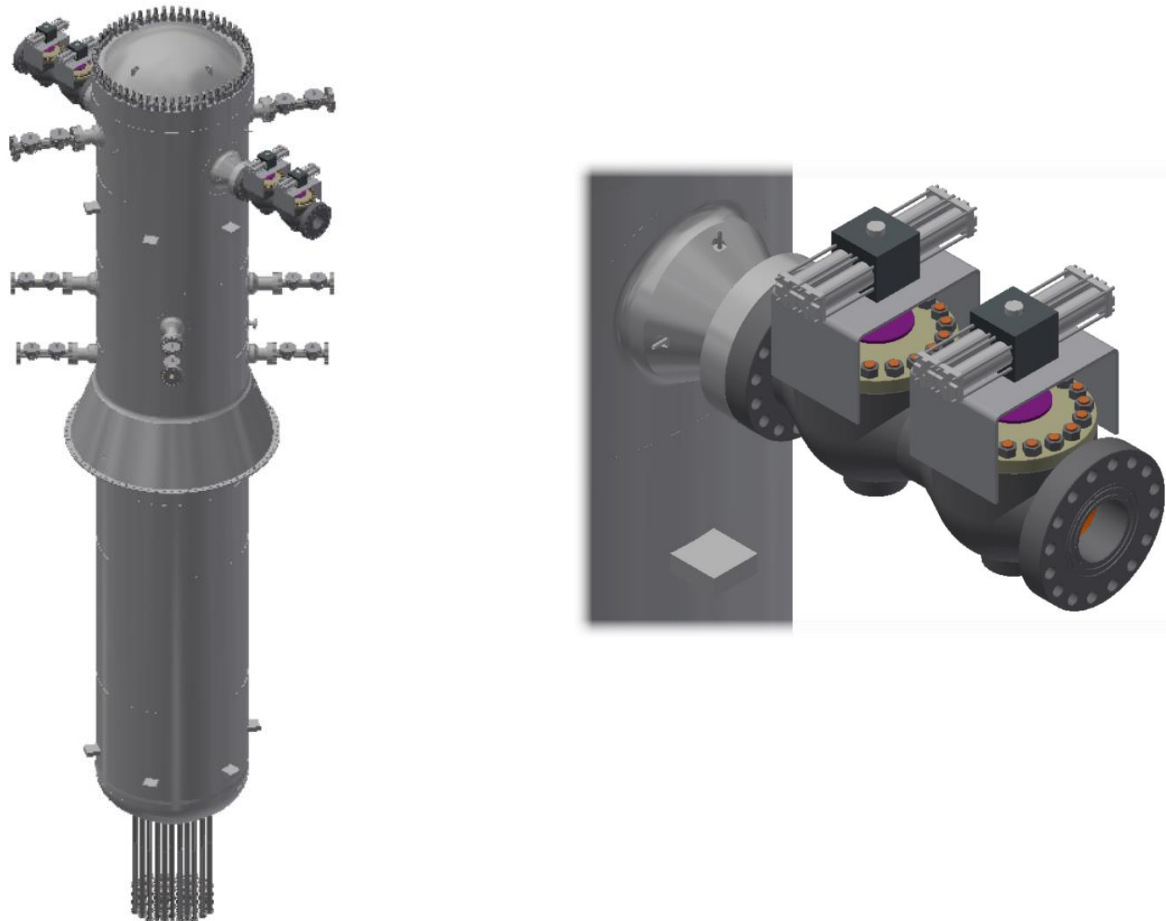

Figure 3-3: BWRX-300 Reactor Pressure Vessel Isolation Valve Design

3.1.1.3 Reactor Pressure Vessel Head Vent Subsystem

The BWRX-300 RPV design includes internal piping routed from the inside of the top of the RPV steam dome area to below the RPV shell flange. The Head Vent piping penetrates the RPV through a nozzle on the side of the reactor with two RIVs flange mounted in series; this eliminates external piping that must be removed/disconnected during each refueling outage. During normal operations, non-condensable gases in the steam dome area are vented through the Head Vent piping to a Main Steam Line (MSL). During reactor shutdown periods, reactor water level can be measured using the vent connection as the upper tap for the level instrumentation sensor. During cold shutdown, filling of the vessel for flood up and hydrostatic testing is performed using the RPV vent. Non-condensable gases are vented to the drywell equipment sump while the connection to the steam line is blocked. When draining the vessel during shutdown, air enters the vessel through vacuum breakers in the vent line.

3.1.2 Main Steam Subsystem

The MS subsystem consists of two steam lines from the discharge flange of the outboard Main Steam Reactor Isolation Valves (MSRIVs) to the Turbine Stop Valves (TSVs), the Turbine Bypass Valves (TBVs), the MSL drains, and other load isolation/maintenance valves. The supply lines to these loads, all connecting branch lines up to and including their respective isolation valves, and all associated piping supports are also part of the MS subsystem.

The MSL drains drain any condensate from the MSLs to the main condenser during startup, low power operation, normal power operation, and shutdown. A reduction in power to a low-level result in the automatic opening of the air-operated drain line valves, thereby establishing drain flow to the main condenser.

3.1.3 Nuclear Instrumentation

The nuclear (core) instrumentation consists of the Local Power Range Monitors (LPRMs), GTs, and Wide Range Neutron Monitors (WRNMs).

There are 13 vertical "strings" of LPRMs arranged radially throughout the BWRX-300 core. Each string has four LPRMs equally spaced vertically and equally along height of the core. The LPRM strings are located between the corners of the fuel channels of the adjacent four fuel bundles. The total number of 52 LPRMs are divided into the three divisions such that each division gets an approximately equal number of vertical and radial LPRM core locations.

GTs are an in-core devices that convert local gamma flux to an electrical signal; gamma flux is representative of core thermal power. It represents a completely diverse technology to the neutron detecting LPRMs. The GTs are co-located in the instrument tubes with the 13 LPRM strings. The GTs are axially located next to each of the four LPRMs, between each LPRM and between the lowest LPRM and core bottom. This totals eight GTs in each of the 13 LPRM strings. There are a total of 104 GTs measuring dispersed radial and axial local power in the core.

The ten WRNM detectors are distributed radially in the core at fixed heights. Each detector is sensitive to neutrons from fluxes below criticality to greater than 100% thermal power – a range of over 11 decades. At low power levels, the WRNMs produce pulse signals; as power increases, the signal becomes a voltage level proportional to the power level.

See Figure 3-4, *Core Map and Instrumentation Layout* for a map of the core instrumentation.

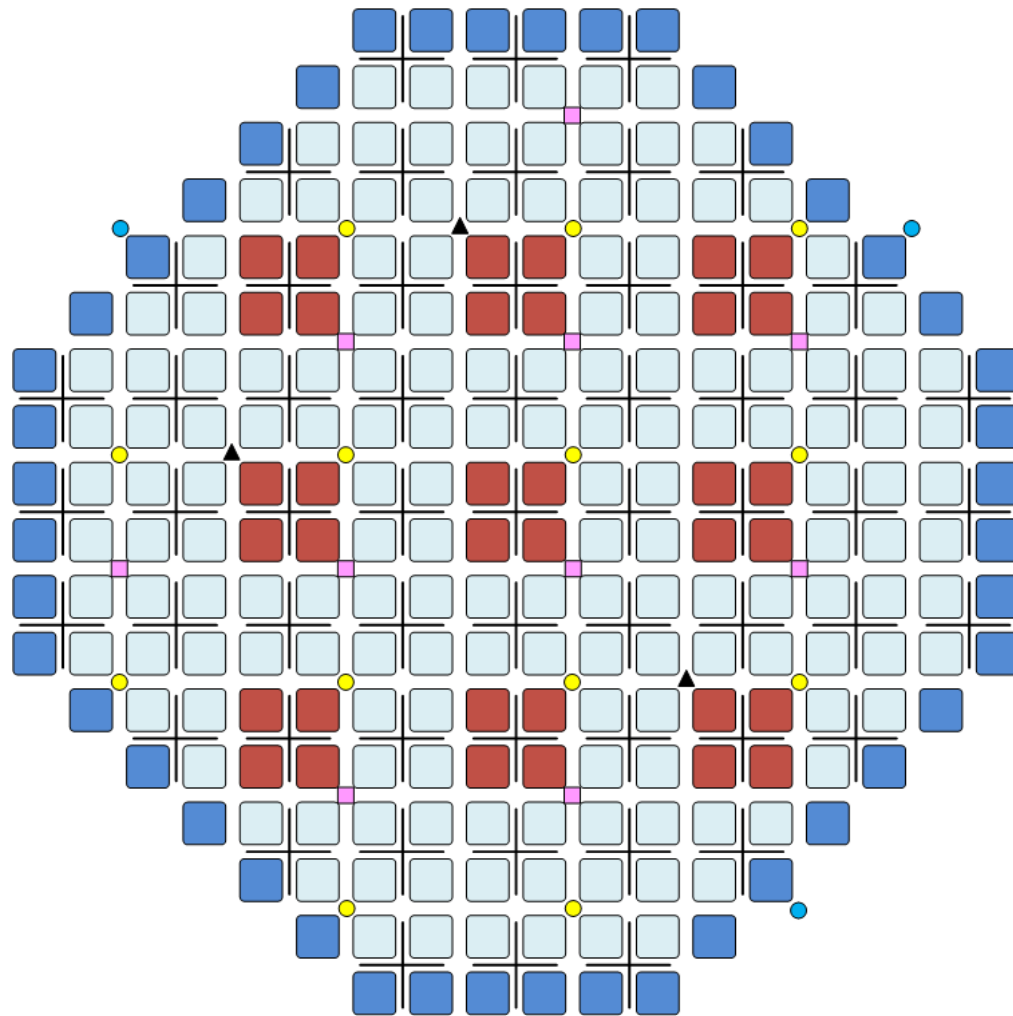

- Interior Assembly Locations
 - Interior Control Cells (A2)
 - Peripheral Assembly Locations
- LPRM + GT Locations (13)
 - WRNM Locations (10)
- Optional collocated supplemental GTs
 - Level Sensor Locations (3)
 - Neutron Source Locations (3)

Figure 3-4: Core Map and Instrumentation Layout

3.2 Control Rod Drive System

The CRD System includes three major elements: FMCRD mechanisms, HCU assemblies, and the CRDH subsystem.

There are 57 FMCRDs mounted in housings welded into the RPV bottom head. Each FMCRD has a movable hollow, piston that is coupled at its upper end, inside the reactor vessel, to the bottom of a control rod. The piston is designed such that it can be moved up or down, both in fine increments and continuously over its entire range, by a ball nut and ball screw driven by the motor. In response to a scram signal, the piston rapidly inserts the control rod into the core hydraulically using stored energy in the HCU scram accumulator (see cross-section in Figure 3-5, *Fine Motion Control Rod Drive*). The FMCRD design includes an electromechanical brake on the motor drive shaft and a ball check valve at the point of connection with the scram inlet line. These features prevent control rod ejection in the event of a failure of the scram insert line.

In addition to hydraulic powered scram the FMCRD motors also provide continuous electric motor-driven run-in of all control rods as a path to rod insertion that is diverse from the hydraulic powered scram. In the event of a PIE that requires a rapid reactor shutdown, and if the reactor scram fails or is delayed, then the reactor is shut down by the electric motor run-in of FMCRDs function. The FMCRD does not interfere with refueling and is operative even when the head is removed from the RPV.

There are 29 HCUs, each of which provides sufficient pre-charged accumulator water storage to scram two FMCRDs, except for the FMCRD in the center of the core which has its own HCU, at any reactor pressure. Each HCU contains a nitrogen-water accumulator and the necessary valves and components to scram FMCRDs. Additionally, during normal operation, the HCUs provide a flow path for purge water to the associated FMCRDs which then flows into the reactor, adding to reactor coolant inventory.

The CRDH subsystem provides clean, demineralized water that is regulated and distributed to provide charging of the scram accumulators and purge water flow to the FMCRDs during normal operation. The CRDH subsystem is also the source of pressurized water for purging the Shutdown Cooling System pump seals and the NBS reactor water level reference leg instrument lines.

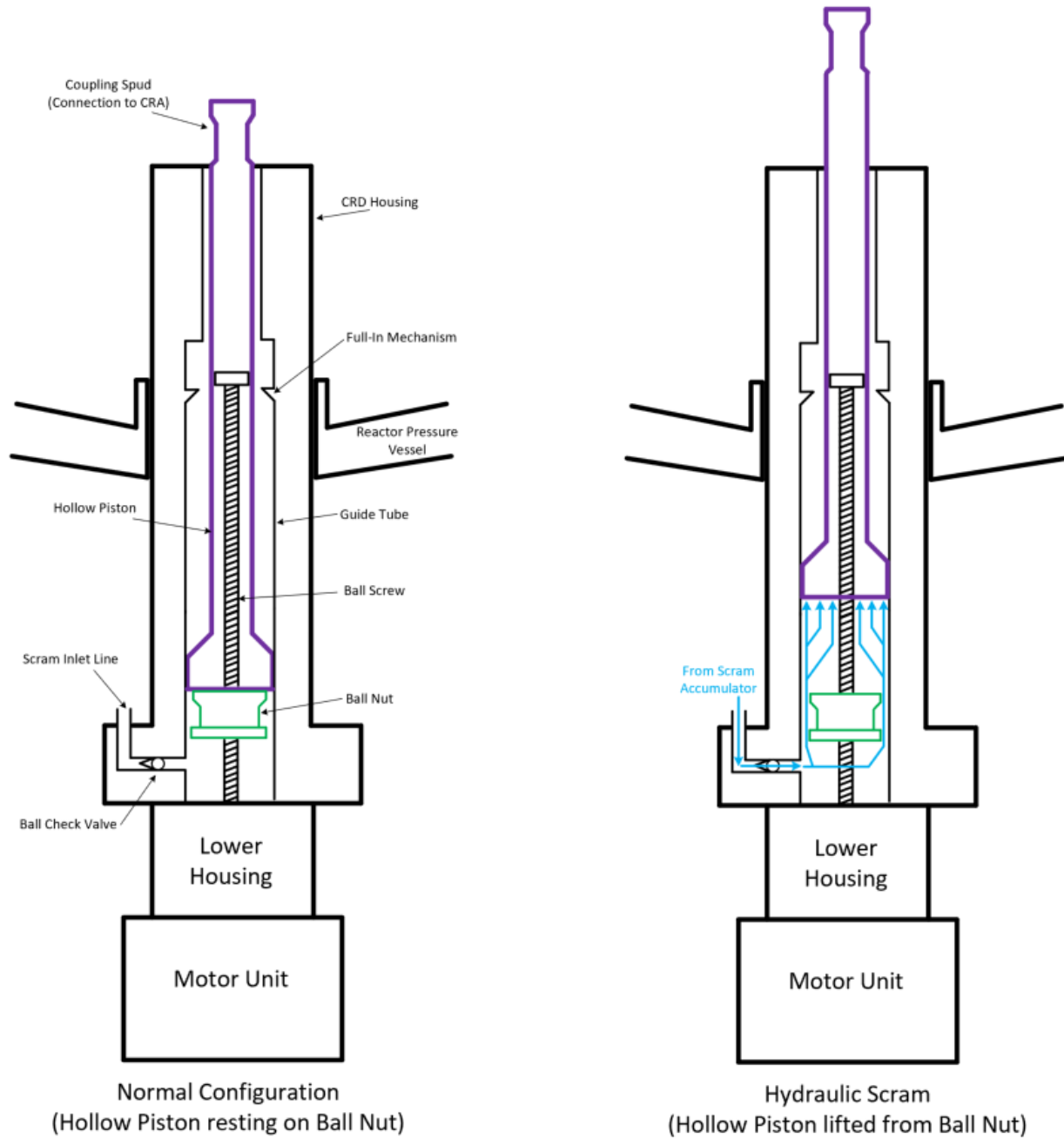

Figure 3-5: Fine Motion Control Rod Drive

3.3 Isolation Condenser System

The ICS consists of three independent trains, each containing a Heat Exchanger (HX) or IC that is submerged in a dedicated pool of water and is connected to the RPV by steam supply and condensate return piping. The complex of ICS pools represents the ultimate heat sink for protecting the reactor core when the main condenser is not available, and the RPV becomes isolated. Each IC has a capacity of approximately 33 MW (approximately 3.7% of rated thermal power).

When in operation, the ICS removes heat from the reactor coolant and rejects it to the environment. The ICS also minimizes increases in steam pressure and maintains the RPV pressure at an acceptable level through decay heat removal. This is accomplished by condensing reactor coolant supplied as steam from the RPV on the tube side of the ICs and then returning the condensate back to the RPV in a closed loop. Heat removed from the steam is transferred by the IC to the water in the pool, and the pools are vented to atmosphere. The ICs are placed at an elevation above the steam source, causing natural circulation that is driven passively by gravitational force. The arrangement of the IC is shown in Figure 3-6, *Isolation Condenser System*.

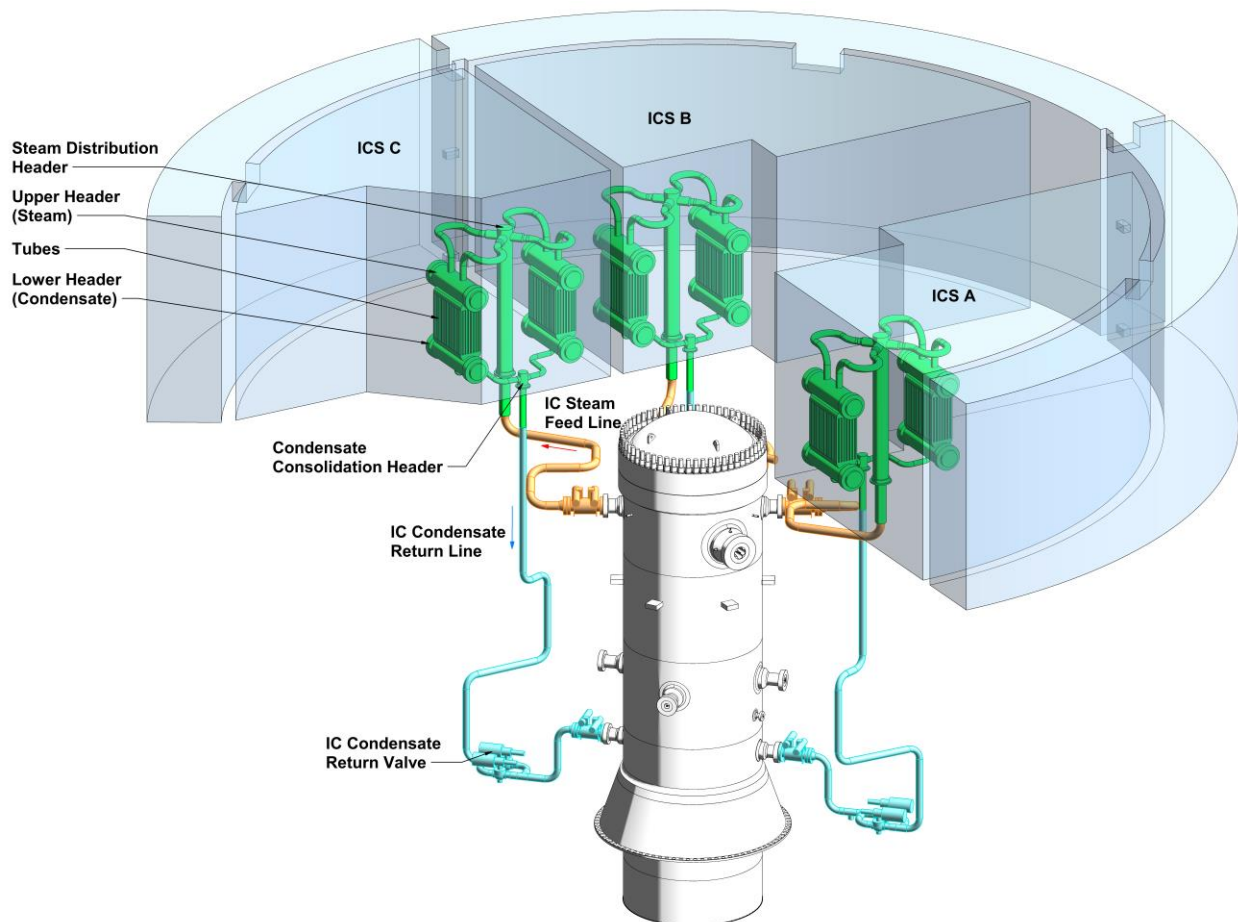

Figure 3-6: Isolation Condenser System

One ICS train is needed to mitigate AOOs. Two ICS trains are required for LOCA mitigation (analysis assumes one ICS train has a single failure). With two ICS trains in service, decay heat removal is sustained for seven days without operator action. All three ICS trains are credited for beyond design basis events, and the IC pool inventories can be replenished indefinitely. The heat rejection process is continued beyond seven days if the IC pool inventory is replenished. The ICS pools are located above ground and are not pressurized. Clean makeup water can be added directly to the ICS pools using readily available transportable sources such as a fire truck.

The ICS may be placed in service manually from the Main Control Room (MCR), automatically by the protection systems signal or by passive means if a loss of Direct Current (DC) power occurs (fail-safe). To place a train of the ICS in service, one of the parallel condensate return valves is opened (or fails open), allowing the standing condensate to drain to the RPV inlet in the chimney region.

3.4 Containment

The BWRX-300 Primary Containment System (PCS) encloses the RPV and some of its related systems and components, provides radiation shielding, and acts as a boundary for radioactive contamination released from the NBS or from portions of systems connected to the NBS inside the containment system. The minimization of potential LOCAs and application of a dry containment eliminates the need for a suppression pool.

The BWRX-300 uses a traditional containment system for the ultimate containment of radioactive materials for various postulated events. The BWRX-300 containment is a vertical cylinder approximately 17.5 meters diameter and 38 meters high. It comprises a Steel-Plate Composite Containment Vessel (SCCV), consisting of steel-plate composite cylindrical wall, basemat, and top slab, and a steel containment closure head. The containment structure is completely enclosed within the deeply embedded RB and includes personnel/equipment hatches, containment penetrations, and other safety components. The BWRX-300 RB General Arrangement Drawing includes the PCS outlined in red in Figure 3-7, *BWRX-300 Dry Containment*. The SCCV is also integrated with the RB and the integrated structure is supported by a common steel-plate composite basemat.

The PCS design uses a nitrogen-inerted containment atmosphere during most operating modes. Atmosphere control is provided by the Containment Inerting System. The inerted atmosphere provides dilution of hydrogen and oxygen gases that can be released in a post-accident condition by radiolytic decomposition of water and the released hydrogen from water and fuel cladding (zirconium) reaction during a severe accident condition. The dilution provides protection to the PCS and its internal components from hydrogen combustion or detonation. The inert atmosphere design has the additional benefit of minimizing long-term corrosion and degradation of the SCCV and the contained components by limiting the exposure to oxygen during plant operating service life.

The PCS has provisions for personnel access and for habitability during plant outages to perform maintenance, inspections, and tests required for assuring SCCV integrity and reliability, and the integrity and performance reliability of interfacing SSCs contained inside the PCS boundary.

The PCS is designed for a design life of 60 years of operation plus an assumed {20 years} for decommissioning.

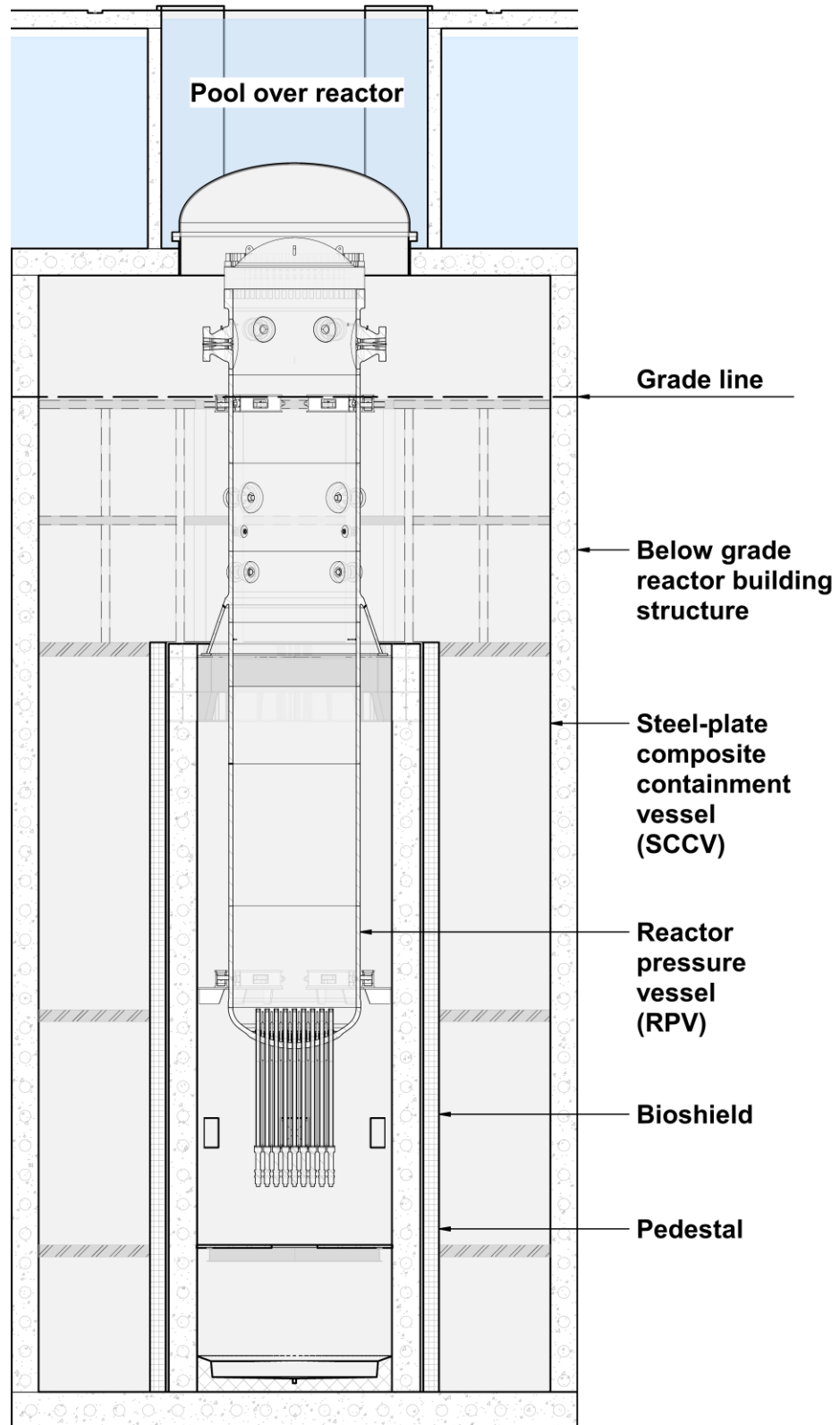

Figure 3-7: BWRX-300 Dry Containment

3.5 Containment Cooling System

The Containment Cooling System (CCS) is used to ensure the containment bulk average temperature is maintained according to technical specifications. CCS maintains normal temperature operating envelope in the SCCV to ensure initial conditions assumed in safety analysis are met and ensure that environmentally qualified equipment is within design envelope in operating modes where the containment is not open.

The CCS is a closed loop recirculating cooling system with no outside air introduced into the system except during outages. The CCS is comprised of two fully redundant trains of Air Handling Units (AHUs). Each AHU is cooled by a corresponding Chilled Water Equipment (CWE) system train, so that SCCV cooling is still possible even with loss of one train of CWE or one train of CCS.

The SCCV is purged with nitrogen before startup and kept inerted during normal plant operation.

During normal operation, hot nitrogen gas is drawn from the upper containment space over the coils, cooled, and discharged to the common distribution header. At the header, a portion of the cooled nitrogen gas is ducted directly to the CRD area, and the remaining nitrogen is ducted to the upper containment area.

During outages requiring containment entry, the Heating, Ventilation, and Cooling System, supplies filtered, conditioned outside air into the SCCV through piping interface to purge the nitrogen out of the SCCV. In this mode, the SCCV temperature is maintained for human comfort by the CCS.

The CCS does not perform any safety functions but does assist with containment cooldown following a Loss-of-Offsite Power (LOOP) during the period from hot shutdown to cold shutdown and limits containment temperature during LOOP.

3.6 Passive Containment Cooling System

The Passive Containment Cooling System (PCCS) relies on natural circulation to transfer heat from the containment to the equipment pool to maintain containment pressure and temperature within the design limits during accident conditions or loss of active containment cooling. Supply and discharge connections from the pool are connected to closed loop piping within containment. Heat transfer occurs from the containment to the PCCS by natural circulation and condensation.

The PCCS consists of three independent trains of LP HXs that transfer heat from the containment to the equipment pool which is located above the PCS and is filled with water during normal operation.

The equipment pool is vented to the atmosphere. PCCS operation requires no sensing, control, logic, or power actuated devices for operation. The PCCS condensers are closed loop and the fluid inside does not contact the containment atmosphere. Since there are no containment isolation valves between the PCCS HXs and the containment, the mode is always in "ready standby". The PCCS is in service during normal operation. However, the PCCS does not contribute to the heat removal significantly during normal operation since the containment temperature is maintained by the CCS.

The PCCS becomes effective when steam is discharged into the containment following a pipe break. The steam discharge to containment raises containment temperature and increases the steam content for condensation to occur. Heat transferred to the PCCS from the containment is removed by the natural circulation of water in single phase flow and rejected to the equipment pool.

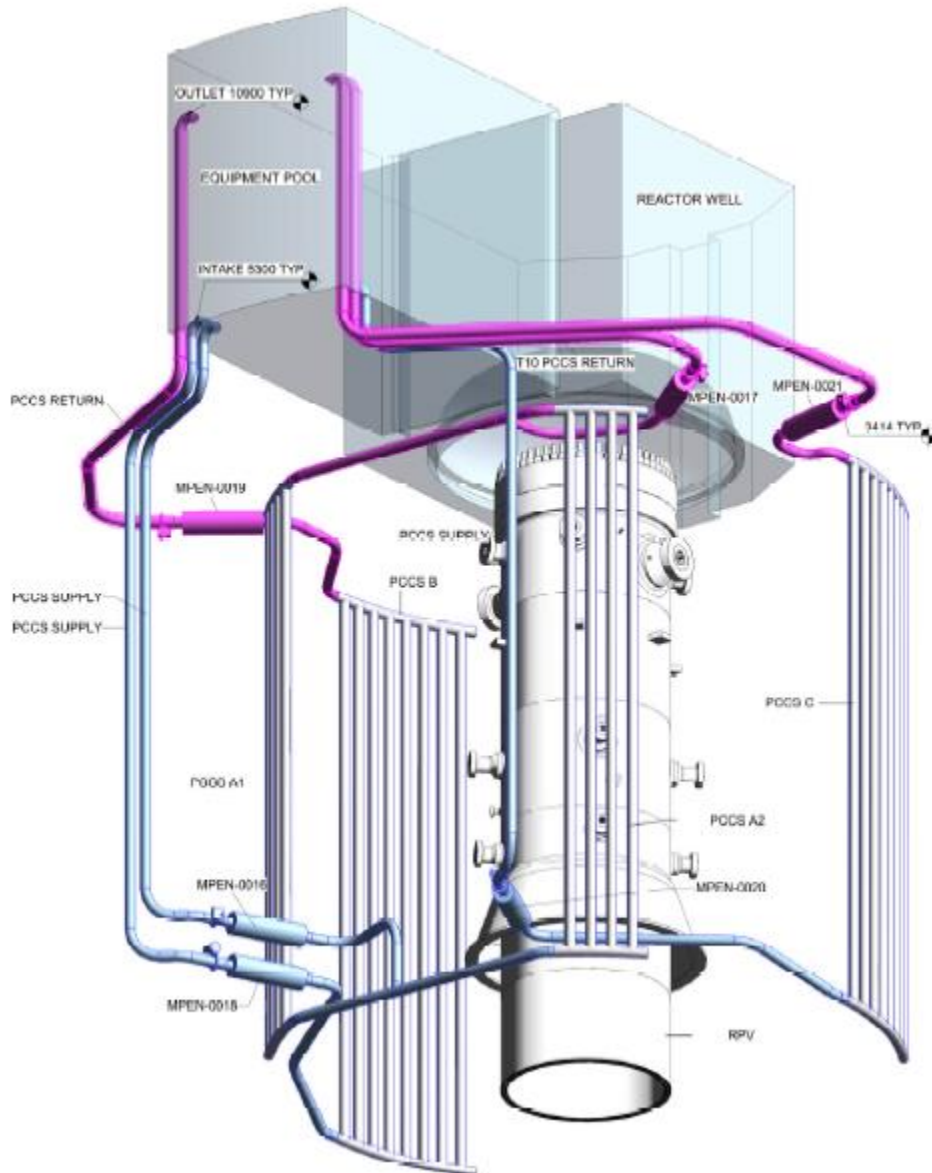

Figure 3-8: Passive Containment Cooling System

3.7 Boron Injection System

The purpose of the Boron Injection System (BIS) is to introduce sufficient negative reactivity into the reactor primary system to assure a reactor shutdown from the full power operating condition

to the cold 20°C (68°F) subcritical state with no control rod motion. The BIS dispenses the minimum required neutron absorber of natural boron using a Boron-10 solution or equivalent into the core zone to meet the minimum shutdown concentration required throughout the core region while providing reasonable margin for leakage or imperfect core mixing.

The system is provided for and only for a situation which causes the normal reactor control system to be unable to shut down the reactor. The BIS acts as an emergency backup to the insertion of control rods to provide a diverse means of making the reactor subcritical.

The BIS consists of a storage tank, test tank, injection pump, piping, valves, and I&C necessary to prepare and inject a neutron absorbing solution into the reactor and to test the system. The injection line contains an air-operated injection valve and a check valve as the outboard and inboard containment isolation, respectively.

The BIS is manually initiated from the Main Control Room (MCR), as directed by the emergency operating procedures, if the operator believes the reactor cannot be shut down, or kept shut down, with the control rods. Actuation of the system requires a conscious operator action, and the design is such that a single operator can readily initiate the system into the injection mode.

3.8 Reactor Water Cleanup System

The CUW provides blowdown-type cleanup flow for the RPV during reactor power operating mode. Cleanup or filtration and ion removal is performed by the Condensate and Feed System (see Section 5.1.4). The CUW also provides an overboarding flow path to the condenser hotwell or liquid radwaste directly from the RPV lower region to control water level during startup. CUW suction piping can be used to reduce reactor temperature stratification with reverse flow from the Shutdown Cooling System.

The CUW system consists of one train fed by two suction nozzles located on the RPV. The train's suction is independently connected to RPV penetrations located at about the mid-vessel height and take suction from nozzles located near the RPV bottom head. The piping from the suction nozzles combines inside containment to form a single line; this line is provided with a containment isolation valve where it penetrated containment. This valve receives signal from the CUW leak detection system and closes upon a detected leak.

Major components of the CUW system are the CUW HX and pressure reduction station. The CUW HX is a Regenerative Heat Exchanger (RHX) cooled by FW flow. The RHX and pressure reduction station are designed to condition the water to acceptable temperatures and pressures for processing to the condensate system or overboarding. The RHX is designed to recover heat back to the vessel. Discharge piping is connected either to a condensate line for the normal CUW function or routed to the condenser hotwell or liquid radwaste for overboarding.

3.9 Shutdown Cooling System

The Shutdown Cooling System (SDC) provides for decay heat removal when shutting down the plant for refueling or maintenance. The system is also used to reduce RPV inventory and can be used in conjunction with CUW piping to reduce RPV thermal stratification.

The SDC system comprises two independent pump and HX trains. These trains together provide redundant decay heat removal capacity such that each train is designed to remove 100% of decay heat as soon as 4 hours after reactor shutdown. The major components of each train are a pump and an HX, along with valves, piping, I&C, and power inputs. The two trains operating in parallel provide the system's full rated Shutdown Cooling performance. Bypass lines and valves are

included around the tube side of each HX to allow bypassing of the HX for SDC functions such as reducing RPV thermal stratification.

3.10 Isolation Condenser System Pool Cooling and Cleanup System

The primary function of the ICS Pool Cooling and Cleanup System (ICC) is to remove heat from the ICS pools such that the bulk temperature of water in the pools is maintained below Technical Specification (TS) limits and thereby ensure the readiness of the ICS to perform its Safety Category function. Secondary functions of the ICC include maintaining the cleanliness of the ICS pool water and providing the capability to add clean makeup water during normal reactor operations to offset the minor routine loss of water inventory due to evaporation.

The ICC processes water from the three ICS Cubicle Pools and surrounding Outer Pools to maintain water temperature and quality within the prescribed TS limits established for the plant. The ICC includes two identical, 50% capacity trains, each equipped with a centrifugal pump and frame-and-plate HX to transfer energy from the ICS pools to the Plant Cooling Water System (PCW). The system also includes a single integrated skid-mounted demineralizer to remove soluble and insoluble impurities from the ICS pool water.

3.11 Fuel Pool Cooling and Cleanup System

The primary function of the Fuel Pool Cooling and Cleanup System (FPC) is to provide continuous cooling of the water volume in the fuel pool to remove decay energy from spent fuel, and to provide replacement coolant inventory from a variety of sources to ensure spent fuel is kept cool and submerged throughout the life of the plant. In addition, the FPC includes demineralization and particulate filtration to maintain coolant quality and to reduce general area dose. The FPC can be realigned to provide cooling and cleanup to the reactor cavity and equipment pools as necessary.

The FPC consists of two trains of equipment, each with a pump, demineralizer, and HX. The capability to bypass the demineralizer while providing active cooling to support restoration of the pool temperature from conditions exceeding the demineralizer operational temperature limits is provided. Each set of components are placed in parallel to provide single train operation and cross connecting of trains should a component fail. A single train is sufficient to prevent bulk boiling in the fuel pool. If both trains are rendered inoperable, the fuel pool is sized such that it can retain sufficient coverage of the fuel for seven days, and the FPC can provide makeup capacity from various sources to ensure pool level during off-normal conditions.

The FPC takes suction from two skimmer surge tanks which remove coolant from the tops of the three pools, passes it through the system, and returns it through spargers at the bottom of each pool which are protected by anti-siphon devices to prevent inadvertent draining of the pools if a breach of the FPC occurs. The demineralizer allows for removal of small particulate matter through back-washable filters, with ionic cleanup performed with deep bed demineralization using mixed anion and cation bead resin.

4.0 FUEL AND FUEL CYCLE

The BWRX-300 core design includes a 240-bundle configuration. The core uses Global Nuclear Fuel's GNF2 (GNF2 (5)) fuel assemblies because they have low hydraulic resistance which benefits natural circulation. The core configuration (shown in Figure 4-1, GNF2 Lattice) has equal spacing between the control rod and non-control rod sides of the fuel bundle (N-lattice). This configuration provides more shutdown margin for variations in burnup histories imposed by load following.

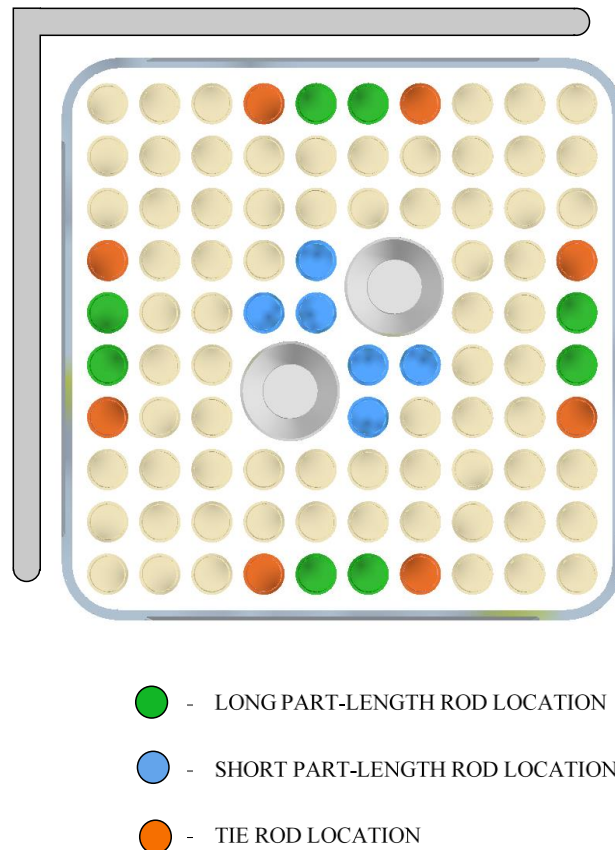

Figure 4-1: GNF2 Lattice

4.1 Core Configuration

The reactor core of the BWRX-300 is arranged as an upright cylinder containing fuel assemblies located within the core shroud. The coolant flows upward through each fuel assembly. The BWRX-300 reactor core includes fuel assemblies, control rods, and nuclear instrumentation. The fuel assembly and control rod mechanical designs are the same as existing operating GE BWRs.

4.2 Fuel Assembly Description

A BWR fuel assembly consists of a fuel bundle and a coolant channel. The fuel bundle contains the fuel rods and the hardware necessary to support and maintain spacing between fuel rods.

The channel is a Zircaloy box surrounding the fuel bundle and directing core coolant flow through the bundle; it also serves to guide the movable control rods.

The BWRX-300 GNF2 design is a 10x10 array of 78 full-length fuel rods, 14 part-length rods and two large central water rods. The low core power density of BWRX-300, enhanced natural circulation flow, and higher FW temperature maintains thermal-hydraulic stability.

Figure 4-2, *GNF2 Fuel Bundle* shows the GNF2 fuel bundle design with major components identified. This figure shows the bundle in a horizontal orientation but during storage and operation the bundles are in a vertical position.

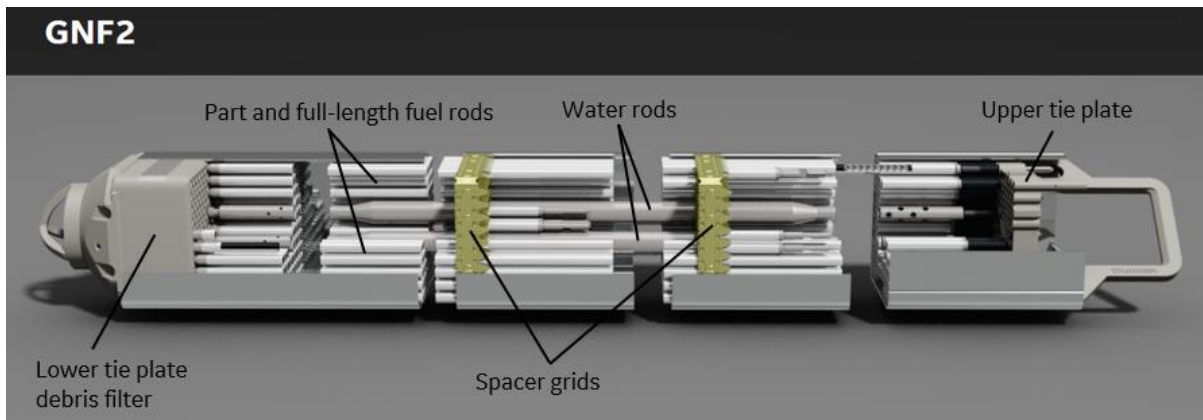

Figure 4-2: GNF2 Fuel Bundle

The cast stainless steel lower tie plate has a conical section to promote seating into the orificed fuel support. Multiple spacer grids along the length of the fuel assembly maintain the proper fuel rod spacing. A debris filter lower tie plate prevents foreign material from entering the flow channel and potentially damaging the fuel cladding. The cast stainless steel upper tie plate is also a spacer grid and provides the bundle lifting handle.

The fuel assembly is held together by eight tie rods located around the periphery of the fuel bundle (see Figure 4-1 for cross-sectional view for part, full, tie, and water rod arrangement within a bundle, as well as bundle orientation within a four-bundle cell). In all but 12 peripheral locations, fuel bundles are arranged in a four-bundle grouping around a control blade. Figure 4-1 shows a horizontal cross-section of this four-bundle cell. The four gray squares with rounded corners are the channels. The black cross that the four bundles surround is the control blade.

4.3 Fuel Handling and Refueling Process

The BWRX-300 fuel handling and refueling process takes advantage of historical BWR practices. The refueling process is an intricately scheduled series of tasks to disassemble/assemble the containment head, RPV head, remove/replace the RPV internals to access the fuel assemblies and remove/replace/shuffle the fuel assemblies.

The RB includes a refueling platform (gantry crane) for fuel movement and servicing. The refueling platform spans the reactor vessel and storage pools on tracks in the refueling floor. A telescoping mast and grapple suspended from a trolley system lift and orient fuel assemblies for placement either in the core or in storage racks in the fuel pool.

A position indicating system is provided to locate the grapple over the vessel core and prevent collision with pool obstacles. The mast grapple has redundant features so that no single

component failure results in a fuel bundle drop. Multiple interlocks are provided on the refueling machine to prevent mishandling of the fuel assemblies.

Storage racks provide for the short-term and long-term storage of new or used fuel and associated equipment. The fuel storage racks are spaced to prevent inadvertent criticality. Fuel racks are in the fuel pool in the RB. The racks are top loading, with a fuel assembly bail extended above the rack. The fuel racks storage capacity is approximately 275% of a complete reactor core or 600 fuel storage positions. This capacity is equivalent to eight years of refueling operations plus a full core off-load and new fuel storage. The fuel racks maintain a subcriticality margin of at least 5% $\Delta k/k$ under dry or flooded conditions. The rack arrangement prevents accidental insertion of fuel assemblies between adjacent racks and is spaced to allow flow between assemblies such that pool water does not exceed 100°C.

Additional long-term storage of used fuel using dry cask storage units located in an on-site Independent Spent Fuel Storage Installation (ISFI) facility may be available. A characteristic ISFI facility has a capacity of 28 canisters at 89 bundle each for a total of 2492 fuel bundles. BWR plant fuel canister movement activities are typically scheduled every 3-4 years and performed while the plant is at power.

Upon completion of fuel movement operations, procedures require verification of each individual fuel assembly serial number and verify each is installed in the correct position and orientation consistent with the core reload analysis.

After fuel installation verification, the RPV and containment are reassembled, and leak tests are performed to verify that primary pressure boundary and containment pressure boundaries are intact. The reactor cavity pool is then flooded, and the reactor is readied for heat-up, criticality and power ascension.

Refueling outages are 10-15 days based on the number of fuel assemblies to be replaced considering plant cycle duty. The cycle times are 12 months for load following duty and 24 months for baseload duty. About 32 bundles are replaced following a 12-month cycle and 72 bundles following a 24-month cycle.

A major equipment inspection outage of 25 days is anticipated every 120 months to perform turbine inspections and in-service inspection of the reactor vessel and internals.

5.0 BALANCE OF PLANT

The BWRX-300 Balance of Plant (BOP) systems are configured like those in use throughout the BWR fleet adjusted for gross power output. The gross power of ~315 MWe eliminates the need for custom designed turbines and generators as standard frame sizes are available from turbine generator set manufacturers.

5.1 Steam and Power Conversion System

5.1.1 Main Steam

The BWRX-300 MS subsystem is part of the NBS (see Section 3.1.2) and consists of two steam lines from the discharge flange of the outboard MSRIVs (Figure 5-1, *Main Steam Piping*) to the TSVs (Figure 5-2, *BWRX-300 Turbine Building Main Steam Top 3D View*), the TBVs, the MSL drains, and other load isolation/maintenance valves. The supply lines to these loads, all connecting branch lines up to and including their respective isolation valves, and all associated piping supports are also part of the MS subsystem.

The BWRX-300 design includes an outboard Main Steam Containment Isolation Valve (MSCIV) (Figure 5-1) on each MSL. The MSCIVs provide the isolation of the containment in the event of accidents or other conditions and prevent the unfiltered release of containment contents that exceed appropriate limits. This containment isolation is single failure proof. The MSCIVs are fast-closing and fail-closed type valves.

The MS flow restrictors are in the RPV MS nozzles. The function is to limit the overall steam flow through one steam line when the steam flow exceeds preselected operational limits (if a large break of a MSL is sensed) and the corresponding MSRIVs and MSCIVs have not closed. The MS flow restrictor provides LP sensing taps for instrumentation lines for differential pressure transmitters that are used to measure steam flow. MS flow is measured through the MS nozzle venturis using Bernoulli's equation of differential pressure to derive the MS mass flow.

The MSL drains remove any condensate from the MSLs to the main condenser during startup, low power operation, normal power operation, and shutdown. A reduction in power to a low-level, results in the automatic opening of the air-operated drain line valves, thereby establishing drain flow to the main condenser.

The TBVs are opened by I&C system when the actual steam pressure exceeds the steam pressure needed by the turbine. One or two bypass valves may be modulated as required in response to changes in the bypass demand. Bypass steam is discharged to the main condenser.

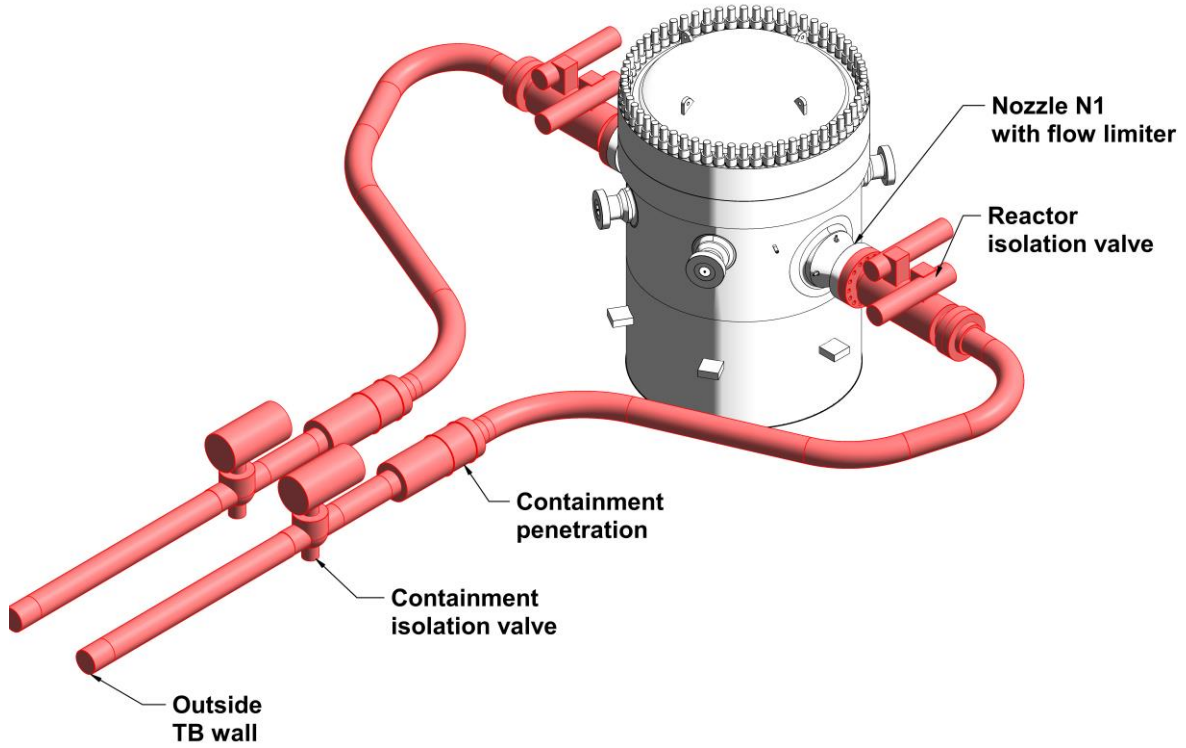

Figure 5-1: Main Steam Piping

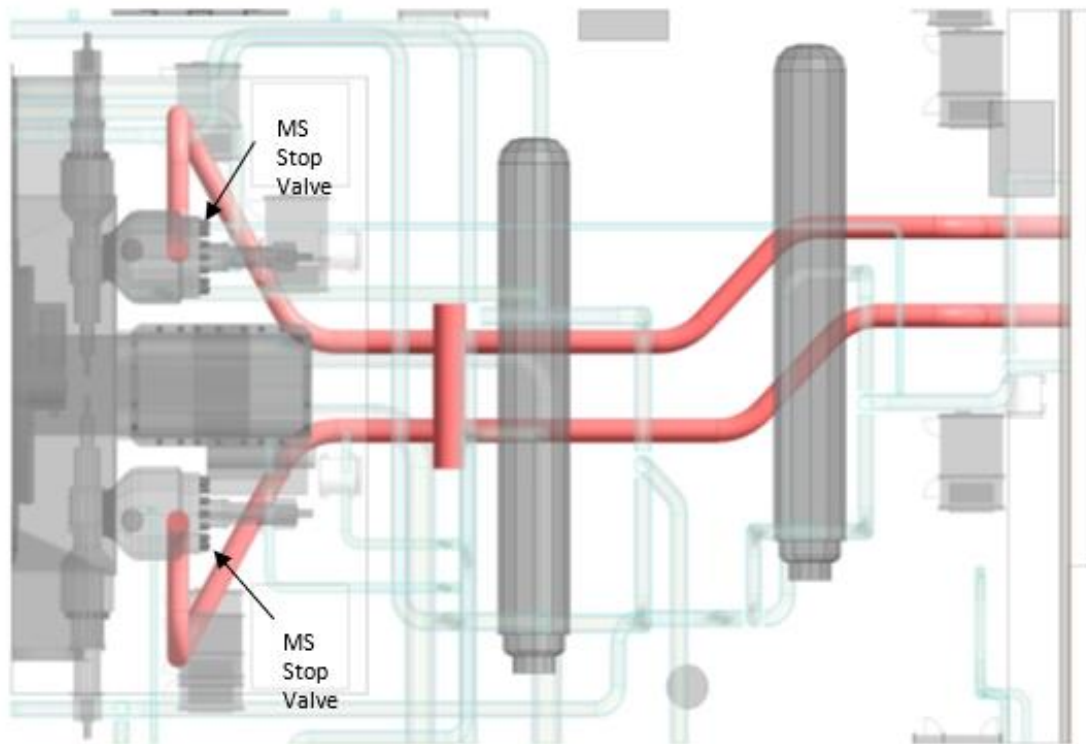

Figure 5-2: BWRX-300 Turbine Building Main Steam Top 3D View

5.1.2 Turbine Generator

A typical GE steam turbine such as planned for BWRX-300 is shown in Figure 5-3, *GE Steam Turbine*. The turbine is a 3000/3600 rpm, single-shaft, tandem compound, impulse-reaction, two-stage reheat, condensing steam turbine (*Steam Turbines for Fossil, Nuclear, and Renewable Applications* (6)). The turbine generator and associated piping, and valves, are located completely within the Turbine Building (TB).

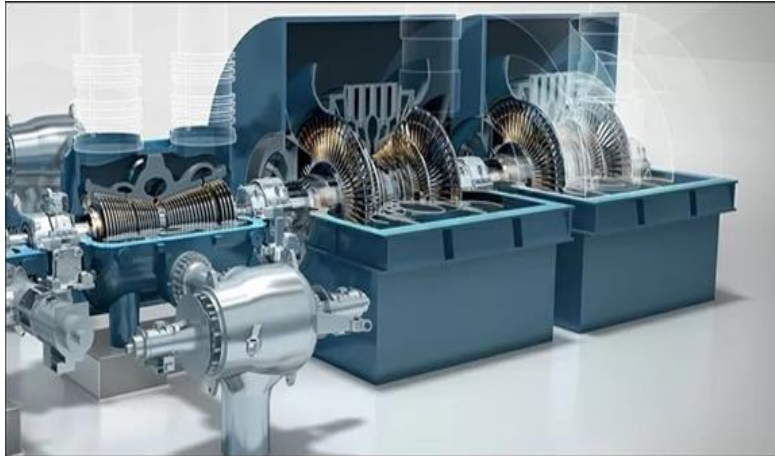

Figure 5-3: GE Steam Turbine

Two hydraulically operated TSVs, and control valves (four valves total) admit steam to the HP turbine. The primary function of the MS TSVs is to isolate the MS from the turbine and quickly shut off the steam flow to the turbine under emergency conditions. The primary function of the control valves is to control steam flow to the turbine in response to the Turbine Generator Control System. In addition to the normal speed control function provided by the Turbine Generator Control System, a separate and redundant turbine overspeed protection system is included to minimize the possibility of turbine rotor failure and turbine missile damage.

The HP turbine receives steam through two steam leads, one from each control valve outlet. The steam is expanded axially across several stages of stationary and moving blades. Extraction steam from the HP turbine is used to supply the fifth stage of FW heating and Moisture Separator Reheater System (MSR) first stage reheater heating steam. HP turbine exhaust steam is collected in a cold reheat pipe and routed to the MSR inlet.

Two units of LP turbines coupled together with the HP turbine shaft convert thermal energy into mechanical rotational energy to drive the generator. Each LP turbine receives hot reheat steam from its connected MSR outlet through the intermediate stop and intercept valves. Each LP turbine is a double flow with six extraction points for FW heating. Each LP turbine exhausts directly to the main condenser connected underneath each LP turbine.

The main turbine is equipped with a turning gear which is used to rotate the turbine generator shafts slowly and continuously, as needed when the main turbine is not in service, such as the early part of turbine warming and after the rotor has stopped at shutdown.

The turbine gland seal steam supplies sealing steam to the turbine shaft/casing penetrations and to the valve stems of the turbine stop and control valves, bypass valves and intermediate stop and intercept valves to prevent the escape of radioactive steam and to prevent air in-leakage through sub-atmospheric turbine glands.

The Turbine Lube Oil System (TLOS) supplies the lube oil to the turbine, generator, and exciter brush bearings. The TLOS skid includes redundant AC pumps and a DC pump to continuously supply oil to the bearings to provide asset protection. The lube oil skid also contains storage tank and HXs which support the TLOS. An oil conditioning system is provided with TLOS.

A typical GE TOPAIR generator such as planned for BWRX-300 is shown in Figure 5-4, *GE TOPAIR Generator*. The generator is a direct driven, three-phase 50/60 Hz, synchronous generator with an air-cooled armature winding and rotor. The generator shaft is connected to the main turbine equipment system, as the shaft (rotor) spins within the generator frame (stator) electricity is produced. There are more than 3,570 TOPAIR units in operation (*Air-Cooled Generator (GEN-A) (4)*).

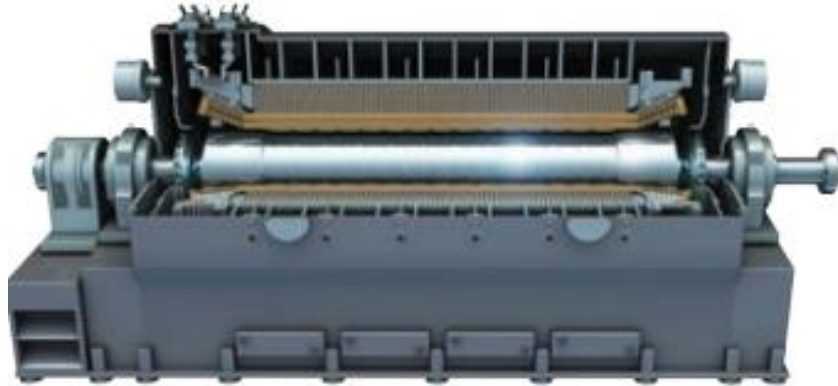

Figure 5-4: GE TOPAIR Generator

5.1.3 Main Condenser

The Main Condenser and Auxiliaries (MCA) System is the heat sink for the power generation and normal reactor cooldown and plant startup activities. The MCA System consists of the main condenser, two Steam Jet Air Ejector (SJAE) skids, and two condenser vacuum pump skids as well as associated piping, valves, instrumentation, and controls. The main condenser is a single-pressure, two-shell unit. Each shell is located beneath its respective LP turbine. The two condenser shells operate at similar pressures and drain to hotwells that are cross connected. Circulating water flows through each of the two single-pass tube bundles to condense the turbine exhaust steam into the hotwells.

The main condenser receives and condenses turbine exhaust steam and turbine bypass steam during all modes of operation. The main condenser provides hold-up for N16 decay and supplies condensate to the condensate pumps. The main condenser also serves as a collection point for other steam cycle miscellaneous drains, vents, and relief valve discharges. The condenser is cooled by the Circulating Water System configured as either a closed system (i.e., heat rejection via cooling towers) or an open system (i.e., rejects heat to an appropriately sized body of water).

Two 100% capacity SJAEs are used to maintain the turbine backpressure and remove non-condensable gases from the main condenser. Non-condensable gases extracted from the condenser are exhausted to the Offgas System. During startup, two condenser vacuum pumps draw the initial condenser vacuum and exhaust the gases to the TB Heating, Ventilation, and Air Conditioning (HVAC) system.

5.1.4 Condensate and Feedwater System

The CFS contains two condensate pumps, two reactor FW pumps, three stages of LP closed FW heaters, and three stages of HP FW heaters. The condensate pumps are each 100% capacity. The LP FW heaters are arranged with two 50% capacity duplex FW heaters in parallel and the third stage 100% capacity heater in series. The two reactor FW pumps are driven by electrical motors and powered by adjustable speed drives, each is 100% capacity and used to maintain RPV water level. The three HP FW heaters are arranged in series. There are bypass valves around each FW heater.

CFS provides a vent and drain path for condensate, vapor, and non-condensable gases during all modes of system operation to maintain level in the FW Heaters and MSR drain tanks. The final stage HP FW heater accommodates final FW temperature control during power maneuvering.

The Condensate Filters and Demineralizers System (CFD) purifies the condensate to maintain reactor FW purity. The CFD uses filtration to remove suspended solids, including corrosion products, and ion exchange resin to remove dissolved solids from condenser leakage and other impurities. The CFD is a full-flow system that consists of high efficiency backwash type filters followed by mixed bed demineralizers.

5.2 Balance of Plant Auxiliary Systems

5.2.1 Circulating Water System

The Circulating Water System (CWS) provides cooling water to the main condenser and transfers heat from the condenser to the environment through the NHS. The CWS also supplies cooling water to reject the heat loads from the PCW HXs through the NHS. All CWS pumps are in the NHS structure.

The CWS has two subsystems: the main condenser supply and the PCW supply. The main condenser supply uses 2x50% pumps to provide cooling water to the MCA during all modes of condenser heat removal. A hot circulating water return line is provided to recycle water returning from the condenser in cold weather conditions as required to prevent freezing in the NHS structure.

The PCW system consists of two trains, each containing one pump and one HX, that address the reactor component and turbine component cooling loads. The plant cooling water supply uses 2x100% pumps to provide cooling water to the PCW HXs for all normal and abnormal operating modes. The PCW system provides cooling water to non-safety components in the BWRX-300 plant and provides a barrier against radioactive contamination of the CWS.

The PCW supplies cooling water for two subsystems, Reactor Component Cooling Water Subsystem (RCCWS), and Turbine Component Cooling Water Subsystem (TCCWS).

The RCCWS piping distribution consists of two redundant piping distributions that support all RB equipment cooling functions, plant pneumatic system, and any equipment located outside the RB associated with reactor cooling activities.

The TCCWS piping distribution is a single piping distribution that serves all equipment in the TB that does not support reactor cooling functions.

Although the PCW supports all plant equipment cooling functions, the design redundancy and isolation capability is centered around the ability to provide redundant cooling supply to nuclear systems. Two independent cooling equipment trains with one pump and HX in each train are

provided to satisfy the need for redundant cooling supplies to nuclear systems in the redundant RCCWS piping distribution and the single TCCWS piping distribution.

These independent trains are cross connected using manual cross ties to allow for online maintenance. If necessary, the TCCWS can be isolated from each RCCWS by closing the supply and return header valves on each train, and each RCCWS train operates independent of the other.

5.2.2 Chilled Water System

The CWE provides chilled water cooling to the Heating Ventilation and Cooling Systems throughout the plant and to the CCS in the RB.

The CWE is a closed loop chilled water system that supplies chilled water to various non-safety category function AHU cooling coils and plant equipment coolers in the TB, Radwaste Building (RWB), RB, and Control Building (CB). Heat absorbed by the CWE is rejected from the CWE chiller condensers to atmosphere above the Radwaste Building.

The CWE is comprised of four CWE air-cooled chillers, four CWE pumps, one expansion tank, four air separators, one chemical bypass feeder, one glycol auto-fill unit, piping, valves, instruments, and controls.

Each chiller has its own dedicated pump. Four by 33% (4X33%) capacity chiller/pump combinations are provided for all plant chilled water use and two of the four chiller/pump combinations are part of the D-in-D protection functions.

6.0 INSTRUMENTATION AND CONTROL SYSTEMS

6.1 Instrumentation and Control Design Architecture

The BWRX-300 I&C system (also referred to as the Distributed Control and Information System (DCIS)) is an integrated control and monitoring system for the power plant. The DCIS is arranged in three Safety Classified DCIS segments and a Non-Safety Class (SCN) segment with appropriate levels of hardware and software quality corresponding to the system functions they control and their DL location. The DCIS provides control, monitoring, alarming, and recording functions. The various segments of the integrated DCIS are designed to operate autonomously and independently.

The various DCIS systems are implemented on different hardware and software platforms appropriate to the of the functions they are performing. It is desirable to use DCIS equipment commercially available such that only BWRX-300 application programming need be added; specifically, platforms whose operating systems and hardware have already been designed and licensed for the BWRX-300 requirements.

The BWRX-300 DCIS is divided into three parts according to SC and DL. The SC1 I&C System (C10 – Primary Protection System), the SC2 and SC3 I&C Systems (C20 – Diverse Protection System), and the SCN I&C System (C30 – Anticipatory Trip System).

The SC1 DCIS (C10) is completely isolated from the rest of the BWRX-300 DCIS except for the optically isolated data links provided through unidirectional boundary devices to SC3 (C20). The Visual Display Units (VDUs) dedicated to C10 are the only mechanism by which the SC1 systems can be controlled. They can also be monitored by the C10 VDUs and be monitored, alarmed, and recorded in C20. The SC1 DCIS is divided into three divisions and those divisions are separately powered by the three divisions of the R10 – Emergency Power Backup DC and UPS Electrical System (described in Section 7.0). The three SC1 DCIS divisions operate completely independently from each other (except for voting) and from the lower SC DCIS. Isolated information only flows in one direction through boundary devices to the SC3 networks so that SC1 system information may be alarmed, monitored, and recorded (but not controlled) with SC2 and SC3 equipment (e.g., VDUs, printers, alarm system, and historians).

C20 is divided into two DLs. One is DL4a and performs Safety Category 2 functions using SC2 equipment. The other is DL2 and performs Safety Category 3 functions using SC3 equipment. DL4a actuation logic operates on an analog based I&C platform. It communicates status and diagnostic information to the DL2 portion of C20, which is based on digital I&C technology.

The C20 DCIS is redundant and segmented into two parts. The two network segments are the Nuclear Segment and the BOP Segment. The two bus segments are classified as SC3. The Nuclear Segment uses controllers classified as SC3. The BOP Segment interfaces with C30 and SCN controllers to acquire information to support Human-System Interfaces (HSI) integration in C20. Both segments have their own redundant Unit Data Highway, and each independently provides the control and monitoring capability of nuclear and BOP I&C for their segment.

Each segment has their own redundant network managed switches classified as SC3. Each segment can operate independently of the other (although it appears seamless to the operator). Each segment has associated VDUs, historians, and a common alarm system. The C20 segments use Triple Modular Redundant (TMR) and redundant controller architectures for various functions to support reliability goals or prevent adverse actuations for anticipated hardware component failures.

The Nuclear Segment supports the SC3 controllers (which include the major reactor control systems) by acquiring DL3 data from the C10, SC1 controllers via unidirectional boundary devices. It also acquires DL4a diagnostics.

The BOP Segment provides for control of the SCN plant functions and controllers used mainly for power generation. It also provides gateways to interface non-native controllers to the BOP network segment. Although lower classified equipment, these functions use TMR controller architectures (referred to hereafter as TMR controllers) to prevent random I&C component failures from causing plant transients.

The C30 system includes functional requirements for the non-safety BOP components that contain the control and monitoring systems associated with power generation and support systems. The design basis of this C30 BOP Segment is to provide for the control and monitoring of the power generation and support equipment. This equipment is not credited for safety functions although they may be available for beyond design basis and severe accident scenarios. The equipment is intended to be reliable enough such that a BOP controller failure does not cause an AOO.

Even though the BOP Segment is used for non-safety power generation systems, the controllers are TMR. For the TMR controlled systems, single controller failures (and some double failures) have no adverse effect on system or plant operation and failed single controller parts may be replaced online. The intent is that no controller failure initiates an AOO.

The BWRX-300 plant has passive safety systems that get actuated the various DCIS platforms that provide specific safety functions. In general, the safety functions include reactor shutdown (bringing the reactor subcritical), isolation of the reactor vessel and containment, monitoring of reactor power in the power range, initiation of heat removal and pressure control, and overall and control and monitoring of the plant. The safety systems are automatically initiated upon detection of specific conditions and can be initiated manually by an operator. The safety systems are designed to be fail-safe, so they actuate the safety function upon loss of power. The DCIS also provides for monitoring of post-accident parameters to support emergency procedures and guidelines.

The defined safety functions are provided with high reliability, diversity, independence, and redundancy features. Specifically, the BWRX-300 design performs the safety functions given single (and sometimes multiple) failures and, for software-based systems, assuming CCF of the hardware/software platforms.

Figure 6-1, *Instrumentation and Controls Architecture* shows the four partitions of the BWRX 300 DCIS. The three DCIS platforms are powered by three electrical systems with like safety classifications.

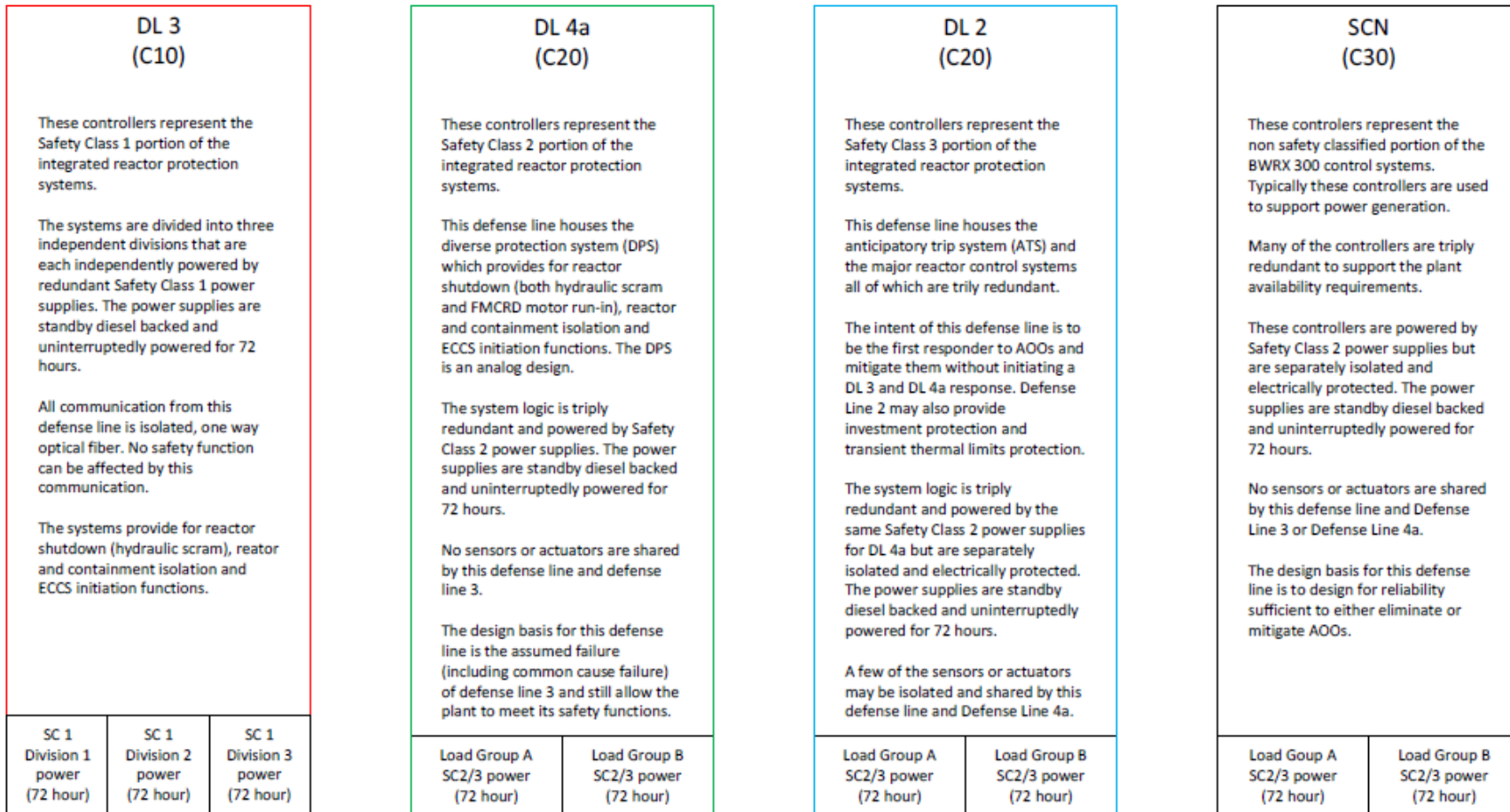

Figure 6-1: Instrumentation and Controls Architecture

6.2 Main Control Room

The MCR is in the CB. The MCR is the primary location for plant monitoring and control during normal, abnormal, and emergency conditions. The MCR includes controls, indications, and alarms that enable operators to perform the defined set of functions during normal operation modes and PIE conditions. It is expected that the safety and Human Factors Engineering (HFE) analyses being performed as an integral part of the design of the BWRX-300 is to dictate a requirement for an alternate control location; as such, the current concept design includes the Secondary Control Room (SCR). In the event the MCR becomes uninhabitable, or is expected to become uninhabitable, or if functionality is unacceptably impaired, personnel are to move to the SCR. The intended functionality of the SCR is to maintain the unit in a safe shutdown condition with the capability to place the unit in a safe shutdown condition. It is not the purpose of the SCR to allow continued operation of the plant at power. Egress from the MCR and access to the SCR is designed such that required minimum operations staffing can safely transition from the MCR to the SCR.

The MCR is designed with HSI to support tasks such as:

1. Assessing the overall status and performance of the plant in any condition and providing necessary information to support operator actions.
2. Monitoring the status and trends of key plant parameters (such as reactor power and rates of power change).
3. Operating the plant safely during all operational states, automatically or manually.
4. Taking measures to maintain the plant in a safe state or to bring it back into a safe state after design basis events and DEC.
5. Maintaining the plant within the specified limits and conditions for the parameters associated with plant systems and equipment.
6. Monitoring for failure of critical instrumentation and equipment.
7. Confirming safety actions for the actuation of safety systems are automatically initiated when needed and that the relevant systems perform as intended.
8. Determining the need and the time for manual initiation or intervention of specified safety actions.
9. Implementing emergency operating procedures, Emergency Mitigating Equipment guidelines, and severe accident management guidelines.

The design provides the ability to for user selectable display screens and user-defined trending and parameter value monitoring. A robust visual and audible alarming system is provided to alert operators when value thresholds are exceeded. Considering the control technology, the design supports query of control input status (e.g., interlocks, start permissive, auto-start signals) at the point of operation. The Safety Parameter Display System is integrated in the overall MCR HSI designs.

Figure 6-2, *Main Control Room and Surrounding Areas Layout (Top View)* provides an overview of the MCR layout.

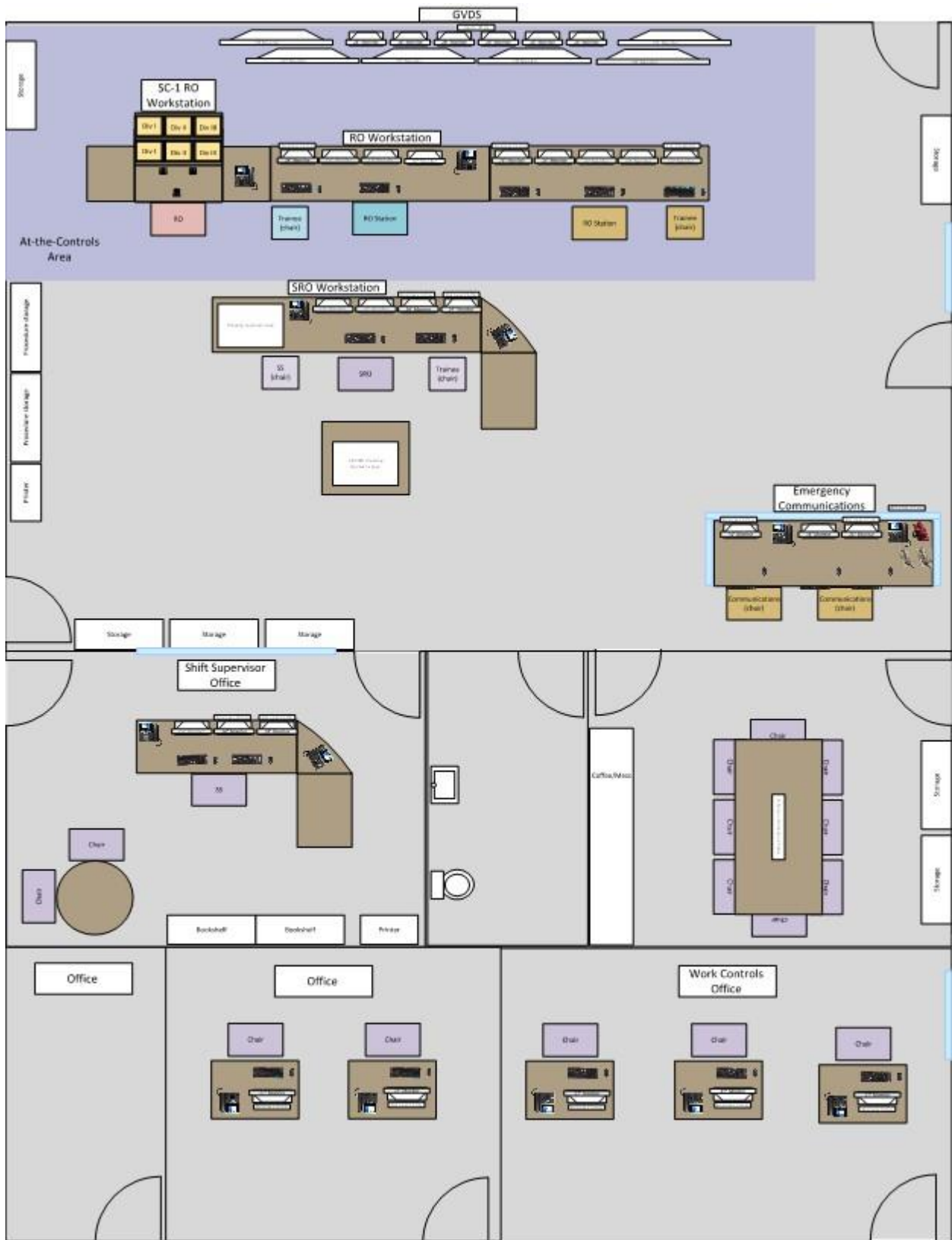

Figure 6-2: Main Control Room and Surrounding Areas Layout (Top View)

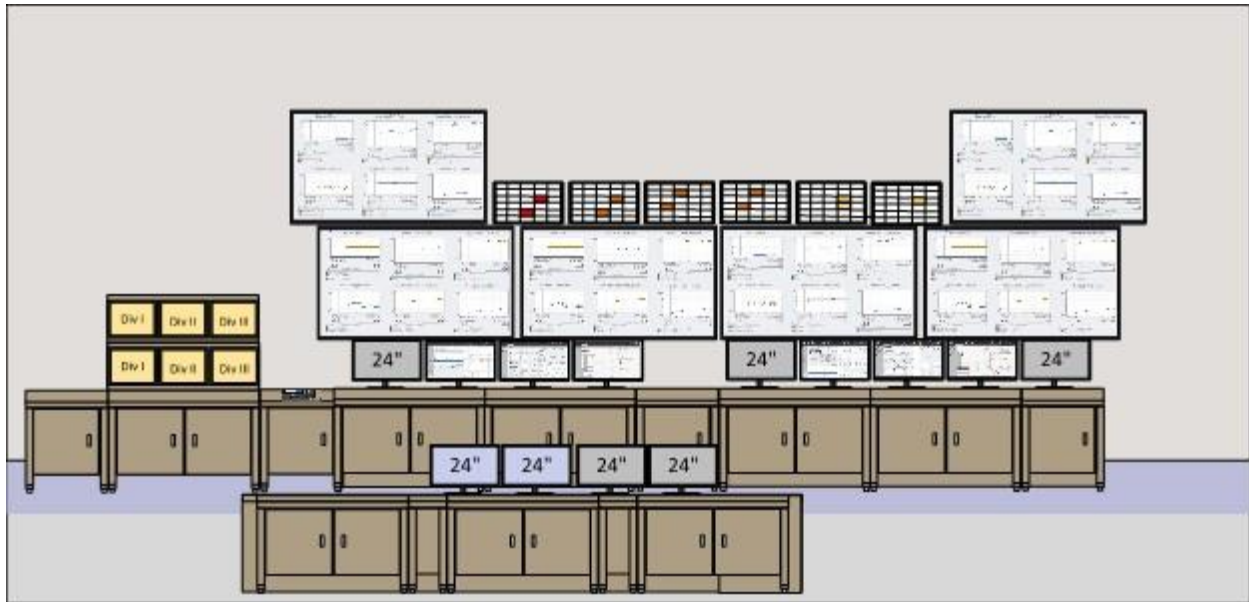

Figure 6-3: Group View Display System Concept (Front View)

6.3 Secondary Control Room

The SCR is in the RB. The SCR includes the required HSI that enable operators to perform the defined set of functions required for responding to the identified plant events and conditions for which the MCR cannot be used.

The SCR is designed in accordance with current international best practice codes and standards for control room design, integrating results from HFE analyses and specified HFE design requirements.

The SCR is utilized to perform the functions required to keep the plant in a safe state when the MCR is unavailable. The required functions are derived from a safety and HFE analyses.

The SCR includes suitable facilities for habitability and well as workspace for tasks to support required usage. The SCR contains a suitable supply of food and water. The SCR also contains adequate space and provisions for sleeping as required by the postulated scenarios in which it is used.

7.0 ELECTRICAL SYSTEMS

The BWRX-300 Electrical Distribution System (EDS) is an integrated power supply and transmission system. The EDS is arranged like the DCIS with three safety classified segments and an SCN segment with appropriate levels of hardware and software quality corresponding to the system functions they control and their DL. The three parts of the BWRX-300 EDS are separated according to SC and DL. The SC1 EDS (R10), the SC2 and SC3 EDS (R20 – Standby Power System), and the SCN EDS (R30 – Preferred Power System).

The three subsystems are grouped based on safety classification as shown in Figure 7-1, *Electrical System Architecture*.

- R10 – Power supply for SC1 systems
- R20 – Power supply for combined SC2 and 3 systems
- R30 – Power supply and transmission system for non-safety systems

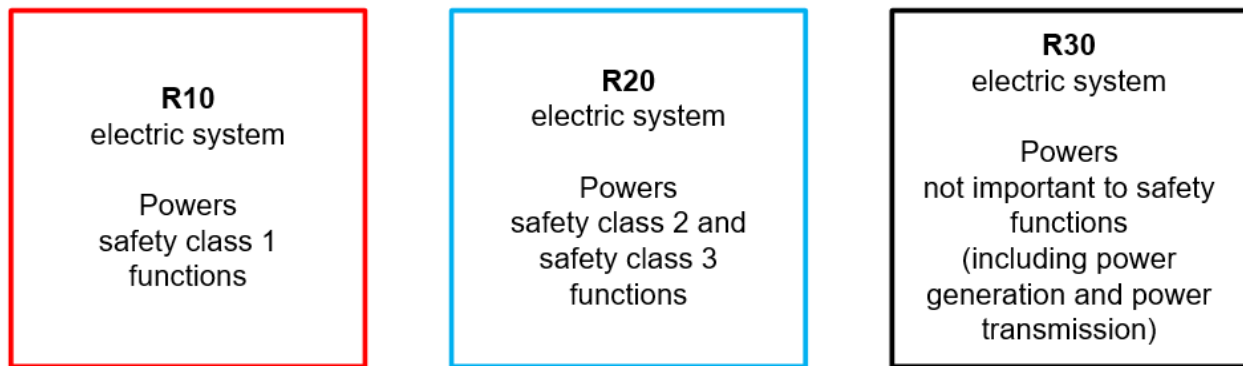

Figure 7-1: Electrical System Architecture

Each subsystem has appropriate levels of hardware and software quality (corresponding to the systems they power) to provide power to plant loads and a transmission path for the main generator to the utility switchyard/grid. The EDS is monitored and controlled by plant operators from the MCR. Various segments of the EDS can operate independently.

Power is supplied to the plant from an offsite power source, the grid, and is called the “Normal Preferred” power source. The loss of the preferred source may be referred to as a Loss of Preferred Power or a LOOP. The terms may be used interchangeably. The power source is designed to provide reliable power for the plant auxiliary loads. The Preferred Power Supply consists of the Normal Preferred source and includes those portions of the offsite power system and the on-site power system required for power flow from the offsite transmission system to the medium voltage A and B busses.

The on-site AC power system consists of SCN, SC1, SC2, and SC3 power systems. The off-site power source provides the Normal Preferred and Alternate Preferred AC power to SCN, SC1, SC2, and SC3 loads. In the event of total LOOP sources, two on-site independent SC3 Standby Diesel Generators are provided and are capable of supplying SC loads. There are two independent SC2 DC load groups and one SC3 DC load group, each with an uninterruptible power supply to provide power to the respective SC2 and SC3 loads.

The emergency power systems consist of three independent SC1 DC divisions with uninterruptible power supplies to provide power to SC1 loads.

The electrical system is designed with sufficient capacity to meet load requirements to support FSFs. The design incorporates an appropriate D-in-D strategy to ensure availability and reliability of the supported systems.

The function of the highest SC BWRX-300 electric subsystem is to provide power to the highest SC I&C system and any mechanical components needed to support the FSFs.

SC1 batteries in the R10 subsystem are designed to provide backup power for at least 72 hours. The external connections provide for connection of Emergency Mitigating Equipment (also known as FLEX equipment) as needed.

In addition to the safety design criteria and rules and regulations, the following issues specific to the BWRX-300 electrical power systems are included:

- The design of the EDS is to provide for reliable power supply to all SC1, SC2 and SC3 loads during normal conditions.
- The EDS is divisionalized to ensure that a division can be taken out of service and not disrupt the operations of the plant.
- Battery power is provided to ensure that monitoring equipment can be powered for at least 72 hours following a Design Basis Event.
- SC3 Standby Diesel Generators are provided to supply backup power to loads.
- The BWRX-300 EDS has been designed to not be required to shut down and cool down the reactor following a Design Basis Event.

8.0 RADIOACTIVE WASTE MANAGEMENT SYSTEMS

8.1 Discharges During Normal Operation

The types of radwaste discharge during normal operations are well understood for BWRs. The BWRX-300 incorporates decades of lessons learned from the operating fleet to minimize radwaste amounts. The following summarizes types of radwaste generated during normal operation:

- Liquids: BWRX-300 is designed to be a zero-discharge plant for liquid radioactive wastes during normal operations. During outages when a large amount of discharge water inventory is generated by equipment decontamination, the plant may discharge up to 2 m³/hr with adequate dilution flow to meet USNRC Code of Federal Regulations (CFR) Title 10, "Energy". GEH is expected to reconcile to the requirements of other jurisdictions.
- Solids: BWRX-300 is estimated to generate about 36 m³ of low-level wet radwaste per year for disposal of resins and other materials used to filter the water from the condenser and liquid waste cleaning systems. Operations and maintenance are estimated to generate up to 148 m³, prior to compaction or incineration of very low solid radwaste such as HVAC filters, paper, and plastic materials per year.
- Gaseous: BWRX-300 normal offgas flow is estimated to be less than 15 liters per second discharged from the plant stack at a height of approximately 35 m. The plant is designed to meet the dose limits of USNRC 10 CFR 20, "Standards for Protection Against Radiation" (17) and 10 CFR 50 Appendix I, "Numerical Guides for Design Objectives and Limiting Conditions for Operation to Meet the Criterion "As Low As Reasonably Achievable" for Radioactive Material in Light-Water-Cooled Nuclear Power Reactor Effluents" (18) and is expected to meet the requirements of other regulatory jurisdictions.

8.2 Liquid Waste Management System

The Liquid Waste Management System (LWM) receives, handles, stores and processes potential liquid radioactive waste generated as the result of normal plant operation, including AOOs.

The filtered water is reused in the plant. The LWM consists of the collection tanks, sample tanks, filtration skids, Refueling Water Storage Tank, Condensate Storage Tank (CST), and associated pumps/piping/instrumentation. Liquid wastes are sent to the collection tanks located in the Radwaste Building via the Equipment Floor Drain System.

The LWM normally operates on a batch basis. Each batch is sampled to determine the concentrations of suspended solids and chemical contaminants. The sampling is performed from sample ports downstream of the collection and sample tanks and analyzed in the lab of the Radwaste Building. Processed liquid waste that meets effluent criteria are pumped into the CST for reuse. Accidental discharge is monitored by the Process Radiation Monitor system through detection and alarm of abnormal conditions and by administrative controls.

The intent of the filtration and processing of all liquid radwaste is to recycle all processed water back to the CST to maintain zero liquid release.

8.3 Solid Waste Management System

The Solid Waste Management (SWM) system controls, collects, handles, process, packages, and temporarily stores solid waste generated by the plant prior to shipping the waste offsite. The SWM system processes filter backwash sludges, charcoal media, and bead resins generated by FPC, ICC, and CFD.

Contaminated solids such as high efficiency particulate air and cartridge filters, rags, plastic, paper, clothing, tools, and equipment are also disposed of in the SWM system.

The SWM system may also receive, process, and dewater solid radioactive waste inputs for permanent offsite disposal. Liquids from the SWM system are sent to LWM for processing.

System components are designed and arranged in shielded enclosures to minimize exposure to plant personnel during operation, inspection, and maintenance. Tanks, processing subsystems equipment, pumps, valves, and instruments that contain radioactivity are in controlled access areas.

Protection against accidental discharge is provided by steel liners in the tank cubicles, detection, and alarm of abnormal conditions, and augmented by administrative controls.

To the maximum extent practicable, mixed waste and non-radioactive hazardous waste are kept out of the SWM. Mixed wastes and potentially radioactive oily wastes are collected primarily in 55-gallon (208-liter) collection drums and sent offsite to an appropriately permitted vendor processor. However, should circumstances dictate the storage or disposal of larger quantities of mixed waste, other approved containers can be used.

In each tank cubicle in the RWB, a small sump with a level alarm is provided for leak detection.

8.4 Offgas System

The Offgas System (OGS) processes and controls the release of gaseous radioactive effluents to the area of the site to limit personnel exposure to radioactive gases as low as reasonably achievable. The OGS holds and allows for the decay of radioactive gases in offgas from the main condenser. OGS delays and filters offgas process steam containing the radioactive isotopes krypton, xenon, iodine, hydrogen, nitrogen, and oxygen to achieve decay before discharge from the plant.

During normal plant operation, non-condensable gases develop in the reactor steam. These need to be removed to maintain turbine efficiency. The gases are drawn from the main condenser via the SJAES. The mixture is then passed through the offgas recombiner where hydrogen and oxygen are catalytically recombined to form water. After recombination, the offgas is routed to a condenser to remove moisture then routed to effluent conditioning components and then to charcoal adsorber tanks. The charcoal adsorber tanks provide a delay period for radioisotope decay as the offgas mixture passes through. The mixture exiting the adsorber tanks is routed to a chimney for release to the environment.

The OGS includes sample capability from various points for radiochemistry information and system health information.

9.0 PLANT LAYOUT AND ARRANGEMENT

An innovative design-to-cost solution developed for the BWRX 300 optimizes the construction cost and schedule and maximizes safety performance during the operational and decommissioning life of the plant. The RPV, SCCV, and SC SSCs are in the below-grade portions of the RB. The RB is a vertical right cylinder shaft that mitigates the effects of external events including aircraft impact, adverse weather, flooding, fires, and earthquakes. Fuel handling equipment and pools for passive SC cooling systems are in the above-grade portion of the RB directly supported by the below-grade vertical shaft. Advanced construction methods are used for the RB to reduce construction cost and schedule by minimizing the amount of excavation, concrete, and the need for backfill materials.

The RB is the only Seismic Category 1 structure in the BWRX-300 design. The below-grade cylindrical shaft for the RB design and construction method is unique compared to existing NPPs. The SCCV and RPV are situated at or below grade within the RB. A pool rests above the SCCV and interfaces with the SCCV dome. The three ICS pools sit next to the pool above the SCCV with one IC located in each pool (see Figure 9-1, *Reactor Building*). The fuel pool is located at grade in the RB and has a capacity of eight years of used fuel and a full core off-load.

The CB, TB, and RWB structures are designed to prevent structural failure or interaction that could:

- Degrade the functioning of the RB SC1 SSCs to an unacceptable level of safety.
- Result in incapacitating injury to occupants of the CB control room.
- Compromise the safety functions of those SSCs that are required to remain functional following a seismic event.

The preliminary site secure or Protected Area (PA) layout for BWRX-300 (see Figure 9-2, *BWRX-300 Plant Layout*) is a 4-hectare (10-acre) footprint that includes the security building, roadways around the power block, generator step up transformer, auxiliary transformer for site power, fencing, and general laydown areas.

The owner's area of 13.8 hectares (34 acres) includes other plant buildings, switchyard, cooling tower (if needed), site office, parking lot, warehouse, and other supporting facilities. The reference site uses mechanical draft cooling towers, but other options are available including hybrid or dry cooling towers or once-through cooling to a lake, river, or ocean. This area can vary greatly from site to site.

The CB, TB, and RWB structures are supported by a near-surface basemat foundation adjacent to the deeply embedded RB structure. The CB, TB, and RWB are separated from the RB by seismic gaps. The CB houses the control room, electrical, control, and instrumentation equipment. The RWB houses rooms and equipment for handling, processing, and packaging liquid and solid radioactive wastes. The TB encloses the turbine generator, main condenser, CFSs, condensate purification system, OGS, turbine generator support systems, and bridge crane.

The power block is comprised of the RB, TB, CB, RWB, and the Turbine Maintenance Building. The footprint of the power block is approximately 148 m x 78 m.

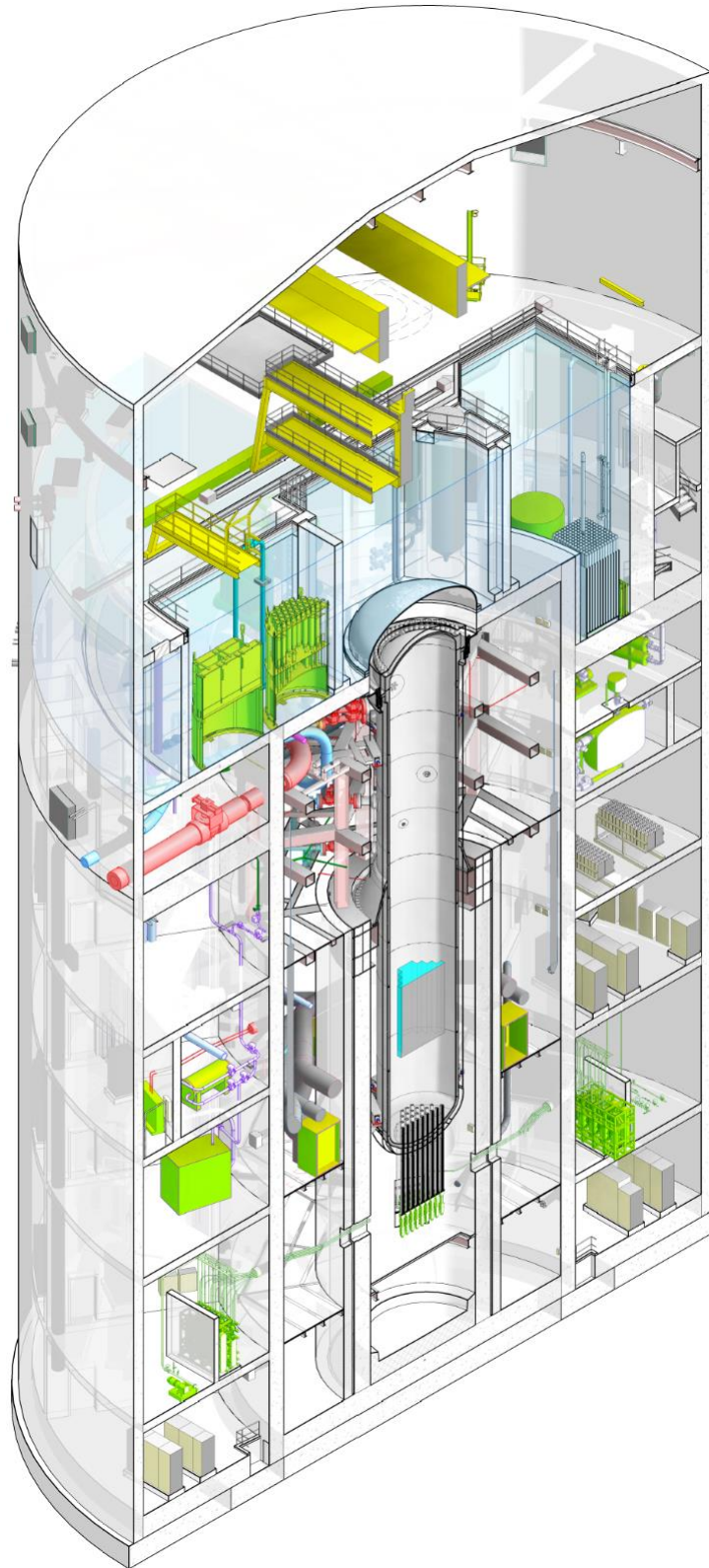

Figure 9-1: Reactor Building

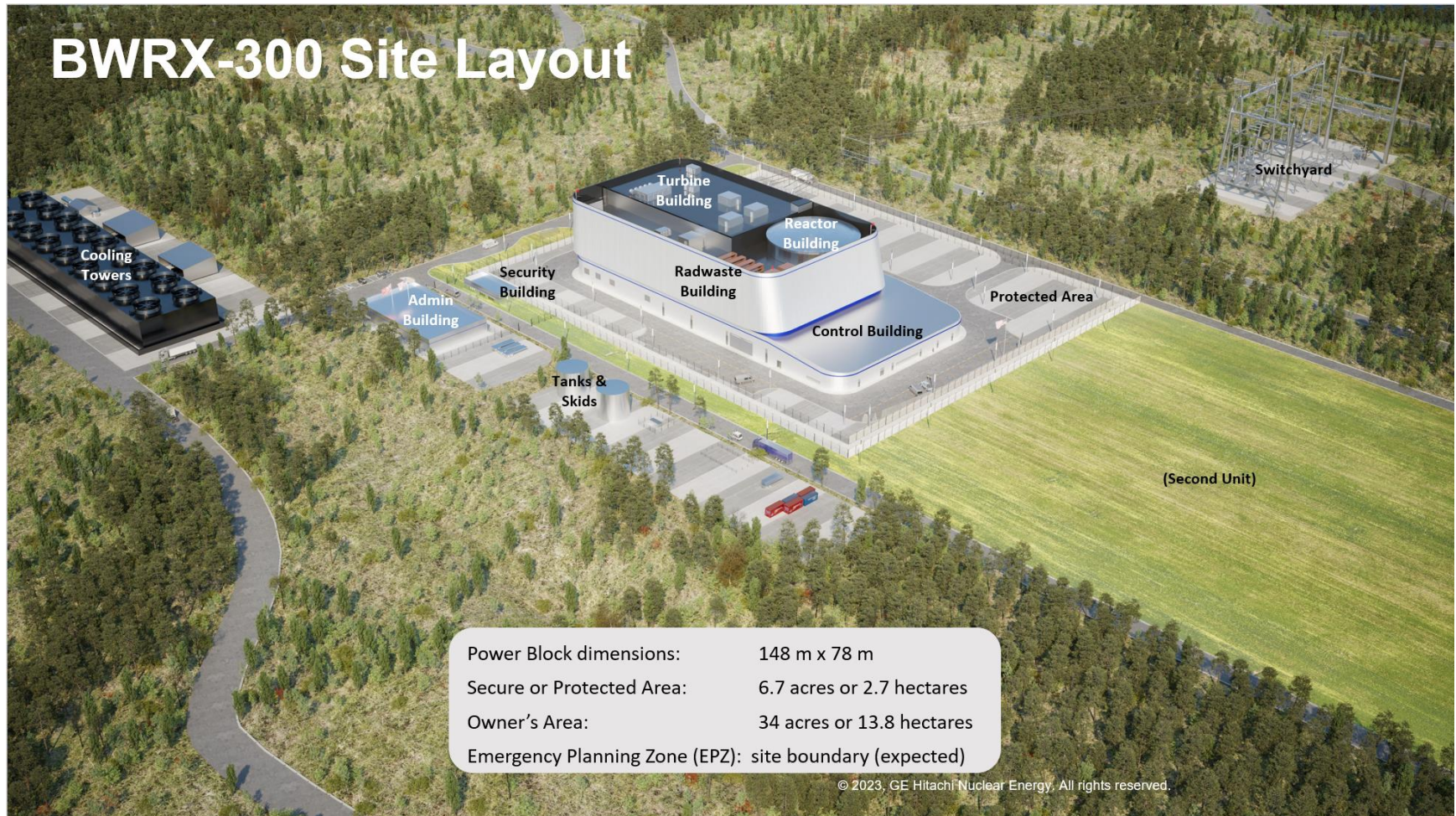

Figure 9-2: BWRX-300 Plant Layout

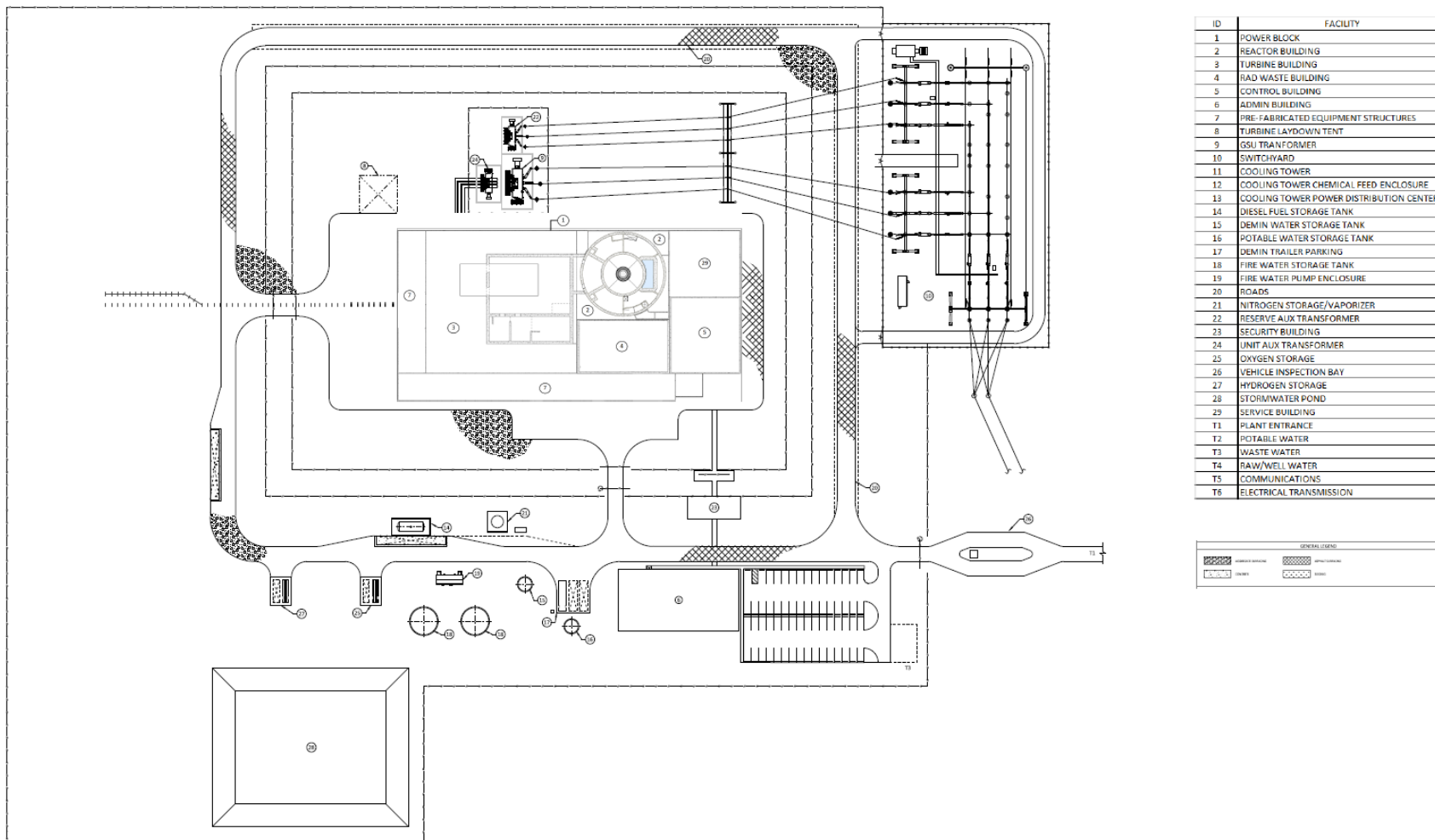

Figure 9-3: BWRX-300 Site Arrangement

10.0 SITE CONSIDERATIONS AND GRID INTEGRATION

For construction, the site needs a deep-water pier for barging or heavy haul routes for land transportation. The largest component transported to site is the RPV, which is approximately 27.4 m long and 4 m in diameter and weighs approximately 650 metric tons with pressure vessel, self-propelled modularized transports, rigging, and cribbing.

10.1 Site Considerations During Operation

The seismic design considers a wide variety of soil conditions (soft, medium, and hard rock). During normal operation, the reference site maximum acceptable ambient air temperature is 37.8°C dry bulb (100°F) / 26.1°C (79°F) mean coincident wet bulb. Maximum recommended inlet temperature for the main condenser/HX is 37.8°C (100°F). The BWRX-300 can be equipped with a wide variety of cooling options, including dry cooling towers and once-through cooling.

10.2 Grid Integration

Switchyard requirements are minimal and typical and are met with a breaker and a half, dual high voltage bus design, and a relay house with controlled access as shown in Figure 10-1, *BWRX-300 Switchyard Interface*. The BWRX-300 plant only requires a minimum of one incoming/outputting transmission line capable of handling the 300 MWe/355 MVA plant output. This is possible since the BWRX-300 safety systems do not require AC power to function. The switchyard may be any voltage or frequency as needed to interface with the transmission system. The switchyard can be designed such that no single switchyard breaker or switchyard bus failure results in loss of transmission or loss of plant input power. It is recommended that the switchyard protection schemes are redundant with separate batteries and separate chargers. If required, the plant standby diesel generators can power the switchyard battery chargers. Finally, the various chargers, batteries, and protective relays are to be housed in a physically secure and protected enclosure if required. This equipment is considered critical digital assets by the Federal Energy Regulatory Commission in the U.S.

The BWRX-300 plant I&C have required interfaces with the switchyard breakers/protective relays; cyber security reasons restrict the interface to hardwired.

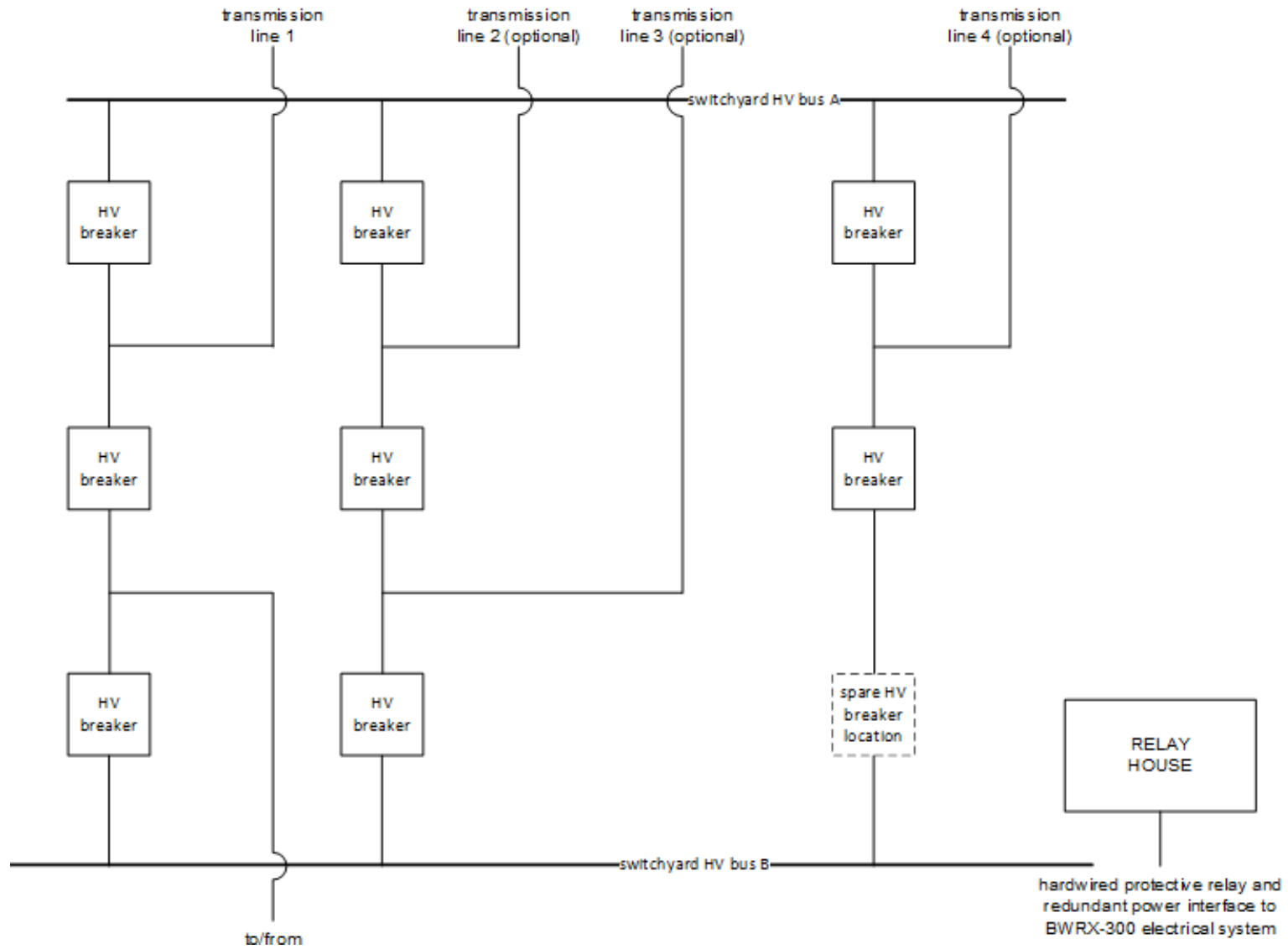

Figure 10-1: BWRX-300 Switchyard Interface

10.3 Research, Development, and Testing

The BWRX-300 research and development program is implemented as part of the project risk management and design processes. GEH may subcontract portions of the research and development scope to engineering and test vendors, national laboratories, or universities. For most SSCs, the BWRX-300 uses commercial off-the-shelf equipment and proven construction techniques, so the research and development program is focused on a small subset of the overall design.

System and component testing are an aspect of the design verification. Design verification is performed to ensure the design complies with customer requirements, technical requirements, regulatory requirements, and codes and standards. Verification ensures that appropriate design methods are used, design inputs are correctly incorporated into the design, and design output is reasonable when compared with the design input.

Design verification qualification tests demonstrate adequacy of performance under conditions that simulate the most adverse design conditions. Where the test is intended to verify only specific design features, other features of the design are verified by alternate approved verification methods.

Engineering tests that provide product performance or design basis information, or impact the design, licensing, or operation of a product, product line, or environmental qualification, are also used. The tests include requirements, acceptance criteria and results, and are performed by qualified individuals with sufficient controls (environmental, calibrated equipment qualified personnel) to demonstrate compliance to pertinent requirements, industry codes and standards, and regulatory requirements.

The test program also includes prototype qualification tests, production tests, proof tests before installation, and pre-operational tests to demonstrate satisfactory performance of the system/components of the BWRX-300.

11.0 TECHNOLOGY MATURITY/READINESS

The BWRX-300 leverages the main features of the power cycle from NPPs that have been or are in service. The BWRX-300 is the 10th generation BWR and draws heavily from previous designs. For example, it leverages natural circulation from the Dodewaard and ESBWR and utilizes key components from the ABWR.

The nuclear core uses the proven GNF2 fuel assemblies that are manufactured and sold to over 80% of the BWR fleet, and over 26,000 GNF2 fuel assemblies have been delivered worldwide as of 2023.

Below is a brief list of pre-established foundations which support and streamline the BWRX-300 design:

- GEH has approximately 40 BWR plants currently in service with hundreds of years of reactor operating experience.
- GEH administers and coordinates a BWR Owners' Group, which deals with fleet-wide issues and concerns and operating experience.
- GEH has a USNRC-approved NQA-1 quality program, which is also approved internationally and meets the IAEA requirements for an overall quality program.
- GEH uses its version of the Transient Reactor Analysis Code thermal-hydraulic code to perform design basis analyses. The code was qualified through a series of tests that covered important phenomena which largely overlap BWRX-300 phenomena and have been approved by the USNRC for ESBWR safety analysis.

GEH is supported by GE Global Research, U.S. universities, and national labs for work with a goal of optimizing the design. None of these are needed to commercialize the technology but are expected to be leveraged to lower costs in the future.

Previous GE BWR designs have been licensed worldwide, including in the U.S., Japan, U.K., Taiwan, Switzerland, Italy, and Spain. In addition, the World Association of Nuclear Operators, and the U.S.-based Institute of Nuclear Power Operations both coordinate the sharing of nuclear reactor operating experience.

One of the design goals of the BWRX-300 is to be licensed internationally. The design has been developed using a philosophy which is based on the IAEA D-in-D guidelines. This creates a transparent and easy-to-follow foundation for plant SSC classification that can be adapted to the requirements of individual country regimes.

The BWRX-300 leverages proven designs with very little research and technology development needed. Only certain components need component-level testing. GEH is also exploring new nuclear manufacturing methods such as those using powder metallurgy and advanced design optimization methods. Features such as these are expected to be extensively tested before being incorporated into the design.

11.1 Technical Development Needs

In certain cases, technical development is desirable to achieve a lower cost, shorter schedule, better performance, and enhanced safety characteristics. 40 of 45 systems are at a high enough level of readiness where no additional technical development is required. For these systems, there are design activities needed to integrate the system into the plant, perform safety analyses, define interfaces between systems, define procurement specifications, develop installation and construction requirements, and prepare inputs to licensing/permitting applications.

12.0 PLANT OPERATIONS AND MAINTENANCE

It is a primary objective of the BWRX-300 design to achieve a competitive LCOE by minimizing the required on-site staff and operations and maintenance costs, along with capital costs. Financing costs also have a significant impact on LCOE. GEH can work with potential customers to assist in modeling a project specific LCOE.

The BWRX-300 is designed for minimal staffing while meeting all requirements for safe and reliable nuclear operations. The site staffing of approximately 70 employees is achievable by informing the design early on, optimizing operations and maintenance programs, and implementing fleet services. Cycle operation between refueling outages is determined by the owner/utility and can range from 12-24 months. Annual refueling outages that last approximately 12 days are expected. This refueling outage period is intended to allow refueling of the reactor and maintenance of key mechanical equipment. Major outages, that last about 25 days, are expected every 10 years. These major outages allow major turbine inspections and any other non-routine inspections, as required.

Fleet operations, maintenance, and training options are being developed for a fleet of BWRX-300 plants. These options include the collection and analyses of plant data, optimization of work control, configuration management, plant procedures, centralized training, supply chain, refueling/maintenance teams, and engineering for maintenance and modifications. The savings potential and structure of moving to a centralized fleet operation, maintenance, and training model is to be evaluated from an LCOE standpoint, taking the entire lifecycle of the plant into account (i.e., not just capital cost).

13.0 SAFEGUARDS AND SECURITY

13.1 Safeguards

The BWRX-300 is consistent with operating BWRs with respect to safeguards on nuclear material. Fuel received on-site enters a Special Nuclear Material (SNM) Material Control and Accounting Program, which is the responsibility of the plant operator and management. As such, the features described here are typical, and the program can be tailored for the individual site.

The criteria prescribed in the Material Control and Accounting Program are applicable to SNM and various material mixtures containing SNM. The U-235 content varies depending on various reactor parameters. SNM is typically in the form of ceramic pellets encapsulated in metal fuel rods. Criteria are established for the SNM control and accounting system, including criteria for the receipt, internal control, physical inventory, and shipment. The remainder of this section provides key portions of a typical program.

Written procedures are prepared and maintained covering the SNM control and accounting system. These procedures address, as a minimum, the following topics:

- Organization and personnel responsibilities and authorities.
- Designation and description of item control areas.
- Material control records and reporting.
- Notification for events concerning SNM.
- Receiving and shipping SNM.
- Internal transfer of SNM.
- Physical inventory of SNM.
- SNM element and isotopic calculation method.
- Characterization and identification of items as SNM or non-SNM to preclude loss of control of SNM items.

Shipment procedures are established to provide for:

- Verification and recording of the serial number or unique identifier of each item containing SNM.
- Recording of the quantities of SNM contained in each item.
- Reporting the quantity of SNM shipped if the quantity is reportable.
- Verification of compliance with regulations, including licensing, transportation, and security requirements for shipment.
- Reporting the completion of each shipment to the accounting group.

Care is taken to assure that SNM contained in fuel is not shipped inadvertently with shipments of non-fuel SNM waste.

Shipment of fuel assemblies, fuel components, or non-fuel SNM is documented in the material control records and the book inventory is updated for the applicable item control area. Nuclear Material Transaction Reports are completed.

Records are created and retained in accordance with SNM accountability requirements.

When a fuel assembly has been received by the utility, the SNM custodian takes over SNM accounting responsibilities of the fuel.

13.2 Physical Security

The Security Plan of BWRX-300 is withheld from public disclosure. This section provides general and partial information on physical security features which generally apply to BWRX-300 and to other new nuclear plants.

All vital equipment is in vital areas to which access is monitored and controlled. Much of the vital area is within radiological control areas, which are inaccessible during operation and typically only accessed during refueling intervals. Additionally, all vital areas are located within the PA, providing a second physical barrier and means of access control. The D-in-D concepts of redundancy and physical separation of redundant systems, as well as simple passive safety systems, further support the physical security of the plant in that multiple vital SSCs must be compromised to realize effective radiological sabotage. All vital systems and components are housed within robust reinforced concrete structures that are accessed only through a minimal number of normally locked access points that are controlled and monitored by the site security system. Many of the components of vital systems are located below site grade, thereby minimizing exposure to external threats.

Site physical protection is provided through a combination of a security organization, including armed personnel, physical barriers, controlled access to the PA, controlled access to vital areas located within the PA, and administrative policies and procedures for screening and monitoring personnel and material allowed access to the site.

13.3 Cyber Security Capabilities

GEH implements strong cyber security programs to control the product development lifecycles for all disciplines susceptible to cyber security issues, including I&C technology platforms. GEH's product security program is based on common industry standard frameworks, including the National Institute of Standards and Technology Framework for Improving Critical Infrastructure Cyber Security and the North American Energy Reliability Corporation Critical Infrastructure Protection plan. GEH further augments the GE Power product security program by ensuring that USNRC specific cyber security requirements are implemented for and integrated to DCIS offerings delivered to nuclear customers, such as 10 Code of Federal Regulations 73.54, *Protection of Digital Computer and Communication Systems and Networks*, and its common implementation frameworks, such as Nuclear Energy Institute (NEI) 08-09, *Cyber Security Plan for Nuclear Power Reactors* (16). GEH addresses cyber security requirements under the applicable business policies and common procedures.

13.4 Resistance to Electromagnetic Pulse and Geomagnetic Disturbances

The BWRX-300 is designed to minimize the use of electrically controlled and operated components (for example, using natural circulation for cooling instead of forced pumping). Using fewer electrical components reduces its vulnerability to electromagnetic pulse and geomagnetic disturbances. The requirements for electromagnetic pulse are to be established early on, and these mitigation features are added as required during the detailed design. The appropriate design features to adequately harden the distributed control system equipment are used in accordance with industry best practices and lessons learned.

13.5 Electromagnetic Compatibility

Electromagnetic Compatibility (EMC) qualification involves two elements: 1) testing to assess susceptibility of equipment to interference levels that bound the expected electromagnetic environment; and 2) testing to assess emissions of equipment to ensure that the contribution to the electromagnetic environment does not invalidate bounding interference levels applied for susceptibility testing.

EMC involves susceptibility testing and emissions testing. Susceptibility testing allows assessment of equipment immunity to Electromagnetic, and Radio Frequency Interference (EMI/RFI) and confirmation of its surge withstand capability. Emissions testing provide assurance that equipment is compatible with the expected electromagnetic environment.

14.0 OTHER PLANT CHARACTERISTICS

14.1 Load Following

BWR core loadings are designed such that power maneuvering via control rod movement is performed within the BWR Fuel Operating Guidelines. The BWRX-300 core nuclear design can be optimized for daily load following, using control rods only, while maintaining conformance with these guidelines. The BWRX-300 can maneuver from 100% and 50% power, with a ramp rate of +0.5%/minute, and return to full power with the same ramp rate, daily. The plant can reduce electric power at a faster rate by dumping steam to the condenser instead of using the main turbine/generator control valves. If dumping steam is expected to occur regularly for a particular plant, then an optional, higher capacity condenser is implemented.

14.2 Lower Waste Yields

Although the BWRX-300 is an LWR, it has lower lifetime waste yields and a lower end-of-life decommissioning volume compared to the current generation of operational reactors. This is due to the use of proven improvements from the current fleet of BWRs for both piping material (stainless steel) and modern in-use radioactive waste demineralizer resin material. In addition, the fuel cycle for this plant is efficient and the use of a 12-month cycle leads to fewer used fuel assemblies overall compared to 18 or 24-months operating cycles, which is the experience from BWRs in Europe. The focus on design-to-cost and a reduced construction schedule duration led to a construction method that yields less material for decommissioning purposes.

14.3 Ability to Integrate with Electric and Non-Electric Applications

Unlike current generation plants, the smaller size makes for more flexible operation and fits in existing electrical grid transmission systems without extensive upgrades. The BWRX-300 can also provide process heat for industrial usage and district heat from the waste heat generated from the MS turbine and other steam heat loads as required. Another application the BWRX-300 can be used for is green hydrogen generation. Utilizing the electrical output to power electrolyzers can produce green hydrogen that can be used for a variety of applications such as transportation or heat source for steel mills.

14.4 Energy Resilience

The BWRX-300 provides for energy resilience with the ability to avoid, prepare for, minimize, adapt to, and recover from anticipated and unanticipated energy disruptions. The BWRX-300 can be deployed to ensure energy availability and resiliency is sufficient to provide mission assurance and readiness. This includes powering critical assets and other mission essential requirements.

As baseload power plants are being retired, there is an emerging need for newly constructed power sources. Environmental considerations are driving consumers to look toward clean energy options. However, renewable power sources are not as reliable as traditional power stations, and thus, are ill-suited sources of baseload power. Although natural gas power plants do release far less carbon than today's coal-heavy generation portfolio, they do, nonetheless, emit significant amounts of air pollutants. Hence, there is an opportunity for an environmentally friendly, reliable, and fast-responding power source.

Compared to certain other baseload power alternatives, the BWRX-300 presents an opportunity to reduce emissions from baseload power generation in the future; offers a more secure, resilient power source; and provides more reliable power as compared to renewable generation.

- **Fuel Security:** The BWRX-300 can store at least two years of new fuel on-site. Storing that much fuel on-site for a natural gas plant is impractical and expensive, given the massive gas storage facilities which are required. Natural gas deliveries can be subject to volatile markets and occasional shortages, especially during unusually cold winter weather. Coal and other fossil fuel are susceptible to excess moisture during wet periods.
- **Ramp Up and Ramp Down:** The BWRX-300 allows for output to ramp up from 50%-100% in 2 hours. This feature enables the BWRX-300 to ramp up quickly in the case of a grid outage and adjust power supply to be in line with changing load demands. The plant can reduce power quicker, if necessary, by dumping steam to the condenser instead of the main turbine/generator.
- **Islanding:** The BWRX-300 can operate connected to the grid or can be operated independently with additional transformers and electrical protection relays. If attached to a mini grid with islanding, the BWRX-300 could power a facility campus in the event of grid failure.
- **Black Start:** Black Start capabilities are not included in the standard BWRX-300, but the BWRX-300 can start up from a completely de-energized state without receiving energy from the grid if equipped with a 25-50 MW gas turbine and additional transformer connections. This can help an electricity grid meet system requirements in terms of voltage, frequency, and other attributes when recovering from an outage.
- **Underground Construction:** The BWRX-300 reactor is built using mainly underground structures. This design feature reduces the vulnerability to natural phenomena, EMP, and other intentional destructive acts.
- **Minimal Use of Electrical Components:** The BWRX-300 is designed to minimize the use of electrically controlled and operated components (for example, using natural circulation for cooling instead of forced pumping). Using fewer electrical components reduces vulnerability to EMP.

15.0 REACTOR END-OF-LIFE

The BWRX-300 is designed for a 60-year life with a possible life extension to 80 years. The reactor end-of-life decommissioning is another aspect of the BWRX-300 lifecycle where GEH has experience. GEH is currently engaged in decommissioning activities all around the world and this operating experience is to be included in the BWRX-300 design considerations.

15.1 BWRX-300 Design Life

While self-consolidating concretes are designed for a nominal 60-year life, they are expected to offer a plant life well beyond the designed lifetimes. The principal SSCs for the BWRX-300 are designed for a 60-year life. The layout of the systems within structures considers component replacements. The BWRX-300 life can be extended to 80 years depending on operations history and system health.

15.2 BWRX-300 Decommissioning

The decommissioning process of an LWR involves:

- Removing the used nuclear fuel from the reactor and placing it into on-site dry storage containers once the decay heat has dropped to the appropriate level.
- Dismantling systems or components containing radioactive products (e.g., the reactor vessel).
- Cleaning up or dismantling contaminated materials from the facility.
- Disposing contaminated materials either on-site or shipping it to an available waste-processing, storage, or disposal facility.

Due to the focus on reduced quantities and overall SSCs simplification, the amounts of material (e.g., concrete, steel) is lower for the BWRX-300 compared to existing LWRs. Also, since the BWR is a direct cycle plant, there are fewer and smaller high contaminated pieces. The RPV has bolted internal components designed to be removed which simplifies the handling of contaminated materials.

At the time of BWRX-300 decommissioning, the current generation BWRs are all expected to have been decommissioned, and the lessons learned from those activities are being considered in the BWRX-300 design, operation, and decommissioning strategies. GEH is currently involved in decommissioning activities worldwide including reactor vessel and internal cutup projects in Europe, the U.S., and Japan. There are no first-of-a-kind issues for the BWRX-300 that pose a risk to future decommissioning processes.

16.0 MANUFACTURING AND CONSTRUCTION

GEH expects to leverage the GE parent global knowledge and supply chain to deploy the BWRX-300 to those countries having Nuclear Cooperation Agreements in place with the U.S. government. Project specific contract terms are to be negotiated on an individual basis. The base design of the BWRX-300, and therefore the base cost estimate, is intended to cover a variety of sites. However, individual site parameters and characteristics such as seismicity, restrictions on water usage, local infrastructure, and availability of skilled labor impact the cost for a specific project.

Training programs with supporting simulators that are compliant with international and country-specific standards are to be deployed in parallel with physical plant construction. Additional training can be made available for customers new to nuclear energy.

The BWRX-300 design philosophy of “simplicity” and “designed for constructability” enables it to be constructed and commissioned within an anticipated duration of 30-36 months from the time of first safety-related concrete to ready to load fuel. For deployment in countries that are new to nuclear energy, nuclear experienced EPCs are available to team with GEH and local EPCs to implement the project. Local supply of commodities is encouraged to minimize the cost of deployment. However, overall supply chain localization depends on the capability, readiness, and aspirations of the receiving country, along with considering project cost versus localization.

The BWRX-300 leverages prior BWR technology to include the USNRC licensed ESBWR, ABWR, and the in-production GNF2 nuclear fuel. The BWRX-300 uses commercial off-the-shelf equipment to the greatest extent possible. This includes nuclear and non-nuclear components that are currently used in the BWR fleet (see Figure 16-1, *Existing Technology Use in BWRX-300 Reactor*) and BOP components that are deployed at dozens of combined-cycle steam turbine generating locations of similar size.

The BWRX-300 uses advanced construction methods and modularization to reduce construction time and cost. Many attributes of the BWRX-300 leverage the latest 3D and Four-Dimensional (4D) modeling during manufacturing and construction and are expected to utilize field data to keep the digital twin current with the physical construction.

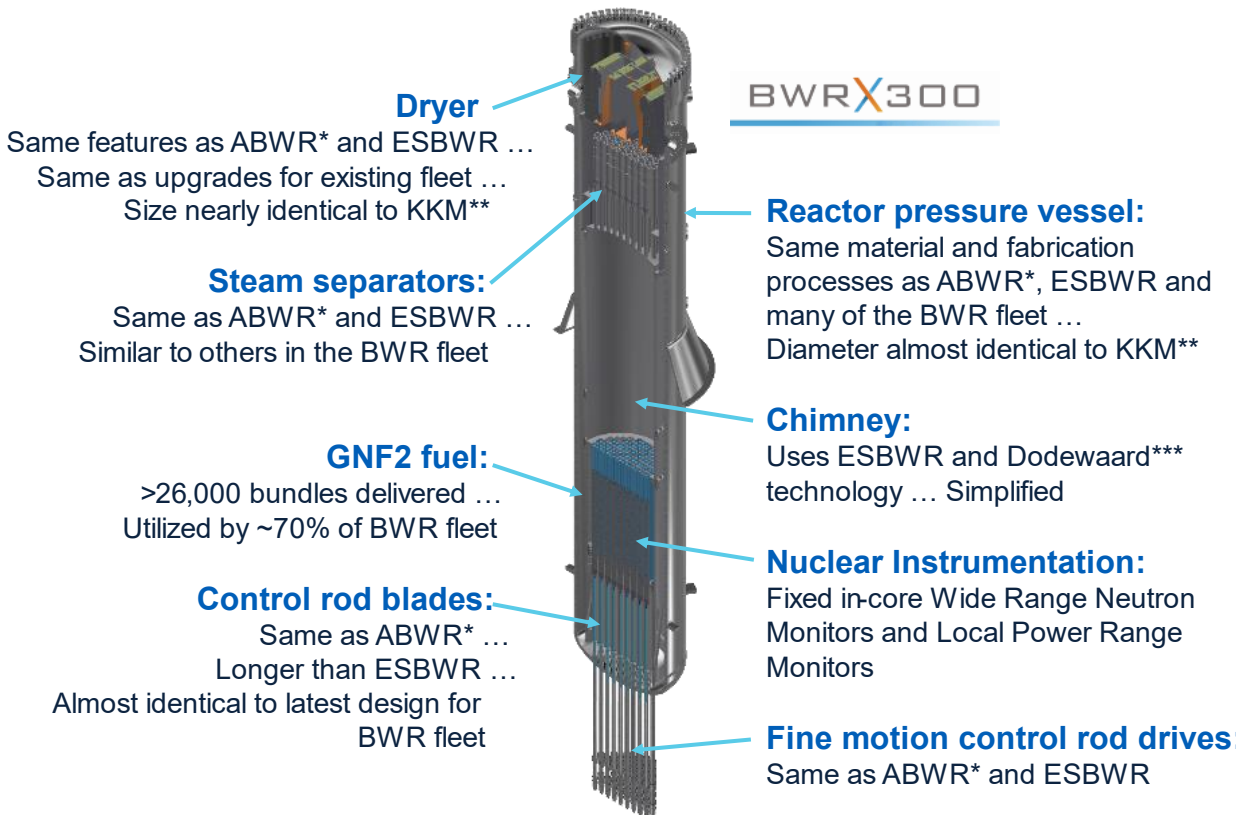

* ABWR fleet has combined 22+ years of operating experience | ** Kernkraftwerk Mühleberg (KKM): 355 MWe BWR/4 in operation since 1972 | *** Dodewaard: 58MWe natural circulation BWR, 1969 ~ 1997

Figure 16-1: Existing Technology Use in BWRX-300 Reactor

16.1 General Plans for Construction

The approaches to plant construction have been chosen to reduce the risk of schedule and cost overruns. The BWRX-300 draws from proven construction methods outside of the nuclear construction industry such as the water and tunneling industry for validation of construction schedule and cost. The design allows for large modular components that can be consistently lifted, set, aligned, and fixed in place to shorten the construction schedule. The BWRX-300 also relies on the use of the latest computer-aided tools including a digital twin and 4D building information model for construction planning.

A construction sequence model is to be developed to support detailed construction sequencing for determination of travel routes, laydown areas, fabrication and storage facilities, and general construction site layout. This model determines the required site improvement changes.

Rock excavation to establish the trenches for circulating water piping and cooling tower basin/pump pit may be included with site improvement to utilize the earth moving equipment on-site and perform blasting, if required, while the craft count is low at site. Installation of circulating water piping begins as a section of trench is completed. This underground piping is excavated and installed early in the schedule to allow un-impeded access to the full construction footprint.

Pre-assembly and modularization of the RB underground structure begins simultaneously with the start of RB underground shaft excavation. This ensures the modules are available for pick and set according to schedule.

Construction of the RB shaft begins with a survey and establish the centerline of RB. If required, pressure grouting of voids and fractures is used in the rock strata around the perimeter and underlying the shaft as determined from site boring conducted during site investigation testing. A reinforced concrete ring is placed, outlining the outside diameter of the shaft for use as an equipment platform. Earthmoving equipment is established in the shaft and excavation commences. A circular, flat-bottomed hole is excavated to accommodate the reactor shaft and provide sufficient working area around the hole for excavation equipment. Rock anchors, wire mesh, and shotcrete lining are installed on the exposed rock face as required to prevent water entry and spalling of loose rock as the shaft is excavated to depth.

An alternate method is to re-establish the centerline of the RB in the excavation. A circular concrete guide ring is laid out and installed. This is used to align the slurry wall excavation. A circular slurry wall is installed down to sound rock in accordance with an engineered specification. Reinforcing steel is installed in each slurry wall panel to ensure the completed construction retaining shaft resists lateral loading due to construction equipment along the shaft perimeter and possibly foundation loads from adjacent buildings. This may allow adjacent building foundations to be constructed in parallel path with construction of the below-grade portion of the RB and shorten the overall project schedule. Water stop is used between slurry wall panels to reduce ground water in-leakage into the shaft during excavation. The bottom of the slurry wall is "keyed" into the bedrock to strengthen the overall shaft and provide an additional barrier to ground water in-leakage.

Soil material is removed using conventional earth moving equipment such as tracked hoes to excavate the shaft enclosed by the slurry wall. The bedrock portion of the shaft is excavated using pavement breakers, drill and blast, or a combination of the two depending on the rock structure. All spoils and rock tailings are removed from the shaft via skip pan and crane. Once on the ground surface, the spoils from excavation are transported to the designated on-site spoils pile.

Dewatering systems are employed during shaft excavation. Areas of notable water entry are sealed via an engineered pressure grouting process, or by installing wire mesh reinforcement in combination with a shotcrete concrete layer on the wall face.

Completion of shaft excavation is followed by inspection of rock geology in the shaft walls and bottom, and noted defects are repaired per Engineering disposition. Then there is placement of a construction mud mat, waterproofing membrane, and protective concrete mat. The modular steel-concrete composite reactor base mat is set in place and joined, and the concrete mat is placed.

Modular wall and floor modules are sequentially set and joined, and concrete is placed as the RB shaft is constructed from the bottom up to grade. Major pieces of equipment, piping, and electrical gear are top-loaded and positioned as the floors are placed. Alternately, the structural modules are configured to allow this equipment to be installed later to prevent late material delivery from impacting RB shaft construction progress.

Piling installation and the subsequent excavation for the steam turbine foundation starts once the RB shaft construction has stabilized soil conditions to support perimeter loading. Steam turbine base mat, pedestals, and tabletop construction follow the completion of pile installation. The turbine pedestal and tabletop are modularized via steel-concrete composite methods to the degree economical to reduce the possibility of steam turbine work activities becoming critical path on the schedule. Radwaste and CB foundations begin when the RB shaft is brought to

grade. These structures are constructed simultaneously with the TB. An extract of the preliminary crane plan is shown in Figure 16-2, *Preliminary Crane Plan*.



Figure 16-2: Preliminary Crane Plan

BOP facilities are constructed to support startup and commissioning of the plant.

16.2 Improved Construction Approaches

A standardized construction plan that requires minor modifications to estimate and plan is the overall goal for a SMR design and construction. The key excavation feature is the reactor shaft development. Straight line shaft excavation minimizes material removal and backfill requirements. Techniques used by tunneling and hydraulic industries allow the use of proven methods to accomplish this type of excavation. Initial preparation uses a diaphragm wall technique to stabilize soft side walls and allow vertical excavation down to a hard rock layer. Once the diaphragm wall is in place, standard excavating techniques are used for internal soil removal. Rock excavation allows vertical wall material removal with the possibility of rock anchor stabilization. A shotcrete liner is likely required to help stabilize and seal the rock surface. With excavation completed, the bottom of the hole is sealed with a seal plug that doubles as an initial working surface to begin the structural build.

Based on lessons learned from the AP1000 units, Diaphragm Plate Steel-Plate Composite (DP-SC) modules are being utilized for the basemat, walls, floors, and roof of the RB. DP-SC provide modularity and off critical path construction capability. DP-SC modules also eliminate the basemat to wall interface challenges experienced with the AP1000 units.

Before concrete casting, the diaphragm plates and steel faceplates provide stiffness and strength to the empty steel modules. When compared to conventional Steel-Plate Composite designs, DP-

SC modules can have greater stiffness and stability in the empty module configuration due to the continuous support provided by the diaphragm plates to the steel faceplates. After concrete casting, the diaphragm plates provide structural integrity to the composite section by preventing delamination of the concrete core. Additionally, the diaphragm plates provide composite action between the steel faceplates and the concrete infill, and out-of-plane shear reinforcement for the composite section. Additional ties or shear stud anchors may be used to anchor the steel faceplates to the concrete infill and control faceplate local buckling.

DP-SC panels are fabricated in factories in sizes that that can be shipped to the construction site via truck, rail or barge depending on the location of the site. The panels are then assembled into modules at site before being lifted into final position.

A multi-layered water proofing philosophy is undertaken to ensure leak tightness. A waterproof membrane is installed between the shaft wall and the DP-SC outer plate for a first protective layer. A grouting or concrete medium is then placed between the membrane and the steel liner. The DP-SC outer plate provides an additional layer of sealing.

DP-SC construction techniques developed for the RB are being evaluated for use in Turbine and Radwaste Buildings.

The modularization concepts are analyzed in a three-phase approach:

1. Shop fabrication and assembly into sub-modules that can be shipped to site.
2. Site erection into modules that can be lifted into place with equipment available at site.
3. Final in-place assembly.

This approach reduces the higher cost of final in-place assembly and inspection with lower cost and off critical path assembly in both on-site fabrication areas and shop fabrication.

A layered approach to shaft structure assembly also improves the opportunity to perform "Open-Top" assembly of components and piping. Setting pipe and equipment in place can be a time intensive operation. By setting equipment modules and pipe spools into place prior to setting the next level, a time savings can be realized. Design of the RB structure still allows the placement of all equipment in a non "Open-Top" which provide schedule flexibility and simplifies future maintenance. This allows schedule control to remain with the EPC contractor and removes potential issues caused by manufacturing delays.

These modularization techniques shift cost and schedule risk off critical path. With this type of process available on-site, it is expected to generate further benefit on smaller, less critical assemblies due to availability of facilities which further improve the construction process.

16.3 Approaches to Component Manufacture

Many of the components utilized in the BWRX-300 have significant experience in the nuclear and power industries along with an existing supply chain, which minimizes risk and cost uncertainty. The risks minimized include removal of uncertainty in the manufacturing, material behavior, testing, Quality Assurance (QA), and acceptance by the USNRC and various codes. Novel approaches such as electron beam welding and powder metallurgy hot isostatic pressing are expected to be utilized for the BWRX-300 once they are proven and accepted by regulators.

Two items that have complex geometries are being investigated for cost and schedule improvements using additive manufacturing techniques. Oak Ridge National Laboratory is leading the effort to determine if additive manufacturing can improve the cost and schedule for the swirling vanes in the steam separators and the header/tube assembly in the ICs. A schedule

has been laid out with several decision points to determine the cost/benefit, choose the best advanced manufacturing methodologies and materials to apply, prototype manufacturing of subassemblies, and create a full-scale mockup. The end goal is to develop an automated process to rapidly manufacture the components with specific surface finish at a high level of quality, short schedule, and low cost.

The BWRX-300 is expected to employ factory assembly of the turbine and generator, which has proven to be cost-effective in the combined-cycle industry. This approach eliminates the need for open-top or open-ended assembly of tolerance critical equipment in a construction environment, reduces the risk of foreign particle entry, and minimizes exposure of the internal components to elements. Assembling this equipment in a shop environment by craftsmen that perform these tasks on manufacturer specific equipment daily improves quality.

16.4 Procurement Plans

16.4.1 Engineering, Procurement, and Construction Procurement

Part of the BWRX-300 design-to-cost target is to focus on minimizing equipment which requires a specialized manufacturer to potentially be outside the EPC's normal supply chains. This allows the EPC to maximize the use of established supply chains that contain vendors the EPC has previously vetted for performance and quality.

The BWRX-300 desires to leverage integration of an experienced EPC vendor using established, proven materials and control programs, for the purchase of SC and SCN commodity items, such as cable, tubing, and concrete. Historically, nuclear projects have far more safety-related components than the BWRX-300 and typically procure most commodity items to the higher, safety-related pedigree to prevent inadvertent application of a commodity. The materials control program lowers procurement costs and shortens lead time. Procurement of SC1 and ASME commodities can be made early for potential long lead items, but SC2, SC3, and SCN commodities are readily available and can be procured closer to a just-in-time method to minimize storage costs and initial capital outlay.

EPC procurement professionals provide expertise in all aspects of a procurement management program, including sourcing, purchasing, subcontracting, expediting, shop inspection, logistics, diversity management, change management, invoice administration, material management, and warranty. The EPC vendor maintains an emphasis on the fundamentals of safety, quality, schedule, cost, performance, and documentation.

Use of the EPC vendor's existing supply chains is key because it enables the EPC vendor to rely on its prequalified suppliers instead of expending resources to qualify new vendors under the EPC vendor's QA program.

The EPC vendor's contract management coordinates key equipment inspections and supplier surveillance, mitigates schedule impacts through early intervention, provides shipping logistics to support equipment and material arrival and storage on-site, and manages the overall warranty program.

16.4.2 GEH Supply Chain

The overall supply chain strategy for procuring equipment, material, and services for new nuclear plants follows these basic steps:

- A. Understand customer requirements for procurement of equipment, components, and materials (e.g., "Maximize Localization", supplier indigenous participation targets, cost).

- B. Align GEH business requirements with customer requirements.
- C. Perform initial supplier search:
 - 1. Existing and proven GEH supply chain (currently in use by GEH Services).
 - 2. Proven nuclear suppliers with an already established relationship with GEH (e.g., used in past projects to fabricate ABWR and BWR components).
 - 3. Other existing commercial nuclear suppliers currently providing components to the existing Global fleet.
- D. Screening of suppliers to meet project requirements.
- E. Supplier assessment – site visit.
- F. Finalization of suppliers to receive request for quotation.
- G. Request for quotation sent to and received from suppliers.
- H. Review of supplier proposals and negotiate, as required.
- I. QA audit to approve the supplier, if required.
- J. Final selection of supplier.
- K. Finalization of contractual documents (e.g., Supply Agreement, Purchase Order).
- L. Placement of purchase order.
- M. Supplier management and oversight.

GEH has a proven supply chain for critical equipment and components. Lead times for these components have been incorporated into the overall project schedule. GEH continues to ensure that specific customer requirements are identified and incorporated into the procurement process.

17.0 ACRONYMS, DEFINITIONS, AND SYMBOLS

17.1 Acronyms

Acronym	Explanation
3D	Three-Dimensional
4d	Four-Dimensional
ABWR	Advanced Boiling Water Reactor
AC	Alternating Current
AHU	Air Handling Unit
AOO	Anticipated Operational Occurrence
ASME	American Society of Mechanical Engineers
BDBA	Beyond Design Basis Accident
BIS	Boron Injection System
BPVC	Boiler and Pressure Vessel Code
BWR	Boiling Water Reactor
CCF	Common Cause Failure
CCS	Containment Cooling System
CFD	Condensate Filters and Demineralizers System
CFR	Code of Federal Regulations
CFS	Condensate and Feedwater Heating System
CNSC	Canadian Nuclear Safety Commission
CRD	Control Rod Drive
CRDH	Control Rod Drive Hydraulic
CST	Condensate Storage Tank
CWE	Chilled Water Equipment
CWS	Circulating Water System
D-in-D	Defense-in-Depth
DBA	Design Basis Accident
DC	Direct Current
DCIS	Distributed Control and Information System
DEC	Design Extension Condition
DL	Defense Line
DP-SC	Diaphragm Plate Steel-Plate Composite
EDS	Electrical Distribution System
EPC	Engineering, Procurement, and Construction
ESBWR	Economic Simplified Boiling Water Reactor

Acronym	Explanation
FMCRD	Fine Motion Control Rod Drive
FPC	Fuel Pool Cooling and Cleanup System
FSF	Fundamental Safety Function
FW	Feedwater
GE	General Electric
GEH	GE Hitachi Nuclear Energy
GT	Gamma Thermometer
HCU	Hydraulic Control Unit
HFE	Human Factors Engineering
HP	High Pressure
HSI	Human-System Interface
HVAC	Heating, Ventilation, and Air Conditioning
HX	Heat Exchanger
I&C	Instrumentation and Control
IAEA	International Atomic Energy Agency
IC	Isolation Condenser
ICC	ICS Pool Cooling and Cleanup System
ICS	Isolation Condenser System
INSAG	International Nuclear Safety Group
ISFI	Independent Spent Fuel Storage Installation
LCOE	Levelized Cost of Electricity
LOCA	Loss-of-Coolant Accident
LOOP	Loss-of-Offsite Power
LP	Low Pressure
LPRM	Local Power Range Monitor
LTR	Licensing Topical Report
LWM	Liquid Waste Management System
LWR	Light Water Reactor
MCA	Main Condenser and Auxiliaries
MCR	Main Control Room
MIT	Massachusetts Institute of Technology
MS	Main Steam
MSL	Main Steam Line
MSR	Moisture Separator Reheater System
MSRIV	Main Steam Reactor Isolation Valve

Acronym	Explanation
MVA	Megavolt Ampere
NBS	Nuclear Boiler System
NEI	Nuclear Energy Institute
NHS	Normal Heat Sink
NSSS	Nuclear Steam Supply System
OGS	Offgas System
ONR	Office for Nuclear Regulation (United Kingdom)
PA	Protected Area
PAA	National Atomic Energy Agency (Poland)
PCCS	Passive Containment Cooling System
PCS	Primary Containment System
PIE	Postulated Initiating Event
QA	Quality Assurance
RB	Reactor Building
RCCWS	Reactor Component Cooling Water Subsystem
RCPB	Reactor Coolant Pressure Boundary
RHX	Regenerative Heat Exchanger
RIV	Reactor Isolation Valve
RPV	Reactor Pressure Vessel
SBWR	Simplified Boiling Water Reactor
SC	Safety Class
SCCV	Steel-Plate Composite Containment Vessel
SCN	Non-Safety Class
SCR	Secondary Control Room
SDC	Shutdown Cooling System
SJAE	Steam Jet Air Ejector
SMR	Small Modular Reactor
SNM	Special Nuclear Material
SRV	Safety Relief Valve
SSCs	Structures, Systems, and Components
SÚJB	State Office for Nuclear Safety (Czech Republic)
SURAO	Radioactive Waste Repository Authority (Czech Republic)
TCCWS	Turbine Component Cooling Water Subsystem
TLOS	Turbine Lube Oil System
TMR	Triple Modular Redundant

Acronym	Explanation
TS	Technical Specification
TSV	Turbine Stop Valve
U.K.	United Kingdom
U.S.	United States
USNRC	U.S. Nuclear Regulatory Commission
VDU	Visual Display Unit
WRNM	Wide Range Neutron Monitor

17.2 Definitions

Term	Definition
C10	Protection System
C20	Diverse Protection System
C30	Anticipatory Trip System
R10	Emergency Power Backup DC and UPS Electrical System
R20	Standby Power System
R30	Preferred Power System

17.3 Symbols

Symbol	Definition
°C	Degrees Celsius
°F	Degrees Fahrenheit
$\Delta k/k$	Reactivity
g	Gram
GWd	Gigawatt Days
hr	Hour
Hz	Hertz
kg	Kilogram
km	Kilometer
kW	Kilowatt
m	Meter
mm	Millimeter
MPa	Megapascal
MTU	Metric Ton of Uranium
MW	Megawatt
MWe	Megawatts Electric

Symbol	Definition
MWth	Megawatts Thermal
rpm	Revolutions per Minute
s	Second
USD	United States Dollars
Yr	Year

18.0 REFERENCES

1. 26A6642AD, *ESBWR Design Control Document, Tier 2 – Chapter 1: Introduction and General Description of Plant Sections 1.1 – 1.11*, GE-Hitachi Nuclear Energy Americas, LLC.
2. Energy and Environmental Economics, Inc. (January 29, 2020). *Pacific Northwest Zero-Emitting Resources Study*. <https://www.energy-northwest.com/Documents/E3%20Study%20Executive%20Summary%20final.pdf>
3. EPRI 3002011803, *Exploring the Role of Advanced Nuclear in Future Energy Markets: Economic Drivers, Barriers, and Impacts in the United States*, Electric Power Research Institute, 2018.
4. General Electric. (April 14, 2023). *Air-Cooled Generator (GEN-A)*. <https://www.ge.com/power/gas/generators/air-cooled-topair>
5. General Electric. (April 14, 2023). *GNF2*. <https://nuclear.gepower.com/fuel-a-plant/products/gnf2-advantage>
6. General Electric. (April 14, 2023). *Steam Turbines for Fossil, Nuclear, and Renewable Applications*. <https://www.ge.com/power/steam/steam-turbines>
7. IAEA SSG-2, Rev.1, *Deterministic Safety Analysis for Nuclear Power Plants*, International Atomic Energy Agency, Vienna, 2019.
8. IAEA SSG-30, *Safety Classification of Structures, Systems and Components in Nuclear Power Plants*, International Atomic Energy Agency, Vienna, 2014.
9. IAEA SSG-53, *Design of the Reactor Containment and Associated Systems for Nuclear Power Plants*, International Atomic Energy Agency, Vienna, 2019.
10. IAEA SSR-2/1, *Safety of Nuclear Power Plants: Design*, International Atomic Energy Agency, 2016.
11. INSAG-10, *Defence in Depth in Nuclear Safety*, International Atomic Energy Agency, Vienna, 1996.
12. International Energy Agency. (2019). *Nuclear Power in a Clean Energy System*. <https://www.iea.org/reports/nuclear-power-in-a-clean-energy-system>
13. International Atomic Energy Agency. (July 21, 2011). *Status Report 98 – Advanced Boiling Water Reactor II (ABWR II)*. <https://aris.iaea.org/PDF/ABWR-II.pdf>
14. International Atomic Energy Agency. (July 21, 2011). *Status Report 100 – Economic Simplified Boiling Water Reactor*. <https://aris.iaea.org/PDF/ESBWR.pdf>.
15. Massachusetts Institute of Technology, MIT Energy Initiative. (2018). *The Future of Nuclear Energy in a Carbon-Constrained World*. <http://energy.mit.edu/research/future-nuclear-energy-carbon-constrained-world/>
16. NEI 08-09, Rev. 6, *Cyber Security Plan for Nuclear Power Reactors*, Nuclear Energy Institute, April 2010.
17. *U.S. Code of Federal Regulations*, "Standards for Protection Against Radiation," Part 20, Chapter 1, Title 10, "Energy."

18. *U.S. Code of Federal Regulations*, "Domestic Licensing of Production and Utilization Facilities," Part 50, Chapter 1, Title 10, "Energy," Appendix I, "Numerical Guides for Design Objectives and Limiting Conditions for Operation to Meet the Criterion 'As Low As Reasonably Achievable' for Radioactive Material in Light-Water-Cooled Nuclear Power Reactor Effluents."

19.0 APPENDIX A – BWRX-300 PARAMETERS OF INTEREST**Table 19-1: Draft BWRX-300 General Parameters of Interest**

Parameter Description	Value	Comments
Current/Intended Purpose	Commercial – Electric	
Main Intended Application (once commercial)	Baseload with load following capabilities	
Reference Location	Below-Ground	
Reference Site Design (reactor units per site)	Single Unit	
Reactor Core Size (1 core)	Small	Small (<1000 MWth)
Reactor Type	BWR	
Core Coolant	H ₂ O	
Neutron Moderator	H ₂ O	
NSSS Layout	Direct cycle	
Primary Circulation	Natural	
Thermodynamic Cycle	Rankine	
Secondary Side Fluid	n/a	No secondary side since it is direct cycle
Fuel Form	Fuel Assembly/Bundle	
Fuel Lattice Shape	Square	
Rods/Pins per Fuel Assembly/Bundle	92	
Fuel Material Type	UO ₂	
Design Status	Preliminary	
Licensing Status	Licensing and Pre-licensing Initiated	Licensing is underway in Canada and pre-licensing in the U.S. and U.K.

Table 19-2: Draft BWRX-300 Detailed Parameters of Interest

Parameter Description	Value	Units or Examples
Plant Infrastructure		
Design Life	60	Years
Lifetime Capacity Factor	95	%, defined as Lifetime MWe-yrs delivered / (MWe capacity * Design Life), incl. outages

Table 19-2: Draft BWRX-300 Detailed Parameters of Interest

Parameter Description	Value	Units or Examples
Major Planned Outages	10-15 days every 12-24 months (refueling) 25 days every 120 months (major turbine inspection and in-service inspection on reactor vessel and internals)	# days every # months (specify purpose, including refueling)
Operation/Maintenance Human Resources	~70 total	# Staff in Operation / Maintenance Crew during Normal Operation for a single unit
Reference Site Design	1	# Units/Modules
Capacity to Electric Grid	~300	MWe (net to grid)
Non-electric Capacity	Flexible	
In-House Plant Consumption	10-30	MWe
Plant Footprint	9,800	m ² (rectangular building envelope)
Site Footprint	27,100	m ² (fenced area)
Emergency Planning Zone	0.5 (At site boundary)	km (radius)
Load Following Range and Speed	50 – 100% daily, 0.5% per minute	
Seismic Design (SSE)	0.3	g (Safe Shutdown Earthquake)
NSSS Operating Pressure	7.17	MPa(abs)
Primary Coolant Inventory (incl. pressurizer)	1,820,000	kg
Nominal Coolant Flow Rate	1827	kg/s
Core Inlet / Outlet Coolant Temperature	270/288	°C / °C
Available Temperature as Process Heat Source	Flexible 100-260	°C
NSSS Largest Component	RPV	
dimensions	27.4 / 4 / 650,000 (includes self-propelled modularized transports, rigging, and cribbing)	m (length) / m (diameter) / kg (transport weight)
Reactor Vessel Material	SA508	
Containment Type and Total Volume	Dry (single, underground) / 12,000	Type / m ³
Rated Containment Pressure	4.14/60	bar/PSI

Table 19-2: Draft BWRX-300 Detailed Parameters of Interest

Parameter Description	Value	Units or Examples
Spent Fuel Pool Capacity and Total Volume	8 / ~1,300	Years of full power operation / m ³
Fuel/Core		
Single Core Thermal Power	870	MWth
Refueling Cycle	12-24	Months
Fuel Material	UO ₂	
Enrichment (avg./max.)	3.81/ 4.95	%
Fuel Cladding Material	Zircaloy-2	
Number of Fuel "Units"	240	Assemblies
Mass of one Fuel Unit	299	kg
Total Fissile Loading (initial)	~ 44,760 kg of U	kg fissile material (specify isotopic and chemical composition)
Core Discharge Burnup	~50	GWd/MTU
Reprocessing	None	
Main Reactivity Control	Rods	
Solid Burnable Absorber	B ₄ C, Hf, Gd ₂ O ₃	
Core Volume (active)	22	m ³ (used to calculate power density)
Safety Systems		
Reactor shutdown	3	Three trains with diverse backup systems that control hydraulic scram and electric run-in of control rods
Core injection	2	100% (HP injection through CRD system) / (no core injection required for LOCA mitigation)
Decay heat removal	2	Two 100% trains
Emergency Core Cooling	3	Three 100% Passive ICS trains
Containment Isolation	3	Three trains with diverse backup systems
Containment cooling	2	Two 100% trains
Passive Containment	3	Three passive trains – always in services
Emergency AC supply (e.g., diesels)	2	Two non-emergency diesels for plant investment protection. The

Table 19-2: Draft BWRX-300 Detailed Parameters of Interest

Parameter Description	Value	Units or Examples
		diesels are not required for reactor safety
DC Power Capacity (e.g., batteries)	72	Hours
Events in which Immediate Operator Action is required	None	
Limiting (shortest) Subsequent Operator Action Time	24	Hours (that are assumed when following EOPs)
Core Damage Frequency (CDF)	Estimated <1E-7	per reactor-year (based on reference site and location)
Large Release Frequency (LRF)	Estimated <1E-8	per reactor-year (based on reference site and location)
Overall Build Project Costs Estimate or Range (excluding Licensing, based on the Reference Design Site and Location)		
Construction Time (n th -of-a-kind)	<30	Months from first concrete to criticality